

OVERVIEW OF THE ELECTRODYNAMIC DELIVERY EXPRESS (EDDE)

Jerome Pearson*
STAR Inc., Mount Pleasant, SC

Joseph Carroll†
Tether Applications, Inc., Chula Vista, CA

Eugene Levin‡, John Oldson§
STAR Inc., Mount Pleasant, SC

Paul Hausgen¶
Air Force Research Lab, Space Vehicles Directorate, Kirtland AFB, NM

ABSTRACT

The ElectroDynamic Delivery Express (EDDE) is an autonomous space vehicle that can deliver multiple small satellites from any low earth orbit (LEO) to any other desired low earth orbit within months, without using fuel. EDDE uses solar power to drive multi-ampere currents through a multi-kilometer aluminum tape. The tape sees a force normal to both itself and the local magnetic field. The tape is electrically connected to the ambient ionosphere to close the current loop externally. EDDE spins at ~8X/orbit to improve both stability and operational flexibility. Changing the current as a function of orbit and spin phase imposes forces and torques that allow any desired changes in orbit and spin. This allows far higher performance than possible with a “hanging” electrodynamic tether. For high-inclination orbital plane changes in LEO, EDDE can be more than twice as fast as more conventional high-specific-impulse electric rockets, and has much higher delta-V capability, since it does not expend propellant. EDDE seems particularly well suited to distributing multiple small payloads to custom orbits. EDDE may also enable removal of most existing orbital debris from LEO. We describe two options for a low-cost proof-of-concept demonstration in space.

INTRODUCTION

Tethers in space have been proposed for many uses, including tethering satellites together; transferring momentum between objects by capturing or releasing

them with hanging, swinging, or spinning tethers; and orbit change using electrodynamic tethers.

As shown below in Figure 1, electrodynamic tethers use the electromagnetic force generated by a current through a long conductor in the earth’s magnetic field to generate net forces that cause orbit changes:

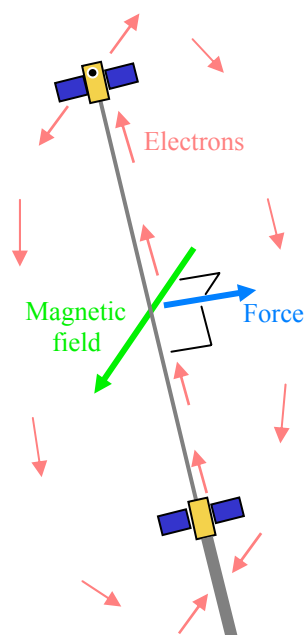

Figure 1. Electrodynamic Loop and Force

The current flows through the long conductor and returns through the ambient plasma around the conductor. (Not shown in the figure is the “equal and opposite force” in the cross-field return path.) The force on the conductor can be in either of two opposite directions, depending on the current flow direction in the conductor. If it flows with the EMF induced by orbit motion through the earth’s magnetic field, then no external power is needed and there is orbit decay. (If power is available, it can be used to

*President, STAR, Inc.; Associate Fellow, AIAA

†President, Tether Applications, Inc.

‡Chief Scientist, STAR, Inc.

§Senior Engineer, STAR, Inc.

¶Project Engineer, Space Vehicles Directorate, AFRL
Copyright © 2003 by STAR, Inc. Published by the American Institute of Aeronautics and Astronautics, Inc. with permission.

increase the current.) In the other direction, boosting is obtained, and external power must supply a voltage equal to the EMF plus all other voltage drops in the overall current loop: electron collection, conduction, emission, and external cross-field conduction.

Varying the current versus orbital position and tether orientation allows a conducting tether to change orbit parameters as desired. Spinning the tether (either in or out of the orbit plane) helps stabilize the tether. Spinning also allows the average force to be vectored anywhere in the plane normal to the local field, rather than just roughly east or west, as with a vertical tether. In particular, spinning normal to the orbit plane in high-inclination orbit allows far faster altitude change than possible with “hanging” tethers.

Key requirements on electrodynamic thrusters are a conductor that can survive micrometeoroid, debris, and atomic oxygen fluxes; ways to collect and emit electrons; a wide-voltage-range power supply; and adequate magnetic field strength and plasma density. The payoff is a system that can provide >50 km/sec delta-V per year for many years, with zero propellant usage. (If the plasma contactors are hollow cathodes, a small amount of xenon gas is required). EDDE can be used in lieu of conventional electric propulsion systems, but its best roles may be more-demanding classes of missions that are simply not feasible with existing propulsion systems that operate by ejecting part of their own mass at very high speed.

SUMMARY OF PAST EXPERIMENTS

Many short and long tethers have flown in space. There have been both manned experiments (Gemini XI and XII deployed 30-meter tethers between the Gemini and the Agena stages they docked with), and unmanned ones (mostly sounding rocket tests involving wires <1 km long).

The first long tether experiment in orbit was TSS-1, flown on the Space Shuttle and deployed in early August 1992. This was a large and complex system. The deployer jammed after 1% of the tether deployed, due to mechanical interference caused by late hardware modifications.

The successful long orbiting tether experiments have mostly involved SEDS, which Tether Applications developed under NASA MSFC funding. SEDS-1 was a secondary payload on a Delta II/GPS launch on 29 March 1993¹. SEDS-1 deployed a 26 kg mass on a 20 km long non-conducting tether, and released them into a controlled reentry trajectory.

Three months later, NASA JSC's Plasma Motor Generator (PMG) flew on another Delta/GPS². It deployed 500 m of insulated 18 AWG copper wire from a SEDS-like deployer developed by Tether Applications. PMG demonstrated current flow both with and against the motion-induced voltage, using hollow cathodes at each end of the tether to create “plasma balls” to couple to the ambient plasma.

A third Delta/GPS secondary payload, SEDS-2, flew in March 1994. It demonstrated that the simple SEDS deployer could stabilize a 20 km tether very close to vertical (i.e., a residual swing amplitude of only 4°)³. The end-mass and 2/3 of the tether separated 4 days after deployment, apparently due to micrometeoroid impact. The remaining 7 km length of tether survived for another 53 days until stage re-entry, without another length change being observed visually or by unexpected changes in orbit decay rate. Under good viewing conditions, the 0.8 mm diameter braided white SEDS-2 tether was surprisingly visible from the ground, from distances up to 1000 km. Amateur observers obtained videos of about 20 viewing passes during the SEDS-2 mission. The tether remained close to the vertical throughout the 6-week period when dawn or dusk views were available in the US.

The TSS was re-flown on the shuttle as TSS-1R in February 1996. The tether deployed to a length of 19.7 km without problem, but then an intermittent arc started from the deploying tether to the deployer hardware. As the arc moved away from the deployer, it continued directly to the ambient plasma. The arc burned through the tether in ~10 seconds. Data sent back by the now-free satellite showed that the arc continued for ~1 minute after separation, and then stopped near the time the satellite went into eclipse.

In June 1996, the Naval Research Lab deployed the “Tether Physics and Survivability” (TiPS) flight experiment. TiPS was a 2 mm diameter, 4 km long non-conducting SEDS tether launched into a 1024 km circular orbit. TiPS has traveled a billion miles in 7 years without being cut by micrometeoroids or orbital debris. Tether Applications designed the TiPS tether for enhanced impact resistance, using high-strength Spectra braided around a puffy acrylic “sweater yarn” core. In 1999 NRL launched the Advanced Tether Experiment (ATEX). ATEX was intended to deploy a 6 km long fiber-reinforced plastic tape and test active libration control. ATEX ended early when optical departure-angle sensors indicated a large bend in the tape, seconds after the 20m length of deployed tape came into the sun. ATEX automatically ejected itself from the host spacecraft to keep the tether from fouling on the host.

The ProSEDS experiment (for “Propulsive SEDS”) was designed to verify that electrodynamic forces could cause observable reductions in the orbit altitude of the Delta/GPS second stage launching it⁴. The ProSEDS experiment will start with ejection of a 20 kg student satellite called Icarus. Icarus is ejected energetically enough to pull out the first ~1 km of a 10 km non-conducting “pilot” tether. Then gravity gradient forces are enough to deploy the rest of the pilot tether and then a heavier 5 km wire. The wire consists of 7 strands of AWG 28 aluminum wire twisted around a braided Kevlar core. ProSEDS is currently scheduled for launch in 2004.

This tether flight experience highlights some of the practical problems of tethers. TSS experienced both jams and arcing failures during its 2 deployments. In addition, two SEDS experiments have been scrubbed shortly before flight due to potential impact risks with high-value spacecraft. There are also issues specific to ED tethers, including limitations on available ED thrust direction from the magnetic field, tendencies toward dynamic instability, and operating altitude limits imposed by high aerodynamic drag and by low plasma density or magnetic field strength.

THE “EDDE” CONCEPT

STAR Technology and Research proposed the EDDE concept to the AFRL in 1999. A Phase I SBIR study⁵ established the feasibility and basic design features of a spacecraft optimized for fast orbit change using electrodynamic forces. The Phase I study showed that electrodynamic thrusters (EDTs) can work well over a wide enough rate of altitudes in low earth orbit to be useful. Below a minimum altitude of roughly 300 km, aerodynamic drag may approach or exceed the thrust, while above 600-1200 km (depending on the 11-year solar activity cycle) low plasma density seriously limits electron collection and hence thrust.

Our Phase I focus was on hanging tethers, which use mainly the horizontal (mostly N-S) component of the magnetic field. Because of this, the ED thrust on hanging tethers is mostly east or west. As a result, hanging EDTs can change orbit planes fast in near-polar orbit but only very slowly at low inclinations, while altitude changes can be fast in low inclination orbits but are very slow in high-inclination orbits.

In Phase II we developed the spinning EDDE design concept that can change orbital elements effectively in any inclination, and delivered key components^{6, 7}. We also developed a very general feedback control law that estimates system dynamics from recent tether voltage and current data and any other conveniently available data such as tension or

acceleration⁸. The control law finds current-control strategies that simultaneously damp all deviations from the desired dynamics that have effects large enough to observe.

SPIN STABILIZATION OF ED THRUSTERS

A lightweight high-powered “hot rod” ED thruster has more serious stability problems than do lower-performance ED thrusters. Earlier stability work by one of us (Levin) had showed that it was hard to control tether swinging, bending, and end-mass attitude motion for an ED thruster in 51.6° orbit, if the average tether thrust exceeded ~10% of the gravity gradient force. This led Levin to consider spinning EDDE to stiffen and stabilize it. It was not initially clear to us how good an idea this might be, because it sacrifices some of the EMF on a vertical tether at low latitudes, and hence reduces boost or drag forces. Spinning tethers spend 50-75% of their time closer to horizontal than to vertical, depending on whether the spin is in or normal to the orbit plane. This reduces the EMF from a horizontal field. But as shown in Figure 2, the vertical field exceeds the horizontal field over much of the earth; so horizontal tether orientations might often be useful.

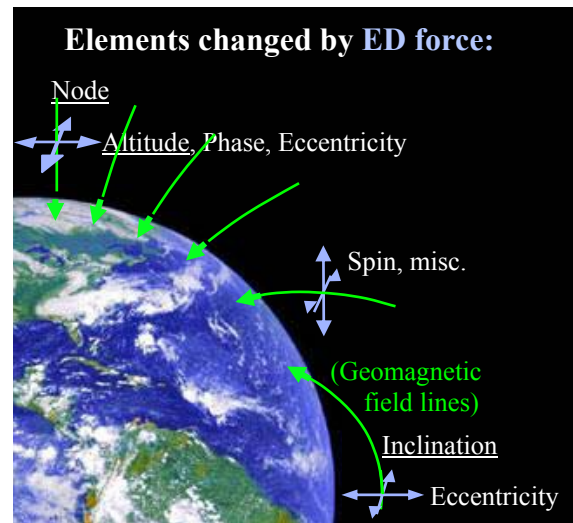

Figure 2. Possible ED Thrust Vectors vs. Latitude

Most satellites in LEO have orbit inclinations >70°. The average vertical magnetic field around their orbits exceeds the average horizontal field. So ED thrusters might often provide more boost or decay thrust when horizontal than when vertical. Far more important is that a spinning tether is far more flexible operationally: it can vary the current with spin phase to direct the net thrust anywhere in the plane normal to the local field, rather than just thrusting roughly east or west (i.e., normal to both the horizontal field and a hanging and hence roughly vertical conductor).

Besides allowing far higher drive levels and more flexible maneuvering, spinning also allows the system to be simpler and lighter, by eliminating a tendency that hanging ED tethers have towards unstable swing dynamics if driven much harder during the day than at night. To avoid this, hanging tethers need heavy batteries to power nighttime operation. They also need more electron-collection area to collect enough current despite factors of 3-10 reduction in plasma density at night. A spinning system does not need to run at night for stability, so it can get by with smaller electron collectors sized for denser daytime plasmas, and without the heavy batteries needed for operation at night. We thought these benefits seemed valuable, so we filed for patent coverage of spinning LEO ED thrusters to improve performance, operations, and/or system design⁹.

EDDE DYNAMICS AND CONTROL

Controlling EDDE involves maintaining a suitable spin plane for the desired orbit changes, executing the orbit changes by varying the current appropriately, and damping any undesired dynamics due to tether bending, etc. EDDE controls all of these dynamics the same way, by adjusting the current. Below we discuss the details of the dynamics and control.

“Born Spinning” Deployment

Changing between “hanging” and “spinning” modes electrodynamically may be tricky, so we plan to keep EDDE spinning during its entire mission, starting before deployment. A small amount of cold gas can be used to spin EDDE up. Then one winding and a solar array can be released. They can be used to increase the spin electrodynamically. Eventually centrifugal force will unwind some more tether. This exposes more conductor and collector, aiding the spin-up and further deployment. Additional solar arrays and windings are released over a several day period. If EDDE does not work properly, then it stays undeployed, because gravity-gradient forces are too low to overcome a weak adhesive that bonds the tether windings together.

Controlling the Spin Plane and Rate

Once EDDE is fully deployed, we envision typical spin rates of order 8 revs/orbit. This is high enough for good centrifugal stabilization, without imposing large mass penalties for tether strength reinforcement. Far higher rates may be appropriate in applications requiring artificial gravity, or release of payloads into orbits well above or below EDDE’s orbit.

There are several ways to apply electrodynamic torques to adjust the spin plane or rate. For example, collecting electrons near the middle of a wire and

driving them out to emitters at both ends of the wire causes little net force but a large torque. The torque direction varies with orbit phase, so selective operation in this mode can change the spin plane and/or rate as desired. (One can reverse this torque without needing an electron emitter in the middle of the wire, by waiting until the field direction reverses.) If EDDE has a heavy payload at one end, so its CM is far from the middle of the wire, then any current along most of the length will impose a torque. Then a DC current component has a secular effect on spin, while an AC component at one cycle per turn will induce little torque but large translational forces. Here too, one can vary the “DC” current around the orbit, to get any desired net torque by adding or subtracting torques from different points in the orbit.

Effects of Different Spin Planes

In high-inclination orbits, in-plane spin seems useful primarily when fast node and/or inclination changes are desired, rather than altitude change. Spin normal to the orbit allows faster boost or decay, whether the spin is horizontal near the pole or near the equator. The spin plane also affects the output of EDDE’s solar cells (which track only around the tether axis), so power issues may affect spin-plane selection. It appears that EDDE may usually want to spin either close to the orbit plane or nearly normal to it, because then little effort is required to maintain a fixed spin axis. A tilted spin requires more effort to maintain, and may be useful mainly while going between in-plane and normal spins. (With spin rates of ~8/orbit, such transitions can be done in hours rather than days, and spin axis nutation is acceptable then.)

Modifying Orbit Parameters

Careful consideration of Figure 2 will allow insight into the best conductor position and orientation to affect the different orbit elements:

Inclination:	vertical tether, near equator
Node:	align w/velocity vector, near pole
Altitude:	tether normal to orbit, near pole, or vertical at low inclination
Phase:	change altitude; wait; change back
Eccentricity and Apsides:	boost and drag once each orbit, or align tether E-W near equator

The effectiveness of the above strategies often varies with the cosine of the position and spin phase offsets. Two strategies operating in quadrature can often be 71% as effective as if only one was done at a time. This means that two or more orbit elements can often be changed fairly efficiently at the same time.

Detailed Current Switching Strategy

The general operating strategy is to drive current in one direction for about half a spin, and then in the other direction for the next half-spin. The net effect is a force whose average direction is nearly that of the force halfway through each half-spin. Adjusting the length of each cycle allows adjustment of the switch phasing over several spins, to provide the most useful thrust vector as the magnetic field and desired thrust direction both slowly change around each orbit. Changing the duty cycle away from 50/50 can affect the spin rate and spin plane, and also affects tether bending modes. Varying how much of the tether length is used to carry current will have even more effect on spin and bending modes. If the most effective time for control is far from a switching time, then current can simply be reduced temporarily to have a desired effect. If desired, each time the current is reversed (16X/orbit, for an 8X/orbit spin), and at other times around each spin, the current can be left off briefly to allow more accurate estimation of EMF and unperturbed plasma properties.

Performance might improve if we use small batteries to save energy collected near the switching times and use it closer to the middle of each half cycle, when thrust is more valuable. This should be easier to justify if EDDE spins faster than 8X/orbit, since that reduces the amount of energy to be stored. But fast spins increase the tether reinforcement mass needed. The required battery cycling life and currents would be very high, so ultra-capacitors may be more appropriate than batteries. Compared to investing similar masses in larger solar arrays, storage may provide modest benefits, while increasing complexity and failure modes. So we now plan to size EDDE's batteries for avionics and communication (and maybe hollow-cathode heating), and to drive the tether in a simple "use it or lose it" power-management mode.

EDDE Dynamics Model

We developed an EDDE dynamics model based on the theory of motions of space tether systems¹⁰. The model considers motions with small deflections of a massive tether. Our geomagnetic field model is based on the World Magnetic Model developed by DoD, and includes harmonics up to the 12th order. We model the modules and payload as point masses. The orbit of the mass center evolves slowly under the effect of electrodynamic forces distributed along the conductor. The goal of control design is to stabilize the resulting dynamics of the conductor, while making a required orbit change as fast as possible. The orbit change may involve inclination, altitude, eccentricity, apsides, and phase, and also matching the moving ascending node of a desired target object.

Tether Dynamics Simulation

To test and verify various control concepts, we developed suitable dynamics simulation software. The software allows graphic visualization of the evolution of various characteristics of conductor motion. The model and the simulation software allow for differences in system behavior between forward and reverse current modes, to allow modeling of asymmetrical designs. We developed an approximate altitude profile of plasma density for the model, and a model to determine the effects of plasma variability on dynamics and control. We also developed models of voltage-dependent electron and ion collection by a narrow tape at an angle to the local magnetic field. Finally, we developed model variants for both hanging and spinning ED thrusters, including variations in available power due to one-axis solar-array tracking (around the tether axis).

State Estimation

The real key to controlling EDDE is being able to estimate its state from easily observable phenomena. This is needed to determine both how it deviates from a desired state, and to evaluate the effects of current changes. Our work showed that measurements of system drive voltage, current, and plasma properties allow estimation of the EMF, and that additional voltage measurements at zero or low current allow refinement of EMF estimates. A one-orbit history of EMF appears to allow adequate estimation of spin dynamics. With hanging tethers, EMF variations indicate out-of-plane dynamics fairly well, but not in-plane dynamics. For in-plane dynamics, it appears very useful to also measure acceleration or tension.

Our estimator uses simpler environmental and tether models than the simulator model. This represents expected limitations in the actual flight software, and also mimics biases and differences between estimated and actual data. The estimator uses its internal model of the system to integrate the equations of conductor motion backward in time, to find what present tether state most closely fits the last orbit's worth of measured data when projected backward. It then integrates the equations of motion forward in time from the present estimated state, to develop a current schedule that fits the orbit and spin change priorities and required damping adjustments. The controller uses the new electric current schedule until the next call to the estimator. During this interval, new voltage, current, and possibly tension data are collected. The updated last-orbit data is submitted to the estimator, along with the time and orbit elements. The process repeats at uniform intervals. In typical missions, the flight computer might cycle through this sequence at roughly one-minute intervals.

Damping Strategy

Electrodynamic thrusters develop instabilities when energy is pumped into conductor dynamics. This can occur even at constant current^{10, 11}, but is usually worse due to current variations forced by the environment. Further, the magnetic field is seldom aligned exactly as needed, so modulating current to obtain a desired effect usually excites undesired modes. Limiting the undesired dynamics requires persistently draining energy out of the system.

Our feedback control strategy starts with an ideal reference frame moving and rotating with the ideal tether motion we want (no bending, an ideal spin rate and plane, etc.). We then take the tether state inferred by the estimator, compute the tether motion relative to the ideal reference frame, and compute the “error EMF” caused by motion relative to the ideal frame. If that error EMF actually drove the current, then we would get passive eddy-current damping of the undesired motion. But the actual EMF is not the same as the error EMF, so we must actively mimic the effect of an error EMF. We do this by specifying a current schedule that correlates with the error EMF.

Constraints on ED force direction limit how much each mode can be driven or damped each instant, but on timescales $>1/4$ orbit, all modes are accessible. The main goal is a long-term trend of damping any dynamics with effects large enough to observe. All large dynamics are clearly observable, including skip-rope. The required control current is usually small. The slow growth rate of most of the dynamics and the cumulative nature of damping makes this strategy very tolerant of periods when problems with the power, data acquisition, or control systems make active stabilizing control temporarily unavailable.

With EDDE’s “use it or lose it” power strategy, the performance penalty due to control currents is least if current reductions or reversals occur near switching times, when ED forces may be large but the force component in the desired direction is smallest.

EDDE NAVIGATION TOOL

As part of the SBIR Phase II effort, we developed a program to allow mission planners to evaluate particular configurations and specific orbit transfer missions. We call this mission-planning program the EDDE Navigation Tool. It finds the fastest way to get an electrodynamic thruster from an initial low earth orbit to any other low earth orbit, using Pontryagin’s principle. The resulting solutions often seem counter-intuitive at first. For example, changes in ascending node are often the most time-consuming

part of an orbit change, because they range over 360° , whereas popular inclinations range over a much narrower range (mostly 50° to 100°). The tool will often change EDDE’s inclination and/or altitude the “wrong way” at the start of a maneuver, to increase differential nodal regression compared to the target orbit and hence reduce the overall duration of the orbit change. For simplicity and speed, the tool does not simulate the detailed tether dynamics but rather just the long-term evolution of the orbit as it can be affected by electrodynamic thrust.

A typical output is shown in Figure 3 below. It illustrates a common feature, which is a tendency to quickly go to a low or high altitude, loiter there to maximize passive differential nodal regression compared to the destination orbit, actively change inclination and node, and then move to the desired altitude at the end of the maneuver.

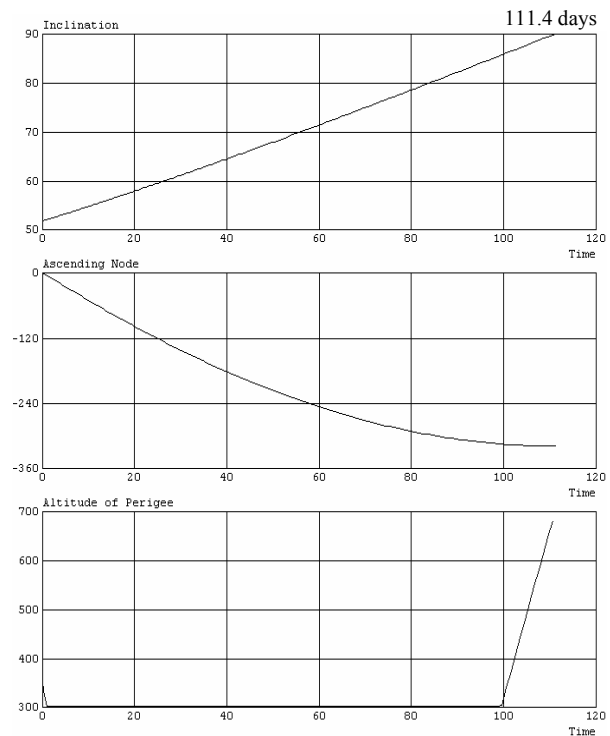

Figure 3. Example Orbit Transfer, ISS to Polar, Calculated by EDDE Navigation Tool

The EDDE Navigation Tool provides all necessary facilities to make the process of estimating orbit transfers user-friendly and efficient. The program is designed for Windows PCs running the following operating systems: Windows XP, 2000, NT 4.0, and Windows ME/98/95. Processors faster than 300 MHz are preferable, but not required. Because of high graphics content, screen resolutions 800 x 600 or higher are recommended.

KEY EDDE SYSTEM FEATURES

The baseline EDDE design is shown in Figure 4. Three of its key features are discussed below:

- bi-directional current capability,
- full-length electron collector, and
- distributed power system design.

EDDE must reverse the ED current direction twice per spin to provide a net translational force, and also to avoid seeing a net spin-up torque. This means it needs to be able to collect and emit electrons at each end of the tether. (Hanging ED thrusters generally also need current reversal, twice per orbit, if they are to make large plane changes rather than just altitude changes.) Rather than using two short collectors, one at each end, we make the whole conductor into a large-area electron-collector. This raises EDDE's maximum operating altitude, by allowing collection of adequate current down to lower plasma densities.

The other key feature of EDDE is that its solar arrays are distributed along the tether length. This allows the arrays to "pump the electrons along the tether." This in turn allows preferential electron collection at the end furthest from the emitter, to get the most work out of each electron collected. Distributed solar arrays also reduce the peak potential between the tether and local plasma. This helps prevent arcing from the tether to the ambient plasma. If arcing does start, it can be quenched by electrically isolating the tether segments upstream of the arcing section, using high-voltage tether control switches in each power module. This makes it feasible to pull the arcing segment positive to quench the arc. Finally, if the EDDE conductor is cut, each piece of EDDE still has its own hollow cathode, solar arrays, and controls. The pieces have reduced thrust and see secular spin changes if driven hard, but they can actively de-orbit themselves within a few days, before this becomes a problem. And they can still maneuver to avoid other known space objects while de-orbiting themselves.

KEY EDDE COMPONENTS

The above description of EDDE's basic architecture now allows a more detailed discussion of key EDDE components: the tether, solar arrays and tracking, power management, electron emitters, and avionics.

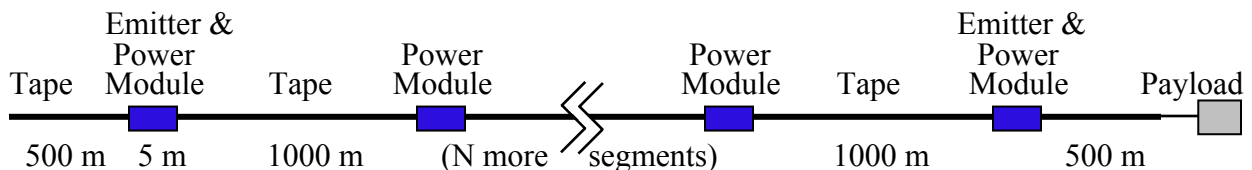

Figure 4. Schematic of Operational Version of EDDE

The Conducting Tether

Positively biased objects in plasma collect electrons across magnetic field lines only within several Debye lengths and electron gyro radii of the object. At low plasma densities, where EDDE must collect best, the Debye length is ~15mm and the gyro radius ~30 mm. So wires or narrow tapes should collect more electrons than equal areas of larger spherical or "window shade" collectors can.^{12, 13, 14} This led us to select a 30mm wide, 38-micron thick aluminum-foil tape as the EDDE collector (and conductor). The tape has 12X the collecting area of the ProSEDS wire at only 2X its mass. Note that in drag mode, the EMF leads to electron collection at the end furthest from the emitter, with a self-adjusting collection length that varies with plasma density. A mostly-bare-wire design like ProSEDS can work well for drag, but will not work well against the EMF, because then electron collection occurs mostly near the emitter. This drastically reduces the working tether length and hence thrust. But EDDE's distributed power lets it "pump" electrons against the EMF. If the ambient plasma density is low, the lower current allows power system operation at higher voltage. This biases more of the tape positive and hence allows collection along more of the length, but still preferentially far from the emitter. As with passive self-adjusting collection by drag-only bare wires, EDDE's adaptive powered collection may allow useful operation up to much higher altitudes than would be feasible otherwise.

EDDE's foil tape is reinforced against tearing by an 8 mm wide composite tape bonded to one side. This tape consists of quartz fiber in a cyanate ester matrix. The reinforcing tape also has a high thermal emittance. This helps keep the bare aluminum from overheating in the sun. The quartz fiber is an oxide, so atomic oxygen will erode only exposed matrix. The conductor is made of sections 250 m long (200 m for our initial prototype). Two lengths are bonded together at one end and wound on a lightweight stackable flangeless core, with the two reinforcing strips offset. This gives a dense and stable winding, with both free ends of the double-length available at the outside of the winding. This allows us to daisy chain multiple windings together, either directly or with power modules connected between them.

To ensure a controlled deployment, the tapes are wound together with a weak adhesive that provides a suitable deployment tension. The peel strength varies little with temperature over a wide range. Even more useful is that the peel force increases significantly with unwinding rate. This gives passive “viscous damping” of deployment. The tether windings are baked out in vacuum after winding. This artificially ages the adhesive bond and also reduces outgassing during the mission. Figure 5 shows a pair of 400 m windings stacked together (with nesting cores).



Figure 5. Two Stacked Dual-200-m Windings

Figure 6 shows the approximate cross-section of several layers of the wound tether (adhesive, reinforcement, and foil). This is roughly to scale except for a 15X vertical exaggeration. The bends in the wound tape are due to competition for the neutral-stress plane between foil and quartz. Winding under modest tension is enough to make the winding solid.

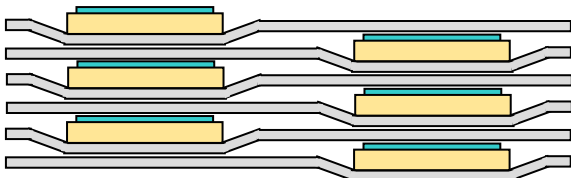

Figure 6. Wound Cross-Section (thickness X15)

Operational versions of EDDE may want to use two distinct reinforcing strips 5 mm wide with a 9mm gap between them, for enhanced impact tolerance. We did not do this on our initial prototype, because it is intended for a test flight. We could not figure out how to determine whether one of two strips was cut, so we decided to let the tape fail if a full reinforcing strip was cut, and use that data point to estimate the expected much-longer life of an operational version of EDDE with two separated reinforcing strips.

Solar Arrays and Tracking

EDDE can use either conventional crystalline solar cells or thin-film cells. The added solar array area needed with low-efficiency thin-film arrays is not an issue with EDDE. The tape tether has a far larger area anyway, so all a larger solar array does is increase the minimum operating altitude a few km. Thin-film arrays seem preferable due to their expected lower mass and cost, but their low maturity has led us to consider backup designs using crystalline-cell arrays.

EDDE may spend most of its time at altitudes below 500 km. Orbit plane change rates are high there, and debris density is lower than at higher altitudes. As a result, EDDE’s solar arrays may not need much radiation shielding. Also, EDDE is not sensitive to attitude jitter, so the solar arrays can be quite flexible without causing dynamics problems. This has led us to baseline centrifugally deployed flexible array designs that laminate the solar cells and interconnects between two thin layers of polymer film.

We plan to fold the array like a doubled-over folded “bolt” of cloth, as shown in Figure 7. This eliminates the tight creases that occur with tight zigzag folding. This concept requires variable gaps between cells. Very long arrays can be made without requiring large gaps, by joining and stacking several shorter “bolts.”

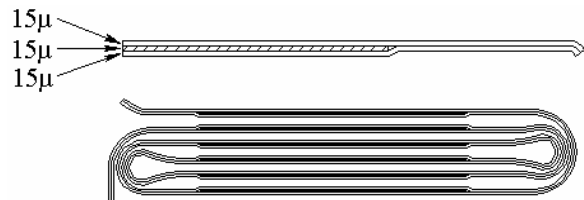

Figure 7. Laminated Thin-Film Cell and Array

Similar concepts can be used with crystalline cells, as shown in Figure 8. Here the front cover must be thick enough to reduce ionizing radiation to tolerable levels at the cell junctions. To improve the flexibility of the film hinges, the thicker front cover does not cross the hinges. Any cell interconnect that crosses a hinge needs its own insulation to prevent exposure to the plasma. This array concept can use either zigzag or “bolt of cloth” folding schemes.

We have not made a final selection of film materials or lamination techniques, but plan to do so after the MISSE experiment is returned from ISS. MISSE has been exposing materials to the space environment since November 2001. The samples include a variety of polymeric films being tested for potential use as “cover-glass” materials for solar cells.

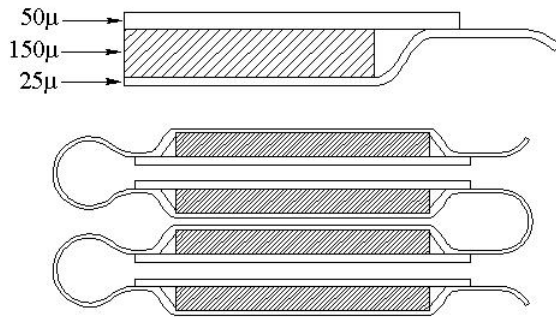

Figure 8. Laminated Crystalline Cell and Array

The detailed design of the array requires attention to issues such as materials selection to minimize arcing problems, keeping cells at widely different potentials far enough apart and eliminating trapped gas and hidden arcing paths between them, protection against atomic oxygen, and ensuring that extensive thermal cycling and flexing do not fatigue the films, interconnects, or cell/interconnect bonds.

To simplify EDDE's design and reduce mass, we plan to use only one-axis solar array tracking, around the tether axis. (EDDE performance estimates include losses from 1-axis array tracking.) The torque required for array tracking may be mostly due to tape torsional stiffness and "snap-through" response to skip-rope modes. Those effects are hard to quantify but they may be the key to the solution, since they provide something to react against. We plan more detailed analyses and tests as time and funding allow.

Tether Power Management

Our initial plans were to use DC/DC converters between the solar arrays and the tether. But the DC/DC converters could actually outweigh our lightweight solar arrays. So we now plan on a less efficient but far lighter voltage-control concept. The arrays operate direct-coupled to the tether, but each array consists of 4 sub-arrays that can be connected in parallel, in series, or 2x2. (This requires only 6 diodes, 3 MOSFETs, and 3 isolated gate drivers.) This should allow an average efficiency >75% that of peak-power efficiency, over an 8:1 voltage range, even with switch losses. This is less than the ~90% available with wide-range DC/DC converters, but the controls are so much lighter that the overall power system has much higher useful output per unit mass.

Each power module includes an "H-bridge" so the solar array can drive current through the tether in either direction. Turning the bridge off isolates the tether segments and array from each other, to help quench arcs from either the array or the tether. The bridge also includes a shunt switch so tether current

can bypass the solar array. This lets EDDE continue operating despite failed power switches or mis-aimed solar arrays. It also allows EMF-driven "drag-mode" operation at night. The switches are all soft-switching solid-state devices for low EMI and long cycle life.

The overall energy efficiency of EDDE is modest, because of the combined effects of one-axis tracking, direct-coupled array use at off-ideal voltages, and EDDE's "use it or lose it" operational strategy. These features reduce efficiency, but they reduce complexity, mass, and cost far more, so they greatly improve EDDE's overall system performance.

Electron Emitters

Our baseline electron emitters are hollow cathodes. They partially ionize a low flow of xenon inside a hot thermionically emitting cylinder. Ions and neutrals leak out a small hole at one end, and electrons stream out through this cloud, ionizing additional neutrals by impact. The slow ions neutralize the space charge of a far larger but faster electron flow. This reduces the voltage needed to emit multi-amp currents to ~20V, vs. kilovolts that might otherwise be needed to emit such currents from a small region. Many spacecraft have used hollow cathodes to neutralize charging in auroras and other energetic environments, but only PMG has used them to emit significant currents (up to 0.3A) into a large ionospheric current loop.

Some researchers have proposed using field-emitter arrays or other concepts that don't expend kilograms of xenon per year, but most designs proposed to date seem likely to have short operating lives in LEO, mostly due to neutral or ionized atomic oxygen. We think that typical operational versions of EDDE will need to weigh roughly 100 kg, to allow enough conductor length and area for effective use over a wide altitude range. For this size EDDE, the xenon usage required with hollow cathodes seems tolerable. Alternative emitter concepts may be most useful with short, light versions of EDDE that may perform well only at reasonably high plasma densities (>3E11/m³).

Avionics

Controlling EDDE requires on-board state-estimation using mathematical models of the tether dynamics, ionosphere, and earth's magnetic field. This requires extensive calculations. But these calculations need be repeated only roughly once a minute. A modest computer, such as the Small Intelligent Datalogger (SID) from Tether Applications, can meet the computing requirements. SID is a credit-card-sized 15 MHz 32-bit RISC flight computer. SID has on-board sensors, signal conditioning, three independent real-time clocks, and board-wide latch-up protection.

We were able to port “C” code developed in a PC environment to SID. We verified that we could fit the code in SID and run it fast enough to be useful, while leaving enough memory and throughput for all other tasks such as data collection, telemetry, etc. The deliverable SID hardware, Figure 9, will let the Air Force test the control system in representative environments.



Figure 9. EDDE Flight Computer

EDDE APPLICATIONS

In this section we describe 4 major classes of EDDE applications in LEO that we have found so far:

- placing multiple payloads in custom orbits
- inspecting multiple satellites in different orbits
- moving failed satellites to ISS for repair and back
- removing or relocating large orbital debris

Placement of Multiple Payloads in Custom Orbits

EDDE’s low cost, mass, volume, and lack of high-energy or toxic propellants make EDDE a safe, easy-to-integrate bus for secondary payloads needing delivery to orbits far from the primary payload orbit. This may have recurring value for programs like the Air Force Space Test Program, some of whose tests are delayed for years due to unusual orbit needs. EDDE’s capabilities are shown in Figure 10:

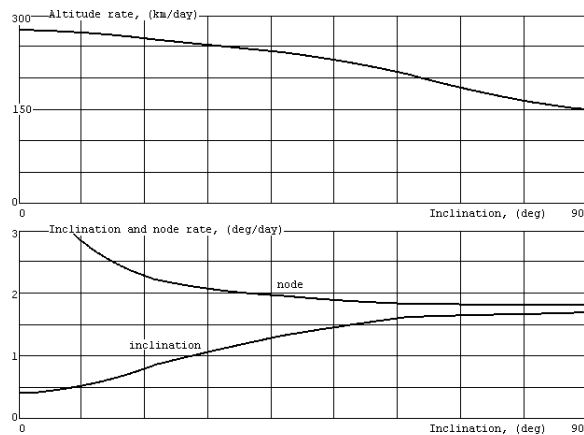

Figure 10. EDDE Orbit Transfer Rates

The above rates are without payload. With payload, the time taken typically scales with the ratio of EDDE plus average payload mass to EDDE mass. EDDE can create a multi-orbit-plane constellation of small satellites from a single launch. EDDE and its payloads can also be stored on orbit, to replace satellites anywhere in a constellation when they fail. EDDE can be launched as a secondary payload on Delta II, EELV, or Shuttle. A 36-kg minimal test version that includes 8 kg of nanosat payloads could mount in the same location as SEDS (see Figure 11).

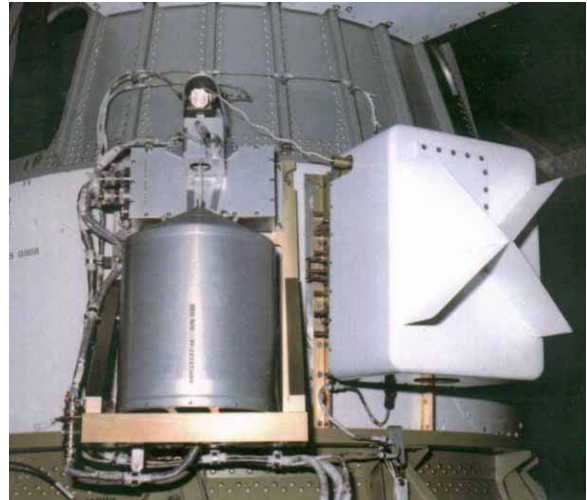

Figure 11. SEDS-1 on Delta II 2nd Stage

Inspection of Multiple Objects in Different Orbits

One particularly interesting class of nanosatellites that need delivery to individual orbits is low-deltaV inspectors. Due to the high deltaVs between random orbits in LEO, “nanosat-class” inspectors seem to make sense only if they are launched with the object they are to inspect. If not, then they require a dedicated launch, so there is no need to make any inspector smaller than a full small-launcher payload.

EDDE changes this logic. EDDE can distribute many small low-deltaV inspectors to individual orbits, with the number limited only by how light the inspectors can be, how many months are allowed to distribute them, and what orbit changes are needed from one object to the next. Because of potential risks to the objects inspected, the best “first targets” might be failed satellites or large orbital debris. Collecting close-up images of old and new objects in a variety of orbits should allow a radical improvement in estimation of orbital debris impact risks for a critical size range: debris that is too small to see from the ground but can make craters large enough to be seen by nearby inspectors.

Moving Failed Satellites to ISS for Repair and Back

If one can maneuver close enough to an object to drop off a low-deltaV inspector to rendezvous with and image it, then one may be able to do far more, using a scenario like that shown below in Figure 12. It requires EDDE carry with it two “sheepdogs,” one tethered and one that can be released and recaptured.

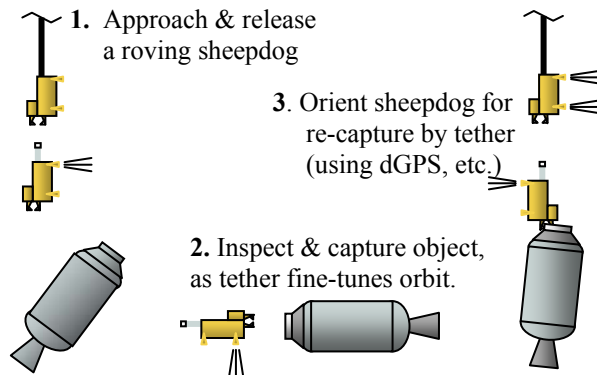

Figure 12. “Sheepdogs” for Two-Stage Capture

A tethered sheepdog can drop off a free one close enough to a failed satellite or other object that it can easily find and rendezvous with it. Then the free sheepdog will inspect the object so ground control can decide whether it can be safely captured and repaired, and if so then where to capture it (e.g. by a marman clamp flange). During a good pass over a ground station the free sheepdog can move in for the capture, perhaps using a low-latency man-in-the-loop video-game-like interface. Finally the sheepdog can de-spin its captured payload and orient itself for cooperative recapture by the tethered sheepdog.

During this process, EDDE can tune its orbit relative to the free sheepdog, using relative GPS and/or other sensors. If EDDE is in a flat spin at the anti-node of the orbit, it can make free returns every orbit, with the tethered sheepdog tracing an out-of-orbit-plane cycloidal approach to the free sheepdog. Once it gets close enough, it can thrust and/or reel tether to null out errors. Then EDDE can move its new payload close to ISS or another servicing facility, release it and the sheepdog a safe distance away, capture a new sheepdog, and start its next assignment. After the satellite is repaired, EDDE can return, re-capture the satellite, and return it to its operational orbit.

The most challenging parts of this scenario are likely to be the capture operations. Hence the first few captures (or maybe even a few dozen!) might best be done with satellite-sized orbital debris, to test the concept without risking even a failed satellite.

If EDDE can indeed capture objects, this may allow a solution of much of the orbital debris problem in low earth orbit. This leads to the fourth major EDDE use:

Removal or Relocation of Large Orbital Debris

The near-term risk to ISS and other high-value satellites is primarily due to existing debris that is too small to track from the ground and hence avoid. But the long-term risk will probably be due mainly to much larger numbers of small objects that will be created by future collisions of modest to large objects with large objects, which have most of the mass and area. Hence it may be very useful to either de-orbit large objects, or just move them out of altitude bands crowded by other debris. For example, moving most of twenty 9-ton rocket bodies out of an altitude band near 850 km would significantly reduce the overall risk of large step increases in LEO debris population.

A recent NIAC study by one of us (Carroll) suggests that about a dozen EDDEs might allow removal or relocation of most large orbital debris from LEO within 5 years¹⁵. This is noteworthy because no prior concept for removing or relocating most of the 2,000 tons of orbital debris now in LEO has ever appeared close to affordable. About 95% of the debris mass is in 1230 objects weighing 400 kg or more. Such objects seem large enough to be worth going after.

Most large objects are in 3 inclination bands (71-74°, 81-83°, and 96-100°), so several EDDEs could focus on each band. Then only small inclination and node changes are needed between assignments. Typical assignments might take 3 weeks for orbit change, rendezvous, inspection, free and tethered capture, and relocation to short-lived or otherwise safe orbits. In a ~5-year campaign near the next solar-max, each EDDE might relocate ~80 objects, typically weighing 1-3 tons each. Hence a fleet of ~12 EDDE “Debris Shepherds” could greatly reduce LEO debris density. The rate of small debris generation by collision scales with population density times total debris area, so moving most of the large objects should greatly reduce the long-term risk from small debris objects.

EDDE PERFORMANCE VS. ION ENGINES

EDDE provides thrust without using propellant, but its hollow cathodes use a small flow of xenon gas. This makes it difficult to quote a specific impulse for fair comparison with other types of electric thrusters. One measure is the “specific stage impulse” or total impulse (=thrust times duration) divided by full stage mass. This has units of N·s/kg. Table 1 on the next page compares EDDE with other electric propulsion systems, using our best estimates of key parameters.

Table 1. Comparison of EDDE with Other Orbit Transfer Propulsion Systems

System	Fluid Mass, kg	Dry Mass, kg	Thrust MN	Specific Power, kW/N	Isp, seconds	Run time, months	Sp. Stage Impulse, Ns/kg
NH3 Arcjet	500	200	2000	13	800	1	6K
SPT-100	72	25	78	17	1600	8	12K
DS-1 Ion	82	253	92	27	3100	14	7K
10 kW Hall	400	250	450	22	3000	13	18K
Test-EDDE	4	21	20	50	-	24	19K
EDDE	15	85	500	20	-	60	295K

EDDE thrust is for typical orbit changes; all run times are calendar months, sun-only operation.

EDDE FLIGHT DEMONSTRATION OPTIONS

EDDE is highly modular, so it can easily be scaled to a wide range of sizes, and packaged in various ways for launch. This allows launch on anything from the Delta II to Evolved Expendable Launch Vehicles (EELV). Two versions of EDDE appear particularly worth consideration for flight test.

Figure 13 shows one version. It weighs only 36 kg, including support hardware and 8 kg of payload. This allows launch as a Delta/GPS secondary payload like SEDS and PMG, even with a recent reduction in payload margin. The payload might include plasma diagnostics plus Cubesats or inspectors. The satellites can be dropped off one at a time into widely different orbits, to form an Earth-observing constellation, or to inspect satellites in widely different orbits. For this minimal version, the hollow cathode outweighs the tether, so it makes sense to use one cathode between two tether segments for bi-directional current. Using only one cathode means we can use only half the tether at a time. This reduces EDDE’s orbit-change performance, but it still allows a full test of all components and most operations. A large CM offset is needed here to decouple control of thrust and spin. Table 2 shows a mass budget for this option.

This option appears adequate for a test of all of EDDE’s key components and operations: the tether and its born-spinning deployment, a laminated-film high-voltage solar array with one-axis tracking and

control switching, a hollow cathode and possibly other electron emitter concepts, plasma sensors, and the flight computer and dynamics control software.

Another option is the larger 10-km operational version of EDDE shown earlier in Figure 4. It should weigh ~100 kg. It simply uses more of the same components found in the small version. Using hollow cathodes near both ends of the tape allows current flow in either direction along most of the tape length. The aluminum foil and solar arrays are each ~1/3 of the total mass. An EDDE this size can collect far more electrons and conduct them much further than a small test version can. This makes it far more agile, and lets it work well up to considerably higher altitudes. (But orbit change rates will slow down significantly at $N_e < 3E10/m^3$.)

Figure 14 shows the new ESPA secondary payload adapter for EELVs, and Figure 15 shows a 10-km, 100-kg version of EDDE stowed in 12” of the available 38”. This leaves at least 24”x24”x26” for EDDE payloads. ESPA can handle 180 kg payloads, so even a 100 kg EDDE leaves 80 kg for payload.

Figures 4 and 13 both have payloads at the tip rather than near the CM. This minimizes constraints on payload appendages and payload release dynamics. Similarly, Figure 15 shows the payload mounting on EDDE rather than the reverse. Then we need only one mounting surface on the payload rather than two.

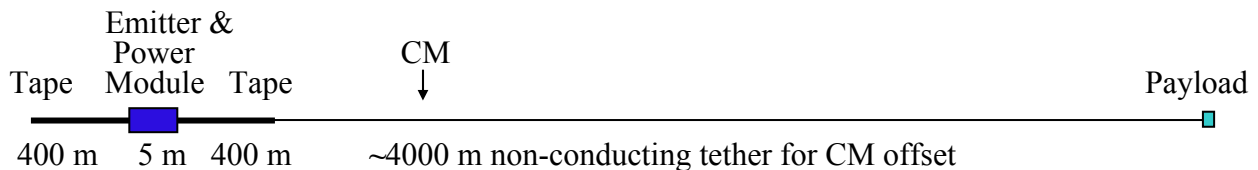

Figure 13. Schematic of 36-kg Test Version of EDDE

Table 2. Mass Budget for 36 kg Test Version of EDDE

Component	Description	Mass, kg
Conductor/collector	2 X 400 m Al foil w/quartz & cores	3.4
Solar array & end rails	1 kW thin film or 500W crystalline	3
Power handling	Batteries & power control	1
Avionics	Computer, GPS, telemetry, etc.	1
Hollow cathode emitter	Assumed mass, with gas for 1 year	10
EDDE structure & PAF	1 kg PAF + 12% of other EDDE	4.9
Structure on Delta	Marman clamp, supports, misc.	3
Non-conducting tether	4 km flat Spectra braid + deployer	2
EDDE payloads	Satellites, diagnostic sensors, etc.	8
Total	Max Delta/GPS secondary payload	36.3

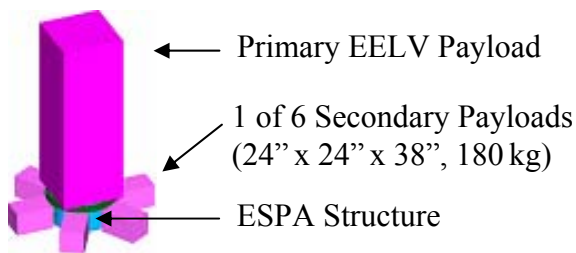

Figure 14. EELV Payloads and ESPA Structure

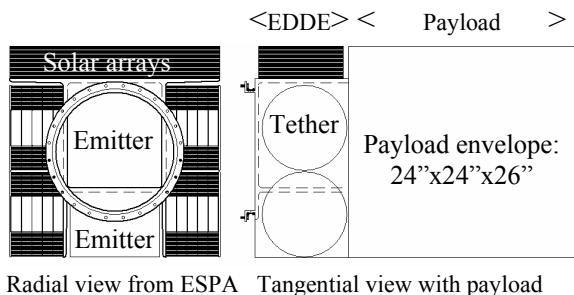

Figure 15. EDDE Stowed in ESPA Envelope

CONCLUSIONS AND RECOMMENDATIONS

The EDDE operational vehicle concept proposed in this report is the most flexible, high-performance, useful, realistic, and cost-effective electrodynamic thruster vehicle concept proposed to date. EDDE’s spinning mode of operation allows far higher performance than possible with any non-spinning electrodynamic thruster; its control law allows minimum-time orbit transfers throughout LEO; and its distributed power and power control improve electron collection, reduce arcing susceptibility and damage, and allow EDDE to promptly de-orbit itself if it is cut or otherwise partially disabled. EDDE enables at least 4 major new classes of multiple-payload missions that are hard if not impossible to accomplish with other forms of propulsion.

EDDE and thin-film solar arrays may be very compatible and complementary in a combined flight test. EDDE and thin-film solar arrays both require environmental and other tests that cannot be done completely on the ground, and they need similar plasma diagnostics and other instrumentation for a useful flight test. In addition, each can provide capabilities that the other needs. EDDE needs high daytime power at low weight and cost, while a thorough test of a thin-film array needs variations in array bias voltage to test environmental robustness, an ability to actively quench arcs, and an agile host vehicle that can expose the array to environments of gradually increasing severity, including atomic oxygen, ionizing radiation, and spacecraft charging. EDDE and thin film arrays can be tested separately, but they appear to be natural partners in a thorough but cost-effective combined flight test.

A 36 kg minimal test version of EDDE sized for a Delta/GPS secondary payload may be a reasonable basis for a low-cost combined EDDE/thin-film flight test, but EDDE could also fly on ESPA or some other flight opportunity. In any case, considerable ground-development and testing work are needed on key EDDE components and the overall system and mission design, before EDDE and a suitable solar array will be ready for a good flight experiment. We particularly recommend work in the following areas:

1. Analyze operational missions in more detail.
2. Design a combined EDDE/thin-film flight test.
3. Design, build, and test lightweight solar arrays.
4. Develop and test an array steering mechanism.
5. Develop and test solar-array switching circuits.
6. Refine and test EDDE’s current control laws.
7. Integrate avionics suite (telemetry, GPS, etc.).
8. Extend and refine the EDDE Navigation Tool.

ACKNOWLEDGEMENTS

The development of EDDE by STAR, Inc. and its subcontractors has been funded by the Air Force Research Laboratory (AFRL) under a Small Business Innovation Research (SBIR) Phase I contract, and by the AFRL and NASA Marshall Space Flight Center under an SBIR Phase II contract. Work on an EDDE application involving collection of orbital debris has been funded by the NASA Institute for Advanced Concepts (NIAC)¹⁶. We are indebted to Gene Fosness and Greg Spanjers of AFRL, Les Johnson and Greg Garbe of NASA MSFC, and Nick Johnson of NASA JSC for invaluable support, advice and technical consultations.

REFERENCES

¹ Carroll, J. A., "SEDS Deployer Design and Flight Performance," AIAA Paper 93-4764, 1993.

² McCoy, J., et al., "Plasma Motor-Generator (PMG) Flight Experiment Results," *Proceedings of the Fourth International Conference on Tethers in Space*, pp. 57-82, Smithsonian Institution, Washington, DC, April 1995.

³ Lorenzini, E., S. Bortolami, C. Rupp and F. Angrilli, "Control and Flight Performance of Tethered Satellite Small Expendable Deployment System-II," *Journal of Guidance, Control, and Dynamics*, Vol. 19, No. 4, pp. 1148-1156, 1996.

⁴ Johnson, L. and J. Ballance, "Propulsive Small Expendable Deployer System (ProSEDS) Space Demonstration," NASA MSFC white paper, 1998.

⁵ Pearson, J., J. Carroll, and E. Levin, Electrodynamic Delivery Experiment, Air Force Research Laboratory Technical Report AFRL-VS-TR-2000-1029, April 2000.

⁶ Pearson, J., E. Levin, J. Oldson, and J. Carroll, "The ElectroDynamic Delivery Experiment (EDDE)," Space Technology and Applications International Forum-2001, American Institute of Physics CP552, pp. 425-432, February 2001.

⁷ Pearson, J., J. A. Carroll, E. M. Levin, and J. C. Oldson, ElectroDynamic Delivery Express (EDDE) Autonomous Space Vehicle, Air Force Research Laboratory Technical Report AFRL-VS-TR-2002-1111, December 2002.

⁸ Levin, E. and J. Carroll, "Method and Apparatus for Observing and Stabilizing Electrodynamic Tethers," U. S. Patent Application SN 60/274,073, March 7, 2002.

⁹ Levin, E. and J. Carroll, "Method and Apparatus for Propulsion And Power Generation Using Spinning Electrodynamic Tethers," U. S. Patent Application SN 60/274,072, March 5, 2002.

¹⁰ Beletsky, V. M. and E. M. Levin, *Dynamics of Space Tether Systems*, Vol. 83, Advances in the Astronautical Sciences, American Astronautical Society, 1993.

¹¹ Pelaez, J., E. Lorenzini, O. Lopez-Rebollal and M. Ruiz, "A New Kind of Dynamic Instability in Electrodynamic Tethers," *The Journal of the Astronautical Sciences*, Vol. 48, No. 4, pp. 449-476, 2000.

¹² Sanmartin, J., M. Martinez-Sanchez, and E. Ahedo, "Bare Wire Anodes for Electrodynamic Tethers," *Journal of Propulsion and Power*, Vol. 9, No. 3, pp. 353-360, 1993.

¹³ Onishi, T., and M. Martinez-Sanchez, "Computation of Current to a Moving Bare Tether," 6th Spacecraft Charging Technology Conference, AFRL-VS-TR-2000-1578, 1 September 2000.

¹⁴ Van Noord, J. L., B. West, and B. Gilchrist, "Electrodynamic Tape Tether Performance with Varying Tether Widths at Low Earth Altitudes," AIAA-2001-1141, 39th Aerospace Sciences Meeting & Exhibit, Reno, NV, 8-11 January 2001.

¹⁵ Andringa, J. M, and D. E. Hastings, "A Systems Study on How to Dispose of Fleets of Small Satellites," MIT Department of Aeronautics and Astronautics MS Thesis, February 2001. ssl.mit.edu/publications/theses/SM-2001-AndringaJason.pdf.

¹⁶ Carroll, J.A., "Space Transport Development Using Orbital Debris," NIAC Phase I review presentation and final report, both available at www.niac.usra.edu, October and November 2002.