



# Gen 3 Wall Connector Manual

Type 2 Handle, Three Phase

- Important Safety Information..... 2
- Product Specifications.....4
- Wall Connector Label..... 5
- Power Supply Options..... 6
- Circuit Breaker Rating / Maximum Output.....  
..... 9
- Using Wall Connector..... 11
- Features..... 12
  - Connectivity.....12
  - Hosted Access Point.....12
  - Local Network.....12
  - Residual Current Device (RCD).....13
  - Ground Monitor Interrupter.....13
  - Power Outages.....14
  - Firmware Updates.....14
  - Thermal Monitoring.....14
- Wall Connector External Components.....15
- Wall Connector Internal Components.....16
- In the Box.....17
- Tools..... 18
- Installation Considerations..... 19
- Installation Steps..... 22
  - STEPS 1, 2, 3: Preparing and Mounting the Wirebox...  
..... 22
  - STEP 4: Sizing and Routing Conductor Wires..... 24
  - STEP 5: Stripping and Securing Wires in Wirebox  
Terminals..... 25
  - STEP 6: Securing Main Unit to Wirebox.....26
- Commissioning Procedure..... 27
- Wall Connector LEDs..... 28
  - Light Codes.....28
  - Error Codes..... 29
- Warranty Information..... 30
- Limits of Liability..... 31
- Dispute Resolution.....32



# IMPORTANT SAFETY INFORMATION

Read all instructions before using this product. Save these instructions. Wall Connector features built-in RCD Type A + DC 6mA.

This manual contains important instructions for the Tesla Gen 3 Wall Connector that shall be followed during installation, operation, and maintenance. Please review all warnings and cautions before installing and using the Wall Connector.

 **WARNING:** When using electric products, basic precautions should always be followed, including the following.

## INSTRUCTIONS RELATING TO RISK OF FIRE OR ELECTRIC SHOCK

 **WARNING:** Do not install or use the Wall Connector near flammable, explosive, harsh, or combustible materials, chemicals, or vapors.

 **WARNING:** Turn off power at the circuit breaker before installing or cleaning the Wall Connector.

## WARNINGS

 **WARNING:** This device should be supervised when used around children.

 **WARNING:** The Wall Connector must be earthed through a permanent wiring system or an equipment-earthing conductor.

 **WARNING:** Use the Wall Connector only within the specified operating parameters.

 **WARNING:** Never spray water or any other liquid directly at the wall mounted control box. Never spray any liquid onto the charge handle or submerge the charge handle in liquid. Store the charge handle in the dock to prevent unnecessary exposure to contamination or moisture.

 **WARNING:** Do not use the Wall Connector if it is defective, appears cracked, frayed, broken, or otherwise damaged, or fails to operate.

 **WARNING:** Do not use the Wall Connector if the flexible power cord or cable is frayed, broken, or otherwise damaged, or fails to operate.

 **WARNING:** Do not attempt to disassemble, repair, tamper with, or modify the Wall Connector. The Wall Connector is not user serviceable. Contact Tesla for any repairs or modification.

 **WARNING:** When transporting the Wall Connector, handle with care. Do not subject it to strong force or impact or pull, twist, tangle, drag, or step on the Wall Connector, to prevent damage to it or any components.

 **WARNING:** Do not touch the Wall Connector's end terminals with fingers or sharp metallic objects, such as wire, tools, or needles.

 **WARNING:** Do not insert fingers or foreign objects into any part of the Wall Connector.





 **WARNING:** Do not forcefully fold or apply pressure to any part of the Wall Connector or damage it with sharp objects.

 **WARNING:** Use of the Wall Connector may affect or impair the operation of any medical or implantable electronic devices, such as an implantable cardiac pacemaker or an implantable cardioverter defibrillator. Check with your electronic device manufacturer concerning the effects that charging may have on such electronic devices before using the Wall Connector.



# IMPORTANT SAFETY INFORMATION

## CAUTIONS

-  **CAUTION:** Do not use private power generators as a power source for charging.
-  **CAUTION:** Incorrect installation and testing of the Wall Connector could potentially damage the vehicle's battery, components, and/or the Wall Connector itself. Any resulting damage is excluded from the New Vehicle Limited Warranty and the Charging Equipment Limited Warranty.
-  **CAUTION:** Do not operate the Wall Connector in temperatures outside its operating range of -30° C to 50° C (-22° F to 122° F).
-  **CAUTION:** Wall Connector should only be installed by personnel who are trained and qualified to work on electrical systems.
-  **CAUTION:** Ensure that Wall Connector is within storage temperature when moving, transporting, or storing.



# PRODUCT SPECIFICATIONS

This manual applies to Wall Connectors identified by part number 1529455-\*\*-\*\*.\*.

|                                  |   |
|----------------------------------|---|
| Voltage and Wiring               | 1-phase 230 V L-N<br>3-phase 230 V L-L<br>3-phase 400 V L-L                                 |
| Current Output Range             | Maximum 32 A (adjustable by installer)  |
| Terminal Blocks                  | Stranded: 4-25 mm <sup>2</sup> , copper only<br>Solid: 1.5-20 mm <sup>2</sup> , copper only |
| Supported Earthing Scheme        | TN/TT/IT  |
| Frequency                        | 50/60 Hz  |
| Cable Length                     | 7.3 m (24 ft) or 2.6 m (8.5 ft)   |
| Wall Connector Dimensions        | Height: 345 mm (13.6 in)<br>Width: 155 mm (6.1 in)<br>Depth: 110 mm (4.3 in)                |
| Wire Box Bracket Dimensions      | Height: 250 mm (9.8 in)<br>Width: 120 mm (4.7 in)<br>Depth: 50 mm (2.0 in)                  |
| Weight (including wirebox)       | 6.8 kg (15 lb)  |
| Operating Temperature            | -30 °C to 50 °C (-22 °F to 122 °F)  |
| Storage Temperature              | -40 °C to 85 °C (-40 °F to 185 °F)  |
| Enclosure Rating                 | IP 55   |
| Ventilation                      | Not required  |
| Means of Disconnect              | External branch circuit breaker   |
| Residual Current Detection (RCD) | Integrated (Type A + DC 6 mA)   |
| Wi-Fi                            | 2.4 GHz, 802.11b/g/n  |
| Certifications                   | CE, IEC CB  |



## WALL CONNECTOR LABEL

Each Wall Connector has a label on the exterior side with information that is unique to the product, including:

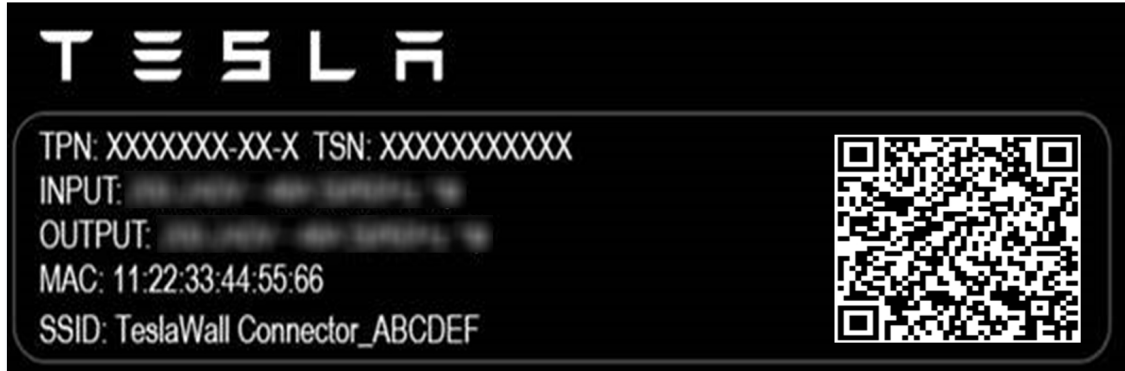

- TPN: Tesla Part Number
- TSN: Tesla Serial Number
- Input: Max input power
- Output: Max output power
- MAC: Unique MAC address assigned to the Wall Connector
- SSID: Unique Wi-Fi access point assigned to the Wall Connector



## POWER SUPPLY OPTIONS

For basic operation, Wall Connector requires an electrical connection to Line 1, Neutral, and Protective Earth (PE) terminals. Connection to Line 2 and Line 3 terminals is supported for some grid types.

**⚠ CAUTION:** Wall Connector supports 230 V L-N (+/- 10%). Mis-wiring the neutral terminal with >264V to PE can damage Wall connector

Wall Connector can operate on a three-phase power supply or a single-phase power supply.

**Table 1. Most Common Installation Option**

**Wiring Configuration Option for Five Wires: Line 1, Line 2, Line 3, Neutral, PE**

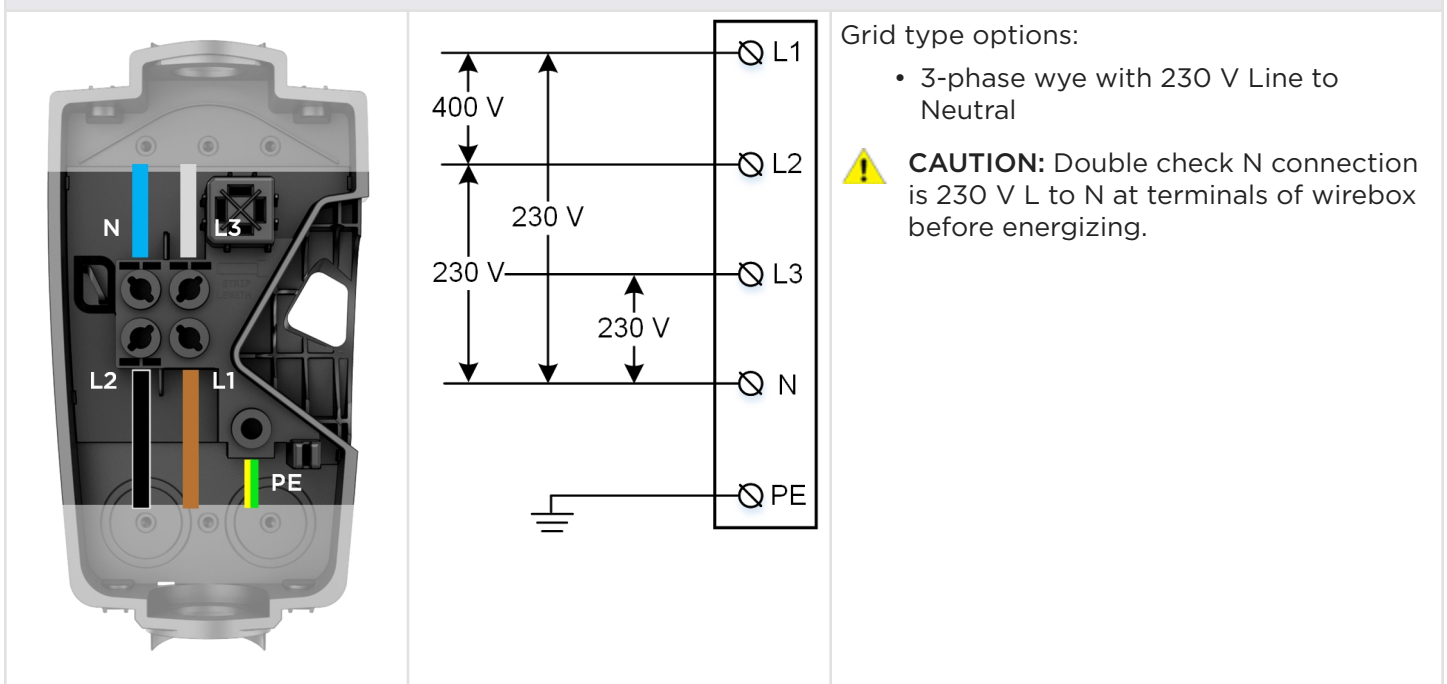

**NOTE:** Blue is used as the IEC standard for neutral. Some markets may use other colors to symbolize neutral and line conductors.



# POWER SUPPLY OPTIONS

Table 2. 2nd Most Common Installation Option

Wiring Configuration Option for Three Wires: Line 1, Neutral, PE

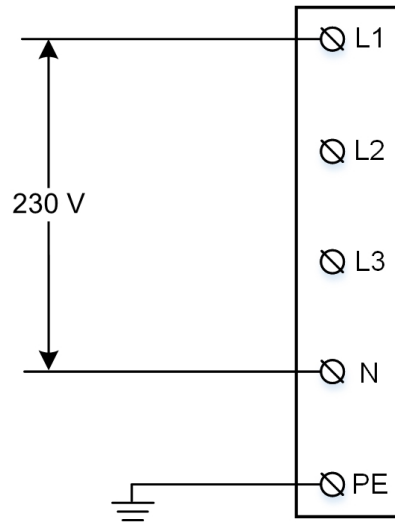
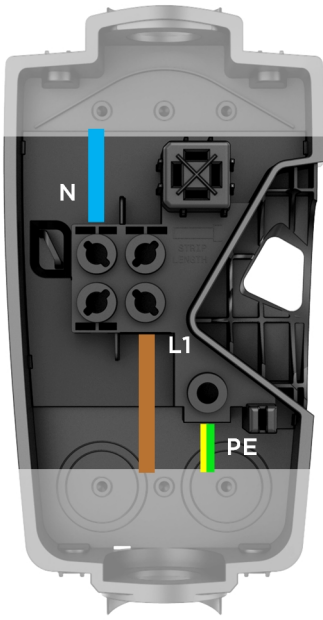

Grid type options:

- 230 V Line to Neutral
- 230 V Line to Line

**NOTE:** For 230V Line to Line connections, without a Neutral, connect one Line from the grid to the Neutral terminal of the wirebox

**CAUTION:** Double check N connection is 230 V L to N at terminals of wirebox before energizing.





# POWER SUPPLY OPTIONS

Table 3. Least Common, but Supported Installation Option

## Wiring Configuration Option for Four Wires: Line 1, Line 2, Neutral, PE



\*When connecting to a 230 V delta no neutral grid, land one of the line connections in the neutral terminal of the wirebox.

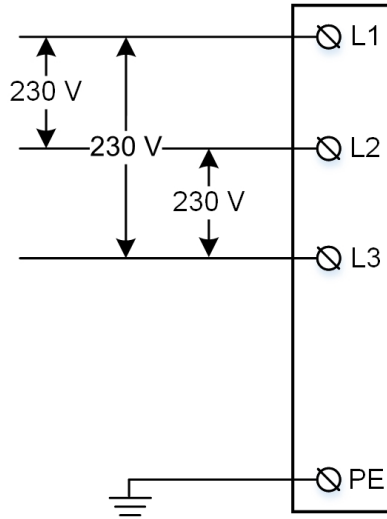

Grid type options:

- Delta 230 V Line to Line
- Open wye with 230 V Line to Neutral
- Split phase 230 V Line to Neutral

**NOTE:** In the case of a Delta grid connection, land one of the line conductors from the grid in the neutral terminal of Wall Connector wirebox.

**NOTE:** The conductor with lowest voltage to Protective Earth (PE) should be connected to the Neutral terminal.

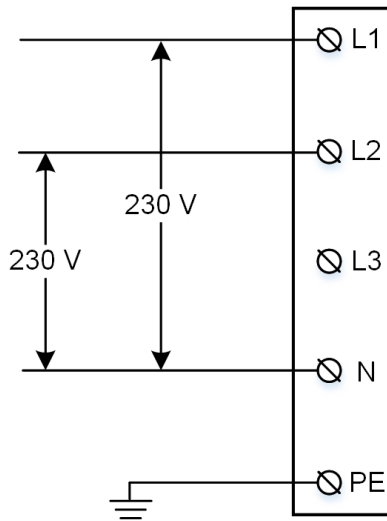

**CAUTION:** Double check N connection is 230 V L to N at terminals of wirebox before energizing.



# CIRCUIT BREAKER RATING / MAXIMUM OUTPUT

## Power Output

For maximum power output, install a three phase circuit breaker capable of 32 A continuous output. Wall Connector features built-in RCD Type A + DC 6mA.

Maximum current output (amps) can be programmed by the installer as part of the commissioning process. Any amperage between 6 A and 32 A can be selected. Estimate power output for various grid connections below:

**NOTE:** Some Tesla vehicles may draw less current than the max output. Actual charging rate depends on Wall Connector output and onboard charger in the vehicle. See Tesla website for vehicle specifications.

| Maximum current output (A) | Single phase (PE, L1 ,N) power output (kW) | Three-phase Delta Connection (PE, L1 ,L2, L3 landed in N terminal) power output (kW) | Two phase with neutral (PE, N, L1, L2) power output (kW) | Three phase wye connection (PE, L1, L2, L3, N) power output (kW) |
|----------------------------|--|--|--|--|
| 32                         | 7.4  | 8.5  | 14.7   | 22.1   |
| 25                         | 5.8  | 6.6  | 11.5   | 17.3   |
| 20                         | 4.6  | 5.3  | 9.2  | 13.8   |
| 16                         | 3.7  | 4.2  | 7.4  | 11.0   |
| 13                         | 3.0  | 3.4  | 6.0  | 9.0  |
| 10                         | 2.3  | 2.7  | 4.6  | 6.9  |
| 8                          | 1.8  | 2.1  | 3.7  | 5.5  |
| 6                          | 1.4  | 1.6  | 2.8  | 4.1  |

**NOTE:** Refer to local regulations regarding any disconnect requirements.

**NOTE:** See [Commissioning Procedure on page 27](#) for details on how to set maximum amperage.



# CIRCUIT BREAKER RATING / MAXIMUM OUTPUT

## Branch Circuit Conductors and Earth Wire

- Refer to local electrical code to select correct conductors and earth wire size that are suitable for the chosen circuit breaker.
- Wall Connector wirebox terminals can accept stranded wire sized between 4 mm<sup>2</sup> to 25 mm<sup>2</sup>, or solid wire 1.5 mm<sup>2</sup> to 25 mm<sup>2</sup>. Installer is responsible for selecting a wire size that will be compliant with local code, possibly taking into account amperage, distance and other site conditions.



**NOTE:** If using stranded wiring smaller than 4 mm, use a correctly sized ferrule so it can be securely terminated.

- For sites with multiple Wall Connectors, each Wall Connector must have its own branch circuit and dedicated circuit breaker.
- For outdoor installations, use watertight fittings when securing feeder wires to the wirebox.
- For this installation guide, IEC standard colors are used for L1, L2, L3, Neutral, and PE. Some regions may use other standardized colors.

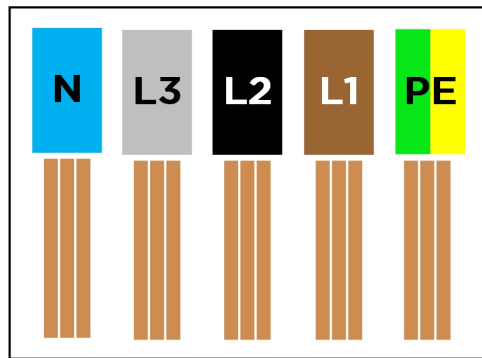

## Earth Connections

Wall Connector must have an earth path back to the main equipment earthing point on site. Without a proper earth connection, the Wall Connector will not charge a vehicle during an earth assurance test. Equipment-earth conductor must be run with the circuit conductors and connected to the equipment-earth terminal in the wirebox. Install a earth wire sized according to local electrical code.

**NOTE:** To support TT and IT grids, earth assurance can be disabled as part of the commissioning process. Earth assurance must always be enabled for TN grids.

Additional requirements apply to UK properties fed from a TN-C-S supply. In most scenarios, these properties will require an external device which provides PEN fault detection and isolation in accordance with BS 7671. It is the responsibility of the installer to ensure that the requirements of BS7671 are met - please refer to Tesla's application note (xref) that discusses this topic in more detail.

**NOTE:** The use of an dedicated earth rod for the EVSE will not generally be a practical solution to meet the BS 7671 requirements



## USING WALL CONNECTOR

1. Open the vehicle charge port by pressing the button on the charge handle, pressing on the charge port door, using the mobile app, using the vehicle touchscreen, or by pressing and holding the trunk button on the keyfob.
2. Insert the charge handle into the vehicle charge port.
3. Check the vehicle controls to verify charging.
4. To remove the charge handle from the vehicle, press and hold the button on the handle to unlock the charge port.

**NOTE:** The vehicle must be unlocked for the charge handle to be removable.



5. Remove the charge handle from the vehicle charge port.
6. Wrap the charge cable counter-clockwise around the Wall Connector and insert the charge handle into the holster.





# FEATURES

## Connectivity

Wall Connector is equipped with Wi-Fi to communicate with local site routers, vehicles, mobile devices, other Wall Connectors, and other Tesla products.



## Hosted Access Point

Wall Connector hosts a WPA2 password-secured, 2.4 GHz, 802.11 Wi-Fi access point network to facilitate commissioning and connecting to other devices.

A unique SSID Wi-Fi network name and WPA2 password for connecting to the Wall Connector are printed on a label at the rear of the main unit, as well as on the front cover of the Quickstart Guide included in the box.

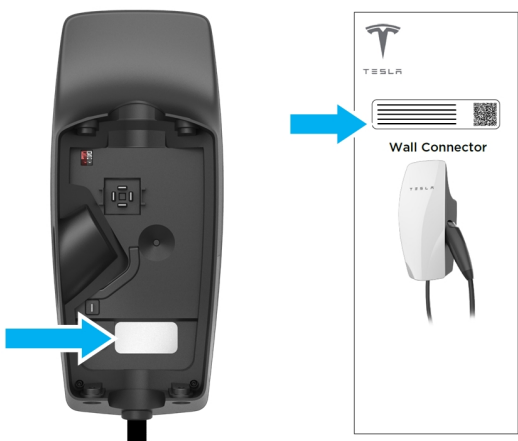

## Local Network

Connecting Wall Connector to a local Wi-Fi network enables it to receive over-the-air firmware updates, remote diagnostics access, and usage data tracking capability. A Wi-Fi connection is required for sites that utilize authentication, billing, and other property management features.

**NOTE:** Some features will be added over time.

Wall Connector only supports WPA2/3-secured, 2.4 GHz, 802.11 infrastructure mode networks.

**NOTE:** Hidden networks are supported.

**NOTE:** WPA enterprise will be supported in a future firmware update.

**NOTE:** Property management features will be enabled via future firmware updates.

## Residual Current Device (RCD)

Wall Connector features built-in RCD Type A + DC 6mA. The benefit of this protection is that RCD Type B are not required when installing Gen 3 Wall Connectors, consult local regulations on the type of breaker required.

AC earth fault interruption automatically detects an AC current mismatch between power delivery conductors that would indicate that current is flowing through the earth conductor. AC fault protection will trip at 20 mA.

DC earth fault interruption automatically detects DC leakage through earth. DC fault protection will trip at 6 mA.

User interaction such as pressing the cable button or unplugging from vehicle is required to clear this fault. If fault continues, consult with an electrician to review power supply.

## Ground Monitor Interrupter

The ground monitor interrupter allows the installer to select different early monitor options. Wall Connector continuously checks for the presence of a safe earth connection and automatically recovers from faults. Earth assurance operates by injecting a small amount of current into the earth conductor in order to measure the impedance between line and earth. If high impedance is detected, the Wall Connector will lock out charging and display a error code of two (2) red blinks. See [Error Codes on page 29](#) for a full list of error codes.

For earth assurance to operate on TN grids, one leg of the distribution transformer must be earth-bonded (Neutral). Earth bond should only occur at one location in a site's electrical system.

Wall Connector earth assurance may be adjusted in countries with TT or IT grid configurations.

The Earth Monitor Interrupter feature monitors the Wall Connector earth connection. Select the correct option based on the installation's earthing system and earth impedance.

Depending on country, three options are available:

- **Enable:** Earth connection will be monitored and a high detected earth resistance will disable the Wall Connector. This is the preferred setting to provide protection, and should be selected where earth connection is expected to be strong (as in the case on TN networks and most TT networks), and where required by regulation.
- **Disabled:** Earth connection will not be monitored. This should be selected where the earth connection is not made (as is the case for IT networks), or where the current induced by this check would be problematic (as is the case on some TT networks with sensitive residual-current devices).

**NOTE:** Earth Monitoring is always enabled for installations in North America.

Temporary problems such as earth faults or utility power surges are resolved automatically.



## Power Outages

If there is a power outage while Wall Connector is charging a vehicle, charging will automatically resume within 1 to 3 minutes after power restoration. The Wall Connector will display a solid blue light on the faceplate to indicate that it is communicating with the vehicle and waiting to resume charging. Alternatively, pressing the button on the charge handle after power restoration will cause Wall Connector to resume charging immediately.

## Firmware Updates

Firmware updates will be automatically applied to the Wall Connector to improve the user experience and introduce new features. Connect Wall Connector to Wi-Fi for access to the most recent firmware update. See [Commissioning Procedure on page 27](#).

Tesla vehicles can provide firmware updates to Wall Connectors.

## Thermal Monitoring

Wall Connector actively monitors temperatures in multiple locations while charging to ensure stability of the charge session. Temperature sensors are located at the relays, microcontroller, charge handle, and rear of the main unit to monitor the temperature of the terminals in the wirebox.

In warmer conditions, Wall Connector may reduce current and charge speed to protect itself. When this happens, the light bar on the faceplate will continue to display the “streaming green” and a blink code of three red flashes to indicate that charging has been reduced due to high temperatures. If heat continues to rise, Wall Connector will stop charging and display a blink code of three red flashes.

**NOTE:** See [Error Codes on page 29](#) for full list of error codes.

For optimal performance, install Wall Connectors in areas where ambient temperature will remain below 50°C (122°F). In rare circumstances, Wall Connector may begin reducing amperage at 35°C (95°F) ambient temperatures. Adjustments to amperage are automatic and do not require user input; Wall Connector will return to starting current when temperatures are reduced.



## WALL CONNECTOR EXTERNAL COMPONENTS

"Wall Connector" refers to the product as a whole.

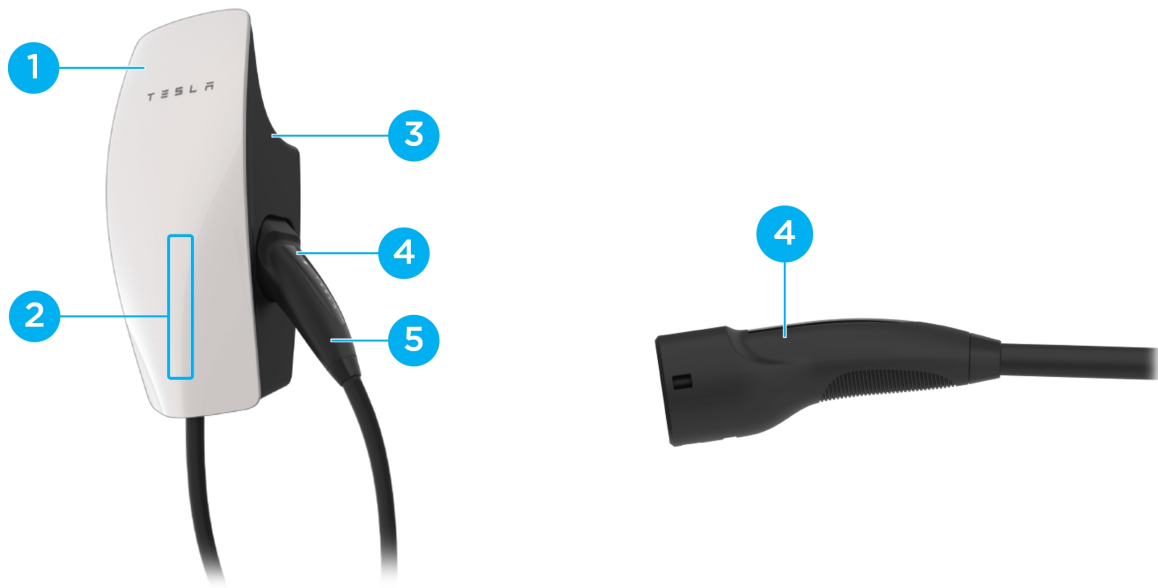

1. Faceplate
2. Light bar (vertical)
3. Main unit
4. Charge handle button
5. Charge handle







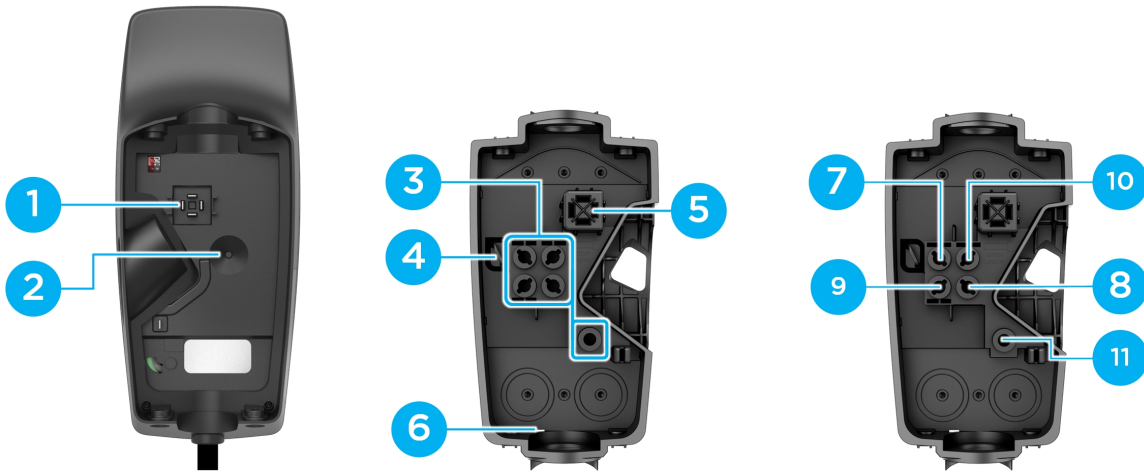





## WALL CONNECTOR INTERNAL COMPONENTS

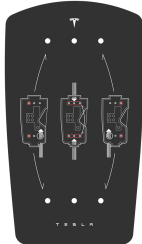

1. Contact blades
2. Temperature sensor
3. Conductor terminals
4. Zip tie anchor
5. Sliding contacts
6. Wirebox drainage opening (enables Type 3R protection)
7. Neutral
8. Line 1
9. Line 2
10. Line 3
11. Earth



## IN THE BOX

|  |   |  |   |
|--|---|--|---|
|  <p>Main Unit</p>     |  <p>Wirebox</p>                                  |  <p>Wirebox Mounting Template</p>   |  <p>Hex Bit (4 mm)</p>   |
|  <p>Zip tie (x1)</p> |  <p>Wall Connector-to-Wirebox Fastener (x4)</p> |  <p>Wirebox-to-Wall Fastener (x2)<br/>4.0 x 50 mm (PZ2)<br/>(#8 x 2 in)</p> |  <p>Quickstart Guide (contains sticker with SSID network name and unique password)</p> <p><b>SAVE THIS DOCUMENT</b></p> |

**NOTE:** The hex bit, zip tie, and fasteners are located in a plastic bag inside the wirebox, which comes attached to the main unit of the Wall Connector.











**NOTE:** Wall plugs are not included. If installing in concrete or other like materials, use 6 mm wall plugs.



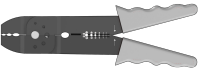

# TOOLS

## Required Tools

**NOTE:** Drill bit sizes assume wood mounting surfaces. If installing on concrete or other masonry, consult with an electrician for optimal pilot hole sizes.

|  |   |   |   |
|--|---|---|---|
| <br>Torque Driver (5.6 Nm, 50 lbf . in) | <br>Multimeter   | <br>Stud Finder<br>(If installing on wood walls)                 | <br>Tape Measure |
| <br>Wire Stripper                       | <br>Drill Bit, 5 mm (3/16 in)<br>(If installing on wood walls) | <br>Drill Bit, 2.5 mm (3/32 in)<br>(If installing on wood walls) | <br>Bit Driver   |
| <br>Level                             | <br>Smartphone (with Wi-Fi)                                  | <br>Power Drill  |   |

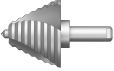
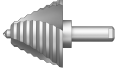
## Optional Tools

|   |   |  |
|---|---|--|
| <br>Step Bit, 29 mm (1-1/8 in) | <br>Step Bit, 35 mm (1-3/8 in) | <br>Computer (with Wi-Fi) |
|---|---|--|



## INSTALLATION CONSIDERATIONS

Wall Connector may be installed on any flat, vertical surface capable of supporting its weight (e.g. wall, pedestal, etc.). Wall Connector (wirebox, faceplate, and long cable) weighs 6.8 kg (15 lb).

### Choosing Location

Install Wall Connector in a location that allows the charge cable to reach the vehicle charge port without putting strain on the cable.

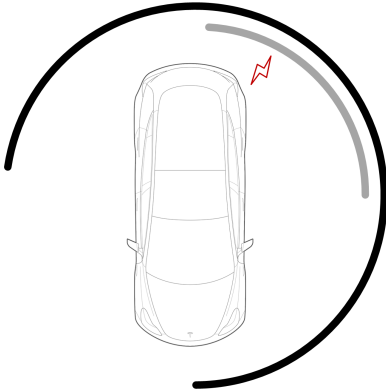

- Dark gray: Recommended installation area for Wall Connectors with 7.3 m (24 ft) cable
- Light gray: Recommended installation area for Wall Connectors with 2.6 m (8.5 ft) cable

Install Wall Connector in a location with ample clearance on all sides to allow the charge cable to loop around the unit and the charge handle to comfortably land in the side dock.

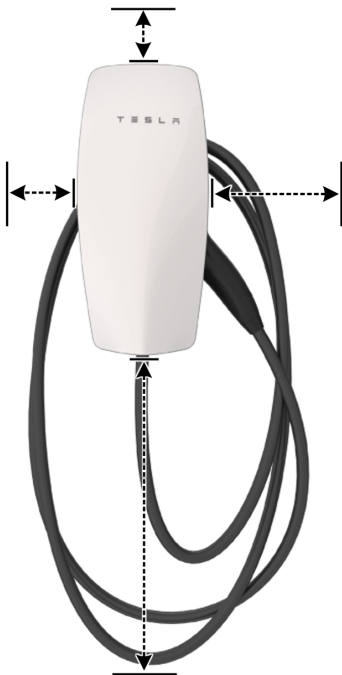

**NOTE:** If constrained by space, a cable organizer can be installed near the Wall Connector.



# INSTALLATION CONSIDERATIONS

## Choosing Height

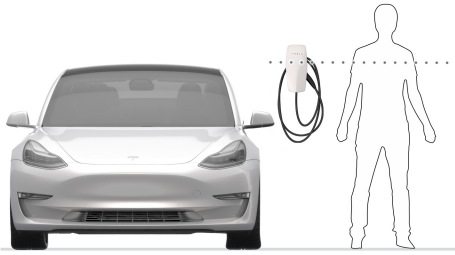

- Maximum height (indoor and outdoor): 1.52 m (60 in)
- Recommended height: ~1.15 m (~45 in)
- Minimum outdoor height: 0.6 m (24 in)
- Minimum indoor height: 0.45 m (18 in)

## Maximizing Wi-Fi Signal Reception

Wall Connectors should be connected to a local Wi-Fi network for optimal functionality. For maximum signal reception, avoid installing Wall Connector on opposite sides of concrete, masonry, metal studs, and other physical obstructions that could impede Wi-Fi signal reception.

**NOTE:** If a mobile device is able to connect to local Wi-Fi at a given location, it is a good indication that Wall Connector will also be able to connect.





# INSTALLATION CONSIDERATIONS

## Wire Entry Options



Wall Connector's wirebox has multiple wire entry options. Choose one entry path and follow installation instructions based on chosen entry path.

1. Top entry location
2. Rear entry locations (left or right)
3. Bottom entry location



# INSTALLATION STEPS

## STEPS 1, 2, 3: Preparing and Mounting the Wirebox

This procedure has 4 different variations depending on the chosen wire entry option, but the general order of steps will be the same for all wire entry options:

1. Drill 5 mm holes into the wirebox\*. If wiring for rear entry, use step bit.
2. Use cardboard template to plan or drill pilot holes into mounting surface\*. A 2.5 mm pilot hole is recommended for most surfaces.

**NOTE:** Drill larger pilot holes that can accommodate 6mm wall plugs if installing on concrete, masonry, or similar materials.

**NOTE:** Installer can adjust pilot hole size based on mounting surface

**NOTE:** Use a level to ensure that the template is completely level.

3. Attach wirebox to mounting surface using included fasteners, which include an integrated sealing washer. The fastener head is compatible with both #2 Phillips or #2 square head bit. Attach conduit/fittings and bring in conductor wires\*.

**NOTE:** It is the responsibility of the installer to select appropriate conduit/fitting materials for the installation.

*\*Exact locations depend on the wire entry option*

**Table 4. For Top Wire Entry**

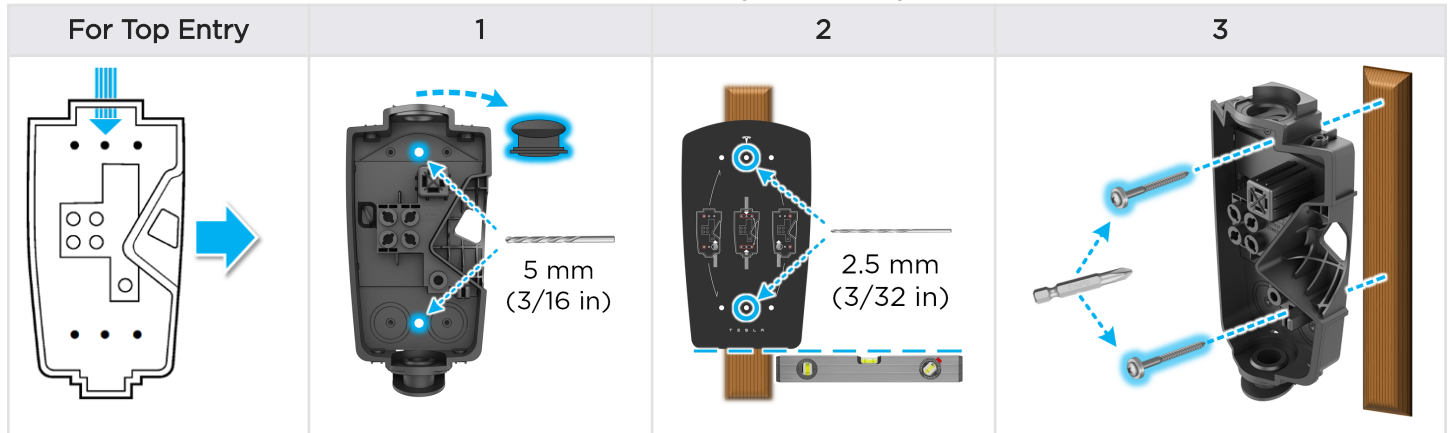

**Table 5. For Bottom Wire Entry**

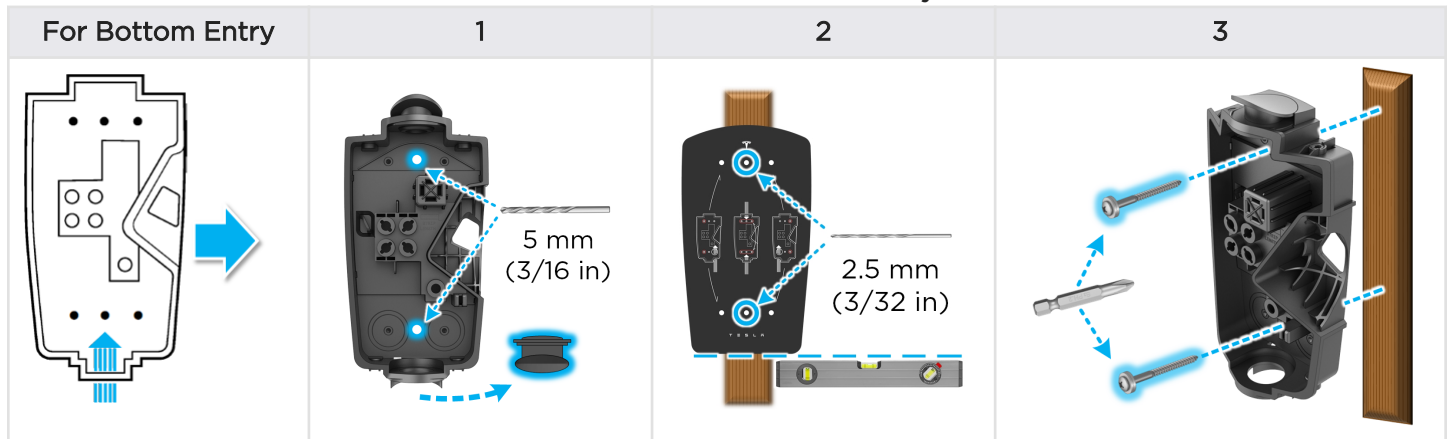



# INSTALLATION STEPS

Table 6. For Rear Left Wire Entry

| For Rear Left Entry | 1 | 2 | 3 |
|---------------------|---|---|---|
|                     |   |   |   |

Table 7. For Rear Right Wire Entry

| For Rear Right Entry | 1 | 2 | 3 |
|----------------------|---|---|---|
|                      |   |   |   |

**CAUTION:** Wall Connector is IP 55 rated and does not need caulking. Refrain from using any bonding, sealant, or adhesives as part of the Wall Connector installation. The provided screws have sealant washers which provide adequate sealing.

Installer is responsible for providing appropriate glands, fittings, and conduit to secure incoming power supply to Wall Connector wirebox. Top and bottom entry are 28 mm in diameter when sealing plug is removed. If needed, bottom entry can be expanded using a step bit. Do not expand top entry.





# INSTALLATION STEPS

## STEP 4: Sizing and Routing Conductor Wires

Pull excess wire first, then cut to length. Use a wire stripper to cut each conductor wire appropriately based on entry point and position. Attach the conduit/fittings and route each conductor wire into the wirebox so it lands in the correct terminal.

**NOTE:** Insulation wire colors may vary based on market.

### For Top Wire Entry

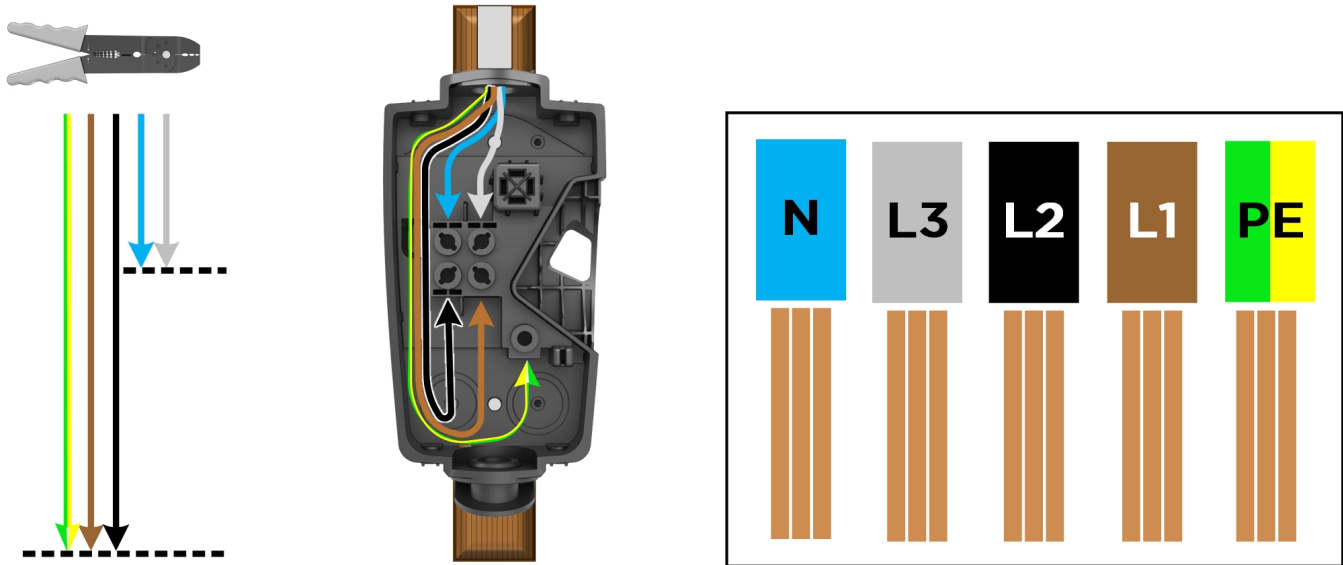

*Wire lengths/proportions shown are not to scale.*

### For Bottom (1), Rear Left (2), or Rear Right (3) Wire Entry

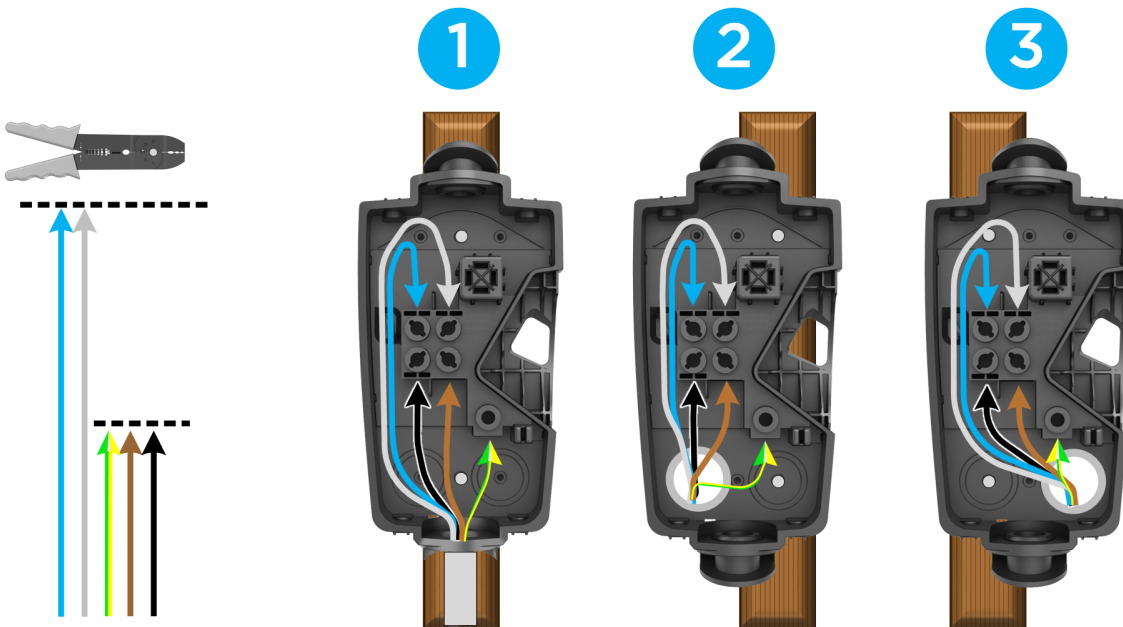

*Wire lengths/proportions shown are not to scale.*



## INSTALLATION STEPS

### STEP 5: Stripping and Securing Wires in Wirebox Terminals

1. Use a wire stripper to strip the ends of each wire to ~12 mm.

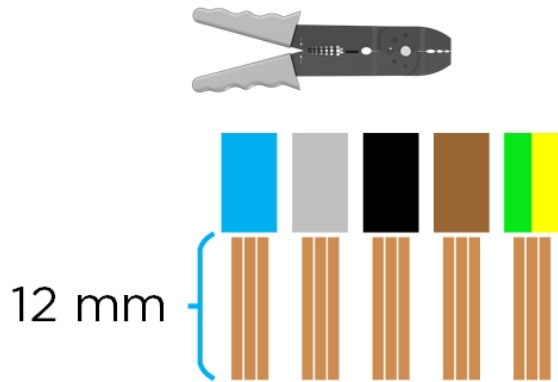

2. Insert each stripped wire into the correct terminal.
3. Use the included bit to torque each terminal to 5.6 Nm (50 lbf.in). Use zip ties to secure wires to service loop on the left side of the wirebox.

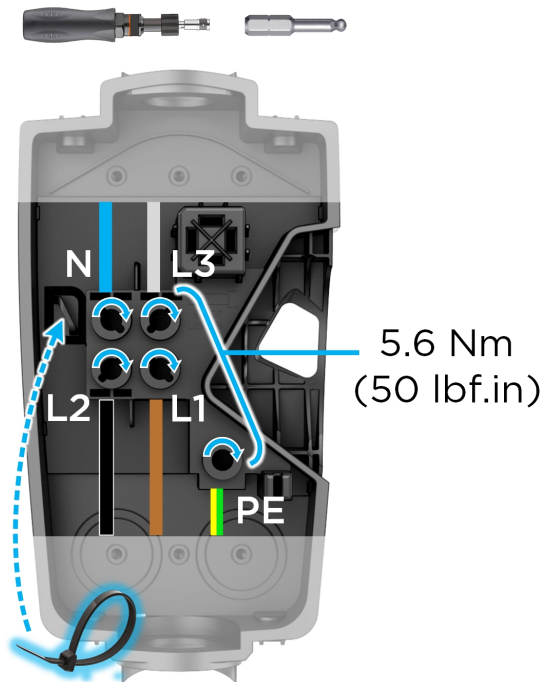

4. Use scissors to cut excess plastic off zip tie after securing in place. Ensure no wiring or other obstruction crosses over the terminal block screws before proceeding to the next step.

**NOTE:** Rear of Wall Connector has a sensor to monitor the terminal block, any obstruction from wiring or zip tie can interfere with Wall Connector operation.



# INSTALLATION STEPS

## STEP 6: Securing Main Unit to Wirebox

1. Attach the main unit to the wirebox.



2. Secure the main unit to the wirebox with the 4 included fasteners using the included bit. Use a bit driver to hand-tighten the fasteners.





## COMMISSIONING PROCEDURE

The commissioning process for Wall Connector enables easy configuration of circuit breaker size, Wi-Fi connectivity, and power sharing options. **Wall Connectors must be commissioned before first use.**

1. Turn on Wall Connector's corresponding circuit breaker to energize the unit.
2. Use a Wi-Fi-enabled device such as a smart phone to connect to the SSID Wi-Fi signal broadcasted by the Wall Connector. Joining the Wall Connector network can be done by scanning the sticker QR code on the Quickstart Guide cover page, or by manually selecting the network and typing in the WPA2 password (found on the sticker on the Quickstart Guide cover page).

**NOTE:** SSID will broadcast for 15 minutes.

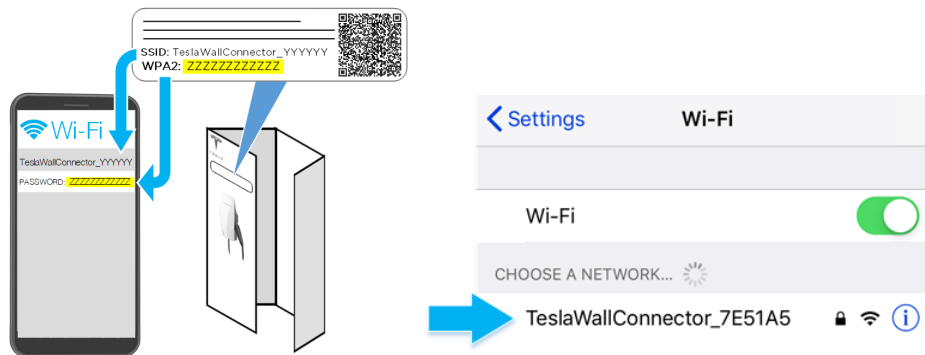

**NOTE:** If you are unable to connect to the Wall Connector SSID, turn off the cellular data function on your mobile device and try again.

**NOTE:** If the Wall Connector has not been commissioned, a solid yellow light will display on the front of the main unit to indicate that it is ready to be commissioned.

3. Scan the QR code below with the device that is connected to the Wall Connector to access the web browser commissioning interface. Alternatively, manually type the URL address (<http://192.168.92.1>) into the web browser.

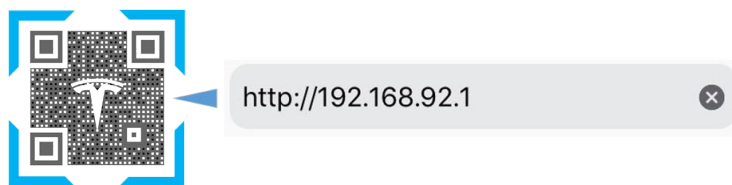

4. Follow the onscreen commissioning steps on the web browser.

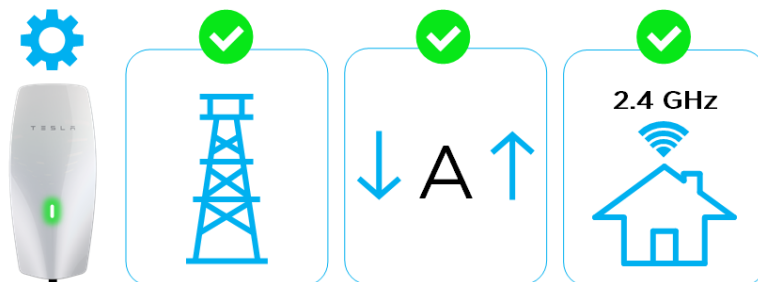

**NOTE:** To have the Wall Connector broadcast the SSID again, hold the button on the charge handle for 5 seconds or turn the circuit breaker off, then on again.



# WALL CONNECTOR LEDS

## Light Codes

### Startup

Once energized at the circuit breaker, every LED (seven total) on the faceplate will illuminate for one second.



### Other

| After startup, waiting for commissioning | Standby, waiting to plug in | Charging in progress  | SSID broadcasting, ready to commission | Waiting to charge, communicating with vehicle |
|--|-----------------------------|-----------------------|--|---|
| Solid yellow (green + red)               | Top green solid             | Every green streaming | Green pulsing                          | Blue solid                                    |
|  |                             |                       |  |   |

**NOTE:** Connect to Wall Connector App or see next table for all error codes. Contact [chargingsupportemea@tesla.com](mailto:chargingsupportemea@tesla.com) for any issues.



## Error Codes

| All red blink codes pause for one second, and then repeat. |  |   |
|--|--|---|
| Light Bar  | What It Means  | Details   |
| No Lights  | Power supply issue, charging disabled  | Verify that the power supply is turned on. If the issue persists, have an electrician remove the Wall Connector from the wirebox and confirm that voltage is present at the terminal block using a multimeter. Record measurements at terminals of wirebox.   |
| Solid yellow   | Wall Connector is ready to be commissioned                                     | See <a href="#">Commissioning Procedure on page 27</a> to commission the Wall Connector.  |
| Solid red  | Internal error, charging disabled  | Turn the circuit breaker off, wait 5 seconds, and turn it back on. If solid red light remains, document part number and serial number, then contact Tesla Energy.   |
| One (1) red blink  | Earth fault circuit interruption due to unsafe current path, charging disabled | Inspect the handle, cable, Wall Connector, and vehicle charge port for damage or signs of water ingress. Contact Tesla Energy if power supply has been checked and confirmed as okay by an electrician.   |
| Two (2) red blinks   | Earth assurance fault, high earth resistance detected, charging disabled       | Verify that the Wall Connector is properly connected to earth. The earth connection must be bonded in the upstream power supply for proper operation. Check all physical connections, including the wirebox terminals, electrical panel(s), and junction boxes. If connected to a transformer, contact the transformer's manufacturer for direction on how to bond the earth connection. If charging on a IT or TT grid, check ground monitor settings. |
| Three (3) red blinks                                       | High temperature detected; charging limited or disabled                        | Verify that Wall Connector is connected to Wi-Fi and updated with the latest available firmware for optimal temperature sensing functionality. Check the faceplate and cable handle for excessive warmth. Have an electrician remove the Wall Connector from the wirebox and verify that the conductors used are sized correctly and that the terminal block is torqued to specification.   |
| Four (4) red blinks  | Internet connection lost, online features disabled                             | Check for objects that could interfere with the area's Wi-Fi signal strength. Confirm that the local Wi-Fi router is operational. If the Wi-Fi password was changed recently, follow the commissioning process on your mobile device to update the Wi-Fi settings.  |
| Five (5) red blinks  | Power-sharing communication issue, charging reduced                            | Check for objects that could interfere with the area's Wi-Fi signal strength. Follow the commissioning process on your mobile device to re-link the Wall Connectors for power-sharing.  |
| Six (6) red blinks   | Overvoltage or poor grid quality detected, charging disabled                   | Connect to Wall Connector with commissioning process to view live voltage info. If the issue persists, have an electrician remove the Wall Connector from the wirebox and confirm that voltage readings are as expected at the terminal block using a multimeter. Record voltage readings at terminals.   |
| Seven (7) red blinks                                       | Vehicle overcurrent detected   | Reduce the vehicle's charge current setting. If the issue persists and the attached vehicle is manufactured by Tesla, record the vehicle's VIN and approximate time of the fault and contact Tesla. If the vehicle is not manufactured by Tesla, contact the vehicle's manufacturer.  |



## WARRANTY INFORMATION

Subject to the exclusions and limitations described below, the Charging Equipment Limited Warranty covers the refund, repair or replacement necessary to remedy any manufacturing defects in a Tesla manufactured and supplied Wall Connector that occur under normal personal use for a period of 48 months, or a period of 12 months for normal commercial use\*, and a Tesla manufactured and supplied Mobile Connector or charging adapter that occur under normal use for a period of 12 months, starting from the date of invoice to the customer for any charging equipment. Any Tesla manufactured and supplied connector or adapter included in the initial purchase and delivery of a Tesla vehicle by Tesla is covered under the Basic Vehicle Limited Warranty section of the New Vehicle Limited Warranty for 4 years or 50,000 miles (80,000 km), whichever comes first, subject to the terms and conditions of the New Vehicle Limited Warranty.

\*For warranty claims specific to Wall Connectors, “commercial use” means Wall Connectors used for purposes other than charging at a residential single family home for daily personal use, which includes, but is not limited to, charging at hotels, offices, parking lots and complexes (including apartment, condominiums and other multi-family or unit dwellings), and retail and other locations that allow (including by being listed online or publicly) for pay-for-use charging, or are located where users other than the owner could reasonably obtain access to the Wall Connector.

This Charging Equipment Limited Warranty does not cover any damage or malfunction directly or indirectly caused by, due to, or resulting from, normal wear or deterioration, abuse, misuse, negligence, accident, lack of or improper installation, use, maintenance, storage or transport, including, but not limited to, any of the following:

Failure to follow the instructions, operation, maintenance and warnings published in the documentation supplied with your Tesla connector or adapter;

External factors, including but not limited to, objects striking the Tesla connector or adapter, faulty or damaged electrical wiring or connections, external electrical faults, junction boxes, circuit breakers, receptacles or power outlets, the environment or an act of God, including, but not limited to, fire, earthquake, water, lightning and other environmental conditions;

General appearance or damage to paint, including chips, scratches, dents and cracks;

Failure to contact Tesla upon discovery of a defect covered by this Charging Equipment Limited Warranty;

Any repair, alteration or modification to the Tesla connector or adapter or any part, or the installation or use of any parts or accessories, made by a person or facility not authorized or certified to do so; and

Lack of or improper installation, repair or maintenance, including use of non-genuine Tesla accessories or parts.

Although Tesla does not require you to perform all maintenance, service or repairs at a Tesla Service Center or Tesla authorized repair facility, this Charging Equipment Limited Warranty may be voided, or coverage may be excluded, due to lack of or improper maintenance, service or repairs. Tesla Service Centers and Tesla authorized repair facilities have special training, expertise, tools and supplies with respect to Tesla connectors and adapters and, in certain cases, may employ the only persons, or be the only facilities authorized or certified to work on Tesla connectors and adapters. Tesla strongly recommends that you have all maintenance, service and repairs done at a Tesla Service Center or Tesla authorized repair facility in order to avoid voiding, or having coverage excluded under, this Charging Equipment Limited Warranty.



## LIMITS OF LIABILITY

This Charging Equipment Limited Warranty is the only express warranty made in connection with your Tesla connector or adapter. Implied and express warranties and conditions arising under applicable local laws, federal statute or otherwise, in law or in equity, if any, including, but not limited to, implied warranties and conditions of merchantability or merchantable quality, fitness for a particular purpose, durability, or those arising by a course of dealing or usage of trade, or any warranties against latent or hidden defects, are disclaimed to the fullest extent allowable by your local law, or limited in duration to the term of this Charging Equipment Limited Warranty. To the fullest extent allowable by your local law, the performance of necessary repairs and/or replacement of new, reconditioned, or remanufactured parts by Tesla for the covered defects is the exclusive remedy under this Charging Equipment Limited Warranty or any implied warranties. To the maximum extent permissible under your local law, liability is limited to the reasonable price for repair or replacement of the applicable Tesla connector or adapter, not to exceed the manufacturer's suggested retail price. Replacement may be made with parts of like kind and quality, including non-original manufacturer's parts, or reconditioned or remanufactured parts, as necessary. This Charging Equipment Limited Warranty covers only parts and factory labor necessary to repair but does not include any on-site labor costs related to un-installing, reinstalling or removing the repaired or replacement charging equipment. Parts repaired or replaced, including replacement of a Tesla connector or adapter, under this Charging Equipment Limited Warranty are covered only until the applicable warranty period of this Charging Equipment Limited Warranty ends, or as otherwise provided by applicable law. Under no circumstances will the original warranty period be extended as a result of your Tesla connector or adapter being repaired or replaced.

Tesla shall not be liable for any defects under this Charging Equipment Limited Warranty that exceed the fair market value of the applicable Tesla connector or adapter at the time immediately preceding the discovery of the defect. In addition, the sum of all benefits payable under this Charging Equipment Limited Warranty shall not exceed the price you paid for the applicable Tesla connector or adapter.

Tesla does not authorize any person or entity to create for it any other obligations or liability in connection with this Charging Equipment Limited Warranty. Subject to local laws and regulations, the decision of whether to repair or replace a part or to use a new, reconditioned or remanufactured part will be made by Tesla, in its sole discretion. Tesla may occasionally offer to pay some or all of the cost of certain repairs that are not covered by this Charging Equipment Limited Warranty, either for specific models or on an ad hoc, case-by-case basis. Tesla reserves the right to do the above at any time without incurring any obligation to make a similar payment to other Tesla charging equipment owners.

To the maximum extent permissible under local law, Tesla hereby disclaims any and all indirect, incidental, special and consequential damages arising out of, or relating to, the Tesla connector or adapter, including, but not limited to, transportation to and from a Tesla Authorized Service Center, loss of the Tesla connector or adapter, loss of vehicle value, loss of time, loss of income, loss of use, loss of personal or commercial property, inconvenience or aggravation, emotional distress or harm, commercial loss (including but not limited to lost profits or earnings), towing charges, bus fares, vehicle rental, service call charges, gasoline expenses, lodging expenses, damage to tow vehicle, and incidental charges such as telephone calls, facsimile transmissions, and mailing expenses.

The above limitations and exclusions shall apply whether your claim is in contract, tort (including negligence and gross negligence), breach of warranty or condition, misrepresentation (whether negligent or otherwise), or otherwise at law or in equity, even if Tesla is advised of the possibility of such damages or such damages are reasonably foreseeable.

Nothing in this Charging Equipment Limited Warranty shall exclude, or in any way limit, Tesla's liability for death or personal injury solely and directly caused by Tesla's negligence, or that of its employees, agents or sub-contractors (as applicable), fraud or fraudulent misrepresentation, or any other liability to the extent the same is proven in a court of competent jurisdiction in a final nonappealable judgment and may not be excluded or limited as a matter of local law.





## DISPUTE RESOLUTION

To the fullest extent allowed by local law, Tesla requires that you first provide written notification of any manufacturing defect within a reasonable time, and within the applicable coverage period specified in this Charging Equipment Limited Warranty, and allow Tesla an opportunity to make any needed repairs before submitting a dispute to our dispute settlement program (described below). Please send written notification on dispute resolution to the following address:

### **Vehicles registered in the Hong Kong:**

Tesla Motors HK Limited

Units 01-08, 11/F, KITEC, 1 Trademart Drive

Kowloon Bay, Kowloon, Hong Kong

Phone: +852 3974 0201

### **Vehicles registered in the Australia:**

Tesla Motors Australia, Pty Ltd

ACN 142 889 816

Level 14, 15 Blue Street

North Sydney NSW 2060, Australia

Phone: 1800 646 952

### **Vehicles registered in the New Zealand:**

Tesla New Zealand ULC

c/o Quigg Partners

Level 7, The Bayleys Building,

36 Brandon Street,

Wellington 6011, New Zealand

Phone: 0800 005 431

### **Vehicles registered in the EU:**

Burgemeester Stramanweg 122

1101EN Amsterdam, Netherlands

Charging Equipment Limited Warranty



## Vehicles registered in the UK:

Tesla Motors Ltd

Company number: 04384008

197 Horton Road, West Drayton

England, UB7 8JD

## Please include the following information:

- Tesla Part Number and Serial Number
- Your name and contact information
- Name and location of the Tesla Store and/or Tesla Service Center nearest to you
- Description of the defect
- History of the attempts you have made with Tesla to resolve the concern, or of any repairs or services that were not performed by Tesla
- In the event any disputes, differences, or controversies arise between you and Tesla related to this Charging Equipment Limited Warranty, Tesla will explore all possibilities for an amicable settlement

TESLA

Revision 1.0