



Panoramic Roof Creaking

Classification	Repair Bulletin	Section/Group	24 - Roof	Country/Region	All
Year	2012-2013	Model	Model S	Version	All

Bulletin Classification: *This repair bulletin provides instructions and guidelines for a noted condition or a customer concern. The information provided can address a broad range of known or perceived issues with the operation of Tesla vehicles. This bulletin might not be VIN-specific. These instructions assume knowledge of motor vehicle and high voltage electrical component repairs, and should only be executed by trained professionals. Tesla Motors assumes no liability for injury or property damage due to a failure to properly follow these instructions or repairs attempted by unqualified individuals.*

This Service Bulletin supersedes SB-13-24-004 R3, dated 03-Jan-14. Each content change is marked by a vertical line in the left margin. Discard the previous version and replace it with this one.

In R3, the steps in the Pre-Repair Work section were modified to accurately reflect changes to the panoramic roof. Some steps that were previously in the Pre-Repair Work section were moved to Section C - Install Shims Between the B-Pillar Crossmember and Roof Track.

This bulletin is related to SB-13-12-004, C-Pillar Brightwork Creaking. These two sources of creaking are often mistaken for each other.

Two of the repairs from earlier versions of this panoramic roof creaking bulletin were found to be ineffective and have been discontinued. The 5 approved repairs are:

- A. Install a piece of felt tape between the curtain airbag and the panoramic roof track.
- B. Use a rotary multi-tool (for example, Dremel tool) to grind sections of the B-Pillar crossmember.
- C. Install 4 shims between the panoramic roof tracks and B-Pillar crossmember.
- D. Loosen 4 spacer bolts in the panoramic roof track.
- E. Bend 2 J clips to prevent them from rubbing against the panoramic roof track.

Depending on a particular vehicle's VIN and whether or not the vehicle has previously been serviced for a customer complaint of panoramic roof creak, a vehicle might not need all 5 repairs. Upon customer complaint of a creaking noise from the roof, determine which procedures to perform by checking the "Bulletins and Services Due" section of ATTAC. If SB-13-24-001 is not present in the "Closed" bulletin section for the vehicle, perform all 5 sections. If SB-13-24-001 is present in the "Closed" bulletin section for the vehicle, note the correction code in the "Status" column. After performing the "Pre-Repair Work" section in this bulletin, perform the sections according to Table 1.

NOTE: Some sections are VIN-dependent or require additional inspection to determine whether to perform that section. Read the note at the beginning of each section to ensure that it applies to a particular vehicle.

Closed Correction Code in ATTAC	Action
No codes for SB-13-24-001	Perform sections A, B, C, D, and E.
S011211001 S011324001 S021324001 S031324001	Perform sections A, B, C, D, and E.
S041324001	Perform sections A and B only.
S051324001	Perform section A only.

Table 1

Required Part(s):	Part Number	Description	Quantity
	1018764-00-A	FELT TAPE, 25x150 (One box contains enough material for over 150 cars)	1
If necessary:	1025689-00-A	SHIM STOCK-PETG (508 X 1270 X 0.76 mm)) (McMaster Carr part 9513K75) (One sheet contains enough material to perform this bulletin on over 150 cars)	1
Shop supplies:			
Butyl Patch (Qty. 2, if necessary)			
Loctite 242 Threadlock or equivalent removable threadlocker			

These part numbers were current at the time of publication. Use the revisions listed or later, unless otherwise specified in the Parts Manual.

Correction Description	Correction	Time
SB-13-24-004 Not Applicable	S011324004	0.00
Install Felt Tape on Curtain Airbag Canisters Only	S021324004	0.40
Install Felt Tape and Grind B-Pillar Crossmember	S031324004	0.80
Install Felt Tape, Inspect/Grind Crossmember, Inspect/Install Shims, Inspect/Back out Spacer Bolts, Inspect/Move J Clips	S041324004	3.25
Vehicle Inspection Only; No Roof Creak Repairs Required	S051324004	1.10

Pre-Repair Work

1. Remove the moving glass panel (Refer to Service Manual procedure 24101002).
2. Remove the roof bow trim panel.

3. If equipped, remove the 3 screws and 2 trim buttons from the bottom side of the sunshade carrier (Figure 1). If the vehicle does not have a sunshade carrier, skip to step 5.

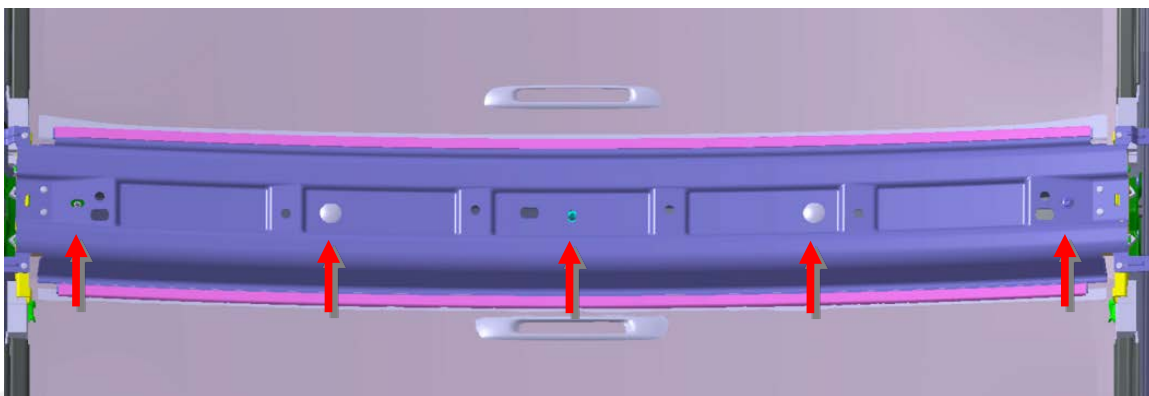

Figure 1

4. If equipped, lift both sides of the sunshade carrier (Figure 2). Remove the sunshade carrier by rotating one side towards the front of the car and the other side towards the rear of the car (Figure 3).



Figure 2



Figure 3

5. If the vehicle has a bolt that secures each side of the headliner to the B-Pillar crossmember, remove the 2 bolts (torque 3 Nm) (Figure 4)



Figure 4 (LH side shown)

6. Lower the headliner enough to expose the B-Pillar brackets. On most vehicles, the headliner is secured with Dual Lock (Figure 5).



Figure 5 (Dual Lock shown in blue)

NOTE: If the vehicle has butyl patches covering the B-Pillar brackets, remove the butyl patches. Use fender covers or shop towels to create more clearance and protect the headliner from staining (Figure 6). Thoroughly clean all residual adhesive.

⚠ CAUTION: To prevent staining, do not get any butyl adhesive on the interior headliner.

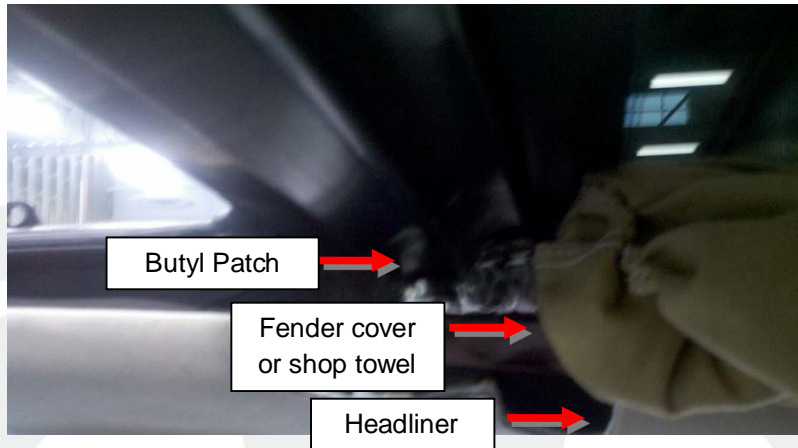

Figure 6

NOTE: After performing the required sections below, installation is reverse of removal with the following exception: If the car had butyl patches covering the B-Pillar brackets, replace the butyl patches.

⚠ CAUTION: To prevent staining, do not get any butyl adhesive on the interior headliner.

Section A - Install Felt Tape

NOTE: This section is not VIN-dependent and does not require additional inspection. Perform this section on all vehicles with panoramic roofs.

1. Disconnect 12V power (refer to Service Manual procedure 17010100).

NOTE: Perform steps 2-6 on both sides of the vehicle.

2. Loosen the forward bolt that secures the curtain airbag bracket to the body (torque 10 Nm), but do not fully remove it (Figures 7 and 8).

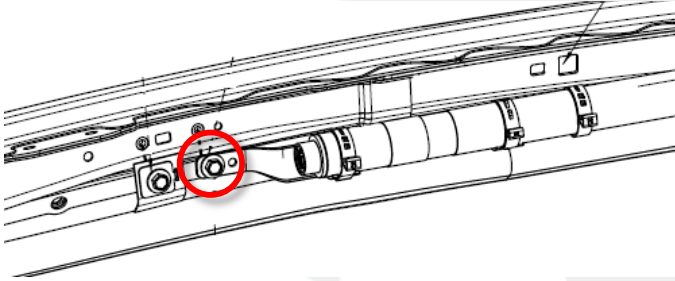

Figure 7



Figure 8

3. Use a pick or similar tool to pull out the latch on the curtain airbag harness connector (Figures 9 and 10). Disconnect the harness.

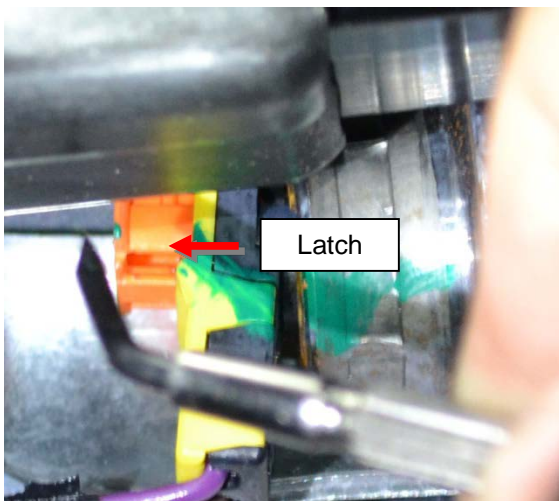

Figure 9

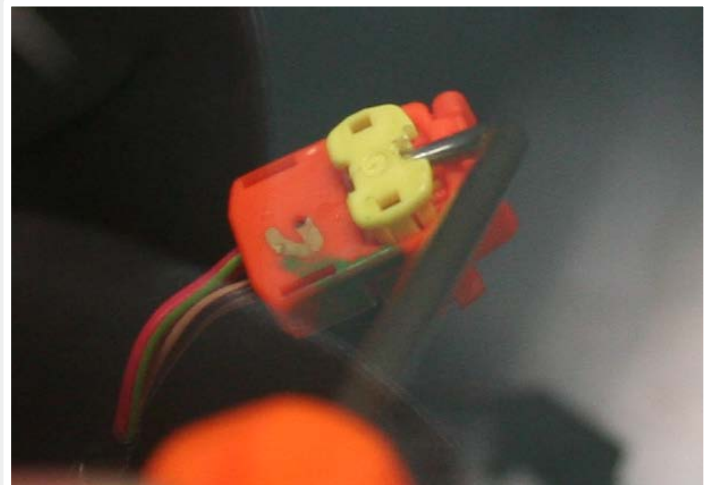

Figure 10 (Colors might be different)

4. Pull down very gently on the curtain airbag canister. Insert a piece of felt tape between the clip on the canister and the panoramic roof track (Figure 11). Ensure that the tape protrudes far enough to cover the round protrusion on the clip (Figure 12).

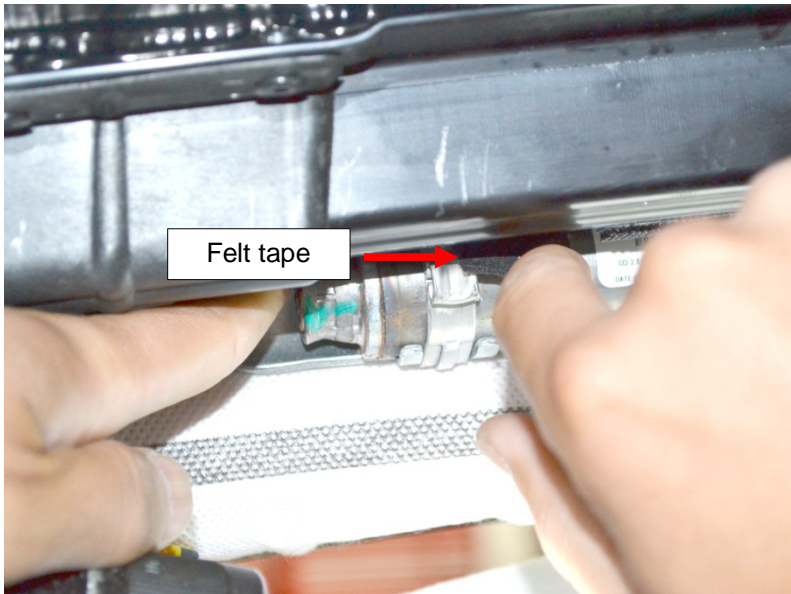

Figure 11

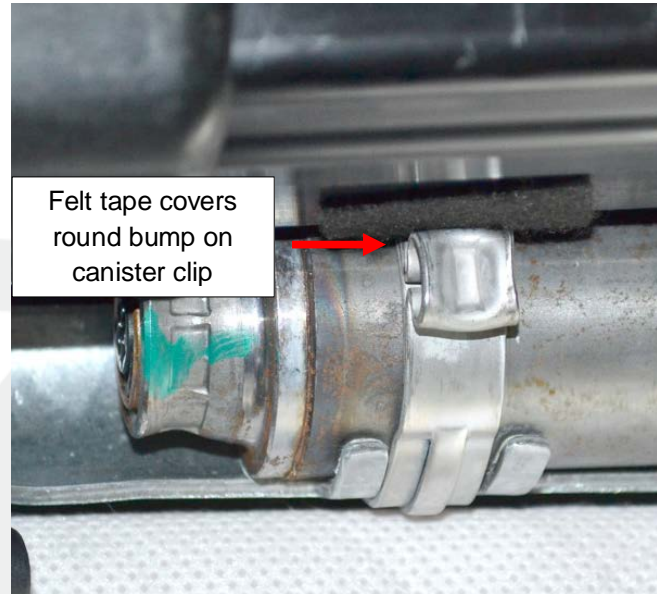
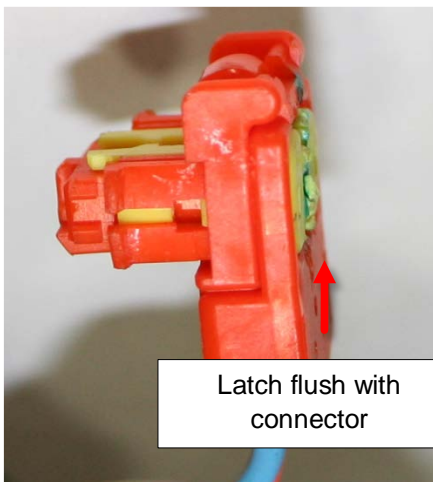

Figure 12

5. Reconnect the curtain airbag harness. After reconnecting the harness, press in on the latch so that it is flush with the face of the connector (Figures 13 and 14). Gently try to pull the connector out again without releasing the latch to ensure that the connection is tight.



✓ Correct
Figure 13



✗ Incorrect
Figure 14

6. Tighten the forward bolt that secures the curtain airbag bracket to the body (torque 10 Nm) (Figures 7 and 8).

7. Before returning the vehicle to the customer, connect 12V power and test drive the vehicle to ensure that there are no airbag warnings.

Section B - Grind B-Pillar Crossmember

NOTE: Before performing the procedure in this section, inspect the outboard edges on the front ridge of the B-Pillar crossmember. Do not perform this procedure if:

- The edges of the ridge appear to have been ground down or are noticeably lower than the rest of the ridge (Figure 15).
- There are bolt holes in line with the ridge (Figure 16).

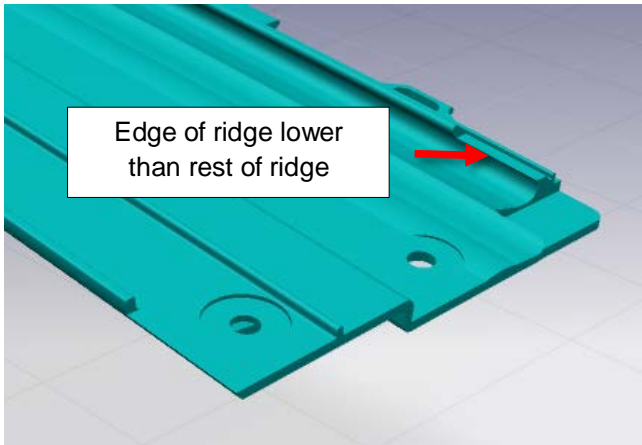

Figure 15 (RH side shown)

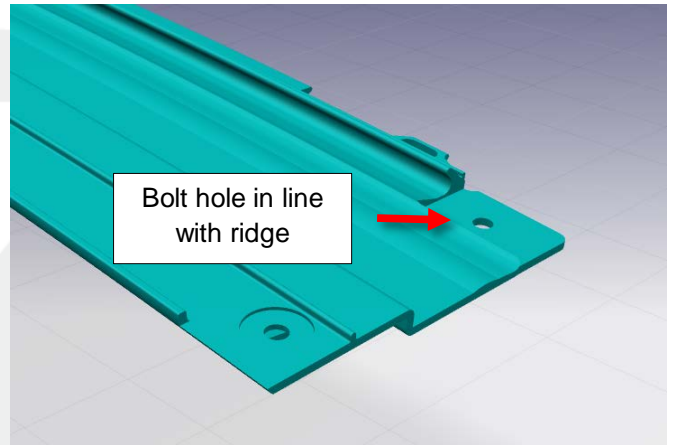

Figure 16 (RH side shown)

NOTE: Perform steps 1-4 on both sides of the vehicle.

1. On the ridge at the front of the B-Pillar crossmember, draw a mark 15 mm inward from the edge (Figure 17).

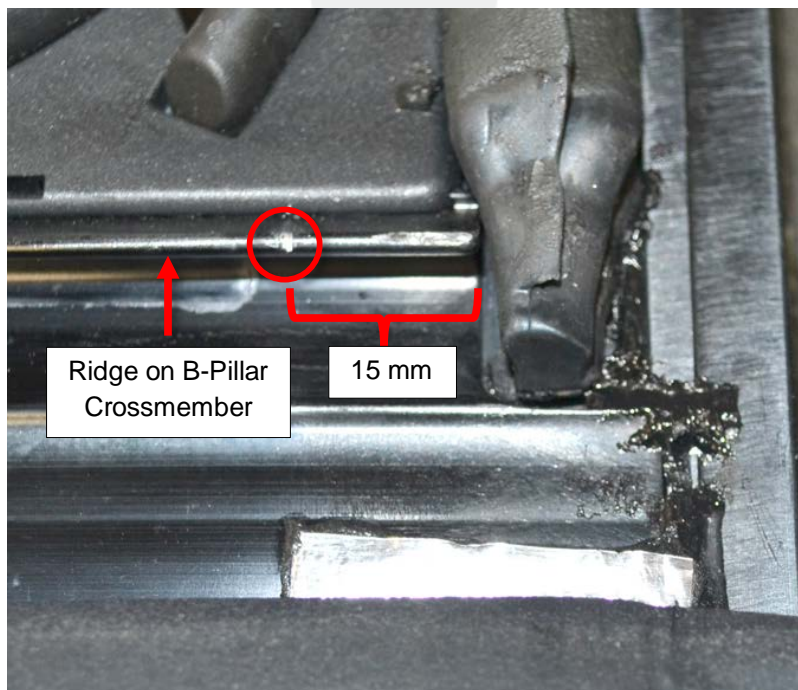

Figure 17

2. Cover the panoramic roof track and side applique with shop towels (Figure 18). This prevents debris from entering the panoramic roof track or scratching the body when using the rotary multi-tool in a later step.



Figure 18

3. Use a rotary multi-tool (for example, Dremel tool) with a deburring or grinding bit to grind down 2 mm of the 15 mm section on the ridge of the B-Pillar crossmember that was marked in step 1 (Figure 19).

⚠ WARNING: Wear protective eyewear and hearing protection when using the rotary multi-tool.



Figure 19

4. Use a file to remove any sharp edges on the areas that were ground in step 3.

5. Use a vacuum to clean up any metal shavings.

Section C - Install Shims Between the B-Pillar Crossmember and Roof Track

NOTE: Only perform the procedure in this section on founders' series vehicles, North American signature series vehicles, release candidate (RC) vehicles, and production VINs prior to P09800. Before beginning this section, check the area around the forward screw that secures the B-pillar crossmember and panoramic roof tracks. If no orange shim stock is present, perform this section. If shim stock is present but only covers the rear divot in the roof track (Figures 20 and 21), remove the shim stock and perform steps 4-12 of this section. If the shim extends to the forward divot in the roof track (Figures 22 and 23), do not perform this section.



Figure 20 (LH side shown)



Figure 21 (LH side shown)

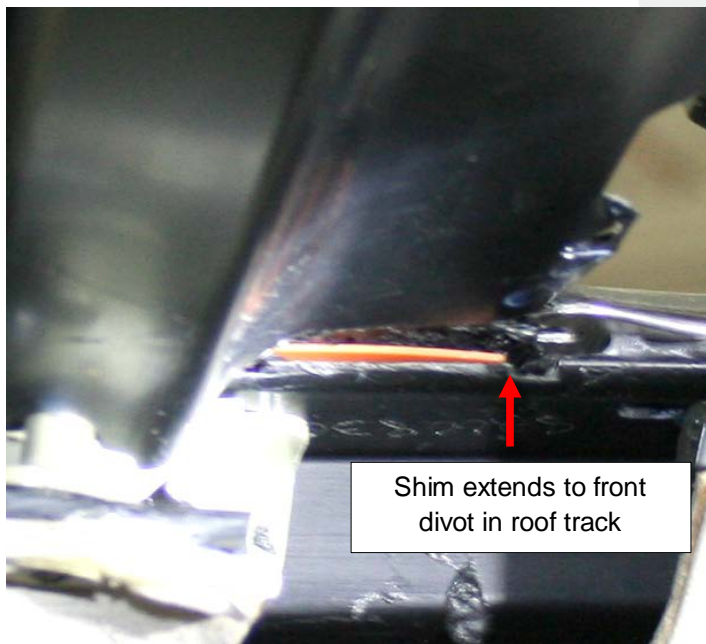

Figure 22 (LH side shown)

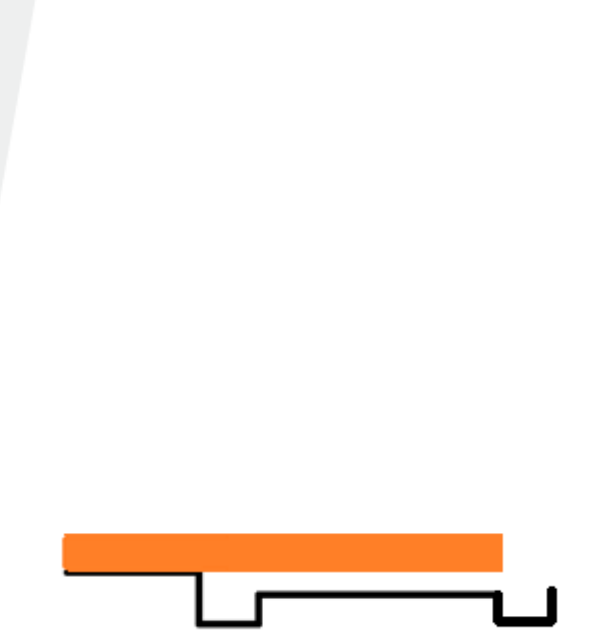

Figure 23 (LH side shown)

1. Cut 2 pieces of shim stock 28 mm x 18 mm. Place a drill mark 7 mm from one of the short edges and centered 9 mm from each long edge on each shim (Figure 24). Drill the marked area with a 13/64 in bit on each shim (Figure 25).

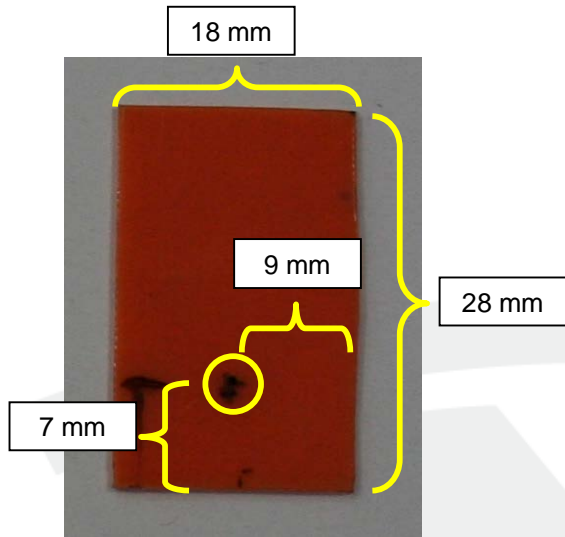

Figure 24

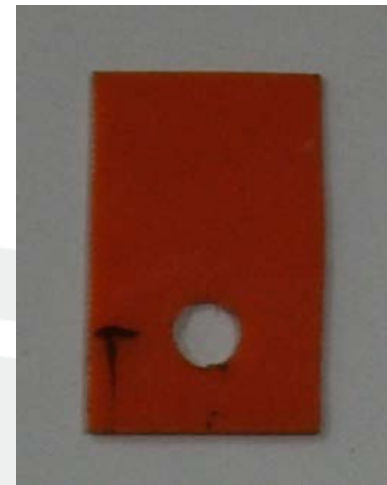

Figure 25

2. Extend the hole on both shims to the closest short (18 mm) edge (Figure 26).

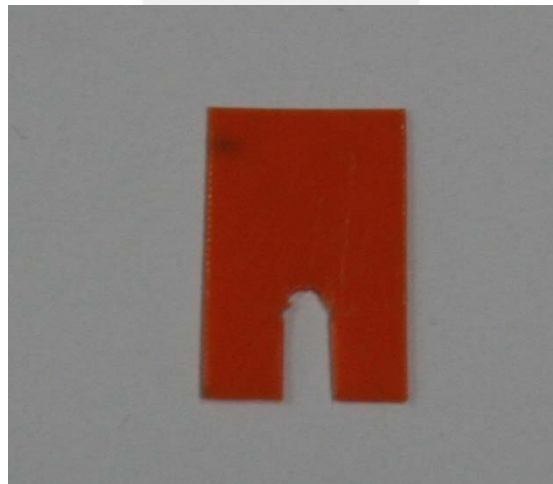

Figure 26

3. Remove any leftover material from the holes in the shims (Figure 27).



Figure 27

4. Cut 2 pieces of shim stock 50 mm x 25 mm. On one of the short (25 mm) edges, cut off the corners 5 mm inward from each side (Figure 28).

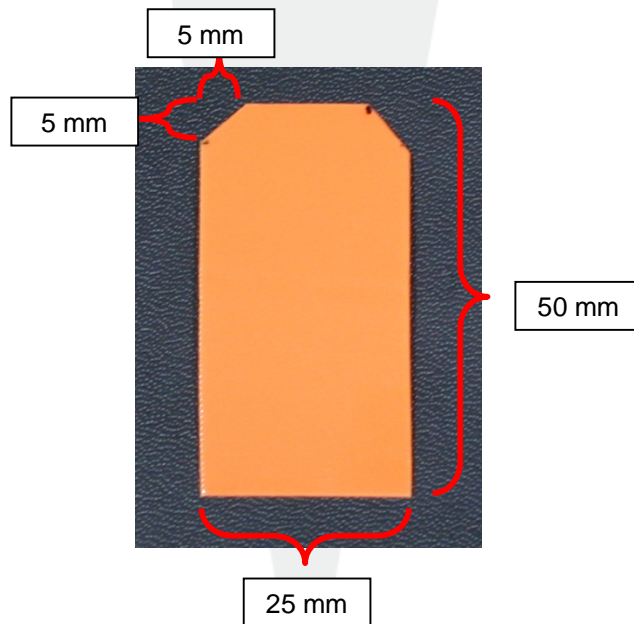

Figure 28

5. From the top of both sides of the vehicle, remove the front screw (torque 3 Nm) that secures the B-Pillar bracket, panoramic roof track, and B-Pillar crossmember (Figure 29).



Figure 29 (LH side shown)

6. Remove the 3 screws (torque 5 Nm) from each B-Pillar bracket (Figure 30).

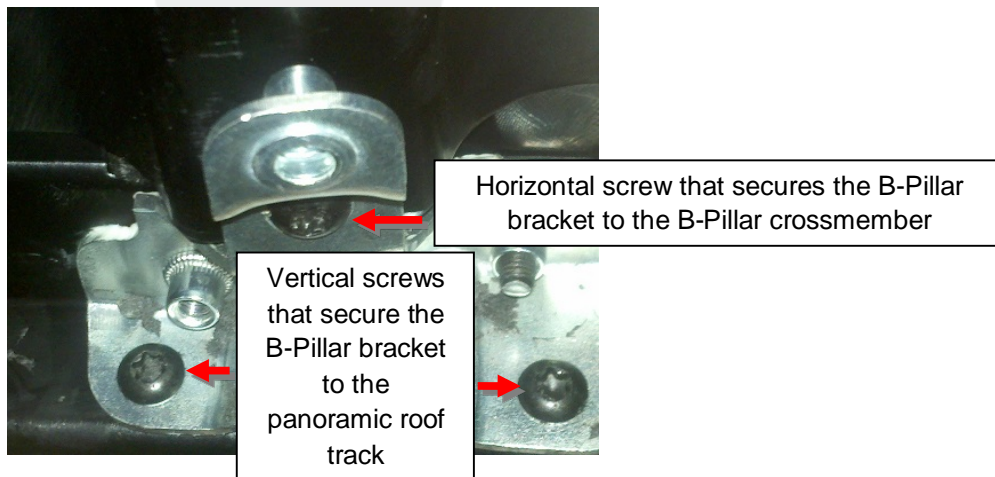

Figure 30

NOTE: The goal of steps 7-14 is to position the 50 mm x 25 mm shims between the B-pillar crossmember and the panoramic roof tracks (Figure 31).

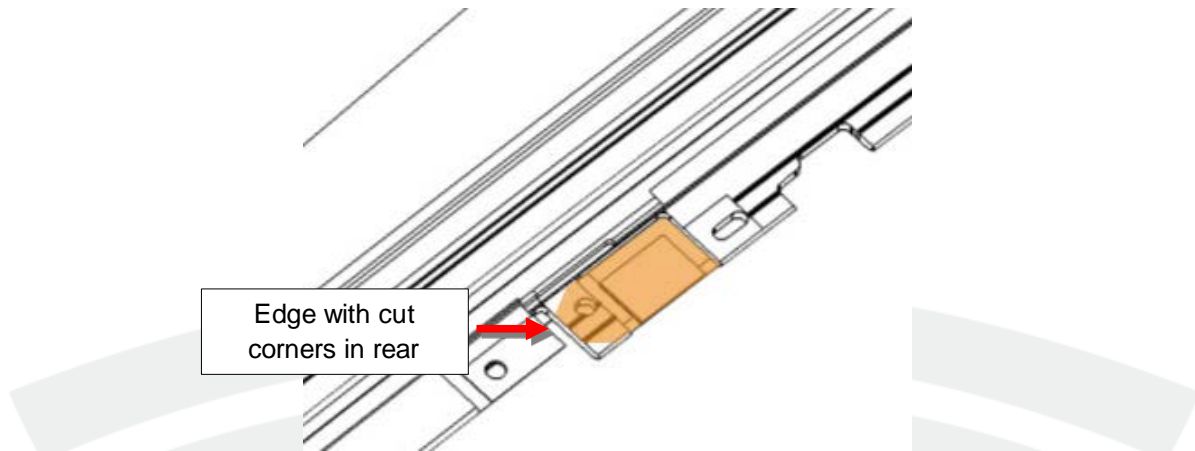

Figure 31 (LH side shown)

7. Peel back the track seal on each side of the vehicle (Figure 32).



Figure 32 (LH side shown)

8. Use a screwdriver to gently pry apart the B-Pillar crossmember from the panoramic roof track (Figure 33).

NOTE: Depending on the vehicle, it might be helpful to continue to apply leverage to the screwdriver through step 14. An assistant can be helpful with this.

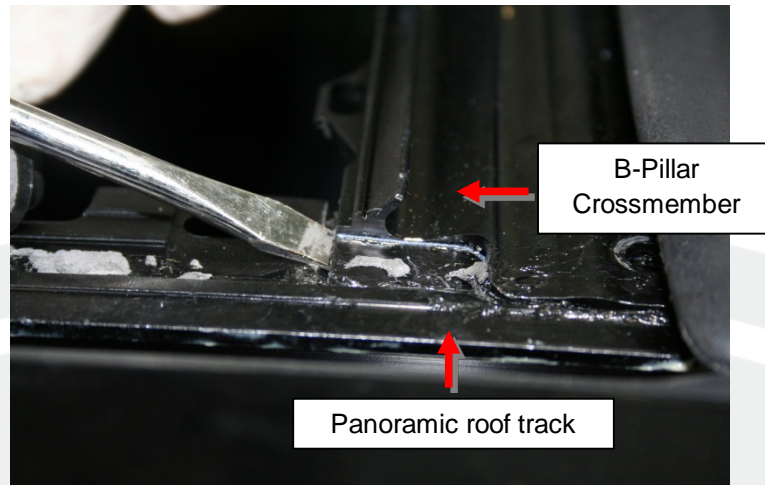

Figure 33 (LH side shown)

9. Insert the edge of the shim that has the cut corners between the B-Pillar crossmember and the panoramic roof track (Figure 34).

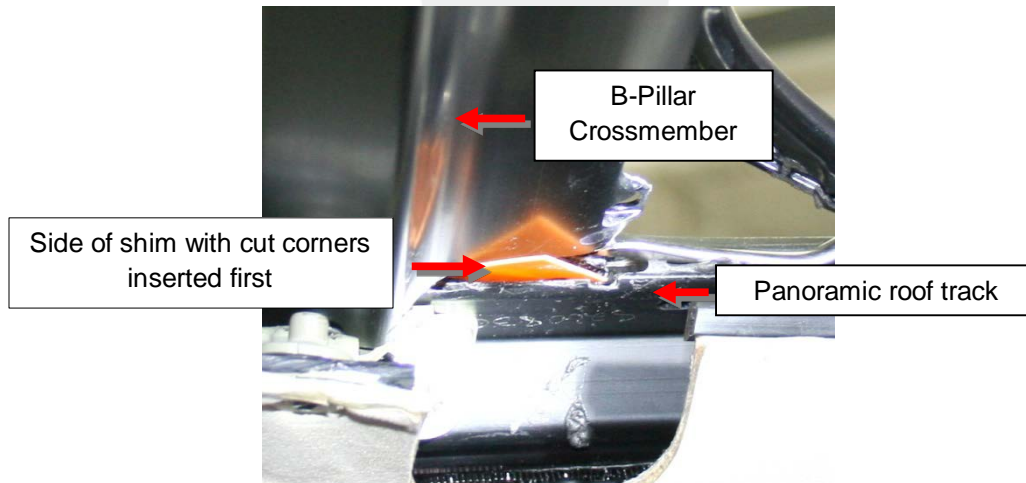

Figure 34 (LH side shown)

10. Push the shim outboard and rearward until it entirely blocks the hole for the front screw that secures the B-Pillar bracket, panoramic roof track, and B-Pillar crossmember (Figure 35).

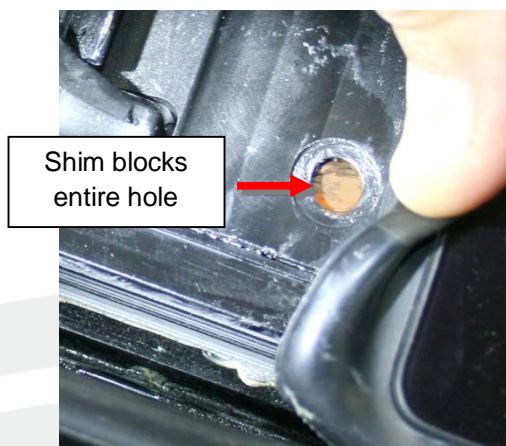

Figure 35 (View of left front hole from above)

11. Rotate the shim into position lengthwise along the panoramic roof track (Figure 36). Use a pick to push it as far outboard as possible.

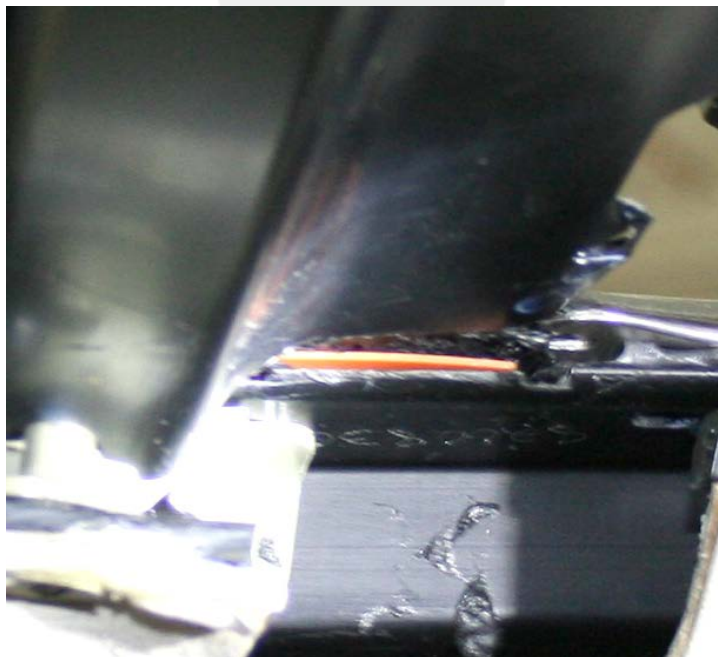

Figure 36 (LH side shown)

12. Peel back the fixed glass seal and secure it in place with duct tape. Ensure that the shim still blocks the entire hole for the front screw that secures the B-Pillar bracket, panoramic roof track, and B-Pillar crossmember (Figure 37).

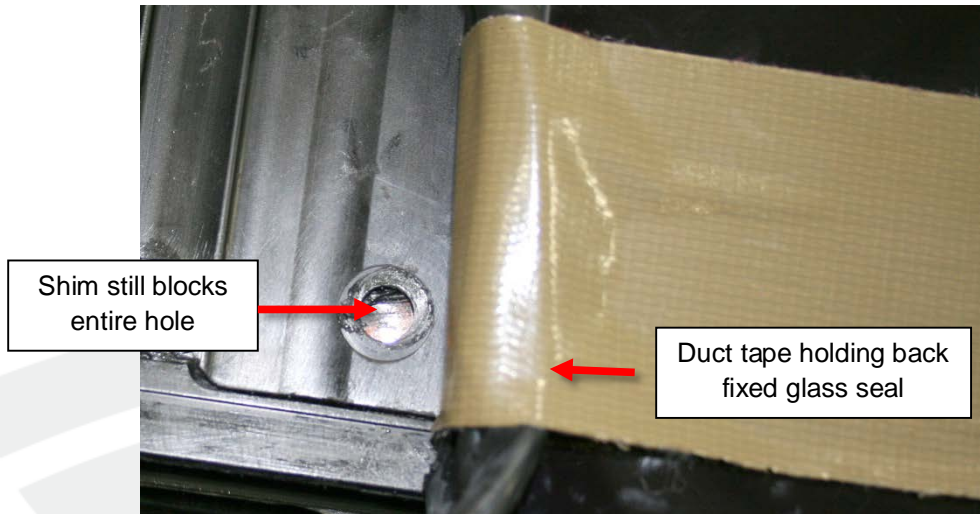

Figure 37

13. Using a 7/32 in (5.6 mm) drill bit, drill a hole in the shim stock (Figure 38).

⚠ CAUTION: The drill penetrates the shim stock very easily. Hold the drill with both hands and drill slowly in order to pull the drill out as soon as the hole is made. Do not drill through the panoramic roof track.



Figure 38

14. Place the screw through the front hole, but do not tighten it. This holds the front shims in place while installing the rear shims in a later step.

NOTE: The goal of steps 15-16 is to position the 28 mm x 18 mm shims between the B-pillar crossmember and the panoramic roof. The notch in each shim surrounds the rear hole for the bolt that secures the B-Pillar bracket, panoramic roof track, and B-Pillar crossmember (Figure 39).

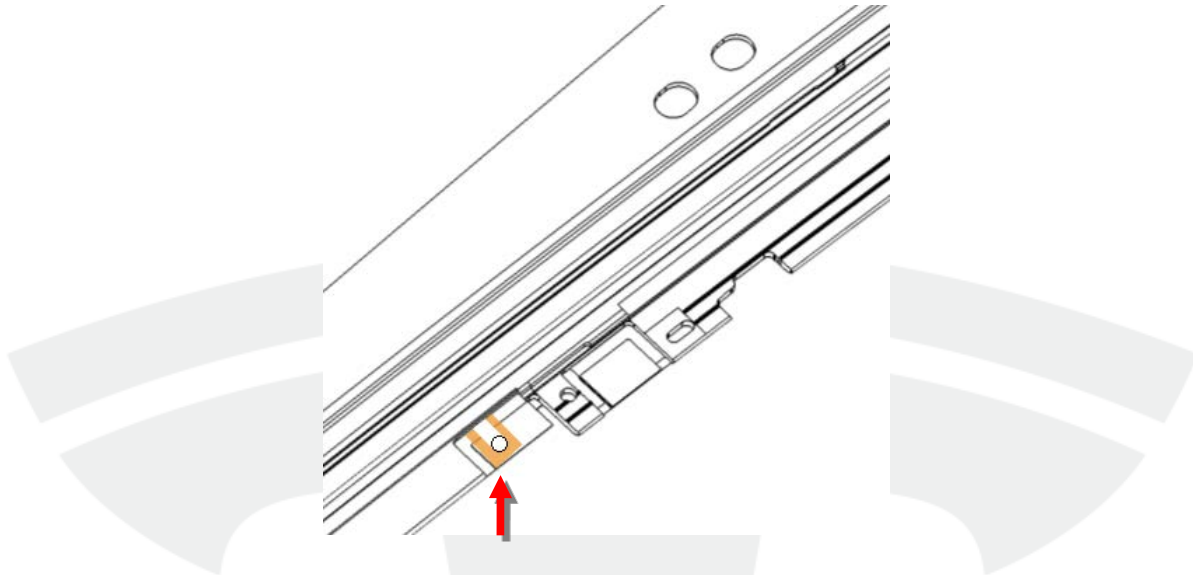

Figure 39 (LH side shown)

15. In order to provide a small amount of clearance between the B-Pillar crossmember and the panoramic roof track, use vise grips from inside the vehicle to loosen the rear screw by 2 threads (Figure 40).

NOTE: Although this step damages the lower threads, take as much care as possible when loosening the screw.



Figure 40 (LH side shown)

16. While pushing up on the B-Pillar crossmember with one hand, wedge the shim around the rear screw. Use a pick or similar tool to push the shim towards the outside of the vehicle until the notch is no longer visible (Figure 41).

NOTE: The rear shims cannot be inserted as far outboard as the forward shims; approximately 14 mm of shim remains exposed (Figure 42).



Figure 41 (LH side shown)



Figure 42 (LH side shown)

Section D - Loosen 4 Spacer Bolts in the Panoramic Roof Track

NOTE: Only perform the procedure in this section on founders' series vehicles, North American signature series vehicles, release candidate (RC) vehicles, and production VINs prior to P09800.

NOTE: Perform this procedure on both sides of the vehicle.

1. Unscrew the spacer bolt that is behind the side curtain airbag bolt as much as possible without completely removing it (Figures 43 and 44). The screw can back out approximately 12 mm and remain threaded in place.

⚠ CAUTION: If the bolts cannot be removed with normal force, it is possible that this section has already been performed. Do not continue this section.

⚠ CAUTION: Do not damage the side curtain airbag tether.

NOTE: If the screw is accidentally removed and falls into the headliner, use a magnet to retrieve it.

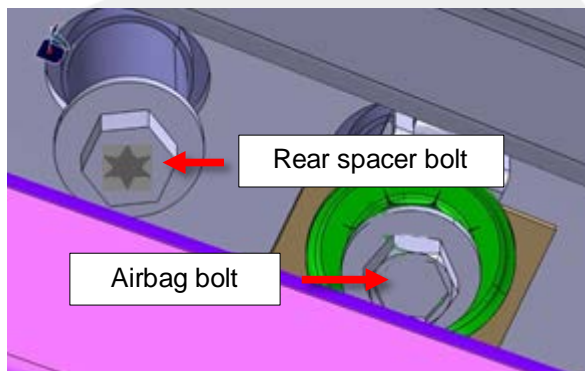

Figure 43 (LH side shown)

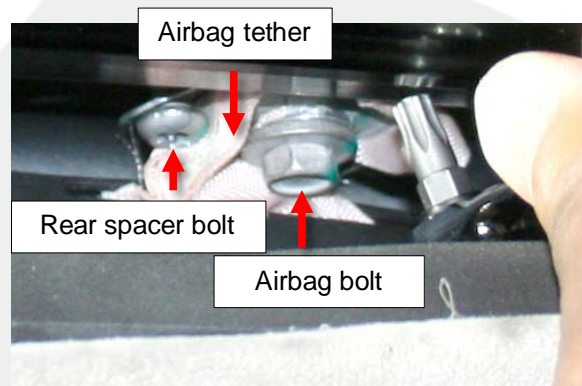

Figure 44 (LH side shown)

2. Use a cotton swab or similar item to apply Loctite 242 Threadlock to all exposed spacer bolt threads (Figure 45).

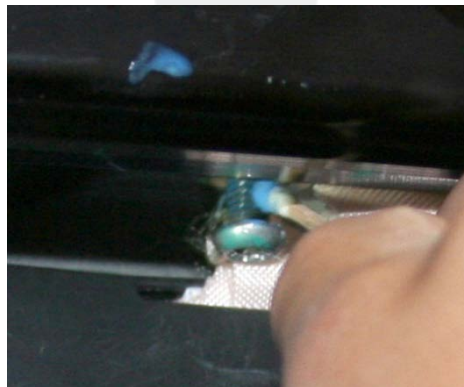

Figure 45 (LH side shown)

3. Thread the spacer back into place, applying just enough torque to seat the head of the bolt. Do not tighten the bolt any further.

⚠ CAUTION: Do not allow the airbag tether to come between the spacer bolt and the panoramic roof track.

4. Repeat steps 1-3 for the spacer that is in front of the airbag bolt.

Section E - Bend J Clips on Airbag Bolt

NOTE: Only perform the procedure in this section on founders' series vehicles, North American signature series vehicles, release candidate (RC) vehicles, and production VINs prior to P09800.

NOTE: Perform this procedure on both sides of the vehicle.

1. Use a mirror to locate the J clip on the airbag bolt above the body (Figures 46 and 47).



Figure 46 (LH side shown)

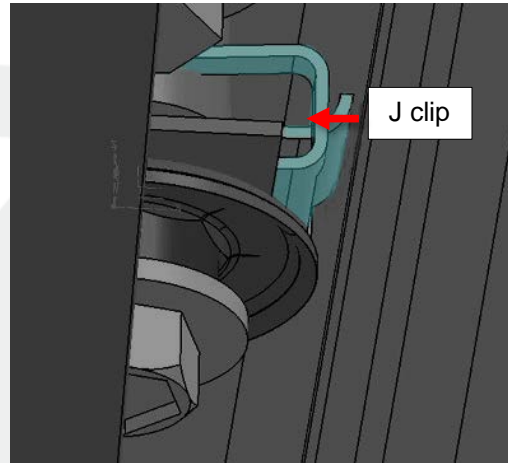

Figure 47 (LH side shown)

2. Ensure that the J clip does not touch the panoramic roof track (Figure 48). If it does, slightly loosen the airbag bolt (torque 10 Nm) and use a suitable tool, such as an elongated pick (Figure 49), to push the J clip outboard. Hold the J clip in place while retightening the airbag bolt.

! CAUTION: Do not damage the curtain airbag tether.

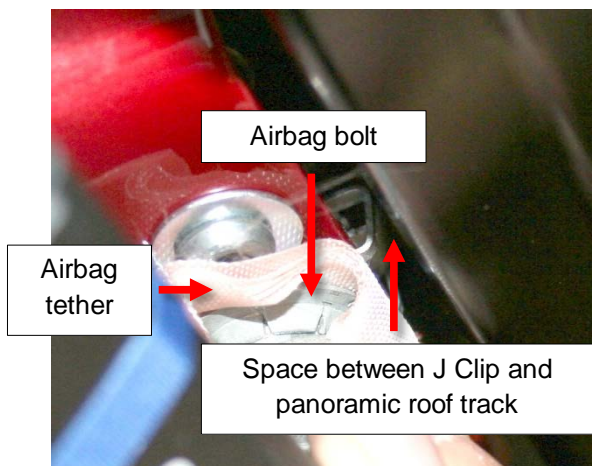

Figure 48 (LH side shown)



Figure 49

Affected VIN(s) 5YJSA1DP8CFF00001 - 5YJSA1DP0CFF00042
5YJSA1AP7CFR00102 - 5YJSA1AP9CFR00117
5YJSA1DP7CFP01255 - 5YJSA1CP9CFP01999
5YJSA1CN9CFP02200 - 5YJSA1AG4DFP11800
5YJSA1CN7DFP12046 - 5YJSA2DP3DFP12292
5YJSA1CP8DFP12574 - 5YJSA2DP7DFP14174
5YJSA2DP1DFP14221 - 5YJSA1CP5DFP14749
5YJSA1DP4DFP14773 - 5YJSA1DP9DFP14896
5YJSA2CN2DFP14907 - 5YJSA2CPXDFP15174
5YJSA2DN3DFP15188 - 5YJSA1CP3DFP17150
5YJSA1CG8DFP17161 - 5YJSA2CNXDFP18381
5YJSA1CN1DFP18392 - 5YJSA2DN8DFP18491
5YJSA2DP7DFP18502 - 5YJSA2DN0DFP18534
5YJSA2DP5DFP18580
5YJSA1CP9DFP18593
5YJSA1CN3DFP18605 - 5YJSA1CN0DFP18657
5YJSA2DP0DFP18678 - 5YJSA2CN5DFP18756
5YJSA1DP9DFP18785 - 5YJSA2DP2DFP19055
5YJSA2DN2DFP19068
5YJSA2DN3DFP19080
5YJSA2DP6DFP19107
5YJSA2CN2DFP19122
5YJSA2DN8DFP19141 - 5YJSA2DP9DFP19148
5YJSA2CN7DFP19164
5YJSA2DN3DFP19192
5YJSA2CP4DFP19205
5YJSA2DP2DFP19234 - 5YJSA2DN8DFP19236
5YJSA2DP5DFP19261
5YJSA2CN6DFP19267
5YJSA2DN5DFP19291
5YJSA2DP7DFP19309
5YJSA2DP6DFP19320
5YJSA2CN0DFP19359 - 5YJSA2DN0DFP19375
5YJSA2DP2DFP19413 - 5YJSA2DP1DFP19435
5YJSA1DP7DFP19465 - 5YJSA2DP5DFP20118
5YJSA2CN1DFP20133 - 5YJSA1DN4DFP20720
5YJSA1CP3DFP20744 - 5YJSA2CN2DFP21193
5YJSA1DP6DFP21207
5YJSA1CNXDFP21212
5YJSA2CN4DFP21230 - 5YJSA2DN3DFP21234
5YJSA2CNXDFP21247 - 5YJSA1CN3DFP21259
5YJSA1CN9DFP21282
5YJSA2CNXDFP21295
5YJSA2DN9DFP21335
5YJSA1DN5DFP21357 - 5YJSA2DN8DFP21360
5YJSA1DN9DFP21376 - 5YJSA2DN3DFP21377
5YJSA1CN7DFP21393 - 5YJSA2DN2DFP21399
5YJSA1DP6DFP21420 - 5YJSA1CG4DFP21935
5YJSA1DP0DFP21946 - 5YJSA1CG7DFP22044
5YJSA1CN9DFP22075 - 5YJSA1CN0DFP22076
5YJSA1CN6DFP22275
5YJSA1CNXDFP22294 - 5YJSA1CN0DFP22434
5YJSA1CN5DFP22445 - 5YJSA1DP3DFP22475
5YJSA2DP4DFP22491 - 5YJSA1CN5DFP22543
5YJSA1DN1DFP22554 - 5YJSA1CG7DFP22559
5YJSA1CN8DFP22570 - 5YJSA1CPXDFP22586
5YJSA1CN4DFP22615 - 5YJSA1CP9DFP22630
5YJSA1CN8DFP22648 - 5YJSA2CN6DFP22654
5YJSA1CP8DFP22666 - 5YJSA1CP1DFP22685
5YJSA2DP0DFP22696

5YJSA2CN7DFP22856
5YJSA1CP1DFP22962 - 5YJSA2DN9DFP22999
5YJSA1CN9DFP23016 - 5YJSA1DP5DFP23028
5YJSA1CNXDFP23073
5YJSA1CN4DFP23103 - 5YJSA1DP9DFP23114
5YJSA1DP2DFP23133
5YJSA1CG0DFP23150 - 5YJSA1CN4DFP23151
5YJSA2DP4DFP23172
5YJSA1CN7DFP23595
5YJSA1DN0DFP23615 - 5YJSA2DN9DFP23621
5YJSA1DP5CFS00266 - 5YJSA1DPXCFS00277
5YJSA1DP6CFS00292 - 5YJSA1DPXCFS00294
5YJSA1DN0CFS00352
5YJSA1DN2CFS00367 - 5YJSA1DN4CFS00368
5YJSA1DP8CFS00407 - 5YJSA1DP9CFS00416
5YJSA1DP7CFS00429 - 5YJSA1DPXCFS00439
5YJSA1DNXCFS00455 - 5YJSA1DN0CFS00478
5YJSA1DP3CFS00489 - 5YJSA1DP0CFS00496
5YJSA1DP3CFS00511
5YJSA1DPXCFS00523 - 5YJSA1DP0CFS01096
5YJSA1DP1CFS02001 - 5YJSA1DP9CFS02120
5YJSA1DP3DFS07475
5YJSA2DP0DFS13045 - 5YJSA2DP8DFS13049
5YJSA2DN7DFS13879 - 5YJSA2DP1DFS13880
5YJSA2DP1DFS14169 - 5YJSA2DP7DFS14323
5YJSA2DP5DFS14336 - 5YJSA2DP5DFS14367
5YJSA2DP1DFS14382
5YJSA2DP3DFS14416
5YJSA2DPXDFS14428
5YJSA2DP0DFS14468
5YJSA2DP4DFS14490
5YJSA2DN9DFS14497
5YJSA2DP1DFS14513
5YJSA2DP7DFS14547
5YJSA1DP8DFS14700
5YJSA2DP4DFS14750 - 5YJSA2DP3DFS14772
5YJSA2DP9DFS14811
5YJSA2DP8DFS14816
5YJSA2DP9DFS14887 - 5YJSA2DP5DFS15003
5YJSA2DP8DFS15027
5YJSA2DP8DFS15044
5YJSA2DP0DFS15054
5YJSA2DP2DFS15069
5YJSA2DP6DFS15074
5YJSA2DP8DFS15139 - 5YJSA2DP5DFS15230
5YJSA2DN1DFS15241 - 5YJSA2DN3DFS15242
5YJSA2DP6DFS15253 - 5YJSA2DP7DFS15262
5YJSA2DN0DFS15280 - 5YJSA2DPXDFS15384
5YJSA2DP1DFS15533
5YJSA2DP5DFS15549 - 5YJSA2DP6DFS15558
5YJSA2DP1DFS15595 - 5YJSA2DP1DFS15600
5YJSA2DP0DFS15863 - 5YJSA2DP0DFS16026
5YJSA2DP6DFS16192 - 5YJSA2DP8DFS16193
5YJSA2DP8DFS16274
5YJSA2DN9DFS16508
5YJSA2DN7DFS16555
5YJSA2DP4DFS16689 - 5YJSA2DP1DFS16830
5YJSA2DP9DFS16946
5YJSA2DP8DFS16985 - 5YJSA2DP5DFS16989
5YJSA2DP6DFS17178 - 5YJSA2DP6DFS17195

5YJSA2DP7DFS17898 - 5YJSA2DP0DFS17922
5YJSA2DP7DFS17934 - 5YJSA2DN3DFS17959
5YJSA2DN1DFS18155
5YJSA2DN7DFS18239
5YJSA2DN8DFS18329
5YJSA2DPXDFS18902 - 5YJSA2DP0DFS18911
5YJSA2DP0DFS21470
5YJSA1DP6CFP01201 - 5YJSA1DP5CFP01254
5YJSA1DP2CFS00001 - 5YJSA1DP4CFS00291
5YJSA1DN0CFS00299 - 5YJSA1DN7CFS00381
5YJSA1DP2CFS00385 - 5YJSA1DP2CFS00726
5YJSA1DP6CFS00728 - 5YJSA1DP6CFS00731
5YJSA1DN1CFS00733 - 5YJSA1DN5CFS00735
5YJSA1DP7CFS00737 - 5YJSA1DP7CFS00799

NOTE: This is a simplified summary of the affected VIN list. Refer to the VIN/Bulletin Tracker or Customer/Vehicle profile to determine applicability of this bulletin for a particular vehicle.

For feedback on the accuracy of this document, email ServiceBulletinFeedback@teslamotors.com.