



2nd Generation Premium Center Console Retrofit

Classification	Parts and Accessories Bulletin	Section/Group	15 - Interior Trim	Country/Region	All
Year	2012-2016	Model	Model S	Version	All

Bulletin Classification: This bulletin provides instructions and guidelines for a vehicle procedure that is not the result of a defect. This bulletin might not be VIN-specific. These instructions assume knowledge of motor vehicle and high voltage electrical component repairs, and should only be executed by trained professionals. Tesla Motors assumes no liability for injury or property damage due to a failure to properly follow these instructions or repairs attempted by unqualified individuals.

This Service Bulletin supersedes SB-16-15-001, dated 11-Mar-16. Each content change is marked by a vertical line in the left margin. Discard the previous version and replace it with this one

The 2nd generation premium center console is now available. This is a customer pay retrofit. Use the following job lines when creating the Repair Order:

NOTE: Refer to SB-13-15-014 for instructions on how to retrofit the 1st generation premium center console.

Job Line 1:

Symptom: Retrofit Premium Center Console

Correction Code: 7100001, no labor performed
 Part: 1075270-00-A, MS PREMIUM CONSOLE SERVICE

Pay Type: Customer Pay

Job Line 2:

Symptom: Additional items for Premium Center Console Retrofit

Correction Code: S021615001
 Part: Refer to the Required Parts table

Pay Type: Customer Pre-Paid

Correction Description	Correction	Time
SB-16-15-001 Not Applicable	S011615001	0.00
Retrofit 2 nd Generation Premium Center Console	S021615001	0.95

Required Part(s):	Part Number	Description	Quantity
	1075270-00-A	MS PREMIUM CONSOLE SERVICE	1

These part numbers were current at the time of publication. Use the revisions listed or later, unless otherwise specified in the Parts Manual.

Special Tool(s):	Part Number	Description
	1087318-00-A	CLAMP (x2)
	1087319-00-A	FEELER GUAGE
	1065399-00-A	SKIN WEDGE TOOL
	1060071-00-A	TORQUE WRENCH 1-5 NM

Procedure

1. Remove the LH and RH rear wrapped center console panels (refer to Service Manual procedure 15193002).
2. Remove the center console armrest trim (refer to Service Manual procedure 15191602).
3. On both sides of the center console assembly, remove and discard the bolt that secures the rear center console bracket to the back of the center console carrier (Figure 1). Remove the rear center console bracket from the center console carrier.



Figure 1

4. Disconnect the following electrical connectors:
 - 12V power socket
 - Passive entry antenna
 - USB connectors (x2)
5. Carefully release the 6 clips that secure the harness to the center console carrier. Remove the harness from the carrier.
6. Remove and discard the 2 screws that secure the USB and passive entry bracket assembly to the center console carrier. Release the USB and passive entry bracket from the center console carrier.
7. Release the 12V power socket from the center console carrier.
8. Discard all of the old components except for the following, which will be transferred to the new center console assembly:
 - Front closeout panel and in-vehicle temperature sensor assembly
 - LH and RH armrest pads and tracks
 - Armrest trim
 - USB and passive entry bracket assembly
 - 12V power socket
 - Rear vent assembly (the bezel is replaced)
 - LH and RH closeout extension trim
 - Center console harness

9. Transfer the electrical components to the new center console carrier:
 - a. Working from the bottom of the new center console carrier, route the harness and install the 6 fir tree clips to secure it to the center console carrier (Figure 2).

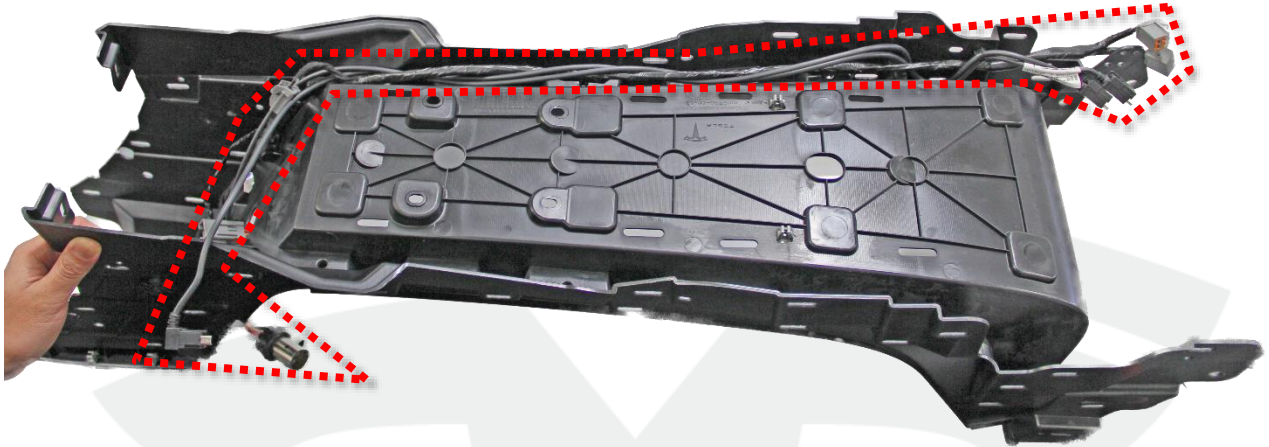

Figure 2

- b. Insert the 12V power socket into the hole in the front of the center console carrier and connect the electrical connector (Figure 3).

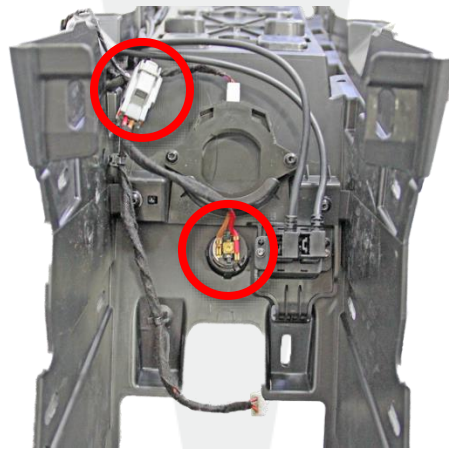

Figure 3

c. Install the USB and passive entry bracket and secure it with 2 new screws (torque 2 Nm) (Figure 4).

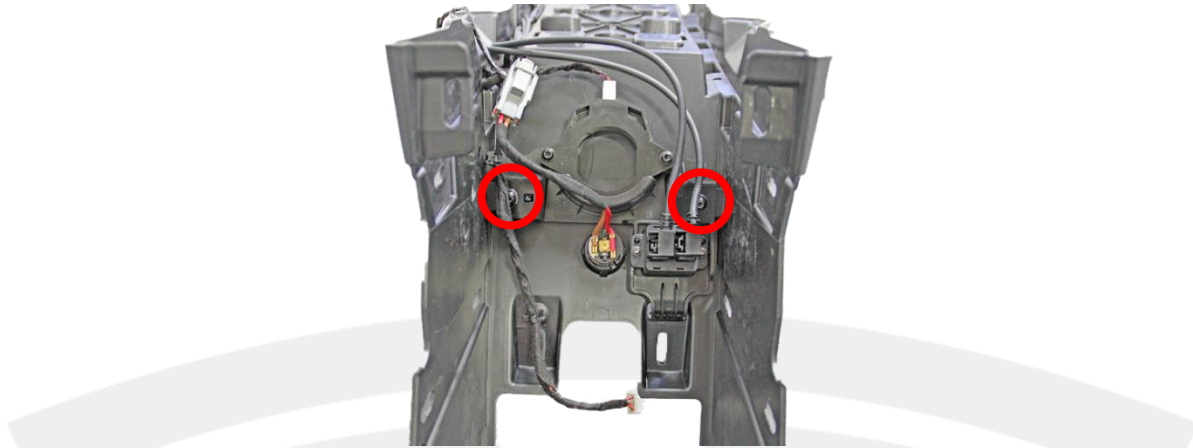

Figure 4

d. Connect the electrical connector for the passive entry antenna and install the 2 USB connectors (Figure 5).

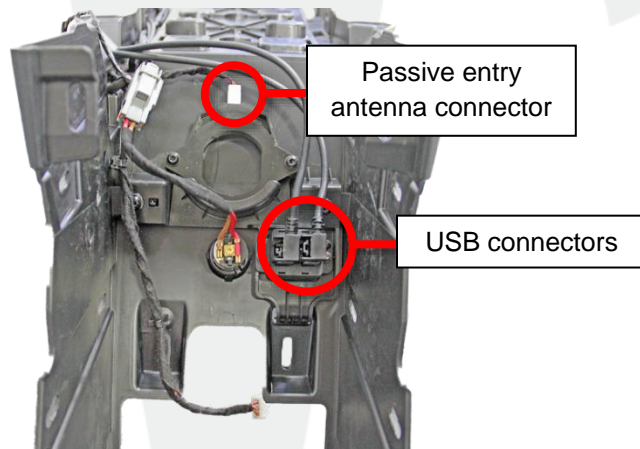

Figure 5

10. Secure the rear cup holder assembly to the rear center console bracket:

a. Push the rear cup holder towards the rear center console bracket (Figure 6) until the 4 bolt holes are aligned.



Figure 6 (Rear cup holder assembly highlighted)

b. Loosely install the 4 bolts that secure the rear cup holder assembly to the rear center console bracket (Figure 7).

⚠ CAUTION: Do not fully tighten the bolts at this time. The bolts are fully tightened later in the procedure after the rear cup holder has been aligned.

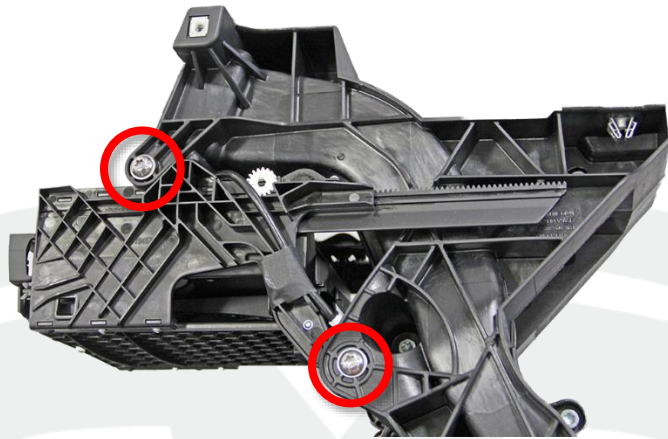

Figure 7

11. Insert the rear center console bracket assembly into the back of the center console carrier (Figure 8) and secure it with 2 new bolts (torque 2.5 Nm) (Figure 9).

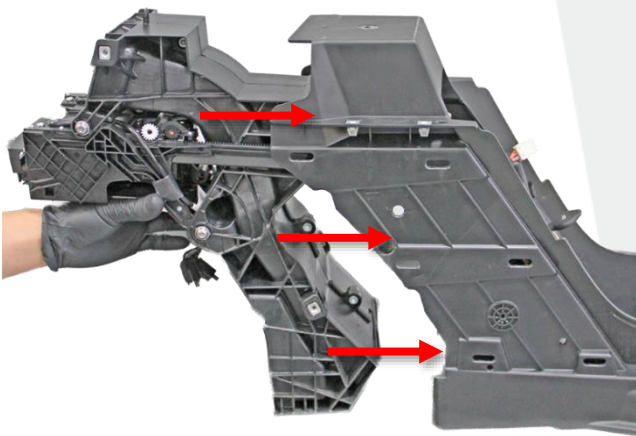

Figure 8



Figure 9

12. Transfer the old armrest trim and armrest pads to the new armrest base assembly:

- a. Carefully press the armrest trim straight down until the clips are secured to the new armrest base (Figure 10).



Figure 10

- b. Place a protective cloth on a clean, flat surface.
- c. Place both armrests on the cloth so that the pads are touching the cloth and the rails are facing upwards.
- d. Turn the armrest base assembly over and place the armrest base on top of the armrest pads as shown (Figure 11).

⚠ CAUTION: To avoid damaging the armrest trim, ensure that the armrest pads and the armrest base are aligned.

NOTE: Ensure that the armrest pads are positioned correctly; stickers indicate if the armrest pad is the LH or RH part.

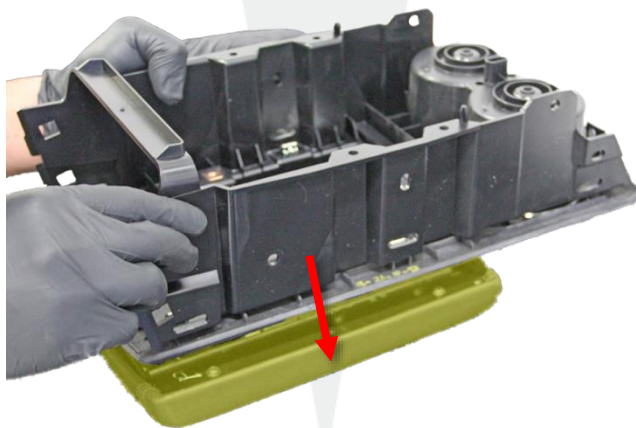

Figure 11 (LH armrest pad highlighted)

- e. Install the 4 nuts that secure the armrest pad tracks to the armrest base assembly (torque 2.5 Nm) (Figure 12).

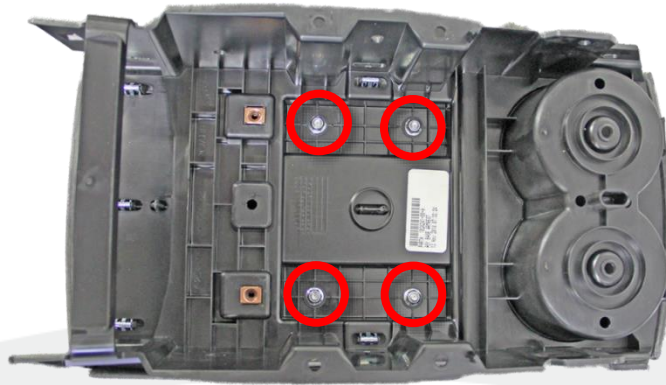

Figure 12

- 13. Secure the armrest base assembly to the center console carrier:

- a. Install 2 new bolts inside the cup holders (torque 2.5 Nm) (Figure 13).



Figure 13

- b. On the LH and RH side of the center console carrier, install 3 new bolts that secure the armrest base to the center console carrier (torque 2.5 Nm) (Figure 14).



Figure 14
TESLA

14. Insert the new rubber cup holder mat into the cup holder.
15. Move both armrests fully forward.
16. Carefully transfer the new rear vent bezel to the old rear vent assembly. Ensure that all clips are fully secure (Figure 15).

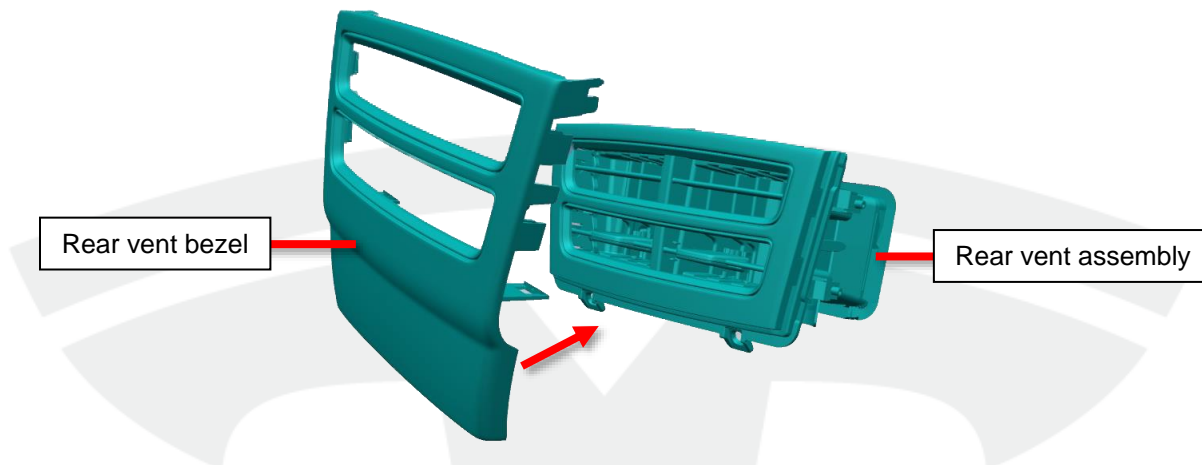

Figure 15

17. Temporarily secure the rear vent assembly to the center console carrier by carefully pushing it in towards the center console carrier (Figure 16).

NOTE: Installing the rear vent assembly allows the rear cup holder assembly to be aligned properly. The rear vent assembly is removed and reinstalled later in this procedure.



Figure 16

18. Install the rear cup holder trim panel (Figure 17). Ensure that all clips are fully secure.



Figure 17 (Rear cup holder trim panel highlighted)

19. Close the rear cup holder.

20. Align the rear cup holder assembly:

- a. Insert the 0.9 mm feeler gauge in the gap between the rear cup holder and rear vent assembly (Figure 18).

NOTE: The feeler gauge represents the appropriate gap between the rear cup holder and the rear vent.



Figure 18 (Feeler gauge highlighted)

- b. Carefully secure the 2 clamps so that the top rests on the cup holder trim and the bottom touches the underside of the cup holder assembly (Figure 19).

NOTE: Do not block access to the bolts that secure the rear cup holder assembly to the rear center console bracket.



Figure 19

- c. Slowly tighten the 2 clamps until the feeler gauge is snug between the rear cup holder and rear vent assembly.

CAUTION: To prevent damage to the cup holder trim, do not overtighten the clamps.

- d. On the LH and RH side of the center console assembly, fully tighten the 2 bolts that secure the rear cup holder assembly to the rear center console bracket (torque 2.8 Nm) (Figure 20).



Figure 20

- e. Remove the feeler gauge and 2 clamps from the center console.

21. Open the rear cup holder, then remove the rear cup holder trim.
22. Remove the rear vent assembly from the center console carrier.
23. Install the center console insert:
 - a. Place the sliding lid décor on top of the center console insert so that the clips align with the 6 holes on the top of the center console insert (Figure 21).

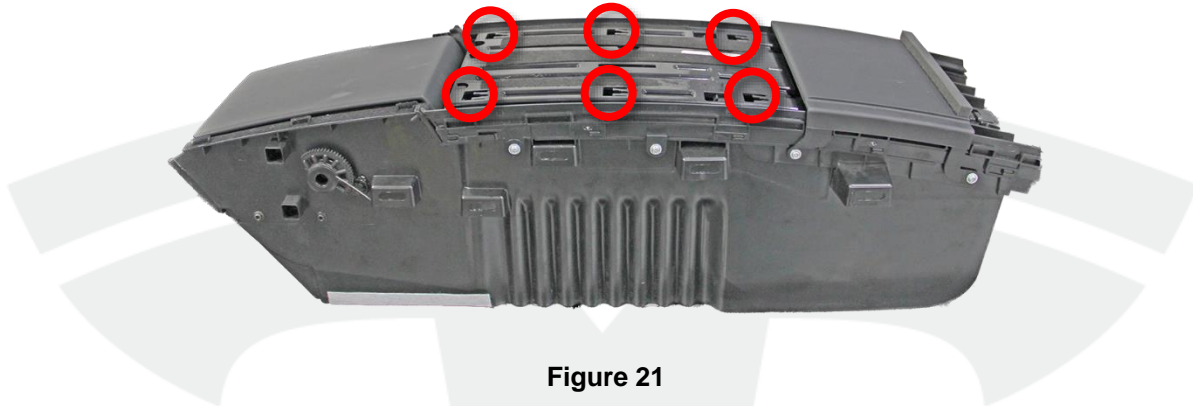

- b. Carefully press the sliding lid décor downwards and towards the front of the center console insert (Figure 22) until the sliding lid décor snaps into place.



- c. Open the sliding lid.

- d. Position the center console insert into place on the center console carrier so that the holes for the 2 screws in the center console insert align with the 2 holes in the center console carrier (Figure 23).

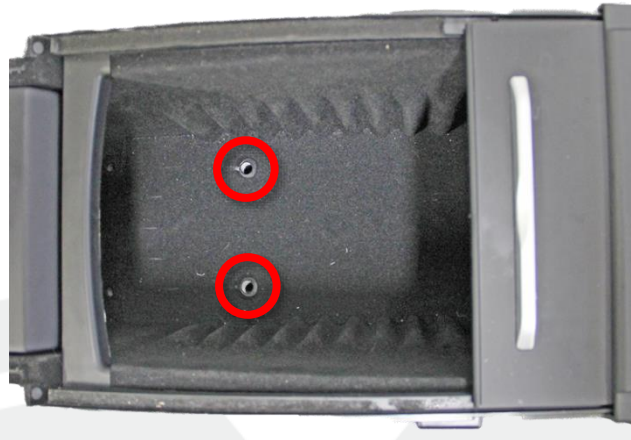

Figure 23

- e. Install the 2 bolts that secure the center console insert to the center console carrier (torque 2.5 Nm).
- 24. Connect the in-vehicle temperature sensor electrical connector.
 - 25. Secure the front closeout panel assembly to the center console (Figure 24). Ensure that all clips are fully secure.



Figure 24 (Front closeout panel highlighted)

26. Carefully place the center console assembly on its side, then install the center console air duct extension (Figure 25).

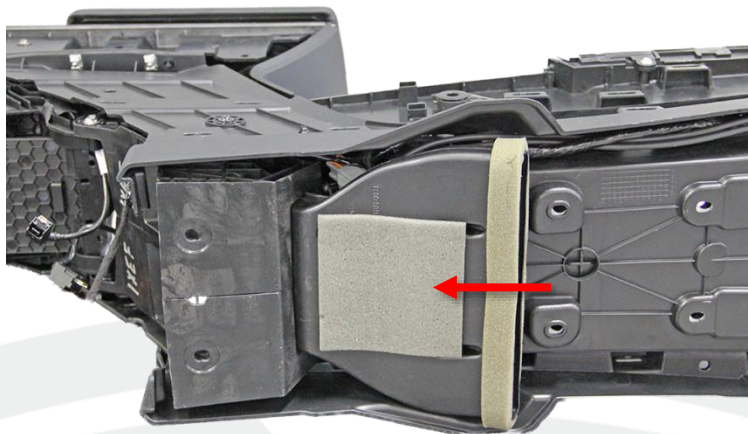

Figure 25

27. Open the rotating door on the center console insert.

28. Install the LH and RH center console closeout panels (Figure 26).

⚠ CAUTION: Take care not to damage the upper tabs on the center console insert (Figure 27) when installing the closeout panels. If necessary, use a trim tool to maneuver the closeout panels over the upper tabs (Figure 28).

NOTE: It is necessary for the closeout panels to be attached to the center console before it is installed in the vehicle, but the front and rear portions of the closeout panels are loosened later in this procedure. Ensure that the middle section of each closeout panel is fully secure.



Figure 26 (RH center console closeout panel highlighted)



Figure 27



Figure 28

29. Close the rotating door on the center console insert.

30. Maneuver the front seats to prepare for installing the center console assembly:

- The passenger's seat is in the rearmost position and is leaned back slightly.
- The driver's seat is in the center position, approximately parallel with the B-pillar.

NOTE: The next step requires an assistant.

31. While working from the 2nd row, maneuver the center console through the driver's side of the vehicle and it into position.

NOTE: Ensure that the forward bolt holes are aligned; use the locator post at the front of the center console carrier to ensure that the center console is positioned properly.

32. Loosely install the 8 new fasteners that secure the center console assembly:

- a. 2 screws that secure the front of the center console to the instrument panel (Figure 29).

TIP: Ensure that the sliding lid is open. If a screw falls, use a magnetic pickup tool to retrieve it.



Figure 29

- b. 2 screws that secure the front of the center console to the cross car beam (Figure 30).

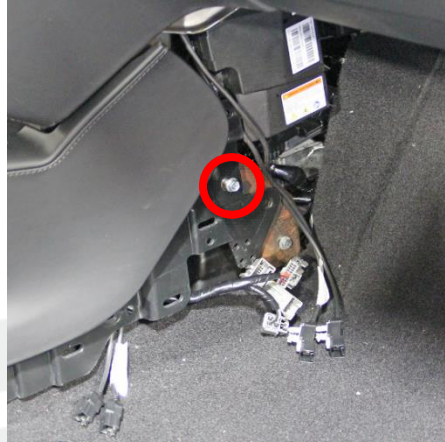

Figure 30

- c. 2 bolts that secure the rear of the center console to the body (Figure 31).

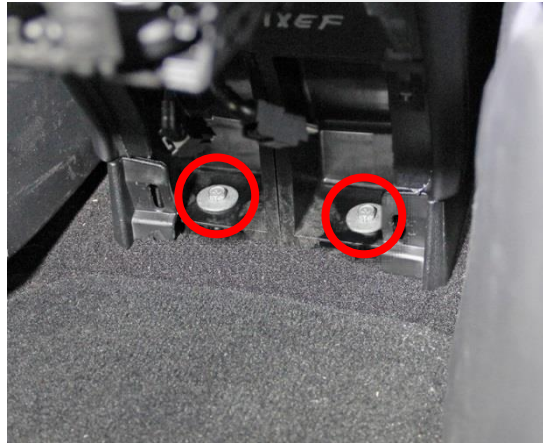

Figure 31

- d. 2 bolts that secure the center console insert to the body (Figure 32).



Figure 32

33. Fully torque the 8 fasteners that secure the center console assembly:
 - a. 2 screws that secure the front of the center console to the instrument panel (torque 2.5 Nm).
 - b. 2 screws that secure the front of the center console to the crosscar beam (torque 2.5 Nm).
 - c. 2 bolts that secure the rear of the center console to the body (torque 7.5 Nm).
 - d. 2 bolts that secure the center console insert to the body (torque 2.5 Nm).

34. Install the storage center compartment assembly.

TIP: The storage center compartment bin might be easier to install with the front portion of the LH and RH closeout panels released from the center console carrier.

35. Install the center console front mat into the center console insert.

36. Place the 4 center console dividers into the channels inside the center console insert.

37. Close the sliding lid.

38. Connect all electrical connectors on the RH side of the center console assembly (Figure 33). Secure the fir tree clips to the center console as necessary.



Figure 33

39. With the front portion of the LH and RH center console closeouts still released from the center console carrier, install the LH and RH center console closeout extensions (Figure 34).



Figure 34

40. Secure the front of the LH and RH center console closeouts to the center console carrier.
41. Move both front seats fully forward.
42. Install the new center console rear trim. Ensure that all clips are fully secure.
43. Install the rear vent assembly.

TIP: The rear vent assembly might be easier to install with the rear portion of the closeout panels released from the center console carrier.

44. Install the rear cup holder trim panel (Figure 35).



Figure 35

- 45. Close the rear cup holder.
- 46. Ensure that the rear of the LH and RH closeout panels are fully secured to the center console carrier.
- 47. Ensure that all electrical components function properly.
- 48. Move the front seats to their original positions.
- 49. Reinstall the floor mats if they were removed from the vehicle.

Affected VIN(s) Affected Model S vehicles built before approximately April 11, 2016.

NOTE: This is a simplified summary of the affected VIN list. Refer to the VIN/Bulletin Tracker or Customer/Vehicle profile to determine applicability of this bulletin for a particular vehicle.

For feedback on the accuracy of this document, email ServiceBulletinFeedback@tesla.com.