



## WALL CONNECTOR, NEMA 14-50 INSTALLATION MANUAL

Approved Markets: North America





Warranty Enforcement Laws and Dispute Resolution.....	17
--	----

## About this Manual..... 2

Communications Regulations.....	2
Errors or Inaccuracies.....	2
Copyrights and Trademarks.....	2

## Safety Information..... 3

Important Safety Instructions.....	3
Warnings.....	3
Cautions.....	3
Notes.....	4

## Specifications..... 5

## Features..... 6

Circuit Ratings.....	6
Self-Monitoring and Recovery.....	6
Power Outages.....	6

## Planning Your Installation..... 7

Minimum Requirements.....	7
Choose the Best Location for the Wall Connector and Outlet.....	7

## Check the Box Contents..... 8

## Step-by-Step Installation

### Instructions..... 9

Tools and Materials Required.....	9
Overview of Installation Steps.....	9
Installation.....	10

### Troubleshooting..... 11

Reset.....	14
Questions?.....	15

## Charging Equipment

### Limited Warranty..... 16

General Terms.....	16
Limits of Liability.....	17



## Communications Regulations

This device complies with Part 15 of the FCC rules and Industry Canada license-exempt RSS standard(s). Operation is subject to the following two conditions: (1) This device may not cause harmful interference and (2) this device must accept any interference received, including interference that may cause undesired operation.

**⚠ Important:** Changes or modifications to this product not authorized by Tesla could void the FCC compliance.

## Errors or Inaccuracies

To communicate any inaccuracies or omissions, or to provide general feedback or suggestions regarding the quality of this manual, send an email to:

[ownersmanualfeedback@tesla.com](mailto:ownersmanualfeedback@tesla.com)

## Copyrights and Trademarks

All information in this document is subject to copyright and other intellectual property rights of Tesla, Inc. and its licensors. This material may not be modified, reproduced or copied, in whole or in part, without the prior written permission of Tesla, Inc. and its licensors. Additional information is available upon request. The following are trademarks or registered trademarks of Tesla, Inc. in the United States and other countries:

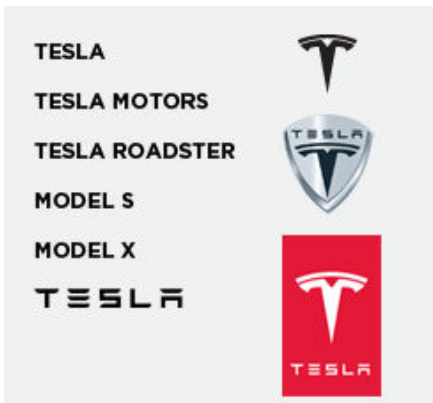











All other trademarks contained in this document are the property of their respective owners and their use herein does not imply sponsorship or endorsement of their products or services. The unauthorized use of any trademark displayed in this document or on the vehicle is strictly prohibited.





## Important Safety Instructions





This document contains important instructions and warnings that must be followed when installing and maintaining the Wall Connector.

### Warnings

-  **Warning:** Read all the instructions before using this product.
-  **Warning:** This device should be supervised when used around children.
-  **Warning:** The Wall Connector must be grounded via the provided plug.
-  **Warning:** Do not install or use the Wall Connector near flammable, explosive, harsh, or combustible materials, chemicals, or vapors.
-  **Warning:** Unplug the power cord before cleaning the Wall Connector.
-  **Warning:** Use the Wall Connector only within the specified operating parameters.
-  **Warning:** Never spray any liquid onto the charge handle or wall plug. Never submerge the charge handle or wall plug in liquid. Store the charge handle in the dock to prevent unnecessary exposure to contamination or moisture.
-  **Warning:** Stop using and do not use the Wall Connector if it is defective, appears cracked, frayed, broken, or otherwise damaged, or fails to operate.
-  **Warning:** Do not attempt to disassemble, repair, tamper with, or modify the Wall Connector. The Wall Connector is not user serviceable. Contact Tesla for any repairs or modification.
-  **Warning:** When transporting the Wall Connector, handle with care. Do not subject it to strong force or impact or pull, twist, tangle, drag, or step on the Wall Connector, to prevent damage to it or any components.
-  **Warning:** Do not touch the Wall Connector's end terminals with fingers or sharp metallic objects, such as wire, tools, or needles.

-  **Warning:** Do not forcefully fold or apply pressure to any part of the Wall Connector or damage it with sharp objects.
-  **Warning:** Do not insert foreign objects into any part of the Wall Connector.
-  **Warning:** Use of the Wall Connector may affect or impair the operation of any medical or implantable electronic devices, such as an implantable cardiac pacemaker or an implantable cardioverter defibrillator. Check with your electronic device manufacturer concerning the effects that charging may have on such electronic devices before using the Wall Connector.

### Cautions

-  **Caution:** Do not use private power generators as a power source for charging.
-  **Caution:** Incorrect installation and testing of the Wall Connector could potentially damage either the vehicle's Battery and/or the Wall Connector itself. Any resulting damage is excluded from the New Vehicle Limited Warranty and the Charging Equipment Limited Warranty.
-  **Caution:** Do not operate the Wall Connector in temperatures outside its operating range of -22°F to 122°F (-30°C to +50°C).
-  **Caution:** Do not use an extension cord to power the Wall Connector.



## Notes

**Note:** Ensure that the Wall Connector's charging cable is positioned so it will not be stepped on, driven over, tripped on, or subjected to damage or stress.

**Note:** Do not use cleaning solvents to clean any of the Wall Connector's components. The outside of the Wall Connector, the charging cable, and the connector end of the charging cable should be periodically wiped with a clean, dry cloth to remove accumulation of dirt and dust.

**Note:** Be careful not to damage the circuit boards or components during installation.



The maximum power rating for the Wall Connector is 10 kW or 40A at 250V AC single phase power.

Description	Specifications
Voltage and Wiring	208V or 240V AC single-phase: L1, L2, and earth
Current	Maximum output: 40A
Frequency	50 to 60 Hz
Cable Length	8.5' (2.6 m) and 24' (7.4 m)
Wall Connector Dimensions	Height: 15.0" (380 mm) Width: 6.3" (160 mm) Depth: 5.5" (140 mm)
Top Entry Bracket Dimensions	Height: 10.8" (275 mm) Width: 5.1" (130 mm) Depth: 2.0" (50 mm)
Weight (including bracket)	20 lb (9 kg)
Operating Temperature	-22°F to 122°F (-30°C to 50°C)
Storage Temperature	-40°F to 185°F (-40°C to 85°C)
Enclosure Rating	Type 3R
Agency Approvals	cULus listed for United States and Canada under file number E354307, FCC Part 15.
Ventilation	Not Required
Power Cord Length	35.5" (90 cm)
Power Plug	NEMA Type 14-50



## Circuit Ratings

Use a single-phase circuit rated for 50A single-phase to obtain the fastest charging.

**Note:** Tesla vehicles must be configured with optional onboard charging equipment to accept higher amperages. Contact Tesla if you have questions about the onboard charging capabilities of your vehicle.

## Self-Monitoring and Recovery

The Wall Connector has a ground monitoring circuit that continuously checks for the presence of a safe ground connection and automatically recovers from faults. Manual testing and resetting is not required.

Temporary problems such as ground faults or utility power surges are overcome automatically. If a residual current fault occurs that interrupts charging, the Wall Connector automatically tries to clear the fault and re-attempt charging.

If the problem is immediately sensed a second time, the Wall Connector waits 15 minutes before trying to charge. This process repeats 4 times and if all attempts are unsuccessful, power is removed and no further attempts are made. In this case, you will see a red error light on the front panel (refer to Troubleshooting on page 11). It is recommended that when you see a red error light, you power off the Wall Connector by switching off the upstream circuit breaker, and then power it back on again.

The Wall Connector can alternatively be reset when a red error light is encountered using the RESET button (refer to Reset on page 14).

## Power Outages

If a power outage occurs, the Wall Connector automatically resumes charging when power is restored. If the charging cable is plugged into the vehicle when power is restored, the lights blink and the unit does not energize the charging cable for approximately 15 seconds to three minutes. This prevents the utility grid from experiencing a large surge when power is restored and allows vehicles to begin drawing current at random times, rather than all at once.





## Minimum Requirements

Installation of the Wall Connector requires that you:

- Install an outlet per local electrical and construction codes.
- Provide the outlet with adequate electrical service.
- Control the outlet with an adequately sized breaker or fuse.
- Calculate the distance to ensure minimal voltage drop.
- Use only copper conductors.

**Note:** Consult with an electrician to ensure that the installation meets local regulations.

## Choose the Best Location for the Wall Connector and Outlet

Determine the parking location of the vehicle to ensure that the charge cable reaches the charge port. The Wall Connector should be located:

- In an enclosed garage, typically on the vehicle's charge port side.
- In a well-ventilated area. Avoid installation in an enclosed box, or adjacent to hot appliances.
- 4 ft (1.2 m) above the floor.
- 8 in (190 mm) from any obstructions to allow for cable looping.

**Note:** The Wall Connector is approved for outdoor use, but it is not designed for complete immersion in liquid. Protection from rain is recommended but not required.

**Note:** Outdoor outlets and receptacles should be mounted in rain proof NEMA 3R enclosures.



## Check the Box Contents

The shipping box contains parts for all installation methods, as well as this manual. If any parts are damaged or missing, contact Tesla (refer to Questions? on page 15).

**Note:** Not shown is the supplied cardboard template.

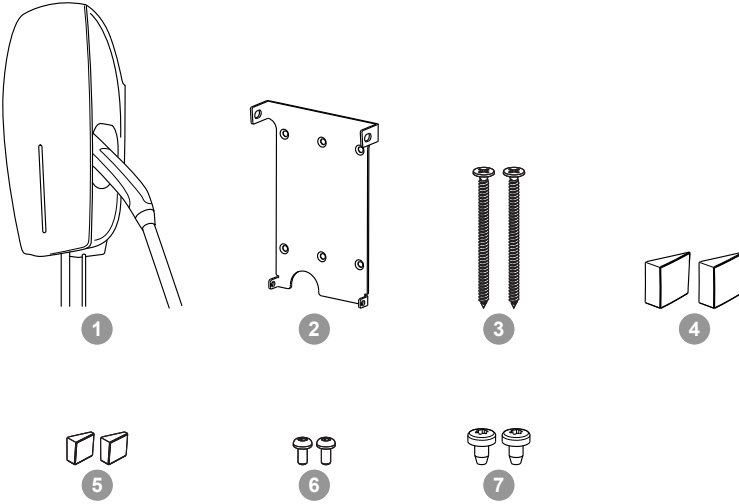

Item	Description (Quantity)
1	Wall Connector
2	Low profile bracket **
3	Low profile bracket screws (2) **
4	Top bracket-to-housing screw covers (2)
5	Bottom bracket-to-housing screw covers (2)
6	Bottom bracket-to-housing screws (2)
7	Top bracket-to-housing screws (2)
* Items used in only top entry installations.	
** Items used in only bottom or rear entry installations.	



## Tools and Materials Required

Before installing the Wall Connector, gather the following tools and materials:

- Pencil or marker
- Hole punch (optional, to push through cardboard template)
- Phillips screwdriver
- T20 security pin Torx driver
- Level
- Machine drill

## Overview of Installation Steps



**Warning:** After an outlet is properly installed, TURN OFF AND VERIFY POWER IS OFF BEFORE CONTINUING.

Then follow these steps to install the Wall Connector:

- Install the Low Profile Bracket.
- Connect the wall connector to the bracket
- Plug in and power up



## Installation

1. Use the low profile bracket as a guide to mark the location on the wall for the mounting screws.
  - Use a level to ensure that the marks are perfectly vertical.
  - Space the holes 4.5" (114 mm) apart.

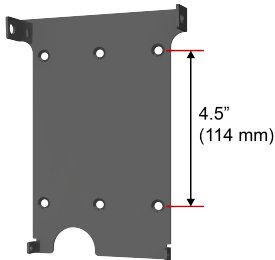

- For U.S.A. installations, position the bracket so that the Wall Connector is located at a maximum of 60" (150 cm) from floor level. The minimum height is 18" (45 cm) if mounting indoors, and 48" (122 cm) if mounting outdoors.

**Note:** Ensure that the minimum and maximum height of the bracket is carefully selected. It should be installed out of the way of any reasonably foreseeable impacts.

2. Attach the bracket using fasteners that are appropriate for the type of wall material, drilling pilot holes if necessary. Use the supplied screws only if mounting the bracket directly to a wooden stud. If mounting the bracket directly to a wooden stud. If mounting to another type of wall (hollow, masonry, etc.), use fasteners that are long enough to securely anchor the Wall Connector and can hold at least 80 lb (36 kg).



3. Plug in the Wall Connector to the wall power outlet.



Green Lights	Yellow Light	Red Light	Auto-Retry	What it Means	What to Do
Top light on	Off	Off	Not applicable	Power on. The Wall Connector is powered and in standby but not charging the vehicle.	Not applicable.
Streaming lights	Off	Off	Not applicable	The Wall Connector is charging the vehicle.	Not applicable.
Streaming lights	1 flash	Off	Not applicable	Charging current is reduced due to high temperature detected in the Vehicle Connector.	Make sure the connector is fully inserted into the charge inlet in the vehicle's charging port, is not covered by anything, and there is no heat source is nearby. If the problem persists in normal ambient temperatures (under 100°F or 38°C), contact Tesla.
Streaming lights	2 flashes	Off	Not applicable	Charging current is reduced due to high temperature detected in the wall plug or on the input terminals to the Wall Connector.	If the Wall Connector is hard-wired, make sure it is not covered by anything, and there is no heat source nearby. If the problem persists in normal ambient temperatures (under 100°F or 38°C), contact Tesla.
Streaming lights	3 flashes	Off	Not applicable	Charging current is reduced due to high temperature detected inside the Wall Connector.	Make sure the Wall Connector is not covered by anything and there is no heat source nearby. If the problem persists in normal ambient temperatures (under 100°F or 38°C), contact Tesla.



Green Lights	Yellow Light	Red Light	Auto-Retry	What it Means	What to Do
Off	Off	1 flash	After 15 minutes and up to 4 times	Ground fault. Current is leaking through an unsafe path. Possible Line to ground or Neutral to ground fault.	Try again by disconnecting the Wall Connector from the vehicle and reconnecting. If the problem persists, turn OFF the circuit breaker servicing the Wall Connector, wait 10 seconds, turn the circuit breaker ON again, then try reconnecting the Wall Connector to the vehicle. If the problem persists, contact Tesla.
Off	Off	2 flashes	After 1 minute and up to 4 times	No ground connection detected in the Wall Connector.	Make sure the Wall Connector is properly grounded. If uncertain, consult your electrician to ensure proper grounding at your circuit breaker or power distribution box and that appropriate connections are made to the Wall Connector.
Off	Off	3 flashes	No	Input miswired: possibly Line and Neutral are swapped.	The power outlet has been incorrectly installed. Consult your electrician.
Off	Off	4 flashes	After 1 minute and up to 4 times	Over or under voltage protection.	Consult your electrician to ensure appropriate voltage on the circuit breaker that services the Wall Connector.



Green Lights	Yellow Light	Red Light	Auto-Retry	What it Means	What to Do
Off	Off	5 flashes	After 1 minute retry (no limit on retries)	Over current protection.	Reduce the vehicle's charge current setting. If the problem persists and the attached vehicle is manufactured by Tesla, contact Tesla. If the problem persists and If the attached vehicle is not manufactured by Tesla, contact the original manufacturer.
Off	Off	6 flashes	After 1 minute retry (no limit on retries)	A communication error occurred between the Wall Connector and the vehicle.	If possible, plug the vehicle into another Wall Connector or a Mobile Connector to determine if the vehicle is able to communicate with other charging equipment. Then contact Tesla Service.
Top light on	Off	1 flash	No	Over temperature protection (latch-off)	Make sure the Wall Connector, vehicle connectors, and wall plug (if used) are not covered by anything and there is no heat source nearby. If the problem persists in normal ambient temperatures (under 100°F or 38°C), contact Tesla.



Green Lights	Yellow Light	Red Light	Auto-Retry	What it Means	What to Do
Off	Off	Solid red	No	Wall Connector hardware failure. Possible failures include the following: <ul style="list-style-type: none"><li>• Contactor failed</li><li>• Self test failed in CCID circuitry</li><li>• Other possible hardware failures might be MCU, 3V3output, or the thermal sensor.</li></ul>	Contact Tesla.

## Reset

If a fault causes a RED error light to illuminate or flash and the fault condition is corrected, you use RESET the Wall Connector to resume normal operation. There are two ways to REST the Wall Connector:

- Press the RESET button for two to three seconds until the top lights changes from RED to GREEN. This clears the fault message but does not reboot the Wall Connector.
- In a rare situation, you might need to force the Wall Connector to reboot without recycling the input power. Hold the RESET button for five seconds. When the top light changes from RED to GREEN, release the RESET button. The top light should continue to illuminate GREEN. If the light returns to flashing RED, the fault state has not been corrected.





## Questions?

- United States and Canada:
  - [charginginstallation@tesla.com](mailto:charginginstallation@tesla.com)
  - +1-650-681-6133
- Mexico:
  - [charging\\_mx@tesla.com](mailto:charging_mx@tesla.com)
  - +1-877-798-3752



## General Terms

Subject to the exclusions and limitations described below, the Charging Equipment Limited Warranty covers the refund, repair or replacement necessary to remedy any manufacturing defects in Tesla manufactured and supplied Wall Connector that occur under normal use for a period of 48 months, and Mobile Connector or charging adapter that occur under normal use for a period of 12 months from the date of invoice to the customer. Any Tesla connector or adapter included in the initial purchase and delivery of a Tesla vehicle by Tesla is covered under the Basic Vehicle Limited Warranty section of the New Vehicle Limited Warranty for 4 years or , whichever comes first, subject to the terms and conditions of the New Vehicle Limited Warranty.

This Charging Equipment Limited Warranty does not cover any damage or malfunction directly or indirectly caused by, due to, or resulting from, normal wear or deterioration, abuse, misuse, negligence, accident, lack of or improper use, maintenance, storage or transport, including, but not limited to, any of the following:

- Failure to follow the instructions, maintenance and warnings published in the documentation supplied with your Tesla connector or adapter;
- External factors, including but not limited to, objects striking the Tesla connector or adapter, faulty or damaged electrical wiring, junction boxes, circuit breakers, receptacles or power outlets, the environment or an act of God, including, but not limited to, fire, earthquake, water, lightning and other environmental conditions;
- General appearance or damage to paint, including chips, scratches, dents and cracks;
- Failure to contact Tesla upon discovery of a defect covered by this Charging Equipment Limited Warranty;
- Any repair, alteration or modification to the Tesla connector or adapter or any part, or the installation or use of any parts or accessories, made by a person or facility not authorized or certified to do so;
- Lack of or improper repair or maintenance, including use of non-genuine Tesla accessories or parts; and
- Use for commercial purposes.

Although Tesla does not require you to perform all maintenance, service or repairs at a Tesla Service Center or Tesla authorized repair facility, this Charging Equipment Limited Warranty may be voided, or coverage may be excluded, due to lack of or improper maintenance, service or repairs. Tesla Service Centers and Tesla authorized repair facilities have special training, expertise, tools and supplies with respect to Tesla connectors and adapters and, in certain cases, may employ the only persons, or be the only facilities authorized or certified to work on Tesla connectors and adapters. Tesla strongly recommends that you have all maintenance, service and repairs done at a Tesla Service Center or Tesla authorized repair facility in order to avoid voiding, or having coverage excluded under, this Charging Equipment Limited Warranty.



## Limits of Liability

This Charging Equipment Limited Warranty is the only express warranty made in connection with your Tesla connector or adapter. Implied and express warranties and conditions arising under applicable local laws, federal statute or otherwise, in law or in equity, if any, including, but not limited to, implied warranties and conditions of merchantability or merchantable quality, fitness for a particular purpose, durability, or those arising by a course of dealing or usage of trade, are disclaimed to the fullest extent allowable by your local law, or limited in duration to the term of this Charging Equipment Limited Warranty. To the fullest extent allowable by your local law, the performance of necessary repairs and/or replacement of new, reconditioned, or remanufactured parts by Tesla for the covered defects is the exclusive remedy under this Charging Equipment Limited Warranty or any implied warranties. To the maximum extent permissible under your local law, liability is limited to the reasonable price for repair or replacement of the applicable Tesla connector or adapter, not to exceed the manufacturer's suggested retail price. Replacement may be made with parts of like kind and quality, including non-original manufacturer's parts, or reconditioned or remanufactured parts, as necessary.

Tesla shall not be liable for any defects under this Charging Equipment Limited Warranty that exceed the fair market value of the applicable Tesla connector or adapter at the time immediately preceding the discovery of the defect. In addition, the sum of all benefits payable under this Charging Equipment Limited Warranty shall not exceed the price you paid for the applicable Tesla connector or adapter.

Tesla does not authorize any person or entity to create for it any other obligations or liability in connection with this Charging Equipment Limited Warranty. The decision of whether to repair or replace a part or to use a new, reconditioned or remanufactured part will be made by Tesla, in its sole discretion.

To the maximum extent permissible under local law, Tesla hereby disclaims any and all indirect, incidental, special and consequential damages arising out of, or relating to, the Tesla connector or adapter, including, but not limited to, transportation to and from a Tesla Authorized Service Center, loss of the Tesla connector or adapter, loss of vehicle value, loss of time, loss of income, loss of use, loss of personal or commercial property, inconvenience or aggravation, emotional distress or harm, commercial loss (including but not limited to lost profits or earnings), towing charges, bus fares, vehicle rental, service call charges, gasoline expenses, lodging expenses, damage to tow vehicle, and incidental charges such as telephone calls, facsimile transmissions, and mailing expenses.

The above limitations and exclusions shall apply whether your claim is in contract, tort (including negligence and gross negligence), breach of warranty or condition, misrepresentation (whether negligent or otherwise) or otherwise at law or in equity, even if Tesla is advised of the possibility of such damages or such damages are reasonably foreseeable.

Nothing in this Charging Equipment Limited Warranty shall exclude, or in any way limit, Tesla's liability, for death or personal injury solely and directly caused by Tesla's negligence or that of its employees, agents or sub-contractors (as applicable), fraud or fraudulent misrepresentation, or any other liability to the extent the same is proven in a court of competent jurisdiction in a final nonappealable judgment and may not be excluded or limited as a matter of local law.

## Warranty Enforcement Laws and Dispute Resolution

To the fullest extent allowed by local law, Tesla requires that you first provide written notification of any manufacturing defect within a reasonable time, and within the applicable coverage period specified in this Charging Equipment Limited Warranty, and allow Tesla an opportunity to make any needed repairs before submitting a dispute to our dispute settlement program (described below). Please send written notification on dispute resolution to the following address:



## Charging Equipment Limited Warranty

United States:  
Tesla Motors, Inc.  
3500 Deer Creek Road  
Palo Alto, California 94304  
Telephone: 1-877-798-3752

Canada:  
Tesla Motors Canada ULC  
1325 Lawrence Avenue East  
Toronto, ON M3A 1C6  
Telephone: 1-877-798-3752

Mexico:  
Tesla Motors Mexico  
Av. Paseo De La Reforma 404 Piso 13  
Col. Juarez, Cuauhtemoc Distrito Federal  
06600  
Telephone: 01-800-228-8145

Please include the following information:

- Tesla connector or adapter invoice date;
- Your name and contact information;
- Name and location of the Tesla Store and/or Tesla Service Center nearest you;
- Description of the defect; and
- History of the attempts you have made with Tesla to resolve the concern, or of any repairs or services that were not performed by Tesla.

In the event any disputes, differences or controversies arise between you and Tesla related to this Charging Equipment Limited Warranty, Tesla will explore all possibilities for an amicable settlement. In case an amicable settlement is not reached, Tesla offers a dispute settlement program through:

NATIONAL CENTER FOR DISPUTE  
SETTLEMENT (“NCDS”)  
P.O. Box 526  
Mt. Clemens, MI 48046  
1-866-629-3204

Tesla requires that you submit your dispute to our dispute settlement program and wait for a decision to be issued prior to pursuing any remedy under federal or state laws (including 15 U.S.C. Section 2310 or California Civil Code Section 1793.22(b)), although you may be entitled to pursue a remedy without submitting under certain state laws or if you pursue any rights or remedies not created by these laws. This dispute settlement program administered by NCDS is free of charge to you and is conducted by local NCDS professionals who are trained and experienced in mediation and arbitration.

NCDS resolves disputes involving this Charging Equipment Limited Warranty which arise during the applicable warranty period specified in this Charging Equipment Limited Warranty. You must file a request for arbitration with NCDS within 60 days (or 6 months in certain jurisdictions) of the expiration of the applicable warranty period, provided you sent written notice to Tesla of the alleged defect was brought to the attention of Tesla during the applicable warranty period.

To initiate arbitration, you must contact NCDS at 1-866-629-3204 or P.O. Box 526, Mt. Clemens, MI 48046, and complete an NCDS customer claim form and mail it to NCDS. Please also provide a copy of your written notification sent to Tesla and/or all information required in such notification specified above, your desired resolution, and all receipts if requesting reimbursement. Upon receipt of your request, NCDS will contact you regarding the status of your case and provide you with additional details about the program.

When NCDS receives your request, it will be forwarded to Tesla for response. After analyzing all information pertaining to your case, NCDS will schedule a technical evaluation if applicable. If you request it, an oral hearing will be held prior to a decision being rendered. At this hearing, all evidence is admissible. After considering all testimony and documents, the arbitrator will review the applicable legal standards and render a decision. A settlement satisfactory to all parties may be negotiated at any time, including prior to or after the arbitrator’s decision.

NCDS’s decision is binding on Tesla but not on you. If you accept NCDS’s decision, Tesla will comply with the decision in a reasonable time not to exceed 30 days after Tesla receives notice of your acceptance. Remedies include but are not limited to repairs; reimbursement for repairs and incidental expenses, such as transporting costs; and repurchase or replacement of the applicable Tesla connector or adapter. NCDS decisions do not include attorney fees or punitive, multiple, or consequential damages, except incidental damages as required by applicable law. NCDS findings and decisions are admissible as evidence in any legal proceedings concerning the applicable Tesla connector or adapter.



The description provided above is only a brief summary of the dispute settlement program administered by NCDS. The dispute settlement program may be changed at any time without prior notice. Contact NCDS at the above listed address or phone number for the most current information concerning the dispute settlement program.



## B

- bottom or rear entry
  - installing the low profile bracket for 10

## C

- cardboard template, using the 10
- cautions 3
- check the box contents 8
- circuit ratings, optional 6
- circuit ratings, optional 6
- communications regulations 2
- copyrights 2

## D

- dimensions 5
- documentation errors, sending feedback 2

## F

- features
  - circuit ratings, optional 6
  - recovery from power outages 6
  - self-monitoring and recovery 6

## I

- installation
  - for rear or bottom entry wiring 10
  - information, about 2
  - planning your 7
  - tools and materials required 9
- installation overview 9

## L

- lights, diagnostic 6
- lights, LED 11
- low profile bracket
  - installing the 10

## M

- minimum requirements 7

## N

- notes 4

## P

- planning your installation
  - location of the wall connectors 7
  - minimum requirements 7
- power outages, recovery from 6
- power ratings 5

## R

- reset button 6, 14

## S

- safety instructions 3, 4
- self-monitoring and recovery 6
- specifications
  - dimensions 5
  - power ratings 5
  - temperature limits 5

## T

- temperature limits 5
- Tesla, contacting 15
- trademarks 2
- troubleshooting 11, 14, 15

## W

- wall connectors
  - checking the box contents 8
  - location of 7
  - reset 14
- warnings 3



# TESLA

P/N: 1107723-00-A

MANUAL, WALLCONNECTOR, 14-50



(P) PN:1107723-00-A  
(T) TLN:TT1450