



# NBX<sup>®</sup> Administrator's Guide

Release 4.3

- SuperStack 3 NBX
- NBX 100

<http://www.3com.com/>

Part Number:900-0156-01  
Published: June 2004

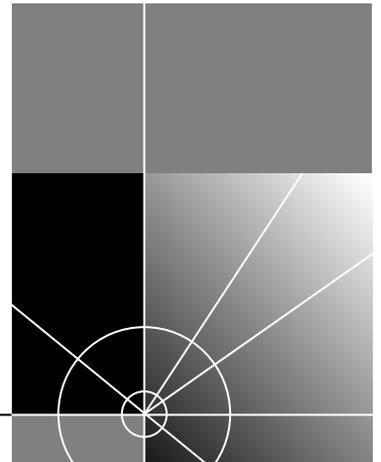

**3Com Corporation  
350 Campus Drive  
Marlborough, MA  
01752-3064**

Copyright © 2004, 3Com Corporation. All rights reserved. No part of this documentation may be reproduced in any form or by any means or used to make any derivative work (such as translation, transformation, or adaptation) without written permission from 3Com Corporation.

3Com Corporation reserves the right to revise this documentation and to make changes in content from time to time without obligation on the part of 3Com Corporation to provide notification of such revision or change.

3Com Corporation provides this documentation without warranty, term, or condition of any kind, either implied or expressed, including, but not limited to, the implied warranties, terms, or conditions of merchantability, satisfactory quality, and fitness for a particular purpose. 3Com may make improvements or changes in the product(s) and/or the program(s) described in this documentation at any time.

If there is any software on removable media described in this documentation, it is furnished under a license agreement included with the product as a separate document, in the hardcopy documentation, or on the removable media in a directory file named LICENSE.TXT or !LICENSE.TXT. If you are unable to locate a copy, please contact 3Com and a copy will be provided to you.

#### **UNITED STATES GOVERNMENT LEGEND**

*If you are a United States government agency, then this documentation and the software described herein are provided to you subject to the following:*

All technical data and computer software are commercial in nature and developed solely at private expense. Software is delivered as "Commercial Computer Software" as defined in DFARS 252.227-7014 (June 1995) or as a "commercial item" as defined in FAR 2.101(a) and as such is provided with only such rights as are provided in 3Com's standard commercial license for the Software. Technical data is provided with limited rights only as provided in DFAR 252.227-7015 (Nov 1995) or FAR 52.227-14 (June 1987), whichever is applicable. You agree not to remove or deface any portion of any legend provided on any licensed program or documentation contained in, or delivered to you in conjunction with, this guide.

Unless otherwise indicated, 3Com registered trademarks are registered in the United States and may or may not be registered in other countries.

3Com, NBX, the 3Com logo, and SuperStack are registered trademarks of 3Com Corporation. NBX NetSet and pXset are trademarks of 3Com Corporation.

Adobe is a trademark and Adobe Acrobat is a registered trademark of Adobe Systems Incorporated. InstallShield is a registered trademark of InstallShield Software Corporation. SESS is a registered trademark and 4ESS is a trademark of Lucent Technologies. Microsoft, Windows, Windows 2000, and Windows NT are registered trademarks of Microsoft Corporation.

All other company and product names may be trademarks of the respective companies with which they are associated.

# CONTENTS

---

## **ABOUT THIS GUIDE**

How to Use This Guide	15
Conventions	16
International Terminology	16
Your Comments	17

---

## **1 INTRODUCTION**

Network-based Telephony	19
Overview of the System Software	20
Auto Attendant	20
Auto Discovery and Auto Relocation	20
Virtual Tie Lines	20
Integrated Voice Mail and Messaging Features	20
Redialing From Call Logs	21
Call Recording	21
NBX NetSet Administration Utility	22
NBX NetSet Features	23

---

## **2 DIAL PLAN**

Dial Plan Concepts and Overview	28
Call Process Flow	29
Inbound and Outbound Call Processing	29
NBX System Database	30
NBX System Dial Plan	30
Pretranslation	31

Routing	31
System Features Affected by the Dial Plan Configuration	32
Dial Plan Tables	33
Dial Plan Command Format	34
Internal Dial Plan Table	38
Incoming Dial Plan Table	38
Least Cost Routing Dial Plan Table	39
Adding New Dial Plan Tables	40
Dial Plan Pretranslators	40
Pretranslators for Incoming Calls	41
Pretranslators for Certain Outgoing Calls	42
Managing the Dial Plan Configuration File	44
Accessing the Dial Plan	44
Creating Dial Plan Configuration Files	44
Importing and Exporting Dial Plan Configuration Files	45
Importing a User-Defined Dial Plan	47
Exporting (Saving) a Dial Plan Configuration File	48
Testing a Dial Plan	49
Generating a Dial Plan Report	50
Modifying a Dial Plan Configuration File	51
Outdialing Prefix Settings	52
Managing Extensions	52
Extension Settings Overview	52
Changing Extension Length and Ranges	56
How Auto Discovery Assigns Extensions	56
Modifying Extensions	57
Managing Extension Lists	59
Adding an Extension List	60
Modifying an Extension List	61
Removing an Extension List	62
Managing Dial Plan Tables	63
Determining Which Devices Use Dial Plan Tables	63
Removing a Dial Plan Table	64
Managing Dial Plan Pretranslators	64
Identifying Devices Using Pretranslators	65
Creating a Pretranslator for VTL Calls	65
Identifying Devices Using Pretranslators for CLI	68
Removing a Pretranslator from the Dial Plan	68

Configuring the Dial Plan for the 4ESS Protocol (T1)	69
Overview of Voice Profile for Internet Mail	70
Configuring the Dial Plan for VPIM	71
Configuring VPIM Parameters	74
VPIM Control Parameters	74
Operations Management	74
Statistics	76
Advanced Settings	77
Configuring Domain Name Server Information	80
Overview of Virtual Tie Lines	80
VTL Connections Using Unique Extension Ranges	81
VTL Connections Using Site Codes	82
Conference Calls Using VTL Connections	83
How to Configure a Virtual Tie Line	84
License Installation	84
Dial Plan Configuration	85
Updating the Extension List	88
Adding VTL Devices to the Pretranslators (Optional)	89
Verification of the Virtual Tie Line	90
Call Rerouting for Virtual Tie Lines	94
Example Dial Plan Entries	94
Managing Existing Virtual Tie Lines	96
Modifying a Virtual Tie Line Name	96
Viewing and Resetting Virtual Tie Line Statistics	97
Enabling Audio Compression for VTL Calls	98
Enabling Silence Suppression on VTL Calls	98
Using a VTL Password	99
Configuring a VTL Password	99
Configuring VTL Passwords in the Dial Plan	100
Toll Calls Without a VTL Password	103
Music On Hold	103
Troubleshooting VTL Calls	103
Dial Plan Configuration File Commands	105
Dial Plan Command Summary	105
List of Dial Plan Commands	107
Sample Solutions Using Dial Plan Configuration File Commands	120

---

### **3 DEVICE CONFIGURATION**

Adding, Removing, and Modifying Telephones	130
Adding a New Telephone	130
Modifying a Telephone	132
Checking a Telephone's Status	132
Removing a Telephone	132
Rebooting a Telephone	132
Adding a Remote Telephone	133
Remote NAPT Device Configuration	133
Creating and Managing Bridged Extensions	134
Example Bridged Extensions Configurations	136
Defining Bridged Extensions	137
Defining Bridged Extensions on a Primary Telephone	137
Defining Bridged Extensions on a Secondary Telephone	138
Modifying Bridged Extensions	139
Sample Calling Situations Using Bridged Extensions	139
Viewing Bridged Extension Information	141
Creating and Managing Telephone Groups	142
Creating a New Telephone Group	142
Modifying a Telephone Group	142
Removing a Telephone Group	143
Viewing Telephone Group Membership	143
Recording and Monitoring Telephone Calls	144
Recording Calls Between Telephones with Different Recording Settings	144
Remote Telephones	145
Music On Hold	145
Non-NBX Telephones	145
Creating and Managing Button Mappings	146
Mapping Access Buttons	146
Mappings for Users and Groups	147
Creating a Busy Lamp/Speed Dial Button Mapping	148
Creating a Delayed Ringing Pattern	148
Creating Groups and Button Mappings	149
Changing Device IP Settings	150
Configuring Call Park	152
Adding a Call Park Extension	152

Changing the Name of a Call Park Extension	152
Removing a Call Park Extension	153
Configuring the NBX Attendant Console	153
Adding an Attendant Console	154
Modifying an Attendant Console	154
Viewing Attendant Console Status	154
Removing an Attendant Console	155
Configuring Attendant Console Buttons	155
Changing Attendant Console IP Settings	156
Configuring and Managing Analog Line Card Ports	156
Configuring a Line Card Port	157
Modifying a Line Card Port	160
Removing a Line Card Port	160
Verifying Line Card Port Status	161
Rebooting a Line Card Port	161
Advanced Settings	161
Connecting and Managing Analog Devices	162
Adding an Analog Terminal Card	162
Adding an Analog Terminal Adapter (ATA)	164
Modifying an Analog Terminal Port	165
Removing an Analog Terminal Adapter	165
Viewing The Status of an Analog Terminal Adapter	165
Advanced Settings	166
Configuring and Managing BRI-ST Digital Line Cards	167
Adding an ISDN BRI-ST Digital Line Card	167
Configuring the BRI-ST Digital Line Card	170
BRI-ST Card Status Lights	172
Modifying a BRI-ST Card	173
Adding or Modifying a BRI Group	174
Modifying BRI Card Channels	176
Modifying IP Settings for a BRI Card	177
Removing a BRI Digital Line Card	178
Configuring and Managing E1 Digital Line Cards	179
Adding an E1 Digital Line Card	179
Configuring an E1 Digital Line Card	182
E1 Card Status Lights	184
Modifying an E1 Card	186
Adding or Modifying an E1 Group	188
Modifying E1 Card Channels	191

Modifying IP Settings for an E1 Card	192
Removing an E1 Digital Line Card	194
Configuring and Managing T1 Digital Line Cards	194
Adding a T1 Digital Line Card	195
Configuring a T1 Digital Line Card for the DS1 Protocol	198
Configuring a T1 Digital Line Card for ISDN PRI Signaling	202
T1 Card Status Lights	206
Modifying a T1 Card	207
Support of AT&T's 4ESS Switch Protocol	209
Modifying a T1 Group	212
Modifying T1 Card Channels	214
Modifying IP Settings for a T1 Card	216
Removing a T1 Digital Line Card	217
Setting Up a Digital Line Card at a Remote Location	217
Setting Up T1/E1 Logging	220
Viewing CSU State Information and Statistics	220
T1.231 Near End	221
T1.231 Far End	221
TR54016 Near End	221
TR54016 Far-End	221
G.826 Near End	222
G.826 Far End	222
Using Loopback Tests	222
Enabling or Disabling Loopback Tests	223

---

## **4 USER CONFIGURATION**

Users	225
Phantom Mailboxes	225
Call Pickup	226
Group Numbers	226
TAPI Route Points	227
Redirect Behaviors	228
TAPI Route Point Capacities	229
Creating a TAPI Route Point	229
Modifying a TAPI Route Point	230

Viewing TAPI Route Point Statistics	230
Specifying TAPI Line Redirect Timeout	231
Hunt Groups	231
Hunt Group Considerations	232
Linear and Circular Hunt Groups	232
Calling Groups	233
Call Coverage	233
Class of Service (CoS)	233

---

## **5 SYSTEM CONFIGURATION**

System Settings	235
System-wide Settings	237
Audio Settings	240
Regional Settings	244
Date and Time	246
Timers	246
Ringing Patterns	247
Multicast Addresses	247
IP Addresses	249
Maintenance Alerts	249
Speed Dials	250
Business Identity	251
Business Information	251
Business Hours	251
System Mode	251
Security	252
TAPI Settings	253
Disk Mirroring	253
Adding a Mirror Disk	253
Verifying a Failed Disk Drive	256
Reverting to a Single-Disk System	256

---

## 6 NBX MESSAGING

NBX Voice Mail	259
Voice Mail Extensions	262
Voice Mail Passwords	262
IMAP for Integrated Voice Mail	262
Off-Site Notification	264
Status	265
Port Usage	266
User Usage	267
Auto Attendant	268
Overview of Auto Attendant Features	268
Adding an Auto Attendant	270
Managing Auto Attendants	280
Voice Application Setup Utility	282
Testing the Auto Attendant	283
Voice Profile for Internet Mail	284
Control Parameters	285
Operations Management	285
Statistics	287
Advanced Settings	288

---

## 7 OPERATIONS

Software Upgrade	291
System Software Licensing	292
Restricted Operation	294
Considerations	294
Customer Service	295
Reboot/Shutdown	295
Manage Data	296
Backup	296
Restore	299
Convert Database	300
Purge Database	300
Purge Database and CDR	300
Purge All Voice Mail	300
Event Log	300

Licenses	301
Add a License	302
Remove a License	302
Usage Report	302
Backing Up Licenses	302
Restoring Backed-Up Licenses	302
Obtaining Details of License History	303
Regional Software	303
Install	303
Remove	303
Details	304
Third-Party Drivers	304
NBX Software Upgrades	305
Third-Party Telephone Groups	305

---

## **8 REPORTS**

Directory	307
Device List	308
System Data	308
Disk Status	308
Power Supply Status	308
Call Reporting	309
Windows Environment Specifications	309
Installing Call Reports	310
Configuring Call Reporting	310
Purge CDR	310

---

## **9 DOWNLOADS**

Software	311
LabelMaker	312
NBX Documentation and Quick Reference Guides	314

---

## **10 TROUBLESHOOTING**

- Overview 315
- Using the Telephone Local User Interface Utility 316
- Using H3PingIP 325
- System-level Troubleshooting 326
  - Digital Line Card Troubleshooting 329
  - Alarm Conditions (Overview) 330
  - Alarm Descriptions 330
  - Alarms on NBX Digital Line Cards 331
  - Configuration and Status Reports 332
- Connecting a Computer to a Serial Port 339
- Servicing the Network Call Processor Battery 341
- Getting Service and Support 341

---

## **A INTEGRATING THIRD-PARTY MESSAGING**

- Installing Software on the Third-Party Messaging Server 343
- Configuring the NBX System 343
- Configuring NBXTSP on the Server 345

---

## **B ISDN COMPLETION CAUSE CODES**

---

## **C CONFIGURING OPTION 184 ON A WINDOWS 2000 DHCP SERVER**

- Overview 353
- Creating Option 184 354
- Editing Option 184 Values 354
- Activating Option 184 355

---

## **D CONNEXTIONS H.323 GATEWAY**

- Overview of ConneXtions 358
- Installation Requirements 358
  - WAN Router 358

Windows-based System	359
ConneXtions Software	362
Preparing for Installation	362
Assembling System Information	362
Verifying the G.723 Converter	363
Checking Service Pack (Windows NT Only)	363
Configuring Licenses	363
Installing ConneXtions	365
Finishing the Installation	367
Overview of H.323	368
Negotiated Connections	368
Negotiated Voice Compression	369
Standard Extensions	370
Remote Internet Device Connections	370
The H.323 Connection	371
Connection Considerations	372
Overall Connectivity	372
Quality of Service	373
Quality of Service Control	376
Special Issues	378
Firewall Security	378
Gateway Load	380
Remote Access	380
PBX Connections	381
Class of Service	384
IP Type of Service and Differentiated Services	384
Alternate Gatekeepers	384
Checking Connections	384
Gateway Checks	385
Network Checks	385
Placing Calls	389
IP Address Entry	389
Speed Dials	391
One Button Access	392
Entering Digits During Calls	393
Receiving Calls	393
Auto Attendant	394
Attendant Console	395

Other Extensions	395
Handling Conference Calls	396
Related H.323 Documentation	396

---

## **E CALLER ID**

Forwarded Calls and Caller ID	397
Long Caller ID Character Strings	397
Specific Caller ID Situations	398
Analog Telephones	398
Bridged Extension Telephones	399
Calls That Are Forwarded Multiple Times	399
External Calls	399
Internal Calls	401
Nortel Phones	401
Parked Calls	401
Second Incoming Call	401
TAPI Calls	401
TAPI Redirected Calls	401
VTL Calls	401
Calls Transferred to Hunt Groups	401

---

## **GLOSSARY**

---

## **INDEX**

---

## **FCC CLASS A VERIFICATION STATEMENT**

---

## **INDUSTRY CANADA NOTICE**

---

## **3COM END-USER SOFTWARE LICENSE AGREEMENT TERMS AND CONDITIONS AND LIMITED WARRANTY**

# ABOUT THIS GUIDE

This guide describes how to configure and manage the SuperStack® 3 NBX® and the NBX® 100 Networked Telephony Solutions. For information about installing either system for the first time, see the *NBX Installation Guide*.



*If the information in the release notes differs from the information in this guide, follow the instructions in the release notes. Release notes are available on the NBX Resource Pack CD and the 3Com Partner Access Web Site.*

---

## How to Use This Guide

[Table 1](#) can help you find information in this guide.

**Table 1** Overview of This Guide

<b>If you are looking for</b>	<b>Turn to</b>
An overview of the NBX systems	<a href="#">Chapter 1</a>
How to prepare and configure the dial plan	<a href="#">Chapter 2</a>
How to configure devices	<a href="#">Chapter 3</a>
How to configure user settings	<a href="#">Chapter 4</a>
How to configure system settings	<a href="#">Chapter 5</a>
How to configure NBX Voice Messaging (voice mail), the Auto Attendant, and Voice Profile for Internet Mail (VPIM)	<a href="#">Chapter 6</a>
Basic operations information	<a href="#">Chapter 7</a>
How to create reports	<a href="#">Chapter 8</a>
How to download software and label makers	<a href="#">Chapter 9</a>
Troubleshooting information	<a href="#">Chapter 10</a>
Using a third-party messaging system	<a href="#">Appendix A</a>
Information about ISDN Completion Cause Codes	<a href="#">Appendix B</a>
How to configure Option 184 on a Windows 2000 DHCP server	<a href="#">Appendix C</a>
How to configure 3Com ConneXtions software	<a href="#">Appendix D</a>

**Table 1** Overview of This Guide

If you are looking for	Turn to
Caller ID behavior	<a href="#">Appendix E</a>
Definitions of telephony and networking terms	<a href="#">Glossary</a>
References to all topics in this book	<a href="#">Index</a>
FCC and Industry Canada information, Software End-User License Agreement, and Limited Warranty for Software and Hardware	End of the book

## Conventions

[Table 2](#) lists conventions that are used throughout this guide.

**Table 2** Notice Icons

Icon	Notice Type	Description
	Information note	Information that describes important features or instructions.
	Caution	Information that alerts you to potential loss of data or potential damage to an application, device, system, or network.
	Warning	Information that alerts you to potential personal injury.

## International Terminology

[Table 3](#) lists the United States and international equivalents of some of the specialized terms that are used in the NBX documentation.

**Table 3** International Terminology

Term used in U.S.	Term used outside the U.S.
Toll restrictions	Call barring
Pound key (#)	Hash key (#)
CO (central office)	Telephone Exchange
Toll-free	Free-phone
Analog Line Card	Analog Trunk Line Interface Module

---

## Your Comments

Your suggestions are important to us. They help us to make the NBX documentation more useful to you.

Send comments about this guide or any of the 3Com NBX documentation and Help systems to:

[Voice\\_TechComm\\_Comments@3com.com](mailto:Voice_TechComm_Comments@3com.com)

Please include the following information with your comments:

- Document title
- Document part number (found on the front page)
- Page number

Example:

*NBX Administrator's Guide*

Part Number 900-0156-01 Rev AA

Page 25



*As always, address all questions regarding the NBX hardware and software to your authorized 3Com NBX Voice - Authorized Partner.*



# 1

## INTRODUCTION

The *NBX Administrator's Guide* explains how to configure your NBX® system. This chapter covers these topics:

- [Network-based Telephony](#)
- [Overview of the System Software](#)
- [NBX NetSet Administration Utility](#)
- [NBX NetSet Features](#)



*For information about installing hardware components, see the NBX Installation Guide.*

---

### Network-based Telephony

3Com Networked Telephony Solutions merge telephony with networking by delivering business telephone service over a data network.

To a telephone user, an NBX Telephone is an office telephone. You can use it to make and receive calls, transfer calls, park calls, use voice mail, and so on. Inside, the NBX Telephone is a network device that can communicate over the LAN using Ethernet frames or IP packets. The telephone also includes a LAN port. You can connect your computer to your network through the telephone and avoid the need for a second LAN connection at the desktop.

The core of 3Com Networked Telephony Solutions is the *Network Call Processor* (NCP). The NCP manages the processes of making and receiving calls, providing voice mail and auto attendant services, and responding to requests for special services, such as access to the NBX NetSet administration utility, Computer Telephony Integration (CTI) services, or the system's IMAP (Internet Message Access Protocol) server.

The NBX system provides the reliability required in a business environment because NBX system voice traffic is independent of computer traffic on the same network. In fact, after the NCP completes

the processing required to connect two telephones, the telephones communicate directly with each other. Therefore, existing conversations are not affected if power to the NCP fails.

---

## Overview of the System Software

This section describes the major features of the NBX system.

### Auto Attendant

With the Auto Attendant, a full-featured call answering service, you set up automated call answering, including multiple Auto Attendants, each with separate menu structures, to manage incoming calls.

### Auto Discovery and Auto Relocation

The Network Call Processor and the NBX Telephones communicate with each other to streamline configuration. When you connect a new telephone, the system discovers it and adds it to the configuration database. The communication between devices means that if telephone users move their telephones to a new location, the telephones retain their extension number and personal settings. You do not have to change telephone addresses and data for them.

### Virtual Tie Lines

You can connect two or more NBX systems that are connected to your Wide Area Network. Calls made over Virtual Tie Lines incur no toll charges. G.729 compression allows you to make the most of your bandwidth.

### Integrated Voice Mail and Messaging Features

NBX Voice Messaging is a standard feature of the 3Com Networked Telephony Solution. Voice Messaging supports Off-Site Notification, which alerts you if you receive new voice messages when you are out of the office. Voice Messaging also includes an IMAP (Internet Message Access Protocol) mail server that allows you to retrieve voice mail messages through any IMAP4-compatible e-mail client.

### Standard NBX Telephone Features

NBX systems support the standard features, such as call park, conference, speed dial, and paging, that you expect in a business telephone system.

- Redialing From Call Logs** In an NBX Telephone display panel, you can view logs of recent Missed Calls, Answered Calls, and Dialed Calls. You can select and redial a call from any of these lists, as well as from the directory of internal users, your personal speed dial list, or the system-wide speed dial list.
- Calling Line Identity Restriction (CLIR)** When an NBX Telephone user makes a call on an ISDN channel, the receiving party can see the identity of the caller (normal ISDN behavior). When the NBX option Calling Line Identity Restriction (CLIR) is enabled, the receiving party cannot see your identity when you call.
- Computer Telephony Integration (CTI) Connectivity** 3Com Networked Telephony Solutions provide a software-based CTI solution through the Microsoft Telephony Applications Programming Interface (TAPI). Your telephone and your computer connect to the same LAN so that your computer does not need any special hardware, such as proprietary cards. The NBX system works with TAPI 2.X-compliant CTI applications.
- Call Recording** You can integrate a third-party call recording system into your NBX system so that selected calls can be recorded. (Optional license required.)
- NBX Call Reports** NBX Call Reports, a Windows client program, is a standard feature of 3Com Networked Telephony Solutions. Call Reports allows you to save calling data about inbound and outbound calls, present it in a report, or export it to spreadsheets, word processors, or reporting programs.
- NBX Resource Pack CD** 3Com Networked Telephony Solutions include the *NBX Resource Pack CD* with the most recent system software for backup and upgrade purposes, optional software, and electronic versions of system documentation.
- Support for Multiple Languages** The NBX system's Administrator Help is in English, by default, but the User side of the NetSet administration utility's Help system can be configured for other languages. In addition, the three telephone Quick Reference Cards, the *NBX Telephone Guide*, and the Auto Attendant and system prompts are available in multiple languages on the *NBX Resource Pack CD*.

## NBX NetSet Administration Utility

The NBX NetSet utility is a web interface in which you configure and manage the NBX system. You need Microsoft Internet Explorer (version 5.5 or later is optimal) to administer the system. You do not need Internet access to use the NBX NetSet utility.

[Figure 1](#) shows the NBX NetSet - Main Menu window, which appears when you log on to the NBX NetSet utility.

**Figure 1** NBX NetSet - Main Menu Window

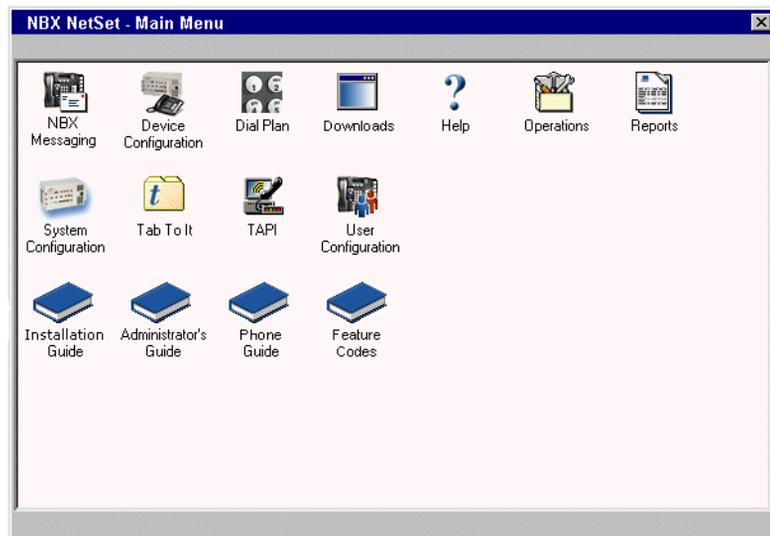

NBX systems present the NBX NetSet utility through an embedded web server that is integrated in system software. NBX NetSet passwords grant system administrators and users different levels of access privileges.

Individual telephone users can view or change their personal settings such as personal speed dial lists, off-site notification settings, and ringing tones.

System administrators can manage user profiles and devices, change system parameters, such as speed dial lists and dial plan settings, and upgrade the system software.

## NBX NetSet Features

[Table 4](#) describes the features that administrators can access through the NBX NetSet - Main Menu window.

**Table 4** NBX NetSet Features for the NBX Administrator

Icon	Description
 NBX Messaging	Configure and manage system-wide NBX Voice Messaging, Auto Attendants, and VPIM settings. If you install a license for a third-party messaging application and disable NBX Messaging, this icon is not available.
 Device Configuration	Configure and manage NBX devices, such as: <ul style="list-style-type: none"> <li>■ Telephones and telephone groups</li> <li>■ Analog Line Cards</li> <li>■ Digital Line Cards (T1, E1, and BRI-ST cards)</li> <li>■ Analog Terminal Adapters (ATAs)</li> <li>■ Call Park</li> <li>■ Attendant Consoles</li> <li>■ Virtual Tie Lines</li> </ul>
 Dial Plan	Configure and manage your system Dial Plan.
 Downloads	Download, install, configure, and manage additional system features, such as: <ul style="list-style-type: none"> <li>■ Optional NBX software, such as NBX Call Reports and TAPI software</li> <li>■ LabelMaker utility for telephones and NBX Attendant Consoles</li> <li>■ <i>Quick Reference Guides</i> for the NBX Business and Basic Telephones, and analog telephones on the NBX system</li> <li>■ NBX manuals including the <i>NBX Installation Guide</i>, <i>NBX Administrator's Guide</i>, <i>NBX Telephone Guide</i>, and <i>NBX Feature Codes Guide</i></li> </ul>

**Table 4** NBX NetSet Features for the NBX Administrator (continued)

Icon	Description
 Operations	<p>Configure and manage these system-level operations:</p> <ul style="list-style-type: none"> <li>■ Upgrading software</li> <li>■ Rebooting and shutting down the NBX system</li> <li>■ Managing data (backup and restore)</li> <li>■ Viewing and managing event log files</li> <li>■ Viewing and adding licenses for optional features</li> <li>■ Setting regionally different information (voice-prompt language, dial tones and cadences, and documentation language)</li> <li>■ Installing third-party drivers (for example, for telephones other than NBX Telephones)</li> </ul>
 Reports	<p>View and manage system reports:</p> <ul style="list-style-type: none"> <li>■ Directory lists of users</li> <li>■ Device List</li> <li>■ System Data</li> <li>■ Call Reporting</li> </ul>
 System Configuration	<p>Configure and manage the system-level settings for:</p> <ul style="list-style-type: none"> <li>■ System Settings</li> <li>■ Audio Settings including compression and silence suppression</li> <li>■ System-wide Speed Dials</li> <li>■ Business Identity</li> <li>■ Security</li> <li>■ TAPI Settings</li> </ul>
 TAPI	<p>Configure settings for TAPI (Telephony Applications Programming Interface). (Can also be configured from the System Configuration icon.)</p>
 User Configuration	<p>Configure and manage:</p> <ul style="list-style-type: none"> <li>■ Users</li> <li>■ Call Pickup Groups</li> <li>■ TAPI Route Points</li> <li>■ Hunt Groups</li> <li>■ Class of Service (CoS) Settings for users</li> </ul>

[Table 5](#) describes the additional icons that appear on or below the NBX NetSet - Main Menu window. They are shortcuts to specific areas within the NBX NetSet utility and to some of the online documentation.

**Table 5** NBX NetSet Shortcuts

Icon	Description
 Help	The Help icon in the <i>NBX NetSet - Main Menu</i> window provides access to the Contents, Index, and search features of the online Help system. The Help icon on individual dialog boxes takes you directly to content-specific Help in addition to accessing the global Help features.
 Tab To It	Displays Tab To It, a window that shows all the tabs for the entire system. Click on a tab in the Tab to It window to go directly to that tab's interface. The Tab To It icon also appears on most dialog boxes throughout the NBX NetSet utility.  If you install a license for a third-party messaging application, the tab for NBX Messaging is disabled in the Tab To It window
 Installation Guide	Opens the online (PDF) version of the <i>NBX Installation Guide</i> . This icon is available in the <i>NBX NetSet - Main Menu</i> window only.
 Administrator's Guide	Opens the online (PDF) version of the <i>NBX Administrator's Guide</i> (this book). This icon is available in the <i>NBX NetSet - Main Menu</i> window only.
 Phone Guide	Opens the online (PDF) version of the <i>NBX Telephone Guide</i> . This icon is available in the <i>NBX NetSet - Main Menu</i> window, and below the User Settings window when users log on to the NBX system.
 Feature Codes	Opens the online (PDF) version of the <i>NBX Feature Codes Guide</i> . This icon is available in the <i>NBX NetSet - Main Menu</i> window, and in the User Settings window when users log on to the NBX system.
	Returns you to the <i>NBX NetSet - Main Menu</i> window.





# DIAL PLAN

The NBX system's *dial plan* determines how the system handles calls. It defines the set of destinations that the system can reach, how to get to these destinations, and which telephone numbers to dial to reach these destinations. This chapter provides information about understanding, developing, and managing the dial plan. It covers these topics:

- [Dial Plan Concepts and Overview](#)
- [Dial Plan Tables](#)
- [Dial Plan Pretranslators](#)
- [Managing the Dial Plan Configuration File](#)
- [Outdialing Prefix Settings](#)
- [Managing Extensions](#)
- [Managing Extension Lists](#)
- [Managing Dial Plan Tables](#)
- [Managing Dial Plan Pretranslators](#)
- [Configuring the Dial Plan for the 4ESS Protocol \(T1\)](#)
- [Overview of Voice Profile for Internet Mail](#)
- [Configuring the Dial Plan for VPIM](#)
- [Configuring VPIM Parameters](#)
- [Overview of Virtual Tie Lines](#)
- [How to Configure a Virtual Tie Line](#)
- [Call Rerouting for Virtual Tie Lines](#)
- [Managing Existing Virtual Tie Lines](#)
- [Using a VTL Password](#)
- [Dial Plan Configuration File Commands](#)
- [Sample Solutions Using Dial Plan Configuration File Commands](#)

## Dial Plan Concepts and Overview

The dial plan configuration file is an ASCII text file that implements the dial plan and specifies pretranslation (digit manipulation). The system is shipped with several default dial plan configuration files, typically, a 3-digit and a 4-digit file for each supported country.

The dial plan configuration file includes several tables:

- **Internal** — Must be table ID 1
- **Incoming** — Must be table ID 2
- **Least Cost Routing** — Must be table ID 3
- **Routes**
- **Pretranslators**

You can create additional tables if necessary.

Each dial plan table consists of a series of entries, each of which includes a sequence of digits and the action to be performed by the NBX system in response to sending or receiving those digits. For more information on the Internal, Incoming, and Least Cost Routing dial plan tables, see [“Dial Plan Tables”](#) on [page 33](#).



*Usually, you access the dial plan configuration file and manage dial plan operations, tables, pretranslators, and extension lists through the NBX NetSet administration utility. If your dial plan is larger than 32,000 characters, however, you cannot edit the dial plan using the NBX NetSet utility. You must export the dial plan, edit it, and then import it.*

Before you configure the dial plan, please be sure that you understand these concepts:

- [Call Process Flow](#) ([page 29](#))
- [Inbound and Outbound Call Processing](#) ([page 29](#))
- [NBX System Database](#) ([page 30](#))
- [NBX System Dial Plan](#) ([page 30](#))
- [Pretranslation](#) ([page 31](#))
- [Routing](#) ([page 31](#))

In addition, be sure to understand how the dial plan configuration file can affect other parts of the NBX system. See [“System Features Affected by the Dial Plan Configuration”](#) on [page 32](#).

**Call Process Flow** The dial plan configuration file is a key component of inbound and outbound call processing. The dial plan tables in the configuration file process *incoming* calls in this order:

- 1 Incoming Dial Plan Table
- 2 Pretranslator Table

The dial plan tables process *outgoing* calls in this order:

- 1 Internal Dial Plan Table
- 2 Least Cost Routing Table

After pretranslation (if performed), the final translation process routes the call to the destination.

### **Inbound and Outbound Call Processing**

The system routes all inbound and outbound calls through the dial plan.

#### **Inbound Call Processing**

The system processes inbound calls using the *Incoming* table. The system can also use *pretranslators* to perform digit manipulations on incoming calls before it uses the Incoming table.

Each pretranslator operation performs a digit manipulation operation on the dialed digits. For incoming calls, if the DID/DDI range matches the internal extensions, the dial plan requires no pretranslator. However, you can use pretranslators to map nonmatching dialed numbers on an incoming DID/DDI channel to desired internal extensions. See the example in Customer Requirement 1 in [“Sample Solutions Using Dial Plan Configuration File Commands”](#) on [page 120](#).

#### **Outbound Call Processing**

The system processes outbound calls using the *Internal* dial plan table or the *Least Cost Routing* table.

You can add entries to the Internal dial plan table to match the system to your service. See Customer Requirement 2 in [“Sample Solutions Using Dial Plan Configuration File Commands”](#) on [page 120](#).



*If you have entries in both the Least Cost table and the Internal table for the same purpose, the behavior of the dial plan can be confusing. 3Com recommends that you accomplish least cost routing using Internal Table*

entries. For more information, see [TimedRoute Create](#), [TimedRouteEntry Create](#), and [TimedRouteOperation Create](#) later in this chapter.

### **NBX System Database**

The NBX system database contains a default dial plan that is initially loaded at the factory and is reloaded if you purge the database. The default dial plan for the SuperStack 3 NBX system is a 4-digit plan; for the NBX 100, it is a 3-digit plan.

Changes that you make to any system settings, including changes made by importing a modified dial plan configuration file, are stored in the database. When you reboot the system, it loads the database with any changes that you have made. The NBX system database includes all of the settings necessary for system operation.

### **NBX System Dial Plan**

You can import a dial plan configuration file to provide the system with a set of operating instructions for managing the telephone system. Alternatively, if you have made changes to the currently loaded instructions through the NBX NetSet utility, you can export the dial plan configuration file to save it. You can also make changes by editing the configuration file off-system, using any ASCII editor, and then importing the modified file. You can easily reuse a given configuration file on many systems. For more information, see [“Importing and Exporting Dial Plan Configuration Files”](#) on [page 45](#).

The system is shipped with several default dial plan configuration files, typically, a 3-digit and a 4-digit file for each country that is supported. In addition, the file `samples.txt` contains several examples that illustrate how you can configure the dial plan configuration file to control how the system manages incoming and outgoing calls.

Normally, you completely configure a dial plan before you start to use the system to control the telephones. Although you can make changes later, major changes in the dial plan can disrupt the system.

Decide whether you want to use a 3-digit or 4-digit dial plan before you create the dial plan, autodiscover, or manually add telephones or other devices to the NBX system.

When you import a dial plan, some parameters of the system change immediately. Others change only when you reboot the NBX system. 3Com recommends that you reboot the NBX system each time that you change the dial plan.



*Rebooting the system disrupts service to the telephones. Plan to reboot at a time that does not inconvenience telephone users.*

## Pretranslation

*Pretranslation is the process of translating (or manipulating) dialed digits before they are passed to the appropriate dial plan table for subsequent routing. You can set the dial plan to perform pretranslation on incoming or outgoing calls. For more information, see [“Dial Plan Pretranslators”](#) on [page 40](#).*

## Routing

*Routing specifies how a call reaches a destination. You define the routes for the system to use in the Routes section of the dial plan configuration file.*



*When you define call routing, you can also instruct the system to perform pretranslations (digit manipulations). Both destination routes and timed routes have digit manipulation operations (append, prepend, replace, stripLead, or stripTrail).*

The system passes dialed digits first through the device's Least Cost Routing table (if there is one). If the system finds no entry there, it then uses the Normal dial plan table. If it does find an entry in the Least Cost Routing table, it attempts to use that entry and, even if the attempt is unsuccessful, it does *not* use the Normal table.

You can route incoming calls to the Auto Attendant port, and you can instruct the Auto Attendant to route these calls to any internal or external number.



**CAUTION:** *If you configure the Auto Attendant so that it can access any external number, you risk the possibility of toll fraud. You can reduce the possibility of toll fraud by explicitly putting specific external numbers into the outgoing dial plan table. This precaution prevents outside callers from dialing any external number except the ones that you define.*

There are two types of routes:

- **Destination routes** — Specify the extension of a destination device. They can also perform digit manipulation operations on the dialed digits that resulted in the selection of this route before those digits are dialed on the destination device.
- **Timed routes** — Specify time of day and day of week criteria which, when met, result in a particular destination route being selected.



**CAUTION:** *If you operate the NBX system in Keypad Mode, routes are not applicable.*

For more information, see [“DestinationRoute Create”](#) on [page 107](#), [“TimedRoute Create”](#) [page 116](#), and related entries under [“Dial Plan Configuration File Commands”](#) on [page 105](#).

### **System Features Affected by the Dial Plan Configuration**

The dial plan configuration affects several system features:

- [Keypad Mode Operation Using the Dial Plan](#)
- [Hybrid Mode Operation Using the Dial Plan](#)
- [Off-Site Notification](#)

#### **Keypad Mode Operation Using the Dial Plan**

If you map any telephone buttons that have LEDs to specific Analog Line Card ports, you enable Keypad mode in the NBX system. Instead of dialing a single digit (typically 8, 9, or 0) before placing an outside call, the user presses a button to select an available Analog Line Card port. The user defines the routing (that is, the selection of a destination device) by pressing the button to select the Analog Line Card port; however the NBX system controls the call using the dial plan.



*You cannot map a digital line extension in Keypad mode.*

The NBX system applies any Class of Service restrictions that are associated with the user's telephone to determine whether to make a call. The system also uses any pretranslator that a device uses and performs any required digit manipulation operations before it actually transmits the digits on the Analog Line Card or Digital Line Card port.

#### **Hybrid Mode Operation Using the Dial Plan**

If you map telephone buttons for some telephones but not others, you enable Hybrid mode (a mixture of standard and Keypad behaviors). The system provides a system-wide External Prefix setting, which allows the administrator to establish a prefix.

#### **Off-Site Notification**

The NBX system uses off-site notification to notify users when new voice mail messages arrive. You can define notification devices and assign them in the Internal dial plan as well as through the NBX NetSet utility.

**Example:** When voice mail arrives, the NBX system dials the telephone number of the user's pager. Typically, you use a system-wide prefix to designate the device or devices you want to use for outdialing purposes, including off-site notification calls.

**Example:** If the user's pager number is 800-555-3751, and the system-wide prefix digit is 9, the system dials 98005553751 to send a call to the user's pager.

To tell the system to dial a single Line Card port or a restricted number of Line Card ports, create a suitable pool of Line Card ports for that purpose, and then use an existing set of dial plan table entries (such as the entries that begin with 8) or create a new set of entries to allow the dial plan devices to route calls via the selected line card ports.

**Example:** You set up one 4-port card to handle all off-site notification calls. You create a set of entries in the Internal dial plan table that each start with the digit 8. You define a route to the 4-port card for all of these dial plan entries so that whenever the system acts on one of these entries, it uses one of the 4 ports on that card to dial out and notify the user.

To apply different off-site CoS restrictions to different users, you need multiple dial plan entries. If you are not trying to apply the CoS restrictions, then a single dial plan entry is sufficient.

---

## Dial Plan Tables

Dial plan tables contain information that controls how the system routes calls. Each dial plan configuration file consists of at least three dial plan tables. This section discusses these topics:

- [Dial Plan Command Format](#)
- [Internal Dial Plan Table](#) — Must be table ID 1
- [Incoming Dial Plan Table](#) — Must be table ID 2
- [Least Cost Routing Dial Plan Table](#) — Must be table ID 3
- [Adding New Dial Plan Tables](#)



**CAUTION:** Tables 1, 2, and 3 must exist. Do **not** delete them. You may create additional dial plan tables if necessary, but they must be numbered 4 or higher.

If the Least Cost Routing table exists, it takes precedence over the Internal table. If the system cannot find a Least Cost Routing table, it attempts to

find a corresponding entry in the Internal table. If you have entries for the same purpose in both the Least Cost and Internal tables, the behavior of the dial plan can be confusing.

See [“Dial Plan Command Format”](#) next for a description of dial plan command syntax and structure. For a complete list and description of dial plan commands, including command arguments and examples, see [“Dial Plan Configuration File Commands”](#) on [page 105](#).

### **Dial Plan Command Format**

Each dial plan table contains a sequence of commands. These commands collectively determine how calls are handled.

Most of the dial plan commands have a very similar format, as shown in [Figure 2](#).

**Figure 2** Dial Plan Command Format

Labels in the diagram:

- Leading Digits to Collect
- Table Entry ID Number
- Table Name
- Table ID Number
- Command
- Call Classification — Used with Class of Service
- Maximum and Minimum Characters to Collect
- Priority (Not Used)
- Number of the route (dial tone facility) from Routing Tables

```

Table Create 1 Internal
/
/
TableEntry Create 1 1 0
TableEntry Create 1 2 1
TableEntry Create 1 3 2

Table Create 2 Incoming
/
/
TableEntry Create 2 1 0
TableEntry Create 2 2 1

Table Create 3 Least Cost Routing
/
TableEntry Create 3 1 91607387
  
```

	Id	Entry	Digits	Min	Max	Class	Prio	Route
<b>Table Create 1 Internal</b>								
/								
/								
TableEntry Create	1	1	0	1	1	Internal	0	4
TableEntry Create	1	2	1	3	3	Internal	0	0
TableEntry Create	1	3	2	3	3	Internal	0	0
<b>Table Create 2 Incoming</b>								
/								
/								
TableEntry Create	2	1	0	1	1	Internal	0	4
TableEntry Create	2	2	1	3	3	Internal	0	0
<b>Table Create 3 Least Cost Routing</b>								
/								
TableEntry Create	3	1	91607387	12	12	LongDistance	0	10

[Table 6](#) describes each field of a dial plan command.

**Table 6** Dial Plan Command Fields

Field	Description
Command	Command name. For example, TableEntry Create is the command that makes Class of Service and call routing decisions based on the correspondence of dialed digits and table entry digits. See <a href="#">"Dial Plan Configuration File Commands"</a> later in this chapter for a description of each command.
Table ID Number	Table ID number. This is always 1 for the Internal dial plan table, 2 for the Incoming dial plan table, and 3 for the Least Cost Routing Table.

**Table 6** Dial Plan Command Fields (continued)

Field	Description
Table Entry ID Number	Table entry number (a unique number for each entry in the table). These numbers are usually in ascending order in the table, but you can change the order. For example, you might want to place a new item near other items of the same type (that begin with the same digit) in order to help you when you troubleshoot the configuration file.
Digits	<p>One or more digits that begin the dial sequence. Either single or multiple entries can start with the same digit. The system uses this field in conjunction with Min and Max to determine when to make the call routing decision.</p> <p>Most sample tables have a single entry for digit 0 (zero) to specify how the system handles a telephone number which has zero as the first digit.</p> <p>If you want the system to handle calls differently, depending on whether they start with 90 or 91, you must have one entry in the table for each of these 2-digit sequences.</p>
Min	Minimum number of digits that the system collects before routing the call.
Max	Maximum number of digits the system collects before routing a call.
Class	<p>Class of Service (CoS). The system uses this information to decide whether a caller is allowed to make this specific type of call. The possible classifications are:</p> <p>Internal, Local, LongDistance, International, WAN, Toll- Free, Emergency, COCode, Wireless, Toll, Operator, AlternateLong, TrunkToTrunk, Diagnostics, NotAllowed, Other</p> <p>Each of these values corresponds to a selection in the NBX NetSet utility.</p>
Priority	Priority number. This field is not used at this time, but must be present and should always be 0 (zero).
Route	Route number. This identifies an entry in the Routes section of the dial plan. Zero is a typical value for internal calls, and indicates that this call uses no route, in which case, digits are transmitted as soon as they are dialed.



*If a new entry in the Internal table appears not to work, it is possible that the system is using an entry from the Least Cost table instead. To avoid such conflicts, you can accomplish least cost routing using only the Internal table. 3Com strongly recommends that, to keep the dial plan as simple as possible, you use only the Internal table for least cost routing.*

For more information on how to use the dial plan configuration file, see [“Managing the Dial Plan Configuration File”](#) on [page 44](#).

### Basic Dial Plan Table Examples

These examples describe the basic operation of a dial plan table.

**Example:** If you are using a 4-digit dial plan and the telephone extensions start with 2, then the table entry with 2 in the *Digits* column typically has 4 in the *Min* column. Before making a decision, the system

would collect all 4 digits of the extension. If the caller dials fewer than the Min number of digits, the system times out in 20 seconds.

**Example:** If Digits = 2, Min = 4, and Max = 4, the system knows that if the first digit is 2, it must collect no less than 4 and no more than 4 digits before making the call routing decision.

If the caller dials at least the minimum number of digits and not more than the maximum number of digits, the system waits 5 seconds and then routes the call based on the digits dialed. If the caller dials more than the maximum number of digits, the system attempts to place the call.

Often, Max value and the Min value are identical, because you want the system to collect a specific number of digits, no more and no less.

**Example:** For internal extensions, you want the system to collect exactly 3 digits (4 in a 4-digit dial plan) before making a decision, so you would set both Min and Max to 3 (4 in a 4-digit dial plan).

The two columns may be different if the table entry applies to more than one situation.

**Example:** In the United States, the Min value for the 90 entry is 2, because 90 allows an internal caller to reach a telephone company operator (9 to get an outside line, and then 0 to get the operator). The Max value is 64, because the caller can continue to dial after the zero, entering a number to call, plus a telephone credit card number, and possibly an identification code number.

If the caller dials only 90 (which satisfies the minimum of two digits) and stops dialing, the system waits for 5 seconds. If no other digits are entered, the system connects the caller to the operator.

If other digits are dialed, the system accepts them up to the limit of 64. If the caller stops after dialing fewer than 64 digits, the system again waits 5 seconds before acting on the dialed sequence of digits.

**Example:** You can assign a new employee to the *Default User Group*. You can then set the permissions for that group so that group members have permission to make *LongDistance* calls when the system mode is Open or Lunch, but not when the system mode is Closed or Other.

**Example:** You can assign the company's Vice President of Finance to a group that you name the *All Privileges Group*. You can set the permissions for that group so that group members have permission to make *LongDistance* calls during all system modes.

### Internal Dial Plan Table

The Internal dial plan table (table ID 1) defines how to handle calls placed from internal devices, such as NBX Business or Basic Telephones, to a destination. A destination can be another internal device, such as a local telephone, or an external telephone line (Analog Line Card or Digital Line Card) that connects the NBX system to other facilities.

The Internal dial plan table consists of a series of commands. For an example of the command format, see [“Dial Plan Command Format”](#) earlier in this chapter. [Table 6](#) on [page 35](#) describes each element of the command. [Table 7](#) describes the predefined routes.

**Table 7** Predefined Routes

Route Number	Description
1	Local CO (strip)
2	Local CO (no strip)
3	Voice Application (Auto Attendant on extension 500)
4	Attendant (person)
5	H.323 Gateway
6	Least Cost Route example
Other	User-defined routes



*You cannot delete or modify predefined routes, only create new routes.*

Each device must have a Normal table. The Least Cost Routing table is optional. Telephones use the Internal dial plan table (table ID 1) as their normal outbound table and the Least Cost Routing table (table ID 3) as their long distance routing table.

### Incoming Dial Plan Table

The Incoming dial plan table (table ID 2) defines how calls arriving from outside the NBX system are routed to extensions. Incoming calls can arrive on analog telephone lines or through Digital Line Card ports.

The incoming dial plan table consists of a series of commands. For an example and basic understanding of the command format, see [“Dial Plan](#)

[Command Format](#) on [page 34](#). For a description of the each element of a dial plan command, see [Table 6](#) on [page 35](#).

By default, Line Card ports, Digital Line Card ports, and H.323 gateways use the Incoming dial plan table as their normal dial plan table. An Incoming dial plan table typically has a more restricted list of dialable digits than the Internal dial plan table. You usually cannot dial extensions associated with internal paging or Analog or Digital Line Card ports.

### Least Cost Routing Dial Plan Table

The Least Cost Routing table (table ID 3) defines how to route calls in order to minimize the cost of those calls.

**Example:** You might use two different long distance carriers, one for a specific geographic region, and one for all other areas of the country. In the Least Cost Routing table, you can create entries that route calls differently for those two geographic areas. Each country uses a different method to accomplish this. In the United States, you can specify the area codes that apply to a geographic region. In France, you can specify a carrier by adding prefix digits to the telephone number.

By default, internal telephones specify the Least Cost Routing table as their least cost table. Typically, devices associated with the Incoming dial plan table (Line Card ports, Digital Line Card ports, and H.323 gateways) do not use the Least Cost Routing table.



*The Least Cost Routing table is optional. If it does not exist, the system uses the Internal table routing destinations. If you have entries in both the Least Cost and Internal tables for the same purpose, the behavior of the dial plan can be confusing. Therefore, 3Com recommends that you accomplish least cost routing using Internal Table entries. See [TimedRoute Create](#), [TimedRouteEntry Create](#), and [TimedRouteOperation Create](#).*

**Example:** If a new entry in the Internal table appears not to work, it is possible that the system is using an entry from the Least Cost table instead. To avoid such conflicts, accomplish least cost routing using only the Internal table. 3Com strongly recommends that you keep the dial plan as simple as possible by using only the Internal table.

## Adding New Dial Plan Tables

If you are sharing the system with another company or group and want to control calls differently at the two sites, you can add a fourth table.

**Example:** You assign one extension range to Company A and a different range to Company B. The fourth table controls the extension range for Company B, so that outbound calls from Company B's extensions use only their external telephone lines.

You might also need a fourth table if a single company had two sites but only one NBX system. In order to properly route emergency (911) calls, you use the fourth table to define which extensions use each dedicated 911 telephone line.

**Example:** Users at site A dial 911 and the system uses the Internal table (table ID 1) to make the emergency call on one external telephone line. Users at site B dial 911 and the system uses table ID 4 to make the emergency call on a different external telephone line. The emergency staff know, based on the dialing number, which site has the emergency.

Enhanced 911, E911, is available in some areas. This service enables emergency staff to identify the specific location of the emergency. For example, in a campus of buildings, the emergency staff can identify the specific building, floor, and location from which the emergency call originated. The NBX system supports E911 over ISDN. The administrator must define an outbound call pretranslator to provide the specific extension number from which the 911 call originated.

---

## Dial Plan Pretranslators

The system uses pretranslators to modify digit sequences of incoming or outgoing calls. On incoming calls, pretranslators can map the entire dialed number (including area code) to an internal extension number. For example, an external party dials 978-555-0101 to reach the person on extension 101. Pretranslators ensure that the proper digits are mapped to the correct extension number.

For more information, see:

- [Pretranslators for Incoming Calls](#) on [page 41](#)
- [Pretranslators for Certain Outgoing Calls](#) on [page 42](#)

A typical pretranslator function involves mapping incoming DDI/DID telephone calls to internal extension numbers.

**Example:** Say that the DDI/DID (Direct Inward Dial/Direct Dial Inward) telephone numbers range from 508-555-4200 through 508-555-4299. The telephone company sends you the last 4 digits of the total telephone number. Internally, you want to use extensions 2000 through 2099. You can define a pretranslator to:

- Remove (stripLead) the first two digits of the incoming 4-digit sequence.
- Add (prepend) the digits 20 in front of the remaining 2 digits.

See [“Managing Dial Plan Pretranslators”](#) on [page 64](#) for detailed information and examples on creating and managing dial plan pretranslators.

## Pretranslators for Incoming Calls

For incoming calls, pretranslation reformats the dialed number *before* it is passed to the Incoming dial plan table (Table ID 2). See [“Incoming Dial Plan Table”](#) on [page 38](#). For information on how to properly handle caller ID information over incoming VTL calls, see [“Creating a Pretranslator for VTL Calls”](#) on [page 65](#).

### Incoming Pretranslator Example 1

If, for an incoming telephone call, the telephone company passes you 4-digit numbers from 6100 through 6199, the system can use a pretranslator to remove the first digit; the remaining 3 digits can then be used as internal extension numbers in a 3-digit dial plan. Tell the system which pretranslations that you want to perform by defining digit manipulation operations (*append*, *prepend*, *replace*, *stripLead*, or *stripTrail*) within the *PreTranslator* section of the dial plan configuration file.

### Incoming Pretranslator Example 2

Assume the telephone company passes 10-digit numbers to the system for each incoming telephone call (for example, numbers in the range 4567-89-3000 to 4567-89-3500). If the system uses 4-digit extensions in the range 2000 to 2500, you could pass an incoming 10-digit number such as 4567-89-3210 to extension 2210.

This strategy requires two pretranslation operations: The first operation performs a *stripLead* operation to remove the initial 7 digits, leaving 210. The second operation *prepends* the number 2 in front of the remaining 3 digits. The result is 2210, which matches an extension within the extension range. [“Sample Solutions Using Dial Plan Configuration File”](#)

[Commands](#)” on [page 120](#) shows how to accomplish this pretranslation using the dial plan configuration file.



*Each device can specify only one DDI/DID pretranslator and one CLIP pretranslator. To create or modify a pretranslator, you either edit a dial plan configuration file and import it, or use the NBX NetSet utility and modify an existing dial plan configuration file.*



*The system performs operations in ascending order of operation ID. Operations are both sequential and cumulative.*

You can also use pretranslators with virtual tie lines to link multiple NBX systems. Incoming calls within a defined numeric range arrive at the first system, are modified through digit manipulation operations, and are then routed to a tie line connected to a second system.

Each sample dial plan that is shipped with the system includes a default pretranslator.

### Pretranslator Example 3

Assume that the telephone company passes 4-digit numbers to the system for each incoming telephone call (for example, numbers in the range 5200 through 5300). If the system uses 3-digit extensions in the range 200 through 300, you could define a single pretranslation operation to *stripLead* (remove) the first digit, for instance, the number 5 from an incoming number such as 5278, and pass the call to extension 278. [“Sample Solutions Using Dial Plan Configuration File Commands”](#) on [page 120](#) shows how to accomplish this pretranslation using the dial plan configuration file.

### Pretranslators for Certain Outgoing Calls

**On outgoing calls using an ISDN PRI card**, pretranslators allow the external called party to identify the full number of the internal calling party, including the area code. For example, if the person on extension 101 within a company calls an external number, the caller’s entire number is displayed to the called party when Calling Line ID Presentation (CLIP) pretranslators are used. Pretranslation reformats the outgoing dialed number *before* it is passed to the Internal dial plan table (Table ID 1) or possibly the Least Cost Routing table (Table ID 3). For more information, see [“Internal Dial Plan Table”](#) on [page 38](#) and [“Least Cost Routing Dial Plan Table”](#) on [page 39](#).

**Example:** If the DDI/DID telephone numbers range from 508-555-4200 through 508-555-4299, internally, you dial extensions from 2000 through 2099 to reach another internal telephone.

When you place a call to an external telephone number, the system can use these pretranslator steps to create the full 10-digit number:

- 1 Remove (*stripLead*) the first two digits (20) from the internal extension number of the telephone making the call.
- 2 Add (*prepend*) the digit sequence 50855542 to the two remaining digits, creating the full DDI/DID telephone number.
- 3 Pass the full number to the telephone company.

**Example:** To transmit Calling Line ID Presentation (CLIP) information on outgoing calls, you can define a pretranslator that transforms internal extensions into full telephone numbers (the numbers that someone external to the company uses to dial in). Assume that you are using telephone extension numbers from 1000 to 1099 and that only the last two digits match the DDI/DID numbers that are assigned to the company. You can define a pretranslator to remove (*stripLead*) the first two digits from the internal extension number and add (*prepend*) the appropriate digit string. This pretranslator constructs the full telephone number.

**Example:** If you use two different long-distance carriers at different times of the day to save costs, you can prepend different digit sequences to the outgoing dialed number to select which carrier that you want. If you prepend 1010321 between the time the business opens and 3:00 p.m., you select one long-distance carrier. If you prepend 1010220 from 3:00 p.m. until the next time the business opens (including weekends), you select the other carrier and obtain a lower rate.

To tell the system which outgoing pretranslations that you want to perform, you define digit manipulation operations (*append*, *prepend*, *replace*, *stripLead*, or *stripTrail*) in the Routes section of the dial plan configuration file. You can define these commands for both destination routes and timed routes. For more information on configuring pretranslators, see [“Managing Dial Plan Pretranslators”](#) on [page 64](#).

## Managing the Dial Plan Configuration File

This section describes the dial plan configuration file and how to manage it. From the *Operations* tab of the Dial Plan window, you can perform these tasks:

- [Accessing the Dial Plan](#)
- [Creating Dial Plan Configuration Files](#)
- [Importing and Exporting Dial Plan Configuration Files](#)
- [Importing a User-Defined Dial Plan](#)
- [Exporting \(Saving\) a Dial Plan Configuration File](#)
- [Testing a Dial Plan](#)
- [Generating a Dial Plan Report](#)
- [Modifying a Dial Plan Configuration File](#)

### Accessing the Dial Plan

To import a dial plan configuration file and modify it, select **NBX NetSet > Dial Plan > Operations**. From this tab, you can access customer-defined and default dial plans.

### Creating Dial Plan Configuration Files

The simplest way to create a new dial plan is to model it after an existing one.

- 1 Go to the *Operations* tab.
- 2 Browse for a dial plan, or select one from the list.
- 3 Click *Open* to open the file in your browser.
- 4 Click *Save As* and save the dial plan as a new file.

You can now edit the file with an ASCII editor. After you customize the new dial plan, Import it to the NBX system. see [“Importing and Exporting Dial Plan Configuration Files”](#) on [page 45](#).

3Com recommends that you enter these commands at the top of every dial plan configuration file:

```
Table Delete *
DestinationRoute Delete *
TimedRoute Delete *
PreTranslator Delete *
```

When you subsequently import this dial plan, these commands purge any traces of the old dial plan and prevent any conflicts that can result from importing one dial plan on top of an existing one.

You create new entries in the dial plan configuration file by typing in new commands (see [“Dial Plan Configuration File Commands”](#) on [page 105](#)) or by cutting, pasting, and editing existing lines in the file.



*When you cut and paste new lines into dial plan tables, be sure to change the Entry number in the pasted line. If two or more lines have the same Entry number, only the last one takes effect.*

## Importing and Exporting Dial Plan Configuration Files

You import a dial plan configuration file either to implement changes you have made by editing the file, or to reload a previously saved configuration.

From the *Operations* tab of the Dial Plan window, you can:

- [Import a North American Dial Plan](#)
- [Import an International Dial Plan](#)

This section concludes with a discussion of [International Dial Plan Issues](#).

When you export the working dial plan, the NBX system constructs a *new* configuration file from the values in the database and displays it. The new file shows the current date and time. You name the file when you save it.



*The sample default files include examples of such things as timed routes and pretranslators. To preserve the default (sample) dial plan configuration included with the system, 3Com advises you to choose a unique file name different than any of the default (sample) dial plan configuration files so that you do not overwrite the sample default files.*

### Import a North American Dial Plan

The default dial plan for the SuperStack 3 NBX system is `NorthAmerica-4-digit.txt`. The default dial plan for the NBX 100 system is `NorthAmerica.txt`. Some customized dial plans are provided for use in other countries.



*Always read the system Release Notes (called `readme.txt`) for the most up-to-date information on dial plans.*

To import a default dial plan configuration file:

- 1 In the *NBX NetSet – Main Menu* window, click *Dial Plan*. The Dial Plan window appears, displaying the *Operations* tab.
- 2 Click the *Default File* radio button. From the Default File list, select the default file that you want to use.
- 3 Click *Import*.
- 4 Reboot the system.



**CAUTION:** When you import a dial plan configuration file, the NBX system immediately implements the dial plan. You are always warned that the system may become inoperative. The system becomes inoperative **only** if you have manually modified a dial plan and have made syntax or content errors. Carefully check any changes that you make to the configuration file before you import.

### Import an International Dial Plan

To change the default North American dial plan to a country-specific dial plan:

- 1 In the *NBX NetSet – Main Menu* window, click *Dial Plan*. The Dial Plan window appears, displaying the *Operations* tab.
- 2 Click the *Default File* radio button.
- 3 In the list next to the Default File button, select the default file that you want to use.
- 4 Click *Import*.



**CAUTION:** When you import a dial plan configuration file, a message warns you that the dial plan may become inoperative. The system becomes inoperative **only** if you have manually modified a dial plan and have made syntax or content errors. Carefully check any changes that you make to the configuration file before you import.

- 5 Click *Yes*. The system imports the new dial plan and produces a report of any errors.
- 6 Reboot the system.



You may see a warning that “destination extension list is empty.” This means that a particular type of device is not installed. You may safely ignore this type of warning.

## International Dial Plan Issues

Several international dial plan issues warrant attention. See these topics:

**Customizing an International Dial Plan.** If there is no customized dial plan for your country, you may need to modify the default dial plan. See [“Modifying a Dial Plan Configuration File”](#) on [page 51](#). If you edit the default dial plan, you can test the changes by making a simulated call. See [“Testing a Dial Plan”](#) on [page 49](#).

**Autodiscovering Internal Telephones.** The default dial plan for the NBX 100 allows you to allocate internal telephones to extension numbers 100 through 449. The default dial plan for the SuperStack 3 NBX system allows you to allocate internal telephones to extension numbers 1000 through 3999. If you autodiscover your company’s internal telephones, Auto Discovery usually begins at number 100 or 1000. However, for some countries, internal telephones begin at a higher number to allow you to directly dial numbers of “national importance.” Auto Discovery allocates telephone extensions numbers within this range. For more information on Auto Discovery, see “Using Auto Discovery for Initial System Configuration” in the *NBX Installation Guide*.

**Dialing Outside Lines.** To obtain an outside line, dial 9 or 0 as appropriate for your country.



**WARNING:** You must first obtain an outside line before you can dial emergency numbers.

## Importing a User-Defined Dial Plan

To import a customer-defined (user-defined) dial plan configuration file:

- 1 In the *NBX NetSet – Main Menu* window, click *Dial Plan*. The Dial Plan window appears, displaying the *Operations* tab.
- 2 In the *User-Defined File* box, enter the path and name of the user-defined configuration file, or click *Browse* to find the file that you want.



*The NBX system has no predefined location for dial plan configuration files. You can specify any directory or path that you want.*

- 3 Click *Import* and reboot the system.



**CAUTION:** When you import a dial plan configuration file, the NBX system immediately implements the dial plan. You are always warned that the system may become inoperative. The system becomes inoperative **only** if you have manually modified a dial plan and have

*made syntax or content errors. Carefully check any changes that you make to the configuration file before you import them.*

### Exporting (Saving) a Dial Plan Configuration File

When you export (save) the current configuration, the system creates a new dial plan configuration file from the current database. You save the new text file using a name that you choose.



*This example refers to Internet Explorer. If you use another browser, you may need to use slightly different procedures.*

To export a dial plan configuration file:

- 1 In the *NBX NetSet – Main Menu* window, click *Dial Plan*. The Dial Plan window appears, displaying the *Operations* tab.
- 2 Click *Export*. The system constructs a new configuration file from the current values in the database and displays it. [Figure 3](#) shows a partial display. Scroll your browser window to see your complete dial plan.

**Figure 3** Dial Plan Configuration File (partial)

```

////////////////////////////////////
/ First, delete all existing dialplan information

Table Delete *
DestinationRoute Delete *
TimedRoute Delete *
PreTranslator Delete *

/ Now, create all dialplan information

////////////////////////////////////
/           Settings
////////////////////////////////////

ExtensionLength 4
ExtensionRange Telephone      1000 1999
ExtensionRange Park          6000 6099

```

- 3 Click the *File* menu and select *Save As*.
- 4 From the list box at the top of the *Save As* window, select the destination folder.
- 5 In the *File Name* text box, replace the default file name with a new name.



*The sample default files include examples of such things as timed routes and pretranslators. Verify that you rename the new configuration file with a unique file name so that you do not overwrite the sample default file.*

- 6 Click Save.

## Testing a Dial Plan

This section describes how to test the currently loaded dial plan by placing a simulated call.



*Even if the NBX system is completely installed and operational, a test places a simulated, not an actual call.*

**Example:** If you have an entry in the dial plan for digit sequences starting with 91, with MIN and MAX set to 5, and you test the sequence 9123, the dial plan test reports an insufficient number of digits. However, in actual operation, the NBX system would time out waiting for the fifth digit, and then attempt to place the call. Assuming that the outside line prefix is 9 (such as in the United States), this situation would obtain an outside line (9) and then dial the numbers 123.

You can specify a day of the week and a time by selecting entries from the *Day/Time* list boxes. This choice instructs the system to act as if the day and time you select are the current day and time.

If you have timed routes defined in the dial plan, you use different day and time settings to determine whether the timed route works properly.

**Example:** Assume that you want a timed route to select route 35 during open business hours Monday through Friday, but route 36 when business is closed on those days and on weekends. After you define the timed route commands and import the modified file, you then test using days and times within business hours (to verify that the system selects route 35) and during closed hours and weekends (to verify that it selects route 36).

You can also use day and time settings to test whether the Class of Service settings operate as expected.

**Example:** You can configure the dial plan to allow toll calls from an extension during open business hours, but to disallow such calls when the business is closed and on weekends. Test using days and times within business hours (to confirm that you can make toll calls from that extension) and during closed hours and weekends (to confirm that the system prevents such calls).

To create and run a test using the currently loaded dial plan:

- 1 In the *NBX NetSet – Main Menu* window, click *Dial Plan*. The Dial Plan window appears, displaying the *Operations* tab.
- 2 Click *Test*. The *Test Dial Plan* dialog box appears.
- 3 To set up the simulated call, from the *Device to dial from* list box, select the number from which you want to dial.
- 4 In *Number to dial*, enter the number that you want the system to dial.
- 5 Select the desired date and time in the *Day/Time* lists.



*For some tests, the day and time settings are irrelevant. You can leave the settings at their default values (Sunday, 00, and 00).*

- 6 Click *Test*. The test runs and the results appear in the dialog box.

### **Generating a Dial Plan Report**

This section describes how to create a report containing all dial plan settings, tables, routes, and pretranslators. The report also performs a consistency check to ensure that all dial plan table entries point to valid routes which, in turn, point to valid extensions. The report also identifies how many devices are using each dial plan table and each pretranslator.

Consider these common dial plan problems:

- Dial plan table entries that point to nonexistent routes
- Timed route entries that point to nonexistent destination routes
- Destination route entries that point to nonexistent extensions or empty extension lists
- Timed route entries that overlap
- Devices that do not specify a normal table
- Devices that point to nonexistent Normal tables, Least Cost Routing tables, or pretranslators
- Pretranslator entries that have no operations

If a telephone has no table assigned, that telephone does not have permission to dial. This error is flagged in Reports. If a device has only a Normal table, no error is reported.

If a device has only a Least Cost table, an error is reported. The telephone is still usable and has permissions defined in whatever table has been chosen as Least Cost. If a device has both a Normal and Least Cost table, no error is reported (the usual condition).



When the NBX system detects an error in any line of an imported dial plan configuration file, it ignores that line and continues to process all remaining lines in the file. This precaution minimizes the impact of errors on the dial plan.

To generate a dial plan report:

- 1 In the *NBX NetSet – Main Menu* window, click *Dial Plan*. The Dial Plan window appears, displaying the *Operations* tab.
- 2 Click *Report*. The dial plan report appears. Scroll up and down the browser window to see the full display.
- 3 Click *Close*.

The person validating the dial plan test is responsible for verifying that the test call used the correct dial plan table and dial plan table entry.



To record test results and send them to someone, select the text in the results pane and use the browser's copy function (typically found in the *Edit* menu) to copy the test results to another application window, such as an editor or e-mail.

Errors can prevent calls from being successfully routed. Warnings are conditions that you can easily correct to successfully route the call.

- 4 When you are finished, click *Close* at the bottom of the screen.

## Modifying a Dial Plan Configuration File

This section describes how to modify the currently loaded dial plan configuration file.



**CAUTION:** Modifications must be syntactically correct. Each time that the system imports a dial plan configuration file, it verifies the file for errors and displays the results. To avoid typing mistakes, 3Com suggests that you start with an existing dial plan (for example, one of the default plans that are shipped with the NBX system or a plan from another NBX system), modify it, and save it as a renamed file.

To modify a dial plan configuration file:

- 1 In the *NBX NetSet – Main Menu* window, click *Dial Plan*. The Dial Plan window appears, displaying the *Operations* tab.
- 2 Click *Modify*. The Modify Dial Plan dialog box shows a partial display. Scroll up and down the browser window to see the complete dial plan.

- 3 Edit the dial plan configuration file. A single line of space is *required* between each dial plan entry. You can type a complete dial plan entry anywhere in the file.
- 4 Click *OK*. The *Import Confirmation* dialog box prompts you to confirm the changes.
- 5 Click *Yes*. The system imports the modified dial plan. The *Dial Plan Consistency* dialog box appears, displaying the results of the error and consistency checks.
- 6 Make a note of any errors, and correct them by editing the file. You may be required to make changes based on warning messages.
- 7 Click *Close*.

---

## Outdialing Prefix Settings

A telephone user can look up a call in the call logs (Missed Calls, Answered Calls, and Dialed Calls) using the telephone display panel, select a telephone number from any of the logs, and redial it.

To redial a number from the Missed Calls or Answered Calls list, the NBX system needs to know the appropriate dial prefix to prepend to the digits in the telephone number.

For information and examples about how to configure outdialing prefixes, see the Help at **NBX NetSet > Dial Plans > Operations > Outdialing Prefixes**.

---

## Managing Extensions

This section describes how to add, change, and manage extensions:

- [Extension Settings Overview](#)
- [Changing Extension Length and Ranges](#)
- [How Auto Discovery Assigns Extensions](#)
- [Modifying Extensions](#)

### Extension Settings Overview

The NBX system establishes connections between extension numbers. The concept of an extension applies to more than just telephones. Extensions are also assigned to NBX applications such as Call Park zones, Auto Attendants, hunt groups, Line Card ports, voice mail ports, and virtual devices such as the pcXset™ PC soft telephone Client and the ConneXtions H.323 Gateway.

The extension length (either 3 or 4), which applies to all extensions on a system, indicates that all extensions contain that number of digits. You cannot mix 3-digit and 4-digit extensions within the same NBX system.

The NBX 100 and the SuperStack 3 NBX systems both support 3-digit and 4-digit dial plans, although there are some differences in the extension ranges as noted in these tables. By default, the NBX 100 uses a 3-digit dial plan, and the SuperStack 3 NBX uses a 4-digit dial plan.

[Table 8](#) lists typical extension ranges in a 3-digit and a 4-digit dial plan. [Table 9](#) describes these ranges in more detail and gives the default ranges and values for 3-digit and 4-digit dial plans.



**CAUTION:** *The NBX dial plan does not support extensions that begin with 0. An extension or an extension range in your dial plan that begins with 0 can cause unpredictable results.*

**Table 8** Typical Extension Ranges for 3-digit and 4-digit Dial Plans

Extension Type	3-digit	4-digit
Telephones	<b>NBX 100:</b> 100–449	<b>SuperStack 3 NBX:</b> 1000–3999
Auto Attendant	500–599	500, 501, plus 5500–5599
Hunt Group	<b>NBX 100:</b> 450–499	<b>SuperStack 3 NBX:</b> 4000–4099
External Extensions (includes line card ports and Call Park)	600–799 (external Auto Discovery starts at 750)	6000–7999 (external Auto Discovery starts at 7250)
Call Park (must fall within External Extension range)	<b>NBX 100:</b> 601–609	<b>SuperStack 3 NBX:</b> 6000–6099

**Note 1:** The NBX 100 is shipped with a factory default 3-digit dial plan. If you import any 4-digit plan, you must manually specify any 4-digit extension ranges that are not set by the imported plan. You must also manually change any device extensions so that they fall within the appropriate range.

**Note 2:** The Superstack 3 NBX is shipped with a 4-digit dial plan. If you import any 3-digit plan, you must manually specify any 3-digit extension ranges that are not set by the imported plan. You must also manually change any device extensions so that they fall within the appropriate range.

**Note 3:** TAPI Route Point extensions occur in the same range as telephones. TAPI Route Point extensions do not appear in telephone lists within the NBX NetSet utility. For more information about TAPI Route Points, see [TAPI Route Points](#) on [page 225](#).

[Table 9](#) provides a more detailed explanation of extension types, including default extension ranges and values for 3-digit and 4-digit dial plans.

**Table 9** Dial Plan Extension Settings

Field	Purpose (See Notes 1 and 2)
Telephone Extensions Range	<p>The range of extensions for telephones.</p> <ul style="list-style-type: none"> <li>■ <b>SuperStack 3 NBX:</b> 1000–3999</li> <li>■ <b>NBX 100:</b> 100–449</li> </ul> <p>TAPI route point extensions are included in the telephone extensions range.</p> <p><i>Length</i> — This pull-down field specifies the number of digits for telephone extensions.</p>
Auto Attendant Extensions Range	<p>The range of extensions for Auto Attendants.</p> <p>Default:</p> <ul style="list-style-type: none"> <li>■ <b>SuperStack 3 NBX:</b> 5500–5599</li> <li>■ <b>NBX 100:</b> 500–599</li> </ul> <p>For both 3-digit and 4-digit dial plans:</p> <ul style="list-style-type: none"> <li>■ Extension 500 is reserved as the default Auto Attendant.</li> <li>■ Extension 501 is reserved as the voice mail Auto Attendant.</li> </ul>
Default Auto Attendant Extensions	<p>Default extension that the NBX system assigns to the default Auto Attendant. The Auto Discovery process assigns this extension.</p> <p>The system must direct each call coming in on an external line to an extension. During the Auto Discovery of external lines (analog lines and Digital Line Card channels), the NBX system assigns the default extension (500) as the Auto Attendant extension. After you import the dial plan configuration file and complete the Auto Discovery process, you can manually configure the extension for each analog line and each Digital Line Card channel.</p> <p>For both 3-digit and 4-digit dial plans:</p> <ul style="list-style-type: none"> <li>■ Extension 500 is reserved as the default Auto Attendant.</li> <li>■ Extension 501 is reserved as the voice mail Auto Attendant.</li> </ul>
Hunt Group Extensions Range	<p>The range of extensions for hunt groups.</p> <ul style="list-style-type: none"> <li>■ <b>SuperStack 3 NBX:</b> 4000–4099</li> <li>■ <b>NBX 100:</b> 450–499</li> </ul>

**Table 9** Dial Plan Extension Settings (continued)

Field	Purpose (See Notes 1 and 2)
External Extensions Range	<p>The range of extensions that are connected to external devices, such as Analog Line Card ports, Digital Line Card ports (BRI-S/T, T1, E1, ISDN PRI), Call Park, and Paging extensions.</p> <p>Default:</p> <ul style="list-style-type: none"> <li>■ <b>SuperStack 3 NBX:</b> 6000–7999</li> <li>■ <b>NBX 100:</b> 600–799</li> </ul>
Call Park Extensions Range	<p>The range of extensions for Call Park. This feature allows the user to temporarily park a telephone call and then pick it up at a different telephone. Call Park extensions must be a subset of <i>external</i> extensions.</p> <ul style="list-style-type: none"> <li>■ <b>SuperStack 3 NBX:</b> 6000–6099</li> <li>■ <b>NBX 100:</b> 601–609</li> </ul>
Start External Discovery At	<p>The extension to use when autodiscovering external devices. The system assigns extensions starting with this number and incrementing upward as they are discovered. If the highest extension is reached, the system starts looking from the beginning of the external range and selects the first unused one.</p> <p>Typically, systems do not use all of the available external extensions from 600–799 in a 3-digit dial plan or from 6000–7999 in a 4-digit dial plan.</p> <p>Default:</p> <ul style="list-style-type: none"> <li>■ <b>SuperStack 3 NBX:</b> 7250</li> <li>■ <b>NBX 100:</b> 750</li> </ul>
External Keypad Prefix	<p>In Keypad mode, when a button on an NBX Business Telephone directly accesses an outside line, the NBX system must check Class of Service. The system prepends the <i>External Keypad Prefix</i> value (typically 8, 9, or 0) when it makes a call in Keypad mode.</p>

**Note 1:** The NBX 100 is shipped with a factory default 3-digit dial plan. If you import any 4-digit plan, you must manually specify any 4-digit extension ranges that are not set by the imported plan. You must also manually change any device extensions so that they fall within the appropriate range.

**Note 2:** The Superstack 3 NBX is shipped with a 4-digit dial plan. If you import any 3-digit plan, you must manually specify any 3-digit extension ranges that are not set by the imported plan. You must also manually change any device extensions so that they fall within the appropriate range.

Some countries reserve numbers beginning with 11 for numbers of national importance. To accommodate this requirement, you can begin the telephone extension range at 120.

## Changing Extension Length and Ranges

You can view and change extension settings, such as extension length and extension ranges.



*If you are changing from a 3-digit to a 4-digit plan, import the 4-digit dial plan configuration file before you configure or autodiscover any devices.*



**CAUTION:** *The NBX dial plan does not support extensions that begin with 0. An extension or an extension range in your dial plan that begins with 0 can cause unpredictable results.*

To view and change extension settings:

- 1 On the *Operations* tab, click *Settings*. The *Settings* dialog box appears.
- 2 Make the desired changes to the extension settings. [Table 9](#) describes each field.
- 3 Click *OK* to enable your changes and exit the dialog box.

### Planning Extension Ranges

By planning extension range on your system, you can accommodate your present and future needs.

**Example:** If you initially have 60 telephones and expect to add no more than 100 additional telephones in the future, choose 100–299 as the telephone extension range (1000–1199 in a 4-digit system). This arrangement provides 200 extension numbers to handle the planned 160 telephones plus 40 extra extensions to handle unexpected additions.



*Once you set the telephone extension range, you can extend it later, provided that the new range does not overlap any other number range.*

**Example:** For a 4-digit dial plan, you can set the initial telephone extension range to 1000–1099. This arrangement allows for up to 100 telephone extensions. Later, you can extend the range up to 3999 to allow for 400 telephone extensions. By default, the Hunt Group range starts at 4000 on the SuperStack 3 and 450 on the NBX 100, so you cannot assign telephone extensions in either of those ranges.

## How Auto Discovery Assigns Extensions

The Auto Discovery process assigns new extensions to telephones and other devices. For example, if you install a T1 or E1 card, you can use Auto Discovery to assign extension numbers to each port on the card. The Auto Discovery process initially assigns a default name (*new user*) to

each new telephone, and assigns the next available extension number. Later, you can replace (*new user*) with the appropriate user's name.



*It is possible to bypass the Auto Discovery process and to manually add a new telephone and assign an extension. However, 3Com strongly recommends that you take advantage of the Auto Discovery process. For instructions on using the Auto Discovery process or manually adding and configuring a new telephone, see the section on ["Adding a New Telephone"](#) on [page 129](#).*

You can define a user in the system database without assigning a telephone to that user. By defining a user with no device, but with a telephone extension only, you create a *phantom mailbox*. The NBX system associates an extension with this phantom mailbox so that the user can have voice mail capability. To access voice mail from any telephone, the user calls either extension 500 (the default Auto Attendant extension), or 501 (the default Auto Attendant voice mail extension.)

Telephones and Line Card ports reserve most of the extensions within the system. However, there are other extensions within the system. [Table 8](#) shows the default extension ranges for 3-digit and 4-digit dial plans.

## Modifying Extensions

You can modify the extension number of any device in the system. Normally, you make changes *only* after you have changed the extension ranges for the NBX system, in order to align the extensions with the new ranges.



**CAUTION:** *Be very careful when you change extensions. The system does not validate changes that you make here, and there is no Undo or Cancel function. A mistake can compromise the operation of the system. The NBX dial plan does not support extensions that begin with 0. An extension or an extension range in your dial plan that begins with 0 can cause unpredictable results.*

To modify extensions:

- 1 From the NBX NetSet main menu, click *Dial Plan > Operations > Modify Extensions* to open the *Modify Extensions* dialog box.
- 2 In the extensions list, select the extensions that you want to modify. Use Shift-click to select a block of extensions or Ctrl-click to select several extensions at different locations in the list.

- 3 Select an operation from the *Operation* drop-down list. [Table 10](#) lists and describes the operations.
- 4 Make the appropriate entry in the text box to the right of the *Operation* list. The system uses this number in conjunction with the operation that you selected in step 3. For examples, see [“Changing Extensions”](#) below.
- 5 Click *Apply*. If the requested change creates a duplicate extension or an extension of zero length, the change is discarded.
- 6 Click *OK* to enable your changes and exit the dialog box.

**Table 10** Modify Extension Operations

Operation	Purpose
Change Extension	Modifies the first selected extension. Change Extension applies to only one extension at a time. If you select multiple extensions, the NBX system changes only the first extension that you selected.
Prepend	Prepends the digits in front of all selected extensions.
Append	Appends the digits to the end of all selected extensions.
Strip Leading Digits	Strips (removes) the specified number of digits from the beginning of all selected extensions.
Strip Trailing Digits	Strips (removes) the specified number of digits from the end of all selected extensions.

### Changing Extensions

You can perform several operations through the Modify Extensions dialog box ([Table 10](#)). This section describes several examples.

**Example:** If you select *Change Extension* from the *Operation* list, the system replaces the selected extension with the number you type in the text box.

**Example:** If you select *Strip Leading Digits* from the *Operation* list, and type the number 2 in the text box, the system strips (removes) two digits from the beginning of the extension.

**Example:** If you select extensions 1000 through 1009 and select *Strip Trailing Digits* from the *Operation* list, the system does not make any change, because the result is a series of identical numbers (all 100).

## Managing Extension Lists

An extension list contains extension numbers that are assigned and dedicated to specific dial tone facilities or to specific NBX applications (voice mail, Auto Attendant, and so on), or both. You can add an extension list to define a subset of devices such as fax machines.

The system default extension lists are numbered starting at \*0001 in either a 3-digit or 4-digit plan. By convention, a default extension list number is preceded by an asterisk. See [Table 11](#) for a description of the standard extension lists.



**CAUTION:** *Extension lists must not overlap.*

**Table 11** Extension Lists

Extension List ID	Description
*0001	Contains extension numbers assigned to Analog Line Card ports. Routes 1 and 2 use this list.
*0002	Contains extension numbers assigned to Digital Line Card ports. Routes 1 and 2 use this list.
*0003	Contains extension numbers assigned to voice mail. <ul style="list-style-type: none"> <li>■ <b>SuperStack 3 NBX:</b> 6400–6499 (See Note 1)</li> <li>■ <b>NBX 100:</b> 651-662 (See Note 2)</li> </ul> Route 3 uses this list.
*0004	Contains the extension for the attendant (that is, the person who monitors incoming calls). The system automatically assigns to this list the lowest extension found during Auto Discovery. Route 4 uses this list.
*0005	Contains extension numbers assigned to H.323 ports.
*0006	Contains extension numbers assigned to Virtual Tie Lines.
*0008	Contains extension numbers assigned to the 8-pool.

**Note 1:** The NBX 100 is shipped with a factory default 3-digit dial plan. If you import any 4-digit plan, you must manually specify any 4-digit extension ranges that are not set by the imported plan. You must also manually change any device extensions so that they fall within the appropriate range.

**Note 2:** The Superstack 3 NBX is shipped with a 4-digit dial plan. If you import any 3-digit plan, you must manually specify any 3-digit extension ranges that are not set by the imported plan. You must also manually change any device extensions so that they fall within the appropriate range.

Within an extension list, you can assign a priority to each extension. When the system accesses an extension list, it tries to use the highest priority extension first. The highest priority is 1 and the lowest is 99.

For example, If the extension list contains extensions that are assigned to T1 channels, you can assign unique priorities to each of the extensions. If you instruct the system to place an outgoing call using the T1 line, it attempts to use the highest priority extension/channel first. If the first is unavailable, it tries the next highest priority extension/channel, and so on.

From the *Extensions List* tab of the Dial Plan window, you can perform these tasks:

- [Adding an Extension List](#)
- [Modifying an Extension List](#)
- [Removing an Extension List](#)



*The system restricts access to any specific Analog Line Card port or Digital Line Card port. To directly dial the extension number that is associated with one of these devices, you must have diagnostic privileges. In addition, you cannot dial a prefix to obtain a Digital Line Card port.*

## Adding an Extension List

To add a new extension list:

- 1 From the Dial Plan window, click the *Extension Lists* tab.
- 2 Click *Add*. The Add Extension List dialog box appears.
- 3 In the *List Extension* text box, type the number that you want to assign to the new extension list. Do not select a number that is currently in use by the system as either an extension or as the number of an extension list.  
You may use the default extension number.
- 4 Type an asterisk preceding the extension number. By convention, the asterisk indicates that the number represents an extension list.
- 5 In the *Name* text box, type the name that you want to assign to the new extension list. Names can include uppercase and lowercase alphanumeric characters, spaces, underscores, and hyphens.
- 6 If you want calls to cycle through the extensions in the list, check the Cycle Extensions checkbox. Each time the system accesses the extension list, it uses the next extension in the list. Calls effectively progress through

the list to balance the load of calls. If Cycle Extensions is not checked, the extension selection always starts from the top of the list.

If an extension in the list has a higher priority, the highest priority extension is used regardless of the Cycle Extension setting.

- 7 To move an extension from *Extensions not in List* to *Extensions in List*, select the extension and click <<.

Use Shift-click to select a block of extensions, and Ctrl-click to select several extensions in different locations in the list.

- 8 To change the priority of extensions:
  - a Select the extension from the *Extensions in List* scroll list.
  - b Enter a priority number in the text box below the list (from a high of 1 through a low of 99).
  - c Click the *Change Priority in List* button.

The new priority appears as the number to the left of the item within square brackets. The default value is 50. When the system accesses an extension list, it first attempts to use the highest priority extension.

- 9 Click OK to enable your changes and leave the dialog box.

**Example:** If the extension list contains extensions that are assigned to T1 channels, you can assign unique priorities to each extension. If you instruct the system to place an outgoing call using the T1 line, it attempts to use the highest priority extension/channel first, and, if the first is unavailable, tries the next highest priority extension/channel, and so on. Priorities range from 1 (highest) through 99 (lowest).



**CAUTION:** If you add an extension list, you must change the dial plan configuration file to create a destination route to the new list. This arrangement enables the system to route calls to the new list.

### Modifying an Extension List

To modify an extension list:

- 1 On the *Extension Lists* tab, select an extension list.
- 2 Click *Modify*. The *Modify Extension List* dialog box appears.
- 3 To modify the name of the Extension List, edit the contents of the *Name* text box.



If you change the name of an extension list, you invalidate any aspect of the dial plan that refers to the name. You must change all references

to the extension list name in the dial plan configuration file. If you made your changes using an editor (as opposed to modifying the dial plan from within the NBX NetSet utility), you must reimport the dial plan.

- 4 If you want calls to cycle through the extensions in the list, check the Cycle Extensions checkbox. Each time that the system accesses the extension list, it uses the next extension in the list. This arrangement effectively progresses through the list to balance the load of calls. If Cycle Extensions is not checked, the extension selection always starts from the top of the list.
- 5 To add an extension to the *Extensions in List* scroll list, select it in the *Extensions not in List* scroll list and click the << button. Use Shift+click to select a block of extensions, or Ctrl+click to select several extensions at different locations in the list.
- 6 To remove an extension from the extension list, select it the *Extensions in List* scroll list and click the >> button. The extension moves to the *Extensions not in List* scroll list.
- 7 To change the priority of extensions:
  - a Select the extension from the *Extensions in List* scroll list.
  - b Enter a priority number in the text box below the list (from a high of 1 through a low of 99).
  - c Click the *Change Priority in List* button.The new priority appears as the number to the left of the item within square brackets. The default value is 50. When the system accesses an extension list, it attempts to use the highest priority extension first.
- 8 Click *OK* to enable your changes and exit the dialog box.

### Removing an Extension List

The system does not let you remove an extension list that the dial plan is using even if that extension list is empty. You must remove the extension list from the dial plan before you can delete the extension list.

To remove an extension list:

- 1 On the *Extension Lists* tab, select the extension list you want to remove.
- 2 Click *Remove*. A dialog box prompts you to confirm the removal.
- 3 Click *Yes*.



**CAUTION:** Do not remove any of the predefined lists (lists 1 through 8).

## Managing Dial Plan Tables

The NBX system associates a normal dial plan table and a Least Cost Routing table with each device. Devices include, for example, telephones, Analog Line Card ports, or Digital Line Card ports. A telephone that has no table assigned does not have permission to dial. A telephone without an assigned table is flagged in Reports. For details, see [“Generating a Dial Plan Report”](#) on [page 50](#). For more information, see these topics:

- [Determining Which Devices Use Dial Plan Tables](#)
- [Removing a Dial Plan Table](#)

## Determining Which Devices Use Dial Plan Tables

You can view or change the devices associated with a particular dial plan:

- 1 In the *NBX NetSet – Main Menu* window, click *Dial Plan*. The Dial Plan window appears, displaying the *Operations* tab.
- 2 Click the *Tables* tab.
- 3 From the list, select a dial plan table for which you want to list associated devices. To list devices not assigned to any table, select *(none)*.
- 4 Click *Devices Using* to open the *Devices Using Dial Plan* dialog box. For descriptions of the field, see [Table 12](#). If you select *(none)*, the *Devices That Have No Dial Plan* dialog box appears.
- 5 Select *Normal* to see which devices use table ID 1 (in this example) as the Normal table.
- 6 Click *Least Cost* to see which devices use table ID 1 (in this example) as the Least Cost table. Each device can use only one normal and one least cost table.
- 7 To move a device to the *Devices Using Table* list, select it in the *Devices Not Using Table* list and click <<. To move a device to the *Devices Not Using Table* list, select it in the *Devices Using Table* list and click >>.
- 8 Click *Close*.

**Table 12** Devices Using Dial Plan Table Fields

Field	Purpose
Dial Plan Table ID	The identification number of the dial plan table as specified in the dial plan configuration file.
Dial Plan Table Name	The name of the dial plan table.

**Table 12** Devices Using Dial Plan Table Fields (continued)

Field	Purpose
Table Usage	The type of table (either <i>Normal</i> or <i>Least Cost</i> ). To select a type, click either <i>Normal</i> or <i>Least Cost</i> .
Devices Using Table	A list of devices using this Normal or Least Cost Routing table.
Devices Not Using Table	A list of devices <i>not</i> using this Normal or Least Cost Routing table.

### Removing a Dial Plan Table

Note that you must *not* remove any of the predefined tables (Internal, Incoming, or Least Cost).



**CAUTION:** You cannot remove a dial plan table if a device is using it. To remove the table, you must first remove all devices from the Devices Using Table list.

To remove a dial plan table:

- 1 In the *NBX NetSet – Main Menu* window, click *Dial Plan*. The Dial Plan window appears, displaying the *Operations* tab.
- 2 Click the *Tables* tab.
- 3 Select the table you want to remove.
- 4 Click *Remove*. A dialog box prompts you to confirm the removal.
- 5 Click *Yes*.

### Managing Dial Plan Pretranslators

Pretranslators are tables in the dial plan configuration file. Each entry in a pretranslator table contains a string of one or more digits that are compared to incoming or outgoing digits. When the digits match an entry in the table, the NBX system performs the associated pretranslator operations.

For more information, see:

- [Identifying Devices Using Pretranslators](#)
- [Creating a Pretranslator for VTL Calls](#)
- [Identifying Devices Using Pretranslators for CLI](#)
- [Removing a Pretranslator from the Dial Plan](#)

## Identifying Devices Using Pretranslators

To view a list of devices and their associated pretranslators, or to associate a pretranslator with a specific device:

- 1 In the *NBX NetSet – Main Menu* window, click *Dial Plan*.
- 2 Click the *Pretranslators* tab.
- 3 Select a pretranslator, or (none) for devices that have no pretranslator.
- 4 Click *Devices Using*. The *Devices Using Pretranslator* dialog box appears. If you selected (none) in step 3, you see a list of devices that do not use a pretranslator. [Table 13](#) describes each field. The fields are the same for the *Devices Using Pretranlator for CLI* dialog box.
- 5 To move a device to the *Devices Using Pretranslator* list, select it in the *Devices Not Using Pretranslator* list and click <<. To move a device to the *Devices Not Using Pretranslator* list, select it in the *Devices Using Pretranslator* list and click >>. Then
- 6 Click *Close*.

**Table 13** Pretranslator Fields

Field	Purpose
Pretranslator ID	The identification number of the pretranslator as specified in the dial plan.
Pretranslator Name	The name of the pretranslator as specified in the dial plan.
Devices Using Pretranslator	Devices currently using the pretranslator.
Devices Not Using Pretranslator	Devices not using the pretranslator.

To enable a specific pretranslator, update the dial plan. See [“Importing and Exporting Dial Plan Configuration Files”](#) on [page 45](#).

## Creating a Pretranslator for VTL Calls

Calls from one NBX system to another NBX system over a VTL connection include caller ID information that includes the IP address of the caller's system and the caller's extension. Each field of numbers in this caller ID string is separated by the "\*" character. For example, if extension 1002 on System A calls someone on system B over a VTL connection, the display panel on the System B telephone shows 10\*234\*208\*2\*1002, which indicates an incoming call from extension 1002 on the NBX system with the IP address 10.234.208.2.

If the System B dial plan has a pretranslator that removes the IP address when the call arrives at System B, (see [Figure 4](#) on [page 67](#)), the display

panel on the System B telephone shows the calling extension and no IP address or "\*" characters. This solution works well when the extensions on System A and System B do not overlap, for example, System A user extensions are 1000-1999 and System B extensions are 2000-2999.

### Site Codes

If the dial plan on System B uses a site code, such as 69, for VTL calls to System A, you could create a pretranslator that prepends the site code after it removes the IP address. (See [Figure 5](#) on [page 67](#).) This pretranslator would provide caller ID information that the System B extension can use to return a call to the System A extension. For example, a call from System A (10.234.208.2) extension 1002 would appear on a System B telephone's display panel as 691002 instead of 10\*126\*14\*200\*1002. The pretranslator removes the IP address and prepends the calling extension with the System A site code, 69.



*You might choose to not implement this pretranslator if calls from System A can hop off at System B onto a PRI line because the site code would be included as caller ID information on the PRI line, and that caller ID information would be meaningless to someone outside the NBX system. For hop-off calls, you could create a separate pretranslator.*

### VTL Calls, Caller ID and Hop Off

If a VTL call from System A to System B hops off System B and onto an ISDN PRI trunk, the "\*" characters in the caller ID string can present problems for the PRI service. The PRI service cannot interpret the "\*" symbols so it ignores the caller ID string it has received and instead uses the PRI line phone number. For example, if you must dial 1-508-555-1234 to get into the PRI from the outside world, that number is used for the outgoing caller ID. If System A or System B has CLIR (Calling Line Identity Restriction) enabled, the PRI service ignores the CLIR setting and it sends the PRI line phone number as the caller ID.

If you have a pretranslator on System B that removes the IP address from the caller ID string of incoming VTL calls, then the caller ID will be the extension of the phone making the call. If system A and/or System B has CLIR enabled, then CLIR will be in effect. The only exception is for emergency calls (as defined in System B's dial plan), which never have caller ID blocked.

[Figure 4](#) shows an example of a pretranslator that removes the "\*" character from VTL calls that originated on an NBX system with the IP address 10.234.208.2. The Value column of the PreTranslatorOperation Create line of [Figure 4](#) specifies how many digits to strip from the beginning of the string. That value depends on the length of the received IP address. In the example, the IP address, 10\*234\*208\*2, is 12 digits, and then you must also count the trailing "\*" in the string. That trailing "\*" is the character that separates the IP address from the caller extension and you must count it when you specify the number of digits to remove.

**Figure 4** Pretranslator to Remove IP Address

```

PreTranslator Create 2 VTL
/
/
PreTranslatorEntry Create
/
/
PreTranslatorOperation Create

```

	PreTransId	Entry	Digits		
	-----	-----	-----		
PreTranslatorEntry Create	2	1	10*234*208*2*		

	PreTransId	Entry	OperId	Operation	Value
	-----	-----	-----	-----	-----
PreTranslatorOperation Create	2	1	1	stripLead	13

[Figure 5](#) shows an example of a pretranslator that removes the "\*" character from VTL calls that originated on an NBX system with the IP address 10.234.208.2 and prepends the site code, 69, of NBX system 10.234.208.2.

**Figure 5** Pretranslator to Remove IP Address and Prepend Site Code

```

PreTranslator Create 2 VTL
/
/
PreTranslatorEntry Create
/
/
PreTranslatorOperation Create
PreTranslatorOperation Create

```

	PreTransId	Entry	Digits		
	-----	-----	-----		
PreTranslatorEntry Create	2	1	10*234*208*2*		

	PreTransId	Entry	OperId	Operation	Value
	-----	-----	-----	-----	-----
PreTranslatorOperation Create	2	1	1	stripLead	13
PreTranslatorOperation Create	2	1	2	prepend	69

To add a pretranslator for VTL caller ID issues:

- 1 Open your dial plan for editing as described in ["Accessing the Dial Plan"](#) on [page 44](#).
- 2 Search for the section titled Pretranslators.

- 3 Add a new pretranslator for each system from which you will be receiving calls over a VTL.
- 4 Save the edited dial plan and import it into the system. For more information, see [“Importing and Exporting Dial Plan Configuration Files”](#) on [page 45](#).
- 5 Specify the devices that should use the pretranslator. See [“Adding VTL Devices to the Pretranslators \(Optional\)”](#) on [page 89](#).

### Identifying Devices Using Pretranslators for CLI

To view a list of devices that use a particular pretranslator to present Calling Line ID (CLI) information on outgoing calls:

- 1 In the *NBX NetSet – Main Menu* window, click *Dial Plan*.
- 2 Click the *Pretranslators* tab and select a pretranslator from the scroll list. For a list of devices that have no pretranslator, select (none).
- 3 Click *Devices Using Pretranslator for CLI*. The *Devices Using Pretranslator for CLI* dialog box appears. If you selected (none) in step 3, you see a list of devices that do not use a pretranslator for Calling Line ID.
- 4 To move a device to the *Devices Using Pretranslator* list, select it and click <<. To move a device to the *Devices Not Using Pretranslator* list, select it and click >>. Then click *Close*. See [Table 13](#) for field descriptions.

### Removing a Pretranslator from the Dial Plan

To remove a pretranslator:

- 1 In the *NBX NetSet – Main Menu* window, click *Dial Plan*.
- 2 Click the *Pretranslators* tab.
- 3 Select a pretranslator from the scroll list.
- 4 Click *Remove*.



**CAUTION:** You cannot remove a pretranslator if any device is currently using it. If you want to remove the pretranslator, you must first remove all devices from the *Devices Using Pretranslator list*.

## Configuring the Dial Plan for the 4ESS Protocol (T1)

The 4ESS protocol, used on T1 Digital Line Cards that are configured for PRI operation, requires specific configuration entries in the NBX system dial plan. If you purchase the 4ESS protocol and SDN (Software Defined Network) service from your long-distance carrier, you must make dial plan changes similar to those outlined in [“Configuring the Dial Plan for Software-Defined Network Calls”](#) on [page 69](#). If you want to make long distance calls or international long distance calls using the 4ESS protocol, you must make dial plan changes similar to those outlined in [“Configuring the Dial Plan for North American Long Distance”](#) on [page 69](#) and [“Configuring the Dial Plan for International Long Distance”](#) on [page 70](#).

### Configuring the Dial Plan for Software-Defined Network Calls

In the NBX system dial plan, if you are using the 4ESS protocol and you want to make SDN calls, you must configure a unique route to use for SDN calls and include the letters SDN at the beginning of the dial string.

**Example:** The dial plan entry shown in adds the characters SDN (must be capital letters) before the long-distance dialed digits. This example assumes that route 4 is used for SDN calls.

**Figure 6** Dial Plan Entries for SDN

	Route	Entry	OperID	Operation	Value
	-----	-----	-----	-----	-----
/					
/					
DestinationRouteOperation Create	4	1	1	prepend	SDN

### Configuring the Dial Plan for North American Long Distance

In the NBX system dial plan, if you are using the 4ESS protocol and you want to make long-distance calls, you must remove from the dial string any digits that are dialed by users to access the long-distance service. For example, if users normally dial 9 and then 1 to obtain a long-distance dial tone, and then dial a 10-digit number, the dial plan must remove the 9 and the 1 and present only the 10-digit number to the long-distance carrier. Otherwise, the 4ESS protocol rejects the call.

**Example:** If you use route 1 in the dial plan for Long Distance, and users must dial 91 to make a long-distance call, the dial plan entries shown in [Figure 7](#) remove the first two digits (91) and submit the remaining 10 digits to the long-distance carrier.

**Figure 7** Dial Plan Entries for North American Long Distance

```

Table Create 1 Internal 4 Digit Extensions
/
/      ID Entry Digits Min Max  Class           Prio Route
/      --  -----  ---  ---  -----
TableEntry Create 1      2 91      12 12  LongDistance      0      1

/
/                        Route Entry OperID Operation Value
/                        -----
DestinationRouteOperation Create 1      1      1      stripLead      2

```

### Configuring the Dial Plan for International Long Distance

In the NBX system dial plan, if you are using the 4ESS protocol and you want to make international long-distance calls, you must remove from the dial string the digits 9011 that are dialed by users to access the international long-distance service. For example, if the user dials the string 9-011-44-1234-567890, the dial plan must remove the 9011 before passing the dialed digits to the long-distance carrier or the 4ESS protocol rejects the call. See [Figure 8](#).

**Figure 8** Dial Plan Entries for International Long Distance

```

Table Create 1 Internal 4 Digit Extensions
/
/      ID Entry Digits Min Max  Class           Prio Route
/      --  -----  ---  ---  -----
TableEntry Create 1      3 9011      12 64  International      0      1

/
/                        Route Entry OperID Operation Value
/                        -----
DestinationRouteOperation Create 3      2      1      stripLead      4

```

## Overview of Voice Profile for Internet Mail

With Voice Profile for Internet Mail (VPIM), users on one NBX system can send voice mail to a user on another NBX or VPIM-compliant system. VPIM is an optional component that requires a license, which appears in the NBX NetSet Licenses dialog as *Internet Voice Messaging License*.



*VPIM uses an SMTP server that is embedded in the NBX operating system. To avoid abuse by spammers, an SMTP server should always be protected by a firewall. Configure the firewall to allow access to port 25 on the NBX system only from valid VPIM systems that need to deliver VPIM messages to the phone system. The NBX SMTP server is started only when the system has a valid license for VPIM.*

To send a voice mail message to a user on another VPIM-compliant system, an NBX user first composes the voice mail message, using the commands in the user's voice mailbox. Depending on how the system's dial plan is configured, the user can specify the destination in two ways:

- If the dial plan is configured for site codes, the user specifies the destination site code followed by the extension of the person for whom the voice mail message is intended.
- If the dial plan is configured without site codes, the user specifies the extension of the person for whom the message is intended. This is easier, but requires that each site use a unique extension range for telephones.
- A user who knows the IP address of a VPIM-compliant voice mail system and the extension of a person who uses that system can compose a voice mail message and then send it using these steps:
  - Dial the IP address, pressing the \* key after each field in the address, including the last field.
  - Dial the extension of the person followed by #.

The system administrator configures the dial plan and decides whether to use site codes or unique extension ranges.

---

## Configuring the Dial Plan for VPIM

To fully define a VPIM connection between two NBX systems, you must create entries in the dial plan for the following items:

- The digit sequence that a telephone user must dial to access the VPIM connection
- The route number that is used to access the other NBX system
- The extension list to which the VPIM route belongs
- The operations that must be performed on the dialed digits in order to create the appropriate outgoing digit sequence

[Figure 9](#) contains sample lines which, when added to an existing dial plan, implement VPIM connections to two other NBX systems, one in Atlanta and one in Dallas. [Table 14](#) explains each entry.

**Figure 9** Dial Plan with VPIM Implementation Commands

```

Table Create 1 Internal Extensions
/
/
TableEntry Create 1 45 V82 5 5 WAN 0 532
TableEntry Create 1 46 V83 6 6 WAN 0 533

/
/
Route Description
-----
DestinationRoute Create 532 Atlanta VPIM Connection
DestinationRoute Create 533 Dallas VPIM Connection

/
/
Route Entry DestinationExtension
-----
DestinationRouteEntry Create 532 1 *0003
DestinationRouteEntry Create 533 1 *0003

/
/
Route Entry OperId Operation Value
-----
DestinationRouteOperation Create 532 1 1 stripLead 3
DestinationRouteOperation Create 532 1 2 prepend 10*234*101*222*
DestinationRouteOperation Create 533 1 1 stripLead 3
DestinationRouteOperation Create 533 1 2 prepend 10*234*101*100*

```

**Table 14** Explanation of Entries in [Figure 9](#)

Field	Purpose
<b>Table Create 1 Internal Extensions</b>	
	This command is already present in all default dial plans, and is included here as a reference point for subsequent commands.
<b>TableEntry Create 1 45 V82 5 5 WAN 0 532</b>	
TableEntry Create 1 45	This portion of the command creates entry 45 in dial plan table 1 (the <i>Internal Extensions</i> table). The choice of 45 as the entry number depends on how many entries exist in table 1. This example assumes that the highest number assigned to a previously existing entry was 44.

**Table 14** Explanation of Entries in [Figure 9](#) (continued)

<b>Field</b>	<b>Purpose</b>
V82 (Digits column)	<p>The letter V (required, and must be a capital letter) indicates that this is a VPIM connection, and the 82 indicates that the user must dial 82 to access the VPIM connection and then dial the extension the user wants to reach.</p> <p>You can select any number of digits for a site code. The selected number must not conflict with other dial plan entries. This example assumes that 82 is not used in any other way in the dial plan.</p> <p>Long digit sequences can annoy telephone users and create the opportunity for dialing errors.</p>
Min (5) Max (5)	Indicates that the total digit sequence dialed by the user is 5 digits. The first two digits are the site code (82 in this example) and the remaining 3 digits are the destination extension.
Class (WAN)	Indicates that this call is classified as <i>WAN</i> . All VPIM calls have this classification.
Priority (0)	This field is unused by the dial plan; the default value is zero (0).
Route (532)	In this example, the VPIM connection to the other NBX system uses route 532. The route number must be unique in the dial plan and in the range of 1–32768.
<b>DestinationRoute Create 532 Atlanta VPIM Connection</b>	
	This command creates route number 532 and gives it the name <i>Atlanta VPIM Connection</i> .
<b>DestinationRouteEntry Create 532 1 *0003</b>	
	This command (mandatory for all VPIM routes) assigns route 532 to the extension list *0003.
<b>DestinationRouteOperation Create 532 1 1 stripLead 3</b>	
	For DestinationRoute 532, entry 1, this command creates operation 1, which removes the first three digits, including the letter V, from the digit string, leaving only the extension that the user dialed.
<b>DestinationRouteOperation Create 532 1 2 prepend 10*234*101*222*</b>	
	For DestinationRoute 532, entry 1, this command creates operation 2, which places the string 10*234*101*222* in front of the extension. This string represents the IP address of the target NBX system. You must use the star character (*) to separate the fields within the IP address and to separate the IP address from the extension field.

## Configuring VPIM Parameters

Using the NBX NetSet utility, you can configure several VPIM control parameters, check the status of the VPIM queues, and obtain statistics on recent VPIM activity.

### VPIM Control Parameters

To set the VPIM control parameters:

- 1 In the *NBX NetSet - Main Menu* window, click *NBX Messaging*.
- 2 Click the *VPIM* tab. [Table 15](#) describes the fields.

**Table 15** VPIM Tab Fields

Field	Purpose
Max message size	Controls the size of incoming messages from other sites. If a message is larger than the specified value, the NBX system rejects it. The default value represents a voice mail message approximately 4 to 5 minutes in length.  Default: 3000 Kbytes
<i>Time between send attempts (minutes)</i>	For outgoing messages, the NBX system may not be able to contact the target system on the first attempt. If so, the NBX system attempts to contact the target system later. To change the time between attempts, change this number.  Default: 15 minutes Minimum: 1 minute Maximum: 60 minutes
Max number of send attempts	Specifies the number of times (Default: 4) that the NBX system tries to connect to the target system.  After the specified number of send attempts, the message is returned to the sender's voice mailbox with a notice that the message could not be sent.

### Operations Management

To manage outgoing voice mail messages, click Queue Management. The Operations Management dialog box appears. See [Table 16](#).

**Table 16** Operations Management Dialog Box Fields

Field	Purpose
Operations status	The status of the queue of outgoing voice mail messages.  <b>Possible values:</b> Starting, Ready, Processing, Stopped.

**Table 16** Operations Management Dialog Box Fields (continued)

<b>Field</b>	<b>Purpose</b>
Number of outgoing messages	The number of messages in the outgoing queue when this dialog box was last accessed or refreshed.
<b>Outgoing Messages</b>	
Time Waiting	The number of minutes that the voice mail message has been waiting in the queue.
# Attempts	The number of times the NBX system has attempted to send the voice mail message.
Sender	The e-mail address of the user who sent the voice mail message.
Destination	The IP address and extension to which the voice mail message is to be sent.
Remove	<p><b>NOTE:</b> You must stop the message queue before you can remove any message.</p> <p>Select a voice mail message in the scroll list and click this button to remove the message from the queue. The NBX system prompts you to confirm that you want to delete the selected message.</p> <p>Use Shift+Click to select a block of messages, or Ctrl+Click to select several messages that are not in a single block.</p>
<b>Apply Buttons</b>	
Send all messages now	The NBX system attempts to send all messages immediately and then waits for the required number of minutes before making another send attempt.
Send all messages now and then delete them	<p>The NBX system makes a single attempt to send each message on the queue.</p> <p>Any undelivered messages are returned to sender with delivery failure notices, and then deleted from the outgoing mail queue.</p>
Delete all messages now	<p>The NBX system deletes all messages from the outgoing mail queue.</p> <p>These messages are not returned to sender with delivery failure notices.</p>
Stop operations	Stops the queue if it is currently active.
Start operations	Starts the queue if it is stopped.

**Statistics** To view the most recent statics for voice mail messages, click the *Statistics* button. The Statistics window appears. [Table 17](#) lists the fields in this window and explains their purpose.

**Table 17** Statistics Window Fields

Field	Purpose
<b>Incoming Messages</b>	
Total messages received by system	The number of messages received by this NBX system from voice mailboxes on other systems
Total messages delivered to user mailboxes	The number of voice mail messages delivered to user voice mailboxes on this NBX system. If this number is smaller than the total number of messages received, some messages have not yet been delivered.
<b>Outgoing Messages</b>	
Total messages submitted for external delivery	The number of messages submitted by users of this NBX system for delivery to voice mailboxes on other systems
Total messages delivered to external recipients	The number of messages for which a confirmation of delivery has been received.
Total messages returned to sender on failed delivery	The number of messages that have been returned because they could not be delivered.
<b>Failed Outgoing Messages</b>	
If a message appears in this list, the NBX system has tried to deliver the message and has failed. The NBX system attempts to resend the message up to the retry limit. Default: 4. Minimum: 1. Maximum: 10.	
Date/Time	The date and time that the message was originally submitted for delivery
Attempts	The number of attempts that the NBX system has made to send each message
Sender	The person on the local NBX system who created and sent the voice mail message
Destination	The defined target for the voice mail message
Reason	The reason for the most recent failure to deliver the message
<b>Reset and Reboot Times</b>	
Last reset command	The date and time of the last reset command. Sets all VPIM statistics to 0 (zero) and deletes all messages from the Failed Outgoing Messages queue.  If this field's date and time are more recent than <i>Last system reboot</i> , then the NBX system began to collect the currently displayed statistics at this date and time.

**Table 17** Statistics Window Fields (continued)

Field	Purpose
Last system reboot	<p>The date and time of the most recent reboot of the NBX system. An NBX system reboot resets all VPIM statistics to 0 (zero).</p> <p>If this field's date and time are more recent than <i>Last reset command</i>, then the NBX system began to collect the currently displayed statistics at this date and time.</p>

## Advanced Settings

The NBX system transmits VPIM voice mail messages by attaching them to e-mail messages that are sent using SMTP (Simple Mail Transfer Protocol) or ESMTP (Extended Simple Mail Transfer Protocol).

Click the Advanced Settings button to access the Advanced Settings dialog box. Set the parameters to control the behavior of SMTP. [Table 18](#) describes the fields.

**Table 18** VPIM Advanced Settings Dialog Box

Field	Purpose
SMTP OK response	<p><b>Definition:</b> The amount of time that the local system waits for a response from the remote system.</p> <p><b>Detail:</b> After the local system attempts to open a connection to the remote system, it waits for a response giving the status of the connection.</p> <p><b>Minimum:</b> 5 minutes</p> <p><b>Default:</b> 5 minutes</p>
SMTP HELO response	<p><b>Definition:</b> The amount of time that the local system waits for an acknowledgement of a HELO message.</p> <p><b>Detail:</b> After the greeting, the local system sends either a HELO (or EHLO to get ESMTP) message to identify itself. The other site then responds with an acknowledgement of that message.</p> <p><b>Minimum:</b> None defined.</p> <p><b>Default:</b> 5 minutes</p>

**Table 18** VPIIM Advanced Settings Dialog Box (continued)

<b>Field</b>	<b>Purpose</b>
SMTP EHLO response	<p><b>Definition:</b> The amount of time that the local system waits for acknowledgement of a EHLO message.</p> <p><b>Detail:</b> After the greeting, the local system sends either a HELO (or EHLO to get ESMTP) message to identify itself. The other site then responds with an acknowledgement of that message.</p> <p><b>Minimum:</b> None defined.</p> <p><b>Default:</b> 5 minutes</p>
SMTP MAIL response	<p><b>Definition:</b> The amount of time that the local system waits for an acknowledgement of a MAIL command.</p> <p><b>Detail:</b> After the local system sends out a MAIL command along with the From information, it waits for a response from the other site to indicate that the MAIL command was received.</p> <p><b>Minimum:</b> 5 minutes</p> <p><b>Default:</b> 5 minutes</p>
SMTP RCPT response	<p><b>Definition:</b> The time that the local system waits for an acknowledgement of a RCPT command.</p> <p><b>Detail:</b> After the system sends out a RCPT command (one per recipient), it waits for a response from the other site indicating acceptance or rejection of the recipient.</p> <p><b>Minimum:</b> 5 minutes</p> <p><b>Default:</b> 5 minutes</p>
SMTP DATA response	<p><b>Definition:</b> The time that the local system waits for an acknowledgement of a DATA command.</p> <p><b>Detail:</b> After the local system has specified all of the recipient information, it sends a DATA command to indicate that it is ready to send the mail message itself. It then waits for the other site to acknowledge the DATA command.</p> <p><b>Minimum:</b> 2 minutes</p> <p><b>Default:</b> 2 minutes</p>

**Table 18** VPIM Advanced Settings Dialog Box (continued)

<b>Field</b>	<b>Purpose</b>
SMTP DATA END response	<p><b>Definition:</b> The time that the local system waits, after sending the entire message, for an acknowledgement from the other site that the message was received.</p> <p><b>Detail:</b> After the local system sends the entire message, it waits for a response from the other site indicating acceptance of the message.</p> <p><b>Minimum:</b> 10 minutes</p> <p><b>Default:</b> 10 minutes</p>
SMTP RSET response	<p><b>Definition:</b> The time that the local system waits for an acknowledgement of a RSET command.</p> <p><b>Detail:</b> Since the RSET command resets the SMTP connection, the local system must wait for the other site to reset itself and acknowledge.</p> <p><b>Minimum:</b> None defined</p> <p><b>Default:</b> 10 minutes</p>
SMTP QUIT response	<p><b>Definition:</b> The time that the local system waits for an acknowledgement of the QUIT command.</p> <p><b>Detail:</b> When the local system is finished transmitting a message and wants to break the connection, it sends a QUIT command. It then waits for the other site to acknowledge the QUIT command. When the acknowledgement arrives, or when the time-out value is reached, whichever comes first, the local system breaks the connection.</p> <p><b>Minimum:</b> None defined</p> <p><b>Default:</b> 5 minutes</p>

## Configuring Domain Name Server Information

When the SMTP utility attempts to send e-mail, it must be able to resolve a host name within an e-mail address and determine the proper IP address from that name. Domain Name Servers on the Internet perform this function. You can configure up to three DNS entries with the NBX NetSet utility. The NBX system uses the second and third entries if the first or second cannot be reached. To configure DNS information in the NBX NetSet utility:

- 1 In the *NBX NetSet - Main Menu* window, click *System Configuration*.
- 2 Click the System Settings tab and the System-wide button. The System Settings dialog box appears.
- 3 In the *Primary DNS*, *Secondary DNS*, and *Tertiary DNS* text boxes, type the IP addresses of three Domain Name Servers. If you have the IP address of only one server, type it in the *Primary DNS* text box. If you have the IP address of only two servers, type them in the *Primary and Secondary DNS* text boxes. Click *OK*.

---

## Overview of Virtual Tie Lines

A Virtual Tie Line (VTL) provides a way to make calls between NBX system sites that are separated geographically but tied together by a Wide Area Network (WAN). An NBX 100 system can support up to 8 simultaneous VTL connections; a SuperStack 3 NBX system can support up to 48. VTLs are a licensed feature of the NBX systems.

On any NBX system, a VTL connection can be used either for an incoming VTL call from any site or for an outgoing VTL call to any site. A VTL connection is not dedicated in the same way as a physical tie line, which always connects the same pair of sites. In the example in [Figure 10](#), the VTLs on the Chicago NBX system can be used for any combination of incoming and outgoing VTL calls to either Atlanta or Dallas.

The NBX system can reroute VTL calls that fail to reach their destination on the first attempt. For details, see [“Call Rerouting for Virtual Tie Lines”](#) on [page 94](#).



- You must configure the system for either *IP On-the-Fly* or *Standard IP* in order to use VTL connections to other NBX systems.
- VTL connections cannot be configured to run through firewalls or NAT routers.
- When you calculate the number of devices on an NBX system, do not include the number of VTLs.

There are two implementation techniques you can use: unique extension ranges, as described next, or site codes, which begins on [page 82](#).

### VTL Connections Using Unique Extension Ranges

If you can restrict the extension ranges on each of the NBX systems so that they do not overlap, you can configure the dial plans to route calls based only on the extension that is being dialed. The caller does not have to dial any digits to specify the site.



*Assess your growth plans for each site to verify that as you add telephones you do not exceed your defined extension ranges.*

[Figure 10](#) depicts a configuration that uses unique extension ranges

**Figure 10** Multi-site Network using Virtual Tie Lines

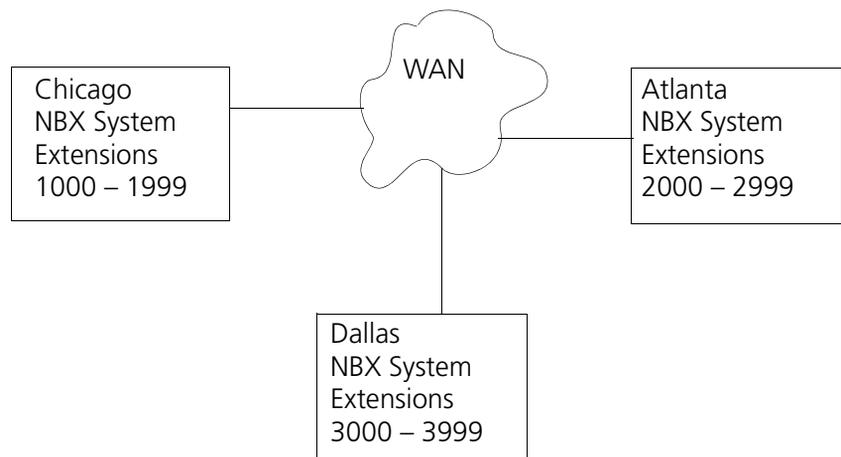

In the sample network shown in [Figure 10](#), each site is set up to use a unique range of telephone extensions. The dial plan on each of the systems is configured so that whenever a call is made to an extension not located at the local site, the NBX system sets up a VTL connection to the appropriate site.

To make a call to a user in Dallas, a user in Chicago dials a Dallas extension (3000 through 3999). The dial plan on the Chicago NBX system is configured to set up the necessary VTL connection to the Dallas NBX system, and then to the extension at that site.

See [“Dial Plan Configuration”](#) on [page 85](#) for further information on how to set up VTLs in the dial plan.

## VTL Connections Using Site Codes

The simpler way to implement VTL connections uses a site code, consisting of one or more digits that a user must dial to specify the site that is being called. This approach requires no restriction on the telephone extension ranges, but does require the caller to dial the site code digits as well as the extension.

A site code can be any number of digits, but typically, one- or two-digit numbers make the most sense. The dial plan at each site must include appropriate routing instructions for each of the possible site code.

[Figure 11](#) shows three sites connected by VTLs. All sites use the same range of extension numbers (1000 through 3999). To reach someone on another NBX system, a user must dial a site code (61, 62, or 63 in this example) followed by an extension.

**Figure 11** Virtual Tie Lines Using Site Codes

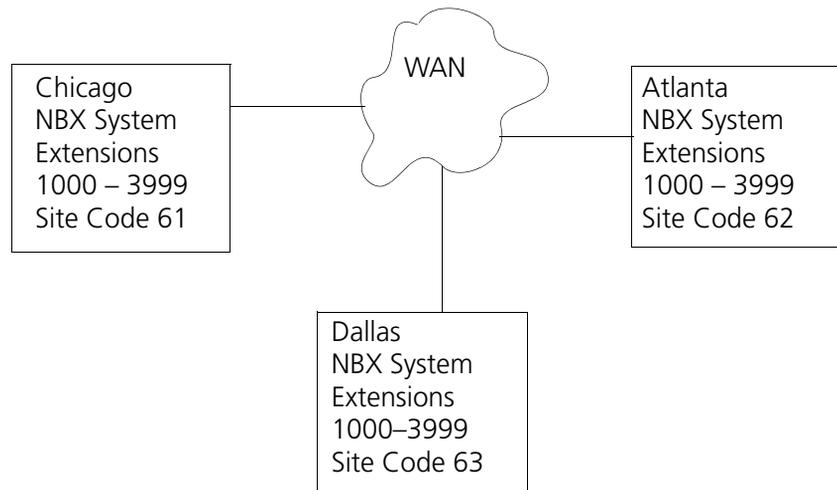

To call someone in Atlanta, a user in Chicago must dial the site code 62 and then the appropriate extension (1000 through 3999). To reach a user in Dallas, a user in Chicago must dial 63 and then the appropriate extension (1000 through 3999). Because the extension is preceded by the site code, there is no conflict between the extension dialed and an identical extension number at the local site (Chicago). The choice of site codes is made by the person who configures the dial plans for the sites.

See [“Dial Plan Configuration”](#) on [page 85](#) for more information on how to set up VTLs in the dial plan.

## Conference Calls Using VTL Connections

Users can set up conference calls over VTLs in much the same way that they set up conference calls with other users at their local site, or at a site reachable by an external telephone line. On NBX 100 systems, you can have up to four 4-person conference calls simultaneously. On a SuperStack 3 NBX system, you can have up to twelve 4-person conference calls simultaneously.



*To be able to make conference calls between sites, you must have IGMP (Internet Group Management Protocol) implemented on your network.*

### Conference Calls Using Site-Unique Extensions

In [Figure 10](#), a user in Chicago establishes a conference call with two users in Atlanta and one user in Dallas as follows:

- 1 Dial the first extension in Atlanta.
- 2 After the user answers, press **Conference** and dial the second extension in Atlanta.
- 3 When the second user answers, press **Conference** again to connect all three users.
- 4 Press **Conference** again and dial the extension of the user in Dallas.
- 5 When the fourth party answers, press **Conference** to connect all four users.

### Conference Calls Using Site Codes

In [Figure 11](#), if you work in the Chicago office, to establish a conference call with two people in Atlanta and one person in Dallas:

- 1 Dial the site code (62) and the first extension.
- 2 After the first user answers, press **Conference**, dial the same site code (62) and the second extension in Atlanta.
- 3 When the second Atlanta user answers, press **Conference** again to connect all three users.
- 4 Press **Conference** again and dial the Dallas site code (63) and then the extension of the user in Dallas.
- 5 When the Dallas user answers, press **Conference** again to connect all four users.

## Conference Calls Involving Site Codes and Off-Site Telephones

In [Figure 11](#), you work in the Chicago office and want to establish a conference call with someone in Atlanta, someone in Dallas, and someone at an external telephone number, you:

- 1 Dial the Atlanta site code (62) and then the extension.
- 2 After the Atlanta user answers, press Conference and dial the Dallas site code (63) and then the extension.
- 3 When the Dallas user answers, press Conference again to connect all three users.
- 4 Press Conference again and dial the external telephone number.

If the site requires that you dial 9 to reach an outside telephone line, and if the call is a long-distance call, the user might dial a number in area code 367 using the digit sequence 913675551212.

- 5 When the person answers, press Conference again to connect all four users.

---

## How to Configure a Virtual Tie Line

Configuring a working VTL connection between two systems involves:

- [License Installation](#)
- [Dial Plan Configuration](#)
- [Updating the Extension List](#)
- [Adding VTL Devices to the Pretranslators \(Optional\)](#)
- [Verification of the Virtual Tie Line](#)

You can enable silence suppression and different levels of audio compression for your VTL calls. For more information on how silence suppression and compression affect bandwidth, see [“Audio Settings”](#) on [page 240](#). To change the system-wide settings for silence suppression and compression on VTL calls, use the NBX NetSet utility to edit the audio settings: *System Configuration > System Settings > Audio Settings*.

## License Installation

- You must obtain and install a license to enable VTLs.
- Each VTL license applies only to the NBX system on which it is installed. To connect three sites by VTLs and to have each site support up to 8 simultaneous active VTL connections, you must install a separate license key for 8 VTLs on each of the three NBX systems.

- To increase the number of VTLs above one of the levels on a system, you must add one or more incremental licenses of 2 VTLs each.

To install a VTL license:

- 1 In the *NBX NetSet - Main Menu* window, click *Operations*. Click the *Licenses* tab and the *Add License* button. In the text boxes, type the license key code.
- 2 Click *OK* and then restart the NBX system.

### **Dial Plan Configuration**

You configure the dial plan after you install the VTL license. See [“License Installation”](#) on [page 84](#) for information about VTL licenses.

To configure the dial plan for VTLs, you must define:

- Routes within the dial plan
- Digit sequences to be used to select those routes
- Operations to be performed for each route

#### **Example: Dial Plan with Site-Unique Extensions**

In [Figure 10](#), each of the three sites uses a unique extension range. In the Internal table in the Chicago system dial plan, the entries shown in [Figure 12](#) control the routing of calls if a user dials an extension in the 2000 through 2999 range (Atlanta extensions) or the 3000 through 3999 range (Dallas extensions) respectively. The dial plans for the Atlanta and Dallas NBX systems would contain similar, but not identical entries.

An explanation of each line in the dial plan follows [Figure 12](#).

**Figure 12** Sample Dial Plan Entries for Chicago Using Site-Unique Extensions

```

Table Create 1 Internal 4 Digit Extensions
/
/
TableEntry Create 1 3 2 4 4 WAN 0 522
TableEntry Create 1 4 3 4 4 WAN 0 523

/
/
Route Description
-----
DestinationRoute Create 522 Atlanta VTL Connection
DestinationRoute Create 523 Dallas VTL Connection

/
/
Route Entry DestinationExtension
-----
DestinationRouteEntry Create 522 1 *0006
DestinationRouteEntry Create 523 1 *0006

/
/
Route Entry OperId Operation Value
-----
DestinationRouteOperation Create 522 1 1 prepend 192*168*25*100*
DestinationRouteOperation Create 523 1 1 prepend 192*168*35*100*

```

The first *TableEntry Create* command modifies entry 3 in Table 1. Entry 3 watches for 4-digit sequences (Min = 4, Max = 4) beginning with 2 (extensions 2000 through 2999) and specifies route 522 whenever a 4-digit sequence falls within this range. Entry 4 watches for 4-digit sequences (Min = 4, Max = 4) beginning with 3 (extension 3000 through 3999) and specifies route 523 whenever a 4-digit sequence falls within this range. Route numbers 522 and 523 are examples only. The choice of route numbers is made by the person who configures the dial plans for the sites.

Two *DestinationRoute Create* commands create routes 522 and 523. The Description field contains any text you want to use to describe each route.

Two *DestinationRouteEntry Create* commands specify the extension list for routes 522 and 523. Extension list \*0006 is reserved for VTLs.

Two *DestinationRouteOperation Create* commands prepend the IP Address of the destination NBX system to the extension that the user dialed. In this example, the IP address for Atlanta is 192.169.25.100 and

for Dallas, the IP address is 192.168.35.100. You must use the asterisk (\*) character to separate fields within the IP address and to separate the IP address from the destination extension.

### Example: Dial Plan with Site Codes

In [Figure 11](#), each of the three sites uses the same extension range. In the Internal table in the Chicago system dial plan, the entries shown in [Figure 13](#) select route 522 and 523 if a user dials the site codes 62 and 63 respectively, and then dials an extension. The dial plans for the Atlanta and Dallas NBX systems would contain similar, but not identical entries.

An explanation of each line in the dial plan follows [Figure 13](#).

**Figure 13** Sample Dial Plan Entries for Chicago Using Site Codes

```

Table Create 1 Internal 4 Digit Extensions
/
/
/
TableEntry Create 1 100 62 6 6 WAN 0 522
TableEntry Create 1 101 63 6 6 WAN 0 523

/
/
/
DestinationRoute Create 522 Atlanta VTL Connection
DestinationRoute Create 523 Dallas VTL Connection

/
/
/
DestinationRouteEntry Create 522 1 *0006
DestinationRouteEntry Create 523 1 *0006

/
/
/
DestinationRouteOperation Create 522 1 1 stripLead 2
DestinationRouteOperation Create 522 1 2 prepend 192*168*25*100*
DestinationRouteOperation Create 523 1 1 stripLead 2
DestinationRouteOperation Create 523 1 2 prepend 192*168*35*100*

```

The first *TableEntry Create* command creates entry 100 in Table 1. This assumes that the highest previous entry in Table 1 was 99 or lower. Entry 100 watches for the 2-digit sequence 62 followed by a 4-digit extension and specifies route 522 whenever a user dials such a 6-digit (Min = 6 and

Max = 6) sequence. Entry 101 watches for the 2-digit sequence 63 followed by a 4-digit extension and specifies route 523 whenever a user dials such a 6-digit sequence. The choice of route numbers is made by the person configuring the dial plans for the sites.

Two *DestinationRoute Create* commands create routes 522 and 523. The Description field contains any text you want to use to describe each route.

Two *DestinationRouteEntry Create* commands specify the extension list for routes 522 and 523. Extension list \*0006 is the default extension list for VTLs.

For each *DestinationRoute*, two *DestinationRouteOperation Create* commands perform two functions:

- The *stripLead* command removes the two digits (62 or 63) leaving the 4-digit extension the user dialed.
- The *prepend* command adds the IP Address of the destination NBX system to the extension that the user dialed. In this example, the IP address for Atlanta is 192.169.25.100 and for Dallas, the IP address is 192.168.35.100. In the dial plan, you must use an asterisk (\*) instead of a period (.) to separate the fields within the IP address, and to separate the IP address from the destination extension.

### Updating the Extension List

The final step in activating the virtual tie lines is to add the VTL extensions to the appropriate extension list (\*0006).

To update the extension list:

- 1 In the *NBX NetSet - Main Menu* window, click *Dial Plan*.
- 2 Click the *Extension Lists* tab.
- 3 Select the *Virtual Tie Lines* extension list (\*0006).
- 4 Click *Modify*.
- 5 In *Extensions not in List*, scroll down until you see the first VTL item.

The number of VTL items depends on the VTL license you have.

Each VTL item has (VTL) at the beginning of the line, followed by the name of the virtual tie line.

[Table 19](#) describes the VTL extension ranges.

- 6 Select the first VTL, and click << to move the VTL to *Extensions in List*.

- 7 Repeat until all VTLs are moved to *Extensions in List*.

**Table 19** Virtual Tie Line Extension Ranges

Platform	Extension Range
SuperStack 3 4-digit dial plan	6500–6523
SuperStack 3 3-digit dial plan	The default dial plan for a SuperStack 3 NBX system is 4-digit. If you convert to a 3-digit dial plan, you must manually change each 4-digit extension to a 3-digit extension. For VTLs, you can select any unused 3-digit extension from the external extension range (600–799).
NBX 100 4-digit dial plan	The default dial plan for an NBX 100 system is 3-digit. If you convert to a 4-digit dial plan, you must manually change each 3-digit extension to a 4-digit extension. For VTLs, you can select any unused 4-digit extension from the external extension range (6000–7999).
NBX 100 3-digit dial plan	623–630

### Adding VTL Devices to the Pretranslators (Optional)

If you optionally added a pretranslator to the dial plan to reformat the information on incoming calls, you *must* add the VTL devices to that pretranslator. You might need to add a pretranslator to the dial plan to handle caller ID issues. See [“Creating a Pretranslator for VTL Calls”](#) on [page 65](#).

To add the VTL devices to the pretranslator:

- 1 In the *NBX NetSet - Main Menu* window, click *Dial Plan*.
- 2 Click the *PreTranslators* tab.
- 3 In the scroll list, select *VTL*.
- 4 Click the *Devices Using* button.
- 5 In the *Devices Using Pretranslator* window, scroll down in the *Devices Not Using Pretranslator* list until you see the devices associated with VTLs. For a 4-digit dial plan, the VTL device extensions range from 6500 through 6523. For a 3-digit dial plan, VTL device extensions range from 623 through 630.
- 6 Select the first VTL device extension.
- 7 Scroll until you can see all of the VTL device extensions.
- 8 Simultaneously press the Shift key and click the last VTL device extension to select the entire block of VTL device extensions.

- 9 To move all VTL device extensions to the *Devices Using Pretranslator* list, click <<.

### Verification of the Virtual Tie Line

After you have configured the VTLs on each of two NBX systems, you must verify that the VTL connection works properly.

To verify that a working VTL connection exists between two systems, you must verify that:

- [Local System Verification](#) — Verify that the configured VTLs appear on each system.
- [Remote Access Verification](#) — Verify that each of the systems can access each other.
- [Placing Telephone Calls](#) — Verify that telephone calls can be made between all pairs of connected systems in both directions.

#### Local System Verification

On each system you must verify that you can view the VTLs using the NBX NetSet utility. To verify that you can view the local VTLs:

- 1 In the *NBX NetSet - Main Menu* window, click *Device Configuration*.
- 2 Click the *Virtual Tie Lines* tab.
- 3 Verify that all of VTLs you have configured appear in the list.

In our example, if you perform this verification test on the Chicago NBX system, the results appear as shown in [Figure 14](#).

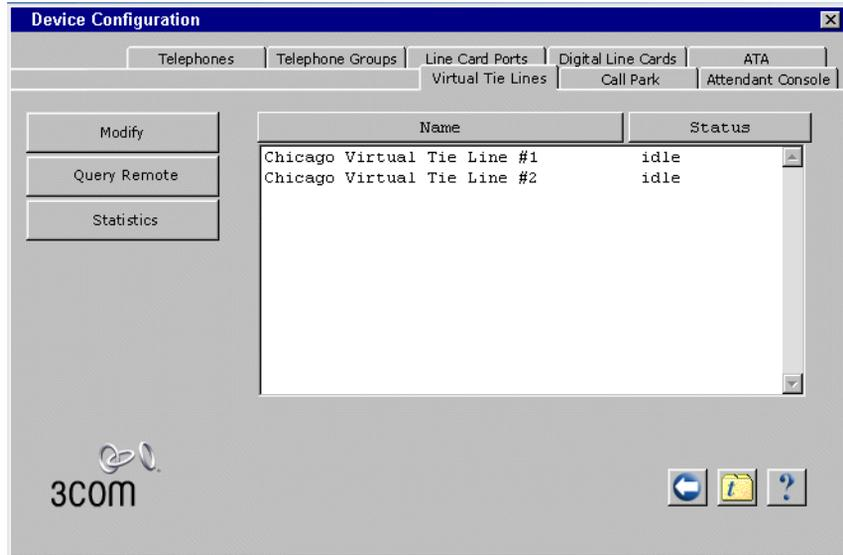
**Figure 14** Example: Virtual Tie Lines Tab

### Remote Access Verification

To verify that each system can access the other, on each system:

- 1 On the *Virtual Tie Lines* tab, select the VTL and then click the *Query Remote* button.
- 2 In the *Query Remote System* window, type the IP address of the remote system in the *IP address* text box. Click the *Query* button. If the verification is successful, the window displays the VTLs configured at the remote site.

**Example:** You have installed an NBX system in Chicago, Atlanta, and Dallas, and you have configured two VTL connections on each of the Chicago and Atlanta systems. The IP addresses of the three systems are:

- Chicago — 192.168.15.100
- Atlanta — 192.168.25.100
- Dallas — 192.168.35.100

If you perform the Query Remote operation from the Chicago system to the Atlanta system, the results might look like [Figure 15](#).

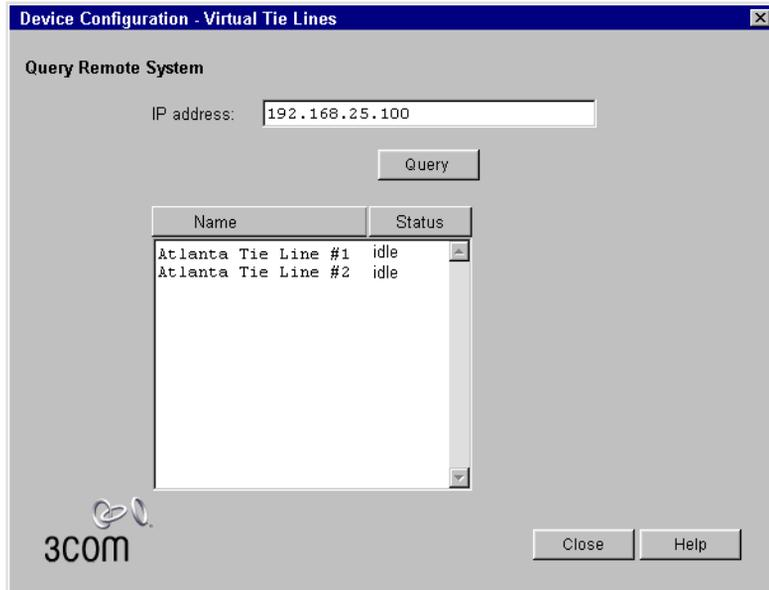
**Figure 15** Query Remote Window (Example)

The Atlanta system (IP address 192.168.25.100) shows two installed but idle VTL connections. If you performed the Query Remote test from the Atlanta office and specified the IP address of the Chicago system, it should show two installed but idle VTL connections.

If the local NBX system fails to access the remote system, an error message appears similar to the one shown in [Figure 16](#).

**Figure 16** Query Remote Error Message

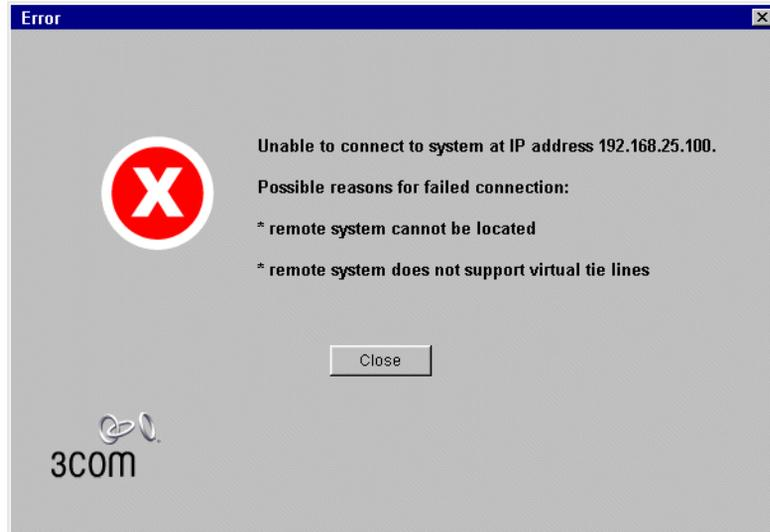

If you have not yet configured the remote system to support VTLs, this message indicates that you must do so before the Query Remote operation can succeed.

If you have configured the remote system to support VTLs, the error message indicates that the local NBX system cannot access the remote system using the IP address you specified. To remedy the problem:

- 1 Verify that you specified the correct IP address for the remote system.
- 2 Verify that the remote NBX system is running properly.
- 3 Verify that the remote NBX system is using the dial plan which you modified to configure VTLs on that system.
- 4 Work with your network administrator to verify that WAN connection between the two sites is properly configured and is working.
- 5 Verify that the VTL extensions are included in the *Devices Using Pretranslator* table.

### Placing Telephone Calls

The final step when verifying a virtual tie line connection is to place telephone calls in both directions between each pair of connected sites.

---

## Call Rerouting for Virtual Tie Lines

To enable the NBX system to better deal with network problems, you can configure the system dial plan so that some virtual tie line (VTL) calls can be rerouted if a VTL connection cannot be made.

VTL calls can be rerouted if:

- The dial plan contains an invalid IP address
- The remote NBX system is not responding
- All VTL channels on the remote NBX system are currently busy
- All IP addresses in the IP On-the-Fly address pool are in use

Some VTL calls are not rerouted. Example situations in which a call is not rerouted include:

- Placing a VTL call to another system with the intention of hopping off (dialing a telephone number local to the other system) when all trunks are busy on the other system
- Dialing an invalid telephone number

If you normally connect calls from site A to site B using VTL connections, you can define an alternate route to site B using Analog Line Card ports, Digital Line Card channels, etc. If a network problem such as a router failure occurs, or if all VTL ports on the site A NBX system are busy, VTL calls that fail to reach site B are then dialed using the alternate route.

If your VTL call is rerouted, you see additional routing information in the display panel on your NBX telephone.

The NBX system log file contains records of failed VTL calls that were rerouted.

### Example Dial Plan Entries

If you normally dial a site code such as 72 to reach site B, and if the telephones at the other site use four-digit extensions, the dial plan entries to handle the initial call and the rerouting of the call might look like the example shown in [Figure 17](#).

**Figure 17** Sample Dial Plan Entries for Rerouting VTL Calls**Table Create 1 Internal 4 Digit Extensions**

```

/
/
/
TableEntry Create      Id Entry Digits      Min Max Class      Prio Route
/
/
/
TableEntry Create      1      8 72              6   6 WAN            0      6

```

**Routes**

```

/
/
/
DestinationRoute Create      6 Site B

```

```

/
/
/
Route Entry DestinationExtension
/
/
/
DestinationRouteEntry Create      6      1 *0006
DestinationRouteEntry Create      6      2 *0001

```

```

/
/
/
Route Entry OperId Operation Value
/
/
/
DestinationRouteOperation Create      6      1      1 stripLead 2
DestinationRouteOperation Create      6      1      2 prepend 192*168*155*100*
DestinationRouteOperation Create      6      2      1 stripLead 2
DestinationRouteOperation Create      6      2      2 prepend 1978247

```

**Explanation:**

The TableEntry Create command specifies that when a user on the local NBX system dials a six-digit number beginning with the digits 72, the call is routed via route 6, which is the route that normally contains only the VTL extension list (\*0006).

To allow VTL calls to be rerouted, route 6 is configured to use both the VTL extension list and the Line Cards extension list (\*0001). Calls that use route 6 can be completed using devices in either of these extension lists.

There are four DestinationRouteOperation lines. The first two lines specify the primary way to handle the call, using VTL methods. The last two lines specify the backup way to handle the call if the first method fails.

### Successful VTL Call

If there are no network problems:

- 1 The first line (Entry 1, OperId 1) removes the digits 72.
- 2 The second line (Entry 1, OperId 2) prepends the IP address of the NBX system at site B in front of the dialed extension number.

### Unsuccessful VTL Call

If a network problem or a lack of VTL ports prevents the VTL call from reaching its destination:

- 1 The third line (Entry 2, OperId 1) removes the digits 72.
- 2 The fourth line (Entry 2, OperId 2) prepends an appropriate dial string and dials out over an analog telephone line.

---

## Managing Existing Virtual Tie Lines

After VTLs are installed and you have verified that they are working properly, you can manage them using the NBX NetSet utility. There are NBX NetSet utility functions for:

- [Modifying a Virtual Tie Line Name](#)
- [Viewing and Resetting Virtual Tie Line Statistics](#)
- [Enabling Audio Compression for VTL Calls](#)
- [Enabling Silence Suppression on VTL Calls](#)

### Modifying a Virtual Tie Line Name

You can change the name of a VTL. The name appears in NBX NetSet lists, and helps you identify each VTL.

To modify the name of a VTL:

- 1 In the *NBX NetSet - Main Menu* window, click Device Configuration.
- 2 Click the *Virtual Tie Lines* tab. The window that appears contains the list of existing VTLs, and the status of each one.
- 3 Select a VTL from the list.
- 4 Click *Modify*. The Modify dialog box appears.
- 5 In the *New VTL name* text box, type the name you want to assign to this VTL. Click *OK*. Verify that the name change is on the Virtual Tie Lines tab.

## Viewing and Resetting Virtual Tie Line Statistics

You can view the statistics for a VTL at any time.

To view statistics for a VTL:

- 1 In the *NBX NetSet - Main Menu* window, click *Device Configuration*.
- 2 Click the *Virtual Tie Lines* tab.
- 3 From the list, select the VTL.
- 4 Click the *Statistics* button. The Statistics dialog box appears. The fields are described in [Table 20](#).
- 5 To reset all VTL statistics, click *Reset*.



*Another way to reset all VTL statistics is to restart the NBX system.*

- 6 When you are finished, click *Close*.

**Table 20** Virtual Tie Line Statistics Fields

Field	Description
<b>NOTE:</b> All statistics apply to the time period since the most recent Reset command or since the most recent system reboot, whichever was more recent. To determine the starting time for the displayed statistics, compare the <i>Last reset command</i> with the time of the <i>Last system reboot</i> . Both are displayed at the bottom of the VTL Statistics window.	
Number of outgoing VTL calls made	The number of outgoing calls made over all virtual tie lines (VTLs) since the most recent reset command or since the time the NBX system was last restarted. Each time you restart the NBX system, you reset the statistics for all VTLs.
Number of incoming VTL calls received	The number of incoming calls received over all VTLs since the most recent reset command or since the time the NBX system was last restarted.
Number of active VTL calls	The number of calls currently active on all VTLs.
Maximum number of concurrently active VTL calls	The maximum number of VTL calls that have been active at the same time on this NBX system since the most recent reset command or since the time the NBX system was last restarted.
Incoming VTL calls rejected due to all VTLs busy	The number of telephone calls that would have arrived from other NBX systems over VTL channels, but could not be accepted because all local VTL ports were busy when the calls arrived.
Outgoing VTL calls rejected due to all VTLs busy	The number of telephone calls that would have been sent from the local NBX system over VTL channels, but could not be sent because all local VTL ports were busy when the calls were made.

**Table 20** Virtual Tie Line Statistics Fields (continued)

Field	Description
Rerouted VTL calls	The number of calls that did not reach their destination when attempted over VTL channels, and were rerouted using another device.
Last reset command	The date and time of the most recent <i>Reset</i> for this VTL.
Last system reboot	The date and time of the most recent reboot of the NBX system.

### Enabling Audio Compression for VTL Calls

You can set audio compression for VTL calls. The default condition is no audio compression because compression can compromise audio quality. For more information on how compression affects bandwidth, see [“Audio Settings”](#) on [page 240](#).

During VTL call setup, the VTL software at each end of the call negotiates a compression level that is supported by both systems. For example, System A is configured for G729, high compression, and System B is configured for G711, no compression. A VTL call between System A and System B will use G711, no compression. It does not matter which system initiates the call.

To enable VTL audio compression:

- 1 In the *NBX NetSet - Main Menu* window, click *System Configuration*.
- 2 On the *System Settings* tab click *Audio Settings*.
- 3 Click the *Audio Compression on VTL Calls* check box and then click *OK*.

### Enabling Silence Suppression on VTL Calls

You can enable silence suppression for VTL calls. The default condition is disabled because silence suppression can compromise audio quality. For more information on how compression affects bandwidth, see [“Audio Settings”](#) on [page 240](#).

When you enable VTL silence suppression, the VTL software attempts to use silence suppression on all VTL calls. If the other NBX system is not configured to support silence suppression, the local VTL software attempts to find a compatible communications mode.



*Do not enable silence suppression unless you have network congestion problems you cannot solve otherwise. Enabling silence suppression can reduce network traffic, but the result is a compromise to audio quality.*

To enable silence suppression on VTLs:

- 1 In the *NBX NetSet - Main Menu* window, click *System Configuration*.
- 2 On the *System Settings* tab click *Audio Settings*.
- 3 Click the *System-wide Silence Suppression on VTL Calls* check box, and then click *OK*.

---

## Using a VTL Password

To allow users on one NBX system to place VTL calls to another NBX system and then place long-distance (toll) calls from that location (a practice called 'hop off'), you can configure a VTL password.

When an NBX system receives a VTL call from a user on another NBX system, it can allow that user to make long-distance calls if the incoming VTL call contains the password. Otherwise, such calls are not allowed. If you set up two classes of VTL calls (with and without passwords), you can permit or disallow hop off.

To enable an NBX system to handle incoming hop off calls, create or modify a VTL password, as described in the next topic, [Configuring a VTL Password](#).

To enable an NBX system to send hop off VTL calls, configure the dial plan to include the VTL password, as described in [Configuring VTL Passwords in the Dial Plan](#) on [page 100](#).

## Configuring a VTL Password

For each NBX system that can receive VTL calls, you use the NBX NetSet utility to configure a local system VTL password.

To configure the password:

- 1 In the *NBX NetSet - Main Menu* window, click *System Configuration*.
- 2 Click the *Security* tab.
- 3 Click the *Virtual Tie Lines Password* button. The *Change Virtual Tie Lines Password* dialog box appears.
- 4 Type the administrator password in the *Current Admin Password* text box.
- 5 Type the new VTL password in the *New Virtual Tie Line Password* text box.



*Passwords are from 8 to 15 characters in length and must contain only letters and numbers. Upper and lower case letters are permitted.*

- 6 Retype the new VTL password in the *Re-enter New Password* text box.
- 7 Click *OK*.

### **Configuring VTL Passwords in the Dial Plan**

For each remote NBX system that controls hop-off by means of a VTL password, you must configure that password into the VTL commands in the local dial plan.

If you use site codes to access other NBX systems through VTL connections, you can configure one set of VTL connections that permit hop-off and are accessed by one set of site codes. You can configure another set of VTL connections that do not permit hop-off and are accessed using a different set of site codes.

If you use unique extension ranges at each site, and therefore do not dial a site code when placing VTL calls to users at those sites, you can still use codes to access VTL connections that permit hop-off at the far end.

[Figure 18](#) shows how to configure VTL passwords in a dial plan, using site codes that permit hop-off and other site codes that do not.

**Figure 18** Dial Plan Entries for VTL Passwords

```

Table Create 1 Internal 4 Digit Extensions
/
/
/
/
TableEntry Create 1 100 62           6 6 WAN           0 522
TableEntry Create 1 101 63           6 6 WAN           0 523
TableEntry Create 1 102 72           6 32 WAN          0 524
TableEntry Create 1 103 73           6 32 WAN          0 525

/
/
/
/
DestinationRoute Create 522 Atlanta VTL Connection
DestinationRoute Create 523 Dallas VTL Connection
DestinationRoute Create 524 Atlanta VTL Connection with password
DestinationRoute Create 525 Dallas VTL Connection with password

/
/
/
/
DestinationRouteEntry Create 522 1 *0006
DestinationRouteEntry Create 523 1 *0006
DestinationRouteEntry Create 524 1 *0006
DestinationRouteEntry Create 525 1 *0006

/
/
/
/
DestinationRouteOperation Create 522 1 1 stripLead 2
DestinationRouteOperation Create 522 1 2 prepend 192*168*25*100*
DestinationRouteOperation Create 523 1 1 stripLead 2
DestinationRouteOperation Create 523 1 2 prepend 192*168*35*100*
DestinationRouteOperation Create 524 1 1 stripLead 2
DestinationRouteOperation Create 524 1 2 prepend192*168*25*100*ATLPassW*
DestinationRouteOperation Create 525 1 1 stripLead 2
DestinationRouteOperation Create 525 1 2 prepend 92*168*35*100*DALPWord*

```

The first *TableEntry Create* command creates entry 100 in Table 1. This assumes that the highest previous entry in Table 1 was 99 or lower. Entry 100 watches for the 2-digit sequence 62 followed by a 4-digit extension and specifies route 522 whenever a user dials such a 6-digit (Min = 6 and Max = 6) sequence. Entry 101 watches for the 2-digit sequence 63 followed by a 4-digit extension and specifies route 523 whenever a user dials such a 6-digit sequence. The choice of route numbers is made by the person configuring the dial plans for the sites.

The next two *TableEntry Create* commands are set up in a similar manner to handle VTL connections with passwords. If a user dials 72 followed by a 4-digit extension, the VTL call uses route 524. If a user dials 73 followed by a 4-digit extension, the VTL call uses route 525. These two commands specify a minimum of 6 digits (for example, if the caller is calling an internal extension preceded by the site code) and a maximum of 32 digits (for example if the caller is calling a long-distance or international number preceded by the site code).

The first two *DestinationRoute Create* commands create routes 522 and 523. The Description field contains text that describes each route.

The second two *DestinationRoute Create* commands create routes 524 and 525, the routes that are used with a VTL password.

The four *DestinationRouteEntry Create* commands specify the extension list for routes 522, 523, 524, and 525. Extension list \*0006 is the default extension list for VTLs.

For the first two DestinationRoutes, two *DestinationRouteOperation Create* commands perform two functions:

- The *stripLead* command removes the two digits (62 or 63) leaving the 4-digit extension the user dialed.
- The *prepend* command adds the IP Address of the destination NBX system to the extension that the user dialed. In [Figure 18](#), the IP address for Atlanta is 192.169.25.100; for Dallas, 192.168.35.100. In the dial plan, you must use an asterisk (\*) instead of a period (.) to separate the fields within the IP address, and to separate the IP address from the destination extension.

For the second two DestinationRoutes, two DestinationRouteOperation Create commands perform two similar functions.

- The *stripLead* command removes the two digits (72 or 73) leaving the 4-digit extension the user dialed.
- The *prepend* command adds the IP address and system password of the destination NBX system to the extension dialed by a user. In [Figure 18](#), the IP address for Atlanta is 192.169.25.100 and the password is ATLPassW. For Dallas, the IP address is 192.168.35.100 and the password is DALPWord. In the dial plan, you use an asterisk (\*) instead of a period (.) to separate fields within the IP address and to separate the IP address from the destination extension.

To place a hop-off call to 555-1212 in area code 903 through the Atlanta system, a user on a remote system would dial 72919035551212. The 72 code sets up a VTL connection to Atlanta that includes the Atlanta system's VTL password, and the remaining digits are used to dial the number (9 accesses an outside line to obtain dial tone from the local carrier, 1 accesses the long-distance carrier, and the remaining digits specify the long-distance number).

If the same user used site code 62 to place a call to the Atlanta office, only toll-free, emergency, and internal call would be allowed.

### **Toll Calls Without a VTL Password**

If a local user has configured his telephone to forward calls to a long-distance number, then an incoming VTL call to that telephone does not need to supply the local system's VTL password in order for the call to be forwarded.

### **Music On Hold**

If two users are talking on a VTL connection, and the first user places the call on hold, the second user hears Music On Hold only if his local system is configured to play it.

### **Troubleshooting VTL Calls**

[Table 21](#) contains a list of error situations, the possible causes and the action to take in each case.

**Table 21** VTL Errors and Corrections

<b>Error Condition</b>	<b>Possible Causes</b>	<b>Actions</b>
Long pause after dialing. Telephone display contains "VTL" during the pause. Busy signal is then heard.	Remote server does not respond	Test the connection to the remote system using the Query Remote function.
After you finish dialing a VTL call, you get a busy signal and the message "All ports busy" appears in the telephone display panel.	<ol style="list-style-type: none"> <li>1. No VTL license installed.</li> <li>2. VTL device extensions not added to Extension List *0006.</li> <li>3. All local VTL connections are currently in use.</li> <li>4. All VTL connections at the remote site are currently in use.</li> </ol>	<ol style="list-style-type: none"> <li>1. Verify that the licenses appear when you access the tab.</li> <li>2. Verify that the *0006 extension contains the VTL device extensions.</li> <li>3. On the Virtual Tie Line tab, verify that there is at least one idle VTL connection.</li> <li>4. Use the Query Remote function to verify that there is at least one idle VTL connection.</li> </ol>

**Table 21** VTL Errors and Corrections (continued)

Error Condition	Possible Causes	Actions
After you finish dialing a VTL call, you get a busy signal and the message “Invalid Number” appears in the telephone display panel.	<ol style="list-style-type: none"> <li>1. Local dial plan is not properly configured.</li> <li>2. Dial plan on the remote (target) system is not properly configured.</li> <li>3. You are trying to use hop-off without the necessary password.</li> </ol>	<ol style="list-style-type: none"> <li>1. Examine the local dial plan for errors.</li> <li>2. Examine the dial plan on the remote system for errors.</li> <li>3. Verify that the password for the remote system is used in both dial plans.</li> </ol>
No audio	<ol style="list-style-type: none"> <li>1. Telephones are not configured to use either IP On-the-Fly or Standard IP.</li> <li>2. VTL Audio compression is supported on only one of the two NBX systems.</li> <li>3. 3C10165D E1 and 3C10116D T1 Digital Line Cards do not have static IP addresses.</li> </ol>	<ol style="list-style-type: none"> <li>1. Verify that the IP setting in the System Settings, System-wide dialog box is “IP On-the-Fly” or “Standard IP.” Change the setting, if necessary.</li> <li>2. Verify that audio compression is enabled on both systems.</li> <li>3. If your NBX system is set up for IP-On-the-Fly, verify that 3C10165D E1 and 3C10116D T1 Digital Line Cards have a static P address. These cards cannot receive an IP On-the-Fly address.</li> </ol>
Caller ID information does not appear correctly in the telephone display panel.	<ol style="list-style-type: none"> <li>1. Invalid local pretranslator.</li> <li>2. VTL extensions are not in the VTL pretranslator “Devices Using” table.</li> </ol>	<ol style="list-style-type: none"> <li>1. Examine the local dial plan for pretranslator errors.</li> <li>2. Verify that VTL extensions appear in the left-hand table for the pretranslator.</li> </ol>

## Dial Plan Configuration File Commands

This section provides the syntax and description of each command used to create the information in the dial plan configuration file. In addition, [Table 22](#) categorizes and summarizes all the dial plan commands. See also [“Dial Plan Command Format”](#) on [page 34](#).

The Alphabetical List of Dial Plan Commands provides a detailed description and syntax of each command. See [“Dial Plan Command Summary”](#), next, for a description of each component of dial plan commands.

To see how these commands are implemented in a dial plan, see [“Sample Solutions Using Dial Plan Configuration File Commands”](#) on [page 120](#). You can also open and examine any of the dial plans shipped with your NBX system.

### Dial Plan Command Summary

[Table 22](#) provides a brief summary the dial plan commands. These commands are listed and categorized in the order that they might logically appear in a working dial plan.

See [“List of Dial Plan Commands”](#) on [page 107](#) for a complete list and description of each dial plan command, including syntax and arguments.

Command syntax is case insensitive. In the sample dial plans (supplied with the system), and in this section, commands use upper and lower case to make them easier to read.

An entry that begins with “n” for example, nDialPlanID, indicates an integer field. Integer IDs are used in many places, and must be within the range 1 through 32768. The system reserves dial plan table ID numbers 1, 2, and 3 for Internal, Incoming, and Least Cost Routing, respectively.

An entry that begins with “sz” (for example, szDescription) indicates a field composed of alphanumeric characters. Acceptable characters are a through z, A through Z, and 0 through 9.

Each line in the configuration file must contain a complete command. The NBX system reads all lines in the configuration file, and ignores only those lines containing one or more syntax errors. The system treats any line beginning with / (forward slash) as a comment and ignores it.



**CAUTION:** Do not place comments at the end of a command line.

**Table 22** Dial Plan Command Summary

<b>Command Name</b>	<b>Description</b>
<a href="#">Table Create</a>	Creates a dial plan table.
<a href="#">TableEntry Create</a>	Creates an entry in a dial plan table.
<a href="#">DestinationRoute Create</a>	Creates a route that specifies the primary and alternative destination device of a call.
<a href="#">DestinationRouteEntry Create</a>	Creates a destination route entry that identifies a single destination device or device list.
<a href="#">DestinationRouteOperation Create</a>	Creates a digit manipulation operation for a destination route entry.
<a href="#">TimedRoute Create</a>	Creates a timed route (a route that the system uses based on defined criteria for time of day and day of week).
<a href="#">TimedRouteEntry Create</a>	Creates a timed route entry specifying either a time of day or system mode, day of the week criteria, and the destination route to use if that criteria are met.
<a href="#">TimedRouteOperation Create</a>	Creates a digit manipulation operation for a timed route entry.
<a href="#">PreTranslator Create</a>	Creates a pretranslator entry and specifies a string of digits that are compared to the incoming digits.
<a href="#">PreTranslatorEntry Create</a>	Creates a pretranslator entry and specifies a string of digits that are compared to the incoming digits.
<a href="#">PreTranslatorEntry Delete</a>	Deletes a pretranslator entry or deletes all entries for a particular pretranslator.
<a href="#">PreTranslatorOperation Create</a>	Creates a digit manipulation operation for a pretranslator entry.
<a href="#">ExtensionLength</a>	Specifies the length of extension numbers for system devices.
<a href="#">ExtensionRange</a>	Specifies a range of extensions for each type of device.
<a href="#">ExternalSettings</a>	Specifies settings for several aspects of external devices.

## List of Dial Plan Commands

The dial plan commands are described in this section. They are listed in alphabetical order:

- [DestinationRoute Create](#)
- [DestinationRouteEntry Create](#)
- [DestinationRouteOperation Create](#)
- [ExtensionLength](#)
- [ExtensionRange](#)
- [ExternalSettings](#)
- [PreTranslator Create](#)
- [PreTranslatorEntry Create](#)
- [PreTranslatorEntry Delete](#)
- [PreTranslatorOperation Create](#)
- [Table Create](#)
- [TableEntry Create](#)
- [TimedRoute Create](#)
- [TimedRouteEntry Create](#)
- [TimedRouteOperation Create](#)

### *DestinationRoute Create*

#### **Syntax**

```
DestinationRoute Create nRouteId szDescription
```

**Description** Creates a route that specifies the primary and alternative destination device of a call (for example, which CO Line or Digital Line Card port over which to route the call). If the destination route already exists, this command removes all of its entries and operations, and overwrites its description with the new information.

#### **Arguments**

*nRouteId* — An integer in the range 1 – 32768, uniquely identifying this destination route.

*szDescription* — The description or name of the destination route.

**Example:** This example creates destination route 3 and names it “Voice Application”:  
`DestinationRoute Create 3 Voice Application`

### *DestinationRouteEntry Create*

#### **Syntax**

```
DestinationRouteEntry Create nRouteId nEntryId szExtension
```

**Description** creates a destination route entry that identifies a single destination device or device list.

If the specified destination route entry already exists, this command overwrites it with the new information. During routing, the system checks the list of destinations in ascending *nEntryId* order (*nEntryId* 1 first).

#### **Arguments**

*nRouteId* — An integer in the range 1 through 32768.

*nEntryId* — An integer in the range 1 through 32768. The system checks the list of destinations in ascending *nEntryId* order, and uses the first available one.

*szExtension* — The extension of the destination device or device list. Note that the system does not dial this extension (that is, it neither checks the extension against a dial plan nor subjects it to Class of Service restrictions, digit manipulation, or routing) but instead uses the extension only to look up the device in the internal device directory.

**Example:** This example command creates, in route table 3, entry 1 and defines extension list \*0003 as the destination for this route entry. Extension list \*0003 contains the voice mail extensions/ports.

```
DestinationRouteEntry Create 3 1 *0003
```

### *DestinationRouteOperation Create*

#### **Syntax**

```
DestinationRouteOperation Create nRouteId nEntryId nOperId  
szOperation szValue
```

**Description** Creates a digit manipulation operation for a destination route entry. If the specified digit manipulation operation already exists, this command overwrites it with the new information. During routing the

system processes the entire list of operations in ascending nOperId order (nOperId 1 first).

### **Arguments**

*Routeld* — An integer in the range 1 through 32768.

*nEntryId* — An integer in the range 1 through 32768 specifying the destination route entry to which this operation applies.

*nOperId* — An integer in the range 1 through 32768. The system processes the list of operations in ascending nOperId order.

*szOperation* — The name of the digit manipulation operation to perform: stripLead, stripTrail, replace, prepend, append.

*szValue* — A value used by the operation, either the string of digits to prepend, append, replace with, or the number of digits to strip.

**Example:** This example command creates, for destination route 3, entry 1, an operation numbered 1, with the associated function stripLead, and an argument of 1, indicating that the command removes (strips) one leading digit from the dialed number before dialing.

```
DestinationRouteOperation Create 3 1 1 stripLead 1
```

## *ExtensionLength*

### **Syntax**

```
ExtensionLength nExtensionLength
```

**Description** The length of extension numbers for system devices. The default is 3 for NBX 100 systems. The default is 4 for SuperStack 3 NBX systems.

### **Arguments**

*nExtensionLength* — specifies either 3 to designate a 3-digit dial plan, or 4 to designate a 4-digit dial plan.

## *ExtensionRange*

### **Syntax**

`ExtensionRange szExtensionType szLowestExtension szHighestExtension`

**Description** A range of extensions for each type of device. When the system automatically generates extensions it assigns them from within this range. When you manually generate an extension number, verify that it is within the valid range. During a dial plan import operation, the system does not validate that existing extensions are within the specified range. 3Com *strongly* recommends that you configure the dial plan *before* you define any devices in the system.

### **Arguments**

*szExtensionType* — One of these: Telephone, Park, Auto Attendant, Hunt Group, External.

*szLowestExtension* — The lowest desired extension for this device type.

*szHighestExtension* — The highest desired extension for this device type.

**Example:** These commands define the extension range for telephones as 100 through 449, for call park as 601 through 609, for Auto Attendants as 500 through 599, for hunt groups as 450 through 499, and for external lines as 600 through 799.

```
ExtensionRange Telephone 100 449
ExtensionRange Park 601 609
ExtensionRange Autoattendant 500 599
ExtensionRange HuntGroup 450 499
ExtensionRange External 600 799
```



**CAUTION:** Do not define extension ranges that overlap. The only exception is Park, which must be within the External range.

## ExternalSettings

### Syntax

```
ExternalSettings szExternalKeysetPrefix  
szFirstAutoDiscoverExtension szDefaultAutoExtension
```

**Description** Specifies settings for several aspects of external devices.

### Arguments

*szExternalKeysetPrefix* — The digits that are prepended to external calls made in Keyset mode. This is used to determine the Class of Service (CoS) for external calls made in Keyset mode. Typical values for this digit are 8, 9, or 0 (zero). This prefix is set to the appropriate number in each country's dial plan.

**Example:** In the default internal dial plan table, the digit 9 instructs the system to connect the call to an external line. When a telephone has a button mapped to an external device, and the user places a call using that external device, the system prepends the *szExternalKeysetPrefix* digit to the digits dialed by a user; then the system applies the dial plan tables to determine call Class of Service.

*szFirstAutoDiscoverExtension* — The first extension used when autodiscovering external devices. This must be in the specified range of lowest/highest external extensions.

The system assigns extensions starting with this number and incrementing upward. For information on the Auto Discovery topic, see "Using Auto Discovery for Initial System Configuration" in the *NBX Installation Guide*.

The default value for a 3-digit system is 750, and for a 4-digit system is 7250. Typically, systems do not use all of the extensions from 600 through 799 (or 6000 through 7999). If, however, the system uses all of these extensions and needs another one, it starts looking from the beginning of the range and selects the first unused one.

*szDefaultAutoExtension* — The default extension the system uses for forwarding incoming calls. This is always 500.

The system must direct each incoming call (on an external line) to an extension. After you import the dial plan configuration file, and complete

the Auto Discovery process, you can manually configure the extension for each analog line and each Digital Line Card channel, if you want.

### *PreTranslator Create*

#### **Syntax**

```
PreTranslator Create nPreTranslatorId szDescription
```

**Description** Creates a pretranslator. If the pretranslator already exists, this command removes all of its entries and operations, and overwrites its description with the new information.

#### **Arguments**

*nPreTranslatorId* — An integer in the range 1 through 32768.

*szDescription* — The description or name of the pretranslator.

**Example:** This command creates a pretranslator, designates it as the first one (number 1) and give it the title “4-to-3-digit DID/DDI pretranslator.”

```
PreTranslator Create 1 4-to-3-digit DID/DDI pretranslator
```

### *PreTranslatorEntry Create*

#### **Syntax**

```
PreTranslatorEntry Create nPreTranslatorId nEntryId szDigits
```

**Description** Creates a pretranslator entry and specifies a string of digits that are compared to the incoming digits. If the pretranslator entry already exists, this command overwrites it with the new information.

#### **Arguments**

*nPreTranslatorId* — An integer in the range 1 through 32768.

*nEntryId* — An integer in the range 1 through 32768.

*szDigits* — The digits to compare to the incoming digits.

**Example:** These example commands create, in pretranslator 1, entries 1 through 10, each of which looks for a different single digit (0 through 9) in the incoming digits.

```
PreTranslatorEntry Create 1 1 0
```

```
PreTranslatorEntry Create 1 2 1
PreTranslatorEntry Create 1 3 2
PreTranslatorEntry Create 1 4 3
PreTranslatorEntry Create 1 5 4
PreTranslatorEntry Create 1 6 5
PreTranslatorEntry Create 1 7 6
PreTranslatorEntry Create 1 8 7
PreTranslatorEntry Create 1 9 8
PreTranslatorEntry Create 1 10 9
```

## PreTranslatorEntry Delete

### Syntax

```
PreTranslatorEntry Delete nPreTranslatorId nEntryId
```

**Description** Deletes a pretranslator entry or deletes all entries for a particular pretranslator.



*Use caution when using this command to delete Pretranslator entries in an existing Dial Plan. In general, it is best to delete all tables, routes, and pretranslators at the beginning of each dial plan configuration file. This precaution avoids the potential conflicts or unpredictable actions caused by importing new dial plan entries on top of an existing dial plan.*

*For instructions on how to edit the dial plan configuration file to delete existing tables, routes, and pretranslators, see [“Creating Dial Plan Configuration Files”](#) on [page 44](#).*

### Arguments

*nPreTranslatorId* — An integer in the range 1–32768.

*nEntryId* — An integer in the range 1–32768 or \* for all entries.

**Example:** This command deletes pretranslator entry 3 from pretranslator 2.

```
PreTranslatorEntry Delete 2 3
```

This command deletes all pretranslator entries from pretranslator 2.

```
PreTranslatorEntry Delete 2 *
```



*Normally this command is not necessary. It is better to delete an entire dial plan rather than import a new dial plan over it. To accomplish this, 3Com recommends using specific commands at the top of every dial plan*

configuration file. For an example of this technique, see [“Creating Dial Plan Configuration Files”](#) on [page 44](#).

### *PreTranslatorOperation Create*

#### **Syntax**

```
PreTranslatorOperation Create nPreTranslatorId nEntryId
nOperId szOperation szValue
```

**Description** Creates a digit manipulation operation for a pretranslator entry. If the specified digit manipulation operation already exists, this command overwrites it with the new information. During pretranslation, the system processes the list of operations in ascending *nOperId* order (*nOperId* 1 first).

#### **Arguments**

*nPreTranslatorId* — An integer in the range 1 through 32768.

*nEntryId* — An integer in the range 1 through 32768 specifying the pretranslator entry to which this operation applies.

*nOperId* — An integer in the range 1 through 32768. The system processes the list of operations in ascending *nOperId* order (*nOperId* 1 first).

*szOperation* — The name of the digit manipulation operation to perform. Values are: stripLead, stripTrail, replace, prepend, append.

*szValue* — The value to use in the operation, either the string of digits to prepend, append, replace with, or the number of digits to strip.

### *Table Create*

#### **Syntax**

```
Table Create nDialPlanTableId szDescription
```

**Description** Creates a dial plan table to control the routing of calls placed by devices. Dial plan tables apply to internal devices such as telephones, incoming calls from outside the NBX system, and Least Cost Routes. If the dial plan table already exists, this command removes all entries from the table, and fills the table with the new information.

### Arguments

*nDialPlanTableId* — An integer in the range 1 through 32768. The default dial plan tables use ID numbers 1 through 3:

- 1 — Internal dial plan table
- 2 — Incoming dial plan table
- 3 — Least Cost Routing table

*szDescription* — The description or name of the dial plan table. the NBX NetSet utility uses this name to refer to the table.

**Example:** This example command creates dial plan table 1 and names it "Internal 4 Digit Extensions."

```
Table Create 1 Internal 4 Digit Extensions
```

### TableEntry Create

#### Syntax

```
TableEntry Create nDialPlanTableId nEntryId szDigits  
nMinDigits nMaxDigits szCallClass nPriority nRouteId
```

**Description** Creates an entry in a dial plan table that specifies a string of digits that are compared to the dialed digits. If the dial plan table entry already exists, this command overwrites it with the new information.

Dial plan table entries make Class of Service and call routing decisions based on the correspondence of dialed digits and table entry digits.

#### Arguments

*nDialPlanTableId* — An integer in the range 1 through 32768. The system reserves three ID numbers:

- 1 — Internal dial plan table
- 2 — Incoming dial plan table
- 3 — Least Cost Routing table

*nEntryId* — An integer in the range 1 through 32768. Each entry must have a unique ID. If two entries have the same ID, the system uses the entry closer to the bottom of the configuration file (the one processed last).

*szDigits* — A string of dialed digits in a dial plan entry.

*nMinDigits* — An integer specifying the minimum number of digits to collect.

*nMaxDigits* — An integer specifying the maximum number of digits to collect.

*szCallClass* — The call class for this dial plan entry. The call class corresponds to permissions granted to users in their Class of Service. Values are Internal, Local, LongDistance, International, WAN, TollFree, Emergency, COCode, Wireless, Other, Toll, AlternateLong, Operator, TrunkToTrunk, Diagnostics, and NotAllowed.

*nPriority* — Not presently used. Always set to zero (0).

*nRouteId* — An integer specifying the ID of the route to use when this dial plan entry is matched. A route ID of zero (0) indicates that this entry has no defined route; digits are transmitted as soon as they are dialed.

**Example:** This example command creates (in table ID 1) table entry 1, which looks for 3 as the first digit in a 4-digit string (minimum and maximum number of characters are both specified as 4), classifies the call type as “Internal”, assigns the call a priority of zero (the only acceptable priority in this product release). Because the destination is an internal extension, there is no need for a defined route so the route number is zero.

```
TableEntry Create 1 1 3 4 4 Internal 0 0
```

## TimedRoute Create

### Syntax

```
TimedRoute Create nRouteId nDefaultDestinationRouteId  
szDescription
```

**Description** Creates a timed route (a route that the system uses based on defined criteria for time of day and day of week). If the timed route already exists, this command removes all of its entries and overwrites its description and *defaultDestinationRoute* with the new information.

### Arguments

*nRouteId* — An integer in the range 1 through 32768 which uniquely identifies this timed route.

*nDefaultDestinationRouteId* — An integer in the range 1 through 32768 identifying the destination route the system must use if none of the entries in this timed route match the current time of day.

*szDescription* — A description or name of the timed route.

**Example:** This example command creates timed route 7 which uses destination route 1, defined in the “Routes” section of the system configuration file. The description of route 7 is “Business Hours Long Distance.”

```
TimedRoute Create 7 1 Business Hours Long Distance
```

## TimedRouteEntry Create

### Syntax

```
TimedRouteEntry Create nRouteId nEntryId szStartTime  
szEndTime szDaysOfWeek nDestinationRouteId
```

**Description** Creates a timed route entry specifying either a time of day or system mode, day of the week criteria, and the destination route to use if that criteria are met. If the specified timed route entry already exists, this command overwrites it with the new information. During routing, the system checks the list of timed route entries in ascending *nEntryId* order (*nEntryId* 1 first). The system performs any digit manipulation operations that apply to the specified destination.

### Arguments

*nRouteId* — An integer in the range 1 through 32768.

*nEntryId* — An integer in the range 1 through 32768. The system checks the list of timed routes in ascending order based on *nEntryId*.

*szStartTime* — Start time in 24-hour format, for example, 13:30 for 1:30 p.m. You can use either 24:00 or 00:00 to specify midnight. Instead of specifying times, you can enter a system mode name (*open*, *closed*, *lunch*, or *other*). For each system mode, the system knows the start and stop times. If you use one of the system modes, both *szStartTime* and *szEndTime* parameter must be the same.



You define start and end times for system modes through the NBX NetSet utility. Click System Configuration, then the Business Identity tab, and the Business Hours button. Enter the times that you want and click OK.

**Example:** If you define business hours from 8:00 to 17:00 on Mondays, Wednesdays and Fridays, and from 9:00 to 18:00 Tuesdays and Thursdays, then a timed route entry both `szStartTime` and `szEndTime` set to "open" applies differently on Monday, Wednesday, and Friday than on Tuesday and Thursday.



*You set the beginning and ending times for open, lunch, and other using the NBX NetSet utility. Click System Configuration, then the Business Identity tab, and the Business Hours button. The NBX system treats all times not included these three categories as closed.*

`szEndTime` — End time in 24-hour format, for example, "18:30" for 6:30 p.m. You can use either 00:00 or 24:00 to indicate midnight. If you use a system mode (open, lunch, or other) for `szStartTime`, you must use the same system mode for `szEndTime`.

`szDaysOfWeek` — A seven character mask in which each character position represents one day of the week, beginning with Sunday as the first character and ending with Saturday as the last character. The NBX system excludes any day if a dot "." character appears in that day's position. (As a convention, you place the first letter of each day in the appropriate character position to indicate that the day is included, but you can use any letter you want; the presence of a dot "." in a given position excludes the day of the week and the presence of any other character in that position selects that day.

You use the `szDaysOfWeek` parameter to specify when this timed route is active. You can specify that the timed route entry apply to all days of the week. If you specify the start and end times for open mode differently on some days of the week than for other days, one timed route entry can operate differently depending on the day.

**Example:** The system interprets "SMT.T.S" (or "XXX.X.X") as "all days except Wednesday and Friday." The "dot" characters in positions four and six exclude the fourth and sixth days of the week (Wednesday and Friday).

`nDestinationRouteId` — The Id of the destination route to use if this entry's time of day and day of week criteria are met.

**Example:** This example command creates two entries, one to define the route to use during business hours (open) and the other to define the route when the business is closed.

The first entry is timed route 7, timed route entry 1. The two occurrences of the word "Open" instruct the system to use the start time and end time defined by the "open for business" hours, and the letters "SMTWTFS" indicate that this entry applies to all seven days of the week (Sunday through Saturday).

The number 6 designates destination route 6, defined in the system routes table. Because this entry applies to the "open for business" hours, route 6 could define a least cost route for outgoing long distance calls.

The second entry is timed route 7, timed route entry 2. The two occurrences of the word "Closed" instruct the NBX system to use the start time and end time defined by the "business closed" hours, and the letters "SMTWTFS" indicate that this entry applies to all seven days of the week (Sunday through Saturday). The number 3 designates destination route 3, defined in the system routes table. Because this route applies to the "business closed" hours, route 3 could connect the incoming call to an Auto Attendant menu that tells the caller that the company is closed and gives instructions on how to leave a message and how to reach someone in an emergency.

```
TimedRouteEntry Create 7 1 Open Open SMTWTFS 6
TimedRouteEntry Create 7 2 Closed Closed SMTWTFS 3
```

## *TimedRouteOperation Create*

### **Syntax**

```
TimedRouteOperation Create nRouteId nEntryId nOperId
szOperation szValue
```

**Description** Creates a digit manipulation operation for a timed route entry. If the specified digit manipulation operation already exists, this command overwrites it with the new information. During routing, the system processes the list of operations in ascending *nOperId* order (*nOperId* 1 first).



**CAUTION:** *Timed route operations are performed before Destination Route operations. So if you strip a leading 9 using a TimedRouteOperation Create command verify that you don't mistakenly perform the same action in a DestinationRouteOperation Create command. If you made that error, you would lose the first dialed digit.*

### Arguments

*nRouteId* — An integer in the range 1 through 32768.

*nEntryId* — An integer in the range 1 through 32768 specifying the timed route entry to which this operation applies.

*nOperId* — An integer in the range 1 through 32768. The system processes the list of operations in ascending *nOperId* order (*nOperId* 1 first).

*szOperation* — The name of the digit manipulation operation to perform: *stripLead*, *stripTrail*, *replace*, *prepend*, *append*.

*szValue* — The value used by the operation, either the string of digits to prepend, append, replace with, or the number of digits to strip.

---

## Sample Solutions Using Dial Plan Configuration File Commands

This section describes several requirements that a customer might have, and for each one, provides a sample solution. An explanation follows each step in the solution.

For a detailed explanation of each command, see [“Dial Plan Configuration File Commands”](#) on [page 105](#).

**Customer Requirement 1.** Assume that the telephone company passes 4-digit numbers to the NBX system for each incoming telephone call (for example, numbers in the range 5200 through 5300). If the system uses 3-digit extensions in the range 200 through 300, you could define a single pretranslation operation that performed a *stripLead* to remove the first digit. For example, the system could remove the number five from an incoming number such as 5278, and pass the call to extension 278.

To accomplish the pretranslation:

```
PreTranslator Create 1 4-to-3-digit T1 DID/DDI Pretranslator
```

**Explanation:** Create pretranslator table 1, called “4-to-3-digit T1 DID/DDI Pretranslator.”

```
PreTranslatorEntry Create 1 1 5
```

**Explanation:** Create, in pretranslator table 1, entry number 1, which applies when the first digit in the sequence is 5.

```
PreTranslatorOperation Create 1 1 1 stripLead 1
```

**Explanation:** For pretranslator table 1, PreTranslatorEntry 1, create the first PreTranslatorOperation. This performs a stripLead operation, removing a single leading digit from the incoming number.

**Customer Requirement 2.** Assume that the telephone company passes 10-digit numbers to the NBX system for each incoming telephone call (for example, numbers in the range 4567-89-3000 through 4567-89-3500). If the system uses 4-digit extensions in the range 2000 through 2500, you can pass an incoming 10-digit number such as 4567-89-3210 to extension 2210 by using two pretranslation operations. The first operation performs a *stripLead* operation to remove the first 7 digits, leaving 210. The second would perform a *prepend* to add the digit 2 to the front of the number, creating 2210, which matches an extension within the extension range.

These entries in a dial plan configuration file would accomplish the pretranslation:

```
PreTranslator Create 1 10-to-3-digit T1 DID/DDI Pretranslator
```

**Explanation:** Create pretranslator table 1, called "10-to-3-digit T1 DID/DDI Pretranslator."

```
PreTranslatorEntry Create 1 1 4567893
```

**Explanation:** Creates the first entry in pretranslator table 1. This entry looks for sequence of digits 4567893.



*This example assumes that all numbers begin with the same 7 digits (4567-89-3) and differ only in the last 3 digits. If this assumption is incorrect, you can add PreTranslatorEntry Create lines to describe all of the possible variations.*

```
PreTranslatorOperation Create 1 1 1 stripLead 7
```

```
PreTranslatorOperation Create 1 1 2 prepend 2
```

**Explanation:** For PreTranslator table 1, PreTranslatorEntry 1, create the first PreTranslatorOperation. This performs a stripLead operation, removing the first seven leading digits from the incoming number.

Then create operation 2, which prepends the digit 2 to the remaining 3-digit number. The resulting 4-digit number matches one of the internal extensions in the system.

**Customer Requirement 3.** Assume that the telephone company assigns a group of 4-digit DID/DDI numbers from 6000 through 6199; however, you want to use internal telephone extensions from 3000 through 3199. Also, you want the number 6111 to connect the caller to an Auto Attendant line for the customer service group.

Add these lines to the dial plan configuration file:

```
PreTranslator Create 1 6XXX to 3XXX Translator
```

**Explanation:** Creates PreTranslator 1, and names it “6XXX to 3XXX Translator”

```
PreTranslatorEntry Create 1 1 6111
```

**Explanation:** Creates the first entry in Pretranslator 1. This entry looks for the specific sequence of digits 6111.

```
PreTranslatorOperation Create 1 1 1 replace 5502
```

**Explanation:** Creates the first operation associated with PreTranslator 1, PreTranslatorEntry 1. Defines a replace operation that replaces all digits in the incoming sequence (6111) with 5502. In this example, 5502 connects you to the Auto Attendant menu for customer service.

```
PreTranslatorEntry Create 1 2 6
```

**Explanation:** Creates, the second entry in Pretranslator 1; this entry looks for any incoming digit string beginning with the number 6.

```
PreTranslatorOperation Create 1 2 1 stripLead 1
```

**Explanation:** Creates the first operation associated with PreTranslator 1, PreTranslatorEntry 2. Defines a stripLead operation that removes (strips) the first (leading) digit from the incoming 4-digit sequence. This removes the 6 from the incoming numbers (6000 through 6199) leaving 3-digit numbers from 000 through 199.

```
PreTranslatorOperation Create 1 1 2 prepend 3
```

**Explanation:** Creates the second operation associated with PreTranslator 1, PreTranslatorEntry 2. Defines a prepend operation that adds the digit 3 at the beginning of the 3-digit string (created by the previous operation). The incoming numbers from 000 through 199 become numbers from 3000 through 3199.

The Incoming dial plan table may already contain this line. If necessary, modify the line to match.

```
TableEntry Create 2 4 3 4 4 Internal 0 0
```

**Explanation:** In table ID 2 (Incoming dial plan table) entry 4 instructs the system to look for 3 as the first in a sequence of 4 digits (both Min and Max are 4). If the system finds such a sequence, it assigns *Internal* as the call class. The system does not use the number in the priority column, so it remains 0 (zero). The system directs the call to route 0 (zero), the default route for internal extensions.

**Customer Requirement 4.** Assume that the company is located in New York, and has two long distance telephone carriers: ABC, which provides a low-cost service to four Boston area codes (508, 617, 781, and 978), and DEF, which provides service to the rest of the United States. You want to use one 4-port Analog Line Card, connected to analog trunk lines owned by ABC, for all calls to the Boston area. You want to use the T1 line, which you lease from DEF, for all other long distance calls within the United States.

The system users dial 9 to get an outside line, 1 to obtain a long distance carrier, 3 digits to specify the area code, and 7 digits to specify the telephone number. To ensure that long distance calls are handled in the least-cost way that you want, you place these entries in the Internal dial plan table. The numbering of the entries assumes that the table has 46 entries before you make any additions. Columns in each table entry are titled: Command, Table Number, Entry Number, Digits, Min, Max, Class, Priority, and Route Number.

Add these lines to the dial plan configuration file:

```
TableEntry Create 1 47 91 12 12 LongDistance 0 2
```

**Explanation:** Creates, in table ID 1 (the Internal table), entry 47, which directs the system to look for the digits 91 at the beginning of any 12-digit sequence (Min and Max are both 12). If the system detects such a sequence, it assigns LongDistance as the class of service.

Because the system software does not use the priority value, the system leaves 0 (zero) as the value, and assigns the call to route 2 (the T1 route).



*Dial plan entries are searched in sequential order. As soon as dialed digits match a dial plan entry, the dial plan acts on that match without further analysis. So if a previous dial plan entry (entries 1 through 46 in this example) was matched, entry 47 would not be found or used.*

```
TableEntry Create 1 48 91508 12 12 LongDistance 0 1
```

**Explanation:** In table ID 1 (the Internal table), creates entry 48, which directs the system to look for the digits 91508 at the beginning of any 12-digit sequence (Min and Max are both 12). If the system detects such a sequence, it assigns LongDistance as the class of service. Because the system software does not use the priority value, the system leaves 0 (zero) as the value, and assigns the call to route 1 (the route that uses the 4-port card).

```
TableEntry Create 1 49 91617 12 12 LongDistance 0 1
```

**Explanation:** In table ID 1 (the Internal table), creates entry 49, which directs the system to look for the digits 91617 at the beginning of any 12-digit sequence (Min and Max are both 12). If the system detects such a sequence, it assigns LongDistance as the class of service. Because the system software does not use the priority value, the system leaves 0 (zero) as the value, and assigns the call to route 1 (the route that uses the 4-port card).

```
TableEntry Create 1 50 91781 12 12 LongDistance 0 1
```

**Explanation:** In table ID 1 (the Internal table), creates entry 50, which directs the system to look for the digits 91781 at the beginning of any 12-digit sequence (Min and Max are both 12). If the system detects such a sequence, it assigns LongDistance as the class of service. Because the system software does not use the priority value, the system leaves 0 (zero) as the value, and assigns the call to route 1 (the route that uses the 4-port card).

```
TableEntry Create 1 51 91978 7 7 LongDistance 0 1
```

**Explanation:** In table ID 1 (the Internal table), creates entry 51, which directs the system to look for the digits 91978 at the beginning of any 12-digit sequence (Min and Max are both 12). If the system detects such a sequence, it assigns LongDistance as the class of service. Because the system software does not use the priority value, the system leaves 0 (zero) as the value, and assigns the call to route 1 (the route that uses the 4-port card).

In combination, the five lines in the internal table work with these two lines in the Routes section of the dial plan.

```
DestinationRoute Create 1 Boston Low-cost Carrier
DestinationRoute Create 2 T1 Line to DEF Telephone Company
```

**Explanation:** Creates two routes, numbered 1 and 2, with the names “Boston Low-cost Carrier” and “T1 Line to DEF Telephone Company.”

```
DestinationRouteEntry Create 1 1 *0001
DestinationRouteEntry Create 2 1 *0001
```

**Explanation:** In route 1, creates entry number 1, which defines extension list \*0001 (TLIM extensions) as the destination. Then creates, in route 2, an entry that defines extension list \*0002 (Digital Line Card extensions) as the destination.

```
DestinationRouteOperation Create 1 1 1 stripLead 1
DestinationRouteOperation Create 2 1 1 stripLead 1
```

**Explanation:** Creates, in route 1, entry 1, operation number 1. This is a stripLead operation, which removes the first digit from the dialed string, then and passes the remaining digits to the carrier.

**Customer Requirement 5.** Assume that you want to transmit Calling Line ID Presentation (CLIP) information on outgoing calls. You use internal telephone extension numbers from 3000 to 3099. There is no DDI/DID, so the T1 or E1 line has only a single number (555-555-1212). All incoming calls are routed by default to the Auto Attendant.

Add these lines to the dial plan configuration file:

```
PreTranslator Create 1 CLIP Internal Ext to Single Number
```

**Explanation:** Create pretranslator table 1 called “CLIP Internal Ext to Single Number.”

```
PreTranslatorEntry Create 1 1 3
```

**Explanation:** For pretranslator 1, create entry 1, which applies when the first digit in the sequence is 3. (All internal telephone extensions begin with the number 3.)

```
PreTranslatorOperation Create 1 1 1 replace 555 555 1212
```

**Explanation:** For pretranslator 1, entry 1, create operation 1, which replaces the extension number with the string 555 555 1212.

**Customer Requirement 6.** Assume that you want to use two different long distance carriers at different times of the day, to obtain a cost saving. To select one long distance carrier from 7:30 a.m.) to 3:00 p.m., prepend 1010321 to each call. To select another carrier and obtain a lower rate from 3:00 p.m. until opening business hours the next day, prepend 1010220. This assumes the business is not open on weekends.

Add these lines to the dial plan configuration file:

```
TableEntry Create 1 99 91 12 12 LongDistance 0 27
```

**Explanation:** In Table 1 (Internal table) entry 99, creates an entry which looks for the digits 91 at the beginning of any 12-digit sequence (since both Min and Max are set to 12). If the system detects such a sequence, it assigns LongDistance as the class of service.

Because system software does not use the priority value, the system leaves 0 (zero) as the value, and assigns the call to route 27.



*If Table 1 already contains an entry with 91 in the digits column, delete it and substitute the above TableEntry Create line.*

```
TimedRoute Create 27 28 3PM Switchover
```

**Explanation:** Create TimedRoute 27, with a default DestinationRoute of 28. Assign the title “3PM Switchover” to TimedRoute 27.

```
TimedRouteEntry Create 27 1 7:30 15:00 .MTWTF. 29
```

**Explanation:** For TimedRoute 27, create entry 1, which applies from 7:30 a.m. through 3:00 p.m. Monday through Friday. The route to use is 29.

```
DestinationRouteCreate 29 Open Hours Carrier
```

**Explanation:** Create DestinationRoute 29, and call it “Open Hours Carrier.”

```
DestinationRouteEntry Create 29 1 *0002
```

**Explanation:** For DestinationRoute 29, create entry 1, which uses extension list \*0002, the extension list that contains all extensions associated with Digital Line Cards.

```
DestinationRouteOperation Create 29 1 1 stripLead 2
```

**Explanation:** For DestinationRoute 29, entry 1, create operation 1, which strips 2 digits (9 and 1) from the beginning of the dialed string.

```
DestinationRouteOperation Create 29 1 2 prepend 1010321
```

**Explanation:** For DestinationRoute 29, entry 1, create operation 2, which prepends 1010321 to select the long distance carrier to use from 7:30 a.m. Monday through Friday.

```
DestinationRoute Create 28 Carrier After 3pm and Closed
```

**Explanation:** Create DestinationRoute 28 and call it "Carrier After 3 p.m. and Closed."

```
DestinationRouteEntry Create 28 1 *0002
```

**Explanation:** For DestinationRoute 28, create entry 1, which uses extension list \*0002, the extension list that contains all extensions associated with Digital Line Cards.

```
DestinationRouteOperation Create 28 1 1 stripLead 2
```

**Explanation:** For DestinationRoute 28, entry 1, create operation 1, which strips 2 digits (9 and 1) from the beginning of the dialed string.

```
DestinationRouteOperation Create 28 1 2 prepend 1010220
```

**Explanation:** For DestinationRoute 28, entry 1, create operation 2, which prepends 1010220 to select the other long distance carrier. Route 28 is the default route, so it is used at all other times than those defined for route 29.

**Example 1** If you make a long distance call at 2:00 p.m. on any Tuesday, the system uses these timed route definitions, and:

- Determines that the date is a valid business date.
- Determines that the time is prior to 3:00 p.m.
- Selects timed route 29.
- Prepends 1010321 to the outgoing call to select the first long distance carrier.

**Example 2** If you make a long distance call at any time on any Saturday, the system uses these timed route definitions, and:

- Determines that the date is not a valid business date.
- Selects timed route 28.
- Prepends 1010220 to the outgoing call to select the second long distance carrier.



# 3

## DEVICE CONFIGURATION

This chapter describes how to configure and manage devices on the NBX system. It covers these topics:

- [Adding, Removing, and Modifying Telephones](#)
- [Adding a Remote Telephone](#)
- [Creating and Managing Bridged Extensions](#)
- [Creating and Managing Telephone Groups](#)
- [Recording and Monitoring Telephone Calls](#)
- [Creating and Managing Button Mappings](#)
- [Changing Device IP Settings](#)
- [Configuring Call Park](#)
- [Configuring the NBX Attendant Console](#)
- [Configuring and Managing Analog Line Card Ports](#)
- [Connecting and Managing Analog Devices](#)
- [Configuring and Managing BRI-ST Digital Line Cards](#)
- [Configuring and Managing E1 Digital Line Cards](#)
- [Configuring and Managing T1 Digital Line Cards](#)
- [Setting Up a Digital Line Card at a Remote Location](#)
- [Setting Up T1/E1 Logging](#)
- [Viewing CSU State Information and Statistics](#)
- [Using Loopback Tests](#)



*For information about installing the system hardware components, see the NBX Installation Guide.*

## Adding, Removing, and Modifying Telephones

This section describes how to add, remove, and modify telephones in the NBX NetSet utility. You can also review the status of each device and configure button mappings for NBX telephones.

### Adding a New Telephone

You can configure a new telephone in two ways: using Auto Discovery or manually.

- **Auto Discovery method** — Auto Discovery is the simplest and most common method of adding a new telephone. When you enable Auto Discovery and then connect a new NBX Telephone to the LAN, the new telephone receives the next lowest available extension number, which appears on the telephone's display panel, and a default set of properties.
- **Manual method** — You can disable Auto Discovery and configure telephones manually using the NBX NetSet utility. However, if you have many telephones to configure, manual configuration can be a tedious and error-prone process.

For either method of adding a telephone, you must connect the telephone to the network. If you use Auto Discovery, enable the Auto Discover Telephones check box *before* you connect the telephone. If you add a telephone manually, it does not matter whether you connect the telephone before or after you use the NBX NetSet utility to add it.

### Connecting the Telephone

Instructions for connecting the phone to power and the network depend on your power source and the type of telephone. See Chapter 3 in the *NBX Installation Guide* or the telephone packing sheet for telephone connection information.

### Adding a New Telephone Using Auto Discovery



*Before you enable Auto Discovery, verify that a 3-digit or 4-digit dial plan is installed on the Network Call Processor and that you have specified a starting extension. See the NBX Installation Guide.*

To add a new telephone using Auto Discovery:

- 1 Select *System Configuration > System Settings* tab.
- 2 Click *System-wide*. The System Settings dialog box appears.
- 3 Optionally, clear all check boxes associated with autodiscovering devices.

- 4 Enable *Auto Discover Telephones*, and then click *Apply*.
- 5 Optionally, enable the *Auto Add Phones to Call Pickup Group 0* check box.



*Regardless of whether you select this check box, you can change the call pickup group for any telephone later. See [“Call Pickup”](#) on [page 226](#) for information about Call Pickup Groups.*

- 6 Click *OK*.
- 7 For each telephone that you want to autodiscover:
  - a Remove the telephone from the packing box.
  - b Connect the phone to power and the network according to the instructions in the telephone packing sheet or the *NBX Installation Guide*.
  - c Wait until an extension number appears in the telephone’s display panel.



*NBX devices that require a license, such as the 3102 Business Telephone, the 3101 and 3101SP Basic Telephones, and the 3105 Attendant Console, will not display an extension number until you add the license to the system. If you have not entered a license for a telephone, its display panel will show the device’s MAC address and a rotating hyphen.*

You can now disconnect the telephone and move it to its destination. The telephone retains its extension and button mappings.

### **Adding a Telephone Manually**

To add a new telephone manually:

- 1 From the NBX NetSet main menu, click *Device Configuration > Telephones*.
- 2 Click *Add*. The Add Telephones dialog box appears.
- 3 Fill in the fields with the appropriate values. Click the Help button to see more information about the dialog box fields.
- 4 Click *Apply* to configure this telephone. You can then configure additional telephones using the same menu.
- 5 Click *OK*.

**Modifying a Telephone** To modify a telephone:

- 1 Select *NBX NetSet > Device Configuration > Telephones*.
- 2 Select the telephone that you want to modify from the list.
- 3 Click *Modify*. The Modify Telephones dialog box appears.
- 4 Change the desired fields. Click the Help button to see more information about the dialog box fields.
- 5 Click *Apply* to make your changes.
- 6 Click *OK*.

**Checking a Telephone's Status** To check the status of a telephone:

- 1 Select *Device Configuration > Telephones*.
- 2 Select the telephone for which you want a status report from the list box.
- 3 Click *Status*. The Device Status dialog box appears.
- 4 View the device status and make any desired changes. Click the Help button to see more information about the dialog box fields.
- 5 When you finish, click *Apply*, and then click *OK*.

**Removing a Telephone** To remove a telephone from the system:

- 1 Select *Device Configuration > Telephones* tab.
- 2 Select the telephone that you want to remove from the list box.
- 3 Click *Remove*. A dialog box prompts you to confirm removal.
- 4 Click *Yes*. The system removes the selected telephone.
- 5 On the *Users* tab, delete the extension. If you do not perform this step, the extension of the removed telephone becomes a phantom mailbox.

**Rebooting a Telephone** To reboot a telephone:

- 1 Select *Device Configuration > Telephones*.
- 2 Choose a telephone from the list, and then click the *Status* button to open the *Telephones Status* dialog box.



**CAUTION:** If the telephone has an active call, resetting the telephone disconnects the call.

- 3 Click *Reset Device* and then click *OK*.

You can also reboot a telephone by unplugging the power connector from the telephone and then plugging it in again.

---

## Adding a Remote Telephone

NBX system software (release R4.2 and higher) supports Network Address Port Translation (NAPT, also called NAT overloading). NAPT allows you to put an NBX Telephone behind a device that applies network address translation at a remote location, such as a home office, and connect to the NBX call processor through an Internet connection. One typical configuration is to connect a cable/DSL modem to a small office/home office router that includes a firewall and Ethernet ports. You connect the NBX Telephone directly to one of the Ethernet ports. Another option is use the pcXset soft telephone application instead of an NBX Telephone.

## Remote NAPT Device Configuration

This section summarizes the tasks you must complete to configure an NBX Telephone for operation behind the NAPT device. Because the configuration interface on each device varies, detailed procedures for NAPT device configuration are beyond the scope of this document. For information about configuring the NAPT device, see the documentation for that device.

To add a broadband connected telephone behind a NAPT device:

- 1 Make sure the NBX system is set up for IP operations, either Standard IP or IP On-the-Fly. If you are not using a VPN connection to establish access from your home system to the NBX system network, the NBX system must have a public IP address.
- 2 Use the NBX NetSet utility to enable *Auto Discover Telephones* (*System Configuration > System Settings > System-wide*) and then connect the NBX Telephone to the NBX system.

Auto discovering the telephone while it is connected locally to the NBX network allows the system to configure the phone in the database and assign an extension number. You could manually add the telephone to the database instead of using the Auto Discover feature.

- 3 Move the telephone to its intended location. Connect it to power and then use the telephone Local User Interface (LUI) utility to program these settings:

- NCP MAC address — Required only when the network has more than one network call processor.
- Telephone IP address — A private IP address matching the IP address scheme on the LAN side of the NAPT device but outside of the DHCP address range configured in the NAPT device. The telephone must have a static IP address. For pcXset, this would be the IP address of the computer.
- NCP IP address — The IP address of the call processor that the phone must communicate with. If you are not connecting to the network through a VPN connection, the NBX system must have a public IP address.
- Subnet Mask — The address mask in use on the LAN side of the NAPT device.
- Default Gateway — The IP address of the NAPT device on the LAN.

For details on how to use the LUI utility, see [“Using the Telephone Local User Interface Utility”](#) on [page 316](#).

#### 4 Configure the NAPT device:

Use the device’s user interface to map UDP ports 2093-2096 to the NBX telephone IP address. These UDP ports are registered ports for NBX operations. This mapping feature, known as virtual server, port mapping, port range forwarding, or rules, is required to allow traffic to pass to and from the NBX Telephone.

---

## Creating and Managing Bridged Extensions

Bridged extensions allow you to have the extension of a primary telephone appear on one or more secondary telephones. Most activities associated with the extension can be performed on both the primary telephone and any of the secondary telephones. However, you cannot use a bridged extension on a secondary telephone to place a call.



*On any NBX system, you can configure a maximum number of primary telephones and a maximum number of bridged extension on primary telephones. See [Table 23](#).*

**Table 23** Maximum Bridged Extensions

System	Device Limit	Maximum Number of Primary Telephones	Maximum Number of Bridged Extensions on Primary Phones
NBX 100	200	100	300
SuperStack 3 NBX	250	250	1200
SuperStack 3 NBX	More than 250	400	1200



*There are no restrictions on the number of secondary telephones or the number of bridged extensions on secondary telephones.*

Provided that you do not exceed the limits shown in [Table 23](#), you can configure the maximum number of bridged extensions using any combination of primary telephones and bridged extensions. For example, on a SuperStack 3 NBX system, you can configure 400 primary telephones with three bridged extensions each or 300 primary telephones with 4 bridged extensions each to reach the limit of 1200.

You can configure a different number of bridged extension buttons on a primary and an associated secondary telephone. For example, if a primary telephone has 5 bridged extensions, one of the secondary telephones can be configured to have fewer (1 through 4) bridged extensions. However, if all of the primary bridged extensions are in use, the person at the secondary telephone will not be able to see all of the calls.

You can define any one telephone as either a primary telephone or a secondary telephone, but not both. If the telephone has an Attendant Console associated with it, the bridged extension functions for the telephone extend to the Attendant Console. For example, an NBX 2101 Basic Telephone with an associated Attendant Console, can be configured as a primary telephone with up to 11 bridged extensions on Attendant Console buttons.

You can configure bridged extensions on the same buttons that are used for the telephone's extension or on non-extension buttons. Before you can create a bridged extension on a telephone, you must unlock the button settings in the telephone group button mappings dialog box for the telephone group to which the telephone belongs.

You can view a report that lists the primary and secondary telephones on which bridged extensions have been defined. See [“Viewing Bridged Extension Information”](#) on [page 141](#).

When you define bridged extension appearances on a primary telephone:

- Incoming calls appear on the bridged extension buttons first, followed by the buttons (if any) associated with the primary telephone’s extension. For example, by default, buttons 1, 2, and 3 are extension appearances of the primary telephone. If you define buttons 4, 5, 6, and 7 as bridged extensions on the primary telephone, incoming calls appear on primary telephone buttons in the order 4, 5, 6, 7, 1, 2, 3.
- Any bridged extension appearance that overlaps one of the defined extension appearances for the primary telephone take precedence over those extension appearances. For example, if you define buttons 3, 4, 5, 6, and 7 as bridged extension appearances on the primary telephone, incoming calls appear on primary telephone buttons in the order 3, 4, 5, 6, 7, 1, 2.

### Example Bridged Extensions Configurations

**Example 1:** An NBX Business Telephone, extension 1044, is defined as a primary telephone and buttons 2, 3, and 4 are defined as bridged extension buttons. Two other NBX Business Telephones, extensions 1055 and 1066, are defined as secondary telephones on which extension 1044 appears. On the 1055 telephone, buttons 10, 11, and 12 are configured as the three bridged extension buttons for the 1044 telephone. On the 1066 telephone, buttons 4, 5, and 6 are configured as bridged extension appearances.

If a call is made to extension 1044, it can be answered using any of the following buttons:

- Extension 1044 (primary telephone) — button 2
- Extension 1055 (secondary telephone) — button 10
- Extension 1066 (secondary telephone) — button 4

In this example, both secondary telephones use buttons 1, 2, and 3 as extensions appearances for their own extensions.

**Example 2:** An NBX Business Telephone with extension 1077 is defined as a primary telephone and buttons 4, 5, 6, 7, and 8 are defined as bridged extension buttons. Two other NBX Business Telephones (extensions 1088 and 1099) are defined as secondary telephones on

which extension 1077 is to appear. On the 1088 telephone, buttons 10, 11, and 12 are configured as bridged extension buttons. On the 1099 telephone, buttons 3, 4, 5, 6, and 7 are configured as bridged extension appearances for extension 1077.

If a call is made to extension 1077, it can be answered using any of the following buttons:

- Extension 1077 (primary telephone) — button 4
- Extension 1088 (secondary telephone) — button 10
- Extension 1099 (secondary telephone) — button 3

Secondary telephone 1099 has only two extension appearances for the 1099 extension because button 3, by default an extension appearance for the local telephone, has been used as a bridged appearance of extension 1077.

The primary telephone has buttons 1, 2, and 3 as local appearances of its own extension (1077). If multiple calls arrive at this telephone, they appear on buttons 4, 5, 6, 7, and 8, followed by 1, 2, 3.

Buttons 1, 2, and 3 on the 1077 telephone are not defined as bridged extension appearances. Therefore, they do not appear on either of the secondary telephones. If the owner of the 1077 telephone makes a call using any of these buttons, there is no indication (status light) of the call on either secondary telephone. If there are five active calls on the 1077 telephone, and a sixth call is made to that extension, it rings only on the 1077 telephone, on the first unused button in the 1, 2, 3 group).

### **Defining Bridged Extensions**

The process of defining bridged extensions involves:

- [Defining Bridged Extensions on a Primary Telephone](#)
- [Defining Bridged Extensions on a Secondary Telephone](#)

### **Defining Bridged Extensions on a Primary Telephone**

On a primary telephone, you can define from 1 to 11 buttons as bridged extensions. The buttons do not have to be next to each other.

To define the bridged extensions for the primary telephone:

- 1 Select *NBX NetSet > Device Configuration > Telephones*.
- 2 Select the primary telephone from the scroll list.

- 3 Click *Button Mappings*. The Telephone Button Mappings dialog box ([Figure 19](#)) appears.

**Figure 19** Telephone Button Mappings Dialog Box

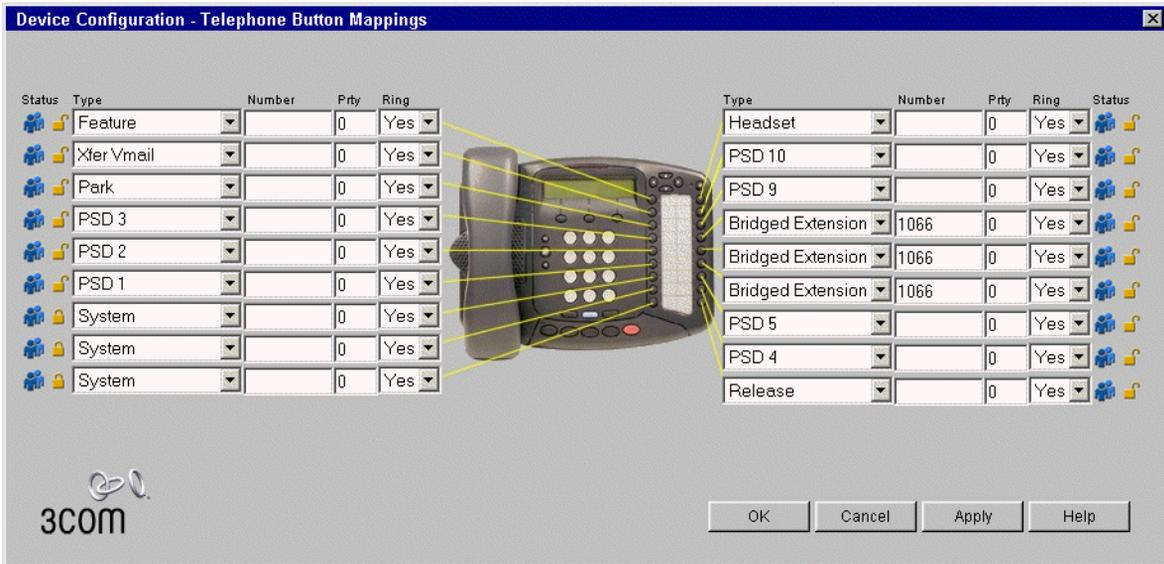

- 4 For each button that you want to include in the group of bridged extension buttons:
  - a Select *Bridged Extension* from the drop-down list in the *Type* column.
  - b Type the extension number of the primary telephone in the *Number* column.

[Figure 19](#) shows a group of three buttons that have been configured as bridged extension appearances for the extension (1066) on the primary telephone.

- 5 Click *OK*.

### Defining Bridged Extensions on a Secondary Telephone

After you have defined the bridged extension buttons on the primary telephone, you can define the corresponding bridged extension buttons on a secondary telephone. You can do this for as many secondary telephones as you want.

To define the bridged extensions for a secondary telephone:

- 1 Select *NBX NetSet > Device Configuration > Telephones*.
- 2 Select the secondary telephone from the scroll list.

- 3 Click *Button Mappings*. The Telephone Button Mappings dialog box appears.
- 4 For each button that you want to include in the group of bridged extension buttons:
  - a Select *Bridged Extension* from the drop-down list in the *Type* column.
  - b Type the extension number of the primary telephone in the *Number* column. See [Figure 20](#).

**Figure 20** Button Mapping Dialog Box After Mapping

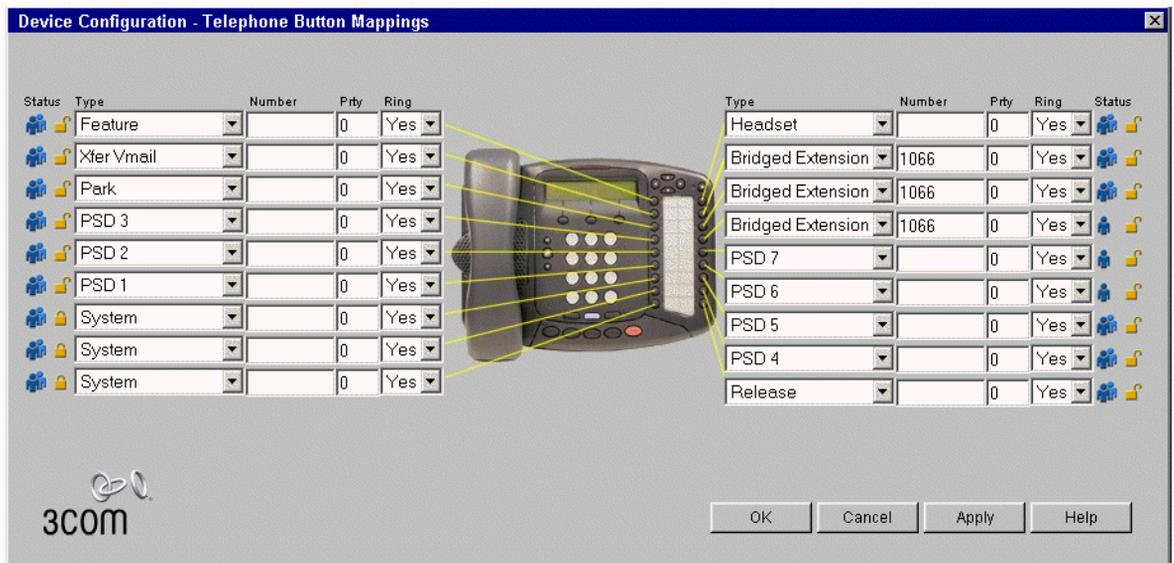

[Figure 20](#) shows a group of three buttons that have been configured as bridged extension appearances for the extension (1066) associated with the primary telephone.

- 5 Click *OK*.

### Modifying Bridged Extensions

You can modify bridged extensions on a primary telephone at any time. Bridged extensions do not need to be on adjacent buttons on a primary or a secondary telephone. You can have a different number of bridged extensions on a primary and a secondary telephone.

### Sample Calling Situations Using Bridged Extensions

This section describes typical telephone call situations involving bridged extensions on primary and secondary telephones. For all of the examples:

- The primary telephone is an NBX Business telephone (extension 1027) used by a manager (Alicia). This telephone has buttons 2, 3, and 4 defined as bridged extension buttons. Button 1 is the manager's private line.
- One secondary telephone, an NBX Business Telephone (extension 1051), is used by the manager's assistant (Bradley). On this telephone, buttons 1, 2, and 3 are extension appearances for extension 1051 and buttons 4, 5, and 6 are configured as bridged extension appearances of the manager's telephone (1027).
- The other secondary telephone is also an NBX Business Telephone (extension 1018). The telephone is used by the person (Connie) who answers the manager's telephone whenever the manager's assistant is not available. Buttons 10, 11, and 12 are configured as bridged extension appearances of the manager's telephone (1027).

**Example 1:** If there are no active calls on Alicia's telephone, a call made to her telephone from either an internal or outside telephone rings on button 2 on her telephone, button 4 on Bradley's telephone and button 10 on Connie's telephone.

Bradley answers the call by pressing button 4. After identifying the person who is calling, Bradley places the call on hold and informs Alicia of the call. Alicia presses button 2 on her telephone to take the call.



*During the time that Bradley is talking to the caller, neither Alicia nor Connie can access the call. Alicia can pick up the call only after it is placed on hold by Bradley. Similarly, after Alicia picks up the call, neither Bradley nor Connie can access the call. If Alicia wants to include either Bradley or Connie in the call, she can set up a conference call.*

**Example 2:** Alicia wants to place a call but wants to keep all three bridged extensions available for incoming calls. Alicia can place the call using button 1.

Neither Bradley's telephone nor Connie's telephone shows any indication that there is a call on Alicia's telephone, because button 1 on Alicia's telephone is not configured as a bridged extension.

**Example 3:** Three incoming calls have arrived on Alicia's telephone (on buttons 2, 3, and 4). Alicia is talking on button 2, Bradley has placed the second call on hold, and is talking to the third caller.

A fourth call arrives at Alicia's extension and rings on button 1. Neither Bradley nor Connie can answer this call because that button on Alicia's telephone is not a bridged extension appearance.

If a fifth call arrives at Alicia's extension before the fourth call stops ringing, it is sent directly to Alicia's voice mailbox, because all buttons are being used.

**Example 4:** A call arrives at Alicia's telephone and the building has been evacuated because of a fire. Neither Alicia, nor Bradley, nor Connie is available to answer the call. After the number of rings that are configured for Alicia's telephone, the call is sent to Alicia's voice mailbox.

**Example 5:** A call arrives at Alicia's telephone and Bradley answers the call, then places it on hold, and Alicia picks up the call. Bradley leaves the area, asking Connie to answer his telephone and Alicia's until he returns.

Alicia places the call on hold in order to pass the call back to Bradley but finds that he is not available. Connie is not close enough to Alicia's office to permit Alicia to talk directly to her, so Alicia presses another button on her telephone, calls Connie's extension, and asks her to pick up the call.

### Viewing Bridged Extension Information

You can view a list of all telephones on the NBX system and determine which are primary telephones and which are secondary telephones.

To view the bridged extensions information, select *NBX NetSet > Device Configuration > Telephones > Bridged Extensions*. The NBX Bridged Extensions Report appears.

If a telephone is a primary telephone, the Bridged Exts column contains the extension of the telephone and the extension of each associated secondary telephone. The Mapped Buttons column displays the telephone's extension once for each button that is mapped as a bridged extension.

**Example:** If extension 1002 is a primary telephone and extensions 1005, 1008, and 1019 are secondary telephones with 1002 mapped to them, the Bridged Exts column contains four extension numbers (1002, 1005, 1008, and 1019). If 3 buttons on the 1002 telephone are mapped as bridged extensions, the Mapped Buttons column contains extensions 1002, listed 3 times.

---

## Creating and Managing Telephone Groups

Telephone groups let you create common Button Mappings. Button mappings let you assign specific actions to the buttons on an NBX Business Telephone. When you associate a Group with a specific telephone, the telephone inherits all the mappings of the Group.

For example, you can create a Group called Sales that includes Access buttons mapped to a set of CO lines. When you add a new salesperson to the group, you simply specify the Sales group for the telephone assigned to that person. All of the Sales group's Button Mappings are then available on that person's telephone.

This section covers these topics:

- [Creating a New Telephone Group](#)
- [Modifying a Telephone Group](#)
- [Removing a Telephone Group](#)
- [Viewing Telephone Group Membership](#)

### Creating a New Telephone Group

To create a new telephone group,

- 1 Select *NBX NetSet > Device Configuration*.
- 2 Click the *Telephone Groups* tab.
- 3 Click *Add*. The Add Telephone Group dialog box appears.
- 4 Enter the name of the new group in the *Group Name* field.
- 5 Select an entry from the *Telephone Type* drop-down list.
- 6 To enable call recording and monitoring as the default setting for all telephones in this group, enable the *Call Record & Monitor* check box.
- 7 Click *OK*.

The group now appears in the Telephone Group group list box.

### Modifying a Telephone Group

You may want to change the name of a telephone group to reflect a change in your organization, or you may want to change whether the group is configured for call recording and monitoring.

To change the name of a telephone group:

- 1 Select *NBX NetSet > Device Configuration > Telephone Groups*.
- 2 Select the group whose name you want to change.
- 3 Click *Modify*. The Modify Telephone Group dialog box appears.
- 4 Change the name of the telephone group in the *Group Name* field.
- 5 To set call recording and monitoring as the default condition for all telephones in this telephone group, enable the *Call Record & Monitor* check box. To disable call recording and monitoring, clear the check box.



*You must have installed a call recording license before you can enable the Call Record & Monitor check box.*

- 6 Click *OK*.

### Removing a Telephone Group

You can remove a telephone group if it is no longer needed.

To remove a telephone group:

- 1 Select *NBX NetSet > Device Configuration > Telephone Groups*.
- 2 Select the group you want to remove.
- 3 Click *Remove*. A confirmation window appears.
- 4 Click *Yes*.

The system removes the group.

### Viewing Telephone Group Membership

You can view a report that describes which telephones belong to each telephone group. The report also includes membership information about Class of Service groups.

To view the membership report, click *Membership*.



*You do not need to select a telephone group first. The report includes information about all telephone groups.*

In the report window, click any of the column headings to arrange the information in ascending or descending order.

---

## Recording and Monitoring Telephone Calls

If you have call recording application software that runs on a PC that is external to the NBX system, you can record and monitor telephone calls to and from telephones on the NBX system.

To enable call recording and monitoring on the NBX system, you must purchase a system-wide license. After you install the license, you can enable call recording and monitoring for these devices:

- Analog telephones connected to ports on an Analog Terminal Card or to a single-port Analog Terminal Adapter. For instructions on enabling these features, see:

[“Adding an Analog Terminal Card”](#) on [page 162](#)

[“Adding an Analog Terminal Adapter \(ATA\)”](#) on [page 164](#)

[“Modifying an Analog Terminal Port”](#) on [page 165](#)

- NBX Telephones. For instructions on enabling these features, see:

[“Adding a New Telephone”](#) on [page 130](#)

[“Modifying a Telephone”](#) on [page 132](#)

- Telephone Groups. For instructions on enabling these features, see:

[“Creating a New Telephone Group”](#) on [page 142](#)

[“Modifying a Telephone Group”](#) on [page 142](#)

## Recording Calls Between Telephones with Different Recording Settings

For a call that involves NBX telephones or analog telephones that are connected to either ATC ports or to ATAs, the NBX system verifies the current recording setting for each NBX device involved in order to determine which recording setting to use for the call.

### Two-party Calls

In a two-party call involving only NBX devices, if either NBX device has recording enabled, the NBX system enables recording for both devices for the duration of the call. When the call has been completed, the NBX system restores the recording settings that were in effect prior to the call.

### Conference Calls

If any NBX device in a conference call has recording enabled, the NBX system enables recording for all NBX devices for the duration of the conference call. When the call has been completed, the NBX system restores the recording settings that were in effect prior to the call.

**Example:**

A three-party conference call involves these telephones:

- An NBX Business Telephone on the local NBX system
- An analog telephone connected to an ATC port on the local NBX system
- An NBX Basic Telephone on a different NBX system, connected to the local NBX system by a virtual tie line (VTL)

Only the NBX Basic Telephone has recording enabled. For the duration of the conference call, the NBX system enables recording for the analog telephone and the NBX Business Telephone. After the call ends, the NBX system disables the recording for the analog telephone and the NBX Business Telephone.

**Remote Telephones**

If an NBX telephone or an analog telephone connected to an ATA is connected to a subnetwork different than the NBX Call Processor's, you can enable recording for that remote device.

**Music On Hold**

On an NBX system, music on hold is always recordable. During a call with two NBX devices (NBX telephones, or analog telephones attached to ATC ports or to ATAs) that both normally have recording disabled, if either person puts the call on hold, the NBX system enables recording while music on hold is playing. When the call is taken off hold, the NBX system restores the recording settings that were in effect prior to the call.



*If music on hold is disabled for the NBX system, recording is not enabled while the call is on hold.*

**Non-NBX Telephones**

If your NBX system has telephones other than NBX Telephones attached, you can include these telephones in NBX telephone groups, provided that the other telephones are configured to emulate an NBX telephone.



**CAUTION:** *If a telephone other than an NBX Telephone is configured to emulate an NBX telephone, then you can add the telephone to the associated telephone group (for example, the Default Business Phone Group). However, the other telephone may only partially emulate an NBX Business Telephone and may not respond to the commands to enable or disable call recording. If you disable recording for the Default Business Phone Group, it may still be possible to record calls involving the telephones that are not NBX Telephones in that group.*

## Creating and Managing Button Mappings

Button Mappings allow you to place features, such as speed dial numbers and shortcuts, on telephone buttons for individual telephones or for telephone groups. In addition, you can use Button Mappings to map CO telephone lines to buttons and set up your system in one of these modes:

- **Key Mode system** — In Key Mode, all outside lines map to individual buttons on users' telephones. You can share lines by assigning one line to multiple telephones. Incoming calls ring on all telephones that have that line assigned. Any of those telephones can answer the call.
- **PBX (Private Branch eXchange) system** — In a PBX system, outside lines are pooled and arbitrated by the Call Processor. To call an outside number, a user must dial the line pool access number, typically 9, and the Call Processor assigns the next available line.
- **Hybrid Mode system** — In hybrid mode, some lines are assigned as keyed lines, while the rest are pooled.



*You must use NBX Business Telephones to operate the system in key mode or hybrid mode. NBX Basic Telephones operate in PBX mode only.*

This section covers these topics:

- [Mapping Access Buttons](#)
- [Mappings for Users and Groups](#)
- [Creating a Busy Lamp/Speed Dial Button Mapping](#)
- [Creating a Delayed Ringing Pattern](#)
- [Creating Groups and Button Mappings](#)

### Mapping Access Buttons

NBX Telephone Access buttons have these characteristics:

- NBX 3101 and 3101SP Basic Telephones each have four Access buttons. Only two buttons can serve as line appearances, primary or secondary bridged station appearances or any other feature. The other two buttons cannot be mapped as line appearances or primary bridged station appearances, but the NBX administrator can map any other feature to these buttons. These two buttons are mapped by default as Transfer and Feature, and changing these default mappings can limit the features you can access.
- On NBX 1102, 2102, and 1102-IR Business Telephones, you can assign CO telephone lines or line pool access only to buttons that have lights.

You can assign one-touch actions such as Speed Dial or system features such as Do Not Disturb to any Access button.

- NBX 2101 Basic Telephones include three Access buttons. NBX 2101 Basic Telephones operate in PBX mode only, that is, you cannot map CO lines directly to telephone buttons.
- Not all Button Type functions are available on all models of telephones. For a description of each function you can assign to a button, click the Help button in the NBX NetSet Button Mapping Screen.
- The use of the *Prt*y (priority) and *Number* fields depend on the selected Button Type function.
- The *Ring* field is used to enable and disable ringing for a lone appearance button and to set delayed ringing patterns. See [“Creating a Delayed Ringing Pattern”](#) on [page 148](#) for details.
- A *Lock* check box at the Group Mappings level lets you control button inheritance behavior. If you lock a button at the Group Mappings level, a change made to the Group always passes to every telephone in the Group. If you clear the *Lock* box at the Group Mappings level, you can override the mapping at the device level. An icon at the device level indicates whether the button can be remapped.
- Telephone Button Mappings are part of a device. You assign a set of mappings to an individual by associating a particular device or group to the user.
- Users can see the Button Mappings in effect for their telephones by accessing the NBX NetSet interface with a personal password.
- Users can use the NBX NetSet interface to create and print labels for the Access buttons on their telephones.

### Mappings for Users and Groups

When you create a new user and assign the user to a group, the button mappings for that group become active for the user's telephone. You can override group mappings and create mappings for individual telephones. For example, you can create a Group called Sales and assign three shared direct lines to the group. Then you can assign one unshared direct line to each of the telephones currently in use by people in the Sales group.



*The Lock feature (see [“Creating Groups and Button Mappings”](#) on [page 149](#)) allows you to control button behavior. If you enable Lock, a change that you make at the group level passes to every telephone in the group and it cannot be overridden for individual telephones. If you*

*disable Lock, you can override group button mappings at the device level. (This Lock feature is not the same as the Telephone Locking feature that a user can apply to an individual telephone. See the NBX Telephone Guide.)*

### Creating a Busy Lamp/Speed Dial Button Mapping

A Busy Lamp/Speed Dial button is an Access button, with a light, that is mapped so that it can function as a speed dial to another extension and also indicate when that extension is in use. When you press the Access button mapped to the Busy Lamp/Speed Dial button, you dial the mapped extension. When the other extension is in use, the lamp lights on your telephone.

For the NBX Attendant Console, the default configuration created by the Auto Discovery process creates Busy Lamp/Speed Dial mappings for up to the first 100 extensions on the system.

A CO line mapped directly to telephones (Key mode) does not get transferred to any user's voice mail. For more on key mode, see [Creating and Managing Button Mappings](#) on [page 146](#).

To create a Busy Lamp/Speed Dial button mapping:

- 1 Select *NBX NetSet > Device Configuration > Telephones*.
- 2 Select a telephone in the list and click the *Button Mappings* button.
- 3 On the *Telephone Configuration* dialog box, select an available Access button that has a light. In the *Type* box, select *Line/Extension*. In the *Number* box, specify the extension of the telephone that you want as the Busy Lamp/Speed Dial target.

### Creating a Delayed Ringing Pattern

You can define a ringing progression for a line that is mapped to multiple telephones. For example, you can configure a call to ring immediately at telephone 1, begin ringing at telephone 2 after 4 rings, and then begin ringing at telephone 3 after 8 rings. Any of the telephones can pick up the call at any time, even if it has not yet started audibly ringing at a particular telephone. (The light flashes during all rings.)



*Delayed ringing works with Key mode only, that is, with line card ports mapped to buttons on two or more telephones.*

Delayed ringing is useful for backup coverage on shared lines, such as for secretaries who must cover each other's lines.

Additional considerations:

- The first telephone and each succeeding telephone in a delayed ringing pattern continue to ring until the call is answered or transferred to the Auto Attendant.
- Telephones belonging to a delayed ringing pattern do not need to belong to the same group. As long as all the telephones have the same line mapped, you can create the delayed ringing pattern.

To create a delayed ringing pattern:

- 1 Use the *Group Button Mappings* feature of the NBX NetSet utility to map a CO line. See [Creating and Managing Button Mappings](#) on [page 146](#).
- 2 Set *Ring* to *Yes*.
- 3 Clear the *Lock* check box.
- 4 In the *NBX NetSet - Main Menu* window, click *Device Configuration*.
- 5 On the *Telephones* tab, choose the second telephone in the progression of telephones where you want to create the Delayed Ringing pattern, and then click the *Button Mappings* button.
- 6 For the shared line appearance button, set the *Ring* box to the behavior that you want.

To have the telephone begin ringing after one ring, select *1*; after two rings, select *2*. Select *No* to disable ringing entirely. (The indicator light still functions to indicate ringing/call status.) Do not change the settings in the *Type*, *Number*, and *Pty* boxes.

- 7 Repeat the procedure for each telephone in the Delayed Ringing pattern, taking care to set the Ring delay to create the appropriate delay for each extension.

## Creating Groups and Button Mappings

Telephone Button Mappings are part of a device. You assign a set of mappings to an individual by associating a particular device or group to that user.

A user can see the Button Mappings in effect for an assigned telephone by logging on to the NBX NetSet utility with a personal password. The user can also use the NBX NetSet utility to create and print labels for the Access Buttons on the telephone and set up One Touch Speed Dials.

An administrator can define the button mappings for telephone groups and also define exceptions to the group mappings for individual telephones.

To create groups and button mappings:

- 1 Select *NBX NetSet > Device Configuration > Telephone Groups*.
- 2 Click *Add*, type a *Group Name*, and click *OK*.
- 3 Click the *Group* that you want to apply mappings to.
- 4 Click *Button Mappings*. Click the *Help* button to see more information about the dialog box fields.

To define button mappings for an individual telephone:

- 1 Select *NBX NetSet > Device Configuration > Telephones*.
- 2 Click the telephone that you want to apply mappings to.
- 3 Click *Button Mappings*. Click the *Help* button to see more information about the dialog box fields.

---

## Changing Device IP Settings

If you are using Standard IP network protocol, you can manually change the IP address of telephones, Line Card ports, Attendant Consoles, and Analog Terminal Cards. You modify the IP settings of a device if you plan to move the device to a different subnetwork than the one on which the Call Processor resides. If the new subnetwork is served by a DHCP server, the IP address you assign to the device must be outside the address range that the DHCP server uses.



*3C10116D T1 and 3C10165D E1 Digital Line Cards can be installed in a remote location and communicate with their NCP over a routed network. For a detailed description of how to configure remote Digital Line Cards, see [“Setting Up a Digital Line Card at a Remote Location”](#) on [page 217](#).*

See the Help for *NBX NetSet System Configuration > System Settings > System-Wide* for more information on IP network protocols.

To change the IP settings of a telephone:

- 1 Select *NBX NetSet > Device Configuration > Telephones*.



*If you are updating the IP Settings of a different type of device (such as an Attendant Console or a Digital Line Card), click the appropriate tab to see a list of devices.*

- 2 Select the telephone or other device that you want to update and click *IP Settings*.
- 3 Type the new values for IP Address, Subnet Mask, and Default Gateway address in the text boxes. Click the Help button to see more information about the dialog box fields.
- 4 Click *OK*.
- 5 Disconnect the device from the Call Processor subnetwork.
- 6 Connect the device to the new subnetwork as follows:
  - Connect a telephone or a single-port Analog Terminal Adapter to a port on a switch or hub that is connected to the new subnetwork.
  - Plug a card into an NBX chassis that is connected to the new subnetwork.
- 7 Reboot the device:
  - Remove power from a telephone or a single-port Analog Terminal Adapter, and then reconnect it.
  - If the device is a card, it reboots automatically when you insert it into the new chassis. You do not need to remove power to the chassis when adding or removing cards.



*When you change IP Settings, all current calls through this device are terminated.*

- 8 In the NBX NetSet utility, return to the IP Settings dialog box for the device.
- 9 Verify that the IP settings that you entered are now reported by the device.



**CAUTION:** *If you have configured an NBX telephone for operation on a subnetwork other than the Call Processor's subnetwork, and if you access the Modify IP Settings dialog box to verify that the device settings are correct, you must exit the dialog box by clicking the Cancel button. If you click OK, the NBX system applies the IP settings in the Manually Assigned IP Settings text boxes. By default, all of these fields contain 0.0.0.0, and if you click OK, all of the IP settings for the telephone are set to 0.0.0.0, and the telephone no longer works on the "remote" subnetwork.*

## Configuring Call Park

When you park a call, anyone can retrieve it from any other telephone in the system by entering the Call Park extension that is associated with that call. **Example:** You need to transfer an incoming caller, but the person that you need to reach is not available. You can park the call on any unused Call Park extension and then page the person, announcing the Call Park extension where the call is parked. The person can then retrieve the parked call from any internal telephone by dialing the Call Park extension on which you parked the call.

These are the default system configuration extensions for Call Park:

- **SuperStack 3 NBX:** 6000 through 6099



*The Superstack 3 NBX is shipped with a 4-digit dial plan. If you import any 3-digit plan, you must manually specify any 3-digit extension ranges that are not set by the imported plan.*

- **NBX 100:** 601 through 609



*The NBX 100 is shipped with a factory default 3-digit dial plan. If you import any 4-digit plan, you must manually specify any 4-digit extension ranges that are not set by the imported plan.*

### Adding a Call Park Extension

To add a Call Park extension or change the name of a default Call Park extension:

- 1 Select *NBX NetSet > Device Configuration > Call Park* tab.
- 2 Click *Add*. The Add Call Park dialog box appears. Click the Help button to see more information about the dialog box fields.
- 3 Enter the number of an extension you have previously removed in the *Extension* field.
- 4 Enter a name for the extension in the *Name* field.
- 5 Click *OK*.

### Changing the Name of a Call Park Extension

You can change the name of any Call Park extension.

To change the name of an extension:

- 1 Select *NBX NetSet > Device Configuration > Call Park*.
- 2 Select the extension name that you want to change. Click *Modify*. The Modify Call Park dialog box appears. Click the Help button to see more information about the dialog box fields.

- 3 Enter the new name for the Call Park extension in the *Name* field.
- 4 Click *OK*.

### Removing a Call Park Extension

You can remove a Call Park extension at any time.

To remove a Call Park extension:

- 1 Select *NBX NetSet > Device Configuration > Call Park*.
- 2 Select the extension that you want to remove.
- 3 Click *Remove*. You are prompted to confirm that you want to remove this extension.
- 4 Click *Yes*.

To replace any extension that you remove, see [“Adding a Call Park Extension”](#) on [page 152](#).

---

## Configuring the NBX Attendant Console

The NBX Attendant Console provides extended button mappings and displays the current status of each extension mapped to it. A receptionist typically uses the Attendant Console to connect incoming calls to telephone extensions.

This section describes how to configure the Attendant Console manually. Alternatively, you can use Auto Discovery to add and configure the device automatically, and then use the manual configuration procedures in this section to fine-tune your mappings.



*If you auto discover the Attendant Console, do so after you have auto discovered all telephones, Analog Terminal Adapters, and Analog Terminal Cards. The Auto Discovery process maps all existing telephones to the Attendant Console.*

This section covers these topics:

- [Adding an Attendant Console](#)
- [Modifying an Attendant Console](#)
- [Viewing Attendant Console Status](#)
- [Removing an Attendant Console](#)
- [Configuring Attendant Console Buttons](#)
- [Changing Attendant Console IP Settings](#)

## Adding an Attendant Console

On a SuperStack 3 NBX system, you can configure up to 100 Attendant Consoles; on an NBX 100 system, you can configure up to 50. For either system, you can associate at most 3 Attendant Consoles with any one telephone.



*The NBX Model 3105 Attendant Console requires a license. You must enter a valid device license key into the NBX NetSet utility before you can add a 3105 Attendant Console to the system.*

To add a new NBX Attendant Console:

- 1 Select *NBX NetSet > Device Configuration > Attendant Console*.
- 2 The Add Attendant Console dialog box appears.
- 3 Fill in the fields for the new Attendant Console. Click the Help button to see more information about the dialog box fields.
- 4 Click *OK*. The system adds the new NBX Attendant Console.

## Modifying an Attendant Console

This section describes how to modify an existing Attendant Console. You can change an Attendant Console's device number or associated telephone. Every Console must be associated with a telephone. To modify an existing NBX Attendant Console:

- 1 Select *NBX NetSet > Device Configuration > Attendant Console*.
- 2 Select the Attendant Console that you want to modify and click *Modify*. The Modify dialog box appears.
- 3 Change the desired fields. Click the Help button to see more information about the dialog box fields.
- 4 Click *Apply* to make the changes and then click *OK*.

## Viewing Attendant Console Status

Use the *Status* button on the *Attendant Console* tab to check the status of an Attendant Console. You can also reboot it from this tab with the *Reset Device* option.

To view the status of an Attendant Console:

- 1 Select *NBX NetSet > Device Configuration > Attendant Console*.
- 2 Select the Attendant Console for which you want to view the status and click *Status*. The Device Status dialog box appears.

- 3 View the settings and optionally change the Dialog Refresh, Device Refresh, and Reset Device settings. Click the Help button to see more information about the dialog box fields.
- 4 Click *Apply* to apply the settings and then click *OK*.

### **Removing an Attendant Console**

To remove an NBX Attendant Console from the system:

- 1 Select *NBX NetSet > Device Configuration > Attendant Console*.
- 2 Select the Attendant Console that you want to remove.
- 3 Click *Remove*. A dialog box prompts you to confirm the removal.
- 4 Click *Yes*. The system removes the Attendant Console.

### **Configuring Attendant Console Buttons**

This section describes how to configure the buttons on the NBX Attendant Console. The Attendant Console buttons include:

- 50 Access buttons. You can assign each button two settings.
- A Shift button. This button switches between the two settings allowed for each Access button.
- Four Feature buttons.

#### **Configuring Feature Buttons**

To map the Attendant Console Feature Buttons:

- 1 Select *NBX NetSet > Device Configuration > Attendant Console*.
- 2 Select the Attendant Console for which you want to map Feature Buttons.
- 3 Click *Feature Buttons*. The Feature Button Mappings dialog box appears.
- 4 Use the drop down list next to each button to select the feature you want to assign to the button.

To see a description of each function you can assign to a button, click the Help button on the NBX NetSet Button Mappings screen.

- 5 Click *Apply* to implement the new mappings.

#### **Mapping the Attendant Console Access Buttons**

To map the NBX Attendant Console Access buttons:

- 1 Select *NBX NetSet > Device Configuration > Attendant Console*.
- 2 Select the Attendant Console you want.

- 3 Click *Button Mappings*.
  - 4 To map the buttons that you want, follow these steps:
    - a Select the appropriate column of buttons. Click *1-50* to select columns A through E, or *51 through 100* to select columns F through J. (This choice emulates the function of the *Shift* button on the physical Attendant Console.)
    - b Click the letter (A through J) that corresponds to the column of buttons that you want to map.
    - c Map the buttons for the column that you selected using the drop-down list boxes.
- To see a description of each function you can assign to a button, click the Help button on the NBX NetSet Attendant Console Button Mappings screen.
- 5 Click *Apply* for the changes to take effect.

### Changing Attendant Console IP Settings

Although most configurations use IP On-the-Fly or DHCP to assign IP addresses (and thus cannot manually change the addresses), if you use Standard IP network protocol, you can manually change the IP address of Attendant Consoles and other devices.

To set Attendant Console Feature IP settings:

- 1 Select *NBX NetSet > Device Configuration > Attendant Console*.
- 2 Select the Attendant Console you want, and click *IP Settings*.



*When you change IP Settings, all current calls through this device are terminated.*

---

### Configuring and Managing Analog Line Card Ports

Each NBX Analog Line Card provides access for up to four local telephone lines into your NBX system. The Call Processor treats a line card port as an extension, so each line card port needs its own extension number.

You use Auto Discovery to detect Line Card ports, and you define the starting address for Auto Discovery of devices in the system dial plan. For a 3-digit dial plan, the default starting address is 750; for a 4-digit dial plan, the default starting address is 7250. Auto Discovery assigns the first unassigned number, starting at 750 (or 7250 for a 4-digit dial plan), to the first Line Card port.



You typically configure Line Cards during installation. See the NBX Installation Guide for more information.

If you remove a line card from the system, the port information remains in the database. The extension numbers assigned to the four ports do not become available for reuse unless you use the NBX NetSet utility to remove the line card from the configuration database.

This section covers these topics:

- [Configuring a Line Card Port](#)
- [Modifying a Line Card Port](#)
- [Removing a Line Card Port](#)
- [Verifying Line Card Port Status](#)
- [Rebooting a Line Card Port](#)
- [Advanced Settings](#)

## Configuring a Line Card Port

When you configure a line card port, you can assign it as a member of a line pool.

You can configure a line card port automatically (recommended) or manually.



Verify that you have chosen a 3-digit or 4-digit dial plan before you begin to configure line card ports. See [Chapter 2](#).

### Configuring a Line Card Port Automatically

To configure a line card port automatically:

- 1 Select *NBX NetSet > System Configuration*.
- 2 Click *System-wide*. The System Settings dialog box appears.
- 3 Enable the *Auto Discover Line Cards* check box.
- 4 Click *OK*.

### Configuring a Line Card Port Manually

Most organizations use Auto Discovery to automatically configure line card ports. However, you can configure a line card port manually and select all settings.

To configure a line card port manually:

- 1 Select *NBX NetSet > Device Configuration > Line Card Ports*.
- 2 Click *Add*.
- 3 In the *Add Line Card Port* dialog box, specify the port information, and then click *OK*. Click the *Help* button to see more information about the dialog box fields.

### Auto Extension Behavior

The extensions you specify in the AutoExt. fields control where a call is directed. [Table 24](#) describes typical the behaviors for AutoExt.

**Table 24** Auto Extension Configuration

Button Mapping Setting for This Line	Auto Extension Setting	Incoming Call Behavior
Not mapped to any telephone	Extension of the Receptionist	<p>Receptionist's telephone rings. If no one answers, the call transfers to the call coverage point defined for the Receptionist's telephone.</p> <p><i>User Configuration &gt; Users &gt; User Settings &gt; Call Forward</i></p> <p>The transfer occurs after the number of rings specified for the Receptionist's telephone.</p> <p><i>User Configuration &gt; Users &gt; User Settings &gt; Call Forward</i></p> <p>Because the analog line is not mapped to any telephone, the Time-out values (Open, Closed, Lunch, and Other) for the Analog Line Card port are not used.</p> <p><i>Device Configuration &gt; Line Card Ports &gt; Modify</i></p>
Not mapped to any telephone	500	Calls go directly to the Automated Attendant without ringing any telephone.

**Table 24** Auto Extension Configuration (continued)

Button Mapping Setting for This Line	Auto Extension Setting	Incoming Call Behavior
Mapped to a button on the Receptionist's Telephone (or to a button on an Attendant Console associated with the Receptionist's telephone)	Extension of the Receptionist	<p>Receptionist's telephone rings. If no one answers, the call transfers to call coverage point defined for the Receptionist's telephone.</p> <p><i>User Configuration &gt; Users &gt; User Settings &gt; Call Forward</i></p> <p>The transfer occurs after:</p> <ul style="list-style-type: none"> <li>■ The number of seconds specified on the <i>Time Out</i> line in the Modify Line Card Port dialog box for the appropriate time of day (Open, Closed, Lunch, Other): <i>Device Configuration &gt; Line Card Ports &gt; Modify PLUS</i></li> <li>■ The number of rings specified in the user settings for the Receptionist's telephone. <i>User Configuration &gt; Users &gt; User Settings &gt; Call Forward</i></li> </ul> <p><b>Example:</b> If the Time Out value for the Analog Line Card port is 12 seconds, the equivalent number of rings is 2. If the Call Forward settings for the receptionist's telephone is 4 rings, then the call transfers after 6 rings.</p>
Mapped to a button on the Receptionist's Telephone (or to a button on an Attendant Console associated with the Receptionist's telephone)	500	<p>Receptionist's telephone rings. If no one answers, the call transfers to the Automated Attendant.</p> <p><b>NOTE:</b> The call coverage point defined for the receptionist's telephone has no affect.</p> <p>The transfer occurs after the number of seconds specified on the <i>Time Out</i> line in the Modify Line Card Port dialog box for the appropriate time of day (Open, Closed, Lunch, Other). <i>Device Configuration &gt; Line Card Ports &gt; Modify</i></p>
Mapped to a button on a user telephone (or to a button on an Attendant Console associated with the user's telephone)	Extension of the Receptionist	<p>User telephone rings. If no one answers, the call transfers to the Receptionist's telephone.</p> <p>The transfer occurs after the number of seconds specified on the <i>Time Out</i> line in the Modify Line Card Port dialog box for the appropriate time of day (Open, Closed, Lunch, Other). <i>Device Configuration &gt; Line Card Ports &gt; Modify</i></p> <p>If the receptionist's telephone is not answered, the call transfers to the call coverage point defined for the receptionist's telephone. <i>User Configuration &gt; Users &gt; User Settings &gt; Call Forward</i></p>

**Table 24** Auto Extension Configuration (continued)

Button Mapping Setting for This Line	Auto Extension Setting	Incoming Call Behavior
Mapped to a button on a user telephone (or to a button on an Attendant Console associated with the user's telephone)	500	<p>User telephone rings. If no one answers, the call transfers to the Automated Attendant.</p> <p>The transfer occurs after the number of seconds specified on the <i>Time Out</i> line in the Modify Line Card Port dialog box for the appropriate time of day (Open, Closed, Lunch, Other).</p> <p><i>Device Configuration &gt; Line Card Ports &gt; Modify</i></p>

4 Click *OK*.

5 Connect your CO line to the configured port.

### Modifying a Line Card Port

You can modify a line card port that is already configured.

To modify a line card port:

- 1 Select *NBX NetSet > Device Configuration > Line Card Ports*.
- 2 Select the port you want to modify from the list.
- 3 Click *Modify*.
- 4 Specify the port information. The fields are the same as those described in [“Configuring a Line Card Port Manually”](#) on [page 157](#).
- 5 Click *OK*.

### Removing a Line Card Port

When you remove a line card port that is already configured, you remove the port information from the database.

To remove a line card port:

- 1 Select *NBX NetSet > Device Configuration > Line Card Ports*.
- 2 Select the port that you want to remove from the list.
- 3 Click *Remove*. A prompt asks you to confirm that you want to remove the port.
- 4 Click *Yes* to remove the port.

### Verifying Line Card Port Status

You can verify the status of a configured line port at any time.

To view the status of a line card port:

- 1 Select *NBX NetSet > Device Configuration > Line Card Ports*.
- 2 Select the port that you want and click *Status*.

Click the Help button to see more information about the dialog box fields.

### Rebooting a Line Card Port

To reboot a line card port:

- 1 Select *NBX NetSet > Device Configuration > Line Card Ports*.
- 2 From the list, select the port that you want to reboot.
- 3 Click *Status*. The Device Status dialog box appears.
- 4 Click *Reset Device*.
- 5 Click *OK*.



**CAUTION:** *On the 3C10117 Analog Line Card, you can reboot individual ports without affecting the other ports. However, if you reboot a port on the 3C10117C Analog Line Card, all four ports on the card are rebooted. Active telephone calls on any of these ports are disrupted.*

### Advanced Settings

The Advanced Settings button enables you to set the audio gain and timing controls on each port of an Analog Line Card.

To set these parameters:

- 1 Select *NBX NetSet > Device Configuration > Line Card Ports*.
- 2 Select one of the items from the list and click *Advanced Settings*. The Advanced Settings dialog box appears. Click the Help button to see more information about the dialog box fields.



*If you change any of the values in the Advanced Settings dialog box, the settings that you change persist if you later upgrade the NBX system software or change the regional software.*

### Default Values

To reset all parameters to the default values, click the *Reset* button.

---

## Connecting and Managing Analog Devices

An Analog Terminal Card (ATC) or an Analog Terminal Adapter (ATA) allows ordinary analog (2500-series compliant) telephones, including cordless telephones and Group-3 facsimile (fax) devices, to operate with NBX systems.

These limitations apply because of the differences between an analog device and an NBX Telephone:

- A user dials 500, then \*\* on a telephone connected to an ATA to gain access to voice mail.
- An analog telephone can make or receive only one call. A second incoming call goes to voice mail.

This section discusses these topics:

- [Adding an Analog Terminal Card](#)
- [Adding an Analog Terminal Adapter \(ATA\)](#)
- [Modifying an Analog Terminal Port](#)
- [Removing an Analog Terminal Adapter](#)
- [Viewing The Status of an Analog Terminal Adapter](#)

### Adding an Analog Terminal Card

To add an Analog Terminal Card to the NBX system using Auto Discovery:

- 1 Select *NBX NetSet > System Configuration > System-wide*.
- 2 Click the *Auto Discover Telephones* check box to select it.
- 3 Click *OK*.
- 4 Insert the Analog Terminal Card into the chassis.
- 5 Wait 1 minute for the system to discover the card.
- 6 In the *NBX NetSet - Main Menu* window, click *Device Configuration*.
- 7 In the *Device Configuration* dialog box, click the *ATA* tab.
- 8 The four ports of the Analog Terminal Card appear in the list of ATAs, along with the ports of any previously discovered Analog Terminal Cards, and any previously discovered Single-Port Analog Terminal Adapters (ATAs).

## Extension Assignments (3C10117 ATC)

3C10117 has been replaced with model 3C10117C.

Each of the four ports on a 3C10117 Analog Terminal Card has a MAC address. The first port has the same MAC address as the card, and the remaining three ports have sequential MAC addresses incremented by one hexadecimal digit. See [Table 25](#):

**Table 25** MAC Addresses of Analog Terminal Card Ports (3C10117)

Card or Port	MAC Address
Analog Terminal Card	00:e0:bb:00:f8:c8
Port 1	00:e0:bb:00:f8:c8
Port 2	00:e0:bb:00:f8:c9
Port 3	00:e0:bb:00:f8:ca
Port 4	00:e0:bb:00:f8:cb

The extensions assigned to these ports by the NBX system may not be in order. For example, if the NBX system assigns extensions 7258, 7259, 7260, and 7261 to the ATC ports, it might assign 7258 to port 3.

To determine which extension is associated with a given port, you must access the ATA tab in the NBX NetSet utility and examine the list of ATAs and ATC ports. For example, to determine the extension assigned to the third port, look for the ATC port with a MAC address that is two hexadecimal digits higher than the MAC address of the board. The extension of the port is in the first column (Ext.).



*After you have added the Analog Terminal Card, you can configure the parameters for each of the four ports. See [“Modifying an Analog Terminal Port”](#) on [page 165](#).*

## Extension Assignments (3C10117C ATC)

On a 3C10117C Analog Terminal Card, there is only one MAC address. Each of the four ports is assigned a unique virtual device number (1 through 4) so that the NBX software can address each port separately.

When you select the ATA tab, and view the information, the port number appears after the MAC address, enclosed within square brackets. See [Table 26](#).

**Table 26** MAC Addresses of Analog Terminal Card Ports (3C10117C)

Card or Port	MAC Address
Analog Terminal Card	00:e0:bb:00:f8:c8
Port 1	00:e0:bb:00:f8:c8[1]
Port 2	00:e0:bb:00:f8:c8[2]
Port 3	00:e0:bb:00:f8:c8[3]
Port 4	00:e0:bb:00:f8:c8[4]

The extensions that are assigned to these ports by the NBX system may not be in order. For example, if the NBX system assigns extensions 7258, 7259, 7260, and 7261 to the ATC ports, it might assign 7258 to port 3.

To determine the extension assigned to any port on a 3C10117C ATC:

- 1 Click the *ATA* tab.
- 2 Look for the combination of MAC address and port number that you want. The extension associated with the port is in the first column (Ext.).



*After you have added the Analog Terminal Card, you can configure the parameters for each of the four ports. See [“Modifying an Analog Terminal Port”](#) on [page 165](#).*

### **Adding an Analog Terminal Adapter (ATA)**

To add an Analog Terminal Adapter (ATA) to the NBX system:

- 1 Select *NBX NetSet > Device Configuration > ATA*.
- 2 Click *Add*. The Add ATA dialog box appears.
- 3 Fill in the fields in the Add ATA dialog box. Click the Help button to see more information about the dialog box fields.
- 4 Click *Apply* to add the new ATA to the system.
- 5 Repeat as necessary to add more ATAs.
- 6 When you are finished adding ATAs, click *OK*.

## Modifying an Analog Terminal Port

You can modify the configuration of an Analog Terminal Card port or a single-port ATA at any time.

To modify an analog device configuration:

- 1 Select *NBX NetSet > Device Configuration > ATA*.
- 2 Select the port that you want to modify and click *Modify*.
- 3 Modify the desired fields. Click the Help button to see more information about the dialog box fields.
- 4 Click *Apply* to effect the changes.
- 5 Click *OK*.

## Removing an Analog Terminal Adapter

You can remove either an Analog Terminal Adapter (ATA) or one of the ports on an Analog Terminal Card (ATC) from the system at any time. Any device connected to the ATA is also removed from the system.

To remove an Analog Terminal Adapter:

- 1 Select *NBX NetSet > Device Configuration > ATA*.



*Use the MAC addresses to determine whether an item in the list is an Analog Terminal Adapter (ATA) or one of the ports on an Analog Terminal Card. Ports on a 3C10117 Analog Terminal Card have MAC addresses that differ by two hexadecimal digits. Ports on a 3C10117C Analog Terminal Card all have the same MAC address and use a Virtual Device Number to identify each port. The port number appears after the MAC address, enclosed in square brackets. An ATA has a unique MAC address with no port number.*

- 2 Select the ATA or the port on an ATC you want to remove.
- 3 Click *Remove*. A dialog box prompts you to confirm the removal.
- 4 Click *Yes*. The system removes the item you selected.

## Viewing The Status of an Analog Terminal Adapter

You can view the status of either an Analog Terminal Adapter or one of the ports on an Analog Terminal Card at any time.

To view the status of an Analog Terminal Adapter or a port on an Analog Terminal Card:

- 1 Select *NBX NetSet > Device Configuration > ATA* tab.



*Use the MAC addresses to determine whether an item in the list is an ATA or one of the ports on an ATC. Ports on a 3C10114 Analog Terminal Card*

*have sequential MAC addresses. Ports on a 3C10114C Analog Terminal Card all have the same MAC address followed by a Virtual Device Number (VDN), enclosed in square brackets. An Analog Terminal Adapter has a unique MAC address with no port number.*

- 2 Select an ATA or port from the list.
- 3 Click *Status*. The Device Status dialog box appears. Click the Help button to see more information about the dialog box fields.
- 4 View the device status and make any necessary changes.
- 5 To optionally send a status message to the Call Processor about the ATA or ATC port, select *Device Refresh* and click *Apply*.
- 6 To optionally reset the ATA or ATC port, select *Reset Device* and click *Apply*. A dialog box prompts you to confirm the reset.
- 7 Click Yes. The ATA or ATC port resets itself.



**CAUTION:** *On the 3C10114 Analog Terminal Card, you can reboot individual ports without affecting the other ports. However, if you reboot a port on the 3C10114C Analog Terminal Card, all four ports on the card are rebooted. Active calls on any of these ports are disrupted.*

- 8 Click OK.

### Advanced Settings

You can set the audio gain and timing controls on each port of an Analog Terminal Card, or on an Analog Terminal Adapter. To set these parameters:

- 1 Select *NBX NetSet > Device Configuration > ATA*.
- 2 Select one of the ports in the list and click *Advanced Settings*. Click the Help button to see more information about the dialog box fields.



*If you change any of the values in the Advanced Settings dialog box, the settings you change persist if you later upgrade the NBX system software or you change the regional software.*

## Configuring and Managing BRI-ST Digital Line Cards

These sections describe how to add and configure a BRI-ST Digital Line Card to handle a BRI line with four BRI spans using the ST interface.

This section covers these topics:

- [Adding an ISDN BRI-ST Digital Line Card](#)
- [Configuring the BRI-ST Digital Line Card](#)
- [BRI-ST Card Status Lights](#)
- [Modifying a BRI-ST Card](#)
- [Adding or Modifying a BRI Group](#)
- [Modifying BRI Card Channels](#)
- [Modifying IP Settings for a BRI Card](#)
- [Removing a BRI Digital Line Card](#)

Each BRI-ST Digital Line Card (3C10164C) supports the Basic Rate Interface protocol (ST interface only).

### Adding an ISDN BRI-ST Digital Line Card

To add a BRI-ST Digital Line Card to an NBX system, use the information in these sections:

- [Preparing the NBX System for BRI Cards](#)
- [Ordering DID, CLIP, and MSN Services for BRI](#)
- [Inserting the BRI-ST Digital Line Card](#)

### Preparing the NBX System for BRI Cards

Before you insert the BRI-ST Digital Line Card into the chassis, order an ISDN BRI-ST line from your telephone carrier, and have them install the line.

### Ordering DID, CLIP, and MSN Services for BRI

When you order BRI services with DID, CLIP, or MSN, the local telephone carrier assigns a block of telephone numbers to you. Usually, you can request a specific range of numbers, but sometimes the carrier assigns numbers other than the ones you request.

You may be able to request that the local telephone carrier pass you a specific number of digits for each incoming telephone call. Sometimes the carrier does not offer any choice. In either situation, you need to know how many digits the carrier passes.

**Example:** Carriers commonly pass either the last three digits or last four digits of the number for each incoming call.

Sometimes the last digits of the telephone numbers the carrier assigns to you do not match the telephone extension numbers you want to use for internal calls. Create entries in your Dial Plan configuration file to translate the incoming numbers into the corresponding extension numbers.

**Example:** You want to use internal extensions from 4000 through 4999, but the local telephone carrier assigns you numbers from 617-555-3500 through 617-555-4499. You can create translator entries in the Dial Plan configuration file to translate an incoming digit sequence such as 3795 into extension number 4295, and a sequence such as 4213 into 4713. The configuration would require several translator entries to handle subsets of the total range. A unique set of entries would handle incoming digit sequences from 3500 through 3599, from 3600 through 3699, and each of the other sequences in which the first two digits were unique in the range from 37XX through 44XX.

If the DDI/DID numbers match your internal extension numbers, the translator entries in your Dial Plan configuration file can be much simpler.

**Example:** You plan to use internal extensions from 100 through 299, and the local telephone company assigns you numbers from 617-555-4100 through 617-555-4299. If the local telephone carrier passes you three digits, you need no translator entries in the Dial Plan configuration file. If the carrier passes you four digits, you could add a single set of translator entries to the configuration file to remove the first digit (4) and use the remaining three digits as the internal extension.

### Enabling Auto Discovery for Digital Line Cards

To enable Auto Discovery for Digital Line Cards:

- 1 Select *NBX NetSet > System Configuration > System Settings*.
- 2 Click the *Auto Discover Digital Line Cards* check box.



*Other check boxes may be selected based upon previous Auto Discoveries. You do not need to clear these check boxes to install the BRI-ST card.*

- 3 Click *OK*.

## Inserting the BRI-ST Digital Line Card

You do not need to remove the power cable from the chassis before you insert the BRI-ST card.

To insert the BRI-ST card into the chassis:

- 1 Write down the MAC address of the BRI-ST card.
- 2 Select a slot for the BRI-ST card in the chassis, and use a Phillips screwdriver to remove the blank faceplate from the slot.
- 3 Insert the BRI-ST card into the slot.
- 4 Slide the BRI-ST card into the chassis until you feel it touch the connectors.
- 5 To seat the BRI-ST card into the connectors, press the front of the card firmly.
- 6 Tighten the left and right screws on the front of the BRI-ST card to secure it to the chassis.
- 7 Wait 3 minutes.



**CAUTION:** When you insert the BRI-ST Digital Line Card, it begins an initialization sequence. Also, because you enabled the Auto Discover Digital Line Cards check box, the system recognizes the addition of the BRI-ST card and begins to update its database. Allow 3 minutes for both of these processes to be completed.

You are now ready to configure the BRI-ST Digital Line Card.

## Configuring the BRI-ST Digital Line Card

These sections tell you how to use the NBX NetSet utility to set up your BRI-ST Digital Line Card parameters:

- [Configuring for ISDN BRI Signaling](#)
- [Configuring BRI Groups](#)
- [Verifying BRI Group Membership](#)
- [Completing the BRI-ST Configuration](#)

Before you configure the BRI-ST card, you must configure the Dial Plan as described in [Chapter 2](#).

### Configuring for ISDN BRI Signaling



**CAUTION:** Before you begin to configure the BRI-ST card, be sure to wait 3 minutes after you insert the BRI-ST card into the chassis.

To configure for ISDN BRI signaling:

- 1 Select *NBX NetSet > Device Configuration > Digital Line Cards*.
- 2 In the *T1/ISDN Board List*, find the MAC address of the BRI-ST board that you recorded before you inserted the card into the chassis.
- 3 Select the BRI-ST card from the list and click *Modify*.
- 4 Scroll through the *Channel List* to verify that the system lists all eight channels. The channel numbers appear after the MAC address, separated by a hyphen.

#### Example:

2...00:01:03:48:e0:4e-4...New Trunk.

The 4 after the hyphen indicates channel number 4.

- 5 To change the name of the BRI-ST card, edit the contents of the *Board Name* field to help you to identify the BRI-ST card in device lists.
- 6 Enable the *On Line* check box.
- 7 Click *OK*.

To connect the BRI line and activate the span:

- 1 Plug the BRI line into the BRI interface box.
- 2 Using a category 5 Ethernet cable, connect the BRI interface box to one of the four ports on the front panel of the BRI-ST card.

- 3 The *Card Type* field should contain ISDN BRI. If it does not, the system has not properly auto discovered the card. Restart the installation process.

To verify that the span status changes from *Offline* to *Ready*:

- 1 On the *Digital Line Cards* tab, select *ISDN BRI Span List* from the *Select Device Type* list and then click *Apply*.
- 2 Enable the *On Line* check box.
- 3 Click *Apply*.
- 4 Verify that the word *Ready* appears in the *ISDN BRI Span List* line item that corresponds to this span.



The *Digital Line Cards* dialog box includes buttons named *Config & Status Report* and *Export Report*. Both of these buttons generate configuration and status information for the selected *Digital Line Card*. Because this information is used for troubleshooting purposes, these buttons and the generated reports are described in [“\*Digital Line Card Troubleshooting\*”](#) on [page 315](#).

### Configuring BRI Groups

To configure the BRI groups:

- 1 On the *Digital Line Cards* tab, from the *Select Device Type* list, select *ISDN BRI Group List* and then click *Apply*.
- 2 From the *ISDN BRI Group List*, select *BRI Group 1*.
- 3 Click *Modify*. The *Modify Group* dialog box appears.
- 4 Select *Restricted* from the *Trunk to Trunk* drop-down list.



**CAUTION:** If you select **Unrestricted**, users can transfer incoming calls to outgoing trunks. 3Com does not recommend this setting because it enables the possibility of toll fraud.

- 5 Click the *On Line* check box.
- 6 Enter *500* in each of the four *AutoExt* text boxes.
- 7 Click *OK*.

### Verifying BRI Group Membership

To verify that all channels are in the member list:

- 1 On the *Digital Line Cards* tab, from the *Select Device Type* list, select *BRI Group List* and then click *Apply*.
- 2 Select the group you want, and click *Membership*.

- 3 Scroll through the *Member List* to verify that all eight channels are present.
- 4 To transfer a channel from the non-member list to the member list, select the channel and click <<.



*You cannot transfer a channel from the Member List to the Non-Member list.*

### Completing the BRI-ST Configuration

To complete the BRI-ST installation:

- 1 Return to the *Digital Line Cards* tab.
- 2 From the *Select Device Type* list, select *ISDN BRI Channel List*.
- 3 Click *Apply*.
- 4 Wait approximately 30 seconds for the status of each channel to change from *Ready* to *Idle*.



*If the channel status does not change to Idle, verify that you have enabled the On Line check box for the card, the span, and the group.*



*While you are waiting, click Apply to refresh the list of channels and to see the updated status.*

### BRI-ST Card Status Lights

Each of the four spans on a BRI-ST card has status lights that indicate the status of the span ([Table 27](#)).

**Table 27** BRI-ST Card Status Lights

Status	D	B1	B2
<b>Off</b>	No Layer 1 connection is established with the Central Office (CO).	The channel is not carrying a call.	The channel is not carrying a call.
<b>Yellow</b>	A Layer 1 connection is established but the channel is not yet ready to make or receive calls.	A call build-up is occurring.	A call build-up is occurring.
<b>Green</b>	The channel is ready to make and receive calls.	A call is connected.	A call is connected.

## Modifying a BRI-ST Card

These sections tell you how to modify a BRI card that is already installed in the system:

- [Modifying a BRI Span](#)
- [Modifying Audio Controls](#)

For the BRI-ST card, you can modify only a BRI span. You cannot modify the board type for a BRI-ST card.

### Modifying a BRI Span

To modify a span:

- 1 On the *Digital Line Cards* tab, from the *Select Device Type* drop-down list, select *ISDN BRI Span List* and then click *Apply*.
- 2 Select the span you want to modify from the *Span List*. Click *Modify*. The *Modify Span* dialog box appears.
- 3 Make the changes that you want. Click the *Help* button to see more information about the dialog box fields. The ISDN BRI-ST Digital Line Card supports two channels per span.
- 4 Click *Apply*.
- 5 Enable the *On Line* check box to bring the span online. Note that the span does not come online unless the card is online first.
- 6 Click *Apply* to make the changes and then click *OK*.

### Modifying Audio Controls

In a normal environment, you should not need to change the Audio Controls from their default settings. If you have an issue with sound quality and you cannot resolve it using the volume controls on the NBX Telephones, contact your technical support representative.



**CAUTION:** Do not change your Audio Controls settings unless you are instructed to do so by a qualified support representative.

## Adding or Modifying a BRI Group

A BRI-ST Digital Line Card group is one or more BRI channels that are assigned the same characteristics. These sections tell you how to perform these tasks:

- [Adding a BRI Group](#)
- [Modifying a BRI Group](#)
- [Changing BRI Group Membership](#)
- [Removing a BRI Group](#)

### Adding a BRI Group

You add a new group when you need to assign common characteristics to several BRI channels.

To add a BRI Digital Line Card group:

- 1 On the *Digital Line Cards* tab, select *ISDN BRI Group List* from the *Select Device Type* drop-down list and click *Apply*.
- 2 In the dialog box that appears, click *Add*. The Add Group dialog box appears.

### Modifying a BRI Group

You may want to modify a Digital Line Card group to change its name, Auto Extension assignments, or other parameters. When you modify a group, the changes affect all of the Digital Line Cards assigned to that group.



**CAUTION:** *Modifying a BRI group disconnects any active calls on any channels that are associated with the group.*

To modify a BRI group:

- 1 On the *Digital Line Cards* tab, from the *Select Device Type* drop-down list, select *ISDN BRI Group List*.
- 2 Click *Apply*.
- 3 Select the group that you want to modify.
- 4 Click *Modify*. The *Modify Group* dialog box appears. Click the Help button to see more information about the dialog box fields.
- 5 Make the changes that you want to the group parameters.
- 6 Enable the *On Line* check box to bring the group on line. Click *Apply* for the changes to go into effect and then click *OK*.

## Changing BRI Group Membership

You may want to change the channel membership in a group to accommodate changing needs.

To change group membership:

- 1 On the *Digital Line Cards* tab, from the *Select Device Type* drop-down list, select *ISDN BRI Group List* and then click *Apply*.
- 2 Select the group for which you want to change membership.
- 3 Click *Membership*. The Manage Group Membership dialog box appears. Click the Help button to see more information about the dialog box fields.
- 4 To add a channel to the Member List, select the channel in the *Non Member List* and click <<.

If you select the *Copy Group Settings to Channels* check box, the system copies the settings of the selected group to each channel you add or remove. If you do not select this check box, the channel settings are not changed.

- 5 Optionally enable the *Refresh Channels on Add/Remove* check box. This refreshes each channel as you add or remove it.



*You cannot move a channel from the Member List to the Non-Member List.*

Each channel must belong to a group. A channel can belong to only one group. You cannot move a channel from the members list to the non-members list of a group unless the system can assign the channel to another group. If a channel has never been a member of a group, the system cannot determine a group to which it can move the channel. Therefore, it cannot remove the channel from the member list. If a channel has been a member of a group in the past, the system moves the channel to the group of which the channel was most recently a member.

**Example:** By default, the system creates two groups, Group 1 and Group 2, and places all channels in Group 1. If you try to move a channel to the non-member list of Group 1, the operation fails. If you select Group 2, click *Membership*, move a channel from the non-member list to the member list, and then move the same channel back to the non-member list, the operation succeeds because the channel was previously a member of Group 1. If you then view the Group 1 membership list, it contains the channel you just removed from Group 2.

- 6 Click *Close*.

### Removing a BRI Group

You may want to remove any group that you no longer need.

To remove a group:

- 1 Return to the *Digital Line Cards* tab.
- 2 From the *Select Device Type* drop-down list, select *ISDN BRI Group List*.
- 3 Click *Apply*.
- 4 Select the group you want to remove.
- 5 Click *Remove*. A prompt appears asking if you want to remove the group.
- 6 Click *Yes* to remove the group.

### Modifying BRI Card Channels

A channel is an ISDN logical B channel. A channel can take a single call. This section describes how to modify channels for an installed BRI card and how to view the status of an existing channel.



**CAUTION:** Do not modify channels unless a 3Com Technical Support representative advises you to do so. Modifying an ISDN channel disconnects any existing calls on that channel.

To modify a channel on an installed BRI-ST card:

- 1 On the *Digital Line Cards* tab), from the *Select Device Type* drop-down list, select *ISDN BRI Channel List*.
- 2 Click *Apply*. The system updates the window to show the BRI channels.
- 3 Select the channel that you want and click *Modify*. The *Modify Channel* dialog box appears.
- 4 Fill in or change the fields in the appropriate *Modify Channel* dialog box. Click the *Help* button to see more information about the dialog box fields.
- 5 Enable the *On Line* check box to bring the channel on line. Note that the channel does not come online unless, previously, the card and the span have come online. Click *OK*.

### Viewing the Status of a BRI Channel

To view the status of a channel on an installed BRI-ST card:

- 1 On the *Digital Line Cards* tab, select *ISDN BRI Channel List*.
- 2 Click *Apply*.

- 3 Select the channel for which you want status information.
- 4 Click *Status*. The BRI Channel Status dialog box appears.
- 5 View the status of the channel.
- 6 Refresh the Channel Status dialog box.

To manually refresh the *Channel Status* dialog box, select *Manual* from the *Dialog Refresh* list, and click *Apply*.

To automatically refresh the *Channel Status* dialog box, select *Auto* from the *Dialog Refresh* list, and click *Apply*.

- 7 To reboot the card, select the *Device Refresh* check box.

### Viewing Digital Signal Processor Status

To view DSP (Digital Signal Processor) details:

- 1 Return to the *Digital Line Cards* tab.
- 2 From the *Select Device Type* list, select *T1/ISDN Board List* and click *Apply*.
- 3 Select the BRI card you want and click *Status*.
- 4 In the Board Status dialog box, select a DSP from the *DSP List* and click *Details*. The DSP Status window appears.
- 5 Click *Close* to close the *DSP Status* window.
- 6 Click *OK*.

### Modifying IP Settings for a BRI Card

You can modify the IP settings for a Digital Line Card to meet changing requirements.



*The card must be on the same subnetwork as the Call Processor to modify IP settings using the NBX NetSet utility.*

To modify the IP settings of a BRI Digital Line Card:

- 1 On the *Digital Line Cards* tab, from the *Select Device Type* drop-down list, select *T1/ISDN Board List*.
- 2 Click *Apply*.
- 3 Select the BRI card for which you want to change the IP settings.
- 4 Click *IP Settings*.
- 5 To assign IP addresses, enter the first address in the *First IP Address* field. The system sequentially adds the remaining addresses.

To assign IP addresses one at a time per channel:

- 1 In the *Digital Line Card IP Settings* dialog box, click *Assign Addresses Individually*.
- 2 Enter the desired IP addresses for the channels.
- 3 Enter the mask number appropriate for your site in the *Common Subnet Mask* field.
- 4 Enter IP address for the *Common Default Gateway*.
- 5 Click *Apply*.
- 6 Click *OK*.
- 7 In the *Digital Line Card IP Settings* dialog box dialog box, click *OK*.

### Removing a BRI Digital Line Card



You can remove a Digital Line Card at any time.

**CAUTION:** *Removing a Digital Line Card may affect your Dial Plan.*

To remove a Digital Line Card:

- 1 On the *Digital Line Cards* tab, from the *Select Device Type* drop-down list, select *T1/ISDN Board List* and click *Apply*. A list of installed T1, ISDN PRI, or ISDN BRI boards appears in the *T1/ISDN Board List*.
- 2 Select the board (Digital Line Card) you want to remove from the list.
- 3 Click *Remove*. A dialog box prompts you to confirm the removal.
- 4 Click *Yes*.

---

## Configuring and Managing E1 Digital Line Cards

This section describes how to add and configure an E1 Digital Line Card to connect to an E1 service provided by the local telephone company. You can configure an E1 Digital Line Card for ISDN PRI signaling only. In the NBX NetSet utility, Digital Line Cards are referred to as either cards or boards.

These topics explain NBX E1 card configuration:

- [Adding an E1 Digital Line Card](#)
- [Configuring an E1 Digital Line Card](#)
- [E1 Card Status Lights](#)
- [Modifying an E1 Card](#)
- [Adding or Modifying an E1 Group](#)
- [Modifying E1 Card Channels](#)
- [Modifying IP Settings for an E1 Card](#)
- [Removing an E1 Digital Line Card](#)

3C10165D E1 Digital Line Cards have expanded capabilities that are described in these topics:

- [Setting Up a Digital Line Card at a Remote Location](#)
- [Setting Up T1/E1 Logging](#)
- [Viewing CSU State Information and Statistics](#)
- [Using Loopback Tests](#)

### Adding an E1 Digital Line Card

These sections tell you how to add an E1 Digital Line Card to an NBX system:

- [Preparing the NBX System for E1 Cards](#)
- [Ordering DID, CLIP, and MSN Services for E1](#)
- [Inserting the E1 Digital Line Card](#)

### Preparing the NBX System for E1 Cards

Before you insert the E1 Digital Line Card into the chassis, order an E1 line, with the specifications you want, from your telephone carrier, and have them install the line.

### Ordering DID, CLIP, and MSN Services for E1

When you order E1 with DID, CLIP, or MSN services, the local telephone carrier assigns a block of telephone numbers to you. Usually, you can request a specific range of numbers, but sometimes the carrier assigns numbers other than the ones you request.

You may be able to request that the local telephone carrier pass you a specific number of digits for each incoming telephone call. Sometimes the carrier does not offer any choice. In either situation, you need to know how many digits the carrier passes.

**Example:** Carriers commonly pass either the last three digits or last four digits of the number for each incoming call.

Sometimes the last digits of the telephone numbers the carrier assigns to you do not match the telephone extension numbers you want to use for internal calls. You can create entries in your Dial Plan configuration file to translate the incoming numbers into the corresponding extension numbers.

**Example:** You want to use internal extensions from 4000 through 4999, but the local telephone carrier assigns you numbers from 617-555-3500 through 617-555-4499. You can create translator entries in the Dial Plan configuration file to translate an incoming digit sequence such as 3795 into extension number 4295, and a sequence such as 4213 into 4713. The configuration would require several translator entries to handle subsets of the total range. A unique set of entries would handle incoming digit sequences from 3500 through 3599, from 3600 through 3699, and each of the other sequences in which the first two digits were unique in the range from 37XX through 44XX.

If the DDI/DID numbers match your internal extension numbers, the translator entries in your Dial Plan configuration file can be much simpler.

**Example:** You plan to use internal extensions from 100 through 299, and the local telephone company assigns you numbers from 617-555-4100 through 617-555-4299. If the local telephone carrier passes you three digits, you need no translator entries in the Dial Plan configuration file. If the carrier passes you four digits, you could add a single set of translator entries to the configuration file to remove the first digit (4) and use the remaining three digits as the internal extension.

## Enabling Auto Discovery for Digital Line Cards

To enable Auto Discovery for Digital Line Cards:

- 1 Select *NBX NetSet > System Configuration > System Settings > System-wide*.
- 2 Enable the *Auto Discover Digital Line Cards* check box.  
Other check boxes may be selected based upon previous Auto Discoveries. You do not need to clear these check boxes to install the E1 card.
- 3 Click *OK*.

## Inserting the E1 Digital Line Card

You do not need to remove the power cable from the chassis before you insert the E1 card.

To insert the E1 Digital Line Card into the chassis:

- 1 Write down the MAC address of the E1 card.
- 2 Select a slot for the E1 card in the chassis, and use a Phillips screwdriver to remove the blank faceplate from the slot.
- 3 Insert the E1 card into the slot.
- 4 Slide the E1 card into the chassis until you feel it touch the connectors.
- 5 To seat the E1 card into the connectors, press the front of the card firmly.
- 6 Tighten the left and right screws on the front of the E1 card.
- 7 Wait 3 minutes.



**CAUTION:** *When you insert the E1 Digital Line Card, it begins an initialization sequence. Also, because you enabled the Auto Discover Digital Line Cards check box, the system recognizes the addition of the E1 card and begins to update its database. Allow 3 minutes for both of these processes to be completed.*

You are now ready to configure the E1 Digital Line Card.

## Configuring an E1 Digital Line Card

These sections tell you how to use the NBX NetSet utility to set up your E1 Digital Line Card parameters.

- [Configuring for ISDN PRI Signaling](#)
- [Configuring E1 Groups](#)
- [Verifying E1 Group Membership](#)
- [Completing the E1 Configuration](#)
- [Verifying E1 Span Status](#)

Before you configure an E1 card, you must configure the Dial Plan as described in [Chapter 2](#).

### Configuring for ISDN PRI Signaling

Before you configure the E1 card, read the cautionary note. This section describes how to configure an E1 Digital Line Card for ISDN PRI (Primary Rate Interface) signaling.



**CAUTION:** Before you configure the E1 card, you must wait 3 minutes after you insert the E1 card into the chassis.

- 1 Select *NBX NetSet > Device Configuration > Digital Line Cards*.
- 2 Use the MAC address of the E1 card to identify the board in the *T1/ISDN Board List*. You recorded this address before inserting the board into the chassis.
- 3 Select the E1 board from the *T1/ISDN Board List* and click *Modify*.
- 4 Scroll through the *Channel List* to verify that the system lists all 30 channels. The channel numbers appear after the MAC address, separated by a hyphen.

#### Example:

1...00:e0:bb:04:4e:a5-4 Trunk

The 4 after the hyphen indicates channel number 4.

- 5 To change the name of the E1 board, edit the contents of the *Board Name* field. This name helps you identify the E1 board in a list.
- 6 Enable the *On Line* check box.
- 7 Click *Apply* and then click *OK*.

To connect the E1 line and activate the span:

- 1 Plug the E1 line into the E1 board.
- 2 Select *ISDN PRI Span List* from the *Card Type* drop-down list.
- 3 Select the E1 span from the list and click *Modify*.
- 4 Click the *On Line* check box.
- 5 Click *Apply*.

To verify that the span status changes from *Offline* to *Ready*:

- 1 On the *Digital Line Cards* tab, select *ISDN PRI Span List* from the *Select Device Type* list.
- 2 Click *Apply*.

### Configuring E1 Groups

To configure the E1 Groups:

- 1 On the *Digital Line Cards* tab, select *ISDN PRI Group List* from the *Select Device Type* list.
- 2 Click *Apply*.
- 3 From the *ISDN PRI Group List*, select *PRI Group 1*.
- 4 Click *Modify*. The *Modify Group* dialog box appears.
- 5 Select *Restricted* from the *Trunk to Trunk* drop-down list.



*If you select **Unrestricted**, users can transfer incoming calls to outgoing trunks. 3Com does not recommend this setting because it enables the possibility of toll fraud.*

- 6 Click the *On Line* check box.
- 7 Enter *500* in each of the four *AutoExt* text boxes and click *OK*.

### Verifying E1 Group Membership

To verify that all channels are in the member list:

- 1 On the *Digital Line Cards* tab, select *ISDN PRI Group List* from the *Select Device Type* list and click *Apply*.
- 2 Select the group that you want, and click *Membership*.
- 3 Scroll through the *Member List* to verify that all 30 channels are present.

## Completing the E1 Configuration

To complete the E1 configuration, perform these steps:

- 1 On the *Digital Line Cards* tab, select *ISDN PRI Channel List* from the *Select Device Type* list and click *Apply*.
- 2 Wait approximately 30 seconds for the status of each channel to change from *Ready* to *Idle*. You can also watch the *Nominal* (3C10165C) or the *CO* (3C10165D) status light on the E1 card front panel. When it stops flashing and stays on, the board is active.



*If the channel status does not change to Idle, verify that you have enabled the On Line check box for the card and the span.*



*While you are waiting, you can click Apply to refresh the list of channels and to see the updated status.*

## Verifying E1 Span Status

To verify the E1 span status:

- 1 On the *Digital Line Cards* tab, select *ISDN PRI Span List* from the *Select Device Type* list and click *Apply*.
- 2 Select the span and click *Status*.

## E1 Card Status Lights

The 3C10165, 3C10165B, and 3C10165C E1 cards contains these status lights:

- **CF** — Carrier Fail (when lit, indicates either a red alarm or blue alarm)
- **RA** — Remote Alarm (yellow alarm)
- **LB** — Loopback
- **Nominal** — E1 card is framed

The 3C10165D E1 card contains these status lights:

- **CO** — Central Office:
  - Amber — Alarm condition at the remote end or the CO is not connected or available.
  - Green — No alarm condition; the card has a valid connection to the Central Office.
- **POST** — Power On Self Test:

Off — POST test is running. The test runs approximately 5-seconds after you apply power to the board. After 5-seconds, Off indicates the POST test failed.

Green — POST test completed successfully.

- **DCH** — D channel status of an ISDN PRI connection

Off — No E1 line is attached.

Green — Card is configured for ISDN PRI operation and an active PRI connection has been established.

Amber — The D channel has not yet been established. It can take several seconds after the card has completed its power up tests for the card to establish a connection with the PRI trunk. If the DCH light goes to amber after the connection has been established, it can mean that an active control channel connection through the PRI line has been lost.

- **DNLD** — Download

Flash — The card is downloading software from the NBX Network Call Processor.

Green — The download has been completed.

Amber — The download was interrupted before it completed.

On a LAN, the download process completes quickly. If the download from NCP to digital line card must travel a routed network path, the download may take a few minutes. If the DNLD light remains amber, it can indicate a severely congested network or a hardware problem with the card.

- **CALL** — Call audio traffic

Off — No audio traffic on the link.

Flashing — Audio traffic is present.

- **CARD** — Card Software Status.

Green — The card has finished downloading software from the NCP and all software processes have started successfully.

Amber — A problem with one or more of the software processes running on the card. The card automatically reboots itself if it detects a problem with any of its software processes.

- **DSP** — Reserved for future use.

- **NCP** — Network Call Processor communications status.

Amber — The card is trying to establish contact with an NCP.

Green — The card has established contact with an NCP.

- **LNK** — Ethernet link status.

Green — The 10/100 Uplink port is connected to a 10Mb or to a 10/100 Mb hub or switch.

Red — The 10/100 Uplink port is connected to a 100 Mb hub or switch.

Off — There is no connection to the 10/100 Uplink port.

- **ACT**— Ethernet activity.

Rapid blink — Data is passing into or out of the card through the 10/100 Uplink port.

## Modifying an E1 Card

These sections tell you how to modify a E1 card that is already installed in the system:

- [Modifying the E1 Card Name](#)
- [Modifying an E1 Span](#)
- [Configuring Partial E1 Lines](#)
- [Modifying E1 Span Audio Controls](#)

### Modifying the E1 Card Name

You can change the name of an E1 Digital Line Card at any time. The name you pick helps you identify the E1 card in device lists.

To modify an E1 card name:

- 1 Select *NBX NetSet > Device Configuration > Digital Line Cards*.
- 2 Select the board in the *T1/ISDN Board List*, and click *Modify*.
- 3 In the *Board Name* field, you can enter a name for the board, if you want, or you can accept *Trunk*, the default name that the NBX system assigns. The name that you enter helps you to identify the board in device lists.

### Modifying an E1 Span

To modify an E1 span:

- 1 On the *Digital Line Cards* tab, select *ISDN PRI Span List* from the *Select Device Type* drop-down list.
- 2 Click *Apply*.

- 3 Select the span you want to modify from the *Span List*. The number of channels supported per span depends on the configuration of the Digital Line Card. E1 cards support 30 channels per span.
  - 4 Click *Modify*.
  - 5 Make the desired changes. Click the Help button for more information about dialog box fields.
  - 6 Click *Apply*.
  - 7 Enable the *On Line* check box to bring the span online.
-  *Before the span can come online, the board must be online.*
- 8 Click *Apply* or *OK* for the changes to take effect.

### Configuring Partial E1 Lines

Some telephone companies offer an E1 line that has less than the maximum number of channels implemented. This is called a *Fractional, Partial, or Subequipped E1*. Example: To reduce near-term costs, you may decide to purchase 15 channels now and implement more later.

Some telephone companies offer Partial E1 lines as their standard offering and provide fully implemented E1 lines only if you make a specific request. If you are unaware of this, outbound calls using the E1 line may fail because the system places outbound calls using high numbered channels first, and a Fractional E1 typically has the lower numbered channels implemented.

In the *Span Status* dialog box, under *Details of last five calls*, if you see the error message *REQ\_CHANNEL\_UNAVAIL*, determine if the error is caused by a Partial E1 by following these steps:

- 1 Remove the highest numbered channel from service (set it to offline in the Modify Channel dialog box) and retry the outbound call.
- 2 Continue to remove channels until an outbound call succeeds.
- 3 When the first outbound call succeeds, the highest numbered channel still in service represents the number of active (provisioned) channels in the Partial E1.
- 4 Create two groups. Put all of the active channels in one group, and all of the inactive channels in the other. Mark the active group "online" and the inactive group "offline."

## Modifying E1 Span Audio Controls

Audio Controls settings affect individual spans. You can edit these properties:

- Silence Suppression (3C10165D only) — Enables you to override the system-wide setting. For a detailed description of how silence suppression affects audio quality and bandwidth, see [“Audio Settings”](#) on [page 240](#).
- Audio Compression (3C10165D only) — Enables you to override the system-wide setting. For a detailed description of how audio compression affects audio quality and bandwidth, see [“Audio Settings”](#) on [page 240](#).
- Audio Source Gain — Enables you to adjust the audio gain to resolve volume issues.



**CAUTION:** Do not change your Audio Source Gain settings unless you are instructed to do so by a support representative.

To modify E1 span audio controls:

- 1 On the *Digital Line Cards* tab, select *ISDN PRI Span List* from the *Select Device Type* drop-down list.
- 2 Click *Apply*.
- 3 Select the span you want to modify from the *Span List*. The number of channels supported per span depends on the configuration of the Digital Line Card. E1 cards support 30 channels per span.
- 4 Click *Audio Controls*. Click the Help button for more information about dialog box fields.

## Adding or Modifying an E1 Group

A digital line card group is one or more E1 channels that are assigned the same characteristics, such as Channel Protocol. This section describes how to perform these actions:

- [Adding an E1 Group](#)
- [Modifying an E1 Group](#)
- [Changing E1 Group Membership](#)
- [Removing an E1 Group](#)



**CAUTION:** Modifying an E1 group disconnects any calls in process on any channels associated with the group.

## Adding an E1 Group

You add a new group when you need to assign common characteristics to several E1 channels.

To add a digital line card group:

- 1 On the *Digital Line Cards* tab, select *ISDN PRI Group List* from the *Select Device Type* drop-down list and click *Apply*.
- 2 In the dialog box that appears, click *Add*.

To modify ISDN PRI group parameters:

- 1 Type a name for the new group in the *Group Name* field.
- 2 To enable the transfer of incoming calls to another line card port, select *Unrestricted* from the *Trunk to Trunk* list. To disable this feature, select *Restricted*.
- 3 Use the *AutoExt* fields to select the extension to which calls are routed when they are not answered. You can select different extensions for different times of the day. The default settings route all calls to the Auto Attendant (extension 500). Click *Apply* to add the group.
- 4 Repeat these steps to add additional groups, if desired, and then click *OK*.

## Modifying an E1 Group

You may want to modify a digital line card group to change its name, Auto Extension assignments, or other parameters. When you modify a group, the changes affect all the Digital Line Cards assigned to that group. To modify a digital line card group:

- 1 On the *Digital Line Cards* tab, select *ISDN PRI Group List* from the *Select Device Type* drop-down list and click *Apply*.
  - 2 Select the group that you want to modify.
  - 3 Click *Modify*.
  - 4 Make the changes that you want to the group parameters. Click the Help button for more information about dialog box fields.
  - 5 Enable the *On Line* check box to bring the group on line.
-  *The group does not come online unless the card and the span are online.*
- 6 Click *Apply* to effect the changes.
  - 7 Click *OK*.

## Changing E1 Group Membership

You may want to change the channel membership in an E1 group to accommodate changing needs.

To change group membership:

- 1 On the *Digital Line Cards* tab, select *ISDN PRI Group List* from the *Select Device Type* drop-down list and click *Apply*.
- 2 Select the group for which you want to change membership.
- 3 Click *Membership*.
- 4 To add a channel to the Member List, select the channel in the *Non Member List* and click <<. If you select the *Copy Group Settings to Channels* check box, the system copies the settings of the selected group to each channel that you add or remove. If you do not select this check box, the channel settings are not changed.
- 5 Optionally, enable the *Refresh Channels on Add/Remove* check box. This refreshes each channel as you add or remove it.
- 6 To remove a channel from the *Member List*, select the channel in the *Member List* and click >>.

Each channel must belong to a group. A channel can belong to only one group at a time. You cannot move a channel from the members list to the non-members list of a group unless the system can assign the channel to another group. If a channel has never been a member of another group, the system cannot determine a group to which it can move the channel, so it cannot remove the channel from the member list. If a channel has been a member of another group in the past, the system moves the channel to the group of which the channel was most recently a member.

**Example:** By default, the system creates two groups, Group 1 and Group 2, and places all channels in Group 1. If you try to move a channel to the non-member list of Group 1, the operation fails. If you select Group 2, click *Membership*, move a channel from the non-member list to the member list, and then move the same channel back to the non-member list, the operation succeeds because the channel was previously a member of Group 1. If you then view the Group 1 membership list, it contains the channel you just removed from Group 2.

- 7 Click *Close*.

## Removing an E1 Group

You may want to remove groups if you no longer need them.

To remove a group:

- 1 On the *Digital Line Cards* tab, select *ISDN PRI Group List* from the *Select Device Type* drop-down list and click *Apply*.
- 2 Select the group you want to remove.
- 3 Click *Remove*. A prompt appears asking if you want to remove the group.
- 4 Click *Yes* to remove the group.

## Modifying E1 Card Channels

A channel can take a single call. This section describes how to modify channels for an installed E1 card and how to view the status of an existing channel.



**CAUTION:** *Do not modify channels unless a 3Com Technical Support representative advises you to do so. Modifying an ISDN channel disconnects any existing calls on that channel.*



*If you use Auto Discovery to add channels on an E1 PRI line, note that the 30 channels discovered are numbered 1 through 15, and 17 through 31. This reflects the physical channel mapping on the E1 interface, where channel 16 is the ISDN D-channel, used for signaling.*

To modify a channel on an installed E1 card:

- 1 On the *Digital Line Cards* tab select *ISDN PRI Channel List* from the *Select Device Type* drop-down list and click *Apply*.
- 2 Select the channel that you want to modify.
- 3 Click *Modify*.
- 4 Fill in or change the fields in the appropriate *Modify Channel* dialog box. Click the *Help* button for more information about dialog box fields,
- 5 To bring the card online, enable the *On Line* check box. Click *Apply* and then click *OK*.

### Viewing the Status of an E1 Card Channel

To view the status of a channel on an installed E1 card:

- 1 On the *Digital Line Cards* tab, select *ISDN PRI Channel List* from the *Select Device Type* drop-down list and click *Apply*.
- 2 Select the channel for which you want status information.
- 3 Click *Status*.
- 4 View the status of the channel and then refresh the Channel Status dialog box.
  - a From the Dialog Refresh drop-down list, select:
    - **Manual** — To manually refresh the *Channel Status* dialog box each time that you click the *Apply* button.
    - A time interval (**5, 10, 15, 30, or 60** seconds) — To refresh the *Channel Status* dialog box at the specified intervals.
  - b Enable the *Device Refresh* check box.
- 5 Click *Apply* and then click *OK*.

### Viewing DSP (Digital Signal Processor) Details

To view DSP (Digital Signal Processor) details:

- 1 Return to the *Digital Line Cards* tab.
- 2 From the *Select Device Type* list, select *T1/ISDN Board List* and click *Apply*.
- 3 Select the board you want and click *Status*.
- 4 In the Board Status dialog box, select a DSP from the *DSP List* and click *Details*.
- 5 Click *Close* to close the *DSP Status* window.

### Modifying IP Settings for an E1 Card

You can modify the IP settings for an E1 card to meet changing requirements.

#### 3C10165D E1 Card Configuration Notes

- 3C10165D E1 Digital Line Cards do not support the NBX IP On-the Fly feature. If your system uses IP On-the-Fly, then you must assign a static IP address to the card or use DHCP to assign an IP address to the card, even if the card will be installed on the same subnet as the NCP.
- 3C10165D E1 Digital Line Cards do not support DHCP option 184. Before you install a 3C10165D card at a site that is remote from the

system's NCP, you must first discover the card by connecting it to the same subnet as the NCP. That procedure is described in ["Setting Up a Digital Line Card at a Remote Location"](#) on [page 217](#).

- 3C10165D E1 Digital Line Cards do not support DHCP lease times of less than 20 minutes.

To modify the IP settings of a Digital Line Card:

- 1 Select *NBX NetSet > Device Configuration > Digital Line Cards*.
- 2 From the *Select Device Type* drop-down list, select *T1/ISDN Board List*.
- 3 Click *Apply*.
- 4 Select the board (ISDN PRI) for which you want to change the IP settings.
- 5 Click *IP Settings*.
- 6 To assign IP addresses automatically, enter the first address in the *First IP Address* field. The system sequentially adds the remaining addresses. 3C10165D E1 Digital Line Cards work need only one IP address.

To assign IP addresses one at a time:

- 1 In the *Digital Line Card IP Settings* dialog box, click *Assign Addresses Individually*.

3C10165D E1 Digital Line Cards work need only one IP address, so the *Assign Addresses Individually* button is not present for these cards.

- 2 Enter the desired IP addresses for the channels.
- 3 Enter the mask number for your site in the *Common Subnet Mask* field.
- 4 Enter IP address for the *Common Default Gateway*.
- 5 Click *Apply*.
- 6 Click *OK*.
- 7 In the *Digital Line Card IP Settings* dialog box, click *Apply*.
- 8 Click *OK*.

## Removing an E1 Digital Line Card



You can remove a Digital Line Card at any time.

**CAUTION:** *Removing a Digital Line Card may affect your Dial Plan.*

To remove a Digital Line Card:

- 1 Select *NBX NetSet > Device Configuration > Digital Line Cards*.
- 2 From the *Select Device Type* drop-down list, select *T1/ISDN Board List* and click *Apply*. A list of installed T1, ISDN PRI, and ISDN BRI boards appears in the *T1/ISDN Board List*.
- 3 Select the board (Digital Line Card) you want to remove from the list.
- 4 Click *Remove*. A dialog box prompts you to confirm the removal.
- 5 Click *Yes*.

---

## Configuring and Managing T1 Digital Line Cards

These sections describe how to add and configure a T1 Digital Line Card to connect to a T1 service provided by the local telephone company:

- [Adding a T1 Digital Line Card](#)
- [Configuring a T1 Digital Line Card for the DS1 Protocol](#)
- [Configuring a T1 Digital Line Card for ISDN PRI Signaling](#)
- [T1 Card Status Lights](#)
- [Modifying a T1 Card](#)
- [Modifying a T1 Group](#)
- [Modifying T1 Card Channels](#)
- [Modifying IP Settings for a T1 Card](#)
- [Removing a T1 Digital Line Card](#)

The NBX NetSet utility refers to Digital Line Cards as cards or boards.

3C10116D T1 Digital Line Cards have expanded capabilities that are described in these topics:

- [Setting Up a Digital Line Card at a Remote Location](#)
- [Setting Up T1/E1 Logging](#)
- [Viewing CSU State Information and Statistics](#)
- [Using Loopback Tests](#)

You can configure the T1 Digital Line Card to use one of two types of signaling:

- DS1 protocol (sometimes referred to as “Standard T1”)
- ISDN PRI (Primary Rate Interface) signaling



*By default, the Auto Discovery process selects DS1 as the signaling type for a T1 Digital Line Card.*

The system provides E911 (emergency) connectivity if the T1 Digital Line Card is configured for ISDN PRI (Primary Rate Interface) signaling. The system provides the calling number (ANI) so that the emergency services personnel can determine the location of the caller from the E911 database. You must update the CO (PSAP) databases.

### **Adding a T1 Digital Line Card**

Adding a T1 Digital Line Card to a system requires these procedures:

- [Preparing the NBX System for T1 Cards](#)
- [Ordering DID \(Direct Inward Dialing\) Services for T1](#)
- [Enabling Auto Discovery for Digital Line Cards](#)
- [Inserting the T1 Digital Line Card](#)

#### **Preparing the NBX System for T1 Cards**

Before you insert the T1 Digital Line Card into the chassis, order a T1 line from your telephone carrier and have them install the line. In some cases, the telephone company offers T1 services only with specific, pre-defined parameters. However, some telephone companies offer a number of configuration choices with their T1 services.

#### **Ordering DID (Direct Inward Dialing) Services for T1**

When you order a T1 line with DID capability (Direct Inward Dial), the local telephone carrier assigns a block of telephone numbers to you. Usually, you can request a specific range of numbers, but sometimes the carrier assigns numbers other than the ones you request.

You may be able to request that the local telephone carrier pass you a specific number of digits for each incoming telephone call. Sometimes the carrier does not offer any choice. In either situation, you need to know how many digits the carrier passes.

**Example:** Carriers commonly pass either the last three digits or last four digits of the number for each incoming call.

Sometimes the last digits of the telephone numbers that the carrier assigns to you do not match the telephone extension numbers that you want to use for internal calls. You can create entries in your Dial Plan configuration file to translate the incoming numbers into the corresponding extension numbers.

**Example:** You want to use internal extensions from 4000 through 4999, but the local telephone carrier assigns you numbers from 617-555-3500 through 617-555-4499. You can create translator entries in the Dial Plan configuration file to translate an incoming digit sequence such as 3795 into extension number 4295, and a sequence such as 4213 into 4713. The configuration requires several translator entries to handle subsets of the total range. A unique set of entries handles incoming digit sequences from 3500 through 3599, from 3600 through 3699, and each of the other sequences in which the first two digits are unique in the range from 37XX through 44XX.

If the DDI/DID numbers match your internal extension numbers, the translator entries in your Dial Plan configuration file can be much simpler.

**Example:** You plan to use internal extensions from 100 through 299, and the local telephone company assigns you numbers from 617-555-4100 through 617-555-4299. If the local telephone carrier passes you three digits, you need no translator entries in the Dial Plan configuration file. If the carrier passes you four digits, you could add a single set of translator entries to the configuration file to remove the first digit (4) and use the remaining three digits as the internal extension.

### Enabling Auto Discovery for Digital Line Cards

To enable Auto Discovery for Digital Line Cards:

- 1 Select *NBX NetSet > System Configuration > System Settings > System-wide*.
- 2 Click the *Auto Discover Digital Line Cards* check box (may already be selected).



*Other check boxes may be selected based on previous Auto Discoveries. You do not need to clear these check boxes to install the T1 Digital Line Card. However, it is good practice to clear all check boxes other than the*

one that you want to select so that the Call Processor does not continue to search for added devices.

- 3 Click OK.

### Inserting the T1 Digital Line Card

To insert the T1 card:

- 1 Find the MAC address of the T1 card on the label on the card.
- 2 Record the MAC address for the configuration process.
- 3 Select a slot for the T1 card in the chassis and use a Phillips screwdriver to remove the blank faceplate from the slot.
- 4 Insert the T1 card into the slot.
- 5 Slide the T1 card into the chassis until you feel it touch the connectors.
- 6 To seat the T1 card into the connectors, apply firm pressure to both the left and right sides of the front of the card.
- 7 Tighten the left and right screws on the front of the T1 card to secure it to the chassis.



**CAUTION:** Wait 3 minutes for the T1 card to initialize and for the system to update its database. The T1 card reboots twice during the initialization process. If you attach a console cable to the COM1 port on the T1 card and use Hyperterm software to view the text output from the card, you see status messages associated with the two reboot processes. See [“Connecting a Computer to a Serial Port”](#) on [page 339](#).



Another way that you can be sure that it is safe to proceed is to examine the status lights on the front panel of the T1 card. After the Auto Discovery process has completed, and before you connect the T1 Digital Line Card to the telephone company's T1 line, the CF (Carrier Fail) light should appear solid green on a 3C10116C card. On a 3C10116D card, the POST, DNLD, CARD and NCP lights should appear solid green. For more information on T1 card status lights, see [“T1 Card Status Lights”](#) on [page 206](#).

You are now ready to configure the T1 Digital Line Card for either DS1 signaling or ISDN PRI signaling. Before you configure a T1 card, be sure you have configured the system Dial Plan for you needs as described in [Chapter 2](#).

## Configuring a T1 Digital Line Card for the DS1 Protocol

These sections tell you how to use the NBX NetSet utility to set up your T1 Digital Line Card for DS1 protocol:

- [T1 DS1 Configuration](#)
- [Configuring T1 Groups \(DS1\)](#)
- [Verifying T1 Group Membership \(DS1\)](#)
- [Completing the T1 Configuration \(DS1\)](#)

Before you configure a T1 Digital Line Card for DS1 protocol, read the cautionary note.



**CAUTION:** Wait 3 minutes for the T1 card to initialize and for the system to update its database. The T1 card reboots twice during the initialization process. If you attach a console cable to the COM1 port on the T1 card and use Hyperterm software to view the text output from the card, you see status messages associated with the two reboot processes. See [“Connecting a Computer to a Serial Port”](#) on [page 339](#).



Another way that you can be sure that it is safe to proceed is to examine the status lights on the front panel of the T1 card. After the Auto Discovery process has completed, and before you connect the T1 Digital Line Card to the telephone company's T1 line, the CF (Carrier Fail) light should appear solid green on a 3C10116C card. On a 3C10116D card, the POST, DNLD, CARD and NCP lights should appear solid green. For more information on T1 card status lights, see [“T1 Card Status Lights”](#) on [page 206](#).

### T1 DS1 Configuration

To set up the T1 card for the DS1 protocol:

- 1 On the *Digital Line Cards* tab, select *T1/ISDN Board List* from the *Select Device Type* list, and click *Apply*. All Digital Line Cards (T1, E1, or BRI-ST) that the system has discovered appear in the list. By default, the NBX system autodiscovers a T1 Digital Line Card as a T1 DS1 card and displays it in the list as T1 (not PRI).
- 2 From the list, select the new T1 Digital Line Card. Use the MAC address of the T1 Digital Line Card to identify the card in the list. You recorded the MAC address before inserting the card.
- 3 Click *Modify*.

- 4 Scroll through the *Channel List* to verify that the system lists all 24 channels. The channel numbers appear after the MAC address, separated by a hyphen.

**Example:**

00:e0:bb:00:bd:f0-4...New Trunk

The 4 after the hyphen indicates channel number 4.

- 5 To change the name of the T1 Digital Line Card, enter a new name in the *Board Name* field. The name you choose helps identify this card in lists that contain similar cards. You can use alphanumeric characters, hyphens, and underscores. The maximum name length is 30 characters, but some dialog boxes truncate the name field to 15 characters.
- 6 Click *Apply* to verify your changes.
- 7 Click OK to exit.

**Connecting the T1 Line and Activating the Span**

To connect the T1 line and activate the span:

- 1 Plug the T1 line into the T1 Digital Line Card.
- 2 On the *Digital Line Cards* tab, select *T1/ISDN Board List* from the *Select Device Type* list and click *Apply*.
- 3 From the list, select the new T1 Digital Line Card. Use the MAC address of the T1 Digital Line Card to identify the card in the list.
- 4 Click *Modify*. The *Modify Board* dialog box appears.
- 5 Click the *On Line* check box.
- 6 Click *Apply*.
- 7 Click *OK*.
- 8 In the *T1/ISDN Board List*, verify that the entry for this card in the *Status* column changes from *Offline* to *Online*. You may need to wait a minute or two, and then refresh your browser window to see this change.

**Verifying the T1 Span Status**

To verify the T1 span status:

- 1 On the *Digital Line Cards* tab, select *T1 Span List* from the *Select Device Type* list and click *Apply*.
- 2 Select the span and click *Modify*.

- 3 Enable the *On Line* check box.
- 4 Click *OK*.
- 5 Verify that the word *Ready* appears next to the T1 span list line item that corresponds to this span.

### Configuring T1 Groups (DS1)

To configure a T1 DS1 Group:

- 1 On the *Digital Line Cards* tab, select *T1 Group List* from the *Select Device Type* list and click *Apply*.
- 2 From the *T1 Group List*, select *Group 1*.
- 3 Click *Modify*. The *Modify Group* dialog box appears.



*The fields in the Modify Group dialog box contain default values. No default values are assumed for Called Party Digits or Calling Party Digits.*

- 4 Modify the Wink Wait value:
  - a Select Wink Wait from the Timer Values list.
  - b Type 3000 in the New Value text box.
  - c Click *Apply*.
  - d Ask your telephone service provider to set their Wink Wait value to 3000 msec.
- 5 Modify the Guard value:
  - a Select Guard from the Timer Values list.
  - b Type 2200 in the New Value text box.
  - c Click *Apply*.
  - d Ask your telephone service provider to set their Guard value to 2200 msec.
- 6 Click the *On Line* check box.
- 7 Enter 500 in each of the four *AutoExt* text boxes.
- 8 Click *OK*.

### Verifying T1 Group Membership (DS1)

To verify that all channels are in the *Member List* of a T1 Digital Line Card:

- 1 On the *Digital Line Cards* tab, select *T1 Group List* from the *Select Device Type* list and click *Apply*.
- 2 From the list, select the group that you want.
- 3 Click *Membership*. The *Manage Group Membership* dialog box appears.
- 4 Scroll through the *Member List* to verify that all 23 channels are present for each T1 Digital Line Card in the system.

### Completing the T1 Configuration (DS1)

To complete the T1 installation:

- 1 On the *Digital Line Cards* tab, select *T1 Channel List* from the *Select Device Type* list and click *Apply*.
- 2 Wait approximately 30 seconds for the status of each channel to change from *Ready* to *Idle*.



*Click Apply to refresh the list of channels and to see the updated status. If you have connected the Telephone company's T1 line to the T1 Digital Line Card, the Nominal (3C10116C) or the CO (3C10116D) status light on the front panel of the T1 board should now turn on (solid green). If the status light does not turn on and you have the telephone company's T1 line connected, disconnect the T1 line and connect a loopback connector. If the light now turns on, contact the telephone company for assistance with the T1 line. If the light does not turn on, contact 3Com Technical Support.*

### Enabling and Disabling Echo Cancellation

There are two situations in which it may be desirable to disable echo cancellation on a T1 Digital Line Card.

- An NBX system is connected to a telephone carrier (Central Office) by a T1 Digital Line Card, and the telephone carrier guarantees to provide echo cancellation on all channels, all of the time.
- Two NBX systems are connected together directly using T1 Digital Line Cards and the network between the two is completely composed of digital circuitry, thus eliminating sources of echo.

You can enable or disable echo cancellation for each T1 Digital Line Card.

You cannot enable or disable echo cancellation on individual channels.

Before you enable echo cancellation for a T1 Digital Line Card you must verify that the card is configured for DS1 operation and not ISDN PRI.

To enable or disable echo cancellation:

- 1 On the *Digital Line Cards* tab, select *T1 Span List* from the *Select Device Type* drop-down list and click *Apply*.
- 2 Select the span for which you want to set echo cancellation.
- 3 Click the *Audio Controls* button.
- 4 Enable the *Echo Canceller Enabled* check box to turn on echo cancellation. Remove the check from the *Echo Canceller Enabled* check box to turn off echo cancellation.
- 5 Click *OK*.

### Configuring a T1 Digital Line Card for ISDN PRI Signaling

These sections tell you how to use the NBX NetSet utility to set up your T1 Digital Line Card for ISDN PRI signaling:

- [T1 ISDN PRI Configuration](#)
- [Configuring T1 Groups \(ISDN PRI\)](#)
- [Verifying T1 Group Membership \(ISDN PRI\)](#)
- [Completing the T1 Configuration \(ISDN PRI\)](#)

Before you configure a T1 Digital Line Card for ISDN PRI (Primary Rate Interface) signaling, read the cautionary note.



**CAUTION:** Wait at least 3 minutes for the T1 card to initialize and for the system to update its database. The T1 card reboots twice during the initialization process. If you attach a console cable to the COM1 port on the T1 card and use Hyperterm software to view the text output from the card, you see status messages associated with the two reboot processes. See [“Connecting a Computer to a Serial Port”](#) on [page 339](#).



Another way that you can be sure that it is safe to proceed is to examine the status lights on the front panel of the T1 card. After the Auto Discovery process has completed, and before you connect the T1 Digital Line Card to the telephone company's T1 line, the CF (Carrier Fail) light should appear solid green on a 3C10116C card. On a 3C10116D card, the POST, DNLD, CARD and NCP lights should appear solid green. For more information on T1 card status lights, see [“T1 Card Status Lights”](#) on [page 206](#).

## T1 ISDN PRI Configuration



When you configure a T1 Digital Line Card for ISDN PRI operation, verify that the *Auto Discover Digital Line Cards* check box is enabled (*System Configuration > System Settings > System-wide*).

To configure the T1 card for ISDN PRI signaling:

- 1 On the *Digital Line Cards* tab select *T1/ISDN Board List* from the *Select Device Type* drop-down list and click *Apply*.
- 2 From the list, select the new T1 Digital Line Card. Use the MAC address of the T1 Digital Line Card to identify the card in the list. You recorded the MAC address before inserting the card.
- 3 Click *Modify*. The *Modify Board* dialog box appears.
- 4 To change the name of the T1 Digital Line Card, enter a new name in the *Board Name* field. You can use alphanumeric characters, hyphens, and underscores. The maximum name length is 30 characters.
- 5 From the *Card Type* drop-down list, select *ISDN PRI*.
- 6 Click *OK*. The *Digital Line Cards* tab reappears.
- 7 Wait until the entry for this Digital Line Card in the *Type* column changes to *PRI*. To see the change, you may need to wait a minute or two, and refresh your browser window.
- 8 After the board type changes, from the *Select Device Type* drop-down list, select *ISDN PRI Channel List*.
- 9 Click *Apply*. The dialog box is updated to show the ISDN PRI Channel List.
- 10 Verify that the highest channel in the *Chan* column is 23.

When you configure a T1 Digital Line Card for ISDN PRI signaling, one of the 24 channels is allocated for signaling, leaving 23 for data (voice).

## Connecting the T1 Line and Activating the Span

To connect the T1 line and activate the span:

- 1 Plug the T1 line into the T1 Digital Line Card.
- 2 On the *Digital Line Cards* tab, select *T1/ISDN Board List* from the *Select Device Type* list and click *Apply*.
- 3 From the list, select the new T1 Digital Line Card.



To identify the card, look for those cards that have *PRI* in the *Type* column and use the MAC address to identify the specific card. You recorded the MAC address before inserting the card.

- 4 Click *Modify*. The *Modify Board* dialog box appears.
- 5 Click the *On Line* check box.
- 6 Click *OK*.
- 7 In the *T1/ISDN Board List*, verify that the entry for this card in the *Status* column changes from *Offline* to *Online*. You may need to wait a minute or two, and then refresh your browser window to see this change.

### Verifying the Change in Span Status

To verify that the Span status changes from *Offline* to *Ready*:

- 1 On the *Digital Line Cards* tab, select *ISDN PRI Span List* from the *Select Device Type* list and click *Apply*.
- 2 Select the span from the list and click *Modify*.
- 3 Enable the *On Line* check box and click *OK*.
- 4 Verify that the word *Ready* appears in the *ISDN PRI Span List* line item that corresponds to this span.

### Configuring T1 Groups (ISDN PRI)

To configure a T1 ISDN PRI Group:

- 1 On the *Digital Line Cards* tab, select *ISDN PRI Group List* from the *Select Device Type* list and click *Apply*.
- 2 From the *ISDN PRI Group List*, select *PRI Group 1*.
- 3 Click *Modify*. The *Modify Group — T1 ISDN PRI* dialog box appears.
- 4 To modify the name of the group, enter a new name in the *Group Name* field. You can use alphanumeric characters, hyphens, and underscores. The maximum name length is 30 characters.
- 5 To prohibit call transfers between trunk lines, select *Restricted* (the default value) from the *Trunk to Trunk* drop-down list. Otherwise, select *Unrestricted*.
- 6 Click the *On Line* check box.
- 7 Verify that *500* (the default) is in each of the four *AutoExt* text boxes.
- 8 Click *OK*.

### Verifying T1 Group Membership (ISDN PRI)

To verify that all channels are in the Member List:

- 1 On the *Digital Line Cards* tab, select *ISDN PRI Group List* from the *Select Device Type* list and click *Apply*.
- 2 Select the group you want.
- 3 Click *Membership*. The Manage Group Membership dialog box appears.
- 4 Scroll through the *Member List* to verify that all 23 channels are present.
- 5 To change the membership of a group, you must move channels from the *Non-Member List* to the *Member List*. You cannot move a channel from the *Member List* to the *Non-Member* list of a group.

For each channel that you move to the Member List, you have two options:

- a To copy the current group settings, and apply them to the channel in the new group, enable the *Copy Group Settings to Channels on Add/Remove* check box.
- b To update the status of a channel, enable the *Refresh Channels on Add/Remove* check box.

### Completing the T1 Configuration (ISDN PRI)

To complete the T1 ISDN PRI installation:

- 1 On the *Digital Line Cards* tab, select *ISDN PRI Channel List* from the *Select Device Type* list and click *Apply*.
- 2 Wait approximately 30 seconds for the status of each channel to change from Ready to Idle.



Click *Apply* to refresh the list of channels and to see the updated status. If you have connected the Telephone company's T1 line to the T1 Digital Line Card, the Nominal (3C10116C) or the CO (3C10116D) status light on the front panel of the T1 card should now turn on (solid green). If the light does not turn on and you have a T1 line connected, disconnect the T1 line and connect a loopback connector. If the light now turns on, contact the telephone company for assistance with the T1 line. If the light does not turn on, contact 3Com Technical Support.

## T1 Card Status Lights

The 3C10116C T1 card contains these status lights:

- **CF** — Carrier Fail (when lit, indicates red alarm or blue alarm)
- **RA** — Remote Alarm (yellow alarm)
- **LB** — Loopback (when lit, indicates that the card is in loop-back testing mode; does not indicate any of the red, blue, or yellow alarms)
- **Nominal** — T1 card is framed

The 3C10116D T1 card contains these status lights:

- **CO** — Central Office:
  - Amber — Alarm condition at the remote end or the CO is not connected or available.
  - Green — No alarm condition; the card is connected to the Central office.
- **POST** — Power On Self Test
  - Off — POST test is running. The test runs approximately 5-seconds after you apply power to the board. After 5-seconds, Off indicates the POST test failed.
  - Green — POST test completed successfully.
- **DCH** — D channel status of an ISDN PRI connection
  - Off — No T1 or T1 PRI line is attached or that the card does not need a D channel, such as when the card is running T1-robbed-bit (CAS).
  - Green — Card is configured for ISDN PRI operation and an active PRI connection has been established.
  - Amber — The D channel has not yet been established. It can take several seconds after the card has completed its power up tests for the card to establish a connection with the PRI trunk. If the DCH light goes to amber after the connection has been established, it can mean that an active control channel connection through the PRI line has been lost.
- **DNLD** — Download
  - Flash — The card is downloading software from the NBX Network Call Processor.
  - Green — The download is complete.
  - Amber — The download was interrupted before it completed.

On a LAN, the download process completes quickly. If the download from NCP to digital line card must travel a routed network path, the download may take a few minutes. If the DNLD light remains amber, it can indicate a severely congested network or a hardware problem with the T1 card.

- **CALL** — Call audio traffic
  - Off — No audio traffic on the T1 link.
  - Flashing — Audio traffic is present.
- **CARD** — Card Software Status
  - Green — The card has finished downloading software from the NCP and all software processes have started successfully.
  - Amber — A problem with one or more of the software processes running on the card. The card automatically reboots itself if it detects a problem with any of its software processes.
- **DSP** — Reserved for future use
- **NCP** — Network Call Processor
  - Amber — The card is trying to establish contact with an NCP.
  - Green — The card has established contact with an NCP.
- **LNK** — Ethernet link
  - Green — The 10/100 Uplink port is connected to a 10Mb or to a 10/100 Mb hub or switch.
  - Red — The 10/100 Uplink port is connected to a 100 Mb hub or switch.
  - Off — There is no connection to the 10/100 Uplink port.
- **ACT** — Ethernet activity
  - Rapid blink — Data is passing into or out of the T1 card through the 10/100 Uplink port.

## Modifying a T1 Card

These sections describes how to modify a T1 card that is already installed in the system.

- [Modifying the T1 Card Name or Type](#)
- [Modifying a T1 Span](#)
- [Configuring Partial T1 Lines](#)
- [Modifying T1 Audio Controls](#)

### Modifying the T1 Card Name or Type

You can change the name of a Digital Line Card at any time. You can also set the type to T1 or ISDN PRI.

To modify a T1 card name or type:

- 1 On the *Digital Line Cards* tab, select the board in the *T1/ISDN Board List*.
- 2 Click *Modify*.
- 3 To modify the name of the board, enter a new name in the Board Name field. You can use alphanumeric characters, hyphens, and underscores. The maximum name length is 30 characters.
- 4 To change the type of card, in the *Card Type* field, select either *T1* (for T1 DS1 protocol) or *ISDN PRI* (for T1 ISDN PRI).
- 5 Click *OK*.

### Modifying a T1 Span

To modify a span:

- 1 On the *Digital Line Cards* tab, select either *T1 Span List* (for T1 DS1) or *ISDN PRI Span List* (for T1 ISDN PRI) from the *Select Device Type* drop-down list and click *Apply*.
- 2 Select the span you want to modify from the *Span List*.
- 3 Click *Modify*.

The dialog box that appears depends on which span list you select, either the T1 DS1 Modify Span dialog box or the ISDN PRI Modify Span dialog box.

- 4 Make the desired changes. Click the Help button in the dialog box for detailed information about span parameters.

The number of channels supported per span depends on the configuration of the Digital Line Card. If you configure the T1 Digital Line Card for DS1, it supports 24 channels. If you configure the card for ISDN PRI, it supports 23 channels.

- 5 Click *Apply*.
- 6 Enable the *On Line* check box to bring the span online.



*The span does not come online unless the card is online.*

- 7 Click *OK* to effect the changes.

## Support of AT&T's 4ESS Switch Protocol

4ESS is the AT&T proprietary version of ISDN. You can select the 4ESS protocol when you configure a T1 Digital Line Card for PRI (Primary Rate Interface) operation. If you select the 4ESS protocol, you can optionally use Call By Call Service Configuration which enables you to select one of three access services:

- Long Distance — The default service if the customer selects the 4ESS protocol, but purchases no other services. Long Distance can be used with SDN but not with MEGACOM.
- MEGACOM — A high-volume outward calling service. MEGACOM can be the default setting.
- SDN (Software Defined Network) — A premises-to-premises service with voice and voice-grade data transport, plus a number of customer-controllable call management and call monitoring features (for example, Virtual Private Networking). You cannot configure SDN as the default setting but you can configure the NBX system dial plan to use SDN.

### Selecting the 4ESS Protocol

To select the 4ESS protocol:

- 1 On the *Digital Line Cards* tab, select *ISDN PRI Span List* from the *Select Device Type* drop-down list and click *Apply*.
- 2 From the *CO Switch Protocol* drop-down list, select *AT&T Custom - 4ESS*.
- 3 Click *OK* to enable the 4ESS protocol and exit from the dialog box. Otherwise click *Apply* to enable 4ESS, stay in the *Modify Span* dialog box, and configure Call-By-Call Service. See [“Configuring Call-By-Call Service”](#) in the next section.

### Configuring Call-By-Call Service

You order the optional Call-By-Call Service from your long-distance carrier only if you order the 4ESS protocol. 3Com does not support Call-By-Call Service with any other protocol.

To configure Call-By-Call Service:

- 1 In the *Modify Span* dialog box, click the *Enable Call-By-Call Service* check box.
- 2 In the *Carrier Identification Code* text box, type the identification code for your long-distance carrier.



Your long-distance carrier can supply this code when you order PRI services, or you can ask the carrier for their code number. Another way to obtain the code is to access the web site for the North American Number Plan Administration (<http://www.nanpa.com>). In the menu in the left frame, expand *Number Assignments*, and click *Carrier Identification Codes*. Follow the instructions to download and unzip the two files (*Current Feature Group B (950-XXXX) CIC Assignments* and *Current Feature Group D (101-XXXX) CIC Assignments*). Search the documents to determine the identification code for your long-distance carrier. For example, AT&T is listed next to code 288 in the *Group D* document.

- 3 From the *Default Outbound Service* drop-down list, select either *MEGACOM* or *Standard (LDS)* as the service to use as the default. You can configure the NBX system dial plan to use a particular service.



Select *MEGACOM* as the default service only if you purchased *MEGACOM* from your long-distance carrier. You cannot select *Standard (LDS)* as the default service if you purchased *MEGACOM*, because these two services do not work together.

- 4 Click *OK*.

### Configuring Partial T1 Lines

Sometimes the telephone company supplies a T1 line which has less than the maximum number of channels implemented. This is called a *Fractional, Partial, or Subequipped T1*. For example, you may decide to purchase 15 channels now and implement more later in order to reduce your near-term costs.

Some telephone companies offer Partial T1 lines as their standard offering, and provide fully implemented T1 lines only if you make a specific request. If you are unaware of this policy, outbound calls using the T1 line may fail because, by default, the system places outbound calls using high numbered channels first, and a Fractional T1 typically has the lower numbered channels implemented.

In the *Span Status* dialog box, under *Details of last five calls*, if you see the error message *REQ\_CHANNEL\_UNAVAIL*, determine if the error is caused by a Partial T1:

- 1 Remove the highest numbered channel from service (set it to offline in the *Modify Channel* dialog box) and retry the outbound call.
- 2 Continue to remove channels until an outbound call succeeds.

- 3 When the first outbound call succeeds, the highest numbered channel still in service represents the number of active (provisioned) channels in the Partial T1.
- 4 Create two groups. Put all of the active channels in one group, and all of the inactive channels in the other. Mark the active group online and the inactive group offline.

### Modifying T1 Audio Controls

Audio Controls settings affect individual spans. You can edit these properties:

- Silence Suppression (3C10126D only) — Enables you to override the system-wide setting. For a detailed description of how silence suppression affects audio quality and bandwidth, see [“Audio Settings”](#) on [page 240](#).
- Audio Compression (3C10116D only) — Enables you to override the system-wide setting. For a detailed description of how audio compression affects audio quality and bandwidth, see [“Audio Settings”](#) on [page 240](#).
- Audio Source Gain — Enables you to adjust the audio gain to resolve volume issues.



**CAUTION:** Do not change your Audio Source Gain settings unless you are instructed to do so by a support representative.

To modify T1 Audio Controls:

- 1 On the *Digital Line Cards* tab, select *T1 Span List* or *ISDN PRI Span List* from the *Select Device Type* list.
- 2 Click *Apply*.
- 3 Select the span you want to modify from the *Span List*. The number of channels supported per span depends on the configuration of the Digital Line Card.
- 4 Click *Audio Controls*. Click the Help button for more information about dialog box fields.

In a normal environment, you should not need to change the Audio Controls from their default settings. If you have an issue with sound quality and you cannot resolve it using the volume controls on the NBX Telephones, contact your technical support representative.

## Modifying a T1 Group

A Digital Line Card group is one or more T1 channels that are assigned the same characteristics, such as Channel Protocol and DS1 direction. This section describes how to perform these actions:

- [Modifying a T1 Group](#)
- [Changing T1 Group Membership](#)
- [Removing a T1 Group](#)



**CAUTION:** Modifying a T1 group disconnects any calls in process on any channels associated with the group.

### Modifying a T1 Group

You may want to modify a Digital Line Card group to change its name, Auto Extension assignments, or other parameters. When you modify a group, the changes affect all the Digital Line Cards assigned to that group. To modify a Digital Line Card group:

- 1 On the *Digital Line Cards* tab, from the *Select Device Type* drop-down list, select one:
  - *T1 Group List* (for T1 DS1)
  - *ISDN PRI Group List* (for T1 ISDN PRI)
- 2 Click *Apply*.
- 3 Select the group that you want to modify.
- 4 Click *Modify*. The dialog box that appears depends on the Group List that you selected either the T1 DS1 Modify Group dialog box or the T1 ISDN PRI Modify Group dialog box.
- 5 Make the desired changes to the group parameters. See the Help for details on each parameter.
- 6 Enable the *On Line* check box to bring the group on line.
- 7 Click *Apply* to effect the changes.

## Changing T1 Group Membership

You can change the channel membership in a group to accommodate changing needs.

To change group membership:

- 1 On the *Digital Line Cards* tab, select either *T1 Group List* (for DS1), or *ISDN PRI Group List* (for ISDN PRI) from the *Select Device Type* drop-down list and click *Apply*.
- 2 Select the group for which you want to change membership.
- 3 Click *Membership*. The dialog box that appears depends on the group list you select.
- 4 To add a channel to the Member List, select the channel in the *Non Member List* and click <<.

If you select the *Copy Group Settings to Channels* check box, the system copies the settings of the selected group to each channel you add or remove. If you do not select this option, the channel settings do not change.

- 5 Optionally enable the *Refresh Channels on Add/Remove* check box. This refreshes each channel as you add or remove it.
- 6 To remove a channel from the *Member List*, select the channel in the *Member List* and click >>.

Each channel must belong to a group. A channel can belong to only one group at a time. You cannot move a channel from the members list to the non-members list unless the system can assign the channel to another group. If a channel has never been a member of another group, the system cannot determine a group to which it can move the channel. Therefore, it cannot remove the channel from the member list. If a channel has been a member of another group the system moves the channel to the group of which the channel was most recently a member.

**Example:** By default, the system creates two groups, Group 1 and Group 2, and places all channels in Group 1. If you try to move a channel to the non-member list of Group 1, the operation fails. If you select Group 2, click *Membership*, move a channel from the non-member list to the member list, then move the same channel back to the non-member list, the operation succeeds because the channel was previously a member of Group 1. If you then view the Group 1 membership list, it contains the channel you just removed from Group 2.

- 7 Click *Close*.

## Removing a T1 Group

To remove a group:

- 1 On the *Digital Line Cards* tab, select either *T1 Group List* (for T1 DS1), or *ISDN PRI Group List* (for T1 ISDN PRI) from the *Select Device Type* drop-down list and click *Apply*.
- 2 Select the group you want to remove.
- 3 Click *Remove*. A prompt appears asking if you want to remove the group.
- 4 Click *Yes* to remove the group.

## Modifying T1 Card Channels

A channel is either a T1 DS1 or T1 ISDN PRI time slot. Each channel can accommodate a single telephone call. This section describes how to modify channels for an installed T1 Digital Line Card and how to view the status of an existing channel.



**CAUTION:** Do not modify channels unless a 3Com Technical Support representative advises you to do so. Modifying an ISDN channel disconnects any existing calls on that channel.

To modify a channel on an installed T1 card:

- 1 On the *Digital Line Cards* tab, select either *T1 Channel List* (for T1 channels), or *ISDN PRI Channel List* (for T1 PRI channels) from the *Select Device Type* drop-down list and click *Apply*.

The window that appears depends on the channel list you select.

- 2 Select the channel that you want to modify.
- 3 Click *Modify*. The dialog box that appears depends on the channel list that you selected either the *T1 DS1 Modify Channel* dialog box or the *T1 ISDN PRI Modify Channel* dialog box.
- 4 Fill in or change the fields in the appropriate *Modify Channel* dialog box. See the Help for a description of each parameter. Enable the *On Line* check box to bring the channel on line. Click *Apply* and then *OK*.



*The channel does not come online unless the card and the span are online.*

## Viewing the Status of a T1 Card Channel

To view the status of a channel on an installed T1 Digital Line Card:

- 1 On the *Digital Line Cards* tab, select either *T1 Channel List* (for T1 DS1 channels) or *ISDN PRI Channel List* (for T1 ISDN PRI channels) from the *Select Device Type* drop-down list.
- 2 Click *Apply*.
- 3 Select the channel for which you want status information.
- 4 Click *Status*. A Channel Status dialog box appears.
- 5 The dialog box that appears depends on the channel list that you select.
- 6 View the status of the channel.
- 7 Refresh the Channel Status dialog box.
  - a From the Dialog Refresh drop-down list, select:
    - Manual — To manually refresh the *Channel Status* dialog box each time you click the Apply button.
    - A time interval (5, 10, 15, 30, or 60 seconds) to automatically refresh the *Channel Status* dialog box at the specified intervals.
  - b Enable the *Device Refresh* check box.
- 8 Click *Apply*, and then click *OK*.

## Viewing DSP (Digital Signal Processor) Details

To view DSP (Digital Signal Processor) details:

- 1 On the *Digital Line Cards* tab, select *T1/ISDN Board List* from the *Select Device Type* list and click *Apply*.
- 2 Select the board you want and click *Status*.
- 3 In the Board Status dialog box, select a DSP from the *DSP List* and click *Details*.
- 4 Click *Close* to close the *DSP Status* window.
- 5 Click *Apply* to make the changes.
- 6 Click *OK*.

## Modifying IP Settings for a T1 Card

You can modify the IP settings for a T1 Digital Line Card to meet changing requirements.

### 3C10116D T1 Card Configuration Notes

- 3C10116D T1 Digital Line Cards do not support the NBX IP On-the-Fly feature. If your system uses IP On-the-Fly, then you must assign a static IP address to the card or use DHCP to assign an IP address to the card, even if the card will be installed on the same subnet as the NCP.
- 3C10116D T1 Digital Line Cards do not support DHCP option 184. Before you install a 3C10116D T1 card at a site that is remote from the system's NCP, you must first discover the card by connecting it to the same subnet as the NCP. That procedure is described in [“Setting Up a Digital Line Card at a Remote Location”](#) on [page 217](#).
- 3C10116D T1 Digital Line Cards do not support DHCP lease times of less than 20 minutes.

To modify the IP settings of a T1 Digital Line Card:

- 1 On the *Digital Line Cards* tab, select *T1/ISDN Board List* from the *Select Device Type* drop-down list and click *Apply*.
- 2 Select the board for which you want to change the IP settings and click *IP Settings*.
- 3 To assign IP addresses automatically, enter the first address in the *First IP Address* field. The system sequentially adds the remaining addresses. 3C10116D T1 Digital Line Cards work need only one IP address.

### Assigning IP Addresses One at a Time

To assign IP addresses one at a time:

- 1 In the *Digital Line Card IP Settings* dialog box, click *Assign Addresses Individually*.  
3C10116D T1 Digital Line Cards work need only one IP address, so the *Assign Addresses Individually* button is not present for these cards.
- 2 Enter the IP addresses that you want for the channels.
- 3 Enter the mask number appropriate for your site in the *Common Subnet Mask* field.
- 4 Enter IP address for the *Common Default Gateway*, and then click *Apply* and *OK*.

- 5 In the *Digital Line Card IP Settings* dialog box dialog box, click *Apply* to effect the changes.

### Removing a T1 Digital Line Card



**CAUTION:** Removing a Digital Line Card may affect your Dial Plan.

To remove a Digital Line Card:

- 1 On the *Digital Line Cards* tab, select *T1/ISDN Board List* from the *Select Device Type* drop-down list and click *Apply*.
- 2 From the list, select the Digital Line Card you want to remove.
- 3 Click *Remove*. A dialog box prompts you to confirm the removal.
- 4 Click *Yes*.

---

### Setting Up a Digital Line Card at a Remote Location

Each 3C10116D T1 Digital Line Card and 3C10165D E1 Digital Line Card can function as a standalone unit and communicate with the NBX Network Call Processor over a routed network.

To function as a remote card, the card must have the normal IP settings (IP address, default gateway, and subnet mask), and one extra setting, the IP address of the NBX Network Call Processor.

The 3C10116D and 3C10165D Digital Line Cards can use static IP configuration or they can get their IP configuration from a DHCP server. However, they do not support DHCP option 184 to get the Network Call Processor IP address, so you must perform some manual configuration of the card before you install it in its remote location.

To install a card on a remote network, you must install the card on the same subnet as its Network Call Processor and use the NBX NetSet utility to enable Auto Discovery and to perform some manual configuration. Then you can move the card to its remote location. Auto Discovery downloads the Network Call Processor IP address to the card. The card stores that information in its non-volatile memory.

#### Configuration Notes

- 3C10165D E1 Digital Line Cards and 3C10116D T1 Digital Line Cards do not support the NBX IP On-the Fly feature. If your system uses IP On-the-Fly, you must assign a static IP address to the card or use DHCP

to assign an IP address to the card, even if the card will be installed on the same subnet as the NCP.

- 3C10165D E1 Digital Line Cards and 3C10116D T1 Digital Line Cards do not support DHCP option 184. Before you install a 3C10165D E1 or 3C10116D T1 card at a site that is remote from the system's NCP, you must first initialize the card as described in this section.
- 3C10165D E1 Digital Line Cards and 3C10116D T1 Digital Line Cards do not support DHCP lease times of less than 20 minutes.

To configure a 3C10116D T1 Digital Line Card or 3C10165D E1 Digital Line Card for remote operation:

- 1 Be sure your NBX system is set for IP operation, either Standard IP or IP On-the-Fly. (*System Configuration > System Settings > System-wide.*)
- 2 Install the digital line card in an NBX chassis that is on the same subnet as the NBX Network Call Processor. You do not need to power down the chassis when inserting or removing NBX cards.

To help you identify the card in the NBX NetSet utility, make a note of the card's MAC address printed on the component side of the card.

- 3 Enable Auto Discovery:
  - a Login to the NBX NetSet utility as administrator.
  - b Click *System Configuration > System Settings > System-wide.*
  - c Enable the check box labeled Auto Discover Digital Line Cards, and then click Apply.

When you insert the card, it begins an initialization sequence. Once the power up tests complete, the card communicates with the NCP, which begins to update its database. Allow at least 3 minutes for both of these processes to be completed. When the card finishes its startup tests and establishes contact with its NCP, the NCP status light on the card's front panel turns green. You can then disable Auto Discover Digital Line Cards.

- 4 From the NBX NetSet main menu, click *Device Configuration > Digital Line Cards* to display a list of available T1/ISDN boards.
- 5 Select the card you just installed and click the IP Settings button.



*Unlike earlier NBX Digital Line Cards, the 3C10165D E1 Digital Line Cards and 3C10116D T1 Digital Line Cards use one IP address for all channels on the card.*

- 6** In the section titled Manually Assigned IP Settings, look at the boxes labeled First IP Address, Common Subnet Mask, and Common Default Gateway.

If you are using a static IP address for the card:

- a** Enter the card's IP address in the box labeled First IP Address. The address must be appropriate for the remote network where the card will eventually reside.
- b** Enter the subnet mask and default gateway values that are appropriate for the remote network where the card will eventually reside.
- c** Click OK. The card will restart and go through its startup process. After the card finishes its reboot process, proceed to [step 7](#).

If the remote network where the card will eventually reside uses DHCP to assign addresses:

- a** If the First IP Address, Common Subnet Mask, and/or Common Default Gateway boxes have an IP address, change each box to 0.0.0.0, and then click Apply. After the card finishes its reboot process, proceed to [step 7](#).

If the First IP Address, Common Subnet Mask, and Common Default Gateway all show 0.0.0.0, assign some arbitrary IP address to any one box, and then click Apply. The card will restart and go through its startup process again.

- b** When the card finishes its startup process, refresh the card's IP Settings page. You will see the arbitrary IP address you assigned.
  - c** Change each box to 0.0.0.0, and then click Apply. The card will restart and go through its startup process again.
- 7** When the card finishes its startup process, the card is set with the IP address of its Network Call Processor. You can now move the card to its remote location where it will use its saved Network Call Processor IP address to communicate with the NBX system.

---

## Setting Up T1/E1 Logging

The 3C10116D T1 Digital Line Card and the 3C10165D E1 Digital Line Card can generate logging information. The TEP (**T1**, **E1**, Primary Rate Interface) logs are stored on the system disk drive and you can use the NBX NetSet utility to view, download, and delete log files. Each card has a separate log, up to a maximum of five log files. When a log reaches its maximum size, 5 MB, it begins to overwrite the oldest data.

Because TEP logging has a performance cost, it is disabled by default. To enable TEP logging and to receive help interpreting the log results, contact your 3Com NBX Voice-Authorized Partner.

---

## Viewing CSU State Information and Statistics

3C10165D E1 cards and 3C10116D T1 cards have an onboard channel service unit (CSU). You can use the NBX NetSet utility to view near end (local CSU) and far end (central office) state information and statistics about each connected span.

To view CSU statistics:

- 1 Login to the NBX NetSet utility as Administrator and click *Device Configuration > Digital Line Cards*.
- 2 In the Select Device Type list, select *T1 Span List* or *ISDN PRI Span List* and then click *Apply*.
- 3 In the Span List dialog box, select a span and then click the near end and far end statistics button you want.

Click the Help button in the statistics screen for descriptions of the statistics categories.

T1 state information and statistics are reported in two formats - T1.231 format and AT&T TR54016 format. Both formats report the same information but they use different terminology. E1 state information and statistics are reported in a single format - ITU G.826.

Performance statistics are sampled every 15 minutes. The system saves up to 24-hours of data in 15-minute intervals. By default, the statistics screens display data from the most recent 15-minute interval. To see other intervals or data from the entire 24-hour period, use the *Select Interval* controls on the screen. You can display the currently selected data interval in a bar chart by clicking the *Graph* button on the screen.

- T1.231 Near End** To view T1 Span near end statistics in T1.231 format:
- 1 Log in to the NBX NetSet utility using the administrator username and password.
  - 2 In the *Select Device Type* box, select *T1 Span List* and then click *Apply*.
  - 3 When the Span List appears, click a span and then click *T.231 Near End* to open the T.231 Near End Performance screen.
  - 4 Click the Help button for details about each dialog box field.
- T1.231 Far End** To view T1 Span far end statistics in T1.231 format:
- 1 Log in to the NBX NetSet utility using the administrator username and password.
  - 2 In the *Select Device Type* box, select *T1 Span List* and then click *Apply*.
  - 3 When the Span List appears, click a span and then click *T.231 Far End* to open the T.231 Far End Performance screen.
  - 4 Click the Help button for details about each dialog box field.
- TR54016 Near End** To view T1 Span near end statistics in TR54016 format:
- 1 Log in to the NBX NetSet utility using the administrator username and password.
  - 2 In the *Select Device Type* box, select *T1 Span List* and then click *Apply*.
  - 3 When the Span List appears, click a span and then click *TR54016 Near End* to open the TR54016 Near End Performance screen.
  - 4 Click the Help button for details about each dialog box field.
- TR54016 Far-End** To view T1 Span far end statistics in TR54016 format:
- 1 Log in to the NBX NetSet utility using the administrator username and password.
  - 2 In the *Select Device Type* box, select *T1 Span List* and then click *Apply*.
  - 3 When the Span List appears, click a span and then click *TR54016 Far End* to open the TR54016 Far End Performance screen.
  - 4 Click the Help button for details about each dialog box field.

**G.826 Near End** To view E1 Span near end statistics:

- 1 Log in to the NBX NetSet utility using the administrator username and password.
- 2 In the *Select Device Type* box, select *ISDN PRI Span List* and then click *Apply*.
- 3 When the Span List appears, click a span and then click *G.826 Near End* to open the G.826 Near End Performance screen.
- 4 Click the Help button for details about each dialog box field.

**G.826 Far End** To view E1 Span far end statistics:

- 1 Log in to the NBX NetSet utility using the administrator username and password.
- 2 In the *Select Device Type* box, select *ISDN PRI Span List* and then click *Apply*.
- 3 When the Span List appears, click a span and then click *G.826 Far End* to open the G.826 Far End Performance screen.
- 4 Click the Help button for details about each dialog box field.

---

## Using Loopback Tests

The 3C10116D T1 and 3C10165D E1 cards can respond to commands from the Central Office to loop back data at different points for diagnostic purposes.

You *enable* each loopback test using the NBX NetSet utility. You *initiate* the Local and Framer loopback tests using the NBX NetSet utility. The Line and Payload loopback tests must be initiated by the Central Office or by test equipment emulating Central Office equipment.

For detailed logging information, you can enable TEP logging before you enable loopback testing. However, setting up logging and interpreting the logs are advanced tasks that require help from a support technician. You can see a simple pass/fail result by viewing the span status, as described in ["Enabling or Disabling Loopback Tests"](#) on [page 223](#). To see the loopback test status of all spans, use the *Config & Status Report* button on the *Device Configuration > Digital Line Cards* tab of the NBX NetSet utility.

The cards loop back data at the following points and with the following characteristics:

- **Line Loopback** — A loopback in which the signal returned toward the source of the loopback command comprises the full 1.544 Mbits/s signal with bit sequence integrity maintained, no change in framing, and no removal of bipolar violations.
- **Local Loopback:** An internal (within the framer) diagnostic loopback in which the signal returned towards the source is framed.
- **Framer Loopback** — An internal (within the framer) loopback that tests the path up to where framing is introduced.
- **Payload Loopback** — A loopback in which the signal returned toward the source of the loopback command comprises the payload of the received signal (with bit sequence integrity retained) and newly generated ESF framing (not necessarily maintaining the integrity of the channel timeslots, frames, or superframes of the received signal). The newly generated ESF data link contains a valid performance report message with a value of one in every LB-labeled bit position for the duration of the loopback indicating the signal is the result of a payload loopback.

### Enabling or Disabling Loopback Tests

You can use the NBX NetSet utility to enable or disable loopback test support in the 3C10116D T1 and 3C10165D E1 cards. By default, loopback test support is disabled. Once enabled, you can initiate the Local and Framer tests. The Line and Payload tests must be initiated by the Central Office or by test equipment emulating Central Office equipment.



**CAUTION:** *Enabling one or more loopback tests will terminate any active calls on all channels of the selected span and make that span unavailable for calls until loopback testing is disabled.*

To enable or disable loopback support:

- 1 Login to the NBX NetSet utility as administrator.
- 2 Click *Device Configuration > Digital Line Cards > T1 Span List*  
or  
*Device Configuration > Digital Line Cards > ISDN PRI Span List*
- 3 Choose a span from the list and the click *Modify*.
- 4 Enable or clear the Enable Loopbacks check boxes are required and then click *Apply*.

You can view the results of Local and Framer loopback testing in the Span Status dialog box. To view Span status:

- 1 On the *Digital Line Cards* tab, select *T1 Span List* or *ISDN PRI SPAN List* from the *Select Device Type* list, and then click *Apply*.
- 2 Select the span and click *Status*.

A red alarm indicates that the test failed. No alarm indicates that the test passed.

# 4

## USER CONFIGURATION

This chapter describes these elements of the NBX system:

- [Users](#) (including phantom mailboxes)
- [Call Pickup](#)
- [TAPI Route Points](#)
- [Hunt Groups](#)
- [Class of Service \(CoS\)](#)

---

### Users

You use the User Configuration tab in the NBX NetSet utility to add users and phantom mailboxes to the NBX system and remove them. You can also modify and maintain user profiles and parameters.

To perform these tasks, in the NBX NetSet utility, select *User Configuration > Users* and then see the Help for these buttons: *Add*, *Modify*, *Remove*, and *User Settings*. For information about User Settings that individual users can configure, see Chapter 1 in the *NBX Telephone Guide*.

### Phantom Mailboxes

A phantom mailbox is an extension that has no associated physical telephone. A caller can dial directly into a phantom mailbox and leave a message. The person assigned to a phantom mailbox can create and send a message from within the voice mail system and the Auto Attendant can route callers to a phantom mailbox.

Example: A user who is never in the office can use a phantom mailbox to receive and manage messages, even though no telephone is associated with the mailbox extension. The user can call into voice mail to retrieve and send messages, log onto the NBX NetSet utility to manage messages, including having the system forward voice messages using the Off-Site Notification feature, or use an e-mail client to manage the messages. See [“IMAP for Integrated Voice Mail”](#) in [Chapter 6](#).

To create a phantom mailbox:

- 1 Log on to the NBX NetSet utility using the administrator login ID and password.
- 2 In the *NBX NetSet - Main Menu* window, click *User Configuration*.
- 3 On the *Users* tab, click *Add* to open the *User Configuration* dialog box.
- 4 For *Extension Number*, use any unused extension in your dial plan. Once that extension is assigned to this phantom mailbox, the auto discovery process will not use it when you add new telephones.
- 5 In the *Associated Telephone* list, click *(none)*. Click the *Help* button for information about dialog box fields.

To access a phantom mailbox from any telephone, the user calls the extension, presses \* during the greeting, and then logs in. The first time the user accesses the phantom mailbox, the system prompts for mailbox initiation information. Once the user sets up a password, the user can use the NBX NetSet utility to set up phone options such as Call Forwarding.

---

## Call Pickup

Call Pickup allows any user who hears a telephone ringing to answer the call on her or his own telephone. To enable this feature, you add telephone extensions to Call Pickup Groups.

### Group Numbers

Pickup group numbering differs for SuperStack 3 NBX systems and NBX 100 systems.

#### SuperStack 3 NBX systems:

- 50 Call Pickup groups:
  - Group 0 through group 31 (extension 500 through 531)
  - Group 32 through group 49 (extension 482 through 499)
- 50 Directed Call Pickup groups (extension 540 through 589)

#### NBX 100 systems:

- 32 Call Pickup groups from group 0 (extension 500) through group 31 (extension 531)
- 10 Directed Call Pickup groups from 540 through 549



See *the NBX Telephone Guide for user instruction on how to use Call Pickup.*

If you select *Auto Add Phones to Call Pickup Group 0* (System Settings > System-wide), every telephone that is added to the system is a member of Call Pickup group 0. Administrators can add and remove users to and from any of the groups. Users can remove themselves from Call Pickup group 0, but not from any other Call Pickup groups.

Calls to a user who is a member of default Call Pickup Group 0 (extension 500) can be picked up from any telephone. Users can add or remove their own telephone extensions from the group to allow or prevent others from picking up their calls. See the *NBX Telephone Guide* and the User Help.

You can map Call Pickup Groups to user telephone buttons to provide one-touch access to the Call Pickup groups. See [“Creating and Managing Button Mappings”](#) in [Chapter 3](#).

To modify call pickup groups and group membership:

- 1 Log on to the NBX NetSet utility using the administrator login ID and password.
- 2 In the *NBX NetSet - Main Menu* window, click *User Configuration > Call Pickup*. Click the Help button for information on dialog box fields.

---

## TAPI Route Points

A TAPI Route Point is a virtual device within the NBX system where calls are held pending action by an external TAPI application. Route points are typically used by call center applications to redirect calls. A redirected call is one that is sent from its original destination (the route point) without being answered, to a new location specified in the external application.

A TAPI Route Point in the NBX system is an extension with a voice mailbox in the normal extension range: 1000 - 3999 for the SuperStack3 NBX; 100 - 449 for the NBX 100.

You create the TAPI Route Point, configure the NBX system to route calls to it, and then configure the external application to monitor it. For example, you can configure a line card port to send all incoming calls on that line to a specific TAPI Route Point. When a call arrives at the route point extension, it is queued until the external application examines it and then instructs the NCP to redirect the call to a destination specified in the external application. Typically, the redirect action is based on the caller ID information of the incoming call.

**Redirect Behaviors** [Table 28](#) describes the behavior of TAPI Route Points and redirected calls within the NBX system.

**Table 28** TAPI Route Points and NBX System Features

Call Redirected to	Description
Internal extension	<p>If the internal extension has activated Do Not Disturb, a call redirected to that extension goes immediately to the extension's Call Forwarding setting.</p> <p>If the TAPI Line Redirect Timeout is set to a value greater than the extension's Call Forwarding setting and the call is not answered, the redirected call will be handled by the extension's Call Forwarding setting. The system will log a successful redirect. If the TAPI Line Redirect Timeout is set to a value less than the extension's Call Forwarding setting and the call is not answered, the call will return to the route point. For more information, see <a href="#">"Specifying TAPI Line Redirect Timeout"</a> on <a href="#">page 231</a>.</p>
External number	<p>Subject to the route point extension's Class of Service setting.</p> <p>The call connects as soon as the external line resource (line card port, a PRI line, or a T1 channel) is acquired. The caller hears the call progress tones directly from the CO. At this point, the NBX system logs a successful connection. Calls redirected to an external number cannot timeout, even if the call was redirected to a busy or an invalid number.</p>
Call Park extension	<p>If a call has been previously parked at the specified Call Park extension, the redirected call is connected to the parked call.</p> <p>If no call is waiting at the specified Call Park extension, the call returns to its original destination when the TAPI Line Redirect Timeout expires and the external application can redirect it again. After two failures, the call goes to the Call Coverage specified for the Route Point.</p>
Hunt Group extension	<p>Calls redirected to a Hunt Group extension do not timeout. Once the call is passed to the Hunt Group, the system reports that the call has been successfully redirected.</p> <p>Calls can be redirected from a Hunt Group extension.</p> <p>You cannot add a TAPI Route Point extension to a Hunt Group.</p>
Hunt Group member	<p>A Hunt Group takes precedence over a Route Point. If a call arrives on a Hunt Group member phone because it is a member of a Hunt Group, a redirect is not permitted. If a call arrives on the phone's extension (not as a result of a Hunt Group action), the call can be redirected.</p>
Phantom Mailbox	<p>A call can be redirected to a phantom mailbox.</p>

**Table 28** TAPI Route Points and NBX System Features (continued)

Call Redirected to	Description
Mapped Line	<p>Calls that arrive through an incoming line that is mapped to a line appearance button on a phone cannot be redirected.</p> <p>If you redirect a call to a mapped line, the call does not timeout. It fails and is routed back to the route group until the caller disconnects.</p>
Bridged Station Appearance	<p>Calls can be redirected to or from a phone that has a bridged station appearance. Once a call to a primary bridged station appearance reaches the secondary bridge station appearance, the call cannot be redirected.</p>

### TAPI Route Point Capacities

When the maximum number of calls on a route point is reached (see [Table 29](#)), subsequent calls routed into the route point from an internal extension or through a Virtual Tie Line ring for 10 seconds and are then disconnected. If the call arrives through a line card port, the call continues ringing.

**Table 29** TAPI Route Point Capacities

System	Maximum Number of Route Points	Maximum Number of Calls per Route Point
SuperStack3 NBX	100	400
NBX 100	48	50

### Creating a TAPI Route Point

To create a new TAPI Route Point, the NBX system administrator performs these steps:

- 1 Log on to the NBX NetSet utility using the administrator login ID and password.
- 2 In the *NBX NetSet - Main Menu* window, click *User Configuration > TAPI Route Points* tab.
- 3 Click *Add* to open the *Add TAPI Route Point* dialog box.
- 4 Enter the appropriate information in the fields. Click the *Help* button for information on dialog box fields.

### Modifying a TAPI Route Point

To modify a TAPI Route Point:

- 1 Log on to the NBX NetSet utility using the administrator login ID and password.
- 2 In the *NBX NetSet - Main Menu* window, click *User Configuration > TAPI Route Points* tab.
- 3 From the list of TAPI Route Points, select the one you want to modify.
- 4 Click *Modify* to open the *Modify TAPI Route Point* dialog box. Click the Help button for information on dialog box fields.



*To modify the password for the TAPI Route Point, you must enter the administrator password for the NBX system in the Current Admin Password field.*

### Viewing TAPI Route Point Statistics

You can view the statistics for all of the TAPI Route Points on your NBX system. The NBX system starts to accumulate new statistics each time you reboot the system or each time you click the *Reset* button in the TAPI Route Point Statistics dialog box.

To view TAPI Route Point statistics:

- 1 Log on to the NBX NetSet utility using the administrator login ID and password.
- 2 In the *NBX NetSet - Main Menu* window, click *User Configuration > TAPI Route Points* tab.
- 3 Click the *Statistics* button. The Statistics dialog box appears.
- 4 Click the heading of any column to sort the data in ascending or descending order.
- 5 Click *Reset* to erase all data. The NBX system begins collecting new statistical data.

The *Last reset command* field displays the date and time of the most recent Reset. A row of hyphens (-----) indicates no Reset since the most recent system reboot.

The *Last system reboot* field contains the date and time when the NBX system was most recently rebooted.

Click the Help button for information on dialog box fields.

### Specifying TAPI Line Redirect Timeout

The TAPI Line Redirect Timeout is a system-wide timer that specifies the amount of time before a redirected call goes back to its original destination, which allows the TAPI application to redirect the call again. When a redirected call times out, the system also sends a failure code back to the TAPI application. After two failures, the call goes to the route point's call coverage option.

To set the TAPI Line Redirect Timeout:

- 1 Log on to the NBX NetSet utility using the administrator login ID and password.
- 2 In the *NBX NetSet - Main Menu* window, click *System Configuration*. *System Settings > Timers*. See the Help for the procedure on setting timers.

### Hunt Groups

A hunt group is a set of users that can be accessed by dialing a single extension. A call routed to the hunt group extension can reach any member of the group who is currently logged into the group. A static hunt group is one in which all members are permanently logged in (locked). A dynamic hunt group is one where users can be logged in and out of the group by you, the administrator, or you can allow them to log into or out of the group themselves, using the hunt group password you create.

You can associate one or more of the hunt group login/logout feature codes with a particular group and then map that feature code to a telephone access button to allow users to easily login and logout of the hunt group. The access button light remains lit while the user is logged into the hunt group.

Hunt groups are specified by extension, in these ranges:

- **SuperStack 3 NBX:** 4000–4099 (All 100 can be assigned.)
- **NBX 100:** 450–499 (A maximum of 48 can be assigned.)

To configure hunt groups:

- 1 Log on to the NBX NetSet utility using the administrator login ID and password.
- 2 Click *User Configuration > Hunt Groups* and then see the Help topics associated with these buttons: *Add*, *Modify*, *Remove*, *Status*, and *Feature Mappings*.

### Hunt Group Considerations

- For a telephone to participate in a hunt group, the user must be logged into the hunt group. See the *NBX Telephone Guide*.
- When you create a hunt group, you specify one of three types: **linear hunt group**, **circular hunt group**, or **calling group**. Your choice is based largely on the ringing pattern that you want.
- For each group that you define, you also specify:
  - The **Total Timeout** — The length of time in seconds that the call will ring on the group's telephones before the call goes to the group's call coverage point.
  - The **Per-Device Timeout** — The length of time in seconds that each phone rings in the cycle. (Ignored for Calling Groups.)
  - Whether you want the system to **log a phone out of the hunt group if it does not answer**. (Ignored for Calling Groups.)
- For linear and circular hunt groups, the *order* in which a group telephone rings (the telephone's "priority") is the same as the order in which you added it to the group. For calling groups, all phones ring simultaneously.

### Linear and Circular Hunt Groups

In linear and circular hunt groups, calls ring sequentially on telephones in the group, but the behavior differs when the time specified in the Total Timeout field elapses:

- If the Total Timeout value is less than the sum of all of the Per-Device Timeout values, a call that is routed to either a linear and circular hunt group rings on some, but not all of the telephones in the group and then is routed to the group's call coverage point.
- If the Total Timeout value is greater than the sum of the Per-Device Timeouts:
  - For a Linear Hunt Group, the call rings in order on each group telephone and then goes to the group's call coverage point. Any time remaining in the Total Timeout is ignored, and the call does not ring again on any telephone in the group.
  - For a Circular Hunt Group, the call rings in order on each group telephone and then, for the remainder of the Total Timeout, begins ringing again through the telephones, in order. Depending on the Total Timeout value, an unanswered call may ring through all telephones in the group multiple times.



*If the Total Timeout value exactly matches the sum of the Per-Device Timeouts, the behavior of a single incoming call is the same for both linear and circular hunt groups.*

When a **second call** is routed to a linear or circular hunt group, the telephone on which the second call first rings is different:

- For Linear Hunt Group, the new call rings on the first telephone in the group.
- For a Circular Hunt Group, the new call rings on the telephone that is next in the ringing sequence.

### Calling Groups

In this special type of hunt group, an incoming call rings on all telephones in the group simultaneously. After the *Total Timeout* value is reached, a call that is still unanswered is routed to the group's call coverage point.



*The value in the Per Device Timeout field has no effect on the behavior of telephones in a calling group.*

### Call Coverage

For each hunt group, you can define where the NBX system routes an unanswered call (the call coverage point):

- **Voice Mail** — An unanswered call goes to the hunt group extension's voice mailbox.
- **Auto Attendant** — An unanswered call goes to the Automated Attendant that you specify.
- **Phone Number** — An unanswered call goes to the extension that you specify, such as the receptionist, or another hunt group.

---

## Class of Service (CoS)

Class of Service (CoS) is a set of calling permissions that you assign to users. Most permissions are subject to the Business Hours parameters: Open, Lunch, and Other. For example, you can create a class that allows toll calls during normal business hours, but denies them at other times.

Additional considerations:

- Emergency calls (such as calls to 911) are not subject to CoS restrictions.
- System-wide Speed Dial numbers are not subject to Class of Service restrictions. For example, if you want to enable calling to a specific toll

number to all users without regard to their CoS settings, create a System Speed Dial for that number.

- When you create a new profile, the system assigns the default CoS unless you specify a different one. If you edit the properties of the default CoS, verify that it contains a minimum set of permissions.
- You can enable or disable Offsite Notification at the system level. The system-wide setting takes precedence over the CoS setting.

Service classes control these types of calls:

- Intercom
- External (local, long distance, international, long distance toll-free, and long distance toll)
- CO Code (optional telephone company services, such as Call Waiting)
- Trunk to trunk transfers
- Off-site Notification

To configure Class of Service

- 1 Log on to the NBX NetSet utility using the administrator login ID and password.
- 2 Click *User Configuration > CoS* and then see the Help screens for these buttons: *Add, Modify, Remove, and View*.

# 5

## SYSTEM CONFIGURATION

This chapter provides information about using the *System Configuration* function of the NBX NetSet utility to configure system level settings. It covers these topics:

- [System Settings](#)
- [Speed Dials](#)
- [Business Identity](#)
- [Security](#)
- [TAPI Settings](#)
- [Disk Mirroring](#)

---

### System Settings

You can use the System Settings tab to configure these system-level items:

- [System-wide Settings](#)
- [Audio Settings](#)
- [Regional Settings](#)
- [Date and Time](#)
- [Timers](#)
- [Ringing Patterns](#)
- [Multicast Addresses](#)
- [IP Addresses](#)
- [Maintenance Alerts](#)

On the System Settings tab, you can also view the current system settings, such as the software version, the IP address of the system, and the amount of free memory. [Table 30](#) describes the fields.

To view system settings:

- 1 Log on to the NBX NetSet utility using the administrator login ID and password.
- 2 Click *System Configuration > System Settings*. [Table 30](#) describes the System Settings fields.

**Table 30** System Settings

Field	Purpose
Software Version	The call control software for the NBX system.
System Serial #	The serial number on the Call Processor circuit board.
Host Name	This is an IP setting. It is a name you can give to the NBX system so you do not have to specify the IP address when accessing NBX NetSet through a browser.
IP Address	The IP address of the NBX system.
Default Gateway	The IP address of the destination host for any IP packet not addressed to a host on the local subnetwork.
Subnet Mask	An IP setting that identifies the network and host portions of an IP address on the network.
Network Protocol	The transport mechanism for voice packets.  <i>Ethernet only:</i> All communications are at the Ethernet frame layer.  <i>Standard IP:</i> IP communications are used for traffic between NBX system addresses. Every device needs an IP address.  <i>IP On-the-Fly:</i> An implementation of IP communications in which Layer 2 (Ethernet) devices are temporarily assigned a Layer 3 (IP) address only when they need to communicate with a Layer 3 device on a different subnetwork. The IP address is assigned from an address pool defined by the NBX system administrator. After the Layer 2 device returns to the idle state the IP address is returned to the pool of available addresses for future use.
MOH MAC Address	The hardware address of the Music-on-Hold device.
Free Memory	Available memory on the NBX system.
Date and Time	The current system date and time. To modify, click the Date and Time button.
System Start Time	The last time the system was initialized (boot time).

**System-wide Settings** You use the System-wide dialog box to make changes to System-wide settings. [Table 31](#) describes each setting.

To configure system-wide settings:

- 1 Log on to the NBX NetSet utility using the administrator login ID and password.
- 2 Click *System Configuration > System Settings > System-wide*. See the Help for procedures on modifying system-wide settings.

**Table 31** System Settings System-wide Dialog Box Fields

Field	Purpose
Host Name	An IP setting for the NBX system.  A Host name functions only if you add the name to the name resolution system. If you do not do this, then you must enter the IP address in the browser when you want to access NBX NetSet.
SMTP Domain Name	The name of your SMTP domain.  Required for Off-Site Notification by e-mail.
IP Address	The IP address of the NBX system.
Default Gateway	The IP address of the destination host for any IP packet not addressed to a host on the local subnetwork.
Subnet Mask	An IP setting that identifies the network and host portions of an IP address on the network.
Primary DNS	The IP address of the primary DNS server. You must specify at least a primary address to use e-mail Off-Site Notification.
Secondary DNS	The IP address of the secondary DNS server. If you specify two DNS IP addresses, they must be the primary and secondary addresses.
Tertiary DNS	The IP address of the tertiary DNS server.

**Table 31** System Settings System-wide Dialog Box Fields (continued)

Field	Purpose
Network Protocol	<p>The transport mechanism for voice packets.</p> <p><i>Ethernet only:</i> All communications are at the Ethernet frame layer.</p> <p><i>Standard IP:</i> IP communications are used for traffic between NBX system addresses.</p> <p><i>IP On-the-Fly:</i> An implementation of IP communications in which Layer 2 (Ethernet) devices are temporarily assigned a Layer 3 (IP) address only when they need to communicate with a Layer 3 device on a different subnetwork. The IP address is assigned from an address pool defined by the NBX system administrator. After the Layer 2 device returns to the idle state the IP address is returned to the pool of available addresses for future use.</p> <p>If you select IP On-the-Fly in the Network Protocol list, you must return to the Current System Settings window, select IP Addresses and add the IP addresses associated with IP On-the-Fly. There may be unpredictable results in other system functions if you have Network Protocol set to IP On-the-Fly but do not have any IP addresses.</p>
Extensions Start at	<p>The starting extension number used by Auto Discover Telephones.</p> <p>You may select any unused telephone number extension from these ranges:</p> <p><b>NBX 100:</b> 3-digit dial plan — 100–449 4-digit dial plan — 1000–4949</p> <p><b>SuperStack 3 NBX:</b> 3-digit dial plan — 100–399 4-digit dial plan — 1000–3999</p>
External Prefix	The prefix required for an outside line.
Caller ID Wait Timer	Amount of time to wait for receiving Caller ID information.
Auto Add Phones to Call Pickup Group 0	When selected, this adds telephones to the default Call Pickup Group 0 (zero) when telephones are added to the system. Turn this ON before Auto Discovering telephones if you want the telephones to appear in Call Pickup Group 0.

**Table 31** System Settings System-wide Dialog Box Fields (continued)

<b>Field</b>	<b>Purpose</b>
Handsfree on Transfer	<p>This setting defines the way an NBX Business Telephone responds to a <i>transferred</i> call when a user enables the HANDS FREE button on the telephone or uses the HANDS FREE feature code (100).</p> <p>Transferred calls include:</p> <ul style="list-style-type: none"> <li>■ Internal calls from other NBX users, both direct and transferred</li> <li>■ External calls transferred via an automated attendant</li> </ul> <p><b>NOTE:</b> Calls that directly arrive at an NBX Business Telephone via an analog telephone line or Digital Line Card channel ring on the telephone in the normal way. To answer the call, the user must pick up the handset or press the Speaker button.</p> <p><b>Handsfree on Transfer Enabled</b></p> <p>When the <i>HANDS FREE</i> button on an NBX Business Telephone is activated and the <i>Handsfree on Transfer</i> function is enabled on the NBX system, a call that is <i>transferred</i> to the telephone causes the telephone to issue a two-second hands-free warning tone.</p> <p>The telephone user does not need to take action to answer the call because, immediately after the warning tone, the call is connected using the speaker phone.</p> <p><b>Handsfree on Transfer Disabled</b></p> <p>When the <i>HANDS FREE</i> button is activated but the <i>Handsfree on Transfer</i> function is disabled on the NBX system, a call that is <i>transferred</i> to the telephone rings in the normal manner, whether or not the HANDS FREE button is activated.</p> <p>Internal calls cause the telephone to issue a two-second hands-free warning tone. The user does not need to take action to answer the internal call because, immediately after the warning tone, the system connects the call using the speaker phone.</p> <p>If an external call is blind transferred manually to the NBX Business Telephone, the call rings on the telephone in the normal manner and the HANDS FREE button is ignored.</p>
Virtual LAN Enabled	Adds a Priority 6 Virtual LAN identifier to each Ethernet frame.
Virtual LAN ID	If the VLAN Enabled box is checked, you must specify the Virtual LAN identifier in this field.
IP VLAN Tagging Enabled	If you enable the IP VLAN Tagging Enabled check box, the NBX system adds VLAN tags to outgoing voice and control packets intended for devices on the VLAN you specified in the Virtual LAN ID text box.

**Table 31** System Settings System-wide Dialog Box Fields (continued)

Field	Purpose
System-wide CLIR	Suppresses the transmission of caller ID for outgoing calls. <b>NOTE:</b> For calls over VTL connections, you might need to add a pretranslator to the dial plan. See <a href="#">“Creating a Pretranslator for VTL Calls”</a> on <a href="#">page 65</a> .
Music On Hold	Enables Ethernet multicasts for Music On Hold (MOH). MOH is automatically enabled if Music on Transfer is enabled. MOH Audio should be enabled only if you have a MOH device connected to the system.
Music on Transfer	Enables MOH audio for Call Transfer; requires MOH to be installed and enabled. Music on Transfer is automatically disabled if MOH is disabled.
One Button Transfer	Enables system users to transfer a call by pressing the Transfer button only once. If this box is not checked, call transfers require users to press the Transfer button once to start the call transfer and another time to complete the transfer of the call.
NBX Messaging	Allows you to enable or disable NBX Messaging after you install a third-party messaging license. By default, this check box is selected but not accessible until you install a third-party messaging license. If you disable NBX Messaging by clearing this check box, all NBX Messaging icons and headings become inactive throughout NBX NetSet.
Third-Party Messaging	This check box is active only if you have installed a third-party messaging license. You can enable the third-party messaging application by selecting this check box or by clearing the <i>NBX Messaging</i> check box.
Pulse Dialing	Enables pulse dialing for all telephones in the system.

## Audio Settings

Audio Settings enable you to affect the network impact of your audio packets by enabling or disabling compression, silence suppression, and echo suppression. You can enable and disable these settings for the entire system and then override the system-wide setting for individual devices.

### Compression Overview

Before voice traffic can be transmitted over a digital network, the audio waveform, an analog signal, must be encoded into a digital format. The digitized audio is packetized and delivered over the network to a destination, and then decoded back into a voice waveform. Software called a codec (coder/decoder) converts the audio information between digital and analog formats.

Digitized audio formats have different properties. Each format represents a compromise between bandwidth and audio quality, that is, high quality audio typically requires more network bandwidth. Compressing the digitized audio data can conserve bandwidth with little compromise in audio quality, but compression requires increased processing overhead when encoding and decoding the audio information. Too much processing overhead can introduce delay.

[Table 32](#) lists the codecs supported by the NBX system and describes the characteristics of each one.

**Table 32** Supported Codecs

Codec	Description
G.711 No Compression	An International Telecommunications Union (ITU) standard for audio encoding. Encoding and decoding is fast and support is widespread. Also called MULAW or $\mu$ LAW. There is a slight variation called A-law used in European telephone systems. G.711 provides high quality audio at 64 kbit/sec. G.711 encoding is used by telephone companies worldwide to provide “toll-quality audio.”
ADPCM Medium Compression	Adaptive Differential Pulse Code Modulation (ADPCM) provides good quality audio at a lower bitrate (32kbit/sec.) than G.711. The NBX system uses the International Multimedia Association (IMA) version of ADPCM.
G.729 High Compression	G.729, an ITU standard, employs a more sophisticated compression technique than ADPCM and it is supported worldwide. The G.729A codec compresses the audio information to 8kbit/sec., although processing overhead results in actual bandwidths greater than 8kbit/sec.

### Codecs and NBX Devices

Codecs reside on the NBX devices — telephones, analog terminal adapters, and so forth. Some older NBX devices do not support the latest codecs so during call setup NBX devices negotiate an encoding scheme that is supported by both devices (or all devices on a conference call).

[Table 33](#) lists each NBX device that must encode or decode audio and shows how each device supports the available codecs.

**Table 33** Audio Encoding Supported by NBX Devices

NBX Device	Part Number	G.729	ADPCM	G.711
NBX 1102, 2102, and 2102-IR Business Telephones	3C10121 3C10122 3C10226A 3C10228IRA	No	Yes	Yes
	3C10226PE 3C10226B 3C10228IRPE 3C10228IRB 3C10281PE 3C10281B	Yes	Yes	Yes
NBX 3102 Business Telephone	3C10402A	Yes	Yes	Yes
NBX 2101 Basic Telephones	3C10248PE 3C10248B	Yes	Yes	Yes
NBX 3101, and 3101SP Basic Telephones	3C10401A 3C10401SPKRA	Yes	Yes	Yes
NBX Analog Terminal Adapter	3C10120 3C10120B	No	Yes	Yes
	3C10400	Yes	Yes	Yes
NBX Analog Terminal Card	3C10117 3C10117B-INT	No	Yes	Yes
	3C10117C	Yes	Yes	Yes
NBX Analog Line Card	3C10114 3C10114-ANZ	No	Yes	Yes
	3C10114C	Yes	Yes	Yes
NBX Digital Line Card	3C10116, 3C10116B 3C10116C 3C10164-ST (BRI) 3C10164C-ST (BRI) 3C10165 3C10165C	No	Yes	Yes
	3C10116D 3C10165D	Yes	Yes	Yes

### Silence Suppression Overview

Silence suppression is a method of reducing the number of packets transmitted during a conversation. Silence suppression can help you avoid dropped packets on a congested network. During a conversation there are periods of silence. A packet of silence takes up as much bandwidth as

a packet with audio data. If you enable Silence Suppression, the phone sends a 'silence indicator' when it senses the start of a silent period and it suppresses all subsequent voiceless frames. When another NBX device receives this indicator, it generates and inserts white noise until it receives the next frame that contains audio data. If you enable Silence Suppression, a careful listener might notice a difference in audio quality. The background white noise generated by the receiving phone is subtly different from the silence in an audio stream.



*Silence suppression and echo suppression (described next) both result in compromises to audio quality. Do not enable suppression settings unless you are trying to solve network bandwidth congestion issues that you cannot solve through other means such as increasing network capacity.*

### Echo Suppression Overview

Echo suppression is a method of reducing or eliminating audio feedback (echo). The NBX system has internal mechanisms to deal with echo, however, external conditions can induce echo that is beyond the scope of the internal mechanisms. Echo on external calls is usually due to older equipment at the phone company's central office. Echo can also be caused by user behavior. If a caller has the phone volume turned up and then that caller does not hold the phone flush to their ear, the handset's mouthpiece can pick up audio from the ear piece, which can cause echo.

To enable audio settings, select *System Configuration > System Settings > Audio Settings*.

**Table 34** System Settings Audio Settings Dialog Box Fields

Field	Purpose
<b>Bandwidth Controls</b>	reduce the number or the size of packets transmitted during a conversation. You can enable bandwidth controls to help reduce network congestion, however, enabling bandwidth controls can compromise audio quality.
System-wide Silence Suppression	Reduces the number of packets transmitted during a conversation by not transmitting packets during times of silence during a conversation. Enabling this check box enables silence suppression on <i>all</i> conversations.
System-wide Silence Suppression on VTL Calls	Implements silence suppression on calls carried over Virtual Tie Lines.

**Table 34** System Settings Audio Settings Dialog Box Fields (continued)

Field	Purpose
System-wide Audio Compression	Select one of these compressions settings as the default setting for all calls:  None - G711 — No compression, G.711 (MULAW) audio encoding  Med - ADPCM — Medium compression, ADPCM audio encoding  High - G729 — High compression, G.729 audio encoding.  You can override the system wide setting for individual telephones, line card ports or T1/E1 spans (3C10116D and 3C10165D only).
Audio Compression on VTL Calls	Select one of these compressions settings as the default setting for calls over virtual tie lines:  None - G711 — No compression, G.711 (MULAW) audio encoding  Med - ADPCM — Medium compression, ADPCM audio encoding  High - G729 — High compression, G.729 audio encoding.
<b>Echo Troubleshooting</b> controls can reduce or eliminate audio feedback (echo) during conversations. The NBX system has default mechanisms to deal with echo, however, extreme conditions can induce echo that is beyond the scope of the default mechanisms.  <i><b>NOTE:</b> When additional echo suppression is enabled for analog and digital line cards, echo should be reduced or eliminated. However, in rare conditions, the additional echo suppression may cause incoming audio to occasionally fade in and out.</i>	
NBX Handset Acoustic Echo Suppression	Enables additional echo suppression on calls between internal extensions. Acoustic echo typically occurs when the phone volume is set to maximum and audio feeds back from the ear piece to the mouthpiece.
Analog Line Cards Echo Suppression	Enables echo suppression on calls between internal extensions and outside callers.
Digital Line Cards Echo Suppression	Enables echo suppression on calls that use digital line connections.

## Regional Settings

After you install regional software and components from the regional packs, you can enable regional settings. To enable these regional settings in NBX NetSet, you select the appropriate country and language for the system voice prompts, the technical tones and cadences, and the online user documentation.

To enable regional settings, select *System Configuration > System Settings > Regional Settings*. See the Help for the procedure on enabling regional settings.



See [“Regional Software”](#) on [page 303](#) for information on installing regional language packs.

### Advanced Regional Settings

The NBX system also allows you to choose different regional settings for the system voice prompts, the technical tones and cadences, and the online user (not administrator) documentation. For example, you may require local tones and cadences but may want the documentation to be in English and the voice prompts in Australian English.

You can select separate regional settings for:

- Voice prompts — The Auto Attendant voice prompts.
- Documentation — The *NBX Telephone Guide*, the NBX NetSet user Help, the LabelMaker utility, and the quick reference cards.
- Tones and Cadences — The tones and the patterns of rings (cadence) versus silence. Tones and cadences vary from country to country. Examples:
  - United States ringing cadence (pattern) is 2 seconds of ring followed by 4 seconds of silence.
  - United Kingdom ringing cadence is 2 rings within approximately 2 seconds followed by 2 seconds of silence.
  - United States busy tone is 0.75 seconds of tone followed by 0.75 seconds of silence.

To enable different regional settings:

- 1 Log on to the NBX NetSet utility using the administrator login ID and password.
- 2 Click *System Configuration > System Settings > Regional Settings > Advanced*. See the Help for procedures on selecting regional settings.

**Date and Time** If necessary, you can set the NBX system date and time. It is important that the date and time are accurate because the system date and time affect these NBX features:

- The NBX telephone display panel
- Business hours behavior
- Time-dependent prompts in the Auto Attendant
- Time and date stamp on voicemail

To set the system date and time:

- 1 Log on to the NBX NetSet utility using the administrator login ID and password.
- 2 Click *System Configuration > System Settings > Date and Time*. See the Help for the procedure on setting the system date and time.

**Timers** System timers enable you to set time-out periods for the NBX system features that are described in [Table 35](#).

To set timers:

- 1 Log on to the NBX NetSet utility using the administrator login ID and password.
- 2 Click *System Configuration > System Settings > Timers*. See the Help for the procedure on setting timers.

**Table 35** System Timers Fields

Field	Purpose
Forward Voice Mail On Timeout	When a telephone's FWD VMAIL button is <i>enabled</i> , this field specifies the duration of ringing before a call is forwarded to voice mail.  If you set this time to under 6 seconds, caller ID information is not captured in voicemail.
Forward Voice Mail Off Timeout	When a telephone's FWD VMAIL button is <i>disabled</i> , this field specifies the duration of ringing before a call is forwarded to voice mail.
Line Port Hold Timeout	For a call originating on an outside line (Analog Line Card port), the length of time that the call remains on hold before it rings at the extension that placed the call on hold.
Call Park Timeout	The length of time that a call can be parked before it rings at the extension that parked the call.

**Table 35** System Timers Fields (continued)

Field	Purpose
Conference Timeout	<p>The length of time before a conference attempt is abandoned. Applies to a blind (unannounced) conference only. The timeout takes effect under these conditions:</p> <ul style="list-style-type: none"> <li>■ Two people, A and B, are involved in a call and one of them attempts to blind conference another person, C.</li> <li>■ C does not answer and C's voice mail does not pick up the call.</li> </ul> <p>After the Conference Timeout period, the system stops ringing C's telephone, stops attempting to conference with C, and reverts to the call between A and B.</p>
Transfer Timeout	The length of time that a transferred call attempts the transfer before it rings back to the caller's extension.
TAPI Line Redirect Timeout	The length of time before a call redirected from a TAPI route point by an external application goes back to its original destination. After two failures, the call goes to the TAPI route point's call coverage option. For more information, see <a href="#">"TAPI Route Points"</a> on <a href="#">page 227</a> .

## Ringling Patterns

You can set system-wide ringing patterns to distinguish between internal and external calls. You can choose one, two, or three rings to distinguish between internal and external calls.



*Do not confuse ringing patterns with ringer tones, which NBX system users can set for their telephones using NBX NetSet. For information on setting a user's ringing tones, see the NBX Telephone Guide or the User Help.*

To set ringing patterns

- 1 Log on to the NBX NetSet utility using the administrator login ID and password.
- 2 Click *System Configuration > System Settings > Ringling Patterns*. See the Help for instructions.

## Multicast Addresses

The NBX system uses IP multicast addressing to distribute information for these system features:

- Mapped line appearances
- Music on hold
- Internal page

- External page
- Conference calls

These features are available on Layer 2 and Layer 3 IP devices. The IP implementation uses Internet Group Management Protocol (IGMP) to transmit and distribute the necessary data and audio.



*If you configure your NBX system to use IP On-the-Fly or Standard IP and your switches use IGMP Snooping, you must have an IGMP Host on the network. Typically, an IGMP Host is an IP Multicast Router or a switch that has IGMP Query capability.*

The NBX system IGMP is an implementation of administratively scoped IP multicast that uses three scopes of administration:

- **Local scope** — Limited by local routers with IP addresses 239.255.0.0 through 239.255.0.16
- **Organizational local scope** — Limited by boundary routers with IP addresses 239.192.0.0 through 239.192.0.14
- **Global scope** — IP addresses 224.2.0.0 through 224.2.127.253

IGMP may not be available in all systems or network topologies. All of the routers between the various components must support IGMP and the necessary router protocols to establish a path for the IP multicast packets.

Each event that occurs in an IGMP setup, such as taking a telephone off the hook, causes a packet of 200 Kb to 300 Kb to be sent.

The default settings for the IP multicast addresses should work in most network environments. Certain addresses are reserved.



*The MAC address and the IP address displayed on any one line of the Multicast Address List window are not related.*

There are two methods for selecting multicast addresses:

- **Change IP** — Lets you select a starting address for all entries. Changing IP multicast addresses is a quick way to change the range of NBX system multicast addresses, to avoid conflicts with other equipment on your network.
- **Change bins** — Lets you change a single entry by selecting from a list of available bins. Changing IP bins is useful for changing a single address that may conflict with another system device. Consult your

network administrator to determine which address is in conflict and the new address to choose.

To change multicast addresses:

- 1 Log on to the NBX NetSet utility using the administrator login ID and password.
- 2 Click *System Configuration > System Settings > Multicast Addresses*. See the Help for instructions.

**IP Addresses** The IP Addresses window allows you to add or delete a range of IP On-the-Fly addresses.



*The IP Addresses button appears only if you have IP On-the-Fly enabled in System Configuration > System Settings > System-wide.*

To add IP addresses:

- 1 Log on to the NBX NetSet utility using the administrator login ID and password.
- 2 Click *System Configuration > System Settings > IP Addresses*. See the Help for the procedure on adding or deleting IP addresses.

**Maintenance Alerts** If you have a SuperStack 3 NBX system with disk mirroring or dual power supplies and with NBX Messaging enabled, you can:

- Configure maintenance alert voice mail messages so that they appear to come from one NBX system user.
- Designate up to 15 NBX system users to receive maintenance alerts.



*Alert messages are defined by the NBX system. The content depends on the cause of the alert.*

When a user receives a maintenance alert message, the source of the message depends on whether you have configured an NBX system user as the author of maintenance alert messages. See [Table 36](#) for details.

**Table 36** Source of Maintenance Alert Messages

Message Type	Author Configured	No Author Configured
Local Voice Mail Message	The configured system user is announced as the sender of the message.	An <i>outside caller</i> is announced as the sender of the message.

**Table 36** Source of Maintenance Alert Messages (continued)

Message Type	Author Configured	No Author Configured
Offsite E-mail Message	The name of the configured system user appears in the <i>From</i> field of the e-mail.	The <i>From</i> field in the e-mail contains the word <i>anonymous</i> .
Offsite Voice Mail Message	The system user is announced as the sender of the message.	An <i>outside caller</i> is announced as the sender of the message.

To set maintenance alerts:

- 1 Log on to the NBX NetSet utility using the administrator login ID and password.
- 2 Click *System Configuration > System Settings > Maintenance Alerts*. See the Help for procedures on setting the maintenance alert author and specifying users to receive maintenance alerts.

## Speed Dials

You can create up to 100 System Speed Dial numbers. You can also create system speed dial and personal speed dial button definitions and assign them to groups. Do not confuse speed dial codes with extension numbers.

Any telephone in a Telephone Group has access to the same button definitions. Users can create personal speed dial definitions for buttons that do not already have a button mapping. Users can also change definitions for any buttons mapped as personal speed dial buttons, even if those buttons are defined in the Group Button Mappings.

System speed dial numbers are not subject to Class of Service (CoS) restrictions, so a speed dial number mapped to a number that is a toll call is available to users even if their CoS does not allow toll calls. Personal speed dial numbers are subject to CoS.

To set up system speed dials:

- 1 Log on to the NBX NetSet utility using the administrator login ID and password.
- 2 Click *System Configuration > Speed Dials*. See the Help for these speed dial procedures:
  - Adding or modifying a system speed dial
  - Removing a system speed dial
  - Printing system speed dials

---

**Business Identity**

You can configure information about your business, such as business address and hours, including time of day service modes. You can also view the current mode and force the system into a different mode.

To enter business information:

- 1 Log on to the NBX NetSet utility using the administrator login ID and password.
- 2 Click *System Configuration > Business Identity*. See the Help for procedures to modify these types of information:
  - Business information
  - Business hours
  - System mode

**Business Information**

You can enter basic information about your business on this dialog box, including name, address, and telephone and Fax numbers.

**Business Hours**

The business hours dialog box allows you to define business hours for three separate times of day, or service, modes: *Open*, *Lunch*, and *Other*. Any time period that does not fall within these specified hours is considered *Closed*. Business hours are directly linked to time-of-day service modes and can affect other settings in the system, such as the Auto Attendant.

You can manually specify that the system operate in a given mode, or set it to operate automatically. See "[System Mode](#)" next. If the system is left in an automatic state, it constantly compares the current time of day and day of week with the business hour tables. The system knows the current day of the week and proceeds across the tables in a sequential manner, looking for business hours that match the current time of day. The system examines the three tables sequentially: first the *Other* mode, then the *Lunch* mode, and then the *Open* mode. The system moves across the tables until it finds a match. It skips a blank table.

**System Mode**

You can specify that the system operate in a given mode, or set it to operate automatically. If necessary, you can force the system into a specific Time of Day Service mode without changing other system settings, such as Business Hours. If the system is left in an automatic state, it constantly compares the current time of day and day of week with the business hour tables.

---

## Security

The Security tab enables an administrator to manage NBX passwords. The most common use is to reset a user's forgotten password.

To set system passwords:

- 1 Log on to the NBX NetSet utility using the administrator login ID and password.
- 2 Click *System Configuration > Security*. See the Help for procedures on changing these types of passwords:

- **Change Administrator Password** — Resets the password for administrator access to NBX NetSet.

After you change an administrator password, write it down and store it appropriately. There is no "back door" password to use if this password is lost. If you change the default 4-digit password to an 8-digit or longer password, you cannot revert to a 4-digit password.

- **Reset User Password** — Resets the password to a user's telephone extension. After you reset the password, instruct the user to change to a new password as soon as possible to ensure system security.
- **Auto Attendant Password** — Limits access to Auto Attendant settings and functions.
- **System Backup Password** — Enables automated backups from an external system.
- **Reporting Password** — Limits access to Call Detail Reports, an optional component of the NBX system. See ["Call Reporting"](#) on [page 309](#) for more information.
- **Virtual Tie Lines Password** — Enables calls over virtual tie lines to "hop off" after they reach the destination NBX system. The call then appears to originate at the destination NBX system. See [Chapter 2](#) for more information on setting up VTLs.
- **Reset Password for a Hunt Group** — The password for the Hunt Group is reset to the extension number of the Hunt Group.
- **Reset Password for a TAPI Route Point** — The password for the TAPI Route Point is reset to the extension number of the Route Point.

---

## TAPI Settings

You must configure system-wide Telephony Application Programming Interface (TAPI) settings before users can download the NBX TAPI Service Provider (NBXTSP). NBXTSP enables a TAPI application on a user's PC to interact with the user's NBX telephone. You can set a maximum number of TAPI clients in the system. You can also require users to enter passwords for TAPI devices.

Before you configure system-wide TAPI settings, install the appropriate TAPI software. After you have the software installed, select *System Configuration > TAPI Settings* to configure TAPI settings. See the System Configuration Help for procedures on configuring TAPI settings. See the Downloads Help for procedures on downloading NBX TSP software.



*The System Configuration TAPI settings do not apply to TAPI Route Points. For security reasons, the NBX system always requires that an external application supply a password to access a TAPI Route Point.*

---

## Disk Mirroring

The SuperStack 3 NBX Solution supports disk mirroring, using RAID1 technology, to provide data security and throughput speed. When the mirror disk is fully partnered with the master system disk, all data that is written to the master disk is also written to the mirror disk. If data is read from disk, the software has the option of reading from either disk, which can improve data access times.

If either disk fails in a fully mirrored system, the system software switches to use only the remaining good disk, and system operation continues. Status information is available on the Call Processor front panel LEDs to indicate when a disk has failed and which disk to replace. After you replace a failed disk and restart the system, the software starts bringing the new disk up to a fully mirrored state. The system typically takes from 30 to 90 minutes to complete the mirroring process, depending on the amount of data on the master disk.

### Adding a Mirror Disk

If your SuperStack 3 NBX system uses a single disk, you can add a mirror disk. The disk you add must have at least the same storage capacity as the disk in the system. You must obtain a disk mirroring license to convert a single-disk system to use disk mirroring. You need a Phillips screwdriver to complete this process.



**CAUTION:** Adding a mirror disk involves a system database backup and a system shutdown. 3Com advises that you add a mirror disk during nonbusiness hours.

To add a mirror disk:

- 1 Back up the database on the system.
  - a Select *Operations > Manage Data*.
  - b Click *Backup* and specify a location for the backup file.
- 2 Install the disk mirroring license.
  - a Obtain the license key from your dealer.
  - b Select *Operations > Licenses > Add License*.
  - c Type the license key in the two license key fields.
  - d Click *OK*.
- 3 Shut down the system by selecting *Operations > Reboot/Shutdown > Shutdown*.
- 4 Install the second disk drive.
  - a Unlock the disk tray.
  - b Unscrew the two retaining screws.
  - c Remove the disk tray.
  - d Connect the IDE disk cable to the disk drive.
  - e Connect the power harness to the disk drive.
  - f Fasten the new disk to the disk tray using your Phillips screwdriver and the screws provided with the disk.
  - g Reinsert the disk tray.
  - h Screw in the two retaining screws and lock the disk tray in place.
- 5 Restart the system.
- 6 Verify that the disks begin the mirroring process.

On the Call Processor front panel, check the four LEDs under the PWR and S1 labels. The LEDs labeled 1, 2, and 3 ([Figure 21](#)) indicate disk status.

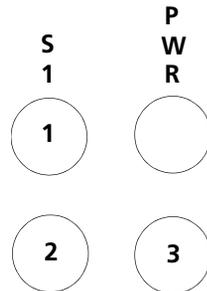
**Figure 21** Disk and Power LEDs

[Table 37](#) describes the possible states of the LEDs.

**Table 37** Disk LED States

Explanation	LED 1	LED 2	LED 3	PWR
Attempting to boot from disk 0 (zero)	Off	On	Off	On
Attempting to boot from disk 1	Off	Off	On	On
Boot process completed, system initializing	Flashing	N/A	N/A	On
System is running	On	N/A	N/A	On
Flash codes indicate disk problem:	N/A	Flashing	Flashing	On
<ul style="list-style-type: none"> <li>■ <b>2 flashes:</b> No valid disk (system is halted)</li> <li>■ <b>3 flashes:</b> Two valid disks, but they are not paired (system is halted)</li> <li>■ <b>4 flashes:</b> Configuration problem (system is halted)</li> <li>■ <b>5 flashes:</b> Two disks present, but no mirroring license</li> </ul>				
Using disk 0 (zero) only	N/A	On	Off	On
Using disk 1 only	N/A	Off	On	On
Synchronizing — disk 0 is valid, disk 1 is becoming a fully mirrored disk. LED 3 flash rate indicates progress.	N/A	On	Flashing	On
If LED 3 stops normal flashing and intermittently flashes twice, the mirroring process has failed.				
Synchronizing — disk 1 is valid, disk 0 is becoming a fully mirrored disk. LED 2 flash rate indicates progress.	N/A	Flashing	On	On
If LED 2 stops normal flashing and intermittently flashes twice, the mirroring process has failed.				

**Table 37** Disk LED States (continued)

Explanation	LED 1	LED 2	LED 3	PWR
LED 2 and LED 3 flash alternately: the two disks are resynchronizing	N/A	Flashing	Flashing	On
Synchronized	N/A	On	On	On

### Verifying a Failed Disk Drive

If either disk fails while in a fully mirrored state, the system continues to operate. The disk LED states described in [Table 37](#) indicate which drive has failed. In addition, the Disk Status window in NBX NetSet shows the status of your disk drives.

To verify the status of a disk drive:

- 1 Log on to the NBX NetSet utility using the administrator login ID and password.
- 2 Click *Reports > System Data > Disk Status*. See the Help for information on verifying disk status.

### Reverting to a Single-Disk System

If the disk mirroring is currently active, you can convert the system to operate with a single disk. You need a Phillips screwdriver to complete this process.

To revert to a single-disk system:

- 1 Use [Table 37](#) to determine which disk is the mirrored disk.
- 2 Shut down the system. In NBX NetSet, select *Operations > Reboot/Shutdown > Shutdown*.
- 3 Remove the mirrored disk drive:
  - a Unlock the disk tray.
  - b Unscrew the two retaining screws.
  - c Remove the disk tray.
  - d Disconnect the disk data cable from the mirrored disk drive.
  - e Disconnect the power harness from the mirrored disk drive.
  - f Unfasten the mirrored disk from the disk tray using the Phillips screwdriver and the screws provided with the disk.
  - g Reinsert the disk tray.
  - h Screw in the two retaining screws and lock the disk tray in place.

- 4** Restart the system.
- 5** Remove the disk mirroring license from NBX NetSet:
  - a** Select *Operations > Licenses > Remove License*.
  - b** In the *Remove License* dialog box, select *Disk Mirroring License* from the list.
  - c** Click *OK*.



# 6

## NBX MESSAGING

This chapter describes how to configure these features of NBX Messaging:

- [NBX Voice Mail](#)
- [Auto Attendant](#)
- [Voice Profile for Internet Mail](#)



*If you have installed a third-party messaging system, the NBX Messaging screen is not available in the NBX NetSet utility. Follow the documentation for your voice messaging system.*

---

### **NBX Voice Mail**

You use the NBX Voice Mail tab on the NBX Messaging screen to configure system-wide settings for users' voice mailboxes. When you add new users to the system, the system creates a mailbox for each user. Users must record a name announcement, a personal greeting, and create a password before they can retrieve their messages.

The system also creates mailboxes for extensions that are not associated with a particular telephone, such as hunt group extension or a TAPI route point extension.

To configure system-wide voice mail settings, select *NBX Messaging > NBX Voice Mail*. See the Help for instructions.

[Table 38](#) describes the fields on the NBX Voice Mail tab.

**Table 38** Voice Mail Settings

Field	Purpose
Max Number of Messages	<p>The number of messages, regardless of length, that an individual mailbox can have. A typical voice message lasts about 20 to 30 seconds.</p> <p><b>Default:</b> 30 messages</p> <p><b>Maximum:</b> 512 messages</p> <p><b>Minimum:</b> 1 message</p>
New Msg Retention (days)	<p>The maximum number of days that a new (unheard) message remains in a voice mailbox before the NBX system marks it for deletion. However, the message is not deleted until the end of this sequence of events:</p> <ul style="list-style-type: none"> <li>■ The user logs in.</li> <li>■ The NBX system informs the user that the message will be deleted.</li> <li>■ The user takes no action to prevent the deletion of the message.</li> <li>■ The user logs out.</li> </ul> <p><b>Default:</b> 30 days</p> <p><b>Maximum:</b> 1826 days (5 years)</p> <p><b>Minimum:</b> 1 day</p> <p><b>NOTE:</b> When a user listens to a new message or saves it, the system resets the time stamp for that message. The <i>Msg Retention</i> value (described next) controls when the system marks the message for deletion.</p>
Msg Retention (days)	<p>The maximum number of days that a message remains in the mailbox after a user has listened to it or saved it. The NBX system then marks the message for deletion. However, the message is not deleted until the end of this sequence of events:</p> <ul style="list-style-type: none"> <li>■ The user logs in.</li> <li>■ The NBX system informs the user that the message will be deleted.</li> <li>■ The user takes no action to prevent the deletion of the message.</li> <li>■ The user logs out.</li> </ul> <p><b>Default:</b> 30 days</p> <p><b>Maximum:</b> 1826 days (5 years)</p> <p><b>Minimum:</b> 1 day</p>

**Table 38** Voice Mail Settings (continued)

<b>Field</b>	<b>Purpose</b>
Max Incoming Msg Length (minutes)	The maximum length, in minutes, for any one message. <b>Default:</b> 5 minutes <b>Maximum:</b> 10 minutes <b>Minimum:</b> 1 minute
Voice Mail Compression Format	The system uses ADPCM as the voice mail compression format for voice prompts and messages.
On Disk Voice Mail Format	The system uses ADPCM as the compression format for voice prompts and mail on your disk.
Disable AA Transfer Prompt	Enables or disables the transfer prompt (" <i>Please hold while your call is transferred</i> ") when a call is transferred from the Auto Attendant. <b>Default:</b> disabled (unchecked)

### Additional Considerations

- The maximum length of a voice mail message is 10 minutes. If accumulated messages use up the system's message storage space before individual users reach their capacity limits, you should either lower the mailbox settings or upgrade your message storage option. Decreasing mailbox settings does not affect data already in storage. You can also encourage users to delete old messages.
- To view your system's current message storage capacity, select *Operations > Licenses*. The system displays the number of NBX Voice Mail/Auto Attendant ports and storage space (in hours on an NBX 100 system). The number of ports determines how many voice mail sessions and Auto Attendants can be in use simultaneously.
- Each voice mail extension (port) enables one voice message session. If all voice mail extensions are in use, call behavior differs depending on the operation. If the Attendant Console is forwarding calls to the Auto Attendant, and all voice mail extensions are in use, a caller from outside the system hears ringing but no answer until an extension is free. If an internal user transfers a caller to voice mail, but no voice mail extensions are available, the call rings back to the caller's extension.
- As the administrator, you can configure voice mail extensions, settings, passwords, and off-site notification. The NBX NetSet utility

also offers reports on the status and usage of voice mail ports and voice mail storage usage by user. For details, see these sections:

- [Voice Mail Extensions](#)
- [Voice Mail Passwords](#)
- [IMAP for Integrated Voice Mail](#)
- [Off-Site Notification](#)
- [Status](#)
- [Port Usage](#)
- [User Usage](#)

**Voice Mail Extensions** The number of voice mail ports on your system determines the number of voice mail sessions that can take place at one time. The default NBX system includes 4 voice mail ports. You can purchase a license for additional capacity. Each voice mail port has an extension number. See [“Extension Settings Overview”](#) on [page 52](#) for more information.

**Voice Mail Passwords** To retrieve voice messages, a user must log on using the extension number and password. The password, a 4-digit to 10-digit number, allows access to Personal Settings in the NBX NetSet utility and to voice mail from the telephone.

- The user can change the password from the telephone or by logging in to the NBX NetSet utility
- The administrator can reset a user password to the user’s extension number. See [“Security”](#) on [page 252](#) for information on Security features.
- For more information about the menus and features available to users, see the *NBX Telephone Guide* and the Help available on User screens in the NBX NetSet utility.

**IMAP for Integrated Voice Mail** NBX Voice Mail uses an Internet Message Access Protocol (IMAP) server, which enables users to access and manage their voice messages through any IMAP-compliant e-mail client. As the administrator, you may need to help users to configure e-mail clients.

Voice mail messages can be sent as mail messages with .WAV file attachments. Double-clicking an attachment activates the computer’s media player, and the voice message plays through the speakers or

earphones on the user's computer. After the user listens to a message, it loses its "new" status, but it remains on the server until the user deletes it using the IMAP e-mail client, the telephone, or the Personal Settings screen in the NBX NetSet utility, or until the system deletes it when it is older than the system limit (after a warning message to the user). The computer used to receive messages must support multimedia.

Users cannot compose new voice mail messages through their IMAP e-mail client. They must use their NBX Telephones.

To process both e-mail and voice mail on one computer, the user needs:

- An e-mail client that can connect to two servers
- OR
- Two instances of the e-mail client

Each e-mail client has a unique configuration interface, so the following procedure is presented in general terms only. See your e-mail client's documentation to determine how to accomplish a specific task.

### Setting Up an e-mail Client to Access Messages

- 1 Determine if the e-mail client can communicate with an IMAP 4 server.

Some versions of Microsoft Outlook and Outlook Express, Netscape, and Eudora support IMAP. Check the documentation that came with your e-mail program to determine if it supports IMAP.

- 2 Set the *Incoming Mail Server* to the IP address or to the host name of your NBX system.

Set the *Outgoing Mail Server* to the mail server in use for regular e-mail.



*The NBX IMAP server cannot perform address translation, so you cannot use the NBX system as your company e-mail server.*

- 3 If necessary, identify the server type as *IMAP*.
- 4 For the username, specify the user's telephone extension number. For the password, specify the user's NBX voice mail password.

**Off-Site Notification** Off-site Notification can notify users by pager, e-mail, or telephone when they receive a new voice mail message. Users can specify the methods by which they receive notification.

You can configure these system-wide Off-site Notification settings:

- Enable or disable Off-site Notification for the entire system
- Set the maximum number of out-calling ports
- Assign an out-dialing prefix for Off-site Notification

To configure Off-site Notification, select *NBX Messaging > NBX Voice Mail > Off Site Notification*. See the Help for the procedure on setting up Off-site Notification.

### Notes About Off-Site Notification

- To allow users to take advantage of Off-Site Notification, verify that Off-Site Notification is enabled in System-wide Settings, the group Class of Service settings, and by the individual user. For Off-Site Notification to work correctly, it must be enabled in all these locations. To change group Class of Service settings, select *User Configuration > CoS > CoS Group Name > Modify*.
- Before Off-Site Notification can send e-mail, you must define an SMTP Domain Name and one or more valid Domain Name Servers. These settings are configured in *System Settings > System-wide*.
- If users choose *Pager* or *Voice Mail* as the *first* notification method, they are notified only of the *first* new message they receive after the time they have most recently logged in to their voice mailbox. They are not notified each time they receive a new message. The next time they log on to their voice mailbox, Off-Site Notification is re-enabled.
- If users choose *EMail* as the *first* notification method, they receive a notice for each message. The message is attached to the e-mail as a .WAV file. If users configure *any* method in any of the remaining four attempt lines, each specified method is also attempted for each new voice mail message.
- If you configure more than one notification attempts, you must configure them in order. For example, if you configure three attempts, you must configure them on lines 1 through 3, with no unconfigured lines in between.

- If you disable NBX Messaging in favor of another messaging application, the *Off-Site Notification* button on the *Voice Mail* tab is disabled.

[Table 39](#) provides details on Off-site Notification fields.

**Table 39** Systemwide Settings Fields

Field	Purpose
Enabled	<p>Check the box to enable Off-site Notification throughout the system. By default, Off-site Notification is disabled.</p> <p>If you select Enabled, you must also enable Off-site Notification in these locations:</p> <ul style="list-style-type: none"> <li>■ Class of Service Settings. See “Configuring Class of Service” in Chapter 4.</li> <li>■ User’s personal settings. See “Off-Site Notification” in the <i>NBX Telephone Guide</i>.</li> </ul>
Max Out-calling Ports	<p>The number of voice mail ports available for simultaneous use by Off-site Notification. This parameter can be configured up to the number of voice mail ports licensed for the NBX system. The system ships with 4 ports; you must purchase an upgrade license to enable additional ports.</p>
Out-dialing Prefix	<p>A prefix used by every call made by Off-Site Notification.</p> <p>If this setting is empty, the call uses only the information specified by the user.</p>

**Status** To view the status of all voice mail ports on your NBX system, click the *Status* button.

In the status window, to reset a voice mail port, select it and click Reset.

[Table 40](#) explains the information in the Status window.

**Table 40** Fields in the Status Window

Column	Purpose
Ext.	The extension associated with the voice mail port.
Name	The name associated with the voice mail port.

**Table 40** Fields in the Status Window (continued)

Column	Purpose
Used By	<p>The person or device that is using the voice mail port.</p> <p><b>Values:</b></p> <ul style="list-style-type: none"> <li>■ Extension number, name — An internal user is using the voice mail port. The user's extension number and name appear in this column.</li> <li>■ Auto Attendant — The automated attendant is using the port.</li> <li>■ Blank — The port is not being used. The word <i>Idle</i> appears in the <i>In Use</i> column.</li> </ul>
In Use (Secs)	<p>The length of time, in seconds, that the voice mail port has been in use.</p> <p>If the port is not in use, the word <i>Idle</i> appears in this column.</p>
On Hold	<p>Indicates whether the voice mail port is on hold. Voice mail ports can be placed on hold in the same way that a call can be placed on hold.</p> <p><b>Values:</b> Yes, No</p>

**Port Usage** To help you determine how busy the NBX system's voice mail ports are, and whether additional ports may be necessary, click the *Port Usage* button. Click the Help button in the Port Usage screen for details about the fields in the report.



*If a parameter in the Port Usage window turns red, the NBX system is alerting the system administrator that a problem exists. For example, if "Missed messages caused by full mailboxes" turns red, it may be time to increase the maximum number of messages allowed per mailbox.*

**Figure 22** Port Usage Report

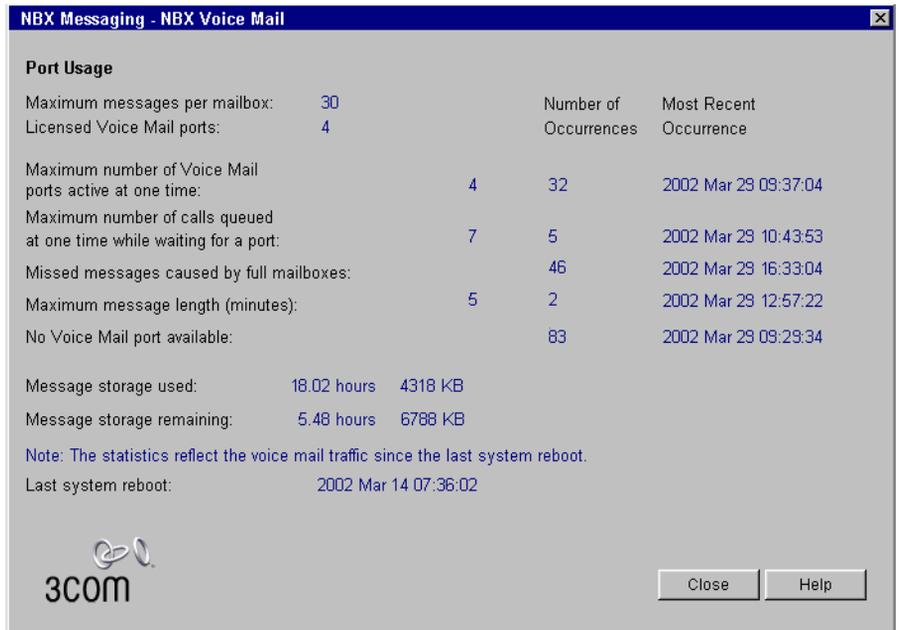

**User Usage** To help you determine the impact that users are having on the NBX voice mail voice mail system, you can click the *User Usage* button.

The User Usage report provides the current number of new and saved voice mail messages for each user and calculates the amount of storage each user's messages consume. This report lists any type of mailbox, including telephone, phantom, TAPI route point, and hunt group mailboxes.

**Deleting User Voice Mail**

From the User Usage report dialog box, you can also delete the voice mail messages for a selected user. Click the Help button in the User Usage screen for details about the fields in the report.



*The time required to delete a user's voice mail depends on the number of voice mail messages in the user's mailbox.*

---

## Auto Attendant

The NBX Messaging system includes an Auto Attendant that answers incoming calls. The Auto Attendant includes a series of recorded messages (prompts) describing actions that a caller can take to access individual services. You can customize the menu structure and record or import your own prompts to fit the system to your business needs. This section provides information on these topics:

- [Overview of Auto Attendant Features](#)
- [Adding an Auto Attendant](#)
- [Voice Application Setup Utility](#)
- [Testing the Auto Attendant](#)

### Overview of Auto Attendant Features

The Auto Attendant is the centerpiece of the voice mail system. The administrator can create and configure Auto Attendants, and can record or import messages and prompts to direct the actions of callers.

Use the NBX NetSet utility to administer and configure these Auto Attendant features:

- **Multiple Auto Attendants** — The system supports multiple, independent Auto Attendants. Different Auto Attendants can be assigned to different extensions, inbound lines or DID numbers. See [“Adding an Auto Attendant”](#) on [page 270](#) for more information.
- **Multiple-Level Menus** — Each Auto Attendant can support a main menu and up to 19 levels of submenus. This enables you to configure an automated system in which inbound callers can select specific departments or groups, and then further select subgroups or individuals. See [“Prompt Menus”](#) on [page 272](#) for more information.
- **Voice Prompts** — To the caller, the time-dependent greeting, main menu prompt, and submenu prompt are integrated into the Auto Attendant system. The administrator can customize the system by recording or importing voice prompts in a time-dependent greeting main menu, or submenu. Depending on the time of day and selections that the caller makes, the caller hears the appropriate prompts and receives appropriate directions.
- **Default Time-out** — If a caller does not respond to the Auto Attendant prompts (for example, a caller using a rotary telephone), the system routes the call to a designated time-out destination. See [“Prompt Menus”](#) on [page 272](#) for more information. (Note: if you do not specify a valid time-out destination for an Auto Attendant, the

system drops a call when it reaches the time-out value.) To set the default timeout, click *NBX Messaging > Auto Attendant > Menu Tree*.

- **Shortcuts** — Callers can move to a function without listening to an entire greeting or prompt. For example, if you call to leave a message for a person, you can bypass the greeting by pressing the appropriate shortcut button.
- **Dialing by Extension or Name** — A caller can reach a party either by dialing the person's extension or by using the telephone key pad to spell the person's name. The system plays the announcement of each person identified as a possible match and asks the caller to pick one.
- **Manual and Automatic Activation** — You can activate the Auto Attendant manually, by pressing the FWD MAIL button on the Attendant Console. The system also activates automatically, according to the Business Hours settings (see ["Business Hours"](#) on [page 251](#)), or after an incoming call exceeds a set number of rings. To set the number of rings, select *User Configuration > Users > User Settings > Call Forward*.
- **Routing Calls to Specific Auto Attendants** — You can use the dial plan to map Auto Attendants to specific extensions of analog telephones. This enables incoming calls to go directly to a specific Auto Attendant.
- **Voice Application Setup Utility** — From the NBX Business Telephone, you can use the Auto Attendant Voice Application Setup utility to set up these Auto Attendant features:
  - Button actions
  - Time-dependent greetings and schedule
  - Main menu greeting
  - Administrator's Auto Attendant password

For more information, see ["Voice Application Setup Utility"](#) on [page 282](#).

## Adding an Auto Attendant

The NBX system includes two Auto Attendants: the Default Menu (extension 500), which handles incoming calls, and the VoiceMail Menu (extension 501), for employee access to voice mail. These two Attendants cannot be deleted. The default Auto Attendant processes calls as soon as you install the system. When you add a new Auto Attendant, you are adding a “blank” Auto Attendant, which you can configure.

To add a new Auto Attendant, select *NBX Messaging > Auto Attendant > Add*, and then click *Add*.

[Table 41](#) describes the entries and checkbox that appear on the *Add Auto Attendant Menu* dialog box.

**Table 41** Add Auto Attendant Menu Fields

Field	Purpose
Name	In the <i>Name</i> field, enter the name of the new Auto Attendant.
Extension	<p>The next available extension is automatically assigned when you add a new Auto Attendant. You can change the extension number to an unused number that falls within the Auto Attendant extension range of your dial plan.</p> <p><b>Default range:</b>            3-digit dial plan: 500–599            4-digit dial plan: 5500–5599</p> <p>For both 3-digit and 4-digit dial plans, the default Auto Attendant is extension 500 and the voice mail Attendant is extension 501.</p>
Maximum number of prompt repeats	<p>Select the number of times the Auto Attendant prompt repeats. You can select a number from 1 through 3. The default is 3.</p> <p><b>CAUTION:</b> If Maximum number of prompt repeats is set to 1 and the time-out action for the Auto Attendant menu tree is set to Disabled, the system disconnects a call forwarded to the Auto Attendant because the forwarding party always hears a portion of the Auto Attendant prompt. Likewise, if the time-out action for the Auto Attendant Menu Tree is set to Disabled, and Maximum number of prompt repeats is set to 2 or 3, the system disconnects the forwarded call if the forwarding party stays on the line long enough to hear at least a portion of the final repeated prompt. To ensure that forwarded calls eventually reach a valid destination, you must configure a time-out action for each Auto Attendant menu tree.</p>

**Table 41** Add Auto Attendant Menu Fields (continued)

Field	Purpose
Use System-wide Greetings checkbox	If you select the <i>Use System-wide Greetings</i> check box, all three system-wide greetings (Morning, Afternoon and Evening) are used by default. To enable or disable individual system-wide greetings for a particular Auto Attendant, select the required Auto Attendant in the main Auto Attendant screen, click <i>Menu Tree</i> and then click <i>TD Greetings</i> .

After you add or modify an Auto Attendant, you can configure the following features:

- [Play/Record Extension](#)
- [Time-dependent Greetings](#)
- [Prompt Menus](#)
- [Auto Attendant Buttons](#)

### Play/Record Extension

The *Play/Record Extension* identifies the telephone where you can work interactively with the NBX NetSet utility to record and listen to Auto Attendant prompts. Typically, this is the extension of the person who is configuring and administering the Auto Attendant. An Auto Attendant prompt is simply an audio file (.WAV) that is associated with a specific Auto Attendant. It describes the actions a caller can take.

When you click the button in the NBX NetSet utility to record or play a prompt, the extension rings. When you answer it, you either hear the prompt you selected to play or you are prompted to record a prompt.



*You cannot customize any greetings or prompts until you have specified this extension.*

You can specify a play/record extension in any of these locations:

- *NBX Messaging > Auto Attendant*
- *NBX Messaging > Auto Attendant > Menu Tree > Prompt*
- *NBX Messaging > Auto Attendant > Menu Tree > TD Greetings*
- *NBX Messaging > Auto Attendant > System Wide Greetings*

See the Help for the procedure on specifying a play/record extension.

## Time-dependent Greetings

The system clock and the greeting schedule control when the system changes from one time-dependent greeting to the next. For example, the morning greeting might start at 12 midnight, the afternoon greeting would begin at noon, and the evening greeting might begin at 6 p.m. If time-dependent greetings are enabled, the caller hears the current active one before the main menu prompt.

You can create time-dependent greetings that are enabled on all Auto Attendants in your system. An example of this system-wide greeting would be “Good morning.” To record or to import system-wide time-dependent greetings and define the times during which they play, select *NBX Messaging > Auto Attendant > System-wide Greetings*.

See the Help for the procedures on setting up system-wide greetings.

You can also create and schedule time-dependent greetings for individual Auto Attendants. These greetings can be up to five minutes long. To record, import, or schedule customized time-dependent greetings, select *NBX Messaging > Auto Attendant > Menu Tree > TD Greetings*.

See the Help for the procedures on setting up time-dependent greetings.

## Prompt Menus

You can use a main menu and submenus of prompts to direct callers to individuals and services in your organization. You configure prompt menus for each Auto Attendant by using the *Menu Tree* dialog box. The *Menu Tree* dialog box consists of 13 button rows that you use to assign actions to the key pad buttons (see “[Auto Attendant Buttons](#)” on [page 277](#)). Be sure to define the menu time-out behavior so that if a caller does not respond to the Auto Attendant prompts (for example, a caller using a rotary telephone) the system automatically routes the call to a time-out destination.



**CAUTION:** *To ensure that forwarded calls eventually reach a valid destination, you must configure a time-out action for each Auto Attendant menu tree. For example, if the time-out action for the Auto Attendant menu tree is set to Disabled, and Maximum number of prompt repeats is set to 1, the system disconnects a call forwarded to the Auto Attendant because the forwarding party always hears a portion of the Auto Attendant prompt. Likewise, if the time-out action for the Auto Attendant Menu Tree is set to Disabled, and Maximum number of prompt repeats is set to 2 or 3, the system disconnects the forwarded call*

*if the forwarding party stays on the line long enough to hear at least a portion of the final repeated prompt.*

**Main Menus** The main menu prompt follows the time-dependent greeting if you have one enabled. The main menu prompt should describe all Auto Attendant options and can be up to five minutes long. The default Auto Attendant main menu prompt says:

*“If you know the extension of the party you want to reach, you may enter it at any time. To reach the name directory, press 9. To reach the Auto Attendant, press 0 or remain on the line. Thank you for calling.”*

By default, the Auto Attendant main menu provides callers with the functions that are described in [Table 42](#).

**Table 42** Auto Attendant Default Configuration

Button	Action
1–4	Identifies internal extension range and allows callers to dial user extensions.  <b>NBX 100:</b> 100–449 (See note 1) <b>SuperStack 3 NBX:</b> 1000–3999 (See note 2)
9	Goes to the Name Directory.
0	Performs a single-digit transfer to the extension specified in the menu tree for the auto attendant, usually the extension of the receptionist’s telephone. The default extension is the lowest extension specified in the factory default dial plan:  <b>SuperStack 3 NBX:</b> 1000 <b>NBX 100:</b> 100
*	Transfers to voice mail box.
#	Exits from the system.
T/O	Defines what happens when a call times out, typically, a transfer to the extension specified in the menu tree for the auto attendant, usually the extension of the receptionist’s telephone. You should always define a time-out action. If a call times and there is no time-out action defined, the system disconnects the call.

To create a main menu, select *NBX Messaging > Auto Attendant > Menu Tree*. To create or import voice prompts, select *NBX Messaging > Auto Attendant > Menu Tree > Prompt*. See the Help for these procedures.

**Submenus** An Auto Attendant main menu can branch to submenus to keep the main menu brief, and to give the caller a variety of choices. Each

submenu should have a prompt that informs the caller of the option that each key pad button provides.

If you have a large organization, the caller may have to enter several digits and listen to several submenus before reaching the person or department. For example, the caller may hear:

"To reach our Sales Department, press 1. For Technical Support, press 2..."

The caller selects option 1 for sales and hears:

"For European Sales, press 1. For North American sales, press 2."

The caller requires North American sales, presses 2, and is connected to a sales hunt group.

To configure submenus, select *NBX Messaging > Auto Attendant > Menu Tree*. See the Help for procedures on setting up submenus.

For an example that uses submenus, see ["Three Greetings, a Main Menu, and a Submenu"](#) in the next section.

### Examples

These examples illustrate some typical Auto Attendant systems. They illustrate the kind of information that you might include in your time-dependent greetings, main menu prompts, and submenu prompts.

**No Greetings** [Figure 23](#) shows the simplest configuration. The time-dependent greetings are disabled; the Main Menu contains all of the prompts. In Example 1, callers hear the same message no matter what time they call.

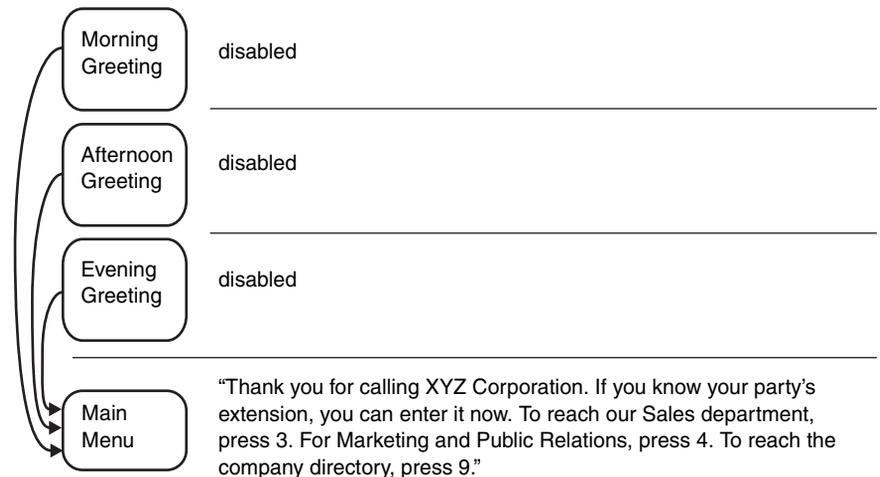
**Figure 23** No Time-dependent Greetings, All Prompts in Main Menu

In this example, the main menu is configured to have button 3 mapped to a Sales submenu and button 4 to a Marketing and Public Relations submenu. Button 9 is mapped to the Name Directory.

**Three Greetings and a Main Menu** [Figure 24](#) shows a simple Auto Attendant that uses time-dependent greetings to provide different messages for different times of the day.

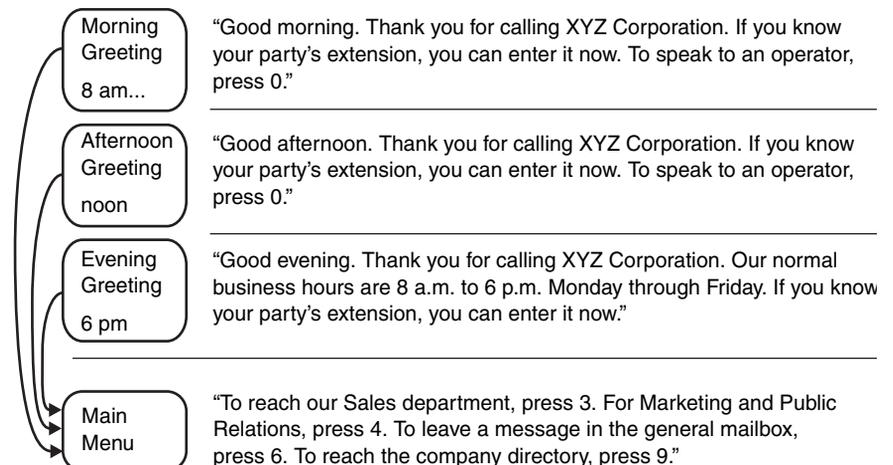
**Figure 24** Three Time-dependent Greetings and Main Menu

In [Figure 25](#), the morning greeting starts at 8 a.m. and is active until the afternoon greeting begins at noon. The evening greeting begins at 6 p.m.

The function that you allocate to a button on the keypad remains the same throughout the day.

**Three Greetings, a Main Menu, and a Submenu** [Figure 25](#) shows an example that uses time-dependent greetings, a Main Menu, and a Submenu.

**Figure 25** Three Time-dependent Greetings, a Main Menu and a Submenu

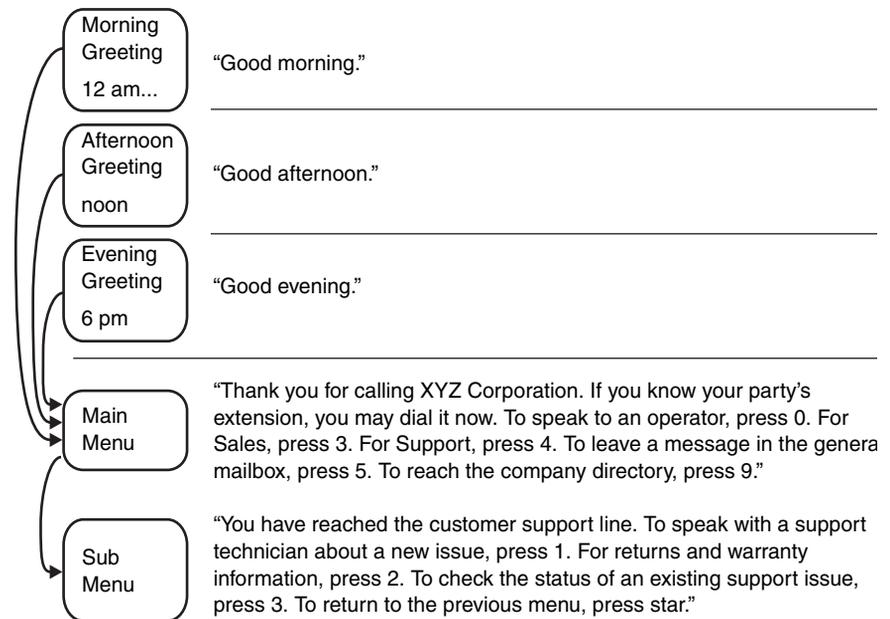

This example uses time-dependent greetings to greet callers according to the time of day. The main menu prompt presents callers with options for reaching the operator, specific departments, or the company directory of names. It also uses a submenu to direct callers to subgroups within the Support department.

## Auto Attendant Buttons

From the *Menu Tree* dialog box, you can configure the key pad button actions presented to a caller by the Auto Attendant. For examples of how you can use prompts and greetings in an Auto Attendant, see [“Examples”](#) on [page 274](#). [Table 43](#) describes the fields of the Menu Tree dialog box.

**Table 43** Menu Tree

Field	Purpose
Button	Lists the buttons on the telephone key pad.
Task Description	Describes the key pad button operation. If you assign the <i>Enter Submenu</i> action to the button, this description is used as the Submenu name.
Action	Contains a drop-down list box that lists the actions you can assign to a key pad button. The Auto Attendant prompts callers to press buttons to perform specific actions. You must configure the Menu Tree to so that each button performs the proper action.  For a complete list of button actions, see <a href="#">Table 44</a> .
Value	Describes the value associated with each key pad button action. For a complete list of key pad button actions, see <a href="#">Table 44</a> .

You can assign keypad actions to each button on a typical telephone key pad, 0 through 9, #, and \*. [Table 44](#) describes the actions you can assign to buttons. Most systems use no more than five action choices to avoid confusing callers. If you need to present more than five choices, use submenus to configure these additional options. See [“Submenus”](#) on [page 273](#).



*You can create an unannounced option by mapping a button without creating a corresponding prompt. Callers do not hear a message that the choice is available.*

**Table 44** Button Actions

Action	Description
Disabled	<p>The system takes no action when the user presses that button. A prompt announces “invalid key.”</p> <p>If assigned as a menu time-out action (T/O), Disabled either leaves the system or goes to a parent menu, depending on where the attendant is in the menu hierarchy.</p> <p><b>CAUTION:</b> If the time-out action for the Auto Attendant menu tree is set to <i>Disabled</i>, and <i>Maximum number of prompt repeats</i> is set to 1, the system disconnects a call manually forwarded to the Auto Attendant because the forwarding party always hears a portion of the Auto Attendant prompt and the system then performs the time-out action. Likewise, if the time-out action for the Auto Attendant Menu Tree is set to <i>Disabled</i>, and <i>Maximum number of prompt repeats</i> is set to 2 or 3, the system disconnects the forwarded call if the forwarding party stays on the line long enough to hear at least a portion of the final repeated prompt. To ensure that forwarded calls eventually reach a valid destination, make sure you have configured a time-out action for the top-level Auto Attendant menu tree.</p> <p><i>Value</i> — Not used.</p>
Name Directory	<p>Transfers the user to the name directory, which allows a caller to reach a person by spelling the person’s name on the dialpad. The system matches the letters entered by the caller to a Last Name in the list of User Profiles. If the system finds more than three matches, it prompts the caller to enter more letters. When the system narrows the choice to three or fewer, it offers the caller a choice by playing the recorded name greeting of each choice. During a search, the system ignores any User Profile that does not have a recorded greeting.</p> <p><i>Value</i> — Not used.</p>
System Disconnect	<p>Allows the caller to have the system close the connection. This feature can save time for callers who call into the system using a calling card. By having the system disconnect them instead of breaking the connection themselves, callers can make other calls without re-entering all of their calling card information. To activate System Disconnect, the user must press the key defined in the menu and then, when prompted, the key defined in the Value box. Typically, you do not include these instructions in the Auto Attendant prompt, which is heard by all callers. Instead, you make your system users aware of this sequence.</p> <p><i>Value</i> — Any of 0-9, #, *</p>

**Table 44** Button Actions (continued)

Action	Description
Transfer to Voice Mail	Allows callers to leave a voice message for a person without ringing that person's phone, or allows users to call in and listen to their voice mail from a remote location.  <i>Value</i> — Not used.
Exit Menu	Available in submenus only. Allows the caller to return to the next menu up in the menu tree.  <i>Value</i> — Not used
Prompted Transfer	Instructs callers to press a button before dialing a known extension. The prompt should include a message something like this: "If you know your party's extension, press 5, and then dial the extension."  <i>Value</i> — Not used.
Reserved in Dial Plan	Interprets a specified button as the first number of an extension. For example, in the default 4-digit dial plan, extensions begin at 1000, so you could not use 1 as an option for an Auto Attendant menu.  <i>Value</i> — Not used
Single Digit Transfer	Allows a caller to reach a specific destination by pressing a specific button.  For example, you could assign button 6 to a hunt group extension in the Sales Department. In the menu prompt, you would record: "To reach our Sales Department, press 6." You could also use Single Digit Transfer to specify a destination, typically the Attendant Console extension, for the time-out option (T/O).  By default, Single Digit Transfer can forward only to internal extension numbers. To transfer calls to an external number, you must first alter Table 2 of the dial plan (Incoming Table) to specify the external number.  <i>Value</i> — Any valid extension



**CAUTION:** Use care when allowing access to PSTN ports using Dial Plan Table 2, as this can create the possibility of toll fraud.

**Table 44** Button Actions (continued)

Action	Description
Enter Submenu	<p data-bbox="665 307 1282 491">Puts the caller into a submenu of options. When you assign the <i>Enter Submenu</i> action to a button and then click <i>Apply</i>, a down-arrow button appears to the right of the row. Click this down-arrow button to configure the submenu that you want to associate with the main menu. The entry in the <i>Task Description</i> field for this button becomes the submenu name.</p> <p data-bbox="665 508 1282 612">Submenu button actions include “Exit menu” to allow callers to return to the next highest menu. Otherwise, submenu button actions are identical with main menu button actions.</p> <p data-bbox="665 630 1282 656">Each menu can have up to 20 levels of submenus.</p> <p data-bbox="665 673 1282 725">For an example that uses submenus, see <a href="#">“Three Greetings, a Main Menu, and a Submenu”</a> on <a href="#">page 276</a>.</p> <p data-bbox="665 743 1282 760"><i>Value</i> — Not used</p>

To configure telephone buttons, select *NBX Messaging > Auto Attendant > Menu Tree*. See the Help for procedure on configuring telephone buttons for Auto Attendant actions.

### Activating Changes

After you modify a greeting or prompt (or any Auto Attendant setting), you must activate these changes in the Auto Attendant before they become effective. The characters “!>” next to an Auto Attendant in the list on the Auto Attendant tab indicate that an Auto Attendant must be activated.



*This procedure is very important. If you change an Auto Attendant, clicking Apply does not implement the changes.*

To activate changes, select *NBX Messaging > Auto Attendant > Activate*. See the Help for more information on activating changes to Auto Attendants.

### Managing Auto Attendants

This section describes additional ways in which you can manage Auto Attendants.

- [Modifying an Auto Attendant](#)
- [Removing an Auto Attendant](#)
- [Restoring Auto Attendant Greetings](#)

## Modifying an Auto Attendant

To modify an Auto Attendant, select *NBX Messaging > Auto Attendant > Modify*. See the Help for procedures on modifying Auto Attendants.

[Table 41](#) describes the entries and checkbox that appear on the Modify Auto Attendant Menu dialog box.

**Table 45** Modify Auto Attendant Menu Dialog Box

Field	Purpose
Name	Edit the name of the Auto Attendant.
Extension	<p>Edit the extension number by changing it to an unused number that falls within the Auto Attendant extension range of your dial plan.</p> <p><b>Default range:</b>            3-digit dial plan: 500–599            4-digit dial plan: 5500–5599</p> <p>For both 3-digit and 4-digit dial plans, the default Auto Attendant is extension 500 and the voice mail Attendant is extension 501.</p>
Maximum number of prompt repeats	Edit the number of times the Auto Attendant prompt repeats. You can select a number from 1 through 3. The default is 3.
	<p> <b>CAUTION:</b> If the time-out action for the Auto Attendant menu tree is set to Disabled, and Maximum number of prompt repeats is set to 1, the system disconnects a call forwarded to the Auto Attendant because the forwarding party always hears a portion of the Auto Attendant prompt and the system then performs the time-out action. Likewise, if the time-out action for the Auto Attendant Menu Tree is set to Disabled, and Maximum number of prompt repeats is set to 2 or 3, the system disconnects the forwarded call if the forwarding party stays on the line long enough to hear at least a portion of the final repeated prompt. To ensure that forwarded calls eventually reach a valid destination, make sure you have configured a time-out action for the Auto Attendant menu tree.</p>
Use System-wide Greetings	If you select the <i>Use System-wide Greetings</i> check box, all three system-wide greetings (Morning, Afternoon and Evening) are used by default. To enable or disable individual system-wide greetings for a particular Auto Attendant, select the required Auto Attendant in the main Auto Attendant screen, click <i>Menu Tree</i> and then click <i>TD Greetings</i> .

## Removing an Auto Attendant

To remove an Auto Attendant, select *NBX Messaging > Auto Attendant > Remove*. See the Help for procedures on removing an Auto Attendant.



*You cannot remove the Default Menu Auto Attendant or the Voice Mail Auto Attendant.*

### **Restoring Auto Attendant Greetings**

You can restore the greetings to their default values:

- *aamenu.wav* and *aamenu2.wav* prompts
- System-wide Morning, Afternoon and Evening greetings

This feature restores *all* of these prompts and greetings at the same time.



*No other user-defined prompt is affected.*

To restore greetings, select *NBX Messaging > Auto Attendant > Restore AA Greetings*. See the Help for procedures on restoring greetings.

### **Voice Application Setup Utility**

The Auto Attendant Voice Application Setup utility provides a series of voice prompts to guide you in configuring your Auto Attendant. You can access the setup utility through any NBX Business Telephone.

The Voice Application Setup utility is useful for making short-term changes to your Auto Attendant. For example, if you must close your office because of bad weather, you can edit the main menu and direct callers to a message telling them that your office is closed. However, you cannot use the Voice Application Setup to configure submenus. That must be done using the NBX NetSet utility. See [“Submenus” on page 273](#).

Although the setup utility lets you perform tasks in any sequence, 3Com recommends this sequence when setting up the system for first time:

- 1 Plan the system.
- 2 Create profiles (phantom mailboxes and destination extensions).
- 3 Start the Auto Attendant Setup utility.
- 4 Change the Auto Attendant Setup utility password.
- 5 Assign actions to key pad buttons.
- 6 Record greetings and main menu prompts.
- 7 Set the greeting schedule.
- 8 Review and test the system.

## Using the Voice Application Setup Utility

From an NBX telephone, you can use the Auto Attendant Setup Utility. Follow these steps:

- 1 Lift the NBX telephone handset, and then press the *MSG* button to access the Voice Mail system.
- 2 At the voice mail password prompt, press **\***.
- 3 At the voice mail extension prompt, dial **999** if you are using a 3-digit dial plan or **9999** if you are using a 4-digit dial plan.
- 4 Enter the Auto Attendant password. The default password is 0000. 3Com recommends that you change this password.  
**0000 press 1 to assign actions to dial pad key, 9 to record greetings, schedules, change password**
- 5 Follow prompts to assign key pad button actions, record and play back greetings, change the schedule (morning, afternoon, and evening) and change the Auto Attendant password.

## Testing the Auto Attendant

Before using your system, 3Com strongly recommends that you review and test it to verify that all features work as you intend. Use this checklist to verify that your system is ready:

- Do your recorded prompts match your key pad button actions?  
You can define key pad button actions through the NBX NetSet utility (see [“Auto Attendant Buttons”](#) on [page 277](#)) or through the Voice Application Setup utility.
- Do your time-dependent greetings become active at the times you want?  
If not, you can use the NBX NetSet utility (see [“Time-dependent Greetings”](#) on [page 272](#)) or the Voice Application Setup utility to change the start times of your morning, afternoon, and evening greetings.
- Do your single-digit transfers and transfer to the general mailbox take a caller to a valid destination?
- When callers reach a mailbox of a single-digit transfer and transfer to the general mailbox, do they hear an appropriate greeting?
- Is someone responsible for checking messages sent to single-digit transfers and transfer to the general mailbox?

- Do you get an “invalid key” message when you press a button that should not have an action assigned?
- Does the Auto Attendant time-out action perform the correct action? You should always have a time-out action for a top-level Auto Attendant menu tree. Leaving the time-out action set to *Disabled*, the default, can result in calls being disconnected.
- Do all of your submenu prompts match the submenu key pad button actions?

---

## Voice Profile for Internet Mail

Voice Profile for Internet Mail (VPIM) is an optional feature of the NBX system. You must enter a license key through the NBX NetSet utility before you can configure and use VPIM.

The NBX system transmits VPIM voice mail messages by attaching them to e-mail messages. The system then uses SMTP (Simple Mail Transfer Protocol) or ESMTP (Extended Simple Mail Transfer Protocol) to send the e-mail message and its VPIM attachment.

Using VPIM, users on an NBX system can send voice mail to a user on any voice mail system that is VPIM-compliant.

Using the NBX NetSet utility, you can configure several VPIM parameters and check VPIM status. See these sections for more information:

- [Control Parameters](#)
- [Operations Management](#)
- [Statistics](#)
- [Advanced Settings](#)



*VPIM uses an SMTP server that is embedded in the NBX operating system. To avoid abuse by spammers, an SMTP server should always be protected by a firewall. Configure the firewall to allow access to port 25 on the NBX system only from valid VPIM systems that need to deliver VPIM messages to the phone system. The NBX SMTP server is started only when the system has a valid license for VPIM.*

**Control Parameters**

To configure VPIM control parameters, select *NBX Messaging > VPIM*. See the Help for the procedure on configuring control parameters.

[Table 46](#) explains the VPIM control parameter fields and their purpose.

**Table 46** VPIM Tab Fields

Field	Purpose
Max message size	<p>Controls the size of incoming messages from other sites. If a message is larger than the specified value, the NBX system rejects it. The default value represents a voice mail message approximately 4 to 5 minutes in length.</p> <p><b>Default:</b> 3000 Kbytes  <b>Minimum:</b> 500 Kbytes  <b>Maximum:</b> 5000 Kbytes</p>
Time between send attempts (minutes)	<p>For outgoing messages, the NBX system may not be able to contact the target system on the first attempt. If so, the NBX system attempts to contact the target system later. To change the time between attempts to send a voice mail message, change this number.</p> <p><b>Default:</b> 15 minutes  <b>Minimum:</b> 1 minute  <b>Maximum:</b> 60 minutes</p>
Max number of send attempts	<p>To change the number of times the NBX system attempts to connect to the target system, modify the number (default is 4 attempts) in this text box.</p> <p>If the NBX system is unsuccessful in contacting the target system after the specified number of send attempts, the voice mail message is returned to the sender's voice mail box along with an indication that the message could not be sent.</p> <p><b>Default:</b> 4 attempts  <b>Minimum:</b> 1 attempt  <b>Maximum:</b> 10 attempts</p>

**Operations Management**

The *Operations Management* dialog box allows you to manage the queue of outgoing voice mail messages.

To select queue management parameters, select *NBX Messaging > VPIM > Operations Management*. See the Help for procedures on configuring queue management parameters.

[Table 47](#) contains a list of the fields within this dialog box along with a description of their purpose.



*Some commands require that operations be stopped or started. For example, to remove a message from the queue, you must first stop operations. Similarly, unless you start operations or they are currently running, you cannot use the “Send all messages now” command.*

**Table 47** Operations Management Dialog Box Fields

Field	Purpose
Operations status	The status of the queue of outgoing voice mail messages. <b>Possible values:</b> Ready, Starting, Processing, Stopped
Number of outgoing messages	The number of messages in the outgoing queue when this dialog box was last accessed or refreshed.
Time Waiting	The time that the voice mail message has been waiting in the queue.
# Attempts	The remaining number of attempts to send the message.
Sender	The IP address and extension of the user who sent the voice mail message.
Destination	The IP address and extension to which the voice mail message is to be sent.  If a message has multiple destinations, the first destination is listed, and three dots are displayed immediately after the extension number.  <b>Example:</b> 1057@192.168.15.135...
Remove	Select a voice mail message in the scroll list and click this button to remove the message from the queue. The NBX system prompts you to confirm that you want to delete the selected message.  To remove a block of messages, use Ctrl/Shift. Hold down the Ctrl key to select several non-contiguous messages for removal.
Send all messages now	The NBX system attempts to send all messages immediately, and changes the status of each successfully sent message to <i>Sent</i> .
Send all messages now and then delete them	The NBX system attempts to send all messages in the queue and deletes each message that is sent successfully.  If a message cannot be sent, it is also deleted.
Delete all messages now	The NBX system empties the queue of all messages
Stop operations	Stops the queue if it is currently active.
Start operations	Starts the queue if it is stopped.

**Statistics** The *Statistics* window allows you to view the most recent statistics for voice mail messages.

To view statistics, select *NBX Messaging > VPIM > Statistics*. See the Help for information on viewing VPIM statistics.

[Table 48](#) lists the fields in this window and explains their purpose.

**Table 48** Statistics Window Fields

Field	Purpose
Total messages received	Contains the number of messages received from voice mailboxes on other systems.
Total messages submitted for delivery	The number of voice mail messages in the queue.
Total messages queued for external delivery	The number of messages in the queue for delivery outside the system.
Total messages delivered to external recipients	The number of messages for which a confirmation of delivery has been received.
Total messages returned to sender on failed delivery	The number of messages that have been returned because they could not be delivered.
Failed messages	<p>The number of messages that never left the queue either because every attempt to deliver them failed and the retry limit was reached, or because the type of failure caused the retry limit to be ignored (example: a non-existent address would be tried only once).</p> <p>If a message has multiple destinations, the first destination is listed, and three dots are displayed immediately after the extension number.</p> <p><b>Example:</b> 1057@192.168.15.135...</p>
Reset	This button allows you to reset the message totals to zero and clear the listing of failed messages.
Last reset command	The date and time of the last reset command. If this field contains a more recent date and time than <i>Last system reboot</i> , then this is the date and time that the NBX system began collecting the currently displayed statistics.
Last system reboot	The date and time of the most recent reboot of the NBX system. An NBX system reboot resets all VPIM statistics to zero. If this field contains a more recent date and time than <i>Last reset command</i> , then this is the date and time that the NBX system began collecting the currently displayed statistics.

## Advanced Settings

The *Advanced Settings* dialog box allows you to control the behavior of SMTP and how it sends the e-mail messages with VPIM attachments.

To make SMTP settings, select *NBX Messaging > VPIM > Advanced Settings*. See the Help for information on SMTP settings.

[Table 49](#) lists the fields in this dialog box and describes their purpose.

**Table 49** VPIM Advanced Settings Dialog Box

Field	Purpose
SMTP OK response	<p><b>Definition:</b> The amount of time that the local system waits for an acknowledgement of a <i>From</i> message.</p> <p><b>Detail:</b> After the local system sends a <i>MAIL</i> command specifying the sender of the message, it waits for acknowledgement from the other site. The acknowledgement is an <i>OK</i> message.</p> <p><b>Minimum:</b> 5 minutes</p> <p><b>Default:</b> 5 minutes</p>
SMTP HELO response	<p><b>Definition:</b> The amount of time that the local system waits for an acknowledgement of a HELO message.</p> <p><b>Detail:</b> After the greeting, the local system sends either a HELO (or EHLO to get ESMTP) message to identify itself. The other site then responds with an acknowledgement of that message.</p> <p><b>Minimum:</b> None defined.</p> <p><b>Default:</b> 5 minutes</p>
SMTP EHLO response	<p><b>Definition:</b> The amount of time that the local system waits for an acknowledgement of a EHLO message.</p> <p><b>Detail:</b> After the greeting, the local system sends either a HELO (or EHLO to get ESMTP) message to identify itself. The other site then responds with an acknowledgement of that message.</p> <p><b>Minimum:</b> 0 minutes</p> <p><b>Default:</b> 5 minutes</p>

**Table 49** VPIM Advanced Settings Dialog Box (continued)

<b>Field</b>	<b>Purpose</b>
SMTP MAIL response	<p><b>Definition:</b> The amount of time that the local system waits for an acknowledgement of a MAIL command.</p> <p><b>Detail:</b> After the local system sends out a MAIL command along with the From information, it waits for a response from the other site to indicate that the MAIL command was received.</p> <p><b>Minimum:</b> 5 minutes</p> <p><b>Default:</b> 5 minutes</p>
SMTP RCPT response	<p><b>Definition:</b> The time that the local system waits for an acknowledgement of a RCPT command.</p> <p><b>Detail:</b> When the local system receives an SMTP or ESMTP message, it returns a RCPT command to the sending system for each recipient listed in the To: field.</p> <p><b>Minimum:</b> 5 minutes</p> <p><b>Default:</b> 5 minutes</p>
SMTP DATA response	<p><b>Definition:</b> The time that the local system waits for an acknowledgement of a DATA command.</p> <p><b>Detail:</b> After the local system has specified all of the recipient information, it sends a DATA command to indicate that it is ready to send the mail message itself. It then waits for the other site to acknowledge the DATA command.</p> <p><b>Minimum:</b> 2 minutes</p> <p><b>Default:</b> 2 minutes</p>
SMTP DATA END response	<p><b>Definition:</b> The time that the local system waits, after sending the entire message, for an acknowledgement from the other site that the message was received.</p> <p><b>Detail:</b> After the local system sends the entire message, it sends a single dot (ascii code 056) to the other site. It then waits for an acknowledgement from the other site that the dot has been received.</p> <p><b>Minimum:</b> 10 minutes</p> <p><b>Default:</b> 10 minutes</p>

**Table 49** VPIM Advanced Settings Dialog Box (continued)

Field	Purpose
SMTP RSET response	<p><b>Definition:</b> The time that the local system waits for an acknowledgement of a RSET command.</p> <p><b>Detail:</b> Maintaining a cached connection between the local system and any other site requires additional system resources compared to a non-cached connection. If connection caching is enabled, the local system waits for the defined time-out period and if no message is received, it sends a RSET command to the other site.</p> <p><b>Minimum:</b> None defined.</p> <p><b>Default:</b> 10 minutes</p>
SMTP QUIT response	<p><b>Definition:</b> The time that the local system waits for an acknowledgement of the QUIT command.</p> <p><b>Detail:</b> When the local system is finished transmitting a message and wants to break the connection, it sends a QUIT command. It then waits for the other site to acknowledge the QUIT command. When the acknowledgement arrives, or when the time-out value is reached, whichever comes first, the local system breaks the connection.</p> <p><b>Minimum:</b> None defined.</p> <p><b>Default:</b> 5 minutes</p>



# OPERATIONS

This chapter describes how to manage system-level operations for your NBX system.

You can perform these operations from NBX NetSet:

- [Software Upgrade](#)
- [Reboot/Shutdown](#)
- [Manage Data](#)
- [Event Log](#)
- [Licenses](#)
- [Regional Software](#)
- [Third-Party Drivers](#)

See the Help for the procedures for each function.

---

## Software Upgrade

As part of the upgrade and reboot process, you can choose to use your existing configuration data with the new version of the software or use a new (empty) database. NBX NetSet allows you to choose which software version to use when you reboot the system. The ability to select which version to boot allows you to restore an earlier operating environment (both software and configuration data) if you need to.



*Release 4.2 introduced NBS system software licensing. Be sure to review the information in the next topic, [System Software Licensing](#), before you upgrade your NBX system software.*

### Important Upgrade Notes

- To run NBX system software release R4.2 higher, you must install a license key.

- A license key is required only for upgrading to major releases, RX.X. All minor releases, RX.X.X, use the corresponding major release license key.
- To upgrade an NBX system to release R4.3 you must first upgrade to release R4.2.
- To upgrade an NBX system to release R4.2 you must first upgrade to release R4.1.
- A 4.3 license is valid for both a 4.1-to-4.2 upgrade as well as the 4.2-to-4.3 upgrade.
- When you upgrade the system software, do not enter any “cd...” commands using the terminal emulation software on a PC attached to the NBX Network Call Processor.
- When the software upgrade is complete, a new window, containing a confirmation message, appears in NBX NetSet.
- At certain times during an upgrade, the system reboots itself. Do not interrupt the reboot; wait until the upgrade is complete.
- Before you upgrade your system software, 3Com recommends that you back up your system data. (See [“Backup”](#) on [page 296](#).)
- If you are using NBX PC applications, such as pcXset, you must also upgrade these applications after upgrading the NBX software.
- If you are connected to the NCP COM1 port, you see the upgrade activity messages during the upgrade process, but you cannot issue any commands.
- After you upgrade your system software, you must reboot the system.

To upgrade or remove software:

- 1 Log on to the NBX NetSet utility using the administrator login ID and password.
- 2 Click *Operations > Software Upgrade*. See the Help for procedures on upgrading or removing software.

### **System Software Licensing**

To run release R4.2 and all later releases of the NBX system software on your NBX system, you must have and install a license. A license key is required only for upgrading to major releases, RX.X. All minor releases, RX.X.X, use the corresponding major release license key. All NBX systems that ship from the factory with software release R4.2 or any later release, include a license for the software version that is shipped with the system.

## Upgrading to R4.2 From a Previous Release

To upgrade an NBX system to release R4.2 you must first upgrade to release R4.1.

### Upgrading From R4.1.14 and Prior Releases

If your NBX system software is release R4.1.14 or a previous release, you cannot enter the license key for R4.2 before you upgrade because the NBX system software will not recognize the R4.2 license as valid.

Use these steps to upgrade to R4.2:

- 1 Upgrade to R4.2 in the usual way.
- 2 Reboot to R4.2.
- 3 When you see the warning message that indicates you must install a license, click the License button and install the R4.2 license.



*If you decide not to install the R4.2 license key, you can click the Reboot button and select a different release.*

### Upgrading From R4.1.15 and Later Versions

If you are running R4.1.15 or a later release of R4.1, you can enter the R4.2 license key and then upgrade. When you enter the license key, the NBX system software accepts the license key as valid for an unknown feature. When you upgrade and reboot to R4.2, the license for R4.2 takes effect.

### Upgrading From Release 4.2

If you are running R4.2 and you upgrade to a new NBX software version, the final step is to reboot the NBX system specifying the new release. At that time, the NBX software verifies that you have the proper license installed. If you have installed the license prior to the reboot, the upgrade is completed.

If you have not installed the correct license prior to the reboot phase of the upgrade, the NBX system provides a warning message and guidance on the appropriate action for you to take.

## Restricted Operation

If you reboot the NBX system without installing the required license, the NBX system remains operational with these restrictions:

- NBX NetSet is not available.
- Each NBX telephone display panel periodically displays a NO LICENSE message.
- Auto discovery is turned off for all device types.
- Voice mail messages are not allowed.
- The Automated Attendant software is not operational.
- The ability to configure user groups and Automated Attendants from a telephone is not operational.
- If you connect a PC to the NBX system COM1 port using a terminal emulation software application such as Hyperterm, the NBX system sends a message to the Hyperterm application indicating that a required software license has not been installed.



*If you log on using the administrator ID and password, a screen appears giving you two options:*

- *You can click the Reboot button to go to a reboot screen and reboot to a previous NBX software release.*
- *You can click the License button to go to a license screen and enter a license key for R4.2.*



*The installation of a valid upgrade license removes all restrictions without the need for an NBX system reboot operation.*

## Considerations

Some situations require specific actions because of the system software licensing mechanism.

### Chassis or Disk Tray Replacement

If you have an NBX 100 system and you need to replace the main system chassis for any reason, you must provide a valid license backup file to your 3Com NBX Voice-Authorized Partner. This file enables them to provide you with license keys equivalent to those that were associated with the replaced chassis.

If you have a SuperStack 3 NBX system and you need to replace the system disk tray for any reason, you must provide a valid license backup file to your 3Com NBX Voice-Authorized Partner. This file enables them to

provide you with license keys equivalent to those that were associated with the replaced disk tray.

### Licenses for Future Releases

If you purchase a license for a future NBX software release, all software releases up to that version are included. For example, if you purchase a license for release R5.0 and you are currently running R4.2, you can upgrade to any R4.X release without the need to purchase an additional license.

### Downgrading to Previous Releases

If you are running R4.2 with a valid system software license and you want to downgrade to a previous, unlicensed software version (for example, R4.0 or R4.1) you can do so by rebooting to the previous version. No other action is required.

### Customer Service

If you reboot to R4.2 without installing a valid license, and you run your system with the restrictions in place (see [“Restricted Operation”](#) on [page 294](#)), 3Com Customer Service cannot access the information required to help you with problems. To obtain assistance from 3Com Customer Service, you must either reboot to a previous version of the NBX system software or install a license for R4.2.

---

## Reboot/Shutdown

You must reboot the system after you upgrade software. You must shut down the system software before you turn off power to your NBX system.

To reboot or shutdown the system:

- 1 Log on to the NBX NetSet utility using the administrator login ID and password.
- 2 Click *Operations > Reboot/Shutdown*. See the Help for procedures on rebooting and shutting down the system.



**CAUTION:** *If you remove power from the NBX system without first shutting down the system software using the NBX NetSet Shutdown button, the operating system must perform a file system check during the next startup cycle to ensure file integrity. The file system check significantly increases the time it takes for the system to come to a ready state. During a file system check operation, the NCP status lights S1 and S2 flash in an alternating pattern.*

## Manage Data

This section describes these system data management operations:

- [Backup](#)
- [Restore](#)
- [Convert Database](#)
- [Purge Database](#)
- [Purge Database and CDR](#)
- [Purge All Voice Mail](#)

To perform data management operations, select *Operations > Manage Data*. See the Help for procedures on managing your system data.

### Backup

You can back up a database at any time. To ensure a successful restoration of your database, be sure that the version number of the backup file matches the version number of the system software. For example, to restore the data on a system running version R4.3.3, use a backup file from R4.3.3, not from R4.3.2 or lower. Many times, if you try to restore a database that was saved on an older release, you will succeed. However, if a database schema change has occurred between the old and new releases, the restore will fail.



**CAUTION:** 3Com does not support the restoration of a database from an older version of the 3Com NBX system software.

3Com recommends this backup policy:

- Back up your database before you upgrade the NBX system software.
- When you upgrade NBX system software, answer *Yes* when the software asks if you want to include the database in the upgrade process.
- After an upgrade, backup the database again.
- After you make any administrator-level configuration changes, backup the database.
- To ensure that you capture changes that users make to their personal settings, perform frequent, possibly daily backups.



*Voice mail messages are included in a backup of your system data only if you specify that you want them included. If voice mail was not included*

*when the system data was backed up, you cannot specify that you want to restore voice mail during a restore operation.*



*License backup operations are part of a separate backup operation.*

During a backup operation, a series of progress screens track the steps. Some steps may happen quickly enough that the status screen may not appear. For example, you may see the status screen appear to go from step 1 to step 4 if steps 2 and 3 are completed quickly.

The six steps in the backup process are:

- **Backing up NBX Database** — The databases are locked during this step. The status bar shows step 1 of 6.
- **Backing up Voice Mail** — If you enabled the Include NBX Voice Mail check box, voice mail messages for all users are backed up. Auto Discovery and voice mail access are locked during this step. The status bar shows step 2 of 6.
- **Backing up Voicemail Data** — Greetings and name announcements of all users are backed up. The status bar shows step 3 of 6.
- **Creating Backup file** — All files created during the backup process are added to a single backup file. The status bar shows step 4 of 6.
- **Backup Finishing** — Temporary files created during the backup operation are now deleted. The status bar shows step 5 of 6.
- **Backup Finished** — A new screen appears containing the name of the backup file and prompting you to save the backup file in a location of your choice. This screen indicates that the backup process has been completed and represents the last of the six steps.



*Backing up your database is done by a system task that is independent of all other system tasks. This means that you can safely perform any of these actions before the backup operation has been completed without interfering with the backup:*

- *Click your browser's Back button*
- *Click your browser's Stop button*
- *Exit your browser*
- *Shut off your computer*

If another administrator tries to back up the system database before the current backup task has been completed, a message appears warning that a backup is currently in progress.

The message includes:

- The IP address of the computer from which the backup was started
- The time that the backup was started
- The step of the upgrade process that is currently being performed

### **Cancelling a Backup Operation**

You can cancel the currently active backup operation if you want. When you click *Cancel*, the NBX system immediately asks you to confirm that you want to cancel the backup operation. If you click *Yes*, the NBX system first completes the step of the backup operation that it is performing and then cancels the backup operation.



*Depending on the size of your NBX database, some of the steps in the backup operation can take several minutes to be completed. Please allow time for the NBX system to complete the current step and respond to your cancel command.*

After the backup operation has been completed, the final screen displays the name of the backup file and gives you the opportunity to save the file in a location you choose, typically on the disk drive of your PC or on the disk of another computer in your network.



*If you choose not to save the database backup file, the file remains on the NBX system disk until the next time you perform a backup operation.*

### **Accessing the Most Recent Backup File**

During the backup procedure, the NBX system prompts you to save the backup file in a location you choose. 3Com recommends that you save the backup file when prompted to do so.

The NBX system keeps a copy of the most recent backup file on your NBX system. Each time you perform a backup operation on the NBX database, the NBX system overwrites this file.

If you choose to not save the backup file during the backup procedure or if you forget to save it, you can save it later. However, if you perform another backup, the prior backup file is no longer available.

To save the most recent backup file to a location you choose:

- 1 Click the *Save As* button.



*If you do not see a date and time next to Last Backup or if the words Download last backup file are gray, the NBX system does not have a backup file for you to download.*

- 2 In the window that appears, click the *Save* button.
- 3 In the *Save As* window that appears, browse to the location in which you want to save the most recent backup file and click *Save*.

## Restore

Restore a database using a backup file that is from the same version as the running system software. For example, to restore the data on a system running version R4.3.3, use a backup file from R4.3.3 and not from R4.3.2 or lower. Many times, if you try to restore a database that was saved on an older release, you will succeed. However, if a schema change has occurred between the old and new releases, the restore fails.



**CAUTION:** *3Com does not support the restoration of a database from an older version of the 3Com NBX system software.*



*Voice mail is included in a backup of your system data only if you specify that you want it included. If voice mail was not included when the system data was backed up, you cannot specify that you want to restore voice mail during a restore operation.*



*Backing up and restoring your licenses are procedures that are separate from the database backup and restore procedures. You should backup your licenses before and after you add or remove any licenses.*

To restore your NBX database from a saved backup file:

- 1 On the *NBX NetSet Manage Data* tab, click the *Browse* button.
- 2 In the window that appears, locate the backup file that you want to restore and click *Open*.

The *Manage Data* tab reappears.

- 3 Click *Restore*.
- 4 In the window that appears, the NBX system provides cautionary information about the effect of a restoration on system operation and prompts you to confirm that you want to restore the database. Click *Yes* to restore the database, or *No* to cancel the operation.

If you choose to restore the database, the NBX system automatically reboots after the database file is loaded.

**Convert Database** You can migrate configuration data stored with an older software version to a newer software version. You may need to do this if you have installed a new version of the software but you want to use older configuration data. During normal operation, you should not need to use the Convert Database function.

**Purge Database** Purging the database removes existing user and device data you have added to the system, restores factory defaults, and causes an automatic reboot.



*The Purge Database feature does not affect your IP connectivity to NBX NetSet. After a database purge, the system continues to use the IP address, subnet mask, default gateway, and host name that you have assigned.*

**Purge Database and CDR** If you want to purge Call Detail Reports (CDR) data as well as user and device data, you can perform these functions at the same time.

**Purge All Voice Mail** When you perform this operation, the NBX system deletes all voice mail messages for all users. Mailbox greetings are not affected. After the database is purged, the system reboots automatically.

---

## Event Log

You can view these event logs that are maintained by the system:

- **Adminlog** — Tracks activities performed in NBX NetSet under the administrator login. The Adminlog is never renamed or deleted. It continues to grow over time, but it is unlikely that the size of the Adminlog file will ever grow to be a problem.
- **Uplog** — Tracks the history of upgrades and processes that occur during upgrades.
- **TEP Logs** — The 3C10116D T1 Digital Line Card and the 3C10165D E1 Digital Line Card can generate logging information. TEP (**T1**, **E1**, **Primary Rate Interface**) logs are stored on the system disk drive, even for cards that are in remote locations, and you can use the NBX NetSet utility to view, download, and delete log files. Each card has a separate

log, up to a maximum of five log files. When a log reaches its maximum size, it begins to overwrite the oldest data.



*Because TEP logging has a performance cost, it is disabled by default. To enable TEP logging, contact your 3Com NBX Voice-Authorized Partner.*

To view event logs, select *Operations > Event Log*.

See the Help for the procedure on viewing event logs.

---

## Licenses

You can install licenses for these components:

- NBX system software
- H.323 Gateway
- pcXset™ (Soft Telephone)
- Voicemail (Additional voice mail and Auto Attendant ports and voice mail storage)
- Disk mirroring (for Superstack 3 NBX only)
- Devices (specifies the total number of devices allowed on the system)
- Windows Audio Volume (WAV) devices
- Virtual Tie Lines
- Internet Voice Messaging (VPIM)
- Third-Party Messaging
- Complement Attendant Software
- Call Recording & Monitoring
- Polycom Telephones
- Citel Nortel Telephones
- Citel Analog Telephones
- 3102 Business Telephones
- 3101 and 3101SP Basic Telephones
- 3105 Attendant Consoles

To manage your software licenses, select *Operations > Licenses*.

See the Help for procedures on managing licenses.

**Add a License** Each NBX system includes a factory default license, tied to the system serial number. On NBX 100 systems, the serial number is located on the Call Processor backplane. On SuperStack 3 systems, the serial number is located on the disk tray.

To configure the system to support new licenses, contact your 3Com dealer and provide the serial number. The dealer obtains a new license key from 3Com Customer Support that enables the upgrade.

See the Help for procedures for adding a license to an NBX system.

**Remove a License** The only license that you can remove from an NBX system is the disk mirroring license, which enables a SuperStack 3 NBX system to use two disks in a mirrored configuration.



**CAUTION:** See [“Reverting to a Single-Disk System”](#) on [page 256](#) for instructions on how to remove the disk mirroring license. If you do not follow the correct procedure, you may not be able to restart the SuperStack 3 NBX system.

**Usage Report** The Usage Report displays, for each license installed on the NBX system, the current number of devices in use for the license type and the maximum number of devices allowed by that license.

**Backing Up Licenses** 3Com recommends that you make a backup of all licenses on your NBX system.

- 1 In the *Operations > Licenses* dialog box, click *Backup Licenses*.
- 2 Click *Save*, choose a location to save the backup file, and click *Save*.

You can also run license backup from the *Operations > Manage Data* tab.

**Restoring Backed-Up Licenses** You can restore all licenses from a previously created backup file.

- 1 In the *Operations > Licenses* or the *Operations > Manage Data* tab dialog box, click *Restore Licenses*, and browse to the location in which you saved the licenses backup file. Alternatively, type full path to the license backup file in the *Enter path to restore license(s) on this system:* text box.
- 2 Click *Restore*.
- 3 Respond to the confirmation prompt message that appears.

### Obtaining Details of License History

You can view a detailed history, including the date and time on which each license was added to the NBX system.

To view the license detail report:

- 1 In the *Operations > Licenses* dialog box, click *Details*.

### Regional Software

Regional software includes voice prompts, tones and cadences, and user documentation. A region is a country and language pair, for example, "China - Mandarin" or "France - French."

To add or remove regional software:

- 1 Click *Operations > Regional Software*. See the Help for procedures on managing your regional software.
- 2 See the notes in the next sections for important information about managing regional software.

#### Install

You can install regional software including local language voice prompts, regional tones and cadences, and local language versions of certain user documentation for your region.

After you install regional software, you must designate it to be the current system regional software by selecting *System Configuration > Regional Settings*.

#### Remove

You can remove regional software at any time. All versions of the regional software that you select are removed. For example, if you choose to remove the "Mexico - Spanish" regional pack, *all* versions of the selected regional software are removed from the system.



*U.S. English cannot be removed.*

When you remove a version of system software, the system verifies whether the removal might leave any regional software unassigned to a system software version.



*Specific regional languages, tones and cadences, or voice prompts that were associated with earlier releases may no longer be usable by recent system software versions. 3Com recommends that you purge unused regional software to conserve disk space.*



You can only remove unused regional software immediately after you delete a version of system software. If you choose not to remove this software when prompted, you must either:

- Wait until you remove a subsequent version of system software before you can delete any unused regional software.
- Remove all versions of the selected regional software on the system. You can then install the required version.

**Details** The Regional Software Diagnostic Details window displays the status of each region in the current system software. [Table 50](#) defines the displayed values.

**Table 50** Diagnostic Details

Values	Description
In Use	The regional software is currently being used by the system.
Available	The regional software is fully loaded on the system, but it is not currently in use.
Not Fully Installed	The system can access some parts of the regional software, but not all. You probably have not loaded the correct regional software version for the system software you are running.
Error While Loading	An error occurred while loading the regional software. Re-install the software.
Nothing Installed	The system is aware that this regional software exists, but no version is installed.

## Third-Party Drivers

You can add and configure third-party telephones for use on an NBX system. The third-party vendor supplies the interface hardware and a software package to support the telephones.

The process of adding third-party telephones has these steps:

- **Install the device type license** — Each third-party device type (typically a telephone) must be licensed for use on the NBX system. The license governs the type of device and the number of devices of that type that can be added to the NBX system.
- **Installing the software driver** — This step places the third-party driver software on the NBX system disk.
- **Importing** — This step activates the third-party driver software.

See the Help for instructions on these procedures.

**NBX Software  
Upgrades**

When you upgrade the NBX system software, you do not need to reinstall and import the third-party drivers, provided that you continue to use the same NBX database after the upgrade.

If you upgrade the NBX system software and choose to start with a new database, or if you revert to a database that did not include the third-party driver, you must import the third-party driver again.

**Third-Party  
Telephone Groups**

When you install and import a third-party driver, a new telephone group is created for the third-party telephone type. When you add third-party telephones to the NBX system, by default they are added to this group.

You cannot delete the default third-party telephone group.

A third-party telephone can belong to the default third-party telephone group, or to a telephone group that you create for that third-party telephone.



# 8

## REPORTS

This chapter describes how to access details of NBX system data traffic. It covers these topics:

- [Directory](#)
- [Device List](#)
- [System Data](#)
- [Call Reporting](#)

See the Help for procedures on accessing this data.

---

### Directory

The NBX system provides a directory listing of all the telephone extensions in the system (except for special use extensions such as TAPI Route Point extensions).

If a call is picked up by the Auto Attendant, the caller can search this same directory for the person by using the phone's key pad to type the first letters of the person's last name. The Last Name parameter of each user profile forms the dial-by-name directory.



*Only mailboxes that have been initialized and have a recorded greeting are included in the directory. Special purpose mailboxes, such as a mailbox associated with a TAPI Route Point are not included in the directory. You can exclude a user from the directory when you add or modify a user.*

To view, print, or search the system directory, select *Reports > Directory*.

See the Help for the procedures on viewing, printing, and searching the directory.

---

## Device List

The NBX system provides a list of the devices and functions such as telephones, line card ports, voice mail ports, Call Park extensions, and Groups that are currently being used.

To view or print a report of system devices, select *Reports > Device List*.

See the Help for procedures on viewing and printing the system device list.

---

## System Data

NBX NetSet provides basic data about the NBX system.



*Before you contact your 3Com Voice - Authorized Partner or 3Com Technical Support, access this report and record the information.*

To view system data, select *Reports > System Data*.

See the Help for procedures on viewing system data.

## Disk Status

In addition to viewing basic system data, you can also view data specifically about disk drives. If you are using disk mirroring, you can confirm the status of both disks.

To view disk status, select *Reports > System Data > Disk Status*.

See the Help for procedures on viewing disk status.

## Power Supply Status

If your system is configured with two power supplies (**SuperStack 3 NBX only**), you can view the status of each power supply on the Power Supply Status report. To view power supply status, select *Reports > System Data > Power Supply Status*. See the Help for procedures on viewing power supply status.

For each power supply, the report displays these types of information:

**Table 51** Power Status Report Information

Field	Purpose
Connected	The connection status for each power supply. Values: True or False
Output voltage	The output voltage status. Values: Valid or Invalid

## Call Reporting

The NBX Call Processor captures information about all outgoing and incoming calls made through the system. To view this call information in detail, you must install Call Reports (Downloads > Software > NBX Call Detail Reports) on a networked computer as specified later in this section. Then, you must download the call report information, which is referred to as call detail reports, from the system to a local hard drive.

After you install NBX Call Detail Reports, you can:

- Retrieve calling data from the system.
- Generate formatted reports.
- Export reports in formats suitable for use with third-party reporting software, spreadsheets, databases, and word processing applications.
- Export your call data in HTML format for publication on a web server.
- Export reports to a disk file or directly to a Microsoft mail message or a Microsoft Exchange folder.

Call reports do not include information on the locked or unlocked status of telephones.

See the Help in the NBX Call Detail Reports application software for procedures.

### Windows Environment Specifications

Your computer must have these minimum requirements to run Call Reports:

- **Processor** — Pentium 166MHz or higher
- **Operating System** — Windows NT 4.0 (Service Pack 6a), Windows 98, Windows 2000 (Service Pack 2), or Windows XP

- **RAM** — 32 MB on Windows 98; 64 MB on Windows NT or Windows 2000; 128 MB on Windows XP
- **Network** — Network connectivity to the NBX Call Processor
- **Disk Space** — At least 40 MB of free disk space

### Installing Call Reports

To install NBX Call Reports, select *Downloads > Software > NBX Call Reports*.

See the Help topic for *Downloads > Software* in the NBX Call Reports installation procedures.

### Configuring Call Reporting

You can configure your system to save call information, and then use the Call Reports function to view the information in a variety of formats. You can create a password-protected logon for users so that the users can access call report information. This logon does not provide administrator privileges to users.



*The NBX software supplied by or on behalf of 3Com has the ability to mask or scramble the last four digits on call records. If you do not select this function, call numbers are recorded without any digits masked or scrambled.*

*The collection, storage, or manipulation of personal data such as these call numbers may incur obligations under local laws, such as those relating to data protection or privacy. These legal requirements differ from country to country and it is your responsibility to comply with all such obligations.*

*3Com accepts no liability for your failure to comply with local laws regarding the collection, storage, or manipulation of such information and data.*

To configure call reporting, select *Reports > Call Reporting*.

See the Help for procedures on configuring call reporting.

### Purge CDR

You can purge old Call Detail Report (CDR) data from the system.

To purge CDR data, select *Reports > Call Reporting > Purge CDR*.

See the Help for the procedure on purging call report data.

# 9

## DOWNLOADS

This chapter provides information about downloading:

- [Software](#)
- [LabelMaker](#)
- [NBX Documentation and Quick Reference Guides](#)

---

### Software

You can download these applications:

- **NBX Call Reports** — You can install NBX® Call Reports on a Microsoft Windows NT 4.0, Windows 98, or Windows 2000 computer. The application enables you to retrieve call logging information from the NBX system for reporting purposes. See [Chapter 8](#) for prerequisites and details on running these reports.
- **NBX TAPI Service Provider (NBX TSP)** — You can install NBX TSP on a Microsoft Windows NT 4.0, Windows 98, or Windows 2000 computer. The application enables you to use TAPI-enabled programs with the NBX system. For more information, see [Chapter 5](#).

To download software applications, select *Downloads > Software*.

See the Help for procedures on downloading the software.

## LabelMaker

Each NBX Telephone and Attendant Console comes with a set of blank labels on which users and administrators can write Speed Dials and other unique settings that have been applied to the buttons. When you are setting up many telephones with similar features, you can use the LabelMaker utility to create and print your labels.

Users and administrators launch the same LabelMaker. The LabelMaker utility can create labels for these devices:

- 3102 Business Telephone
- 1102, 2102, 2102-IR Business Telephones
- 3101 and 3101SP Basic Telephones
- 2101 Basic Telephone
- 3105 and 1105 Attendant Consoles



*The LabelMaker is a Windows program file. If you use an operating system that cannot run Windows programs, you can get a PDF version of the LabelMaker through your 3Com NBX Voice-Authorized Partner.*

To Launch the LabelMaker and select a label:

- 1 Login as administrator and then click *Downloads > LabelMakers > Universal LabelMaker*.

OR

Login as a User and then click *Speed Dials > Telephone Labels* or *Attendant Console Labels*. Both buttons launch the same LabelMaker.

- 2 If the Windows **File Download** dialog appears, click **Save**, and then specify a location in the **Save As** dialog to save the LabelMaker file. If you click **Open** from the File Download dialog, Windows puts the LabelMaker file in a default location on your hard disk.
- 3 Locate and launch the LabelMaker by double-clicking the file named `label1s.exe` using one of these methods:
  - Open **Windows Explorer** and navigate to the file.
  - Double-click **My Computer** and navigate to the file.
  - Depending on your operating system, click **Start > Find > Files or Folders** or **Start > Search > For Files or Folders**, and then type the name of the file in the appropriate text box.

- 4 Find the page in the LabelMaker that has labels for your telephone. [Figure 26](#) shows the LabelMaker contents page.
- 5 Edit the label template by clicking any of the label text boxes to highlight the existing text, and then typing new text.
- 6 Press **Tab** to move to the next text field in the label.
- 7 Click the **Print** button at the top of the LabelMaker screen to open the Print dialog. Be sure to specify which page you want to print. Typically, the default is to print all pages.
- 8 Click **Print**.
- 9 Cut out the labels and put them in the label holders of your NBX Telephone or your Attendant Console.
- 10 To save the edited LabelMaker, click the **Save** button at the top of the LabelMaker screen. Or you can click **File > Save As** to save the LabelMaker to a new location.



*To reuse your saved LabelMaker, you must run the file that you saved to your computer. If you launch the LabelMaker from NetSet, you always get the default version. If you save the default version to the same place you saved an earlier edited version, you overwrite the earlier version.*

Figure 26 LabelMaker Utility Page 1

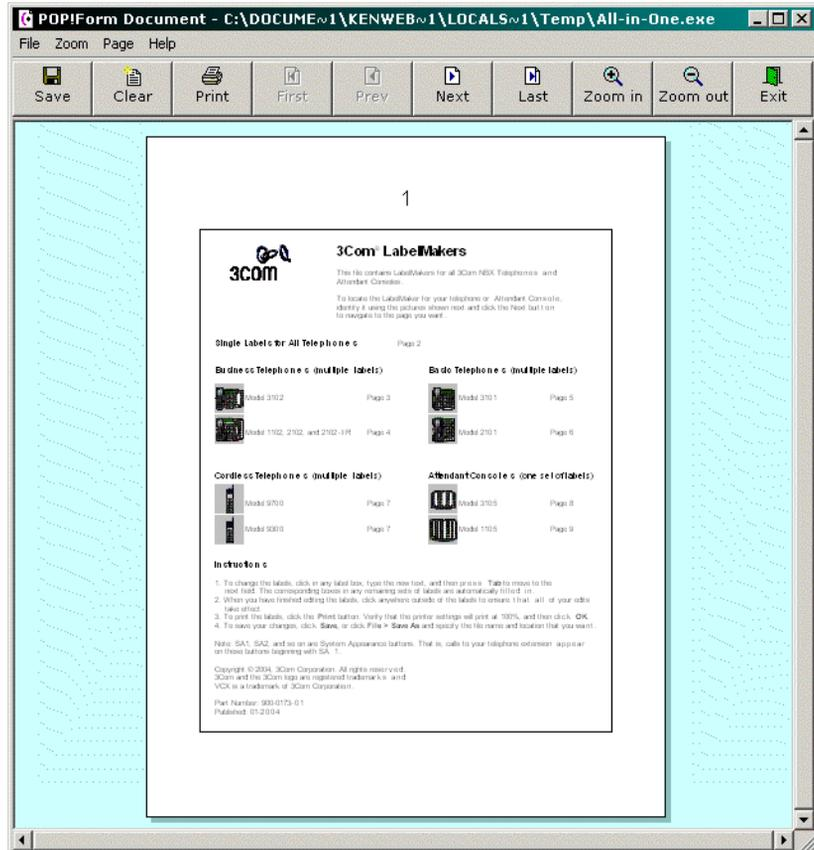

## NBX Documentation and Quick Reference Guides

You can download and print NBX documentation from the *Downloads > Documentation* tab.

Quick Reference Guides and the Telephone User Guide are available to individual users by selecting *Personal Settings > User Information*.

You can get or upgrade your existing version of Adobe Acrobat Reader from the Adobe website, [www.adobe.com](http://www.adobe.com).

# 10

## TROUBLESHOOTING

---

### Overview

This chapter contains maintenance and troubleshooting information that can help you resolve simple problems. It covers these topics:

- [Using the Telephone Local User Interface Utility](#)
- [Using H3PingIP](#)
- [System-level Troubleshooting](#)
- [Connecting a Computer to a Serial Port](#)
- [Servicing the Network Call Processor Battery](#)
- [Getting Service and Support](#)

NBX hardware needs no routine maintenance. However, you should perform periodic backups of the configuration and license databases, especially after you make changes to system or user configurations.

## Using the Telephone Local User Interface Utility

Each NBX Telephone supports a telephone diagnostic and configuration utility called the Local User Interface (LUI). The LUI utility enables you to perform these tasks:

- View telephone settings, both the active settings and the settings stored in the telephone's memory
- Set telephone IP address, subnet mask, and default gateway
- Specify IP address of the Network Call Processor (NCP)
- Specify settings specific to a 3Com VCX Telephone System (not used in an NBX environment)
- Test the telephone buttons, display panel, and LEDs
- Clear all device settings
- Specify the MAC address of the NCP (test environment option)
- View firmware information (technician option)
- Test connectivity
- Restart the telephone



*Early model NBX Telephones support an earlier version of the LUI utility that has a slightly different menu structure. For information on this older version of the LUI utility, see your NBX Voice-Authorized Partner or a version of the NBX Administrator's Guide from a release prior to NBX R4.3.*

To start the LUI utility:

- 1 Cycle power to the telephone by disconnecting and then reconnecting its power connector, and then start the LUI utility (as described in [step 2](#), next) before the telephone finishes its download of code from the call processor.

For telephones that use a powered Ethernet cable instead of a power adapter, disconnect and then reconnect the Ethernet cable.

- 2 To start (or exit from) the LUI utility:

- On the NBX 3102 Business Telephone, press the *Program* button:



- On NBX 1102, 2102, or 2101-IR Business Telephones, press the *Program* button:



- On NBX 3101 or 3101SP Basic Telephones, press the *Select* button (the center button in the cursor control button group):



- On the NBX 2101 Basic Telephone, press the MSG button:



The buttons you use to enter information vary with each type of supported telephone:

- NBX 3102 Business Telephone, see [Figure 27](#) on [page 318](#).
- NBX 3101 or 3101SP Basic Telephones, see [Figure 28](#) on [page 319](#).
- NBX 1102, 2102, or 2101-IR Business Telephones, see [Figure 29](#) on [page 320](#).
- NBX 2101 Basic Telephone, see [Figure 30](#) on [page 321](#).

[Table 52](#) on [page 322](#) describes each LUI utility menu item.

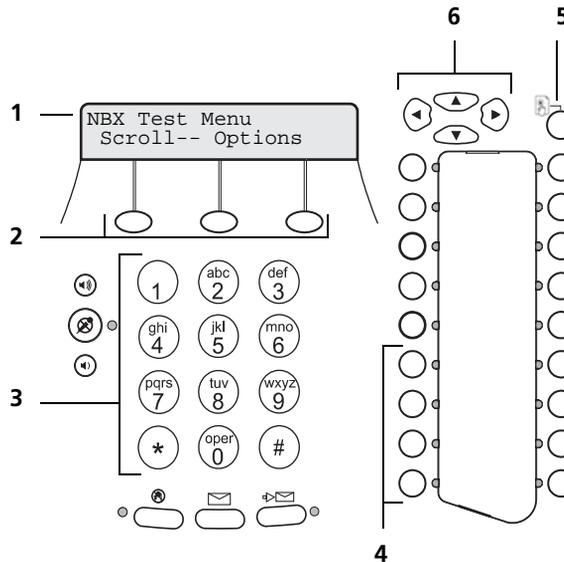
**Figure 27** Local User Interface Controls on the NBX 3102 Business Telephone

- 1 Display panel.
- 2 Soft buttons move the cursor left or right. The middle button is not used.
- 3 Key pad numeric keys select menu items or enter numeric characters in a menu item. Use the # key to save changes after you edit an item.
- 4 Access buttons AB1-AB4 (from bottom to top) select menu items.
- 5 Program button:
  - Start and exit from the LUI utility.
  - Exit from a menu item and move to the next higher menu. If you press the Program button before you save a change to a setting, you exit the menu item without saving the change.
- 6 Scroll buttons:
  - Up and down buttons move up or down through the LUI menu and select hex digits when editing a MAC address.
  - Left and right buttons position the cursor in the display panel when editing a setting, such as an IP address.

**Figure 28** Local User Interface Controls on NBX 3101 and 3101SP Basic Telephones

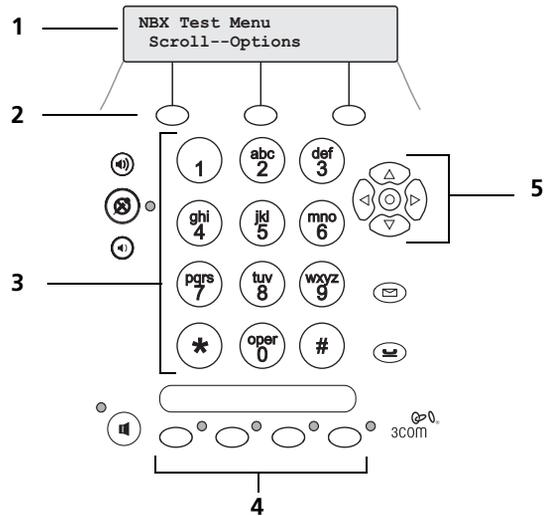

- 1 Display panel.
- 2 Soft buttons move the cursor left or right. The middle button is not used.
- 3 Key pad numeric keys select menu items or enter numeric characters in a menu item. Use the # key to save changes after you edit an item.
- 4 Access buttons AB1-AB4 (from left to right) select LUI menu items.
- 5 Scroll buttons:
  - Center select button starts and exits from the LUI utility or exits from a menu item and moves to the next higher menu. If you press the center select button before you save a change to a setting, you exit the menu item without saving the change.
  - Up and down buttons move up or down through the LUI menu and select hex digits when editing a MAC address.
  - Left and right buttons position the cursor in the display panel when editing a setting, such as an IP address.

**Figure 29** Local User Interface Controls on the NBX 1102, 2102, and 2102-IR Business Telephones

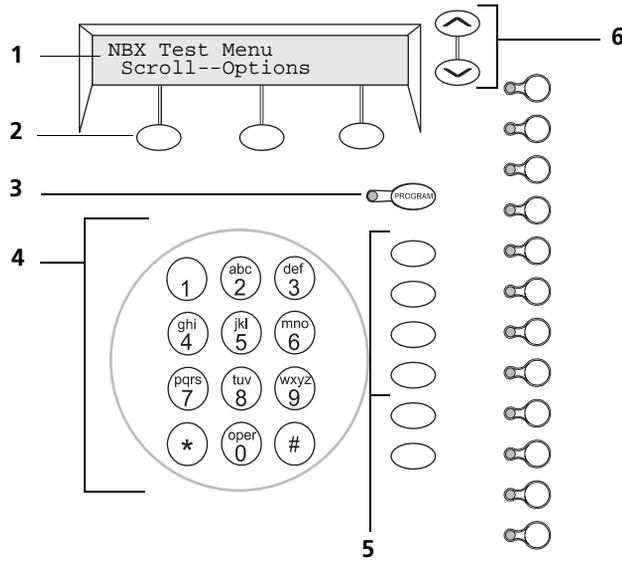

- 1 Display panel.
- 2 Soft buttons move the cursor left or right. The middle button is not used.
- 3 Program button starts and exits from the LUI utility or exits from a menu item and moves to the next higher menu. If you press the Program button before you save a change to a setting, you exit the menu item without saving the change.
- 4 Key pad numeric keys select menu items or enter numeric characters in a menu item. Use the # key to save changes after you edit an item.
- 5 Access buttons AB1-AB4 (from top to bottom) select LUI menu items.
- 6 Scroll buttons move up or down through the LUI menu and select hex digits when editing a MAC address.

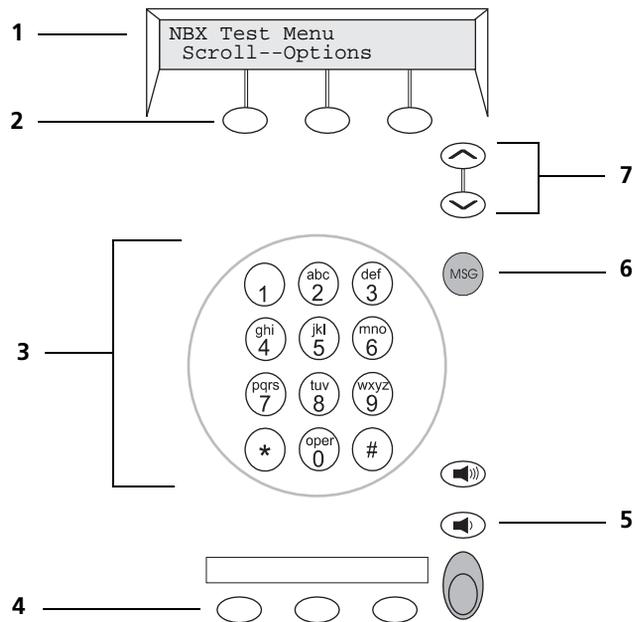
**Figure 30** Local User Interface Controls on the NBX 2101 Basic Telephone

- 1 Display panel.
- 2 Soft buttons move the cursor left or right. The middle button is not used.
- 3 Key pad numeric keys select menu items or enter numeric characters in a menu item. Use the # key to save changes after you edit an item.
- 4 Access buttons AB1-AB3 select LUI menu items.
- 5 Volume Down button selects LUI menu item AB4.
- 6 MSG (voice mail message) button starts and exits from the LUI utility or exits from a menu item and moves to the next higher menu. If you press the MSG button before you save a change to a setting, you exit the menu item without saving the change.
- 7 Scroll buttons move up or down through the LUI menu and select hex digits when editing a MAC address.

**Table 52** LUI Menu Items

Menu Option	Description
1 View Settings	<p data-bbox="626 317 1233 343">Press 1 on the number pad and scroll to view these options:</p> <p data-bbox="626 357 1122 383"><b>MAC Address</b> – MAC address of this telephone.</p> <p data-bbox="626 397 1276 475"><b>NCP MAC Address</b> – MAC address of call processor. All Fs, the normal value for this setting, indicates that the telephone responds to any NCP.</p> <p data-bbox="626 489 1269 515"><b>SW Build Ident.</b> – Software version running on this telephone.</p> <p data-bbox="626 529 1262 555"><b>Serial # Rev</b> – Telephone serial number and hardware version.</p> <p data-bbox="626 569 1222 621"><b>Phone Port Speed</b> – Speed and duplex setting of the LAN connection.</p> <p data-bbox="626 635 1276 687"><b>PC Port Speed</b> – The speed and duplex setting of the PC port to the device, if any, connected to the port.</p> <p data-bbox="626 701 1276 781"><b>Note:</b> The next four settings are all valid only if the device downloads via IP (layer 3). These four settings are acquired from either DHCP or a setting in the telephone’s memory</p> <p data-bbox="626 795 1162 821"><b>My IP Address</b> – Active IP address of this telephone.</p> <p data-bbox="626 835 948 861"><b>Subnet Mask</b> – Active IP mask.</p> <p data-bbox="626 874 1190 900"><b>Gatwy IP Address</b> – Active default gateway IP address.</p> <p data-bbox="626 914 1248 966"><b>NCP IP Address</b> – Active IP address of the call processor with which this telephone communicates.</p> <p data-bbox="626 980 1276 1093"><b>ALT SrvrIP</b> – Active IP address of a secondary download server with which this telephone communicates, acquired from either DHCP option 184 or a setting in the telephone’s memory. (Valid for 3Com VCX Telephone systems only.)</p> <p data-bbox="626 1107 1276 1187"><b>VLAN Config</b> – Active VLAN for this telephone, acquired from either DHCP option 184 or a setting in the telephone’s memory. Valid for 3Com VCX Telephone systems only.</p> <p data-bbox="626 1201 1176 1253"><b>Mem- My IP Addr</b> – The IP address configured in the telephone’s memory though the LUI utility.</p> <p data-bbox="626 1267 1176 1319"><b>Mem- Subnet Mask</b> – The IP mask configured in the telephone’s memory though the LUI utility.</p> <p data-bbox="626 1333 1276 1385"><b>Mem- Gatwy IP</b> – The default gateway IP address configured in the telephone’s memory though the LUI utility.</p> <p data-bbox="626 1399 1233 1451"><b>Mem- NCP IP Addr</b> – The NCP IP address configured in the telephone’s memory though the LUI utility.</p> <p data-bbox="626 1465 1248 1545"><b>Mem- ALT SrvrIP</b> – Secondary download server address configured in the telephone’s memory. (Valid for 3Com VCX Telephone systems only.)</p> <p data-bbox="626 1558 1262 1611"><b>Mem- VLAN Config</b> – VLAN values configured in telephone’s memory. Valid for 3Com VCX Telephone systems only.</p>

**Table 52** LUI Menu Items (continued)

<b>Menu Option</b>	<b>Description</b>
2 Set my IP	Lets you specify the IP information for this telephone.
3 Set SubNMsk	When entering an IP address:
4 Set Gatwy IP	<ul style="list-style-type: none"> <li>■ Use the key pad to enter digits 0–9.</li> <li>■ Use the left and right soft keys or scroll keys to move the cursor left or right.</li> <li>■ If any of the fields within the IP address contain only one or two digits, add leading zeros. Example: Enter 10.234.1.125 as 010.234.001.125</li> <li>■ To change a telephone back to its default setting, enter 255 for each octet of the IP address. To clear all configured settings and return to factory defaults, select menu item AB4.</li> <li>■ Press the # key to commit your address change.</li> </ul>
5 Set NCP IP	<p>Lets you specify the IP address of the Network Call Processor. If the telephone is on the same subnet as the NCP you never need to specify the NCP IP address. If the telephone is on a different subnet, then you must enter this information or provide it by using DHCP option 184.</p> <p>When entering an IP address:</p> <ul style="list-style-type: none"> <li>■ Use the key pad to enter digits 0–9.</li> <li>■ Use the left and right soft keys or scroll keys to move the cursor left or right.</li> <li>■ If any of the fields within the IP address contain only one or two digits, add leading zeros. Example: Enter 10.234.1.125 as 010.234.001.125</li> <li>■ To change a telephone back to its default setting, enter 255 for each octet of the IP address. To clear all configured settings and return to factory defaults, select menu item AB4.</li> <li>■ Press the # key to commit your address change.</li> </ul>
6 VCX Config Menu	Not used in an NBX environment. NBX telephones can operate as SIP clients for the 3Com VCX Telephone System. This option opens a submenu that allows you to set telephone operating settings for a VCX environment.
7 Spare	Reserved for future use.

**Table 52** LUI Menu Items (continued)

Menu Option	Description
8 Test LED & LCD	<p>On all NBX Business Telephones and NBX 3101 and 3101SP Basic Telephones, turns on all LEDs for 5 seconds, then fills every pixel on the display panel for 5 seconds.</p> <p>On all NBX Basic Telephones, turns on the icons and words on the right side of the display panel for 5 seconds.</p> <p>Icons: Telephone icon plus the number 1 (top line) and telephone icon plus the number 2 (bottom line) Words: FWD (top line) and IN (bottom line)</p>
9 Test – Buttons	<p>Puts the telephone in the button test state. Press any telephone button to see a description of the button's function. To return to the main menu, you must press the menu button <b>twice</b>:</p> <ul style="list-style-type: none"> <li>■ On the NBX 3102 Business Telephone:           <ul style="list-style-type: none"> <li></li> </ul> </li> <li>■ On an NBX 1102, 2102, or 2102-IR Business Telephone:           <ul style="list-style-type: none"> <li></li> </ul> </li> <li>■ On an NBX 3101 or 3101SP Basic Telephone:           <ul style="list-style-type: none"> <li></li> </ul> </li> <li>■ On an NBX 2101 Basic Telephone:           <ul style="list-style-type: none"> <li></li> </ul> </li> </ul>
0 EEPROM-Default	<p>Restores the phone to default settings by clearing these configured settings:</p> <p><b>IP Information</b> — My IP, Subnet Mask, Gateway IP, NCP-IP, and the Alt Download Server IP return to 255.255.255.255.</p> <p><b>NCP MAC address</b> — The NCP MAC address returns to ff:ff:ff:ff:ff:ff.</p> <p><b>SIP Parameters</b> — All SIP specific parameters will be set to default 0xffff (data parameters) or 255.255.255.255 for IP addresses.</p> <p><b>NOTE:</b> If you select this option you are prompted to verify your action before the system clears the EEPROM.</p>
AB1 Set NCP MAC	<p>Lets you specify the MAC address of the Network Call Processor. In all but special circumstances, the system messages communicate this information and you do not need to manually configure the MAC address.</p> <p><b>NOTE:</b> This setting is for test networks only.</p> <p>To change a telephone back to its default setting, enter all Fs for the NCP MAC address.</p>

**Table 52** LUI Menu Items (continued)

Menu Option	Description
AB2 Show EEPROM	Lets you scroll through the locations in the memory of the telephone. The information is presented in hexadecimal format and can be properly interpreted only by a 3Com service person.
AB3 Ping H3/IP	Run an H3 IP ping test. See the next topic, <a href="#">Using H3PingIP</a> , for more information.
AB4 Reset Phone	Reset the device. You can perform the same task by removing power from the telephone. However, Option AB4 can be useful for cordless phones, which cannot easily be disconnected from power.

## Using H3PingIP

You can use the H3PingIP menu item to ping another device on the network to test the telephone's connectivity and to check the packet delay.

When using H3PingIP to test for connectivity, you must use the IP address of a device that is connected to the NBX system NCP. You should not use the NCP IP address. The NBX Business Telephone uses the IP Gateway and subnet mask information programmed into it using the AB16 and AB17 buttons.

H3PingIP shows the following information:

- **Port** — The UDP Destination Port
- **Tx** — The number of packets transmitted
- **Rx** — The number of packets received
- **mS** — The delay time, in milliseconds



*If you ping a device on a subnet different than the one on which the telephone is located, the delay time is greater.*

## System-level Troubleshooting

For each symptom listed in [Table 53](#), perform the suggested actions in the order listed.



**WARNING:** Before you remove any component, **shut down the system software** and then turn off the power to the chassis by removing the chassis power cord. If the system has two power supplies, remove both power cords.

**Table 53** Troubleshooting Actions

Symptom	Possible Cause	Suggested Action
Date/time display on telephones is wrong, either incorrect date or shows random characters.	A power surge has corrupted the system time.	<p>If the display shows incorrect date, use NBX NetSet to reset the system time. If the display shows random characters, for example, 00; 0 #, you must:</p> <ol style="list-style-type: none"> <li>1 Disconnect power to the chassis that holds the Call Processor.</li> <li>2 Wait 60 seconds.</li> <li>3 Reconnect power to the system.</li> <li>4 Use NBX NetSet to enter the correct date and time.</li> </ol>
	Problem with Network Call Processor battery.	Contact your 3Com NBX Voice - Authorized Partner.
Your browser cannot find NBX NetSet.	No IP connectivity	Verify that the computer you are using to run the browser has network connectivity. See "Establishing IP Connectivity" in the <i>NBX Installation Guide</i> .
	Routing problems	If your local IP environment includes a proxy server, you might need to reconfigure your browser parameters to ignore the proxy server. See the Help for your browser.

**Table 53** Troubleshooting Actions (continued)

Symptom	Possible Cause	Suggested Action
	Invalid IP configuration	The system has a default IP configuration which might need to be changed to match your local IP environment. Temporarily change the IP configuration of your computer so that the subnet configuration matches the system configuration. Specify 255.255.255.0 as the subnet and use IP address 192.168.1.191. After you change your computer's IP configuration, connect to the system and change its IP configuration to match the IP environment of your local network. Change your computer's IP configuration back to its original settings, and then connect to NBX NetSet using the new IP address. See "Establishing IP Connectivity" in the <i>NBX Installation Guide</i> .
Cannot open NBX NetSet using the administrator username and password.	The CAPS LOCK key on your keyboard is activated.	NBX NetSet username and passwords are case-sensitive. For example, NBX NetSet accepts "administrator" but it rejects "Administrator" and "ADMINISTRATOR".
Callers on hold do not hear music.	No music source is connected to the Call Processor.	See "Adding External Hardware" in the <i>NBX Installation Guide</i> for more information.
	MOH audio is disabled.	Enable MOH audio in NBX NetSet > System Configuration > System Settings > System-wide. See "Connecting a Music-on-Hold (MOH) Input Device" in the <i>NBX Installation Guide</i> .
	MOH volume is set too low.	See "Adjusting Music-on-Hold (MOH) Volume" in the <i>NBX Installation Guide</i> .
Lose date and time when rebooting the system.	Problem with the battery on the Call Processor.	See " <a href="#">Servicing the Network Call Processor Battery</a> " on <a href="#">page 341</a> .

**Table 53** Troubleshooting Actions (continued)

<b>Symptom</b>	<b>Possible Cause</b>	<b>Suggested Action</b>
NBX NetSet is very slow in responding.	Your network uses a proxy server for Internet access.	A common networking practice is to employ a proxy server to shield your network from intrusion by unauthorized users. However, communications with NBX NetSet do not need to pass through the proxy server. To speed access to NBX NetSet, configure your browser to access the NBX system without going through the proxy server.
All greetings and prompts are missing. For example, calling the Auto Attendant or a user's mailbox produces silence instead of the expected greetings.	The wrong message compression format was selected.	<p>Prior to R1.1.0, all audio used MuLaw compression. With R1.1.0, audio, that is, any prompt, message, or greeting, was recorded using ADPCM compression. If you are running R1.1.0 or higher, you must leave the compression format set to ADPCM. The ability to select the format allows you to migrate existing data into an older database for backwards compatibility.</p> <p>In release R2.6 and all later releases, the compression is set to ADPCM and you cannot change it.</p>
Caller ID information is not appearing when an outside call arrives.	Your local telephone company is not providing Caller ID service to you.	<p>Caller ID is typically an optional service which you must order from your telephone company.</p> <p>You may be able to see caller ID by number or by name (or both) depending on the service your telephone company provides.</p>
	You are answering the telephone before the Caller ID information is fully received.	Caller ID information does not appear immediately. It usually appears between the first and second rings. If you answer the call too quickly, the information is never received. If you transfer the call, the person you transfer the call to sees your ID instead of the ID of the original caller.

## Digital Line Card Troubleshooting

In order to correctly troubleshoot a Digital Line Card, you must determine whether the origin of the problem is:

- The hardware
- The software configuration
- The CSU (Channel Service Unit)
- The telephone company's line

To eliminate the Digital Line Card (T1 or E1) attach a loop back connector in place of the telephone company's line. Configure the card as described in the appropriate section of [Chapter 3](#).



*The 3C10116D T1 card and 3C101156D E1 card can respond to commands from the Central Office to loop back data at different points for diagnostic purposes. You enable each loopback test using the NBX NetSet utility. You initiate the Local and Frammer loopback tests using the NBX NetSet utility. The Line and Payload loopback tests must be initiated by the Central Office or by test equipment emulating Central Office equipment. For more information on enabling loopback tests, see [“Using Loopback Tests”](#) on [page 222](#).*

After you complete the configuration, and with the loopback connector in place, verify that the Nominal status light (3C10165C E1 card or 3C10116C T1 card) on the front panel of the Digital Line Card is turned on (appears steady and green). For the 3C10165D E1 card and 3C10116D T1 card, make sure the CO status light is green.

- If the Nominal or CO status light does not turn on, the problem is most likely in the Digital Line Card, and you should contact your 3Com Voice-Authorized Partner to report the problem.
- If the Nominal or CO light turns on, the problem is either in the CSU (Channel Service Unit) or in the telephone company's line. Contact the telephone company for assistance.



*The 3C10165D E1 Card and the 3C10116D T1 card each have an onboard CSU. You can view CSU statistics for the card through the NBX NetSet utility. For more information see [“Viewing CSU State Information and Statistics”](#) on [page 220](#).*

## Alarm Conditions (Overview)

T1 and E1 Digital Line Cards may experience these alarm conditions:

- Red Alarm — Indicates one of these conditions:
  - Loss of Signal (LOS)
  - Loss of Framing (LOF) also known as Out of Frame (OOF)
- Blue Alarm — Indicates an Alarm Indication Signal (AIS)
- Yellow Alarm — Indicates a Remote Alarm Indication (RAI)

An alarm condition may be one of these:

- Signal — Information transmitted either in the upstream or downstream direction, warning of a detected failure:
- State — A condition, activated at a terminal device, indicating that a problem exists and remedial action is required.



*T1 and E1 Digital Line Cards are considered “downstream” equipment.*

## Alarm Descriptions

### Red Alarm

- **Carrier Fail Alarm** (Red CFA) — A state that exists at a downstream terminal device, based upon the terminal device detecting an incoming LOS or LOF.

### Blue Alarms

- **AIS, Keep-alive/Blue** — A signal that is transmitted instead of the normal signal to maintain transmission continuity and to indicate to the receiving equipment that there is a transmission interruption either at the equipment that is generating the AIS signal or upstream of that equipment. The all ones signal is generated:
  - To maintain transmission continuity
  - To notify downstream equipment of a transmission fault
  - To indicate to downstream equipment that a DS1 framed signal is not being generated

The transmission fault may be located at the equipment that is generating the alarm signal, or it may be located upstream of that equipment.

- **AIS CFA** (also known as Blue CFA) — A state that exists at the downstream equipment and indicates that it has detected an AIS signal from the upstream equipment.

## Yellow Alarms

- **RAI** (also known as Yellow Alarm Signal) — A signal transmitted in the outgoing direction when a terminal determines that it has lost the incoming signal. The terminal equipment generates the Yellow Alarm Signal for a minimum of 1 second using one of these methods:
  - If you are using Super Frame (SF), the terminal equipment generates the Yellow Alarm Signal by setting the second bit in all channels of the Super Frame to 0 (zero).
  - If you are using Extended Super Frame (ESF), the terminal equipment generates the Yellow Alarm Signal by sending an alternating pattern of 8 ones followed by 8 zeros on the Facilities Data Link (FDL).
- **Yellow CFA** — A state that is activated at the terminal equipment when the terminal equipment detects a Yellow Alarm Signal. The Yellow Alarm Signal comes from the equipment at the other end when the far end equipment enters a Red CFA state. See Red Alarm, earlier in this section.

### Alarms on NBX Digital Line Cards

NBX T1 and E1 Digital Line Cards support all of the alarm states and signals described in [“Alarm Descriptions”](#) on [page 330](#). [Table 54](#), next, and [Table 55](#) on [page 332](#) describe how the status lights indicate alarm conditions on digital line cards.

**Table 54** 3C10165, 3C10165B, 3C10165C, 3C10116, and 3C10116C Status Lights and Error Conditions

Status Light	Purpose
Nominal	<p><b>On:</b> There are no error or alarm conditions.</p> <p><b>Flashing:</b> A call is active on at least one channel.</p>
CF (Carrier Fail)	<p><b>On:</b> A Red Alarm state or Blue Alarm state exists on the card. To determine which alarm state exists:</p> <ol style="list-style-type: none"> <li>1 Log on to the NBX NetSet utility using the administrator ID and password.</li> <li>2 Click <i>Device Configuration &gt; Digital Line Cards</i>.</li> <li>3 In the <i>Select Device Type</i> list, select <i>T1 Span List</i> or <i>ISDN PRI Span List</i>, and then click <i>Apply</i>.</li> <li>4 Select the span you want and click <i>Status</i>. The words <i>Red Alarm</i> or <i>Blue Alarm</i> appear in the <i>Status</i> field.</li> </ol>

**Table 54** 3C10165, 3C10165B, 3C10165C, 3C10116, and 3C10116C Status Lights and Error Conditions (continued)

Status Light	Purpose
RA (Remote Alarm)	<p><b>On:</b> A Yellow Alarm state on the card. To confirm that the Yellow Alarm state exists:</p> <ol style="list-style-type: none"> <li>1 Log on to the NBX NetSet utility using the administrator ID and password.</li> <li>2 Click <i>Device Configuration &gt; Digital Line Cards</i>.</li> <li>3 In the <i>Select Device Type</i> list, select <i>T1 Span List</i> or <i>ISDN PRI Span List</i>, and then click <i>Apply</i>.</li> <li>4 Select the span you want and click <i>Status</i>. The words <i>Yellow Alarm</i> appear in the <i>Status</i> field.</li> </ol> <p><b>NOTE:</b> This light is used only on the T1 Digital Line Card.</p>
LB (Loop Back)	<p><b>On:</b> The card is in loop-back testing mode.</p> <p><b>NOTE:</b> This light is not used to indicate any of the Red, Blue, or Yellow alarms.</p>

**Table 55** 3C10165D and 3C10116D Status Lights and Error Conditions

Status Light	Purpose
CO	<p><b>Green:</b> There are no error or alarm conditions.</p> <p><b>Amber:</b> An alarm condition at the remote end or the CO is not connected or available. To determine which alarm state exists:</p> <ol style="list-style-type: none"> <li>1 Log on to the NBX NetSet utility using the administrator ID and password.</li> <li>2 Click <i>Device Configuration &gt; Digital Line Cards</i>.</li> <li>3 In the <i>Select Device Type</i> list, select <i>T1 Span List</i> or <i>ISDN PRI Span List</i>, and then click <i>Apply</i>.</li> <li>4 Select the span you want and click <i>Status</i>. The words <i>Red Alarm</i> or <i>Blue Alarm</i> appear in the <i>Status</i> field.</li> </ol>

### Configuration and Status Reports

You can obtain the status of all Digital Line Cards in the NBX system with either of these two methods:

Select *NBX NetSet > Device Configuration > Digital Line Cards* and:

- Click *Config & Status Report*. The formatted report appears on the screen with headings shown in a larger font.

- Click *Export Report*. The unformatted report appears on the screen. To save the report as an ASCII text file, select *Save as* from the *File* menu of your browser.

[Table 56](#) describes in alphabetical order (not the order of appearance) the headings in the Configuration and Status Report.

**Table 56** Configuration and Status Report Headings

Heading	Description
#Chs	Number of channels.
#Dsp	Number of digital signal processors.
#OffChs	Number of channels in the offline state.
#OnChs	Number of channels in the online state.
AEClosed	Autoattendant extension when business is closed.
AELunch	Autoattendant extension when business is at lunch.
AEOpen	Autoattendant extension when business is open.
AEOther	Autoattendant extension for Other hours.
ais	TEP performance data. Alarm Indication Signal. The number of seconds in which an ais was transmitted. An ais signal is transmitted in lieu of the normal signal to maintain transmission continuity and indicate to the receiving terminal that there is a transmission fault located either at the transmitting terminal or upstream of the transmitting terminal. Also referred to as a Blue Alarm.
aissp	TEP performance data. T1.231 Near End. Number of seconds when loss of frame encountered.
ANI	Automatic Number Identification. The telephone number from which the call originated.
Audio Input	Numeric value of audio input control setting.
Audio Output	Numeric value of audio output control setting.
Audio Compr	The type of audio compression selected for this span. Default means that the device is using the system-wide setting.
bbec	TEP performance data. G.826 Near End, Far End. Number of E1 background block errors.
bber	TEP performance data. G.826 Near End, Far End. Background block ratio.
bes	TEP performance data. Bursty Errored Seconds, TR54016 Far End and Far End. Number of seconds during which there were 2 to 319 CRC errors, but no Severely Errored Frame or AIS conditions.
BdId	Board (card) ID number.

**Table 56** Configuration and Status Report Headings (continued)

<b>Heading</b>	<b>Description</b>
BdId Name	Board (card) name.
Brd	The number of the board (card) in a multiple board system.
CO Switch Protocol	Protocol (ETS1, QSIG Slave) used by the CO switch (not applicable to T1).
Card Type	Type of card (T1, ISDN PRI, E1, BRI).
Ch MAC Address	Channel MAC address.
Ch List	Channels supported by a DSP.
Ch Name	Name of a channel.
ChId	Unique identifying number of a channel in a list of channels, possibly including channels from more than one board.
ChNo	Channel number. For example: 1–24 for a T1 board.
css	TEP performance data. Controlled Slip Seconds, TR54016 Near End and Far End. Number of seconds of controlled (benign) slips.
cssp	TEP performance data. Controlled Slip Seconds Path, T1.231 Near End and Far End. Number of seconds of controlled (benign) slips.
CurState	Current state of a channel (in use, idle, available).
cv	TEP performance data. Code Violations, G.826 Near End. Number of bipolar violations and excessive zeroes.
cvl	TEP performance data. Code Violations Line, T1.231 Near End. Number of bipolar violations and excessive zeroes.
cvp	TEP performance data. Code Violations Path, T1.231 Near End and Far End. Number of bipolar violations and excessive zeroes.
datasecs	TEP performance data. The number of seconds with valid data.
DNIS/DID	Number of digits passed that identify the called party.
DSP Name	Name of a digital signal processor.
DSP Status	Status of a digital signal processor.
DSP Version	Version of code running on a digital signal processor.
Digit Collection	Specifies the data the CO sends and the format in which it is sent over the span of an incoming call. Can include both DNIS/DID and ANI, and can specify the order in which they arrive, and the number of digits involved.
EchoCanceller	The state of the echo cancellation function. Values: Enabled, Disabled.
E&M Direction	For a T1 line, the direction of the E&M signaling. Values: Two Way, One Way. Default: Two Way.

**Table 56** Configuration and Status Report Headings (continued)

Heading	Description
ErrorCnt	Reserved for future use.
ErrorCode	Reserved for future use.
es	TEP performance data. Errored Seconds, TR54016 Near End and Far End. Number of one-second intervals with exactly one CRC-6 error and no SEF or AIS defects.
esap	TEP performance data. Errored Seconds Type A, T1.231 Near End and Far End. Number of one-second intervals with exactly one CRC-6 error and no SEF or AIS defects.
esbp	TEP performance data. Errored Seconds Type B, T1.231 Far End. Number of one-second intervals with between 2 and 319 CRC errors.
esc	TEP performance data. Errored Seconds, G.826 Near End and Far End. Number of one-second intervals with exactly one CRC-6 error and no SEF or AIS defects.
esl	TEP performance data. Number of one-second interval with between 2 and 319 CRC errors. (line)
esp	TEP performance data. Errored Seconds, T1.231 Near End and Far End. The number of one-second intervals with between 2 and 319 CRC errors.
esr	TEP performance data. Errored seconds ratio, G.826 Near End and Far End.
Ext.	The extension number for a channel.
fc	TEP performance data. Failure Count, T1.231 Near End and Far End. Total failure count for the sample.
FlashHookTransfer	Status of flash hook transfer function. If enabled, allows user receiving a call to do a flash hook transfer to another trunk line Values: Enabled, Disabled. Default: Enabled
Framing Type	Type of framing used on this board (ES4, D4). For a T1 board, ESF is always associated with a B8ZS line coding, and D4 is always associated with AMI line coding.
Framer Loopback	The state of the setting for the Framer Loopback test, either enabled or disabled.
Gpld	Group ID number.
Group Name	Group name.
Guard	A time out value that controls the waiting period after a call completes, before the channel can be used for another outbound call from NBX system.
InterfaceType	Type of interface. Values: E1, T1, ISDN, no config. Default: T1. Does not apply to T1 E&M.

**Table 56** Configuration and Status Report Headings (continued)

Heading	Description
Interval	TEP performance statistics are sampled every 15 minutes. The system saves up to 24-hours of data in 15-minute intervals.
Intl. Prefix	An advanced configuration setting. An identifier, up to five-digits, that can be manually configured for outgoing calls on this span. Manual configuration of the international prefix is for situations where the telephone company equipment requires special configuration on the NBX system.
Line Code	Type of line coding used (HDB3, AMI). For a T1 board, AMI line coding is always associated with D4 framing, and B8ZS line coding is always associated with ESF framing.
Line Length	Length of the line between the termination and the board.
Line Loopback	The state of the setting for the Line Loopback test, either enabled or disabled.
lofc	TEP performance data. Loss Of Frame Count, T1.231 Near End and Far End. Number of Out-Of-Frame events.
los	TEP performance data. Loss Of Signal Seconds, G.826 Near End. Number of seconds during which the signaling channel was lost.
lossl	TEP performance data. Loss of Signal Seconds, T1.231 Near End. Number of seconds during which no pulses (loss of signal) have arrived within 100 to 250 bit times.
Local Loopback	The state of the setting for the Local Loopback test, either enabled or disabled.
MAC Address	A 48-bit address unique to each network device.
Model Number	The model number of the board.  <b>Values:</b> 0x0700 — T1 board 3C10116B 0x0b00 — T1 board 3C10116C 0x0e00 — T1 board 3C10116D 0x0c00 — E1 board 3C10165C 0x0f00 — E1 board 3C10165D 0x0a00 — BRI board 3C10164C
National Prefix	An advanced configuration setting. An identifier, up to five-digits, that can be manually configured for outgoing calls on this span. Manual configuration of the national prefix is for situations where the telephone company equipment requires special configuration on the NBX system.
NCP Conne	The amount of time that the digital line card waits for the NCP to connect the call. "USER_ALERTING_NO_ANSWER" errors mean that this value may be too small.

**Table 56** Configuration and Status Report Headings (continued)

Heading	Description
NCP Gener	A time-out value that controls how long the digital line card waits for a response from the call processor. Do not modify this value.
Network Digit	A time-out value that controls how long the digital line card waits between digits sent on an incoming call.
OffHk Min	The minimum time an analog telephone, connected to an Analog Terminal Card, must be off hook for the NBX system to recognize that the telephone has been picked up.
On Line	One possible status of a channel.
oof	TEP performance data. Out of Frame Seconds, G.826 Near End. Number of seconds during which there were excessive frame bit errors.
Payload Loopback	The state of the setting for the Payload Loopback test, either enabled or disabled.
Prepend Prefix	Full text: Prepend prefix to Calling Party Number in Setup Indication.  Either enabled or disabled. National and international prefixes can be added for outgoing calls. The prefix is for situations where the telephone company equipment requires special configuration on the NBX system.
Protocol	A signaling method used to make calls.
rai	TEP performance data. Remote Alarm Indicator, G.826 Near End and Far End. Number of seconds during which a remote alarm indication was declared.
Recv. Timer	Full Text: Overlap Receiving timer (T302).  PRI span only. An advanced configuration setting for situations where the telephone company equipment requires special configuration on the NBX system.
Release Complete	Full Text: Send "Release Complete" if incoming call is from incompatible equipment.  Either enabled or disabled. An advanced configuration setting for situations where the telephone company equipment requires special configuration on the NBX system.
RxWnkMax	The maximum duration of a received Wink signal.
RxWnkMin	The minimum duration of a received Wink signal.
sasp	TEP performance data. SEF/AIS Seconds, T1.231 Near End. Number of seconds when at least 2 frame bit errors or loss of frame encountered.

**Table 56** Configuration and Status Report Headings (continued)

Heading	Description
sefsp	TEP performance data. Severely Errored Frame Seconds, T1.231 Far End. Number of one-second intervals with either out-of-frame signals, AIS defects, 390 or more CRC errors, or four or more frame bit errors.
Sending Complete	Full Text: Send "Sending Complete IE" in Setup Request  IE (Information Element) refers to the data fields within an ISDN layer 3 message. An advanced configuration setting for situations where the telephone company equipment requires special configuration on the NBX system.
ses	TEP performance data. Severely errored seconds, TR54016 Near and Far End. Number of one-second intervals with either out-of-frame signals, AIS defects, 390 or more CRC errors, or four or more frame bit errors.
sest	TEP performance data. Number of one-second intervals with either out-of-frame signals, AIS defects, 390 or more CRC errors, or four or more frame bit errors.
sesl	TEP performance data. Severely Errored Seconds Line, T1.231 Near End. Number of one-second intervals with either out-f-frame signals, AIS defects, 390 or more CRC errors, or four or more frame bit errors.
sesp	TEP performance data. TEP performance data. Severely Errored Seconds Path, T1.231 Near End. Number of one-second intervals with either out-of-frame signals, AIS defects, 390 or more CRC errors, or four or more frame bit errors.
sesr	TEP performance data. Severely Errored Seconds Ratio, G.826 Near End and Far End.
Silence Suppr	The state of the silence suppression setting for this span. "Default" indicates that the span is set to use the system-wide setting.
SpId	Span ID.
SpNo	Span number.
Span MAC Address	MAC address assigned to this span.
Span Name	Name of span.
SpanNo	Identifying number for a span.
Start Type	Mechanism used to indicate start of a call.
Status	Status of a channel, span, card. Values: Online, Idle, Unknown. Default: Online

**Table 56** Configuration and Status Report Headings (continued)

Heading	Description
Strip #	Full Text: Strip trailing # from Called Party Number in Setup Request.  Either enabled or disabled. An advanced configuration setting for situations where the telephone company equipment requires special configuration on the NBX system.
TEI	Terminal Equipment Identification number (of BRI board). The telephone company may provide this number or the system may assign it, depending on how you purchased the BRI lines.
TEP Version	The version of software running on the board.
Time Last Seen	Last time activity was recorded for this board.
Timing Mode	Internal: Timing is generated from within the digital line card. Loop: Timing is taken from the central office.
Trunk to Trunk	Whether call transfers are allowed from one trunk to another. Values: Enabled (default), Disabled, Restricted, Unrestricted.
TxGudMin	The minimum duration of a transmitted Guard signal.
TxWnkDura	The duration of a transmitted Wink signal.
uas	TEP performance data. Unavailable Seconds, TR54016 Near End and Far End. Number of seconds during which the frame was unavailable for 10-seconds.
uasc	TEP performance data. Unavailable Seconds, G.826 Near End and Far End. Number of seconds during which the frame was unavailable for 10-seconds.
uasp	TEP performance data. Unavailable Seconds, T1.231 Near End and Far End. Number of seconds during which the frame was unavailable for 10-seconds.
vsecs	TEP performance data. Valid seconds for the selected interval.
Wink Wait	This time out value controls how long the digital line card waits to respond with a wink signal on an outgoing call. If you see "no_wink_received" errors, this value may be too small.

## Connecting a Computer to a Serial Port

On the SuperStack 3 Call Processor, the NBX 100 Call Processor, and on some of the NBX cards, you can connect a computer to a serial port and, by running a terminal emulation program on the computer, you can obtain information about the status of the card or the NBX system.

You can connect a computer directly to the serial port on these cards:

**Table 57** Serial Port Connections

Card	Port
SuperStack 3 NBX Call Processor	COM1
NBX 100 Call Processor	COM1
BRI-ST Digital Line Card	CONSOLE
E1 Digital Line Card	CONSOLE
T1 Digital Line Card	CONSOLE
NBX Analog Line Card (3C10114C only)	CONSOLE
NBX Analog Terminal Card (3C10117C only)	CONSOLE

It does not matter which computer operating system you use. As long as the computer has a terminal emulation program that can emulate a VT100 terminal (for example, Microsoft Hyperterminal), it can communicate with any of the cards listed in [Table 57](#).

To connect the computer to the COM1 or CONSOLE port on a board:

- 1 Using a standard computer serial cable (9-pin male to 9-pin female), connect the male end of the cable to the female connector (COM1 or CONSOLE) on the front panel of the board.
- 2 Connect the female end of the cable to an available serial port on the computer.
- 3 Start the terminal emulation software and create a new connection.
- 4 Configure the connection to use the serial port to which you connected the cable and to use the settings in [Table 58](#).

**Table 58** Terminal Emulation Program Properties

Property	Value
Emulation	VT100
Baud Rate	9600
Data bits	8
Parity	None
Stop bits	1
Flow control	None

All messages associated with the board (for example, the initialization process) appear in the terminal emulation window.

---

## Servicing the Network Call Processor Battery

If you lose the system date and time when you reboot the SuperStack 3 NBX system, it could mean that the Call Processor battery must be replaced. The battery is not a user-serviceable item. If you suspect a problem with the battery, contact your 3Com Technical Support representative.



**WARNING:** *There is a danger of explosion if the battery is incorrectly replaced. Replace only with the same or equivalent type recommended by the manufacturer. Dispose of used batteries according to the manufacturer's instructions.*

---

## Getting Service and Support

Your authorized 3Com NBX Voice-Authorized Partner can assist you with all of your support needs, including systems and cable plant design, installation, configuration, and project management.

A choice of maintenance services, including remote diagnostics, on-site support, telephone technical support, and hardware replacement, is available from your 3Com NBX Voice-Authorized Partner. Training and enhancement services are also available.



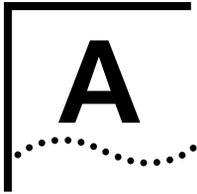

# INTEGRATING THIRD-PARTY MESSAGING

The NBX system can operate with a third-party messaging system. This appendix describes the steps that you must perform to use a third-party messaging system with the NBX system:

- [Installing Software on the Third-Party Messaging Server](#)
- [Configuring the NBX System](#)
- [Configuring NBXTSP on the Server](#)

---

## Installing Software on the Third-Party Messaging Server

You must install the NBX Media Driver and the NBX TAPI Service Provider (NBXTSP) on the third-party messaging server to enable it to interact with the NBX system. See your messaging application's documentation for server requirements.

- 1 Install the NBX Media Driver application from the *NBX Resource Pack CD* or the NBX Partner Access website.
- 2 Install the NBXTSP from the *NBX Resource Pack CD* or the NBX Partner Access website.

You can also download the NBXTSP from your NBX system by connecting to the NBX NetSet utility from a browser located on the third-party messaging server.

---

## Configuring the NBX System

To activate third-party messaging on the NBX system use the NBX NetSet utility to perform the tasks described in this section.

- Add the NBX Third-party Messaging and Media Driver licenses
- Make sure Auto Discover Telephones is enabled
- Disable NBX messaging
- Create a Hunt Group for the third-party messaging system
- Modify the Voice Mail Extensions List

All NBX NetSet procedures require an administrator login.

Add the NBX Third-Party Messaging and Media Driver licenses to your NBX system:

- 1 Select *NBX NetSet > Operations > Licenses > Add License*.
- 2 In the *License Key* field, enter the license key provided by your 3Com Voice-Authorized Partner.
- 3 Click *Apply*.
- 4 Add any additional licenses. When you are finished adding licenses, click *OK*.
- 5 Reboot the system.



*3Com strongly recommends that you back up your licenses each time you make a license change.*

Verify that Auto Discover Telephones is enabled and NBX Messaging is disabled:

- 1 Select *NBX NetSet > System Configuration > System-wide*.
- 2 Verify that *Auto Discover Telephones* is enabled.
- 3 Clear the check box for *NBX Messaging*.
- 4 Click *OK*.

Create an NBX Hunt Group for third-party messaging:

- 1 Select *NBX NetSet > User Configuration > Hunt Groups > Add*.
- 2 Set the following parameters:
  - **Name** — UM Hunt Group (or some similar name)
  - **Type** — HuntGroup - Circular.



*3Com recommends that you use a circular hunt group rather than a linear hunt group.*

- **Extension** — Enter the appropriate extension for your hunt group.
- **Password** — Set the password for this hunt group.
- **Logout if no answer** — Verify that this check box is empty.
- **Users** — Select the WAV phones and the ATA ports that are connected to the third-party messaging system.
- **Call Coverage** — Set to Voicemail.

3 Click *OK*.

Edit the Voice Mail Extensions list:

- 1 Select *NBX NetSet > Dial Plan > Extension Lists*.
- 2 Click *\*0003 VoiceMail*, and then click *Modify*.
- 3 In *Extensions in List*, select all of the Voicemail extensions and then click the *>>* button.
- 4 In *Extensions not in List*, select the Hunt group extension that you created for third-party messaging and click the *<<* button.
- 5 Click *OK*.

---

## Configuring NBXTSP on the Server

On the third-party messaging server, you must add the WAV extensions to the NBX TAPI Control Panel. If your third-party messaging system needs TAPI messages from NBX Analog Terminal Adapter devices or NBX Telephones, you must also add these devices to the NBX TAPI Control Panel.

Update the devices in the NBX TAPI Control Panel:

- 1 **WinNT** — On the server, select *Control Panel > Telephony > Telephony Drivers > NBX TAPI Service Provider*.
- 2 **Win2K** — On the server, select *Control Panel > Phone and Modem Options > Advanced > NBX TAPI Service Provider*.
- 2 Click *Configure* and add the extension numbers.
- 3 Click *OK*.

You are now ready to install your third-party messaging software. See your application's documentation for installation and configuration instructions.



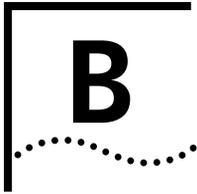

# ISDN COMPLETION CAUSE CODES

This appendix lists the Completion Cause Codes displayed in the digital line card *Span Status* dialog boxes:

- *Digital Line Cards > T1 Span List > Status*
- *Digital Line Cards > ISDN PRI Span List > Status*
- *Digital Line Cards > ISDN BRI Span List > Status*

The codes, listed in [Table 59](#), detail the reasons for the termination of a call. See [“Configuring and Managing E1 Digital Line Cards”](#) on [page 179](#).



*These completion cause code descriptions are only guidelines. The detailed cause may vary according to the Public Switched Telephone Network (PSTN) to which your NBX system is connected.*

**Table 59** Completion Cause Codes

Class Grouping	Hex Code	Decimal Code	Description	Details
Normal events	0x00	0	No diagnostic	
	0x01	1	Unassigned number	The requested destination, although valid, cannot be reached.
	0x02	2	No route	The sending equipment (sending the cause) is requested to route the call through an unrecognized transit network.
	0x03	3	No route to destination	The called user cannot be reached because the network does not serve the destination.
	0x06	6	Channel unacceptable	The last identified channel is not acceptable to the sending entity.
	0x07	7	Call awarded	The incoming call is connected to a channel already established for similar calls (e.g. packet-mode X.25 virtual calls).
	0x10	16	Normal clearing	This call is being cleared by one of the users involved.

**Table 59** Completion Cause Codes (continued)

<b>Class Grouping</b>	<b>Hex Code</b>	<b>Decimal Code</b>	<b>Description</b>	<b>Details</b>
	0x11	17	User busy	The called user cannot accept another call although compatibility is established.
	0x12	18	No user responding	The user does not respond to call establishment messages with either an alerting or connect indication within the allowed time.
	0x13	19	User alerting no answer	The user has provided an alerting indication but no connect indication within the allowed time.
	0x15	21	Call rejected	Equipment sending the cause does not wish to accept this call although it is not busy or incompatible.
	0x16	22	Number changed	The called party number is not assigned.
	0x1A	26	Non-selected user clearing	The user has not been awarded the incoming call.
	0x1B	27	Destination out of order	The destination interface is not operating correctly.
	0x1C	28	Invalid number format	The called party number is invalid, or incomplete.
	0x1D	29	Facility rejected	The network cannot provide the facility requested.
	0x1E	30	Response to status enquiry	The reason for the STATUS message was the prior receipt of a STATUS ENQUIRY message.
	0x1F	31	Unspecified cause	Used to report normal events only when no other cause in the normal class applies.
Resource unavailable	0x22	34	No circuit available	An appropriate circuit or channel is not currently available to handle the call.
	0x23	35	Call queued (AT&T)	The network is not functioning. Immediate redial is unlikely to be successful.
	0x26	38	Network out of order	The network is not functioning. Immediate redial is unlikely to be successful.
	0x29	41	Temporary failure	The network is not functioning. Immediate redial is unlikely to be successful.
	0x2A	42	Network congestion	The switching equipment generating this cause is experiencing a period of high traffic.
	0x2B	43	Access info discarded	The network could not deliver access information to the remote user as requested. May include the type of discarded information (user-to-user information, low layer or high layer compatibility, or sub-address).
	0x2C	44	Requested channel not available	Returned when the circuit (or channel) indicated by the requesting entity cannot be provided by the other side of the interface.

**Table 59** Completion Cause Codes (continued)

<b>Class Grouping</b>	<b>Hex Code</b>	<b>Decimal Code</b>	<b>Description</b>	<b>Details</b>
	0x2D	45	Pre-empted	
	0x2F	47	Resources unavailable – unspecified	Reports a resource unavailable event only when no other cause in the resource unavailable class applies.
Service or option not available	0x31	49	Quality of service unavailable	Throughput or transit delay cannot be supported and that the Quality of Service (as defined in Recommendation X.213) cannot be provided.
	0x32	50	Facility not subscribed	The requested supplementary service could not be provided by the network because the user has not completed the necessary administrative arrangements with its supporting networks.
	0x34	52	Outgoing call barred	
	0x36	54	Incoming call barred	
	0x39	57	Bearer capability not authorized	The user is trying to make unauthorized use of equipment providing a bearer capability.
	0x3A	58	Bearer capability not available	The user has requested a bearer capability, which is implemented by the equipment generating the cause, but is not available at this time.
	0x3F	63	Service not available	Reports a service (or option) not available event only when no other cause in the service (or option) not available class applies.
	Service or option not implemented	0x41	65	Capability not implemented
0x42		66	Chan not implemented	The equipment sending this cause does not support the requested channel type.
0x45		69	Facility not implemented	The equipment sending this cause does not support the requested supplementary service.
0x46		70	Only restricted digital available	One equipment has requested an unrestricted bearer service but the equipment sending this cause only supports the restricted version.
0x4F		79	Service not implemented, unspecified	Reports the service (or option) not implemented event only when no other cause in the service (or option) not implemented class applies.
Invalid message	0x51	81	Invalid call reference	The equipment sending this cause has received a message with a call reference that is not currently in use on the user network interface.

**Table 59** Completion Cause Codes (continued)

Class Grouping	Hex Code	Decimal Code	Description	Details
	0x52	82	Chan does not exist	The equipment sending this cause has received a request to use a channel that is not activated on the interface for a call.
	0x53	83	Suspended call exists, call identity does not	A call resume has been attempted with a call identity that differs from that in use for any currently suspended calls.
	0x54	84	Call identity in use	The network has received a call suspended request that contained a call identity (including the null call identity) that is already in use for a suspended call within the domain of interfaces over which this call may be resumed.
	0x55	85	Incompatible destination	
	0x58	88	Incompatible destination	The equipment sending this cause has received a request to establish a call that has low layer compatibility, high layer compatibility, or other compatibility attributes (for example, data rate) that cannot be handled.
	0x5B	91	Transit network does not exist.	
	0x5F	95	Invalid message (unspecified)	Reports an invalid message event only when no other cause in the invalid message call applies.
Protocol error	0x60	96	Mandatory IE missing	The equipment sending this cause has received a message that is missing an information element that must be present in the message before that message can be processed.
	0x61	97	Nonexistent message	The equipment sending this cause has received a message with a message type that it does not recognize, either because it is an undefined message, or it is defined but not implemented by the equipment sending the cause.
	0x62	98	Wrong message	The equipment sending this cause has received a message that it considers as not permitted while in the call state; or a STATUS message was received indicating an incompatible call state.
	0x63	99	Bad info element	The equipment sending this cause has received a message that includes information elements not recognized because the information element identifier is not defined, or it is defined but not implemented by the equipment sending the cause. However, the information element is not required to be present in the message to enable the equipment sending the cause to process the message.

**Table 59** Completion Cause Codes (continued)

<b>Class Grouping</b>	<b>Hex Code</b>	<b>Decimal Code</b>	<b>Description</b>	<b>Details</b>
	0x64	100	Invalid element contents	The equipment sending this cause has received an information element that it has implemented. However, the sending equipment was not able to implement the code because one or more of the fields were incorrectly coded.
	0x65	101	Wrong message for state	The received message is incompatible with the call state.
	0x66	102	Timer expiry	A timer has expired and an associated Q.931 error handling procedure has been initiated.
	0x67	103	Mandatory IE length error	
	0x6F	111	Protocol error	reports an error event only when no cause in the protocol error class applies.
Interworking	0x7F	127	Interworking unspecified	There has been interworking with a network that does not provide cause codes for its actions. Therefore, the precise cause for a message being sent is not known.



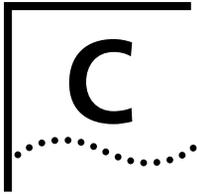

# CONFIGURING OPTION 184 ON A WINDOWS 2000 DHCP SERVER

---

## Overview

[RFC 2132 \(DHCP Options and BOOTP Vendor Extensions\)](#) allows for vendor-specific extensions to the DHCP protocol. It defines that option codes in the range 128 through 254 are set aside for site-specific extensions.

3Com telephones can receive their IP configuration from a DHCP server. However, 3Com telephones need configuration information that is not part of a standard DHCP response. You can use DHCP option 184 to specify this extended information:

- NCP IP Address — Each telephone must receive a download of operating settings from the Network Call Processor.
- Alternate Server IP Address — Specifies a second location from which a telephone can receive its download. (Not used in an NBX system.)
- Voice VLAN Configuration — Reserved for future use.
- Fail-Over Call Route Point — Reserved for future use.

To help you configure option 184, this appendix includes an example of how to configure option 184 on a Windows 2000 server that has been configured to run DHCP server software. It covers these topics:

- [Creating Option 184](#)
- [Editing Option 184 Values](#)
- [Activating Option 184](#)



*This appendix describes how to configure the NCP IP address only. The extended options are not used in an NBX environment. The information in this appendix pertains only to a Windows 2000 server. The configuration instructions differ for other DHCP servers. This appendix describes only the configuration of option 184, not how to install or perform basic configuration of the Windows 2000 server.*

---

## Creating Option 184

If you are configuring more than one subfield for Option 184, the first subfield must be the NCP IP Address for backward compatibility.

- 1 Start the DHCP Microsoft Management Console:  
*Start > Programs > Administrative Tools > DHCP*  
The *DHCP* dialog box appears. In the left pane, look for the name of your Windows 2000 DHCP server.
- 2 Right click the name of your DHCP server. From the menu that appears, select *Set Predefined Options* to open the *Predefined Options and Values* dialog box.
- 3 Click *Add* to open the *Option Type* dialog box.
- 4 In the *Name* field, type a name of your choice.
- 5 From the *Data Type* drop-down list, select *Byte*.
- 6 Enable the *Array* check box.
- 7 In the *Code* text box, type *184*.
- 8 In the *Description* text box, enter a description of your choice. Example: *NBX NCP IP Address*.
- 9 Click *OK*.

In the *Predefined Options and Values* dialog box, the DHCP Microsoft Management Console creates a new option name by combining the option number with the name that you chose and adds this name to the *Option name* drop-down list. Example: If you used NBX as the option name, the system adds *184 NBX* to the drop-down list.

---

## Editing Option 184 Values

- 1 Select the new option name from the *Option name* drop-down list, and click *Edit Array*. The *Numeric Value Array Editor* dialog box appears.
- 2 In the *Data entry* area of the dialog box, click the *Decimal* radio button at the right of the word *Format*.
- 3 In the *Current Values* text box, highlight the 0 (zero), and click *Remove*.
- 4 To create the new value, enter each element of the new value:
  - a Click in the *New value* text box.
  - b Type the individual element value.

- c Click *Add*.
- 5 Repeat steps 4 a, b, and c for each element in the following table. As you add each element, it appears in the *Current values* list, above previously added values.

Add these elements in this order:

What You Type	Description
1	Enter 1 as the only suboption code for option 184. (Some options can have more than one suboption.)
4	The length of the argument that applies to this suboption. For option 184, suboption 1, the argument is an IP address, which is composed of four numerical fields (octets).
<b>NOTE:</b> The next four fields use 10.234.1.254 as the sample IP address of the NBX Call Processor. Enter the IP address of your NBX Call Processor.	
10	The first octet in the IP address of the NBX Call Processor.
234	The second octet in the IP address of the NBX Call Processor.
1	The third octet in the IP address of the NBX Call Processor.
254	The fourth octet in the IP address of the NBX Call Processor.

- 6 After you have entered all elements in the new value, click *OK*. You return to the *Predefined Options and Values* dialog box. The values that you entered appear in the *Value* area of the dialog box under *Byte*.



*The values appear in hexadecimal format although you entered them in decimal format.*

- 7 To accept the values, click *OK*. You return to the *DHCP Microsoft Management Console* dialog box.

## Activating Option 184

To activate option 184, decide whether you want to apply the option to a specific scope or globally, that is, to all scopes that are served by the DHCP server software.

To activate option 184 for a specific scope:

- 1 In the left pane of the *DHCP Microsoft Management Console* dialog box, find the scope that you want. Then highlight *Scope Options*.
- 2 Right click *Scope Options*, and, from the menu that appears, select *Configure Options*. The *Scope Options* dialog box appears.

- 3 Scroll down in the *Available Options* list until you find the option that you just added (*184 NBX* in this example).
- 4 Enable the check box to the left of the option.
- 5 Click *OK*.

In the right pane, the option name now appears in the *Option Name* column. The *Vendor* column contains the word *Standard*. The values of the individual elements that you entered appear in the *Value* column.



*The values appear in hexadecimal format although you entered them in decimal format.*

To activate option 184 globally:

- 1 In the left pane of the *DHCP Microsoft Management Console* dialog box, highlight *Server Options*.
- 2 Right click *Server Options*, and from the menu that appears, select *Configure Options*. The *Server Options* dialog box appears.
- 3 Scroll down in the *Available Options* list until you find the option that you just added (*184 NBX* in this example).
- 4 Enable the check box to the left of the option.
- 5 Click *OK*.

In the right pane, the option name now appears in the *Option Name* column. The *Vendor* column contains the word *Standard*. The values of the individual elements that you entered appear in the *Value* column.



*The values appear in hexadecimal format although you entered them in decimal format.*

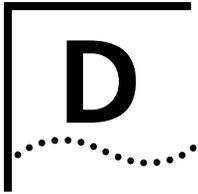

# CONNEXIONS H.323 GATEWAY

This appendix provides information on how to install and configure the 3Com ConneXtions H.323 Gateway.

It covers these topics:

- [Overview of ConneXtions](#)
- [Installation Requirements](#)
- [Preparing for Installation](#)
- [Installing ConneXtions](#)
- [Overview of H.323](#)
- [The H.323 Connection](#)
- [Connection Considerations](#)
- [Special Issues](#)
- [Checking Connections](#)
- [Placing Calls](#)
- [Receiving Calls](#)
- [Handling Conference Calls](#)
- [Related H.323 Documentation](#)

---

## Overview of ConneXtions

ConneXtions is a 3Com software product that allows you to use an appropriately configured Windows system as an H.323 gateway for use with NBX systems.

H.323 gateways implement an ITU standard that allows telephone-like call connections to occur through an IP network. Although this standard addresses the means for transferring data, voice, and images, the NBX ConneXtions H.323 Gateway focuses on delivering low-cost, high-quality, voice connections through IP networks.

The ConneXtions software adapts internal NBX system protocols to equivalent H.323 protocols that are carried across a WAN in IP packets. The H.323 protocol addresses:

- Negotiated connections.
- Negotiated voice compression.
- Standard extensions.
- Remote Internet device connections.

For more information, see [“Overview of H.323”](#) on [page 368](#).

---

## Installation Requirements

The ConneXtions H.323 Gateway software requires an NBX system and at least four additional components:

- A router with access to a wide area network (WAN)
- A Windows-based server connected to the NBX LAN
- ConneXtions software (on the *NBX Resource Pack CD*)
- A ConneXtions license



*Systems that receive H.323 calls through the public Internet may also need a firewall. See [“Firewall Security”](#) [page 378](#).*

### WAN Router

WAN Routers typically connect to ISDN, T1, E1, Frame Relay, or Asynchronous Transfer Mode facilities, depending on the load they carry.

A dedicated router can often reduce problems encountered with firewalls. Firewalls often interfere with connections because they are designed to admit only authorized addresses, and because they discriminate against specific types of packets. The unusual complexity of

the H.323 protocol presents special problems for firewalls because it requires additional processing. To minimize packet delay through a firewall, verify that the firewall is configured to give H.323 packets a high processing priority.



*During installation, you can select a range of TCP or UDP ports to use with H.323 connections to provide more flexibility when using firewalls.*

A ConneXtions gateway can use a separate network interface card to bypass the firewall delay. However, you should implement this solution only if it is consistent with your company's network security policy. For more information, see [“Firewall Security”](#) on [page 378](#).

## **Windows-based System**

The ConneXtions software requires a dedicated computer system that is running Windows NT version 4.0 with service pack 4 (or higher), or Windows 2000. The system hardware must be certified by Microsoft. The installation software checks for the presence of Windows 2000 or Windows NT and then loads the correct NBX packet driver from the *NBX Resource Pack CD*.

Although the ConneXtions software requires little disk storage, processing and memory requirements are crucial, and you may need multiple gateways. Microsoft server licenses do not apply because no additional operating system logons are involved.

The main considerations are [“Windows Compatibility”](#) and [“Processor, Memory, and Bandwidth Requirements”](#), discussed next, and [“Firewall Security”](#), on [page 378](#).

### **Windows Compatibility**

To check the compatibility of your system:

- 1 On a computer that has Internet access, enter `www.microsoft.com/hwdq/hwtest`
- 2 Locate the link to the Hardware Compatibility List.
- 3 Verify that your intended Windows 2000 or Windows NT system is on the Hardware Compatibility List.

### Processor, Memory, and Bandwidth Requirements

Each G.711 call needs about 50 MHz on a Pentium II or 20 Mhz on a Pentium III. Each G.723 call needs about 128 MHz on a Pentium II or 75 Mhz on a Pentium III. These speed requirements increase directly with the number of ports. The IP router bandwidth requirements also increase directly with the number of ports.



*The bandwidth requirements for a Pentium II and a Pentium III are identical.*

[Table 60](#) shows the speed and bandwidth requirements for different numbers of ports. It assumes that each packet carries a 50-byte overhead.

**Table 60** Pentium Processor Capabilities

Ports	Pentium II Speed (MHz)		Pentium III Speed (MHz)		Bandwidth (Kbps) on the LAN	
	G.711	G.723	G.711	G.723	G.711	G.723
2	100	256	40	150	153.6	38.4
4	200	512	80	300	307.2	76.8
8	400	1000	160	600	614.4	153.6
16	800	2000	320	1200	1228.8	307.2
32	1600	4000	640	2400	2457.6	614.4
64	3200	10000	1280	4800	4915.2	1228.8
100	5000	12800	2000	7500	7680	1920

The memory requirements to support port processing also increase with each new port. A fully configured system, with the maximum number of ports (100), needs 600 MB of main memory. Hard disk requirements are less than 40 MB.

[Table 61](#) lists the theoretical maximum number of ports that typical Pentium processors can handle.

**Table 61** Pentium II and III Processor Capabilities

Pentium II (MHz)	Ports		Pentium III (MHz)	Ports	
	G.711	G.723		G.711	G.723
300	6	2	450	22	6
400	8	3	500	25	6
500	10	4	533	26	7
600	12	4	550	27	7
650	13	5	600	30	8
Dual 500	20	8	650	32	8
			667	33	8
			700	35	9
			733	36	9
			750	37	10
			800	40	10
			1500	74	20



*The maximum number of ports can be limited by the number of licenses.*

If your port processing requirements exceed the capacity of a single processor, ConneXtions software supports either multiprocessor (dual and quad Pentium processors) or multiple gateway solutions. A Windows 2000 or Windows NT system that uses a dual 800 MHz Pentium processor achieves the same result.

### Other System Requirements

Each H.323 port requires 6 MB of memory. 3Com recommends a PC with at least 128 MB of memory. Disk storage requirements are minimal. In addition to memory and disk storage, the operating system needs:

- A compact disk drive for loading ConneXtions software from the *NBX Resource Pack CD*.
- A 3Com Network Interface Card for connecting to the NBX LAN (10BASE-T or 100BASE-T).
- A 3Com Network Interface Card for connecting to a separate firewall or router (optional).

The Call Processor coordinates its activities with the gateway through a Network Interface Card (NIC) in that gateway system. The same NIC can also be used to communicate with the IP router. This single NIC

configuration is appropriate if the firewall, which separates Internet and intranet, is either unnecessary or is required by company policy.

### ConneXtions Software

You use the *NBX Resource Pack CD* to install ConneXtions software. The ConneXtions software performs the protocol conversions between an NBX system and the international H.323 standards. To a system administrator, H.323 ports look like PSTN line ports. Both have extensions and are configured the same way but have different license requirements.



*The NBX Resource Pack CD is also required to change H.323 gateway parameters after installation. A dealer who wants to explore possible hardware incompatibilities by running ConneXtions from a substitute laptop must reinstall ConneXtions on the laptop at each site.*

---

### Preparing for Installation

Before you install a ConneXtions H.323 Gateway:

- Assemble system information.
- Check for the G.723 convertor (optional).
- Verify and install the NT Service Pack (Service Pack 4) (if required).
- Assemble permissions, licenses, and notifications.



*Do not uninstall the current version. You would remove the current settings.*

### Assembling System Information

ConneXtions is installed through an InstallShield wizard. It presents a series of dialog boxes that request specific permissions and configuration information. Assemble this information before you begin an installation:

- NBX administrator login name: **<administrator>**
- NBX administrator password: **<xxxxxxxx>**
- NBX H.323 software and associated port licenses.
- Caller ID label for outgoing calls. The default is the caller's extension. Use the main office telephone number (10 digits in the United States).
- NBX system name. Supply the name that H.323 callers see when they connect to the Auto Attendant.
- The TCP or UDP port ranges for use with a firewall, if any.

### Verifying the G.723 Converter

Installations that need G.723.1 audio compression require access to a converter in Microsoft NetMeeting 2.1 or 3.01. NetMeeting must be installed on the same PC that holds the ConneXtions software, but the two cannot run simultaneously.



*G.723.1 does not appear as a selectable option in ConneXtions unless the converter is accessible.*

To confirm that the convertor is present, search for the msg723.acm file on your hard drive or download it from the Microsoft web site.

### Checking Service Pack (Windows NT Only)

If you are using Windows NT 4.0 to run the ConneXtions software, you require Service Pack 4 (or higher).

To verify that you are running Service Pack 4 or higher:

- 1 On the *Start* menu, select *Programs > Administrative Tools (Common)*.
- 2 Select *Windows NT Diagnostics*, and click the *Version* tab.
- 3 Verify that the NT version is 4.0 with Service Pack 4 or higher. If it is not, download the latest version from the Microsoft web site.

### Configuring Licenses

To configure licenses, you must enter system information, such as the number of H.323 ports that you want to install. You can find this information through NBX NetSet.

You can purchase licensed keycodes to unlock additional ports. A license provides a software key that unlocks ports that are already loaded. You can purchase licenses to enable or upgrade a system to 1, 2, 4, 8, or 16 ports on an NBX 100 system, or to 1, 2, 4, 8, 16, 32, 64 or 100 ports on a SuperStack 3 system. Software keys are tied to the system serial number.

To configure licenses:

- 1 Log on to NBX NetSet:
  - a Open your browser and connect to the Call Processor by using its IP address (example: 192.168.1.190) or host name (example: Home).
  - b Click *Administrator*.
  - c Enter your username and password.
  - d Click *OK*.

- 2 Access and record the Call Processor MAC address:
  - a In the *NBX NetSet - Main Menu* window, click *Reports*.
  - b Click the *System Data* tab.
  - c Record the MAC address.



*MAC addresses use colons as separators. Take care to record the Call Processor MAC Address, not the Music-on-Hold MAC address, which also appears in the System Data tab.*

- 3 Determine the number of port licenses:
  - a Return to the *NBX NetSet - Main Menu* window.
  - b Click *Operations*.
  - c Click the *Licenses* tab.
  - d Record the number of licenses for the H.323 Gateway.
  - e Click *Add License*.
  - f Enter the License Key (must be purchased) to unlock the license. To obtain a license key, contact 3Com order management or your supplier.
  - g Click *OK*.



*Do NOT click Apply. If you click Apply and then OK, the system warns you that you have an invalid license.*

- 4 Specify Auto Discovery:
  - a Return to the *NBX NetSet - Main Menu* window.
  - b Click *System Configuration*.
  - c On the *System Settings* tab, click *System Wide*.
  - d Check *Auto Discover Line Cards*.
  - e Click *OK*.

## Installing ConneXtions

To install the NBX ConneXtions H.323 Gateway:

- 1 Insert the *NBX Resource Pack CD* into the PC. Click *NBX Applications*, and then click *NBX ConneXtions*, and then click *OK*.



*If the program does not start automatically, click the Windows Start menu, and then Run. Type D:autorun, substituting the letter of your CD-ROM drive for D, and click OK.*

- 2 Respond to these initial InstallShield dialog boxes:
  - a In the *Welcome* dialog, click *Next*.
  - b In the *License Agreement* dialog, click *Yes*.
  - c In the *Default Destination Location* dialog, click *Next* or browse for an alternative destination location.
  - d In the NBX license request dialog, click *Yes*. This confirms that the NBX system is legal.

- 3 Specify the Audio Channel Format:
  - a Select first option (G.711 only) for uncompressed connections
  - b Select one of the other two options to configure G.723.1 connections.

These options require the file `msg723.acm`. See [“Verifying the G.723 Converter”](#) on [page 363](#).

- 4 Information Block - click *OK*.
- 5 Specify the number of configured H.323 ports for this ConneXtions gateway. 3Com recommends that licenses are allocated equally when using multiple gateways.
- 6 Optionally, specify a Caller ID Label by entering an outgoing caller ID notification label of up to 33 digits. Enter numbers only, no other characters or spaces.

Example: **9787490000**

(The Caller ID shows the caller's extension number followed by the [User Name] if the entry is left blank.)

- 7 Specify the Call Processor name. Enter the name H.323 callers see when they reach the Auto Attendant.

- 8 Only one Gateway? - Click Yes if the NBX system has only one H.323 gateway system.



**CAUTION:** *Multiple gateways must have unique configurations. Multiple gateways need a distinguishing "Gateway Number". Assign the first installed gateway to number 0; the second to number 1; and so on. 3Com recommends that licenses be allocated equally when using multiple gateways.*

- 9 Enter the Call Processor MAC Address. To find it, log on as an administrator in NBX NetSet, and click *Reports*, followed by the *System Data* tab.



*Be sure to record the Call Processor (NCP) MAC Address, not the Music-On-Hold MAC address, which also appears in the System Data tab.*

- 10 Select the country in which you are using ConneXtions. This defines the tones and cadences that ConneXtions uses.
- 11 Specify the UDP and TCP port ranges for use with a firewall. If these ranges are not important in your system, use the default settings. You can coordinate these settings with the firewall administrator.
- 12 Do you want to interface with a Gatekeeper? Click Yes if you want to use a gatekeeper. Gatekeepers act as the central point for all calls within their zones and provide call control services to registered endpoints.
- 13 If you have chosen to use a gatekeeper, enter the IP address of the preferred gatekeeper. This forces ConneXtions to try to use this gatekeeper first and provides a more secure option. If you want ConneXtions to autodiscover a gatekeeper, leave the field empty. You might chose to do this if you only have one gatekeeper on your network.
- 14 Choose what you want ConneXtions to do if it cannot register with the preferred gatekeeper:

**Autodiscover a new Gatekeeper** — ConneXtions allows you to make direct H.323 (unregistered calls) while attempting to contact an alternative gatekeeper on the network.

**Continue unregistered** — ConneXtions continues to function without using a gatekeeper.

**Block Calls** — ConneXtions blocks calls if it cannot register with a gatekeeper. (You must either have a gatekeeper on the network, or select one of the other options which enables ConneXtions to work without a gatekeeper present.) If a gatekeeper becomes available, you must stop the ConneXtions service and then restart it.

- 15** Do you want to use alternate Gatekeepers? If you select *Yes*, the chosen gatekeeper maintains a list of alternate gatekeepers to be used if the preferred gatekeeper does not respond.



*If you choose to use alternate gatekeepers and have also selected to autodiscover new gatekeepers if ConneXtions cannot contact the preferred gatekeeper, ConneXtions first tries to use alternate gatekeepers from the list (in priority order); if this fails, it then tries to autodiscover a new gatekeeper.*

- 16** Do you want to route calls through the Gatekeeper? You can route H.323 calls through the gatekeeper for these reasons:
- To control calls more effectively. For example, service providers need to be able to control call flow to allow them to bill for calls placed through the network.
  - To reroute a call to another endpoint if a called endpoint is unavailable.
  - To maintain interoperability with multi-vendor equipment which routes all calls directly using the gatekeeper.
  - To use address resolution in large multi-zone configurations which have one or more gatekeepers in each zone.
- 17** You are prompted to set the size of the log files. The default value is 1 Mb. ConneXtions maintains two log files, named `ConneXtions01.log` and `ConneXtions02.log`. Data is logged to only one of these at a time. Once the active log file reaches a specified size, data logging switches to the second log file. Any data previously stored in that log file is overwritten.
- 18** Setup Complete: Click *Finish*.

## Finishing the Installation

Verify the installation:

- 1** Select the *Line Card Ports* tab under the Device Configuration heading in NBX NetSet.
- 2** Note the MAC Address, extension, status, and group for each port.
- 3** Record the extension numbers for each H.323 port.
- 4** Enter user-friendly port names that appear when a user dials an H.323 port.
- 5** Close the browser to exit NBX NetSet and end the installation.

---

## Overview of H.323

The H.323 standard provides a foundation for audio, video, and data communications across IP-based networks, including the Internet. By complying with H.323, multimedia products and applications from different vendors can interoperate, allowing users to communicate without concern for compatibility.

An NBX ConneXtions H.323 Gateway provides connections similar to tie lines between existing NBX systems across an IP network. However, it can also support voice connections between a 3Com NBX Telephone and other H.323-compliant devices.

ConneXtions H.323 Gateways support communication with:

- Extensions on other NBX systems that have a ConneXtions gateway.
- Extensions on PBX systems that have an attached H.323 gateway.
- H.323 gatekeepers.
- Miscellaneous H.323-compliant end-point devices such as:
  - H.323 telephones.
  - Suitably equipped personal computers.
  - An emerging class of wireless handsets.



*The quality of H.323 calls over the Internet is determined by the quality of the connection provided by your ISP.*

The H.323 protocol addresses these main areas:

- [Negotiated Connections](#)
- [Negotiated Voice Compression](#)
- [Standard Extensions](#)
- [Remote Internet Device Connections](#)

### **Negotiated Connections**

The H.323 protocol adds negotiated call setup and tear-down capabilities to Internet Protocol (IP) connections. It exists because Internet protocols were designed to deliver text messages and computer files in data packets. IP networks were not originally concerned about involving a person in a real-time conversation as a telephone does.

H.323 provides call setup capability to negotiate the readiness of two parties to exchange information and how they do it. It then keeps the

connection alive until one of the parties ends the connection. A call tear-down signal indicates to the network, and to the other party, when a call ends. On standard telephone networks, the telephone company uses this signal to determine when to start and stop charging for long distance calls, but long distance charges do not normally apply to H.323 calls. Other reasons for call setup and tear-down signals are to indicate when an IP network can release bandwidth to support other calls, and to inform other devices, such as voice mail systems, when to stop their conversation-related activities.

### **Negotiated Voice Compression**

IP networks can carry a lot of traffic, creating competition for the available bandwidth. Devices have the best access, and the least delay, when they communicate messages by using fewer and smaller packets. This also means lower cost.

Voice compression offers a way to reduce the number and size of the data packets needed to carry each second of a voice conversation. However, voice compression needs high-speed processors to remove the redundancies that are inherent in the way standard voice is represented.

The international standard for representing voice (G.711) requires 64 Kb for each second of conversation. NBX Business and Basic Telephones contain a digital signal processor (DSP) that transforms spoken voice into this form. An Ethernet interface, also within each telephone, breaks up the 64 Kbps stream into frames, adds addressing and error checking, and dumps the voice-data frames (now 83 Kbps) onto a 10 Mbps LAN. Elsewhere on the LAN (local or remote), the destination telephone detects its address, recovers the frames, extracts the bit stream, and reproduces the voice.

While LANs have enough bandwidth to support uncompressed digitized voice transfers, WAN bandwidth is less generous. For this reason, compression is often used to squeeze the digitized voice into a smaller bandwidth that can be carried across an Internet in smaller packets.

When an NBX call passes through an H.323 gateway, the ConneXtions software performs an intermediate step that extracts the essential voice information, encapsulates it in packets, and sends it across an IP network.

G.723 is a compression standard that represents each second of voice conversation with 6.3 Kbps. ConneXtions software supports the use of this compression standard. With more than one way to represent voice

(G.711 and G.723), H.323 gateways negotiate the type of compression they use during each call setup. Negotiation ensures that the compression on the transmit side matches the decompression processing on the receiving side. With the frame and packet overhead, each G.723 channel needs about 19.2 Kbps of the available bandwidth.

### Standard Extensions

ConneXtions routes incoming H.323 calls to one designated extension, usually the Auto Attendant. Callers can dial additional digits to redirect calls to internal extensions, but cannot access outside lines by dialing 9.

### Remote Internet Device Connections

A NBX system with a ConneXtions gateway can communicate with remote H.323 devices other than NBX Business and Basic Telephones, such as:

- Wireless handsets
- Personal computers
- Ordinary telephones (POTS) with adapters
- H.323 gatekeepers

#### Wireless Handsets

An emerging class of H.323 wireless handsets is being used by some large outlet stores as portable PBX telephones. A ConneXtions H.323 server is well suited for use with these H.323 handsets.

#### Personal Computers

Microsoft NetMeeting software supports H.323 voice connections over the Internet. The personal computer must be equipped with Internet access, a sound system, and a microphone.

The current version of Microsoft NetMeeting (3.01) cannot conveniently place calls through the Auto Attendant because it has no way of entering extension digits after it reaches an IP address (the Auto Attendant). This is a temporary limitation that usually disappears when those programs upgrade to H.323 version 2. Version 2 requires that compliant devices support out-of-band DTMF (touch-tone) signaling.



*If you choose ConneXtions as the gateway under the Advanced Calling options, and if you configure NetMeeting to “speed-dial” the IP address and extension, Microsoft NetMeeting can place calls to an extension.*

### **POTS Adapters**

You can purchase circuit boards that plug into a personal computer and adapt an analog telephone (POTS) for use with an H.323 connection.

### **H.323 Gatekeepers**

The gatekeeper is an H.323 entity on the network that provides address translation and controls access to the network for H.323 terminals, Gateways, and MCUs. The gatekeeper also provides services to the terminals, Gateways, and MCUs, such as managing bandwidth and locating Gateways.

---

## **The H.323 Connection**

H.323 calls between local and remote NBX Business and Basic Telephones are transparent to users, except for the IP dial plan. The Call Processor sets up the local end of the H.323 call as though it were setting up a call through a line card. However, this connection actually goes to a network interface card (NIC) in a dedicated Windows 2000 or Windows NT system that is running the ConneXtions software.

The Call Processor requests an H.323 port in the ConneXtions software by sending a frame, with a simulated Ethernet address, that contains a requested IP address. The ConneXtions gateway uses this address to request a level three connection between the local router and the remote router associated with another PBX or NBX system.

After an IP connection has been established, the ConneXtions software begins a series of H.323 exchanges by using TCP packets on the IP connection.

These H.323 exchanges set up the call and negotiate the type of voice compression that is used. They also cause the remote NBX (or PBX) system to begin setting up the remote end of the connection.

---

## Connection Considerations

As soon as an end-to-end connection has been set up, all three networks (local LAN, WAN, and remote LAN) are ready to pass voice packets. The NBX Business and Basic Telephones use their DSP to convert spoken words into digital voice packets. The voice packets are transferred across the Ethernet to the local H.323 gateway. The gateway strips off the Ethernet frames, compresses the voice, and encapsulates it within UDP packets which are delivered to the router, again via the Ethernet. The UDP packets are placed on the WAN for IP delivery to a remote H.323 gateway. The remote gateway undoes the process and sends the decompressed voice to an extension.

Connection considerations apply to two areas:

- [Overall Connectivity](#)
- [Quality of Service](#)

## Overall Connectivity

An end-to-end NBX H.323 connection consists of a succession of Physical Connections and Logical Connections, both local and external.

### Physical Connections

An NBX H.323 gateway has few *physical* connections. An installer can add an H.323 gateway to an existing NBX system by creating one physical connection on the LAN that links a network interface card in an operating system to a hub or to a switch. The same connection also gives the H.323 gateway a direct connection to every other device on the near-end LAN. Those devices include any NBX Business or Basic Telephone, the Call Processor, and the firewall or router.

Alternatively, you can use a second NIC in the gateway system to provide a separate connection between the H.323 gateway and the IP router.

### Logical Connections

Locally, every device on an NBX LAN has the same physical access to the local network traffic as any other device. Consequently, addresses control connections because devices can only read information that is addressed to them. This makes addressing, and managing addresses, a key concern for logical continuity.

Logical continuity concerns extend throughout a network connection because the identity of a frame (or packet) and its destination determine where it goes, how it is handled, and what happens to it.

Because so many devices share the same physical media on the Internet and on the local network, there is always the possibility of incomplete or degraded connections that arise from network congestion, device configuration, or addressing problems.

Bridges, switches, routers, and firewalls can help to manage network congestion, conversions, and security. Configuration problems with any of these devices can cause connection difficulties.

Bridges and switches are used to segregate areas of congestion within a local network (switches are multiport bridges). Routers perform a similar function but at the Layer-3 level where they perform conversions between LAN and WAN protocols. Firewalls, which are often built into routers, protect intranets from unauthorized internet users.

All of these devices can filter packets based on source address, destination address or packet type. Depending on how the devices are configured, they can let packets pass or they can block them.

## Quality of Service

Unlike switched network connections, Internet voice connections consist of a sequence of numbered data packets. Packet transfers across the Internet are subject to delays or loss or both. If these delays are great (larger than 200 ms), or if the packet loss is excessive, voice quality deteriorates noticeably. The round-trip delay is typically no greater than 400 ms. You can test this by using several “ping” commands.

Voice conversations occur in “real-time,” so these packets need to be delivered in a consistent manner and with the shortest delay. The goal is to deliver 32 regularly spaced packets to the recipient every second.

The frequency response, dynamic range, and noise of a voice conversation depend on the voice representation. If all data packets reach their destination, the system provides voice of a specified quality.

The H.323 standard accommodates alternative voice compression standards that allow users to trade some voice quality for bandwidth by selecting a different compression standard (G.711 or G.723). Consequently, packet loss and delay are crucial to the Quality of Service.

## Packet Loss

Packet loss can occur for reasons discussed in [Bandwidth, Congestion, and Connections](#), next.

## Bandwidth

Bandwidth is the capacity to carry information. By using H.323, the same bandwidth that supports one uncompressed G.711 voice connection can, instead, support several compressed G.723 conversations with little noticeable difference in quality.

Networks differ in the age of their equipment and in the quality of their service. Traffic can form a bottleneck if network loads force a wide area service provider to route traffic through old equipment.

## Congestion

Users notice congestion when audio “breaks up” during a call. Congestion can occur anywhere on the network, for example, at an overloaded LAN (local or remote), at an overloaded router or firewall, or within an overloaded internet. Because voice packets are only significant during a conversation, IP networks respond to congestion by discarding data packets they cannot accommodate. Resending or delaying packets is not an effective solution.

At the local level, congestion symptoms can be subtle. For example, routers from different vendors can respond differently to congestion because of the way they prioritize their response to packet congestion.

When considering communications problems, it is important to maintain reserve capacity and to use a systematic approach that considers the entire, end-to-end, connection.

You can reduce NBX system’s bandwidth requirements by enabling “silence suppression,” but doing so compromises audio quality. NBX Telephones generate voice frames at regular intervals for the duration of a connection. These frames normally continue when no one is speaking. When silence suppression is enabled, the NBX system sends a “silence indicator” when the NBX Telephone senses the start of a silent period. When another NBX device receives this indicator, it inserts “white noise” until it receives the next frame that contains real voice. All subsequent “voiceless” frames are suppressed during the silent period. However, most telephone users will notice the difference between genuine silence and generated silence.

This type of silence suppression applies to Layer 2 Ethernet transfers. At Layer 3, the ConneXtions software achieves a similar result by not sending empty packets during a silent period. The receiving ConneXtions

gateway generates a silence indicator or sends frames filled with silence, depending on the silence suppression mode.

### **Connections**

Sometimes packet loss is caused by a poor physical connection. This type of packet loss is more likely to occur in a LAN than in a WAN. Typical causes are faulty wiring, connectors, and termination. High-bandwidth LANs (100BASE-T) are more likely to have termination problems than 10BASE-T LANs.

### **Packet Delay**

Latency and jitter delays affect the Quality of Service.

### **Latency**

Latency is the sum of all the fixed delays in an end-to-end connection. Latency prevents a caller from responding immediately to another caller's remarks.

Most people notice latency when the end-to-end delay is above 200 ms. (The round-trip delay is typically no greater than 400 ms.) Conversations sound most natural when latency is below this range. Network latency can be measured by "pinging" the network connection, but the network connection is only part of the delay. The entire end-to-end delay also includes the H.323 gateway, firewall or router, and the LAN itself. System administrators can control some local device delays by controlling the system load and by upgrading system components as needed.

### **Jitter**

Momentary transmission delays can affect the pace of a conversation and, if severe, cause the voice to "break up." This is known as "jitter."

All voice-over-internet devices have a "jitter buffer" at the receiving end whose purpose is to absorb jitter. It does this by delaying the first packets that arrive by some significant amount (from 50 to 200 ms). This delay creates a window of time for receiving the next group of related samples which are then forwarded to a callee at a regular rate. However, if some packets are too late, and exceed the jitter buffer capacity, those packets are lost and there are gaps in the audio.

## Quality of Service Control

NBX systems address Quality of Service (QoS) issues using methods that are discussed in this section.

### Adaptive Jitter Buffering

All IP network devices use buffers to retime the packets that they receive from a network. Retiming allows these devices to compensate for the variable delays that occur as the packets pass through an IP network. H.323 calls take different paths through a network so the ConneXtions gateway uses an adaptive “jitter buffer” to minimize delay variability. Initially, the jitter buffer delays the entire packet stream by 50 ms, an amount that is too small to be noticed in conversation, but large enough to account for the variability.

If the packet delays are too variable, packets may not arrive in time to be useful. This can result in lost packets and gaps in the conversation. When ConneXtions detects the gaps caused by late-arriving packets, it automatically extends the jitter buffer delay to match the delay so similar packets are not lost. ConneXtions can extend the jitter buffer delay up to its 200 ms limit.

### Reconstruction

NBX Business and Basic Telephones expect to receive voice packets at regular intervals, but unanticipated network delays can cause lost packets and gaps in the conversation. Reconstruction makes these gaps less noticeable with “best guess” substitutes based on the preceding and following samples.



*If your network is not optimized for voice, the quality of voice can be affected.*

### Priority Schemes

Packet-based voice systems depend on the speedy and consistent delivery of voice packets for good voice quality. This dependency presents an obstacle to H.323 communication on the Internet because it was designed to treat all packets alike with respect to time. By treating packets that carry e-mail with the same priority as packets that carry real-time voice, the Internet ignores the important differences between these applications.

NBX systems use the latest developments to address voice packet priority concerns at the Layer 2 Ethernet level and at the Layer 3 IP network level.

**Layer 2** NBX systems address Layer 2 priority concerns through the 802.1(p and q) standards. These standards have two parts. The first part addresses the way Ethernet frames get onto the local “wire.” The NBX system uses a special “back-off” algorithm that gives voice frames a higher priority when both voice frames and data frames try to access the Ethernet wire at the same time.

The second part of the 802.1(p and q) standards addresses the way LAN switches prioritize different packets that are competing to enter a different LAN segment. This scheme is based on a 3-bit priority field within the Ethernet header.



*NBX ConneXtions does not support the Layer 2 (Ethernet) 802.1 (p and q) priority field. However, it is usually possible for IP routers to use these priority schemes if they are configured to prioritize H.323 packets.*

**Layer 3** NBX systems address Layer 3 priority concerns through a packet priority scheme called “IP/DS” (for differentiated services). Many routers support this scheme, which replaces an earlier scheme (TOS), which uses a 6-bit priority field within the IP header of every packet. Most routers examine this field and base their pass-through priorities on it.

NBX systems are designed to use the default values that come with 3Com switches. If you use other routers, you may need to reprogram their diff-serv settings. The 3Com default is 101110xx. This setting must be consistent at both ends of the connection. Note that some routers overwrite the TOS field (diff-serv priority field) and eliminate the priority distinctions between packets.



*NBX ConneXtions does not support the Layer 3 (IP) 6-bit TOS/DS priority field. However, it is usually possible for IP routers to use these priority schemes if they are configured to prioritize H.323 packets.*

---

## Special Issues

This section describes issues related to H.323 telephony in general and to ConneXtions gateways in particular. These include:

- [Firewall Security](#)
- [Gateway Load](#)
- [Remote Access](#)
- [PBX Connections](#)
- [Class of Service](#)
- [IP Type of Service and Differentiated Services](#)
- [Alternate Gatekeepers](#)

### Firewall Security

Firewalls determine which packets can cross the boundary between a protected network (intranet) and the public internet. The network administrator specifies crossing privileges according to network needs and policies. Control criteria consists of direction of transfer, source and destination address, packet type, and access ports.

Firewalls affect, and are affected by, H.323 gateways. For example, firewall processing increases packet delay while the complexity of the H.323 protocol complicates the firewall programming.

The only way to safely avoid firewall delays is to exclude outside internet access. This means calls can only be made within the secure intranet.

In some business applications, it is possible to eliminate the firewall delay by setting up a dedicated physical connection between the H.323 gateway and the router. This approach, which requires a second NIC in the ConneXtions PC system, bypasses the firewall and puts the burden of discriminating against non-H.323 packets on the gateway. The PC system that runs the ConneXtions software must be secure.

Systems that must conform to very conservative firewall policies can use a Virtual Private Network (VPN) if they need to filter incoming H.323 calls from the public Internet. An alternative is to use a firewall with H.323 proxy support.

While the operating system that runs the H.323 gateway can be programmed to serve both as an H.323 gateway and as an IP router, such arrangements are usually impractical because the gateway needs so much processing power just to handle audio conversions.



*3Com recommends that a high-performance PC be dedicated to the ConneXtions software.*

The question of whether an operating system is adequately “secure” is a subject of debate. The concern is that Windows has many IP ports of its own. One way to deal with these ports is to set up a firewall that limits the range of externally accessible ports. However, some organizations connect the ConneXtions gateway directly to the Internet through a second NIC that bypasses the firewall protecting the rest of the local network. ConneXtions supports either configuration.

Organizations that want to completely bypass firewall delays can research the large volume of security information on the subject.

These descriptions focus on the firewall-protected approach, and offer guidelines for programming a firewall that can be used to support H.323 connections that are accessible to the public internet.

### **Outbound Calls**

Most firewalls do not restrict outbound packets or IP packets that respond to outbound initiatives. They are configured for unrestricted outbound packets with unrestricted reply packets. They do not have to be changed to support outbound H.323 calls from an NBX system.

### **Inbound Calls**

Firewalls usually discriminate against incoming packets. The network administrator configures a list of acceptable sources for each destination address within a protected network. The configuration list includes a list of entries that the firewall compares to the IP address of the local H.323 gateway and the IP address of an external caller. The configuration list also discriminates for or against specific types of packets. IP addresses and packet types must match for packets to pass.

The H.323 protocol uses TCP packets for call setup, and UDP packets to carry the voice payload. Each type of packet includes an array of port addresses that are used during the connection. Ports 1720 negotiates which of the other available ports is used to carry the connection.

The ConneXtions gateway uses these default port assignments:

- For UDP traffic, ConneXtions uses ports 8000-8099 by default. Calls require four UDP ports each.
- ConneXtions uses ports 1025-5000 for TCP traffic. You can configure TCP ports during installation.

During ConneXtions installation, you can configure the TCP ports that are used for incoming calls. For outgoing calls, no control is possible. Port 1720 must be preserved.



*You must configure a firewall to accommodate both TCP and UDP ports on the same system.*

### **Gateway Load**

If the gateway system NIC is attached to a LAN with heavy packet traffic (more than 700 non-H.323 packets per second), the extra address processing burden, which requires processing power, can slow down the gateway. This occurs because the ConneXtions software makes H.323 ports look like hardware line cards to a Call Processor.

To emulate a group of simulated line cards, the gateway system must read the destination address of every frame that is presented to its Network Interface Card, instead of responding to only one hard-coded Ethernet address. The gateway system is able to examine every Ethernet frame because its NIC does not discriminate between frames. The NIC passes every frame that it sees to the software for address evaluation.

To reduce the load on an H.323 gateway, you can connect it to an existing multi-port switch. For optimum performance, use switches that support 802.1(p and q). The 802.1(p and q) standard offers priority enhancement which NBX systems exploit. Most 3Com switches support this feature.

### **Remote Access**

Business people who travel can make routine calls without long distance line charges by using an internet-ready laptop with Microsoft NetMeeting to make H.323 calls, and a Virtual Private Network (VPN) connection to the NBX system LAN. Microsoft NetMeeting software works with Windows 9x, Windows 2000 and Windows NT, and it can be downloaded for free from [www.microsoft.com](http://www.microsoft.com).

You can use Microsoft's VPN Dial Up Networking (version 1.3) to establish a virtual private network connection between a roaming laptop and the NBX system LAN. One end of the VPN connection is in the laptop while the other end must be located in a VPN server between the router and firewall.

The VPN server provides caller authentication and a secure (encrypted) channel across the internet. After a caller has been authenticated, the connection is passed to the firewall, which sees the VPN connection as coming from a recognizable (and therefore firewall-configurable) IP address. VPN allows a business person to establish an IP connection into the NBX LAN from a hotel room with internet service.

After an Internet connection has been established, you must change your automatic call forwarding number:

- 1 Log on to NBX NetSet as a user.
- 2 On the *User Information* tab, click *Call Forward*.
- 3 Click the telephone number radio button.
- 4 Enter the number to which you want to forward the call and click *OK*.

The caller is now ready to use NetMeeting to place an H.323 to the NBX system at the office. Configure NetMeeting with the IP address of the ConneXtions gateway as the gateway in Advanced Calling options. Dial the NBX extension to place the call.

The call passes through the Auto Attendant to your extension and forwards the call to your previously specified number.

After the call, return to NBX NetSet and remove the forwarded number so that work-related calls to your extension are not forwarded to your home, or to wherever you placed your last H.323 call.

## **PBX Connections**

H.323 gateways allow NBX systems to establish IP connections to other H.323-equipped PBXs as well as to similarly equipped NBX systems. Although H.323 standards describe a universally accepted interface for interconnecting similar systems, each of the 20 or 30 PBX manufacturers brings its own PBX solution to the marketplace. This complexity is further increased by the diversity of products and release levels that are associated with each manufacturer. Because any implementation differences can affect connectivity, this manual can only offer guidelines for connecting NBX and PBX systems.

Tie-line connections between NBX and PBX systems require technical people from both ends of the connection to collaborate in these major areas, discussed next:

- [H.323 Interoperability](#)
- [IP Addressing](#)
- [Voice Ports](#)
- [Extension Dial Plans](#)
- [Extension Delay](#)

### **H.323 Interoperability**

H.323 protocol stacks provide the foundation for H.323 compatibility. Each consists of a collection of engineered software products that implements the H.323 standard. Although PBX manufacturers can develop their own H.323 software stacks, it is more efficient to purchase software licenses from a company that specializes in developing H.323 protocol stacks.

The ConneXtions gateway has been tested for compatibility with PBX H.323 gateways that are licensed to use Lucent Elemedia and RADVision H.323 protocol stacks. It has also been tested with these H.323 telephones:

- Siemens HiNet LP 5100 (phone application version 1.1.3)
- ACT Sagitta PH200
- Microsoft NetMeeting (version 3.0)

### **IP Addressing**

The main goal of an H.323 gateway is to provide telephone-like service through IP connections. This means each end-to-end connection involves two types of addresses: a normal telephone number (E.164 address) and an intermediate IP address. Some H.323 implementations use a “gatekeeper” to convert the E.164 number into the appropriate IP address at the calling side, and then to reconvert the IP address to the E.164 number at the receiving side (for caller ID purposes). ConneXtions allows you to choose if you want to use a gatekeeper on your network.

Outgoing IP addresses can be entered:

- As pre-programmed speed dial numbers that forward callers to the Auto Attendant at a remote NBX system.
- By modifying the dial plan.

You can configure the speed dial numbers to include an appended extension if a person in one NBX system needs to make frequent calls to someone in another NBX system. Alternatively, you can configure the dial plan to route these calls seamlessly to the caller.

NBX system calls to outside numbers must use IP addresses or host names. The ConneXtions software automatically converts host names to their corresponding IP address.

### **Voice Ports**

Multiple voice ports allow the Auto Attendant to respond to multiple incoming calls at the same time. However, since these ports are also used by the voice mail system, voice mail inquiries can slow down incoming H.323 calls. You may have to increase the number of voice port licenses.

### **Extension Dial Plans**

PBX systems can use different dial plans. You must consider dial plan differences when setting up calls between systems. Dial plans differ in their use of leading digits, number of digits, and excluded numbers. For more information, see [Chapter 2](#).

### **Extension Delay**

Call setup times for digital connections, compared to analog connections, are instantaneous so there is no need to include a delay between the IP address and an appended extension.

Incoming H.323 calls to an NBX system usually go directly to the Automated Attendant. Although the Auto Attendant can respond with voice instructions, the call does not have to wait until the end of the voice instruction to respond. The Auto Attendant accepts extensions whether they are entered manually or as part of a speed dial number.

- Class of Service** The use of an H.323 gateway affects the Class of Service assignments that are applied to extensions because:
- H.323 calls use IP addresses instead of the familiar numbers that are used for public switched network calls (different dial plan).
  - The cost of an H.323 call is distance-independent, so you do not need to limit long distance calling for cost reasons.

### External Call Control

Users of ConneXtions-equipped NBX systems can place H.323 calls to other H.323 systems anywhere in the world without having to pay long distance charges. Since there are no long distance charges for H.323 calls, there is no need to restrict them for cost reasons.

### IP Type of Service and Differentiated Services

The header of each IP packet contains an 8-bit Type of Service (TOS) field that indicates the precedence (relative importance) of the packet. Routers then examine the TOS field and give precedence to packets with a higher TOS setting.

Although your telephone system supports prioritization using the TOS field, this facility is not supported for H.323 calls. However, for H.323 calls over the WAN, routers can prioritize voice traffic using alternative means. For example, during installation, you can select a range of UDP or TCP port addresses to help with router setup.

### Alternate Gatekeepers

A zone can contain only one gatekeeper at a time, although multiple distinct devices can provide the gatekeeper function in a zone. Multiple devices that provide the RAS signaling function for the gatekeeper are called alternate gatekeepers. Each alternate gatekeeper appears to each endpoint as a distinct Gatekeeper.

To ensure system availability, redundancy, and scalability, the gatekeeper can provide RAS signaling function by using multiple physical or logical devices, referred to as alternate gatekeepers.

---

### Checking Connections

You can use connection checks to pre-qualify an installation and to help localize connection problems. H.323 gateway installers can conduct connection checks for:

- [Gateway Checks](#)
- [Network Checks](#)

**Gateway Checks** Gateway checks can verify that the NBX systems at each end of an H.323 connection are working properly.

### Gateway Self-Check

A gateway self-check is simply an H.323 call that returns to the local IP address (loopback test).

To perform a gateway loopback test:

- 1 Access a ConneXtions H.323 port from an NBX Business or Basic Telephone by dialing an H.323 port line number or by using a dial plan configured with a ConneXtions pool number.



*You must have Super User Group CoS allowed to dial in to a line port number directly.*

- 2 Enter the IP address of the gateway.
- 3 Verify the connection. If you are using default settings, you are connected to the Auto Attendant. If you are not using default settings, you may be connected to a different extension number.

### Local Considerations

All voice packets that move between an NBX Business or Basic Telephone, Call Processor, ConneXtions gateway, and router on the LAN have a high priority and high quality of service.

However, at the router and beyond, network administrators can influence H.323 call quality through the priority that they give to H.323 packets at both the internet router and at the firewall. If H.323 connections consistently experience significant delays, you should review the local router and firewall configurations at each side of the H.323 connection.

**Network Checks** A network check uses:

- [Network Ping](#)
- [NetMeeting Connections](#)

### Network Ping

A network *ping* is a packet transfer that checks the logical continuity between a personal computer and a specified IP (router) address. For example, you can ping your own address, or the default gateway. The next ping checks the connection to the IP router at the remote end of the intended H.323 connection.

The easiest way to initiate a ping is with a DOS ping command. This command sends four pings to the specified IP address. The router at that address immediately returns the ping, and the command notes the round trip delay for each ping packet. Some firewalls do not return pings for security reasons. If the ping test fails, you can use a “trace router” command (“tracert”) to find out where the logical connection failed.

To check a connection:

- 1 Access the DOS command prompt from the DOS shell in Windows.
- 2 Enter `ping` on the command line:  
`ping <192.168.1.190>` (sample IP address)
- 3 Interpret ping results:
  - a `Request timed out` (all four times)
    - Ping reached the network but couldn't connect to the host
    - (No such address; or the device is down.)
    - Initial request timed-out
    - (It is normal for a first ping to fail and subsequent pings to succeed.)
    - Subsequent requests timed-out
    - (Indicates some packet loss. Rerun using the “-n 100” option. The “request timed out” number represents the percentage of lost packets. These packets could have been lost in either direction.)
  - b `Destination host not reachable`
    - Ping couldn't negotiate a path to the specified address  
(PC is not plugged into LAN, incorrect gateway address in route, or a firewall blocked the ping.)
  - c `Approximate round-trip times in milliseconds`
    - Ping time greater than 10 ms but preferably less than 300 ms.  
(Ping times can differ because the network often routes individual packets along different internal routes depending on congestion.)
- 4 Use `tracert` on the command line:  
`tracert <192.168.1.190>` (example IP address)
- 5 Interpret trace results:

The `tracert` command lists every IP gateway it encounters as it tries to reach the specified destination. It also includes the number of times (3) required to reach each intermediate gateway. If a network connection failure occurred in route, this command indicates where it occurred.

Because the `tracert` command reveals the chain of logical connections across a network, it can be useful for comparing the performance of alternative internet service providers.

### NetMeeting Connections

You can also check H.323 voice packets that are sent between systems that are running Microsoft NetMeeting. ConneXtions software requires it to run G.711 (CCITT mu-law) or G.723.1 compression. NetMeeting is available on the Resource Pack CD, or it is available as a free download from [www.microsoft.com](http://www.microsoft.com).

You can conduct the NetMeeting connect test from the operating system that runs the ConneXtions software, or from another PC on the LAN.



*You must run NetMeeting and ConneXtions on different PCs.*

In addition to the NetMeeting software, participating computers need an audio card with a headset (or speakers) and a microphone. The audio card must support full-duplex 64 Kbps transfers.

Note that it is possible for a NetMeeting connection to be unsuccessful and still have a successful ConneXtions installation. This can occur because ConneXtions restricts the range of TCP and UDP ports used but NetMeeting allocates its ports from a wider pool. For more information, see [“Firewall Security”](#) on [page 378](#). If ConneXtions is installed with a limited range of allowable ports, and the firewall is configured to pass only those ports, it is possible that NetMeeting cannot pass a call through the firewall while the more restricted ConneXtions calls can pass through.

The following procedure uses NetMeeting to test the connection between the operating system that runs the NBX ConneXtions H.323 Gateway and a remote IP address. This end-to-end NetMeeting check can help to recognize firewall problems without the complexity of the NBX system and ConneXtions H.323 server.

To make a NetMeeting check:

- 1 From the *Start* menu, select *Settings*, and then *Control Panel*.
- 2 If you are using Windows NT, double-click *Services*. If you are using Windows 2000, select *Applications*, and then *Services*.
- 3 Select *3ComConnections* from the list, and click *Stop*.
- 4 Access `www.microsoft.com` using a web browser.
  - a Click *Downloads* in the navigation bar.
  - b In the *Product Name* field, select *NetMeeting*.
  - c In the *Operating System* field, select *Windows 95*, *Windows 98*, *Windows 2000* or *Windows NT*.
  - d Click *Find It!* The latest versions of NetMeeting are displayed. Click the version you require.
- 5 Download NetMeeting files and respond to the prompts.
  - a Click the program name (`NM30.exe`) next to *Download Now*.
  - b Click *OK*.
  - c In the *Save As* dialog box, select a folder for the downloaded files.
  - d Click *Save*.
- 6 Install the NetMeeting files and respond to the prompts:
  - a Select *Open* when the download is complete.
  - b Click *Yes* to confirm installation.
  - c Click *Yes* to acknowledge the legal agreement.
  - d Click *OK* to accept the default installation directory.
  - e Click *OK* to acknowledge successful installation.
- 7 Open NetMeeting:
  - a Click *Next* on next two screens.
  - b Enter your details as required.
  - c Click *Next* on next two screens.
  - d Click *Put a Shortcut to NetMeeting on My Desktop*.
  - e Click *Next* on next two screens.
  - f Click *Test*.
  - g Adjust the speaker volume.

- h Click *Next*.
  - i Click *Test*.
  - j Adjust the microphone Record Volume.
  - k Click *Next*.
  - l Click *Finish*.
- 8 To attempt a NetMeeting call:
- a Click the NetMeeting icon, followed by the telephone icon.
  - b Enter the IP address of similar system at remote end, after *To*.
  - c Select *Network* or *Direct Call*, after using.
  - d Click *Call*.
  - e Confirm the connection using a speaker or headset and microphone.
- 9 To end the call, click the “hang-up” icon.

### Interpreting the Results

The NetMeeting check has three possible outcomes:

- No communication with remote NetMeeting.  
Wrong IP address.  
Firewall is blocking call setup (TCP) packets.
- Call rings remote end and it answers, but there is no audio.  
Faulty connection to a microphone, speaker or both.  
Firewall is blocking audio (UDP) packets.
- Calls work in one direction, but not in the reverse direction. Place a call to determine which firewall is blocking TCP traffic. Once you determine this, it is the *remote* firewall that is blocking the traffic.

---

## Placing Calls

You can place an outgoing H.323 call from an NBX system in one of several ways, as discussed in this section.



See [Chapter 2](#) for information on how to use the dial plan to set up the NBX system to use H.323 ports.

## IP Address Entry

Depending on how you set up the dial plan, the most convenient way to place a call to a new number is to dial a ConneXtions extension list

(configured within the dial plan), which provides a connection to an available H.323 port. If a port is available (not busy), enter the extension and IP address from the telephone key pad. Use the \* key to separate the four "octets" in the IP address, and then press the # key to "dial now."

You must configure the dial plan to use ConneXtions. You must have Super User Group CoS privileges to perform this test.

These examples show key pad sequences that request an extension list connection and a specific port connection:

8192\*168\*1\*15#

where extension list access is used

OR

754 192\*168\*1\*15#

if there is no extension list access, or if you want to test specific ports.

The first example begins with an 8 to request any available H.323 port. The second example begins with the 3-digit extension (754) of a specific H.323 port. The remaining digits in both examples represent the IP address of the remote H.323 gateway (192.168.1.15). Note that IP addresses are always four octets long. In this case, 15 is the last octet.

### Extension Lists

You can configure H.323 ports for single-digit access (usually 8) instead of a specific 3-digit line extension. The single-digit access allows the NBX system to select an available line port when you place an external call.

Internet IP line ports and CO (central office) line ports must never be assigned to the same extension list because they use very different dial plans. Conventional practice is to use 9 for external switched network (PSTN) connections and 8 for external IP network connections.

Calls to other NBX systems (or PBX systems) can include a destination extension. This example represents a call to an extension (273) on a remote NBX system that has an H.323 ConneXtions gateway:

8192\*168\*1\*15\*273#

The # sign tells ConneXtions to "dial now." The last asterisk, \*, terminates the IP address, but ConneXtions cannot dial the number until

it sees the “# sign,” or until 4 seconds pass after the last digit. In the preceding example, the IP address (192.168.1.15) and the extension are presented to the device as the “called party.”

The # sign also precedes the extension as shown below. This allows the ConneXtions gateway to complete the IP connection before it presents the remaining digits to the remote terminal:

8192★168★1★15#273

Both configurations produce the same result when dialing into another NBX system; however, other PBXs can be position-sensitive. If you are not sure, use the first format with the # sign after the extension.

**Speed Dials** Your telephone system has a speed dial capability that offers a quick way to dial frequently called numbers. Each telephone is capable of accessing 199 previously stored dial sequences with up to 30 characters in each sequence. These sequences can represent switched network numbers or Internet addresses. Special 3-digit speed dial numbers specify each dial sequence.

Speed dial numbers must be preceded by the “Feature” button when entered from a telephone. This button distinguishes NBX speed dial numbers from ordinary extensions that use the same three digits.

Speed dial numbers can be system-wide or personal. System speed dial numbers (700-799) apply system-wide and are programmed by the system administrator. Personal speed dial numbers (601 through 699) apply only to an individual telephone; they are programmed by its owner.

You can assign any of the first ten speed dial numbers in each type group, system or personal, to any Access button on a telephone. For more information, see Chapter 6 of the *NBX Telephone Guide*.

### Setting Up Speed Dials

The following procedure assumes that you are logged on to NBX NetSet as an administrator, and that you know the H.323 port extensions that were established during installation.

To set up speed dials:

- 1 In the *NBX NetSet - Main Menu* window, click *Device Configuration*.
- 2 Click the *Line Card Ports* tab.

- 3 Note the extension number of each listed NBX H.323 port.
  - 4 Return to the *NBX NetSet - Main Menu* window, and click *System Configuration*.
  - 5 Click the *Speed Dials* tab.
  - 6 To complete the fields:
    - a Note a speed dial number. (One-button dialing requires system speed dial numbers 700 through 709.
    - b In the *New Number* field, type an H.323 extension, or an 8 (for extension list), followed by an IP address, or a system name. Examples are:
 

8192★168★1★15★273#	(IP address plus extension)
8192.168.1.15★273#	(IP address plus extension)
8273@h323.nbx.com#	(extension plus host name)
8h323.nbx.com#	(host name, defaults to AA)
-  Use those characters shown here, that is, no spaces, hyphens or & signs.
- c In the *Comment* field, enter a description with up to 30 characters, such as *Tie-line to NYC*, and then click *Apply*.
- 7 Verify the speed dial entry by pressing the *Feature* button followed by the new speed dial number.

### One Button Access

You can configure an Access button on a NBX system to dial a complete H.323 (or switched) dial sequence.

This procedure assumes that all buttons available for one-button access are configured in the first ten system (or personal) speed dial locations.

To set up one-button dials:

- 1 In the *NBX NetSet - Main Menu* window, click *Device Configuration*.
- 2 Click the *Telephones* tab or the *Group Telephones* tab. Select a telephone extension or a telephone group.
- 3 Click *Button Mappings*.
- 4 Associate one of the first ten speed dial numbers with a telephone Access button:
  - a Locate the *Type* field associated with an available button.

- b Select the speed dial selection (SSD 0 through 9) that is associated with a previously programmed speed dial code (700 through 709).
        - c Click *Apply* and then click *OK* (to return).
  - 5 Verify the one-button dial feature operation by pressing the new button and confirming that it dials the specified number.

### Entering Digits During Calls

When ConneXtions dials a call, it stores the dialed digits until it connects the call. Then it sends those digits, and any subsequent digits, to the remote H.323 device if the device supports version 2, or later, of the H.323 standard.



*The behavior of ConneXtions depends on when the # sign is entered during this process.*

ConneXtions sends digits as messages, which are more reliable than audio tones. ConneXtions also expects to receive digits from H.323 devices in the same way, and therefore does not have a tone detector. This means older (H.323 version 1) devices cannot send or receive digits to or from ConneXtions. For example, the current version of Microsoft NetMeeting, which sends DTMF tones in the audio stream (in-band signaling), cannot use DTMF signaling to pass the Auto Attendant.

In instances where other devices might listen for in-band DTMF signaling, the quality of the tone recognition depends on the selected voice compression. Tones transmitted by G.711 can be reproduced, but tones transmitted by G.723.1 are degraded.

---

## Receiving Calls

ConneXtions gateways route incoming calls to any available H.323 port. The NBX system then connects this port to the extension specified during port configuration. H.323 ports are configured through the NBX software just like line card ports. Selectable extensions are:

- Auto Attendant (500)
- Receptionist's telephone (usually the lowest numbered extension on the system, with a default of 1000 on the SuperStack 3 NBX system or 100 on the NBX 100 system)
- Other extensions (each ConneXtions H.323 port can go to a single extension)

**Auto Attendant**

H.323 calls are usually routed to the Auto Attendant. From there, NBX callers can reach internal extensions without operator assistance by supplying a 3-digit extension when setting up the call (as the called party), or by dialing an extension after the Auto Attendant answers. Callers cannot get an outside line through the Auto Attendant because dialing 9 normally diverts incoming calls to the name directory.

You can configure H.323 calls to appear to go directly to an internal extension by adding a 3-digit extension immediately after the last octet in an H.323 IP address. Do not use commas, spaces, or hyphens between the IP address and an extension when programming an H.323 speed dial number. IP network connections do not incur delays like those that occur with analog PSTN connections.

8192\*168\*1\*15\*273#

The # sign in this example indicates when the last digit was entered so that the Call Processor does not have to wait 4 seconds to determine that a caller has no other digits to dial.

**Caller ID Response**

The Auto Attendant receives caller ID information from an outside caller and passes it to a caller-selected extension. On a telephone, the caller ID name and extension (if applicable) appear in brackets to indicate that the network has not authenticated the enclosed information.

**Attendant Console** By convention, NBX systems reserve extension 100 or 1000 for the Attendant Console (receptionist), although the Attendant Console can be assigned any internal extension number. Outside callers cannot reach internal extensions without operator involvement when incoming calls are directed to the Attendant Console. See [“Adding an Auto Attendant”](#) in [Chapter 6](#).

**Other Extensions** Incoming H.323 calls can be routed directly to some other extension or to a phantom mailbox. Sales people often have phantom mailboxes because they are never in the office. Calls to their extension go directly to their voice mailbox. Note that phantom mailbox extensions cannot be used to forward calls.

### Setting Up an H.323 Port Route

After you install an H.323 line port, you need to configure it.

To configure a H.323 line port:

- 1 In the *NBX NetSet - Main Menu* window, click *Device Configuration*.
- 2 Click the *Line Card Ports* tab.
- 3 Select an H.323 port. This port has the default setting from the Auto Discovery installation process.
- 4 Click *Modify*.
- 5 In the *AutoExt* field, enter the required extension number.



**CAUTION:** Do not route an H.323 port directly to another line port. Routing an H.323 call to a PSTN line, from the Internet, is dangerous because it would allow anyone to make long distance toll calls through the Call Processor — with no accountability.

- 6 Click *OK*.

---

## Handling Conference Calls

You can include gateway port connections in local conference calls along with PSTN line connections. However, ConneXtions does not support conferences at the H.323 level, so, if two or more of the conferring parties are at a remote NBX system, each requires a separate port connection. This characteristic determines who can initiate the conference call.

A four-way conference call with three people at one NBX site and one person at the other site uses one H.323 port if it is set up from the side with three people. Otherwise, it needs three ports.

---

## Related H.323 Documentation

Here are some useful sources of information on the H.323 standard:

### Web Sites

- <http://www.packetizer.com/iptel/h323/>
- <http://www.itu.int/itudoc/itu-t/rec/h/>

### Book

*IP Telephony: Packet-Based Multimedia Communications Systems* — Olivier Hersent, David Gurle, Jean-Pierre Petit (1999).

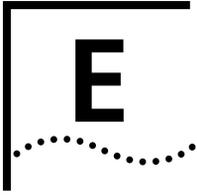

# CALLER ID

Caller ID behavior varies depending on the type of device and the conditions under which the call is received. This appendix describes these caller ID conditions:

- [Forwarded Calls and Caller ID](#)
- [Long Caller ID Character Strings](#)
- [Specific Caller ID Situations](#)

---

## Forwarded Calls and Caller ID

While a *forwarded* call is ringing on a telephone:

- On the top line in the telephone's display panel, the Caller ID of the original caller appears and a greater than (>) character on the left side of the display helps you to visually identify the Caller ID of the original caller.
- On the bottom display panel line, the Caller ID of the telephone that is performing the transfer appears.

After the call is answered, only the Caller ID of the original caller remains in the display and the greater than (>) character is removed.

---

## Long Caller ID Character Strings

Some models of the NBX Business Telephone can display two lines of 16 characters while other models of the NBX Business Telephone can display two lines of 24 characters. The displays of different brands and models of analog telephones with built-in Caller ID can show either 16 or 24 characters per line. The same is true of Caller ID boxes that are connected in-line with analog telephones.

If the length of the Caller ID information on either the top or bottom line exceeds the width of the NBX telephone display panel, the information is truncated for the first five seconds. After five seconds, the Caller ID information on the bottom line is cleared, and any truncated information

from the top line appears on the bottom line. After an additional five seconds, if the Caller ID information from the top line exceeds the capacity of both display lines, the numeric portion is removed and only the name portion appears in the display.

---

## Specific Caller ID Situations

The Caller ID information that appears in the telephone display panel can be different in some specific call situations.

### Analog Telephones

Analog telephones can be connected to the NBX system using these interfaces:

- NBX single port Analog Terminal Adapter
- A port on an NBX Analog Terminal Card
- Citel Analog Interface Card

#### Analog Terminal Adapter and Analog Terminal Card Ports

If you have an analog telephone connected to the NBX system using a single port Analog Terminal Adapter or to a port on an Analog Terminal Card, the behavior of Caller ID on the analog telephone (or on Caller ID boxes connected in-line with the analog telephone) depends on whether the Caller ID device/telephone supports 2-line Caller ID display.

- Most analog telephones with built-in Caller ID and most Caller ID boxes do not support 2-line display of Caller ID information. For this type of device, only the Caller ID of the original caller appears.
- If the analog telephone or Caller ID box supports 2-line display of Caller ID information, the information appears in the same way as it does on an NBX telephone.

If the Caller ID information exceeds the capacity of the Caller ID display (some can display 16 characters and others can display 24 characters) the Caller ID information is typically truncated at the width of the display.

#### Citel Analog Interface Card

If you have analog telephones connected to the NBX system using the Citel analog interface card, the behavior of Caller ID on the analog telephones is the same as the behavior of analog telephones connected to a single port Analog Terminal Adapter or a port on an Analog Terminal Card. See [“Analog Terminal Adapter and Analog Terminal Card Ports”](#) on [page 398](#).

**Bridged Extension  
Telephones**

Caller ID information appears in exactly the same way on a bridged extension telephone as it does on a non-bridged extension telephone. See [“Caller ID” on page 397](#) and [“Long Caller ID Character Strings” on page 397](#).

**Calls That Are  
Forwarded Multiple  
Times**

If a call is forwarded several times, the Caller ID information of the original caller appears on the top line of the display panel of the ringing telephone and the Caller ID of the telephone that most recently forwarded the call appears on the bottom line. A greater than (>) character appears to the left of the original Caller ID on the top line in the telephone display panel.

**Example:** A places a call to B, who answers the call and forwards it to C, whose telephone is forwarded to D. While telephone D is ringing, the top line in the display panel contains the Caller ID for A and the bottom line contains the Caller ID for C. After 5 seconds, only the Caller ID information for A appears.

**External Calls**

The display of Caller ID information for external calls depends on how the call arrives at the NBX system.

**External Analog Line Card Calls**

An external call arrives at an NBX system on an Analog Line Card port and is routed to A's telephone.

When A transfers the call to B, the Caller ID (if any is provided by the telephone company) appears in the top line of B's telephone display panel. If no Caller ID information is available, the extension associated with the Analog Line Card port appears on the top line. A's Caller ID information appears in the bottom line.

**Exception:** An Analog Line Card port is mapped to an internal extension.

The call is not answered and goes to the call coverage point for the extension. If the coverage point is the receptionist's telephone, for example, the receptionist sees the Caller ID information only for the external call, and not for any telephone on which the mapped Analog Line Card Port appears.

### External ISDN BRI Calls

An external call arrives at an NBX system on an ISDN BRI channel and is routed to A's telephone.

When A transfers the call to B, the Caller ID (if any is provided by the telephone company) appears for five seconds in the top line of B's telephone display panel. If no caller ID information is available, the Trunk name and channel number from the Digital Line Card appear on the top line of B's telephone display panel. A's ID appears on the bottom line.

### External ISDN PRI Calls

An external call arrives at an NBX system on an ISDN PRI channel and is routed to A's telephone.

When A transfers the call to B, the Caller ID (if any is provided by the telephone company) appears for five seconds in the top line of B's telephone display panel. If no caller ID information is available, the Trunk name and channel number from the Digital Line Card appear on the top line of B's telephone display panel. A's ID appears on the bottom line.

### External T1 Calls

An external call arrives at an NBX system on a T1 channel and is routed to telephone A. If the call is transferred to B, the display of caller ID information on B's telephone depends on which *Incoming Call Digit Format* is configured on the T1 board.

- **DNIS/DID** — The T1 board is configured to expect either Dialed Number Identification System digits or Direct Inward Dialing digits.  
If DNIS digits arrive, there is no Caller ID information. Instead, the NBX system displays the name of the T1 trunk and the extension associated with the T1 channel.
- **DNISANI** — The T1 board is configured to expect Dialed Number Identification System digits followed by Automatic Number Identification digits.  
The NBX system displays the ANI portion of the incoming digit sequence followed by the name of the T1 trunk and the extension associate with the T1 channel. The ANI field can be configured to capture either 7 or 10 digits of ANI information.

- Internal Calls** On a single NBX system, user A calls B who transfers the call to user C. In C's telephone display panel, the top line contains Caller ID information for A and the bottom line contains Caller ID information for B.
- Nortel Phones** If you have Nortel telephones connected to your NBX system using the Nortel interface card, the behavior of Caller ID on these telephones is identical to the behavior on NBX telephones.
- Parked Calls** When you retrieve a parked call, the Caller ID associated with the call appears for approximately five seconds in your telephone display panel. You do not see the Caller ID of the person who parked the call.
- Second Incoming Call** If you are currently involved in a call on your telephone and another call arrives, for approximately five seconds you see "Incoming Call" on the top line of the telephone display panel and the Caller ID of the incoming call appears on the bottom line.
- TAPI Calls** If a call is forwarded to a telephone that is controlled by TAPI software, both the original Caller ID and the Caller ID of the person forwarding the call are sent to the TAPI software.
- TAPI Redirected Calls** If telephone A is being monitored by an external TAPI application and a forwarded call to A is redirected to telephone B, the TAPI software passes the Caller ID of the original caller and the Caller ID of the forwarding telephone to telephone B.
- VTL Calls** If A1 calls A2 who then forwards the call to B1 over a Virtual Tie Line connection, the Caller ID information for A2 appears in the display panel on B1's telephone. The Caller ID information includes the IP address of NBX system A and the extension number of A2.
- Calls Transferred to Hunt Groups** When someone performs a blind transfer to a hunt group, telephones in the hunt group display the called ID information of the original caller on line 1 and the hunt group name and number on line 2. After a hunt group member answers the call, only the caller ID information of the original caller appears.



# GLOSSARY

- 10BASE-T** A form of [Ethernet](#) and IEEE 802.3 network cabling using [twisted pair](#). It provides 10Mbits/s with a maximum segment length of 100 m (382 ft).
- 10BASE2** An implementation of [IEEE 802.3](#) Ethernet standard, often called thinnet or cheapernet, because it uses thin coaxial cable. 10BASE2 runs at a data transfer rate of 10 Mbits/s with a maximum segment length of 185 m (607 ft) per segment.
- 911** The emergency service that provides a single point of contact for police and fire departments. See also [E911](#).
- account codes** Codes that allow you to keep track of calls associated with a client or account for bookkeeping or billing purposes.
- ADSL** Asymmetrical Digital Subscriber Line. A telephone line that delivers high-speed data services, such as Internet access, videoconferencing, interactive TV, and video on demand. The line is split asymmetrically so that more bandwidth can be used from the telephone company to the customer (downstream) than from the customer to the telco (upstream).
- ATM** Asynchronous Transfer Mode. A cell-based data transfer technique in which channel demand determines packet allocation. ATM offers fast packet technology, real-time, demand-led switching for efficient use of network resources.
- Attendant Console** A standard telephony device that shows the status of each extension in a telephone system. The Attendant Console is usually used by a receptionist to connect incoming calls to the correct extension. All incoming calls ring at the telephone associated with the Attendant Console.
- AUI** Attachment Unit Interface. The IEEE 802.3-specified cable and connector used to attach single-channel and multiple-channel equipment to an Ethernet transceiver. Defined in Section 7 of the 802.3 standard.

- auto dial** A feature that opens a line and dials a preprogrammed telephone number.
- Auto Attendant** A system feature that provides incoming callers with menu options to help them reach the appropriate person or information.
- Auto Discovery** A feature that “discovers” a new telephone or other device on the network. A new telephone receives a default telephone number that appears on the telephone display panel. A new device is assigned one or more extension numbers or device numbers.
- auto redial** A modem, fax, or telephone feature that redials a busy number a fixed number of times before giving up.
- autorelocation** A feature that allows a telephone to keep its extension number and personal and systems settings when you connect it to a different Ethernet jack on the same LAN.
- backbone** A high-capacity network that links together other networks of lower capacity. A typical example is a Frame Relay or [ATM](#) backbone that serves a number of Ethernet LAN segments.
- bandwidth** The capacity of a connection method to carry data.
- BRI** Basic Rate Interface. An [ISDN](#) standard that allows two circuit-switched B (bearer) channels of 64 Kbit/s each plus one D (data) channel at 16 Kbit/s for a total of 144 Kbit/s to be carried over a single twisted pair cable.
- bridge** A networking device that connects two separate local area networks and makes the LANs look like a single LAN, passing data between the networks and filtering local traffic.
- bridged extension** An extension of a primary telephone that appears on one or more secondary telephones. Incoming calls and indeed any activity associated with the primary telephone can be handled on any of the secondary telephones.
- broadcast** A simultaneous transmission method that sends each packet from one [node](#) to all other nodes.
- buffer** A temporary storage area for data that compensates for a difference in transmission speeds.

- bus topology** A type of network in which all devices are connected to a single cable. All devices that are attached to a bus network have equal access to it, and they can all detect all of the messages that are put on to the network.
- byte** A unit of 8 bits that forms a unit of data. Usually each byte stores one character.
- call coverage point** The user-specified destination for the [call forward](#) feature, that is, how the system is to handle incoming calls when the user is unable to answer the telephone.
- caller ID** A telephone company service that displays the name and number associated with an incoming call. Also called calling line ID or CLI. See also [CLIR](#).
- call forward** A feature that allows calls to be transferred to a [call coverage point](#) (voice mail, the Auto Attendant, or a prespecified telephone number) when the user is unable to answer the telephone.
- calling groups** A feature that transfers incoming calls to a specified group of telephones. All telephones ring at the same time. See also [hunt groups](#).
- call park** A feature that places a call in a “holding pattern” and makes it available for others to pick up from any telephone on the system.
- call permissions** Restrictions that an administrator establishes to control the types of calls that users can place from their telephones. Can be based on time of day.
- call pickup** A feature that allows users to retrieve calls that ring on other telephones.
- call reports** A feature that downloads data about calls and creates simple reports or exports the data for use in spreadsheets, word processors, or reporting programs.
- category 3** The cable standard for UTP (unshielded twisted pair) voice-grade cabling that is specified by EIA/TIA 568 for use at speeds of up to 10Mbit/s, including [10BASE-T Ethernet](#).
- category 4** The cabling standard specified by EIA/TIA 568 for use at speeds of up to 20Mbit/s.
- category 5** The cabling standard specified by EIA/TIA 568 for use at speeds of up to 100 Mbit/s including FDDI (TP PMD), 100BASE-T and 100BASE-VG-AnyLan, and potentially ATM at 155Mbit/s.

- Channel Service Unit (CSU)** Equipment installed on customer premises to terminate a DDS or T1 circuit. CSUs provide network protection and diagnostic capabilities and regenerate the signal received from the network. The CSU also controls pulse shape and amplitude for the transmission of the signal into the network.
- client/server computing** The division of an application into two parts that are linked by a network. A typical example is a database application in which the database and application software reside on a server, and the interface for entering or retrieving information resides on individual workstations (clients).
- CLI** See [caller ID](#).
- CLIR** Calling Line Identity Restriction. A telephone company option that allows the caller to withhold caller identity from the person being called.
- coaxial cable** High-capacity networking cable that is formed by an outer braided wire or metal foil shield surrounding a single inner conductor, with plastic insulation between the two conducting layers. "Coax" cable is used for broadband and baseband communications networks. Ethernet employs *thin* coaxial cable in 10BASE2 and *thick* cable in 10BASE5.
- CODEC** **CO**mpressor/**DE**Compressor. A hardware circuit or software routine that compresses and decompresses digitized audio, video, or image data. Most codecs include the functions of A/D and D/A conversion as well as compression and decompression.
- COder/DECoder.** A hardware circuit that converts analog audio or video signals into digital code, and vice versa, using techniques such as pulse code modulation and delta modulation. A CODEC is an A/D and D/A converter.
- collapsed backbone** Network architecture in which the backplane of a device, such as a hub, performs the function of a network [backbone](#). Example: The backplane routes traffic between desktop nodes and between other hubs serving multiple LANs.
- collision** The result of two devices on a shared transmission medium, like Ethernet, transmitting simultaneously. Both devices must retry their transmissions. A delay mechanism used by both senders drastically reduces the chances of another collision.

- collision detection** Ethernet devices detect collisions instantly and attempt to resend. This is the principle on which CSMA/CD (Carrier Sense Multiple Access with Collision Detection) is based and the access control method for Ethernet.
- concentrator** A central chassis into which various modules, such as bridging, supervisory, and 10BASE-T cards are plugged.
- congestion** The result of increased network use on a LAN segment. Standard network partitioning practices must be invoked to reduce bottlenecks and maximize throughput speeds on the segment.
- contention** The method used to resolve which users gain access to crowded bandwidth.
- CO** Central Office. A telephony term for the telephone company site that houses the [PSTN](#) switching equipment.
- CoS** Class of Service. A collection of calling permissions that are assigned to individual users and govern the times and types of calls these users can make.
- CPE** Customer Premises Equipment. Telecommunications equipment, including PBXs and wiring, that is located in a user's premises.
- CSU** Channel Service Unit. Data transmission equipment to repeat the signal from the carrier and link to CPE. Vendors add value to CSUs by adding performance monitoring and management features.
- CTI** Computer Telephony Integration. A generic name for the technology that connects computers and telephone systems through software applications.
- data compression** A method of reducing the amount of data to be transmitted by reducing the number of bits needed to represent the information.
- delayed ringing** Prevents a telephone on a shared line from ringing until the incoming call has rung on other telephones a set number of times.
- delayed ringing pattern** The definition for the order in which telephones ring and how many times each telephone rings.
- demand priority access** A method for supporting time-sensitive applications such as video and multimedia as part of the proposed 100BASE-VG standard offering 100Mbit/s over voice-grade UTP cable.

- DHCP** Dynamic Host Configuration Protocol. A method by which devices are assigned temporary, renewable IP addresses by a server when the devices become active on the network.
- DID/DDI** Direct Inward Dial/Direct Dialing Inward. A feature that allows outside calls to reach an internal extension without going to an operator or Automated Attendant.
- direct mail transfer** Transfers a caller directly to another user's voice mail without requiring them to wait through ringing and without interrupting the recipient.
- domain** A group of nodes on a network that form an administrative entity. A domain can also be a number of servers that are grouped and named to simplify network administration and security.
- DSP** Digital Signal Processor. A special-purpose CPU tailored to handle complex mathematical functions. A DSP takes an analog signal and reduces it to numbers so its components can be isolated, sampled, and rearranged more easily than in analog form.
- DSU/CSU** Digital (or Data) Service Unit/Channel Service Unit. A pair of communications devices that connect an in-house line to an external digital circuit (such as T1 and DDS). It is similar to a modem, but connects a digital circuit rather than an analog circuit.
- DTMF** Dual Tone Multi-Frequency. A term for push button dialing. The pushed button generates a pair of tones which uniquely identify the button that was pressed.
- E911** Enhanced 911. The addition of two features to the standard 911 service: one is ANI (Automatic Number Identification) to identify the person associated with the calling telephone, and the other is ALI (Automatic Location Identification) to identify the physical location of the calling telephone.
- encapsulation** The process of sending data encoded in one protocol format across a network operating a different protocol, where it is not possible or desirable to convert between the two protocols. Also known as protocol tunneling.
- error correction** A technique to restore data integrity in received data that has been corrupted during transmission. Error correction techniques involve sending extra data. The correct form of the data can be reconstructed from the extra information.

- error detection** A set of techniques that can be used to detect errors in received data. Parity checking techniques include the use of parity bits, checksums or a Cyclic Redundancy Check (CRC).
- Ethernet** The most widely used LAN transmission protocol. Based on a network [bus topology](#), it runs at a maximum 10Mbit/s and can use a wide variety of cable types. The IEEE Ethernet standard is [IEEE 802.3](#).
- Ethernet switching** A technique that brings the advantages of a parallel networking architecture to contention-based Ethernet LANs. Each LAN can be segmented with its own path. When users on different segments exchange data, an Ethernet switch dynamically connects the two separate Ethernet channels without interfering with other network segments.
- fast Ethernet** An evolution of Ethernet that raises the bandwidth to 100 Mbit/s.
- fast packet switching** A [WAN](#) technology for transmitting data, digitized voice, and digitized image information. It uses short, fixed length packets.
- FDDI** Fiber Distributed Data Interface. An optical fiber-based token-passing ring LAN technology that carries data at a rate of 100 Mbit/s.
- FRAD** Frame Relay Access Device. A wide-area networking device that forwards traffic to and from the endpoint of a the network.
- frame** A structured group of bits sent over a link. A frame can contain control, addressing, error detection, and error correction information. The term is often used synonymously with the term [packet](#).
- frame relay** A packet-switching wide-area technology for interconnecting LANs at high speeds.
- gateway** A network device that provides a means for network traffic to pass from one topology, protocol, or architecture into a different topology, protocol, or architecture.
- gigabit Ethernet** An Ethernet technology that raises transmission speed to 1 Gbit/s, targeted primarily for use in backbones.
- glare** A condition in telephony where both ends of an available connection are seized at the same time.
- group mailboxes** Mailboxes that are not associated with a single telephone but allow a group of users to have joint access to a single mailbox.

- H.323** An [ITU](#) standard for the transmission of real-time audio, video, and data communications over packet-switched networks, such as local area networks (LANs) and the Internet. H.323 is the basis for Internet telephony.
- header** The control information added to the beginning of a transmitted message. This may consist of packet or block address, destination, message number and routing instructions.
- hierarchical network** A network with one host at its hub, which is the major processing center, and one or more satellite processing units.
- hot swap** The ability of a device to have parts removed and replaced without turning off the device and without interrupting the service the device provides.
- hub** The center of a star topology network or cabling system. A multi-node network topology that has a central multiplexer with many nodes feeding into and through the multiplexer or hub. The nodes do not directly interconnect.
- hunt groups** Informal “call centers” in which a call rings to one member of the group. If there is not answer, the call rings at the next member’s telephone and so on until a member answers.
- hybrid mode** A PBX operating mode in which some outside lines are grouped together in pools while other lines are assigned directly to buttons on telephones. Users access outside lines by dialing a pool access code. See also [key mode](#).
- IEEE** Institute of Electrical and Electronic Engineers. A U.S. publishing and standards organization responsible for many LAN standards, such as the 802 series.
- IEEE 802.2** The Data Link standard for use with IEEE 802.3, 802.4 and 802.5 standards. It specifies how a basic data connection should be set up over the cable.
- IEEE 802.3** The Ethernet standard. A physical layer definition that includes specification for cabling plus the method of transmitting data and controlling access to the cable.

- IETF** Internet Engineering Task Force. The standards-setting body for the Internet. Protocols adopted by the IETF define the structure and the operation of the Internet.
- IMAP** Internet Message Access Protocol. A method of accessing electronic messages that are kept on a server. IMAP defines how an e-mail program can access messages that are stored on a remote server.
- intelligent hub** See [managed hub](#).
- IP** Internet Protocol. The TCP/IP standard protocol that defines the IP datagram as the unit of information passed across an Internet. IP provides the basis for connectionless packet delivery service.
- IP address** The address used by devices on the network to establish their unique identity. IP addresses are composed of four fields separated by dots. Each field is an 8-bit number (0 through 255). IP addresses can be permanently assigned, or they can be temporarily assigned by [DHCP](#).
- IP telephony** Technology that allows voice, data, and video to be transmitted over IP-based networks.
- ISDN** Integrated Services Digital Network. An international telecommunications standard for transmitting voice, video and data over digital lines running at 64 Kbit/s. ISDN uses B channels, or “bearer” channels, to carry voice and data. It uses a separate D channel, or “delta,” channel for control signals to the telephone company computer.
- ITU** International Telecommunication Union. An international standards organization for telecommunications.
- jitter** The variation in latency (waiting time) for different packets on the network. For real time data such as voice transmission, jitter must be kept to a minimum.
- key mode** A telephone system operating model in which each telephone in the system has buttons for each available outside line. Also known as a square plan or a direct system inward access (DISA) system. See also [hybrid mode](#).
- LAN** local area network. A communications system that links computers, printers, and other devices. LANs allow users to communicate and share resources like hard disk storage and printers. Devices linked by a LAN may be on the same floor or within a building or campus.

- LAN segment** A section of a local area network that is used by a particular workgroup or department and separated from the rest of the LAN by a bridge, router or switch.
- LAN switch** A network device that connects stations or LAN segments, also known as a frame switch.
- latency** The sum of all the delays in an end-to-end connection.
- layering** The process of dividing complex software up into several layers, each of which performs a specific task. Layering allows faster and easier software development and is often used in public, open software.
- LCD** Liquid Crystal Display. A low cost display technology.
- line pool** In a PBX system, outside lines are pooled and arbitrated by the Call Processor. To call an outside number, a user must dial the line pool access number, typically 9, and the Call Processor assigns the next available line.
- LLC** Logical Link Control. A data link protocol for LANs that is part of the [IEEE 802.2](#) standard and common to all LAN standards for [OSI model](#) data link, level two transmissions.
- loop start** The most common signaling method in the public telephone network, typically used for residence and business [CO](#) lines.
- MAC** Media Access Control. A sub-layer of the Data Link layer (Layer 2) of the ISO [OSI model](#) responsible for media control. Also known as the "MAC layer."
- MAC address** A unique 48-bit number that is encoded in the circuitry of a device to identify it on a LAN. Also known as a "hardware address" or an "[Ethernet](#) address."
- managed hub** A network device in which each port on the hub can be configured, monitored, and enabled or disabled by a network administrator from a hub management console or utility tied into an SNMP (Signaling Network Management Protocol) platform. Hub management can also include gathering information on network parameters.
- MAU** Medium Attachment Unit. A transceiver that provides the correct electrical or optical connection between the computer and IEEE 802.3 LAN media.

- MIB** Management Information Base. A database that can be accessed by a gateway running CMIP (Common Management Information Protocol), CMOT (CMIP Over TCP/IP), or SNMP (Signaling Network Management Protocol) network management protocols. The MIB defines variables needed by the protocol to monitor and control components in a network. Managers can fetch or store these variables.
- modem** **MO**dulator/**DEM**odulator. A modem converts a binary bit stream to an analog signal and vice versa.
- multiplexer** A device that can send several signals over a single line. A similar device at the other end of the link then separates the signals.
- multi-tasking** The concurrent execution of two or more tasks or the concurrent use of a single program that can carry out many functions.
- NCP** Network Call Processor. The device that manages call traffic, voice mail, the Auto Attendant, and related applications in an NBX system.
- NetBEUI** NetBios Extended User Interface. A network device driver or transport protocol that is the transport driver supplied with LAN Manager.
- NetBios** Network Basic Input/Output System. Software developed by IBM that provides the interface between the PC operating system, the I/O bus, and the network. Since its design, NetBIOS has become a de facto standard.
- NetWare** LAN Network Operating System and related products developed by Novell. NetWare is based on the SPX/IPX networking protocols.
- network collisions** Result of two stations simultaneously attempting to use a shared transmission medium. See [collision](#).
- network congestion** Result of increased network utilization. Creates traffic bottlenecks on a LAN segment. See [congestion](#).
- network layer** Layer 3 in the [OSI model](#) responsible for the routing and relaying through one or more networks in multiple link or wide area environments.
- network management** The process and technique of remotely or locally monitoring and configuring networks.
- network ping** A packet transfer that checks logical continuity between a PC and a specified IP address.

- NIC** Network Interface Card. Controller circuitry that connects a node to a network, usually in the form of a card in a PC expansion slot. In conjunction with the NOS (Network Operating System) and PC operating system, it helps transmit and receive messages on the network.
- node** Device on a network that demands or supplies services. Also, a location where transmission paths are connected.
- NOS** Network Operating System. Software that connects all the devices on a network so that resources can be shared efficiently and managed from a central location. Novell NetWare is one example of a network operating system.
- OEM** Original Equipment Manufacturer. The maker of a product or component that is marketed by another vendor, integrator, VAR (Value Added Reseller), or reseller.
- off-hook** The state of a telephone line that allows dialing and transmission but prohibits incoming calls from being answered. The term stems from the days when a telephone handset was lifted off of a hook. Contrast with on-hook.
- off-site notification** A feature that sends a message to a pager, outside telephone number, or email account that informs a user of a voice mail message. The user can retrieve the messages remotely.
- on-hook** The state of a telephone line that can receive an incoming call.
- OSI model** A conceptual model of hardware and software layers that define when, how, and in what order data can be transmitted on a network. The OSI Model defines seven layers:
- |         |                    |
|---------|--------------------|
| Layer 7 | Application layer  |
| Layer 6 | Presentation layer |
| Layer 5 | Session layer      |
| Layer 4 | Transport layer    |
| Layer 3 | Network layer      |
| Layer 2 | Data Link layer    |
| Layer 1 | Physical layer     |
- out-of-band signaling** An extra signal transmitted with the information signal to monitor and control a transmission. It provides an additional layer of resilience by using a separate channel.

- packet** A collection of bits, including address, data, and control information, that are transmitted together. The terms frame and packet are often used synonymously.
- packet buffer** Memory space reserved for storing a packet awaiting transmission or for storing a received packet.
- packet switching** A method of switching data in a network. Individual packets of a set size and format are accepted by the network and delivered to their destination. The sequence of packets is maintained, and destination established, by the exchange of control information (also contained in the packets) between the sending terminal and the network before the transmission starts.
- paging** 1) A communications service that includes a one-way beeper service, one-way text service, and two-way text and voice service.
- 2) A public address announcement system. Many [PBX](#) telephone systems can do paging through the speakers in the telephone sets.
- PBX** Private Branch eXchange. An in-house telephone switching system that interconnects telephone extensions to each other, as well as to the outside telephone network. It can include functions such as least cost routing for outside calls, call forwarding, conference calling, and call accounting.
- PCS** Personal Communications Services. Refers to a variety of wireless services emerging after the U.S. Government auctioned commercial licenses in late 1994 and early 1995.
- phantom mailbox** A user profile that uses a telephone number with no associated telephone. Messages can be sent to the phantom mailbox from within the voice mail system. The Auto Attendant can route messages to the phantom mailbox, and you can dial the phantom mailbox directly.
- port** A computer interface capable of attachment to another device, such as a modem for communicating with a remote terminal or, if the port is within a hub, to a workstation.
- POTS** Plain Old Telephone Service.
- PPP** Point-to-Point Protocol. An addition to the Internet protocol suite to help connect devices where dissimilar transport protocols exist. Typically used for serial connections to the Internet.

- predictive dialing** Automated dialing feature in which [CTI](#) software predicts when you will end your current call, and dials the next call in advance.
- pretranslator** A device that interprets and modifies a sequence of incoming digits or transmits outgoing digits.
- preview dialing** Automated dialing feature in which CTI software queues the next call to be made but allows you to check and activate the call.
- PRI** Primary Rate Interface. An ISDN service for users with large bandwidth requirements, such as large PBXs or high performance video desktop conferencing systems; the ISDN equivalent of a T1 circuit.
- protocol** A set of rules governing the information flow within a communications infrastructure. A protocol typically specifies the structure of parameters like format, timing, and error correction.
- protocol converter** A device that translates between two protocols to facilitate communications between different computers or different systems.
- PSTN** Public-Switched Telephone Network. The term describes the national telephone network.
- punch-down block** Telephony term describing the connector arrangements for distributing and connecting unshielded and shielded twisted pair wiring inside a building. Typically found in telephone wiring closets.
- Q.921/931** ITU-TS "Q Series" Recommendations describing Lap-D, the Layer 2 protocol for an ISDN D-channel. See [OSI model](#).
- reconfiguration** The process of physically altering the location or functionality of network or system elements. Automatic configuration describes the way sophisticated networks can readjust themselves in the event of a link or device failing, enabling the network to continue operation.
- redundancy** In data transmission, this refers to characters and bits that can be removed from a transmission without affecting the message. In data processing and data communications, it means providing backup for components so that if one of them fails, the system continues to run without interruption.
- REN** Ringer Equivalency Number. A number that indicates how much power is required by a telephone to make it ring. When connecting telephones to

- a telephone line, the sum of the RENs of the telephones must be less than the rated REN capacity of the telephone line.
- repeater** A device that extends the maximum length of cable that can be used in a single network.
- RMON** Remote Monitoring. A facet of SNMP-based network management, the RMON MIB (Management Information Base) defines the standard network monitoring functions for communication between SNMP-based management consoles and remote monitors. A typical MIB captures information about a device, but RMON captures information about traffic between devices.
- RJ-11** A four-wire modular connector used by the telephone system.
- RJ-45** An eight-wire modular connector used by telephone systems. The eight-pin modular connectors used for 10BASE-T [UTP](#) cable resemble RJ-45 connectors, but they have substantially different electrical properties.
- router** A network device that links LANs together locally or remotely as part of a WAN. A network built using routers is often termed an internetwork.
- routing** The process of delivering a packet across one or more networks via the most appropriate path.
- SA** System Appearance
- screen POP** A [CTI](#) term for a window that automatically opens on a user's computer when a predefined telephone event occurs. For example, an incoming call could generate a screen pop that lists [caller ID](#) information.
- segment** A LAN term meaning an electrically continuous piece of the bus. Segments can be joined together using repeaters or [bridges](#).
- serial interface** Hardware for sending and receiving data one bit at a time.
- SMDR** Station Message Detail Recording. A stream of call data from the telephone system. Typically, the data is not stored on the telephone system itself. Rather, it is captured by an external device that connects to the telephone system through an RS232 port.
- SMTP** Simple Mail Transfer Protocol. The [TCP/IP](#) standard protocol for transferring electronic mail messages from one machine to another. SMTP

specifies how two mail systems interact and the format of control messages they exchange to transfer mail.

**SNA** Systems Network Architecture. IBM's layered communications protocol for sending data between IBM hardware and software.

**STP** Shielded Twisted Pair. A twisted pair of wires surrounded by a shield that is typically made of braided wire or metal foil.

**switched Ethernet** An Ethernet network that allows each user the full Ethernet bandwidth of 10 Mbit/s to another node.

**system-wide greetings** A special type of time-dependent greeting that is used throughout the system.

**T1/E1** A high-speed data channel that can handle 24 voice or data channels (T1) or 30 voice or data channels (E1) at 64Kbit/s. Refers to the U.S. T1 line or European E1 equivalent.

**T3** A U.S. standard for high-speed data transmission at 44.736 Mbit/s, providing the equivalent bandwidth of 28 T-1 circuits. The carrier channel can handle 672 voice or data channels.

**TAPI** Telephony Applications Programming Interface

A Microsoft Windows standard interface for integration between telephone systems and Windows-based software. A typical example is integrating Caller ID with a database on your computer that contains detailed information about potential callers. When your telephone rings, a window pops up on your computer with information about the caller.

**TCP/IP** Transmission Control Protocol/Internet Protocol. The suite of protocols that define how to move information over the Internet.

**thin Ethernet** An 802.3 LAN that uses smaller than normal diameter [coaxial cable](#); often used to link PCs together. Also known as [10BASE2](#).

**time-dependent greeting** Greetings that usually indicate the time of day that the caller is calling (morning, afternoon, evening) and are an optional feature of the Automated Attendant.

**toll-free** The U.S. term for "free phone."

**toll restrictions** The U.S. term for "call barring."

- translation** The process of interpreting or modifying dialed digits for incoming or outgoing calls and allows the call to progress through the network.
- trunk** A communications channel between two points. It often refers to large-bandwidth telephone channels between major switching centers, capable of transmitting many simultaneous voice and data signals.
- twisted pair** Two insulated wires twisted together with the twists varied in length to reduce potential signal interference between the pairs. Twisted pair is the most common medium for connecting telephones, computers and terminals.
- UPS** Uninterruptible Power Supply. A secondary power source attached to a piece of hardware, for example a server, which provides backup power for conducting an orderly shutdown if the server's normal power supply fails.
- UTP** Unshielded Twisted Pair. Two insulated wires twisted together with the twists varied in length to reduce potential signal interference between the pairs. The standard cabling used for telephone lines and Ethernet 10BASE-T.
- virtual LAN** A logical, rather than a physical, LAN that includes workgroups drawn together for business reasons or for a particular project regardless of the location of the members.
- VPIM** Voice Profile for Internet Mail. A set of Internet protocols that merges voice messaging and e-mail. VPIM lets voice mail and e-mail servers exchange messages across TCP/IP-based intranets and the Internet.
- VTL** Virtual Tie Line. Allows several NBX domains to create tie lines on demand and to place calls over a [WAN](#). Uses peer-to-peer connections for the audio.
- WAN** Wide Area Network. A network that covers a larger geographical area than a LAN. In a WAN, telecommunications links are normally leased from the appropriate Public Telephone Operator (PTO).
- wiring closet** The location, usually a physical box, in which the cabling on one floor of a building is terminated.
- workstation** Another name for a computer, typically running UNIX or the Windows NT operating system.



# INDEX

---

## Symbols

231

\*

character in VTL caller ID 65

---

## Numbers

10BASE2, definition 403

10BASE-T, definition 403

4ESS protocol

call-by-call service 209

on T1 spans 209

overview 69

selecting 209

4-Port Analog Terminal Card

adding 162

911

and Class of Service 233

---

## A

access buttons

Attendant Console 155

H.323 calls 392

mapping 146

ACT

E1 status light 186

T1 status light 207

adding

Attendant Console 154

BRI-ST Digital Line Card 167

E1 Digital Line Card 179

extension lists 60

mirror disk 253

T1 Digital Line Card 195

telephones 130 to 131

address, IP

Call Processor 322

configuring DHCP server to provide Call

Processor's IP address 353

gateway 322

viewing 322

address, MAC

definition 412

specifying from a telephone 322

viewing in telephone diagnostics 322

administrator password 252

alarms, T1 and E1, Digital Line Cards

blue alarm 330

red alarm 330

yellow alarm 331

analog devices

connecting 162

Analog Line Card

audio gain controls 161

timing parameters 161

Analog Terminal Adapter (ATA)

adding 164

modifying 165

removing 165

status 165

Analog Terminal Card

audio gain controls 166

connecting analog devices 162

timing parameters 166

and DHCP option 184 217

Attendant Console

Access buttons 155

adding 154

configuring 153

Feature buttons 155

modifying 154

removing 155

audio compression

E1 188

T1 212

audio controls

modifying for BRI-ST card 173

modifying for E1 card 188

modifying for T1 card 211, 212

audio gain controls

4-Port Analog Line Card 161

Analog Terminal Card 166

audio quality

VTL calls 244

- audio recording
  - music on hold 145
  - on other than NBX Telephones 145
  - phones with different settings 144
  - remote telephones 145
- audio settings 240
  - changing, system-wide 84, 243
- Auto Discovery
  - Analog Line Cards 156
  - Attendant Console 153
  - BRI-ST Digital Line Card 168
  - E1 channel numbering 191
  - E1 Digital Line Card 181
  - first extension used 111
  - T1 Digital Line Card 196
  - telephones 47, 130
- Automated Attendant
  - activating changes 280
  - adding 270
  - buttons 277
  - configuring 270
  - default functions 273
  - default timeout 268
  - dial by extension or name 269
  - examples 275
  - extension range 54
  - greetings 272
  - H.323 calls 393
  - importing prompts 268
  - importing system-wide greetings 272
  - importing time-dependent greetings 272
  - modifying 281
  - overview 268
  - recording prompts 268
  - restoring defaults 282
  - testing 283
  - timeout 268
  - voice application setup utility 282
- Automated Attendant Setup Utility
  - default password 283
- automatic reboot 300
- BRI channels
  - modifying 176
  - status 176
- BRI groups
  - changing membership 175
  - configuring 171
  - membership status 171
  - modifying 174
  - removing 176
- bridged extensions
  - and TAPI Route Points 229
  - defining 137
  - mapped extensions report 141
  - modifying on the primary telephone 139
  - on the primary telephone 137
  - on the secondary telephone 138
  - overview 134
  - sample calling situations 139
  - sample configurations 136
- BRI-ST Digital Line Card
  - BRI signaling 170
  - channel status 176
  - configuring 170 to 172
  - DSP (Digital Signal Processor) status 177
  - inserting (caution) 169
  - modifying 173
  - modifying IP settings 177
  - removing (caution) 178
  - status lights (LEDs) 172
- business information 251
  - business hours and CoS (Class of Service) 251
  - modifying 251
  - modifying business hours 251
  - modifying system mode 251
- Business Telephone, NBX
  - diagnostics 316
- Busy Lamp/Speed Dial
  - mapping buttons 148
- buttons, Automated Attendant 277
- buttons, telephone
  - mapping 146
  - testing 324

---

## B

- Basic Telephone, NBX
  - diagnostics 316
- battery
  - replacing on the SuperStack 3 Call Processor 341
- blue alarm, T1 and E1 Digital Line Cards 330
- brackets
  - attaching to the telephone 130

---

## C

- CALL
  - E1 status light 185
  - T1 status light 207
- call coverage
  - for hunt groups 233
- Call Detail Reports
  - purging data 300, 310

- Call Park
    - adding extensions 152
    - and TAPI Route Points 228
    - changing extension name 152
    - configuring 152
    - extension range 55
    - removing extensions 153
  - call processing
    - inbound 29
    - outbound 29
  - Call Processor
    - specifying the MAC address from a telephone 322
  - Call Processor IP address
    - configuring DHCP server to provide 353
  - Call Reports
    - capabilities 309
    - configuring 310
    - installing 310
  - call restrictions 233
  - call-by-call service 209
  - caller ID
    - VTL pretranslator 65
  - calling access permissions 233
  - CARD
    - T1 status light 207
  - Central Office (CO)
    - code 234
    - definition 407
  - changing IP bins 248
  - changing multicast addresses 248
  - changing multicast bins 248
  - channel service unit 220
  - Class of Service (CoS)
    - user settings 233
  - CLIR
    - and VTL call pretranslators 65
  - CO
    - E1 status light 184
    - T1 status light 206
  - CO (Central Office)
    - code 234
    - definition 407
  - collision, defined 406
  - compression
    - E1 188
    - T1 212
  - configuration file, dial plan 30, 44
  - configuring
    - BRI groups 171
    - BRI-ST Digital Line Card 170 to 172
    - E1 Digital Line Card 182 to 183
    - E1 groups 183
    - line card port 157
    - T1 Digital Line Card 194 to 201
    - T1 groups 200, 204
  - configuring Automated Attendant 270
  - configuring membership
    - BRI groups 175
    - E1 groups 190
    - T1 groups 213
  - congestion, defined 407
  - connecting
    - BRI lines 170
    - E1 lines 183
    - T1 lines 199
  - ConneXtions H.323 gateway
    - installation preparation 362
    - installation procedure 365
    - installation requirements 358
    - overview 358
    - software 362
  - conventions
    - notice icons, About This Guide 16
  - cordless telephones 162
  - CoS (Class of Service)
    - speed dial numbers 250
    - user settings 233
  - CPE (Customer Premises Equipment), definition 407
  - creating the dial plan configuration file 44
  - CSU (Channel Service Unit), definition 407
  - CTI (Computer Telephony Integration), definition 407
- 
- D**
- database operations
    - backing up 296
    - migrating data 300
    - purging 300
    - purging CDR data 300
    - restoring 299
  - date and time settings 246
  - DCH
    - E1 status light 185
    - T1 status light 206
  - DDI (Direct Dialing Inward) services
    - dial plan configuration (BRI) 168
    - dial plan configuration (E1) 180
  - delayed ringing pattern 148
  - DHCP
    - configuring option 184 353
  - DHCP option 184
    - and digital line cards 217
  - diagnostics 316
    - LUI (local user interface) 316

- NBX Basic Telephone 316
- NBX Business Telephone 316
  - telephone buttons 324
  - telephone LEDs 324
- dial by extension or name 269
- dial plan
  - 3-digit and 4-digit 53
  - configuration file 30, 44
  - configuring VTLs 85
  - default Auto Extension 111
  - exporting 48
  - extension settings 52
  - extension settings (table) 54
  - External Keypad Prefix 111
  - first Auto Discover Extension 111
  - Hybrid mode 32
  - importing 47
  - Keypad mode 32
  - modifying 51
  - off-site notification 32
  - overview 28
  - pretranslation 31
  - pretranslators 31, 64
  - routing 31
  - sample solutions 120
  - tables 33
  - testing 49
  - timed routes 49
  - VPIM configuration 71
  - VTL configuration 80
  - VTL password 100
  - VTLs and site-unique extensions 85
  - VTLs with site codes 87
- dial plan configuration file
  - 4ESS protocol 69
  - accessing 44
  - commands 105
  - creating 44
  - DDI/MSN services for BRI 168
  - DDI/MSN services for E1 180
  - DID services for T1 196
  - translator entries for BRI 168
  - translator entries for E1 180
  - translator entries for T1 196
- dial plan report
  - creating 50
- dial plan settings
  - changing 56
- dial plan tables
  - incoming 38
  - internal 38
  - managing 28
- dial prefix settings 52
- DID (Direct Inward Dialing) services
  - dial plan configuration 196
  - T1 196
- digital line cards 217
- Digital Line Cards, BRI-ST
  - channel status 176
  - DSP (Digital Signal Processor) status 177
  - modifying span 173
  - status lights (LEDs) 172
- Digital Line Cards, E1
  - channel status 192
  - channels per span 187
  - configuring 182 to 183
  - DSP (Digital Signal Processor) status 192
  - ISDN PRI signaling 182
  - modifying span 186
  - partial E1 187
  - status lights (LEDs) 184
  - status lights and alarms 331
- Digital Line Cards, T1
  - channel status 215
  - DSP (Digital Signal Processor) status 215
  - modifying name and type 208
  - modifying span 208
  - partial T1 210
  - status lights (LEDs) 206
  - status lights and alarms 331
- Direct Dialing Inward (DDI) services
  - dial plan configuration (BRI) 168
  - dial plan configuration (E1) 180
- Direct Inward Dialing (DID) services
  - dial plan configuration 196
  - T1 195
- disabled button 278
- disabling transfer prompt 261
- disk mirroring
  - adding mirror disk 253
  - LEDs 255
  - overview 253
  - replacing disk 256
  - reverting to a single disk 256
- DNLD
  - E1 status light 185
  - status light 206
- DNS (Domain Name Server)
  - configuring for VPIM 80
  - number of servers 80
- Do Not Disturb
  - and TAPI Route Points 228
- documentation
  - printing 314

- downloading software
  - Label Makers 312
  - NBX Call Reports 311
  - NBX TAPI Service Provider (NBXTSP) 311
- DS1 protocol, configuring T1 Digital Line Card 198
- DSP
  - E1 status light 185
  - T1 status light 207
- DSP (Digital Signal Processor), description 408

---

## E

- E1
  - audio compression 188
  - gain 188
  - silence suppression 188
- E1 Digital Line Card
  - channel status 192
  - configuring 182 to 183
  - DSP (Digital Signal Processor) status 192
  - inserting (caution) 181
  - ISDN PRI signaling 182
  - modifying IP settings 192
  - modifying span 186
  - removing (caution) 194
  - status lights (LEDs) 184
- E1 groups
  - adding 188
  - changing membership 190
  - modifying 189
  - removing 191
- E1 span, modifying 186
- E911, ISDN PRI signaling 195
- echo cancellation
  - disabling 201
  - enabling 201
- echo suppression
  - system-wide 240
- e-mail, configuring for IMAP 263
- emergency calls
  - 911 40
  - Class of Service 233
  - E911 195
- emergency dialing 195
- enter submenu, button 280
- errors 336
- Ethernet (Layer 2) 236
- event logs, viewing
  - Adminlog 300
  - upgrade log 300

- Exit Menu, button 279
- exporting dial plan 48
- extension length 54
- extension lists 59
  - adding 60
  - managing 52
  - modifying 61
  - removing 62
  - updating for VTLs 88
- extension numbers
  - adding Call Park 152
  - changing Call Park 152
  - changing settings 57
  - line card port 56
  - managing 52
  - phantom mailbox 57
  - removing Call Park 153
- extension ranges
  - Automated Attendant 54
  - Call Park 55
  - changing 56
  - external extensions 55
  - hunt groups 54
  - telephones 54
- extension settings, dial plan 52
- external extensions, extension ranges 55
- External Keypad Prefix, dial plan 55, 111

---

## F

- fax machines
  - Group-3 162
- FCC
  - rules 433
- Feature buttons
  - Attendant Console 155
- firewalls 378
- Frame Relay, definition 409

---

## G

- gain
  - E1 span 188
  - T1 span 212
- Gateway IP Address 322
- glare, definition 409
- greetings
  - importing 268
- greetings and main menu
  - example 276
- greetings, Automated Attendant
  - description 272
  - example 275

---

**H**

- H.323 calls 389
  - access buttons 392
  - dialing 393
  - receiving 393
- H.323 connections 371
  - and firewalls 378
  - controlling quality 376
  - gateway checks 385
  - gateway loads 380
  - logical 372
  - physical 372
  - quality 373
  - receiving calls 393
  - remote calls 380
  - security 378
  - verifying 385
- H.323 gateway
  - class of service 384
- H.323 standard 368
- H3PingIP 325
- handset echo 244
- hexadecimal codes
  - ISDN completion codes 347
- hop off
  - enabling 99
- hunt group
  - telephone priority 232
- hunt groups
  - and TAPI Route Points 228
  - calling groups 231
  - configuring 231
  - extension range 54
  - linear 231
- Hybrid mode
  - button mapping 146
  - dial plan 32

---

**I**

- IMAP (Internet Message Access Protocol)
  - configuring an e-mail client 263
  - definition 262, 411
- importing
  - International dial plan 46
  - North American dial plan 45
  - prompts 268, 273
  - system-wide greetings 272
  - time-dependent greetings 272
  - user-defined dial plan 47

- inbound call processing 29
- incoming calls
  - DDI/MSN for BRI-ST 167
  - DID 197
  - H.323 393
  - pretranslator 41
- incoming dial plan table 38
- installing
  - ConneXtions H.323 gateway 358
- internal dial plan table 38
- international dial plan, importing 46
- Internet Group Management Protocol (IGMP) 248
- Internet Message Access Protocol (IMAP)
  - definition 262
- IP
  - address, viewing 322
  - bins, changing 248
  - configuring DHCP server to pass address of NCP 353
  - modifying BRI-ST Digital Line Card settings 177
  - modifying E1 Digital Line Card settings 192
  - modifying T1 Digital Line Card settings 216
  - multicast bins 248
- IP On-the-Fly 236
- ISDN completion cause codes (table) 347
- ISDN PRI signaling
  - configuring T1 Digital Line Card 202
  - E911 connectivity 195

---

**J**

- jitter buffers 376

---

**K**

- key mode, definition 411
- key pad button actions 278
- Keyset mode
  - dial plan 32
  - prefix 55

---

**L**

- labels, downloading software 312
- Least Cost Dial Plan table 39
- LEDs
  - BRI-ST Digital Line Card 172
  - E1 Digital Line Card 184
  - T1 Digital Line Card 206
- LEDs (status lights)
  - telephone diagnostics 324
- licenses
  - status 301

- viewing 301
  - lights
    - testing on the telephone 324
  - line card port 156
    - automatic configuration 157
    - configuring 157
    - configuring automatically 157
    - configuring manually 157
    - extension number 56
    - manual configuration 157
    - modifying 160
    - rebooting 161
    - removing 160
    - status 161
  - line pool 146
  - LNK
    - E1 status light 186
    - T1 status light 207
  - logging
    - maximum file size 220
  - Loop Start, definition 412
  - LUI
    - and PoE 316
  - LUI (Local User Interface)
    - diagnostic/configuration utility 316
- 
- M**
- MAC address
    - definition 412
    - specifying NCP address from a telephone 322
    - viewing in telephone diagnostics 322
  - mailbox, phantom
    - extensions 57
    - H.323 395
  - main menu
    - default functions 273
  - main menu window, NBX NetSet utility 22
  - maintenance alerts
    - configuring the sender 249
  - mapped extensions report 141
  - mapping buttons
    - access 146
    - Attendant Console 155
    - Busy Lamp/Speed Dial 148
    - telephone groups 147, 149
  - Media Driver, and third-party messaging 343
  - menu time-out action 278
  - menu tree dialog box 272
  - message storage capacity, viewing 261
  - messages
    - maximum length allowed 261
    - maximum number allowed 260
    - retaining 260
  - messaging, voice
    - overview 259
    - phantom mailboxes 225
    - third-party 343
  - Model Number
    - board names for hex values 336
  - modifying
    - audio controls for BRI-ST card 173
    - audio controls for E1 card 188, 212
    - audio controls for T1 card 211
    - BRI channels 176
    - BRI groups 174
    - BRI-ST Digital Line Card 173
    - BRI-ST Digital Line Card IP settings 177
    - channels 191, 214
    - E1 Digital Line Card 186
    - E1 Digital Line Card IP settings 192
    - E1 Digital Line Card name and type 186
    - E1 groups 188
    - T1 Digital Line Card 207
    - T1 Digital Line Card IP settings 216
    - T1 groups 212
  - modifying Automated Attendant 281
  - modifying dial plan 51
  - modifying extension lists 61
  - modifying system settings 247
    - administrator password 252
    - advanced regional settings 245
    - audio settings 240
    - Auto Attendant password 252
    - business information 251
    - date and time 246
    - disk mirroring 253
    - multicast addresses 247
    - regional settings 244
    - removing a system speed dial 251
    - reverting to single disk 256
    - ringing patterns 247
    - speed dial numbers 250
    - system mode 251
    - TAPI telephony 253
    - timers 246
  - multicast addresses
    - changing IP addresses 248
    - changing IP bins 248
    - overview 247

---

**N**

- name directory button 278
- NAPT 133
- NBX Call Reports software 311
- NBX NetSet utility 22
  - icons 25
  - main menu window 25
  - shortcuts 25
- NBX Resource Pack CD 21
- NBX system database 30
- NBX system software, overview 20
- NBXTSP 343
- NCP
  - E1 status light 185
  - T1 status light 207
- NCP IP Address 322
- NCP MAC Address 322
- NetSet, NBX administration utility 22
- Network Address Port Translation 133
- network protocol
  - Ethernet only 236
  - IP On-the-Fly 236
  - standard IP 236
- North American dial plan, importing 45
- Number
  - telephone button mapping 147

---

**O**

- off-site notification 264
  - behavior 264
  - configuring 265
  - dial plan 32
  - enabling 264
  - system-wide settings 265
- Option 184, configuring on DHCP server 353
- outbound call processing 29
- outgoing calls
  - H.323 389
  - pretranslator 42
- overloading 133

---

**P**

- packet reconstruction 376
- partial E1 187
- partial T1 210
- passwords
  - administrator 252
  - voice mail 262

- PBX connections 381
- permissions 233
- phantom mailbox 225
  - and TAPI Route Points 228
  - creating 226
  - extensions 57
  - H.323 calls 395
  - overview 225
- play/record extension
  - where to specify 271
- Port Usage, voice mail 266
- POST
  - E1 status light 184
  - T1 status light 206
- powered Ethernet cable
  - and LUI 316
- pretranslation
  - dial plan 31
- pretranslators 40
  - assigning 65
  - dial plan 31, 40
  - incoming calls 41
  - managing in dial plan 64
  - optional for VTLs 89
  - outgoing calls 42
  - removing from dial plan 68
  - viewing devices 65
  - VTL calls and caller ID 65
- PRI signaling, configuring
  - T1 Digital Line Card 202
- prompted transfer, button 279
- prompts 268
  - importing 268
- prompts, defining 272
- Prty
  - telephone button mapping 147

---

**Q**

- Quality of Service (QoS) 376
- Quick Reference Guides, viewing 314

---

**R**

- rebooting
  - automatically 300
  - line card port 161
  - telephones 132
- recording
  - time-dependent greetings 272

- red alarm, T1 and E1 Digital Line Cards 330
  - redialing, dial prefix settings 52
  - redirected call, definition 227
  - regional settings 244
  - regional software
    - installing and configuring 303
  - removing
    - Analog Terminal Adapter (ATA) 165
    - Attendant Console 155
    - BRI groups 176
    - BRI-ST Digital Line Card 178
    - E1 Digital Line Card 194
    - E1 groups 191
    - line card port 160
    - T1 Digital Line Card 217
    - T1 groups 214
    - telephones 132
  - removing extension lists 62
  - removing telephone groups 143
  - REN (Ringer Equivalency Number)
    - definition 416
  - replacing a failed disk 256
  - replacing NCP battery 341
  - reports
    - calls 309
    - dial plan 50
    - system data 308
    - system devices 308
    - system directory 307
  - REQ\_CHANNEL\_UNAVAIL, E1 error 187
  - rerouting, VTL calls 94
  - reserved in dial plan, button 279
  - restoring factory defaults 300
  - Ring
    - telephone button mapping 147
  - ringing patterns 247
  - Route Point
    - definition 227
    - system capacities 229
  - routing dial plan 31
- 
- S**
- SDN (Software Defined Networks) 69
  - security
    - firewalls 378
    - system settings 252
  - serial number, telephone 322
  - settings
    - system-level 235
    - system-wide 265
  - signaling, configuring
    - BRI 170
    - E1 ISDN PRI 182
    - T1 DS1 198
    - T1 ISDN PRI 202
  - silence suppression 374
    - E1 188
    - system-wide 240
    - T1 212
  - single digit transfer button 279
  - site codes
    - pretranslator for caller ID 66
    - using for VPIM 71
    - using for VTLs 82
  - software
    - downloading NBX Label Makers 312
    - NBX Call Reports 311
    - NBX Label Makers 312
    - NBX TAPI Service Provider (NBXTSP) 311
  - software version number 322
  - span
    - activating for T1 lines 199
    - modifying, for BRI-ST card 173
    - status for T1 lines 184, 199, 224
  - speed dial numbers 250
    - Class of Service 233
    - mapping 148
  - standard IP 236
  - statistics
    - TAPI Route Point 230
    - voice mail port usage 266
  - status 336
    - Analog Terminal Adapter (ATA) 165
    - BRI channels 176
    - BRI group membership 171
    - Digital Line Card troubleshooting 329
    - disk 256
    - E1 channels 192
    - E1 DSP (Digital Signal Processor) 192
    - licenses 301
    - line card port 161
    - T1 channels 215
    - T1 Digital Line Card DSP (Digital Signal Processor) 215
    - T1 group membership 205
    - T1 span 184, 199, 224
    - telephones 132
  - status lights (LEDs)
    - BRI-ST Digital Line Card 172
    - E1 Digital Line Card 184, 331
    - T1 Digital Line Card 206, 331

- submenus for greetings 276
- subnet mask 236
- system database 30
- system disconnect button 278
- system level operations
  - installing licenses 302
- system mode 251
- system security 252
- system settings
  - advanced regional settings 245
  - audio settings 240
  - Auto Attendant password 252
  - business hours 251
  - business information 251
  - disk mirroring 253
  - multicast addresses 247
  - regional settings 244
  - reverting to single disk 256
  - ringing patterns 247
  - speed dial numbers 250
  - TAPI telephony 253
  - timers 246
  - viewing 235
- system-level operations
  - installing software upgrades 291
  - managing data 296
  - viewing event logs 300
- system-wide greetings 272
- system-wide settings 237

---

## T

- T1
  - audio compression 212
  - gain 212
  - silence suppression 212
- T1 channel status 215
- T1 Digital Line Card
  - adding 195
  - configuring 194 to 201
  - DS1 protocol 198
  - ISDN PRI signaling 202
  - removing (caution) 217
- T1 groups
  - changing membership 213
  - configuring 200, 204
  - membership status 205
  - modifying 212
  - removing 214
- T1 lines, connecting 199
- T1 span
  - activating 199
  - echo cancellation 201
  - modifying 208
  - status 184, 199, 224
- TAPI
  - Route Point, definition 227
- TAPI (Telephony Application Programming Interface)
  - definition 418
  - maximum clients 253
  - system settings for 253
- TAPI Line Redirect Timeout 231
- TAPI Route Point
  - statistics 230
  - system capacities 229
- telephone
  - adding 130 to 131
  - analog 162
  - Auto Discovery 130
  - button mappings 146
  - connections 325
  - cordless 162
  - diagnostics 316
  - extension length 54
  - extension range 54
  - rebooting 132
  - status 132
  - viewing MAC address through 322
- telephone groups
  - Access Button types 147
  - call recording and monitoring 142
  - changing names 142
  - creating 142
  - mapping buttons 147, 149
  - removing 143
- TEP log
  - maximum file size 220
- TEP Logs 300
- testing
  - Automated Attendant 283
  - dial plan 49
  - telephone buttons 324
  - telephone connections 325
  - telephone LEDs 324
- third-party messaging 343
- third-party telephones 304
- time-dependent greetings
  - adding 272
  - example 275
  - importing 272
  - recording 272
- timers 246
- timing parameters
  - 4-Port Analog Line Card 161
  - 4-Port Analog Terminal Card 166

transfer prompt, disabling 261  
transfer to voice mail button 279  
troubleshooting 326

---

## U

unique extension ranges for VTLs 81  
upgrading software 291  
    migrating data 300  
user settings  
    Class of Service 233  
USER\_ALERTING\_NO\_ANSWER 336

---

## V

version number, software 322  
voice application setup utility 282  
voice mail 259  
    creating a phantom mailbox 226  
    extensions 262  
    incoming call behavior 261  
    password 262  
    phantom mailboxes 225  
    port usage 266  
    storage space 261  
    transferring calls to 279  
VPIM (Voice Profile for Internet Mail) 70  
    advanced settings 77, 288  
    configuring DNS server information 80  
    configuring parameters 74  
    configuring the dial plan for 71  
    control parameters 74  
    managing the message queue 74  
    operations management 285  
    overview 284  
    statistics 76, 287  
    using unique extension ranges 71  
VTL (Virtual Tie Line) 80  
    audio compression option 98  
    configuring 84  
    dial plan configuration 85  
    license installation 84  
    managing VTLs 96  
    modifying name of 96  
    music on hold 103  
    password configuration 99  
    password in dial plan 100  
    rerouting VTL calls 94  
    silence-suppression option 98  
    statistics 97  
    toll calls 103  
    troubleshooting 103  
    unique extension ranges 81

using site codes 82  
verifying access to remote system 91  
verifying local system operation 90  
verifying operation of 90

## VTL Calls

audio quality 244

## VTL calls

pretranslator for caller ID 65

---

## Y

yellow alarm, T1 and E1 Digital Line Cards 331



## FCC CLASS A VERIFICATION STATEMENT

This equipment has been tested and found to comply with the limits for a Class A digital device, pursuant to Part 15 of FCC rules. These limits are designed to provide reasonable protection against harmful interference when the equipment is operated in a commercial environment. This equipment generates, uses, and can radiate radio frequency energy and, if not installed and used in accordance with the instruction manuals, may cause harmful interference to radio communications. Operation of this equipment in a residential area is likely to cause harmful interference, in which case the user will have to correct the interference at his or her own expense.

Changes or modifications not expressly approved by 3Com could void the user's authority to operate this equipment.

This equipment complies with Part 68 of the FCC rules. This unit bears a label which contains the FCC registration number and Ringer Equivalency Number (REN). If requested, this information must be provided to the telephone company.

This equipment uses the following standard FCC Part 68-compliant jacks and plugs for network connections:

USOC RJ11C for connecting to the telephone network

USOC RJ45 and BNC connectors for connecting to the local area network

This equipment contains FCC-compliant modular jacks. It is designed to be connected to the telephone network or premises wiring using compatible modular plugs and cabling which comply with the requirements of FCC Part 68 rules.

The Ringer Equivalency Number (REN) is used to compute the number of devices that can be connected to a telephone line. An excessive REN value on a line can result in the devices not ringing in response to incoming calls. In most, but not all areas, the sum of the RENs should not exceed five (5.0). To be certain of the number of devices that may be connected to a line, as determined by the total RENs, contact the local telephone company. For products approved after July 23, 2001, the REN for this product is part of a product identifier that has the format US:AAAEQ##TXXXX. The digits represented by ## are the REN without a decimal point (for example, 03 is a REN of 0.3). For earlier products, the REN is separately shown on the label.

In the unlikely event that this equipment causes harm to the telephone network, the telephone company can temporarily disconnect your service. The telephone company will try to warn you in advance of any such disconnection, but if advance notice is not practical, it may disconnect the service first and notify you as soon as possible afterwards. In the event that such a disconnection is deemed necessary you will be advised of your right to file a complaint with the FCC.

From time to time, the telephone company may make changes in its facilities, equipment, operations, or procedures which could affect the operation of this equipment. If this occurs, the telephone company is required to provide you with advance notice so you can make the modifications necessary to maintain uninterrupted service.

Repairs to this equipment can be made only by the manufacturer or its authorized agents. In the event that this equipment requires service, contact your equipment vendor or the manufacturer, 3Com Corporation.

NBX Telephones are compatible with inductively coupled hearing aids.

If trouble is experienced with this NBX equipment, for repair or warranty information, please contact 3Com Corporation, 5400 Bayfront Plaza, P.O. Box 58145, Santa Clara, California, USA, Telephone: 800-NET-3Com or visit the web site at [www.3com.com](http://www.3com.com). If the equipment is causing harm to the telephone network, the telephone company may request that you disconnect the equipment until the problem is resolved.

Connection to party line service is subject to state tariffs. Contact the state public utility commission, public service commission or corporation commission for information.

If your home has specially wired alarm equipment connected to the telephone line, ensure the installation of this NBX equipment does not disable your alarm equipment. If you have questions about what will disable alarm equipment, consult your telephone company or a qualified installer.

This equipment is capable of providing users access to interstate providers of operator services through the use of access codes. Modification of this equipment by call aggregators to block access to dialing codes is a violation of the Telephone Operators Consumers Act of 1990.

## INDUSTRY CANADA NOTICE

**NOTICE:** The Industry Canada (IC) label identifies certified equipment. This certification means that the equipment meets the telecommunications network protective, operational, and safety requirements as prescribed in the appropriate Terminal Equipment Technical Requirements document(s). The department does not guarantee the equipment will work to the user's satisfaction.

Before installing this equipment, users should ensure that it is permissible to be connected to the facilities of the local telecommunications company. The equipment must also be installed using an acceptable method of connection. The user should be aware that compliance with the above conditions might not prevent degradation of service in some situations.

Repairs to certified equipment should be coordinated by a representative designated by the supplier. Any repairs or alterations made by the user to this equipment, or equipment malfunctions, may give the telecommunications company cause to request the user to disconnect the equipment.

Users should ensure for their own protection that the electrical ground connections of the power utility, telephone lines, and internal metallic water pipe system, if present, are connected together. This precaution may be particularly important in rural areas. **Caution:** Users should not attempt to make such connections themselves, but should contact the appropriate electrical inspection authority or electrician, as appropriate.

**NOTICE:** The Ringer Equivalency Number (REN) assigned to each terminal device provides an indication of the maximum number of terminals allowed to be connected to a telephone interface. The termination of an interface may consist of any combination of devices subject only to the requirement that the sum of the ringer equivalency numbers of all devices does not exceed 5.

## Important: Read before using this product.

### 3COM END-USER SOFTWARE LICENSE AGREEMENT TERMS AND CONDITIONS AND LIMITED WARRANTY

READ THE TERMS AND CONDITIONS OF THIS AGREEMENT CAREFULLY BEFORE USING THE 3Com PRODUCT ACCOMPANYING THIS AGREEMENT (THE "PRODUCT"). BY USING THE PRODUCT YOU ARE ACCEPTING AND AGREEING TO BE BOUND BY THIS AGREEMENT. IF YOU ARE NOT WILLING TO BE BOUND BY THE TERMS OF THIS AGREEMENT, YOU SHOULD PROMPTLY RETURN THE UNUSED PRODUCT AND PACKAGING TO THE DEALER THAT SOLD THE PRODUCT TO YOU, AND YOU WILL RECEIVE A REFUND OF THE PURCHASE PRICE. THIS AGREEMENT REPRESENTS THE ENTIRE AGREEMENT CONCERNING THE PRODUCT BETWEEN YOU AND 3Com CORPORATION ("3Com"), AND IT SUPERSEDES ANY PRIOR PROPOSAL, REPRESENTATION, OR UNDERSTANDING CONCERNING THE PRODUCT BETWEEN YOU AND 3Com.

3Com and you, the purchaser, agree that the following terms and conditions (sometimes referred to herein as this "Agreement") shall govern your purchase of the Product from an authorized 3Com dealer. The term "Product" includes (i) the equipment accompanying these terms and conditions and (ii) the software included in such equipment or otherwise furnished to you in connection with your purchase and/or use of such equipment (the "Software"). This Agreement covers Products for use only in the United States and Canada.

#### 1 Software License.

- (a) License Grant. Subject to the terms and conditions contained herein, 3Com grants you a personal, non-transferable and non-exclusive license to use the Software, in object code form only, for your internal business needs on a single Product in accordance with the accompanying system documentation (the "Documentation"). This license grant shall be limited to use with the equipment for which the Software was obtained, or, on a temporary basis, on back-up equipment when the original equipment is inoperable. Use of the Software on multiple processors is prohibited unless otherwise agreed to in writing by 3Com.
- (b) Restrictions. Except as expressly authorized by this Agreement or under applicable law, you are not permitted to copy or use the Software in any manner. Without limiting the generality of the foregoing, you agree that you will not do any of the following: (i) decompile, reverse engineer, disassemble, or otherwise reduce the Software to a human-perceivable form; (ii) transfer the Software from one computer to another, including other servers and/or other storage devices; (iii) transfer the Software to any other party, except when transferring it with the Product in accordance with the terms of this Agreement; or (iv) modify, adapt, translate, rent, sublicense, lease, loan, resell for profit, distribute, network or create derivative works based upon the Software or any part thereof.
- (c) Ownership of Software. Title to and ownership of the Software shall remain with 3Com and its suppliers. This license is not a sale of the Software or any copy.
- (d) Third-Party Applications. Any third party supplier of computer programs included in the Software is a third party beneficiary of the provisions of this Section 1, and such third party may protect its rights in the Software against violations of this license.
- (e) Confidentiality. You agree to maintain the Software in confidence and to not disclose the Software to

any third party without the express written consent of 3Com. You further agree to take all reasonable precautions to preclude access of unauthorized persons to the Software.

(f) **Termination.** 3Com may terminate this Section 1 and the licenses granted hereby upon the breach by you of any the provisions of this Section 1. Upon such termination, you agree to return the Product, including the Software and all copies and portions thereof, to 3Com.

- 2 **Limited Warranty.** If the Product does not operate in accordance with 3Com's standard specifications or Documentation during the Warranty Period, you must promptly notify the authorized 3Com dealer from whom you purchased the Product. You must provide your authorized 3Com dealer with proof of purchase price and dated invoice. During the Warranty Period, upon being contacted, your authorized 3Com dealer (or another authorized 3Com dealer designated by 3Com) will, at its option, either repair or replace the Product, provided it is delivered at your expense to an authorized 3Com service facility designated by 3Com or your authorized 3Com dealer. Your authorized 3Com dealer (or another authorized 3Com dealer designated by 3Com) will provide you with a replacement Product if either the NCP (Network Call Processor) Card fails and/or if 25% of the system (lines and/or stations) becomes inoperable at any time during the Warranty Period. You have the right, as your exclusive remedy, to return the Product to your authorized 3Com dealer (or another authorized 3Com dealer designated by 3Com) for a refund of the purchase price from such authorized 3Com dealer if such authorized 3Com dealer is unable to repair or replace the Product pursuant to the terms of this warranty. You shall bear all shipping, packing, and insurance costs and all other costs, excluding labor and parts, necessary to effectuate repair, replacement or refund under this warranty.

The "Warranty Period" shall commence on the date that the Product was purchased by the authorized 3Com dealer from whom you purchased the Product and shall expire on the second anniversary thereof. At the time of purchase, your authorized 3Com dealer will notify you in writing of the commencement date and the expiration date of the Warranty Period.

Purchased or replacement parts and products may be new, remanufactured or refurbished. Any removed parts and/or Products shall become the property of 3Com.

Coverage under this warranty program shall require the authorized 3Com dealer to contact the 3Com Customer Service Department to generate a Return Merchandise Authorization (RMA) Number for any Product(s) the 3Com Service Representative deems defective.

- 3 **Warranty Exclusions.** EXCEPT AS STATED IN SECTION 2 HEREOF, 3Com AND ITS AFFILIATES, DISTRIBUTORS, DEALERS AND SUPPLIERS, MAKE NO WARRANTIES, EXPRESS OR IMPLIED, AND TO THE EXTENT PERMITTED BY APPLICABLE LAW, 3Com DISCLAIMS ALL OTHER WARRANTIES WHETHER EXPRESS OR IMPLIED, INCLUDING ANY IMPLIED WARRANTIES OF MERCHANTABILITY, TITLE, FITNESS FOR A PARTICULAR PURPOSE AND NON-INFRINGEMENT. IF IMPLIED WARRANTIES MAY NOT BE DISCLAIMED UNDER APPLICABLE LAW, THEN ANY IMPLIED WARRANTIES ARE LIMITED IN DURATION TO 90 (NINETY) DAYS AFTER DELIVERY OF THE PRODUCT TO YOU. SOME STATES DO NOT ALLOW LIMITATIONS ON HOW LONG AN IMPLIED WARRANTY LASTS SO THE ABOVE LIMITATION MAY NOT APPLY TO YOU. THIS WARRANTY GIVES YOU SPECIFIC LEGAL RIGHTS, AND YOU MAY HAVE OTHER RIGHTS WHICH VARY FROM STATE TO STATE.

THE WARRANTY SET FORTH IN SECTION 2 HEREOF, DOES NOT EXTEND TO ANY PRODUCT, WHICH HAS BEEN DAMAGED AS A RESULT OF (1) ACCIDENT, MISUSE OR ABUSE; (2) YOUR FAILURE TO FOLLOW 3Com'S INSTALLATION, OPERATION OR MAINTENANCE INSTRUCTIONS; OR (3) UNAUTHORIZED SERVICE OR PARTS.

- 4 **Post-Warranty Service.** 3Com highly recommends purchasing an extended warranty for all 3Com Products to significantly reduce unexpected repair costs after the Warranty Period. You can purchase a post-warranty service contract from your authorized 3Com dealer. Please contact your authorized 3Com dealer for post-warranty service on all 3Com Products.
- 5 **Infringement.** 3Com shall defend you, at 3Com's expense, from and against any claim brought by a third party alleging that the Product infringes any: (i) United States patent issued on or before the commencement date of the Warranty Period; (ii) United States trademark issued on or before the commencement date of the Warranty Period; (iii) copyright, or (iv) trade secret, and shall indemnify you against all damages and costs assessed against you that are payable as part of a final judgment or settlement. The indemnification obligation of this Section 5 shall not apply to any claim arising out of (i) the combination of the Product with other products not claimed to be owned or developed by or on behalf of 3Com; (ii) the modification of the Product, or any part thereof, unless such modification was made by or on behalf of 3Com; (iii) any software or other technology not claimed to be owned by 3Com; or (iv) any infringement caused by your action.

If you seek indemnification pursuant to this Section 5 from or against the assertion of any claim by a third person (a "Third Person Assertion"), you shall give prompt notice to 3Com. Within twenty (20) business days of receipt of notice from you pursuant to this Section 5, 3Com shall have the right exercisable by written notice to you, to assume the defense of a Third Person Assertion. If 3Com assumes such defense, 3Com may select counsel. If 3Com controls the defense of a Third Person Assertion, 3Com shall have the right to consent to the entry of judgment with respect to, or otherwise settle, such Third Person Assertion with your prior written consent, which consent shall not be unreasonably withheld. You shall reasonably cooperate in the defense of any Third Person Assertion.

- 6 **Exclusive Remedies and Limitations of Liability.** THE ENTIRE LIABILITY OF 3Com AND ITS AFFILIATES, DISTRIBUTORS, DEALERS AND SUPPLIERS (AND THE DIRECTORS, OFFICERS, EMPLOYEES, AGENTS AND AFFILIATES OF ALL OF THEM) AND YOUR EXCLUSIVE REMEDIES FOR ANY DAMAGES SHALL BE (1) FOR FAILURE OF PRODUCTS DURING THE WARRANTY PERIOD, THE REMEDIES STATED IN SECTION 2 HEREOF; (2) FOR INFRINGEMENT, THE REMEDIES STATED IN SECTION 5 HEREOF; AND (3) FOR CLAIMS OTHER THAN SET FORTH ABOVE, 3Com LIABILITY SHALL BE LIMITED TO PROVEN DIRECT DAMAGES IN AN AMOUNT NOT TO EXCEED THE ORIGINAL DISCOUNTED PURCHASE PRICE OF THE PRODUCT.

3Com SHALL IN NO EVENT BE LIABLE FOR THE FOLLOWING TYPES OF DAMAGES: (1) INCIDENTAL DAMAGES; (2) SPECIAL OR CONSEQUENTIAL DAMAGES; (3) LOST PROFITS, SAVINGS OR REVENUES OF ANY KIND, INCLUDING WITHOUT LIMITATION LOSS OF DATA, MESSAGES, OR TELEPHONE CALLS; AND (4) CHARGES FOR COMMON CARRIER TELECOMMUNICATIONS SERVICES OR FACILITIES ACCESSED THROUGH OR CONNECTED TO PRODUCTS. TO THE EXTENT PERMITTED BY LAW, SUCH DAMAGES ARE HEREBY EXCLUDED BOTH FOR PROPERTY DAMAGE, AND TO THE EXTENT NOT UNCONSCIONABLE, FOR PERSONAL INJURY DAMAGE.

THE FOREGOING LIMITATIONS OF LIABILITY SHALL APPLY REGARDLESS OF THE CAUSE OF ACTION UNDER WHICH SUCH DAMAGES ARE SOUGHT.

SOME STATES DO NOT ALLOW THE EXCLUSION OR LIMITATION OF INCIDENTAL OR CONSEQUENTIAL DAMAGES, SO THE ABOVE LIMITATION OR EXCLUSION MAY NOT APPLY TO YOU.

- 7 **Third-Party Products.** The decision to acquire hardware, software (in any form), supplies or service (other than the Product accompanying this Agreement) from parties other than 3Com ("Third Party Products") is yours, even if 3Com helps you identify, evaluate or select them. EXCEPT AS SPECIFICALLY AGREED TO IN WRITING, 3Com IS NOT RESPONSIBLE FOR, AND EXPRESSLY DISCLAIMS LIABILITY FOR, PERFORMANCE OR QUALITY OF THIRD PARTY PRODUCTS OR THEIR SUPPLIERS; any claim that you have in connection with the Third Party Products and any remedies for such claim will be against the supplier of such Third Party Products.
- 8 **Assignment.** You may not assign this Agreement (including the licenses granted hereby), either in whole or in part, whether by operation of law or otherwise, without the prior written consent of 3Com. Any attempt to assign your rights, duties or obligations under this Agreement without such consent shall be null and void. Subject to the foregoing, the rights and liabilities of the parties under this Agreement will bind and inure to the benefit of the parties' respective successors and permitted assigns.
- 9 **General.** You acknowledge that you have read this Agreement, understand it, and that by using the Product you agree to be bound by the terms and conditions of this Agreement. You assume full responsibility for the use of the Software and agree to use the Software legally and responsibly. This Agreement shall be governed by the substantive laws of the State of California, without regard to conflicts of law principles, except as to copyright matters, which are governed, by federal law. This Agreement is deemed entered into, by both parties, in Santa Clara, California. In the event that any provision of this Agreement shall be held by a court or other tribunal of competent jurisdiction to be unenforceable, such provision shall be enforced to the maximum extent permissible and the remaining provisions of this Agreement shall remain in full force and effect. All rights in the Software not specifically granted in this Agreement are reserved by 3Com, and, except for the express licenses granted herein, no other licenses are granted by 3Com by implication, estoppel or otherwise. You agree not to export the Product, without the express written consent of 3Com.

Should you have any questions concerning this Agreement, you may contact 3Com at the address set forth below.

## **3Com Corporation**

5400 Bayfront Plaza  
P.O. Box 58145  
Santa Clara, California, USA  
95052-8145

## **North America:**

Tel: 800-NET-3Com

## **Outside North America:**

[www.3com.com](http://www.3com.com)