

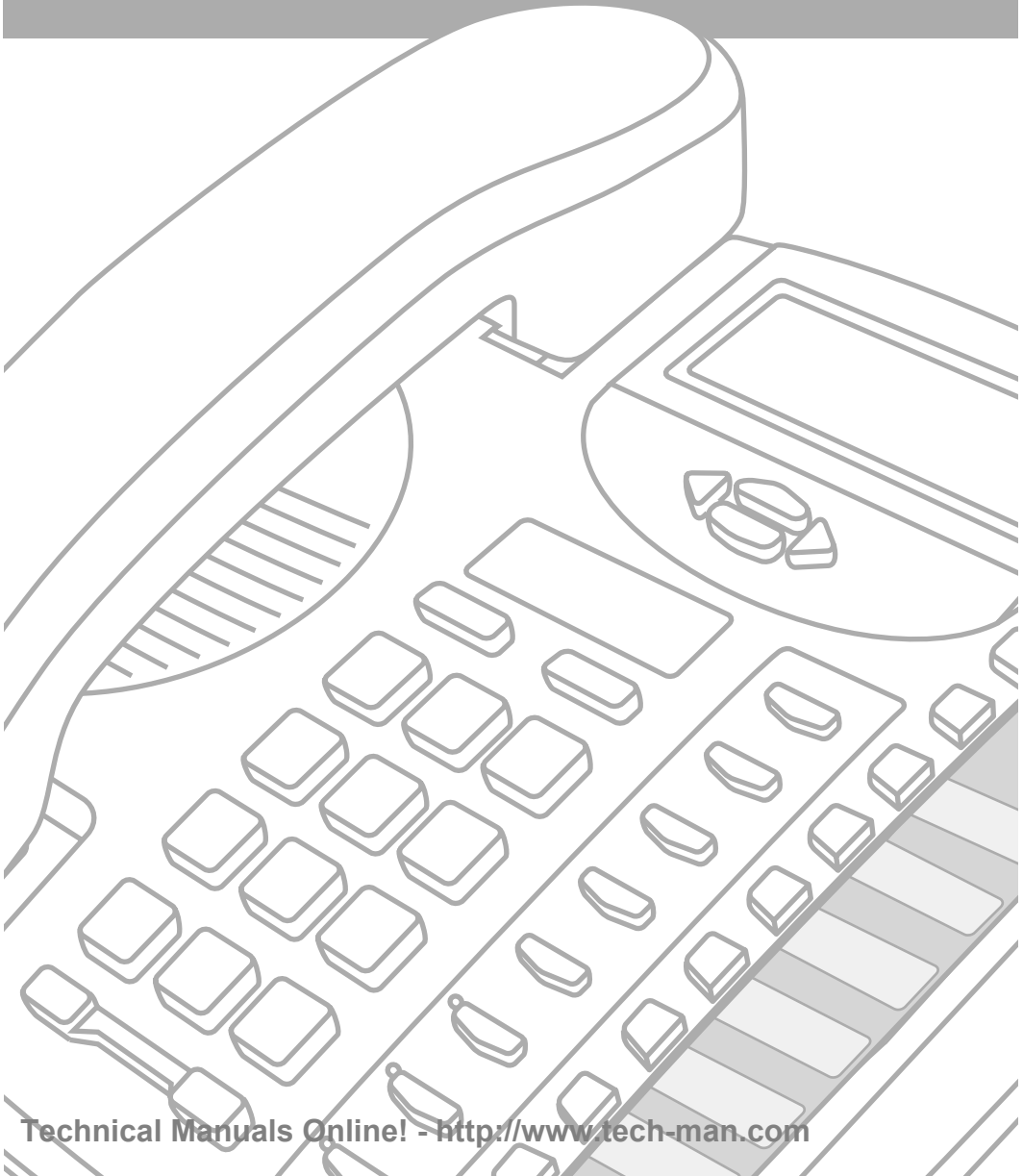

**ASTRA**

# 9120 USER GUIDE



# Table of Contents

<b>Introduction .....</b>	<b>1</b>
Emergency service Feature .....	1
Unpacking your phone .....	1
Key Descriptions .....	2
<b>Basic Installation.....</b>	<b>4</b>
Pre-installation information for the 9120 telephone.....	4
Special information.....	5
<b>Making and Answering Calls .....</b>	<b>8</b>
Making a call .....	8
Answering a Call .....	8
Using the Hold Key.....	8
Switching between two lines .....	9
Using the Conference key .....	9
Extension in Use .....	9
Making a Handsfree call.....	9
Muting a Handsfree call .....	10
Using the Redial List .....	10
Call Waiting ID.....	11
Turning the display of Call Waiting ID on or off.....	12
Changing the display language .....	12
Setting the date and time .....	13
Turning the ringer on and off .....	13
Setting the ring tone and ringer volume .....	13
Changing the Prime Line.....	14
Clear Message Lamp .....	14
<b>Directory .....</b>	<b>15</b>
Directory names .....	15
Saving numbers and names to the Directory .....	15
Saving an active call into the Directory .....	16
Saving a memory key entry to the Directory .....	16
Entering Names .....	16
Making a call from the Directory.....	16
Finding items in the Directory.....	17
Editing in the Directory .....	17
Deleting items from the Directory.....	17
<b>Callers List.....</b>	<b>18</b>
Using the Callers List .....	18
Setting up the Callers List .....	18
Finding an item in the Callers List.....	19
Making a call from the Callers List .....	19
Editing in the Callers List.....	19
Saving Callers List numbers to the Directory or a Memory key .....	20
Deleting from the Callers List .....	20
<b>Memory keys .....</b>	<b>21</b>
Saving numbers and names into memory keys .....	21
Saving from the display into memory keys.....	21
Saving an active call into a memory key .....	22

# Table of Contents

Saving numbers and names into shift memory keys .....	22
Labeling the memory keys .....	22
Making calls from memory keys .....	23
Editing memory keys .....	23
Deleting memory keys .....	23
Saving features in memory keys .....	23
Using feature keys .....	24
Saving a feature and light in memory keys .....	24
Using Feature Light keys .....	25
<b>Advanced Options .....</b>	<b>26</b>
Turning the Call timer on or off .....	26
Selecting the dial pad mode .....	26
Entering area codes .....	26
The Secure Numbers Feature .....	27
Using a headset with your telephone .....	28
Extension in use .....	28
<b>Display Icons and Messages .....</b>	<b>29</b>
The Callers List screen .....	29
Knowing when you have a message .....	29
Icon in the Callers List .....	29
General display messages .....	30
Callers List display messages .....	31
Learning about the lights .....	31
Set indicator light messages .....	32
Line and Handsfree indicator light messages .....	32
Viewing multiple display and light messages .....	32
<b>Troubleshooting .....</b>	<b>33</b>

## Introduction

**Congratulations.....** on the purchase of your 9120 telephone.

This guide contains information on the 9120.

The 9120 is an advanced two-line telephone, that offers the following features:

- Handsfree (speakerphone) with mute capabilities
- Headset compatible
- 100 name and number Callers List
- Personal Directory for 100 name and number directory
- 14 speed dial positions for frequently called numbers or feature access codes
- Last number redial



### Emergency Service Feature

The Model 9120 will provide basic telephone service during a power failure. However, only the dial pad, ringer and handset will function. If on a handset call when a power failure occurs, the Model 9120 will keep the call. Handsfree calls will not be re-established during a power interruption.

### Unpacking your phone

Along with this user guide the following items are included with your telephone.

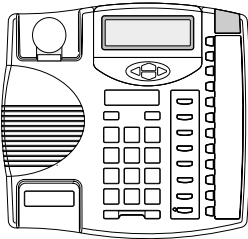

Telephone

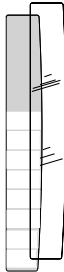

Memory key card  
and plastic lens



Handset

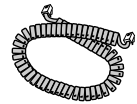

Handset cord



Number card  
and plastic lens



Power adaptor

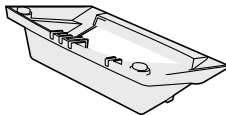

Telephone stand

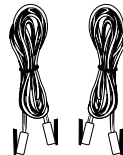

Telephone line cord









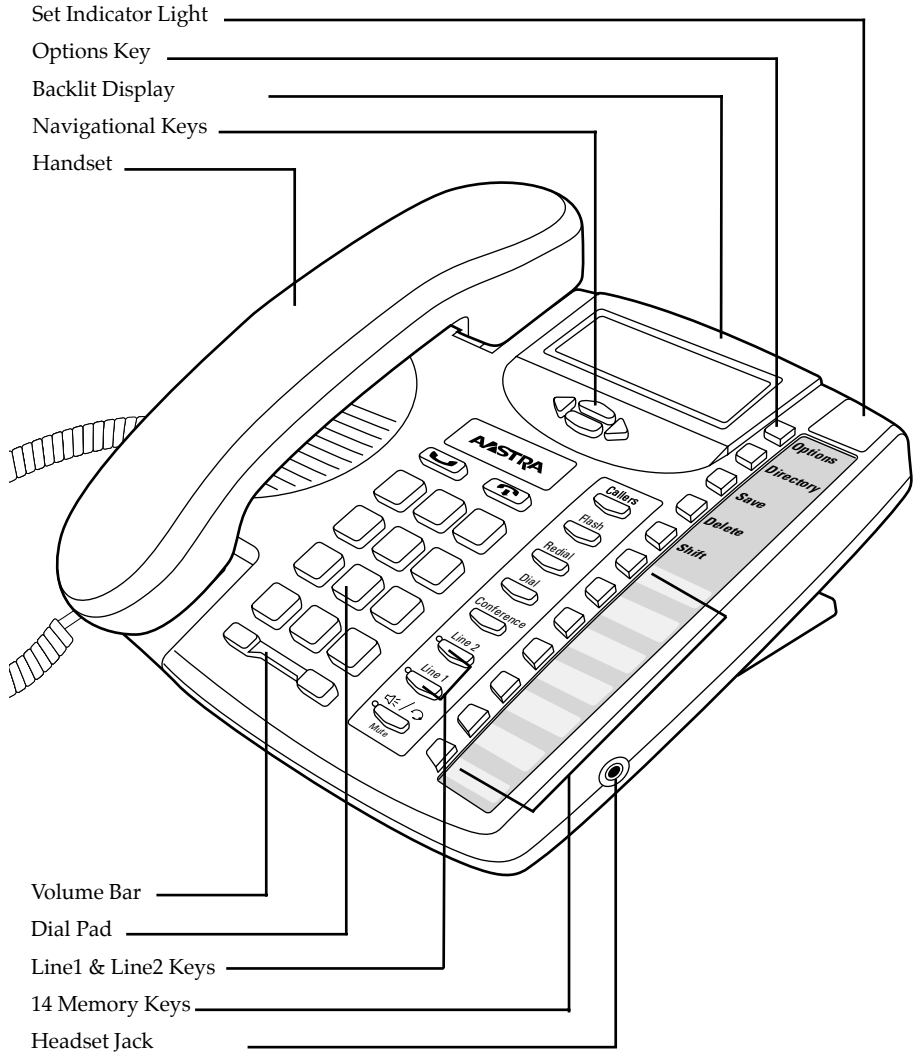













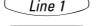
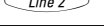
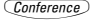

Regulatory sheet

The power adaptor is 16 VAC, 250mA - please see the regulatory sheet for safety instructions regarding the power adaptor and operation of the telephone.

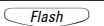
## Key Descriptions

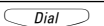
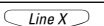

Keys	Key Description
Set Indicator Light	Flashes when the telephone rings, or when a call is on hold; lights up when a message is waiting or when a feature or extension is in use. See <b>Set indicator light messages</b> on page 31 for more information.
14 Programmable Keys	Stores a name and number or feature for easy access.
Internal Headset Jack	Allows you to plug a headset with a standard 2.5mm jack. See <b>Using a headset with your telephone</b> on page 28.

Keys	Key Description
	Access a list of 11 basic options to customize the features of your telephone.
	Stores up to 100 names and phone numbers (stored in alphabetical order). See <b>Directory</b> on page 15 for more information.
	Use to store numbers and names in Directory, in memory keys and to save Option feature settings.
	Removes individual entries in the Directory, or Callers List. Erases memory key information.
	Use to access the seven two-touch memory positions.
	  allows you to move up or down in the Directory, Callers List, Options List and the Redial List. When you are editing entries on the display,  allows you to backspace and erase characters and  allows you to view multiple messages on the telephone display or adds a space between characters.
	Ends an active call. Goodbye exits an open list, such as the Directory Options or Callers List. It will not hang up a call that is on hold.
	Places calls on or off hold. See <b>Using the Hold Key</b> on page 8 for more information.
	Sets the ringer volume when the telephone is idle; sets the handset and speaker volume while on call. See <b>Setting the ring tone and ringer volume</b> on page 13 for more information.
	Activates the speaker and microphone so you can listen and talk without using the handset; also mutes the microphone so that your caller cannot hear you (the light indicator will flash when the microphone is muted) .
 	Select either line key to answer ringing calls (line indicator light will flash for ringing calls). Press either line key to place outgoing calls.
	Joins the calls on the two lines together. See <b>Using the Conference key</b> on page 9 for more information.
	Access a list of the last 100 calls received. The list begins with the newest call and ends with the oldest. The oldest call is automatically deleted to make room for the new calls when the list becomes full. See <b>Callers List</b> on page 18 for more information
	Use with the network features such as Call Waiting and Three Way Calling (flash is also referred to as link).
	Displays the last ten phone numbers dialed out on the telephone. See <b>Using the Redial List</b> on page 10 for more information.
	Dials the displayed telephone number, automatically activates the handsfree mode if the handset is not picked up.
	To indicate  or  in this user guide.
	Memory keys store numbers, names and features. See <b>Memory keys</b> on page 21.

# Basic Installation

## Pre-installation information for the 9120 telephone

The 9120 telephone is a two-line telephone. Before you begin installing it, you need to know how the telephone lines are connected to the phone jacks at your home or office.

When two telephone lines are installed on the same phone jack, one telephone cord is required to connect both lines to your 9120 telephone.

When two telephone lines are installed on separate phone jacks, two telephone cords are required to connect both lines to your 9120 telephone. A second telephone cord will be required to connect both lines to your 9120 telephone.

If you want to combine two telephone lines onto one phone jack, contact your telephone company.

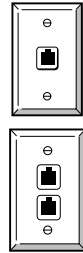

### 1. Connect the Handset

Attach one end of the coiled handset cord to the handset and the other end to the handset port  on the back of the telephone.

Route the handset cord along the groove leading off the side of the telephone as shown in the illustration.

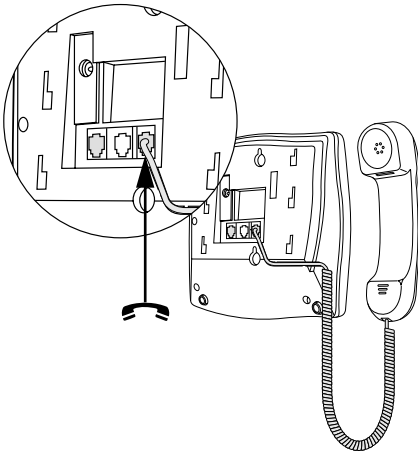

### 2. Connect the Cords

Plug one end of the telephone cord into 1  on the back of the telephone and the other end to the phone jack.

Connect the small end of the power adaptor to the  port on the back of the telephone, and plug the other end into an electrical outlet.

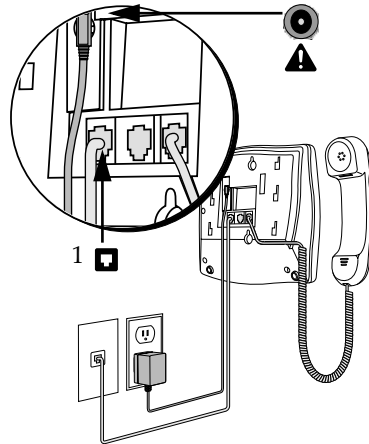

### 3. Attach the Stand for Desk Mount

If you plan to mount the telephone on the wall, you do not need to attach the stand.

Lower the stand as shown below into the slots on the back of the telephone.

Slide the stand in the direction shown below until it clicks into the locked position.

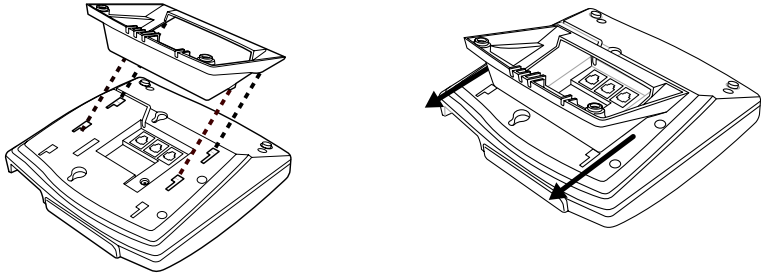

### Special information

You must confirm if the two telephone lines are installed on the same phone jack, or on two separate phone jacks.

Read your 9120 telephone display. If it prompts you to select a language, follow the directions on the telephone display to choose your language of choice.

When both lines are installed on the same phone jack, the telephone display shows the time and date.

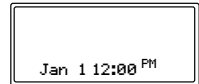

When only one line is installed on a phone jack, the telephone display shows a **Check line cord** message.

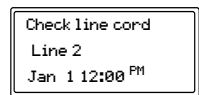



#### 4. Connect the second telephone cord

You must use the second telephone cord that was provided with your 9120 telephone to complete installation step 4.

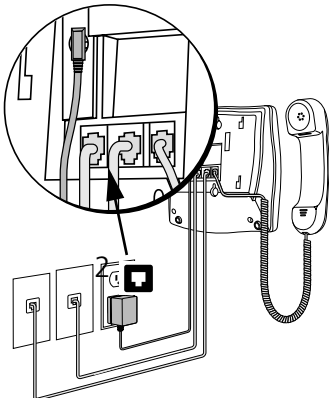
Plug one end of the telephone cord into 2  on the back of the telephone and the other end to the phone jack.



#### 5. Connect optional equipment to the telephone

Both telephone lines on the 9120 telephone must be connected to 1  on the back of the telephone to connect a fax or modem peripheral. Plug one end of the telephone cord into 2  on the back of the telephone and the other end to a fax machine or modem.

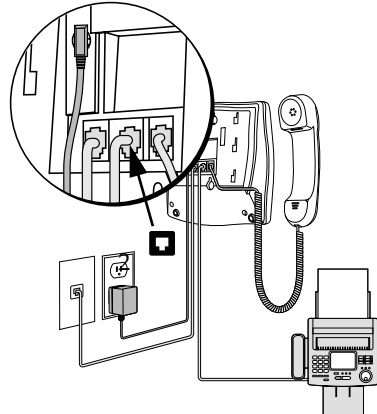



**6. Attach the cords to the telephone stand**

Route the cords along the groove on the telephone stand as shown in the illustration.

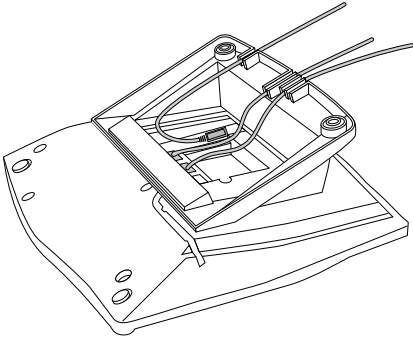

**7. Mount the telephone on the wall**

It is recommended that you use a wall-mounting plate which is available through your telephone company or a local retailer. You will find it easier to wall-mount the telephone if you purchase one or two short 20 cm (8") telephone cords and use them in place of the long telephone cord(s).

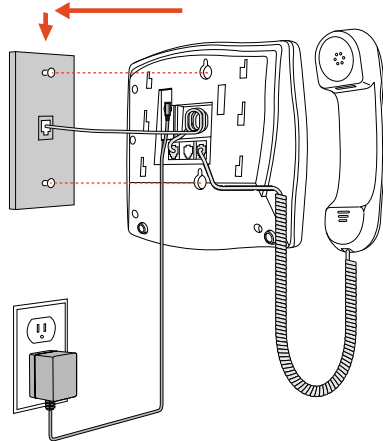

Coil the telephone cord(s) into the space provided on the back of the telephone. Line up the keys on the wall mounting plate with the key holes on the back of the telephone. Place the telephone onto the wall mounting plate, and then push down to secure the telephone into place.

**8. Insert the number card on your telephone**

Write your telephone number on the number card.

Place the number card into the slot underneath the handset cradle on the on the telephone.

Gently bend the clear plastic lens and place it on top of the number card in the slot.

**9. Insert the Memory key card on your telephone**

This card contains the feature names for the dedicated keys and label identification spaces for the eight programmable memory keys.

Place the card into the memory key card slot on the telephone.

Gently bend the clear plastic lens and place it on top of the memory key card in the slot.

For more information on programming memory keys, refer to **Memory keys** on page 21

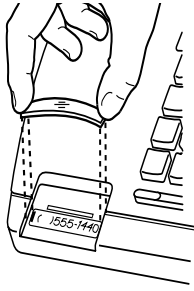

To avoid potential electrical shock hazard to personnel or damage to the telephone, use **only** the manufacturer-supplied equipment and installation procedures. Specifically, use only 4 conductor modular teledapt plug/cords with this product, and an AC transformer that is CSA/UL or CSA-NRTL/C approved Class 2 level C, rated as follows:

**For North American Markets AC voltage 110-120V**, Input: 120VAC, 60Hz, 10W and Output: 16V AC, 250mA.



Substitution of non-approved equipment will void the Aastra Telecom Inc., warranty. For more information about installation and safety concerns, call 1-800-574-1611.

# Making and Answering Calls



## Making a call

With your telephone you can make and answer calls using your handset or  for speakerphone capabilities. A headset attachment can also be used with your telephone, refer to page 28. You can use the 9120 to simply make a regular call, or you can predial a telephone number to ensure it is correct before it is dialed out. Follow the procedures below to make a regular or predialed call.



### To make a regular call:

1. Lift the handset or press either  or .
2. Enter the number using the dial pad.

### To make a predialed call:

1. Enter the number using the dial pad.
2. Lift the handset or press either ,  or .

**Note:** If you have turned on the live dial pad option, you will not have to lift the handset or press any buttons after entering the number. Refer to **Selecting the dial pad mode** on page 26.

When you use ,  or lift the handset rather than using a line key to make a call, the prime line is automatically selected. The default prime line is Line 1. If you want to change the prime line to Line 2, see **Changing the Prime Line** on page 14.

## Answering a Call

### To answer a call:





1. Lift the handset, press  or press the key for the line you want to answer.

When you subscribe to the Caller ID service from your telephone company, Caller ID information is sent from the telephone company to your 9120 telephone between the first and second ring. Therefore, if you want the telephone number of the incoming call to appear on the display and in the Callers List, you must wait until the information appears on the display before answering the telephone.

If you lift the handset or press  when both lines are ringing, the line that was ringing first is automatically answered.

## Using the Hold Key

### To put a call on hold and take a call off hold:

1. Make or answer a call.
2. Press . **Line 1 held** or **Line 2 held** appears on the display and the line indicator light flashes.  
**Note:** You won't lose the call if you hang up the handset.
3. To retrieve the call, press ,  or . If you don't retrieve the call within 15 minutes, the call is automatically dropped.

**Note:** The 9120 automatically releases a call on hold when a person on an extension telephone on the same line picks up the call. If you don't hang up the handset after you have put a call on hold and that call is picked up by someone at

another extension, the call is taken off hold but remains connected to your telephone. If this happens, any background noise from your area will be heard by the caller and the person at the other extension.

### Switching between two lines

**To put a call on hold and make or answer a second call:**

1. Make or answer a call on one line.

---

2. To make or answer a second call on the other line, press the second line key. This automatically puts the original line on hold.

---

3. To hold one line automatically and speak on the other, press the line keys alternately.

---

4. To end a call which is not on hold, press  or hang up.

---

### Using the Conference key

**To join two calls in a Conference:**

1. Make or answer a call on one of the lines.

---

2. Press  to place the first call on hold.

---

3. Make or answer a call on the second line.

---

4. Once you have callers on both lines, press .

---

**Note:** You can speak privately with one particular caller by pressing that caller’s line key. This automatically puts the other caller on hold. You can re-establish the conference by pressing .

### Extension in Use



When you are on a call and someone on an extension telephone picks up the handset, the set indicator light comes on if the person on the extension is using your line. The light remains on and the message **Extension in use** appears until the person at the other extension hangs up.

When another extension is using a line, the line indicator light for that line (located beside the line key) is illuminated. Line indicator lights let you know if a line is available for you to use. Also see **Extension in Use** on page 28.

### Making a Handsfree call

You don’t have to use the handset to use your telephone. Instead, you can use Handsfree mode to place a call, or you can switch to Handsfree mode while a call is in progress.

**To dial without picking up the handset:**

1. Press  or .

---

2. Enter the number using the dial pad.

---

3. When the call is over, press .

---

**To switch to a Handsfree call:**

1. Lift the handset.

---

2. Dial a number using the dial pad.

---

43. When the call is answered, press .

---

**To dial without picking up the handset:**







**To switch to a Handsfree call:**

4. Hang up the handset.
5. When the call is over, press  .





**Muting a Handsfree call**

You can turn off the microphone so that the caller can't hear you but you can still hear the caller. Muting a call only works when you are in Handsfree mode.



**To mute a handsfree call:**

1. Press  .
2. Without lifting the handset, make a call.
3. To turn off the microphone, press  . You can hear your caller but your caller cannot hear you. The light beside  flashes. The display shows **Microphone muted**.
4. To speak to your caller, press  again. Each time you press  , you turn the microphone on or off.
5. When the call is over, press  .

**To mute headset call:**







1. Press  .
2. Without lifting the handset, make a call.
3. To turn off the microphone, press  . You can hear your caller but your caller cannot hear you. The display shows **Microphone muted**.
4. To speak to your caller, press  again. Each time you press  , you turn the microphone on or off.
5. When the call is over, press  .

**Using the Redial List**

The Redial List stores the last ten numbers you dialed. When you press  the last number you called appears on the screen. If you are off hook and press  , the telephone will automatically dial the last number called.

You can scroll through the list to view the other numbers.

**To make a call from the Redial List:**

1. Press  . The display shows the last number you dialed.
2. Use  or  to scroll through the list to view the other numbers.
3. When the number is displayed, lift the handset or press either  ,  or  .

There may be times when you want to delete the contents of the Redial List. For example, if you have dialed a personal number such as a password or your calling card number, you may not want it to appear in the list where anyone can see it.

**To delete the Redial List:**

1. Press .

---



2. Press  twice. The entire Redial List is deleted.

**Note:** You cannot delete individual entries in the Redial List.

**Call Waiting ID<sup>†</sup>**

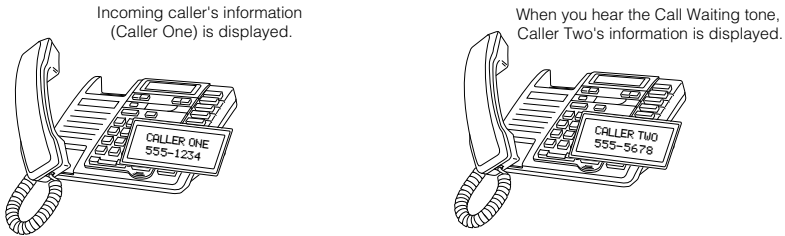
The 9120 is capable of displaying Caller ID information of a second incoming call while you have a call in progress. When you are on a call and you hear the Call Waiting tone, the Call Waiting information is displayed as shown below.



If you decide you want to speak to the new caller, simply press . Your first call will not be disconnected. You may switch between callers as often as you like by pressing . When you press  and see a caller's Identification information but only hear a dial tone, it means that the caller has hung up. Your second call will be stored in the Callers List even if it is not answered. For more information about stored calls, see **Callers List** on page 18.

**Note:** The Call Waiting ID display option must be enabled in order to see the Call Waiting ID information on the display.

<sup>†</sup> You must subscribe to your telephone company for the Call Waiting with Calling ID service.



## Turning the display of Call Waiting ID on or off

You can choose whether or not Call Waiting ID is displayed on your telephone for Line 1 and Line 2 .

### To turn Call Waiting on or off:

1. Press  *Options* .

---

2. Press  or use  or  to scroll to Setup Option 11.



---

3. Press  to enter Call Waiting ID.

---

4. Press  *Line X* .

---

5. Press  to turn the Call Waiting ID feature on or press  to turn the feature off.

---

6. Press  .

---

7. Repeat these steps for the other telephone line.

**Note:** Turning the display of Call Waiting ID on or off does not turn the feature itself on or off. When the Call Waiting display is turned off, you will still hear the Call Waiting tone when a Call Waiting call comes in, but the identification information for the Call Waiting caller will not appear on your display screen. Contact your local telephone company to subscribe or unsubscribe to Caller ID or Call Waiting ID services.



## Changing the display language

For changing business requirements, you may wish to change the language of your display messages and prompts. There are three language choices available for your telephone (English, French and Spanish).

### To change the display language:

1. Press  *Options* .

---

2. Press  or use  to scroll to Option 01.

---

3. Press  to enter Language choice.

---

4. Use  to scroll to the desired language.

---

5. Press  to select the displayed language.

---

6. Press  .



## Setting the date and time

If you subscribe to the Caller ID service from your telephone company, the date and time are set automatically after you receive your first incoming call. If you do not subscribe, you must set the date and time manually.

### To set the date and time:

1. Press  *Options* .

---

2. Press  or use  or  to scroll to Option 09.

---

3. Press  to enter the time / date.

---















4. Follow the instructions on the display.

---

5. Press  .

To resume the automatic date and time setting (if the date and time has been set manually), disconnect the power supply, then re-connect it. After your first incoming call, the date and time are automatically set if you subscribe to the Caller ID service from your telephone company.













### Turning the ringer on and off

To turn the ringer on:	To turn the ringer off:
1. Press    .	1. Press    .
2. Press  .	2. Press  .
3. Press the right side of    . Continue pressing the right hand side until you reach the desired ring volume.	3. Press the left side of    . Continue pressing the left hand side until the ringer is off.



**Note:** Do not lift the handset while you are turning the ringer on or off.

### Setting the ring tone and ringer volume



You can choose one of four different ring tones and set the ringer volume for each line.

To set the ring tone and volume:
1. Make sure that the ringer is turned on.
2. Press  .
3. Press  or use  or  To scroll to Option 04.
4. Press  to enter Select ring tone.
5. Select a  .
6. Press  and follow the instructions on the display. When picking the ring tone, press    to adjust the volume.
7. Press  to end only when you are satisfied with ring tone and ringer volume.
8. If required, repeat these instructions for the other line.
9. Press  .



### Controlling the ringer volume

While the telephone is ringing on one line, you can press the left or right side of the volume bar    to adjust the ringer volume for that line.

### Controlling the handset volume



While you are on the telephone, you can press the left or right side of the volume bar    to adjust the handset volume. The handset volume returns to normal after you have completed your call.

### Controlling the speaker volume

While you are listening through the speaker, you can press the left or right side of the volume bar    to adjust the speaker volume. The speaker volume remains at the volume you last selected until the next time you change it.





## Changing the Prime Line

The prime line is the line that is automatically selected when you lift the handset or press or  or . The default setting for prime line is Line 1. You can select either line as your prime line.



### To change the prime line:

1. Press  *Options* .

---

2. Press  or use  or  to scroll to option 10.

---

3. Press  to change the prime line. Pressing  allows you to toggle between the two lines.

---

4. Press  .

---



## Clear Message Lamp

There may be times when **Message Waiting** appears on the display when there are no more Voice Mail messages. You can turn the display message off using the Clear Message Waiting feature.

### To clear message waiting:

1. Press  *Options* .

---

2. Press  or use  or  to scroll to Option 02.

---

3. Press  to enter Clear msg. lamp.

---

4. Select  .

---

5. If required, repeat these instructions for the other line.

---

**Note:** This only applies when you subscribe to Voice Mail services from your telephone company.



## Directory

The 9120 telephone directory can store the names and telephone numbers of your business associates, clients, contacts, friends and relatives.

### Directory names

There is a maximum of 100 entries in your Directory. Names are sorted alphabetically starting with their first character. If you want your Directory sorted by the last name, enter the last name first. If you do not enter a name, the Directory record is sorted by telephone number. The Directory records with only a telephone number are numerically sorted at the beginning of the Directory.

### Saving numbers and names to the Directory

To save a new number and name:	To save from the display:
1. Press <input type="checkbox"/> Save .	1. Ensure that a number is on the display.(For example, access the Redial List or the Callers List).
2. Press <input type="checkbox"/> Directory .	2. Press <input type="checkbox"/> Save .
3. Enter the number using the dial pad. You can enter a maximum of 24 digits. <b>Note:</b> If you require a pause (for example, between a telephone number and an access code), press  where you want the pause.	3. Press <input type="checkbox"/> Directory . If the name is displayed with the number, both are now saved in the Directory.
4. Press <input type="checkbox"/> Save . Only the number is stored at this point.	4. If no name is displayed, you are prompted to enter one. If you do not want a name, go to step 5. To enter a name, use the dial pad. (See <b>Entering Names</b> on page 16.)
5. Use the dialpad to enter a name. (See <b>Entering Names</b> on page 16.)	5. Press <input type="checkbox"/> Save .
6. Press <input type="checkbox"/> Save .	
7. Press  .	

## Saving an active call into the Directory

### To save an active call:

1. Answer or make a call.

---

2. Press  Save .

---

3. Press  Directory . If the name was displayed with the number, both are now saved in the Directory.

---

4. If no name is displayed, you are prompted to enter one. If you do not want to enter a name, go to step 5. To enter a name, use the dial pad.

---

5. Press  Save .

---

6. Press   .

---

## Saving a memory key entry to the Directory

### To save a memory key entry into the Directory:

1. Press the desired memory key. Ensure the live dial pad option is turned off.

---

2. Press  Save .



---

3. Press  Directory . If the name was displayed with the number, both are now saved in the Directory. If no name was displayed, only the number is saved to the directory.

---

## Entering Names

You can program names to correspond with numbers you have entered into the Directory or a memory key. The following paragraphs explain how to enter letters using the dial pad. Before you can use the dial pad to enter names, you must first save or edit a number in the Directory or memory key.

To program a name, find the dial pad key that has the first character of the name. Keep watching the display as you press the key until that character appears on the display. Press a different dial pad key for the next character. If the next character is on the same key, press  to move to the next space or wait a few seconds and it will automatically advance to the next space. To insert a space, press . To backspace and erase a mistake, press  and  Delete . For example, to enter the name RUTH press these keys:

7 7 7, 8 8, , 8, 4 4.

If you wish to change a digit or letter after you have entered it, press  to erase it .



<input type="checkbox"/> 1	, - . 1	<input type="checkbox"/> 2	A B C 2	<input type="checkbox"/> 3	D E F 3
<input type="checkbox"/> 4	G H I 4	<input type="checkbox"/> 5	J K L 5	<input type="checkbox"/> 6	M N O 6
<input type="checkbox"/> 7	P Q R S 7	<input type="checkbox"/> 8	T U V 8	<input type="checkbox"/> 9	W X Y Z
<input type="checkbox"/> *	*	<input type="checkbox"/> 0	0	<input type="checkbox"/> #	#

## Making a call from the Directory

### To make a call from the Directory:

1. Press  Directory .

---

2. Press  or  or use the dial pad to find the item you want to dial out.

---

3. Lift the handset or press either   Mute ,  Dial or  Line X .

---





4. To end the call, press   or hang up.

---

Note: To leave the Directory at any time, press  Directory or  .











## Finding items in the Directory

### To find items in the Directory:

1. To see the Directory List heading, press  *Directory* .
2. Use the  and  to look at each individual directory entry one at a time.
3. To leave the Directory at any time, press  *Directory* or  .







## Editing in the Directory

### To edit a number and/or name in the Directory:





1. Press  *Directory* .
2. Press  or  to find the item you want to edit.
3. To begin editing, press  .
4. If you do not want to change the number, go to step 5. To backspace and erase digits, press  . To add digits, use the dial pad.
5. Press  *Save* .
6. If you do not want to change the name, go to step 7. To change or add to the name, use  and the dial pad. (See **Entering Names** on page 16.)  
 Note: If you edit the wrong item or want to quit without saving changes, press  *Directory* or  .
7. Press  *Save* .
8. Press  .

## Deleting items from the Directory

### To delete individual items:

1. Press  *Directory* .
2. Press   to find the item you want to delete.
3. Press  *Delete* twice. You are still in the Directory.
4. Press  or  *Directory* to exit the Directory at any time.

### To delete all items:

1. Press  *Directory* .
2. Press  *Delete* .
3. Press  *Delete* again to confirm deletion of the entire Directory.
4. Press  .

## Callers List<sup>†</sup>

### Using the Callers List

The 9120 telephone stores up to 100 calls in the Callers List. Your telephone logs the number (and name if available) of the caller, when they last called, and the number of times they tried to reach you. When the Callers List is full, the oldest call records are deleted to accommodate the information of new callers. See **Callers List display messages** on page 31 for a description of the display messages.

If the telephone number of the incoming call matches a number that you have programmed with a name in a memory key or the Directory, the Callers List shows the name you have saved in the memory key or Directory, and the number.

You can choose to record all of your incoming calls, only unanswered calls, or no calls in the Callers List. Setting the Callers List to record no calls turns the Callers List off.



### Setting up the Callers List

The Callers List records up to 100 incoming calls. You can program the telephone to record unanswered calls, all incoming calls, or no calls.

#### To set up the Callers List:

1. Press  Options .

---

2. Press  or use  or  to scroll to Option 08.

---

3. Press  to enter the Callers log.



---

4. Press .

---

5. Press  to view the Unanswered, All calls, or No calls options.

---

6. There is a ✓ beside the option that is currently selected. To change to a different option, press  until you see the option you want to select. Press  to select this option.

---

7. Repeat these steps for the other telephone line.

---









8. Press .

The Callers List is split by line, to allow you to view the Callers List for each line separately. The Callers List for one line can exceed 50 calls, as long as the list for the other line has less than 50 calls. The total number of calls in the two Callers Lists cannot exceed 100.

<sup>†</sup> You must subscribe to your telephone company for the Caller ID service.







## Finding an item in the Callers List

### To find items in the Callers List:

1. To see the Callers List heading, press .
2. Press .
3. Press  to view other caller records one at a time starting from the second most recent caller. To view from the oldest caller record to the most recent press . The screen may display **END OF LIST** but continue to press  to see the oldest call record.
4. To leave the Callers List at any time, press  or . Note: If you're on a call while viewing the Callers List, pressing  will not drop the call.

## Making a call from the Callers List







### To dial a number in the Callers List:

1. Press . The display shows the most recent caller record.
2. Press .
3. Find the caller record you wish to dial to.
4. Lift the handset or press either , , or .
5. To end the call, press  or hang up.

If you call a number from the Callers List and you don't get connected, you may have to edit the number (for example, the number may be long distance and you may have to add "1").









## Editing in the Callers List

### To edit a number in the Callers List:

1. Press .
2. Press .
3. Find the item you want to edit.
4. Press any key on the dial pad to begin editing. This may be required if you have tried to dial the number and there is no connection.
5. To add digits, use the dial pad. To erase one digit to the right of the cursor, press . To erase one digit to the left of the cursor, press . **Caution:** The Callers List does not save changes. If you plan to call the number again, save it to the Directory or a memory key.
6. To dial the edited number, lift the handset or press either , , or .







To have the Callers List show local numbers without the area code and internal numbers as extensions, see **Entering area codes** on page 26.

### To dial back a long distance number in the Callers List:

1. Press .
2. Select a Line key. Use  or  to find the item you want to edit.
3. Using the dial pad, press  and the area code if necessary.
4. To dial the edited number, lift the handset or press either ,  or .
5. If you want to save the number to the directory, press .





### Saving Callers List numbers to the Directory or a Memory key

#### To copy a number from the Callers List to the Directory or to a memory key:



1. Press .
2. Press .
3. Find the item you want to copy.
4. Press .
5. Press  or the memory key where you want to store the number.
6. If no name is displayed, you are prompted to enter one. To enter a name, use the dial pad. (See **Entering Names** on page 16.) If you don't want a name, go to step 7.
7. Press .
8. To leave the Callers List at any time, press  or .

### Deleting from the Callers List

#### To delete a number in the Callers List:

1. Press .
2. Find the item you want to delete.
3. Press  twice.  
You are still in the Callers List.
4. To leave the Callers List at any time, press  or .

#### To delete all numbers in the Callers List:

1. Press .
2. Press .
3. Press  twice while the Callers header is showing to delete the entire list.

## Memory keys

### Saving numbers and names into memory keys

You can save up to 14 speed dial numbers and names of your customers, business associates, or anyone you call frequently in 9120's seven memory keys. You can store more numbers and names in the Directory. See the **Directory** on page 15 for more information.

#### To save or edit a number and name in a memory key:

1. For a one touch memory key, press any of the seven lower memory keys. The screen will show **EMPTY** or whatever name and number have already been programmed into the memory key. For a two touch memory key, press the  *Shift* (display will show **SHIFT**) and then one of the memory keys.

---

2. Press  *Save* . Display indicates **ENTER NUMBER**.

---

3. Enter the number using the dialpad. You can enter up to 16 digits. To add a pause to a number, press  . To add Flash to a number, press  *Flash* .

---

4. Press  *Save* . Display indicates **ENTER NAME**. If you do not wish to add a name for the Memory key, go to the next step. To add a name, use the dialpad. See page 14, **Entering Names**.

---

5. Press  *Save* . The display shows **SAVED: MEMORY KEY**.

Note: You can also program a memory key by copying a caller record in the Callers List. See page 16, **To copy from the Callers List**.

### Saving from the display into memory keys

#### To save from the display:

1. Ensure that a number is on the display. (For example, access the Redial List or Callers List.)

---

2. Press  *Save* .

---

3. Press the desired memory key. If the name was displayed with the number, both are now saved in the memory key and you're finished.

---

4. If no name is displayed, you are prompted to enter one. If you don't want a name, go to step 5. To enter a name, use the dial pad. (See **Entering Names** on page 16.)

---

5. Press  *Save* .

### Saving an active call into a memory key

#### To save an active call:

1. Answer or make a call.

---

2. Press  *Save* .

---

3. Press the desired memory key. If the name was displayed with the number, both are now saved in the memory key.

Note: Do not press  or else you will hang up on your caller.



## Saving numbers and names into shift memory keys

Use to access the seven memory position.

### To save a number and name to a shift memory key:

1. Press  Save .

---

2. Press the memory key, in this case press shift then the memory key .

---

3. Enter the number using the dial pad. You can enter a maximum of 24 digits.  
**Note:** If you require a pause (for example, between a telephone number and an access code), press  where you want the pause.

---

4. Press  Save .

---

5. To skip the name, go to step 6. To enter a name, use the dial pad.  
 (See **Entering Names** on page 16.)

---

6. Press  Save .

---

7. Label the memory key.

---

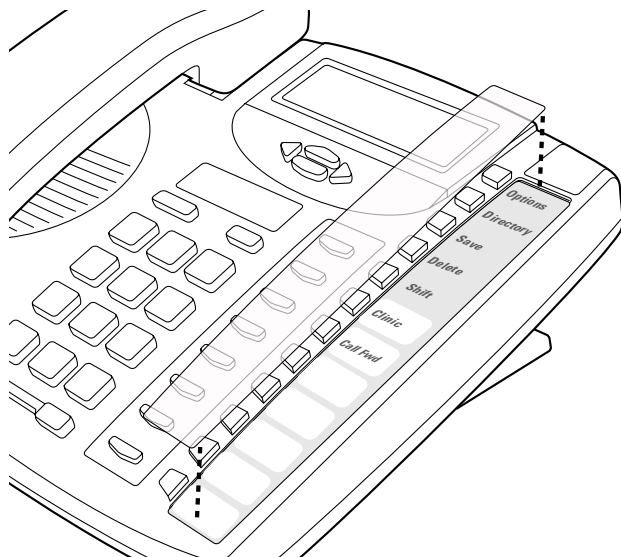

### Labeling the memory keys

Your Memory key card has label identification spaces (shaded in grey) for each of the seven programmable memory keys. Write the name of the person or feature on these spaces when you program a memory key.





## Making calls from memory keys

### To call from a memory key:

1. Lift the handset or press  or  or .
2. Press the memory key with the number you want to dial out.





### To predial from a memory key:

1. Press the memory key with the number you want to dial out.
2. Lift the handset or press either , , or .

**Note:** If the Live dial pad option is turned on, you do not have to lift the handset or press any other button. Pressing the memory key will automatically dial the number and put the telephone in Handsfree mode.

## Editing memory keys

### To edit a memory key:

1. To see its contents, press the memory key.
2. Press .
3. If you don't want to change the number, go to step 4. To backspace and erase digits, press . To add digits, use the dial pad.
4. Press .
5. If you don't want to change the name, go to step 6. To add letters, use the dial pad. (See **Entering Names** on page 16.) To erase letters, press .
6. Press .

**Note:** The Live dial pad option must be turned off to edit memory keys.

## Deleting memory keys

### To delete a memory key:

1. To see its contents, press the memory key.
2. To erase, press  twice.

**Note:** The Live dial pad option must be turned off to edit memory keys.

## Saving features in memory keys<sup>†</sup>

For easy access, you can save the feature codes of telephone company services in your memory keys. This works well with network features such as Call Forwarding and Call Return. Some features require an On and Off code in two separate keys, while other features are stored on only one key. The following procedures show you how to save both an On and Off code.

### To save a Feature On code:

1. Press .
2. Press the memory key where you want to save the number.

### To save a Feature Off code:

1. Press .
2. Press the memory key where you want to save the number.

<sup>†</sup> You must subscribe to your telephone company for Custom Calling Features.

**To save a Feature On code:**

3. Enter the telephone company feature code for turning the feature on.<sup>†</sup>

Read the display to confirm the number.

4. Press  Save .

5. Enter the feature name using the dial pad. (See **Entering Names** on page 16.)

6. Press  Save .

7. Label the memory key.

**To save a Feature Off code:**

3. Enter the telephone company feature code for turning the feature off.<sup>†</sup>

Read the display to confirm the number.

4. Press  Save .

5. Enter the feature name using the dial pad. (See **Entering Names** on page 16.)

6. Press  Save .

7. Label the memory key.

<sup>†</sup>Note: Contact your telephone company for the appropriate feature codes.

**Using feature keys**

When a memory key is programmed with a feature code, you can use the memory key to activate or deactivate the feature.

**To turn a feature on or off:**

1. Press the memory key where you stored the desired feature. The display shows the feature name and code.
2. Lift the handset or press either  ,  or  .  
The feature code is dialed out, which turns the feature on or off.

The active feature applies only to the line you selected or to the prime line if you did not press a line key. For example, if you want to forward all incoming calls, you must turn the feature on for each line.

**Note:** If the Live dial pad option is turned on, you do not have to lift the handset or press any other button. Pressing the memory key will automatically dial the feature code and put the telephone in Handsfree mode.

**Saving a feature and light in memory keys**

You can make the set indicator light come on when you turn a feature on and go off when you turn that same feature off. You can only do this with one feature, and the feature must have separate On and Off codes (such as Call Forwarding).

For example, you may want the light to remind you that you have turned Call Forwarding on. To do this, use one key to turn the indicator light on when you activate the feature. Use the second key to turn the indicator light off when you deactivate that same feature. The following procedure shows you how to program a FeatureLight On and Off key.

**To save a FeatureLight On key:**

1. Press  Save .
2. Do NOT select a memory key yet.  
To program the light on, press .
3. Press the desired memory key.

**To save a FeatureLight Off key:**

1. Press  Save .
2. Do NOT select a memory key yet.  
To program the light off, press .
3. Press the desired memory key.

**To save a FeatureLight On key:**

4. Enter the telephone company feature code for turning the feature on.<sup>†</sup>

---

Read the display to confirm the number.

5. Press  Save .

6. Label the memory key.
- 

**To save a FeatureLight Off key:**

4. Enter the telephone company feature code for turning the feature off.<sup>†</sup>

---



Read the display to confirm the number.

5. Press  Save .

6. Label the memory key.
- 

<sup>†</sup>Note: Contact your telephone company for the appropriate feature codes.

**Using Feature Light keys****To turn a feature and light on or off:**

1. Press the memory key where you stored the FeatureLight. The display shows **FeatureLight ON** or **FeatureLight OFF**.
  2. Lift the handset or press either ,  or . The feature and light turn on or off. (When the feature and light are on and you're not using the telephone, the display shows Feature ON and the line that it applies to as a reminder.)
- 

**Note:** If the Live dial pad option is turned on, you do not have to lift the handset or press any other button. Pressing the memory key will automatically dial the feature code and put the telephone in Handsfree mode.

## Advanced Options



### Turning the Call timer on or off

You can program the call timer to always appear on the 3rd line of the telephone display instead of the date and time when you are on an active call.



#### To turn the Call timer on or off:

1. Press  *Options* .

---

2. Press   or use  to scroll to option 03.

---



3. Press  to turn the Call Timer on or off. Pressing  allows you to toggle from on to off.

---

4. Press  .

Note: This feature is not available when using the conference option.





### Selecting the dial pad mode

When you select the dial pad mode, you are turning the Live dial pad option on or off. With Live dial pad on, the telephone chooses the prime line and automatically dials out and turns on Handsfree as soon as you press a dial pad key or a memory key. When Live dial pad is off, the telephone is in predial mode. This means after you dial the telephone number you must lift the handset or press either , , or  before the telephone number is dialed.



#### To select the dial pad mode:

1. Press  *Options* .

---

2. Press   or use  or  to scroll to Option 06.

---

3. Press  to change the dialpad mode from on to off. Pressing  allows you to toggle from on to off.

---

4. Press  .





### Entering area codes

When you enter an area code or prefix using this feature, your 9120 telephone will remove that code or prefix from incoming numbers. For example, if you enter your area code into this option, all calls in your area code will appear in the Callers List with the area code stripped off (the area code will appear in brackets after the number). This may make it easier to identify local calls. You can enter three separate area codes or prefixes, each up to seven digits long.

#### To enter area codes and prefixes:

1. Press  *Options* .

---

2. Press   or use  or  to scroll to Option 05.

---

3. Press  to enter Area codes.



---

4. Enter the Area code or prefix using the dialpad and press  *Save* . Repeat this step for each area code or prefix you want to enter.

**To delete or edit an area code or prefix:**

1. Press  *Options* .

---

2. Press  **5** or use  or  to scroll to Option 05.

---

3. Press  to enter Area codes.

---

4. Press  until you see the number you want to change or delete.

---

5. Press  to backspace and delete, or change the area code or prefix.

---

6. Press  .

---

7. Press  .

---

**The Secure Numbers Feature**



The 9120 telephone is equipped with a Secure Numbers feature to keep selected numbers private when you dial. When you have entered a secure number using this option, your telephone does not display or store the digits that you dial after that secure number. Instead, the numbers that follow the secure number are replaced with the \* symbol on the display. You can secure up to three 12-digit numbers.

For example, Joe enters 291-9000 as a secure number through the Set Options list. His Voice Mail number is 1234 and his password is 5678. To access his messages, Joe dials 291-9000 1234 5678. Because the Voice Mail number and password follow the secure number, the display shows 291-9000 \*\*\*\* \*, and Joe's password is not displayed or stored in the Redial List. For more information on the Redial List, refer to **Using the Redial List** on page 10.

**To enter a Secure number:**

1. Press  *Options* .

---

2. Press  **7** or use  or  to scroll to Option 07.

---

3. Press  to enter the Secure number.

---

4. Using the dialpad, enter the secure number.

---

5. Press  to end.

---

6. Repeat steps 6 and 7 for each secure number you want to enter.

---



7. Press  .

---



**To delete or edit a Secure number:**

1. Press  *Options* .

---

2. Press  **7** or use  or  to scroll to Option 07.

---

3. Press  to enter the Secure number.

---

4. Press  until you find the number you want to change or delete.

---

5. Press  to backspace and simply delete the secure number, or delete the secure number and use the dialpad to enter the changed number.

---

6. Press  .

---

7. Press  .

---

## Using a headset with your telephone

The built in standard 2.5 mm jack allows you to use a headset with this telephone.



### Using Headset

The headset jack automatically detects the headset when it is plugged in. This will allow all handsfree functionality to be enabled through the headset.

You can mute a call when on the headset, see **To Mute a headset call** on page 13.

**Note:** When the headset mode is enabled, the handset must remain in the cradle.

### Extension in use

When you lift the handset or press , the 9120 telephone automatically selects the prime line. If your prime line is Line 2 and the peripheral device (e.g. fax machine) is using that line, the line is not selected and the message **Extension in use** appears on the first line of the display and **Press line key** appears on the second line of the display. If you press , you access Line 1 and can make a call. If you press , you will access Line 2 and may interrupt the call to the peripheral.

## Display Icons and Messages

The Model 9120 telephone has a three-line display that uses both icons and text messages to supply call information.

### The Callers List screen

A sample Callers List screen is shown below.

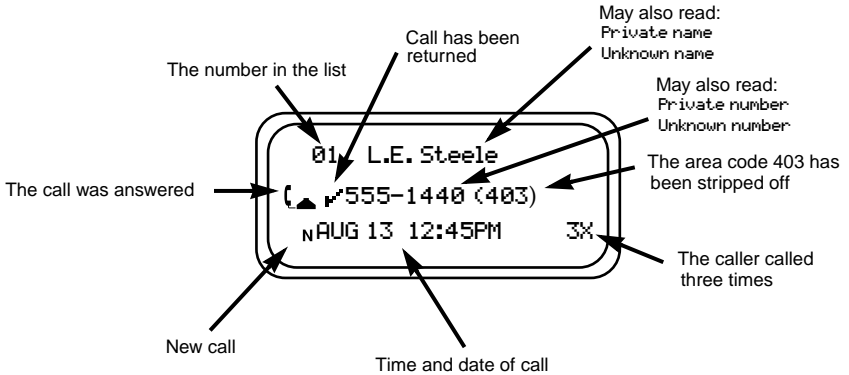





### Knowing when you have a message

9120 set indicator light lets you know that your Voice Mail system has a message for you. The set indicator light flashes slowly and the display shows

Message Waiting or Message Waiting  
Line x                      Line 1 Line 2

after your Voice Mail has received a call. Contact your local telephone company to find out how you can subscribe to Voice Mail services.











### Icons in the Callers List

	Voice message waiting <sup>†</sup>
	Phone is not in use
	Phone is in use
	Incoming call
	Incoming call waiting call <sup>†</sup>



<sup>†</sup>This service may have a different name in your area. Contact your telephone company for information.



## General display messages

Message	What it means
Check line cord	If there is no dial tone, make sure the line cord and handset cord are attached securely.
Directory empty Use SAVE to add	The Directory remains empty until you add numbers and names to it.
Directory full No changes made	The Directory has a 100 entry limit. If you want to add an item, delete an item you no longer use.
Extension in use	An extension telephone is using the same line that you want to use. Select the other line instead. Or, someone is trying to use the same line on an extension telephone.
Feature ON	The FeatureLight On key has been pressed and the code dialed out. To turn off the feature and the light, press the FeatureLight Off key and lift the handset or press either  ,  , or  .
Key is locked	The memory key is factory-programmed and cannot be erased or reprogrammed. Program a different memory key.
Make calls first or Make second call	You must make two calls before you press  .
Message Waiting Line x	Your Voice Mail service has received a call for you. To subscribe to Voice Mail service contact your telephone company.
Press Conference	Both calls of a Conference are on hold. Press  to re-establish the Conference.
Press line key	This appears when the call you want is on hold. You must press  to retrieve the held call.
Private number or Private name	The caller has requested that the telephone company not deliver the number or name.
Redial list is empty	This appears if you press  before making any calls on your telephone or if power has been interrupted.
Ringer is OFF Line x	The ringer volume is turned off for that line. Without lifting the handset, press the volume bar.
Unknown name or Unknown number	The name or number is unavailable from the telephone company.
>...xxxxxxxxxxxxxxxxx ...xxxxxxxxxxxxxxxxx	The telephone number is longer than the display. The display shows ... and the last 15 or 16 digits of the number.
XX New Callers	When you're not on the telephone and not in the Callers List, the display shows you how many callers have been added to the list since you last checked it.
	Indicates an incoming call.
	Indicates that the phone is off hook.
	Indicates an incoming Call Waiting call.

## Callers List display messages

Message	What it means
Callers List is empty	Your telephone does not record incoming calls until you subscribe to Caller ID service. If you do subscribe, you haven't received any calls in the list yet or you've deleted all numbers in the Callers List.
Calls bumped=xx	xx is the number of old calls automatically removed to make room for incoming new calls in the Callers List. The limit is 100 calls.
No number	You are trying to call someone in your Callers List and the number is unknown or private.
Private number or Private name	The caller has requested that the telephone company not deliver the number or name.
Unknown name or Unknown number	The name or number is unavailable from the telephone company.
✓555-1449 (403)	✓ means you have returned the call from the Callers List.
N MAR04 3:30PM 2x	N means a new call.
...xxxxxxxxxxxxxxxxxx	... means the number is longer than the display.
	Indicates an unanswered call in the Callers List.
	Indicates an answered call in the Callers List.
	Indicates a Call Waiting call in the Callers List.
R Smith 123-456-7890 MAR 04 3:30PM 2x	2x means this caller has called twice. The display shows the date and time of the last call from that caller.

## Learning about the lights

The set indicator light also alerts you when another extension is on the same line you're using, the telephone rings, or a feature is on. There are also indicator lights beside the line keys and  to show you the status of the lines and of Handsfree and Mute.

## Set indicator light messages

Feature	Light
Feature ON	Set indicator light is on.
Message Waiting <sup>†</sup>	Set indicator light flashes slowly.
Visual Ringing	Set indicator light flashes very quickly.

<sup>†</sup>You must subscribe to Voice Mail services from your telephone company for this feature to work

## Line and Handsfree indicator light messages

Feature	Light
Extension in use	The appropriate line indicator light is on.
Call is ringing on a line	Line indicator light and set indicator light flashes very quickly.
Call is on hold	Line indicator light flashes quickly.
Call is on Handsfree	Handsfree/Mute indicator and line indicator light are on.
Line is in use	Line indicator light is on.
Microphone is muted	Handsfree/Mute indicator light flashes quickly.

### Viewing multiple display and light messages

When you aren't using the telephone, there are several messages that can be active at any time, such as date and time, **X New Callers**, **Feature ON**, **Message Waiting**, and **Ringer is OFF**. When more than one of these messages is active, the display shows the most recent message and an arrow beside it (e.g., **1 New Caller →**). You can view the other messages by pressing **▶**. Each time you press **▶**, the display shows the next active message and its associated light.

## Troubleshooting

### The display is in the alternate language.

You can change to another language by pressing  *Options* and , then pressing . Press  until the desired language is displayed and then press  to set the language.

### The cursor doesn't move when saving in the Directory.

The number or name is too long. Numbers can be no longer than 24 digits and names can be no longer than 16 characters.

### There is no information on the display and the ringer volume is low.

Make sure the power adaptor is plugged in to a working electrical outlet.

### I cannot hear a caller.

Make sure the handset cord is inserted securely into the jack and make sure the receiver volume is high enough.

### The power is out and the display is blank.

The 9120 still operates as a regular telephone during a power failure. You can dial using the dial pad and you can receive calls, but the other keys and the display do not operate until the power is restored. Only Line 1 works in this situation.

### The display works but you can't hear dial tone.

Your telephone lines may be wired differently from the telephone jack. To have a service person correct the wiring, contact your local telephone company.

### The telephone wobbles.

Check that the handset cord is placed in the channel between the stand and the telephone. See the illustration on page 7.

### I cannot program a memory key.

Some of the memory keys may be factory-programmed. These keys are locked and cannot be erased or reprogrammed.

### Callers are not identified on the display.

Let the telephone ring at least twice before answering. If that doesn't work, you may not have a Calling Line Identification<sup>†</sup> service. To subscribe, contact your local telephone company.

### The Callers List is empty.

Until you subscribe to Calling Line Identification<sup>††</sup> service, your telephone does not record incoming calls. Also, the Call Log option may be set to log no calls. See page 18 for information.

### I cannot dial a number in the callers list.

The caller may have an unknown number.

### I have only one line connected to my phone, and I keep getting the message

Check line cord.

Check that the line cord is connected to a jack.

<sup>†</sup> This service may have a different name in your area. Contact your telephone company for information.

<sup>††</sup> This service may have a different name in your area. Contact your telephone company for information.

**The light is stuck on, and the message feature on is displaying.**

A Feature Light On code has been entered, and you need to program a Feature Light Off key. Follow the steps that appear in **Using Feature Light keys** on page 25.

**Live dialpad has stopped working.**

It may be that the Live Dialpad option has been turned off in the Options List. Setup option 6 should be on. If this does not solve the problem, disconnect and then reconnect the AC adapter.

**The display is blank on my phone.**

Check that the power adapter is connected to the phone, and that the phone is connected to a working outlet. You can test the outlet with another device, such as a lamp.

**How do I answer Call Waiting?**

To answer a Call Waiting call, press . You may have to subscribe to a Call Waiting<sup>†</sup> service to use this feature.

**I can view regular Caller ID information, so why can I not see who is calling on Call Waiting?**

Ensure that the Call Waiting Identification option (setup option 11) is on, and that you have subscribed to a Call Waiting ID<sup>†</sup> service from your telephone company. Also note that you will not receive Call Waiting ID when an extension is in use.

<sup>†</sup>This service may have a different name in your area. Contact your telephone company for information.

## Index

**A**

- Answering a call 8
- Area codes 26, 27

**C**

- Call Waiting Identification 11
- Callers List
  - deleting in 20
  - editing 19
  - finding items 19
  - making a call 19
  - saving to the Directory or a memory key 20
  - set up 18
- Calling
  - from a memory key 23
  - from the Callers List 19
  - from the Directory 17
  - from the Redial List 10

**D**

- Date and time
  - automatic 13
  - setting 13
- Deleting
  - Directory items 17
  - items in the Callers List 20
  - memory keys 23
- Directory 15
  - deleting items 17
  - entering names 16
  - finding items 17
  - making a call 17
  - saving numbers and names 15

## Display

- language changing 12
- messages 30

**E**

## Editing

- area codes 26, 27
- memory keys 23
- the Callers List 19
- the Directory 17

**F**

## Feature Light keys 25

**H**

- Handsfree 9, 10
- Headset 28
- Helpful hints
  - see Troubleshooting 33
- Hold 3, 8

**I**

## Installation 4

**K**

## Key descriptions 2

**L**

- Language
  - see Display language 12
- Letters
  - entering 16

Lights  
set indicator lights 31, 32

## M

Memory keys  
deleting 23  
editing 23  
labeling 22  
making calls from 23  
saving features 21  
saving numbers and names 21

Mute 3, 10

## N

Names entering 16

## O

Options 3, 12, 27

## P

Prime line  
answering 8  
changing 14  
selecting 26, 28

## R

Redial 10

## S

Saving  
feature codes to memory  
keys 23  
from Callers List to Directory or memory key 20

Setting  
date and time 13  
ring tone and volume 13  
Switching between lines 14

## T

Troubleshooting 33

## V

Voice Mail 14, 29  
Volume  
handset 14  
muting a handsfree call 13  
ringer 3, 13, 14  
speaker 14

**GENERAL INQUIRIES**

If you have read the guide and you still have questions, call 1-800-574-1611 in Canada and the USA. In other areas, contact your telephone company.

© Aastra Telecom Inc., 2003 41-0052-00 Rev 02