

THREE-LINE TELEPHONE

User Guide



# Venture

Multiline Communications System

<b>Introduction .....</b>	<b>1</b>
Your Venture phone .....	2
Key descriptions.....	3
Unpacking the phone.....	4
<b>Getting started.....</b>	<b>5</b>
Preparing for the installation .....	5
Installing the phone .....	7
Installing a phone on a wall.....	11
Setting up your phone .....	12
Your Phone list.....	13
Checking the installation .....	13
What's next?.....	13
<b>Making and receiving calls.....</b>	<b>14</b>
Dialing calls.....	14
Answering calls .....	15
Answering second calls .....	15
Answering Call Waiting calls .....	15
Adjusting the receiver volume .....	16
Using the Handsfree and Mute features during calls .....	16
Transferring calls.....	16
Making conference calls.....	17
Paging all phones .....	17

Paging one phone.....	18
To answer a page .....	18
Setting up a Room monitor .....	18
<b>Programming your phone .....</b>	<b>20</b>
To set an option.....	20
<b>Using the memory keys.....</b>	<b>26</b>
To save information .....	26
To change information.....	26
To delete information.....	27
To make a call using a memory key .....	27
To activate an option or feature using a memory key.....	27
To page one phone .....	27
To view call duration information .....	27
To save an option to a memory key .....	27
To turn a feature on or off.....	28
To turn a feature and light on or off.....	28
<b>Using the list keys .....</b>	<b>29</b>
To retrieve an item .....	29
To make a call or activate a feature .....	29
To change information.....	29
To save information .....	30

To save information from another list or a memory key.....	31
To delete information .....	31
To turn a feature on or off in the Services list.....	32
To turn a feature and light on or off .....	32
To name a Private Directory .....	32
To delete a Directory .....	33
To set up your Callers lists .....	33
Callers list display information .....	33
To delete a Callers list .....	33
List descriptions .....	34
<b>Status messages .....</b>	<b>36</b>
Status message descriptions .....	36
<b>Troubleshooting .....</b>	<b>37</b>
Blank display .....	37
Display language error .....	37
No dial tone .....	37
Communication problems .....	37
Duplicate ID is displayed for unexplained reason .....	39
You can't hear .....	39
You forgot your password.....	39
Your caller can't hear you .....	39
You can't dial from the Callers list .....	39

You can't turn off the message waiting light.....	39
<b>Maintenance and repair .....</b>	<b>41</b>
Warranty and repairs.....	41
Cleaning the display.....	41
General inquiries.....	41
<b>Glossary.....</b>	<b>42</b>
<b>Appendix .....</b>	<b>45</b>
Running cable to phone jacks .....	45
Wiring the jacks .....	45
Connecting the cord adapter module (CAM).....	45
<b>Regulatory .....</b>	<b>49</b>
Canadian regulatory information .....	49
U.S. regulatory information .....	51
<b>Index .....</b>	<b>57</b>

**W**elcome to Venture, the three-line phone/system that you can customize to function the way you want.

Up to eight Venture phones can be linked to form a system by wiring them so that

- the same telephone line appears as line 1 on all other phones
- there can be up to 500 feet of wiring between two phones

Individual Venture phones have access to the following features:

- the display of telephone service provider caller ID
- full duplex Handsfree speakerphone
- a Directory of 200 names and numbers
- a log of the name and number of your last 200 callers
- call Hold and Conference

- eight memory keys
- a Redial list of the last 10 numbers called from your phone
- a Services list used to activate 20 services and features to which you subscribe from your telephone service provider

Venture phones linked together in a system have these additional features:

- calling and paging between Venture phones
- Call Transfer
- an automatically generated list that includes the user name and ID number for every phone in your system
- shared Directory
- line and phone status indication on all phones sharing lines

The Quick Start Card enclosed with your phone provides the basic

information you need to use your Venture phone right away, including a description of the functionality of each key on the phone. Detailed information about features and using your Venture phone is available in this user guide.

# Your Venture phone

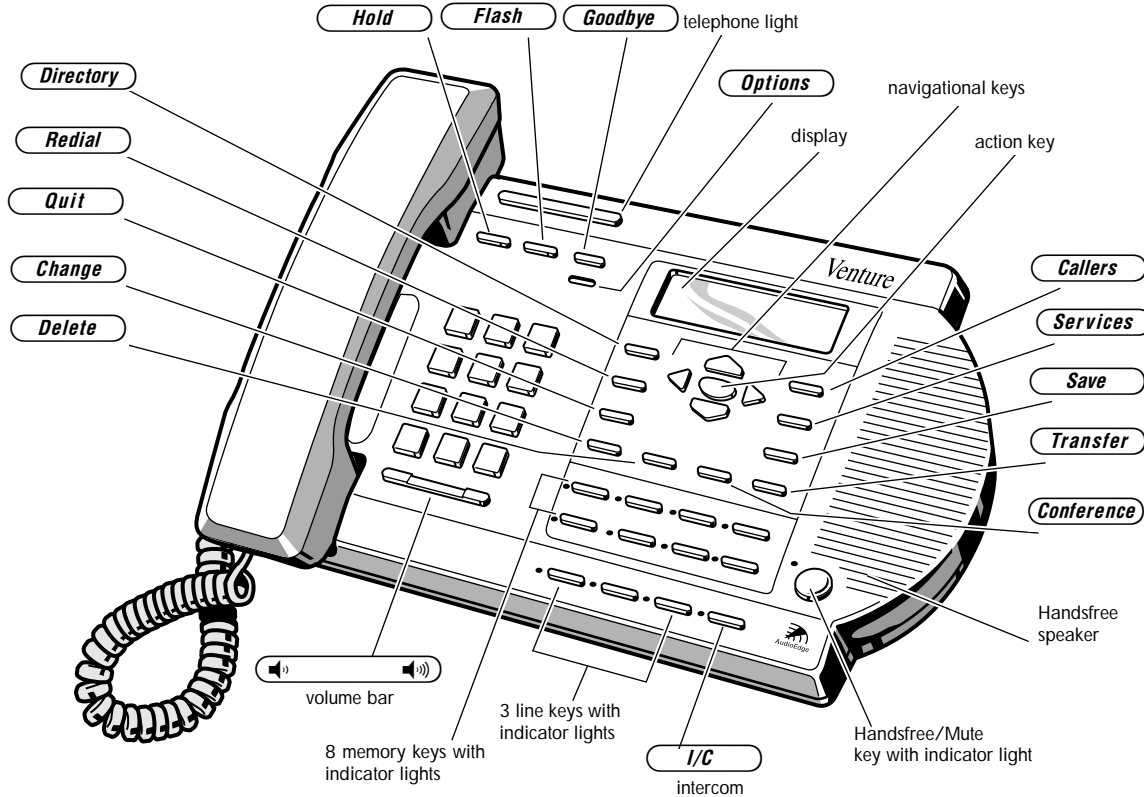

## Key descriptions

**Hold** put calls on hold and releases calls from hold.

**Flash** or Link connects you to telephone service provider features such as Three-way Calling.

**Goodbye** always ends an active call.

**Options** lets you access the Options list to customize your Venture phone.

**Callers** lets you access information on the last 200 callers—when they called and how many times they called—when you subscribe to calling line identification from your telephone service provider.

**Services** lets you have easy access to a list you create for services your phone service provider provides, such as Call Forward.

**Save** stores numbers and names in the Directory, the Services list or a memory key. It may also be used to activate or deactivate an option while in the Options list.

**Transfer** transfers a call from your Venture phone to another Venture phone

in your system.

**Conference** creates and controls a conference call using the other lines or other phones in your Venture system.

**I/C** used to answer or initiate calls between Venture phones.



**Delete** erases items from a list or memory key.

**Change** changes an item within the Directory, Callers or Services lists, or information stored to a memory key.

**Quit** stops what you're doing with the phone and clears the display, but does not end a call.





**Redial** displays the last 10 numbers you dialed.

**Directory** stores and provides access to up to 200 names and numbers.

  adjusts the receiver, speaker and ringer volume.

**Telephone light** lights when you have an incoming call, message waiting (if you have telephone service provider voice mail or message waiting on your telephone line), features turned on, or when an extension is in use.

**Display** gives you instructions and information about calls and features.

**Navigational keys** (, , , ) enable you to travel through the Options, Directory, Callers, Redial, Phone and Services lists. They also let you backspace and erase when entering or changing names and numbers in lists.

In addition, pressing the  key when your phone is at idle opens the Phone list.

**Action key** enables you to dial a number or activate a feature shown on the display.

**Memory keys** store information that can be used to make calls or activate features. Memory key lights also provide a visual indication when features are activated using a memory key and when another Venture phone is busy when its phone ID is stored to a memory key.

**Line keys** are used to initiate or answer calls on your phone's three lines.

**Handsfree/Mute key** activates the speaker and microphone so you can listen and talk without lifting the handset, or it mutes the microphone.



# Unpacking the phone

When you unpack the phone, you should ensure that you have a Documentation Package, a Termination Module Package and all of the parts shown here.

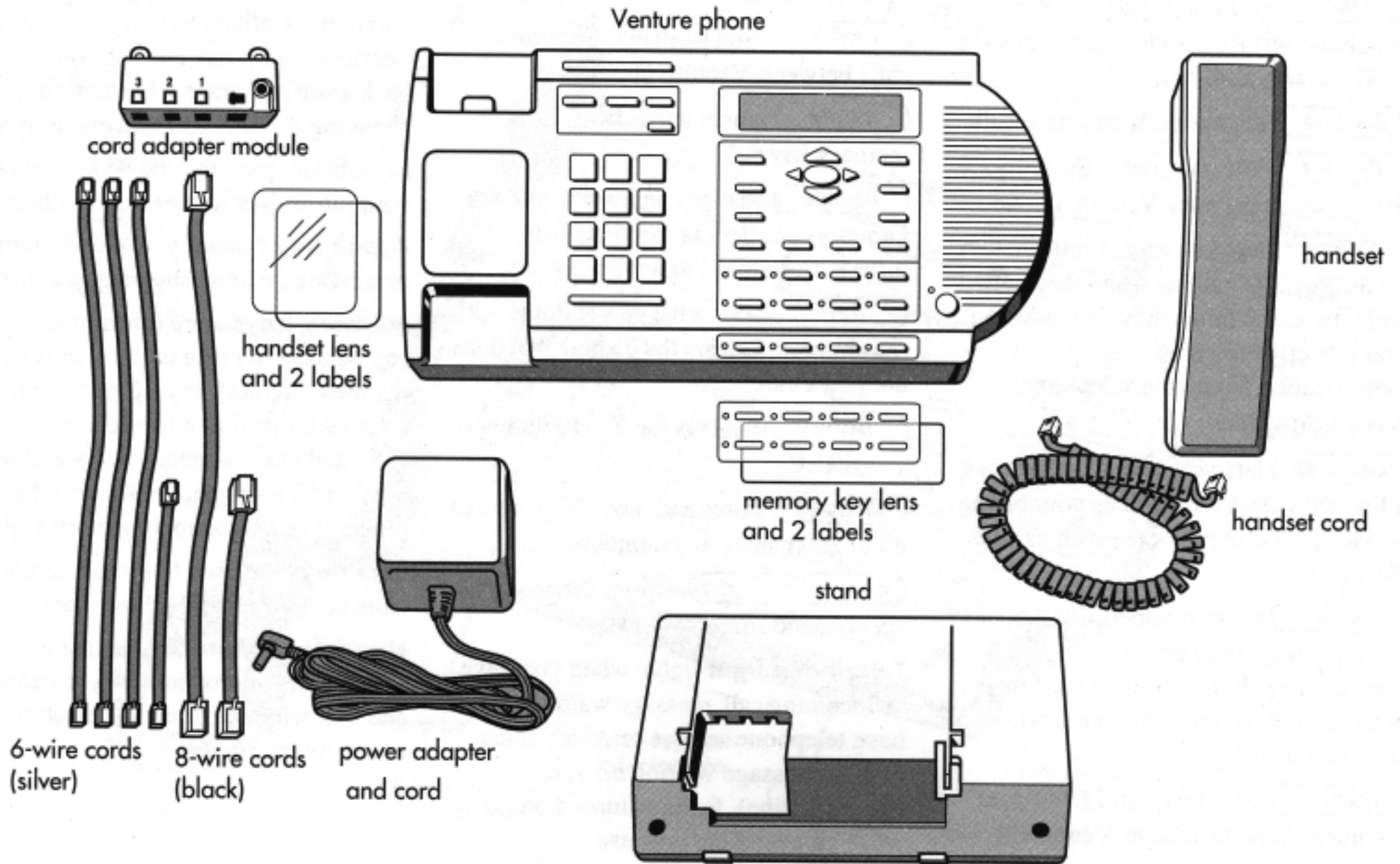

**I**nstalling your Venture phone is easy. Simply connect your phone lines, assemble the phone and follow the instructions on your display.

If you are installing one phone and all of your phone lines are terminated on one phone jack, you can “get started” by following the instructions on the Quick Start Card. If you are installing more than one phone or have lines terminated on more than one jack, follow the instructions in this chapter to get started.

## Preparing for the installation

Preparing to install your phone includes locating the existing phone jacks in your home or office, deciding where you want your phone(s) located, determining how your telephone lines are connected to the jacks you plan to use, and deciding how you want the telephone lines to appear on your phone(s).

The same telephone line *must appear as line one* on all of your Venture phones. If you cannot tell in what order your telephone lines are terminated on the jacks you plan to use, call your telephone service provider to assist you.

There should be an electrical outlet within 10 feet of where you locate your phone. In addition, if you are installing more than one Venture phone, there should be no more than 500 feet of wire connecting any two phones in the system.

In a building with existing wiring, you may find phone lines terminated on one, two or three phone jacks. If you are installing new wiring and phone jacks, see “Appendix” on page 45.

## Installation planning worksheet

Use the worksheet on page 6 to determine how to set up your system.

In column one fill in the unique two-digit phone ID and the name that will identify the phone on the system. In columns two, three and four record the phone number and the jack on which it appears for Venture line 1, 2 or 3. In column five record the room or area where the phone will be located.

## Installation planning worksheet Example

Your first phone is located in the reception area and has access to telephone lines 555-4443, 555-4444 and 555-4445 through one jack. The user’s name is Michael. The second phone is located in the service area and has access to telephone lines 555-4443, 555-4444 and 555-4446 through one jack. The user’s name is Gord. The third line is in the lab and has access to lines 555-4443 and 555-4447 through two jacks. The user’s name is Dave.

### Installation planning worksheet example

Phone ID/Name	Line 1/Jack	Line 2/Jack	Line 3/Jack	Location
01- Michael	555-4443/ jack 1	555-4444/ jack 1	555-4445/ jack 1	reception
02- Gord	555-4443/ jack 1	555-4444/ jack 1	555-4446/ jack 1	service
03- Dave	555-4443/ jack 1	555-4447/ jack 2		lab

### Installation planning worksheet

Phone ID/Name	Line 1/Jack	Line 2/Jack	Line 3/Jack	Location

 **Note:** The same telephone line *must be* used as line 1 on every phone in your system so that the phones can communicate with each other.

## Installing the phone

1. Plug one end of the handset cord into the handset.
2. Plug the other end of the handset cord into the handset port on the back of your phone.

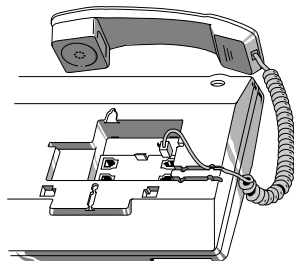

3. Press the cord into the channel provided.
4. If the phone will be mounted on a wall, skip to “Installing a phone on a wall” on page 11.
5. Disconnect all other equipment (such as phones or faxes) that share the phone lines used in the Venture system. This equipment will be reconnected after the

installation of your Venture phones. (See step 2 on page 13.)

6. Determine which telephone line configuration, shown in the following three examples, is like your configuration.
  - “One or more lines, one phone jack” on page 8
  - “Two lines, two phone jacks” on page 9
  - “Two lines, two phone jacks” on page 9



**Note:** For more complex configurations see “Appendix” on page 45

7. Connect the cords to the cord adapter module (CAM) and to the phone as shown in the example you identified in step 6.



**Note:** The CAM is a cord management device that connects the telephone lines and

the power adapter to the phone through one cord.

**One or more lines, one phone jack**

1. Plug one end of a silver *6-wire cord* into the phone jack and the other end into port 1 of the CAM.
2. Plug one end of a black *8-wire cord* into the phone port of the CAM, run the cord through the stand and plug the other end into the CAM port on the back of phone.
3. Plug the *power adapter cord* into the power adapter port on the top of the CAM and the other end into an electrical outlet.

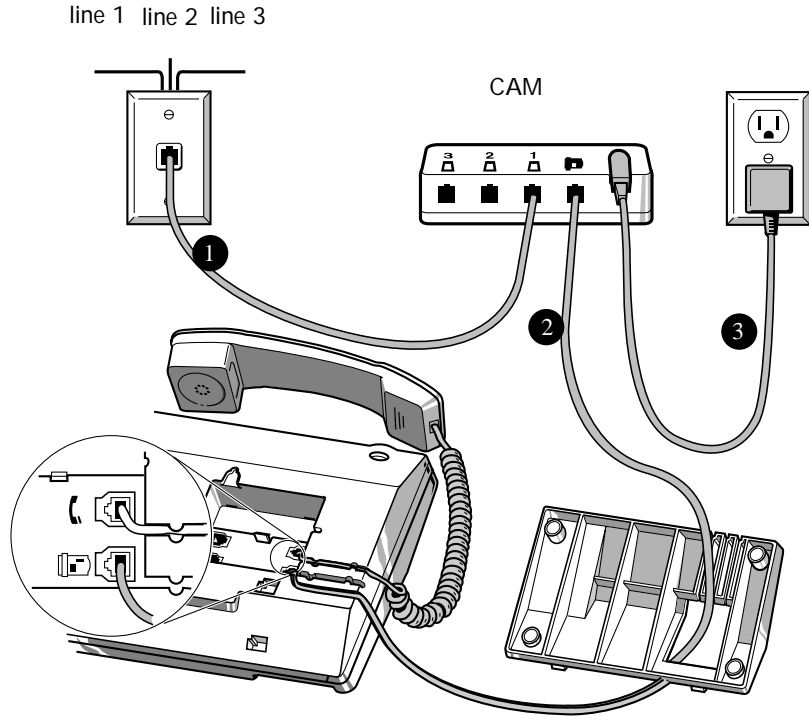

## Two lines, two phone jacks

1. Plug one end of a silver *6-wire cord* to the line 1 phone jack and the other end to port 1 on the CAM.
2. Plug one end of another silver *6-wire cord* to the line 2 phone jack and the other end to port 2 on the CAM.
3. Plug one end of a black *8-wire cord* into the phone port of the CAM, run the cord through the stand and plug the other end into the CAM port on the back of the phone.
4. Plug the *power adapter cord* into the power adapter port on the top of the CAM and the other end into an electrical outlet.

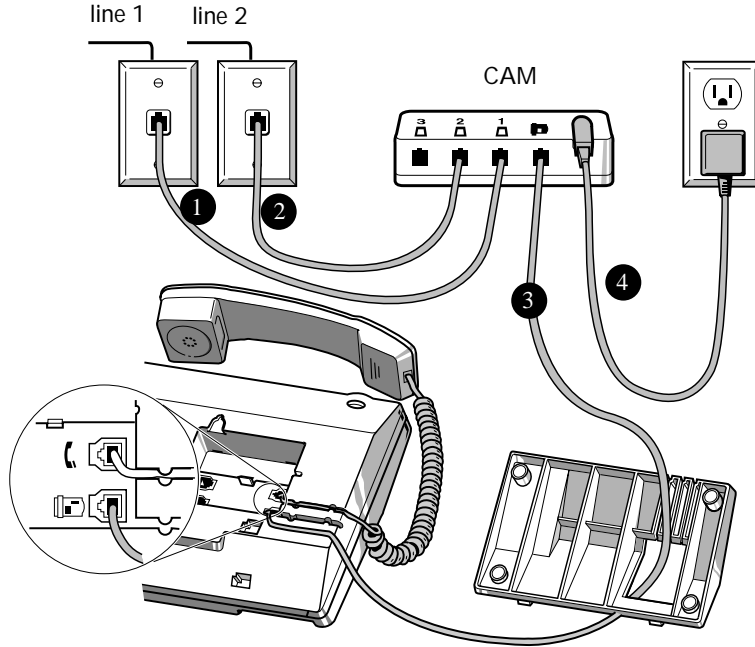

### Three lines, three phone jacks

1. Connect one end of a silver 6-wire cord to the line 1 phone jack and the other end to port 1 on the CAM.
2. Connect one end of another silver 6-wire cord to the line 2 phone jack and the other end to port 2 on the CAM.
3. Connect one end of another silver 6-wire cord to the line 3 phone jack and the other end to port 3 on the CAM.
4. Plug one end of a black 8-wire cord into the phone port on the CAM, run the cord through the stand and plug the other end into the CAM port on the back of the phone.
5. Plug the power adapter cord into the power adapter port on the top of the CAM and the other end into an electrical outlet.

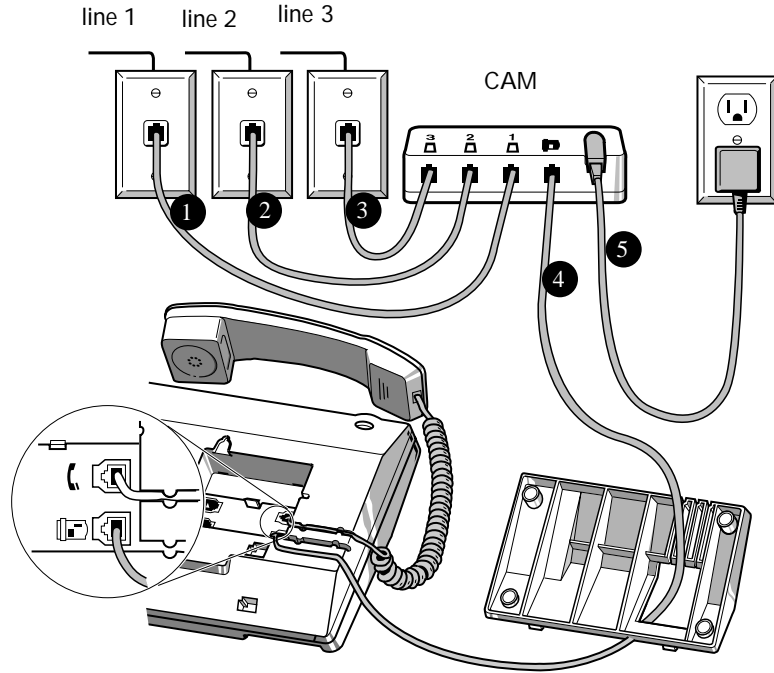

## Attaching the stand

1. Align the tabs on the edge of the stand with the holes on the back of the phone.

 **Note:** You can adjust the phone to sit at a higher or lower angle by choosing between the two sets of holes on the stand.

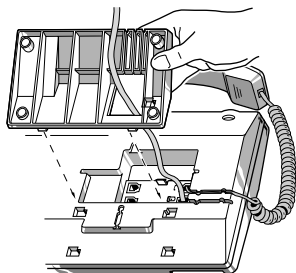

2. Lower the tabs into the holes that you have chosen.
3. Push the stand against the phone until the side tabs click into the locking holes.
4. Press the cord into the channels on the bottom of the stand.

## Removing the stand

1. Firmly grasp the stand and the phone.
2. Pull hard until the units separate.

 **Note:** You will hear a loud cracking sound as the units separate.

## Installing a phone on a wall

If you want to install a Venture phone on the wall, you must terminate all the telephone lines you want to appear on it on one phone jack. In addition, you may need to purchase a wall-mount plate from a telephone service provider or from an electronics store.

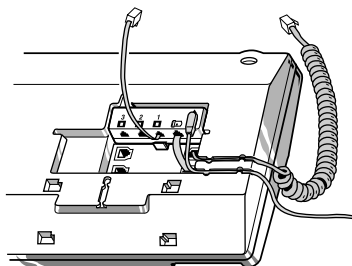

1. Press the CAM into the cavity in the back of your phone.
2. Plug one end of the black *short* 8-wire cord to the phone port of your CAM.
3. Plug the other end of the black *short* 8-wire cord into the CAM port on the back of your phone.
4. Plug the *power adapter cord* into the power adapter port on the CAM.
5. Plug the power adapter into an electrical outlet.
6. Plug one end of the silver *short* 6-wire cord into CAM port 1.
7. Plug the other end of the silver *short* 6-wire cord into the wall-mount plate jack.
8. Align the slots on the back of the phone with the studs on the wall-mount plate.
9. Slide the phone down until it locks into place.



## Setting up your phone

After plugging in the phone, you will see

```
*=English
#=Españ Franc:1
JAN 1 12:00AM
```

1. Press **\***, **#** or **1** to select the language for your phone display.

**Note:** If you want to change the language you have selected, see “Display language error” on page 37.

2. Enter a number between 01 and 99 for the phone ID.

If you have more than one phone, each phone must be assigned a different phone ID. The display shows **Please wait** while it confirms that the two-digit number you entered has not been used for another phone. When it is finished checking, the display shows **confirmed**.

**Note:** If your display shows **Invalid phone ID** **Please try again** instead of **confirmed**, enter a different number.

3. Press **Save**. Your display shows **Enter a name for this phone**.
4. Repeatedly press the dial pad key on which the letter or symbol is located until the display shows the one you want.

1	./' & .() 1	2	ABC 2	3	DEF 3
4	GHI 4	5	JKL 5	6	MNO 6
7	PQRS 7	8	TUV 8	9	WXYZ 9
*	*	0	0	#	#

**Note:** In each word an initial capital letter is followed by lower case letters. Press **▲** to change to a capital or lowercase letter.

5. If the next letter or symbol is on the same key as the last one, or

you want to insert a space, press **▶** to advance the cursor.

6. Repeat steps 4 and 5 until you have entered the name.

**Note:** A name can have up to 16 characters including spaces.

7. Press **Save**.
8. Fill out the handset card.
9. Insert the handset card on the front of the phone.



10. Press each line key (to which a telephone line is connected) and the I/C key and listen for dial

the I/C key and listen for dial tone. If you hear no dial tone see “No dial tone” on page 37.

## Your Phone list

When the phone ID and name of each new phone is entered by the owner of that phone, this information is automatically added to your Public Directory as part of the Phone list. If you have more than one phone in your Venture system, you can use the Phone list to call the other phones. For more information on using the information in a list see “Using the list keys” on page 29.

## Phone list changes

When anyone changes the name or ID of any phone in your Phone list, the phone list of every phone in your system is automatically updated.

When you delete a phone or move a phone from one location to another location in your home or office, the Phone lists on all phones in your

system include the old phone name and ID. To delete a phone ID and name from the Phone list, see “To delete information” on page 31.

## Checking the installation

When you have installed more than one Venture phone, you should verify that all of your phones in your system are communicating.

1. On each Venture phone, press to review each phone in your system as shown in your phone list. If the user of phone 01 is named Jane and she is not using the phone, the display will show **Jane**  
**Phone 01 idle**  
If Jane is on the phone, the word **idle** will be replaced by **busy**. If neither idle nor busy shows, see “Communication problems” on page 37.
2. Reconnect any non-Venture equipment that shares the

telephone lines used by your Venture phones. (This equipment was disconnected before the installation of your Venture phones. See step 5 on page 7.)

3. Repeat step 1.

## What’s next?

At this point if you want to



- begin making calls see “Making and receiving calls” on page Left
- program your options (such as Don’t disturb or Receive page) see “Programming your phone” on page 20.
- learn more about, or program, your memory keys, see “Using the memory keys” on page 26.
- learn more about, or program, your Venture lists, see “Using the list keys” on page 29.

**W**ith your Venture phone you can make and receive calls using many different methods, transfer calls, reserve lines and use features while making or on a call.

## Dialing calls

When you make a call, you can select a line by pressing one of the line keys on your phone or, if you have selected a prime line (See “11 Prime is” on page 22.) and have live dial pad activated (See “13 Live dialpad” on page 22), your call is automatically placed as soon as the phone number is on the display.

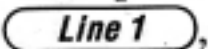
### To make a phone call



1. Pick up the handset, or press , ,  or the Handsfree/Mute key.

 **Note:** If you select a line that is already in use, to prevent accidental intrusions on ongoing

calls, your display shows  
\*=Join call #=Reserve  
line.

- Press  to join the ongoing call.

### OR

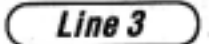
- Press  to reserve the line. (When the reserved line becomes available, your phone beeps and the display shows **Line x available**.)
- If you decide to cancel your reservation, press ,  or  again.

2. Use the dial pad to enter the phone number you want to call.
3. When you complete your call, hang up, or press  to release the call.

### To make an intercom call

An intercom call is a call to another phone in your Venture system.

1. Press .
2. Use the dial pad to enter the ID number for the Venture phone you want to call.

 **Note:** When you cannot complete your intercom call, one of the following three messages appears on your display:  
**System is busy** –no intercom channel is available.  
**Phone busy** –the phone you are trying to reach is busy.  
**Phone not responding**–the phone is not communicating, see “Communication problems” on page 37.

### Other ways to make a call

Any number stored in a Venture list or to a memory key can also be used to make calls. See “Using the list keys” on page 29 and “Using the memory keys” on page 26.

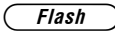
 **Note:** When you make a conference call using the telephone service provider Three-way Calling feature, you must use  to connect each participant in the call. Until you have connected all the conference call participants, no one else in your system can be on the telephone line used to set up the conference.

## Answering calls

If you subscribe to the telephone service provider Calling Line ID feature, your phone displays the information provided by the telephone service provider (usually the caller's name and number) when you receive a call.

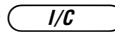
1. Pick up the handset, or press the Handsfree/Mute key, the flashing  key, the flashing line key, or the flashing memory key.

 **Note:** If more than one incoming call is ringing, your phone automatically selects either your prime line or the line that has been ringing the longest based on the way you have set “12 Answer Line” on page 22.

## Answering second calls

When you are on a call and second call comes in on another line, your phone beeps, the indicator light for the line on which the second call is coming blinks, and if you subscribe to the telephone service provider Calling Line ID feature,  appears on your display.



1. Press  to see information about the second call.
2. If you want to interrupt your current call to answer this new call, press the line key with the blinking indicator light. You are connected to the second call and your first call is on hold.

 **Note:** You can switch back and forth between the two calls by pressing these two line keys in turn.

## Answering Call Waiting calls

When you subscribe to the telephone service provider Call Waiting or Call Waiting ID feature, you can answer a second incoming call on a line that is already in use. When a second call comes in, you hear a tone in the receiver of your phone. If you have Call Waiting ID, the caller information appears automatically on your display.

- If you want to interrupt your current call to answer this new call, press . You are connected to the second call and your first call is on hold.

 **Note:** You can switch back and forth between the two calls by pressing .

## Adjusting the receiver volume

While making or receiving calls, you may want to adjust the volume of the Handsfree speaker or handset receiver.

- Press the right side of  to increase the volume level.

**OR**

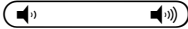
- Press the left side of  to reduce the volume level.

 **Note:** If you want to change the volume of the handset receiver permanently, see Option “14 Hndset deflt.” on page 23.

## Using the Handsfree and Mute features during calls

When making or receiving calls you can use the Handsfree speaker and microphone instead of the handset.

When Handsfree is activated, you can speak and be heard on a call without lifting the handset. When you are on a Handsfree call you can activate Mute so that you can talk privately to someone else in the room without the caller hearing you.

 **Note:** The Handsfree speaker and receiver work most effectively when set at moderate volume levels.

### To activate Handsfree

- Press the Handsfree/Mute key. The Handsfree light turns on and you will hear your caller or dial tone through the Handsfree speaker on your phone.
- Leave or place the handset on the phone.

### To activate Mute

- When Handsfree is activated, press the Handsfree/Mute key again. The light flashes and the





display shows **Microphone muted**. You can hear the caller, but the caller cannot hear you.

- When you want to be heard by the caller again, press the Handsfree/Mute key again. The light stays on.

## Transferring calls

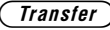
You can answer a call and then send (or transfer) it to another phone in your Venture system.

### To transfer a call

- When you have answered a call that you want to transfer, press . The display shows **Transfer to?** .
- Press  until the display shows the phone to which you want to transfer the call, then press  or .

**OR**

If you have programmed a memory key for the phone that

you want to transfer the call to, press the memory key.

 **Note:** If the destination phone is busy, the transferred call rings back to the sending phone and the display shows **Phone busy**.

## Making conference calls

You can make a conference call that includes any two phone lines or one phone line and another phone in your Venture system.

### To make a conference call

1. Make a call.

 **Note:** If you press **Conference** without placing your calls first, the display shows, **Make calls first**.

2. Press **Hold**.
3. Make your second call.
4. Press **Conference**.

 **Note:** If you have more than two lines on hold or connected, the display shows **Select line key**. Press the line keys you want to include in your conference call.

5. Press **Goodbye** to end the call.

 **Note:** When you hang up everyone on the call is disconnected.

### To put a conference call on hold

1. Press **Hold**. All the conferenced lines are put on hold.

 **Note:** When a conference call is on hold, the conferees cannot speak to each other.

2. To reestablish the call, press **Conference**.

### To consult privately during a conference call

1. Press the line key for the person with whom you want to speak privately. The other line will automatically be put on hold.
2. To reestablish the conference call, press **Conference**.

### Paging all phones

1. Hold down **I/C** for two seconds. The page tone is heard on all phones in the system, unless they are in use.
2. Wait for the tone to end.
3. Speak into the handset or Handsfree microphone.
4. Hang up or press **Goodbye** to end the page.

### Paging one phone

1. Press  repeatedly until the display shows the phone you

2. Wait for the tone to end.
3. Speak into the handset or Handsfree microphone.
4. Hang up or press **Goodbye** to end the page.

## Paging one phone

1. Press **▼** repeatedly until the display shows the phone you want to page. Hold down the intercom key for two seconds.

### OR

If you have saved that phone ID to a memory key, hold down the memory key for two seconds.

2. Wait for the tone to end.
3. Speak into the handset or the Handsfree microphone.
4. Hang up or press **Goodbye** to end the page.

## To answer a page

When all phones in the system are paged, you will hear two short tones before the initiator begins speaking. You can listen but you can not respond.

When only your phone has been paged, you will hear a tone at 15 second intervals until you pick up the phone or press the Handsfree key. If you have Handsfree answer turned on (see Option “03 Hndfree ansr” on page 21), you can answer the page by talking into the Handsfree microphone without picking up your handset.

## Setting up a Room monitor

Room monitor is used to listen to the sounds in a room such as an unattended lobby, or a baby’s room.

### To set up Room monitor on the phone being monitored

1. Press Options.

2. Press **▼** until the display shows, 07 Room monitor OFF.
3. Press **¥** . The display shows Room monitor ON.

### To set up Room monitor on the monitoring phone

1. Press Options
2. Press **▼** until the display shows, 08 Memory keys prog.
3. Press **¥** . The display shows, Don t disturb
4. Press **▼** until the display shows, Room monitor.
5. Press **¥** . The display shows, Press memory key.
6. Press the memory key you want to use. The display shows, Saved: Memory key Room Monitor.

### To activate Room monitor

1. Go to the monitoring phone.



Room monitor ON  
Transmitter.



Your Venture phone is programmed to operate as simply as possible. As you begin using your phone you may decide that you want to change the way your phone operates. You can do this by setting the options in the Option list.

 **Note:** In addition to programming your options, you can also program the way your phone operates by setting up your memory keys and lists, see “Using the memory keys” on page 26 or “Using the list keys” on page 29.

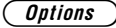
## To set an option

1. Press .
2. Press  or  repeatedly until your display shows the option you want to set.  
*or*  
Use the dial pad to enter the two digit option number.
3. Follow the display prompts to select the setting you prefer.

The following table explains each option that you can set. Options are listed in the order in which they appear in the Options list. The first column shows the option number and name. The second column shows the possible settings for each option. An \* indicates the default setting of an option. The last column explains how the settings for each option affects the way your phone works.

### Options chart

Number and Option	Settings (* = default)	Option function
01 Don't disturb	OFF* ON	Allows the phone to ring for internal and external calls. Stops the phone from ringing for external and internal calls. The telephone light still flashes for incoming calls from outside your Venture system.

## Options chart

Number and Option	Settings (*=default)	Option function
02 Receive page	ON * OFF	Allows the phone to receive pages. Stops the phone from receiving pages.
03 Hndfree ansr	ON *  OFF	When one phone is paged, this setting lets you answer the page automatically, without lifting the handset or pressing the Handsfree/Mute key.  When one phone is paged, this setting lets you answer the page by lifting the handset or by pressing the Handsfree/Mute key.
04 Contrast	level 4 * (levels 1 - 8)	Increases or decreases the contrast of the display on a scale from 1 (the lightest) to 8 (the darkest).
05 Headset	ON  OFF*	Enables you to make or answer calls through a headset plugged into the handset port on the back of the phone when you press the Handsfree key.  Provides dial tone through the Handsfree speaker or the handset.
06 Call timer	OFF*  ON	Turns off the Call timer.  Activates the Call timer so that call duration information replaces the date and time usually shown on the third line of your display. Call duration information is saved for the last call received on each line on your phone and for the last 10 calls you placed. See also "To view call duration information" on page 27.
07 Room monitor	OFF*  ON	Disables the Room monitor function.  Enables one phone to monitor the sounds in an area near another phone (such as a baby's room, or a reception area that is unattended) without ringing the phone. This option allows you to listen <i>only</i> . You cannot be heard when you speak. See also "Setting up a Room monitor" on page 18.

## Options chart

Number and Option	Settings (*=default)	Option function
08 Memory keys Prog		Stores Don't disturb, Page, Room monitor, or Call timer option to a memory key. For additional information, see "To save an option to a memory key" on page 27.
09 Secure number		When you secure a number, the private numbers (such as passwords, PINs [personal identification numbers], and access codes) that follow it are replaced with * to keep them from showing on your display. You can secure up to five 12-digit numbers.  For example if your bank PIN is 3333 and your bank phone number is 555-4444, make 555-4444 a secure number. Then when you call your bank your display will show <b>555-4444</b> and when you dial the PIN (3333) the display will show <b>*:*:**</b> .
10 Clear Msg. Wtg.		If you subscribe to the telephone service provider voice messaging service feature, and the <b>Message waiting</b> prompt and telephone light remain on after you have retrieved your messages, this options turns them off. If this does not work, see "You can't turn off the message waiting light" on page 39.
11 Prime is	Line 1 * (Line 2 or 3)  No Prime line	Sets up a line to be automatically selected each time you pick up the handset or press the Handsfree/Mute key. You can select line 1, 2 or 3 for your Prime line.  If you do not choose a Prime line, you will have to select a line to complete a call.
12 Answer line	Answer Prime  Answer Longest*	The Prime line is automatically selected when more than one line is ringing at the same time and you pick up the handset or press Handsfree without selecting a line.  The line that has been ringing the longest is automatically answered when more than one line is ringing at the same time.
13 Live dialpad	ON  OFF*	The numbers entered using the dial pad are automatically sent on the Prime line to make a call.  The numbers entered using the dial pad are displayed. You must manually select a line to make the call.

## Options chart

Number and Option	Settings (*=default)	Option function
14 Handset deflt.	ON *  OFF	When you change your phone's handset volume while you are on a call, the change lasts for the duration of that call only.  When you change your phone's handset volume while you are on a call, the volume change is saved.
15 Callers log	All calls* Unanswered calls No calls	All calls are logged. Unanswered calls are logged. No calls are logged. (This option is set for each line on your phone.)
16 Repeat caller	Combine calls *  Separate calls	This is available when you subscribe to Calling Line ID from your telephone service provider. The information for the same caller is displayed once and the number of times they called is listed beside it.  This is available when you subscribe to Calling Line ID from your telephone service provider. The information for each call is listed separately, regardless of how many times the same caller calls.
17 Area codes		Prevents selected area code information (received from incoming calls) from being dialed from your phone. The selected area codes will appear in parentheses on the display when incoming call information is viewed. You can select up to three 3- to 7-digit area codes.
18 Restrictions		Stops certain numbers (such as 1-900-555-3333) or numbers beginning with certain digits (such as long-distance calls starting with 0 or 1) from being called from your phone. You can restrict up to five 12-digit numbers.

## Options chart

Number and Option	Settings (*=default)	Option function
19 Overrides		Allows numbers that have been restricted through Option 18 to be called from your phone. For example, if you have restricted long-distance calls beginning with 1 or 0 from being dialed, you can allow 1-800 calls to go through. You can override up to five 12-digit numbers.
20 Ring tone	4* (1,2,3)	Enables you to select one of four styles of rings for <i>each</i> telephone line and intercom line on your phone.
21 Password		Creates an up to four-digit password that must then be used to view or modify the settings in the Options list. To delete a password, delete the numbers used. If you forget your password, see "You forgot your password" on page 39.
22 Lock lists	ON  OFF*	Disables the save, delete and change keys so that no one can change or delete the contents of a list or memory key. You can still erase all items in a Directory using Option 25.  Allows the contents of a list or memory key to be changed or deleted.
23 Phone ID		Enables you to change the two-digit number used to identify your phone to the system or to dial your phone from other phones in the system.
24 Phone name		Enables you to change the name used to identify a Venture phone in the Phone list.
25 Directory		Enables you to erase all items in either the Public Directory or one of the three Private Directories. This can be done even when Option 22, Lock lists is on.
26 Reset options		Enables you to reset all the options on your phone to the factory settings.

### Options chart

Number and Option	Settings (*=default)	Option function
27 Time/Date	(automatic)	If you subscribe to Calling Line ID from your telephone service provider, your first incoming call will set the time and date automatically.
	(manual)	Enables you to manually set the time and date on the display. If you subscribe to Calling Line ID, your first incoming call will reset the time and date.
28 Language choice	English* French, Spanish	Enables you to change the language used on the display to English, French or Spanish.
29 Versions		Displays the software versions used by your phone. This information is necessary when calling a telephone service provider or the Nortel help desk.
30 System test	Key test	When each key is pressed, this test displays a number to indicate that the key is functioning. Fifteen seconds after you stop pressing keys, this test will automatically end.
	LCD test	The display is filled to show that each information display area is functioning.
	LED test	Illuminates the lights on the phone to show that they are working.

**E**ach of the eight memory keys can be used to store a phone number, phone ID, telephone service provider feature or Venture option for quick and direct access. You can make calls, page other Venture phones and activate features using these keys.

## To save information

 **Note:** If the information you want to save is in one of your Venture lists, retrieve the item first. See “To retrieve an item” on page 29.

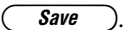

1. Press . Your display will show *Save to?*

 **Note:** If your display shows *Memory key is locked*, see option “22 Lock lists” on page 24.

2. Press a memory key. Your display shows *Enter number*. If the number is already on your display, skip to step 4. If both the



name and the number are already on the display, you are finished.

3. Enter a number using the dial pad.

 **Note:** To insert a two-second pause in the dialing sequence press .

4. Press . The display shows *Press 1st letter to enter name*. If the name is already on your display, skip to step 6.
5. Repeatedly press the dial pad key that has the letter or symbol that you want to use, until the display shows that letter or symbol.

, -'&() 1	A B C 2	D E F 3
G H I 4	J K L 5	M N O 6
P Q R S 7	; T U V 8	Æ W X Y Z 9
¥ * 0		£ #

 **Note:** To change to a capital or lowercase letter press .

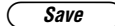
6. If the next letter or symbol is on the same key as the last one, or if you want to insert a space, press  to advance the cursor.
7. Repeat steps 1 and 2 until you have entered the name.
8. Press .

## To change information

1. Press the memory key.
2. Press  to change the information shown on the display.

 **Note:** If your display shows *Key is locked*, see option “22 Lock lists” on page 24.

3. Use  to backspace over the numbers or letters you want to

change and enter the correct information using the dial pad.

4. Press **Save**.

## To delete information

1. Press the memory key.
2. Press **Delete** twice.

 **Note:** If your display shows **Key is locked**, see option “22 Lock lists” on page 24.

 **Note:** You cannot delete an option saved to a memory key. To reuse the memory key, save new information over the option.

## To make a call using a memory key

1. Lift the handset or press the Handsfree key.
2. Press the memory key for the number that you want to call.

 **Note:** When a phone ID is stored to a memory key, the light for that memory key lights when that phone is already in use.

## To activate an option or feature using a memory key

- Press the memory key on which the option or feature that you want is stored. The option is activated and the memory key light is on.

 **Note:** When you have saved Call timer to a memory key, you can display the duration of a call while it is in progress.

## To page one phone

1. Press the memory key for the Venture ID number you want to call for two seconds.
2. Wait for the tone to end.

3. Speak into the handset or the Handsfree microphone.
4. Hang up or press **Goodbye** to end the page session.

## To view call duration information

When you use the Call timer option to time calls, the call duration information on the last 10 calls you made is stored in the Redial list.

1. Press **Redial**.
2. Press  repeatedly until the display shows the list item you want to see.
3. Press the memory key to which you stored the Call timer option.

## To save an option to a memory key

You can save the Don't disturb, Page, Room monitor or Call timer options to a memory key. This will enable you to turn these options on or off by



pressing the memory key. When one of these options is saved to a memory key, the light beside it will light when the option is activated.

1. Press **Options**.
2. Press **▼** repeatedly until the display shows *Memory keys prog.*
3. Press **¥**.
4. Press **▼** repeatedly until the display shows the option you want to save.
5. Press **¥**. The display shows *Press memory key.*
6. Press the memory key you want to use. The display shows *Saved: Memory key* and the name of the option you saved.

### To turn a feature on or off

Some telephone service provider features have two codes—one to turn the feature on and one to turn the

feature off. You must save each code to a separate memory key.

### For each memory key

1. Press **Save**.
2. Press a memory key.
3. Use the dial pad to enter the telephone service provider code to turn the feature on or the code to turn the feature off.
4. Press **Save**.
5. Use the dial pad to enter the feature name.
6. Press **Save**.

### To turn a feature and light on or off

The telephone light on your phone can be programmed to turn on or off with *one* of the telephone service provider features (such as Call Forward) that you program to a memory key or to the Services list.

The feature and the light must be turned on together.

### For each memory key





1. Press **Save**.
2. Press **▲** to turn the light on or, to turn the light off. The display shows *Save feature ON* (or *OFF*) to.
3. Press a memory key.
4. Use the dial pad to enter the telephone service provider code to turn the feature on or the code to turn the feature off.
5. Press **Save**. The display shows *Press 1st letter to enter a name.*
6. Use the dial pad to enter the feature name.
7. Press **Save**. The display shows *Saved: Memory key* and the name of the feature.

**T**he Venture Directory, Phone list, Redial list, Callers list and Services list are information storage and access areas. You can use the information stored in these lists to place calls and activate features.

- The **Phone list** stores the name and ID of every phone in a Venture system.
- The **Directory** stores 200 names and phone numbers.
- The **Redial list** stores information on the last 10 calls dialed from a Venture phone.
- The **Callers list** stores information on the last 200 calls received by a Venture phone.
- The **Services List** stores information on up to 20 telephone service provider features.

 **Note:** For more specific information about size and characteristics of these storage areas, see “List descriptions” on page 34.

### To retrieve an item



1. Press , ,  or  to access the list. If the number is in the Phone list, skip to step 3.

 **Note:** If you receive an incoming call while you are in any list, you will be bumped out of the list.

2. To go to a Directory or Callers sublist, press  to locate the sublist that you want.

 **Note:** To locate a name in the Directory quickly, press the key with the first letter of the name until the letter appears on your display.

3. Press  or  to find the item.

 **Note:** You can press  at any time to exit a list.

### To make a call or activate a feature

1. Retrieve the item.

 **Note:** If the phone number on the display is not exactly what you would dial (for example a required area code is missing, or an area code that you do not need is included) see, “To change information” on page 29.

2. Press .
3. If you are activating a feature, follow the instructions provided by your telephone service provider.

### To change information



 **Note:** Phone list information can only be changed by the owner of

a phone using options “23 Phone ID” or “24 Phone name” on page 24.

1. Retrieve the item. If you are in the Redial list skip to step 4.
2. Press **Change**.

 **Note:** If your display shows *List is locked*, see option “22 Lock lists” on page 24.

3. Follow the display prompts to locate the information you want to change.

 **Note:** For the Callers list enter the numbers you wish to dial before the number on the display or use  to delete numbers you do not wish to dial. You can now press  to dial.

4. Press **¥**.
5. Use  to backspace over the letters you want to change. Enter

the correct information using the dial pad.

6. Press **Save**.

 **Note:** If Lock lists is turned on, your display will show *List is locked* No changes made. To turn Lock lists off, see Option “22 Lock lists” on page 24.

### To save information

 **Note:** If the information you want is in another list, see “To save information from another list or a memory key” on page 31.

1. Press **Save**. Your display shows *Save to?*

 **Note:** If your display shows *List is locked*, see option “22 Lock lists” on page 24.

2. Press **Directory** or **Services**. Your Directory display shows *Enter number*. Your Services display shows *Enter feature code*.



3. Enter the number you want to save using the dial pad.





 **Note:** To insert a two-second pause in the dialing sequence press **Hold**.

4. Press **Save**. The display shows *Press 1st letter to enter name*. If you do not want to enter a name, go on to step 8.
5. Repeatedly press the dial pad key that has the letter or symbol that you want to use, until the display shows that letter or symbol.

, - ' & . ( ) 1	A B C 2	D E F 3
G H I 4	J K L 5	M N O 6









P	Q	R	S	7	;	T	U	V	8	Æ	W	X	Y	Z	9
¥	*				0					£	#				

 **Note:** To change to a capital or lowercase letter press .



6. If the next letter or symbol is on the same key as the last one, or if you want to insert a space, press  to advance the cursor.
  7. Repeat steps 1 and 2 until you have entered the name.
  8. Press . If you are saving to the Directory, the display shows *Save to?* Use  to choose.
-  **Note:** If you are saving to the Services list, you are finished.
9. Press  to locate the directory to which you want to save the information.

10. Press .

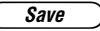
### To save information from another list or a memory key

1. Press , , ,  or a memory key where the information is stored. If the number is in the Phone list, skip to step 3.
2. If you are in a list with sublists (such as the Directory), press  or  to locate the sublist you want.
3. Press  or  to find the phone number you want to save.
4. Press . The display shows *Save to?*

 **Note:** If your display shows *List is locked*, see option “22 Lock lists” on page 24.

5. Press  or . If you are saving to the Directory, the display shows *Save to?* Use  to choose.

 **Note:** If you are saving to the Services list, you are finished.

6. Press  to locate the directory to which you want to save the information.

 **Note:** If you have saved information to a new location and no longer want it in the original location, you must delete it from the original location.

### To delete information

1. Retrieve the item.
2. Press  twice. The display shows *Item erased*.



 **Note:** If your display shows *List* is locked, see option “22 Lock lists” on page 24.

- Follow the prompts on the display to complete the action.

### To turn a feature on or off in the Services list

Some telephone service provider features have two codes—one to turn the feature on and one to turn the feature off. You must save each code to a space in the Services list or to a memory key. For more information on saving to a memory key, see “To turn a feature on or off” on page 28.

#### To save each code

- Press .
- Press . The display shows *Enter feature code*.
- Use the dial pad to enter the telephone service provider code

to turn the feature on or the code to turn the feature off.

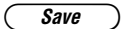
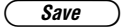



- Press . The display shows *Press 1st letter to enter name*.
- Use the dial pad to enter the feature name.
- Press . The display shows *Saved: Services* and the name of the feature.

### To turn a feature and light on or off

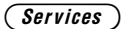
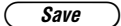

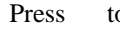
The telephone light on your phone can be programmed to turn on or off with *one* of the telephone service provider features (such as Call Forward) that you program to a memory key or to the Services list.

#### To save a code and a light setting

- Press .
- Press .

- Press  to turn the light on or, to turn the light off. The display shows *Save feature ON (or off) to?*
- Press .
- Use the dial pad to enter the telephone service provider code to turn the feature on or the code to turn the feature off.
- Press . The display shows *Press 1st letter to enter a name*.
- Use the dial pad to enter the feature name.
- Press . The display shows *Saved: Services* and the name of the feature.

### To name a Private Directory

- Press .
- Press  or  to locate the Private Directory (Directory A, B, or C).

3. Press **Change**.
4. Enter the name. (See step 5 in “To save information” on page 30.)
5. Press **Save**.

### To delete a Directory

1. Press **Options**.
2. Press **▼** repeatedly until the display shows 25 Directory.  
**▼**=Next \*=**Erase**
3. Follow the display prompts.

### To set up your Callers lists

To control the type of call information you want to record and the way it is recorded in your Callers list, see Option “15 Callers log” on page 23 and Option “16 Repeat caller” on page 23.

### Callers list display information

When you subscribe to Calling Line Identification from your telephone

service provider, when your phone rings your display looks like this.





The *first line* shows the list number (001 to 200) and the name of the caller.

 **Note:** If the phone number of a call received matches one that you have programmed on a memory key or in the Directory, the Callers list displays the name as listed in the Directory or on the memory key.

The *second line* shows the type of call, the phone number of the caller and ^ if you have returned the call.

### Type of call icons

 You answered this incoming call.

 You did not answer this incoming call.

 You were on another call when this call came in on the line you were using.

The *third line* indicates if the call displayed is new, the date and time of the most recent call, whether the call was long-distance, and how many times the caller has called.

### Icons on the third line

**N** The call is new.

 The call is long distance.

**4X** The caller called four times.

### To delete a Callers list

1. Press **Callers**.
2. Press **Delete** twice.

## List descriptions

The **Phone list** includes the phone ID and name of each phone in a Venture system. As new Venture phones are added to your system this information is automatically added to your Phone list.

The information in the Phone list is stored in your Public Directory. The Phone list can also be accessed by pressing  when the phone is not in use.

The **Redial list** stores the last 10 numbers you have dialed from your phone. It also stores the time each call was made and the duration of the call. Numbers in the Redial list can be modified for use in dialing; however, changed numbers can only be saved into the Directory or to a memory key.

The **Callers list** records call information for up to 200 incoming calls provided by the telephone

service provider when you subscribe to Calling Line ID.

The Callers list can be set to record information on all calls, unanswered calls or no calls. In addition, call information can be grouped so that a caller's name appears only once with the number of times he or she tried to reach you, or so that each call is listed separately.

The Callers list consists of a main list, which includes all call information stored, and four sublists, one for each telephone line in your system and one for the intercom line. If a line is shared with other phones, the Callers list for that line appears on every phone with that line.

If you do not subscribe to Calling Line ID and Callers list is activated, only internal calls will be logged.

The **Directory** stores up to 200 numbers and names. The Directory

includes five sections: a main list, which includes all shared and private directory information for this phone; the Public Directory which includes all phones in your system and all numbers shared by all telephones in the system; and three Private Directories, which are unique to each phone. Each Private directory can be named, and each Directory indicates how many items it currently contains.

You can save information directly to any of your Directories and view information in either one of your Directories or the main list. Entries saved to each Directory that includes only a phone number are listed first in the Directory and are sorted by first digit. For example, 555-4111 appears before 555-8989. Entries that include a name and a number are listed after the numeric listings and are sorted by name alphabetically.

The number of items in a shared Public Directory affects the number

of items that can be stored in the three Private Directories of each phone in the system. For example, if the Public Directory has 50 items in it, each user has 150 spaces for use in Private Directories.

The **Services list** can store the feature codes and names of up to 20 telephone service provider features (such as Call Forward or Call Return).

Telephone service provider features are offered by subscription or on a pay-per-use basis. For more information about features offered in your area, contact your telephone service provider.



**T**he following status messages may be displayed when the handset is on hook.

If you have more than one status message, you can view additional messages using ►. When you clear one status message from the display, the next one appears.

## Status message descriptions

### Check line cord

A line cord may be damaged, not plugged in, or otherwise disabled.

### Copying... directory

The Public Directory in the existing Venture system is being copied to this phone.

### Don't disturb ON

The Don't disturb option is on and your phone will not ring aloud for incoming calls.

### Feature ON

When you program Feature On to your Services list or to a memory key, this message reminds you that a telephone service provider feature (such as Call Forward) has been activated.

### Line x Reserved

This message means that you have reserved line 1, 2 or 3.

### Message Waiting on line X

If you subscribe to voice message services from your telephone service provider, your phone display indicates when you have a message waiting, and on which line the message is stored.

### xxx New Callers

Indicates the number of new callers that have been added to your Callers list since you last reviewed it.

### xx New Phone(s)

Indicates the number of new phones that have been added to your Venture system.

### xx New Services

Indicates the number of new services that have been added to your Services list.

### Ringer is OFF

The ringer for a line or intercom is turned off on your phone.

### xx Calls Bumped

Indicates the number of calls that have been dropped from your Callers List.

**T**roubleshooting is designed to help you overcome difficulties that may occur when installing and using a new Venture 3-line phone.

### Blank display

Your display is blank and the lights on your phone are not working.

1. Check that the power adapter is plugged into a working power outlet and that proper connections have been made to the CAM.
2. Be certain that you have an 8-wire cord connected from the CAM to your Venture phone.

### Display language error

1. Press **Options**.
2. Press 28.
3. Press  $\yen$  .

4. Press **☐** repeatedly until your display shows the language you want.
5. Press  $\yen$  .

### No dial tone

1. Check the connections of line cords from the phone jack to the CAM and from the CAM to your Venture phone.
2. Ensure that working telephone lines are connected to the wall jack(s).
3. If you have a dial tone on the handset but not when you are using the Handsfree speaker, turn off the headset using option 05. If **Headset** is on, the Handsfree speaker is disabled.
4. If you have dial tone on the Handsfree speaker but not when you are using the handset, ensure that the handset cord is firmly plugged into the handset and the

handset jack on the back of your phone.

### Communication problems

You have more than one Venture phone linked together, and you experience any of the following:

- Other phones do not appear on your phone list.
- Your display shows ... as the status of other phones in your system.
- Public directory information is not shared.
- You experience difficulty calling other Venture phones. Your display shows Phone not responding when you try to place an intercom call or page other phones.
- You hear clicking noises when calling other Venture phones.

In order to communicate, all Venture phones must share the same telephone line as line 1.

- To ensure that the same telephone line is connected to line 1 on all Venture phones you can
  - Press **Line 1**.
  - If you do not hear dial tone, see “No dial tone” on page 37.
  - If you hear dial tone, check every Venture phone — the **Line 1** indicator light should be turned on.
  - If the **Line 1** indicator light is not turned on, verify that the jacks are wired correctly and the line cords are connected correctly, see “Appendix” on page 45.
- Press **Goodbye**.
- Press **⏏**. For every Venture phone in your system, the

display should show the **Name** assigned to the phone, **Phone xx** and one of four possible status messages:

- idle** — the phone is not in use
  - busy** — the phone is in use
  - owner** — this is the phone you are using
  - ...** — the phones aren’t communicating or that phone has been removed from the system
- Call your phone from any Venture phone that does not appear in the Phone list.
  - If the call was placed successfully, the phone will now appear in the Phone list. Repeat step 3 to verify.
  - If all the phones appear in the Phone list, call each phone. If you don’t encounter problems, you are finished. If your display

shows, **Phone not responding** or you hear clicking noises, see “Interference caused by non-Venture phones or unused telephone jacks” on page 38.

## Interference caused by non-Venture phones or unused telephone jacks

Some non-Venture equipment connected to the telephone line that is used as line 1 on your Venture system can cause interference. Follow these steps to eliminate those problems:



- Following the installation instructions included with the termination module, plug a termination module into **every** phone jack in your home or office that is not used for a Venture phone.



**Note:** Do not plug your Venture phones into a termination module.

 **Note:** If you require more termination modules than those supplied with your phones, call 1-800-574-1611 to order additional modules.

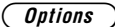
### Duplicate ID is displayed for unexplained reason

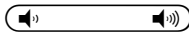

1. Press .
2. Enter 23. The display shows, Phone Id  
 = next \* = change
3. Press  $\yen$  .
4. Enter your two-digit ID.
5. Press  $\yen$  .
6. If the display shows Duplicate ID again, repeat steps 1 to 5 using a different number.

### You can't hear

Use  to adjust the volume of the handset, the Handsfree speaker or both.

### You forgot your password

You can't enter the Options list because you have forgotten the password.

1. Press . The display reads  
Please enter password .
2. Enter the month, date and hour (in 24 hour format) displayed on the phone.

If your phone is displaying FEB 21 3:45pm, the password would be 02211545.

3. Press  repeatedly until your display shows 21 Password.
4. Press  $\yen$  . The display shows Password > and the number.

### Your caller can't hear you

1. If you are using the handset, check the handset cord connections.

2. If you are using the Handsfree speaker, make sure that you have not muted it. The light beside the Handsfree/Mute key flashes when mute is turned on.

### You can't dial from the Callers list

You can dial a number in the Callers list, but the call does not connect or you get a recorded announcement.

- You may need to add or delete a long-distance prefix or an area code. See "To change information" on page 29.

### You can't turn off the message waiting light

Your message waiting light cannot be turned off using Option, "10 Clear Msg. Wtg." on page 22.

The problem is related to the type of message waiting signalling provided by your telephone service provider, and not with your Venture phone.

- Report the problem to your telephone service provider.

**T**he Venture phone is fully supported by Aastra Telecom.

### **Warranty and repairs**

If you have a problem with your phone, return it to where it was acquired.

### **Cleaning the display**

Use only a soft cloth soaked in isopropyl alcohol to clean the display.

**Warning:** Do *not* use a dry cloth—it might scratch the surface. Do *not* use ketone, acetone, toluene or xylene. They may damage the coating.

### **General inquiries**

If you have read this guide and have questions, visit our web site at <http://www.aastra.com>, or call 1-800-574-1611.

**Action key** This key (●) is located in the center of the arrow keys on the right side of your Venture phone. It is used to dial anything on your display or to change options.

**Call log** This is another name for the Callers list.

**Call Waiting** This is a telephone service provider feature to which you can subscribe. The phone beeps, letting you know that a call is waiting. If you also have Calling Line ID, the display shows who is calling. You can choose to take the second call or to continue with the first call.

**Calling Line ID (CLID)** This is a telephone service provider feature to which you can subscribe. It provides information (usually the name and phone number of the caller) on incoming calls. This information is shown on your Venture phone

display and stored in your Callers list.

**Conference calling** A three-way call between you and callers on two other lines. On your Venture phone you can conference two separate phone lines or one phone line and an intercom line.

**Connecting block** A plastic block containing metal wiring terminals that connect one group of wires to another. Each wire is usually connected to several other wires in a bus (an electrical connection that allows two or more wires or lines to be connected together) or in a common arrangement.

**Daisychain** A method of connecting devices in a series. The phone signal is passed through the chain from one device to the next.

**Differentiated ring** This is a telephone service provider feature to

which you can subscribe. It enables you to have a second phone number with a unique ring on a single phone line.

**Display prompts** Instructions shown on your display.

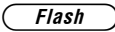
**Flash** This Venture feature works like a break in the phone line connection. For example, if you subscribe to Call Waiting or Calling Line ID from your telephone service provider, when you are on a call and second call comes in on the same line, you can press  to answer the other call.

**Home run (Star)** Phone system wiring in which the individual cables run from each phone to a connecting block where your phone lines are brought into your building.

**KSU-less systems** Systems, like Venture, that include only phones directly linked to each other so that

they can call each other and share information and lines.

**Lists** Information storage areas from which information can be used to place calls and activate features.

**Lock lists** A security feature that prevents unauthorized users from deleting or changing items in lists, such as your Directory or Callers list.

**Memory key** Eight memory keys are located on the lower right side of your Venture phone. When programmed with a number, a memory key enables you to dial frequently called numbers by pressing the memory key twice. Memory keys can also be used to activate telephone service provider and Venture features.

**Message Waiting** If you subscribe to a call messaging service from your telephone service provider, you will see this prompt on

your display when a message has been left for you.

**Navigational keys** The four arrow keys that surround the action key (●): ▲, ▼, ► and ◀. With these keys you can move up, down, and sideways through the Callers list, Directory, Phone list, Redial list and Services list.

**Non-square** In the Venture system, a system configuration in which the first line must be the same on all the phones, but the other lines can be arranged in any order.

**Phone list** The name and identification number of all phones in a Venture system are automatically stored in this list. You can view Phone list information by pressing ▼ when your phone isn't busy, or by accessing your Public Directory.

**POTS** Plain Old Telephone Service is what you receive during a power

failure. You can receive and make calls on line 1, but you cannot use any other lines or features. The display on your phone is blank when your phone is operating in POTS mode.

**Square system** A system configuration in which the same lines in the same order appear on each phone.

**Star** See Home run.

**Teledapt jack** A wall jack that is the termination point for the telephone lines being connected to phones or other communications equipment in a building.

**Termination module** An Aastra solution to problems that sometimes occur when analog phones share lines with phones in any KSU-less system.



**Tip and ring** The pair of wires provided for each telephone line from the telephone service provider's central office.

**Twisted pair** Two insulated copper wires twisted around each other to reduce interference.

**T**his appendix is intended for use by installers or individuals with system wiring experience. It provides in-depth information required to complete the wiring of a Venture system, from the connecting blocks through the jacks and the Venture cord adapter module (CAM) to a Venture phone. It also provides information relevant to new installations and previously wired facilities.

## Running cable to phone jacks

The following factors should be considered when new wiring is required for new installations or to provide additional phone lines.

- The same telephone service provider line must appear as line 1 on each phone so that the phones in the system can communicate.
- Three (or more) twisted-pair cable is recommended.

- Running cable from the connecting blocks to each telephone (a home run configuration) is recommended.
- Running a cable from one phone to the next (a daisychain configuration) is also supported, although it may cause more work if the system is modified later.
- Individual cables for each phone line can also be run; however, there is no advantage in incurring the additional expense.

## Wiring the jacks

- One jack for each telephone is recommended.
- On a standard 6-pin teledapt jack, the lines terminate on the tip and ring pins as follows: line 1—green and red pins, line 2—black and yellow pins, line 3—white and blue pins.

 **Note:** Wire color may vary from region to region.

## Connecting the cord adapter module (CAM)

The CAM connects the phone lines and the power adapter to the Venture phone through one 8-wire cord. The CAM has three line ports, labeled as port 1, port 2 and port 3.

- Port 1 provides a connection to Venture lines 1,2 and 3.
- Port 2 provides a connection to Venture lines 2 and 3 only.
- Port 3 provides a connection to Venture line 3 only.

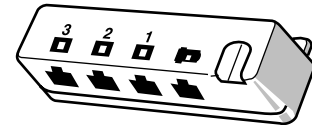

The phone port, located next to port 1, is used to connect the CAM to the phone. The power port, located on the top of the CAM, is used to connect the CAM through the power adapter to an electrical outlet.

## **Two jack examples**

The following two examples explain how to connect three telephone service provider lines terminated on two jacks to a CAM. Other more simple configurations, shown only from the jack to the phone, are explained in “Getting started” on page 5.

Applying the instructions presented in these two examples should enable you to connect telephone service provider lines from the connecting blocks in a building to the CAM for any configuration. If you require more information, call 1-800-574-1611.

**Line 1 on a separate jack and lines 2 and 3 on one jack**

1. Connect line 1 to the red and green pins of the first teledapt jack.
2. Connect one end of a 6-wire cord to the first teledapt jack and the other end to port 1 on the CAM.
3. Connect line 2 to the red and green pins of the second teledapt jack.
4. Connect line 3 to the black and yellow pins of the second teledapt jack.
5. Connect one end of the 6-wire cord to the second teledapt jack and the other end to port 2 on the CAM.

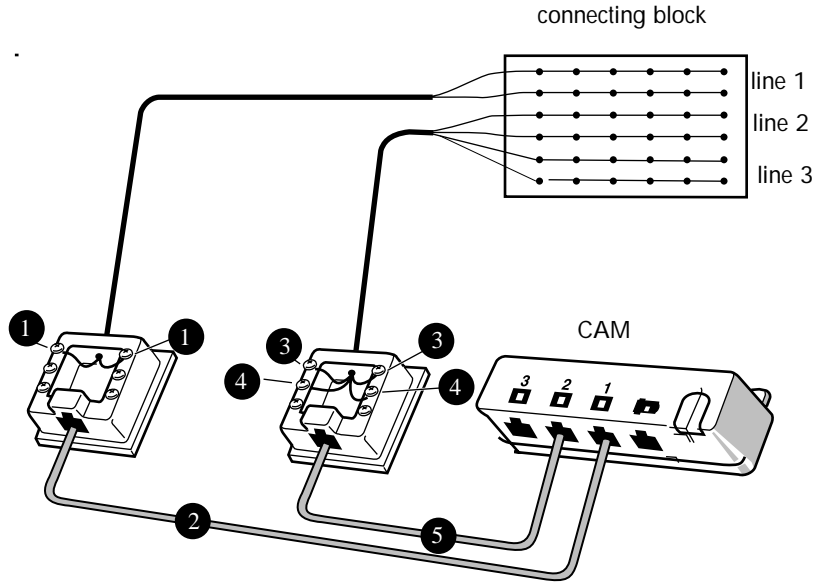

### Lines 1 and 2 on one jack and line 3 on a separate jack

1. Connect phone line 1 to the red and green pins of the first teledapt jack
2. Connect phone line 2 to the black and yellow pins of the first teledapt jack.
3. Connect one end of the 6-wire cord to the first teledapt jack and the other end to port 1 on the CAM.
4. Connect line 3 to the red and green pins of the second teledapt jack.
5. Connect one end of the 6-wire cord to the second teledapt jack and the other end of the line cord to port 3 on the CAM.

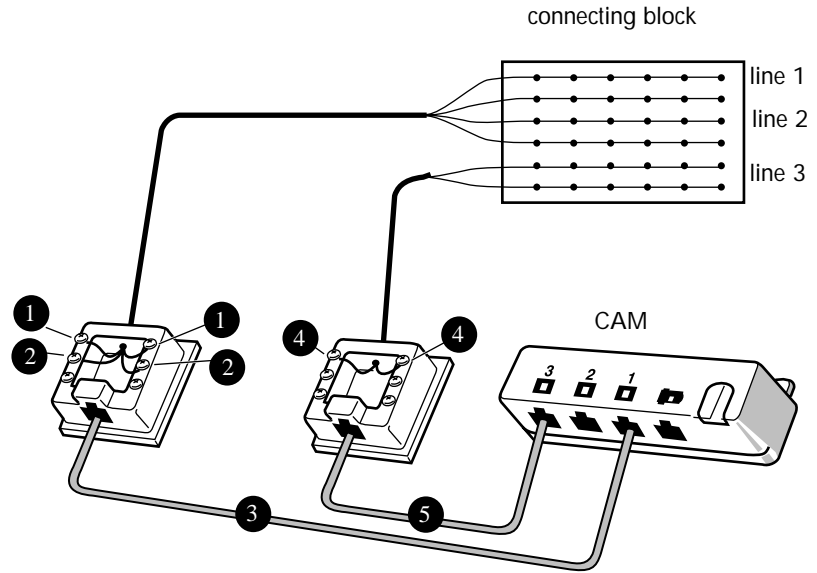

## Canadian regulatory information

### Industry Canada Notice

The Industry Canada label identifies certified equipment. This certification means that the equipment meets certain telecommunications network protective, operational and safety requirements. The Department does not guarantee the equipment will operate to the user's satisfaction.

Before installing this equipment, users should ensure that it is permissible to be connected to the facilities of the local telecommunications company. The equipment must also be installed using an acceptable method of connection. The method of connection approved for this equipment as designated by D.O.C. Standard CS-03 is a CA11A/CA14A or CA11W/CA14W connection arrangement. The A or W suffix

indicates that either desk or wall mounting is approved. In some cases, the company's inside wiring associated with a single line individual service may be extended by means of a certified jack-plug-cord ensemble (telephone extension cord). The customer should be aware that compliance with the above conditions may not prevent degradation of service in some situations.

Existing telecommunications company requirements do not permit their equipment to be connected to customer provided jacks except where specified by individual telecommunications company tariffs.

Repairs to certified equipment should be made by an authorized Canadian maintenance facility designated by the supplier. Any repairs or alterations made by the user to this equipment, or equipment malfunctions, may give the

telecommunications company cause to request the user to disconnect the equipment.

Users should ensure for their own protection that the electrical ground connections of the power utility, telephone lines and internal metallic water pipe system, if present, are connected together.

This precaution may be particularly important in rural areas.

**CAUTION:** Users should not attempt to make electrical ground connections themselves, but should contact the appropriate electric inspection authority, or electrician, as appropriate.

**NOTICE:** The Load Number (LN) assigned to each terminal device denotes the percentage of the total load to be connected to a telephone loop which is used by the device, to prevent overloading. The termination

of a loop may consist of any combination of devices subject only to the requirement that the sum of the LN of all the devices does not exceed 100.

This telephone has been tested and found to comply with the limits for a Class B digital device in accordance with the Canadian EMI requirement ICES-003.

**CAUTION:** To eliminate the possibility of accidental damage to cords, plugs, jacks and the telephone, do not use sharp instruments during the assembly procedures.

**WARNING:** Do not insert the plug at the free end of the receiver cord directly into a wall or baseboard jack. Such misuse can result in unsafe sound levels



The exclamation point within an equilateral triangle is intended to alert the user to the presence of important operating and maintenance (servicing) instruction in the literature accompanying the product.

This symbol on the product is also used to identify the following important information:

***Shock Hazard Warning:***

To avoid potential electrical shock hazard to personnel or damage to the telephone, use only the manufacturer supplied equipment and installation procedures. Specifically, use only 6 conductor modular Teladapt plug/cords with this product, and the AC transformer must be CSA/UL or CSA-NRTL/C approved Class 2, level C, rated as follows:

For North American Markets mains nominal AC voltage 110-117V:

For Venture- Input: 117/120VAC, 50/60Hz, 12W and Output: 16VAC 500 mA.

For International Markets mains nominal AC voltage 220-240V:

For Venture- Input: 220/240VAC, 50/60Hz, 12W and Output: 16VAC 500 mA.

Substitution of non approved equipment will void the Aastra warranty.

For address for warranty and repairs in Canada:

Please call Aastra Telecom at 1-800-574-1611

U.S. regulatory information

### ***Radio/TV interference***

Terminals equipped with electronic push-key dials generate and use radio frequency energy, and if not installed and used properly and in strict accordance with the manufacturer's instructions, may cause interference to radio and television reception.

These terminals have been tested and found to comply with the limits for a Class B digital device in accordance with the specifications in Part 15 of the FCC rules. While these rules are designed to provide reasonable protection, there is no guarantee that interference will not occur in a particular installation. You can determine whether interference occurs by monitoring your radio or television reception while placing a call.

If your terminal causes interference, one of the following measures may correct the problem:

Reorient or relocate the receiving TV or radio antenna, where this may be done safely.

To the extent possible, move the telephone and the radio or television farther away from each other, or connect the telephone and the radio or television to outlets on separate circuits.

Consult the dealer or an experienced radio/television technician for additional suggestions.

### ***Federal Communications Commission (FCC) notice***

FCC registration number: This telephone equipment complies with Part 68, Rules and Regulations, of the FCC for direct connection to the Public Switched Telephone Network. (The FCC registration number appears on a sticker affixed to the bottom of the telephone.)

 **Note:** FCC registration does not constitute an expressed or implied guarantee of performance.

Your connection to the telephone line must comply with these FCC rules:

Use only an FCC standard RJ11W/RJ14W or RJ11C/RJ14C network interface jack and FCC compliant line cord and plug to connect this telephone to the telephone line. (To connect the telephone, press the small plastic tab on the plug at the end of the telephone's line cord. Insert into a wall or baseboard jack until it clicks. To disconnect, press the tab and pull out.)

If a network interface jack is not already installed in your location, you can order one from your telephone company. Order RJ11W/RJ14W for wall-mounted telephones or RJ11C/RJ14C for desk/table use. In some states, customers are permitted to install their own jacks.



Your telephone may not be connected to a party line or coin telephone line. Connection to Party Line Service is subject to state tariffs. (Contact the state public utility commission, public service commission or corporation commission for information.)

It is no longer necessary to notify the Telephone Company of your phone's Registration and REN numbers. However, you must provide this information to the telephone company if they request it.

If this terminal equipment causes harm to the telephone network, the telephone company will notify you in advance that temporary discontinuance of service may be required. If advance notice isn't practical, the telephone company will notify the customer as soon as possible. Also, you will be advised of your right to file a complaint with the FCC if you believe it necessary.

The telephone company may make changes in its facilities, equipment, operations or procedures that could affect the operation of the equipment. If this happens the telephone company will provide advance notice in order for you to make necessary modification to maintain uninterrupted service.

Do not attempt to repair this equipment yourself. If trouble is experienced with this equipment, for repair or warranty information please contact 1-800-574-1611 or write to Aastra Telecom  
155 Snow Blvd.  
Concord, Ontario  
L4K 4N9.

If the equipment is causing harm to the telephone network, the telephone company may request that you disconnect the equipment until the problem is resolved.

**Signaling method:** The unit's push-key dial allows it to signal in tones (DTMF). It can complete calls to local and long distance lines and can also complete long distance calls via computer-phone systems such as MCI or SPRINT.

**Ringer Equivalence Number:** The FCC Registration label (on bottom of phone), includes a Ringer Equivalence Number (REN), which is used to determine the number of devices you may connect to your phone line. A high total REN may prevent phones from ringing in response to an incoming call and may make placing calls difficult. In most areas, a total REN of 5 should permit normal phone operation. To determine the total REN allowed on your telephone line, consult your local telephone company.

**Hearing aids:** The telephone is compatible with hearing aids equipped with an appropriate telecoil

option and is compliant with the requirements for hearing aid compatibility of the Americans with Disabilities Act (ADA).

Programming emergency numbers: When programming emergency numbers and/or making test calls to emergency numbers:

1. Check with local authorities before making any test calls to emergency numbers.
2. Remain on the line and briefly explain to the dispatcher the reason for calling before hanging up.
3. Perform such activities in the off-peak hours, such as early mornings or late evenings.

### **CSA-NRTL/C installation instructions**

**Warning:** Avoid electrical shock hazard to personnel or equipment damage observe the following

precautions when installing telephone equipment:

1. Never install telephone wiring during a lightning storm.
2. Never install telephone jacks in wet locations unless the jack is specifically designed for wet locations.
3. Never touch uninsulated telephone wires or terminals unless the telephone line has been disconnected at the network interface.
4. Use caution when installing or modifying telephone lines.

### **Important safety instructions**

When using your telephone equipment, basic safety precautions should always be followed to reduce risk of fire, electric shock and injury to persons, including the following:

1. Read and understand all instructions.
2. Follow the warnings and instructions marked on the product.
3. Unplug this product from the wall outlet before cleaning. Do not use liquid cleaners or aerosol cleaners. Use a damp cloth for cleaning.
4. Do not use this product near water, for example, near a bath tub, wash bowl, kitchen sink, or laundry tub, in a wet basement, or near a swimming pool.
5. Do not place this product on an unstable cart, stand or table. The product may fall, causing serious damage to the product.
6. This product should never be placed near or over a radiator or heat register. This product should not be placed in a built-in installation unless proper ventilation is provided.

7. Do not allow anything to rest on the power cord. Do not locate this product where the cord will be abused by persons walking on it.

8. Do not overload wall outlets and extension cords as this can result in the risk of fire or electric shock.

9. Never spill liquid of any kind on the product.

10. To reduce the risk of electric shock do not disassemble this product, but have it sent to a qualified service person when some service or repair work is required.

11. Unplug this product from the wall outlet and refer servicing to qualified service personnel under the following conditions:

(A) When the power supply cord or plug is damaged or frayed.

(B) If the product has been exposed to rain, water or liquid has been

spilled on the product, disconnect and allow the product to dry out to see if it still operates; but do not open up the product.

(C) If the product housing has been damaged.

(D) If the product exhibits a distinct change in performance.

12. Avoid using a telephone during an electrical storm. There may be a remote risk of electric shock from lightning.

13. Do not use the telephone to report a gas leak in the vicinity of the leak.

14. **CAUTION:** To eliminate the possibility of accidental damage to cords, plugs, jacks, and the telephone, do not use sharp instruments during the assembly procedures.

15. **WARNING:** Do not insert the plug at the free end of the handset

cord directly into a wall or baseboard jack. Such misuse can result in unsafe sound levels or possible damage to the handset.

16. Save these instructions.



The exclamation point within an equilateral triangle is intended to alert the user to the presence of important operating and maintenance (serving) instruction in the literature accompanying the product.

This symbol on the product is used to identify the following important information:

### Shock Hazard Warning:

To avoid potential electrical shock hazard to personnel or damage to the telephone, use only the manufacturer supplied equipment and installation procedures. Specifically, use only 6-conductor modular Teladapt plug/cords with this product, and the AC

transformer must be CSA/UL or CSA-NRTL/C approved Class 2, level C, rated as follows:

For North American Markets mains nominal AC voltage 110-117V:

For Venture- Input: 117/120VAC, 50/60Hz, 12W and Output: 16VAC 500 mA.

For International Markets mains nominal AC voltage 220-240V:

For Venture- Input: 220/240VAC, 50/60Hz, 12W and Output: 16VAC 500 mA.

Substitution of non approved equipment will void the Aastra warranty.

### ***Warranty and repair***

If you have several telephones and you are having problems with all of them, or if your telephone works in some outlets and not in others, your problem may originate with the local

telephone lines or with central office equipment. Contact your telephone company repair service listed in the front of your phone book.

Should the terminal fail during the twelve month warranty period, please return it for repair to the manufacturer, or to the authorized agent as specified in the product literature. You will be responsible for shipping charges, if any, and for presenting proof of your telephone's date of purchase.

If the terminal is covered by a Telephone Company Maintenance Agreement, follow the procedure set forth in the Maintenance Agreement for obtaining repair or replacement of the terminal.

If the terminal is no longer covered by the manufacturer or its authorized agents' Warranty, and is not covered by a Telephone Company Maintenance Agreement, you may

return the terminal to the manufacturer or its authorized agents for repair or refurbishment. You will be billed for any repairs.

Repair to this equipment can only be made by Aastra Telecom Inc. and its authorized agents, and by others who may be authorized by the FCC. Questions about the warranty or requests for the manufacturer's policy and procedure on repair and refurbishment should be directed to the manufacturer or authorized agent as specified in the product literature.

### ***Manufacturer's limited twelve month warranty***

**Coverage:** The manufacturer warrants this terminal against defects and malfunctions for a period of twelve months from the date of original purchase. If there is a defect or malfunction, Aastra Telecom Inc. or its authorized agents will, at its option, and as the exclusive remedy, either repair or replace the terminal at

no charge if returned within the warranty period.

If replacement parts are used during repair, these parts may be refurbished or may contain refurbished materials. If it is necessary to replace the terminal, it may be replaced with a refurbished terminal of the same design and color. If it should become necessary to repair or replace a defective or malfunctioning terminal set under this warranty, the provisions of this warranty shall apply to the repaired or replaced terminal until the expiration of ninety (90) days from the date of pick-up, or the date of shipment to you of the repaired or replacement set or until the end of the original twelve month warranty period whichever is later.

**Exclusions:** Aastra Telecom Inc. does not warranty this terminal to be compatible with the equipment of any particular telephone company. This warranty does not extend to

damage to product resulting from improper installation or operation, alteration, neglect, abuse, misuse, fire or natural causes such as storms or floods after the terminal is in your possession.

Aastra Telecom shall not be liable for any incidental or consequential damages, including but not limited to loss, damage, or expense directly or indirectly arising from the customer's use or inability to use this product, either separately or in combination with other equipment. This paragraph, however, shall not apply to consequential damages for injury to the person in the case of telephones used or bought for use primarily for personal, family, or household purposes.

The warranty sets forth the entire liability and obligations of Aastra Telecom Inc. and its authorized agents with respect to breach of warranty, and the warranties set forth

or limited herein are the sole warranties and are in lieu of all other warranties, expressed or implied, including warranties or fitness for particular purpose and merchantability.

State law provisions: This warranty gives you specific legal rights and you may have other rights which vary from state to state. Some states do not allow the exclusion of incidental or consequential damages or allow limitation on implied warranties or their duration, so that above exclusions or limitations may not apply.

**A**

- access codes 22
- activate
  - a feature using a memory key 27
  - an option using a memory key 27
  - feature using a list 29
  - Handsfree 16
  - Mute 16
  - Room monitor 18
- allowing calls to restricted numbers 24
- answer line 22
- answering calls 15
- area codes, prevent display 23
- assembling the phone 7
- automatically generated lists 34

**C**

- Call timer 21, 27
  - on a memory key 22

- Call Waiting 15, 23
- Callers list 29, 34
  - delete a list 33
  - Directory 33
  - memory key 33
  - set up 33
- Callers log 23
- Calling Line ID 15, 25, 34
- calls logged
  - all, unanswered, none 23
- CAM
  - connecting 45
- Canadian regulatory information 49
- change
  - disable key 24
- change language selected 25
- check line cord 36
- cleaning the display 41
- Clear Msg. Wtg 22
- conference calls 17
  - dialing 14
- connecting

- cord adapter module (CAM) 45
- handset 7
- line one on a separate jack and lines two and three on one jack 47
- lines 1 and 2 on one jack and line 3 on a separate jack 48
- one or more lines, one phone jack 8
- three lines, three phone jacks 10
- two lines, two phone jacks 9

- contrast, increase or decrease 21
- cord
  - short 11

**D**

- daisychain 45
- date, setting 25

- delete
  - a Callers list 33
  - a Directory 33
  - disable key 24
  - list information 27, 31
- dial tone, headset 21
- dialing
  - autodialer 27
  - calls 14
  - from a list 29
- Directory 24, 29, 34
  - Callers list information 33
  - delete a Directory 33
  - information organization 34
  - item retrieval shortcut 29
  - items in list 34
  - main list 34
  - Private 24, 32, 34
  - Public 24, 34
  - setting up 34
- display
  - Callers list 33

- cleaning 41
- language 12
- Don't disturb 20, 27
  - on a memory key 22
  - status message 36

**E**

- electrical outlet 5
- end a call 14
- enter

- name 12
  - number 13

- external calls
  - answering 15
  - placing 14

**F**

- feature
  - ON 36
  - turn light on/off 28, 32
- feature codes 35

**H**

- handset
  - card 12

- connecting 7

- cord 7

- Handsfree 16
  - activate 16
  - automatic page answer 21
  - dialing 14

- Handsfree/Mute key 21

- Headset 21

- home run 45

**I**

- information storage and access
  - areas 29

- installation 5

- Installation planning
  - worksheet 5, 6

- intercom

- dialing 14

- look up numbers 13, 34

- making calls using a memory key 27

**J**

- jack pin-out 45

join call 14

## L

language

change selected 25

display 12

line

automatic answer 22

automatic selection 22

longest ringing 22

reservation 14

ring tone 24

line in use 14

Line x available 14

Line x Reserved 36

lines

connecting three lines to  
phone jack 47, 48

list

definitions 34

retrieve an item 29

lists

activate a feature 29

delete information 27, 31

make a call 29

using 29

locate a sub-directory 31

lock lists 24

## M

main list 34

Make calls first 17

making a call 14

dialing 14

lists 14, 29

memory key 14, 27

using a memory key 27

using an autodialer 27

using handsfree 14

using line keys 14

memory key 22, 31, 35

activate a feature 27

activate an option 27

Callers list information 33

making calls 27

page one phone 27

programming 22

Room monitor 18

setting up 34

transfer using 17

message waiting 36

microphone

Handsfree 16

monitor a room 18

more than one line ringing 15

mute 16

Mute, activate 16

## N

name, a Private Directory 32

Aastra help desk 25, 41

## O

options

reset 24

setting 20

other equipment 7

overrides 24

## P

page



- on a memory key 22
- one phone 18
- one phone using a memory key 27
- receiving 21
- page all 27
- password 22
  - delete 24
- phone
  - busy 14
  - programming 20
- phone busy 17
- phone ID 12, 13, 24
- phone jacks 5
- Phone list 29, 31, 34
  - using 13, 34
- phone name 24
- Phone not responding 14
- phone numbers
  - automatically sent 22
- PINs 22
- power adaptor cord 11
- powering up your phone 12

- Prime line 22
- prime line 22
- Private Directories 34
- Private Directory
  - name 32
- private numbers 22
- Public Directory 34

**Q**

- Quick Start Card 5

**R**

- Receive page 21
- receiver volume 16
- Redial list 29, 34
- repairs 41
- repeat caller 23
- reserve line 14
- reset options 24
- Restrictions 23
- retrieve a list item 29
- ring tone, choosing 24
- Ringer is OFF 36
- Room monitor 18, 21, 27

- activate 18
- memory key 18
- on a memory key 22
- set up 18

running cable to the jacks 45

**S**

- save
  - disable 24
- save information
  - to Directory 26, 30, 31
  - to Services list 26, 30, 31
- second call
  - answering 15
  - display information 15
- secure number 22
- select line key 17
- send number, automatic 22
- separate calls 23
- Services list 29, 35
  - feature light on/off 28, 32
  - setting up 34
- set the time and date 25

- setting up
  - Callers lists 33
  - Directory 34
  - memory keys 34
  - Services list 34
- speaker
  - Handsfree 16
- stand
  - angle adjustment 11
  - attaching 11
- status messages 36
- stopping calls 23
- System is busy 14
- T**
- telephone company features 35
- Telephone light 20, 28, 32
- telephone light 32
- time, setting 25
- Time/date 25
- timing calls 21
- Transfer 16
- troubleshooting 37
- turn on a feature and light 28, 32
- twisted-pair cable 45
- type of call
  - Callers list information 33
  - icons 33
- types of rings 24
- U**
- U.S. regulatory information 51
- using the lists 29
- V**
- version of software 25
- volume, adjusting 16
- W**
- wall-mount 11
- warranty 41
- wiring 5, 7
  - phone jacks 45