



RL

Rear Camera System Owner's Manual

Special Messages

- We provide many important safety messages in this manual. For your safety and safety of others, pay special attention to all warnings preceded by this alert symbol . Failure to follow the warnings contained in this manual can result in serious injury or accident.



DANGER

- **Indicates that severe personal injury or death will result if instructions are not followed. (Not applicable)**



WARNING

- **Indicates a strong possibility that serious injury or death may result if instructions are not followed. (Not applicable)**



CAUTION

- **Indicates a possibility that personal injury may result if instructions are not followed.**

Other Symbols

- If instructions are preceded by the following symbols, they will give helpful advice or information.



ADVICE

- Gives advice to prevent damage to the product.
- Gives advice to handle emergency situation.



INFORMATION

- Gives helpful information or instructions to be followed in using the product.

Introduction	4
Warnings and Advice	5
Reading Picture Taken by Rear Camera System	9
Installation of CCD Camera (Example)	10
Dimensional Drawing	11
Specifications	12
Troubleshooting.....	13
Warranty Card	14

Introduction

Thank you for purchasing this Acura accessory.

Please read this Owner's Manual carefully before using the rear camera, and keep this manual in the glove box for future reference.

This product is designed to be used exclusively on an Acura RL. Acura is not responsible if the unit is used for any other intended purpose.

This Owner's Manual should be considered a permanent part of the vehicle. It should remain with the vehicle at all times and stay with the vehicle when sold.

This accessory should be installed only by a skilled technician who has the proper tools, equipment, and training to correctly and safely add equipment to your vehicle. Installation should not be attempted by "do-it-yourselfers."

This Owner's Manual contains important information about the safe operation of the rear camera. We urge you to read this manual carefully, become familiar with the controls it describes, and follow its recommendations to help make your driving trouble-free and enjoyable.



DANGER

Not applicable



WARNING

Not applicable



CAUTION

**Use this rear camera system as a Supplementary System to check the obstructions.
Avoid rain drops on the camera as it can cause poor photographing performance of the camera.
When you reverse the vehicle, use extreme care and check for safety behind the vehicle with your eyes.**



ADVICE

- Do not disassemble or modify this rear camera system.
It can cause malfunction of the system.
- The camera of this system is structured as the drip-proof sealed type for prevention of dew condensation on the lens. Do not loosen the screws on the camera and do not disassemble the camera, either.
It can deteriorate the drip-proof performance of the system resulting in failure of the system.
- Do not hang down the camera with the cable and do not pull the cable to move the camera, either.
It can deteriorate the drip-proof performance of the system and it can cause open circuit in the cable that lead to malfunction of the system.

- Do not install the rear camera system near the antenna of radio system.
Install at least 2 ft (60 cm) away from the antenna. Bands appear across the monitor screen aslant when the electric wave of the radio system jumps into the cable of the rear camera system.
- Fogged or dirty lens does not assure of the clear pictures. Remove the drops of water, snow, mud, etc. from the lens with a moist soft cloth.
Do not rub the lens with a dry cloth with force as it will scratch the lens.
- When you are obliged to warm up the rear camera system with hot water, apply hot water to the camera system slowly. Avoid sharp change of the temperature of the camera.
It can damage the rear camera system.



ADVICE

- The smear phenomenon*, characteristic to the CCD camera, occasionally appears on this rear camera system, as it uses the solid image pickup element (CCD element) for the image receiving element. Note that this phenomenon is not a problem.

The smear phenomenon occurs under the following conditions.

- When the camera directly catches the strong light such as the sunlight, headlight beam, etc.
- When the camera directly catches the strong light such as the sunlight, etc. reflected by the vehicle body or a part near the vehicle.

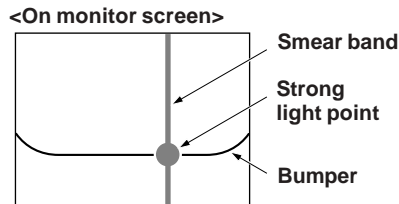

- * Smear phenomenon:

Phenomenon where the vertical band appears above and below the strong light point when the strong light (e.g. sunlight reflected to the vehicle body, etc.) is reflected to the lens.

- Replace the fuse with a fuse of the specified capacity.
Use of a fuse not specified or use of a part but fuse will cause damage to the rear camera system.
- Stop the rear camera system when a picture is not reflected in the monitor screen or it smells abnormally.
The system failure can occur and/or the system can give out smoke causing unrepairable serious damage to the system. When either of these symptoms occurs, stop the system immediately and consult with your authorized Acura dealer.

 **INFORMATION**

- The picture reflected in the monitor screen is the mirror image.
The mirror image represents the bilaterally symmetric image just like the picture you look in the rear view mirror or door mirror of a vehicle. The picture that you directly look at with your eyes is referred to as the normal image.
- Note that the picture taken by the rear camera system at night or in a dark place can be too dark to read or it cannot be very clear.
- Adjust the rear camera system so that a part of the vehicle body is reflected in the monitor screen.
- Note that the wide angle lens is used on the camera, so the distance you feel on the monitor screen differs from the actual distance.

Reading Picture Taken By Rear Camera System

1. Turn the ignition switch key to the ON (II) position.

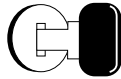

2. Move the gearshift lever to the "R" (Reverse) position.
The monitor screen automatically switches to the CCD camera's picture.

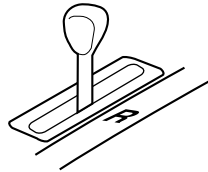

ADVICE

The rear camera's picture can be different from the color of the actual subject.



INFORMATION

- The rear camera's picture is reflected in the monitor screen taking precedence over the pictures of the audio system and TV/navigation system.
- The picture reflected in the monitor screen is the mirror image.
The mirror image represents the bilaterally symmetric image just like the picture you look in the rear view mirror or door mirror of a vehicle.

Installation Of CCD Camera (Example)

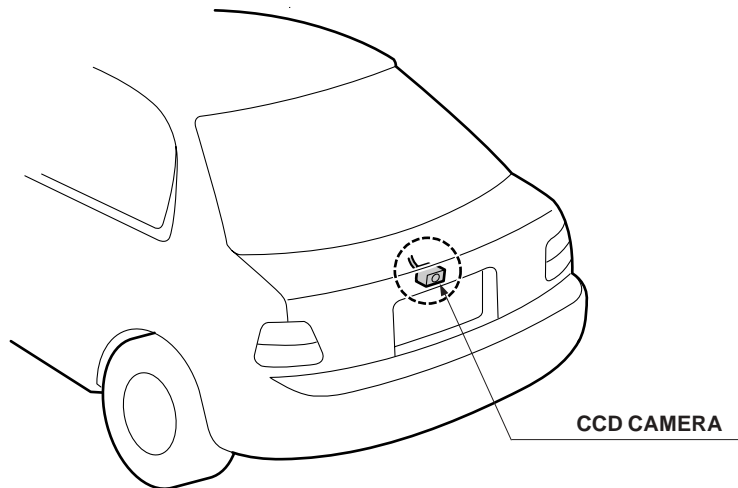

5628080H



CAUTION

Note that the area where is reflected to the monitor screen is limited. When you reverse the vehicle, use extreme care and check for safety behind the vehicle with your eyes.

■ Color CCD camera

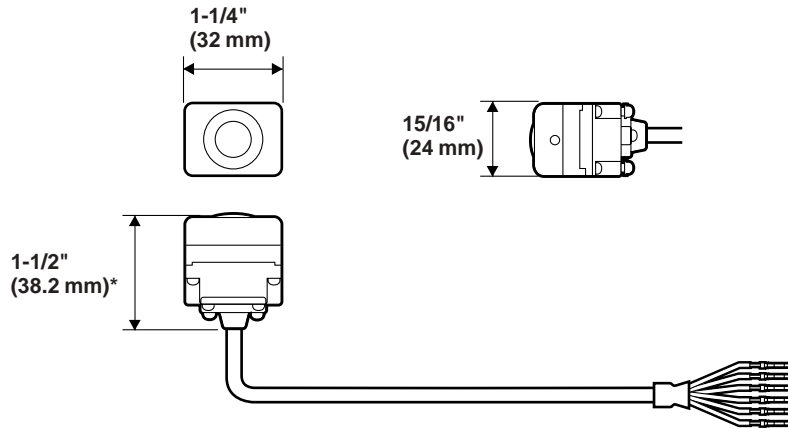

4219030M

* Dimension changes in the range of $\pm 1/64"$ (0.5 mm) depending on the focus position of the lens.

Specifications

■ Color CCD camera

Image pickup element:

1/4-inch interline transfer type CCD
(Picture element: approx. 250,000)

Lens:

Angle of view:

Horizontal Approx. 126°
Vertical Approx. 83°

Image pickup performance:

Resolution:

Horizontal 300 min.
(Around the center of the picture)
Vertical 300 min.
(Around the center of the picture)

Minimum illuminance of subject:

1.5 Lux max.
(5 OIRE)

Image output: 1 Vp-p/75Ω

Supply voltage: DC 7V ± 2V

Power consumed: 1.2W max.

Mass of the body: Approx. 0.37 lb (170 gr.)

■ Color CCD camera connector pin arrangement

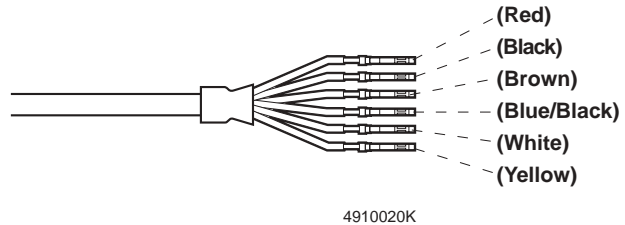

(View from the terminal side)

4910030K

Symptom	Probable cause	Remedy
No picture reflected in the monitor screen.	Gearshift lever not in the “R” position	Check that the gearshift lever is in the “R” position.
	Blown fuse	Replace the fuse with the fuse of the specified capacity.
Poor reflection of the picture	Drops of water (rain), snow or mud on the cover in front of the lens.	Wipe the cover lightly with a moist soft cloth. Drive the vehicle carefully while checking for safety behind the vehicle with your eyes.
Difference of color between the picture and actual subject	Near infrared radiation range used for higher sensitivity of the camera	This is not a problem.
White vertical band of the light in the picture	<ul style="list-style-type: none"> • When the camera directly catches the strong light such as the sunlight, headlight beam, etc. • When the camera directly catches the strong light such as the sunlight, etc. reflected by the vehicle body or a part near the vehicle. 	This phenomenon is not a problem but characteristic to the CCD camera is not a problem. Drive the vehicle carefully while checking for safety behind the vehicle with your eyes.
Error between the distance judged with the guide lines on the monitor screen and actual distance on road or actual distance to the objection	Guide line positions change according to the vehicle condition (number of passengers and load) and environmental condition.	Drive the vehicle carefully while checking for safety behind the vehicle with your eyes.
	Camera out of the installation position or out of the angle.	Consult with your authorized Acura dealer.

Warranty Card

■ Warranty card

- Check the signature stamp of your dealer and the date of purchase on the Warranty Card. Read the Warranty Card carefully and store it in a safe place securely.

■ After-sale service

- When the rear camera system does not work well:
Read this Owner's Manual carefully and check the rear camera system accordingly.
- If the rear camera system is still out of order:
The rear camera system will be repaired according to the provisions on the Warranty Card. Have your authorized Acura dealer repair the rear camera system.
- Repair during the period covered by warranty:
The rear camera system will be repaired according to the provisions on the Warranty Card. Refer to the Warranty Card for further information.
- Repair after the period covered by warranty:
If the function can be restored by repair, the rear camera system will be repaired by request with charge.
- Repair parts:
The repair parts are available for at least 6 years after the production discontinues.

ACURA