

FXS+ Quad Voice Option Module

Part Number 1200300L1

&

FXS+ Dual Voice Option Modules

Plug-in Part Number 1200302L1

Plug-on Part Number 1200304L1

User Manual

Trademarks:

MEGACOM is a registered trademark of AT&T
SLC96 is a registered trademark of AT&T



901 Explorer Boulevard
P.O. Box 140000
Huntsville, AL 35814-4000
(256) 963-8000
© 1999 ADTRAN, Inc.
All Rights Reserved.
Printed in U.S.A.

ADTRAN Year 2000 (Y2K) Readiness Disclosure

ADTRAN has established a Year 2000 program to ensure that our products will correctly function in the new millennium. ADTRAN warrants that all products meet Y2K specifications regardless of model or revision.

Information about ADTRAN's Y2K compliance program is available at the following locations:

ADTRAN Web Site	www.adtran.com
Product Matrix	www.adtran.com/y2kfax.html
Faxback Document Line	(256) 963-8200 <i>Y2K plans and product certifications are listed in the matrix.</i>
Y2K Project Line	(256) 963-2200
E-mail	year2000@adtran.com



Notes provide additional useful information.



Cautions signify information that could prevent service interruption.



Warnings provide information that could prevent damage to the equipment or endangerment to human life.

Federal Communications Commission Radio Frequency Interference Statement

This equipment has been tested and found to comply with the limits for a Class A digital device, pursuant to Part 15 of the FCC Rules. These limits are designed to provide reasonable protection against harmful interference when the equipment is operated in a commercial environment. This equipment generates, uses, and can radiate radio frequency energy and, if not installed and used in accordance with the instruction manual, may cause harmful interference to radio frequencies. Operation of this equipment in a residential area is likely to cause harmful interference, in which case the user will be required to correct the interference at his own expense.



Change or modifications to this unit not expressly approved by the party responsible for compliance could void the user's authority to operate the equipment.

Important Safety Instructions

When using your telephone equipment, please follow these basic safety precautions to reduce the risk of fire, electrical shock, or personal injury:

1. Do not use this product near water, such as near a bath tub, wash bowl, kitchen sink, laundry tub, in a wet basement, or near a swimming pool.
2. Avoid using a telephone (other than a cordless-type) during an electrical storm. There is a remote risk of shock from lightning.
3. Do not use the telephone to report a gas leak in the vicinity of the leak.
4. Use only the power cord, power supply, and/or batteries indicated in the manual. Do not dispose of batteries in a fire. They may explode. Check with local codes for special disposal instructions.

SAVE THESE INSTRUCTIONS

WARRANTY AND CUSTOMER SERVICE

ADTRAN will replace or repair this product within five years from the date of shipment if the product does not meet its published specifications or if it fails while in service. For detailed warranty, repair, and return information see the ADTRAN Equipment Warranty and Repair and Return Policy Procedure on the inside back page of this manual.

Return Material Authorization (RMA) is required prior to returning equipment to ADTRAN.

For service, RMA requests, or more information, contact one of the numbers found on the inside back page of this manual.

Table of Contents

Chapter 1. Introduction	1-1
FXS+ Quad and Dual Voice Overview	1-1
FXS+ Uses	1-1
Functional Description	1-2
Features.....	1-2
FXS+ Option Module Specifications.....	1-3
Physical Description	1-4
Chapter 2. Installation	2-1
Unpack and inspect	2-1
Items Shipped by ADTRAN.....	2-1
Items Provided by Customer.....	2-1
INstalling the FXS+ Voice Option Module	2-2
Determine Revision Level of TSU 100/120/600.....	2-2
Placement of the Option Module.....	2-3
Power Connection.....	2-3
Wiring.....	2-4
Power Up Testing And Initialization	2-5
Successful Self-Test	2-5
Failed Self-Test.....	2-5
Operation Alarms.....	2-5
Configuration of TX Level (TLP)	2-6
Chapter 3. Operation	3-1
Overview	3-1
Menu Structure.....	3-1
Menu Operation	3-1
FXS+ Menu Items	3-3
Port Status	3-3
PORT CONFIG (Port Configuration).....	3-6
MODE	3-7
RX LVL (TLP) (Receive Level/Transmit Level Point)	3-10
TX LVL (TLP) (Transmit Level/Transmit Level Point)	3-10
FAULT RESP (Fault Response)	3-10

ANSWER S'VSN (Line Side Answer Supervision)	3-10
TANDEM OPTIONS (Tandem Options)	3-11
Port Configuration Menu Items/Parameters Summary	3-13
PORT UTIL (Port Utility)	3-14
Port Test	3-15
1 KHZ TONE	3-15
VIEW SIG BITS (View Signalling Bits)	3-16
SET TX SIGNAL (Set Transmit Signal)	3-16
SET 2W OUTPUT (Set 2-Wire Output)	3-16
TSU Features Used With FXS+ Options.....	3-17
FACTORY RESTORE	3-17
RUN SELF-TEST	3-17
 Appendix A. FXS+ Failure Messages.....	 A-1
 Appendix B. Signalling States	 B-1
 Index	 Index-1

List of Figures

Figure 1-1. FXS+ Quad & Dual Voice Option Modules	1-4
Figure 2-1. Installing Option Module	2-3
Figure 3-1. TSU Main Menu	3-2
Figure 3-2. Port Status Submenus	3-4
Figure 3-3. 2-Wire Status Display	3-4
Figure 3-4. View Signalling Bits Display	3-5
Figure 3-5. SLC96 Status Display	3-5
Figure 3-6. Port Configuration Submenus	3-6
Figure 3-7. Port Utility Submenus	3-14
Figure 3-8. Port Test Submenus	3-15
Figure 3-9. View Signalling Bits Display	3-16

List of Tables

Table 2-1.	2-Wire Voice Pinout Connection	2-4
Table 3-1.	Port Configuration Parameters	3-13
Table 3-2.	Port Test Parameters	3-16
Table A-1.	Failure Messages at Power-Up	A-1
Table B-1.	PLAR Mode	B-1
Table B-2.	Tandem Modes	B-2
Table B-3.	FXS+ Mode (Loop-Start)	B-3
Table B-4.	FXS+ Mode (Ground Start)	B-4
Table B-5.	Single Mode	B-5
Table B-6.	UVG Mode: Loop Start Provisioning on T-Span	B-6
Table B-7.	UVG Mode: Ground Start Provisioning on T-Span	B-7

FXS+ QUAD AND DUAL VOICE OVERVIEW

The FXS Quad and FXS Dual Voice option modules can be used with the ADTRAN TSU 100/120/600. The Quad FXS+ module provides four, 2-wire voice-grade interfaces serving as the source of line-current and ringing voltage to a telephone or station interface. The Dual FXS+ provides two, 2-wire voice-grade interfaces in either a plug-in or plug-on module.

FXS+ Uses

The FXS+ may serve as the station-side of a foreign exchange FXS/FXO application. It may be paired with another FXS+ to provide a hotline or private line automatic ringdown (PLAR) function to a remote location at the far end of the T-Span.

When the FXS+ is used in the tandem mode, it can be set to accept phone service directly from a toll switch using E&M signalling on the T-Span (e.g., 1-800 services, Megacom). It may also be used to provide trunk services to a PBX from a local switch. The FXS+ is intended for use in applications where the 2-wire port wiring remains on premises.

The FXS+ option modules support *Single Party and Universal Voice Grade (UVG) Channel Unit Operation* as specified by TR-TSY-000008. The FXS+ module and a TSU 600/600e can act as a remote terminal in a digital loop carrier application.

The FXS+ Dual plug-in option module also accepts the TSU 100/120/600 plug-on boards to provide up to four functional ports per option slot used. Signalling and interfaces comply

with portions of *EIA/TIA-464-A*, *T1.401*, and *AT&T Pub. 41458* and *Pub. 43801*.

Functional Description

- The FXS+ is designed to fit in the option slot of the TSU 100/120/600 and is subject to its operation and control.
- The FXS+ is configured from the front panel of the TSU 100/120/600 or by an external personal computer (PC) program.
- The internal menus for its configuration are a part of the FXS+ module and are automatically installed when the FXS+ is plugged into the unit.

Features

The FXS+ option module has the following features:

- Each 2-wire port operates at 64 kbps (1 DS0)
- Supports loop resistances to 730 Ω
- Menu configurable Tx and Rx levels
- FXS, PLAR, Tandem, Single Party, and Universal Voice Grade operating modes
- Ground Start or Loop Start signalling
- Wink or Immediate Supervision in Tandem mode
- Wink delay for ANI/DNIS services
- Integral ringback and dial-tone generation
- Integral per channel 20 Hz ring generation
- Extensive testing capabilities, such as:
 - Rx and Tx signal bit monitoring
 - SLC96 Status monitoring
 - Busy and Ringing status monitoring
 - Integral 1 kHz tone generation sends test tone toward near or far end
 - Manual control of Tx A and Tx B signal bits
 - Manual control of 2-wire interface supervision output

- Selectable response during carrier failure
- Full V.90 modem connect capability (56.6 kbps)
- Provides FXS forward disconnect capability
- Line Side Answer Supervision (LSAS) is supported for FXS_LS, FXS_GS, TANDEM_LS, TANDEM_GS, Single, and UVG modes of operation
- Hot replaceable

FXS+ Option Module Specifications

The FXS+ option module conforms to the following specifications:

Voice Channels	2/4
Transmission Levels	TX: +3 to -5 dB TLP, 1 dB steps RX: 0 to -8 dB TLP, 1 dB steps
Frequency Response	300 - 3400 Hz (\pm 1.0 dB)
2-Wire Impedance	600 Ω + 2.15 μ F
2-Wire ERL	>26 dB
2-Wire SRL	>20 dB
THL ERL	>26 dB
THL SRL	>20 dB
Longitudinal Bal	>52 dB
Rx Idle Channel Noise	<15 dBrc
Tx Idle Channel Noise	<20 dBrc
Loop Current	25 mA (constant current)
Loop Range	0-600 Ω
Extended Range	Up to 730 Ω at >20mA
Operating Temperature	0 - 45 degrees C, 95% humidity, non-condensing
Connector	RJ-45
Ring Generator	20 Hz 40 Vrms 2.0 REN, per port
Tests	Power-on circuit test Signal bits monitoring and setting 1 kHz test tone generation Force 2-wire port output state

PHYSICAL DESCRIPTION

The FXS+ is an option module which plugs into the option slot in the rear of the TSU 100. The plug-on module is placed on top of a plug-in module. See *Figure 1-1*.

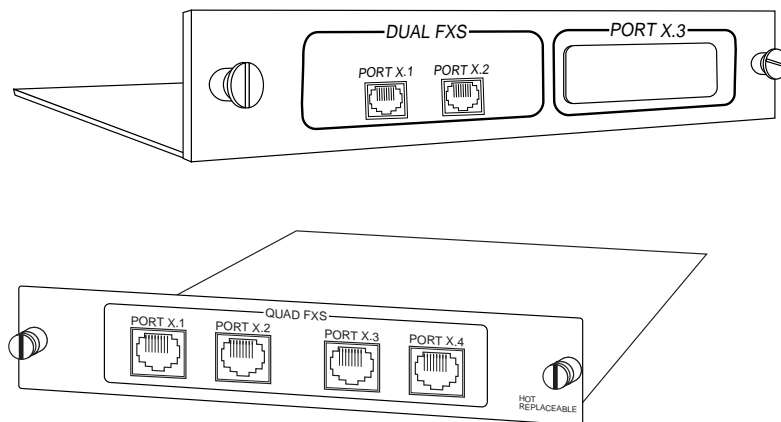

Figure 1-1. FXS+ Quad & Dual Voice Option Modules

The rear panel of the dual plug-in module includes a plastic plug over a cutout for additional connectors. This allows a plug-on board to be added to the FXS+ dual plug-in module. The 1200302L1 (FXS+ Dual) voice module can accept any plug-on module except the 1200082L1#HS. The FXS+ dual plug-on can be placed on top of any option module that accepts plug-ons.

The **PORT X.3** indication is linked to the port numbering philosophy of the TSU 100 product family. The **X** represents the slot number, and the **.3** indicates the port number. For the TSU 100 application, there is only one option slot. Therefore the port designations for the two plug-in FXS voice ports will be **1.1** and **1.2**. If added, the plug-on board port designation would be **1.3** and **1.4**. These port numbers will appear in the front panel LCD menu displays. The remainder of the manual will refer to port numbers as **1.1** or **X.1** for illustrative purposes.

UNPACK AND INSPECT

Carefully inspect the FXS+ Quad/Dual Voice option module for any shipping damages. If damage is suspected, file a claim immediately with the carrier and then contact ADTRAN Customer and Product Service (CAPS). (See the last page of this manual.) If possible, keep the original shipping container for use in shipping the FXS+ module back for repair or for verification of damage during shipment.

Items Shipped by ADTRAN

- FXS+ Quad/Dual Voice option module
- FXS+ Quad/Dual Voice Option Module User Manual (to be inserted into main TSU 100/120/600 manual)

Items Provided by Customer

- Cable to connect the unit to the station.

INSTALLING THE FXS+ VOICE OPTION MODULE

Determine Revision Level of TSU 100/120/600

All TSU chassis support the FXS+ Quad/Dual Voice option modules. TSU 100 units must have Software Revision L or later, and the TSU 600 (1200076L1 and 1200076L2) must have Software Revision F or later. To determine the revision level, do the following:

Step	Action	Result
1	Power on the TSU.	
2	Using the front panel keypad, select item 3) UTIL .	The Utility Menu displays.
3	From the Utility Menu, select item Software Revision .	The unit displays the revision of the operating software.

If the card is to be installed in a TSU 100, 120 or 600 with an earlier software revision, ADTRAN recommends that the TSU first be upgraded to the most recent revision to ensure proper operation with the FXS+.



For assistance with software revision upgrades, please contact ADTRAN Technical Support at 1-888-4ADTRAN.

For ease of replacement, power to the TSU 100/120/600 may be **On** when installing or removing the FXS+ Quad and Dual Voice option modules.

Placement of the Option Module

Figure 2-1 shows the proper placement of the option module. To install the option module, follow these steps:

Step	Action
1	Remove cover plate from the TSU 100/120/600 rear panel.
2	Slide option module into the rear panel until it is positioned firmly against the front of the TSU 100/120/600 unit.
3	Fasten thumbscrews at both edges of the option module.

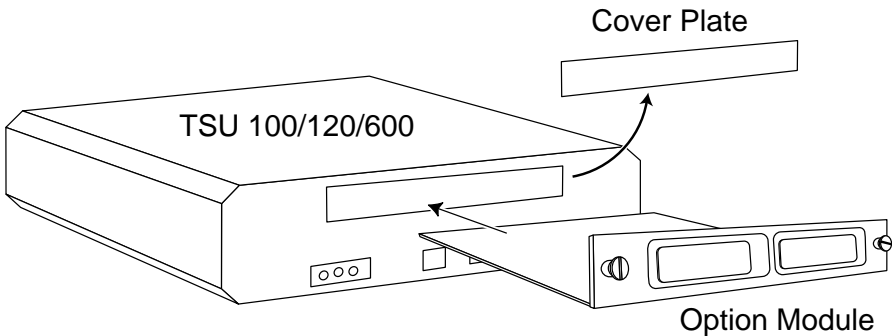

Figure 2-1. Installing Option Module

Power Connection

Each FXS+ module derives power from the base TSU 100/120/600 unit. Power to the TSU 100/120/600 is supplied by a captive eight-foot power cord.

Wiring

The FXS+ Quad and Dual Voice option module analog voice interface connectors are universal and accept either an RJ-45 (8-pin modular plug) or an RJ-11 (6-pin modular plug). The pinout is shown in *Table 2-1*.

The required wiring connection is:

Connector Type (USOC) - RJ-45
Part number - AMP # 555164-1

Table 2-1. 2-Wire Voice Pinout Connection

Pin	Name	Description
5	Tip	Tip lead of 2-wire interface
4	Ring	Ring lead of 2-wire interface
1,2,3,6,7,8	Unused	-

Pins used to mate with FXS+ connector are as follows:

Connector	Pin	
RJ-11	Tip	4
	Ring	3
RJ-45	Tip	5
	Ring	4

POWER UP TESTING AND INITIALIZATION

The FXS+ option module executes an abbreviated self-test during the power-up sequence, as described in the TSU 100/120/600 manual. Any previously configured setting for the FXS+ is restored automatically upon power up.

Successful Self-Test

The green **OK LED**, located with the module LEDs on the front panel, illuminates when a successful self-test is completed and the configuration is successfully restored. See the *Front Panel Operation* section in the TSU 100/120/600 User Manual.

Failed Self-Test

If the FXS+ module fails one or more of the self-tests, a message displays in the LCD during power-up. See the TSU 100/120/600 User Manual for more information. Specific failures of the FXS+ module are identified in *Appendix A, FXS+ Failure Messages*.

Operation Alarms

The red **ALARM LED** with the module LEDs on the front panel illuminates when an alarm condition is detected.

Configuration of TX Level (TLP)

For any installation where the analog channel (DS0) terminates within the Public Switched Telephone Network, the TX LVL should be set to **+3 dB**. For point-to-point applications where the channel terminates in other customer equipment, any TX LVL may be used.



NOTE

A +3 dB TLP setting attenuates the analog signal by 3 dB.

OVERVIEW

The FXS+ module is controlled as part of the TSU 100/120/600 using the same methods described in the User Manual.

See the TSU 100/120/600 User Manual for descriptions of front panel indicators and buttons.

Menu Structure

When an option module is installed in the TSU 100/120/600, the unit adds it to the list of available options under the Port menu items. These menu items are shown in *Figure 3-1* on page 3-2.

Menu Operation

An option module must be selected from a **PORT MENU** item before any of its menus are displayed.

With the cursor on one of the Port menu items, press **Enter** to display a list of the currently installed option modules.

To activate menus for the FXS+ option module, scroll through the list to display **X.1 FXS+** and press **Enter**.

Once the option module is selected, the FXS+ menus appear as a subset of, and operate the same as, menus for the TSU 100/120/600. With the cursor on one of the TSU 100/120/600 four main menu choices, press **Enter** or a **menu number** to display the first two submenu items.

Use the **up and down arrows** to place the cursor on the desired item and press **Enter** to display the first two submenu choices.

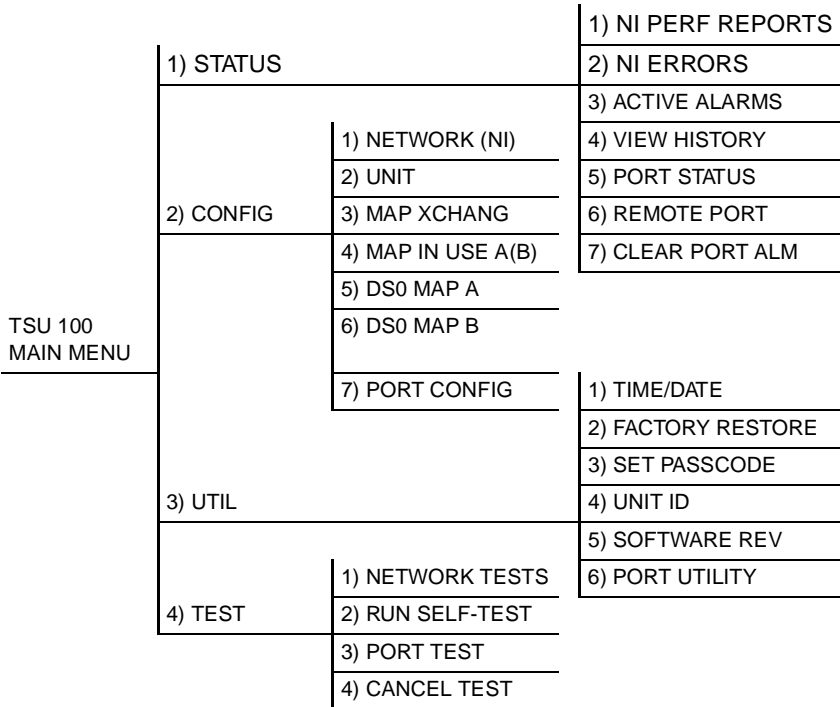

Figure 3-1. TSU Main Menu



Additional item menus may be displayed on the TSU 600/600e products

FXS+ Menu Items

The FXS+ menus are accessed from, and operate the same as, menus for the TSU 100/120/600. The FXS+ items are submenu choices of the TSU 100/120/600 four main menus, as shown in *Figure 3-1*. For information on **Factory Restore** and **Run Self-Test**, see *TSU Features Used With FXS+ Options* on page 3-17.

The FXS+ menu items are discussed in the following pages. These items are:

- Port Status
- Port Configuration
- Port Utility
- Port Test

Port Status

Port Status, a submenu of TSU 100/120/600 Main menu item Status, displays active status information about the FXS+ interface.

When **Port Status** displays, place the cursor on it and press **Enter** to display the first available port. See *Figure 3-2*. Scroll to select **1.1 FXS+** and press **Enter** to activate one of the following submenus.

- 2W STATUS (2-wire status)
- VIEW SIG BITS (View Signalling Bits)
- SLC96 STATUS (2-wire status when SINGLE or UVG modes)

1) STATUS	1) NI PERF REPORTS		
	2) NI ERRORS		
	3) ACTIVE ALARMS		
	4) VIEW HISTORY		
	5) PORT STATUS	1.1 FXS+	2W STATUS
	6) REMOTE PORT		VIEW SIG BITS
	7) CLEAR PORT ALM		SLC96 STATUS

Figure 3-2. Port Status Submenus

2W STATUS (2-Wire Status)

Contains two information fields, **Busy** and **Ringig**, as shown in *Figure 3-3*. An asterisk (*) indicates an item is active.

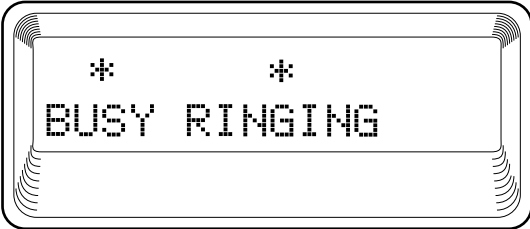

Figure 3-3. 2-Wire Status Display

- Busy** An asterisk is present if loop current is flowing through the 2-wire circuit.
- Ringig** An asterisk is present if ringing voltage is being applied to the 2-wire circuit from the ring-generator on the FXS+ option module

VIEW SIG BITS (View Signalling Bits)

Use **VIEW SIG BITS** to view the status of the RX and TX signalling bits in the DS-1 stream. See *Figure 3-4*. If you are operating in a SLC96 mode, **1/0** may be displayed. This means that the signalling bit is toggling in each successive frame for that port.

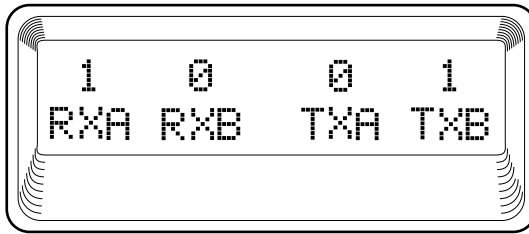

Figure 3-4. View Signalling Bits Display

SLC96 STATUS (Single and UVG Status)

SLC96 Status is used to view the signalling states on a per-channel basis related to the **Channel (Network Interface)** and the **Customer (2W Ports)**. The states are shown in lexical representation to aid in determining system status without monitoring and translating the signalling bits (**VIEW SIG BITS**). **SLC96 STATUS** is only available when **SINGLE** or **UVG** modes of operation are selected. See *Figure 3-5*.

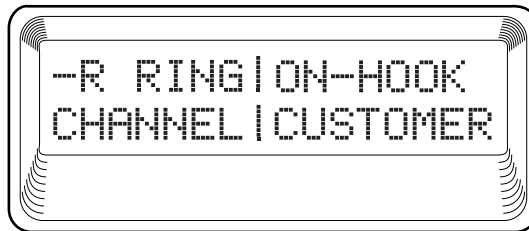

Figure 3-5. SLC96 Status Display

PORT CONFIG (Port Configuration)

Port Configuration, a submenu of TSU 100/120/600 main menu item **Configuration**, is used to configure the FXS+ option module. The following submenu items are used to configure the parameters:

- MODE
- RX LVL (TLP)
- TX LVL (TLP)
- FAULT RESP
- ANSWER S'VSN
- TANDM OPTIONS
 - Supervision
 - Dial Tone
 - Loop Rev Bat
 - Ringback
 - DNIS Delay
 - DNIS Wink Timeout

When **Port Configuration** displays, place the cursor on it and press **Enter** to activate. Scroll to display the port to be configured and press **Enter**. See *Figure 3-6*.

The unit displays the first of five submenu items. *Table 3-1* on page 3-13 identifies the available selections for **Port Configuration**. Continue with standard operating procedure.

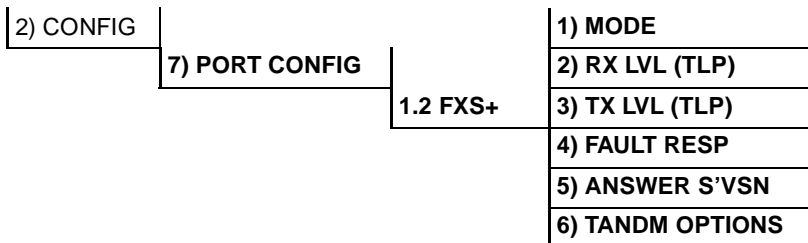

Figure 3-6. Port Configuration Submenus

MODE

Mode sets the type of 2-wire to T1 signalling and supervision to be used. Choices include:

FXS_LS

This mode sets the port to use FXS loop-start signalling on the T-Span and loop-start supervision on the analog 2-wire interface.

It also supports far-end disconnect by removing tip-ground during the call if signalled to do so over the T-Span. When used with an ADTRAN FXO+, this feature allows line-current dropouts to be passed on to equipment connected to the FXS+ 2-wire port.

Line Side Answer Supervision (LSAS) reverses Tip and Ring polarity when a call originated from the FXS+ is answered. To use this feature, **ANSWER S'VSN** must be enabled and the port must receive Reverse Loop Current Feed (RLCF) signalling on the T-span. Ringing cadence will follow that provided over the T-Span or detected by the FXO port at the far-end.

FXS_GS

This mode sets the port to use FXS ground start supervision on the analog 2-wire interface. Ground start operation is often used with trunk interfaces to PBS and key systems to prevent glare conditions. Ringing cadence will follow that provided over the T-Span or detected by the FXO port at the far-end. Line Side Answer Supervision is also supported.

TANDEM_LS

This mode sets the port to use E&M signalling on the T-Span and loop-start supervision or on the analog 2-wire interface. When using this mode, line-current dropout for 500 ms is provided when a call terminates and the far-end hangs up.

This may be useful for voice-mail or modem systems that need far-end disconnect supervision. This mode also requires

other options to be selected. These options are **Supervision** on page 3-11, **Dial Tone** on page 3-11, **Loop Reverse Battery** on page 3-11, **Ringback** on page 3-11, **DNIS Delay** page 3-12 and **DNIS Wink Timeout** on page 3-12 .

Ringling cadence for incoming calls is **two seconds on, four seconds off**.

TANDEM_GS

This mode sets the port to use E&M signalling on the T-Span and ground start supervision on the analog 2-wire interface. Ground-start operation is often used with trunk interfaces to PBX and key systems to prevent glare conditions. Appropriate **TANDEM_OPTIONS** must be chosen in this mode as described for **TANDEM_LS**.



The Loop Reverse Battery is not applicable in this mode.

Ringling cadence for incoming calls is **two seconds on, four seconds off**.

PLAR

This mode sets the port to use PLAR signalling on the T-Span and loop-start supervision on the analog 2-wire interface. This mode is used to provide a point-to-point hot line so that when one telephone is lifted off-hook, the telephone at the other end rings until it is also picked up.

When both ends are off-hook, a direct point-to-point connection is established. Ringling cadence is **two seconds on, four seconds off**.

SINGLE-SLC96

This mode sets the port to use Single Party channel unit signalling on the T-Span (as defined by TR-TSY-000008) and Loop Start supervision on the analog 2-wire interface. This mode is used in a Digital Loop Carrier configuration when the TSU/FXS+ combination acts as the Remote Terminal.

Channel Test signalling is ignored and the Forward Disconnect feature is implemented by removing tip-ground during the call. Line Side Answer Supervision is also supported.

UVG-SLC96

This mode of operation will configure the port to use Universal Voice Grade signalling on the T-span (as defined by TR-TSY-000008) and either Loop Start or Ground Start Supervision on the analog 2-wire interface. LSAS is supported. The supervision on the 2-wire interface is determined by the provisioning on the far side.

If...	Then...
the signalling for the T-Span is set for UVG (Loop Start) at the Digital Switch...	the FXS+ will have Loop Start supervision on the 2-wire interface.
the signalling for the T-Span is set for UVG (Ground Start) at the Digital Switch...	the FXS+ will have Ground Start supervision on the 2-wire interface.

No other settings are necessary to configure the supervision, as the far-end determines it. Channel Test signalling is ignored.

RX LVL (TLP) (Receive Level/Transmit Level Point)

RX LVL (TLP) sets the RX direction transmission level points (TLP). The TLP is indicated in dB and the relative loudness is indicated by a bar graph display. Settings change immediately as the bar graph is scrolled.

Choice range: -8 dB to 0 dB, in 1 dB steps

TX LVL (TLP) (Transmit Level/Transmit Level Point)

TX LVL (TLP) sets the TX direction transmission level points (TLP). The TLP is indicated in dB and the relative loudness is indicated by a bar graph display. Settings change immediately as the bar graph is scrolled.

Choice range: +3 dB to -5 dB, in 1 dB steps

FAULT RESP (Fault Response)

FAULT RESP is used to set the 2-wire response to a carrier alarm. For a network alarm, the ground start 2-wire trunk would appear busy if **Fault Resp** is set to **seized**. If set to **normal**, no seizure of a ground start trunk occurs.

Choices: Normal, Seized

ANSWER S'VSN (Line Side Answer Supervision)

ANSWER S'VSN is used to signal the 2W interface when the far end (NI) has gone **OFFHOOK**. When the far end is **OFFHOOK**, the FXS+ reverses polarity on the 2W interface. This option is valid for all modes of operation except PLAR. Enabling **ANSWER S'VSN** will not cause polarity reversal on the 2W when receiving a wink in **TANDEM** modes. Use the **LOOP REV BAT** setting to respond to a wink.

Choices: Enable, Disabled

TANDEM OPTIONS (Tandem Options)

Some options are valid only when operating in the tandem mode. These options are provided below.

SUPERVISION

Supervision sets the supervision method used when the card is configured to operate in the Tandem mode.

Choices: Immediate, Wink

DIALTONE

DIALTONE is used to enable or disable the on-board dial-tone generation when the FXS+ is operating in the tandem mode. When the on-board dial-tone generation is enabled, the dial-tone will turn off after a five second time-out.

Choices: Enabled, Disabled

LOOP REV BAT (Loop Reverse Battery)

In **TANDEM_LS** mode, this option reverses Tip and Ring polarity when **OFFHOOK** is received from the far-end. Loop Reverse Battery responds to WINKS and OFFHOOK signals. Use **ANSWER S'VSN** to respond only to the far-end going OFFHOOK. Loop Reverse Battery is used to emulate DPO functionality.

Choices: Enabled, Disabled

RINGBACK

This option generates ringback tone towards the T-Span when enabled and the FXS+ card is in one of the tandem modes. This may be needed in cases where the network does not provide ringback tone.

Choices: Enabled, Disabled

DNIS DELAY

The option allows the FXS+ to be used in applications such as automatic voice mail or paging systems with telephone interfaces for POTS lines, which need to receive routing information supplied from the Central Office (CO).

The FXS+ is placed in **TANDEM_LS** or **TANDEM_GS** mode as required by the Customer Premises Equipment (CPE). Supervision must be set to **WINK** mode. Signalling conversion between the DID protocol expected by the CO and POTS signalling on the 2-wire interface is made by the FXS+.

After the CO seizes the trunk, the FXS+ waits for the CPE to go off-hook and then sends a wink. After the wink, the FXS+ waits for the amount of time set by DNIS delay, then sends answer supervision toward the CO.

The CPE must be able to answer calls within a carrier-specified time (usually 5 seconds), receive digits immediately on answer, and route calls to their destinations within the time set by DNIS delay.

Choices: Disabled, 0.5 sec, 1.0 sec., 1.5 sec. 2.0 sec., 2.5 sec., 3.0 sec., and 5.0 sec.

DNIS WINK T/O (DNIS Wink Timeout)

When **DNIS DELAY** and **DNIS WINK T/O** are both enabled, the FXS+ option module winks to Telco if the equipment connected to the 2W does not answer within 5 seconds to an incoming call. The wink timeout feature ensures that Telco will always see a response from the CPE, even if there is no answer. If this option is left disabled, the FXS+ option module will not wink until the incoming call is answered.

Choices: Enabled, Disabled

Port Configuration Menu Items/Parameters Summary

Table 3-1 provides a summary of the Port Configuration menu items and their parameters.

Table 3-1. Port Configuration Parameters

Menu Item	Parameter Choices
MODE	*FXS_LS, FXS_GS, TANDEM_LS, TANDEM_GS, PLAR, SINGLE-SLC96, UVG-SLC96
RX LVL (TLP)	-8 dB to 0 dB, 1 dB steps *(-6dB)
TX LVL (TLP)	+3 dB to -5 dB, 1 DB steps *(+1 dB)
FAULT RESP	*Normal, Seized
ANSWER S'VSN	*Disabled, Enabled
SUPERVISION	*Immediate, Wink
DIAL TONE	*Disabled, Enabled
LOOP REV BAT	*Disabled, Enabled
RINGBACK	*Disabled, Enabled
DNIS DELAY	*Disabled, 0.5 to 5 seconds
DNIS WINK T/O	*Disabled, Enabled

*Factory Default

PORT UTIL (Port Utility)

Port Utility, a submenu of the TSU 100/120/600 Main menu item **Utilities (UTIL)**, displays the current software information for each port installed in the unit. This information is required when requesting assistance from ADTRAN Customer and Product Service or when updates are needed.

When **Port Utility** displays, place the cursor on it and press **Enter** to display the first available port. See Figure 3-7.

	1) TIME/DATE		
	2) FACTORY RESTORE		
	3) SET PASSCODE		
3) UTIL	4) UNIT ID		
	5) SOFTWARE REV		
	6) PORT UTILITY	1.1 FXS+	1) SW REVISION
			2) COMMAND MODE

Figure 3-7. Port Utility Submenus

Display **1.1 FXS+** (scroll to display if necessary), and press **Enter**. The unit displays the option module name and the software version installed.

The **Port Utility** submenu contains a second option, **Command Mode**, for the FXS+ module. This option is reserved for factory use only.

Press **Cancel** to exit or to select another port.

Port Test

Port Test, a submenu of the TSU 100/120/600 Main menu item **Test**, activates tests of the selected data ports. Selecting the **FSX+** displays tests available for this option module. See Figure 3-8, below and Table 3-2 page 3-16.

	1) NETWORK TESTS		1) 1KHZ TONE
4) TEST	2) RUN SELF-TEST		2) VIEW SIG BITS
	3) PORT TEST	1.1 FXS+	3) SET TX SIGNAL
	4) CANCEL TEST		4) SET 2W OUTPUT

Figure 3-8. Port Test Submenus

When **Port Test** displays, place the cursor on it and press **Enter** to display the first available port. Scroll to select **1.1 FXS+** and press **Enter** to activate the following submenu items:

- 1 KHZ TONE
- VIEW SIG BITS
- SET TX SIGNAL
- SET 2W OUTPUT

These items are discussed on the following pages.

1 KHZ TONE

This test injects a **1 KHZ SINE WAVE** either toward the far-end (TX direction toward the T1 network) or toward the near-end (the 2-wire interface on the option module). This tone may be used for testing or relative level measurements. When **1 KHZ TONE** is enabled, ringing and dial-tone for other channels on the slot are suspended.

Choices: Off, Near, Far

VIEW SIG BITS (View Signalling Bits)

VIEW SIG BITS is used to view the status of the RX and TX signalling bits in the DS-1 stream. See Figure 3-9. If you are operating in a SLC96 mode, **1/0** may be displayed. This means that the signalling bit is toggling in each successive frame for that port. The status of both the A and B bits is displayed.

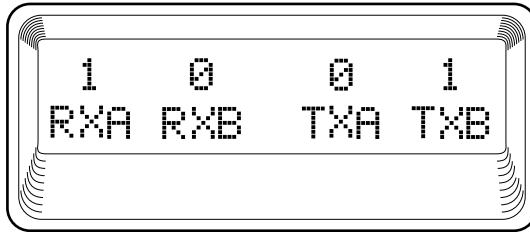

Figure 3-9. View Signalling Bits Display

SET TX SIGNAL (Set Transmit Signal)

SET TX SIGNAL allows the **A and B signal bits** in the TX direction to be forced to a desired state for test.

SET 2W OUTPUT (Set 2-Wire Output)

SET 2W OUTPUT allows the 2-wire voice interface output to be forced to a desired state for test.

Table 3-2. Port Test Parameters

Menu Item	Parameter Choices
1 KHZ TONE	Off, Near, Far
VIEW SIG BITS	Display only
SET TX SIGNAL	Off, (A=0, B=0), (A=0, B=1), (A=1, B=0), (A=1, B=1)
SET 2W OUTPUT	Off, Disabled, Tip Open, Active, Reverse Battery, Ringing

TSU Features Used With FXS+ Options

In addition to the FXS+ menu items, two additional menu items of the TSU 100/120/600 may be operated in conjunction with the FXS+ option module. These are **FACTORY RESTORE** and **RUN SELF-TEST**.

FACTORY RESTORE

FACTORY RESTORE, a submenu of the TSU 100/120/600 Main menu item **Utilities (UTIL)**, restores the factory installed default setting for all FXS+ option module parameters.

When **FACTORY RESTORE** displays, place the cursor on it and press **Enter**. The unit is restored to preset factory defaults and returns to the main TSU 100/120/600 menu. The factory default for port configuration parameters is shown in Table 3-1 on page 3-13.

RUN SELF-TEST

RUN SELF-TEST, a submenu of the TSU 100/120/600 Main menu item **TEST**, executes both the FXS+ internal test and the TSU 100/120/600 internal test. The results of the self-test are displayed in the LCD. See the TSU 100/120/600 User Manual for additional information on **Self-Test**.

When **RUN SELF-TEST** displays, place the cursor on it and press **Enter** to execute the test. The unit continuously changes the display in the LCD window until all test results are shown.

Appendix A FXS+ Failure Messages

FAILURE MESSAGES AT POWER-UP

The following messages indicate a probable component failure on the FXS+ Module:

Table A-1. Failure Messages at Power-Up

E01 - EPROM CS	EPROM checksum error
E02 - RAM ERR	Static RAM error
E03 - OFF-HOOK	Could not detect loop closure
E04 - RING GND	Could not detect ring ground
E05 - RINGING	Could not detect ring trip
E10 - SIGNALING	Failure of signal bit transmission

FXS+ Alarm Messages

No alarms are specified for the FXS+ Voice option module.

SIGNALLING STATES VS. MODE OF OPERATION

The tables in this appendix describe the signalling states for voice card and the DS-1 PCM stream. Ground start signalling is not used in PLAR mode. See Table B-1.

Table B-1. PLAR Mode

FXS+ 2W Input	RX A	RX B	TX A	TX B	FXS+ 2W Output
Loop Open	X	X	1	1	_
Loop Closed	X	X	0	0	_
Loop Open	1	1	1	1	No Ringing
Loop Open	0	X	1	1	Ringing
Loop Closed	0	X	0	0	No Ringing

The A and B signal bit states on the DS-1 signal are as follows:

Signal	Means
0	logic 0 is the DS-1 stream
1	logic 1 is the DS-1 stream
X	value is not significant
Loop Open	phone on-hook
Loop Closed	phone off-hook

Ground start signalling provides its own tip ground in response to ring ground in the Tandem Mode. See Table B-2.

Table B-2. Tandem Modes

FXS+ 2W Input	RX A	RX B	TX A	TX B	FXS+ 2W Output	Switch to FXS+ Condition
(Outgoing call from FXS+1)						
Loop Open	0	X	0	0	_	Idle
Loop Closed	0	X	1	1	_	Idle
Loop Closed	1	X	1	1	Dial Tone	Wink
Loop Closed	0	X	1	1	_	Wink Done
Loop Closed	1	X	1	1	_	Answer Far End
(Incoming call to FXS+)						
Loop Open	0	X	0	0		Idle
Loop Closed	1	X	0	0	Ringing	Far end off hook
Loop Closed	1	X	1	1	Answers	Far end off hook

The A and B signal bit states on the DS-1 signal are as follows:

Signal	Means
0	logic 0 is the DS-1 stream
1	logic 1 is the DS-1 stream
X	value is not significant
Loop Open	phone on-hook
Loop Closed	phone off-hook

Tables B-3 and B-4 describe FXS mode for signalling states.

Table B-3. FXS+ Mode (Loop-Start)

FXS+ 2W Input	RX A	RX B	TX A	TX B	FXS+ 2W Output
(Outgoing call from FXS+)					
Loop Open	X	1	0	1	No Ringing (Idle)
Loop Closed	X	1	1	1	No Ringing
Loop Closed	X	1/0	1	1	Reverse Battery
(Incoming call to FXS+)					
Loop Open	X	0	0	1	Ringing
Loop Closed	X	0	1	1	No Ringing

The A and B signal bit states on the DS-1 signal are as follows:

Signal	Means
0	logic 0 is the DS-1 stream
1	logic 1 is the DS-1 stream
1/0	logic 1 followed by a logic 0 in each successive signalling frame.
X	value is not significant
Loop Open	phone on-hook
Loop Closed	phone off-hook

Table B-4. FXS+ Mode (Ground Start)

FXS+ 2W Input	RX A	RX B	TX A	TX B	FXS+ 2W Output
(Outgoing call from FXS+1)					
No Ring Gnd or Loop Open	1	1	0	1	Idle
Ring Gnd	1	1	0	0	No Tip Gnd
Ring Gnd or Loop Closed	0	1	1	1	Tip Gnd
Loop Closed	0	1/0	0	1	Reverse Battery
Loop Open	0	1	0	1	Tip Gnd
Loop Open	1	1	0	1	Idle
(Incoming call to FXS+)					
(Idle)	1	X	-	-	No Tip Gnd & No Ringing
	0	1	-	-	Tip Gnd & No Ringing
Loop Open	0	1	0	1	Tip Gnd & Ringing
Loop Closed	0	0	1	1	Tip Gnd & No Ringing

The A and B signal bit states on the DS-1 signal are as follows:

Signal	Means
0	logic 0 is the DS-1 stream
1	logic 1 is the DS-1 stream
1/0	logic 1 followed by logic 0 in each successive signalling frame
X	value is not significant
Loop Open	phone on-hook
Loop Closed	phone off-hook

Table B-5. Single Mode

FXS+ 2W Input	RX A	RX B	TX A	TX B	FXS+ 2W Output
(Outgoing call from FXS+)					
Loop Open	X	1	0	0	No Ringing (Idle)
Loop Closed	X	1	1	0	No Ringing
Loop Closed	1/0	1/0	1	0	Reverse Battery
(Incoming call to FXS+)					
Loop Open	X	1	0	0	No Ringing (Idle)
Loop Open	X	1/0	0	0	Ringing
Loop Closed	X	1	1	0	No Ringing

The A and B signal bit states on the DS-1 signal are as follows:

Signal	Means
0	logic 0 is the DS-1 stream
1	logic 1 is the DS-1 stream
1/0	logic 1 followed by logic 0 in each successive signalling frame
X	value is not significant
Loop Open	phone on-hook
Loop Closed	phone off-hook

Table B-6. UVG Mode: Loop Start Provisioning on T-Span

FXS+ 2W Input	RX A	RX B	TX A	TX B	FXS+ 2W Output
(Outgoing call from FXS)					
Loop Open	X	1/0	0	0	No Ringing (Idle)
Loop Closed	X	1/0	1	0	No Ringing
Loop Closed	1/0	1/0	1	0	Reverse Battery
(Incoming call to FXS+)					
Loop Open	0	1/0	0	0	No Ringing (Idle)
Loop Open	0	1/0	0	0	Ringing
Loop Closed	0	1/0	1	0	No Ringing

The A and B signal bit states on the DS-1 signal are as follows:

Signal	Means
0	logic 0 is the DS-1 stream
1	logic 1 is the DS-1 stream
1/0	logic 1 followed by logic 0 in each successive signalling frame
X	value is not significant
Loop Open	phone on-hook
Loop Closed	phone off-hook

Table B-7. UVG Mode: Ground Start Provisioning on T-Span

FXS+ 2W Input	RX A	RX B	TX A	TX B	FXS+ 2W Output
(Outgoing call from FXS+)					
Loop Open	0	0	0	0	No Ringing (Ground Start)
Ring Ground	0	0	0	1	No Tip Ground
Loop Closed	0	1/0	1	0	Tip Ground
Loop Closed	1/0	1/0	1	0	Reverse Battery
(Incoming call to FXS+)					
Ground Start	0	0	0	0	No Ringing
Loop Open	1	1/0	0	0	Tip Ground & Ringing
Loop Open	0	1/0	0	0	Tip Ground & No Ringing
Loop Closed	0	1/0	1	0	Tip Ground & No Ringing

The A and B signal bit states on the DS-1 signal are as follows:

Signal	Means
0	logic 0 is the DS-1 stream
1	logic 1 is the DS-1 stream
1/0	logic 1 followed by logic 0 in each successive signalling frame
X	value is not significant
Loop Open	phone on-hook
Loop Closed	phone off-hook

Index

Numerics

2W STATUS (2-Wire Status) 3-4
2-Wire ERL, specification 1-3
2-Wire impedance, specification 1-3
2-Wire SRL, specification 1-3
2-Wire Status Display 3-4
2-Wire Voice Pinout Connection 2-4

A

ADTRAN Technical Support 2-2
ADTRAN Web Site iii
ADTRAN Y2K Information iii
ANSWER S'VSN 3-7, 3-10
ANSWER S'VSN, port config menu item 3-13

C

Configuration of TX Level (TLP) 2-6
Connector, specification 1-3
Customer Service vii
Customer Service, Warranty vii

D

Dial Tone, port config menu item 3-13
DIALTONE, tandem option 3-11
DNIS Delay, port config menu item 3-13
DNIS Delay, tandem option 3-12
DNIS WINK T/O 3-12
DNIS Wink T/O, port config menu item 3-13
DNIS Wink Timeout 3-12

E

E-mail, for Y2K info iii
Extended Range, specification 1-3

F

Factory Restore, TSU feature used with FXS+ options 3-17
Failure Messages at Power-Up A-1
Fault Resp (Fault Response) 3-10
FAULT RESP, port config menu item 3-13
Faxback Document Line, Y2K iii
Features, for FSX+ option module 1-2
Federal Communications Commission Radio Frequency Interference Statement v
Frequency Response, specification 1-3
Functional Description, FXS+ 1-2
FXS+ Alarm Messages A-1
FXS+ connector pins 2-4
FXS+ Dual Voice option module, features 1-2
FXS+ Dual Voice option module, specifications 1-3
FXS+ Menu Items 3-3
FXS+ module, overview 3-1
FXS+ Option Module Specifications 1-3
FXS+ Options, features 3-17
FXS+ Quad and Dual Voice, overview 1-1
FXS+, description 1-2
FXS+, physical description 1-4

FXS+, used in tandem mode 1-1

FXS_GS 3-7

FXS_LS 3-7

I

installing option module, how to 2-3

Items Provided by Customer 2-1

L

Line Side Answer Supervision 1-3, 3-7, 3-9

Line Side Answer Supervisor, ANSWER S'VSN 3-10

Longitudinal Bal, specification 1-3

Loop Current, specification 1-3

Loop Range, specification 1-3

Loop Rev Bat, port config menu item 3-13

loop reverse battery 3-11

Loop Reverse Battery, tandem option 3-11

LSAS, line side answer supervision 3-7

M

Menu Operation 3-1

Menu Structure, of FXS+ module 3-1

MODE, port config menu item 3-13

O

Operating Temperature, specification 1-3

Operation Alarms 2-5

option module, placement 2-3

P

Physical Description, of FXS+ modules 1-4

PLAR 3-8

PORT CONFIG (Port Configuration) 3-

6

PORT CONFIG, menu tree 3-6

Port Configuration Menu Items/Parameters Summary 3-13

Port Configuration Submenus, menu tree 3-6

Port Status 3-3

Port Status, menu tree 3-4

Port Test 3-15

Port Test Parameters 3-16

Port Test, menu tree 3-15

port utility menu tree 3-14

Power Connection 2-3

Power up testing 2-5

Power-Up, failure messages A-1

Product Matrix iii

Product Matrix, Y2K information iii

R

rear panel , dual module 1-4

repair, and return information vii

Ring Generator, specification 1-3

Ringback, port config menu item 3-13

Ringback, tandem option 3-11

Run Self-Test, TSU feature used with FXS+ options 3-17

Rx Idle Channel Noise, specification 1-3

RX LVL (TLP) (Receive Level/Transmit Level Point) 3-10

RX LVL (TLP), port config menu item 3-13

S

Safety Instructions vi

Self-test, failed 2-5

Self-Test, successful 2-5

SET 2-W OUTPUT (Set 2-Wire Output) 3-16

Set TX SIGNAL (Set Transmit Signal)

-
- 3-16
 - shipping damages, what to do 2-1
 - Signaling states vs. mode of operation B-1
 - Single Party, supported by FXS+ option modules 1-1
 - SINGLE-SLC96 3-9
 - SLC96 STATUS (Single and UVG Status) 3-5
 - SLC96 Status, example 3-5
 - software revision upgrades, assistance with 2-2
 - Specifications, FXS+ Option Module 1-3
 - Supervision, port config menu 3-13
 - Supervision, tandem option 3-11
- T**
- TANDEM_GS 3-8
 - TANDEM_LS 3-7
 - TANDEM_LS, loop reverse battery 3-11
 - Tandm options 3-11
 - Tests, specification 1-3
 - THL ERL, specification 1-3
 - THL SRL, specification 1-3
 - Tip and Ring polarity, FXS_LS 3-7
 - Transmission Levels, specification 1-3
 - TSU Main Menu 3-2
 - TSU Menu Tree 3-2
 - Tx Idle Channel Noise, specification 1-3
 - TX LVL (TLP) (Transmit Level/Transmit Level Point 3-10
 - TX LVL (TLP), port config menu item 3-13
- U**
- Universal Voice Grade 3-9
 - Unpack and inspect 2-1
 - UVG-SLC96 3-9
- V**
- VIEW SIG BITS (View Signalling Bits) 3-5
 - VIEW SIG BITS (View signalling Bits) 3-16
 - View Signaling Bits Display 3-16
 - Voice Channels, specification 1-3
- W**
- Warranty and Customer Service vii
 - Wiring, connection for modules 2-4
- Y**
- Y2K Project Line iii
 - Y2K Readiness Disclosure iii
 - Y2K, Faxback Document Line iii

Product Support Information

Presales Inquiries and Applications Support

Please contact your local distributor, ADTRAN Applications Engineering, or ADTRAN Sales:

Applications Engineering (800) 615-1176

Sales (800) 827-0807

Post-Sale Support

Please contact your local distributor first. If your local distributor cannot help, please contact ADTRAN Technical Support and have the unit serial number available.

Technical Support (888) 4ADTRAN

Repair and Return

If ADTRAN Technical Support determines that a repair is needed, Technical Support will coordinate with the Customer and Product Service (CAPS) department to issue an RMA number. For information regarding equipment currently in house or possible fees associated with repair, contact CAPS directly at the following number:

CAPS Department (256) 963-8722

Identify the RMA number clearly on the package (below address), and return to the following address:

ADTRAN Customer and Product Service
6767 Old Madison Pike
Progress Center
Building #6, Suite 690
Huntsville, AL 35807

RMA # _____

