



**TSU IQ+**  
**T1 Frame Relay**  
**Performance Monitoring TSU**  
**with V.35 and DSX-1 Ports**

**User Manual**

1200275L1	TSU IQ+ Unit
1204005L1	Ethernet Card
1204001L1	4-wire SW56 DBU Card
1204002L1	V.34 DBU Card
1204004L1	BRI ISDN DBU Card
1204006L1	External DCE Card
1204008L1	PRI DBU Card
1204002L2	V.34 DBU Card

## **Trademark Information**

OpenView is a registered trademark of Hewlett-Packard Company.  
SunNet Manager is a registered trademark of Sun Microsystems, Inc.  
Netview is a registered trademark of IBM.  
IQ View is a trademark of ADTRAN, Inc.

This product includes software developed by the University of California, Berkeley,  
and its contributors.



901 Explorer Boulevard  
P.O. Box 140000  
Huntsville, AL 35814-4000  
Phone: (256) 963-8000

© 2000 ADTRAN, Inc.  
All rights reserved.  
Printed in USA.

The following conventions are used in this manual.



**NOTE**

*Notes provide additional useful information.*



**CAUTION**

*Cautions signify information that could prevent service interruption.*

**WARNING**

*Warnings provide information that could prevent damage to the equipment or endangerment to human life.*

FCC regulations require that the following information be provided in this manual:

1. This equipment complies with Part 68 of the FCC rules. On the bottom of the equipment housing is a label that shows the FCC registration number and Ringer Equivalence Number (REN) for this equipment, if applicable. If required, this information must be given to the telephone company.
2. The following information may be required when applying to the local telephone company for leased line facilities.

Service Type	REN/SOC	FIC	USOC
T1	6.0N	04DU9-BN/DN/1KN/1SN	RJ48C

3. An FCC compliant telephone cord with a modular plug may be provided with this equipment. This equipment is designed to be connected to the telephone network or premises wiring using a compatible modular jack, which is FCC Part 68 compliant. See installation instructions for details.
4. If this equipment causes harm to the telephone network, the telephone company may temporarily discontinue service. If possible, advance notification is given; otherwise, notification is given as soon as possible. The telephone company will advise the customer of the right to file a complaint with the FCC.
5. The telephone company may make changes in its facilities, equipment, operations, or procedures that could affect the proper operation of this equipment. If this happens, the telephone company will provide advance notification and the opportunity to make the necessary modifications to maintain uninterrupted service.
6. If experiencing difficulty with this equipment, please contact ADTRAN for repair and warranty information. If the equipment is causing harm to the network, the telephone company may request this equipment to be disconnected from the network until the problem is resolved or it is certain that the equipment is not malfunctioning.
7. This unit contains no user-serviceable parts.
8. The FCC recommends that the AC outlet, to which equipment requiring AC power is to be installed, is provided with an AC surge arrester.

## **Important Safety Instructions**

### ***Save These Instructions***

When using your telephone equipment, please follow these basic safety precautions to reduce the risk of fire, electrical shock, or personal injury:

1. Do not use this product near water, such as near a bath tub, wash bowl, kitchen sink, laundry tub, in a wet basement, or near a swimming pool.
2. Avoid using a telephone (other than a cordless-type) during an electrical storm. There is a remote risk of shock from lightning.
3. Do not use the telephone to report a gas leak in the vicinity of the leak.
4. Use only the power cord, power supply, and/or batteries indicated in the manual. Do not dispose of batteries in a fire. They may explode. Check with local codes for special disposal instructions.

## **Warranty and Customer Service**

ADTRAN will replace or repair this product within five years from the date of shipment if it does not meet its published specifications or fails while in service. For detailed warranty, repair, and return information refer to the ADTRAN Equipment Warranty and Repair and Return Policy Procedure.

Return Material Authorization (RMA) is required prior to returning equipment to ADTRAN.

For service, RMA requests, or further information, contact one of the numbers listed at the end of this manual.

## Affidavit for Connection of Customer Premises Equipment to 1.544 MBPS and/or Subrate Digital Services

For the work to be performed in the certified territory of \_\_\_\_\_ (telco name)

State of \_\_\_\_\_

County of \_\_\_\_\_

I, \_\_\_\_\_ (name), \_\_\_\_\_ (business address),  
\_\_\_\_\_ (telephone number) being duly sworn, state:

I have the responsibility for the operation and maintenance of the terminal equipment to be connected to 1.544 Mbps and/or \_\_\_\_\_ subrate digital services. The terminal equipment to be connected complies with Part 68 of the FCC rules except for the encoded analog content and billing protection specification.

With respect to encoded analog content and billing protection:

( ) I attest that all operations associated with the establishment, maintenance and adjustment of the digital CPE with respect to encoded analog content and billing protection information continuously complies with Part 68 of the FCC rules and Regulations.

( ) The digital CPE does not transmit digital signals containing encoded analog content or billing information which is intended to be decoded within the telecommunications network.

( ) The encoded analog content and billing protection is factory set and is not under the control of the customer.

I attest that the operator(s) maintainer(s) of the digital CPE responsible for the establishment, maintenance and adjustment of the encoded analog content and billing information has (have) been trained to perform these functions by successfully having completed one of the following (check appropriate blocks):

( ) A. A training course provided by the manufacturer/grantee of the equipment used to encode analog signals; or

( ) B. A training course provided by the customer or authorized representative, using

training materials and instructions provided by the manufacturer/grantee of the equipment used to encode analog signals; or

( ) C. An independent training course (e.g., trade school or technical institution) recognized by the manufacturer/grantee of the equipment used to encode analog signals; or

( ) D. In lieu of the preceding training requirements, the operator(s)/maintainer(S) is (are) under the control of a supervisor trained in accordance with \_\_\_\_\_ (circle one) above.

I agree to provide \_\_\_\_\_ (telco's name) with proper documentation to demonstrate compliance with the information in the preceding paragraph, if so requested.

\_\_\_\_\_ Signature

\_\_\_\_\_ Title

\_\_\_\_\_ Date

Subscribed and sworn to before me

This \_\_\_\_\_ day of \_\_\_\_\_, 20\_\_

\_\_\_\_\_  
Notary Public

My commission expires: \_\_\_\_\_

## Affidavit Requirements for Connection to Digital Services

- An affidavit is required to be given to the telephone company whenever digital terminal equipment without encoded analog content and billing protection is used to transmit digital signals containing encoded analog content which are intended for eventual conversion into voice band analog signal and transmitted on the network.
- The affidavit shall affirm that either no encoded analog content or billing information is being transmitted or that the output of the device meets Part 68 encoded analog content or billing protection specification.
- End use/customer will be responsible to file an affidavit with the local exchange carrier when connecting unprotected CPE to a 1.544 Mbps or subrate digital service.
- Until such time as subrate digital terminal equipment is registered for voice applications, the affidavit requirements for subrate services are waived.

## Federal Communications Commission Radio Frequency Interference Statement

This equipment has been tested and found to comply with the limits for a Class A digital device, pursuant to Part 15 of the FCC Rules. These limits are designed to provide reasonable protection against harmful interference when the equipment is operated in a commercial environment. This equipment generates, uses, and can radiate radio frequency energy and, if not installed and used in accordance with the instruction manual, may cause harmful interference to radio frequencies. Operation of this equipment in a residential area is likely to cause harmful interference in which case the user will be required to correct the interference at his own expense

**NOTE**

*Shielded cables must be used with this unit to ensure compliance with Class A FCC limits.*

**WARNING**

*Changes or modifications to this unit not expressly approved by the party responsible for compliance could void the user's authority to operate the equipment.*



## **Canadian Emissions Requirements**

This digital apparatus does not exceed the Class A limits for radio noise emissions from digital apparatus as set out in the interference-causing equipment standard entitled “Digital Apparatus,” ICES-003 of the Department of Communications.

Cet appareil numérique respecte les limites de bruits radioélectriques applicables aux appareils numériques de Class A prescrites dans la norme sur le matériel brouilleur: “Appareils Numériques,” NMB-003 édictée par le ministre des Communications.

## Canadian Equipment Limitations

Notice: The Canadian Industry and Science Canada label identifies certified equipment. This certification means that the equipment meets certain telecommunications network protective, operational, and safety requirements. The Department does not guarantee the equipment will operate to the user's satisfaction.

Before installing this equipment, users should ensure that it is permissible to be connected to the facilities of the local telecommunications company. The equipment must also be installed using an acceptable methods of connection. In some cases, the company's inside wiring associated with a single line individual service may be extended by means of a certified connector assembly (telephone extension cord). The customer should be aware that compliance with the above limitations may not prevent degradation of service in some situations.

Repairs to certified equipment should be made by an authorized Canadian maintenance facility designated by the supplier. Any repairs or alterations made by the user to this equipment, or equipment malfunctions, may give the telecommunications company cause to request the user to disconnect the equipment.

Users should ensure for their own protection that the electrical ground connections of the power utility, telephone lines and internal metallic water pipe system, if present, are connected together. This precaution may be particularly important in rural areas.



*Users should not attempt to make such connections themselves, but should contract the appropriate electric inspection authority, or an electrician, as appropriate.*

The Load Number (LN) assigned to each terminal device denotes the percentage of the total load to be connected to a telephone loop which is used by the device, to prevent overloading. The termination on a loop may consist of any combination of devices subject only to the requirement that the total of the Load Numbers of all devices does not exceed 100.

## LIMITED PRODUCT WARRANTY

ADTRAN warrants that for five (5) years from the date of shipment to Customer, all products manufactured by ADTRAN will be free from defects in materials and workmanship. ADTRAN also warrants that products will conform to the applicable specifications and drawings for such products, as contained in the Product Manual or in ADTRAN's internal specifications and drawings for such products (which may or may not be reflected in the Product Manual). This warranty only applies if Customer gives ADTRAN written notice of defects during the warranty period. Upon such notice, ADTRAN will, at its option, either repair or replace the defective item. If ADTRAN is unable, in a reasonable time, to repair or replace any equipment to a condition as warranted, Customer is entitled to a full refund of the purchase price upon return of the equipment to ADTRAN. This warranty applies only to the original purchaser and is not transferable without ADTRAN's express written permission. This warranty becomes null and void if Customer modifies or alters the equipment in any way, other than as specifically authorized by ADTRAN.

EXCEPT FOR THE LIMITED WARRANTY DESCRIBED ABOVE, THE FOREGOING CONSTITUTES THE SOLE AND EXCLUSIVE REMEDY OF THE CUSTOMER AND THE EXCLUSIVE LIABILITY OF ADTRAN AND IS IN LIEU OF ANY AND ALL OTHER WARRANTIES (EXPRESSED OR IMPLIED). ADTRAN SPECIFICALLY DISCLAIMS ALL OTHER WARRANTIES, INCLUDING (WITHOUT LIMITATION), ALL WARRANTIES OF MERCHANTABILITY AND FITNESS FOR A PARTICULAR PURPOSE. SOME STATES DO NOT ALLOW THE EXCLUSION OF IMPLIED WARRANTIES, SO THIS EXCLUSION MAY NOT APPLY TO CUSTOMER.

In no event will ADTRAN or its suppliers be liable to Customer for any incidental, special, punitive, exemplary or consequential damages experienced by either Customer or a third party (including, but not limited to, loss of data or information, loss of profits, or loss of use). ADTRAN is not liable for damages for any cause whatsoever (whether based in contract, tort, or otherwise) in excess of the amount paid for the item. Some states do not allow the limitation or exclusion of liability for incidental or consequential damages, so the above limitation or exclusion may not apply to Customer.



# Table of Contents

---

<b>List of Figures .....</b>	<b>xxvii</b>
------------------------------	--------------

<b>List of Tables .....</b>	<b>xxix</b>
-----------------------------	-------------

## **Chapter 1. Introduction**

Product Overview .....	1-1
Features .....	1-2
Understanding Frame Relay .....	1-3
T1/FT1 Overview .....	1-4
T1 Service Offerings.....	1-4
Fractional T1 .....	1-4
SNMP Management .....	1-5
Network Manager .....	1-5
Agent .....	1-5
MIB .....	1-5
Telnet .....	1-6
Dial Backup Operation .....	1-6
Interface Card Options .....	1-6
Ethernet Card.....	1-6
4-Wire Switched 56 DBU Card.....	1-7
V.34 DBU Card .....	1-7
ISDN DBU Card .....	1-7
PRI DBU Card.....	1-7
DCE Card .....	1-7

## **Chapter 2. Installation**

Unpack, Inspect, Power Up .....	2-1
Receipt Inspection.....	2-1
ADTRAN Shipments Include .....	2-1
Customer Provides .....	2-2

Power Up.....	2-2
Rear Panel .....	2-2
DBU and LAN Card Slots .....	2-4
Network Connector .....	2-4
Test Jacks .....	2-4
Monitor .....	2-4
In/Out .....	2-4
DSX-1 Port .....	2-5
Control Port.....	2-5
V.35 Connector .....	2-5

**Chapter 3. Operation**

Front Panel .....	3-1
LCD Window .....	3-2
Enter Key .....	3-2
Up and Down Arrow Keys .....	3-2
Cancel Key .....	3-2
Quick Key .....	3-2
Numeric Keypad .....	3-2
Next, Prev, Add, Delete Keys .....	3-2
Shift Key .....	3-3
LED Descriptions .....	3-3
RS: Request to Send .....	3-3
CS: Clear to Send .....	3-3
TD: Transmit Data .....	3-3
RD: Receive Data .....	3-3
ERR: Error .....	3-3
ALM: Alarm .....	3-3
TST: Test .....	3-4
Front Panel Operation .....	3-4
VT-100 Terminal Connection and Operation.....	3-5
Telnet .....	3-7
Local Login Via Telnet.....	3-7
Remote Login Via TELNET .....	3-11
TSU IQ+ Menu Structure .....	3-16
Main Menu.....	3-16
Configuration (CONFIG) .....	3-16
View Statistics (STATS) .....	3-16
Test .....	3-16
Dial .....	3-16
Logout (terminal menu only) .....	3-16

**Chapter 4. Applications**

Management Applications .....	4-1
Local VT-100 Terminal Management.....	4-1
Minimum Configuration Requirements for VT-100 Management .....	4-2
Baud Rate .....	4-2
Control Port Mode .....	4-2
Out-of-Band Management.....	4-3
Minimum Configuration Requirements .....	4-4
IP Address .....	4-4
Control Port Options .....	4-4
Subnet Mask .....	4-4
Gateway IP Address (if required) .....	4-4
Read Community .....	4-4
Write Community .....	4-4
Trap Manager DLCI .....	4-4
Trap Manager IP Address .....	4-5
Trap Manager Port .....	4-5
In-Band Management.....	4-5
Local PVC Management .....	4-5
Minimum Configuration Requirements for Local PVC Management ..	4-6
IP Address .....	4-6
Management DLCI .....	4-6
Read Community .....	4-6
Write Community .....	4-7
Trap Manager DLCI .....	4-7
Trap Manager IP Address .....	4-7
Trap Manager Port .....	4-7
Shared PVC Management .....	4-7
Minimum Configuration Requirements .....	4-8
IP Address .....	4-8
Management DLCI 1 and/or DLCI 2 .....	4-8
Management DLCI 1 and/or DLCI 2 Mode .....	4-8
Read Community .....	4-9
Write Community .....	4-9
Trap Manager DLCI .....	4-9
Trap Manager IP Address .....	4-9
Trap Manager Port .....	4-9
Dedicated PVC Management .....	4-9
Minimum Configuration Requirements .....	4-10
Dial Backup Application .....	4-10
DBU Application 1(non-PRI).....	4-12

DBU Application 2 (PRI) .....	4-14
<b>Chapter 5. Configuration Overview</b>	
Local and Remote Configuration .....	5-1
<b>Chapter 6. Data Port Configuration</b>	
Port Map .....	6-2
Nx Port .....	6-2
Physical Layer Options (PHYS LYR OPTS) .....	6-2
Flow Control .....	6-2
None .....	6-2
Hardware .....	6-2
FECN/BECN .....	6-2
CTS Option .....	6-2
Forced On .....	6-2
Follow RTS .....	6-3
DSR Option .....	6-3
Forced On .....	6-3
Normal .....	6-3
CD Option .....	6-3
Forced On .....	6-3
Normal .....	6-3
TC Clock Option (TC CLOCK OPT) .....	6-3
Normal .....	6-3
Inverted .....	6-3
External .....	6-3
Frame Relay Options (FR OPTS).....	6-4
T392 .....	6-4
N392 and N393 .....	6-4
Management DLCI (MGMT DLCI) .....	6-5
Guidelines for Configuring Management DLCI .....	6-5
Management PVC Option (MGMT PVC OPT) .....	6-5
Signaling Responses (SIG RESPONSES) .....	6-5
Always On .....	6-5
Follow Network (FOLLOW NET) .....	6-5
Always Off .....	6-5
DSX Port .....	6-6
Framing Format (FRAMING).....	6-6
Line Code (LNE CODE) .....	6-6
Yellow Alarm.....	6-6
Line Length (LBO).....	6-6



In-Band Loopback (LOOPBACK).....	6-6
Robbed Bit Signaling (ROBBED BIT).....	6-6
<b>Chapter 7. Configuring the Network Port</b>	
Network Port .....	7-1
Physical Layer Options (PHYS LZR OPTS) .....	7-2
Framing Format (FRAMING) .....	7-2
Line Code (LNE CODE) .....	7-2
Clock Source (CLK SOURCE) .....	7-3
Line Buildout (LBO) .....	7-3
Rx Sensitivity (RX GAIN) .....	7-3
Channel Bandwidth (CHANNEL RATE) .....	7-3
Transmit PRM .....	7-3
Frame Relay Options (FR OPTS) .....	7-4
Signal Type (SIGNAL) .....	7-4
T391 .....	7-4
N391 .....	7-4
N392 and N393 .....	7-4
Management DLCI 1 and 2 (DLCI 1 and 2) .....	7-5
Management DLCI 1 and 2 Mode (DLCI 1 and 2 MODE).....	7-5
Maximum PVC Count.....	7-5
History Interval Count (HIST INT COUNT) .....	7-6
PVC Options (PVC CONFIG) .....	7-6
DLCI .....	7-6
DBU DLCI .....	7-6
DBU Phone Number .....	7-6
DBU on Inactive .....	7-7
DBU Call Order # .....	7-7
CIR (Kbps) .....	7-7
Seq Num Checking (SEQ #) .....	7-7
Delay Measurement (PVC DELAY) .....	7-8
Stats Option (STATS OPT) .....	7-8
Auto .....	7-8
Enabled .....	7-8
Disabled .....	7-8
Next (NEXT key on front panel) .....	7-9
Previous (PREV key on front panel) .....	7-9
Add (ADD key on front panel) .....	7-9
Delete (DELETE key on front panel) .....	7-9

**Chapter 8. Configuring DBU Options**

Auto DBU ..... 8-4

DBU Options ..... 8-4

    Answer Always ..... 8-4

    Beeper Option ..... 8-4

    Password Opt ..... 8-4

    DBU Password ..... 8-4

    Daily Lockout ..... 8-5

    Lockout Start ..... 8-5

    Lockout End ..... 8-5

    Weekend Lock ..... 8-5

DBU Criteria ..... 8-5

    With Network Failure (WITH NET FAIL) ..... 8-5

    With No LMI ..... 8-5

    With PVC Inactive ..... 8-5

DBU Timers ..... 8-6

    Fail Timer (FAIL TMR) ..... 8-6

    Restore Timer (RESTORE TMR) ..... 8-6

    Redial Counter ..... 8-6

    Wait to Redial (REDIAL DELAY) ..... 8-6

DBU Card Configuration Options ..... 8-7

    Modem Options..... 8-7

        Tone/Pulse ..... 8-7

        Max Baud Rate ..... 8-7

        Sync/Async ..... 8-7

    ISDN Options..... 8-7

        Switch Type ..... 8-7

        B-Channel Bit Rate (B-CH BIT RATE) ..... 8-8

        Number of B-Channels (NUM B-CHANNELS) ..... 8-8

        SPID 1 and 2 ..... 8-8

        LDN 1and 2 ..... 8-8

Call Screening ..... 8-8

    PRI Options ..... 8-8

        Physical Layer Options ..... 8-9

            Line Code ..... 8-9

            Clock Source ..... 8-9

            Line Buildout ..... 8-9

            Rx Gain ..... 8-9

            Start Channel ..... 8-9

            Number of Channels ..... 8-9

            Tx Yellow Alarm ..... 8-9

Local Loopback .....	8-10
Transmit PRM .....	8-10
Switch Type .....	8-10
LDN .....	8-10
DCE Options.....	8-10
Interface Type .....	8-10
DBU Bit Rate .....	8-10
<b>Chapter 9. System Configuration</b>	
Change Password .....	9-1
IP Address.....	9-1
Subnet Mask.....	9-2
IP Address (IP ADDRESS).....	9-2
Control Port Options (CNTL PORT OPTS).....	9-2
Read Community (RD COMMUNITY) .....	9-3
Write Community (WR COMMUNITY) .....	9-3
Trap Mgr Options (TRAP MGR OPTS) .....	9-3
Trap Manager DLCI (TRAP DLCI) .....	9-3
Trap Manager IP (TRAP IP) .....	9-3
Trap Manager Port (TRAP PORT) .....	9-3
Next (NEXT key on front panel) .....	9-3
Previous (PREV key on front panel) .....	9-4
Add (ADD key on front panel) .....	9-4
Delete (DELETE key on front panel) .....	9-4
Protocols 1 and 2 .....	9-4
System Name .....	9-5
System Time/Date.....	9-5
History Interval Size (HST INT SIZE).....	9-5
Entering Letters Using the Front Panel .....	9-6
<b>Chapter 10. Statistics</b>	
Viewing Statistical Information (Terminal Interface) .....	10-1
Terminal Statistics Display Options.....	10-2
View by Interval .....	10-2
View by Day .....	10-3
Hot Keys.....	10-4
ESC=Menu .....	10-4
D=DLCI .....	10-4
Page (+, -) .....	10-4
Scroll (<, >) .....	10-4
V=View by Day/View by Interval .....	10-4

DTE Port Statistics.....	10-5
Leads On .....	10-6
Interval Remaining .....	10-6
Signaling State .....	10-6
Signaling Detected .....	10-6
Local PVC Rx Frames .....	10-6
Local PVC Rx Bytes .....	10-6
Local PVC Tx Frames .....	10-6
Local PVC Tx Bytes .....	10-6
Signal Down Time .....	10-6
Signal Error .....	10-7
Signal Timeouts .....	10-7
Signal State Change .....	10-7
Rx Full Status .....	10-7
Rx LI Only .....	10-7
Discard Frame .....	10-7
Aborts .....	10-7
CRC Errors .....	10-7
Octet Align .....	10-7
Length Error .....	10-8
EA Violation .....	10-8
Encapsulation Error .....	10-8
Inactive DLCI .....	10-8
Invalid DLCI .....	10-8
Unrouteable .....	10-8
Network Port Statistics.....	10-9
Signaling State .....	10-10
Interval Remaining .....	10-10
TSU State .....	10-10
PRI State .....	10-10
DBU State .....	10-10
Rx Frames .....	10-10
Rx Bytes .....	10-10
Maximum Rx Throughput .....	10-11
Average Rx Throughput .....	10-11
Maximum Rx Utilization .....	10-11
Average Rx Utilization .....	10-11
Tx Frames .....	10-11
Tx Bytes .....	10-11
Maximum Tx Throughput .....	10-11
Average Tx Throughput .....	10-11

---

Maximum Tx Utilization .....	10-11
Average Tx Utilization .....	10-11
Port UA Time .....	10-12
Signal Down Time .....	10-12
Signal Error .....	10-12
Signal Timeouts .....	10-12
Signal State Change .....	10-12
Rx Full Status .....	10-12
Tx Full Status .....	10-12
Rx LI Only .....	10-12
Tx LI Only .....	10-12
Async Status .....	10-12
Discard Frame .....	10-12
Aborts .....	10-12
CRC Errors .....	10-13
Octet Align .....	10-13
T1 State Change .....	10-13
T1 UA Time .....	10-13
Signal Loss .....	10-13
Telco Test .....	10-13
AIS Alarm .....	10-13
Red Alarm .....	10-13
Yellow Alarm .....	10-14
PLL Alarm .....	10-14
Path Code .....	10-14
Line Code .....	10-14
Length Error .....	10-14
EA Violation .....	10-14
Encapsulation Error .....	10-14
Inactive DLCI .....	10-14
Invalid DLCI .....	10-14
Unrouteable .....	10-15
DSX Port Statistics.....	10-15
DSX State .....	10-15
Interval Remaining .....	10-15
DSX State Change .....	10-15
DSX UA Time .....	10-15
AIS Alarm .....	10-15
Red Alarm .....	10-16
Yellow Alarm .....	10-16
PLL Alarm .....	10-16

Path Code .....	10-16
Line Code .....	10-16
Layer 3 Statistics.....	10-16
Px Type (current) .....	10-17
Interval Remaining .....	10-17
Px Type (listed for each interval) .....	10-18
Px Rx Frames .....	10-18
Px Rx Bytes .....	10-18
Px Rx Dist% .....	10-18
Px Tx Frames .....	10-18
Px Tx Bytes .....	10-19
Px Tx Dist% .....	10-19
Top Talkers.....	10-19
Address Type .....	10-20
Interval Remaining .....	10-20
Rx Distribution .....	10-20
Tx Distribution .....	10-20
DBU Port Statistics .....	10-20
PRI Channels .....	10-21
PRI State .....	10-22
DS0 Status .....	10-22
DBU State .....	10-22
Interval Remaining .....	10-22
Rx Frames .....	10-22
Rx Bytes .....	10-22
Maximum Rx Throughput .....	10-22
Average Rx Throughput .....	10-22
Maximum Rx Utilization .....	10-23
Average Rx Utilization .....	10-23
Tx Frames .....	10-23
Tx Bytes .....	10-23
Maximum Tx Throughput .....	10-23
Average Tx Throughput .....	10-23
Maximum Tx Utilization .....	10-23
Average Tx Utilization .....	10-23
Time in DBU .....	10-23
Discard Frame .....	10-23
Aborts .....	10-23
CRC Error .....	10-24
Octet Align .....	10-24
T1 State Change .....	10-24

---

T1 UA Time .....	10-24
Signal Loss .....	10-24
Telco Test .....	10-24
AIS Alarm .....	10-24
Red Alarm .....	10-25
Yellow Alarm .....	10-25
PLL Alarm .....	10-25
Path Code .....	10-25
Line Code .....	10-25
Length Error .....	10-25
Call Manager .....	10-26
DLCI Statistics .....	10-27
DLCI Statistics for a Specific DLCI .....	10-27
Throughput (Tx and Rx) .....	10-27
Utilization .....	10-27
Remaining .....	10-27
Rx Frames .....	10-27
Rx Bytes .....	10-27
Maximum Rx Throughput .....	10-27
Average Rx Throughput .....	10-27
Maximum Rx Utilization .....	10-27
Average Rx Utilization .....	10-28
Tx Frames .....	10-28
Tx Bytes .....	10-28
Maximum Tx Throughput .....	10-28
Average Tx Throughput .....	10-28
Maximum Tx Utilization .....	10-28
Average Tx Utilization .....	10-28
Time in DBU .....	10-28
PVC IA Time .....	10-28
Rx FECN .....	10-28
Tx FECN .....	10-28
Rx BECN .....	10-29
Tx BECN .....	10-29
Rx DE .....	10-29
Tx DE .....	10-29
Rx CR .....	10-29
Tx CR .....	10-29
Lost Frames .....	10-29
Remote Lost Frames .....	10-29
Rx Burst Seconds .....	10-29

Tx Burst Seconds .....	10-29
Minimum Rx Frame .....	10-30
Maximum Rx Frame .....	10-30
Average Rx Frame .....	10-30
Minimum Tx Frame .....	10-30
Maximum Tx Frame .....	10-30
Average Tx Frame .....	10-30
Minimum Frame Delay .....	10-30
Maximum Frame Delay .....	10-30
Average Frame Delay .....	10-30
PVC State Change .....	10-30
DLCI List .....	10-31
System Statistics .....	10-32
Viewing Statistical Information (Front Panel Interface) .....	10-33
DTE Port Statistics Available on Front Panel.....	10-33
Control Signal Status Screen .....	10-33
Signal State .....	10-34
Signal State Change .....	10-34
Signal Timeouts .....	10-34
Signal Errors .....	10-34
Errored Frames .....	10-34
CRC Errors .....	10-34
Abort Frames .....	10-34
Octet Align .....	10-34
Signal Down Time .....	10-34
Network Port Statistics Available on Front Panel.....	10-35
TSU Loop State .....	10-35
PRI Loop State .....	10-35
DBU Status .....	10-35
Signal State .....	10-35
Signal State Change .....	10-35
Signal Timeouts .....	10-35
Signal Errors .....	10-35
Frames In .....	10-35
Frames Out .....	10-35
Errored Frames .....	10-35
CRC Errors .....	10-35
Abort Frames .....	10-35
Octet Align .....	10-35
Port UA Time .....	10-36
Line Code .....	10-36



Path Code .....	10-36
DSX-1 Port Statistics Available on Front Panel .....	10-36
TSU Loop State .....	10-36
Line Code .....	10-36
Path Code .....	10-36
DBU Port Statistics Available on Front Panel .....	10-36
PRI Loop State .....	10-36
D Channel State .....	10-36
DBU Status .....	10-36
Time in DBU .....	10-36
Frames In .....	10-37
Frames Out .....	10-37
Errored Frames .....	10-37
CRC Errors .....	10-37
Abort Frames .....	10-37
Octet Align .....	10-37
System Statistics Available on Front Panel .....	10-37

## Chapter 11. Testing

Ping .....	11-3
Address to Ping (PING ADDRESS) .....	11-3
Start Ping .....	11-3
Pings Transmitted (PING TX) .....	11-3
Ping Responses (PING RX) .....	11-3
Min Response Time (MIN RESP TIME) .....	11-3
Max Response Time (MAX RESP TIME) .....	11-3
Avg Response Time (AVG RESP TIME) .....	11-3
PVC Loopback .....	11-4
DLCI <0 = All> (DLCI) .....	11-4
Test Length .....	11-4
Start Test .....	11-4
Stop Test .....	11-5
View Test .....	11-5
PVC Active/Inactive/Undefined .....	11-5
Test Active/No Test Active .....	11-5
Frames Rx .....	11-5
Frames Tx .....	11-5
Lost Frames .....	11-5
Remote Lost Frames (RMT LOST FRAMES) .....	11-5
Minimum Loop Response Time (MIN RESP TIME) .....	11-5
Maximum Loop Response Time (MAX RESP TIME) .....	11-5

Average Loop Response Time (AVG RESP TIME) .....	11-6
Reset Test Stats .....	11-6
View DLCI List .....	11-6
DSX Loopback .....	11-7
None .....	11-7
Line .....	11-7
Port .....	11-7
<b>Chapter 12. Activating Dialing Functions</b>	
Dialing Options .....	12-1
Dial Options when Dial Backup is Idle .....	12-2
Dial Backup .....	12-2
Stay on Leased .....	12-2
Dial Options During Dial Backup.....	12-3
Dial Backup .....	12-3
<b>Appendix A. Pinouts.....</b>	<b>A-1</b>
<b>Appendix B. Specifications Summary .....</b>	<b>B-1</b>
<b>Appendix C. Acronyms and Abbreviations.....</b>	<b>C-1</b>
<b>Appendix D. Glossary .....</b>	<b>D-1</b>
<b>Index .....</b>	<b>Index-1</b>

# List of Figures

---

Figure 2-1.	TSU IQ+ Rear View .....	2-3
Figure 3-1.	TSU IQ+ Front Panel .....	3-1
Figure 3-2.	Example of Front Panel Menu Navigation .....	3-4
Figure 3-3.	Terminal Login Menu .....	3-6
Figure 3-4.	Terminal Main Menu.....	3-6
Figure 3-5.	PC Connected to Local and Remote IQs .....	3-7
Figure 3-6.	TSU IQ Beginning Telnet Screen (Local) .....	3-8
Figure 3-7.	Telnet Login Menu Screen (Local) .....	3-9
Figure 3-8.	Local Main Menu Screen .....	3-10
Figure 3-9.	TSU IQ+ Login Screen (Remote) .....	3-11
Figure 3-10.	Telnet Login Menu Screen (Remote) .....	3-12
Figure 3-11.	Remote Login Screen.....	3-13
Figure 3-12.	Continue or Exit Screen .....	3-14
Figure 3-13.	Remote Main Menu Screen .....	3-15
Figure 4-1.	VT-100 Management Application Example.....	4-2
Figure 4-2.	Out-of-Band Management Application Example.....	4-3
Figure 4-3.	Local PVC Management Application .....	4-6
Figure 4-4.	Shared PVC Management Application .....	4-8
Figure 4-5.	Dedicated PVC Management Application .....	4-10
Figure 4-6.	Dial Backup Application .....	4-12
Figure 4-7.	PRI DBU Card at Host Site.....	4-14
Figure 5-1.	Terminal Configuration Menu.....	5-2
Figure 5-2.	Terminal Configuration Tree .....	5-3
Figure 5-3.	Front Panel Configuration Tree .....	5-4
Figure 6-1.	Terminal Data Port Configuration Menu.....	6-1
Figure 7-1.	Terminal Network Port Configuration Menu .....	7-2

Figure 8-1.	DBU Options Menu (with ISDN DBU Card).....	8-1
Figure 8-2.	Dial Backup Menu Tree.....	8-2
Figure 8-3.	Dial Backup Menu Tree with Option Cards Installed .....	8-3
Figure 9-1.	System Configuration Menu.....	9-2
Figure 10-1.	View Statistics Menu .....	10-2
Figure 10-2.	View by Day Statistics Screen .....	10-5
Figure 10-3.	View by Interval Statistics Screen.....	10-5
Figure 10-4.	Network Port Statistics with DBU Card Installed (View by Interval)	10-9
Figure 10-5.	Network Port Statistics (View by Day) .....	10-9
Figure 10-6.	Top Talkers Statistics Menu.....	10-19
Figure 10-7.	DBU Port Statistics (View by Interval) .....	10-20
Figure 10-8.	DBU Port Statistic (View by Day).....	10-21
Figure 10-9.	Call Manager Menu.....	10-26
Figure 10-10.	DLCI Statistics Summary for All DLCIs.....	10-31
Figure 10-11.	System Statistics Screen .....	10-32
Figure 10-12.	Control Signal Status Screen .....	10-33
Figure 10-13.	Signal State Screen .....	10-34
Figure 10-14.	System Statistics Screen .....	10-37
Figure 11-1.	Terminal Test Menu (with Ethernet Card Installed) .....	11-1
Figure 11-2.	Front Panel Test Menu .....	11-2
Figure 11-3.	PVC Loopback Menu .....	11-4
Figure 11-4.	Test Status Screen.....	11-6
Figure 12-1.	Dial Options Menu (non-PRI DBU) .....	12-1
Figure 12-2.	Dial Options Menu (PRI DBU) .....	12-2

# List of Tables

---

- Table 4-1. Example Settings for Dial Backup Options..... 4-13
- Table 4-2. Example Settings for PVC Configuration Table ..... 4-13
- Table 4-3. Example Settings for PRI DBU Card (A)..... 4-15
- Table 4-4. Global DBU Settings (B and C)..... 4-15
- Table 4-5. Example Settings for PRI DBU Card at Host Site ..... 4-15
- Table 10-1. Possible TSU States..... 10-10
- Table 10-2. PRI Channel Descriptions ..... 10-21
- Table 10-3. Possible PRI States..... 10-22
- Table 10-4. PRI Channels and Corresponding Status..... 10-26
- Table A-1. Pin Assignments for Network Connector..... A-1
- Table A-2. Pin Assignments for DSX-1 Connector ..... A-1
- Table A-3. Pin Assignments for Control Connector ..... A-2
- Table A-4. Pin Assignments for 10BaseT Connector ..... A-2
- Table A-5. Pin Assignment for V.35 Connector ..... A-3
- Table A-6. 4-Wire, V.34, and BRI ISDN DBU Card P inAssignments..... A-4
- Table A-7. Pin Assignments for the PRI DBU Card..... A-4
- Table A-8. DTE/DCE Connector Pin Assignments..... A-5



# Chapter 1 Introduction

---

## PRODUCT OVERVIEW

The ADTRAN TSU IQ+ provides the visibility and control needed for both the physical and logical connections made in frame relay networks. The TSU IQ+ provides logical layer monitoring and management for frame relay. Each permanent virtual circuit (PVC) accessed through a TSU IQ+ is managed end-to-end as if it were a leased-line connection. Real-time statistics on throughput, bandwidth utilization, availability, bursting, congestion, and network delay are collected and stored in the Frame IQ MIB (management information base). Protocol-specific information is also gathered, providing information concerning traffic utilization in the frame relay connection. All information can be gathered by management systems and used to monitor network health and perform long-term network planning, allowing optimum use of network resources.

The unit's embedded SNMP (simple network management protocol) agent provides complete SNMP access to the unit. SNMP access is available through the DTE or network port or through an integral SLIP (serial line internet protocol) or PPP (point-to-point protocol) async port. The TSU IQ+'s unique modular approach provides optional 10BaseT ethernet access for SNMP.

## Features

Features of the TSU IQ+ are:

- Complete and comprehensive frame relay monitoring, including Layer 3 protocol monitoring
- Real-time measurement of bandwidth utilization, committed information rates (CIRs), and excess burst rates on each PVC
- True non-intrusive, in-band transmission of statistics
- Embedded SNMP and Telnet through the DTE, network, or SLIP/PPP port (or through the optional ethernet interface)
- Control port provides SLIP and async PPP access to SNMP or VT-100 terminal configuration
- DSX-1 port provides short haul T1 interface for operation with a PBX
- Dial backup (DBU) available with DBU cards; options include 4-wire Switched 56 (SW56), V.34, PRI, and ISDN
- End-to-end network round trip delay measurements for network optimization
- 10BaseT ethernet port available with ethernet card
- Frame IQ MIB is standard ANSI format compatible with popular enterprise reporting systems
- Optional IQ View™ software system provides a cost-effective, easy-to-use GUI (graphical user interface) for performance management
- Standard DTE (data terminal equipment) interfaces

The 4-wire SW56 DBU card is compatible with AT&T Accunet and Sprint SW56 type services. The V.34 DBU card allows switched backup over the public switched telephone network (PSTN). The ISDN 1 B+D card supports a U-interface to the basic rate ISDN and is compatible with National ISDN and AT&T DMS. The DSX-1 port complies with ANSI T1.102.

The PRI DBU card allows the TSU IQ+ to accept or place up to 23 dial backup calls simultaneously.

The TSU IQ+ provides a V.35 electrical and physical DTE interface to accommodate a variety of applications.



## UNDERSTANDING FRAME RELAY

Frame relay is a wide area network (WAN) service designed to minimize physical connections. This is accomplished by using virtual connections within the frame relay cloud and accessing these virtual circuits with normally one physical connection at each location to the frame relay service. Virtual circuits are addressed using header information at the beginning of each frame. These frames are formatted by the user's customer premises equipment (CPE) such as the ADTRAN TSU IQ+.

ANSI (American National Standards Institute) standards describe how each frame must be constructed to provide interoperability between CPE equipment and frame relay switching equipment. Each frame must contain a header, at least one byte of information data, two bytes of CRC16, and a trailing flag 0x7E.

This header information contains a virtual circuit address known as a DLCI (data link connection identifier). The header information also contains bits used for network congestion control.

Frame relay virtual circuits may be defined as permanent (PVC) or switched (SVC). PVCs have the same DLCI for a given path each time a user protocol session is established. The network service provider assigns these DLCIs at subscription time. SVCs, on the other hand, have DLCIs dynamically assigned each time a user protocol session is established. The CPE equipment must request a call and the DLCI is assigned by the network switching equipment. This DLCI is valid until the call is disconnected and may be assigned a different value each time a call is requested.

## T1/FT1 OVERVIEW

The telephone companies (telcos) have used T1 digital communications links for voice transmission since the early sixties. The D4 channel bank is an example of a T1 digital carrier system that was introduced in the mid-seventies and is still widely used by the telcos. Communication demands of businesses continued to grow to the point that the telcos began offering T1 service directly to the public. D4 channel banks began to be used for T1 in corporate network topographies for voice. The technological advances in computer development also created a demand for T1 data communication, which now is a large part of the T1 traffic.

### T1 Service Offerings

T1 is a digital service that the service providers deliver to the user over two pairs of wires. The signal operates at 1.544 Mbps and is usually extended by repeaters that are installed about every mile after the first 6000 feet. The T1 signal is divided into 24 time slots or digital signal level zeros (DS0s) which operate at 64 kbps. Each time slot is occupied by digitized voice or by data.

The T1 signal originally used a type of framing known as D4 superframe which identifies how the T1 is multiplexed. Extended superframe (ESF) is an enhancement of that framing format. ESF provides a non-disruptive means of full-time monitoring on the facility datalink (FDL). The service providers originally used ESF to monitor the performance of their service offering. Since the introduction of ESF, equipment that is installed in private networks can also provide the same performance information to the user.

### Fractional T1

Fractional T1 (FT1) lets the buyer purchase less than a full T1 circuit between two points. Most carriers offer fractional T1 in increments of 56 or 64 kbps. Connection is made to the same network elements. The network allows multiple users to share the same interoffice T1 bandwidth.

FT1 remains almost exclusively an inter-exchange carrier (IXC) service. Local exchange carriers (LECs) typically do not offer FT1, so the user's proximity to the IXC's point-of-presence (POP) is key in the savings that fractional T1 offers.

## SNMP MANAGEMENT

SNMP management capability is provided in-band with support for RFC 1315 (frame relay DTE MIB), RFC 1213 (MIB II), RFC 1406 (DS1/E1 MIB), and ADTRAN Enterprise MIB. MIB files are available from ADTRAN in the support section of the ADTRAN web page at [www.adtran.com](http://www.adtran.com). Telnet capability is also supported. For non-SNMP environments, VT-100 and front panel operation are supported.

The TSU IQ+'s embedded SNMP feature allows the unit to be accessed and controlled by a network manager in-band at the DTE or network interface, out-of-band at the control port via SLIP or async PPP, or using a LAN connection. LAN connection requires the optional ethernet card (P/N 1204005L1). This card provides a 10BaseT ethernet interface to the LAN.

The term SNMP broadly refers to the message protocols used to exchange information between the network and the managed devices, as well as to the structure of network management data bases. The three basic components of SNMP follow.

### **Network Manager**

Control program that collects, controls, and presents data pertinent to the operation of the network devices. It resides on a network management station.

### **Agent**

Control program that resides in each connected network device. This program responds to queries and commands from the network manager and returns requested information or invokes configuration changes initiated by the manager.

### **MIB**

Index to the organized data within a network device. It defines the operation parameters that can be controlled or monitored.

## TELNET

Telnet provides a password-protected, remote login facility to the TSU IQ+. Telnet allows a user on a network manager to control the TSU IQ+ through the terminal menus.

## DIAL BACKUP OPERATION

The TSU IQ+ dial backup (DBU) option cards provide single or multiple sight backup, depending on the DBU card option selected. The TSU IQ+ can be configured to originate a call based on physical layer conditions (i.e., port failures) and/or PVC outages. Once the criteria are met, the TSU IQ+ establishes a call to the configured phone number and the connection is used to carry traffic for the PVC(s) configured for DBU operation.

In the case of PVC outages (not physical layer port failure), the TSU IQ+'s two-port design allows the TSU IQ+ receiving the call to continue to use the T1 frame relay circuit for PVCs that are not affected by the outage, while using the DBU interface for PVCs that are inactive due to the outage. A TSU IQ+ with multiple PVCs to multiple sites can also originate a call to one site during an outage and restore connection for PVCs to that destination.

The TSU IQ+'s unique DBU cards are field-installable by the customer. See *Installation* on page 2-1 for information on installing DBU cards. The DBU cards are compatible with other ADTRAN products supporting DBU. The backup options are described in the following section, *Interface Card Options*. Contact the local telco provider to determine which services are available in your area. See *Applications* on page 4-1 for more information, including an example of a dial backup application.

## INTERFACE CARD OPTIONS

### Ethernet Card

This option card connects to an ethernet LAN, providing communication of management traffic between the LAN and the TSU IQ+.

## 4-Wire Switched 56 DBU Card

This dial-up 4-wire SW56 card allows you to pay for data connection only for the time the unit is active. The regional operating companies provide the 4-wire local loop service to SW56 customers. The 4-wire SW56 DBU card is compatible with AT&T Accunet and Sprint SW56 type services.

## V.34 DBU Card

The V.34 DBU card provides switched backup of the leased line application. This module allows backup data rates of up to 33.6 kbps over the public switched telephone network (PSTN).

## ISDN DBU Card

The ISDN 1B+D card supports a U-interface to the Basic Rate ISDN and is compatible with National ISDN and AT&T DMS. 1B+D Basic Rate ISDN service provides a switched 56/64 kbps circuit.

## PRI DBU Card

The PRI DBU 23 B+D (primary rate interface dial backup) card allows the TSU IQ+ to accept or place up to 23 dial backup calls simultaneously. This card supports 64Kbps data service. Incoming calls will be accepted for 56Kbps or 64Kbps service. Bonding is not supported. Fractional PRI capability is supported.

## DCE Card

This module is used to connect a TSU IQ+ to an external DBU device such as an ISDN terminal adapter. The DTR lead is used to control the dial process in this case.



## Chapter 2 Installation

---

### UNPACK, INSPECT, POWER UP

#### Receipt Inspection

Carefully inspect the TSU IQ+ for any shipping damage. If damage is suspected, file a claim immediately with the carrier and contact ADTRAN Customer Service (see back page for more information). If possible, keep the original shipping container for use in shipping the TSU IQ+ for repair or for verification of damage during shipment.

#### ADTRAN Shipments Include

The following items are included in ADTRAN shipments of the TSU IQ+:

- TSU IQ+ unit
- The user manual
- An 8-position modular to 8-position modular cable and a modular to female DB-9 adapter for access to the Control/SLIP/PPP port
- Two 8-position modular to 8-position modular cables



*The ADTRAN TSU IQ+ MIB is available from ADTRAN in the support section of the ADTRAN web page at [www.adtran.com](http://www.adtran.com).*

The following items are included in ADTRAN shipments of DBU cards:

- DBU card
- An 8-position modular to 8-position modular cable for the 4-wire SW56, ISDN, or PRI DBU options or an 8-position modular to 4-position modular cable for the V.34 DBU option

### Customer Provides

The customer must provide a male V.35 interface cable.

For SNMP management not accessed through the **V.35** or **Network** port, the customer must provide access to the TSU IQ+ either through a SLIP, Async PPP (requires a male 25-pin D-type connector), or a through the **10BaseT Ethernet** port (requires that an ADTRAN Ethernet card be installed in the TSU IQ+). See *Pinouts* on page A-1 for the pin assignments of the **CONTROL** port (for SLIP and Async PPP) and the **ETHERNET** port.

### Power Up

The TSU IQ+ is provided with a captive 8-foot power cord, terminated by a three-prong plug which connects to a grounded 115 VAC power receptacle.



*Power to the TSU must be provided from a grounded 115 VAC, 60 Hz receptacle.*

### REAR PANEL

The rear panel contains a DTE connector which provides primary channel **V.35**. An 8-pin Network jack, Test Jacks, a DSX-1 port, a Control port, a captive power cord, and a power switch are also located on the rear panel. Pin assignments for these connectors are



listed in *Pinouts* on page A-1. The TSU IQ+ rear panel is shown in Figure 2-1 with optional DBU and ethernet cards installed.

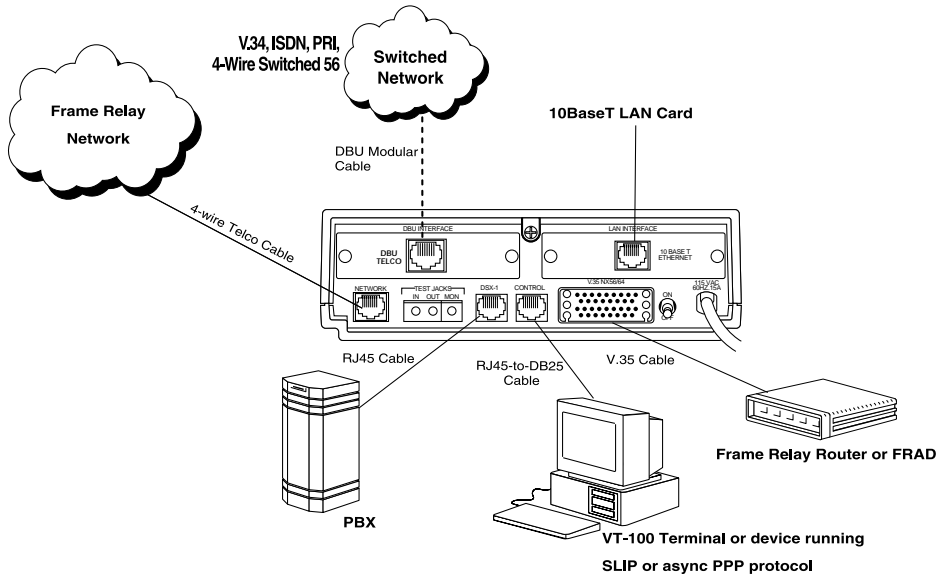

Item	Function
DBU Interface	DBU card slot
LAN Interface	Ethernet card slot
Network	Connects to dedicated circuit
Test Jacks	Connect to a monitoring device or a T1 test set
DSX-1	Connects to equipment requiring short haul T1 (such as a PBX)
Control	Connects to a VT-100 terminal or a device running SLIP or async PPP protocol
V.35	High speed DTE interface
Power Switch	Turns power on or off
115 VAC Connection	Power cord connection

**Figure 2-1. TSU IQ+ Rear View**

## DBU and LAN Card Slots

The TSU IQ+ rear panel has two card slots (labeled **DBU Interface** and **LAN Interface**) for the installation of dial backup, ethernet, and DCE cards. To insert cards, perform the following procedure:

1. On the rear panel, turn off the power switch.
2. Slide the card into the corresponding rear slot until the card panel is flush with the TSU IQ+ chassis.
3. Push card locks in (until they click) to secure the card and ensure proper installation.



*Card slots are keyed to prevent improper installation (i.e., putting a DBU card into the ethernet slot). The DCE card is keyed for the DBU slot.*



*Failure to remove power from the unit before installing or removing option cards can damage the equipment.*

## Network Connector

Connect the TSU IQ+ to the network by using the 8-position modular jack labeled **NETWORK**. The pinout for this connector is listed in *Pinouts* on page A-1.

## Test Jacks

### Monitor

The monitor jack (labeled **MON**) is used as a non-intrusive monitoring point for the data received from the network. The monitoring device needs to be set for high impedance bridge mode.

### In/Out

The **IN** and **OUT** jacks are used to connect to a T1 test set for testing the T1 interface of the TSU IQ+. These connections isolate the T1 interface from the RJ-45 network jack.

## DSX-1 Port

The **DSX-1** interface provides a short haul T1 connection to a PBX or other customer premise equipment (CPE). This port complies with ANSI T1.102.

## Control Port

The TSU IQ+ has an 8-pin modular jack labeled **CONTROL**. The Control port provides connection to a VT-100 EIA-232 compatible interface, a device running SLIP protocol, or a device running Async PPP protocol. An 8-foot cable with adapter connector provides a standard DB-25 EIA-232 interface. See *Pinouts* on page A-1 for the Control port's pin assignments. Chapter 3, *Operation* describes this port's operation.

## V.35 Connector

The DTE should be connected to the V.35 connector (labeled **V.35 Nx56/64**). The maximum cable length is 100 feet. The pin assignments for this connector are listed in *Pinouts* on page A-1.



*To prevent possible radio frequency interference emissions, a shielded cable is required.*



# Chapter 3 Operation

## FRONT PANEL

The TSU IQ+ faceplate is shown in Figure 3-1. Descriptions of each part of the front panel follow.

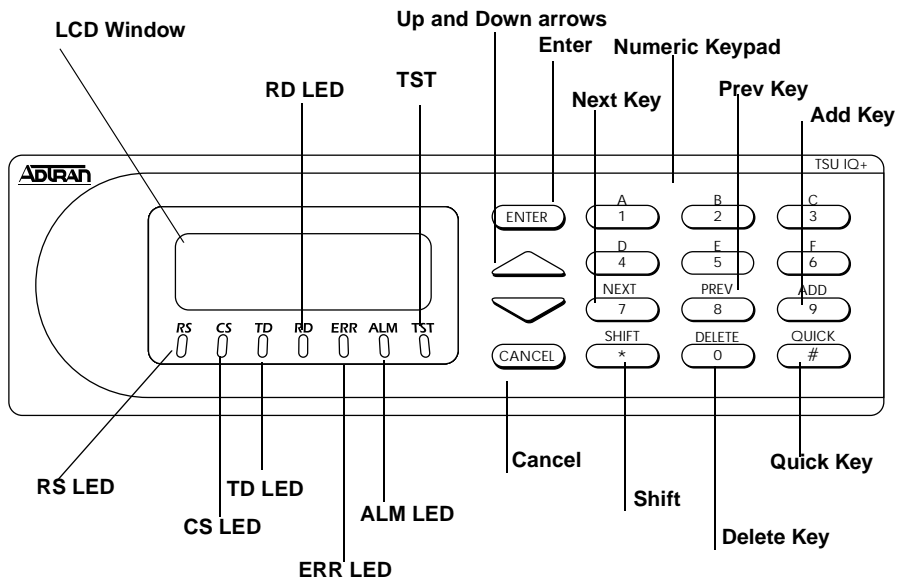

Figure 3-1. TSU IQ+ Front Panel

## LCD Window

Displays menu items and messages in this 2 line by 16 character display.

## Enter Key

Selects active menu items. To activate a menu item, scroll to it using the arrow keys or press the number of the item. The flashing cursor indicates the active parameter. Press **Enter** to select the active menu item.

## Up and Down Arrow Keys

Scrolls through the menu and activates the menu items of the current menu. The flashing cursor indicates an active parameter.

## Cancel Key

Press the **Cancel** key to stop the current activity and return to the previous menu. Press repeatedly until the desired menu level is reached. When a submenu item is displayed, press **Cancel** to exit the current display and return to the previous menu.

## Quick Key

Pressing the **Quick** key returns the front panel to the main menu.

## Numeric Keypad

The numeric keypad contains the numbers **0** through **9** and alpha characters **A** through **F**, which are used to activate menu items and enter information such as the IP address.

## Next, Prev, Add, Delete Keys

To activate these functions, press and release the **Shift** key, then press the **Next**, **Prev**, **Add**, or **Delete** key. Use these keys when editing tables such as the PVC Options table. See *PVC Options (PVC CONFIG)* on page 7-6 for more information.

## Shift Key

Enter alpha characters by first pressing and releasing the **Shift** key and then pressing the desired character. The **Next**, **Prev**, **Add**, and **Delete** keys are also activated by first pressing **Shift**.

To activate a menu item designated by an alpha character rather than a number, place the cursor on the menu item using the up and down arrows or press **Shift** and then the letter. The flashing cursor indicates the active parameter. Press **Enter** to select the item.

## LED Descriptions

The TSU IQ+ has seven LED indicators: **RS**, **CS**, **TD**, **RD**, **ERR**, **ALM**, and **TST**. These LEDs are identified as follows:

### **RS: Request to Send**

Reflects the status of the RS pin of the DTE interface.

### **CS: Clear to Send**

Reflects the status of the CS pin of the DTE interface.

### **TD: Transmit Data**

This LED is active when the TSU IQ+ DTE port is transmitting data.

### **RD: Receive Data**

This LED is active when the TSU IQ+ DTE port is receiving data.

### **ERR: Error**

This LED is active when a T1 line code violation or a T1 path code violation occurs.

### **ALM: Alarm**

This LED is active when an alarm condition exists. Alarm conditions include:

#### T1 Alarm Conditions

- Loss of signal
- Loss of T1 frame sync (red alarm)
- Receiving AIS (alarm indication signal) from the service provider

#### Frame Relay Alarm Condition

- Network frame relay signaling state is down

**TST: Test**

This LED is active when the network interface is in a loopback condition triggered from the service provider.

## Front Panel Operation

To choose a menu item, press the corresponding number or alpha character on the keypad. Press **Shift** to activate menu items with alpha selections. Scrolling to the selection by pressing the up and down arrows also activates the menu items. The flashing cursor indicates the active selection. Press **Enter** to select the item. The following steps and Figure 3-2 illustrate how to select TSU IQ+ options:

1. Activate **CONFIGURATION (CONFIG)** by using the arrow keys or by pressing **1**. The cursor will flash on the number next to the activated selection. Press **Enter**.
2. Use the arrow keys to view submenu items.
3. Choose an item on the submenu such as **DATA PORT**.
4. Activate **DATA PORT** by using the arrow keys or by pressing **1**. Press **Enter**.
5. Activate **NX PORT** by using the arrow keys or by pressing **2**. Press **Enter**.
6. Activate **PHYS LVR OPTS** by using the arrow keys or by pressing **1**. Press **Enter**.
7. Choose **FLOW CONTROL** by using the arrow keys or by pressing **1**. Press **Enter**.
8. Select a flow control type by using the arrow keys. Press **Enter** when the correct type is displayed.

1 CONFIG	1 DATA PORT	1 PORT MAP	1 FLOW CONTROL
	2 NETWORK PORT	2 NX PORT	2 CTS OPTION
	3 DIAL BACKUP	3 DSX PORT	2 FRAME RELAY OPTS
	4 CONTROL PORT		3 DSR OPTION
	5 SYSTEM		4 CD OPTION
			5 TC CLOCK OPT

**Figure 3-2. Example of Front Panel Menu Navigation**



## VT-100 Terminal Connection and Operation

To control the TSU IQ+ using a VT-100 terminal, follow this procedure:

1. Using the front panel interface, set the TSU IQ+ baud rate to match the terminal. Select **1 CONFIG**; then select **CONTROL PORT**.
2. Using the ADTRAN-provided VT-100 terminal adapter, connect the **COM** port of a VT-100 compatible terminal or equivalent to the eight-pin modular jack labeled **CONTROL** on the rear of the TSU IQ+. This connection is used for both local and remote configuration.
3. Open the connection and press **Enter** repeatedly until the **LOGIN** Menu appears (Figure 3-3 on page 3-6).
4. Select **LOCAL LOGIN** to configure the TSU IQ+ unit connected to the terminal.
5. Select **REMOTE LOGIN** to configure a remotely located TSU IQ+ unit.
6. For remote applications, at the remote DLCI prompt, enter the outgoing DLCI (see the following note) by pressing **1**, then **Enter**, entering the DLCI number, and pressing **Enter** again.
7. Select **BEGIN REMOTE SESSION** by pressing **2** and **Enter**.

**NOTE**

*When entering the DLCI for a remote application, enter the DLCI associated with the local unit that you are logged into (not the far end DLCI).*

*If the wrong DLCI is entered or a network problem exists, the screen freezes at the **PRESS ANY KEY TO CONTINUE** prompt. Press **CNTL + L** twice to return the unit to the **LOGIN** screen.*

8. Enter the password. The factory default password is **adtran**. The **MAIN** menu will appear (Figure 3-4 on page 3-6).
9. Make selections by entering the number corresponding to the chosen parameter. Press **ESC** to return to the previous screen.

 **NOTE** *In the upper right-hand corner of the VT-100 screen, LOCAL or REMOTE is displayed, indicating the unit the current screen represents.*

```
                                Login Menu                                ADTRAN TSUIQ+
                                                                <Local> ATLANTA
-----
1 - Local Login
2 - Remote Login

Enter Selection ->
```

Figure 3-3. Terminal Login Menu

```
                                Main Menu                                ADTRAN TSUIQ+
                                                                <Local> ATLANTA
-----
1 - Configuration
2 - View Statistics
3 - Test
4 - Dial
5 - Logout

Enter Selection -> █
```

Figure 3-4. Terminal Main Menu

## TELNET

### Local Login Via Telnet

Before you begin, please note the following:



**NOTE**

*Only one Telnet session can be active at one time.*



**NOTE**

*The Telnet session will time out after 5 minutes of inactivity.*

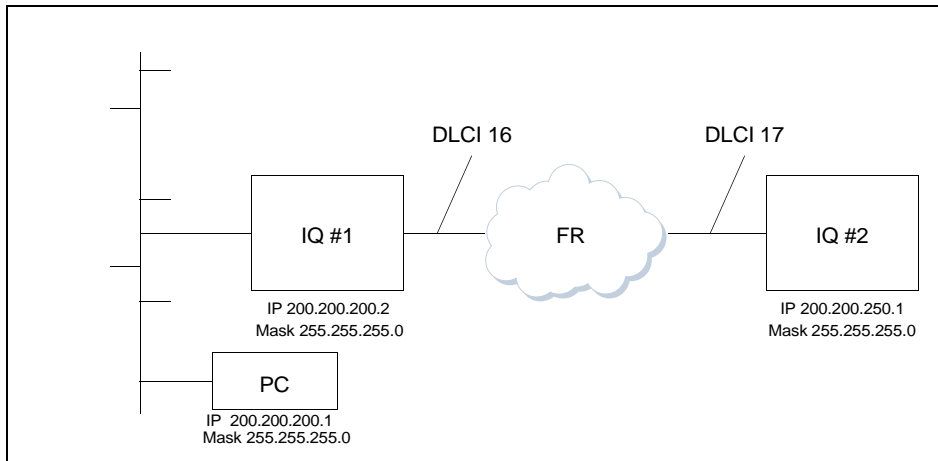

**Figure 3-5. PC Connected to Local and Remote IQs**

Local Login via Telnet is defined as telnetting from the PC into IQ #1 and then choosing Local Login to enter the main menu of IQ#1 and begin configuration of that unit as shown in Figure 3-5.

To connect to the TSU IQ+ via Telnet, follow these steps:

1. Before attempting to connect via Telnet to IQ unit #1, first define the **IP ADDRESS**, the **GATEWAY IP ADDRESS**, and the **SUBNET MASK** using the front panel. These options are under **SYSTEM CONFIG**.
2. When you begin the local login via Telnet session into IQ #1, you will see the following screen (Figure 3-6).



**Figure 3-6. TSU IQ Beginning Telnet Screen (Local)**

3. Press the Enter key. Then you will see the following screen (Figure 3-8).

```
Telnet Login Menu                                ADTRAN TSUIQ+
                                                  Telnet

1 - Local Login
2 - Remote Login
3 - Logout

Enter Selection ->
```

**Figure 3-7. Telnet Login Menu Screen (Local)**

4. To login to the local unit (i.e., the unit you are telnetted into), choose **1** for local login and press **ENTER**.
5. Next, you will be prompted for a password. The default password is **adtran**.



*You can change this password using the **SYSTEM CONFIG** sub-menu. This option is available only via the terminal.*

6. You will now see the **MAIN** menu of the unit (Figure 3-8).

```
Main Menu                                ADTRAN TSUIQ+
                                           Telnet
-----
1 - Configuration
2 - View Statistics
3 - Test
4 - Logout

Enter Selection ->
```

**Figure 3-8. Local Main Menu Screen**

7. Notice that when you are telnetted into the local unit, the word **Telnet** appears in the upper right-hand corner.

## Remote Login Via TELNET

Remote Login via Telnet is defined as telnetting from the PC into IQ #1 and then choosing **REMOTE LOGIN** to enter the **MAIN** menu of IQ #2 and begin configuration of that unit.

1. Before attempting to connect via Telnet to IQ Unit #2, first define the **IP ADDRESS**, the **GATEWAY IP ADDRESS**, and the **SUBNET MASK** using the front panel. These options are under **SYSTEM CONFIG**.
2. When you begin the Telnet session, you will see the following screen (Figure 3-9).

A screenshot of a Telnet session showing the login screen for a TSU IQ+ unit. The text displayed is "ADTRAN TSUIQ+! VER 3.31 27CD" followed by "Enter to continue..". The screenshot is enclosed in a rectangular border.

```
ADTRAN TSUIQ+! VER 3.31 27CD
Enter to continue..
```

**Figure 3-9. TSU IQ+ Login Screen (Remote)**

3. Press **ENTER**. Next, you will see the following screen (Figure 3-10).

```
Telnet Login Menu                                ADTRAN TSUIQ+
                                                    Telnet

1 - Local Login
2 - Remote Login
3 - Logout

Enter Selection ->
```

**Figure 3-10. Telnet Login Menu Screen (Remote)**

4. To login to the remote unit (not the unit you are telnetted into), choose **2** for **REMOTE LOGIN** and press **ENTER**.



Next, you will see the following screen (Figure 3-11).

```
Remote Login                                ADTRAN TSUIQ+
                                           Telnet
-----
1 - Remote DLCI 0
2 - Begin Remote Session

Enter Selection ->
```

**Figure 3-11. Remote Login Screen**

5. At the remote DLCI prompt, enter the outgoing DLCI (see following note) by pressing **1**, **ENTER**, the **DLCI NUMBER**, and **ENTER** (again).
6. Next, select **BEGIN A REMOTE SESSION** by pressing **2** and **ENTER**.



**NOTE**

*When entering the DLCI for a remote application, enter the DLCI associated with the local unit that you are telnetted into (not the far end DLCI).*



**NOTE**

*In this example, if you are telnetted into IQ #1 and choose **REMOTE LOGIN**, the remote DLCI entered would be **16**.*

Next, you will see the following screen (Figure 3-12).

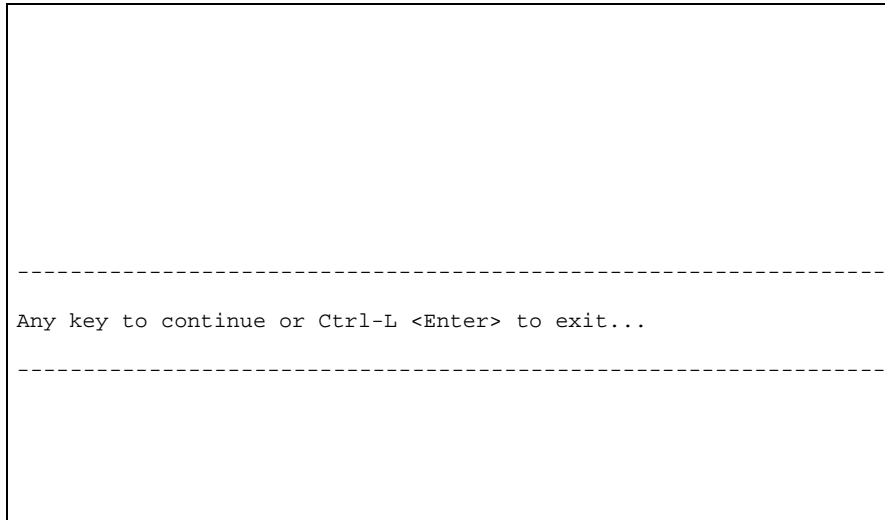

**Figure 3-12. Continue or Exit Screen**

7. Press **Enter** or any key to continue.



*If the wrong **DLCI** is entered or a network problem exists, the screen freezes at the **ANY KEY TO CONTINUE** prompt. Press **CNTL+L** to terminate the Telnet session.*

8. Next, you will be prompted for a password. The default password is **adtran**.



*You can change this password using the **SYSTEM CONFIG** sub-menu. This option is only available via the terminal.*

You will now see the **MAIN** menu of the remote unit (Figure 3-13).

```
                                Main Menu                                ADTRAN TSUIQ+
                                                                    Remote
-----
1 - Configuration
2 - View Statistics
3 - Test
4 - Logout

Enter Selection ->
```

**Figure 3-13. Remote Main Menu Screen**

9. Notice when you are telnetted into the remote unit, the word **Remote** appears in the upper right-and corner.

## TSU IQ+ MENU STRUCTURE

The opening menu is the access point to all other operations. The **MAIN** menu branches are **CONFIGURATION**, **VIEW STATISTICS**, **TEST**, **DIAL**, and **LOGOUT**. See Figure 3-4 on page 3-6. Each **MAIN** menu item has several functions and submenus to identify and access specific parameters.



*The **LOGOUT** selection is available on the terminal interface only.*

*In this chapter, the terminal selections are listed first, followed by the front panel selections.*

### Main Menu

Definitions for the branches of the **MAIN** menu follow:

#### **Configuration (CONFIG)**

**CONFIGURATION** is used to select data port, network port, dial backup, control port, and system operating parameters. For more information on configuration options, see the following chapters: *Configuration Overview* on page 5-1, *Data Port Configuration* on page 6-1, *Configuring the Network Port* on page 7-1, *Configuring DBU Options* on page 8-1, and *System Configuration* on page 9-1.

#### **View Statistics (STATS)**

This selection displays statistical information gathered by the TSU IQ+. See the chapter *Statistics* on page 10-1 for more information.

#### **Test**

**TEST** options allow you to perform ping and loopback tests. See the chapter *Testing* on page 11-1 for more information.

#### **Dial**

This selection allows you to access manual dialing capabilities. See the chapter *Activating Dialing Functions* on page 12-1 for more information.

#### **Logout (terminal menu only)**

This parameter logs out of the system.

## Chapter 4 Applications

---

This chapter provides examples of some common TSU IQ+ management options as well as an example of a dial backup application. The management application examples include VT 100 management, out-of-band SNMP/Telnet management, and in-band PVC SNMP/Telnet management. Descriptions and configuration tips for these options are provided in the sections that follow.



*The application drawings in this chapter show routers as the frame relay device. The frame relay device could be any device with frame relay capabilities. However, to use in-band management, the management DLCI must be RFC 1490 encapsulated IP traffic.*

### MANAGEMENT APPLICATIONS

One of the main advantages of the TSU IQ+ is management flexibility. The TSU IQ+ front panel interface provides complete configuration capabilities and viewing of key frame relay statistical information. Other management options described in this chapter provide configuration and diagnostics capabilities as well as all-inclusive statistical information.

#### Local VT-100 Terminal Management

Connect a VT-100 terminal to the TSU IQ+ **CONTROL** port. This interface provides full-screen configuration and all-inclusive statistics access. VT-100 management also allows for remote configuration. Through this port, a remotely located TSU IQ+ is

fully accessible for configuration, diagnostics, and statistics viewing. Figure 4-1 shows an example of a VT-100 application.

**NOTE** *VT-100 remote mode is proprietary and non-intrusive. Therefore, you can perform all VT-100 management functions without disrupting the flow of data.*

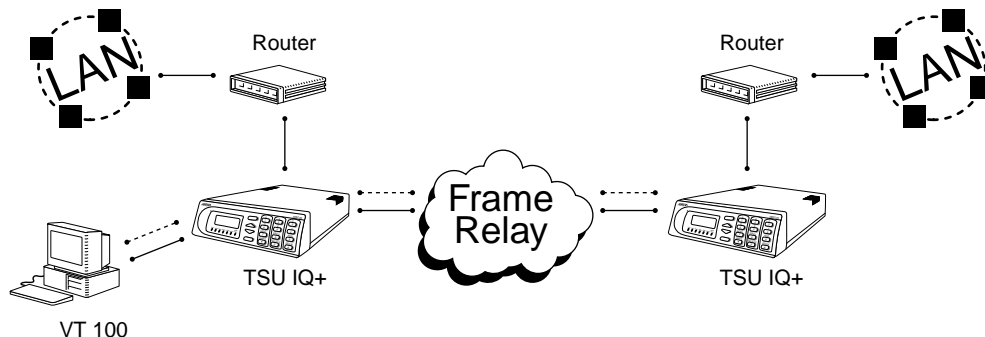

**Figure 4-1. VT-100 Management Application Example**

### Minimum Configuration Requirements for VT-100 Management

The following options are the minimum configuration requirements for establishing VT-100 management access.

#### **Baud Rate**

Set the baud rate to match the VT-100 terminal rate. This is accessible from the front panel only (select **CONTROL PORT** from the **CONFIGURATION** menu).

#### **Control Port Mode**

Set the **CONTROL PORT MODE** for **TERMINAL**. This selection is found in the **SYSTEM** portion of the **CONFIGURATION** menu.

## Out-of-Band Management

This management option (shown in Figure 4-2) is commonly used in situations where the customer is trying to reduce the amount of management traffic flowing through the frame relay device. The TSU IQ+ can be managed through an established Telnet session or an SNMP-based network manager like HP OpenView®, IBM Netview®, or SunNet Manager®.



*The ADTRAN TSU IQ+ MIB is available in the support section of the ADTRAN Web page at [www.adtran.com](http://www.adtran.com).*

SNMP and Telnet management is provided by one of the following interfaces:

- A device (e.g., a router) running SLIP protocol. Connection is made through the TSU IQ+'s Control port.
- A device (e.g., a router) running async PPP protocol. Connection is made through the TSU IQ+'s Control port.
- A LAN. Connection is made through the optional 10BaseT Ethernet interface provided on the ethernet card (part number 1204005L1).

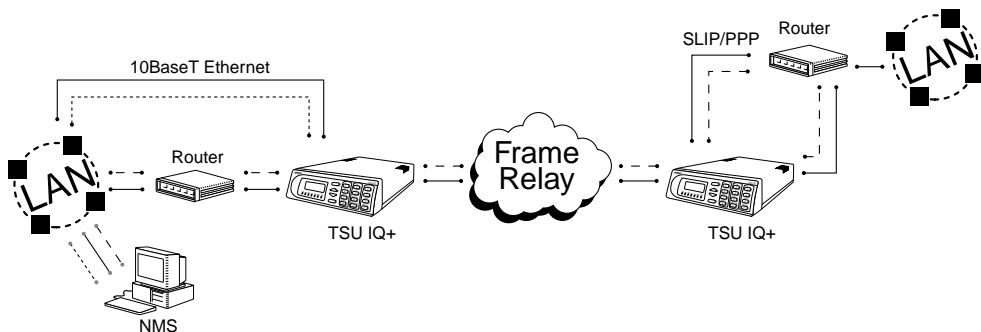

**Figure 4-2. Out-of-Band Management Application Example**

## Minimum Configuration Requirements

The following options (all found in the **SYSTEM** portion of the **CONFIGURATION** menu) are the minimum configuration requirements for establishing out-of-band SNMP or Telnet access. Once these options are configured, the unit may be accessed using SNMP/Telnet.

### IP Address

Enter the TSU IQ+ IP address.

### Control Port Options

If necessary, select **SLIP** or **PPP** as the TSU IQ+ **CONTROL PORT OPTIONS**. If the ethernet card is the interface type, this parameter does not affect setup. This selection is found in the **SYSTEM** portion of the **CONFIGURATION** menu.

### Subnet Mask

Enter the subnet mask number assigned to the network formed by the TSU IQ+ and the other FRAD/routers across the frame relay network. This address is available from the network administrator and is only necessary when using the ethernet card.

### Gateway IP Address (if required)

Enter the Gateway node IP address. This address is applicable only if the TSU IQ+ and the network manager are connected through a Gateway node. This address is available from the network administrator and is only necessary when using the ethernet card.

The next five settings are applicable for SNMP access only.

### Read Community

Set the **READ COMMUNITY** name to match the NMS (network management system) settings.

### Write Community

Set the **WRITE COMMUNITY** name to match the NMS settings.

### Trap Manager DLCI

Identify the virtual circuit used for all traps generated by the TSU IQ+. This selection is found in the **SYSTEM** portion of the **CONFIGURATION** menu.



**Trap Manager IP Address**

Enter the IP address of the SNMP manager to which the TSU IQ+ sends traps. This selection is found under **CONFIGURATION>SYSTEM>TRAP MGR OPTIONS**.

**Trap Manager Port**

Enter the TSU IQ+ port used to transmit traps to the SNMP manager. This selection is found under **CONFIGURATION>SYSTEM>TRAP MGR OPTIONS**.

## In-Band Management

The ADTRAN TSU IQ+ supports three modes of in-band management using the frame relay structure of PVCs. These modes are local, shared, and dedicated PVC management. All three types support complete SNMP management as well as Telnet capabilities.



*All PVC-based in-band management traffic must be noncompressed IP and use RFC 1490 encapsulation.*

### Local PVC Management

Local PVC management refers to a PVC created between the TSU IQ+ and the frame relay router on the DTE (**V.35**) interface of the TSU IQ+ (see Figure 4-3 on page 4-6). This type of management is ideal when local management is needed but an ethernet connection is not available. To support this type of management, all traffic on the selected PVC must be RFC 1490 encapsulated, noncompressed IP traffic.

The local PVC is sent out of the WAN serial port of the router as normal WAN traffic and is terminated in the TSU IQ+. Since the TSU IQ+ responds to Inverse ARP, it is not necessary to set up a static route in the router. The router will discover the IP address automatically; however, it will be necessary to set up a local PVC between the router and the TSU IQ+. Accomplish this by setting a value (between 16 and 1007) for the DTE management DLCI on the TSU IQ+ to a value not used by the frame relay network.

Local PVC management can be used at any location that has a router. Therefore, remote sites can be accessed through the remote router. One consideration when using local PVC management is that if the remote router goes down, access to the remote TSU is lost.

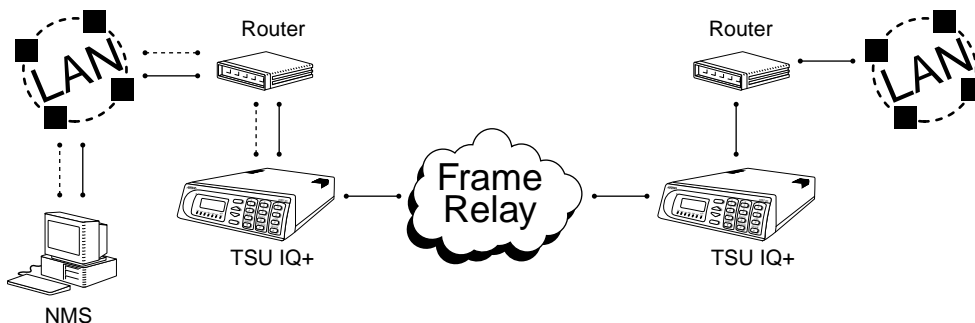

Figure 4-3. Local PVC Management Application

### Minimum Configuration Requirements for Local PVC Management

The following options are the minimum configuration requirements for establishing in-band local PVC management. Once these options are configured, the unit may be accessed using SNMP/Telnet. All options (with the exception of the **MANAGEMENT DLCI** option) are found in the **SYSTEM** portion of the **CONFIGURATION** menu.

#### IP Address

Enter the TSU IQ+ IP address.

#### Management DLCI

Enter a DLCI number (between 16 and 1007) that is not used by the frame relay service. This option is found in the **FRAME RELAY OPTIONS** portion of the **DATA PORT CONFIGURATION** menu (**CONFIG -> DATA PORT -> Nx PORT -> FR OPTS -> MGMT DLCI**).

The next five settings are applicable for SNMP access only.

#### Read Community

Set the **READ COMMUNITY** name to match the NMS settings.

**Write Community**

Set the **WRITE COMMUNITY** name to match the NMS settings.

**Trap Manager DLCI**

Identify the virtual circuit used for all traps generated by the TSU IQ+. This selection is found under **CONFIGURATION> SYSTEM> TRAP MGR OPTIONS**.

**Trap Manager IP Address**

Enter the IP address of the SNMP manager to which the TSU IQ+ sends traps. This selection is found under **CONFIGURATION> SYSTEM> TRAP MGR OPTIONS**.

**Trap Manager Port**

Enter the TSU IQ+ port used to transmit traps to the SNMP manager. This selection is found under **CONFIGURATION> SYSTEM> TRAP MGR OPTIONS**.

**Shared PVC Management**

Shared PVC management refers to a PVC that is used for normal data traffic between locations. The TSU IQ+ monitors this PVC for packets that contain its IP address (see Figure 4-4 on page 4-8). When the TSU IQ+ detects a packet containing a destination IP address that matches the TSU IQ+ IP address, the unit intercepts the packet and processes its TCP/IP information. To support this type of management, all traffic on the selected PVC must be RFC 1490 encapsulated, noncompressed IP traffic.

Shared PVC management is used to manage remote TSU IQ+s without being dependent on services from the remote router. This usually requires a static route at the host location.



*By setting local PVC management and shared PVC management on the remote TSU IQ+, its IP address can be found through Inverse ARP. Since the unit is set up for shared PVC management, all management traffic will be intercepted prior to reaching the remote router.*

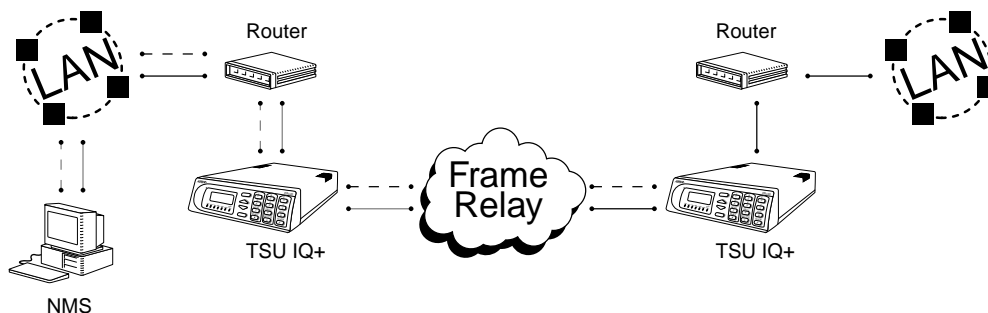

**Figure 4-4. Shared PVC Management Application**

### Minimum Configuration Requirements

The following options are the minimum configuration requirements for establishing in-band shared PVC management. Once these options are configured, the unit may be accessed using SNMP/Telnet. All options (with the exception of the **MANAGEMENT DLCI** options) are found in the **SYSTEM** portion of the **CONFIGURATION** menu.

### IP Address

Enter the TSU IQ+ IP address.

### Management DLCI 1 and/or DLCI 2

Enter the management DLCI(s) used to carry management traffic to and from the network. These options are found in the **NETWORK PORT CONFIGURATION** menu.

### Management DLCI 1 and/or DLCI 2 Mode

Set to **DEDICATED** if the management DLCI is used only to manage the TSU IQ+ (and not used to carry customer traffic). If set to **DEDICATED**, the router is not notified of that DLCI. Set to **SHARED** if the DLCI is used to carry customer traffic as well as management data. These options are found in the **NETWORK PORT CONFIGURATION** menu.



*The TSU IQ+ unit supports management from two network DLCIs either shared or dedicated.*

The next five settings are applicable for SNMP access only.

**Read Community**

Set the **READ COMMUNITY** name to match the NMS settings.

**Write Community**

Set the **WRITE COMMUNITY** name to match the NMS settings.

**Trap Manager DLCI**

Identify the virtual circuit used for all traps generated by the TSU IQ+. This selection is found under **CONFIGURATION> SYSTEM> TRAP MGR OPTIONS**.

**Trap Manager IP Address**

Enter the IP address of the SNMP manager to which the TSU IQ+ sends traps. This selection is found under **CONFIGURATION> SYSTEM> TRAP MGR OPTIONS**.

**Trap Manager Port**

Enter the TSU IQ+ port used to transmit traps to the SNMP manager. This selection is found under **CONFIGURATION> SYSTEM> TRAP MGR OPTIONS**.

**Dedicated PVC Management**

Dedicated PVC management refers to the ability to have a PVC originated from the network and terminated in the TSU IQ+ (see Figure 4-5 on page 4-10). This is an ideal configuration for third-party management. It isolates the customer's data traffic from network management traffic, and it also acts as a fire-wall that restricts management data to the TSU IQ+. Dedicated PVC management is also ideal when the user wants to guarantee access to a remote TSU IQ+ regardless of the state of the remote LAN.

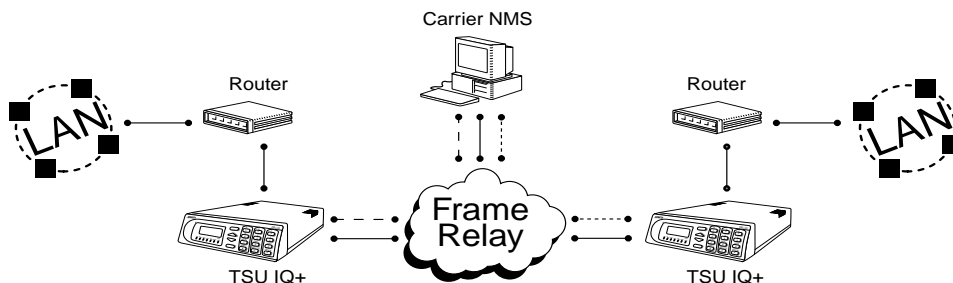

**Figure 4-5. Dedicated PVC Management Application**

### Minimum Configuration Requirements

The configuration requirements for dedicated PVC management are identical to those listed for shared PVC management. See the previous section, *Shared PVC Management* on page 4-7, for more information.

## DIAL BACKUP APPLICATION

The TSU IQ+ dial backup (DBU) option cards provide single or multiple site backup, depending on the DBU card option selected. The TSU IQ+ can be configured to originate a call based on physical layer conditions (i.e., port failures) and/or PVC outages. Once the criteria are met, the TSU IQ+ establishes a call to the configured phone number (see Table 4-1 on page 4-13) and the connection is used to carry traffic for the PVC(s) configured for DBU operation.

In the case of PVC outages (not physical layer port failure), the TSU IQ+'s two-port design allows the TSU IQ+ receiving the call to continue to use the T1 frame relay circuit for PVCs that are not affected by the outage. This is done (without the attached DTE device's intervention) by modifying the status of PVCs that are in DBU state to active when the PVC status is given to the DTE.

A TSU IQ+ with multiple PVCs to multiple sites can also originate a call to one site during an outage and restore connection for PVCs to that destination. With all DBU cards except for the PRI card, you can make only one call at a time. The other PVCs to other sites in this scenario will be inactive. If you have a PRI card you can originate or answer up to 23 calls.

Information entered into the **PVC CONFIGURATION** table (see Table 4-2 on page 4-13) marks PVCs for DBU operation. The key element in each entry of the table is the DBU DLCI. For each PVC connecting two sites for DBU operation, the DLCI field represents the PVC DLCI at the local UNI and the DBU DLCI represents the PVC DLCI at the remote site UNI. The TSU IQ+ uses this information in the outbound side to change the PVC DLCI so the far end DTE device receives frames on the DBU PVC addressed in the same manner as when the frame relay circuit is operational. For PVCs not used for DBU operation, leave the **DBU PHONE NUMBER** field set for a null entry. Enter a space character from the VT-100 terminal to create a null entry for **DBU PHONE NUMBER** field.

The **DBU PHONE NUMBER** information is only required for the TSU IQ+ originating the call.

Dial backup application examples are provided in the following sections.



*The configuration selections given may need modification based on your network configuration.*

## DBU Application 1(non-PRI)

The following application shows the critical configuration required for a case where all end points of the frame circuit are equipped with single call DBU units (see Figure 4-6). This set-up allows any remote site to place a call to the host site or the host site to place a call to each remote site based on PVC failure. This set-up also allows the host to designate primary and alternate sites to call based on port failure criteria using the call order parameter.

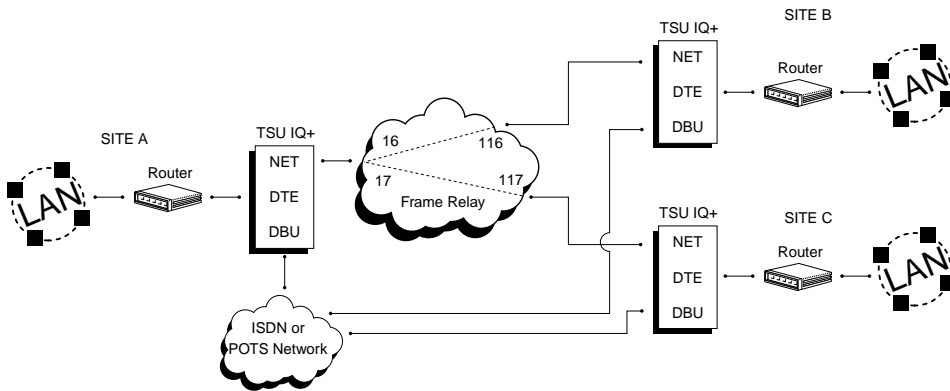

**Figure 4-6. Dial Backup Application**

Table 4-1 and Table 4-2 on page 4-13 provide example setups for the **DBU OPTIONS (CONFIG>DIAL BACKUP)** and the **PVC CONFIGURATION table (CONFIG>NETWORK PORT>PVC CONFIG)**. The tables are based on the example application shown in Figure 4-6.



**Table 4-1. Example Settings for Dial Backup Options**

OPTION	SETTINGS
Auto DBU	Enable
DBU Criteria	With Network Fail: Enable With No LMI: Enable With PVC Inactive: Enable

**Table 4-2. Example Settings for PVC Configuration Table**

	SITE A (ENTRY #1)	SITE A (ENTRY #2)	SITE B	SITE C
<b>DLCI</b>	16	17	116	117
<b>DBU DLCI*</b>	116	117	16	17
<b>DBU Phone #**</b>	Site B #	Site C #	Site A #	Site A #
<b>DBU Call Order</b>	1	2	None	None
<b>DBU on Inactive***</b>	Enabled	Enabled	Enabled	Enabled

\* DBU DLCIs and DBU phone number must be entered to provide dial back-up for a DLCI.

\*\* DBU phone number - All DLCIs to the same site should have the same phone number.

\*\*\* See *DBU on Inactive* on page 7-7.

## DBU Application 2 (PRI)

The following application shows the critical configuration for a case where the Host Site of the frame relay circuit is set up to restore service (see Figure 4-7). This setup uses a PRI ISDN module and service so that multiple calls can be placed simultaneously. The criteria for placing a call are based on Host Site port failure or individual PVC failure. The individual PVC failure should account for remote sites port outages and frame relay service troubles.

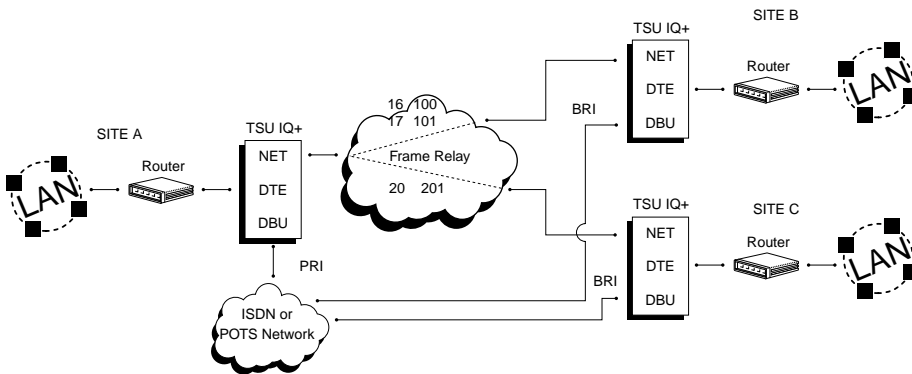

**Figure 4-7. PRI DBU Card at Host Site**

Table 4-3, Table 4-4, and Table 4-5 on page 4-15 show example setups for PRI DBU options at the Host Site. These tables are based on the example application shown in Figure 4-7.

**Table 4-3. Example Settings for PRI DBU Card (A)**

<b>Auto DBU</b>	Enabled
<b>DBU Criteria</b>	With Net Fail: Enabled With No LMI: Enabled With PVC inactive: Enabled

**Table 4-4. Global DBU Settings (B and C)**

<b>Auto DBU</b>	Enabled
<b>DBU Criteria</b>	With Net Fail: Disabled With No LMI: Disabled With PVC inactive: Disabled

**Table 4-5. Example Settings for PRI DBU Card at Host Site**

	<b>SITE A (ENTRY #1)</b>	<b>SITE A</b>	<b>SITE A</b>
<b>DLCI</b>	16	17	19
<b>DBU DLCI*</b>	100	101	200
<b>DBU PHONE #**</b>	Site B #	Site B #	Site C #
<b>DBU on Inactive***</b>	Enabled	Enabled	Enabled

\* DBU DLCIs and DBU phone number must be entered to provide dial backup for a DLCI.

\*\* DBU phone number - All DLCIs to the same site should have the same phone number.

\*\*\* See *DBU on Inactive* on page 7-7.



## Chapter 5 Configuration Overview

---

### LOCAL AND REMOTE CONFIGURATION

The TSU IQ+ can be configured locally or communications can be established so that a local TSU IQ+ can configure a remote TSU IQ+ using a VT 100 interface. See *Operation* on page 3-1 for information on selecting **LOCAL** or **REMOTE** operation.

The **CONFIGURATION** menu consists of submenus relating to specific interfaces or functions of the TSU IQ+ requiring setup:

- Data Port
- Network Port
- Dial Backup (if DBU card is installed)
- Control Port (front panel only)
- System

The **TERMINAL CONFIGURATION** menu is shown in Figure 5-1 on page 5-2.

For detailed information on configuration, see the following chapters: *Data Port Configuration* on page 6-1, *Configuring the Network Port* on page 7-1, *Configuring DBU Options* on page 8-1, and *System Configuration* on page 9-1.

**CONFIGURATION** menu trees are shown in Figure 5-2 on page 5-3 for the terminal and Figure 5-3 on page 5-4 for the front panel interface.

```
Configuration Menu                                ADTRAN TSUIQ+
                                                  (Local) ATLANTA
-----
1 - Data Port
2 - Network Port
3 - Dial Backup
4 - System

Enter Selection ->
```

**Figure 5-1. Terminal Configuration Menu**

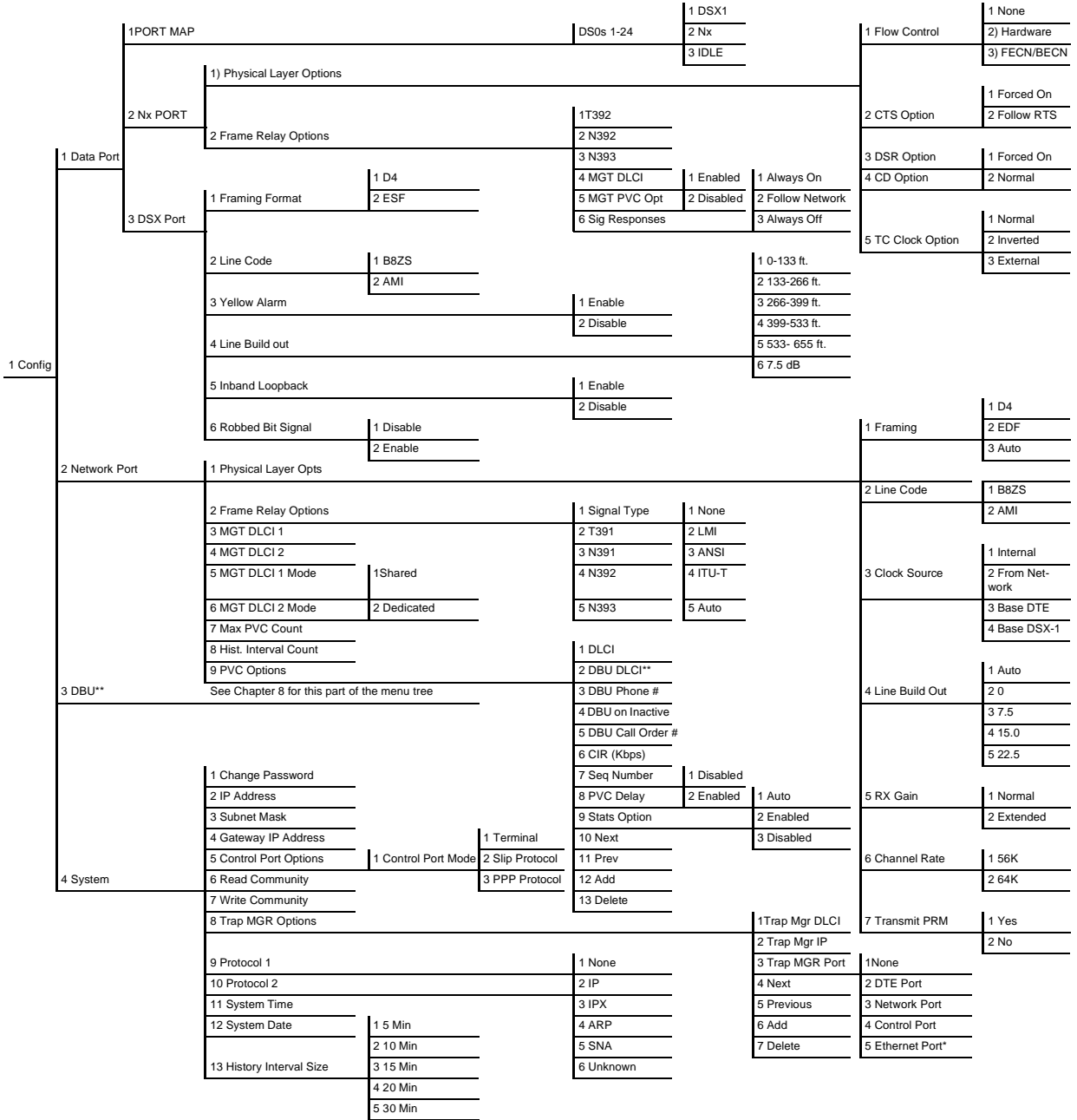

Figure 5-2. Terminal Configuration Tree

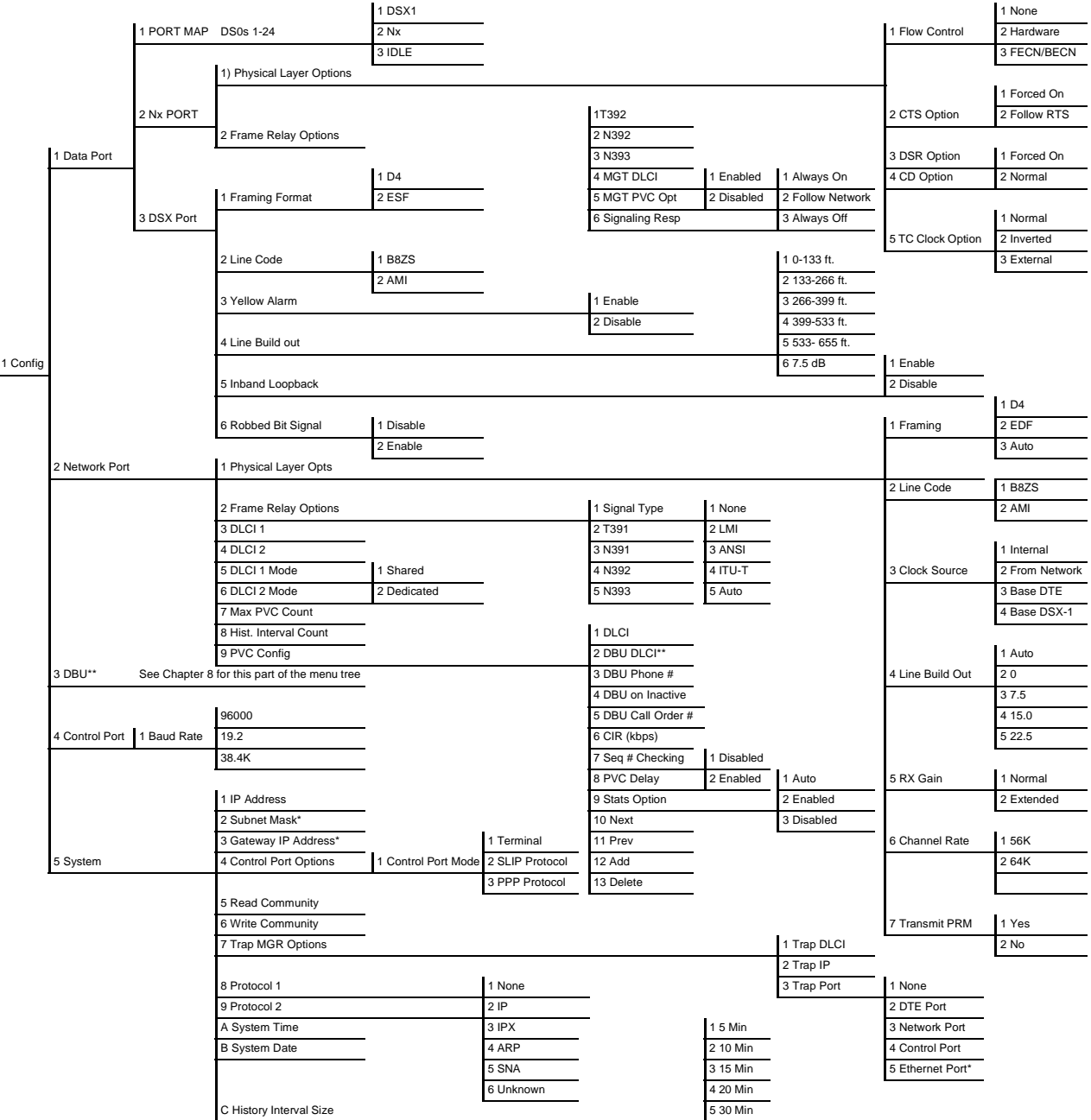

Figure 5-3. Front Panel Configuration Tree



## Chapter 6 Data Port Configuration

---

Use the **DATA PORT CONFIGURATION** menu to create a port map and to configure the V.35 Nx56/64 and DSX-1 ports. Figure 6-1 shows the terminal **CONFIGURATION** menu for the **DATA PORT** selection. The menu tree in Figure 5-2 on page 5-3 shows the choices available in this menu. Descriptions of each **DATA PORT** menu selection follow this section.

CONFIGURE DATA PORTS	ADTRAN TSUIQ+ <Local> ATLANTA
<hr/>	
1 - PORT MAP 2 - Nx PORT 3 - DSX PORT	
<hr/>	
Enter Selection ->	

Figure 6-1. Terminal Data Port Configuration Menu



*In this chapter, the terminal selections are listed first followed by the front panel selections in parentheses (if the names differ).*

## PORT MAP

The **PORT MAP** designates which DS0s are assigned to which port. For example, to pass the channel's data to a PBX, map the channel to the **DSX-1** port. To pass data to another device (such as a router), map the channel to the **Nx** port. Set all unassigned channels to **IDLE**.

## NX PORT

Configure the **PHYSICAL LAYER** and **FRAME RELAY** options for the V.35 Nx56/64 port. Descriptions of the available selections follow.

## Physical Layer Options (PHYS LYR OPTS)

### Flow Control

This option determines how the TSU IQ+ responds to congestion during DBU operation.

#### **None**

No flow control is used and the TSU IQ+ drops frames during severe congestion while in DBU operation.

#### **Hardware**

The TSU IQ+ varies the DTE TC clock as necessary to relieve congestion during DBU operation.

#### **FECN/BECN**

While in a congested state during DBU operation, frames across the DBU PVCs have **FECN** or **BECN** set depending on the direction. Frames outbound to the network have **FECN** set, while frames inbound to the attached DTE device have **BECN** set. This method is useful if the attached DTE devices can respond to congestion notification.

### CTS Option

Set the CTS lead to **FORCED ON** or **FOLLOW RTS**.

#### **Forced On**

The CTS lead is always on and the RTS lead is ignored.

**Follow RTS**

The CTS lead is on when the RTS lead is on (and off when the RTS lead is off).

**DSR Option**

Set the DSR lead to **FORCED ON** or **NORMAL**.

**Forced On**

The DSR lead is always on.

**Normal**

The DSR lead is off when the TSU IQ+ is in a loopback test or an alarm state.

**CD Option**

Set the CD lead to **FORCED ON** or **NORMAL**.

**Forced On**

The CD lead is always on.

**Normal**

The CD lead is off when the TSU IQ+ is in alarm state.

**TC Clock Option (TC CLOCK OPT)****Normal**

Clock for DTE's transmit data normal phase.

**Inverted**

Clock for DTE's transmit data inverted phase. May be used in high speed circuits (>512 kbps) when the DTE's V.35 interface has high delay. This is usually indicated by HDLC errors on the TSU IQ+'s DTE port.

**External**

Clock for the DTE's transmit data is derived from the external DTE device connected to the TSU IQ+.

## Frame Relay Options (FR OPTS)

The frame relay protocol is a synchronous protocol used to concentrate two different devices into a common frame relay link to the network. The TSU IQ+ accepts frame relay frames from a router or a FRAD (frame relay access device) and routes to/from the network port based on the DLCI address. Use the following selections to determine timeout intervals and error thresholds, and to configure PVC management settings.

### T392

Set the timeout (in seconds) between polling intervals. This parameter needs to be a few seconds longer than the T391 setting of the attached frame relay device. Range is 5 to 30 seconds.

### N392 and N393

These parameters define the error threshold for the UNI (user to network interface) formed by the TSU IQ+ DTE port and the attached frame relay device. If the error threshold is met, the signaling state status is changed to down, which indicates a service-affecting condition. This condition is cleared once N393 consecutive error-free events are received. N392 defines the number of errors required in a given event window, while N393 defines the number of polling events in each window.

For example:

If N392=3 and N393=4, then if three errors occur within any four events, the interface is determined inactive.

The status of the connection can be viewed in the **DTE PORT STATISTICS** menu (see the section *Signaling State* on page 10-6). The status returns to **ACTIVE** once the threshold is no longer exceeded. The range is 1 to 10.

## Management DLCI (MGMT DLCI)

To use local PVC management, enter the management data link connection identifier (DLCI). The **MANAGEMENT DLCI** is a special DLCI used between the attached DTE device and the TSU IQ+ to carry SNMP and TELNET packets to/from the TSU IQ+ on the DTE port.

### Guidelines for Configuring Management DLCI

If the attached router or FRAD is used to route SNMP/TELNET frames to the TSU IQ+, set the **MANAGEMENT DLCI** to a unique value (between 16 and 1007) that identifies the virtual circuit between the router/FRAD and the TSU IQ+. The router/FRAD must also be configured to route the TSU IQ+ IP address to this DLCI. The **IP ADDRESS** and **SUBNET MASK** for the DTE (V.35) port must also be set in the **SYSTEM CONFIGURATION** menu.

## Management PVC Option (MGMT PVC OPT)

If this option is set to **ENABLED**, the management DLCI is included in the Full Status response to the router. Enable this option when the management DLCI is used to route management traffic to the TSU IQ+. Options are **ENABLED** and **DISABLED**.

## Signaling Responses (SIG RESPONSES)

This option determines when PVC **SIGNALING RESPONSES** are sent to the router.

### Always On

If enabled, PVC **SIGNALING RESPONSES** are sent to the router regardless of the network signaling state. Enable this option when the TSU IQ+ is used for dial backup.

### Follow Network (FOLLOW NET)

If enabled, PVC **SIGNALING RESPONSES** are sent to the router only when the network signaling state is up. Enable this option when the router is going to use an alternate path for dial backup.

### Always Off

If enabled, PVC signaling responses are NOT sent to the router, regardless of the network signaling state. Enable this option to simulate a PVC failure when the router is going to use an alternate path for dial backup.

## DSX PORT

Configure these options to be compatible with the T1 service provided and with the **DSX-1** port's connection. The menu tree is shown in Figure 5-2 on page 5-3.

### Framing Format (FRAMING)

Set the framing format of the **DSX-1** interface to be compatible with your T1 service. This information is available from your service provider. Choices are **D4** or **ESF**.

### Line Code (LNE CODE)

Set the line coding of the **DSX-1** interface to be compatible with your T1 service. This information is available from your service provider. Choices are **B8ZS** or **AMI**.

### Yellow Alarm

**ENABLE** or **DISABLE** the transmitting of yellow alarms.

### Line Length (LBO)

Select the length of the **DSX-1**'s interface cable (in feet) or select 7.5dB. The unit can then calculate the proper output level for the port. Choices are **0 TO 133**; **133 TO 266**; **266 TO 399**; **399 TO 533**; **533 TO 655** and **7.5 dB**.

### In-Band Loopback (LOOPBACK)

**ENABLE** or **DISABLE** the unit's ability to accept in-band loop-up or loop-down codes (per ANSI T1.403 specifications) which may be sent through the **DSX-1** interface. This loopback is a line loopback.

### Robbed Bit Signaling (ROBBED BIT)

Set **ROBBED BIT SIGNALING** to match the settings of the device connected to the **DSX-1** port.

## Chapter 7 **Configuring the Network Port**

---

### **NETWORK PORT**

Access the **NETWORK PORT** menus by selecting **NETWORK PORT** from the **CONFIGURATION** menu. Full menu trees for the **NETWORK CONFIGURATION** selections are shown in Figure 5-2 on page 5-3 (Terminal Configuration Menu Tree) and Figure 5-3 on page 5-4 (Front Panel Configuration Menu Tree). The **Network PORT** terminates the user end of the frame relay UNI interface. The TSU IQ+ supports three standard PVC signaling formats: LMI (gang of four), ANSI T1.617-D (Annex D), and ITU Q.933-A (Annex A). The selected signaling format is used to poll the network end of the UNI interface and retrieve virtual circuit information. Optionally, the polling process can be disabled.

When configuring from a terminal, the screen in Figure 7-1 on page 7-2 will appear when **NETWORK PORT** is selected.



*In this chapter, the terminal selections are listed first followed by the front panel selections in parentheses (if the names differ).*

```

Network Port                Configure Network Port                ADTRAN TSUIQ+
                               <Local> ATLANTA

1 - Physical Layer Options
2 - Frame Relay Options

3 - Management DLCI 1 1006
4 - Management DLCI 2 1005
5 - Mgmt DLCI 1 Mode Shared
6 - Mgmt DLCI 2 Mode Shared

7 - Maximum PUC Count 20
8 - History Interval Count 157

9 - PUC Options

Enter Selection ->

```

Figure 7-1. Terminal Network Port Configuration Menu

## Physical Layer Options (PHYS LYR OPTS)

The following sections describe the **PHYSICAL LAYER OPTIONS** available for the **Network** port.

### Framing Format (FRAMING)

Set the frame format for the NI (network interface). Options are **D4**, **ESF**, and **AUTO**.

**NOTE**

*D4 is equivalent to superframe format (SF).*

### Line Code (LNE CODE)

Set the line code for the NI. Choices are **AMI** (alternate mark inversion) or **B8ZS**.



### Clock Source (CLK SOURCE)

Select the clock source to be derived from the network, from the unit's internal clock, or from clock recovered from either the DTE (V.35) or DSX-1 port. The selected clocking option designates the clock source for transmission. Clocking necessary for receiving data is recovered from incoming data. This option is most commonly set to **FROM NETWORK**.

Choices: **INTERNAL**, **FROM NETWORK**, **BASE DTE**, and **BASE DSX-1**.

### Line Buildout (LBO)

Select the line buildout for the network interface. In **AUTO** mode, the TSU IQ+ sets the **LBO** based on the strength of the receive signal. Options: **AUTO**, **0**, **7.5**, **15**, and **22.5 dB**.

### Rx Sensitivity (RX GAIN)

Select the desired receiver sensitivity setting. The factory default is **NORMAL**, which is adequate for most applications. The extended setting should be used only in applications where the **NORMAL** setting is not sufficient. If the receive signal strength is less than 30 dB, choose **EXTENDED**.

### Channel Bandwidth (CHANNEL RATE)

Set the channel bandwidth for **56** or **64 kbps**.

### Transmit PRM

Enabling performance report messages (PRM) allows the TSU IQ+ to send messages across the facility data link (FDL) per ANSI T1.403. The terminating device at the telco may use this information for management of the T1 loop.

The TSU IQ+ supports PRM messages per AT&T Pub 54016 which is a poll/response type protocol. Because of this poll/response nature, the transmit PRM option does not disable the TSU IQ+ from processing or responding to 54016-type messages.

Choices: **YES** or **NO**.

## Frame Relay Options (FR OPTS)

The following selections are available when **FRAME RELAY OPTIONS** is selected from the **NETWORK PORT CONFIGURATION** menu:

### Signal Type (SIGNAL)

Set the signaling type option to match the network signaling type. **AUTO** mode forces the TSU IQ+ to use the same signaling type as the attached frame relay DTE. If **AUTO** is selected and there is no DTE device attached, the TSU IQ+ uses ANSI T1.617-D signaling type.

Choices: **NONE**, **LMI** (gang of four), **ANSI T1.617-D** (Annex D), **ITU-T Q.933-A** (Annex A), or **AUTO**.

### T391

Set the time (in seconds) between polls to the frame relay network.  
Range: **5** to **30** seconds.

### N391

Determine how many link integrity polls occur in between full status polls.  
Range: **1** to **255**.

### N392 and N393

These parameters define the error threshold for the UNI formed by the TSU IQ+ **Network** port and the frame relay switch. If the error threshold is met, the signaling state status is changed to down, which indicates a service-affecting condition. This condition is cleared once N393 consecutive error-free events are received. N392 defines the number of errors required in a given event window, while N393 defines the number of polling events in each window.

For example:

If N392=3 and N393= 4, then if three errors occur within any four events the interface is determined inactive.

The status of the connection can be viewed in the **STATISTICS** menu under **NETWORK PORT SIGNALING STATE** (see *Signaling State* on page 10-6). The status will return to active again once the threshold is no longer exceeded.

Range: **1** to **10**.



*The network service provider should recommend the values entered into the T391, N391, N392, and N393 fields.*

## Management DLCI 1 and 2 (DLCI 1 and 2)

Enter the management data link connection identifiers (DLCIs). These DLCIs are used to carry management traffic to and from the network.

Range: **16** to **1007**.

## Management DLCI 1 and 2 Mode (DLCI 1 and 2 MODE)

Set to **DEDICATED** if the management DLCI is used only to manage the TSU IQ+ (and not used to carry customer traffic). If set to **DEDICATED**, the router is not notified of that DLCI. Set to **SHARED** if the management DLCI is used for carrying customer traffic and management data.

Choices: **SHARED**; **DEDICATED**.

## Maximum PVC Count

Set the maximum number of PVCs that the TSU IQ+ will monitor for statistical information. This value determines the amount of history intervals available for storage. To get the maximum amount of statistical history storage, set this value equal to the number of PVCs assigned to the frame relay port. A smaller value increases history interval count but puts some of the PVC statistics into the unknown category.

Range: **1** to **100**.

## History Interval Count (HIST INT COUNT)

Set the number of history intervals to store for statistics. History intervals are displayed in the **VIEW BY INTERVAL** portions of the **STATISTICS** menus. These views provide data divided into columns grouped by the interval of time selected in the **HISTORY INTERVAL SIZE** field. See the section *History Interval Size (HST INT SIZE)* on page 9-5 for more information. The **HISTORY INTERVAL COUNT** field determines how many intervals can be stored at a time. The maximum value allowed is affected by the **MAX PVC COUNT** selection (previously described).

## PVC Options (PVC CONFIG)

The information in this menu must be entered for each PVC. DLCI numbers and their corresponding CIRs are provided by the service provider.



*When configuring PVC options using the front panel, the **Next**, **Prev**, **Add**, and **Delete** keys are used. See *Operation on page 3-1* for more information on front panel operation.*

### DLCI

Enter the Network DLCI.  
Range: **16** to **1007**.

### DBU DLCI

Enter the far end DLCI for each PVC used for dial backup. Only the TSU IQ+ that originates the call is required to have this option set. This selection is only available when a DBU card is installed.  
Range: **16** to **1007**.

### DBU Phone Number

The phone number entry stores the phone number that is used when the TSU IQ+ triggers auto DBU in case of port or PVC failure. The phone number should correspond to a location that is

equipped with an “Adtran Safety Net” device that is capable of restoring the PVC which is designated by the DBU DLCI element.

If auto DBU is triggered by port failure, then the DBU Call Order element determines the order of a dialing list for alternate backup locations.

### **DBU on Inactive**

This option works in conjunction with the dial backup criteria option **WITH PVC INACTIVE**. For the **DBU ON INACTIVE** option to have an affect on auto DBU operation, the **WITH PVC INACTIVE** option must be set to **ENABLE**. See *With PVC Inactive* on page 8-5.

If **DBU ON INACTIVE** is set for **ENABLED** and the PVC designated by the DLCI element goes to an inactive or unknown state, the TSU IQ+ will dial the phone number designated by the **DBU PHONE NUMBER** element in the table entry.

**GROUP** is a special case in which all PVCs that are part of a group must be in an inactive or unknown state before the auto DBU process is triggered. This special case is treated as a port failure in which the **DBU CALL ORDER** entry applies.

### **DBU Call Order #**

This determines the order in which a list of backup locations will be dialed. This applies only to auto dial backup processes that are triggered by port failure. If all DBU Call Order entries are set to **NONE**, then the first entry with a DBU phone number will be used.

### **CIR (Kbps)**

Enter the CIR (committed information rate) in kbps for the corresponding DLCI. The information is provided by your service provider and must be entered for each PVC.  
Range is **0** to **1536**.

### **Seq Num Checking (SEQ #)**

Set to **ENABLE** only if there are TSU IQ+s on both ends of the PVC. When enabled, the TSU IQ+ tags each frame with a sequence number which is then used by the remote TSU IQ+ to detect lost

packets. Lost packet counts are given in the **STATISTICS** menus.  
Choices: **DISABLED** or **ENABLED**.

### Delay Measurement (PVC DELAY)

Set to **ENABLE** only if there are TSU IQ+s on both ends of the PVC. When enabled, the TSU IQ+ periodically transmits a loopback frame to the remote TSU IQ+ which is then returned to measure round trip delay of each PVC. Minimum, maximum, and average delay measurements are given in the **STATISTICS** menus.  
Choices: **ENABLE** or **DISABLE**.

### Stats Option (STATS OPT)

This option prioritizes PVCs for **STATISTICS** counts. The TSU IQ+ tracks statistics for a limited number of the PVCs that pass through. This number is determined in the **MAX PVC COUNT** field (see *Maximum PVC Count* on page 7-5). The three choices for this field are described below:

#### **Auto**

If set to **AUTO**, then statistics will be logged for this PVC if the **MAX PVC COUNT** has not been exceeded. The **AUTO** selection designates a PVC as second priority to a PVC set to **ENABLED**.

#### **Enabled**

If set to **ENABLED**, then statistics will be logged for this PVC if the **MAX PVC COUNT** has not been exceeded. A PVC set to **ENABLED** is designated as a higher priority than one set to **AUTO**.

#### **Disabled**

If set to **DISABLED**, then statistics will not be logged for this PVC at any time.



*If the TSU IQ+ encounters a PVC that has not been entered into the **PVC OPTIONS** table, the PVC is set to **AUTO** by default.*

**Next (NEXT key on front panel)**

Edit the next entry in the **PVC OPTIONS** table.

**Previous (PREV key on front panel)**

Edit the previous entry in the **PVC OPTIONS** table.

**Add (ADD key on front panel)**

Add a new entry to the **PVC OPTIONS** table.

**Delete (DELETE key on front panel)**

Delete the current entry in the **PVC OPTIONS** table.





## Chapter 8 **Configuring DBU Options**

---

The **DIAL BACKUP CONFIGURATION** menu (Figure 8-1) is available only when an optional DBU card is installed. See Figure 8-2 on page 8-2 for a menu tree of the DBU selections and Figure 8-3 on page 8-3 for DBU selections with option cards installed.

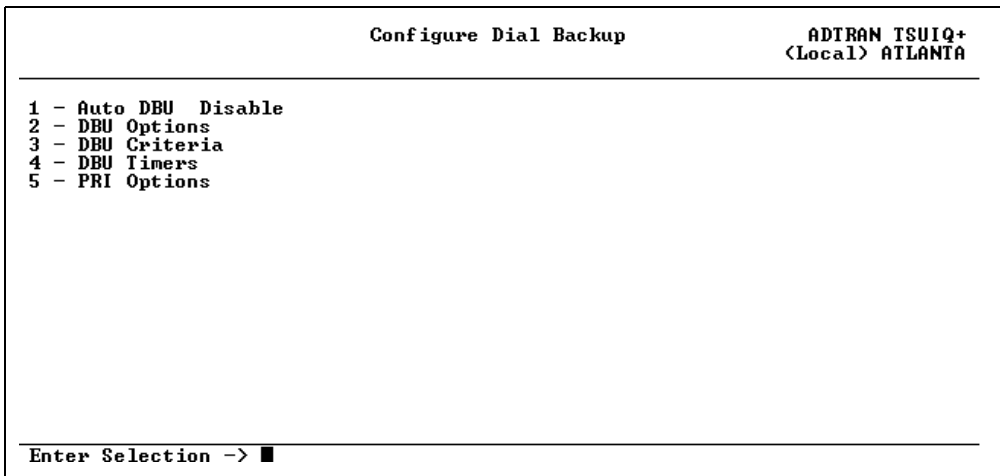

**Figure 8-1. DBU Options Menu (with ISDN DBU Card)**

1 CONFIG	DBU	1 AUTO DBU		1 DISABLE		
				2 ENABLE		
		2 DBU OPTIONS				1 DISABLE
				1 ANSWER ALWAYS		2 ENABLE
				2 BEEPER OPTION		1 DISABLE
				3 PASSWORD OPT		2 ENABLE
		3 DBU CRITERIA		4 DBU PASSWORD		
				5 DAILY LOCKOUT		1 DISABLE
				6 LOCKOUT START		2 ENABLE
				7 LOCKOUT END		
				8 WEEKEND LOCK		1 DISABLE
						2 ENABLE
		4 DBU TIMERS		1 WITH NETWORK FAILURE		
				2 WITH NO LMI		
				3 WITH PVC INACTIVE		
		5 MODEM OPTIONS		1 FAIL TIMER		
				2 RESTORE TIMER		
		5 ISDN OPTIONS		3 REDIAL COUNTER		
				4 WAIT TO REDIAL		
		5 DCE OPTIONS		With V.34 DBU Option Card Installed. See Figure 8-3 on page 8-3.		
5 PRI OPTIONS		With ISDN DBU Option Card Installed. See Figure 8-3 on page 8-3.				
		With External DCE Option Card Installed. See Figure 8-3 on page 8-3.				
		With PRI DBU Option Card installed. See Figure 8-3 on page 8-3.				

**Figure 8-2. Dial Backup Menu Tree**

With V.34 DBU option card installed			
5 MODEM OPTIONS	1 TONE/PULSE	1 TONE	2400
		2 PULSE	4800
	2 MAX BAUD RATE		7200
			9600
			12000
			14400
	3 SYNC/ASYN	1 SYNC	16800
		2 ASYN	19200
			21600
			24000
			26400
			28800
		31200	
		33600	
With ISDN DBU option card installed			
5 ISDN OPTIONS	1 SWITCH TYPE		1 LUCENT 5ESS
			2 DMS 100
			3 NATIONAL
			4 NEC
	2 B-CHANNEL BIT RATE		1 56K
			2 64K
3 # OF B CHANNELS		1 1	
4-5 SPID 1-2		2 2	
6-7 LDN 1-2			
With external DCE option card installed			
5 DCE OPTIONS	1 INTERFACE TYPE		1 EIA-232
			2 V.35
	2 DBU BIT RATE		0-1536 kbps
With PRI DBU option card installed			
5 PRI OPTIONS	1 PHYSICAL LAYER OPTIONS		1 LINE CODE
			2 CLOCK SOURCE
			3 LINE BUILD OUT
	2 SWITCH TYPE		4 RX GAIN
			5 START CHANNEL
	3 LDN (enter phone no.)	LUCENT 5ESS	6 # OF CHANNELS
		DMS 100	7 TX YELLOW ALARM
		NATIONAL	8 LOCAL LOOPBACK
			9 TRANSMIT PRM

Figure 8-3. Dial Backup Menu Tree with Option Cards Installed



*Dial backup is only supported when the unit is operated in point-to-point mode.*

## AUTO DBU

The **AUTOMATIC DBU** option specifies whether the unit automatically enters dial backup mode or waits for manual setup. The factory default setting is **DISABLE**.

## DBU OPTIONS

### Answer Always

If this feature is enabled, the unit will answer a call. If disabled, it will not answer a call. However, the **ANSWER ALWAYS** option must work in conjunction with the **AUTO DBU** and **ORIGINATE/ANSWER** options. The **AUTO DBU** option is the controlling option and if it is disabled, the unit *will not answer* the call regardless of how **ANSWER ALWAYS** is set, except for the DTE DBU which *will answer* the call regardless of the **AUTO DBU** setting. The **ORIGINATE/ANSWER** feature only appears when the unit is programmed for a nonframe-relay circuit (signaling none). If both **ANSWER ALWAYS** and **AUTO DBU** are enabled, the unit will answer the call even if it is set to **ORIGINATE**.

### Beeper Option

If enabled, the TSU IQ+ issues an intermittent beep while in dial backup. Choices are **DISABLE** or **ENABLE**.

### Password Opt

When enabled, the passwords entered in the **DBU PASSWORD** fields of both the near and far end TSU IQ+s are required to match before a dial backup connection can be made. The setting in this field must also be identical in both units (i.e., they both must be set to either **ENABLED** or **DISABLED**). This field is not available when the PRI DBU card is installed.

### DBU Password

Enter the authentication string used for making a dial backup connection. The near and far end TSU IQ+ DBU passwords must

be identical. If using front panel entry, see the section *Entering Letters Using the Front Panel* on page 9-6 in the chapter *System Configuration* for more information. This field is not available when the PRI DBU card is installed.

**Daily Lockout**

Enable/disable the daily lockout specified by the fields **LOCKOUT START** and **LOCKOUT END**.

**Lockout Start**

Enter the hour that the daily lockout begins and dial backup is disabled. This setting only applies if the **DAILY LOCKOUT** parameter is enabled. Choices are **0** to **23**.

**Lockout End**

Enter the hour that the daily lockout ends and dial backup is reactivated (0 to 23). This setting only applies if the **DAILY LOCKOUT** parameter is enabled.

**Weekend Lock**

If enabled, no backup will occur from midnight Friday to midnight Sunday.

## DBU CRITERIA

**With Network Failure (WITH NETFAIL)**

When enabled, the TSU IQ+ enters backup mode when network failure is detected. The factory default setting is **ENABLE**.

**With No LMI**

When enabled, the TSU IQ+ enters backup mode when a loss of signaling from the frame relay switch is detected. The default setting is **ENABLE**.

**With PVC Inactive**

This option works in conjunction with the **DBU ON INACTIVE** option in the PVC configuration table. The **WITH PVC INACTIVE** option acts as a master switch for auto DBU operation based on the PVC state. If this option is set to **ENABLED**, then each **DBU ON INACTIVE** option applies. If this option is set to **DISABLE**, then each **DBU ON INACTIVE** option is disabled. See *DBU on Inactive* on page 7-7.

## DBU TIMERS

### **Fail Timer (FAIL TMR)**

This option sets the amount of time the dedicated circuit failure condition must be active before the TSU IQ+ attempts backup. The value entered is multiplied by 10. The amount of time can be up to 990 seconds (i.e., an entry of 99). The factory default setting is 10 seconds (an entry of 1).

### **Restore Timer (RESTORE TMR)**

Once the T1 circuit is down, the TSU IQ+ remains in backup until the T1 circuit is active for the length of time specified for the restore timer. The selection is entered in minutes (up to 255). If set to 0, the line must be restored manually. The factory default setting is 1 minute.

### **Redial Counter**

This option sets the number of times the TSU IQ+ redials the far end when entering backup mode. The redial count, which is manually entered, can be up to a maximum of 99 attempts. If the TSU IQ+ encounters a busy or reorder, it attempts to establish the call the specified number of times. The factory default setting is 5.

### **Wait to Redial (REDIAL DELAY)**

This option works in conjunction with the preceding **REDIAL COUNTER**. It selects the amount of time between redial attempts to connect the backup line. The amount of time, which is manually entered, can be up to 99 seconds. The factory default setting is 15 seconds.

## DBU CARD CONFIGURATION OPTIONS

The following selections are dependent upon the type of DBU card installed (if any). If no card is installed or if the 4-Wire SW56 card is installed, then the selections in this section do not appear.

### Modem Options

The **MODEM OPTIONS** field is available when the V.34 DBU card is installed. The options are described below.

#### Tone/Pulse

Select the dialing method for the dial backup service.

#### Max Baud Rate

This sets the maximum rate at which the call will connect.  
Choices: **2400, 4800, 7200, 9600, 12000, 14400, 16800, 19200, 21600, 24000, 26400, 28800, 31200, 33600.**

#### Sync/Async

Set to **SYNC** if the unit is connecting to another IQ unit. Set to **ASYNC** if the unit is connecting to an ATLAS.

### ISDN Options

The **ISDN OPTIONS** field is available when the ISDN DBU card is installed. The following options are available:

#### Switch Type

Select which type of telco CO switch is providing the ISDN service. There are four options for ISDN switch types:

- **LUCENT 5ESS**
- **DMS100**
- **NATIONAL**
- **NEC**

### **B-Channel Bit Rate (B-CH BIT RATE)**

Select the channel bit rate for the ISDN service. Select **64K** unless your service only provides **56K**.

### **Number of B-Channels (NUM B-CHANNELS)**

Select the number of B-channels supported by the ISDN service. Select **2** if bonding is used.

### **SPID 1 and 2**

Enter the service profile identifier (SPID) for both B-channels. The SPID is a sequence of digits identifying ISDN terminal equipment to the ISDN switch when more than one ISDN set has been attached to the same central office line. The SPID is assigned by the telco when the ISDN line is installed and normally resembles the phone number.

Only the Lucent 5ESS switch is capable of recognizing a point-to-point configuration, eliminating the need for a SPID. All other switch types require a SPID.

### **LDN 1 and 2**

Enter the LDNs for both B-channels. The LDNs are assigned by the telco when the ISDN line is installed.

## **CALL SCREENING**

If **CALL SCREENING** is set to **ENABLE**, the TSU IQ+ will only accept incoming calls from the numbers entered in the **NUMBER 1** through **NUMBER 5** fields. Calls from any other number or from an unidentifiable number are rejected (for BRI card only).

## **PRI Options**

The **PRI OPTIONS** field is available when the PRI DBU card is installed. The following options are available.



## Physical Layer Options

The following sections describe the **PHYSICAL LAYER OPTIONS** available for the PRI DBU card.

### Line Code

Set the line coding of the PRI DBU card to **B8ZS** for PRI applications.

### Clock Source

Set the clock source to be derived from the network or from the unit's internal clock. The selected clocking option designates the clock source for transmission. Clocking necessary for receiving data is recovered from incoming data. This option is most commonly set to **NETWORK**.

### Line Buildout

Select the output level (in dB) for the PRI DBU card interface. Choices: **AUTO, 0, 7.5, 15.0, and 22.5 dB**.

### Rx Gain

Select the desired receiver sensitivity setting. The factory default setting is **NORMAL**, which is adequate for most applications. The **EXTENDED** setting should be used only in applications where the **NORMAL** setting is not sufficient. If the receive signal strength is less than 30 dB, choose **EXTENDED**.

### Start Channel

Select the channel in which the T1 stream starts. The setting must be consistent with the carrier if using a public network.

### Number of Channels

Select the number of DS0s (channels) that are to be used. Note that the PRI card uses one DS0 per connected call.

### Tx Yellow Alarm

Set **TX YEL ALARM** to **YES** to transmit yellow alarms when a red alarm is detected. Set this entry to **NO** to avoid transmitting yellow alarms upon red alarm detection.

**Local Loopback**

This forces the PRI into loopback on the network. This option can be used instead of setting the loopback up using loop codes from external test equipment.

Choices: **NONE**, **PAYLOAD**, and **LINE**.

**Transmit PRM**

Set this entry to **YES** to enable the unit to send messages across the facility data link (FDL) per ANSI T1.403.

**Switch Type**

Select which type of telco CO switch is providing the ISDN service. This information is available from your service provider.

Choices: **LUCENT 5ESS**, **DMS 100**, **NATIONAL**.

**LDN**

Enter the LDN for this location. This information is available from your service provider.

**DCE Options**

The **DCE OPTIONS** field is available when the External DCE option card is installed.

**Interface Type**

Select the connector type for the **DCE** interface.

Choices: **EIA-232**; **V.35**.

**DBU Bit Rate**

Set to the operating speed of the **DBU** interface.

Choices: **0** to **1536** kbps

## Chapter 9 System Configuration

---

Access System configuration selections by first choosing **CONFIGURATION** from the **MAIN** menu. Then choose **SYSTEM** from the **CONFIGURATION** menu. Full menu trees for the **SYSTEM CONFIGURATION** selections are shown in Figure 5-2 on page 5-3 (*Terminal Configuration Menu Tree*) and Figure 5-3 on page 5-4 (*Front Panel Configuration Menu Tree*). The terminal system **CONFIGURATION** menu is shown in Figure 9-1 on page 9-2.

### Change Password

Enter a new password of ten characters or less. The default password is **adtran** (not available on front panel).

### IP Address

Enter the TSU IQ+ IP (internet protocol) address.

## Subnet Mask

Enter the subnet mask assigned to the LAN that the ethernet card is attached to. This option is only available if the ethernet card is installed.

```

                                Configure Unit
                                ADTRAN TSUIQ+
                                <Local> ATLANTA
-----
1 - Change Password
2 - IP Address  0.0.0.0
3 - Control Port Options
4 - Read Community  public
5 - Write Community  private
6 - Trap Mgr Options
7 - Protocol 1  None
8 - Protocol 2  None
9 - System Name  ATLANTA
10 - System Time  02:15:12
11 - System Date  05/07/99
12 - History Interval Size  30 Min
-----
Enter Selection ->

```

Figure 9-1. System Configuration Menu

## IP Address (IP ADDRESS)

Enter the IP address. The IP address is used when an ethernet packet is transmitted from the TSU IQ+ to a foreign subnet. This option is only available if the ethernet card is installed.

## Control Port Options (CNTL PORT OPTS)

Set the **CONTROL PORT MODE** for **TERMINAL**, **SLIP** protocol, or **PPP** protocol. Set for **SLIP** or **PPP** when using the Control port for an **SNMP/TELNET** path.

---

## Read Community (RD COMMUNITY)

Enter the authentication strings used for SNMP management. Match the TSU IQ+ to the SNMP manager for read privileges. If using front panel entry, see the section *Entering Letters Using the Front Panel* on page 9-6 for more information.

## Write Community (WR COMMUNITY)

Enter the authentication strings used for SNMP management. Match the TSU IQ+ to the SNMP manager for write privileges. If using front panel entry, see the section *Entering Letters Using the Front Panel* on page 9-6 for more information.

## Trap Mgr Options (TRAP MGR OPTS)

The **TRAP MANAGER OPTIONS** table defines routes for up to five SNMP managers.

### Trap Manager DLCI (TRAP DLCI)

If the **TRAP MANAGER PORT** is set for **NETWORK** or **DTE**, this parameter identifies the virtual circuit used for all traps generated by the TSU IQ+.

### Trap Manager IP (TRAP IP)

Enter the IP address of the SNMP manager to which the TSU IQ+ sends traps.

### Trap Manager Port (TRAP PORT)

Enter the TSU IQ+ port used to transmit traps to the SNMP manager.  
Choices: **NONE**, **DTE PORT**; **NETWORK PORT**; **CONTROL PORT**. (The ethernet port selection is available only if the ethernet card is installed.)

### Next (NEXT key on front panel)

Edit the next entry in the Trap Manager Options table.

**Previous (PREV key on front panel)**

Edit the previous entry in the Trap Manager Options table.

**Add (ADD key on front panel)**

Add a new entry to the Trap Manager Options table.

**Delete (DELETE key on front panel)**

Delete the current entry in the Trap Manager Options table.

## Protocols 1 and 2

These selections allow you to arm the TSU IQ+ to gather statistics for particular protocols. Select the protocol types most commonly found on your network. If you have only one type, set **PROTOCOL 1** for that type, and set **PROTOCOL 2** for **UNKNOWN**. The information is displayed in the **LAYER 3** portion of the **STATISTICS** menu (see *Layer 3 Statistics* on page 10-16).

Descriptions for each of the six selections follow:

<b>None</b>	Statistics are not gathered for that protocol number.
<b>IP</b>	Statistical information for all IP protocol traffic (both routed and bridged) is gathered and displayed in the <b>LAYER 3</b> portion of the <b>STATISTICS</b> menu.
<b>IPx</b>	Statistical information for all IPx protocol traffic (both routed and bridged) is gathered and displayed in the <b>LAYER 3</b> portion of the <b>STATISTICS</b> menu.
<b>ARP</b>	Statistical information for all ARP protocol traffic is gathered and displayed in the <b>LAYER 3</b> portion of the <b>STATISTICS</b> menu.
<b>SNA</b>	Statistical information for all SNA protocol traffic is gathered and displayed in the <b>LAYER 3</b> portion of the <b>STATISTICS</b> menu. All ten SNA types defined in FRF-3 are supported.
<b>Unknown</b>	Statistical information for all other protocols (not selected in the other protocol field) is gathered and displayed in the <b>LAYER 3</b> portion of the <b>STATISTICS</b> menu.

## System Name

Enter a descriptive name for the unit. This name can help you distinguish between different installations. Enter up to 20 alphanumeric characters in this field, including spaces and special characters (such as an underbar). The name is then displayed in the terminal menu. This selection is only available for the terminal interface.

## System Time/Date

Set the current hour, minute, day, month, and year. This is used to date/time stamp all statistical data captured by the TSU IQ+.

## History Interval Size (HST INT SIZE)

The time entered in this field affects the **INTERVAL VIEW** in the **STATISTICS** menus. The **INTERVAL VIEW** provides historical data for the current day. The data is divided into columns grouped by the interval of time selected in this field. Once the maximum amount of storage time is reached, new information overwrites existing information, beginning with the least current. Choices are **5**, **10**, **15**, **20**, or **30** minutes.



*If data is not retrieved before the Total Time Stored is exceeded, it is overwritten and cannot be restored. Total Time Stored = History Interval Size x History Interval Count.*

## ENTERING LETTERS USING THE FRONT PANEL

Configuring the **READ/WRITE COMMUNITY** names requires the entry of letters rather than numbers. When configuring the unit using the front panel, the following steps must be taken in order to perform these entries. The following example uses the **WRITE COMMUNITY** name.

1. Select **WRITE COMMUNITY** from the **SYSTEM CONFIGURATION** menu.
2. Press the up arrow key to scroll to the desired character.
3. Press **Enter**.
4. Repeat steps 2 and 3 until all characters have been selected.
5. Press the **Enter** key to complete the entry.



## Chapter 10 Statistics

---

For descriptions of the terminal statistics menus, see the following section, *Viewing Statistical Information (Terminal Interface)*. For front panel menu descriptions, see the section *Viewing Statistical Information (Front Panel Interface)* on page 10-33.

### VIEWING STATISTICAL INFORMATION (TERMINAL INTERFACE)

Select **VIEW STATISTICS** from the **MAIN** menu to access the menu shown in Figure 10-1 on page 10-2. From this menu, select from the following types of statistics:

- DTE Port** (page 10-5)
- Network Port** (page 10-9)
- DSX Port** (page 10-15)
- Layer 3** (page 10-16)
- Top Talkers** (page 10-19)
- DBU Port** (page 10-20)
- Call Manager** (page 10-26)
- DLCI Statistics** (page 10-27)
- DLCI List** (see page 10-31)
- System** (see page 10-32)

```
Statistics Menu                                ADTRAN TSUIQ+
                                                <Local> ATLANTA
-----
1 - DTE Port
2 - Network Port
3 - DSX Port
4 - Layer 3 Stats
5 - Top Talkers
6 - DBU Port
7 - Call Manager

8 - DLCI List
9 - System
10 - Reset Statistics

Enter Selection ->
```

Figure 10-1. View Statistics Menu



*Call Manager will not appear on the screen unless a PRI card is installed.  
DBU Port will not appear unless a DBU card is installed.*

## Terminal Statistics Display Options

**DTE PORT, NETWORK PORT, DSX PORT, LAYER 3, DBU PORT, and DLCI LIST** are given in two formats: **VIEW BY INTERVAL** and **VIEW BY DAY**. These two formats are described in the following sections.

### View by Interval

In this view, the first column is a running total for the current day. All other columns are grouped into user-configured time frames with the most recent information displayed on the left. The first column's header displays the current date, and the interval columns display the time the intervals began. In order to categorize the interval columns by date also, the midnight time stamp is replaced with the date. Note that this column still represents the timed interval (not a day's worth of information).

To configure the interval time frame, go to the **SYSTEM CONFIGURATION** menu under **HISTORY INTERVAL SIZE** and select the time you want the history interval to be set for (from 5 to 30 minutes, in five minute intervals). The TSU IQ+ gathers and displays the information according to the time selected. An example of a **STATISTICS** screen in the **VIEW BY INTERVAL** format is shown in Figure 10-2 on page 10-5.

**NOTE**

*The TSU IQ+ cuts the first gathering session short in order to begin falling on the selected time boundary. For example: If the unit or the statistics information was last reset at 12:03 and the History Interval is set for five minutes, then the first interval session will last only two minutes. Therefore, the first interval column (i.e., the column farthest to the right if no columns have been deleted yet) normally represents a time shorter than the other columns.*

**View by Day**

This view provides historical information for the last seven days (not including the current day). The most recent information is displayed on the left. An example of a **STATISTICS** screen in the **VIEW BY DAY** format is shown in Figure 10-3 on page 10-5.

**NOTE**

*The first day's column (i.e., the column furthest to the right) does not represent a full day's worth of information (unless the unit or the statistics information was reset at exactly 12 AM).*

## Hot Keys

Once you have entered one of the statistics menus, hot keys are displayed across the bottom of the screen, allowing you to access other menus quickly or navigate within the current menu. These keys vary, depending on the menu currently displayed.

### **ESC=Menu**

Press the **ESC** key to return to the main **VIEW STATISTICS** menu (shown in Figure 10-1 on page 10-2).

### **D=DLCI**

When viewing **NETWORK PORT** or **LAYER 3 STATISTICS**, press **D** to view the **DLCI STATISTICS** menu described on page 10-27.

### **Page (+, -)**

Press the **+** and **-** keys to scroll through statistics menu pages.



*The **Shift** key must be used in conjunction with the **+** key in order to advance a menu page.*

### **Scroll (<, >)**

Press the **<** and **>** keys to scroll left and right on a **STATISTICS** menu page.



*The **SHIFT** key must be used in conjunction with the **<** and **>** keys in order to scroll a menu page.*

### **V=View by Day/View by Interval**

Press **V** to change the view format.

The following sections describe the information given on the statistics screens.

## DTE Port Statistics

Information given is for the DTE (V.35) port since the last reset. See Figure 10-2 and Figure 10-3.

DTE Port		View Statistics				ADIRAN TSUIQ+ <Local> ATLANTA			
Leads On --> CTS DSR DCD				Interval Remaining		769			
Signaling State --> DOWN				Signaling Detected --> ANSI					
	May 7	2:00	1:30	1:07	0:00	0:00	0:00	0:00	0:00
Loc PUC Rx Fr	0	0	0	0	0	0	0	0	0
Loc PUC Rx Bt	0	0	0	0	0	0	0	0	0
Loc PUC Tx Fr	0	0	0	0	0	0	0	0	0
Loc PUC Tx Bt	0	0	0	0	0	0	0	0	0
Sig Down Time	4108	1031	1800	1277	0	0	0	0	0
Signal Error	0	0	0	0	0	0	0	0	0
Signal I/O	276	69	120	87	0	0	0	0	0
Sig State Chg	1	0	0	1	0	0	0	0	0
Rx Full Stat	0	0	0	0	0	0	0	0	0
Rx LI Only	0	0	0	0	0	0	0	0	0
Discard Frame	0	0	0	0	0	0	0	0	0
Aborts	0	0	0	0	0	0	0	0	0
CRC Error	0	0	0	0	0	0	0	0	0
Octet Align	0	0	0	0	0	0	0	0	0
Length Error	0	0	0	0	0	0	0	0	0

■ ESC = Menu    -, + = Page    >, < = Scroll    U = View By Day

Figure 10-2. View by Day Statistics Screen

DTE Port		View Statistics				ADIRAN TSUIQ+ <Local> ATLANTA			
Leads On --> CTS DSR DCD				Signaling Detected--> ANSI					
Signaling State --> DOWN									
	NA	NA	NA	NA	NA	NA	NA	NA	NA
Loc PUC Rx Fr	0	0	0	0	0	0	0	0	0
Loc PUC Rx Bt	0	0	0	0	0	0	0	0	0
Loc PUC Tx Fr	0	0	0	0	0	0	0	0	0
Loc PUC Tx Bt	0	0	0	0	0	0	0	0	0
Sig Down Time	0	0	0	0	0	0	0	0	0
Signal Error	0	0	0	0	0	0	0	0	0
Signal I/O	0	0	0	0	0	0	0	0	0
Sig State Chg	0	0	0	0	0	0	0	0	0
Rx Full Stat	0	0	0	0	0	0	0	0	0
Rx LI Only	0	0	0	0	0	0	0	0	0
Discard Frame	0	0	0	0	0	0	0	0	0
Aborts	0	0	0	0	0	0	0	0	0
CRC Error	0	0	0	0	0	0	0	0	0
Octet Align	0	0	0	0	0	0	0	0	0
Length Error	0	0	0	0	0	0	0	0	0

■ ESC = Menu    D = DLCI    -, + = Page    U = View Intervals

Figure 10-3. View by Interval Statistics Screen

Descriptions of the fields shown on the **DTE PORT STATISTICS** screens follow.

**Leads On**

If a lead has become active on the selected port since the last screen reset, it is listed in the **VIEW STATISTICS** menu.

<b>RTS</b>	Request to send
<b>DTR</b>	Data terminal ready
<b>CTS</b>	Clear to send
<b>DSR</b>	Data set ready
<b>DCD</b>	Data carrier detect

**Interval Remaining**

Number of seconds remaining in the current timed interval.

**Signaling State**

Indicates if the frame relay signaling state is currently up or down.

**Signaling Detected**

Displays the current signaling type detected on the DTE port.

**Local PVC Rx Frames**

Total frames received by the DTE port across the local management PVC.

**Local PVC Rx Bytes**

Total bytes received by the DTE port across the local management PVC.

**Local PVC Tx Frames**

Total frames transmitted by the DTE port across the local management PVC.

**Local PVC Tx Bytes**

Total bytes transmitted by the DTE port across the local management PVC.

**Signal Down Time**

Time in seconds the signaling state is down.

**Signal Error**

Number of signal frames received with PVC signaling protocol violations.

**Signal Timeouts**

Number of T392 timeouts that have occurred.

**Signal State Change**

Number of changes in the signaling protocol state.

**Rx Full Status**

Number of full status polls received on the DTE side.

**Rx LI Only**

Number of link integrity (LI) only polls received on the DTE side.



*On the DTE side, transmit and receive counts for full status and link integrity polls would be identical. Therefore, only receive counts are given.*

**Discard Frame**

Number of frames discarded by the TSU IQ+ due to bad IP frames received on the management DLCI, transmission errors, or link violations. This count includes **ABORTS**, **CRC ERRORS**, **OCTET ALIGN**, and **LENGTH ERRORS**.

**Aborts**

Number of frames received without a closing flag. This transmission error is also reflected in the **DISCARD FRAME** field.

**CRC Errors**

Number of frames received with CRC violations. This transmission error is also reflected in the **DISCARD FRAME** field.

**Octet Align**

Number of frames received with a bit count that does not fall on 8-bit boundaries. This transmission error is also reflected in the **DISCARD FRAME** field.

**Length Error**

Number of frames received with fewer than 5 octets or greater than 4500 octets. This link violation is also reflected in the **DISCARD FRAME** field.

**EA Violation**

Number of frames received with an error in the extended address (EA) bit field of the frame relay header.

**Encapsulation Error**

Number of frames received on the management DLCI that have RFC 1490 errors.



*If both management DLCIs are shared, the Encapsulation Error field is non-applicable. See the section Management DLCI 1 and 2 (DLCI 1 and 2) on page 7-5 for more information.*

**Inactive DLCI**

Number of frames received on an inactive DLCI.

**Invalid DLCI**

Number of frames received on a DLCI that is out of range. The valid DLCI range is 16-1007.

**Unrouteable**

Number of frames received on the management DLCI with an IP address that does not match the TSU IQ+ IP address.



## Network Port Statistics

Information given is for the network port since the last reset. See Figure 10-4 and Figure 10-5 for both formats of the **NETWORK PORT STATISTIC** screens.

NETWORK PORT	ADTRAN TSUIQ+VIEW STATISTICS							LOCAL
Signaling State -->	DOWN							Interval Remaining 10
TSU state -->	OPEN LOOP							U.34 DBU State --> IDLE
	JAN 25	18:00	17:55	17:53	0:00	0:00	0:00	
Rx Frames	0	0	0	0	0	0	0	
Rx Bytes	0	0	0	0	0	0	0	
Max Rx Thru	0	0	0	0	0	0	0	
Avg Rx Thru	0	0	0	0	0	0	0	
Max Rx Util %	0%	0%	0%	0%	0%	0%	0%	
Avg Rx Util %	0%	0%	0%	0%	0%	0%	0%	
Tx Frames	60	27	27	5	0	0	0	
Tx Bytes	960	432	432	96	0	0	0	
Max Tx Thru	128	128	128	128	0	0	0	
Avg Tx Thru	11	12	11	11	0	0	0	
Max Tx Util %	0%	0%	0%	0%	0%	0%	0%	
Avg Tx Util %	0%	0%	0%	0%	0%	0%	0%	
Port UA Time	655	287	300	68	0	0	0	
Sig Down Time	614	287	300	27	0	0	0	
Signal Error	0	0	0	0	0	0	0	
ESC = Menu    D = DLCI    -,+ = Page    >,< = Scroll    U = View By Day								

**Figure 10-4. Network Port Statistics with DBU Card Installed (View by Interval)**

NETWORK PORTS	ADTRAN TSUIQ+VIEW STATISTICS							LOCAL
Signaling State -->	DOWN							U.34 DBU State --> IDLE
TSU state -->	OPEN LOOP							
	NA	NA	NA	NA	NA	NA	NA	
Rx Frames	0	0	0	0	0	0	0	
Rx Bytes	0	0	0	0	0	0	0	
Max Rx Thru	0	0	0	0	0	0	0	
Avg Rx Thru	0	0	0	0	0	0	0	
Max Rx Util %	0%	0%	0%	0%	0%	0%	0%	
Avg Rx Util %	0%	0%	0%	0%	0%	0%	0%	
Tx Frames	0	0	0	0	0	0	0	
Tx Bytes	0	0	0	0	0	0	0	
Max Tx Thru	0	0	0	0	0	0	0	
Avg Tx Thru	0	0	0	0	0	0	0	
Max Tx Util %	0%	0%	0%	0%	0%	0%	0%	
Avg Tx Util %	0%	0%	0%	0%	0%	0%	0%	
Port UA Time	0	0	0	0	0	0	0	
Sig Down Time	0	0	0	0	0	0	0	
Signal Error	0	0	0	0	0	0	0	
ESC = Menu    D = DLCI    -,+ = Page    U = View Intervals								

**Figure 10-5. Network Port Statistics (View by Day)**

Descriptions of the fields shown on the **NETWORK PORT STATISTICS** screens are shown below.

**Signaling State**

Indicates if the signaling state is currently up or down.

**Interval Remaining**

Number of seconds remaining in the current timed interval (only shown in the **VIEW BY INTERVAL** screen).

**TSU State**

Current state of the TSU. Possible states are listed in Table 10-1.

**Table 10-1. Possible TSU States**

<b>TSU STATE</b>	<b>DESCRIPTION</b>
OPEN LOOP	No receive signal
TEST FROM TELCO	Loopback code received from telco
AIS ALARM	Unframed all ones received
RED ALARM	Loss of frame synchronization
YELLOW ALARM	Telco side loss of frame synchronization
ESF NORMAL	Normal condition for ESF link
D4 NORMAL	Normal condition for D4 link

**PRI State**

Current state of the PRI circuit (shows only if a PRI card is installed).

**DBU State**

Current state of the DBU circuit (shows only if a DBU card is installed).

**Rx Frames**

Number of frames received by the network port.

**Rx Bytes**

Number of bytes received by the network port.

**Maximum Rx Throughput**

Maximum throughput sample in the receive direction for the given interval. This is displayed in kbps.

**Average Rx Throughput**

Average throughput in the receive direction for the given interval. This is displayed in kbps.

**Maximum Rx Utilization**

Maximum utilization sample in the receive direction for the given interval. Utilization is displayed as a percentage of network port bandwidth.

**Average Rx Utilization**

Average utilization sample in the receive direction for the given interval. Utilization is displayed as a percentage of network port bandwidth.

**Tx Frames**

Number of frames transmitted by the network port.

**Tx Bytes**

Number of bytes transmitted by the network port.

**Maximum Tx Throughput**

Maximum throughput sample in the transmit direction for the given interval. This is displayed in kbps.

**Average Tx Throughput**

Average throughput in the transmit direction for the given interval. This is displayed in kbps.

**Maximum Tx Utilization**

Maximum utilization sample in the transmit direction for the given interval. Utilization is displayed as a percentage of network port bandwidth.

**Average Tx Utilization**

Average utilization sample in the transmit direction for the given interval. Utilization is displayed as a percentage of network port bandwidth.

**Port UA Time**

Time in seconds the network port is unavailable for data delivery. This means that the T1 link is down or in test, or that the frame relay signaling state is down.

**Signal Down Time**

Time in seconds the signaling state has been down.

**Signal Error**

Number of signal frames received with PVC signaling protocol violations.

**Signal Timeouts**

Number of T391 timeouts that have occurred.

**Signal State Change**

Number of changes in the signaling protocol state.

**Rx Full Status**

Number of full status responses received on the network side.

**Tx Full Status**

Number of full status polls transmitted by the TSU IQ+.

**Rx LI Only**

Number of link integrity (LI) only responses received on the network side.

**Tx LI Only**

Number of link integrity polls transmitted by the TSU IQ+.

**Async Status**

Number of asynchronous status messages received by the TSU IQ+.

**Discard Frame**

Number of frames discarded by the TSU IQ+ due to bad IP frames received on the dedicated management DLCI, transmission errors, or link violations.

**Aborts**

Number of frames received without a closing flag. This transmission error is also reflected in the **DISCARD FRAME** field.

**CRC Errors**

Number of frames received with CRC violations. This transmission error is also reflected in the **DISCARD FRAME** field.

**Octet Align**

Number of frames received with a bit count that does not fall on 8-bit boundaries. This transmission error is also reflected in the **DISCARD FRAME** field.

**T1 State Change**

Count of state changes for the T1 port.

**T1 UA Time**

Time in seconds the T1 link is down.

**NOTE**

*The next six parameters (**SIGNAL LOSS**, **TELCO TEST**, **AIS ALARM**, **RED ALARM**, **YELLOW ALARM**, and **PLL ALARM**) are events with two states: active and inactive. If the event occurs one or more times for the given interval, the field is active and **ALARM** is displayed. The first column of the **VIEW BY INTERVAL** menu represents information for the entire current day. Therefore, once an alarm becomes active, it remains active in the first field for the entire 24-hour period.*

**Signal Loss**

If **ALARM** is displayed, a loss of signal occurred one or more times during the given interval.

**Telco Test**

If **ALARM** is displayed, a loopback code was received on the T1 interface one or more times during the given interval.

**AIS Alarm**

If **ALARM** is displayed, unframed all ones were received on the T1 interface one or more times during the given interval. This indicates that the T1 is out of service.

**Red Alarm**

If **ALARM** is displayed, a loss of frame synchronization occurred one or more times during the given interval.

### **Yellow Alarm**

If **ALARM** is displayed, the telco end of the T1 was out of frame sync one or more times during the given interval.

### **PLL Alarm**

**ALARM** displayed in this field usually signifies that both ends of the T1 circuit are set to provide timing.

### **Path Code**

Number of path code violations. Path code violations include frame bit errors for D4 framing and superframes with CRC errors for ESF framing.

### **Line Code**

Number of line code violations. Line code violations include BPVs that are not part of B8ZS code or excess zero violations.

### **Length Error**

Number of frames received with fewer than 5 octets or greater than 4500 octets. This link violation is also reflected in the **DISCARD FRAME** field.

### **EA Violation**

Number of frames received with an error in the extended address (EA) bit field of the frame relay header.

### **Encapsulation Error**

Number of frames received on a dedicated management DLCI that have RFC 1490 errors. These errors are also reflected in the **DISCARD FRAME** field.

**NOTE**

*If both management DLCIs are shared, the **ENCAPSULATION ERROR** field is N/A. See the section *Management DLCI 1 and 2 (DLCI 1 and 2)* on page 7-5 for more information.*

### **Inactive DLCI**

Number of frames received on an inactive DLCI.

### **Invalid DLCI**

Number of frames received on a DLCI that is out of range. The valid DLCI range is 16-1007.

**Unrouteable**

Number of frames received on a dedicated management DLCI with an IP address that does not match the TSU IQ+ IP address.

**NOTE**

*If both **MANAGEMENT DLCIs** are **SHARED**, the **UNROUTEABLE** field is non-applicable. See the section *Management DLCI 1 and 2 (DLCI 1 and 2)* on page 7-5 for more information.*

## DSX Port Statistics

Information given is for the **DSX-1** port since the last reset. Descriptions of the fields shown on the **DSX PORT STATISTICS** screens follow.

**DSX State**

Indicates whether the **DSX-1** port is currently up or down.

**Interval Remaining**

Number of seconds remaining in the current timed interval (only shown in the **VIEW BY INTERVAL** screen).

**DSX State Change**

Count of state changes for the **DSX-1** port.

**DSX UA Time**

Time in seconds the **DSX-1** port is unavailable for data delivery. This means that the T1 link is down or in test, or that the frame relay signaling state is down.

**NOTE**

*The next four parameters (**AIS ALARM**, **RED ALARM**, **YELLOW ALARM**, and **PLL ALARM**) are events with two states: active and inactive. If the event occurs one or more times for the given interval, the field is active and **ALARM** is displayed. The first column of the **VIEW BY INTERVAL** menu represents information for the entire current day. Therefore, once an alarm becomes active, it remains active in the first field for the entire 24-hour period.*

**AIS Alarm**

If **ALARM** is displayed, unframed all ones were received on the T1 interface one or more times during the given interval. This indicates that the T1 is out of service.

**Red Alarm**

If **ALARM** is displayed, a loss of frame synchronization occurred one or more times during the given interval.

**Yellow Alarm**

If **ALARM** is displayed, the telco end of the T1 was out of frame sync one or more times during the given interval.

**PLL Alarm**

**ALARM** displayed in this field usually signifies that both ends of the T1 circuit are set to provide timing.

**Path Code**

Number of path code violations. Path code violations include frame bit errors for D4 framing and superframes with CRC errors for ESF framing.

**Line Code**

Number of line code violations. Line code violations include BPVs that are not part of B8ZS code or excess zero violations.

## Layer 3 Statistics

Layer 3 statistical information provides you with a better understanding of what type of traffic is occupying your bandwidth. Configure this menu specifically for your setup by selecting the two protocol types most commonly found in your network. The selections are called **PROTOCOL 1** and **PROTOCOL 2** and are found in the **SYSTEM** portion of the **CONFIGURATION** menu (see *Protocols 1 and 2* on page 9-4). Layer 3 tracking supports the following four protocols:

- **IP (routed and bridged)**
- **IPX (routed and bridged)**
- **SNA (ten SNA types as defined in FRF-3)**
  - SNA-Subarea (FID4) with Layer 2 (LLC2)
  - SNA-Peripheral (FID2) with Layer 2 (LLC2)
  - SNA-APPN with Layer 2 (LLC2)
  - SNA-HPR with Layer 2 (LLC2)
  - SNA-Netbios with Layer 2 (LLC2)
  - SNA-Subarea (FID4) without Layer 2 (LLC2)



SNA-Peripheral (FID2) without Layer 2 (LLC2)  
 SNA-APPN without Layer 2 (LLC2)  
 SNA-Netbios without Layer 2 (LLC2)  
 SNA-HPR without Layer 2 (LLC2)

- **ARP**

For Layer 3 tracking to function, the data must be RFC-1490 encapsulated data or RFC-2427 encapsulated data (RFC-2427 superseded RFC-1490). For an IP packet to be recognized, it must be carried by an RFC-2427 IP header or an RFC-2427 SNAP header for bridged ethernet. If the SNAP header is carrying a bridged ethernet packet, the MAC header is examined for the protocol type. SNAP headers are also examined for IPX and ARP traffic.



*The ARP option actually tracks inverse ARP where addresses are resolved across the WAN link. SNA traffic is recognized by its RFC-2427 header.*

Information is gathered for the two protocol types you choose and is displayed with **P1** representing information for **PROTOCOL 1** and **P2** representing information for **PROTOCOL 2**.

There are four different views of the Layer 3 Statistics:

- Network Port, View by Interval
- Network Port, View by Day
- DLCI, View by Interval
- DLCI, View by Day

Descriptions of the fields found in these menus follow. Field descriptions are the same for both protocol selections, so “x” represents the protocol number.

**Px Type (current)**

The protocol type currently selected in the **CONFIGURATION** menu is displayed in this field.

**Interval Remaining**

Number of seconds remaining in the current timed interval.

**Px Type (listed for each interval)**

The protocol type being examined for the given interval is displayed in this field.

 **NOTE**

*When the **PROTOCOL** type selection is changed (see Protocols 1 and 2 on page 9-4) the new selection is not accepted by the TSU IQ+ until the end of the current timed interval. For example, if the TSU IQ+ is configured for 5-minute timed intervals, and the **PROTOCOL** type selection is changed at 12:25, the change will not be recognized until 12:30. This allows the unit to display an accurate interval history of the **PROTOCOL TYPE** field.*

 **NOTE**

*When the **PROTOCOL** type selection is changed, the **PROTOCOL TYPE** field (**P1 TYPE** or **P2 TYPE**) for the current day total (left-most column on the **VIEW BY INTERVAL** screens) displays **MIXED**, indicating that the displayed information represents more than one protocol type. **Mixed** is also displayed for the day total on the **VIEW BY DAY** screen once the 24 hour period is complete.*

**Px Rx Frames**

In the Network Port view, this is the number of frames received on the network port that match the selected protocol type. In the DLCI view, this is the number of frames received on a particular DLCI that match the selected protocol type.

**Px Rx Bytes**

In the Network Port view, this is the number of bytes received on the network port that match the selected protocol type. In the DLCI view, this is the number of bytes received on a particular DLCI that match the selected protocol type.

**Px Rx Dist%**

The distribution percentages show what portion of the data can be attributed to the protocols being tracked.

**Px Tx Frames**

In the Network Port view, this is the number of frames transmitted on the network port that match the selected protocol type. In the DLCI view, this is the number of frames transmitted on a particular DLCI that match the selected protocol type.

**Px Tx Bytes**

In the Network Port view, this is the number of bytes transmitted on the network port that match the selected protocol type. In the DLCI view, this is the number of bytes transmitted on a particular DLCI that match the selected protocol type.

**Px Tx Dist%**

The distribution percentages show what portion of the data can be attributed to the protocols being tracked.

**Top Talkers**

The **TOP TALKERS STATISTICS** menu provides information regarding the top five talkers in each direction (Rx and Tx) based on their source IP addresses. This information is useful in diagnosing network problems. If a user is experiencing slow response times, this screen shows whether the problem is the result of the line not having enough total bandwidth to support the number of users, or if a small number of users are using excessive amounts of bandwidth. Lower distribution percentages indicate that there are too many users for that line. High distribution percentages indicate that some users may be using an excessive amount of bandwidth (possibly due to the type of applications they are using). See Figure 10-6 for an example of a **TOP TALKERS** menu.

Top Talkers				View Statistics				ADIRAN TSUIQ+ (Local) ATLANTA					
Address Type --> IP				Interval Remaining									
1	Rx	0.	0.	0.	0.	0.	0.	0.	0.	0.	0.	0.	0.
	Dist	0.	0.	0.	0.	0.	0.	0.	0.	0.	0.	0.	0.
2	Rx	0.	0.	0.	0.	0.	0.	0.	0.	0.	0.	0.	0.
	Dist	0.	0.	0.	0.	0.	0.	0.	0.	0.	0.	0.	0.
3	Rx	0.	0.	0.	0.	0.	0.	0.	0.	0.	0.	0.	0.
	Dist	0.	0.	0.	0.	0.	0.	0.	0.	0.	0.	0.	0.
4	Rx	0.	0.	0.	0.	0.	0.	0.	0.	0.	0.	0.	0.
	Dist	0.	0.	0.	0.	0.	0.	0.	0.	0.	0.	0.	0.
5	Rx	0.	0.	0.	0.	0.	0.	0.	0.	0.	0.	0.	0.
	Dist	0.	0.	0.	0.	0.	0.	0.	0.	0.	0.	0.	0.
1	Tx	0.	0.	0.	0.	0.	0.	0.	0.	0.	0.	0.	0.
	Dist	0.	0.	0.	0.	0.	0.	0.	0.	0.	0.	0.	0.
2	Tx	0.	0.	0.	0.	0.	0.	0.	0.	0.	0.	0.	0.
	Dist	0.	0.	0.	0.	0.	0.	0.	0.	0.	0.	0.	0.
3	Tx	0.	0.	0.	0.	0.	0.	0.	0.	0.	0.	0.	0.

ESC = Menu                      - , + = Page                      > , < = Scroll      U = View By Interval

**Figure 10-6. Top Talkers Statistics Menu**

**Address Type**

The **ADDRESS TYPE** field displays **IP**, indicating that the **TOP TALKERS** feature is tracking IP (routed and bridged) data.

**Interval Remaining**

Number of seconds remaining in the current timed interval (only shown in the **VIEW BY INTERVAL** screen).

**Rx Distribution**

Displays what percentage of the IP traffic received on the network port is from the given source address.

**Tx Distribution**

Displays what percentage of the IP traffic transmitted from the network port went to the given source address.

**DBU Port Statistics**

Information given is for the dial backup port since the last reset. These statistics are only available when a DBU card is installed. See Figure 10-7 below and Figure 10-8 on page 10-21 for both formats of the DBU Port Statistic screens. Descriptions of the fields follow the screens.

DBU PORT DAYS	ADTRAN TSU IQ+ VIEW STATISTICS							LOCAL
U.34 DBU State --> IDLE								
	NA	NA	NA	NA	NA	NA	NA	
Rx Frames	0	0	0	0	0	0	0	
Rx Bytes	0	0	0	0	0	0	0	
Max Rx Thru	0	0	0	0	0	0	0	
Avg Rx Thru	0	0	0	0	0	0	0	
Max Rx Util %	0%	0%	0%	0%	0%	0%	0%	
Avg Rx Util %	0%	0%	0%	0%	0%	0%	0%	
Tx Frames	0	0	0	0	0	0	0	
Tx Bytes	0	0	0	0	0	0	0	
Max Tx Thru	0	0	0	0	0	0	0	
Avg Tx Thru	0	0	0	0	0	0	0	
Max Tx Util %	0%	0%	0%	0%	0%	0%	0%	
Avg Tx Util %	0%	0%	0%	0%	0%	0%	0%	
Time in DBU	0	0	0	0	0	0	0	
Discard Frame	0	0	0	0	0	0	0	
Aborts	0	0	0	0	0	0	0	
ESC = Menu    D = DLCI    -, + = Page    U = View Intervals								

**Figure 10-7. DBU Port Statistics (View by Interval)**

DBU PORT	ADTRAN TSUIQ+VIEW STATISTICS						LOCAL
U.34 DBU State --> IDLE		Interval Remaining				154	
	JAN 25	18:05	18:00	17:55	17:53	0:00	0:00
Rx Frames	0	0	0	0	0	0	0
Rx Bytes	0	0	0	0	0	0	0
Max Rx Thru	0	0	0	0	0	0	0
Avg Rx Thru	0	0	0	0	0	0	0
Max Rx Util %	0%	0%	0%	0%	0%	0%	0%
Avg Rx Util %	0%	0%	0%	0%	0%	0%	0%
Tx Frames	0	0	0	0	0	0	0
Tx Bytes	0	0	0	0	0	0	0
Max Tx Thru	0	0	0	0	0	0	0
Avg Tx Thru	0	0	0	0	0	0	0
Max Tx Util %	0%	0%	0%	0%	0%	0%	0%
Avg Tx Util %	0%	0%	0%	0%	0%	0%	0%
Time in DBU	0	0	0	0	0	0	0
Discard Frame	0	0	0	0	0	0	0
Aborts	0	0	0	0	0	0	0
ESC = Menu    -,+ = Page    >,< = Scroll    U = View By Day							

Figure 10-8. DBU Port Statistic (View by Day)

**PRI Channels**

DS0 Channel identifier (channels 1 through 24) - (PRI DBU only).  
See Table 10-2.

Table 10-2. PRI Channel Descriptions

This Channel	Signifies that...
<b>D</b>	the DS0 is the active D channel
<b>A</b>	there is an active call on the DS0
.	the DS0 is assigned to the PRI interface but there is no active call
—	the DS0 is unassigned to the Fractional PRI interface

**PRI State**

Current state of the PRI Circuit. Possible states are listed in Table 10-3.

**Table 10-3. Possible PRI States**

<b>PRI STATE</b>	<b>DESCRIPTION</b>
<b>OPEN LOOP</b>	No receive signal
<b>TEST FROM TELCO</b>	Loopback code received from telco or manual loopback
<b>AIS ALARM</b>	Unframed all ones received
<b>RED ALARM</b>	Loss of frame synchronization
<b>YELLOW ALARM</b>	Telco side loss of frame synchronization
<b>ESF NORMAL</b>	Normal condition for ESF link

**DS0 Status**

An **A** indicates the DS0 is being used to transfer data. A **D** indicates the D channel is up (PRI DBU only).

**DBU State**

Current state of the DBU circuit (**not used** with PRI DBU card).

**Interval Remaining**

Number of seconds remaining in the current timed interval (only shown on the **VIEW BY INTERVAL** screen).

**Rx Frames**

Number of frames received by the **DBU** port.

**Rx Bytes**

Number of bytes received by the **DBU** port.

**Maximum Rx Throughput**

Maximum throughput sample in the receive direction for the given interval. This is displayed in kbps.

**Average Rx Throughput**

Average throughput in the receive direction for the given interval. This is displayed in kbps.

**Maximum Rx Utilization**

Maximum utilization sample in the receive direction for the given interval. Utilization is displayed as a percent of **DBU** port bandwidth.

**Average Rx Utilization**

Average utilization sample in the receive direction for the given interval. Utilization is displayed as a percent of **DBU** port bandwidth.

**Tx Frames**

Number of frames transmitted by the **DBU** port.

**Tx Bytes**

Number of bytes transmitted by the **DBU** port.

**Maximum Tx Throughput**

Maximum throughput sample in the transmit direction for the given interval. This is displayed in kbps.

**Average Tx Throughput**

Average throughput in the transmit direction for the given interval. This is displayed in kbps.

**Maximum Tx Utilization**

Maximum utilization sample in the transmit direction for the given interval. Utilization is displayed as a percent of **DBU** port bandwidth.

**Average Tx Utilization**

Average utilization sample in the transmit direction for the given interval. Utilization is displayed as a percent of **DBU** port bandwidth.

**Time in DBU**

Time in seconds that the **DBU** port was in DBU mode.

**Discard Frame**

Number of frames discarded due to transmission errors, or link violations.

**Aborts**

Number of frames received without a closing flag. This transmission error is also reflected in the **DISCARD FRAME** field.

**CRC Error**

Number of frames received with CRC violations. This transmission error is also reflected in the **DISCARD FRAME** field.

**Octet Align**

Number of frames received with a bit count that does not fall on 8-bit boundaries. This transmission error is also reflected in the **DISCARD FRAME** field.

**T1 State Change**

Count of state changes for the T1 DBU port (applies to PRI DBU card only).

**T1 UA Time**

Time in seconds the T1 DBU link is down (applies to PRI DBU card only).

**NOTE**

*The next six parameters (**SIGNAL LOSS**, **TELCO TEST**, **AIS ALARM**, **RED ALARM**, **YELLOW ALARM**, and **PLL ALARM**) are events with two states: active and inactive. If the event occurs one or more times for the given interval, the field is active and **ALARM** is displayed. The first column of the **VIEW BY INTERVAL** menu represents information for the entire current day. Therefore, once an alarm becomes active, it remains active in the first field for the entire 24-hour period.*

**Signal Loss**

If **ALARM** is displayed, a loss of signal occurred one or more times during the given interval (applies to PRI DBU card only).

**Telco Test**

If **ALARM** is displayed, a loopback code was received on the T1 DBU interface one or more times during the given interval (applies to PRI DBU card only).

**AIS Alarm**

If **ALARM** is displayed, unframed all ones were received on the T1 DBU interface one or more times during the given interval. This indicates that the T1 is out of service (applies to PRI DBU card only).



**Red Alarm**

If **ALARM** is displayed, a loss of frame synchronization occurred one or more times during the given interval (applies to PRI DBU card only).

**Yellow Alarm**

If **ALARM** is displayed, the telco end of the T1 was out of frame sync one or more times during the given interval (applies to PRI DBU card only).

**PLL Alarm**

**ALARM** displayed in this field usually signifies that both ends of the T1 circuit are set to provide timing (applies to PRI DBU card only).

**Path Code**

Number of path code violations. Path code violations include frame bit errors for D4 framing and superframes with CRC errors for ESF framing (applies to PRI DBU card only).

**Line Code**

Number of line code violations. Line code violations include BPVs that are not part of B8ZS code or excess zero violations (applies to PRI DBU card only).

**Length Error**

Number of frames received with fewer than 5 octets or greater than 4500 octets. This link violation is also reflected in the **DISCARD FRAME** field.

# Call Manager

The **CALL MANAGER** statistics screen (shown and described in Figure 10-9) only applies to PRI dial backup configurations. The fields in this menu provide information regarding the 23 individual calls and PRI channels related to PRI dial backup (Table 10-4).

PRI channels and their corresponding status. See Table 10-4, below.

Local DLCI associated with the connection. An \* displayed to the right of the DLCI signifies that more than one DLCI is associated with the connection.

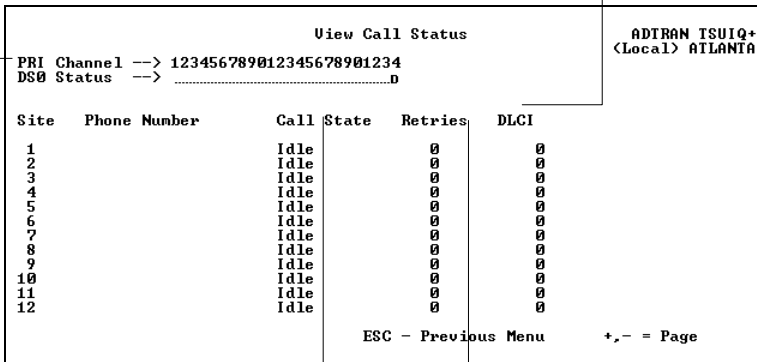

Phone number associated with a call on the site. On an incoming call, this field may display **CALLER UNKNOWN** if the switch does not provide caller identification.

Number of times the unit has attempted to establish a call.

**Figure 10-9. Call Manager Menu**

**Table 10-4. PRI Channels and Corresponding Status**

This Channel	Signifies that...
D	the DS0 is the active D channel
A	there is an active call on the DS0
.	the DS0 is assigned to the PRI interface but there is no active call
_	the DS0 is unassigned to the fractional PRI interface

## DLCI Statistics

Access specific DLCI statistics by pressing **D** from the **NETWORK** or **LAYER 3 STATISTICS** menu. Enter the DLCI number for information on a specific DLCI (displayed in the **VIEW BY INTERVAL** and **DAY** formats). For a status summary of all available DLCIs, select **DLCI LIST** from the **VIEW STATISTICS** menu (see the section *DLCI List* on page 10-31).

### DLCI Statistics for a Specific DLCI

**Throughput (Tx and Rx)**

Displays the current throughput sample for this PVC.

**Utilization**

Displays the current CIR utilization sample for this PVC.

**Remaining**

Number of seconds remaining in the current timed interval (only shown in the **VIEW BY INTERVAL** screen)

**Rx Frames**

Number of frames received by the network port on the specified DLCI.

**Rx Bytes**

Number of bytes received by the network port on the specified DLCI.

**Maximum Rx Throughput**

Maximum throughput sample in the receive direction for the given interval. This is displayed in kbps.

**Average Rx Throughput**

Average throughput in the receive direction for the given interval. This is displayed in kbps.

**Maximum Rx Utilization**

Maximum utilization sample in the receive direction for the given interval. Utilization is displayed as a percentage of CIR.

**Average Rx Utilization**

Average utilization in the receive direction for the given interval. Utilization is displayed as a percentage of CIR.

**Tx Frames**

Number of frames transmitted by the network port on the specified DLCI.

**Tx Bytes**

Number of bytes transmitted by the network port on the specified DLCI.

**Maximum Tx Throughput**

Maximum throughput sample in the transmit direction for the given interval. This is displayed in kbps.

**Average Tx Throughput**

Average throughput in the transmit direction for the given interval. This is displayed in kbps.

**Maximum Tx Utilization**

Maximum utilization sample in the transmit direction for the given interval. Utilization is displayed as a percentage of CIR.

**Average Tx Utilization**

Average utilization sample in the transmit direction for the given interval. Utilization is displayed as a percentage of CIR.

**Time in DBU**

Time (in seconds) that the specified DLCI is in DBU mode.

**PVC IA Time**

Time in seconds that the PVC is in the inactive state.

**Rx FECN**

Number of frames received on the network port over the specified DLCI with the FECN bit of the frame relay header enabled.

**Tx FECN**

Number of frames transmitted from the network port over the specified DLCI with the FECN bit of the frame relay header enabled.

**Rx BECN**

Number of frames received on the network port over the specified DLCI with the BECN bit of the frame relay header enabled.

**Tx BECN**

Number of frames transmitted from the network port over the specified DLCI with the BECN bit of the frame relay header enabled.

**Rx DE**

Number of frames received on the network port over the specified DLCI with the discard eligibility (DE) bit of the frame relay header enabled.

**Tx DE**

Number of frames transmitted from the network port over the specified DLCI with the DE bit of the frame relay header enabled.

**Rx CR**

Number of frames received on the network port over the specified DLCI with the CR bit of the frame relay header enabled.

**Tx CR**

Number of frames transmitted from the network port over the specified DLCI with the CR bit of the frame relay header enabled.

**Lost Frames**

Number of frames lost across the PVC. This field is applicable only if the network port's **SEQUENCE NUMBER CHECKING** option is **ENABLED**. See the section *Seq Num Checking (SEQ #)* on page 7-7.

**Remote Lost Frames**

Number of lost frames reported by the remote TSU IQ+. This field is applicable only if the network port's **SEQUENCE NUMBER CHECKING** option is **ENABLED**. See the section *Seq Num Checking (SEQ #)* on page 7-7.

**Rx Burst Seconds**

Amount of time (in seconds) that throughput in the receive direction is greater than CIR.

**Tx Burst Seconds**

Amount of time (in seconds) that throughput in the transmit direction is greater than CIR.

**Minimum Rx Frame**

Size of smallest frame received across the DLCI.

**Maximum Rx Frame**

Size of largest frame received across the DLCI.

**Average Rx Frame**

Average size of frames received across the DLCI.

**Minimum Tx Frame**

Size of smallest frame transmitted across the DLCI.

**Maximum Tx Frame**

Size of largest frame transmitted across the DLCI.

**Average Tx Frame**

Average size of frames transmitted across the DLCI.

**Minimum Frame Delay**

Minimum round trip delay of the DLCI. This field is applicable only if the network port's **PVC DELAY MEASUREMENT** option is **ENABLED**. See the section *Delay Measurement (PVC DELAY)* on page 7-8.

**Maximum Frame Delay**

Maximum round trip delay of the DLCI. This field is applicable only if the network port's **PVC DELAY MEASUREMENT** option is **ENABLED**. See the section *Delay Measurement (PVC DELAY)* on page 7-8.

**Average Frame Delay**

Average round trip delay of the DLCI. This field is applicable only if the network port's **PVC DELAY MEASUREMENT** option is **ENABLED**. See the section *Delay Measurement (PVC DELAY)* on page 7-8.

**PVC State Change**

Number of changes in the PVC state.

## DLCI List

For a status summary of all available DLCIs, select **DLCI LIST** from the main **VIEW STATISTICS** menu. This screen lists all available DLCIs and classifies them as active (A), inactive (I), or unknown (U). See Figure 10-10. A byte and frame break out of each DLCI is also provided, including an in/out count and a count of how many frames were received with FECN, BECN, or DE enabled.

Previous Days	View Statistics				ADIRAN TSUIQ+ (Local) ATLANTA			
DLCI 100 A	Throughput: Tx	0	Rx	0				
	Utilization: CIR not specified							
	NA	NA	NA	NA	NA	NA	NA	NA
Rx Frames	0	0	0	0	0	0	0	0
Rx Bytes	0	0	0	0	0	0	0	0
Max Rx Thru	0	0	0	0	0	0	0	0
Avg Rx Thru	0	0	0	0	0	0	0	0
Max Rx Util %	0%	0%	0%	0%	0%	0%	0%	0%
Avg Rx Util %	0%	0%	0%	0%	0%	0%	0%	0%
Ix Frames	0	0	0	0	0	0	0	0
Ix Bytes	0	0	0	0	0	0	0	0
Max Ix Thru	0	0	0	0	0	0	0	0
Avg Ix Thru	0	0	0	0	0	0	0	0
Max Ix Util %	0%	0%	0%	0%	0%	0%	0%	0%
Avg Ix Util %	0%	0%	0%	0%	0%	0%	0%	0%
Time in DBU	0	0	0	0	0	0	0	0
PUC IA Time	0	0	0	0	0	0	0	0
Rx FECN	0	0	0	0	0	0	0	0
	ESC = Menu		-, + = Page		U = View Intervals			

Figure 10-10. DLCI Statistics Summary for All DLCIs

## System Statistics

The system time and date (as set in the **SYSTEM CONFIGURATION** menu) and the software revision are displayed in this menu. Also, the elapsed time since the unit was turned on (or since the last restart) is given in seconds. The buffer information provided in this menu is used mainly by ADTRAN technical support in troubleshooting situations. See Figure 10-11.

View System Statistics				ADTRAN TSUIQ+ (Local) ATLANTA	
Buf Type	Curr Use	Curr Free	Curr Use Per	High Buf Use	Avg Buf Use
1	45	209	17	48	45
2	0	5	0	3	0
3	0	20	0	1	0
4	0	200	0	1	0
5	0	88	0	0	0

System Time	---->	02:21
System Date	---->	FRI 05-07-99
Elapsed Time	---->	4443
Layer 3 Overruns	---->	0
S/W Revision	---->	1215

ESC - Stats Menu

Figure 10-11. System Statistics Screen



## VIEWING STATISTICAL INFORMATION (FRONT PANEL INTERFACE)

Select **STATS** from the **MAIN** menu. From this menu, select **DTE**, **NETWORK**, **DSX**, **DBU**, **DLCI**, or **SYSTEM** statistics or reset the statistics. Scroll through the screens using the arrow keys. The number displayed in the upper right-hand corner of the screen indicates which port the displayed information applies to (1= DTE, Network; D= DBU). Statistic counts are running totals for the current day (i.e., since 12 a.m.).

### DTE Port Statistics Available on Front Panel

The following information is displayed when **DTE** port is selected.

#### Control Signal Status Screen

An asterisk (\*) indicates that the signal is active for the DTE port. See Figure 10-12.

<b>RS</b>	request to send
<b>TR</b>	data terminal ready
<b>CS</b>	clear to send
<b>CD</b>	carrier detect
<b>SR</b>	data set ready

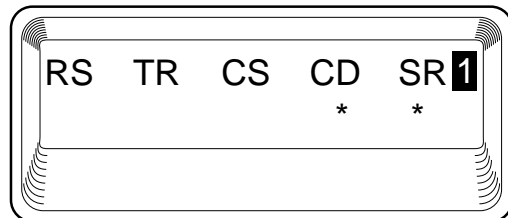
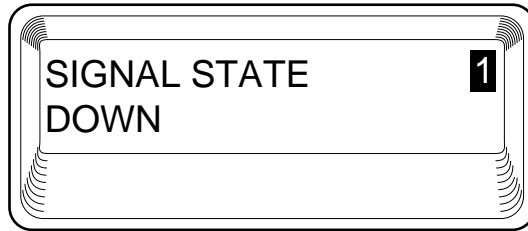

Figure 10-12. Control Signal Status Screen

**Signal State**

Current signaling state of DTE port (up or down). See Figure 10-13.



**Figure 10-13. Signal State Screen**

**Signal State Change**

Number of changes in the signaling protocol state.

**Signal Timeouts**

Total T392 timeouts that have occurred since the last reset.

**Signal Errors**

Total signal frames received with PVC signaling protocol violations.

**Errored Frames**

Total errored frames received since last reset.

**CRC Errors**

Number of frames received with CRC violations.

**Abort Frames**

Total frames received without a closing flag.

**Octet Align**

Number of frames received with a bit count that does not fall on 8-bit boundaries.

**Signal Down Time**

Time in seconds that signaling state has been down.

## Network Port Statistics Available on Front Panel

**TSU Loop State**

Current state of the incoming T1 circuit.

**PRI Loop State**

Current state of the PRI circuit (PRI only).

**DBU Status**

Current state of the incoming DBU circuit.

**Signal State**

Current state of the **Network** port (up or down).

**Signal State Change**

Number of changes in the signaling protocol state.

**Signal Timeouts**

Total T391 timeouts that have occurred since the last reset.

**Signal Errors**

Total signal frames received with PVC signaling protocol violations.

**Frames In**

Total received frames since last reset.

**Frames Out**

Total transmitted frames since last reset.

**Errored Frames**

Total errored frames received since last reset.

**CRC Errors**

Number of frames received with HDLC CRC violations.

**Abort Frames**

Total frames received without a closing flag.

**Octet Align**

Number of frames received with a bit count that does not fall on 8-bit boundaries.

**Port UA Time**

Time in seconds the network port is unavailable for data delivery. This can mean that the T1 link is down or in test, or that the PVC signaling state is down.

**Line Code**

Number of line code violations. Line code violations include BPVs that are not part of B8ZS code or excess zero violations.

**Path Code**

Number of path code violations. Path code violations include frame bit errors for D4 framing and superframes with CRC errors for ESF framing.

## **DSX-1 Port Statistics Available on Front Panel**

**TSU Loop State**

Current state of the incoming T1 circuit.

**Line Code**

Number of line code violations. Line code violations include BPVs that are not part of B8ZS code or excess zero violations.

**Path Code**

Number of path code violations. Path code violations include frame bit errors for D4 framing and superframes with CRC errors for ESF framing.

## **DBU Port Statistics Available on Front Panel**

**PRI Loop State**

Current state of the PRI circuit.

**D Channel State**

Current state of the PRI D channel (PRI only).

**DBU Status**

Current state of the DBU circuit (not available for PRI card). For PRI status, see *Call Manager* on page 10-26.

**Time in DBU**

The amount of time (in seconds) that the unit has been in dial backup mode.

**Frames In**

Total received frames since the unit went into dial backup mode (or since last reset).

**Frames Out**

Total transmitted frames since the unit went into dial backup mode (or since last reset).

**Errored Frames**

Total errored frames received since the unit went into dial backup mode (or since last reset).

**CRC Errors**

Number of frames received on the dial backup circuit with CRC violations.

**Abort Frames**

Total frames received on the dial backup circuit without a closing flag.

**Octet Align**

Number of frames received on the dial backup circuit with a bit count that does not fall on 8-bit boundaries.

## System Statistics Available on Front Panel

Select **SYS** from the **STATS** menu to display the software version and checksum. This screen is shown in Figure 10-14. Press **Cancel** to return to the **STATS** menu.

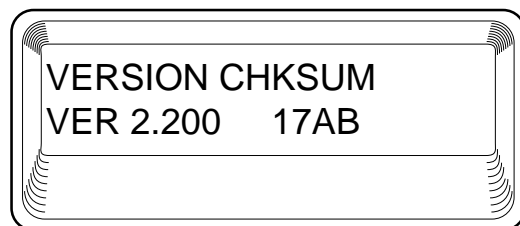

**Figure 10-14. System Statistics Screen**



## Chapter 11 Testing

---

This menu allows you to perform diagnostics by initiating ping tests (if the ethernet card is installed), PVC loopback tests, or DSX loopback tests. See Figure 11-1 for the terminal **TEST** menu. See Figure 11-2 on page 11-2 for the front panel menu tree.

Test Menu	ADTRAN TSU IQ+ Local
<b>1 - PING</b> <b>2 - PVC LOOPBACK</b> <b>3 - DSX LOOPBACK</b>	
<b>ENTER SELECTION -&gt; _</b>	

**Figure 11-1. Terminal Test Menu (with Ethernet Card Installed)**

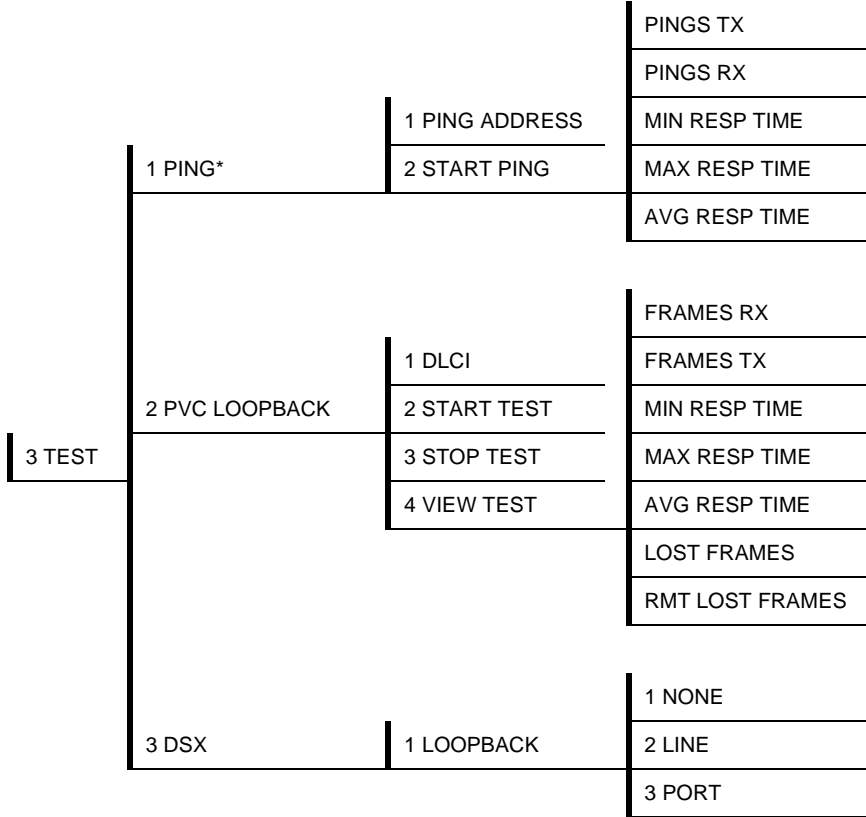

\*with Ethernet Card Installed

**Figure 11-2. Front Panel Test Menu**

**NOTE** *In this chapter, the terminal selections are listed first followed by the front panel selections in parentheses (if the names differ).*



## Ping

Select **PING** to send a ping request to a specific address. This option is available only with ethernet card installed.

### Address to Ping (PING ADDRESS)

Enter the IP address of the unit the TSU IQ+ is sending an echo request (ping) to.

### Start Ping

Results are shown once you start the ping. The **START PING** command causes the TSU IQ+ to send ten ping requests to the target station. At the end of the ten-ping test, the following results are shown:

#### **Pings Transmitted (PINGS TX)**

This field shows the number of pings sent (always 10).

#### **Ping Responses (PINGS RX)**

This field shows the number of responses received from the pinged device.

#### **Min Response Time (MIN RESP TIME)**

This field shows the shortest round-trip delay (in ms) of the received responses. Round-trip delay is counted from the time the ping is sent until the response is received.

#### **Max Response Time (MAX RESP TIME)**

This field shows the longest round-trip delay (in ms) of the received responses. If a response is not received before the unit times out, the delay is not calculated in.

#### **Avg Response Time (AVG RESP TIME)**

This field shows the average response time (in ms) based on all received responses.

## PVC Loopback

A **PVC LOOPBACK** test is a non-intrusive loopback option for each PVC. During this test, the TSU IQ+ periodically sends test frames to the remote TSU IQ+ which are then returned for analysis. The bandwidth required is approximately 1 kbps for each PVC in test. See Figure 11-3 for the terminal menu.

```

                                PVC LOOPBACK                                ADTRAN TSUIQ+
                                                                LOCAL
-----
1 - DLCI <0=ALL> 0
2 - TEST LEN : MIN <0=UNTIMED> 0
3 - START TEST
4 - STOP TEST
5 - VIEW TEST
6 - RESET TEST STATS
7 - VIEW DLCI LIST

ENTER SELECTION ->

```

Figure 11-3. PVC Loopback Menu

### DLCI <0 = All> (DLCI)

Enter the DLCI of the PVC to be tested (or enter 0 to test all available PVCs). Range is **0** to **1007**.

### Test Length

Amount of time (in minutes) that you want the test to take place. Enter 0 for a continuous test. This option is not available on the front panel. Range is **0** to **1440**.

### Start Test

Starts the test.

---

## Stop Test

Ends the test in progress prematurely or terminates a continuous test.

## View Test

Displays the **TEST STATISTICS** menu shown in Figure 11-4 on page 11-6. Descriptions of each field in the **TEST STATISTICS** menu follow.

### **PVC Active/Inactive/Undefined**

Displays current state of the selected PVC as determined by the switch.

- **Active:** The PVC is currently operational.
- **Inactive:** There is currently a physical or frame relay layer problem at the remote end of the PVC, or a problem exists inside the frame relay cloud for the selected PVC.
- **Undefined:** The PVC is undefined for the switch.

### **Test Active/No Test Active**

Displays current testing state of the TSU IQ+.

### **Frames Rx**

Number of frames received on the selected PVC during the current loopback test.

### **Frames Tx**

Number of frames transmitted across the selected PVC during the current loopback test.

### **Lost Frames**

Number of frames lost in the receiving direction (traveling from the remote TSU IQ+ to the local TSU IQ+).

### **Remote Lost Frames (RMT LOST FRAMES)**

Number of frames lost in the transmitting direction (traveling from the local TSU IQ+ to the remote TSU IQ+).

### **Minimum Loop Response Time (MIN RESP TIME)**

Minimum round-trip time (in seconds) for the current test.

### **Maximum Loop Response Time (MAX RESP TIME)**

Maximum round-trip time (in seconds) for the current test.

**Average Loop Response Time (AVG RESP TIME)**  
Average round-trip time (in seconds) for the current test.

```

                                VIEW TEST RESULTS                                ADTRAN TSU IQ+
                                -----                                LOCAL
1 - DLCI <0=ALL> 100
PVC ACTIVE
NO TEST ACTIVE
FRAMES RX----->          0          FRAMES TX----->          0
LOST FRAMES----->        0          RMT LOST FRAMES----->    0
MIN LOOP RSP TIME->        0          MAX LOOP RSP TIME->      0
AVG LOOP RSP TIME->
ENTER SELECTION -> _

```

Figure 11-4. Test Status Screen

### Reset Test Stats

Resets the information shown in the **TEST STATISTICS** menu. This selection is not available on the front panel.

### View DLCI List

See the section *DLCI List* on page 10-31 for a description of this menu. This selection is not available on the front panel.

## DSX Loopback

A **DSX LOOPBACK** test allows the user to initiate a loopback test at the **DSX-1** interface.

### None

Select **NONE** to stop a test in progress.

### Line

Select **LINE** to execute a line loopback test at the **DSX-1** port. During this test, data loops back toward the terminal equipment (usually a PBX) connected to the **DSX-1** port.

### Port

Select **PORT** to execute a port loopback test at the **DSX-1** port. During this test, data loops back toward the network interface.



# Chapter 12 Activating Dialing Functions

---

## DIALING OPTIONS

The dial options available from the main menu (**4=DIAL**) for the **DIAL OPTIONS** menu (non-PRI) appear in Figure 12-1. These selections are available only if a DBU card is installed.

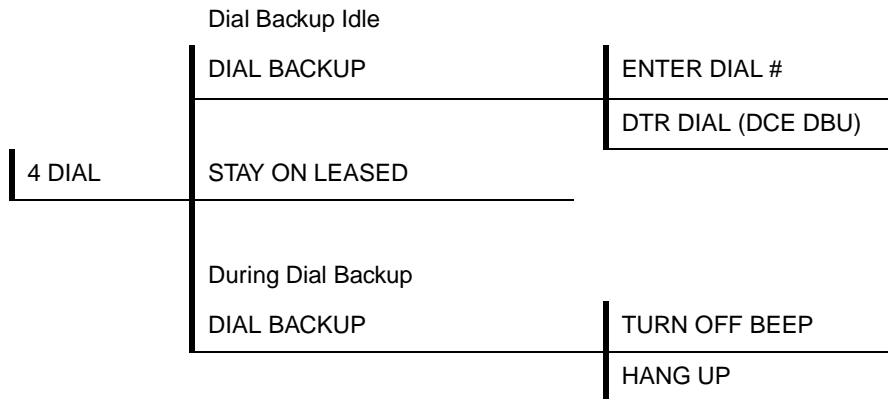

**Figure 12-1. Dial Options Menu (non-PRI DBU)**

The Dial Options menu with the PRI DBU is shown in Figure 12-2 on page 12-2.

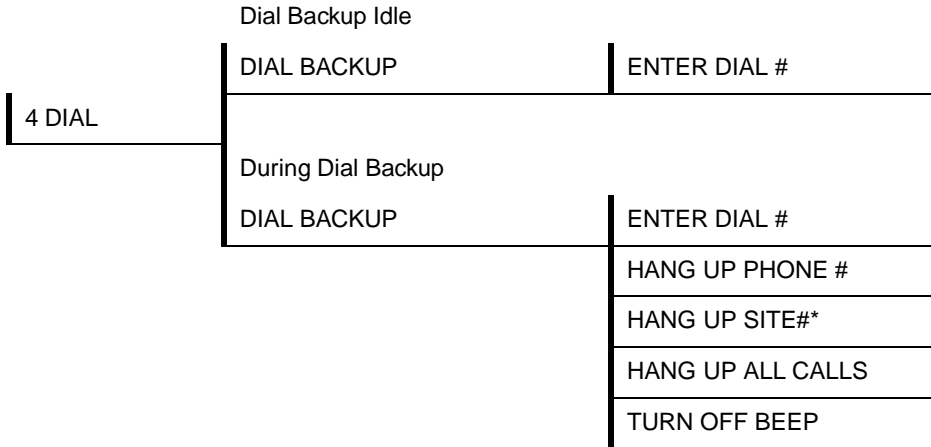

\*This can be obtained from View Statistics Call Manager screen (VT 100 only).

**Figure 12-2. Dial Options Menu (PRI DBU)**

## Dial Options when Dial Backup is Idle

### Dial Backup

The TSU IQ+ prompts you to enter a number to dial for dial backup.

### Stay on Leased

The TSU IQ+ remains on the leased line and does not enter dial backup mode. This does not apply to the PRI card.



## Dial Options During Dial Backup

### Dial Backup

The TSU IQ+ prompts you to enter a number to dial for dial backup, or to hang up an existing call. The PRI card selections allow you to choose to hang up a single phone number, an individual site, or all calls at once.

In all cases, once **HANG UP** is selected, the dial backup connection is terminated and the unit attempts to reestablish communication on the T1 line.



## Appendix A Pinouts

---

The following tables give the pin assignments for the TSU IQ+ and card connectors. For more information on these connectors, see the section *Rear Panel* on page 2-2.

**Table A-1. Pin Assignments for Network Connector**

Pin	Name	Description
1	R1 RXDATA-RING	Receive data from the network
2	T1 RXDATA-TIP	Receive data from the network
3	UNUSED	--
4	R TXDATA-RING	Send data toward network
5	T TXDATA-TIP	Send data toward network
6,7,8	UNUSED	--

**Table A-2. Pin Assignments for DSX-1 Connector**

Pin	Name	Description
1	R1 RXDATA-RING	Receive data from the DTE (PBX)
2	T1 RXDATA-TIP	Receive data from the DTE (PBX)
3	UNUSED	--
4	R TXDATA-RING	Send data toward DTE (PBX)
5	T TXDATA-TIP	Send data toward DTE (PBX)
6,7,8	UNUSED	--

**Table A-3. Pin Assignments for Control Connector**

RJ Pin#	Function	Direction
1	GND	
2	RTS	I
3	TD	I
4	DSR	O
5	RD	O
6	CTS*	O
7	DTR	I
8	DCD	O
* Used for hardware flow control.		

**Table A-4. Pin Assignments for 10BaseT Connector  
(Ethernet Card)**

Pin	Name	Description
1	TD+	The positive signal for the TD differential pair. This signal contains the serial output data stream transmitted onto the network.
2	TD-	The negative signal for the TD differential pair (pins 1 and 2).
3	RD+	The positive signal for the RD differential pair. This signal contains the serial input data stream received from the network.
4, 5	N/A	not used
6	RD-	The negative signal for the RD differential pair (pins 3 and 6).
7, 8	N/A	not used

**Table A-5. Pin Assignment for V.35 Connector**

<b>Pin</b>	<b>CCITT</b>	<b>Description</b>
A	101	Protective ground (PG)
B	102	Signal Ground (SG)
C	105	Request to Send (TRS)
D	106	Clear to Send (CTS)
E	107	Data Set Ready
F	109	Received Line Signal Detector (CD)
H	-	Data Terminal Ready (DTR)
J	-	Ring Indicator (RI)
L	-	Local Loopback (LL)
N	-	Remote Loopback (RL)
R	104	Received Data (RD-A)
T	104	Received Data (RD-B)
V	115	Receiver Signal Element Timing (SCR-A)
X	115	Receiver Signal Element Timing (SCR-B)
P	103	Transmitted Data (SD-A)
S	103	Transmitted Data (SD-B)
Y	114	Transmitter Signal Element Timing (SCT-A)
AA	114	Transmitter Signal Element Timing (SCT-B)
U	113	External TX Signal Element (SCX-A)
W	113	External TX Signal Element (SCX-B)
NN	-	Test Indicator (TI)

**Table A-6. 4-Wire, V.34, and BRI ISDN DBU Card  
Pin Assignments**

Pin	Name	Description
<b>4-wire Switched 56</b>		
1	R1	Transmit Data from DSU to Network-Ring 1
2	T1	Transmit Data from DSU to Network-Tip 1
3-6	-	Not Used
7	T	Receive Data from Network to DSU-Tip
8	R	Receive Data from Network to DSU-Ring
<b>V.34 and 1 B+D ISDN</b>		
1-3	-	Not Used
4	T	Network-Tip
5	R	Network-Ring
6-8	-	Not Used

**Table A-7. Pin Assignments for the PRI DBU Card**

Pin	Name	Description
1	R1 RXDATA-RING	Receive data from the network
2	T1 RXDATA-TIP	Receive data from the network
3	UNUSED	--
4	R TXDATA-RING	Send data toward network
5	T TXDATA-TIP	Send data toward network
6,7,8	UNUSED	--

**Table A-8. DTE/DCE Connector Pin Assignments  
(DCE Card Option)**

DB25 Pin#	V.35 Pin#	Function	DTE Port Direction	DCE Port Direction
1	A	FGND		
2		TD(EIA-232)	I	O
3		RD(EIA-232)	O	I
4	C	RTS	I	O
5	D	CTS	O	I
6	E	DSR	O	I
7	B	GND		
8	F	DCD	O	I
9		NEG		
10		POS		
11	AA	TC-B(V.35)	O	I
12	Y	TC-A(V.35)	O	I
13	V	RC-A(V.35)	O	I
14	T	RC-B(V.35)	O	I
15		TC(EIA-232)	O	I
16	R	RD-A(V.35)	O	I
17		RC		
18	S	TD-B(V.35)	I	O
19	P	TD-A(V.35)	I	O
20	H	DTR	I	O
21	W	ETC-B(V.35)	I	O
22	-	-	-	-
23	U	ETC-A(V.35)	I	O
24		ETC(EIA-232)	I	O
25	X	RC-B(V.35)	O	I





# Appendix B Specifications Summary

---

## SPECIFICATIONS AND FEATURES

This appendix provides the standard specifications and features of the TSU IQ+.

### Operating Modes

T1/FT1 frame relay

### Line Interfaces

- RJ-48C, 4-wire
- Time derived from frame relay network, from the internal oscillator, from the DTE, or from the DSX
- Framing: SF/ESF with auto detection
- ESF Format: AT&T 54016, ANSI T1.403
- Line Coding: AMI/B8ZS
- Input signal: 0 to -36 dB
- Programmable DS0 assignment

### DTE Interfaces

- V.35: V.35 Winchester: M block female
- 56k or 64k synchronous DTE rates: 56 to 1.536, Nx56, or Nx64 kbps (N=1 to 24)
- Control- EIA-232, 8-pin modular connector (DB-25 adapter provided)

### **DSX**

- RJ-48C, 4-wire
- Framing: SF/ESF with auto detection
- ESF Format: AT&T 54016, ANSI T1.403
- Line Coding: AMI/B8ZS
- Input signal: 0 to -7.5 dB
- Programmable DS0 assignment

### **DBU Interfaces**

- 4-Wire SW56 DBU Card: RJ-48S
- V.34 and ISDN DBU Cards (BRI and PRI): RJ-11
- PRI DBU Card: RJ-48C

### **DCE Card**

- EIA-232: DB-25 female DTE emulation
- V.35: V.35 Winchester male or female via optional adapter cable (part numbers: male 1200193L1; female 1200194L1).

### **Diagnostics**

- PVC and DSX loopbacks
- Ping tests

### **SNMP**

- Embedded SNMP and TELNET in-band access through shared or dedicated PVC
- Integrated SLIP/PPP (async) port
- Optional 10BaseT interface
- RFC 1213 MIB II, RFC 1315 and 1406 compliant
- ADTRAN enterprise MIB for frame monitoring and TSU control

**Agency Approvals**

- FCC Part 15, Class A
- FCC Part 68
- Industry Canada CS03
- UL and CUL

**Relevant Protocol Standards**

- Frame Relay
  - ANSI T1.606
  - ANSI T1.607
  - ANSI T1.617
  - ANSI T1.618
  - ITU Q.922
  - ITU Q.933
  - Frame Relay Forum FRF 1.1 and 3.1
  - RFC 1490
- SLIP
  - RFC 1055
- SNMP MIB
  - RFC 1315
  - RFC 1213
  - RFC 1406

**Physical**

- Operating temperature: 0 to 50 °C (32 to 122 °F)
- Storage: -20 to 70 °C (-4 to 158 °F)
- Relative humidity: Up to 95%, non-condensing
- Dimensions: 2.4-inch H, 8.0-inch W, 10.4-inch D
- Weight: 4.5 lbs
- Power: 115 VAC, 60 Hz, 7 W



## Appendix C Acronyms and Abbreviations

---

<b>ACK</b> .....	acknowledgment
<b>AIS</b> .....	alarm indication signal
<b>ALM</b> .....	alarm
<b>ANSI</b> .....	American National Standards Institute
<b>AR</b> .....	access rate
<b>ARP</b> .....	address resolution protocol
<b>ASCII</b> .....	American National Standards Code for Information Interchange
<b>async</b> .....	asynchronous
<b>BECN</b> .....	backward explicit congestion notification
<b>BES</b> .....	bursty errored seconds
<b>BOP</b> .....	bit oriented protocol
<b>bps</b> .....	bits per second
<b>BPV</b> .....	bipolar violation
<b>CCITT</b> .....	Consultive Committee for International Telephony and Telegraphy
<b>CD</b> .....	carrier detect
<b>CIR</b> .....	committed information rate
<b>CO</b> .....	central office
<b>CPE</b> .....	customer premise equipment
<b>CR, C/R</b> .....	command response
<b>CRC</b> .....	cyclic redundancy check
<b>CS</b> .....	clear to send

<b>CSU</b> .....	channel service unit
<b>CTS</b> .....	clear to send
<b>CV</b> .....	code violation
<b>dB</b> .....	decibel
<b>DBU</b> .....	dial backup
<b>DCD</b> .....	data carrier detect
<b>DCE</b> .....	data communications equipment
<b>DDS</b> .....	digital data service
<b>DE</b> .....	discard eligible
<b>DLCI</b> .....	data link connection identifier
<b>DS0</b> .....	digital signal level zero
<b>DSAP</b> .....	destination service access point
<b>DSR</b> .....	data set ready
<b>DSU</b> .....	data service unit
<b>DSX</b> .....	digital signal cross connect, level 1
<b>DTE</b> .....	data terminal equipment
<b>DTR</b> .....	data terminal ready
<b>EA</b> .....	extended address
<b>EBCDIC</b> .....	extended binary coded decimal interexchange code
<b>EER</b> .....	excess error rate
<b>ESF</b> .....	extended superframe
<b>FCS</b> .....	frame check sequence
<b>FDL</b> .....	facility data link
<b>FECN</b> .....	forward explicit congestion notification
<b>FEP</b> .....	front end processor
<b>FIFO</b> .....	first in first out
<b>FR</b> .....	frame relay
<b>FRAD</b> .....	frame relay access device
<b>FRF</b> .....	frame relay forum

<b>FSU</b> .....	frame relay service unit
<b>FT1</b> .....	fractional T1
<b>GUI</b> .....	graphical user interface
<b>HDLC</b> .....	high-speed data link control
<b>IA</b> .....	inactive
<b>IP</b> .....	internet protocol
<b>ISDN</b> .....	integrated services digital network
<b>ITU</b> .....	International Telecommunications Union
<b>IXC</b> .....	interexchange carrier
<b>KA</b> .....	keep alive
<b>kbps</b> .....	kilobits per second
<b>LAN</b> .....	local area network
<b>LBO</b> .....	line buildout
<b>LEC</b> .....	local exchange carrier
<b>LED</b> .....	light emitting diode
<b>LI</b> .....	link integrity
<b>LLC</b> .....	logical link control
<b>LOS</b> .....	loss of signal
<b>LMI</b> .....	local management interface
<b>LRC</b> .....	lateral redundancy check
<b>MIB</b> .....	management information base
<b>ms</b> .....	millisecond
<b>NI</b> .....	network interface
<b>OCU</b> .....	office channel unit
<b>OOS</b> .....	out of service
<b>POP</b> .....	point-of-presence
<b>PPP</b> .....	point-to-point protocol
<b>PRM</b> .....	performance report message
<b>PRI</b> .....	Primary Rate ISDN

<b>PU</b> .....	physical unit
<b>PVC</b> .....	permanent virtual circuit
<b>RD</b> .....	receive data
<b>RDL</b> .....	remote digital loopback
<b>RFC</b> .....	request for comments
<b>RFECN</b> .....	remote forward explicit congestion notification
<b>RIP</b> .....	routing information protocol
<b>RMA</b> .....	return material authorization
<b>RNR</b> .....	receiver not ready
<b>RR</b> .....	receiver ready
<b>RS</b> .....	request to send; also recommended standard
<b>RTS</b> .....	request to send
<b>Rx</b> .....	receive
<b>SAP</b> .....	service access point
<b>SDLC</b> .....	synchronous data link control
<b>SES</b> .....	severely errored seconds
<b>SF</b> .....	superframe
<b>SLIP</b> .....	serial line internet protocol
<b>SNA</b> .....	systems network architecture
<b>SNMP</b> .....	simple network management protocol
<b>SR</b> .....	data set ready
<b>SVC</b> .....	switched virtual circuit
<b>SW56</b> .....	switched 56
<b>sync</b> .....	synchronous
<b>TD</b> .....	transmit data
<b>telco</b> .....	telephone company
<b>TR</b> .....	data terminal ready
<b>Tx</b> .....	transmit
<b>UA</b> .....	unavailable



<b>UAS</b> .....	unavailable seconds
<b>UNI</b> .....	user-to-network interface
<b>VRC</b> .....	vertical redundancy check
<b>WAN</b> .....	wide area network



## Appendix D Glossary

---

### ***AIS***

alarm indication signal. A signal transmitted instead of the normal signal to maintain continuity of transmission. The AIS indicates to the far end the existence and direction of the transmission fault on the line.

### ***ANSI***

American National Standards Institute. Devices and proposes recommendations for international communications standards.

### ***ASCII***

American National Standard Code for Information Interchange. The standard and predominant 7-bit (8-bit with parity) character code used for data communications and data processing.

### ***asynchronous***

A method of data transmission which allows characters to be sent at irregular intervals by preceding each character with a start bit, followed by a stop bit.

### ***attenuation***

The loss of signal amplitude during transmission. The received signal is lower in signal amplitude than the transmitted signal due to losses in the transmission medium (resistance in the cable). Attenuation is measured in decibels.

### ***B8ZS***

A method of ensuring the ones density requirements in the data flow (12.5% must be ones) are met by replacing eight zero bits with a code containing intentional bipolar violations (BPVs).

***bandwidth***

The bandwidth determines the rate at which information can be sent through a channel (the greater the bandwidth, the more information that can be sent in a given amount of time).

***BECN***

backward explicit congestion notification. A bit set by a frame relay network to notify an interface device (DTE) that congestion avoidance procedures should be initiated by the sending device.

***BES***

bursty errored second. A second in which between 2 and 319 CVs (code violations) occurred.

***bipolar***

The predominant signalling method used for digital transmission services, such as DDS and T1. In this method, the signal carrying the binary value successively alternates between positive and negative. Zero and one values are presented by the signal amplitude at either polarity (no-value spaces are at zero amplitude).

***bipolar violation***

See BPV.

***bit***

A binary digit. A signal, wave, or state is represented as either a binary 0 or 1.

***bits per second (bps)***

The number of bits passing a specific point per second. Examples of common rates are:

A Kilobit is one thousand bits per second (kbps)

A Megabit is one million bits per second (Mbps)

T1 operates at 1.544 Mbps per second.

***BPV***

bipolar violation. A violation in the alternate mark inversion line code for which consecutive 1s are represented by pulses of opposite polarity. Bipolar violations that are not intentional (B8ZS) are counted as errors. Could also be the presence of two consecutive 1 bits of the same polarity on the T-carrier line.

**bridge**

A device that supports LAN-to-LAN communications. Bridges may be equipped to provide frame relay support to the LAN devices they serve. A frame relay capable bridge encapsulates LAN frames in frame relay frames and feeds them to a frame relay switch for transmission across the network. A frame relay capable bridge also receives frame relay frames from the network, strips the frame relay frame off each LAN frame, and passes the LAN frame on to the end device. Bridges are generally used to connect LAN segments to other LAN segments or to a WAN. They route traffic on the level 2 LAN protocol (e.g., the Media Access Control address), which occupies the lower sub-layer of the LAN OSI data link layer. See also router.

**bursty errored second**

See BES.

**byte**

Generally, an 8-bit quantity of information, used mainly in referring to parallel data transfer, semiconductor capacity, and data storage. Also, it is generally referred to in data communications as an octet or character.

**carrier**

The provider of the T1 service to the customer site. Carriers can be local telephone companies, regional telephone companies or any inter-exchange carrier such as AT&T, Sprint, or MCI.

**CD**

carrier detect. A signal generated by a modem or DSU/CSU. CD indicates the presence of a carrier signal on a communications link.

**channel bank**

Equipment in a telephone central office or customer premises that performs multiplexing of lower speed digital channels into a higher speed composite channel. The channel bank also detects and transmits signalling information for each channel, thereby transmitting framing information so that time slots allocated to each channel can be identified by the receiver.

**CIR**

committed information rate. Less than or equal to the access rate, the CIR is used by the service provider for rate enforcement when the network is congested. When rates exceed the CIR, frames may be discarded.

***clocking***

An oscillator-generated signal that provides a timing reference for a transmission link. A clock provides signals used in a transmission system to control the timing of certain functions. The clock has two functions: (1) to generate periodic signals for synchronization and (2) to provide a time base.

***code violation***

See CV.

***control port***

The electrical interface between the TSU IQ+ unit and a control terminal. The control terminal is used to communicate commands to the unit.

***CPE***

customer premise equipment. All telecommunications terminal equipment located on the customer premises, including telephone sets, private branch exchanges (PBXs), data terminals, and customer-owned coin-operated telephones.

***C/R bit***

In the Q.921 protocols, a bit that identifies a data-link-layer frame as either a command or a response.

***CRC***

cyclic redundancy check. A computational means to ensure the accuracy of frames transmitted between devices in a frame relay network. The mathematical function is computed, before the frame is transmitted, at the originating device. Its numerical value is computed based on the content of the frame. This value is compared with a recomputed value of the function at the destination device.

***CS***

See CTS.

***CSU***

channel service unit. A device used to connect a digital phone line (T1 or Switched 56 line) coming in from the phone company to either a multiplexer, channel bank, or directly to another device producing a digital signal (for example: a digital PBX, a PC, or data communications device). A CSU performs certain line-conditioning and equalization functions and responds to loopback commands sent from the central office. A CSU regenerates digital signals. It monitors them for problems, and provides a way of testing the digital circuit.

**CTS**

clear to send. A signal on the DTE interface indicating that the DCE is clear to send data.

**CV**

code violation. Cyclic redundancy check (CRC) errors and frame bit errors when in ESF (extended super frame) format, or bipolar violations and frame bit errors when in SF (super frame) format.

**data link**

See FDL.

**dB**

The standard abbreviation for decibel. A decibel is a unit of measure for signal. A decibel is usually the relation between a transmitted signal and a standard signal source. Therefore, 6 dB of loss would mean that there is a 6 dB difference between what arrives down a communications circuit and what was transmitted by a standard signal generator.

**DCE**

data communications equipment. A device that provides all the functions required for connection to telephone company lines and for converting signals between telephone lines and DTE. Also see DTE.

**DDS**

digital data service. AT&T private line service for transmitting data over a digital system. The digital transmission system transmits electrical signals directly, instead of translating the signals into tones of varied frequencies as with traditional analog transmission systems. Digital techniques provide more efficient use of transmission facilities, resulting in lower error rates and costs than analog systems.

**DE**

discard eligibility. A user-set bit indicating that a frame may be discarded in preference to other frames if congestion occurs, to maintain the committed quality of service within the network. Frames with the DE bit set are considered excess data.

***DLCI***

data link connection identifier. A unique number assigned to a PVC end point in a frame relay network. Identifies a particular PVC endpoint within a user's access channel in a frame relay network and has local significance only to that channel.

***DSU***

data service unit. A device designed to transmit and receive digital data on digital transmission facilities.

***DTE***

data terminal equipment. The end-user terminal or computer that plugs into the termination point (DCE) of a communications circuit. The main difference between the DCE and the DTE is that pins two and three are reversed.

***EER***

excess error rate. The number of code violations (CVs) are counted to determine a current error rate. If this rate exceeds a threshold set by the user, the line is said to be in an excess error rate (EER) condition or state.

***encapsulation***

A process by which an interface device places an end device's protocol-specific frames inside a frame relay frame. The network accepts only frames formatted specifically for frame relay; therefore interface devices acting as interfaces to a frame relay network must perform encapsulation. See also interface device and frame-relay-capable interface device.

***end device***

The ultimate source or destination of data flowing through a frame relay network sometimes referred to as DTE. As a source device, it sends data to an interface device for encapsulation in a frame relay frame. As a destination device, it receives de-encapsulated data (i.e., the frame relay frame is stripped off, leaving only the user's data) from the interface device.

***ESF***

extended superframe. A framing format which consists of 192-bit frames grouped into 24-frame superframes where 12 of the 24 framing bits are used as an out-of-band communications channel. Of these twelve bits, six are used for frame synchronization and six are used for a cyclic redundancy check (CRC). This method greatly increases performance monitoring capability and enables remote performance monitoring not available in superframe (SF).



***far end***

The unit or units not on-site (at the customer's premises or the other end of the T1 link).

***FCS***

frame check sequence. The standard 16-bit cyclic redundancy check used for HDLC and frame relay frames. The FCS detects bit errors occurring in the bits of the frame between the opening flag and the FCS, and is only effective in detecting errors in frames no larger than 4096 octets. See also CRC.

***FDL***

facility data link. A 4 kbps data channel provided by 12 of the ESF framing bits. The FDL can be used by both the carrier and the TSU IQ+ unit for communication purposes. The TSU IQ+ unit uses the FDL for report requests, clearing error counters, and activation of the loopbacks.

***FECN***

forward explicit congestion notification. A bit set by a frame relay network to notify an interface device (DTE) that congestion avoidance procedures should be initiated by the receiving device. See also BECN.

***file server***

In the context of frame relay network supporting LAN-to-LAN communications, a device connecting a series of workstations within a given LAN. The device performs error recovery and flow control functions as well as end-to-end acknowledgment of data during data transfer, thereby significantly reducing overhead within the frame relay network.

***frame-relay-capable interface device***

A communications device that performs encapsulation. Frame-relay-capable routers and bridges are examples of interface devices used to interface the customer's equipment to frame relay network. See also interface device and encapsulation.

***frame relay frame***

A variable-length unit of data, in frame-relay format that is transmitted through a frame relay network as pure data. Contrast with packet.

***frame relay network***

A telecommunications network based on frame relay technology. Data is multiplexed. Contrast with packet switching network.

***framing***

A control procedure used with multiplexed digital channels (such as T1 carriers) where bits are inserted so the receiver can identify time slots allocated to each subchannel. Framing bits may also carry alarm signals indicating specific alarm conditions, cyclic redundancy checks (CRCs), and an out-of-band data channel in the case of an extended superframe (ESF) T1 link. In T1 terminology, a frame consists of 192 data bits and one framing bit.

***gateway***

A device which enables information to be exchanged between two dissimilar systems or networks.

***HDLC***

high level data link control. A generic link-level communications protocol developed by the International Organization for Standardization (ISO). HDLC manages synchronous code-transparent, serial information transfer over a link connection. See also SDLC.

***host computer***

The primary or controlling computer in a multiple computer operation.

***in-band***

Signaling (dialing, diagnostics, management, configuration, etc.) over the same channel used for data.

***ingress***

Frame relay frames leaving from an access device in a direction toward the frame relay network.

***interface device***

Provides the interface between the end device(s) and a frame relay network by encapsulating the user's native protocol in frame relay frames and sending the frames across the frame relay backbone. See also encapsulation and frame-relay-capable interface device.

***IP***

internet protocol. A protocol which provides for transmitting blocks of data between hosts identified by fixed-length addresses.

**ISDN**

integrated services digital network. A network architecture that enables end-to-end digital connections. The network supports diverse services through integrated access arrangements and defines a limited set of standard, multipurpose interfaces for equipment vendors, network providers, and customers. Interworking with a public switched telephone network is retained.

**LAN**

local area network. A privately owned network that offers high-speed communications channels to connect information processing equipment in a limited geographic area.

**LBO**

line buildout. The introduction of gain or loss in a signal to optimize the signal level for a receiver.

**local loop**

In telephony, the wire pair that connects a subscriber to a phone company end office. Four-wire local loops are common and are used on T1 facilities.

**local loopback**

A type of test used to verify the operation of the local terminal equipment, the CSU, and the connection between the two units. The signal from the DTE is looped back by the CSU and is sent back to the DTE.

**loopback**

The technique for testing the processing circuitry of a communications device. May be initiated locally or remotely via a telecommunications circuit. Device being tested will echo back received test data. The results are compared with the original data.

**LOS**

loss of signal. Defined as a line state in which no pulses are received for 175 bit positions.

**MIB**

management information base. A database of network management information used by SNMP.

**modem**

The equipment that connects DTE to analog (voice) communications.

***near end***

The unit on-site.

***network interface (NI)***

The point of interconnection between the TSU IQ+ unit and the carrier's T1 network.

***out-of-band***

Signaling that is separated from the channel carrying information (voice, data, video, etc.). Typically the separation is accomplished by a filter. The signaling includes dialing and other supervisory signals.

***packet***

A message containing both control information and data. The control information is used for routing the packet through a network to its final destination. Contrast with frame relay frame.

***packet-switching network***

A telecommunications network based on packet-switching technology, wherein a transmission channel is occupied only for the duration of the transmission of the packet. Contrast with frame relay network.

***parameter***

A numerical code that controls an aspect of terminal and/or network operation. Parameters control such aspects as page size, data transmission speed, and timing options.

***PRI***

Primary rate ISDN.

***PRM***

performance report message. A message sent to the network interface (NI) once per second over the FDL which contains performance monitoring and status information. This is available in ESF only.

***ping***

An internet protocol standard that provides loopback on demand for any device in an IP network. One device "pings" another by sending a loopback request to the device's IP address.

***point-to-point***

Type of communications link that connects a single device to another single device, such as a remote terminal to a host computer.

***PVC***

permanent virtual circuit. A frame relay logical link, whose endpoints and class of service are defined by network management. Analogous to an X.25 permanent virtual circuit, a PVC consists of the originating frame relay network element address, originating data link control identifier, terminating frame relay network element address, and termination data link control identifier. Originating refers to the access interface from which the PVC is initiated. Terminating refers to the access interface at which the PVC stops. Many data network customers require a PVC between two points. Data terminating equipment with a need for continuous communion use PVCs. See also DLCI.

***red alarm***

A red alarm is declared on detection of an LOS or OOF not caused by an alarm indication signal (AIS) that persists for two seconds.

***remote configuration***

A feature designed into ADTRAN products that allows remote units to be configured from a local unit or VT 100 compatible terminal.

***router***

A device that supports LAN-to-LAN communications. Routers may be equipped to provide frame relay support to the LAN devices they serve. A frame-relay-capable router encapsulates LAN frames into frame relay frames and feeds those frame relay frames to a frame relay switch for transmission across the network. A frame-relay-capable router also receives frame relay frames from the network, strips the frame relay frame off of each frame to produce the original LAN frame, and passes the LAN frame on to the end device. Routers connect multiple LAN segments to each other or to a WAN. Routers route traffic on the Level 3 LAN protocol (e.g., the internet protocol address). See also bridge.

***SDLC***

synchronous data link control. A link-level communications protocol used in an IBM systems network architecture (SNA) network that manages synchronous, code-transparent, serial information transfer over a link connection. SDLC is a subset of the HDLC protocol developed by ISO.

**service**

The provision of telecommunications to customers by a common carrier, administration, or private operating agency using voice, data, and/or video technologies.

**SES**

severely errored second. A second in which more than 319 code violations (CVs) occurred or an OOF condition occurred.

**SF**

See superframe.

**SNA**

systems network architecture. The IBM protocol group which governs main-frame communication.

**SNMP**

simple network management protocol. A control and reporting scheme widely used to manage devices from different vendors. SNMP operates on top of the internet protocol.

**SR**

data set ready. A signal on the DTE interface that indicates if the communications is connected and ready to start handshaking control signals so communications can begin.

***statistical multiplexing***

Interleaving the data input of two or more devices on a single channel or access line for transmission through a frame relay network. Interleaving of data is accomplished using the DLCI.

***superframe (SF)***

A T1 framing format in which 192-bit frames are grouped into 12 frame superframes and all 12 framing bits are used for all frame synchronization.

***switched network***

The network of dial-up telephone lines using circuit switching to provide communications services to network users.

***synchronizing bits (sync bits)***

A fixed pattern in synchronous transmission used to identify the boundaries of frames.

***synchronous***

Communications in which the timing is achieved by sharing a single clock. Each end of the transmission synchronizes itself with the use of clocks and information sent along with the transmitted data.

***T1***

A digital transmission link with a capacity of 1.544 Mbps. T1 uses two pairs of normal twisted wires. T1 normally can handle 24 voice conversations with each conversation being digitized at 64 kbps. With more advanced digital voice encoding techniques, it can handle more voice channels. T1 is a standard for digital transmission in North America. It is also called T-1.

***TELNET***

The standard TCP/IP remote login protocol specified in RFC-854.

***transmission***

The dispatching of a signal, message, or other form of intelligence by wire, radio, telegraphy, telephony, facsimile, or other means. A series of characters, messages, or blocks including control information and user data. The signalling of data over communications channels.

***T-span***

A telephone circuit or cable through which a T1 carrier line runs.

***UAS***

unavailable seconds. An unavailable second (UAS) state is declared at the onset of ten consecutive severely errored seconds (SES). The UAS state is cleared at the onset of ten consecutive seconds with no SES.

***VT 100***

A non-intelligent terminal or terminal emulation mode used for asynchronous communications. Used to configure the TSU IQ+.

***yellow alarm***

When the local CSU is in a red alarm condition, it sends a bit pattern (in-band in SF, out-of-band in ESF) towards the network to tell the carrier and the far-end CSU that there is a problem in the receive direction.





# Index

---

## Numerics

10BaseT connector, pinout A-2  
4-wire SW56 DBU card, description, 1-7  
4-wire, pinout A-4

## A

activating menu items, how to 3-2  
adapter cables, for unit, 2-1  
agency approvals, specifications for B-3  
alarm conditions, frame relay 3-3  
alarm conditions, on front panel 3-3  
alarm conditions, T1 3-3  
Answer 8-4

## B

back panel, view of, 2-3  
BRI ISDN DBU, pinout A-4

## C

Call Manager 10-26  
Call Screening 8-8  
Canadian emissions requirements ix  
Canadian Equipment Limitations x  
change password 9-1  
clock source, 7-3  
configuration, overview, 3-16  
configuring read/write community names 9-6  
congestion, during DBU operation, 6-2  
control connector, pinout A-2  
Control Port, modular jack 2-5  
customer service v

## D

data port configuration 6-1

DBU card  
    configuration options, 8-7  
DBU interfaces, B-2  
DBU Port Statistics 10-20  
DBU port statistics  
    on front panel, 10-36  
DBU timers, 8-6  
DCE card, description, 1-7  
DCE Card, specification for, B-2  
diagnostic tests 11-1  
diagnostics, for TSU IQ+, B-2  
dial backup application  
    non-PRI 4-12  
    PRI 4-14  
dial backup operation, general description, 1-6  
dial backup, applications 4-10  
dial backup, criteria 8-5  
dial backup, menu tree 8-2  
dial backup, options, 8-4  
dial options  
    during DBU, 12-3  
dial options, when DBU is idle, 12-2  
Dial, manual dialing 3-16  
DLCI List (View Statistics) 10-31  
DLCI Statistics 10-27  
DSX loopback test 11-7  
DSX port 6-6  
DSX, specifications for, B-2  
DSX-1 connector, pinout A-1  
DSX-1 port interface, 2-5  
DSX-1 port statistics 10-15  
    on front panel 10-36  
DTE connector, on rear panel, 2-2  
DTE Interfaces B-1  
DTE port statistics 10-5  
    on front panel 10-33

DTE rates, B-1

DTE/DCE connector, pinout A-5

## E

ethernet card, description, 1-6

## F

FCC radio frequency interference statement viii

FCC regulations iv

features, of unit 1-2

fractional T1, general description, 1-4

frame relay alarm conditions, 3-3

frame relay, general description, 1-3

front panel operation, 3-4

front panel, drawing 3-1

## H

history interval count, 7-6

history interval size, 9-5

hot keys, for statistics menus 10-4

## I

in & out test jacks 2-4

installation

    items provided by Adtran 2-2

    items provided by customer 2-2

installation, 2-1

installing option cards 2-4

interface card options, 1-6

ISDN DBU card, B-2

ISDN DBU card, configuration options, 8-7

ISDN DBU card, description, 1-7

ISDN, switch type, 8-7

## L

Layer 3 statistics 10-16

LED descriptions, on front panel 3-3

line interfaces, B-1

local configuration 5-1

logout, of terminal menu, 3-16

## M

main menu, overview 3-16

monitor test jack, 2-4

## N

network connector, 2-4

network connector, pinout A-1

network port 7-1

network port statistics

    on front panel, 10-35

## O

operating modes, B-1

option cards, how to install 2-4

## P

Physical Layer Options, for PRI DBU card, 8-9

physical specifications, B-3

ping tests, 11-3

pinouts

    10BaseT connector, A-2

    4-wire A-4

    BRI ISDN DBU card, A-4

    control connector A-2

    DSX-1 connector, A-1

    DTE/DCE connector A-5

    network connector, A-1

    PRI DBU card A-4

    V.34 connector A-4

    V.35 connector A-3

power cord, 2-3

power up

    connecting the unit 2-2

PRI DBU card, 8-8

PRI DBU Card, description, 1-7

PRI DBU card, pinout, A-4

product overview, 1-1

product warranty xi

protocol standards

    for frame relay, SLIP, and SNMP, B-3

protocol statistics 9-4

PVC loopback test, 11-4

PVC management (dedicated), programming 4-9

PVC management (local)

    configuration requirements 4-6

PVC management (shared), programming 4-7

PVC signaling formats 7-1

## R

rear panel

    how to install DBU, ethernet, and DCE cards  
    2-4

rear panel, general description, 2-2

receipt inspection, 2-1

remote configuration, 5-1

---

return material authorization (RMA) v

## S

Safety Instructions v

signaling formats 7-1

SNMP, general description, 1-5

SNMP, specifications for, B-2

specifications, for TSU IQ+, B-1

statistical data

    how to calculate storage 9-5

    stored by unit 9-5

statistics

    calculating data storage 7-6

statistics data storage

    how to calculate 9-5

statistics menu

    resetting monitoring data 10-2

statistics, data storage 7-6

system configuration, 9-1

System Statistics 10-32

    on front panel 10-37

system time/date, 9-5

## T

T1 alarm conditions 3-3

T1 service, general description, 1-4

T1/FT1, general description, 1-4

Telnet

    local login, 3-7

    remote login, 3-11

TELNET, general description, 1-6

test jacks, 2-4

Test options, overview, 3-16

testing 11-1

timing

    clock source 7-3

top talkers 10-19

Trademark Information ii

## V

V.34 DBU card, 8-7, B-2

V.34 DBU card, description, 1-7

V.34, pinout A-4

V.35 connector, pinout A-3

V.35, connector 2-5

view statistics,overview, 3-16

VT 100 management

    configuration requirements, 4-2

VT 100, connection/operation 3-5

## W

warranty information v



## Product Support Information

### Pre-Sales Inquiries and Applications Support

Please contact your local distributor, ADTRAN Applications Engineering, or ADTRAN Sales:

Applications Engineering	(800) 615-1176
Sales	(800) 827-0807

### Post-Sale Support

Please contact your local distributor first. If your local distributor cannot help, please contact ADTRAN Technical Support and have the unit serial number available.

Technical Support	(888) 4ADTRAN
-------------------	---------------

### Repair and Return

If ADTRAN Technical Support determines that a repair is needed, Technical Support will coordinate with the Customer and Product Service (CAPS) department to issue a Return Material Authorization (RMA) number. For information regarding equipment currently in house or possible fees associated with repair, contact CAPS directly at the following number:

CAPS Department	(256) 963-8722
-----------------	----------------

Identify the RMA number clearly on the package (below address), and return to the following address:

ADTRAN Customer and Product Service  
6767 Old Madison Pike  
Progress Center  
Building #6 Suite 690  
Huntsville, Alabama 35807

**RMA #** \_\_\_\_\_

