

# CHIME TONE INTERCOM

**MODELS: IBG-2AD** (master station; DC-12V)  
**IBG-2CD** (sub station)

## — INSTRUCTIONS —

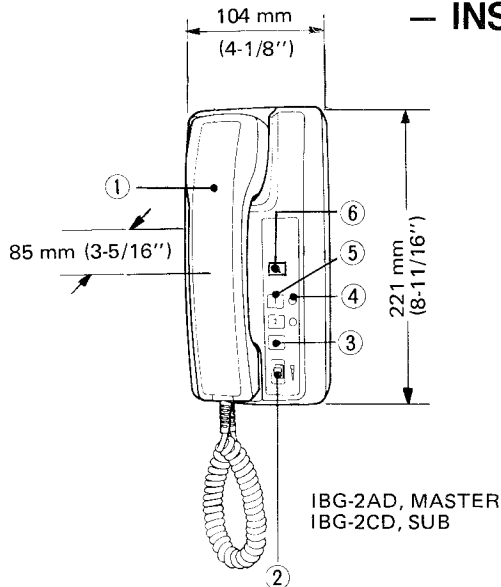

### NAMES AND FUNCTIONS

- ① Handset
- ② Chime volume control
- ③ Room station call button
- ④ LED for door station call in (x 2)
- ⑤ Door station selector button (x 2)
- ⑥ Door release button

### FEATURES AND SPECIFICATIONS

- \* One master system which may include up to two door stations and two room subs.
- \* Melodic two stroke chime with volume control and lamp memory for door station call in.
- \* Includes a button for door release.
- \* Chime call from door may be extended with IBR-1.
- \* Designed for either desk use or wall mounting.
- \* LED on door station indicates door station location in the dark.
- \* Works also with MB-D·DA/MB-U video intercom system.
- \* Power source: DC-12V. Use a power supply adaptor of DC-12V, 200mA.
- \* Wiring. Single pair of wires (non-polarized) from master to door station.  
 Please refer to wiring diagram on Page 3 showing complete IBG-2AD system.

### COMPONENTS AVAILABLE FOR USE WITH YOUR CHIME INTERCOM SYSTEM



- IBG-2AD:** Master station. Replies to 2 door stations and also allows calling and talking with up to 2 room subs.
- IBG-2CD:** Room sub station. Replies to 2 door stations and also allows calling and talking with up to 2 room stations.
- EL-9S:** Electric door release. Requires separate transformer.
- IBR-1:** Chime extension device. Announces a call from door in a place remote from master and room subs.

**FOUR DIFFERENT DOOR STATIONS ARE AVAILABLE:  
 ALL WEATHER-RESISTANT TYPE**  
 \* Please select the most suitable one for your requirement.



- IB-DA:** With plastic cover (surface mount).
- IB-NA:** With plastic cover (semi-flush mount).
- IC-RA:** With brown metal cover. (semi-flush mount)
- IB-JA:** With stainless steel cover (flush mount).

## ACTUAL TERMINAL LOCATION

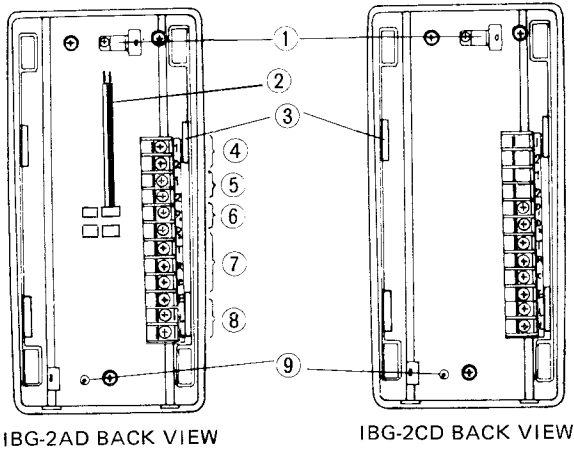

- ① Cable clamp
- ② Wires for power supply  
RED wire: Connect to Plus(+) wire of power supply adaptor.  
BLACK wire: Connect to Minus (-) wire of power supply adaptor.
- ③ Hole for mounting bracket
- ④ Terminals **1** , **2** : Connect to door station #1 (non-polarized)
- ⑤ Terminals **1** , **2** : Connect to door station #2 (non-polarized)
- ⑥ Terminals **D<sub>1</sub>** , **D<sub>2</sub>** : For communication with door
- ⑦ Terminals **T** , **R** , **C** , **E** : Connect to room station
- ⑧ Terminals **L** , **L** : Connect to electric door release
- ⑨ Cable clamp hole

## WALL MOUNTING INSTALLATION

### IBG-2AD, IBG-2CD

Attach the mounting bracket to wall or gang box. Insert the prongs of the bracket into the holes of the body and pull the body downward. Be careful not to attach the bracket upside down.

NOTE: Locate IBG-2AD master within convenient reach of AC receptacle –  
IBG-2AD power supply wires length: About 18 cm (7-1/8")

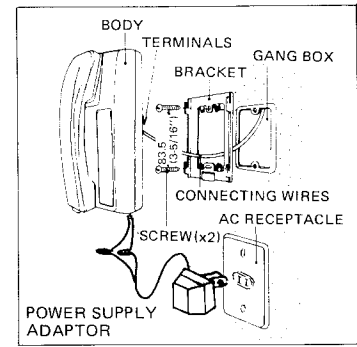

### IB-DA, IB-NA, IC-RA

- \* Remove screws and separate back box from front cover.
- \* Mount the back box (or bracket) to wall or gang box with supplied screws.
- \* Wire two terminals and replace front cover on the back box.

#### IB-DA

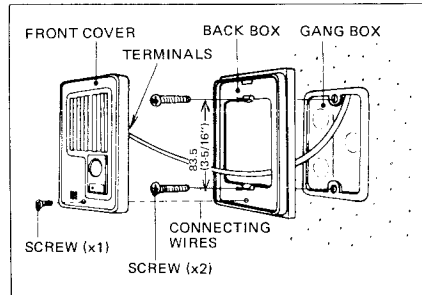

#### IB-NA

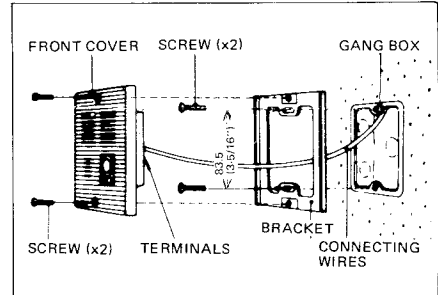

#### IBR-1

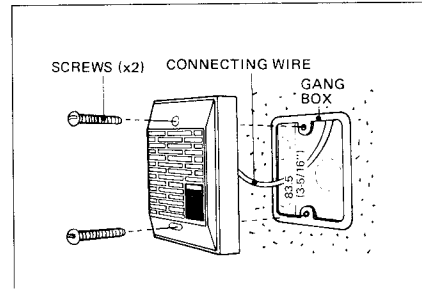

#### IC-RA

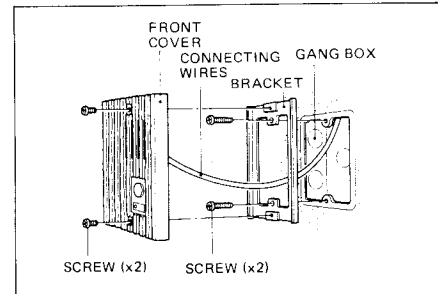

### IBR-1

After wiring terminals, mount IBR-1 to wall or gang box with supplied screws, as shown.

## WIRING

Lay out your system in advance. Determine the exact location of each station. Make a sketch showing the number of wires required from each station to other stations.

Refer to the chart below and select the proper wire gauge to meet your requirements.

Diameter of wire	0.5mm	0.65mm	0.8mm	24 AWG	22 AWG	20 AWG
Door station to IBG-2AD	90m	150m	230m	300'	450'	700'
IBG-2AD to IBG-2CD	45m	75m	115m	150'	230'	350'

## WIRING DIAGRAM

## COMPLETE IBG-2AD SYSTEM

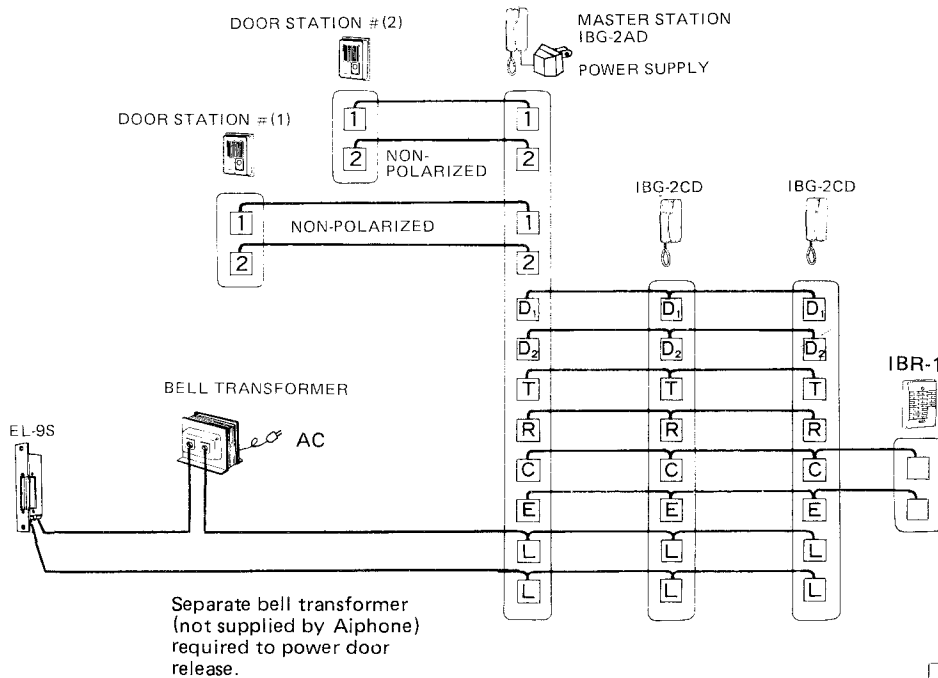

### NOTE:

**D<sub>1</sub>** terminals may remain unused when door station # ① is not connected.

**D<sub>2</sub>** terminals may remain unused when door station # ② is not connected.

## WIRING POWER SUPPLY ADAPTOR

- \* Connect RED wire on back of IBG-2AD master to Plus (+) wire of power supply adaptor.
- \* Connect BLACK wire on IBG-2AD to Minus (-) wire of power supply adaptor.
- \* Secure insulation at the junction part by vinyl tape, etc., otherwise power supply adaptor will be damaged.

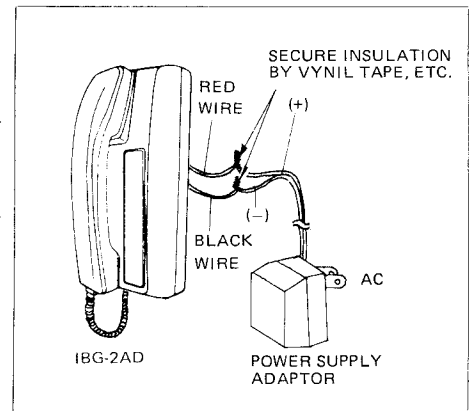

## WIRING DOOR RELEASE EL-9S

- \* Separate bell transformer (AC 12V, 0.2A or more) is required to power EL-9S door release.
- \* Wiring for door release should be SEPARATED from wiring for communication (DO NOT RUN THEM IN THE SAME CONDUIT).
- \* Attach two wires from terminals **L** , **L** on room station to EL-9S as shown.

NOTE: Your IBG-2AD chime intercom will operate other brands of door releases. It is recommended they do not exceed 50V, 1A.

## INSTALLATION OF OPTIONAL EXTENSION CHIME: IBR-1

Aiphone offers IBR-1 optional device for signaling chime call from door to a place remote from room station.

A reply from IBR-1 can not be made.

- \* Wiring: Attach two wires from terminals **C** , **E** on either IBG-2AD or IBG-2CD room station to IBR-1 call extension.

NOTE: One IBR-1 may be used per system.

## ADJUSTING CHIME CALL TONE VOLUME

Chime call tone volume may be adjusted to three levels by setting switch as desired.

NOTE: The volume switch also adjusts room station call tone at the same time, while the chime call tone at IBR-1 remains unchanged.

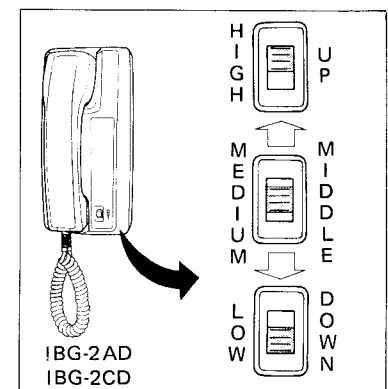

## ROOM STATION IBG-2AD & IBG-2CD OPERATION

- (1) Receiving a call from door station; A call is annunciated by chime and LED at all room stations. Pick up handset at convenient station and depress the selector button at the left of the lighted LED (LED remains lit for about 15 seconds).
- (2) Transferring a call from door to another room: Depress the room call button, which shuts off talk path of door station. The transferred room station can communicate with door after depressing the corresponding selector button. When the called station is not available, depress the selector button to resume conversation with door station.
- (3) Operating door release; EL-9S door lock, if included, may be released while depressing and holding the door release button on room station.
- (4) Placing a call to another room station; Pick up handset and depress the call button. If your chime intercom includes three room stations (one IBG-2AD and two IBG-2CD), a call from one station will be annunciated at both remaining stations. It is recommended to determine in advance the call signal for each individual room. For example,
  - ■ ■ ■ to call room # ①,
  - ■ ■ ■ to call room # ②,
  - ■ ■ ■ to call room # ③.

NOTE: (1) If door station calls during conversation between room stations, chime will sound only at the room station not occupied and (if installed at IBR-1 extension device. The two occupied stations will hear the incoming call thru handset.

When a communication is heard upon your picking up handset, do not depress room call button, which will cut off the communication with door station.

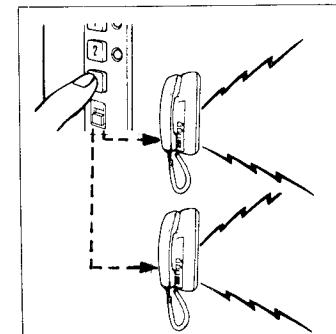
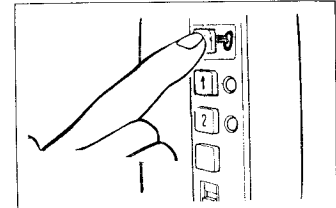
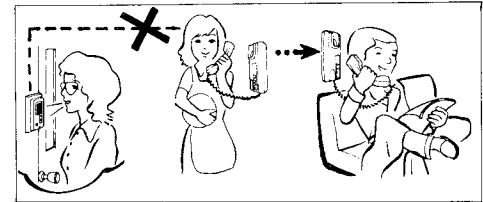
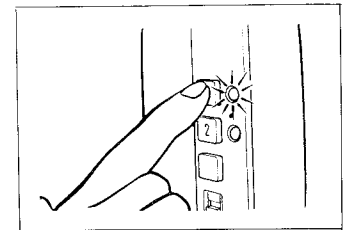

## DOOR STATION CALLING OPERATION

Momentarily depress the call button. Talk and listen hands free to room station. Conversation will not be interrupted even if you push the call button.

### TO PREVENT ELECTRIC SHOCK:

- \* DO NOT CONNECT ANY TERMINAL ON ANY UNIT TO AC POWER LINES.
- \* When you mount IBG-2AD in place of existing bell or chimes, be sure to disconnect wires from present transformer.
- \* BE SURE TO REMOVE PLUG OF POWER SUPPLY FROM POWER OUTLET BEFORE YOU OPEN THE UNIT, OR MAKE WIRING CONNECTIONS.
- \* Do not pinch connecting wires in windows, doors or desks.
- \* IBG-2AD equipment must be installed in as dry and dust-free environment as possible.

### CLEANING YOUR INTERCOM STATIONS:

- \* Your Aiphone intercom stations may be cleaned with a soft cloth dampened with household cleanser, such Mr. Clean or Fantastik.

## WARRANTY

Aiphone warrants its products to be free from defects of material and workmanship under normal use and service for a period of one year after delivery to the ultimate user and will repair free of charge or replace at no charge, should it become defective upon which examination shall disclose to be defective and under warranty. Aiphone reserves unto itself the sole right to make the final decision whether there is a defect in materials and/or workmanship, and whether or not the product is within the warranty.

This warranty shall not apply to any Aiphone product which has been subject to misuse, neglect, accident, or to use in violation of instructions furnished, nor extended to units which have been repaired or altered outside of the factory.

This warranty does not cover batteries or damage caused by batteries used in connection with the product.

This warranty covers bench repairs only, and any repairs must be made at the shop or place designated in writing by Aiphone. Aiphone will not be responsible for any costs incurred involving on site service calls.