

CALL EXTENSION

Model; **IER-2** (Call extension speaker, surface-mount)

INSTRUCTIONS

1

NAMES AND FUNCTIONS

Mounting accessories,

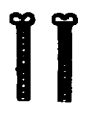
 Screw (x 2)
(for mounting to electrical gang box)

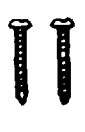
 Wood screw (x 2)
(for mounting to pillar/wall surface)

① Speaker
② Chime call tone volume switch

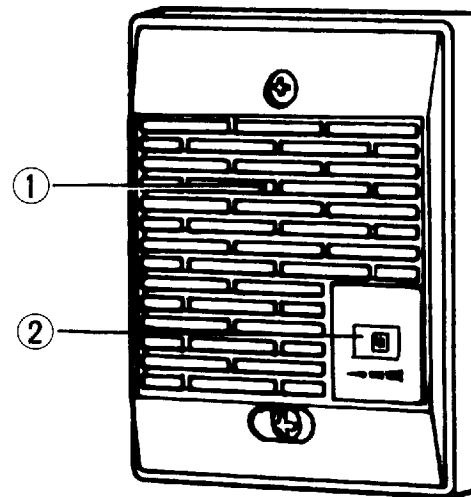

ADJUSTING CALL TONE VOLUME

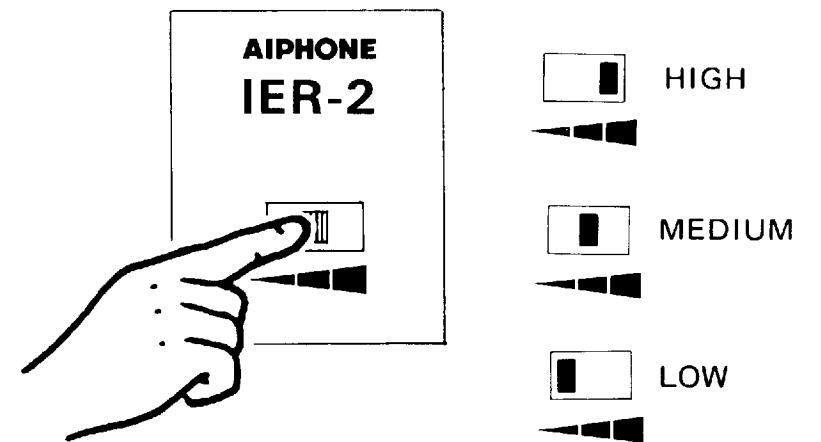

2

FEATURES & SPECIFICATIONS

IER-2 IS A CALL EXTENSION SPEAKER UNIT FOR USE WITH THE FOLLOWING AIPHONE INTERCOM SYSTEMS;

NO.	SYSTEM	MODELS	CALL TONE	CONNECTING TERMINALS
1	Video entry security system	MY-1AD	4-stroke chime	S SG
2	Chime tone intercom Type 1 door-1 room	IC-1AD (D) IC-1AD (U)	4-stroke chime	S S Two WHITE wires
3	Chime tone intercom Type 1 door-3 rooms	IC-1GD (D) IC-1GD (U)/A	4-stroke chime	C E (on either main or sub)
4	Chime tone intercom Type 2 doors-3 rooms	IC-2AD (D) IC-2AD (U)/A	4-stroke & 2-stroke chime	C E (on either main or sub)
5	Internal telephone intercom	TB-10T TB-20T	Intermittent electronic tone	S S
6	Lamp memory intercom system	NEM-10/10A NEM-20/20A NEM-30/30A NEM-40/40A	Intermittent electronic tone (Volume adjusted by master)	S S
7	Duplex intercom system	RCX-48/n RCX-88/n RCX-128/n XCS-102	Electronic chime	S S (on XC-102)

* Announces a call from sub (or door) station in a place remote from master (or room) station.

* One call extension per system.

* Tone volume switch.

* Reply from IER-2 is not available.

* Wiring: Single pair of wires (non-polarized) from master (or room) station to IER-2.

* Dimensions: H: 120 x W: 88 x D: 29 mm (4-3/4" x 3-1/2" x 1-1/8")

* Weight: Approx. 140 g (0.31 lbs.)

3

INSTALLATION

After connecting wires on two terminals, attach IER-2 unit to wall or single-gang box with supplied screws.

When mounting to wall, the wires may be pulled out either from top or bottom of the back case.

Mounting to electrical gang box;

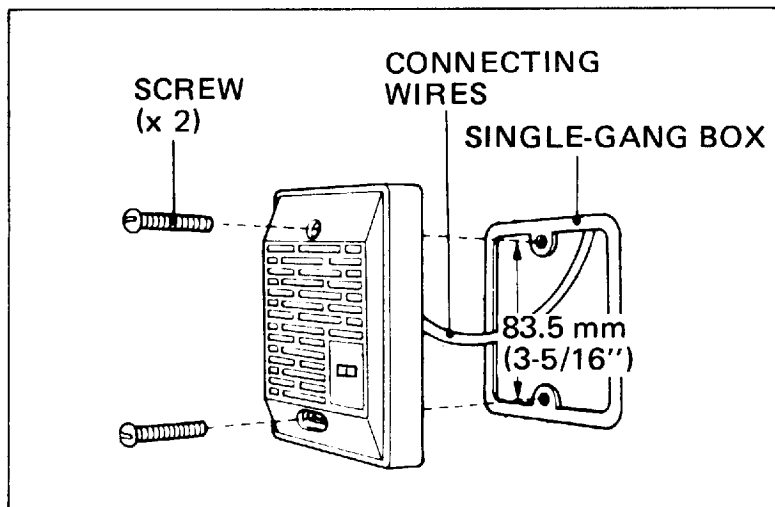

As shown, remove the outlet part of the case when passing wires through the top.

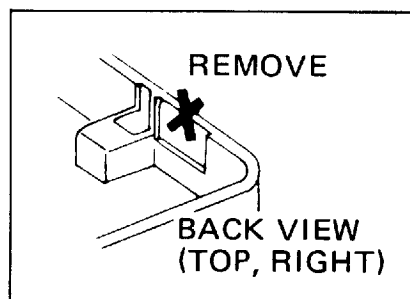

Mounting to wall/pillar;

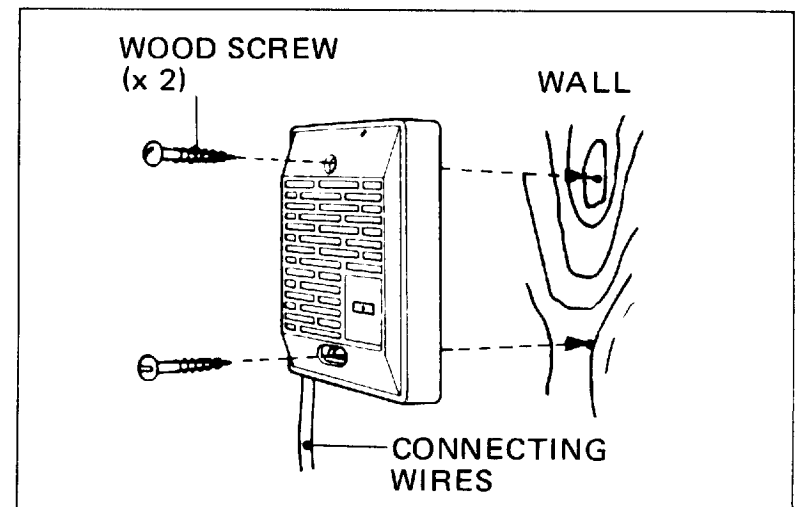

4

WIRING

Wiring is non-polarized. Connect wires on two terminals on IER-2 to either terminal on each intercom station, as shown.

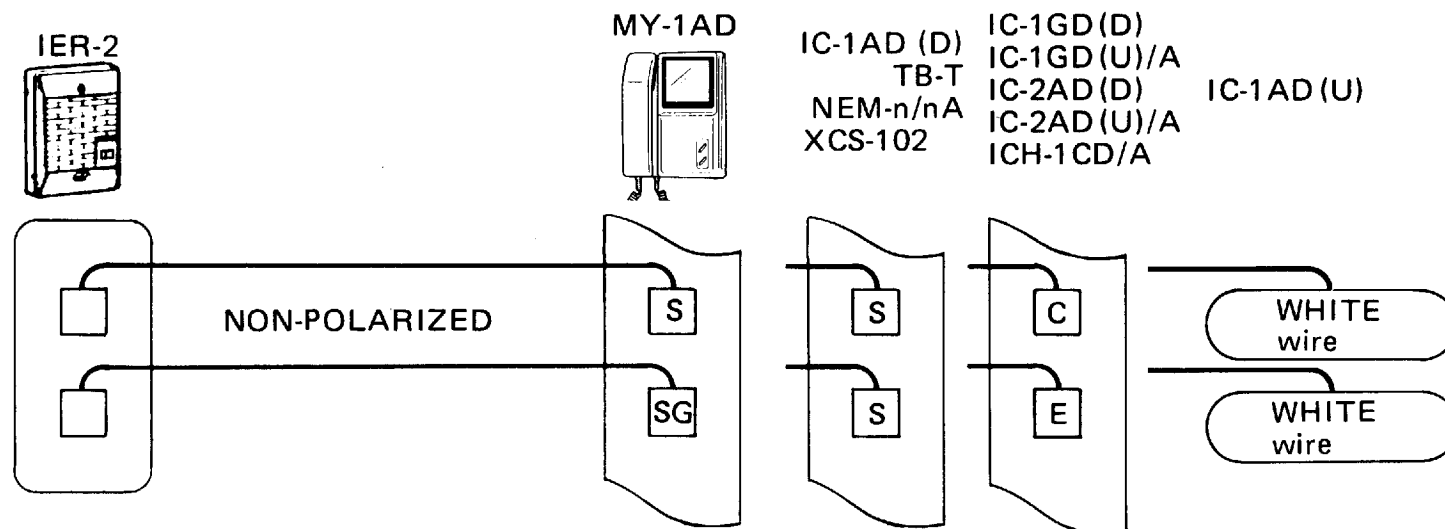

5

IMPORTANT INSTRUCTIONS

- *DO NOT CONNECT ANY TERMINAL ON ANY UNIT TO AC POWER LINES.
- *Avoid running the connecting wires thru doors, windows or between furniture, which may pinch and disconnect the wires.
- *IER-2 is not weather resistant type and must be installed inside the house.
- *Clean IER-2 unit with a soft cloth dampened with neutral household cleanser. Never use thinner or lacquer, benzine, etc.

WARRANTY

Aiphone warrants its products to be free from defects of material and workmanship under normal use and service for a period of one year after delivery to the ultimate user and will repair free of charge or replace at no charge, should it become defective upon which examination shall disclose to be defective and under warranty. Aiphone reserves unto itself the sole right to make the final decision whether there is a defect in materials and/or workmanship; and whether or not the product is within the warranty.

This warranty shall not apply to any Aiphone product which has been subject to misuse, neglect, accident, or to use in violation of instructions furnished, nor extended to units which have been repaired or altered outside of the factory.

This warranty does not cover batteries or damage caused by batteries used in connection with the product.

This warranty covers bench repairs only, and any repairs must be made at the shop or place designated in writing by Aiphone. Aiphone will not be responsible for any costs incurred involving on site service calls.

Aiphone Co., Ltd., Nagoya, Japan
Aiphone Corporation, Bellevue, Washington

