

VIDEO SENTRY COLOR TILT COLOR TILT VIDEO ENTRY SECURITY INTERCOM

Models: **KB-3MRD**, *Master station with monitor*
KB-3HRD, *Sub station with monitor*

INSTALLATION MANUAL

This Manual and the Markings on the product contain various symbols in order that the product can be used safely and properly, and that the installer and user are protected from injury and property damage.

The following precautions must be thoroughly read and understood before proceeding.

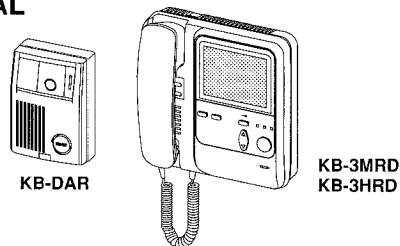











PRECAUTIONS ON INSTALLATION & WIRING

 **WARNING** *Negligence could result in death or serious injury.*







 **CAUTION** *Negligence could result in injury or damage to property.*

The following precautions also apply to KB-3HRD sub station with monitor.

WARNING

1. Do not connect any power source other than specified to terminals +, – on KB-3MRD.  Fire or damage to the unit could result.
2. Do not open KB-3MRD. High voltage is present inside, and it can cause electric shock. 
3. Do not change or alter KB-3MRD. It can cause fire or electric shock. 
4. Make sure wires are connected properly before plugging in power supply. 
5. Keep the KB-3MRD unit away from water or any other liquid. Fire or electric shock could result. 
6. Do not put any forcible strength on the video monitor. Damage may result. 
7. Keep AC plug away from moisture or dust. 
8. Keep AC cord away from being marred or crushed. 
9. Do not plug or unplug with wet hands. 
10. Do not put any metal into KB-3MRD through openings. It can cause fire, electric shock or unit damage. 



CAUTION



1. Do not install or make any wire terminations while power supply is plugged in. It can cause electrical shock or damage to the unit. 
2. Do not manually hold down hook switch to verify chime volume. It sounds very loud in the handset, and can cause hearing damage. 
3. Mount KB-3MRD on wall in a convenient location, but not where it could be bumped or jarred. 
4. In case of electrical storms, unplug power supply from AC outlet. It can cause fire, electric shock, or power surge damage.
5. Do not install KB-3MRD components in any of the following locations, as it may cause the system to malfunction; 
 - **High or extreme cold temperature area:** under direct sunlight, near equipment that varies in temperature, in front of air conditioner, inside a refrigerated area, etc.
 - **Places subject to moisture or humidity extremes.**(bathroom, cellar, greenhouse, etc.) 
 - **Places subject to environmental conditions,** such as oil, dust, chemicals, salt, etc. 
 - **Places subject to constant vibration or impact.**
 - **Places where noise generating devices** such as TV or radio are close by.



GENERAL PRECAUTIONS

1. KB-3MRD equipment, except for KB-DAR, is designed for indoor use only. Do not install outdoors.
2. KB-3MRD system is not operational during a power failure.
3. In areas where broadcasting station antennas are close by, intercom system may be affected by radio frequency interference.
4. Keep all DC wiring at least 30cm(1') away from AC 100~240V wiring, fluorescent lighting, or dimmer switches. Otherwise, cross AC wiring at a 90° angle.

Examples of Symbols;

 **GENERAL PRECAUTIONS:** –  mark indicates caution statement (incl. danger and warning), which is specifically shown inside.

 **GENERAL INSTRUCTIONS:** –  mark indicates contents which demands a specific action shown inside or attached.

 **GENERAL PROHIBITIONS:** –  mark indicates contents which prohibit a specific action shown inside or attached.

 **DISMANTLE PROHIBITIONS**

 **MOISTURE PROHIBITIONS**

1 SYSTEM OUTLINE & COMPONENTS

VIDEO SENTRY COLOR TILT 3 - 5: KB-3MRD is an audio video entry security intercom for 3 video doors & max. 5 room stations with monitor.

PACKAGE CONTENTS

- Master & sub stations w/monitor (**KB-3MRD** or **KB-3HRD**)
- Packet of screws
- Connectors (2) for options (with **KB-3MRD**)
- Installation & Operation Manual

Upon completing installation, give the Operation Manual to the user.

SYSTEM LAYOUT

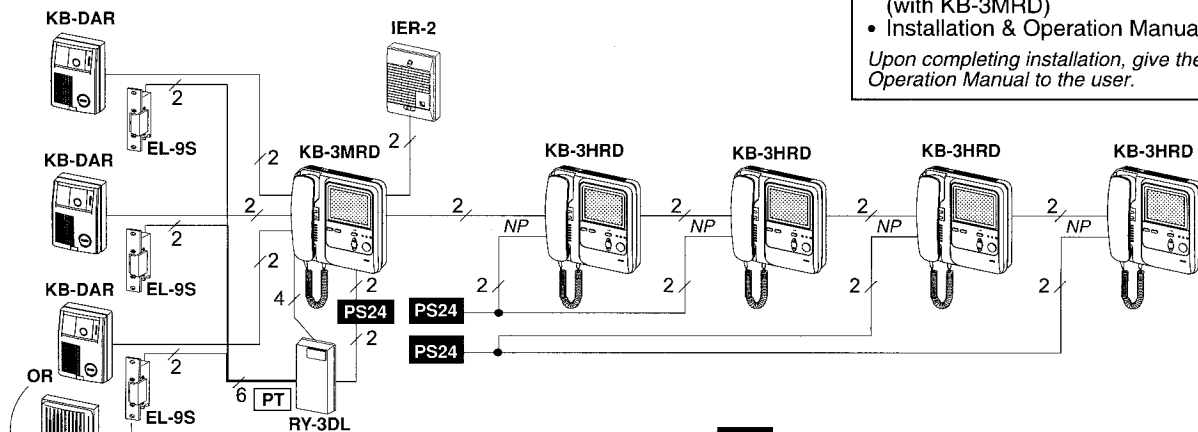

PS24 : PS-24E for KB-3MRD, RY-3DL
PS-24E, PS-24ME or PS-2410A per two KB-3HRD's
PT : AC transformer PT-1210N in USA

SYSTEM COMPONENTS

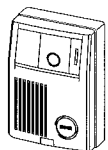

KB-DAR
Video door station

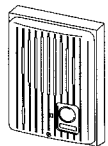

IF-DA
Door station

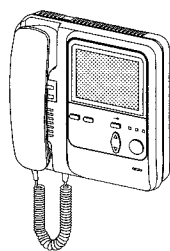

KB-3MRD, Master station w/monitor
KB-3HRD, Sub station w/monitor

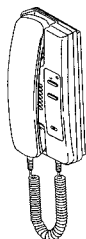

KB-3SD, Audio sub station

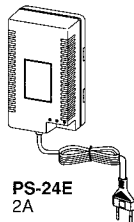

PS-24E
2A

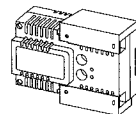

PS-24ME
0.9A

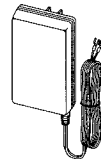

PS-2410A
1A

- KB-DAR:** Video door station.
- KB-3MRD:** Master station w/monitor.
- KB-3HRD:** Sub station w/monitor (1 ~ 4 pcs).
- KB-3SD:** Audio sub station (max. 2).
- IF-DA:** Door station (IE/IF series).

24V DC power supply:

- PS-24E** (2A).
- PS-24ME** (0.9A).
- PS-2410A** (1A) in USA.

OPTIONAL COMPONENTS



IER-2

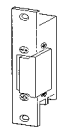

EL-9S

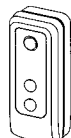

KC-32EU

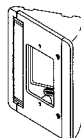

KAW-D

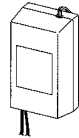

MAW-B

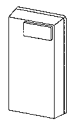

RY-3DL

Model	Description	Functions
IER-2	Call extension speaker	One to KB-3MRD master only
EL-9S	Electric door release. 12V AC, 0.35A.	Requires an AC transformer (PT-1210N in USA)
KC-32EU	Picture memory unit.	Max. 60 image memory. 18V or 24V DC power sourced.
MAW-B	Auxiliary light control relay. 24V DC.	External light turns on when KB-DAR call button or inside monitor button is pressed.
KAW-D	30° Angle Box for KB-DAR	1-gang surface mounting.
KA-DGR PANEL	Stainless steel panel for KB-DAR	1-gang surface mounting.
RY-3DL	Door release adaptor	1-gang surface mounting.

2 NAMES & FEATURES

KB-DAR

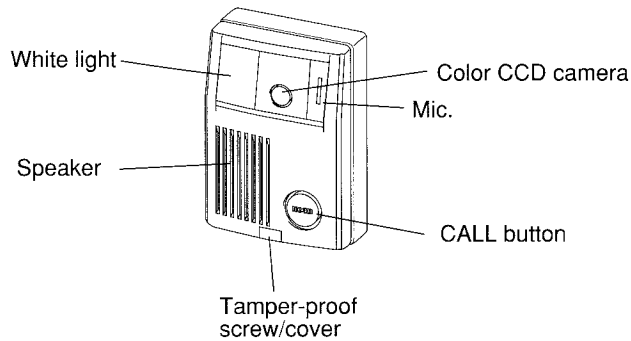

KB-3MRD

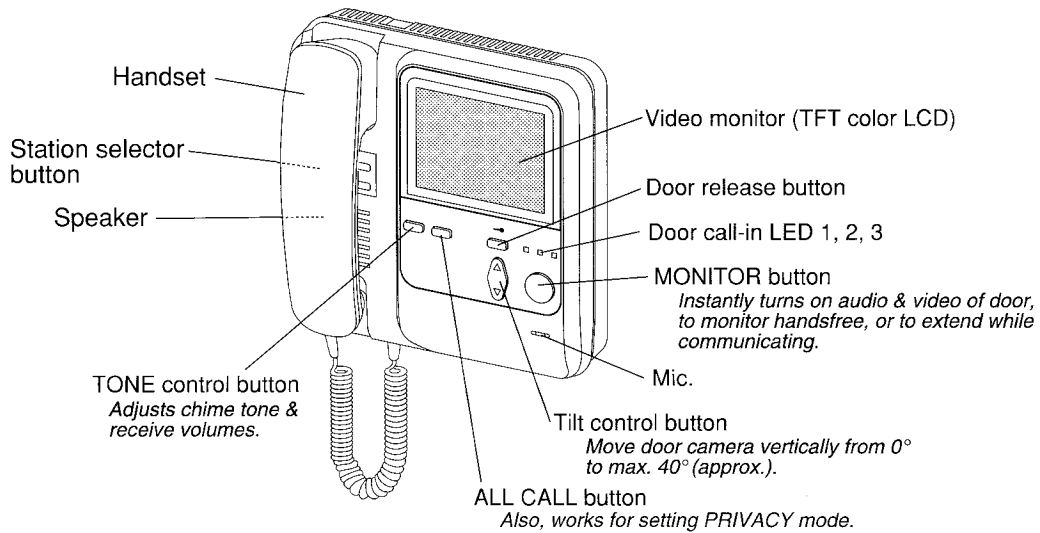

Left side

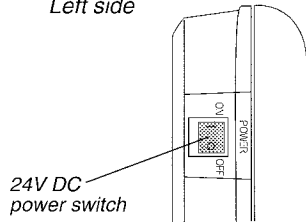

Bottom view

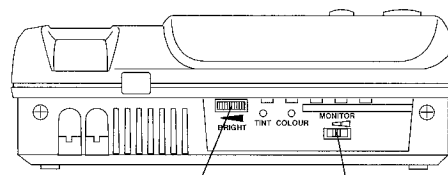

Turn power switch off when system malfunctions.

MONITOR:
Adjust audio monitor volume of door.
Can be cut off: OFF — MID — HIGH.

FEATURES

- Audio video entry security intercom 3 doors - 5 room stations with monitor with TILT camera control.
- Clear and bright image with TFT(*1) Color LCD monitor and DSP(*2) for door station.
- INSTANT - ON audio and video of door station when door calls or during monitoring from room station.
- Selective room calling with handsfree reply at called station.
- ALL CALL button.
- Selective door release control with RY-3DL adaptor.
- Max. 100m distance to farthest sub station w/monitor.
See power supply requirements.

(*1) TFT = Thin Film Transistor
(*2) DSP = Digital Signal Processor

3 INSTALLATION

- Cable** Specify for wiring to both door and inside stations.
- 0.65mmø to 1.2mmø (22AWG to 16AWG).
 - PE (polyethylene) insulation & Vinyl-sheathed cable.**
Attenuation of less than -6.5dB at 10MHz./100m, 330' length.
 - Single-core conductor.
 - Line impedance : ± 75Ω (less than 100Ω at the highest).

Use either Wire type D990 by West Penn or Cable provided by Aiphone Co., Ltd.
For other types, normal operation or max. communication distance cannot be guaranteed.

Wiring

- Use a parallel cable to connect video door station. Do not use any other cable like coax-cable, individual wires, etc.
- When existing chime wires are used, be sure to locate and disconnect the AC transformer. When system does not function properly, install new cable as specified.
- If unused wires exist in the cable, terminate each extra pair with a 120Ω resistor at each end of wires (on audio sub station end as well). Extra wires can interfere with video signal.
- Keep audio/video wires more than 30cm(1') away from AC 100~240V power lines. It will cause noise in communication & malfunction.
- Run internal wiring of audio/video system in such a manner that the cable is run from master to sub without any splices, which will create inferior video quality.

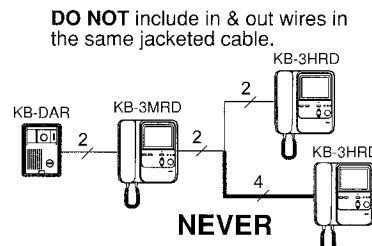
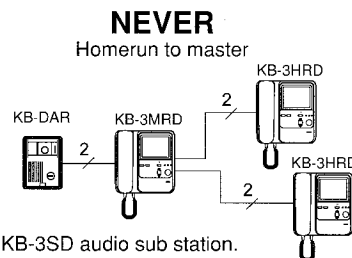
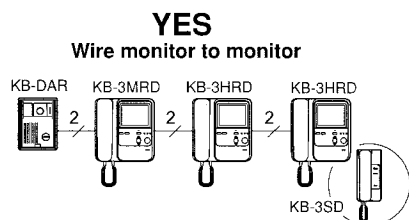
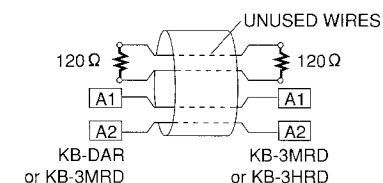
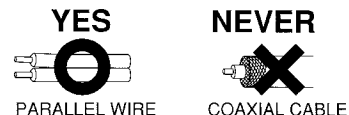

NOTE: The above wiring methods also apply to KB-3SD audio sub station.

Power supply requirements

METHOD 1

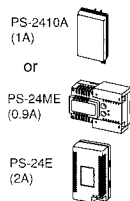
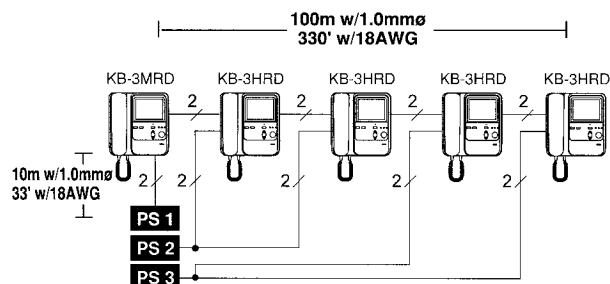

	Europe	USA	Others
PS1	PS-24E	PS-24E	PS-24E
PS2	PS-24E or PS-24ME	PS-24E or PS-2410A	PS-24E
PS3	PS-24E or PS-24ME	PS-24E or PS-2410A	PS-24E

METHOD 2

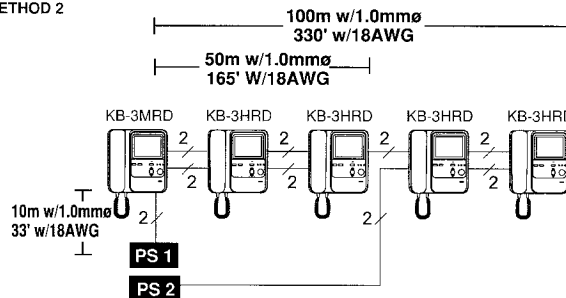

	Europe	USA	Others
PS1	PS-24E	PS-24E	PS-24E
PS2	PS-24E or PS-24ME	PS-24E or PS-2410A	PS-24E

⚠ Use a specified power supply to secure proper operations of system.

⚠ Do not connect power supplies in parallel.



Compatibility

Description	Compatible	Not compatible
Video door station	KB-DAR	KC-DAR, KA-DAR, MK-DS/A, others
Sub station w/monitor	KB-3HRD	KC-1HRD
Audio sub station	KB-3SD	KC-1SD, MY-1HD, IEH-1CD, others

3 INSTALLATION (continued)

Mounting locations & Height

Do not install a video door station in the following locations;

- Places subject to temperature/humidity extremes.
- Places from dust, vapor, smoke and chemicals.
- Places where a call is strongly backlit (white wall is on the background).
- Places where direct sunlight or strong light comes into the camera lens.

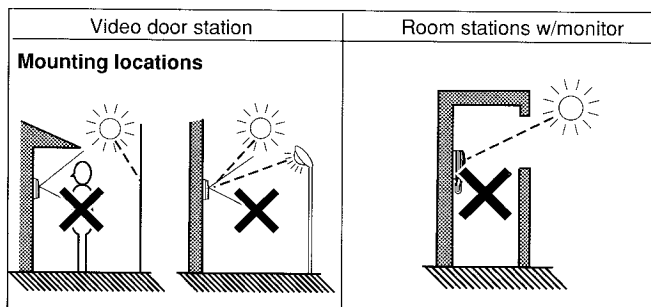
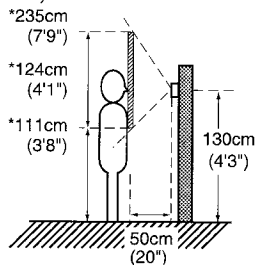
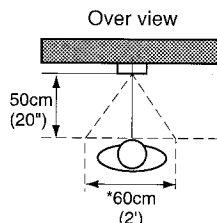

Image view area (approx.) when the door camera is tilted

VERTICAL (tilting)



HORIZONTAL



Mount the station so that the video monitor comes at the user's eye level.

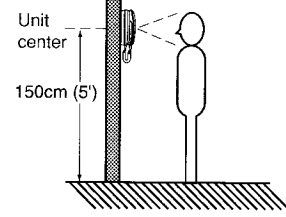

Setting

Place the dip switches to put the corresponding function into effect.

(1) Filling in directory

Open the directory pushing the cut edge. Fill in names with pen.

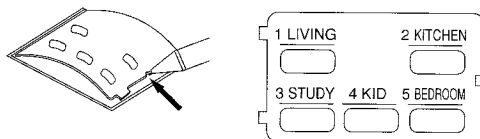

(2) Silencing chime tone

On KB-3MRD & KB-3HRD;

Chime tone will not ring on a particular station as needed.

(3) White light on/off

On KB-3MRD only;

When ambient light is low (during night, etc.), the white light on door station will turn on automatically when door calls or during monitoring.

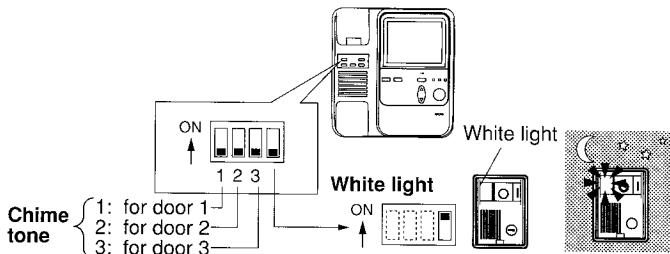

Adjustments

• in standby

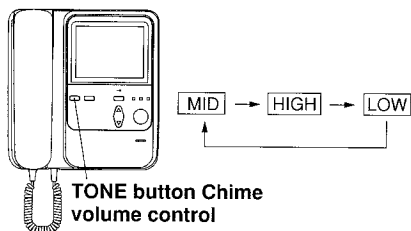

Chime volume

In standby mode, press TONE button. Chime tone sounds at mid level, and changes when the button is pressed.

MID (initially set) – HIGH – LOW – MID ...

When power switch is turned off or after power failure, chime volume will return to MID position.

• while communicating

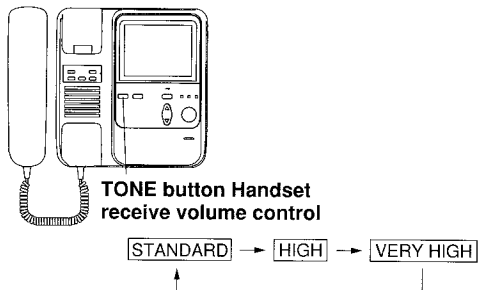

Receive volume

While communicating with door or another room station, press TONE button. Pressing button repeatedly, the receive volume changes:

STANDARD (initially set) – HIGH – VERY HIGH – STANDARD ...

Notes:

1. When acoustic feedback takes place in answering door, with receive volume set to HIGH or EXTRA HIGH position, put the volume back to STANDARD position.
2. Once receive volume is set, it will be in memory after communication. (When power switch is turned off or after power failed, receive volume will return to STANDARD position)

4 WIRING DIAGRAM

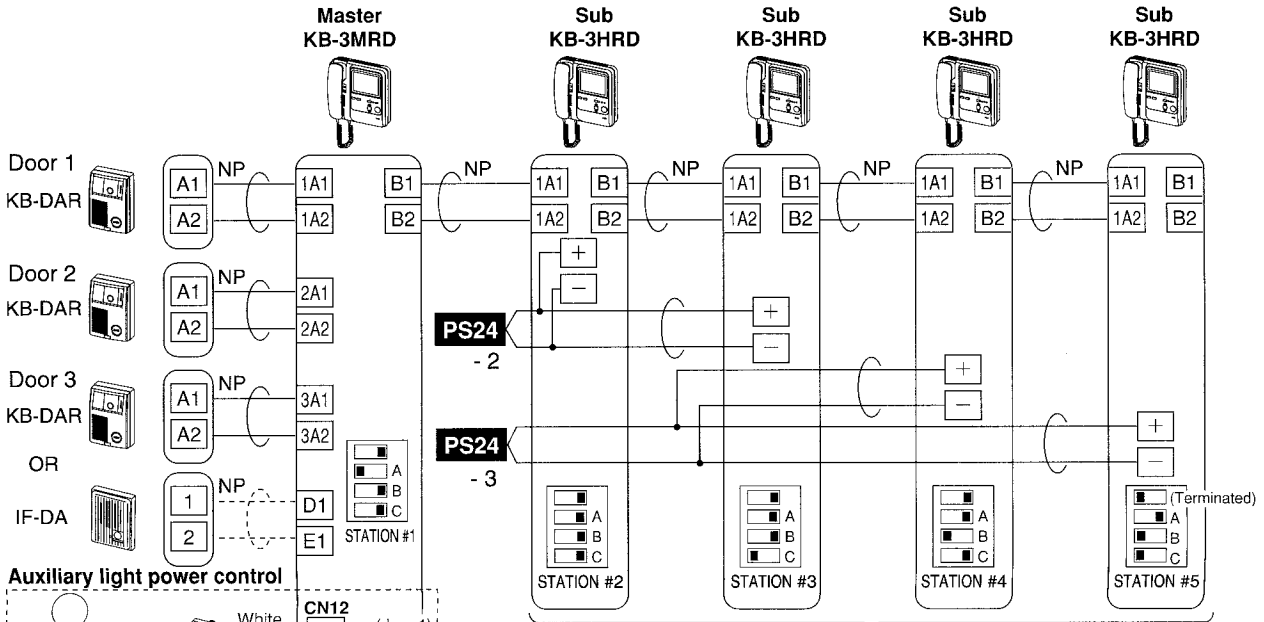
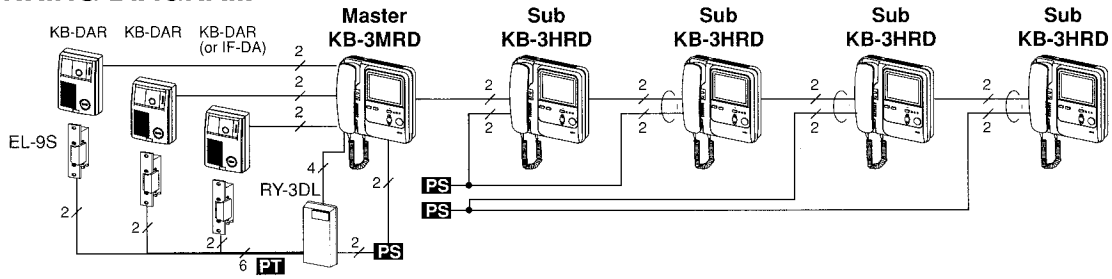

See 5. MOUNTING Item 5 on Page 7.

Connectors for optional devices (supplied with KB-3MRD)

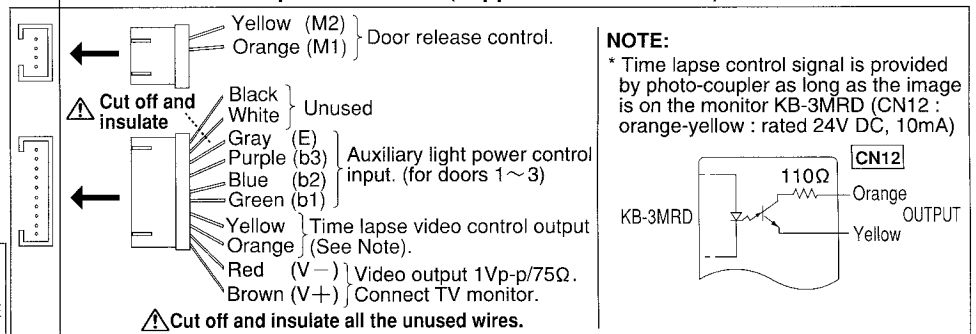

⚠ Door release and auxiliary light controls are alternatively used.

• **Auxiliary light:** When door calls, each light turns on and stays lit until the room station hangs up handset.

• **Cable:** Run audio/video wires in a pair cable. As to power supply, extend 2 wire cable separately from power supply to each monitor location.

⚠ Do not use any vacant terminal for any other purpose.

Power supply

	USA	Europe	Others
PS24 - 1	PS-24E	PS-24E	PS-24E
PS24 - 2	PS-24E or PS-2410A	PS-24E or PS-24ME	PS-24E
PS24 - 3	PS-24E or PS-2410A	PS-24E or PS-24ME	PS-24E

5 MOUNTING

KB-3MRD, KB-3HRD

1 Loosen two screws on bottom.

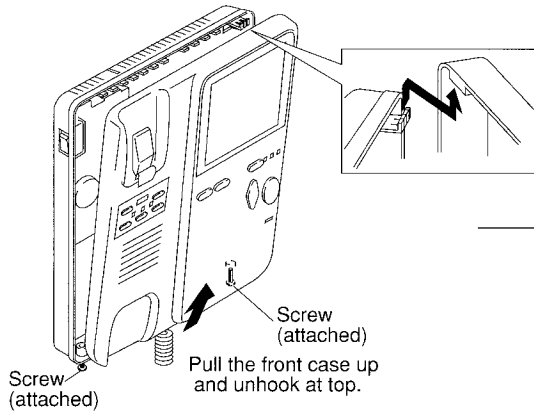

2 Pull up front case slightly, and off the chassis.

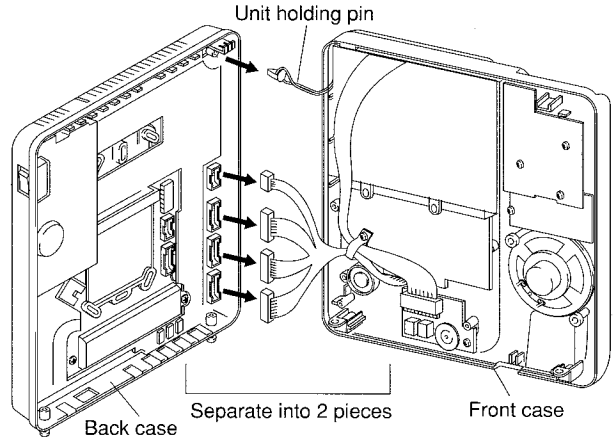

3 Attach the back case to 2-gang box or on wall.

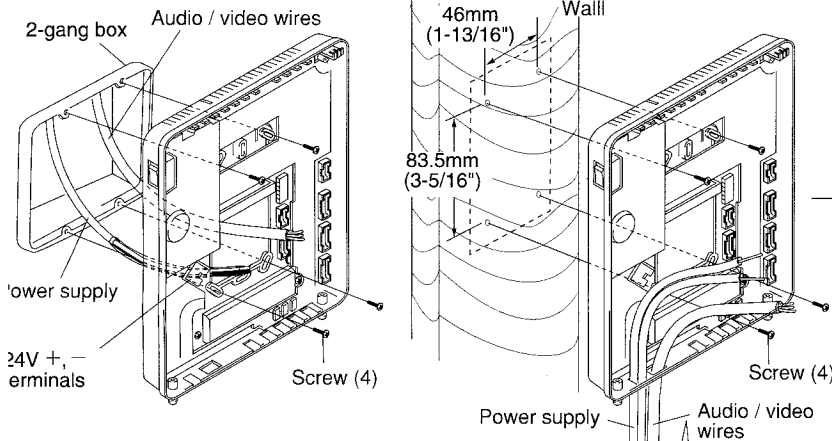

4 Connect wires from each door station, room station, etc.

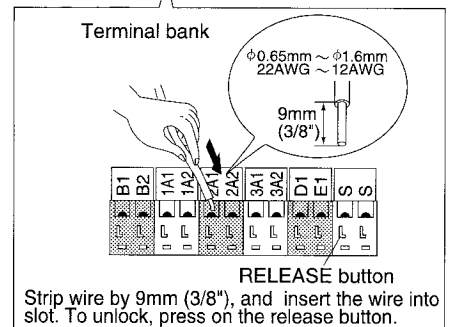
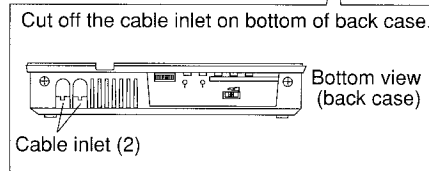
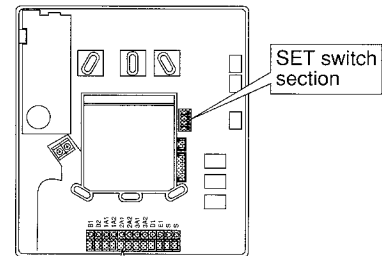

5 Assign station # and set impedance with DIP switches.

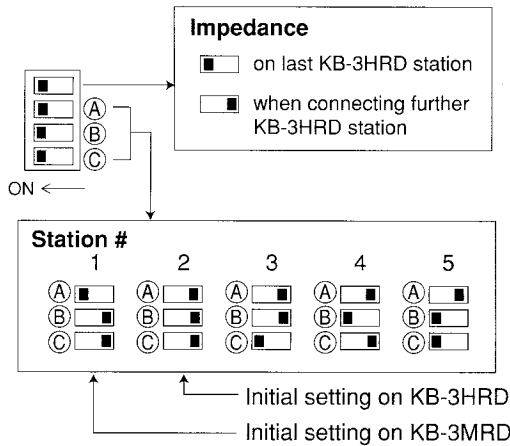

6 Aligning on the hook, put together front case and back case.

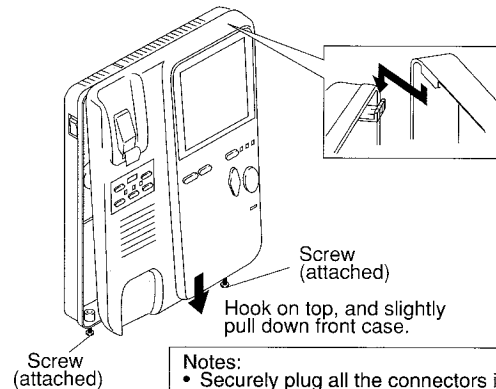

Notes:

- Securely plug all the connectors into each slot.
- Be careful that connecting wires are not pinched between the components.

7 Tighten two screws at bottom.

6 TECHNICAL PRECAUTIONS

OPERATING TEMPERATURE

KB-DAR: - 10°C ~ 60°C (14° ~ 140°F).
KB-3MRD: 0°C ~ 40°C (32°F ~ 104°F).

LCD MONITOR

- It must be noted in advance that the TFT color LCD panel, though manufactured with very high precision techniques, inevitably has a very small portion of picture elements that are steadily lit or not lit at all, which is not considered a unit malfunction. The LCD monitor looks dark in the bright sunlit area, etc. Adjust BRIGHT control to high position to increase monitor luminosity, or reduce ambient lighting.
- When holding handset close to video monitor, the image may vary, but this is not a malfunction.
- KB-3MRD unit surface becomes warmer while being powered, but this is not a malfunction.
- Strong light, such as direct sunlight, etc. may cause silhouette on the monitor, but this is not a malfunction.
- When outside temperature lowers sharply after rainfall, etc., the inside of camera may fog up slightly, causing a blurry picture, but this is not a malfunction. Normal operation will be restored when moisture evaporates.
- KB-3MRD may collect dust on the top of the unit. Clean unit as needed.
- Do not apply any caulking sealant around video door station. The openings at the bottom will help rain to dissipate.

CLEANING

Clean KB-3MRD and KB-DAR with a soft cloth dampened with neutral household cleanser. Never use any harsh cleaner or cloth. Do not spray high-pressure water on KB-DAR.

7 SPECIFICATIONS (KB-3MRD)

- Power source: 24V DC.
- Consumption:

	Max.	Standby
KB-3MRD:	860mA	220mA
KB-3HRD:	410mA	80mA
KB-3SD:	85mA	50mA

- Call-in: 4-, 2- & 8-tone chime from door 1, 2 & 3, with adjustable volume. Pre-tone and voice for internal call, with adjustable volume.
- Communication: Simultaneous with handset. Handsfree simultaneous at room station internally called.
- Wiring: 2 parallel wires, non-polarized to door. 2 parallel wires, non-polarized to room, plus 2 wires to power supply (separately jacketed).
- Wiring distance:

	0.65mmø	1.0mmø
• KB-3MRD to door	100m	200m
• KB-3MRD to farthest monitor/KB-3SD	50m	100m
• KB-3MRD to door IF-DA	150m	360m

	22AWG	18AWG
• KB-3MRD to door	330'	660'
• KB-3MRD to farthest monitor/KB-3SD	165'	330'
• KB-3MRD to door IF-DA	450'	1,000'

⚠ For use of cables not specified, normal operation or max. communication distance cannot be guaranteed.

- Cable** Specify for wiring to both door and inside stations.
1. 0.65mmø to 1.2mmø (22AWG to 16AWG).
 2. **PE (polyethylene) insulation & Vinyl-sheathed cable.**
Attenuation of less than - 6.5dB at 10MHz./100m, 330' length.
 3. Single-core conductor.
 4. Line impedance : ± 75Ω (less than 100Ω at the highest).
- Use either Wire type D990 by West Penn or Cable provided by Aiphone Co., Ltd.**
For other types, normal operation or max. communication distance cannot be guaranteed.

- Housing & color: Fire-retardant ABS plastic, in white.
- Dimensions: 185 (W) x 195 (H) x 84 (D) (mm).
7-1/4" (W) x 7-3/4" (H) x 3-5/16" (D).
- Weight: 1.1Kg. (2.43 lbs.) approx.

AIPHONE CO., LTD., NAGOYA, JAPAN
AIPHONE CORPORATION, BELLEVUE, WA, USA
AIPHONE EUROPE NV, ANTWERP, BELGIUM



COMMUNICATION SYSTEMS
AIPHONE[®]
HOME, BUSINESS, INDUSTRY.

KB-3MRD-I/M(E) 0800C

Printed in Japan (E)