

VIDEO ADAPTOR

Model;
MFW-P3
(3-camera video adaptor)

INSTRUCTIONS

1

NAMES AND FUNCTIONS

- ① Junction terminal (2) for coaxial cable
- ② Cover for setting switch section & mounting screw
- ③ Cover for mounting screw
- ④ Surface-mount back box

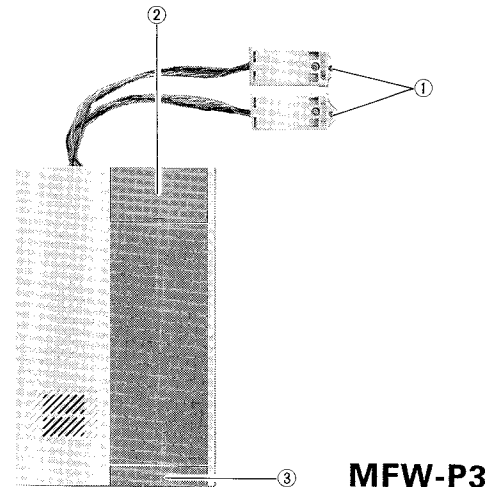
MFW-P3
2

FEATURES

* MFW-P3 is a video adaptor for use with IE/MF-D system or LEF, LEF-B/MF-DL system.

SYSTEM	VIDEO DOOR STATION		ROOM STATION	VIDEO MONITOR	
	Model	(QTY.)		MODEL	(QTY.)
IE	MF-D	1	IE-1AD(U)	MFH-U	10
		1	IE-1GD(U) & IEH-1CD	MFH-U	10
		2	IE-2AD(U) & IEH-1CD	MFH-U	
LEF, LEF-B	MF-DL	3	LEF-5, LEF-10, LEF-10S	MFH-U	10
			LEF-5B, LEF-10SB	MFH-UB	

- * Accepts max. three cameras.
- * Aiphone's video door stations can be used for surveillance purpose, as well as for communication.
- * Includes door release control for each entry (max. 3 per system).
- * Available in a surface-mount box.
- * Video monitoring of 3 entries in succession by pressing MONITOR button on any MFH video monitor.
- * Includes relay output for controlling external/illumination lamp or external camera.

3

INSTALLATION

(1) SETTING SWITCHES;

Remove front cover and five switches are located as shown below. Set switch 1 ~ 3 according to your system configuration.

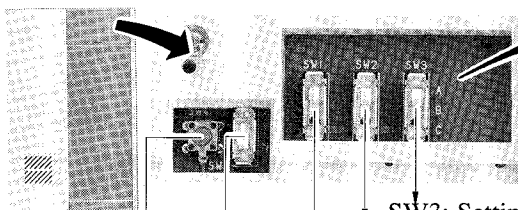

Put to A position when MF-D/MF-DL is connected.
Put to B position when MFW-CZ camera is connected.
Put to C position when camera is not connected at all.

- SW3; Setting switch for camera No. 3 (connected to terminal 3)
- SW2; Setting switch for camera No. 2 (connected to terminal 2)
- SW1; Setting switch for camera No. 1 (connected to terminal 1)
- SW5; System selector switch (shipped in N position; must NOT be changed)
- SW4; Reset switch. Use when putting system to initial standby mode or when changing modes.

3

INSTALLATION

(2) ACTUAL TERMINAL LOCATION;

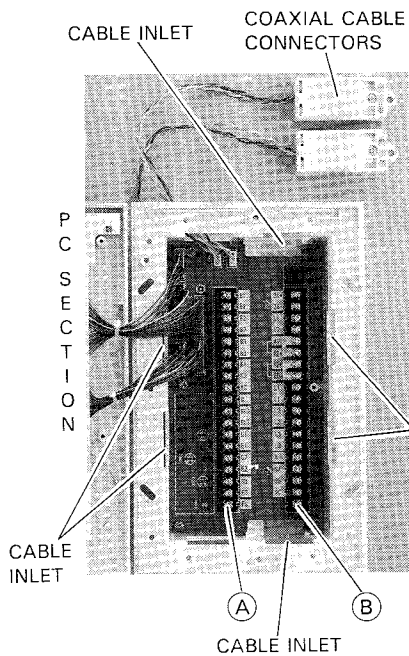

MFW-P3 INSIDE VIEW

SECTION A

- B1 for camera No. 1
- B1 for camera No. 2
- B2 for camera No. 2
- B2 for camera No. 3
- B3 for camera No. 3
- KA for video control
- KB for video control
- KC for video control
- U for video control
- EL2 for door release control (LEF)
- EL1 - do - (IE)
- D1 for video door station No. 1 (IE)
- E1 for video door station No. 1 (IE)
- D2 for video door station No. 2 (IE)
- E2 for video door station No. 2 (IE)
- D3 for video door station No. 3 (IE)
- E3 for video door station No. 3 (IE)
- FG for grounding

SECTION B

- 24+ for MFH monitor power supply
- 24-
- U1
- U2
- AV
- 12+
- 12-
- ED
- L1 for door release control No. 1
- L1 for door release control No. 2
- L2 for door release control No. 2
- L2 for door release control No. 3
- L3 for door release control No. 3
- L3
- R for occupied mode (LEF)
- SA for calling detection (from door No. 1)
- SB for calling detection (from door No. 2)
- SC for calling detection (from door No. 3)

(3) WALL-MOUNTING;

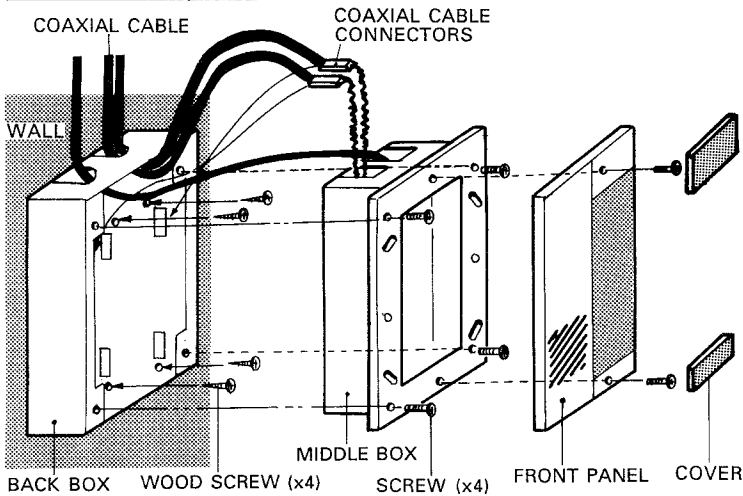

MFW-P3 is shipped with surface-mount back box. After opening knock-out holes for cable inlets, attach the back box with the supplied 4 wood screws. There is no upside-down of the back box. Then, attach the middle unit to the back box with the supplied 4 screws, putting the coaxial cable connectors to each side. After wiring, reattach the front cover to the middle unit.

* MOUNTING ACCESSORIES;

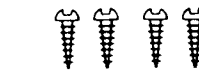

Wood screw (4)
(for mounting back box to wall)

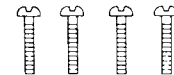

Screw (4)
(for mounting middle box to back box)

(4) NOTES ON SYSTEM LAYOUT;

- MF-D & MF-DL video door stations can be used for both communication and surveillance.
- MFW-P3 adaptor accepts max. 3 video door stations.

SYSTEM	NO. OF STATIONS		SURVEILLANCE
	DOOR (video)	ROOM	CAMERA (*)
IE-1AD(U)	1 (MF-D)	1	2
IE-1GD(U)	1 (MF-D)	3	2
IE-2AD(U)	2 (MF-D)	3	1
LEF LEF-B	3 (MF-DL)	8	0

(*) Shows numbers of camera installable when video door station is used to full capacity.

- Video door station can also be audio only door station plus surveillance camera.
- When installing MFW-CZ camera for surveillance purpose only, connect to VIDEO INPUT terminal 1, so that the picture from MFW-CZ 1 appears by first push of MONITOR button. (In this case, there is no need to connect terminals KA, SA).
- For door station/camera connection, the related terminals must correspond to one another in the manner as on page 3;

For LEF system;

Door station No.	1	2	3
Door-assigned terminal (LEF)	10	9	8
Door station terminal (BGR-10A)	DA	DB	DC
For calling detection (MFW-P3 & BGR-10A)	SA	SB	SC
Video control (MFW-P3)	KA	KB	KC
- do - (LEF)	K10	K9	K8
For door release control (MFW-P3)	L1	L2	L3
Coaxial cable input	1	2	3
Camera/area No.	1	2	3
Camera-assigned terminal (MFW-P3)	B1	B2	B3
Coaxial cable input	1	2	3

EXAMPLE; In LEF system;

No.	1	2	3
Unit connected;	MFW-CZ	MF-DL	MF-DL
Terminals used;	B1	10, DB, SB, KB, K10, L2	9, DC, SC, KC, K9, I3
Coaxial cable input;	1	2	3

For IE system;











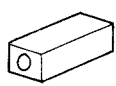
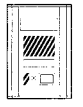
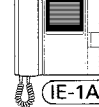
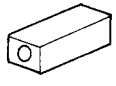
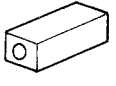

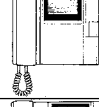
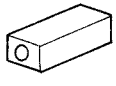

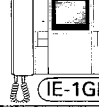
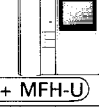
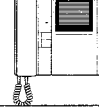
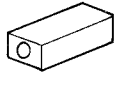
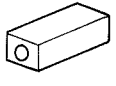

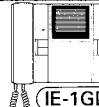
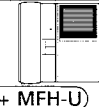
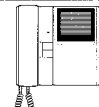
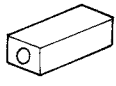
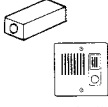

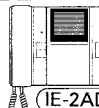

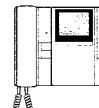
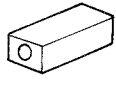



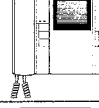
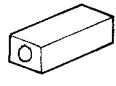





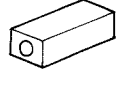
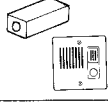

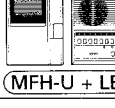



Door station No.	1	2	—
Door-assigned terminal (IE)	D1, E1	D2, E2	—
Coaxial cable input	1	2	3
For door release control	L1	L2	L3
Camera/area No.	1	2	3
Camera-assigned terminal (MFW-P3)	B1	B2	B3
Coaxial cable input	1	2	3

NOTE; When MFW-CZ camera is included, leave the first corresponding terminals unconnected and use each next terminals for video (or audio) door stations.

EXAMPLE; In IE system;

No.	1	2	3
Unit connected;	MFW-CZ	MF-D	MF-D
Terminals used;	B1	D2, E2, L2	D3, E3, L3
Coaxial cable input;	1	2	3

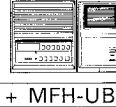
(5) SYSTEM CAPABILITIES

NO.	DOOR/AREA			VIDEO ADAPTOR	ROOM STATIONS			REMARKS
	1	2	3		1	2	3	
1				MFW-P3				* IE-1AD(U) accepts one video door station. * Adds monitoring capabilities of 1 or 2 areas thru camera(s).
2				MFW-P3				
3				MFW-P3				* IE-1GD(U) can have max. 3 room stations.
4				MFW-P3				
5				MFW-P3				* IE-2AD(U) can have 2 video door stations & 3 room stations.
6				MFW-P3				
7				MFW-P3				* LEF system can have max. 3 video door stations and/or cameras.
8				MFW-P3				* Door station call-in can be signalled at max. 2 room stations.
9				MFW-P3				
10								USA ONLY * Door station call-in can be announced by chime tone at all the room stations.

4 WIRING DIAGRAMS

IE-2AD(U) VIDEO SYSTEM

VIDEO DOOR STATION	2
SURVEILLANCE CAMERA	1
VIDEO MONITOR	3

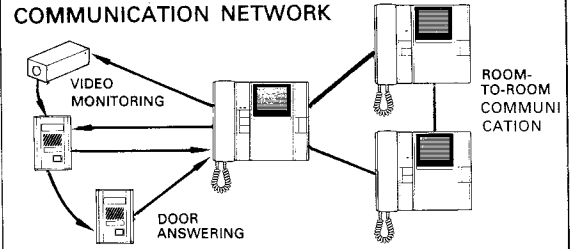
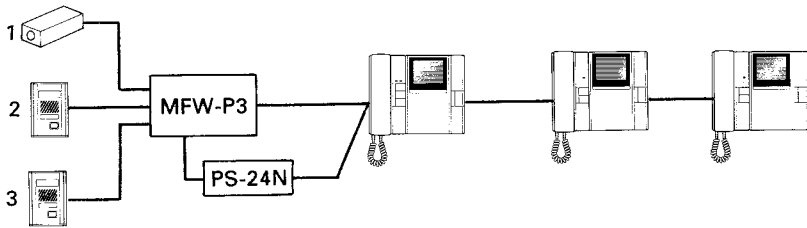

- 1 2 3**

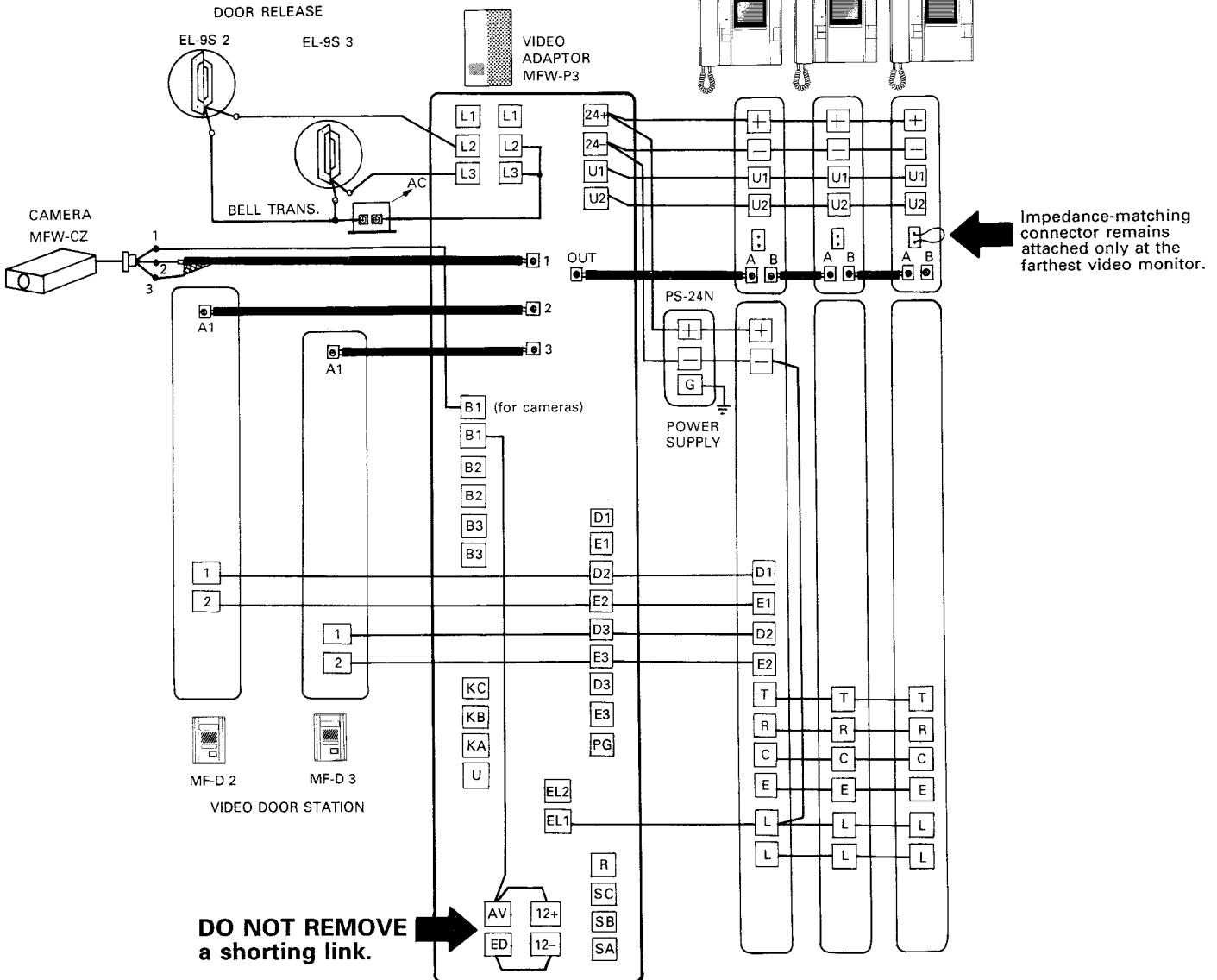

Door/area No.	1	2	3
Door-assigned terminal (IE)	—	D2, E2	D3, E3
for video control	—	—	—
for calling detection	—	—	—
for door release control	—	L2, L2	L3, L3
Camera-assigned terminal (MFW-P3)	B1	No need to connect B2	No need to connect B3
Video input terminal (MFW-P3)	1	2	3

LEF VIDEO SYSTEM

VIDEO DOOR STATION	1
VIDEO MONITOR	2



COMMUNICATION NETWORK

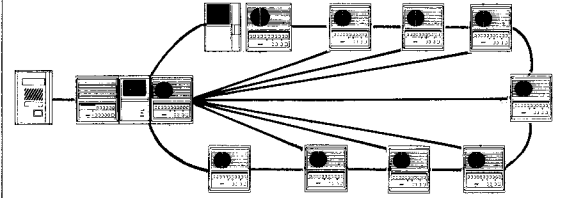

Door/area No.	1	2	3
Door-assigned No. terminal (LEF)	10	—	—
for video control	KA	—	—
for calling detection	SA	—	—
for door release control	L1, L1	—	—
Camera-assigned terminal (MFW-P3)	—	—	—
Video input terminal (MFW-P3)	1	—	—

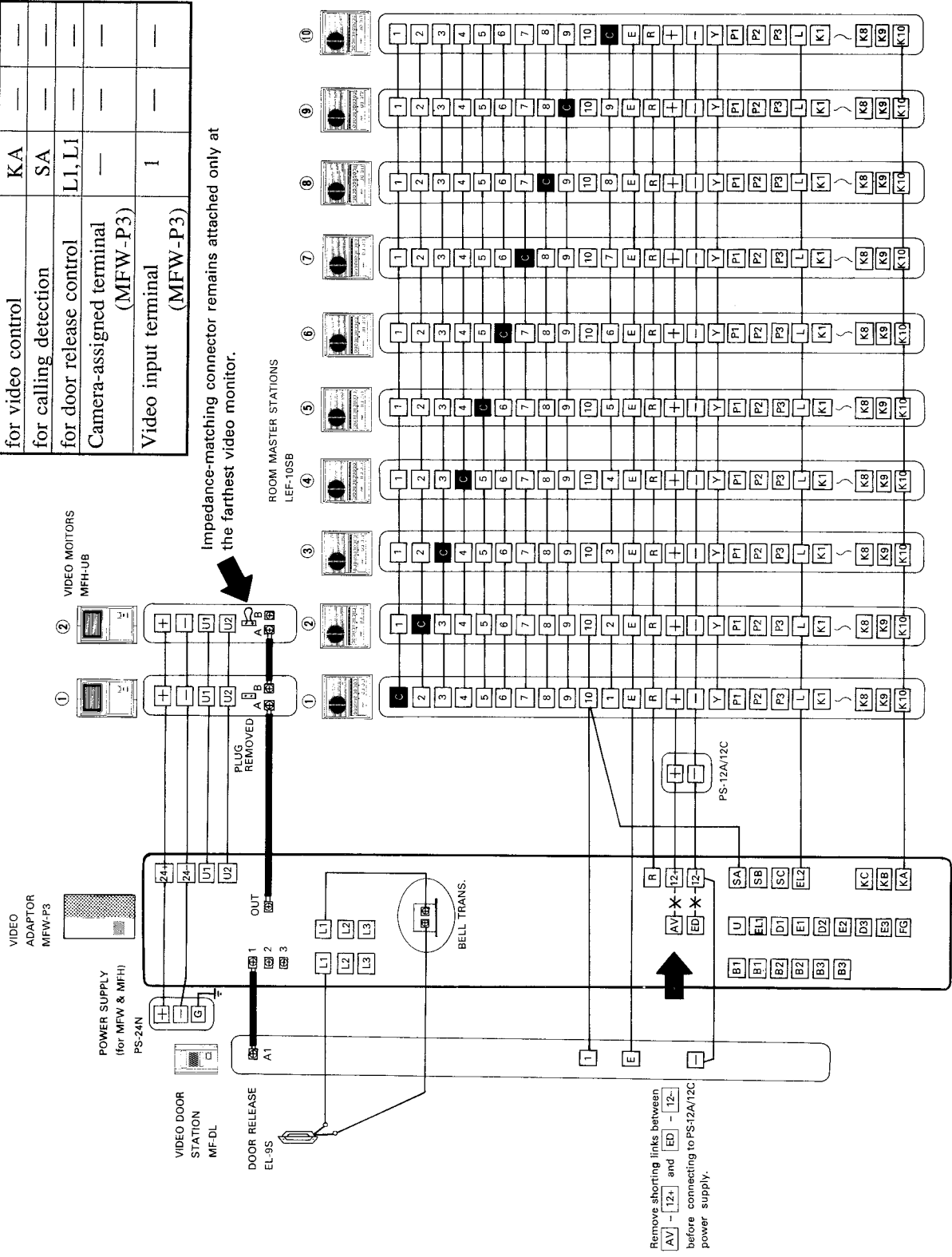

This is the most simple but basic video system with one video door station. MFW-P3 adaptor must be used for any LEF video system configuration, even with one video monitor.

LEF VIDEO SURVEILLANCE SYSTEM

VIDEO DOOR STATION	1
SURVEILLANCE CAMERA	2
VIDEO MONITOR	2

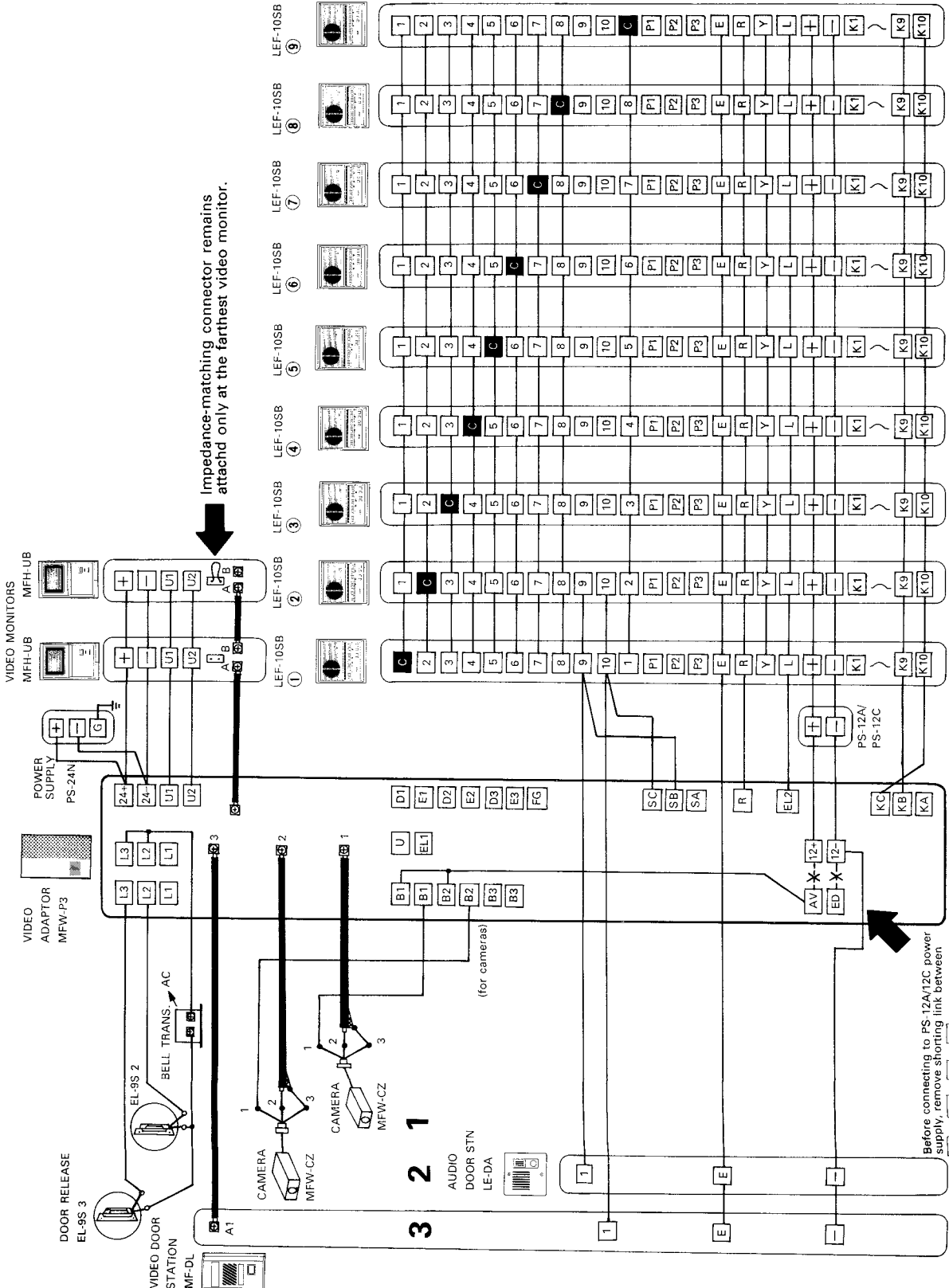

Door/area No.	1	2	3
Door-assigned No. terminal (LEF)	—	9	10
for video control	No need to connect KA	KC	KB
for calling detection	No need to connect SA	SC	SB
for door release control	—	L2, L2	L3, L3
Camera-assigned terminal (MFW-P3)	B1	B2	—
Video input terminal (MFW-P3)	1	2	3

This diagram is to show connection of video door station, audio only door station and camera only.

- * Assign No. 1 to MFW-CZ camera, so that picture from MFW-CZ comes on by the 1st push of MONITOR button.
- * For door/area No. 2, LE-DA audio door station is used with MFW-CZ camera, in lieu of MF-DL video door station.

Before connecting to PS-12A/12C power supply, remove shorting link between [AV] - [12+] & [ED] - [12-]

LEF 3-VIDEO ENTRY SECURITY & SURVEILLANCE SYSTEM

VIDEO DOOR STATION	3
VIDEO MONITOR	2
ROOM MASTER STATIONS	8

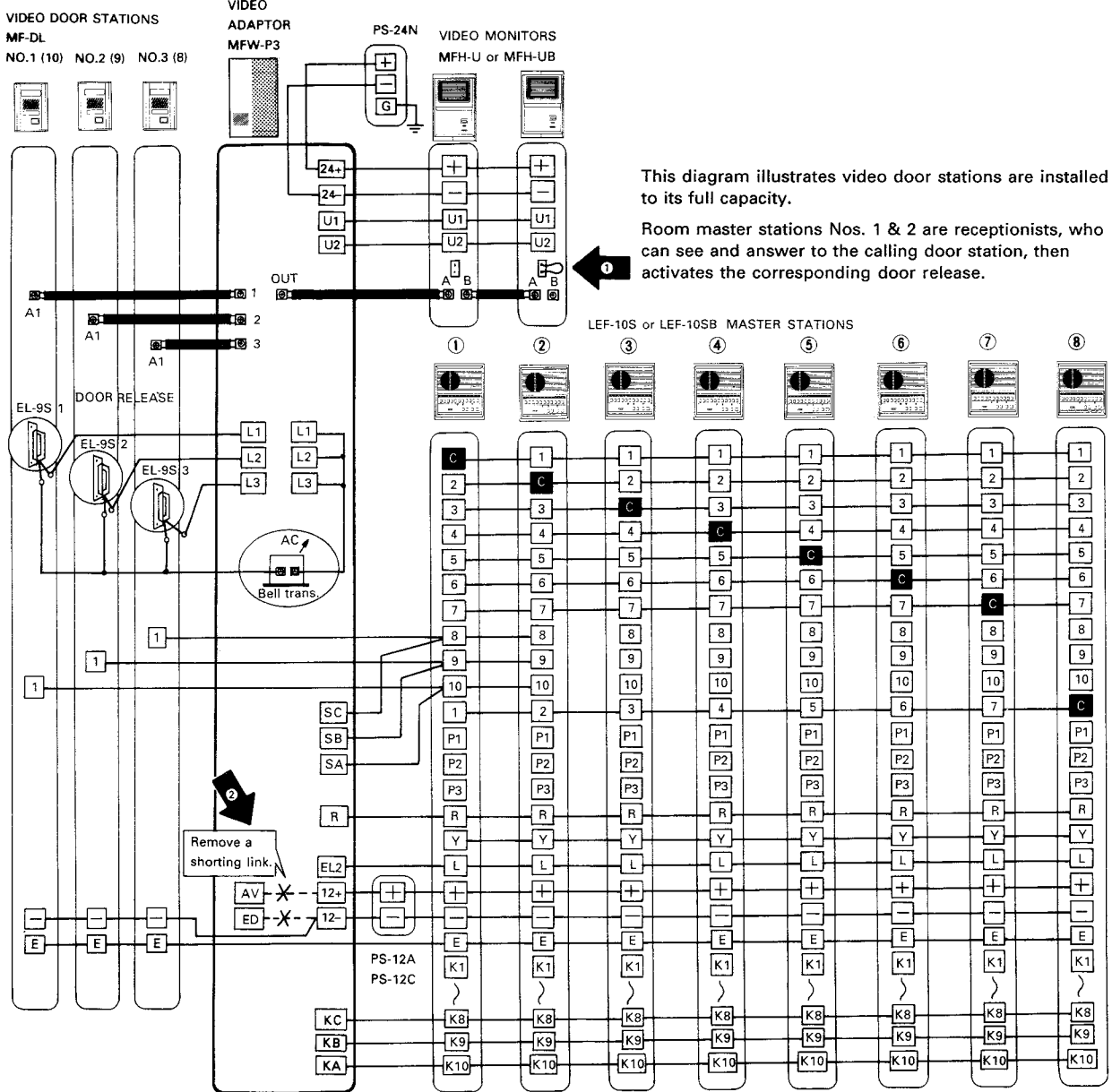
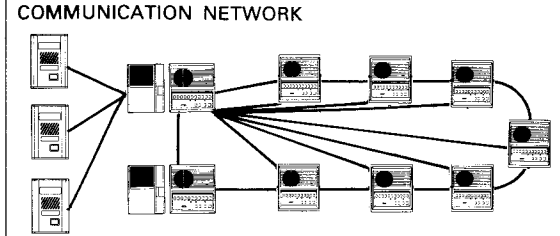
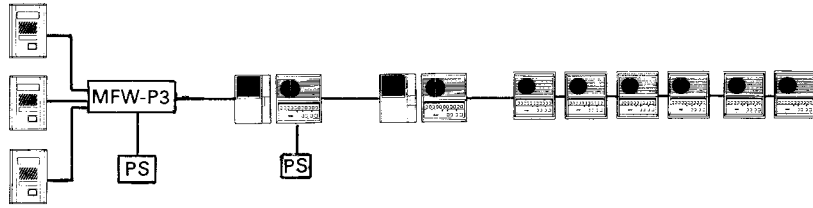

This diagram illustrates video door stations are installed to its full capacity.

Room master stations Nos. 1 & 2 are receptionists, who can see and answer to the calling door station, then activates the corresponding door release.

- ➡ **1** Remove the shorting link at all the video monitors, except at the farthest monitor.
- ➡ **2** Before connecting PS-12A/12C power supply, remove a shorting link between 12+ - AV and 12- - ED

On MFW-P3 adaptor, it must be noted that the door station terminals correspond to one another as follows;

Door station No.	1	2	3
Door-assigned No. terminal (LEF)	10	9	8
for video control	KA	KB	KC
for calling detection	SA	SB	SC
for door release control	L1, L1	L2, L2	L3, L3

5

SPECIFICATIONS

* Power source:	DC 24V. Use PS-24N power supply.																																							
* Current consumption:	0.6A (max.) (without video monitors included). Less than 0.1A (standby).																																							
* Installation:	Surface-mount.																																							
* Wiring:	<p>For LEF/LEF-B system;</p> <table border="1"> <tr> <td>Between MFW-P3 & BGR-10A.</td> <td colspan="4">6 wires (KA ~ KC; SA ~ SC)</td> </tr> <tr> <td>Between MFW-P3 & MFH-U/UB</td> <td colspan="4">4 wires (24+, 24-, U1, U2) and one coaxial cable (OUT)</td> </tr> <tr> <td>Between MFW-P3 & LEF</td> <td colspan="4">4 wires (KA ~ KC; R)</td> </tr> <tr> <td>Between MFW-P3 & MF-DL</td> <td colspan="4">One coaxial cable (1, 2 or 3)</td> </tr> </table> <p>For IE chime tone intercom system;</p> <table border="1"> <tr> <td>Between MFW-P3 & MF-D</td> <td colspan="4">2 wires & one coaxial cable per door station.</td> </tr> <tr> <td>Between MFW-P3 & IE main room station</td> <td colspan="4">2 wires per door station.</td> </tr> <tr> <td>Between MFW-P3 & MFH-U</td> <td colspan="4">4 wires (24+, 24-, U1, U2) and one coaxial cable.</td> </tr> </table>					Between MFW-P3 & BGR-10A.	6 wires (KA ~ KC; SA ~ SC)				Between MFW-P3 & MFH-U/UB	4 wires (24+, 24-, U1, U2) and one coaxial cable (OUT)				Between MFW-P3 & LEF	4 wires (KA ~ KC; R)				Between MFW-P3 & MF-DL	One coaxial cable (1, 2 or 3)				Between MFW-P3 & MF-D	2 wires & one coaxial cable per door station.				Between MFW-P3 & IE main room station	2 wires per door station.				Between MFW-P3 & MFH-U	4 wires (24+, 24-, U1, U2) and one coaxial cable.			
Between MFW-P3 & BGR-10A.	6 wires (KA ~ KC; SA ~ SC)																																							
Between MFW-P3 & MFH-U/UB	4 wires (24+, 24-, U1, U2) and one coaxial cable (OUT)																																							
Between MFW-P3 & LEF	4 wires (KA ~ KC; R)																																							
Between MFW-P3 & MF-DL	One coaxial cable (1, 2 or 3)																																							
Between MFW-P3 & MF-D	2 wires & one coaxial cable per door station.																																							
Between MFW-P3 & IE main room station	2 wires per door station.																																							
Between MFW-P3 & MFH-U	4 wires (24+, 24-, U1, U2) and one coaxial cable.																																							
* Wiring distance:	<p>Between MFW-P3 and MF-DL/MF-D;</p> <table border="1"> <tr> <td>Coaxial cable Diameter</td> <td>3C-2V 0.65 mm</td> <td>5C-2V 0.65 mm</td> <td>Coaxial cable AWG</td> <td>RG-59/U (22GA) 22AWG</td> <td>RG-59/U (20GA) 22AWG</td> </tr> <tr> <td>Distance</td> <td>50 m</td> <td>150 m</td> <td>Distance</td> <td>165'</td> <td>495'</td> </tr> </table>					Coaxial cable Diameter	3C-2V 0.65 mm	5C-2V 0.65 mm	Coaxial cable AWG	RG-59/U (22GA) 22AWG	RG-59/U (20GA) 22AWG	Distance	50 m	150 m	Distance	165'	495'																							
Coaxial cable Diameter	3C-2V 0.65 mm	5C-2V 0.65 mm	Coaxial cable AWG	RG-59/U (22GA) 22AWG	RG-59/U (20GA) 22AWG																																			
Distance	50 m	150 m	Distance	165'	495'																																			
* Dimensions & weight:	<p>Back box; (H x W x D) 240 x 160 x 45 (mm) (9-7/16" x 6-5/16" x 1-3/4"). Front cover; (H x W x D) 240 x 160 x 60 (mm) (9-7/16" x 5-15/16" x 2-3/8"). Projects 20 mm (13/16") from the wall. Approx. 1,320g (2.91 lbs.).</p>																																							

WARRANTY

Aiphone warrants its products to be free from defects of material and workmanship under normal use and service for a period of one year after delivery to the ultimate user and will repair free of charge or replace at no charge, should it become defective upon which examination shall disclose to be defective and under warranty. Aiphone reserves unto itself the sole right to make the final decision whether there is a defect in materials and/or workmanship; and whether or not the product is within the warranty.

This warranty shall not apply to any Aiphone product which has been subject to misuse, neglect, accident, or to use in violation of instructions furnished, nor extended to units which have been repaired or altered outside of the factory.

This warranty does not cover batteries or damage caused by batteries used in connection with the product.

This warranty covers bench repairs only, and any repairs must be made at the shop or place designated in writing by Aiphone. Aiphone will not be responsible for any costs incurred involving on site service calls.

Aiphone Co., Ltd. Nagoya, Japan
Aiphone Corporation, Bellevue, WA, USA



INTERCOM SYSTEMS
AIPHONE

HOME, BUSINESS, INDUSTRY

Printed in Japan(E)

MFW-P3-I(E)0990A