

# Setting Up Your PowerBook

Includes setup, expansion, and troubleshooting  
information for PowerBook computers

 **Apple Computer, Inc.**

© 2000 Apple Computer, Inc. All rights reserved.

Under the copyright laws, this manual may not be copied, in whole or in part, without the written consent of Apple.

The Apple logo is a trademark of Apple Computer, Inc., registered in the U.S. and other countries. Use of the “keyboard” Apple logo (Option-Shift-K) for commercial purposes without the prior written consent of Apple may constitute trademark infringement and unfair competition in violation of federal and state laws.

Every effort has been made to ensure that the information in this manual is accurate. Apple is not responsible for printing or clerical errors.

Apple Computer, Inc.  
1 Infinite Loop  
Cupertino, CA 95014-2084  
408-996-1010  
<http://www.apple.com>

Apple, the Apple logo, AppleFalk, FireWire, Mac, Macintosh, and PowerBook are trademarks of Apple Computer, Inc., registered in the U.S. and other countries.

AirPort, The Apple Store, and Final Cut Pro are trademarks of Apple Computer, Inc.

ENERGY STAR® is a U.S. registered trademark.

PowerPC is a trademark of International Business Machines Corporation, used under license therefrom.

Other company and product names mentioned herein are trademarks of their respective companies. Mention of third-party products is for informational purposes only and constitutes neither an endorsement nor a recommendation. Apple assumes no responsibility with regard to the performance or use of these products.

Manufactured under license from Dolby Laboratories. “Dolby,” “Pro Logic” and the double-D symbol are trademarks of Dolby Laboratories. Confidential Unpublished Works, © 1992–1997 Dolby Laboratories, Inc. All rights reserved.

The product described in this manual incorporates copyright protection technology that is protected by method claims of certain U.S. patents and other intellectual property rights owned by Macrovision Corporation and other rights owners. Use of this copyright protection technology must be authorized by Macrovision Corporation and is intended for home and other limited viewing uses only unless otherwise authorized by Macrovision Corporation. Reverse engineering or disassembly is prohibited.

Apparatus Claims of U.S. Patent Nos. 4,631,603, 4,577,216, 4,819,098 and 4,907,093 licensed for limited viewing uses only.

Simultaneously published in the United States and Canada.



# Contents

## **1 Getting Started 7**

- Plugging In the Computer 8
  - Connecting the Internal Modem 8
- Opening the Display 9
- Turning the Computer On 10
  - Problems Turning the Computer On? 10
- Moving Items on the Screen 11
  - Tips for Using the Trackpad 11
- Adjusting the Internal Display 12
  - Adjusting the Brightness 12
  - Adjusting the Display Resolution 12
- Where to Go From Here 13
- Additional Information in Online Help and Apple Web Sites 14
- What to Do When You Are Finished Working 16
  - Put Your PowerBook to Sleep 16
  - Shut Down Your PowerBook 16

## **2 Features of Your PowerBook 17**

- Basic Features of Your PowerBook 18
- Additional Features of Your PowerBook 20
- Internal Expansion Capabilities of Your PowerBook 22
- Keyboard Controls, Hot Function Keys, and Numeric Keypad 24
  - Assigning Hot Function Keys 24
  - Using the Standard Function Keys 24
  - Using the Embedded Numeric Keypad 25

|  |    |
|--|----|
| For More Information on Keyboard Controls                    | 25 |
| Universal Serial Bus (USB)                                   | 26 |
| Connecting and Using a USB Device                            | 26 |
| USB Devices and Battery Power                                | 26 |
| Using Multiple USB Devices at the Same Time                  | 27 |
| For More Information on USB                                  | 27 |
| FireWire   | 28 |
| Connecting FireWire Devices                                  | 28 |
| FireWire Devices and Battery Power                           | 29 |
| FireWire Target Disk Mode                                    | 29 |
| For More Information on FireWire                             | 29 |
| AirPort Wireless Internet and Networking                     | 30 |
| How AirPort Provides Wireless Internet Access                | 30 |
| For More Information on AirPort                              | 30 |
| Installing an AirPort Card                                   | 31 |
| External Monitor Support (VGA and S-Video)                   | 38 |
| Connecting an External Monitor                               | 38 |
| Switching Between Extended Desktop and Video Mirroring Modes | 39 |
| Connecting a Television, VCR, or Other Video Device          | 39 |
| Using Your PowerBook With the Display Closed                 | 39 |
| For More Information on Using an External Monitor            | 39 |
| Battery and Dual Battery Support                             | 40 |
| Monitoring Battery Charge Level                              | 40 |
| Removing or Replacing a Battery                              | 40 |
| Charging a Battery   | 40 |
| Battery-Saving Tips  | 41 |
| For More Information on Your PowerBook Battery               | 41 |
| Expansion Bay Modules  | 42 |
| Determining Whether a Module Can Be Removed                  | 42 |
| Ejecting an Expansion Bay Module                             | 43 |
| For More Information on Expansion Bay Modules                | 43 |
| DVD Drive  | 44 |
| Inserting Discs  | 44 |
| Ejecting a Disc From the DVD Drive                           | 45 |

|  |    |
|--|----|
| Playing DVD Discs  | 45 |
| For More Information on Your DVD Drive                     | 45 |
| Infrared (IrDA)  | 46 |
| Making an Infrared Connection                              | 46 |
| For More Information on Infrared                           | 46 |
| PC Cards   | 47 |
| Inserting a PC Card  | 47 |
| Ejecting a PC Card   | 47 |
| For More Information on PC Cards                           | 47 |
| Ethernet (10/100 Base-T)                                   | 48 |
| For More Information on Using Ethernet                     | 48 |
| Security Slot and Keyboard Lock                            | 49 |
| Installing Additional Memory                               | 50 |
| RAM Specifications   | 50 |
| Maximum RAM Configurations                                 | 50 |
| Installing RAM in the Upper RAM Slot                       | 51 |
| Checking to See if Your Computer Recognizes the New Memory | 57 |
| Replacing RAM in the Lower RAM Slot                        | 58 |
| Removable Hard Disk  | 60 |
| PowerBook Specifications                                   | 62 |

### **3 Troubleshooting 65**

|  |    |
|--|----|
| Information in This Chapter                        | 65 |
| Problems That Prevent You From Using Your Computer | 66 |
| Other Problems                                     | 67 |

### **Appendix**

### **Cleaning, Storage, Safety, and Ergonomic Information 69**

|  |    |
|--|----|
| Cleaning Your PowerBook                                    | 69 |
| Cleaning Your PowerBook Display                            | 69 |
| Storing Your PowerBook                                     | 69 |
| Safety Instructions for Setting Up and Using Your Computer | 70 |
| Plugging In the Power Adapter                              | 70 |
| Connecting a Phone Line to the Internal Modem              | 70 |
| Using Your PowerBook                                       | 70 |

|                                       |    |
|---------------------------------------|----|
| General Safety Instructions           | 71 |
| Ergonomics                            | 72 |
| Communications Regulation Information | 75 |
| Laser Information                     | 80 |
| High-Risk Activities Warning          | 80 |
| ENERGY STAR                           | 80 |

# Getting Started

Your PowerBook has been designed so that you can set it up quickly and start using it right away. If you have never used a PowerBook or are new to Macintosh computers, read this section for instructions on getting started and where to get more information.

If you are an experienced user, you may already know enough to get started. Be sure to look over the information in this book to find out about the new features of this PowerBook.

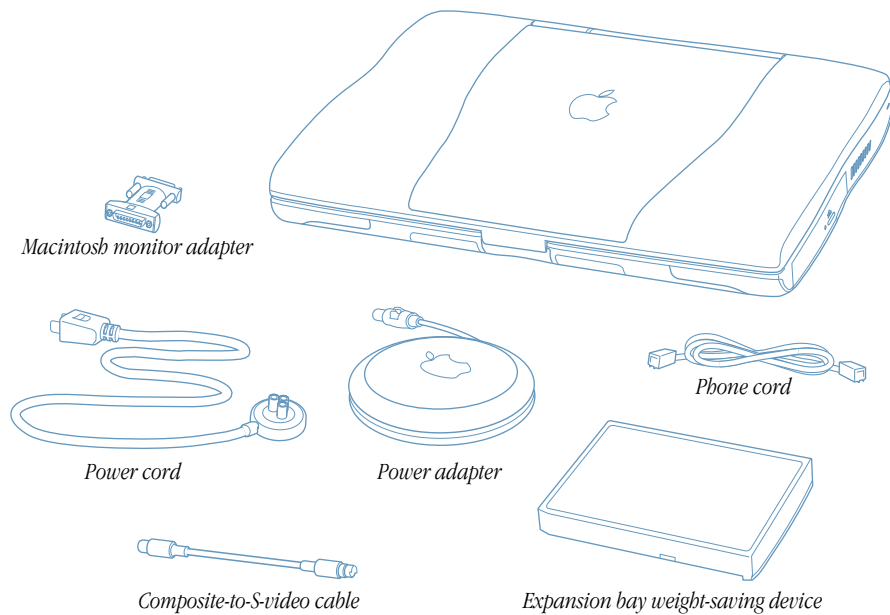

**Important** Read all the installation instructions and safety information (see page 70) carefully before you plug your computer into a wall socket.

## Plugging In the Computer

Plugging in the power adapter recharges the computer's battery. You should plug in the power adapter in case the battery has been drained during shipping or storage.

- 1 Plug one end of the power cord into the power adapter and the other end into an outlet.
- 2 Plug the power adapter plug into the power adapter port (marked with the icon ) on the back of the computer.

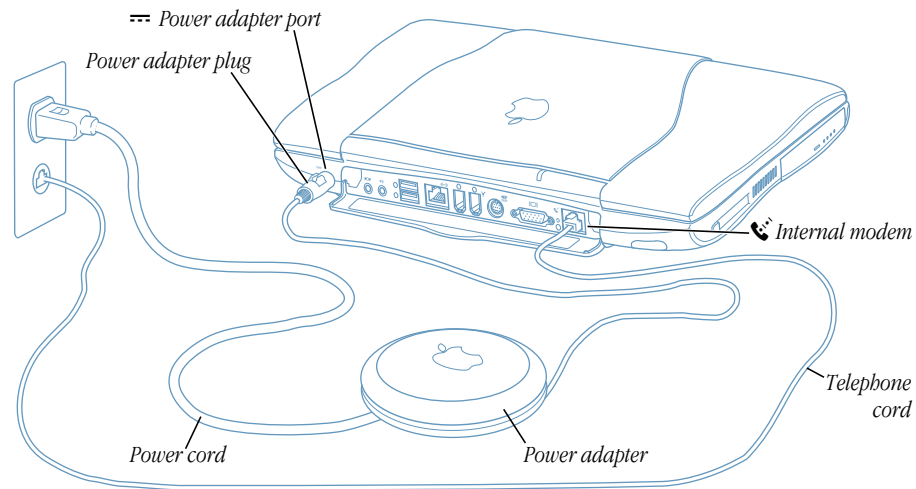

## Connecting the Internal Modem

If you want to get connected to the Internet right away, connect one end of the phone cord to the internal modem port (marked with the icon ) and the other end to an analog telephone line (the type of telephone line found in most residences).

**Warning** Do not connect a digital telephone line to the modem, because the wrong type of line could damage the modem.



## Opening the Display

- 1 Push the display release button.

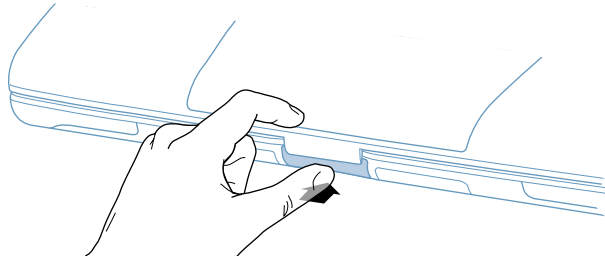

- 2 Open the display and position it at a comfortable viewing angle.

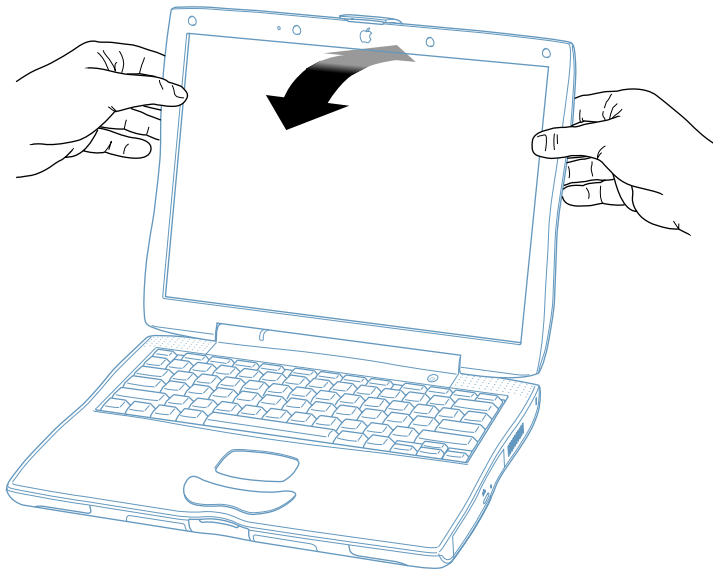

## Turning the Computer On

To turn on the computer, press the Power button (⏻) above the keyboard.

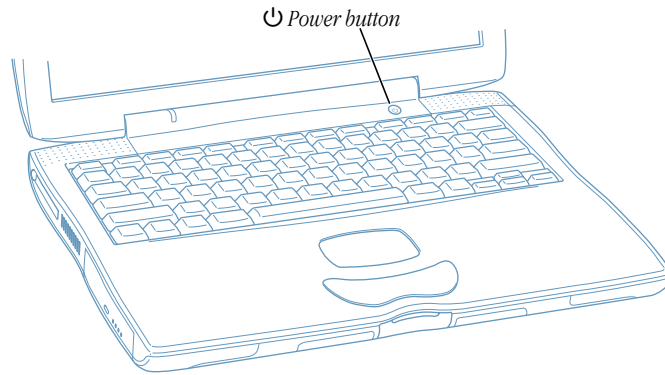

You should hear a tone when you turn on the computer. It takes the computer a few moments to start up.

### Problems Turning the Computer On?

#### **Nothing happens when you press the Power button.**

- The battery may be drained. Make sure that you plugged in the power adapter, and that the adapter is firmly connected to both the computer and a power source.
- If the computer still doesn't start up when you press the Power button, use the tip of a pen to press the reset button (see page 20) on the back of the computer. Wait a few seconds and then press the Power button again.
- If the computer still doesn't start up, see “If the computer won't turn on or start up” on page 67.

#### **After you press the Power button, there is a slight delay before the computer starts up.**

- This is normal. When you press the Power button, the PowerBook checks its memory before it starts up. The more memory installed in the PowerBook, the longer the delay.

#### **You see a picture of a disk or a folder with a blinking question mark.**

- This icon usually means that the computer can't find system software on the hard disk or any disks attached to the computer. You may need to reinstall system software. See “If the computer freezes during startup or you see a flashing question mark” on page 66.

## Moving Items on the Screen

You use your PowerBook trackpad to move items and select items on the screen, much as you use a mouse with a desktop computer. To move the arrow pointer on the screen, slide your finger across the trackpad. To select, click, or double-click an item on the screen, use the trackpad button.

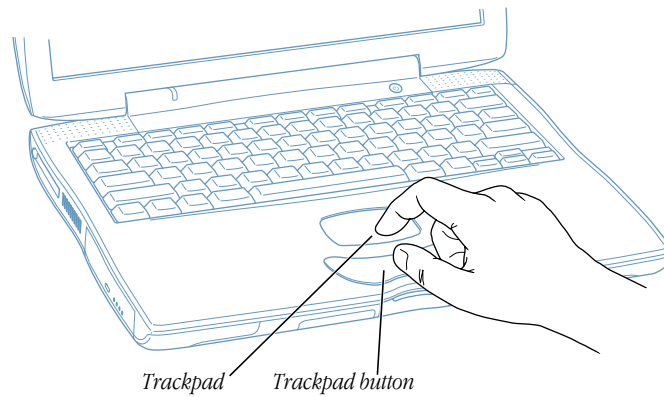

The trackpad is sensitive to how quickly you move your finger. To move the pointer a short distance across the screen, move your finger slowly across the trackpad. The faster you move your finger, the farther the pointer moves on the screen.

### Tips for Using the Trackpad

For best results when using the trackpad, keep in mind these tips:

- Use only one finger.
- Use only your finger on the trackpad. Do not use a pen or any other object.
- Keep your finger and the trackpad dry. If the trackpad becomes moist from humidity or condensation, gently wipe it with a clean cloth before you use it.
- Never use any kind of cleaning solution on the trackpad.

For more information on using the trackpad, see Mac Help, available in the Help menu.

## Adjusting the Internal Display

Before you begin working with your new PowerBook, you may need to adjust your display so that items on the screen are easy to see.

### Adjusting the Brightness

Use the keys labeled with the ☼ icon to adjust screen brightness.

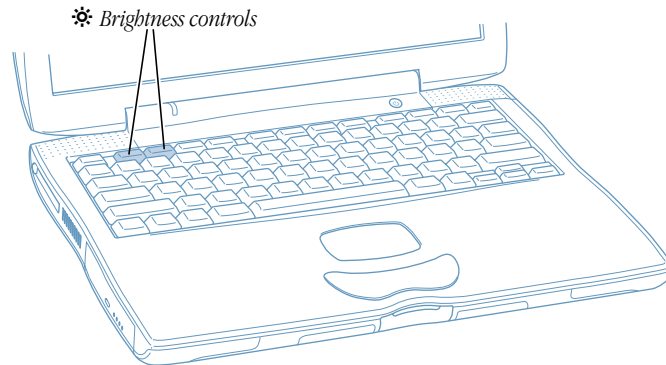

### Adjusting the Display Resolution

You can increase the size of images on your display by switching from the standard resolution to a scaled resolution. Click the Resolution portion of the Control Strip.



When you switch to a scaled resolution, items on the screen appear larger, making them easier to see. However, scaled resolutions may not be as sharp as the standard display resolution.

## Where to Go From Here

That's everything you need to know to get your PowerBook up and running for the first time. The first time that you turn your computer on, the Macintosh Setup Assistant will take you through the rest of the process of configuring your computer for the first time and setting up for the Internet.

If you would like additional information, see the following:

- To learn about the additional information available in the onscreen help and on the Internet, see “Additional Information in Online Help and Apple Web Sites” on page 14.
- For instructions on shutting down your computer or putting it to sleep, see “What to Do When You Are Finished Working” on page 16.
- For information about what you can do with your PowerBook, see Chapter 2, “Features of Your PowerBook.”
- If you have a problem with your PowerBook, see Chapter 3, “Troubleshooting.”

## Additional Information in Online Help and Apple Web Sites

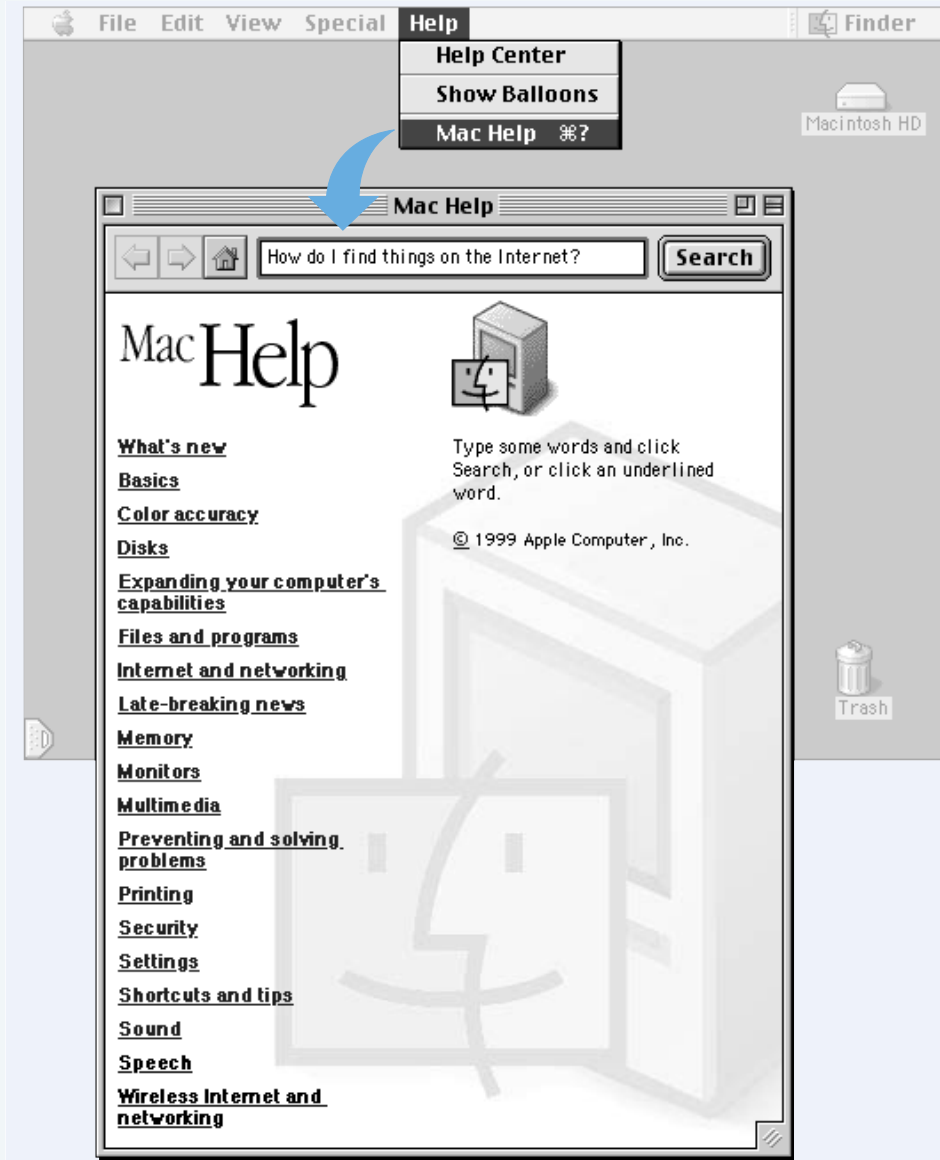



Apple Web Site  
[www.apple.com](http://www.apple.com)  
Links to everything Apple.



The Apple Store  
[www.apple.com/store](http://www.apple.com/store)  
The latest Apple hardware, software, and accessories.



Apple Support Web Site  
[www.apple.com/support](http://www.apple.com/support)  
Need extra help? Visit here for product support, software updates, and technical information.



Apple PowerBook Web Site  
[www.apple.com/powerbook](http://www.apple.com/powerbook)  
News and information specifically for PowerBook users.

## What to Do When You Are Finished Working

When you have finished working with your PowerBook, you have two options.

### Put Your PowerBook to Sleep

If you are only going to be away from your PowerBook for a short period of time, put the computer to sleep. When the computer is in sleep, you can quickly wake it and bypass the startup process. When the computer is in sleep, its screen is dark and appears to be off and a small green light on the case pulsates.

To quickly put the computer to sleep, do one of the following:

- Close the display.
- Choose Sleep from the Special menu.

**Warning** Wait a few seconds until the Apple logo on the top of the case stops glowing (indicating that the computer is in sleep and the hard disk has stopped spinning) before you move your PowerBook. Moving your computer while the hard disk is spinning can damage your computer.

To wake the computer:

- If the display is closed, open it. Your PowerBook will automatically wake from sleep when you open the display. (You can turn off this option in the Energy Saver control panel.)
- If the display is already open, press the Power button (⏻) or any key on the keyboard.

### Shut Down Your PowerBook

If you are not going to use your PowerBook for a day or two, you should shut it down. To shut down the PowerBook, do one of the following:

- Choose Shut Down from the Special menu.
- Press the Power button and click Shut Down in the dialog box that appears on the screen:

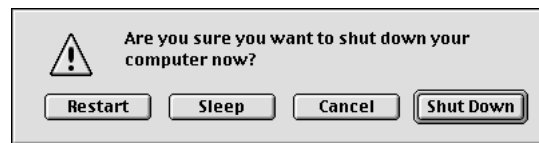



## Features of Your PowerBook

Your PowerBook has many built-in features and expansion capabilities you can use to customize and expand your PowerBook to fit your needs. These include the following:

- Universal Serial Bus (USB) for connecting additional equipment to your PowerBook, such as printers, scanners, joysticks, keyboards, digital cameras, and floppy drives.
- FireWire for connecting high-speed equipment, such as digital video cameras and external hard disks.
- The latest in communications technologies such as a 56K modem, infrared, 10/100 Base-T Ethernet, and optional AirPort wireless Internet and networking.
- The ability to use your PowerBook with an external monitor, video projector, or television, including support for video mirroring and creating an extended desktop. Use your PowerBook's built-in video support to do presentations, work with an external monitor, or play DVD-Video discs on your television.
- Long-lasting battery and the ability to use two batteries at the same time.
- Removable expansion bay modules, one Type II PC Card/CardBus slot, and user-upgradable memory.

To learn about what you can do with your PowerBook, start with the information in this chapter. Additional information can be found in Mac Help (see page 14) and on Apple's many Internet Web sites.

## Basic Features of Your PowerBook

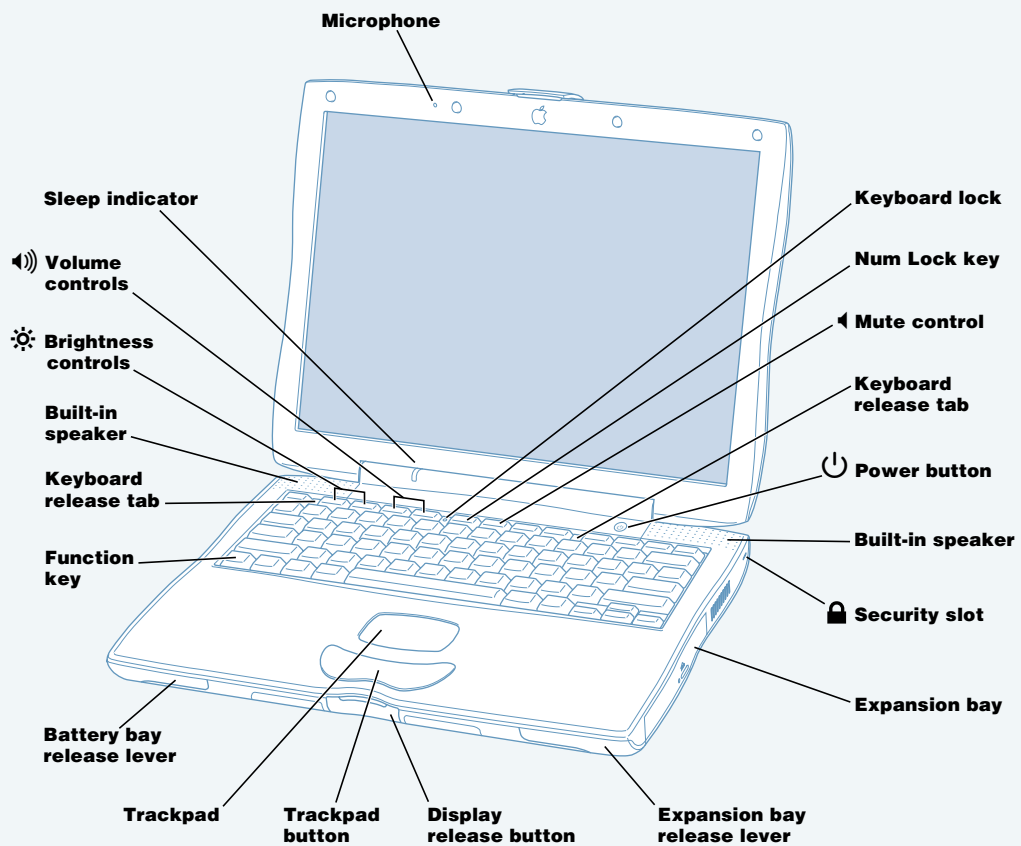

**Brightness controls**

Increase or decrease the brightness of your PowerBook display using these keys on your PowerBook keyboard.

**Volume controls**

Increase or decrease the volume of the sound coming from the built-in speakers and sound output port.

**Mute control**

Turns the sound from the PowerBook built-in speakers and sound output port off and on.

**Expansion bay with a DVD-ROM drive module inserted**

Dual-function expansion bay that accepts removable modules or a PowerBook battery. Use the DVD-ROM drive to install and run programs, play music CDs, play DVD-Video discs, or reinstall system software. To eject an expansion bay module, pull the expansion bay release lever toward you.

**Function (Fn) key**

Hold down this key to activate the function keys (F1–F12).

**Keyboard release tabs**

When you need to install memory, install an AirPort Card, or remove the hard disk, pull these tabs down to release the PowerBook keyboard.

**Microphone**

Record sounds directly on your PowerBook hard disk with this built-in microphone.

**Num Lock key**

Activates the numeric keypad embedded in the PowerBook keyboard.

**Power button**

Turns your PowerBook on and off or puts it to sleep.

**Security slot**

Protect your PowerBook by connecting a security cable.

**Sleep indicator**

A pulsating green light indicates when the PowerBook is in sleep.

**Trackpad**

Moves the pointer on the PowerBook display. With the Trackpad control panel, you can set the trackpad to double-click and select items directly instead of using the trackpad button.

**Keyboard lock**

Protect the internal components of your PowerBook (such as memory and the hard disk drive) by preventing the keyboard from being easily removed.

---

## Additional Features of Your PowerBook

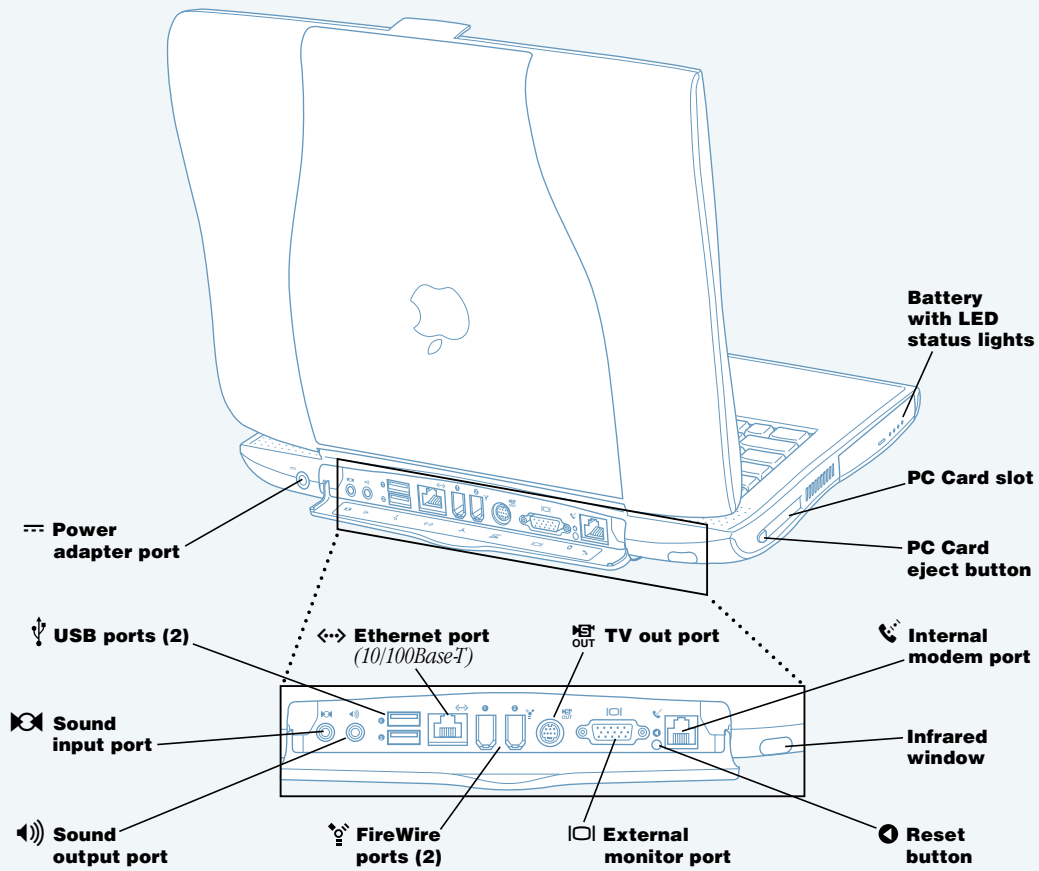

**External monitor port**

Connect to any external monitor or projection device that uses a VGA-style connector or to any older Macintosh monitor using the video adapter included with your PowerBook.

**TV out port**

Connect your PowerBook to a television, VCR, or other video device. You can use TV out for presentations or to play DVD-Video on your television.

**Ethernet port (10/100 Base-T)**

Connect to a high-speed 10/100Base-T Ethernet network or connect to another computer and transfer files.

**Infrared window**

Use infrared (IR) communication to send files to another IR-equipped computer, print on an IR-equipped printer, or connect to an IR network that uses the IrDA standard. You can also use IR to synchronize with certain handheld personal assistants and cellular telephones.

**PC Card slot**

Expand the capabilities of your PowerBook using this Type II PC Card slot that supports both PCMCIA and CardBus formats.

**Internal modem port**

Connect a standard phone line directly to the internal modem.

**PowerBook reset button**

Reset the computer with this button when you cannot shut it down using the Power button.

**Sound input port**

Connect an external line-level microphone or other sound input device.

**Sound output port**

Connect external speakers, headphones, or other sound output device.

**Two FireWire ports**

Connect digital video and other high-speed external devices, such as digital video cameras, printers, and external storage devices.

**Two USB (Universal Serial Bus) ports**

Connect additional equipment to your PowerBook, such as printers, external storage devices, modems, keyboards, and joysticks. Up to 127 devices can be connected at the same time using USB hubs.

---

## Internal Expansion Capabilities of Your PowerBook

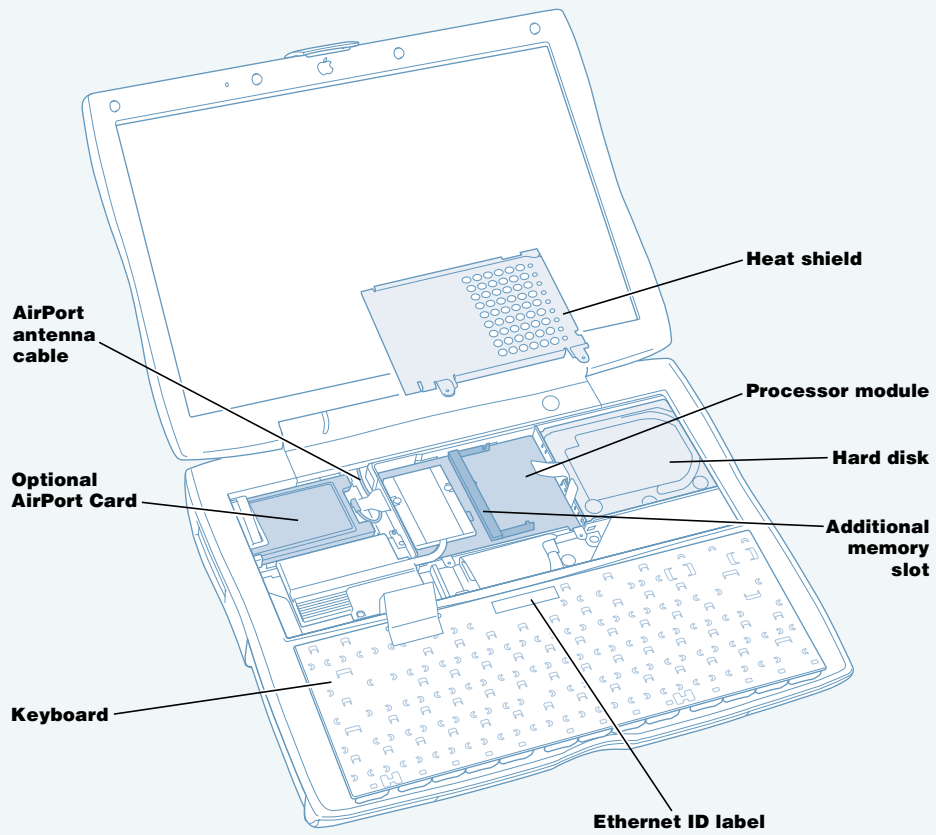

---

**Optional AirPort Card**

Installing an AirPort Card in your computer allows access to a wireless network. After removing the heat shield, connect the end of the antenna cable to the AirPort Card and then insert the card into the AirPort Card slot. For instructions, see “Installing an AirPort Card” on page 31.

**AirPort antenna cable**

The end of the built-in AirPort antenna attaches to the back of the optional AirPort Card.

**Additional memory slot**

You can install up to a 256 megabyte (MB) memory module in this slot (unless your PowerBook already has additional RAM installed). For instructions, see “Installing Additional Memory” on page 50.

**Processor module with main memory slot**

You can replace the memory located in the main slot on the bottom of the processor module. To upgrade your PowerBook to the maximum memory (512 MB), remove the memory and replace it with a 256 MB memory module. For instructions, see “Replacing RAM in the Lower RAM Slot” on page 58.

**Removable hard disk**

You can remove the internal hard disk for service or security. To remove the internal hard disk, you need to remove the processor module and then disconnect the hard disk cable from the main logic board. For instructions, see “Removable Hard Disk” on page 60.

---

## Keyboard Controls, Hot Function Keys, and Numeric Keypad

You can quickly adjust settings such as volume and screen brightness using the keyboard controls for volume and brightness.

Your PowerBook also has six additional keys that you can set up to open your frequently used applications or documents. These keys are known as *hot function keys*. For example, you can use hot function keys to open your Web browser, word processor, or favorite game. Once applications are open, you can use the hot function keys to switch quickly between them.

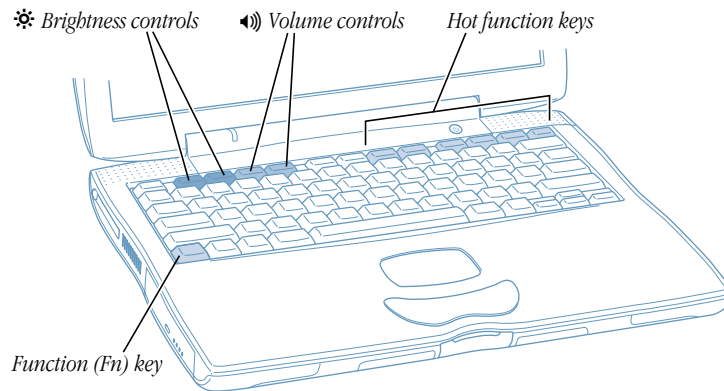

### Assigning Hot Function Keys

Assigning an application to a function key is simple. The first time you press one of the function keys, a dialog box appears that lets you assign any of the function keys to an application. After that, you can change function key assignments using the Keyboard control panel.

### Using the Standard Function Keys

You can quickly change a key from a control or hot function key to a standard function key by pressing the Fn key while you press the other key. You can also use the Keyboard control panel to reverse the keys so that the standard function keys are primary and the screen controls and hot function keys are secondary. (You would hold down the Fn key to change the screen brightness, for example.)



### Using the Embedded Numeric Keypad

Most desktop computer keyboards have a numeric keypad in addition to the regular keyboard keys. Your PowerBook keyboard has a numeric keypad incorporated with the standard keyboard keys. Keys used for the numeric keypad have a smaller secondary label.

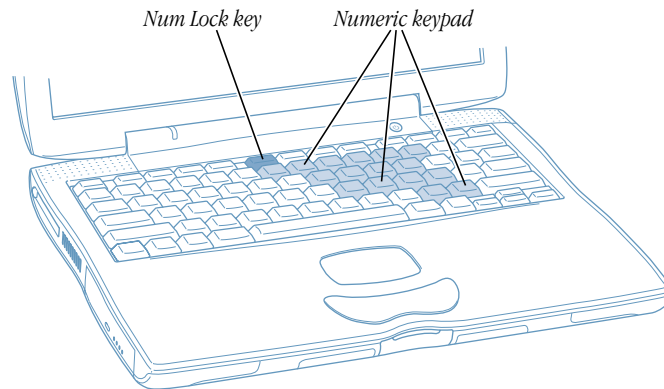

To use the numeric keypad, press the Num Lock key on the keyboard. The green light next to the Num Lock key turns on, indicating that the keypad is active. When you're finished, press the Num Lock key again to turn it off.

**Note:** When the numeric keypad is active, other keys and menu keyboard equivalents (such as  $\mathbb{Q}$ -Q to quit) are deactivated.

### For More Information on Keyboard Controls

Additional information on configuring the keyboard controls and hot function keys is available in Mac Help (see page 14). Choose Mac Help from the Help menu and search for "keyboard."

## Universal Serial Bus (USB)

Your PowerBook comes with two USB ports, which you use to connect many different types of external devices, including printers, digital cameras, game pads, joysticks, keyboards and mouse devices, and storage devices. USB makes it easy to connect external equipment. Once you connect the device, it is ready to use. You don't need to restart or reconfigure your computer.

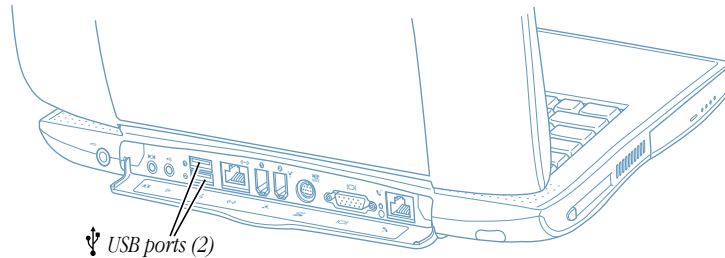

### Connecting and Using a USB Device

To use a USB device with your computer, simply connect the device to the computer. Your computer automatically loads the correct software whenever you attach a new device.

**Note:** Apple has already included software to work with many different USB devices. In most cases you do not need to install the software that came with the device to get the device to work. If, when you connect a USB device, your PowerBook cannot find the correct software, it prompts you to search the Internet to find it.

### USB Devices and Battery Power

USB devices, such as joysticks and keyboards, that get power from the USB connection instead of a separate power adapter can be used with your PowerBook. However, these types of USB devices can cause your PowerBook battery to become depleted faster. Whenever you use devices with your computer, it is a good idea to plug in the power adapter.

### Using Multiple USB Devices at the Same Time

Your PowerBook has two USB ports. If you want to use more than one device on the same USB port, purchase a USB hub. The USB hub connects to an open port on your computer and provides additional USB ports (usually four or seven).

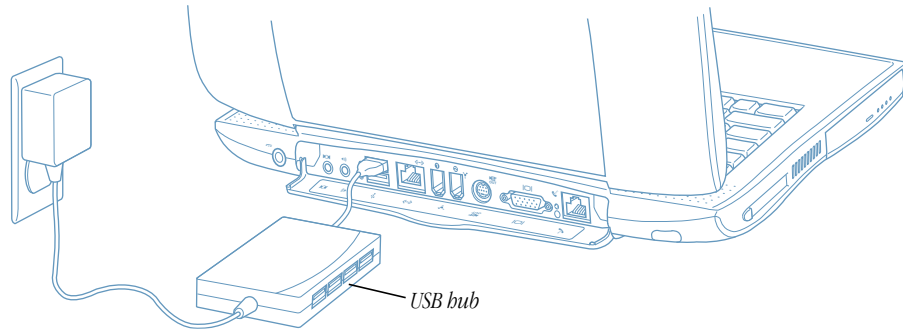

### For More Information on USB

Additional information on USB is available in Mac Help (see page 14). Choose Mac Help from the Help menu and search for “USB.” You can also find information on Apple’s USB Web site at [www.apple.com/usb](http://www.apple.com/usb)

For information on USB devices available for your computer, check out the Macintosh Products Guide at [www.apple.com/guide](http://www.apple.com/guide)

## FireWire

Your computer has two FireWire ports. FireWire is a high-speed data system that lets you easily connect and disconnect external devices—such as digital video (DV) cameras, printers, scanners, and hard disks. You can connect and disconnect FireWire devices without restarting your computer.

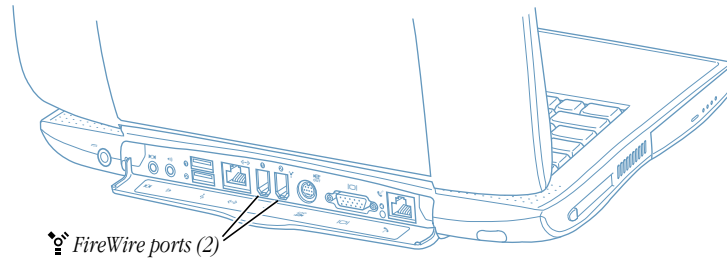

These are some of the things you can do with FireWire:

- Connect a digital video camera and capture or transfer high-quality video directly to your computer. Then you can use video-editing software such as Apple's Final Cut Pro software to edit the video.
- Connect an external FireWire hard disk drive and use it to back up data or transfer files. A FireWire hard disk icon appears on your desktop immediately after you connect the drive to your PowerBook. In addition, most FireWire hard disks get their power from the FireWire cable, so there is no need to carry around a power supply.
- If you have a problem with your computer that prevents you from starting up or you want to transfer files, you can use FireWire to connect your PowerBook to another computer so that your PowerBook will appear as an external hard disk on the other computer (a feature known as "FireWire Target Disk Mode").

### Connecting FireWire Devices

To use a FireWire device with your computer, connect the device to the computer and install any software that came with the device. Your computer automatically senses when you attach a new device.

### FireWire Devices and Battery Power

FireWire devices, such as certain external hard disks, that get power from the FireWire connection instead of a separate power adapter can be used with your PowerBook. However, these types of FireWire devices can cause your PowerBook battery to become depleted faster. Whenever you use devices with your computer, it is a good idea to plug in the power adapter.

### FireWire Target Disk Mode

If you have a problem with your computer that prevents you from starting up or if you just want to transfer files between two computers, you can use FireWire to connect your PowerBook to another computer and then have it appear as an external hard disk on the other computer.

**Important** The computer you want to connect your PowerBook to must have FireWire version 2.3 or later installed. Use Apple System Profiler, available in the Apple menu, to check the version of FireWire installed. If you have an older version, check the Apple FireWire Web site at [www.apple.com/firewire](http://www.apple.com/firewire)

To connect your PowerBook in FireWire disk mode, follow these steps:

- 1 Make sure that your PowerBook is shut down and the power adapter is plugged in.
- 2 Use a FireWire cable to connect your PowerBook to another FireWire-equipped computer.
- 3 Start up your PowerBook and immediately hold down the T key.

Your PowerBook display shows the FireWire disk mode indicator, and the PowerBook internal hard disk icon appears on the desktop of the other computer.

- 4 When you are finished transferring files, drag the PowerBook hard disk icon to the Trash.
- 5 Press the Power button on the PowerBook to shut it down and then disconnect the FireWire cable.

### For More Information on FireWire

Additional information on FireWire, including setting up a network of FireWire devices, is available in Mac Help (see page 14). Choose Mac Help from the Help menu, and search for “FireWire.” You can also find information on Apple’s FireWire Web site at [www.apple.com/firewire](http://www.apple.com/firewire)

For information on the FireWire devices available for your computer, check out the Macintosh Products Guide at [www.apple.com/guide](http://www.apple.com/guide)

## AirPort Wireless Internet and Networking

AirPort offers an easy and affordable way to provide wireless Internet access anywhere in the home, at work, or in the classroom. Instead of using traditional cables, AirPort uses wireless local area network (LAN) technology to provide wireless communication between multiple computers. Through a wireless network you can set up access to the Internet, transfer files, play multiplayer games, and more.

Your PowerBook is AirPort-ready. The only thing you need to add is an AirPort Card. You install the AirPort Card in a slot under the keyboard and connect it directly to the end of the built-in antenna cable.

### How AirPort Provides Wireless Internet Access

With AirPort, you set up a wireless connection to a device known as a *base station*, which has a physical connection to the Internet. AirPort technology works like a cordless telephone. The handset of the cordless phone makes a wireless connection to the base, which is connected to the telephone line.

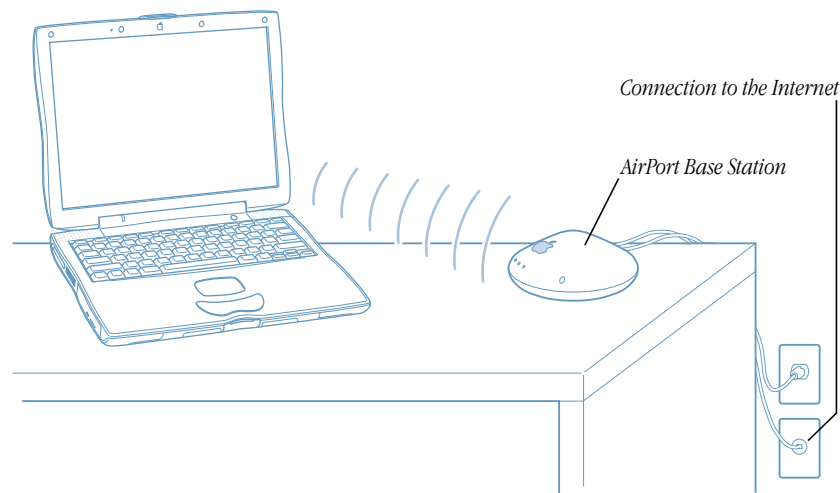

### For More Information on AirPort

To purchase an AirPort Card or AirPort Base Station, contact your Apple-authorized dealer or check out The Apple Store at [www.apple.com/store](http://www.apple.com/store)

Additional information on AirPort is available in Mac Help (see page 14). Choose Mac Help from the Help menu and search for “AirPort.” You can also find information on Apple’s AirPort Web site at [www.apple.com/airport](http://www.apple.com/airport)

## Installing an AirPort Card

You can purchase an AirPort Card from your Apple-authorized dealer or from The Apple Store at [www.apple.com/store](http://www.apple.com/store) and install it yourself or have it installed by an Apple-authorized service provider.

**Warning** The AirPort Card has been designed so that you can install it yourself. If, after reading the instructions, you feel uncomfortable about installing the card, you can have an Apple-authorized service provider install it for you. If you follow the instructions, you should not be concerned about damaging your computer. However, if you do attempt to install the AirPort Card yourself, any damage you may cause to your equipment will not be covered by the limited warranty on your computer. See the service information that came with your PowerBook for additional information about this or any other warranty question and instructions if you want to have your computer serviced.

To install an AirPort Card in your PowerBook, follow these steps:

- 1 Shut down your computer, remove the battery from the expansion bay, and disconnect the power adapter, modem, and any other cables connected to the computer.

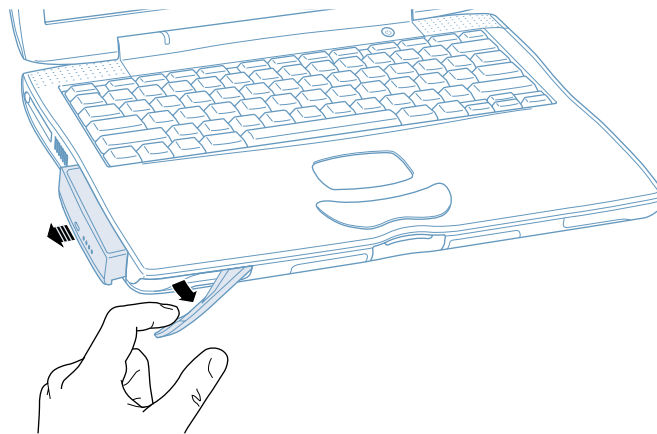

**Warning** The internal components of your PowerBook may be hot. If you have been using your PowerBook, wait 30 minutes after shutting down your computer to let the internal components cool down before continuing.

- 2 Make sure that the keyboard locking screw is not in the locked position. Your new PowerBook comes with the keyboard unlocked, so unless you or someone else locked the keyboard, you can skip this step.

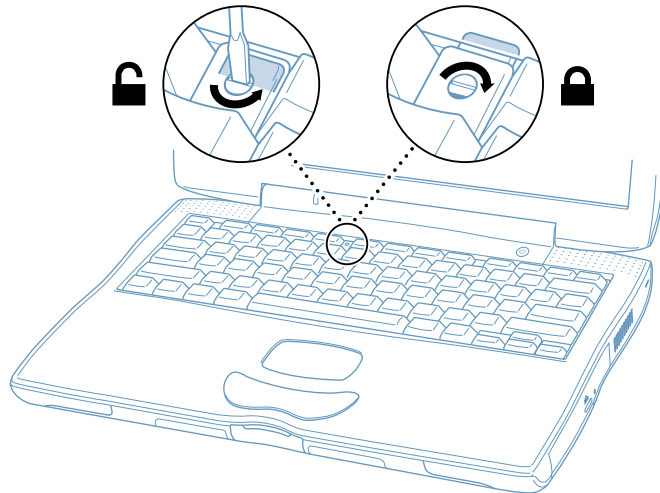

- 3 Release the keyboard by pulling down on the keyboard release tabs (located to the left of the F1 and F9 keys) until the top portion of the keyboard pops up.

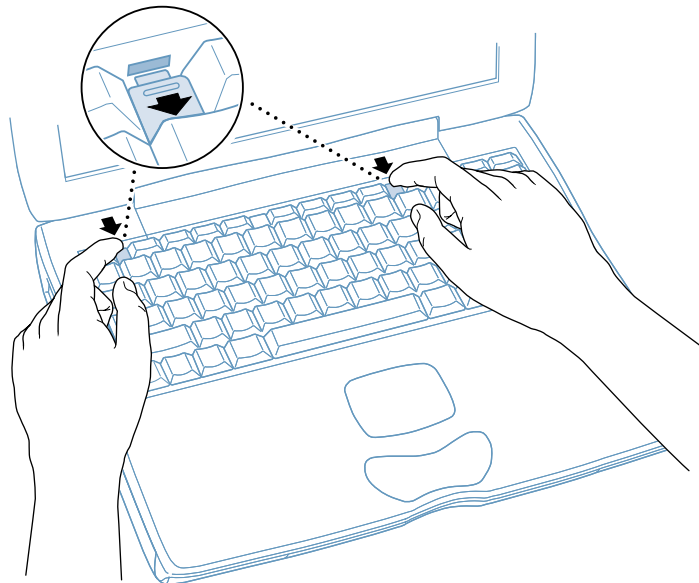



- 4** Lift the top portion of the PowerBook keyboard up slightly near the top row of keys and pull it back far enough to displace the small tabs that hold the bottom of the keyboard in place.

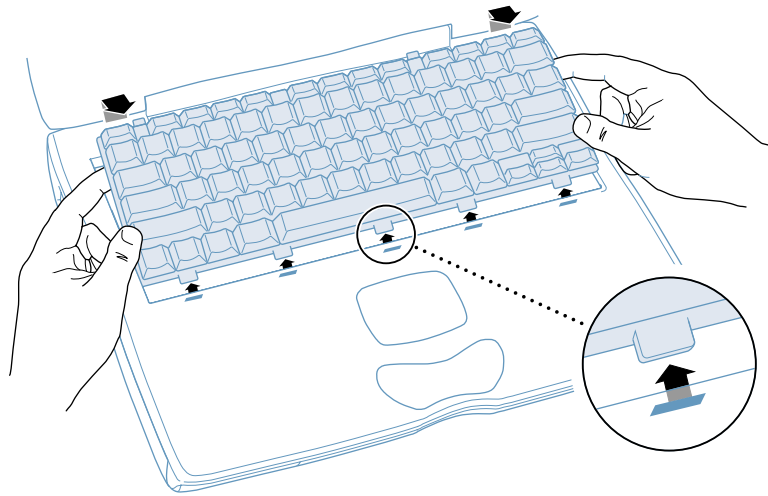

- 5** Flip the keyboard over and lay it on the palm rests and trackpad.

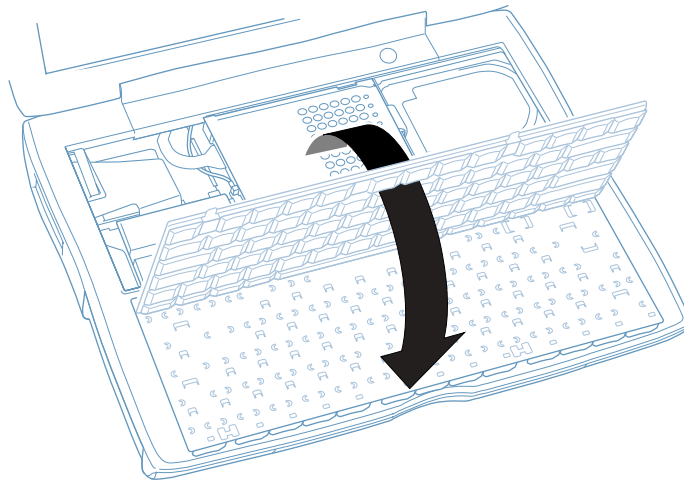

- 6 If your AirPort Card came with the AirPort adapter, remove the metal clip and pull the AirPort Card from the adapter. (The adapter and metal clip are not used with your PowerBook.)

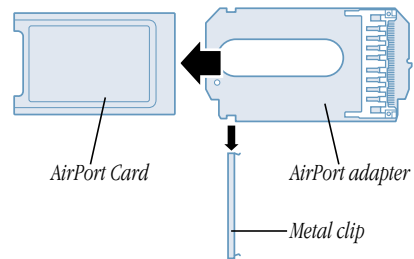

- 7 Touch a metal surface inside the computer to discharge any static electricity.
- 8 With a Phillips screwdriver, remove the screws that secure the internal heat shield.

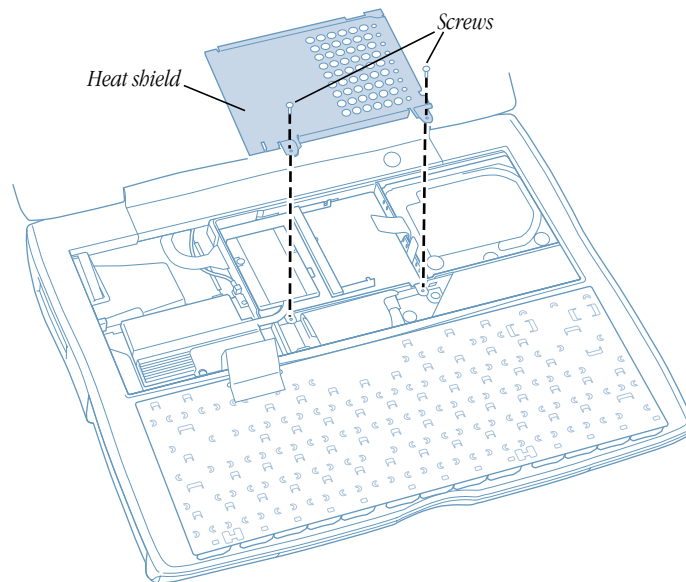

- 9 Lift up the internal heat shield.

- 10 Position the AirPort Card with the AirPort ID numbers and bar code facing up and connect the AirPort Card to the end of the antenna cable. Make sure that the connector on the end of the antenna cable is straight before inserting it into the card.

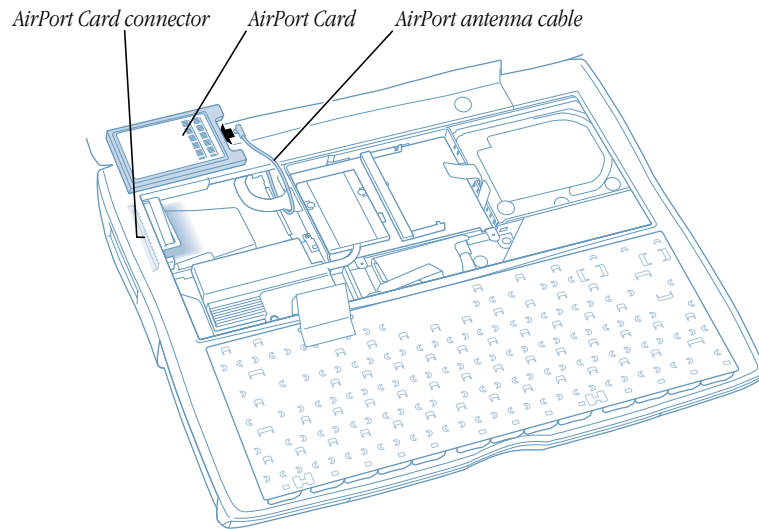

- 11 Slide the card into the connector located just above the PC Card slot. Make sure to slide the card all the way in until you feel that the card is securely attached to the connector.

*When inserting the AirPort Card, you may need to tuck the end of the card under the plastic wall. This helps align the card with the connector and prevents the back end of the card from sticking up after it has been inserted.*

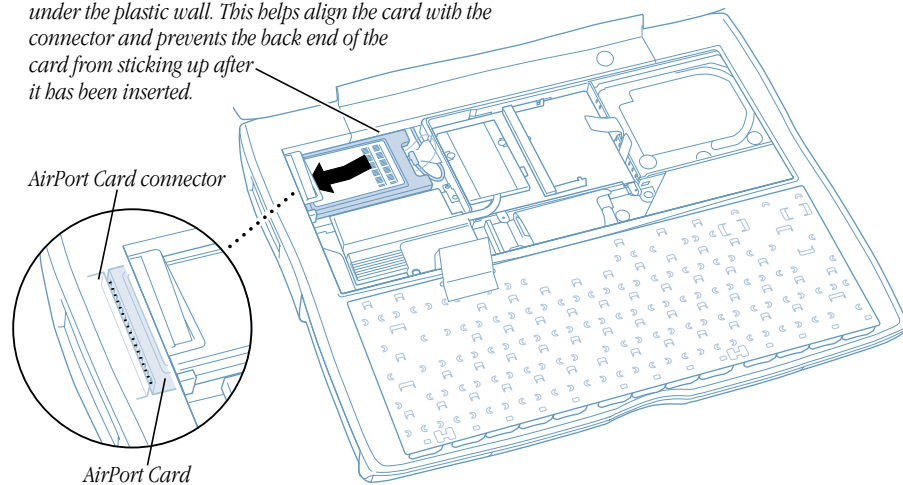

**12** Insert the internal heat shield.

**Important** When replacing the internal heat shield, make sure it does not cover the plastic tabs for the hard disk and AirPort Card. The plastic tab for the processor module should be placed under the heat shield.

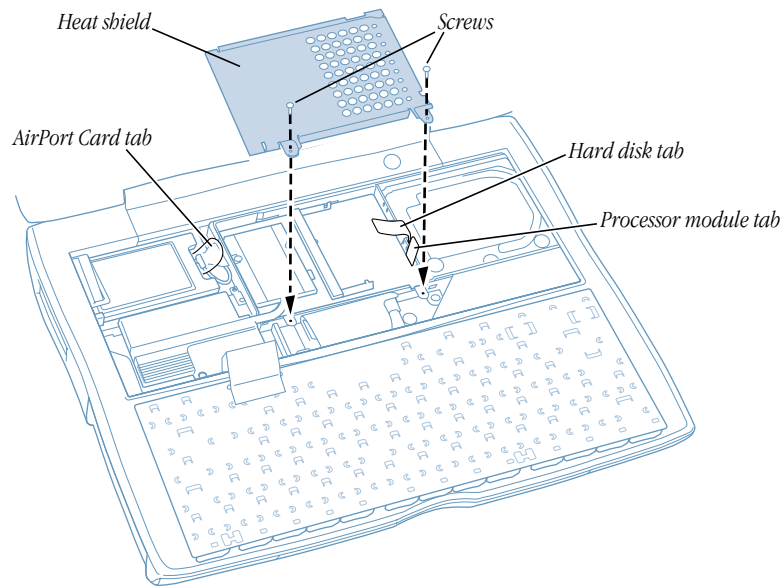

**13** Insert the small metal tabs at the base of the keyboard.

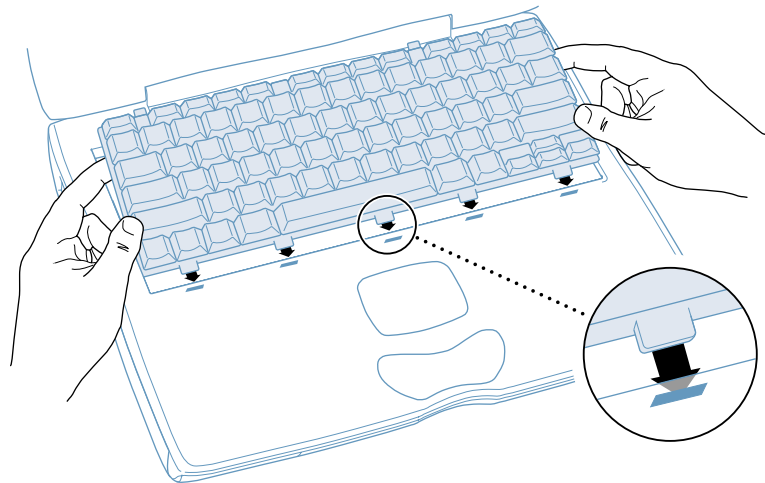

- 14** Pull down on the keyboard release tabs (located to the left of the F1 and F9 keys) and then press down on the top portion of the keyboard.

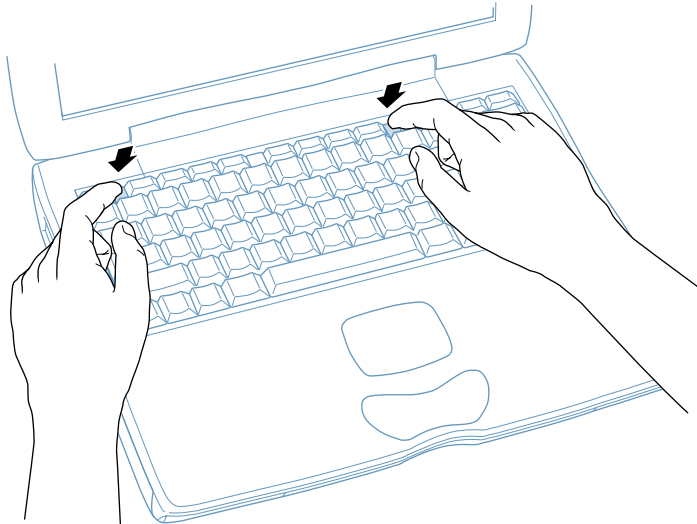

- 15** Let go of the keyboard release tabs to secure the keyboard in place.
- 16** Replace the PowerBook battery or plug in the power adapter.

## External Monitor Support (VGA and S-Video)

Your computer has a monitor port that allows you to directly connect a monitor with a VGA-style adapter or other external video device such as a video projector. If you have an older Macintosh-compatible monitor, you can connect it using the VGA-to-Macintosh video adapter that came with your computer.

The TV out port (also known as an *S-Video out port*) on your computer lets you connect to a television, videocassette recorder (VCR), or video projection system. You can use TV out to display images on a television, record computer images on a VCR, or play DVD discs on your television.

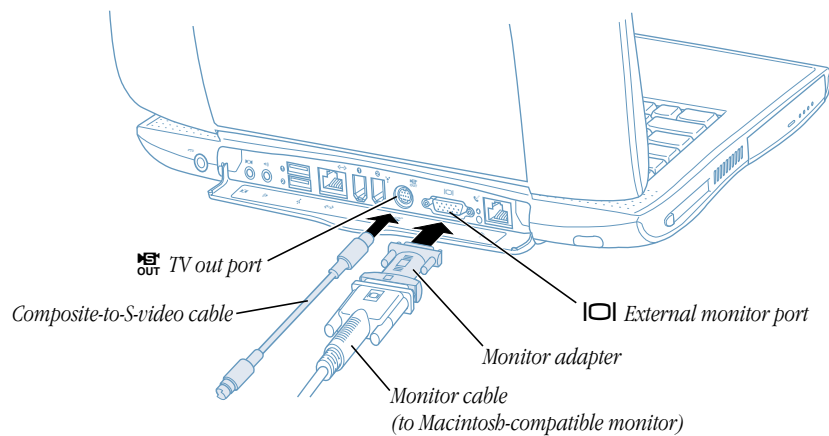

When an external monitor or television is connected, you can either have the same image appear on both the internal display and the external monitor (known as *video mirroring*) or use the external monitor to extend the size of the Mac OS desktop (known as *extended desktop mode*).

**Note:** Because of the display limitations of most televisions, images displayed on the television screen will be of lower quality than those on the built-in display or an external monitor.

### Connecting an External Monitor

To connect an external monitor to your computer:

- 1 Shut down your computer or put it to sleep and turn off the external monitor.
- 2 Connect the monitor cable to your PowerBook (using the monitor adapter if needed).
- 3 Turn on the external monitor.
- 4 Start up or wake your computer.

### Switching Between Extended Desktop and Video Mirroring Modes

By default, your PowerBook starts up in extended desktop mode. You can use the Video Mirroring portion of the Control Strip to make the images on the PowerBook display and the external monitor the same.



### Connecting a Television, VCR, or Other Video Device

To connect a device to the TV out port:

- 1 Shut down your computer or put it to sleep and turn off the external device.
- 2 Connect an S-video cable to the TV out port (📺) on your PowerBook (or use the adapter to connect a composite video cable) and connect the other end to your device.
- 3 If you want to send the sound from your PowerBook to the device, connect a miniplug-to-RCA cable (not included) from the sound output port (🔊) on your PowerBook to the audio input ports on your device.
- 4 Turn on the external device.
- 5 Start up or wake your computer.
- 6 Use the TV Mirroring portion of the Control Strip to adjust how the images are displayed on the device.



### Using Your PowerBook With the Display Closed

You can use your PowerBook with the display closed if the computer is connected to an external monitor. Connect an Apple external USB keyboard and mouse, and then press the Power button on the keyboard to start up the PowerBook. To activate the internal display again, put the PowerBook to sleep and wake it with the display open.

### For More Information on Using an External Monitor

Additional information on using and configuring an external monitor is available in Mac Help (see page 14). Choose Mac Help from the Help menu and search for “monitor.”

## Battery and Dual Battery Support

When the external power adapter is not connected, your computer draws power from a PowerBook battery in the battery bay or expansion bay. You can also insert a second battery in the expansion bay to double the amount of battery life.

### Monitoring Battery Charge Level

You can determine the charge left in your battery by looking at the battery level indicator lights on the battery itself. The charge can be checked with the battery inserted or outside the PowerBook. The lights glow to show how much charge is left in the battery. A lighted circle indicates that the battery has power; an unlighted circle indicates lack of charge. The indicator lights remain lit for a few seconds after you press the button. If only one flashing light is on, very little charge is left in the battery. Plug in the power adapter.

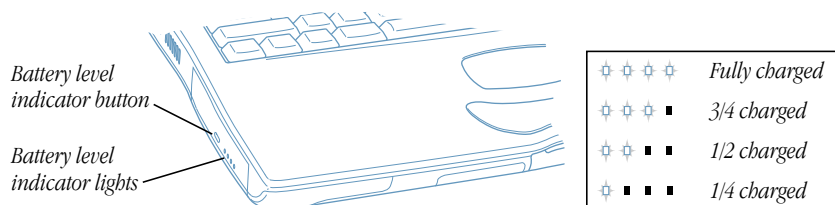

**Note:** The battery level indicator lights stay on while the battery is being charged by the external power adapter. When the battery is fully charged, the lights turn off.

### Removing or Replacing a Battery

PowerBook batteries are removed and inserted the same way as the expansion bay modules. A depleted PowerBook battery can be easily replaced with a charged one when the computer is shut down or in sleep. When the computer is in sleep, the internal backup battery provides enough power to maintain the contents of RAM for one minute while you quickly change batteries.

### Charging a Battery

When the power adapter is connected, the battery is recharged whether the computer is off, on, or in sleep. However, the battery will recharge more quickly if the computer is off or in sleep.



### **Battery-Saving Tips**

The amount of work time your PowerBook battery can provide before you need to recharge depends on the equipment you're using with your computer and the steps you take to conserve power while you work. For example, playing DVD movies, listening to audio CDs, or having certain external devices connected drains the battery more quickly.

Battery-saving measures include the following:

- Disconnect any bus-powered USB or FireWire devices from the computer.
- Quit any open applications that you are not using.
- Turn down the volume when playing DVD movies or listening to audio CDs.
- Turn off AppleTalk when not connected to a network.
- Remove CD-ROM and DVD-ROM discs when they are not in use.
- Reduce screen brightness using the brightness control on the PowerBook keyboard.
- Set the hard disk to spin down after a short time. (Hard disk and other sleep settings are adjustable in the Energy Saver control panel.)
- Make sure that power cycling is turned on in the Energy Saver control panel.
- Set your PowerBook to sleep after inactivity of 5 minutes or less. (Sleep settings are adjustable in the Energy Saver control panel.)
- Use a lighter desktop pattern.
- Take advantage of the sleep feature of your PowerBook whenever your work is interrupted. You just need to close the display to put the computer in sleep.

### **For More Information on Your PowerBook Battery**

Additional information is available in Mac Help (see page 14). Choose Mac Help from the Help menu and search for "battery."

## Expansion Bay Modules

Your PowerBook comes with a dual-function expansion bay (on the right side of the computer) that accepts either expansion bay modules such as the DVD drive or a PowerBook battery. The bay on the left side of the computer accepts only PowerBook batteries. You can change modules while the computer is turned on as long as they are not in use. You can purchase additional expansion bay modules such as Zip drives and hard disks.

**Important** Don't switch modules while the computer is starting up or if a CD-ROM disc or other media is inserted (even if the computer is in sleep). If you remove a module when a disc is inserted, you'll see a message telling you to reinsert the module.

### Determining Whether a Module Can Be Removed

Click the Expansion Bay icon in the Control Strip to determine whether the expansion bay module is ready to be removed.



*Expansion Bay icon*

If the Control Strip indicates that the expansion bay module can't be removed:

- 1 Quit any application programs and close files that may be using the module.
- 2 Drag the icon of the disc or other media that is inserted in the module to the Trash.

### Ejecting an Expansion Bay Module

Place your PowerBook on a hard, flat surface and pull the expansion bay release lever toward you to release the expansion bay.

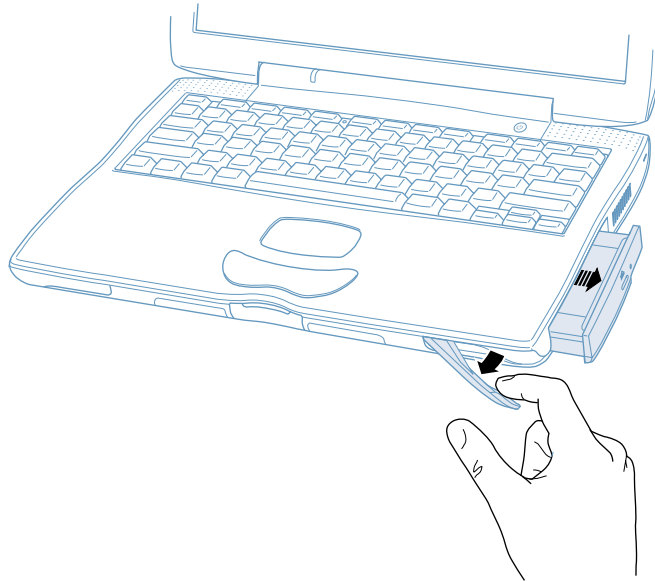

**Note:** The expansion bay can accept the wide DVD-ROM drive module, the narrower PowerBook battery, or third-party modules such as a Zip drive or internal hard disk. When a narrower device is in the expansion bay, a small flap covers the empty part of the bay. When the wider drive module is inserted, the flap folds into the bay.

### For More Information on Expansion Bay Modules

For information on using the DVD drive, see “DVD Drive” on page 44. For information on the expansion bay modules available for your PowerBook, check out the Macintosh Products Guide at [www.apple.com/guide](http://www.apple.com/guide)

## DVD Drive

All the software necessary to use your computer and connect to the Internet is already installed on your PowerBook. (You need to use the PowerBook CDs that came with your computer only if you are having problems and need to reinstall system software.) However, if you purchased additional software with your PowerBook, you can install or run software from CD and DVD discs using the DVD drive in the expansion bay.

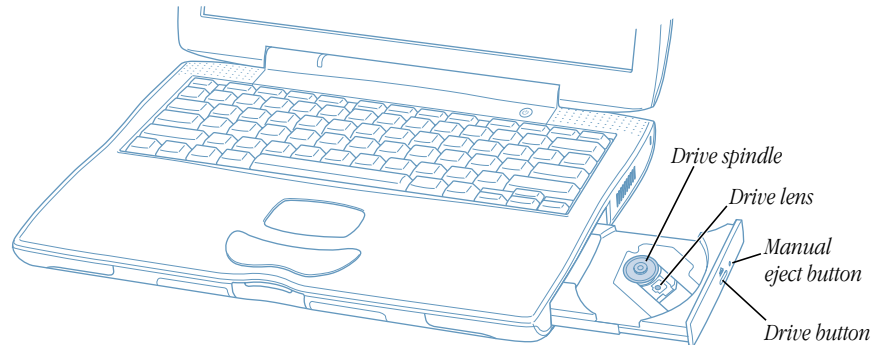

**Note:** If you have older software that comes on floppy disks, contact the software manufacturer to see if the software is available on a CD-ROM disc or purchase a third-party expansion bay or external floppy disk drive (such as an LS120/SuperDisk) for your PowerBook from your Apple dealer or The Apple Store ([www.apple.com/store](http://www.apple.com/store)).

## Inserting Discs

To install or use programs from a CD or DVD disc, follow these steps:

- 1 With the computer turned on, press the drive button on the outside of the drive.
- 2 Pull the tray all the way open.
- 3 Place a disc in the tray, with the label facing up, and make sure the disc is lying flat in the tray and is seated firmly on the spindle.

**Note:** The DVD-ROM drive has small locks on the drive spindle that hold the disc securely in place. When inserting a disc over these locks, you may need to apply additional pressure. Place the hole in the center of the disc directly over the drive spindle and press down until you feel the disc lock into place.

- 4 Push the tray in to close it.
- 5 When the icon for the disc appears on the screen, the disc is ready for use.

### Ejecting a Disc From the DVD Drive

You eject a disc by dragging the disc icon to the Trash. When the DVD drive opens, remove the disc. You cannot use the drive button to eject a disc from the DVD drive.

If you are unable to eject a disc by dragging its icon to the Trash, try the following:

- Quit any applications that may be using the disc.
- If that does not work, use the end of a pen to gently press the manual eject button.

### Playing DVD Discs

You can also use the DVD drive to play DVD-Video discs on your PowerBook. Insert the DVD disc and then open Apple DVD Player (available in the Applications folder on your hard disk).

**Note:** If you want to use S-video to connect your PowerBook to a TV so that you can watch a DVD-Video on the TV screen, select 720 x 480 NTSC (in the United States) or 720 x 576 PAL (in Europe and other regions) in the Resolution portion of the Control Strip, and select Best for Video from the TV Settings portion of the Control Strip.



### For More Information on Your DVD Drive

For instructions on using Apple DVD player, open the player and then choose Apple DVD Player Help from the Help menu.

Additional information on using CD or DVD discs is available in Mac Help (see page 14). Choose Mac Help from the Help menu and search for “discs.”

## Infrared (IrDA)

Because your PowerBook is equipped with infrared (IR), you can exchange files and data without using wires. The type of IR used is the industry-standard IR communication method known as *IrDA*.

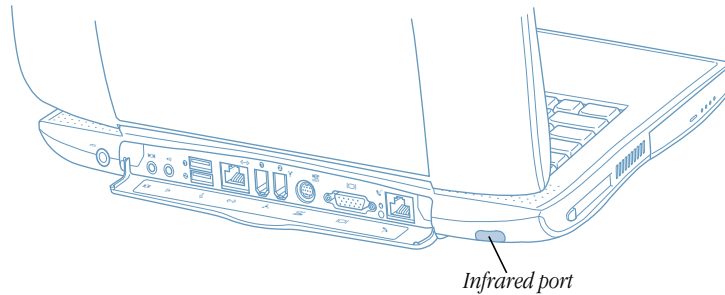

You can use infrared to share files with another IrDA-equipped computer, communicate with other infrared devices such as handheld organizers, connect to an infrared network, and even print on an infrared printer. Sharing files using infrared is the same as sharing files using Ethernet, except that AppleTalk and TCP/IP are set to Infrared instead of Ethernet.

**Note:** You cannot share files with a computer that only supports IRTalk (a non-standard IR communication method used by some older computers).

### Making an Infrared Connection

To connect to another computer using infrared:

- 1 Position the IR windows of the two computers so that they are directly facing and within 3 feet of each other.
- 2 Configure AppleTalk and TCP/IP to communicate using infrared.

Information on configuring AppleTalk and TCP/IP and setting up file sharing is available in Mac Help.

### For More Information on Infrared

Information on configuring the Mac OS to communicate using infrared and setting up file sharing is available in Mac Help (see page 14). Choose Mac Help from the Help menu, and search for “infrared” or “file sharing.”

## PC Cards

You can expand your computer's capabilities using the PC Card slot. Your PowerBook has one Type II PC Card slot that accepts Type I and Type II PCMCIA cards, including CardBus-format cards. You can insert a PC Card when your computer is on, off, or in sleep.

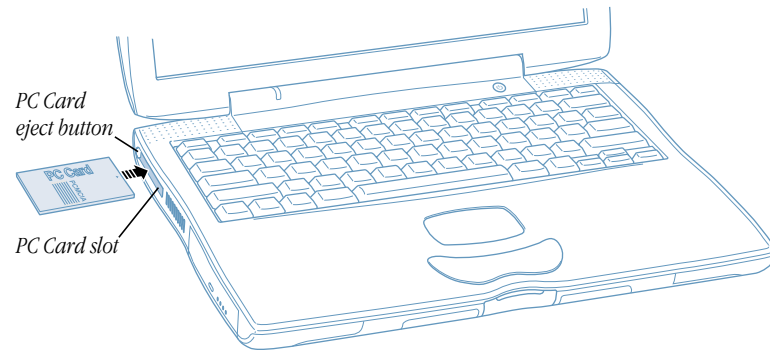

### Inserting a PC Card

When inserting a PC Card, make sure the label is facing up and the card is level. You'll feel some resistance as you slide the card in. When the card is firmly seated in the slot, it clicks into place and an icon appears on the desktop.

### Ejecting a PC Card

You can eject a PC Card when your computer is on or off, but not when it is in sleep. If you eject a PC Card when the computer is in sleep, when you wake the PowerBook, a message tells you to reinsert the card.

To eject a PC Card when the computer is on:

- 1 Drag the card's icon to the Trash.
- 2 Push the PC Card eject button once to release the button.
- 3 Push the button again to eject the card.
- 4 Pull the card out of the slot.

### For More Information on PC Cards

For information on the PC Cards available for your PowerBook, check out the Macintosh Products Guide at [www.apple.com/guide](http://www.apple.com/guide)





## Security Slot and Keyboard Lock

You can purchase a security cable and lock to protect your PowerBook. With a lock, you can secure your computer to a desk or table.

Your PowerBook also comes with a keyboard locking mechanism. When the keyboard is locked, users will be unable to easily access the internal components of the computer, including the memory, hard disk, and optional AirPort Card.

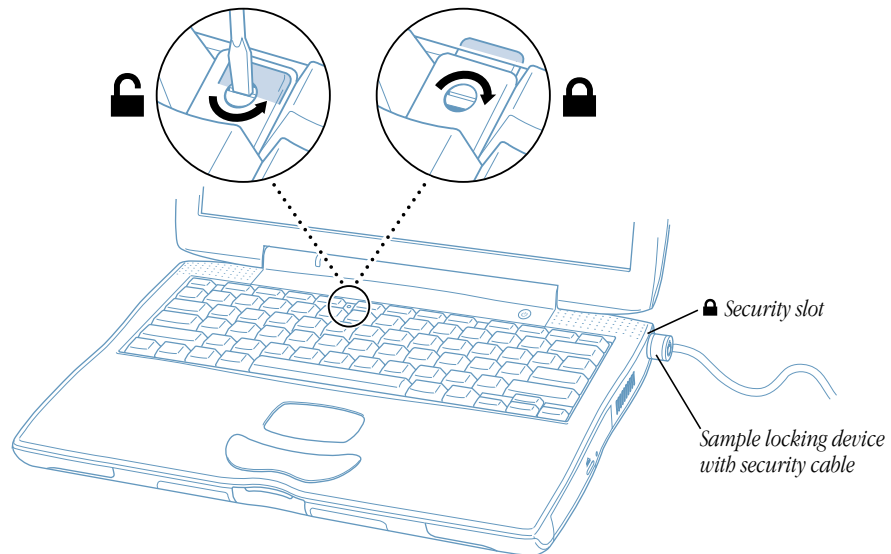

The keyboard locking mechanism is in the small plastic tab to the left of the Num Lock key, which also contains the Num Lock indicator light. Your PowerBook comes with the keyboard unlocked.

To lock the keyboard, use a small flathead screwdriver to turn the screw clockwise 1/2 turn. A small tab prevents the keyboard from being removed.

**Note:** The screw that turns the plastic tab has a small notch on one side that you can use to determine if the keyboard is locked. If the notch in the screw is on the top, the keyboard is unlocked. If the notch in the screw is on the bottom, the keyboard is locked.

## Installing Additional Memory

Your computer comes with a minimum of 64 megabytes (MB) of Synchronous Dynamic Random-Access Memory (SDRAM) installed in a RAM slot on the bottom of the processor module. On the top of the processor module is another RAM slot you can use to add additional memory to your PowerBook.

**Warning** To avoid damage to your computer, Apple recommends that only an Apple-certified technician install additional RAM. If you attempt to install additional RAM yourself, any damage you may cause to your equipment will not be covered by the limited warranty on your computer. Consult the service and support information that came with your Apple product for instructions on how to have your computer serviced and for additional information about this or any other warranty question.

## RAM Specifications

The expansion slots on the top and bottom of the processor module can accept up to a 2-inch SDRAM card that meets the following specifications:

- Small Outline-Dual Inline Memory Module (SO-DIMM) format
- 16, 32, 64, 128, or 256 MB
- 144-pin
- PC-100 Type RAM

**Important** SDRAM from earlier PowerBook models cannot be used.

## Maximum RAM Configurations

The maximum amount of RAM you can install in your PowerBook is 512 MB, using 256 MB DIMMs in both the top and bottom RAM slots. To install RAM in the bottom RAM slot, you must remove the processor module. For instructions, see “Replacing RAM in the Lower RAM Slot” on page 58.

### Installing RAM in the Upper RAM Slot

- 1 Shut down your computer, remove the battery from the expansion bay, and disconnect the power adapter, modem, and any other cables connected to the computer.

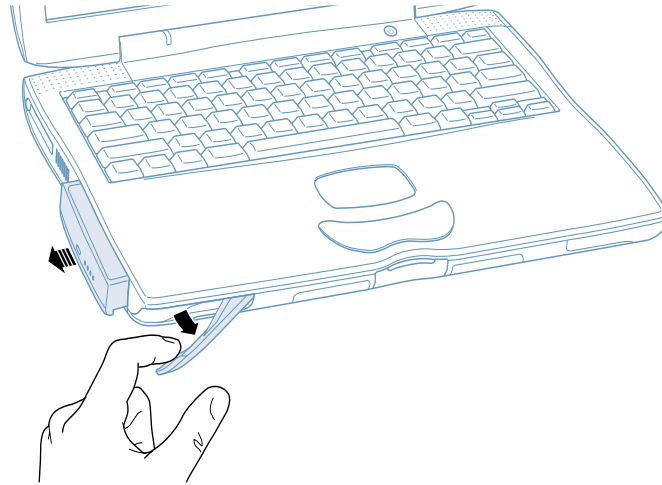

**Warning** The internal components of your PowerBook may be hot. If you have been using your PowerBook, wait 30 minutes after shutting down your computer to let the internal components cool down before continuing.

- 2 Make sure that the keyboard locking screw is not in the locked position. Your new PowerBook comes with the keyboard unlocked, so unless you or someone else locked the keyboard, you can skip this step.

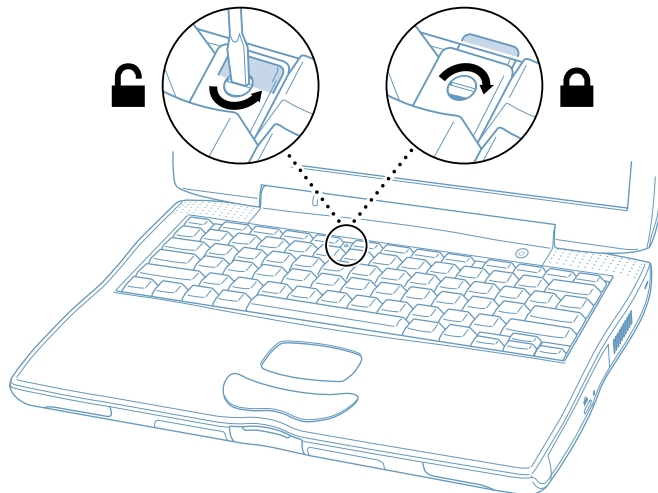

- 3 Release the keyboard by pulling down on the keyboard release tabs (located to the left of the F1 and F9 keys) until the top portion of the keyboard pops up.

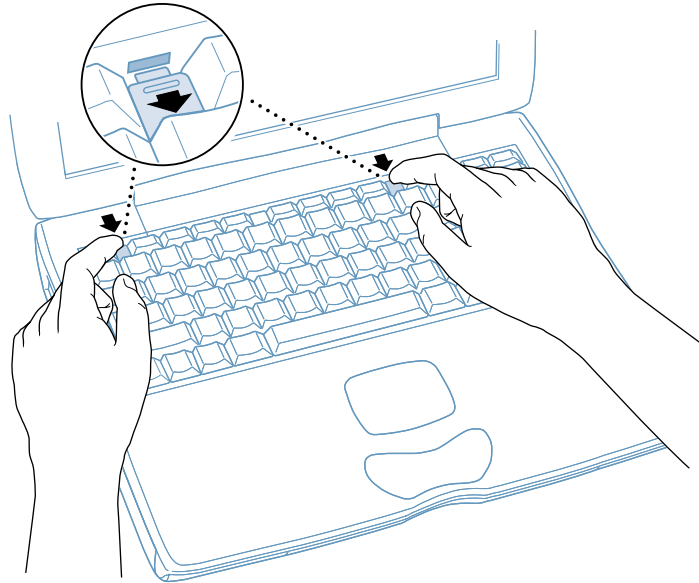

- 4 Lift the top portion of the PowerBook keyboard up slightly near the top row of keys and pull it back far enough to displace the small tabs that hold the bottom of the keyboard in place.

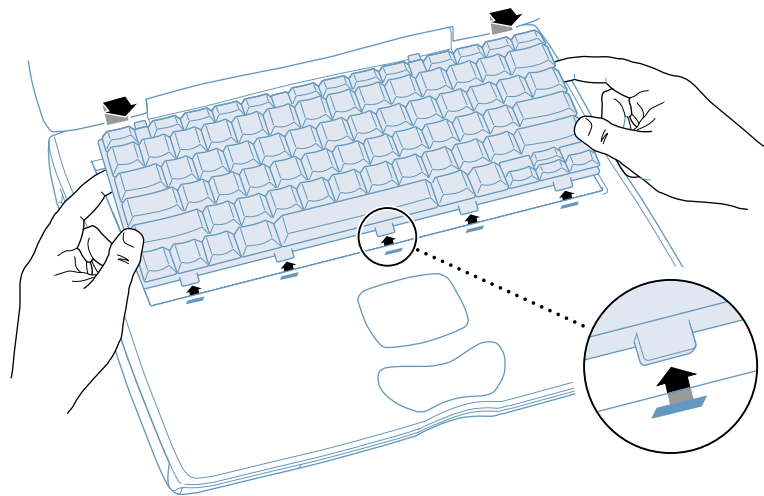

- 5 Flip the keyboard over and lay it on the palm rests and trackpad.

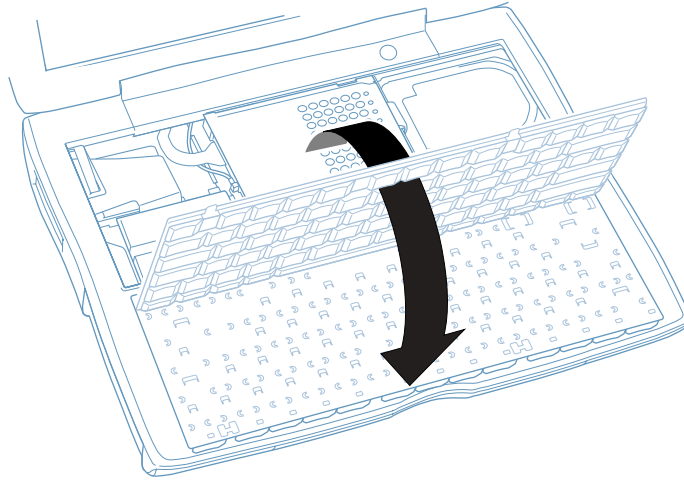

- 6 Touch a metal surface inside the computer to discharge any static electricity.
- 7 With a Phillips screwdriver, remove the screws that secure the internal heat shield.

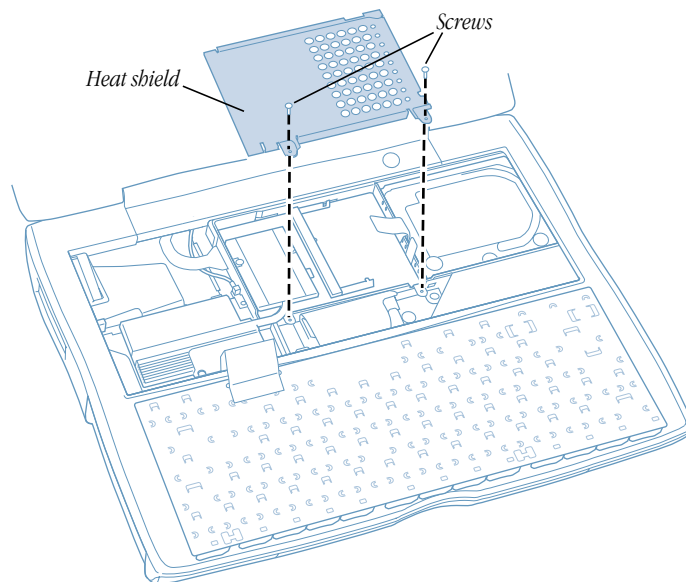

- 8 Lift up the internal heat shield.

- 9 Locate the empty RAM expansion slot.

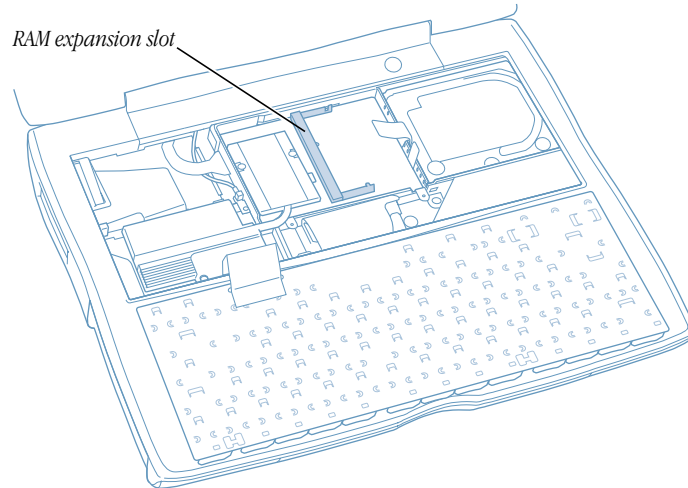

- 10 Hold the RAM expansion card at a 30-degree angle. Line up the notch in the card with the small tab in the RAM expansion slot. Then push the RAM expansion card into the expansion slot.

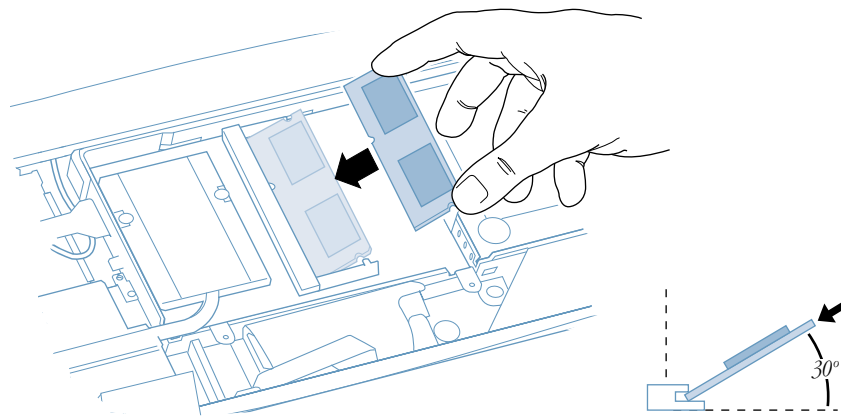

**Note:** You may feel some resistance. If you are having trouble inserting the card, try pushing one side at a time.

- 11** Gently push the RAM expansion card down until the two snaps on either side of the card lock into place.

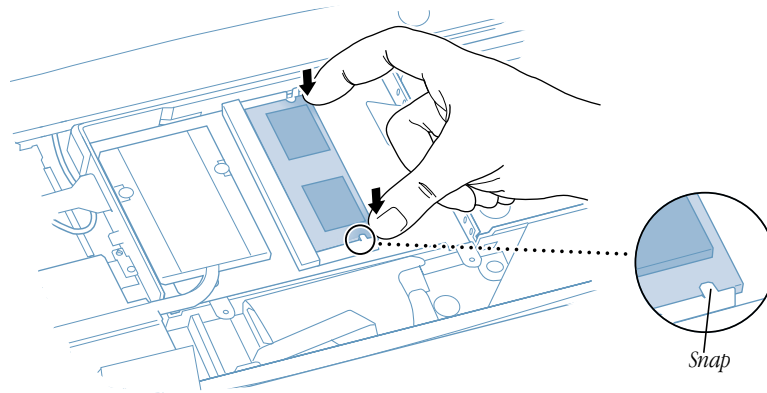

- 12** Insert the internal heat shield.

**Important** When replacing the internal heat shield, make sure it does not cover the plastic tabs for the hard disk and optional AirPort Card. The plastic tab for the processor module should be placed under the heat shield.

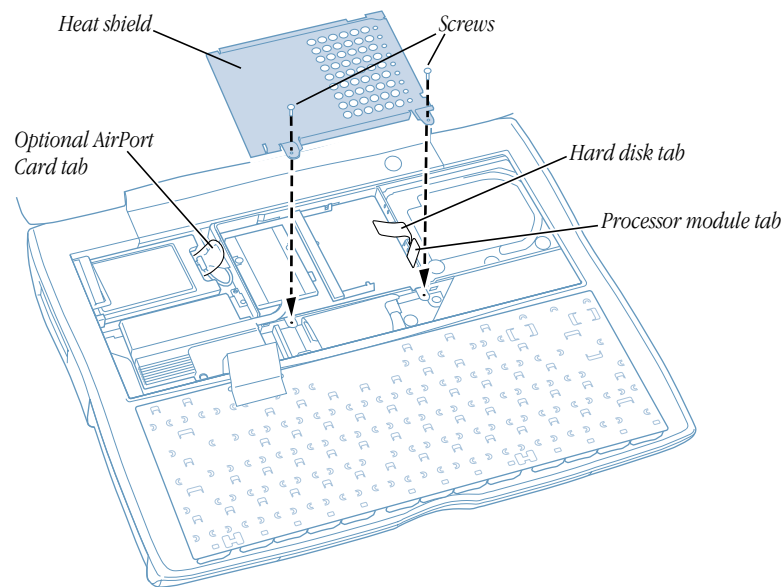

- 13** Press down on the bottom portion of the heat shield to secure it and then replace the screws.

- 14 Flip the keyboard back on top of the opening in your PowerBook and insert the small tabs at the bottom of the keyboard into the openings in the PowerBook case.

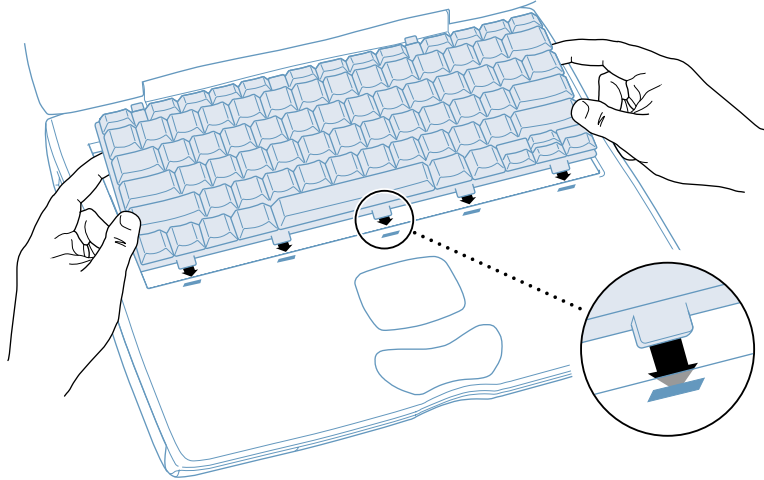

- 15 Pull down on the keyboard release tabs (located to the left of the F1 and F9 keys) and then press down on the top portion of the keyboard.

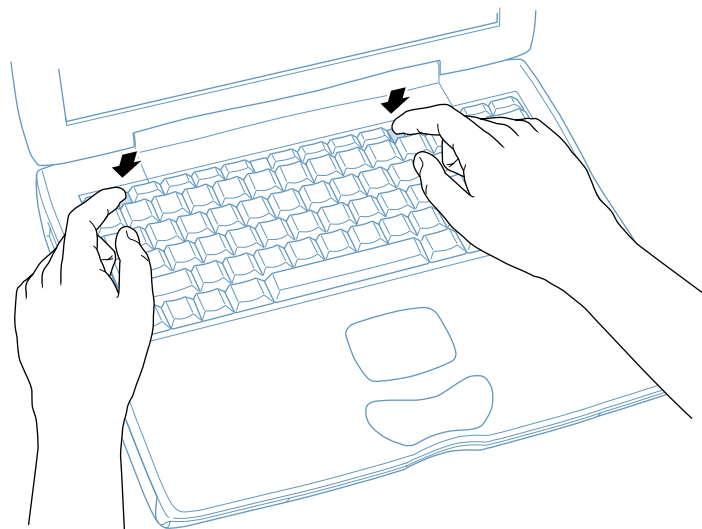

- 16 Let go of the keyboard release tabs to secure the keyboard in place.
- 17 Replace the PowerBook battery or plug in the power adapter.



### Checking to See if Your Computer Recognizes the New Memory

After installing additional memory in your PowerBook, you can check to see if the computer recognizes the new memory you installed.

To check the amount of built-in memory in your computer, do the following:

- 1 Start up your computer.
- 2 When you see the Mac OS desktop, choose About This Computer from the Apple () menu.

The following window shows the total amount of memory in the computer.

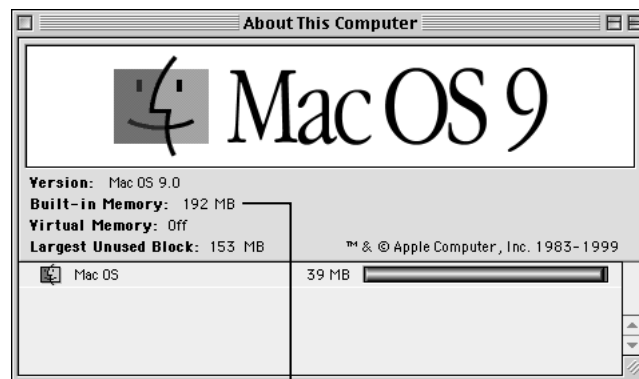

*Total memory installed  
in your PowerBook*

**Note:** The total includes the amount of memory that originally came with the computer plus the new memory you added. For a more detailed breakdown of the amount of memory installed in your computer, open the Apple () menu and choose Apple System Profiler.

### Replacing RAM in the Lower RAM Slot

To replace a RAM module in the lower RAM slot located under the processor module, follow these steps:

- 1 Follow the instructions (starting on page 50) to remove the keyboard and internal heat shield.
- 2 Remove the screw that secures the processor heat spreader.
- 3 Locate the small plastic pull tab on the right side of the processor module and gently pull up on the tab until the processor module disconnects from the logic board.

**Note:** The tab for the processor module is the smaller of the two plastic tabs.

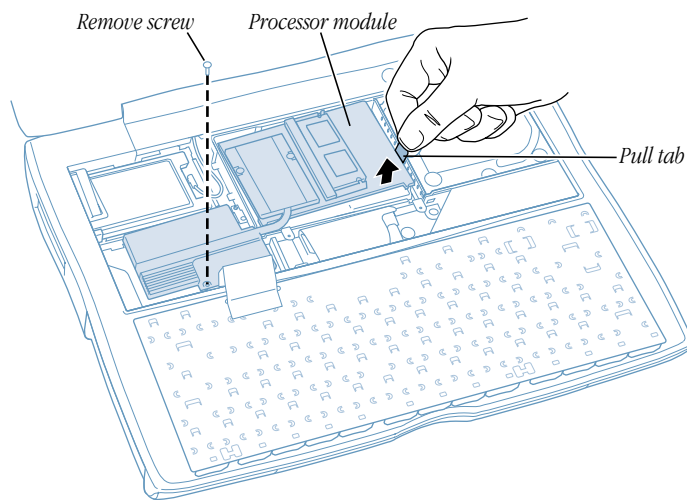

- 4 Lift the processor module straight out and carefully turn it over, and locate the RAM slot.

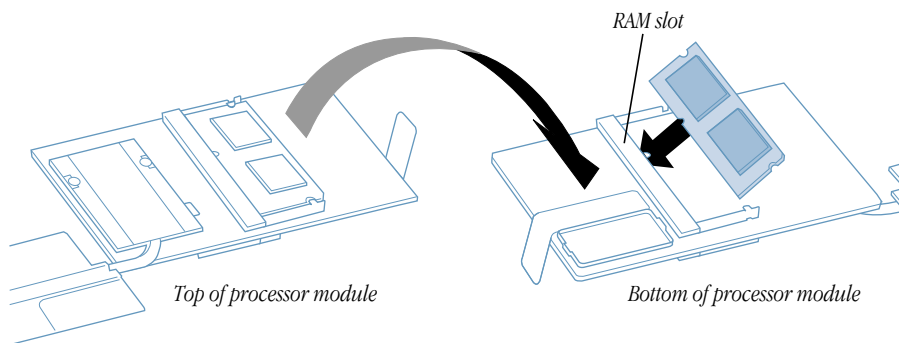

- 5 Pull the tabs apart and remove the DIMM from the slot.
- 6 Insert the new DIMM.

- 7 Reinsert the processor module. (Make sure the tabs on the side of the module line up with the slots on the logic board.)

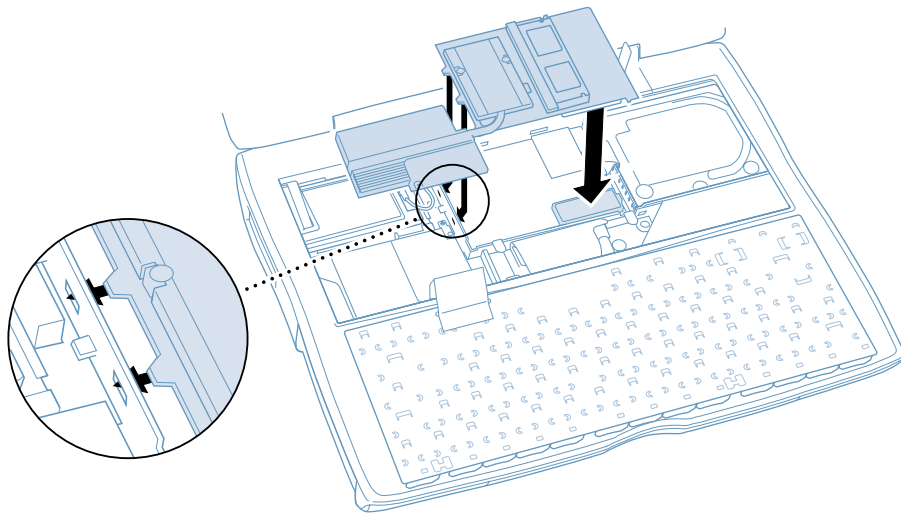

- 8 Press down against the processor module to attach the connector to the logic board, and replace the screw.

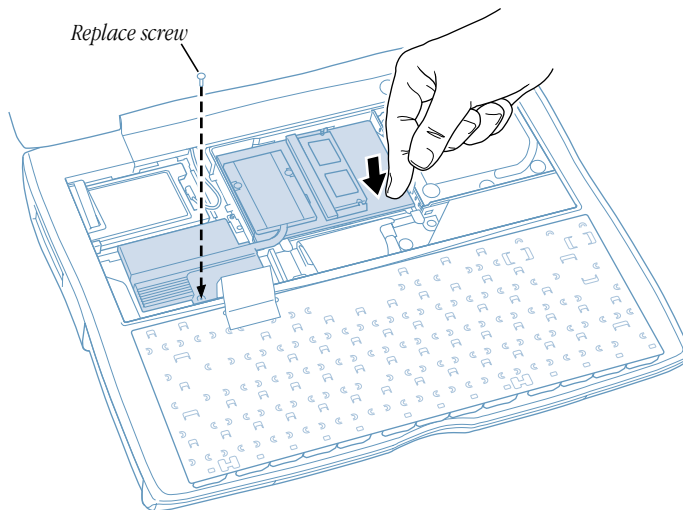

**Important** If you have a 2-inch RAM card in the upper slot, remove it before reinserting the processor module. A 2-inch RAM card blocks the area you need to push against to secure the processor module in place.

- 9 Follow the steps starting on page 55 to reinsert the heat shield and keyboard.

## Removable Hard Disk

When the computer is shut down, the internal hard disk can be removed for security or maintenance.

**Warning** To avoid damage to your computer, Apple recommends that only an Apple-certified technician remove the internal hard disk. If you attempt to remove the hard disk yourself, any damage you may cause to your equipment will not be covered by the limited warranty on your computer. Consult the service and support information that came with your Apple product for instructions on how to have your computer serviced and for additional information about this or any other warranty question.

To remove the internal hard disk, follow these steps:

- 1 Follow the instructions (starting on page 51) to remove the keyboard and the internal heat shield.
- 2 Follow the instructions (starting on page 58) to remove the processor module.
- 3 Locate the hard disk cable and disconnect it from the logic board.

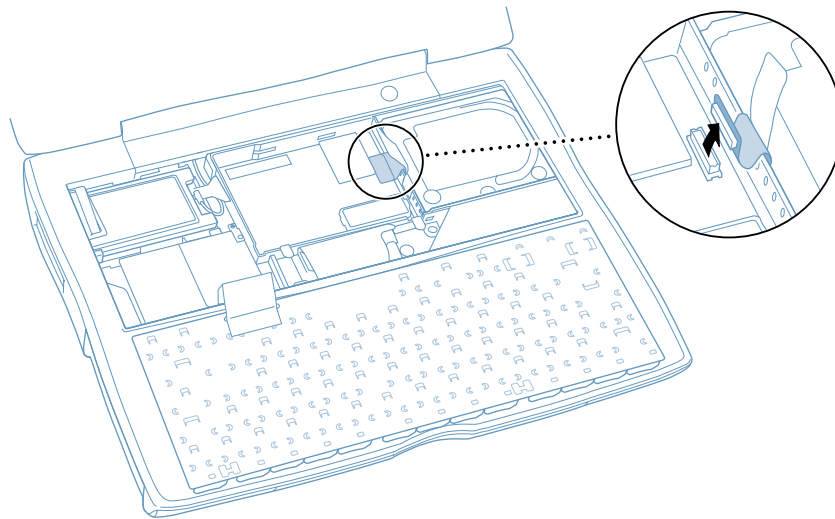

- 4 Use the pull tab to gently remove the hard disk from the computer.

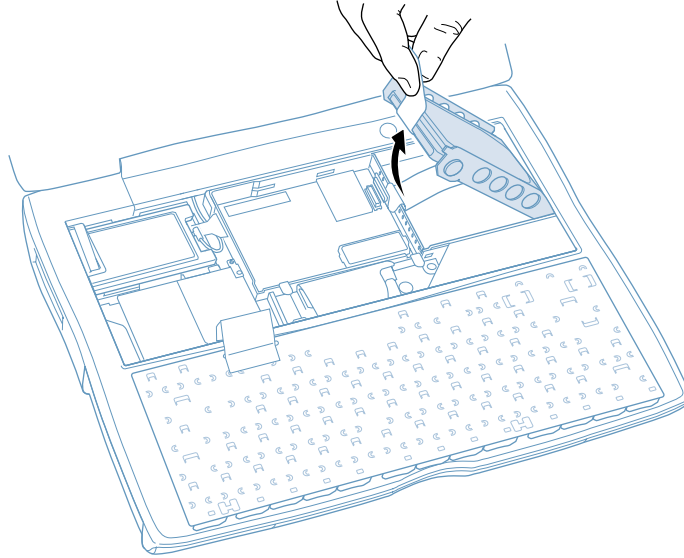

- 5 Replace the processor module, internal heat shield, and keyboard.

## PowerBook Specifications

This section provides basic product specifications. For additional information, choose Apple System Profiler from the Apple (🍏) menu. Additional product specification information is available on the Internet in the Apple Tech Info Library at [www.apple.com/support](http://www.apple.com/support)

### Processor, Memory, and Hard Disk

- *Processor:* PowerPC G3 processor
- *Memory:* minimum of 64 MB (maximum of 512 MB)
- *Hard disk:* minimum 6 gigabytes (GB)

### Video Memory and Graphics

- *Video memory:* 8 MB SDRAM
- *Graphics controller:* ATI Rage Mobility 128

### DVD Drive

- *Drive speed when reading a DVD disc:* 6x maximum
  - *Drive speed when reading a CD disc:* 24x maximum
- Note:** The DVD drive also reads 2.6 GB DVD-RAM discs.

### Modem

- *Modem standards:* K56flex and V.90
  - *Modem speed:* 53 Kbps
- Note:** Download speeds vary with line conditions and the modem capabilities of your Internet service provider (ISP). FCC regulations limit ISP transmission speeds to 53 Kbps in the United States.

### Optional AirPort Card

- *Wireless data rate:* Up to 11 megabits (Mbps) per second
- *Range:* Up to 150 feet (45 meters) in typical indoor use (varies with building)
- *Frequency band:* 2.4 gigahertz (GHz)

### Power Adapter

- *Input:* AC 100–240 volts (V), 50/60 hertz (Hz)
- *Output:* DC 24 V, 1.875 A

### Battery

- *Output:* DC 10.8 V
- *Capacity:* 5100 mAh

### **External Video Modes Supported**

- *External monitor in extended desktop mode:*
  - Up to millions of colors in the following resolutions: 512 x 384, 640 x 480, 640 x 870, 800 x 600, 832 x 624, 1024 x 768, and 1152 x 870
  - Up to thousands of colors in the following resolutions: 1280 x 960 and 1280 x 1024
- *External monitor in video mirroring mode:* Up to millions of colors in the following resolutions: 640 x 480, 800 x 600, and 1024 x 768

**Note:** Selecting a resolution greater than 1024 x 768 while in video mirroring mode will cause an image on the external monitor to scale down (not take up the entire screen) to match the 1024 x 768 of the internal display.

- *S-Video (NTSC):* 512 x 384, 640 x 480, 720 x 480, 800 x 600, 832 x 624, and 1024 x 768 at 60 Hz
- *S-Video (PAL):* 512 x 384, 640 x 480, 720 x 480, 800 x 600, 832 x 624, and 1024 x 768 at 50 Hz

**Note:** Playback of DVD movies on an external monitor or television reduces the amount of video memory available for display. Fewer colors may be available at certain higher resolutions.

### **Size and Weight**

- *Height:* 1.65 in. (42 mm)
- *Width:* 12.6 in. (320 mm)
- *Depth:* 10.4 in. (265 mm)
- *Weight:* 6.1 lbs. (2.8 kg)

**Note:** Weight varies depending on configuration and manufacturing process.

### **Operating Environment**

- *Operating temperature:* 50° F to 95° F (10° C to 35° C)
- *Storage temperature:* -40° F to 116° F (-47° C to 47° C)
- *Altitude:* 3048 m (10,000 ft.) maximum
- *Shipping altitude:* 10668 m (35,000 ft.) maximum
- *Relative humidity:* 20% to 80% noncondensing





# Troubleshooting

Occasionally you may have problems while working with your PowerBook. Most often they are the result of not having your software properly configured or using applications or software extensions that are not compatible with the version of the Mac OS (system software) installed on your computer. Other less likely sources include problems with the Mac OS (usually fixed by reinstalling your computer's system software or through a software update) and problems with your computer's hardware, such as the memory or hard disk.

When you experience a problem with your computer, it is important to remember not to panic. In most cases there is a simple and quick solution. When you encounter a problem, be aware of the conditions that led up to the problem. Making a note of things you did before the problem occurred will help you narrow down the possible causes of the problem and then find the answers you need. Things to note include

- what application you were using when the problem occurred (Problems that occur only when using a specific application may indicate that the application is not compatible with the version of the Mac OS installed on your computer.)
- any software that you recently installed, especially any software that may have added items to the System Folder (Certain applications install extensions that may not be compatible with the version of the Mac OS installed on your computer.)
- any new hardware (such as additional memory) that you installed

## Information in This Chapter

This chapter contains solutions to problems that prevent you from working with your computer, such as a system freeze or a computer that will not start up. You can find more troubleshooting information in Mac Help (see page 14) and on Apple's Support Web site at [www.apple.com/support](http://www.apple.com/support)

## Problems That Prevent You From Using Your Computer

### **If the computer won't respond or the pointer won't move**

- Press the Command (⌘) and period keys at the same time and, if a dialog box appears, click Cancel.
- If that doesn't work, hold down the Option and Command (⌘) keys and then press the Esc key. If a dialog box appears, click Force Quit. Then save your work in any open applications and restart the computer to be sure the problem is entirely cleared up.
- If you are unable to force the application to quit, press and hold the Power button (⏻) for one second to shut down the computer.
- If the computer still doesn't respond, try to restart it by simultaneously pressing the Command (⌘) and Control keys on your keyboard and the Power button (⏻) above the keyboard.
- If that doesn't work, locate the reset button (see page 20) on the back panel of your computer. Carefully press the button using the tip of a pen. Then press the Power button (⏻) to restart it.

If the problem occurs frequently, choose Mac Help from the Help menu. Look at the section on how to prevent and solve problems. You may need to check for extension conflicts or reinstall your computer's system software. If the problem occurs only when you use a particular program, check with the program's manufacturer to see if it is compatible with your computer.

### **If the computer freezes during startup or you see a flashing question mark**

- Turn off your system extensions by starting up your computer while holding down the Shift key.
- If that does not work, insert your system software CD and start up while holding down the C key. (Make sure the Caps Lock key is not engaged.)

After the computer starts up, choose Mac Help from the Help menu. Look at the section on how to prevent and solve problems. You may need to check for extension conflicts or reinstall your computer's system software.

If using your system software CD is the only way you can start up your PowerBook, you need to reinstall your computer's system software. For instructions, look in Mac Help or open the software installation or restore program (depending on which CD you used) and follow the onscreen instructions.



**If the computer won't turn on or start up**

- Make sure the power adapter is plugged into the computer and into a functioning power outlet. (Your battery may need to be recharged. Press the small button on the side of the battery. You should see one to four lights indicating the battery's level of charge.)
- If that does not work, locate the reset button (see page 20) on the back panel of your computer. Carefully press the button using the tip of a pen.
- If that does not work, start up the computer and immediately hold down the Command (⌘), Option, P, and R keys until you hear the startup sound a second time.
- If you recently installed additional memory or another internal component, make sure that it is correctly installed and that it is compatible with your computer. See whether removing it allows the computer to start up.
- If you are still unable to start up your computer, see the service and support information that came with your PowerBook for information on contacting Apple for service.

**Other Problems****If you have a problem with a software program**

- For problems with software from a manufacturer other than Apple, contact the manufacturer. Often software manufacturers provide updates to their software on their Web sites. You can configure your PowerBook to automatically check for and install the latest Apple software using the Software Updates control panel. For more information, choose Mac Help from the Help menu and search for "software updates."

**If you have problems with your Internet connection**

- Make sure your telephone line or network cable is connected and functioning properly.
- Make sure that your telephone cord is plugged into the modem port (marked with the icon ) and not the Ethernet port (marked with the icon ) .
- Choose Mac Help from the Help menu. There you will find how to locate your Internet settings and the contact information for your Internet service provider (if you used the Setup Assistant to get your Internet account).

**If you have a problem using your computer or working with the Mac OS**

- If the answers to your questions are not in this manual, look in Mac Help for instructions and troubleshooting information.
- Check out the Apple Support Web site at [www.apple.com/support](http://www.apple.com/support) for the latest troubleshooting information and software updates.



# Cleaning, Storage, Safety, and Ergonomic Information

## Cleaning Your PowerBook

Follow these general rules when cleaning the outside of your computer and its components:

- Use a damp, soft, lint-free cloth to clean the computer's exterior. Avoid getting moisture in any openings.
- Don't use aerosol sprays, solvents, or abrasives.

## Cleaning Your PowerBook Display

To clean your PowerBook screen, do the following:

- With your PowerBook shut down, dampen a clean, soft, lint-free cloth or paper with water only and wipe the screen. Do not spray liquid directly on the screen.

**Note:** You can also use diluted (at least 50%) isopropyl alcohol. Most office supply stores sell cleaning kits specifically designed for this purpose.

## Storing Your PowerBook

If you are going to store your PowerBook for an extended period of time, do one of the following to prevent your PowerBook battery from becoming completely depleted:

- Keep the power adapter connected.
- Fully charge your PowerBook battery before storing the computer.
- Fully charge and then remove your PowerBook battery when storing your computer (especially important when storing your computer for longer than 5 months).

## Safety Instructions for Setting Up and Using Your Computer

### Plugging In the Power Adapter

**Warning** Use only the power adapter that came with your PowerBook computer. Adapters for other electronic devices (including other PowerBook models and other portable computers) may look similar, but they may damage your computer. If your power adapter came equipped with a three-wire grounding plug (a plug that has a third grounding pin), then this plug will fit only a grounded AC outlet. If you are unable to insert the plug into the outlet because the outlet is not grounded, contact a licensed electrician to replace the outlet with a properly grounded outlet. Do not defeat the purpose of the grounding plug!

- Always leave space around your power adapter. Do not use this equipment in a location where airflow around the power adapter is confined, such as a bookcase.
- Always disconnect the power adapter and remove the battery before opening the computer to perform procedures such as installing memory or removing the hard disk.

### Connecting a Phone Line to the Internal Modem

**Warning** Do not connect a digital telephone line to the modem, because the wrong type of line could damage the modem.

- Always disconnect the phone cord before opening the computer to perform procedures such as installing memory or removing the hard disk.

### Using Your PowerBook

When using your PowerBook or when charging the battery, it is normal for the bottom of the case to get warm. The bottom of the PowerBook case functions as a cooling surface that transfers heat from inside the computer to the cooler air outside. The bottom of the case is raised slightly to allow airflow that keeps the unit within normal operating temperatures.

**Warning** Never turn on your computer unless all of its internal and external parts are in place. Operating the computer when it is open or missing parts can be dangerous and damage your computer.

## General Safety Instructions

For your own safety and that of your equipment, always take the following precautions.

Disconnect the power plug (by pulling the plug, not the cord), remove the main battery, and disconnect the phone cord if any of the following conditions exists:

- You want to remove any parts (leave the cord disconnected as long as the keyboard is open)
- The power cord or plug becomes frayed or otherwise damaged
- You spill something into the case
- Your computer is exposed to rain or any other excess moisture
- Your computer has been dropped or the case has been otherwise damaged
- You suspect that your computer needs service or repair
- You want to clean the case (use only the recommended procedure described earlier)

**Important** The only way to disconnect power completely is to unplug the power cord and phone cord, and remove the batteries from the expansion or battery bays. Make sure at least one end of the power cord is within easy reach so that you can unplug the computer when you need to.

Be sure that you always do the following:

- Keep your computer away from sources of liquids, such as drinks, washbasins, bathtubs, shower stalls, and so on.
- Protect your computer from dampness or wet weather, such as rain, snow, and so on.
- Read all the installation instructions carefully before you plug your computer into a wall socket.
- Keep these instructions handy for reference by you and others.
- Follow all instructions and warnings dealing with your system.

**Warning** Electrical equipment may be hazardous if misused. Operation of this product, or similar products, must always be supervised by an adult. Do not allow children access to the interior of any electrical product and do not permit them to handle any cables.

**Warning** Never push objects of any kind into this product through the openings in the case. Doing so may be dangerous and result in fire or a dangerous electric shock.

## Ergonomics

### Keyboard and Trackpad

When you use the keyboard and trackpad, your shoulders should be relaxed. Your upper arm and forearm should form an angle that is slightly greater than a right angle, with your wrist and hand in roughly a straight line.

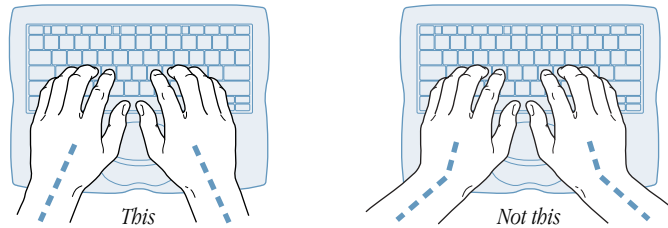

Use a light touch when typing or using the trackpad and keep your hands and fingers relaxed. Avoid rolling your thumbs under your palms.

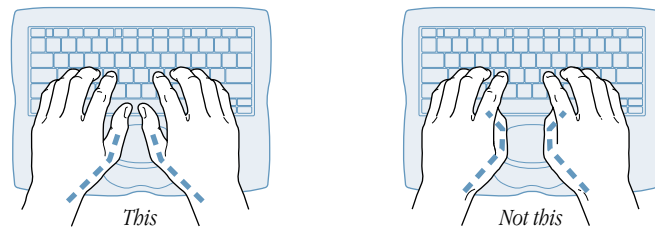

Change hand positions often to avoid fatigue. Some computer users may develop discomfort in their hands, wrists, or arms after intensive work without breaks. If you begin to develop chronic pain or discomfort in your hands, wrists, or arms, consult a qualified health specialist.

### Chair

An adjustable chair that provides firm, comfortable support is best. Adjust the height of the chair so your thighs are horizontal and your feet flat on the floor. The back of the chair should support your lower back (lumbar region). Follow the manufacturer's instructions for adjusting the backrest to fit your body properly.

You may have to raise your chair so your forearms and hands are at the proper angle to the keyboard. If this makes it impossible to rest your feet flat on the floor, you can use a footrest with adjustable height and tilt to make up for any gap between the floor and your feet. Or you may lower the desktop to eliminate the need for a footrest. Another option is to use a desk with a keyboard tray that's lower than the regular work surface.



**External Mouse**

If you use an external mouse, position the mouse at the same height as your keyboard and within a comfortable reach.

**Built-in Display**

Adjust the angle of the display to minimize glare and reflections from overhead lights and windows.

You can adjust the brightness of the screen when you take the computer from one work location to another, or if the lighting in your work area changes.

**For More Information**

Go to [www.apple.com/about/ergonomics](http://www.apple.com/about/ergonomics)



## **Communications Regulation Information**

### **FCC Declaration of Conformity**

This device complies with part 15 of the FCC rules. Operation is subject to the following two conditions: (1) This device may not cause harmful interference, and (2) this device must accept any interference received, including interference that may cause undesired operation. See instructions if interference to radio or television reception is suspected.

### **Radio and Television Interference**

The equipment described in this manual generates, uses, and can radiate radio-frequency energy. If it is not installed and used properly—that is, in strict accordance with Apple’s instructions—it may cause interference with radio and television reception.

This equipment has been tested and found to comply with the limits for a Class B digital device in accordance with the specifications in Part 15 of FCC rules. These specifications are designed to provide reasonable protection against such interference in a residential installation. However, there is no guarantee that interference will not occur in a particular installation.

You can determine whether your computer system is causing interference by turning it off. If the interference stops, it was probably caused by the computer or one of the peripheral devices.

If your computer system does cause interference to radio or television reception, try to correct the interference by using one or more of the following measures:

- Turn the television or radio antenna until the interference stops.
- Move the computer to one side or the other of the television or radio.
- Move the computer farther away from the television or radio.
- Plug the computer into an outlet that is on a different circuit from the television or radio. (That is, make certain the computer and the television or radio are on circuits controlled by different circuit breakers or fuses.)

If necessary, see the service and support information that came with your Apple product for information on contacting Apple for service. Or, consult an experienced radio/television technician for additional suggestions.

**Important** Changes or modifications to this product not authorized by Apple Computer, Inc., could void the FCC Certification and negate your authority to operate the product.

This product was tested for FCC compliance under conditions that included the use of Apple peripheral devices and Apple shielded cables and connectors between system components. It is important that you use Apple peripheral devices and shielded cables and connectors between system components to reduce the possibility of causing interference to radios, television sets, and other electronic devices. You can obtain Apple peripheral devices and the proper shielded cables and connectors through an Apple-authorized dealer. For non-Apple peripheral devices, contact the manufacturer or dealer for assistance.

*Responsible party (contact for FCC matters only):* Apple Computer, Inc., Product Compliance, 1 Infinite Loop, M/S 26-A, Cupertino, CA 95014-2084, 408-974-2618.

### **Exposure to Radio Frequency Energy**

The radiated output power of the optional AirPort Card is far below the FCC radio frequency exposure limits. Nevertheless, it is advised to use the wireless equipment in such a manner that the potential for human contact during normal operation is minimized.

### **Industry Canada Statement**

This Class B device meets all requirements of the Canadian interference-causing equipment regulations.

Cet appareil numérique de la Class B respecte toutes les exigences du Règlement sur le matériel brouilleur du Canada.

## VCCI Class B Statement

### 情報処理装置等電波障害自主規制について

この装置は、情報処理装置等電波障害自主規制協議会（VCCI）の基準に基づくクラス B 情報技術装置です。この装置は、家庭環境で使用することを目的としていますが、この装置がラジオやテレビジョン受信機に近接して使用されると、受信障害を引き起こすことがあります。

取扱説明書に従って正しい取り扱いをして下さい。

### Notify Your Telephone Company

Some telephone companies require that you notify the local business office when you hook up a modem to their lines.

### Information You Need in the United States

The internal modem complies with Part 68 of the FCC rules. On the back of this equipment is a label that contains, among other information, the FCC registration number and ringer equivalence number (REN). If requested, provide this information to your telephone company.

- *Ringer equivalence number (REN):* 0.8 The REN is useful to determine the quantity of devices you may connect to your telephone lines and still have all those devices ring when your telephone number is called. In most, but not all areas, the sum of the RENs of all devices connected to one line should not exceed five (5.0). To be certain of the number of devices you may connect to your line, as determined by the REN, you should contact your local telephone company to determine the maximum REN for your calling area.
- *Telephone jack type: USOC, RJ-11* An FCC-compliant telephone cord and modular plug are provided with this equipment. This equipment is designed to be connected to the telephone network or premises wiring using a compatible modular jack that complies with Part 68 rules. See the installation instructions for details.

### Telephone Line Problems

If your telephone doesn't work, there may be a problem with your telephone line. Disconnect the modem to see if the problem goes away. If it doesn't, report the problem either to your local telephone company or to your company's telecommunications people.

If disconnecting the modem eliminates the problem, the modem itself may need service. See the service and support information that came with your Apple product for instructions on how to contact Apple or an Apple-authorized service provider for assistance.

If you do not disconnect your modem when it is adversely affecting the telephone line, the telephone company has the right to disconnect your service temporarily until you correct the problem. The telephone company will notify you as soon as possible. Also, you will be informed of your right to file a complaint with the FCC.

The telephone company may make changes in its facilities, equipment, operations, or procedures that could affect the operation of your equipment. If this happens, the telephone company will provide advance notice in order for you to make the necessary modifications to maintain uninterrupted service.

The optional internal modem will not work with party lines, cannot be connected to a coin-operated telephone, and may not work with a private branch exchange (PBX).

### Telephone Consumer Protection Act

The Telephone Consumer Protection Act of 1991 makes it unlawful for any person to use a computer or other electronic device to send any message via a telephone fax machine unless such message clearly contains in a margin at the top or bottom of each transmitted page or on the first page of the transmission, the date and time it was sent and an identification of the business or other entity, or individual sending the message and the telephone number of the sending machine of such business, entity, or individual.

### **Information You Need in Canada**

The Industry Canada (IC) label identifies certified equipment. This certification means that the equipment meets certain telecommunications network protective, operational, and safety requirements. The Department does not guarantee the equipment will operate to a user's satisfaction.

Before installing this equipment, make sure that you are permitted to connect to the facilities of the local telecommunications company. Be sure you use an acceptable method of connection to install the equipment. In some cases, you may extend the company's internal wiring for single-line individual service by means of a certified telephone extension cord. Be aware, however, that compliance with these conditions may not prevent degradation of service in some situations.

Repairs to certified equipment should be made by an authorized Canadian maintenance facility designated by the supplier. Any equipment malfunctions or repairs or alterations that you make to this equipment may cause the telecommunications company to request that you disconnect the equipment.

*In Canada, contact Apple at:* 7495 Birchmount Road, Markham, Ontario, L3R 5G2, 800-263-3394

Users should ensure for their own protection that the electrical ground connections of the power utility, telephone lines, and internal metallic water pipe system, if present, are connected together. This precaution may be particularly important in rural areas.

**Warning** Users should not attempt to make such connections themselves, but should contact the appropriate electric inspection authority or electrician.

- *Load number:* 0.3 The load number (LN) assigned to each terminal device denotes the percentage of the total load to be connected to the telephone loop that is used by the device, to prevent overloading. The termination of a loop may consist of any combination of devices, subject only to the requirement that the sum of the load numbers of all devices does not exceed 100.
- *Telephone jack type:* CA-11

### **Informations Destinés aux Utilisateurs Canadiens**

L'étiquette d'Industrie Canada identifie un matériel homologué. Cette étiquette certifie que le matériel est conforme à certaines normes de protection, d'exploitation et de sécurité des réseaux de télécommunications. Le Ministère n'assure toutefois pas que le matériel fonctionnera à la satisfaction de l'utilisateur.

Avant d'installer ce matériel, l'utilisateur doit s'assurer qu'il est permis de le raccorder au réseau de l'entreprise locale de télécommunication. Le matériel doit également être installé en suivant une méthode acceptée de raccordement. Dans certains cas, le câblage appartenant à l'entreprise utilisé pour un service individuel à ligne unique peut être prolongé au moyen d'un dispositif homologué de raccordement (cordon prolongateur téléphonique).

L'abonné ne doit pas oublier qu'il est possible que la conformité aux conditions énoncées ci-dessus n'empêchent pas la dégradation du service dans certaines situations. De fait, les entreprises de télécommunication ne permettent pas que l'on raccorde un matériel aux prises d'abonné, sauf dans les cas précis prévus par les tarifs particuliers de ces entreprises.

Les réparations de matériel homologué doivent être effectuées par un centre d'entretien canadien autorisé désigné par le fournisseur. La compagnie de télécommunications peut demander à l'utilisateur de débrancher un appareil suite à des réparations ou des modifications effectuées par l'utilisateur ou à cause de mauvais fonctionnement.

*Veillez contacter le fournisseur suivant pour des informations supplémentaires :* Apple Canada, Inc., 7495 Birchmount Road, Markham, Ontario, Canada, L3R 5G2, Apple Canada Customer Assistance Line: 800-263-3394

Pour sa propre protection, l'utilisateur doit s'assurer que tous les fils de mise à la terre du secteur, des lignes téléphoniques et les canalisations d'eau métalliques, s'il y en a, soient raccordés ensemble. Cette précaution est particulièrement importante dans les régions rurales.

**Avertissement** L'utilisateur ne doit pas tenter de faire ces raccordements lui-même; il doit avoir recours à un service d'inspection des installations électriques ou à un électricien, selon le cas.

- *Numéro de charge* : 0.3 L'indice de charge (IC) assigné à chaque dispositif terminal indique, pour éviter toute surcharge, le pourcentage de la charge totale qui sera raccordée à un circuit téléphonique bouclé utilisé par ce dispositif. La terminaison du circuit bouclé peut être constituée de n'importe quelle combinaison de dispositifs pourvu que la somme des indices de charge de l'ensemble des dispositifs ne dépasse pas 100.
- *Type de prise téléphonique* : CA-11

#### **Information You Need in the United Kingdom**

This terminal equipment is intended for direct connection to the analogue Public Switched Telecommunications Network and is approved for use within the United Kingdom with the following features:

- Modem facility
- Autocalling facility
- Autoanswer facility
- DTMF signaling
- Operation in the absence of proceed indication or upon detection of proceed indication

This product is in conformity with relevant regulatory standards following the provisions of European Council Directives 73/23/EEC (Low Voltage Directive) and 89/336/EEC amended by 92/31/EEC (EMC Directive).

#### **Information You Need in Germany**

Diese Modem-Karte ist als Endeinrichtung vorgesehen und muss an ein TAE mit F-Kodierung angeschlossen werden.

Diese Endeinrichtung ist in Konformität gemäss Niederspannungsrichtlinie 73 / 23 / EWG sowie EMC-Richtlinien 89 / 336 / EWG und 92 / 31 / EWG.

#### **Information You Need in France**

Ce matériel est conforme aux normes applicables de sécurité électrique d'après la directive 73 / 23 / CEE et aux normes applicables de compatibilité électromagnétique d'après la directive 89 / 336 / CEE, modifiée par la directive 92 / 31 / CEE.

#### **Information You Need in Australia**

All telecommunications devices are required to be labelled as complying to the Australian telecommunications standards, ensuring the health and safety of the operator and the integrity of the Australian telecommunications network. To provide compliance with the Australian Communications Authority's technical standards, please ensure that the following AT commands are maintained:

- ATB0 (ITU/CCITT operation)
- AT&G0 (no guard tone)
- AT&P1 (33/66 pulse dial make/break ratio)
- ATS0 = 0 or ATS0 = 2 (no answer or answer greater than one ring)
- ATS6 = n (blind dial delay acceptable range of 2–5 seconds)
- ATS11 = 95 (DTMF period between 70–255 ms)

For calls that are automatically generated, a total of three call attempts are allowed to a telephone number, with a minimum period between calls of 2 seconds. If the call does not connect after three attempts, 30 minutes must expire before automatic redialing may be initiated. Failure to set the modem (and any associated communications software) to the above settings may result in the modem being non-compliant with Australian telecommunications standards. Under these circumstances a user could be subject to significant penalties under the Telecommunications Act 1997.

**Warning** This modem must be properly secured in order for you to use it. Telecommunications network voltages exist inside the computer and the telecommunications line connection must be removed before opening the computer.

#### **Information You Need in New Zealand**

This modem is fully approved to operate on the New Zealand telecommunications network under Telepermit number PTC 211/99/077. All telecommunications devices are required to hold a Telepermit and be labelled accordingly with the approved Telepermit number to comply with the New Zealand telecommunications standards, ensuring the health and safety of the operator and the integrity of the New Zealand telecommunications network.

To ensure compliance, all calls that are automatically generated should not make more than 10 call attempts to the same number within any 30 minute period with a minimum period between calls of 30 seconds. Failure to adhere to these standards may result in the modem being non-compliant with New Zealand Telecom standards. Under these circumstances a user could be subject to significant penalties.

**Important** The grant of a Telepermit for any item of terminal equipment indicates that only Telecom has accepted that the item complies with minimum conditions for connection to its network. It indicates no endorsement of the product by Telecom, nor does it provide any sort of warranty. Above all, it provides no assurance that any item will work correctly in all respects with another item of Telepermitted equipment of a different make or model, nor does it imply that any product is compatible with all of Telecom's network services.

## Laser Information

**Warning** Making adjustments or performing procedures other than those specified in your equipment's manual may result in hazardous radiation exposure.

Do not attempt to disassemble the cabinet containing the laser. The laser beam used in this product is harmful to the eyes. The use of optical instruments, such as magnifying lenses, with this product increases the potential hazard to your eyes. For your safety, have this equipment serviced only by an Apple-authorized service provider.

Your computer is a Class 1 laser product. The Class 1 label, located in a user-accessible area, indicates that the drive meets minimum safety requirements. A service warning label is located in a service-accessible area. The labels on your product may differ slightly from the ones shown here.

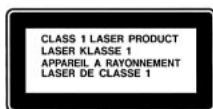

**Class 1 label**

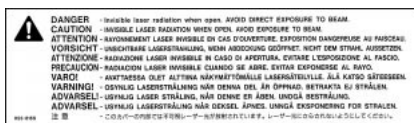

**Service warning label**

## Laser Specifications

Laser on pickup unit (when reading a CD)

- *Type*: Semiconductor GaAlAs laser
- *Wavelength*: 790 nm
- *Power out of objective lens*: 3.3 mW
- *Beam divergence*: horizontal 12° vertical 35°

Laser on pickup unit (when reading a DVD)

- *Type*: Semiconductor GaAs laser
- *Wavelength*: 658 nm
- *Power out of objective lens*: 6 mW
- *Beam divergence*: horizontal 8.5° vertical 27°

## High-Risk Activities Warning

This computer system is not intended for use in the operation of nuclear facilities, aircraft navigation or communications systems, or air traffic control machines, or for any other uses where the failure of the computer system could lead to death, personal injury or severe environmental damage.

## ENERGY STAR

As an ENERGY STAR® partner, Apple Computer has determined that this product meets the ENERGY STAR guidelines for energy efficiency. The United States Environmental Protection Agency's ENERGY STAR program is a partnership with office product equipment manufacturers to promote energy-efficiency. Reducing energy consumption of office products saves money and reduces pollution by eliminating wasted energy.