



TEC VIDEOELECTRONICS INC. SERVICE MANUAL

A. GENERAL

TM-600 and TM-623 is a television monitor for video games. It is designed for operation either from a power supply of 115 volts/50-60 Hz AC or 230 volts/50-60 Hz AC. The complete monitor incorporates a picture tube, an integrated circuit, 20 silicon transistors, 18 silicon diodes, 2 germanium diodes, and a high-voltage selenium diode.

This model is equipped with 5V/3A power supply for the operation of the TTL control board and operation double-pulse-type AFC circuit to obtain a stable picture.

B. SPECIFICATIONS

Power Supply Input

115 volts/230 volts 50-60 Hz $\pm 10\%$

Power Consumption

60 watts

Video Input

0.5 volts composite P/P for 100 volts

2.5 volts P/P maximum

Sync negative at input

Picture Tube

19" (500 mm), 114° deflection for Model TM-600

23" (584.2 mm), 114° deflection for Model TM-623

Integral implosion protection

High Voltage

18 KV nominal at 0 microamperes beam current

Horizontal Retrace Time

12 microseconds maximum

Resolution

500 lines minimum at picture center

Scanning Frequency

Horizontal: 15.750 Hz ± 500 Hz

Vertical: 50-60 Hz

Tone Burst Amplifier

5 watts peak output with TTL drive at nominal line, fully adjustable. 4 watts peak output at low line.

Environment

Operation: Maximum ambient temperature 50°C (122°F)

Storage: Temperature range from -40°C to +65°C

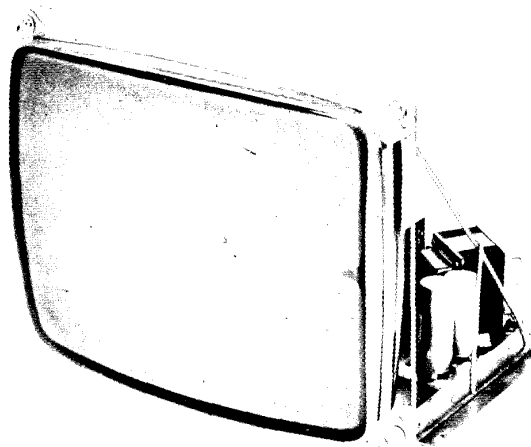

Model TM-600 and TM-623 Monitors

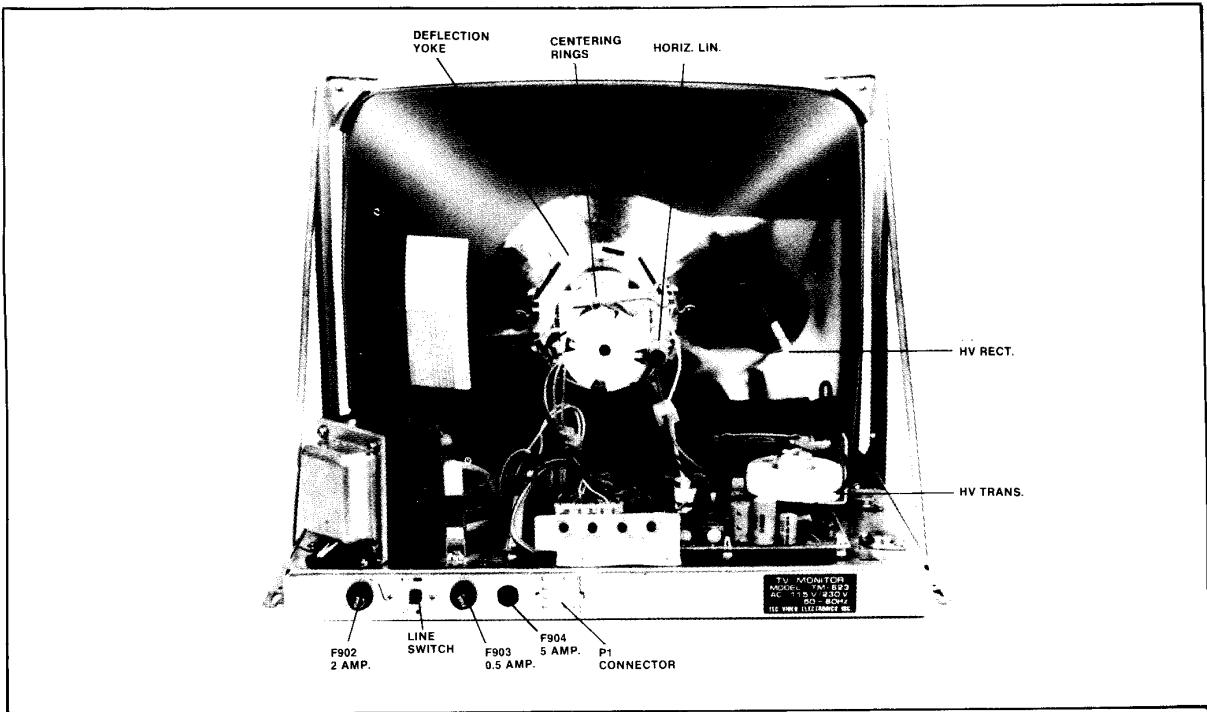

Figure 6-17 TEC Monitor Chassis, Rear View

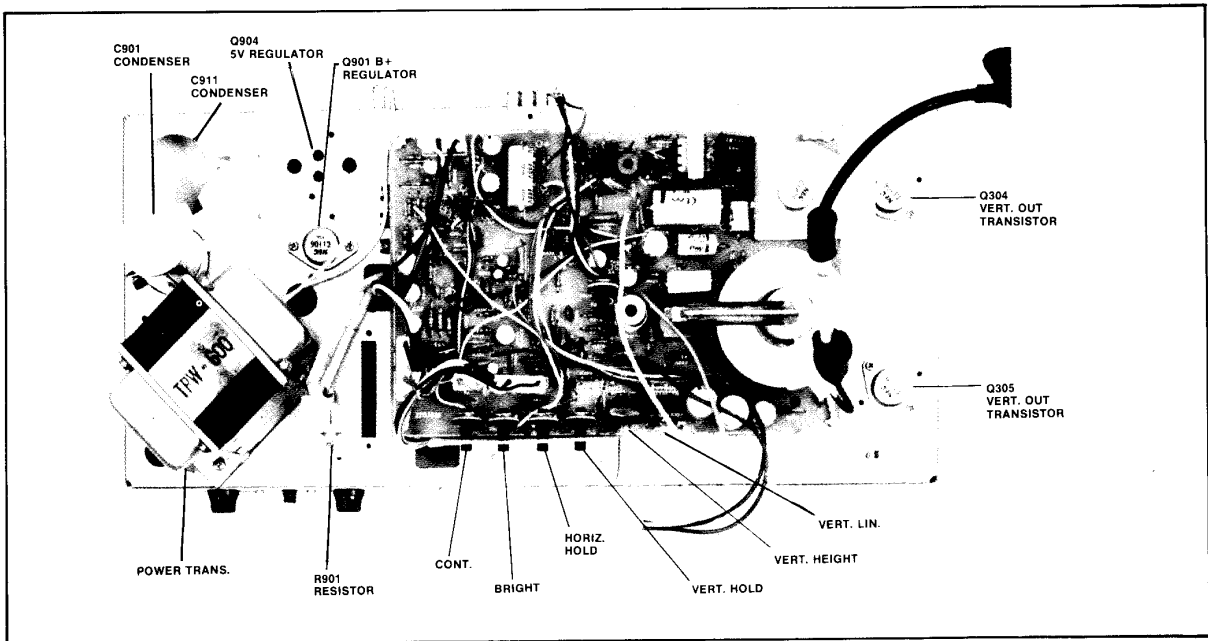

Figure 6-18 TEC Monitor Chassis, Top View

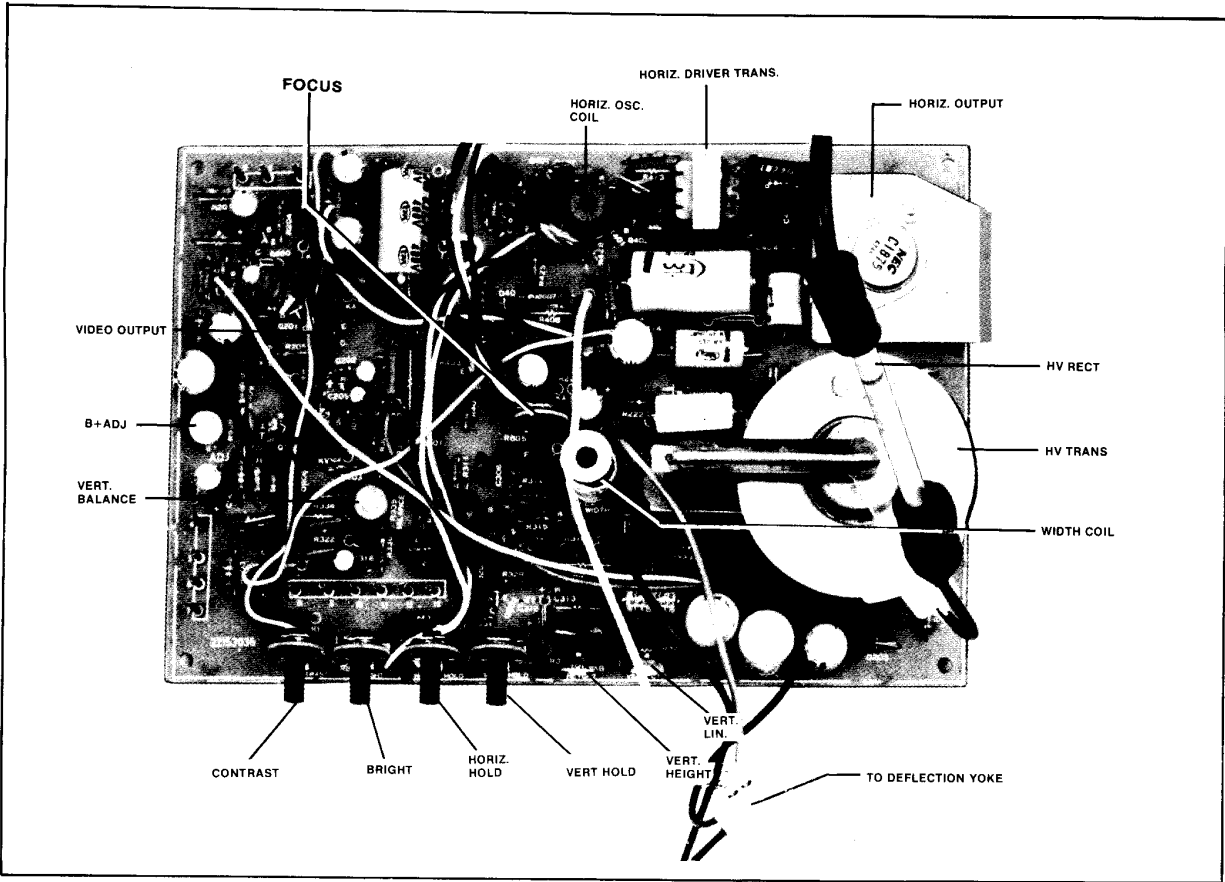

Figure 6-19 TEC Monitor Printed Circuit Board, Top View

Table 6-3 TEC Monitor Replacement Parts Numbers

Ref. No.	Part No.	Description	Ref. No.	Part No.	Description
Electrical Parts:					
PCB1	2215303600	Main PCB	Q303	5300500201	MPS9700U or MPS834 Vert Amp
A801	485TM60003	CRT PCB	Q304	4310400030	2SC1106 Vert Output
Transistor and IC:					
Q200	5310500202	MPS9700T or MPS834	Q305	or 2N6307	or 2N6307 Vert Output
Q201	5310500261	MPS9750T or MPS4356	Q400	5310500202	MPS9700T or MPS834 Phase Inv
Q202	5310500410	2N6558 or MPSU-10	Q401	5310500202	MPS9700T or MPS834 Horiz Osc
Q301	5310500261	MPS9750T or MPS4356	Q402	5310500410	2N6558 or MJE9742 or 2N4354 Horiz Amp
Q302	5310500201	MPS9700U or MPS834	Q403	5310400040	2SC1875 or MJ205 Horiz Output
			*Q901	5310400030	2SC1106 or MJ3430 Power Regulator

Table 6-3 TEC Monitor Replacement Parts Numbers

Ref. No.	Part No.	Description	Ref. No.	Part No.	Description					
Q902	5310500410 or 5310500070	2N6558 MPS-U04	Regulator Amp	T401	589514015	TLN-506BX	Horiz Osc			
Q903	5310500280	LM1796 or MPS-D01	Reference Amp	T402	589518012	TLN-519	Horiz Drive			
Q904	5310500450	MJ2955	5V Regulator	* T403	589517017	TFB-1006AS	F.B.T.			
CRT and Diode:				* T901	589519021	TPW-600	Power Trans			
* V801	5380000060	500SB4	CRT	Resistors						
D203	5340200280	MR9712 or IN4004	Silicon Diode L. V. Rectifier	R201	RD-4L471J	470	ohm J ¼ W			
D204	5340200430	IN4148 or IN4002	Silicon Diode Blanking Clip	R202	RD-4L223J	22 K	ohm J ¼ W			
D205	5340200430	IN4148 or IN4002	Silicon Diode Blanking Clip	R203	RD-4L563J	56 K	ohm J ¼ W			
D206	5340200430	IN4148 or IN4002	Silicon Diode Blanking Clip	R204	RD-4L471J	470	ohm J ¼ W			
D207	534020280	MR9712 or IN4004	200V Rect	R205	RD-4L332J	3.3 K	ohm J ¼ W			
D301	5340200260	MR-9701	Rectifier Silicon Diode	R206	RD-2L823J	82 K	ohm J ½ W			
D401	5340100040	AA143	Phase Det	R207	RD-4L560J	56	ohm J ¼ W			
D402	5340100040	AA143	Phase Det	R208	RD-4L102J	1 K	ohm J ¼ W			
D403	5340200300	MR9722	Damper	R210	RS-029562J	5.6 K	ohm J 2 W			
*D404	5340400120	TV20-2K80J or HS30/lb	H.V. Rectifier	R215	RD-42101J	1 K	ohm J ¼ W			
D801	5340200290	MR9713	400V Rectifier	* R216	RD-4L101J	100	ohm J ¼ W			
D901	5340200270	MR9704 or IN4005	Rectifier Silicon Diode	* R217	RD-4L470J	47	ohm J ½ W			
D902	5340200270	MR9704 or IN4005	Rectifier Silicon Diode	R218	RD-4L223J	22 K	ohm J ¼ W			
D903	5340200270	MR9704 or IN4005	Rectifier Silicon Diode	R219	RD-4L563J	56 K	ohm J ¼ W			
D904	5340200270	MR9704 or IN4005	Rectifier Silicon Diode	R220	RD-4L102J	1 K	ohm J ¼ W			
D906	5340300220 or 5340300310	IN5858A IN6002A	Zener Diode	R221	RD-4L102J	1 K	ohm J ¼ W			
D907 D908 D909 D910	5340200690	MDA970-1	Rectifier	R222	RD-2L102J	1 K	ohm J ½ W			
				R223	RD-2L102J	1 K	ohm J ½ W			
				R224	RD-2L122J	1.2 K	ohm J ½ W			
				* R226	RS01P101J	100	ohm J 1 W			
Coils and Trans:				R227	RD-2L123J	12 K	ohm J ½ W			
*L401	589515015	TDY1005	D.Y. Coil	R228	RD-2L105J	1.5 K	ohm J ½ W			
L402	589512015	HCH1005	Horiz Choke Coil	R229	RD-4M681J	680	ohm J ¼ W			
L403	589512012	HC2-035	Choke Coil	R302	RD-4M331J	330	ohm J ¼ W			
L404	589512012	HC2-035	Choke Coil	R303	RD-4L562J	5.6 K	ohm J ¼ W			
L405	589514013	AZ-9177DM	Width Coil	R304	RD-4M102J	1 K	ohm J ¼ W			
L406	589514016	LH-15J54	Lin Coil	R308	RD-4M104J	100 K	ohm J ¼ W			
				R309	RD-4M155T	1.5 M	ohm J ¼ W			
				R310	RD-4M332J	3.3 K	ohm J ¼ W			
				R311	RD-4M563J	56 K	ohm J ¼ W			
				R312	RD-4L182J	1.8 K	ohm J ¼ W			
				R313	RD-4L153J	15 K	ohm J ¼ W			
				R314	RD-4L183J	18 K	ohm J ¼ W			
				R315	RD-4L203J	20 K	ohm J ¼ W			
				R316	RS-2P333J	33 K	ohm J ½ W			
				R327	RD-4L104J	100 K	ohm J ¼ W			
				R320	RD-4L124J	120 K	ohm J ¼ W			

Table 6-3 TEC Monitor Replacement Parts Numbers

Ref. No.	Part No.	Description	Ref. No.	Part No.	Description
R322	RD-4L224J	220 K ohm J ¼ W	R904	RD-2L123J	12 K ohm J ½ W
R323	RD-4L433J	43 K ohm J ¼ W	R905	RD-2L223J	22 K ohm J ½ W
R324	RD-4L471J	470 ohm J ¼ W	R906	RD-2L563J	56 K ohm J ½ W
R326	RD-4L152J	1.5 K ohm J ¼ W	R907	RD-2L563J	56 K ohm J ½ W
R339	RD-4L101J	100 ohm J ¼ W	R909	RD-2L682J	6.8 K ohm J ½ W
R331	RD-4M331J	330 ohm J ¼ W			
R332	RD-4L102J	1 K ohm J ¼ W	Controls:		
R333	RS01P682J	6.8 K ohm J 1 W	R211	553102005E	1 K ohm Contrast
R334	RD-2L183J	18 K ohm J ½ W	R319	553104005B	100 K ohm Vert. Hold
R336	RD-4L221J	220 ohm J ¼ W	R321	553124008B	220 K ohm Vert. Height
R337	5160122901	2.2 ohm J ½ W	R327	553472008B	4.7 K ohm Vert. Linearity
R338	RS-2P150J	15 ohm J ½ W	R335	553102007B	1 K ohm Vert. Balance
R339	5160112901	1.2 ohm J ½ W	R427	553303005B	30 K ohm Horiz Hold
R340	RS01P220T	22 ohm J 1 W	R803	553254005B	250 K ohm Bright
R401	RD-4L153J	15 K ohm J ¼ W	R805	553205005B	2 M ohm Focus
R402	RD-4L821J	820 ohm J ¼ W	R908	553472007B	4.7 K ohm B+ADJ
R403	RD-4M561J	560 ohm J ¼ W			
R404	RD-4M103J	10 K ohm J ¼ W	Capacitors:		
R405	RD-4M103J	10 K ohm J ¼ W	C201	CE2G1C470	47 mF 16V
R406	RD-4L272J	2.7 K ohm J ¼ W	C202	CE2G1F101	100 mF 25V
R407	RD-4L681J	680 ohm J ¼ W	C203	CE2G1C220	22 mF 16V
R408	RS02P682J	4.7 K ohm J ½ W	C204	CE2G1H101	100 mF 35V
R419	RD-4L270J	27 ohm J ¼ W	C205	CE2G1C220	22 mF 16V
R410	RD-4L182J	1.8 K ohm J ¼ W	C206	C1SL1H561K	560 pF K 50V
R411	RD-4L151J	150 ohm J ¼ W	C207	CE2G0J221	220 mF 6.3V
R412	RD-4L561J	560 ohm J ¼ W	C208	5270322401	0.22 mF M 400V
R413	RS01P682J	6.8 K ohm J 1 W	C209	CE2G2F229	2.2 mF 315V
R414	RD-2L221J	220 ohm J ½ W	C210	CE2G1H220	22 mF 35V
R415	5160122903	2.2 ohm J 1 W	C211	CE2G1H339	3.3 mF 50V
R416	RD-2L569J	5.6 ohm J ½ W	C213	CK1F2H102K	0.001 mF 500V
R417	RS02P182J	1.8 K ohm J 2 W	C220	CE2G2F220	2.2 mF 250V
R418	RS01P123J	12 K ohm J 1 W	C301	CQ1M1H473K	0.047 mF K 50V
*R420	RX05P220J	22 ohm J 5 W	C304	CK1B1H391K	470 pF K 50V
*R421	RD-2L569J	5.6 ohm J ½ W	C305	CE2G1H478	0.47 mF 50V
R422	RD-4L153J	47 ohm J 1 W	C306	56405333	0.033 mF K 50V
R425	RD-4L153J	15 K ohm J ¼ W	C307	CQ1M1H562K	0.0056 mF K 50V
R426	55337153	15 K ohm J ¼ W	C308	CQ1M1H273K	0.027 mF K 50V
R802	RD-2L154J	150 K ohm J ½ W	C309	CQ1M1H123K	0.012 mF K 50V
R804	RD-2L474J	470 K ohm J ½ W	C311	CQ1M1H124K	0.12 mF K 50V
R811	RD-2L561J	2MΩ J ½ W	C312	CQ1M1H392K	0.0039 mF K 50V
*R901	RX20P251J	250 ohm J 20 W	C313	DS5D1C229M	2.2 mF 16V
R902	RD-2L101J	1 K ohm J ½ W	C314	CQ1M1H474J	0.47 mF 50V
R903	RD-2L123J	12 K ohm J ½ W	C315	CQ1M1H333K	0.033 mF K 50V
			C316	CF2G1A470	47 mF 10V

Table 6-3 TEC Monitor Replacement Parts Numbers

Ref. No.	Part No.	Description	Ref. No.	Part No.	Description
C317	CE2G2A101	100 mF 100V			
C318	CK1E2H103K	0.01 mF 500V			
C319	5270310301	0.01 mF 630V			
C401	CQ1M1H103K	0.01 mF K 50V			
C402	CQ1M1H103K	0.01 mF K 50V			
C403	CQ1M1H393K	0.039 mF K 50V			
C404	CK1B2H151	150 mF 500V			
C405	CE2G1H339	3.3 mF 50V			
C406	CQ1M1H104K	0.1 mF K 50V			
C407	CQ1M1H223K	0.022 mF J 50V			
C408	CQ1M1H683K	0.068 mF J 50 V			
C409	CE2G1F470	47 mF 25V			
C410	CK1B2H681K	680 pF K 500V			
C411	CK1B2H222K	0.0022 mF K 500V			
C412	CK1B1H152K	0.0015 mF K 50V			
C413	CK1B1H102K	0.001 mF K 50V			
*C414	CK1B3D471K	470 pF K 2KV			
C415	CQ1M2A104K	0.1 mF K 100V			
*C416	5270333201	0.0033 mF 1.5KV			
C417	CE2G2C100	10 mF 160V			
C418	5270333401	0.33 mF K 200V			
C419	56635101	100 mF 35V			
C420	56625471	470 mF 25V			
C801	5270356302	0.056 mF K 630V			
*C901	5240700400	450 mF 200V			
C902		100 mF 160 V			
C904	F2G2C229	2.2 mF 160V			
C905	CK1F2H102K	0.001 mF 500V			
C911	56625105	10000 mF 25V			
C912	56616018	1 mF 16V			
Discharge Gaps: Z801 } Z802 } 599030001 EGP-H751A Z803 }					
Switches: *SW-1 PE13-1567 115V/230V Power Line Slide Switch					
			Fuses: *F902 6990620011 250V 2 Amp. *F903 5990610013 250V 0.5 Amp. F904 5990630010 30V 5 Amp.		
			Mechanical Parts: *K001 22-463020 Mate-N-Lock Connector (AMP) 60085005 Edge Collector (Molex) S-A3915 Transistor Socket (SMK) *TM60085001 Fuse Holder or *TM60085001 Fuse Holder K005 1-380826-0 Stand-Off Fastener (AMP) P401 PE19-1569 4P Plug Assy. (Yoke Line) P402 PE19-1570 4F Recep Assy (Yoke Line) P403 PE19-1571 3P Connector Assy. (Video Input) A621 PE19-1572 4P Connector Assy. (Q901 Line) A631 PE19-1573 6P Connector Assy. (Q304/Q305 Line) P406 PE19-1574 2P Plug Assy. (Heater Line) P407 PE19-1575 2P Recep Assy. (Heater Line) TE901 PE19-1576 Terminator, 6 Pin E001 135431015 Ground Plate F001 22-164001 Frame H003 5432001-1 Plate Heat Sink A Q403D 54320011 Plate Heat Sink C		
			NOTE		
			1. Design and specifications are subject to change without notice. 2. J—Indicates ± 5% tolerance K—Indicates ±10% tolerance M—Indicates ±20% tolerance		

WARNING

Safety-Critical Components

Components marked with an asterisk (*) on the parts list and with gray shading in the schematic have special characteristics important for safety.

You may create shock, fire, or other hazards by using a replacement that does not have the same characteristics as the recommended part.

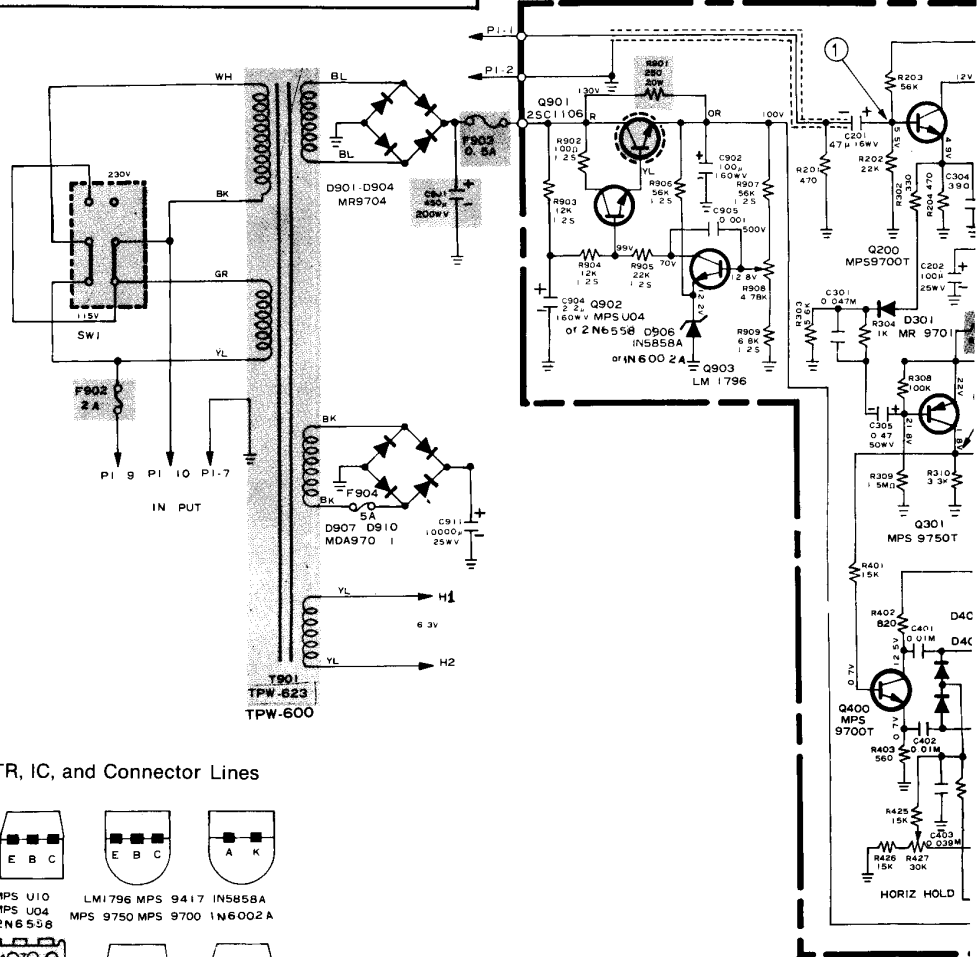

TR, IC, and Connector Lines

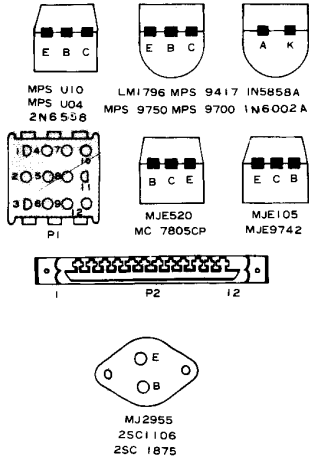

WAVE FORMS

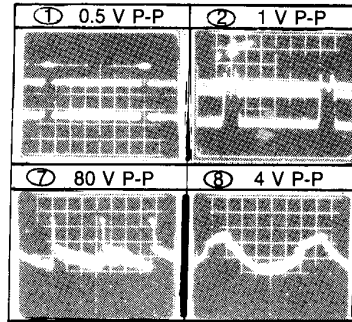

NOTES

1. Unless otherwise specified, all resistance values are in ohms.
2. Unless otherwise specified, in the schematic diagram all capacitor values less than 1 are expressed in mfd, and values more than 1 are in pfd.
3. Voltage readings are taken with VTVM from point indicated on chassis to ground.
4. All waveforms are measured with strong signal input and contrast set to give normal picture.
5. This schematic diagram covers basic or representative chassis only. There may be some differences between actual components on chassis and the schematic diagram.

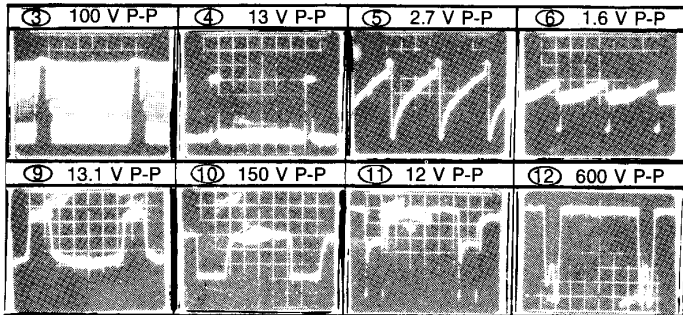
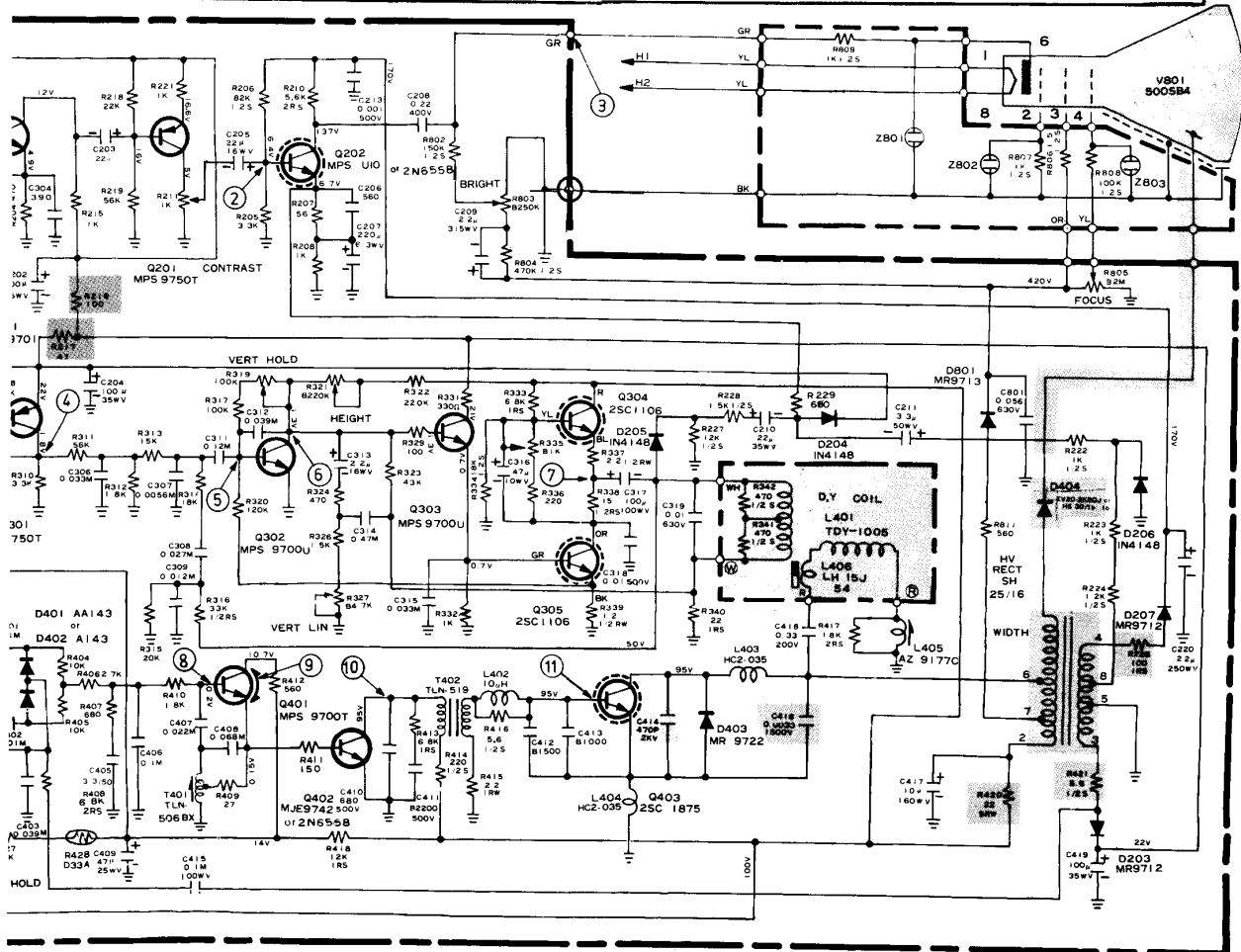
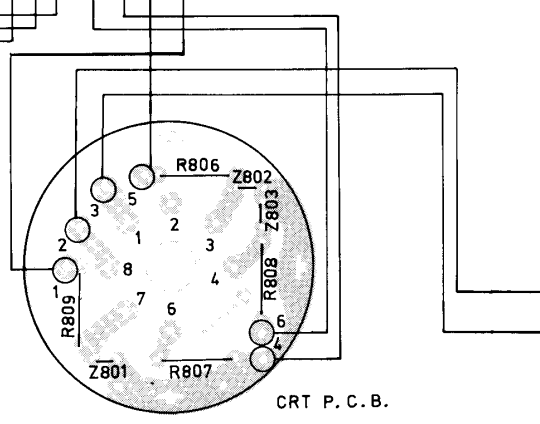
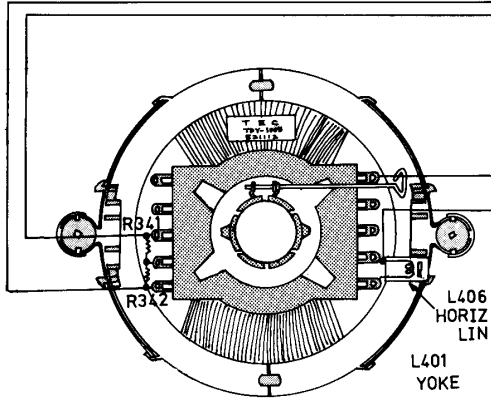
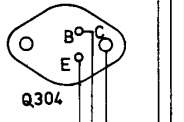
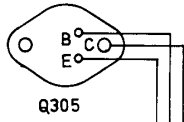
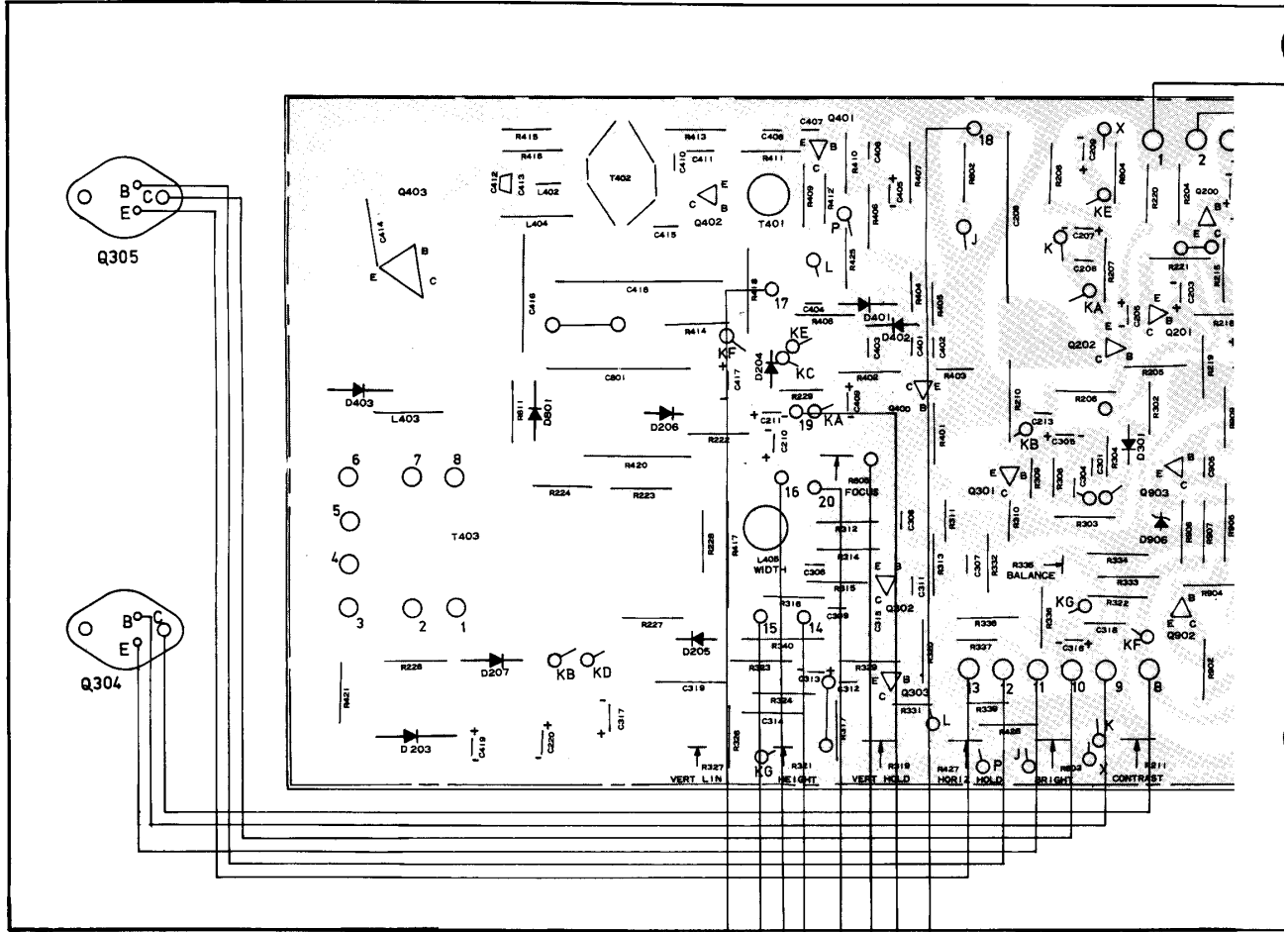
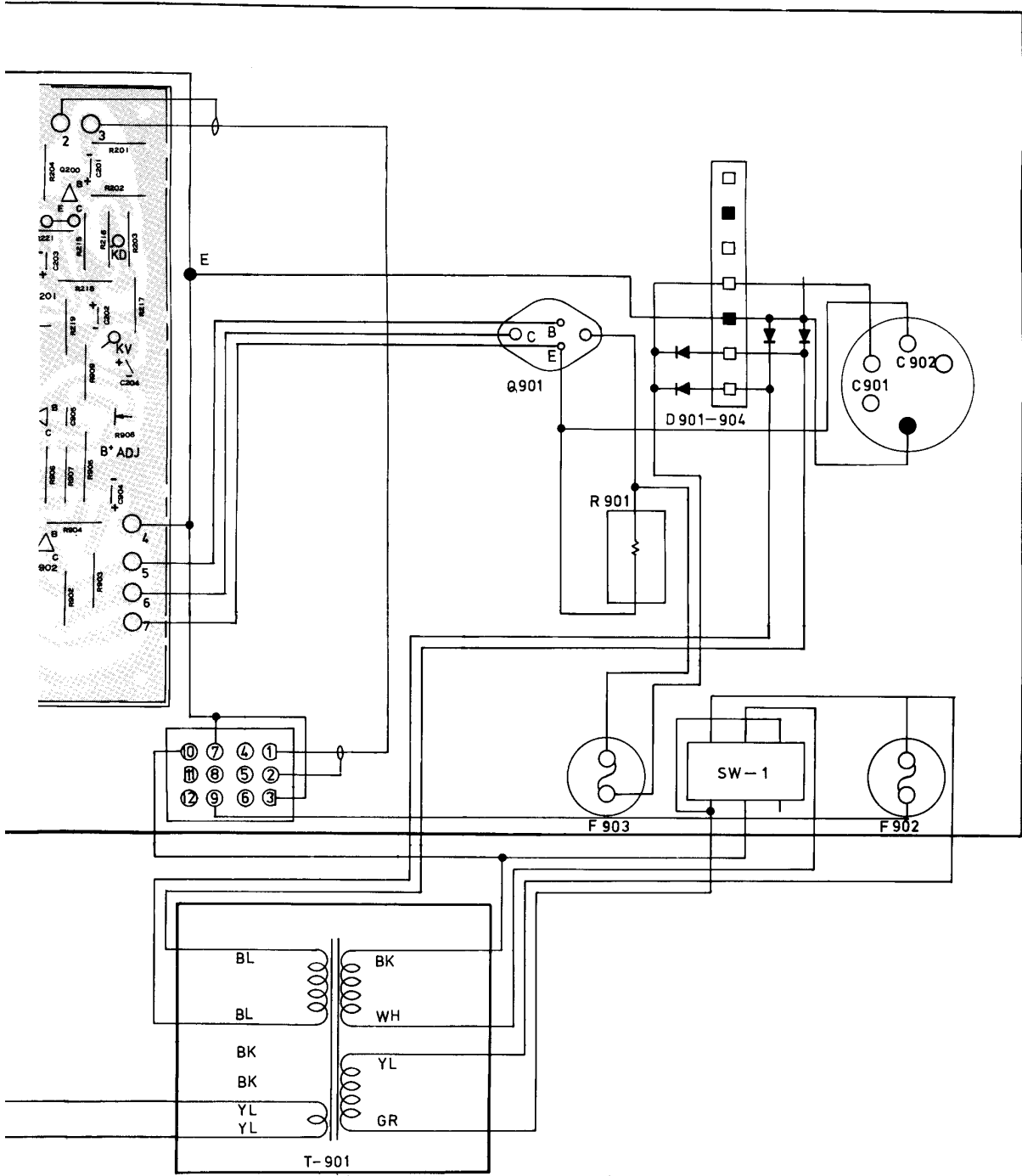

Figure 6-20 TEC Monitor Schematic Diagram





BOTTOM VIEW

Figure 6-21 TEC Monitor Wiring Diagram