

REVISED 03/31/04



USER'S MANUAL
Part 2

Four-Line Intercom Speakerphone 974



For Customer Service Or Product
Information, Visit Our Website At
www.telephones.att.com

Please also read
**Part I — Important
Product Information**

© 2004 Advanced American Telephones. All Rights Reserved.
AT&T and the Globe Design are trademarks of AT&T Corp., licensed to Advanced American Telephones.



In case of difficulty, visit our Service Center at
www.telephones.att.com or call **1 800 222-3111**.

© 2004 Advanced American Telephones.
All Rights Reserved.
AT&T and the Globe Design are
trademarks of AT&T Corp., licensed to
Advanced American Telephones.
Printed in Singapore. Issue 1 AT&T 04/04

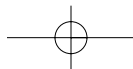

CONTENTS

PRODUCT OVERVIEW	1	Assign the Line Group for this Phone	39
BEFORE YOU BEGIN	2	Erase All Settings and Return the Phone to Default Settings ...	40
Parts List	2	Set This Phone to be the Centrex Console Phone	41
Tools Needed	2	Set the Centrex Console Delayed Ring Time	42
DSL Users	4	Set the Display Language	42
Glossary	5	TELEPHONE OPERATION ..	43
Programmable Features List	7	Make or Answer a Call	43
Audible Signals	10	Switch Between Handset, Headset and Speakerphone	45
INSTALLATION	11	Timer	45
Battery Installation	11	Call Privacy	46
Table/Desk Installation	13	Do Not Disturb	46
Wall Installation	15	Volume	47
Convenience Ports	19	Redial	47
MENU OPERATION	20	Redial Stack	48
Menu Structure	21	Auto Redial	48
Shortcut to Language Menu	22	Hold	49
Rapid Scroll	22	Switch Between Lines	49
FEATURE SETUP	23	Mute	50
Set One Touch Preference	23	Flash	50
Assign an Extension Number to Your Phone	24	Temporary Tone Dialing	50
Turn the Ringer On or Off for Each Line	25	Conference Calls	51
Select the Ringer Type	26	Transfer a Call	52
Set Delay Ring	27	Low Battery Indicator	53
Turn Auto-Mute On or Off	28	Lights and What They Mean	54
Set Dial Mode	29	ONE TOUCH OPERATION ..	55
Turn Hold Reminder On or Off ...	29	Store a Number in a One Touch Location	56
Set the Time and Date	30	Review a One Touch Entry	58
Turn Line Usage On or Off for Each Line	31	Dial a One Touch Number	59
Assign the Prime Line (Line Preference)	32	DIRECTORY OPERATION	60
Set Automatic Mode	33	Menu Structure	60
Set the Scroll Rate	34	Store a Name and Number in the Directory	61
Turn Screen Backlight On or Off	35	Review Directory Entries	64
Turn COVM Indicators On or Off for Each Line	36	Edit a Directory Entry	65
Reset COVM Indicator	37	Dial a Number from the Directory	66
Program Home and Local Area Codes	38		

CONTENTS

DIRECTORY OPERATION

continued

- Remove a Name and Number
from the Directory 66
- Remove All Entries from
the Directory 66

INTERCOM OPERATION..... 67

- Basic Intercom Operations 68
- Make an Intercom Call with
the Handset..... 69
- Make an Intercom Call with the
Speakerphone or Headset..... 70
- Answer an Intercom Call..... 71
- End an Intercom or Page Call 71
- Page a Specific Extension
(Single-phone Page) 72
- Answer a Single-phone Page..... 72
- Page All System Phones..... 73
- Answer a System-wide Page 73
- Make an Intercom
Conference Call 74
- Room Monitor..... 74

CALLER ID OPERATION..... 75

- Caller ID Display 76
- Call Waiting..... 76
- Calls Received on Two or
More Lines Simultaneously..... 77
- Display Screen Messages 78
- Message Waiting and
NEW CALL Light..... 79
- Call History 79
- Remove Calls from
Call History 81
- Dial a Number from
Call History 82
- Save a Name and Number from
Call History to the Directory... 83
- Save a Number from Call History
to a One Touch Location..... 84

ADDING A FAX MACHINE.. 85

- Using a Fax Switch..... 85

GENERAL PRODUCT CARE 86

TECHNICAL SPECIFICATIONS..... 87

IN CASE OF DIFFICULTY.... 88

EXPANDING THE PHONE SYSTEM..... 93

- Line Groups 93
- Private Lines 94

CENTREX OPERATION..... 95

- Setup Checklist..... 95
- Enable the Console Phone 95
- Console Operation..... 95
- Set Ring Delay Duration 96
- Answer a Delayed Ring 96
- Pick Up Another Station's Line..... 96

INDEX..... 97

PRODUCT OVERVIEW

This AT&T 974 Four-Line Intercom Speakerphone is expandable to a 16-extension telephone system. The 974 is compatible with AT&T 945, 984, 944, 955 and 964 telephones. (See **BEFORE YOU BEGIN** starting on page 2 and **EXPANDING THE PHONE SYSTEM** beginning on page 93 for details.)

The 974 is hearing-aid compatible and can be connected to up to four incoming telephone lines. This phone features a speakerphone for hands-free use and a headset jack compatible with most two-band 2.5mm headsets (sold separately). The 974 allows paging, intercom and call transfers between system phones and is capable of connecting three parties in a conference call. This phone also features a 32-number memory for faster dialing and has a directory which can store up to 200 additional numbers with names. This phone has a Caller ID feature which supports Caller ID with Call Waiting service. (Caller ID services are subscriber services available from many local telephone companies for a fee.) There are two convenience ports available for connecting the phone to another device such as a fax machine or modem.

The 974 is compatible with Centrex service. Centrex is a special subscriber service which may be available from your local telephone company for a fee. If you subscribe to Centrex service, refer to the **CENTREX OPERATION** section of this manual, beginning on page 95.

This User's Manual contains detailed instructions for installing, programming and operating your AT&T 974 Four-Line Speakerphone. Please be sure to read **BEFORE YOU BEGIN** starting on page 2 before installing this phone.

BEFORE YOU BEGIN

Parts List

Your box should include:

BEFORE YOU BEGIN

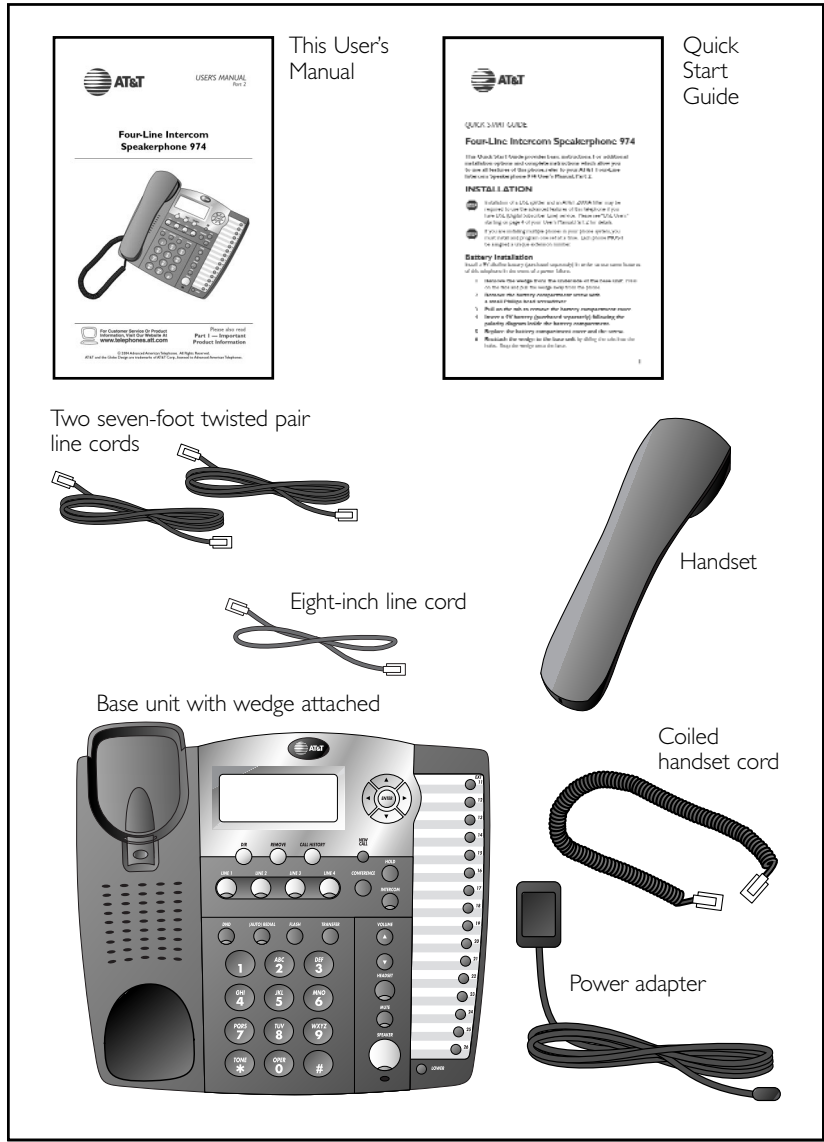

Tools Needed

You will also need a small Phillips head screw driver to install your phone.

This 974 telephone is fully compatible with any AT&T Four-Line Intercom Speakerphone 945 or 984 units you may have installed. You can use a total of 16 945/974/984 units together as extensions in your phone system.

This 974 telephone is also compatible with any AT&T 964/955/944 phones you have previously installed. This 974 telephone is **NOT** compatible with any 843, 853, 854, 874, or 954 telephones you may have previously installed.

 **NOTE:** If you have one or more 964, 955, or 944 phone(s) installed in the same phone system with this 974 telephone, you can have only 12 extensions and 15 telephone lines in the phone system.

- You must have a modular telephone jack and an electrical outlet not controlled by a wall switch near where you're installing the phone.



The total length of telephone wiring used in this system **MUST NOT** be more than 600 feet. In some cases a Z800A filter can be used in a phone system with more than 600 feet of wire.

AT&T highly recommends that a Z800A filter be installed by a professional. AT&T CANNOT guarantee that this telephone will work with such a filter, and IS NOT responsible for the cost of such installations or for arranging the installation. A Z800A filter can be obtained by calling 1 800 222-3111.

- Identify the number of phone lines you'll use.
- Plan the layout of your phone system.
- All connected phones must have the same Line 1 phone number for the Intercom and Page features to work.



Every individual phone in your telephone system **MUST** be assigned a unique extension number for the Intercom feature to work. If you try to assign the same extension number to a second phone, you will hear a repeating short ring and the the screen display will include EXT XX is already used Assign new EXT #. See "Assign an Extension Number to Your Phone" on page 24 of this manual for directions.

- Decide if you want a private line. A private line does not appear on all connected phones.
- Choose your setting for each feature. You will need to program the features after installation. See "Programmable Features List" beginning on page 7 for a brief description of the features. See the FEATURE SETUP section beginning on page 23 for programming instructions.

BEFORE YOU BEGIN

DSL Users



Installation of a DSL splitter and an AT&T Z800A filter is required to use the advanced features of this telephone if you have DSL (Digital Subscriber Line) service.

Set-Up for DSL Users

If you are a DSL (Digital Subscriber Line) customer, you may experience interference with the advanced features of this telephone. Certain features of this phone (e.g., intercom, hold, line privacy, etc.) work by sending a data signal using Line 1. This data signal is sent at some of the same frequencies as those used by your DSL service. Microfilters are used to block the high frequency DSL signals from being transmitted through and interfering with your telephones. These same microfilters that may have been installed for your DSL service will also block the data signals between your system phones. Therefore, some features of this phone may not work properly when DSL filters are installed in your building. This problem can occur even if the DSL line is not one of the lines used by the phone system. If you use the microfilters that your DSL service provider may have supplied when you activated DSL service with this phone, some of the phone features will not work. Once the DSL splitter (described below) is installed, you should no longer experience interference.

Installation, by your DSL service provider or other professional, of a DSL splitter (not a “microfilter”) **AND** an AT&T Z800A Isolation filter as close as possible to the “protection block” or “network interface” (where the telephone line enters the house) may resolve DSL interference. (It may be necessary to use a DSL splitter intended for outdoor use.) A DSL splitter allows the data and voice signals to use the same telephone line without interfering with each other. An AT&T Z800A filter isolates the splitter from your phone system and reduces interference with the signals used by the system phones to communicate with each other.

You can obtain an AT&T Z800A filter at no charge by calling **1 800 222-3111**. You will also receive a diagram showing the proper installation of the AT&T Z800A filter with a DSL splitter, DSL modem and your system phones. AT&T cannot supply the DSL splitter.

Please contact your DSL service provider or professional contractor for details about obtaining and installing a DSL splitter. Your DSL service provider may require you to bear any installation costs. AT&T and the manufacturer of this product have no affiliation with your DSL provider and the type or quality of services they offer. Installation must be performed at your own expense and AT&T cannot troubleshoot or provide installation support.

NOTE: If your DSL service provider cannot supply a DSL splitter, it is possible to purchase an outdoor DSL splitter (such as a Corning or Allen Tel brand DSL splitter) over the Internet.

If you are a new DSL customer, your DSL service provider will likely ask you if you have more than one telephone line in your home or business. If you answer yes, your DSL service provider will probably advise you that you need a splitter. Your DSL service provider may also ask if you are installing a phone system. If you answer yes, your DSL service provider will most likely advise you that you need a splitter. In most cases, your DSL service provider will supply you with the proper splitter for your specific situation. The DSL splitter, installed properly and in conjunction with a Z800A filter, should help overcome any interference between the DSL signal and the signals sent by your phone system.

AT&T shall not be responsible for the cost of installation, any damages, lost business, direct or indirect expenses accrued or associated with installation, or other compatibility issues which may arise as a result of using this product while you subscribe to DSL service.

Glossary

Caller ID: Caller Identification is a subscriber service available from most local telephone companies for a fee. When you subscribe to Caller Identification, you can see who's calling before you answer the phone if you and the caller are both in areas offering Caller ID service with compatible equipment.

Caller ID with Call Waiting: This is a single, combined subscriber service which may be available from your local telephone company. If you subscribe to this service, you can use your 974 telephone to see who's calling even while you are on another call (as long as your caller is in an area with Caller ID service and both telephone companies use compatible equipment).

Centrex Service: A special subscriber service which may be available from your local telephone company for a fee. This 974 telephone can be used with Centrex Service.

COVM: Central Office Voice Mail is a subscriber voice message service which may be available from your local telephone company. This service may be called by another name in your area (e.g., Call Answering).

DND: When activated, the Do Not Disturb (DND) feature prevents interruptions during a call.

continued on page 6

BEFORE YOU BEGIN

Glossary

continued from page 5

Home Area Code: This is the area code for your telephone number. Most users simply dial the seven digits of a phone number to make a call within their own area code and 11 digits outside of their area code. If this applies to you, you should enter your own area code into the unit as the Home Area Code. After programming, if you receive a call from within your Home Area Code, the screen will display the seven digits of the phone number.

You may, however, live in a region where for calls within your own area code, you must dial 10 digits (that is, the area code and phone number). If this applies to you, enter "000" for the Home Area Code and enter your area code as a Local Area Code. After programming, if you receive a call from within your area code, the screen displays the 10 digits of the phone number.

Be sure to follow the directions under "Program Home and Local Area Codes" on page 38 during Feature Setup.

Line Group: A group of system phones sharing some lines within a multi-phone system.

Local Area Code: Most users dial 11 digits to make calls outside their Home Area Codes. If this applies to you, you do not need to program any Local Area Codes.

However, if you dial only 10 digits to make calls to some areas outside your Home Area Code (without dialing "1"), then program these Local Area Codes into the phone. Up to five Local Area Codes can be programmed. See "Program Home and Local Area Codes" on page 38 during Feature Setup for instructions.

After programming, if you receive a call from one of these Local Area Codes, the screen displays the 10 digits of the phone number.

Navigation buttons: These are the buttons used when programming your 974 phone and for scrolling through feature options (**ENTER**), **▲**, **▼**, **▶**, **◀**).

Phone System: Two or more system phones combined to form an interacting system of shared lines. You can have up to 16 phones in the system.

NOTE: If you have one or more 964, 955, or 944 phone(s) installed in the same phone system with this 974 telephone, you can have only 12 extensions in the phone system.

Prime Line: This is the line on your phone you designate to be selected automatically when you lift the handset, press **SPEAKER**, or press **HEADSET**.

System Phone: Any 944, 945, 955, 964, 974 or 984 phone in your phone system (also called an extension).

PROGRAMMABLE FEATURES LIST

Default settings indicated by *.

FEATURE:	FUNCTION:	OPTIONS:
ONE TOUCH PREFERENCE	Choose default mode for One Touch (EXT) buttons.	Intercom* or Telephone
EXTENSION NO	Assign an extension number to this phone.	11*-26
RINGER ON /OFF	Turn the ringer on or off for each line.	On* or Off
RINGER TYPE	Select a ring pattern for this phone.	Type 1*, 2, 3, 4
DELAY RING	Select desired time to delay Central Office ring.	Off*, 2, 4, 6, up to 30 seconds
AUTO-MUTE	Turn Auto-Mute on or off (sounds at this extension will be heard automatically when paged).	On* or Off
TONE/PULSE	Set the dial mode for touch tone or dial pulse (rotary) dialing.	Tone* or Pulse
HOLD REMINDER	Turn on or off the audible reminder that a call at this extension is on hold.	On* or Off
TIME/DATE	Set the time and date.	01:00 AM 01/01 Sunday*
LINE USAGE	Turn Line Usage on or off for each line.	On* or Off

 **NOTE:** One ring is equal to about six seconds, two rings equals twelve seconds, and so on.

continued on page 8

BEFORE YOU BEGIN

Programmable Features List

continued from page 7

Default settings indicated by *.

FEATURE:	FUNCTION:	OPTIONS:
PRIME LINE	Assign a line on this phone to be selected automatically when you lift the handset, press SPEAKER , or press HEADSET .	Line 1*, 2, 3, 4
AUTOMATIC MODE	Choose default mode for calls connected with the handset in the cradle.	Speakerphone* or Headset
SCROLL RATE	Set the scrolling speed for Rapid Scroll.	Very Slow, Slow, Medium* Fast, or Very Fast
LCD BACKLIGHT	Turn the screen display backlight on or off.	On* or Off
COVM ON/OFF	Turn COVM (message/voice mail) indicators on or off for each line.	On or Off*
COVM RESET	Clear COVM indicators when they are lit but no new messages are waiting.	N/A
AREA CODES	Program one Home and up to five Local Area Codes for use with Caller ID features.	1-3 digits, Empty*
LINE GROUP	Assign your phone to a Line Group.	Line Group 4*-15 or PRV (private)

Ⓞ NOTE: One ring is equal to about six seconds, two rings equals twelve seconds, and so on.

Default settings indicated by *.

FEATURE:	FUNCTION:	OPTIONS:
RESET ALL	Return all features to default settings.	N/A
CONSOLE	Specify whether your phone is the Centrex Console phone for your phone system.	On or Off*
CSL DELAY RING	Set the time to delay ring for Centrex Console phone.	Off*, 2, 4, 6, up to 30 seconds
LANGUAGE	Select the language for screen displays.	English*, Espanol, or Français

🎯 **NOTE:** One ring is equal to about six seconds, two rings equals twelve seconds, and so on.

BEFORE YOU BEGIN

Audible Signals

WHEN YOU HEAR:	IT MEANS:
A RAPID DOUBLE-RING PATTERN, REPEATING	You have an incoming intercom call.
A LONG SINGLE RING, REPEATING	You have an incoming transferred call.
A SHORT SINGLE RING, REPEATING	The extension number you just programmed has already been assigned. Choose another number for this extension.
A SHORT SINGLE TONE, REPEATING	The extension you are calling is in DND mode.
A LONG SINGLE TONE, REPEATING	The extension you are calling is busy.
A VERY LONG SINGLE TONE, REPEATING	The extension you are calling is ringing.

INSTALLATION

STOP If you are installing multiple phones in your telephone system, you must install and program one set at a time. If more than one extension is assigned the same extension number, a repeating short ring (error ring) sounds at the extension you are programming and the screen display includes `EXT XX is already used Assign new EXT #`. Assign a different extension number from 11 to 26 (see "Assign an Extension Number to Your Phone" on page 24).

Battery Installation

Install a 9V alkaline battery (purchased separately) in order to use some features of this telephone in the event of a power failure. If power fails and a working battery is installed, all four lines of this phone will work only to answer calls with the handset or headset, and to dial calls using the key pad and the One Touch or Redial features. No other features will work until power is restored.

- 1 Remove the wedge from the underside of the base unit.**
Press on the tabs in the direction of the arrows and pull the wedge away from the phone.

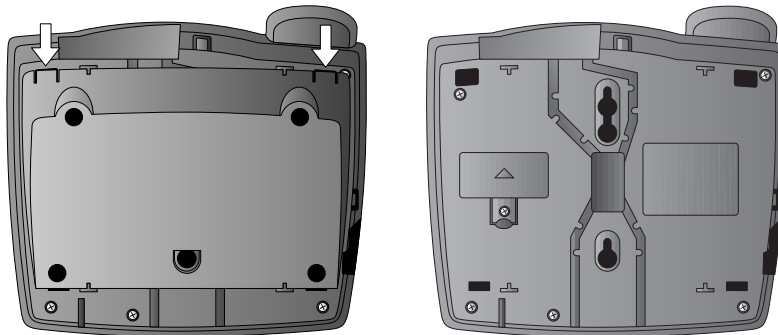

- 2 Remove the battery compartment screw with a small Phillips head screwdriver.**

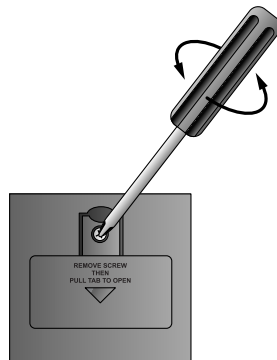

continued on page 12

Battery Installation

continued from page 11

- 3 Pull on the tab to remove the battery compartment cover.**

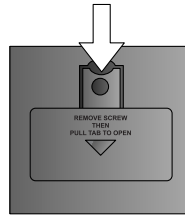

- 4 Insert a 9V battery (purchased separately).**

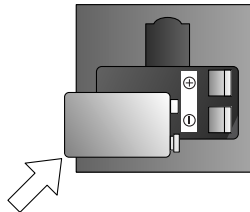

- 5 Replace the battery compartment cover and the screw.**
- 6 If you are wall mounting the phone, turn to "Wall Installation" beginning on page 15. (You will not need the wedge; store it in case you use the phone on a table or desk in the future.)**

— OR —

If you are using the phone on a table or desk, reattach the wedge to the base unit by sliding the tabs into the holes as shown. Snap the wedge onto the base. Then, turn to "Table/Desk Installation" beginning on page 13.

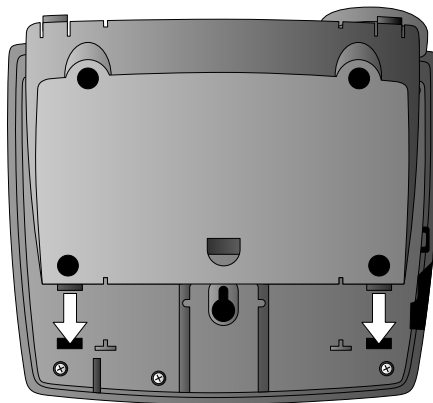

Table/Desk Installation

For best results, follow the directions in “Battery Installation” on page 11 before installing the phone.

I Connect the telephone line cords to the telephone and wall jacks as shown in the appropriate illustration below. Use only the line cords that came with this phone.

- **Four One-Line Jacks** (To use this installation option, you’ll need to purchase two two-line adapters. Adapters are available at retail stores or by calling **1 800 222-3111**.)

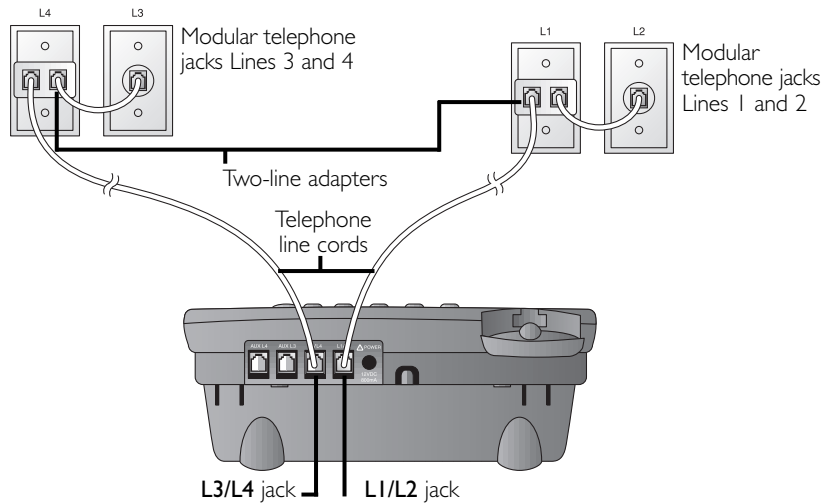

- **Two Two-Line Jacks**

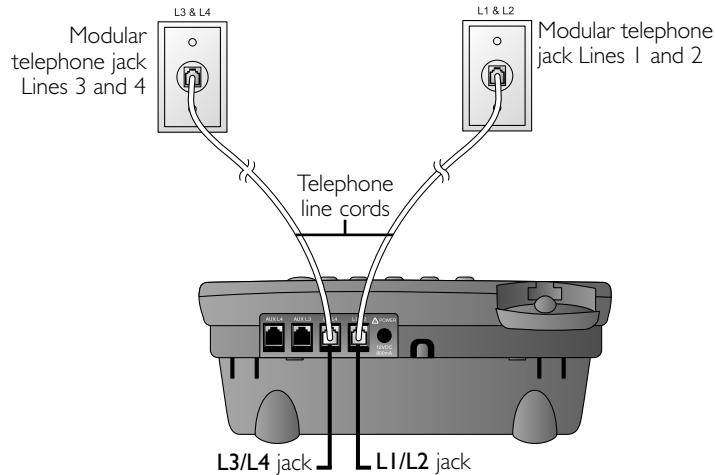

continued on page 14

Table/Desk Installation

continued from page 13

2 Connect the handset cord.

Plug one end of the coiled handset cord into the jack on the left side of the phone. Plug the other end into the handset and hang up.

3 Connect the power adapter to the telephone.

Use only the power adapter provided with this product. To obtain a replacement, call **1 800 222-3111**.

Plug one end of the power adapter into the jack labeled **POWER** on the back of the phone. Plug the other end into a standard electrical outlet not controlled by a wall switch.

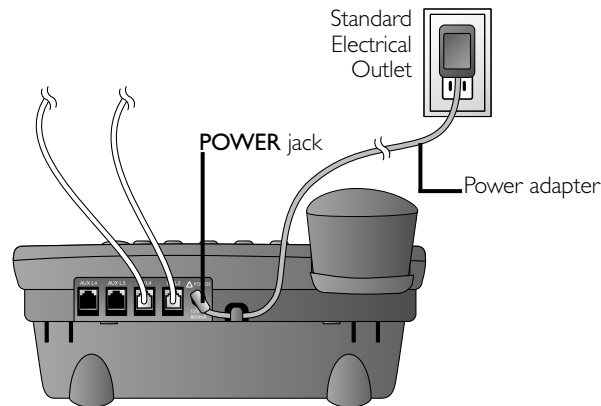
**4 Check for dial tone.**

Lift the handset and listen for a dial tone. If you cannot hear a dial tone, turn to **IN CASE OF DIFFICULTY** beginning on page 88.

5 Initialization.

If no battery is installed when you connect the power cord, the phone runs a quick self-test and the screen displays **Initializing..** for about three seconds.

NOTE: The phone will run through this same initialization any time it is reconnected to AC power if a working battery is not installed (for example, after a power failure or when the unit has been unplugged).

Wall Installation

For best results, follow the directions in "Battery Installation" on page 11 before installing the phone.

- 1 If the wedge is still attached to the underside of the base unit,** follow **Step 1** in "Battery Installation" on page 11 to remove the wedge.

- 2 Reverse the handset tab.**

Hold down the switchhook, then pull out the handset tab and rotate it 180 degrees. Push the handset tab down into the grooves so it settles into position.



- 3 Connect the telephone line cords to the telephone as shown.**

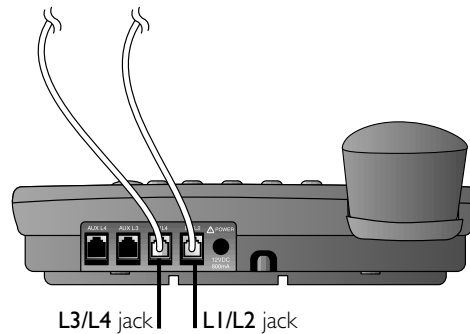

- 4 Connect the handset cord.**

Plug one end of the coiled handset cord into the jack on the left side of the phone. Plug the other end into the handset and hang up.

continued on page 16

Wall Installation

continued from page 15

5 Connect the power adapter to the telephone.



Use only the power adapter provided with this product.

To obtain a replacement, call **1 800 222-3111**.

Plug one end of the power adapter into the jack labeled **POWER** on the back of the phone. Plug the power adapter into a standard electrical outlet not controlled by a wall switch.

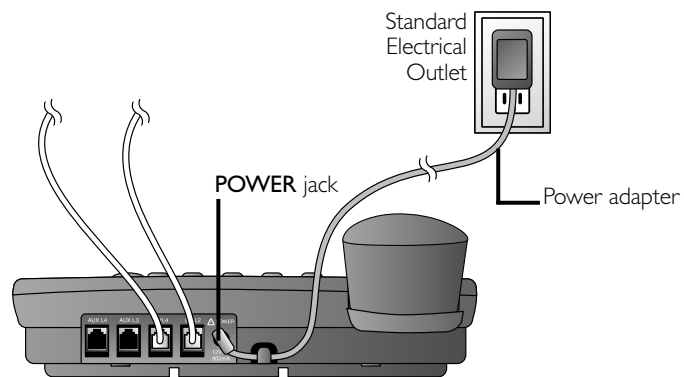

6 Check for dial tone.

Lift the handset and listen for a dial tone. If you cannot hear a dial tone, turn to **IN CASE OF DIFFICULTY** beginning on page 88.

7 Mount the phone on the wall.

- **Four One-Line Jacks** (To use this installation option, you'll need to purchase and install a blank wall plate.)

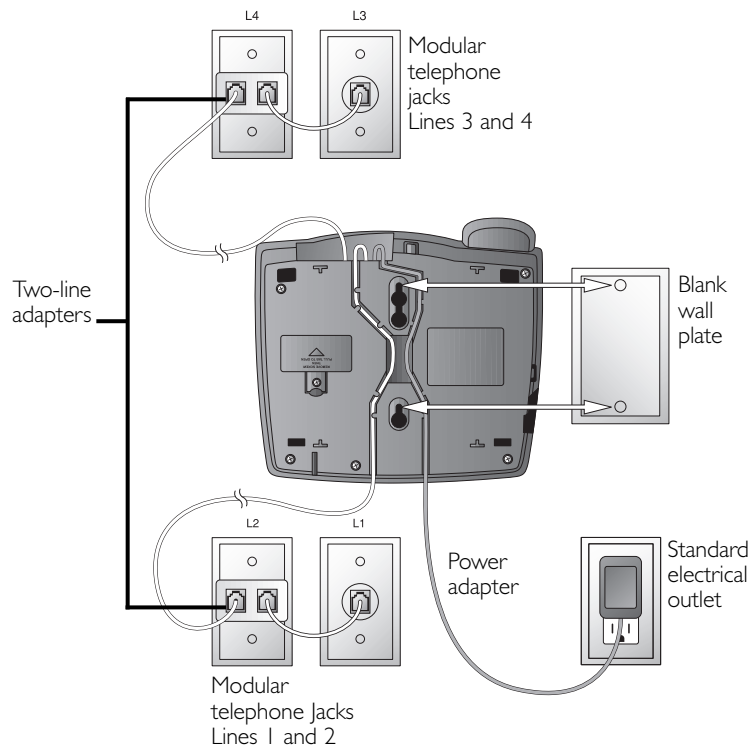

continued on page 18

INSTALLATION

Wall Installation

continued from page 17

- **Two Two-Line Jacks**

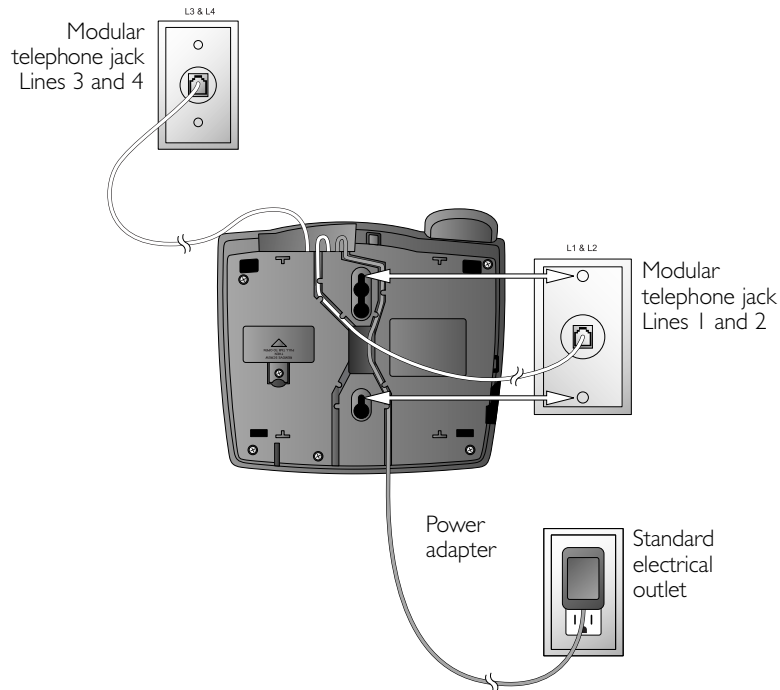

8 Initialization.

If no battery is installed when you connect the power cord, the phone runs a quick self-test and the screen displays **Initializing..** for about three seconds.

Ⓢ **NOTE:** The phone will run through this same initialization any time it is reconnected to AC power if a working battery is not installed (for example, after a power failure or when the unit has been unplugged).

Convenience Ports

If you want to connect another device (such as a modem or fax machine) to the wall jack, you can use the jacks on the phone labeled **AUX**. These convenience ports use Lines 3 and 4; a call picked up on Line 3 or 4 at another extension may interrupt fax, modem, or message transmission.

• Four One-Line Jacks

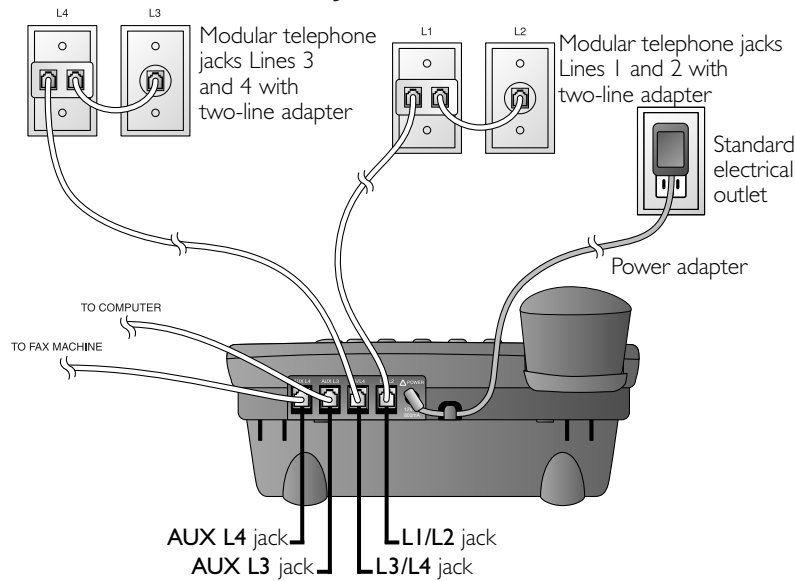

• Two Two-Line Jacks

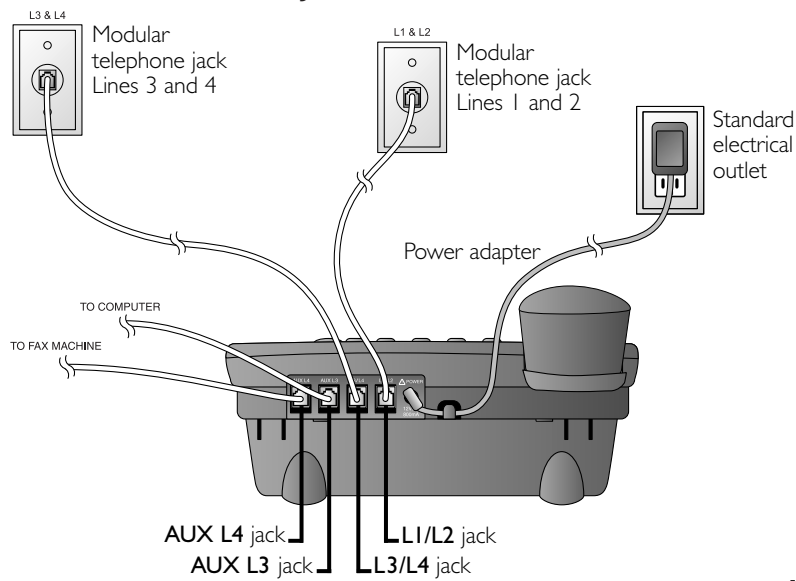

MENU OPERATION

All of the feature setup, memory programming and some individual feature operations for the 974 use menus shown in the screen display. Use the navigation buttons (◀, ▶, ▲, ▼, **ENTER**) to begin, end and move through menu operations (for example, feature setup).

- Press **ENTER** to activate a menu operation. The first menu item for this topic or data will appear in line four of the screen. For example, the screen displays:

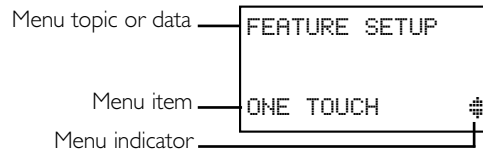

NOTE: If you do not press a key to continue menu operations within 30 seconds, the telephone automatically exits the menu.

- When ☎ is displayed, you can press the ▼ or ▲ button repeatedly to move through the menu.
- Press **ENTER** to choose the menu item currently displayed. This may be a lower level menu, an action, or a feature settings screen. For example:

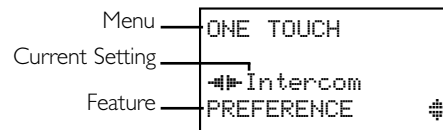

- When ☎ is displayed, you can press the ▶ or ◀ button to scroll through setting choices.
- Press **ENTER** to store the setting, or press ▼ to store the setting and show the next option for the feature currently displayed.
- To return to the main menu, press the ▼ or ▲ button until the screen display includes MAIN MENU or EXIT. Then, press **ENTER**.
- To exit programming mode, press and hold **ENTER**.

NOTE: If the phone beeps twice, repeat the steps to program the feature.

Menu Structure

Use the menu operation to set up the values for the 974 features. Access the menu by pressing **ENTER** when the phone is idle. The menu structure for the feature setup menu is below.

- ONE TOUCH
 - PREFERENCE
 - INTERCOM
 - TELEPHONE
 - PROGRAM
 - PAUSE
 - TONE
 - FLASH
 - CANCEL
 - VIEW
 - DONE
 - MAIN MENU
- PHONE SETTINGS
 - EXTENSION NO
 - RINGER ON/OFF
 - RINGER TYPE
 - DELAY RING
 - AUTO-MUTE
 - TONE/PULSE
 - HOLD REMINDER
 - MAIN MENU
- TIME/DATE
- SPECIAL OPTIONS
 - LINE USAGE
 - PRIME LINE
 - AUTOMATIC MODE
 - SCROLL RATE
 - LCD BACKLIGHT
 - COVM ON/OFF
 - COVM RESET
 - AREA CODES
 - LINE GROUP
 - RESET ALL
 - MAIN MENU
- CENTREX
 - CONSOLE
 - CSL DELAY RING
 - MAIN MENU
- LANGUAGE

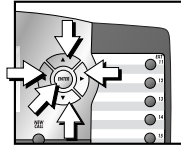

Shortcut to Language Menu

This phone comes programmed for English screen displays. If you need to change the screen language to Spanish or French, you can use these steps to reach the LANGUAGE menu more quickly.

- 1 Press **ENTER** to begin feature setup.
- 2 Press **▲** twice. The screen display includes LANGUAGE and the current setting.
- 3 Press **◀** or **▶** to scroll through the language choices (English, Espanol, or Français). When the language you want to use is displayed, press **▼** to save your choice. The screen display includes EXIT.
- 4 Press **ENTER** to return to the idle screen.

NOTE: You can exit feature setup and return to the idle screen any time. Simply press and hold **ENTER**.

Rapid Scroll

You can scroll through menu items or setting choices more quickly using this feature. Press and hold the desired scroll button (**▲**, **▼**, **▶** or **◀**). The screen will scroll through your choices at the rate you program during Feature Setup. See “Set the Scroll Rate” on page 34 for programming instructions.

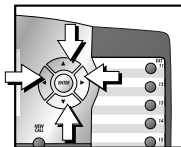

FEATURE SETUP

Set One Touch Preference

Choose whether pressing an EXT button automatically initiates an intercom or One Touch call. If you want to place One Touch calls using only one button, set this feature to TELEPHONE. If you want to place intercom calls using only one button, set this feature to INTERCOM. See ONE TOUCH OPERATION beginning on page 55 and INTERCOM OPERATION beginning on page 67 for details about One Touch and intercom calls.

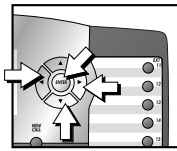

- 1 Press **ENTER** to begin feature setup.
- 2 Press **ENTER**. The screen display includes PREFERENCE and the current setting.
- 3 Press **◀** or **▶** to toggle between INTERCOM and TELEPHONE.
- 4 When the correct setting is shown, press **▼** to save your choice. The screen display includes PROGRAM.
- 5 Press and hold **ENTER** to return to the idle screen.

NOTE: You can exit feature setup and return to the idle screen any time. Simply press and hold **ENTER**.

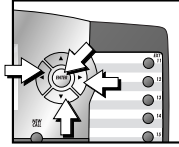

Assign an Extension Number to Your Phone

Every individual phone in your telephone system **MUST** be assigned a unique extension number for the intercom feature to work.

- 1 Press **ENTER** to begin feature setup.
- 2 Press **▼** until the screen display includes PHONE SETTINGS.
- 3 Press **ENTER**. The screen display includes EXTENSION NO and the current setting.
- 4 Press **◀** or **▶** to change the extension number (11...26).
- 5 When the desired extension number is shown press **▼** to save your choice. The screen display includes RINGER ON/OFF.

NOTE: If you duplicate an extension number already in use, you will hear a repeating short ring and the screen display will include EXT XX is already used Assign new EXT #. Repeat **Steps 1–5** at the ringing phone to assign a different extension number (from 11 – 26).

- 6 Proceed to **Step 5** on page 25 to set the next feature (Ringer On or Off)

— OR —

Press and hold **ENTER** to return to the idle screen.

NOTE: You can exit feature setup and return to the idle screen any time. Simply press and hold **ENTER**.

Turn the Ringer On or Off for Each Line

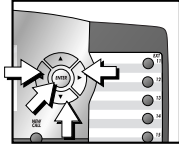

- 1 Press **ENTER** to begin feature setup.
- 2 Press **▼** until the screen display includes PHONE SETTINGS.
- 3 Press **ENTER**. The screen display includes EXTENSION NO.
- 4 Press **▼** until the screen display includes RINGER ON/OFF.
- 5 Press **ENTER**. The screen display includes L1 RINGER and the current setting.
- 6 Press **◀** or **▶** to toggle between On and Off for the line shown.
- 7 When the desired setting for this line is shown, press **▼** to save your choice. The screen display will include the current ringer setting for the next line (L1...L4).
- 8 Repeat **Steps 6** and **7** to turn the ringer on or off for other lines at this phone.
- 9 When you are finished setting the ringer, press **▼** until the screen display includes DONE.
- 10 Press **ENTER**. The screen display includes RINGER ON/OFF.
- 11 Proceed to **Step 4** on page 26 to set the next feature (Ringer Type)
— OR —
Press and hold **ENTER** to return to the idle screen.

NOTE: You can exit feature setup and return to the idle screen any time. Simply press and hold **ENTER**.

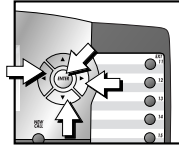

Select the Ringer Type

You can choose a ring pattern for incoming phone calls.

NOTE: Incoming intercom calls use Ringer Type 1 and cannot be changed.

- 1 Press **ENTER** to begin feature setup.
- 2 Press **▼** until the screen display includes PHONE SETTINGS.
- 3 Press **ENTER**. The screen display includes EXTENSION NO.
- 4 Press **▼** until the screen display includes RINGER TYPE.
- 5 Press **ENTER**. The screen display includes L1 RINGER TYPE and the current setting.
- 6 Press **◀** or **▶** to change the ringer type (Type 1 ...Type 4) for the line shown.
- 7 When the desired setting for this line is shown, press **▼** to save your choice and move to the next line with its ringer type.
- 8 Repeat **Steps 6** and **7** to set ringer types for other lines on this phone (L1...L4).
- 9 When you are finished setting the ringer type, press **▼** until the screen display includes DONE.
- 10 Press **ENTER**. The screen display includes RINGER TYPE.
- 11 Proceed to **Step 4** on page 27 to set the next feature (Delay Ring)
— OR —
Press and hold **ENTER** to return to the idle screen.

NOTE: You can exit feature setup and return to the idle screen any time. Simply press and hold **ENTER**.

Set Delay Ring

Set the length of time before incoming calls will ring at this extension.

NOTE: If you choose to set a delayed ring on a phone with Voice Mail service, the phone may not ring at all before Voice Mail picks up the call.

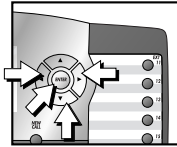

- 1 Press **ENTER** to begin feature setup.
 - 2 Press **▼** until the screen display includes PHONE SETTINGS.
 - 3 Press **ENTER**. The screen display includes EXTENSION NO.
 - 4 Press **▼** until the screen display includes DELAY RING and the current setting.
 - 5 Press **◀** or **▶** to change the delay ring setting (Off, 2 sec...30 sec).
 - 6 When the correct delay setting is shown, press **▼** to save your choice. The screen display includes Auto-Mute.
 - 7 Proceed to **Step 5** on page 28 to set the next feature (Auto-Mute)
- OR —
- Press and hold **ENTER** to return to the idle screen.

NOTE: You can exit feature setup and return to the idle screen any time. Simply press and hold **ENTER**.

FEATURE SETUP

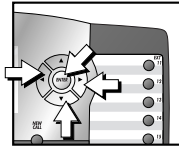

Turn Auto-Mute On or Off

Choose whether sounds at this extension will be heard automatically in response to a page (Auto-Mute Off) or only when **MUTE** is pressed. Auto-Mute Off permits hands-free conversation and room monitoring; Auto-Mute On protects privacy.

- 1 Press **ENTER** to begin feature setup.
- 2 Press **▼** until the screen display includes PHONE SETTINGS.
- 3 Press **ENTER**. The screen display includes EXTENSION NO.
- 4 Press **▼** until the screen display includes Auto-Mute and the current setting.
- 5 Press **◀** or **▶** to toggle between On and Off.
- 6 When the correct setting is shown, press **▼** to save your choice. The screen display includes TONE/PULSE.
- 7 Proceed to **Step 5** of “Set Dial Mode” on page 29 to set the next feature (Tone/Pulse)
— OR —
Press and hold **ENTER** to return to the idle screen.

NOTE: You can exit feature setup and return to the idle screen any time. Simply press and hold **ENTER**.

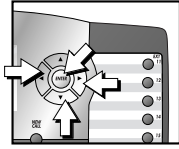

Set Dial Mode

- 1 Press **ENTER** to begin feature setup.
- 2 Press **▼** until the screen display includes PHONE SETTINGS.
- 3 Press **ENTER**. The screen display includes EXTENSION NO.
- 4 Press **▼** until the screen display includes TONE/PULSE and the current setting.
- 5 Press **◀** or **▶** to toggle between Tone and Pulse.
- 6 When the correct setting is shown, press **▼** to save your choice. The screen display includes HOLD REMINDER.
- 7 Proceed to **Step 5** below to set the next feature (Hold Reminder)
— OR —
Press and hold **ENTER** to return to the idle screen.

NOTE: You can exit feature setup and return to the idle screen any time. Simply press and hold **ENTER**.

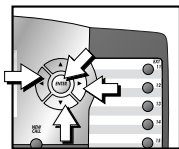

Turn Hold Reminder On or Off

- 1 Press **ENTER** to begin feature setup.
- 2 Press **▼** until the screen display includes PHONE SETTINGS.
- 3 Press **ENTER**. The screen display includes EXTENSION NO.
- 4 Press **▼** until the screen display includes HOLD REMINDER and the current setting.
- 5 Press **◀** or **▶** to toggle between On and Off.
- 6 When the correct setting is shown, press **▼** to save your choice. The screen display includes MAIN MENU.
- 7 Press and hold **ENTER** to return to the idle screen.

NOTE: You can exit feature setup and return to the idle screen any time. Simply press and hold **ENTER**.

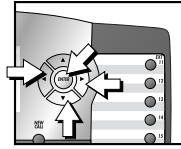

Set the Time and Date

- 1 Press **ENTER** to begin feature setup.
- 2 Press **▼** until the screen display includes **TIME/DATE**.
- 3 Press **ENTER**. The screen display includes **HOUR** and the current hour setting.
- 4 Press **◀** or **▶** until the correct hour is shown.
- 5 Press **▼** to save the hour setting. The screen display includes **MINUTE** and the current minute setting.
- 6 Press **◀** or **▶** until the correct minute is shown.
- 7 Press **▼** to save the minute setting. The screen display includes **AM/PM** and the current setting.
- 8 Press **◀** or **▶** to toggle between **AM** and **PM**.
- 9 Press **▼** to save the **AM/PM** setting. The screen display includes **MONTH** and the number of the current month setting.
- 10 Press **◀** or **▶** until the number of the correct month is shown.
- 11 Press **▼** to save the correct month setting. The screen display includes **DATE** and the current day of the month setting.
- 12 Press **◀** or **▶** until the correct day of the month is shown.
- 13 Press **▼** to save the day of the month. The screen display includes **DAY OF WEEK** and the current setting.
- 14 Press **◀** or **▶** until the correct day of the week is shown.
- 15 Press **▼** to save the Time/Date setting. The screen display includes **MAIN MENU**.
- 16 Press and hold **ENTER** to return to the idle screen.

NOTE: You can exit feature setup and return to the idle screen any time. Simply press and hold **ENTER**.

Turn Line Usage On or Off for Each Line

If you are not using all four phone lines at this extension, you need to turn off Line Usage for the unused lines. If you expand to a second, third or fourth line, turn Line Usage back on.

You may also restrict the use of certain lines on this phone to intercom and paging only, by turning off Line Usage for each line you want restricted. When Line Usage is turned off, that line cannot be used to answer incoming calls or to make outgoing or transfer calls.

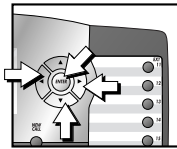

- 1 Press **ENTER** to begin feature setup.
- 2 Press **▼** until the screen display includes **SPECIAL OPTIONS**.
- 3 Press **ENTER**. The screen display includes **LINE USAGE**.
- 4 Press **ENTER**. The screen display includes **L1 USAGE** and the current setting for this line.
- 5 Press **◀** or **▶** to toggle between **On** and **Off** for the line shown.
- 6 Press **▼** to save the current setting for this line and move to the next line with its current Line Usage setting.
- 7 Repeat **Steps 5** and **6** to set Line Usage for other lines at this extension.
- 8 When you are finished setting Line Usage, press **▼** until the screen display includes **DONE**.
- 9 Press **ENTER**. The screen display includes **LINE USAGE**.
- 10 Proceed to **Step 4** on page 32 to set up the next feature (Prime Line)
— OR —
 Press and hold **ENTER** to return to the idle screen.

NOTE: You can exit feature setup and return to the idle screen any time. Simply press and hold **ENTER**.

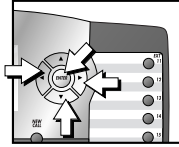

Assign the Prime Line (Line Preference)

- 1 Press **ENTER** to begin feature setup.
- 2 Press **▼** until the screen display includes SPECIAL OPTIONS.
- 3 Press **ENTER**. The screen display includes LINE USAGE.
- 4 Press **▼** until the screen display includes PRIME LINE and the current setting.
- 5 Press **◀** or **▶** to scroll through the line choices (Line 1...Line 4).
- 6 When the line you wish to set as prime is displayed, press **▼** to save your choice. The screen display includes AUTOMATIC MODE.
- 7 Proceed to **Step 5** on page 33 to set the next feature (Automatic Mode)

— OR —

Press and hold **ENTER** to return to the idle screen.

NOTE: You can exit feature setup and return to the idle screen any time. Simply press and hold **ENTER**.

Set Automatic Mode

Choose the mode (headset or speakerphone) to be used automatically when you press a LINE button with the handset in the cradle.

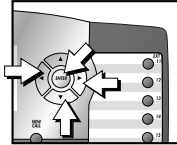

- 1 Press **ENTER** to begin feature setup.
 - 2 Press **▼** until the screen display includes SPECIAL OPTIONS.
 - 3 Press **ENTER**. The screen display includes LINE USAGE.
 - 4 Press **▼** until the screen display includes AUTOMATIC MODE and the current setting.
 - 5 Press **◀** or **▶** to toggle between SpeakerPhone and Headset.
 - 6 When the desired mode is displayed, press **▼** to save your choice. The screen display includes SCROLL RATE.
 - 7 Proceed to **Step 5** on page 34 to set the next feature (Scroll Rate)
- OR —**
- Press and hold **ENTER** to return to the idle screen.

NOTE: You can exit feature setup and return to the idle screen any time. Simply press and hold **ENTER**.

FEATURE SETUP

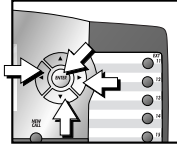

Set the Scroll Rate

You can choose the speed for the Rapid Scroll feature.
(See “Rapid Scroll” on page 22 for details.)

- 1 Press **ENTER** to begin feature setup.
- 2 Press **▼** until the screen display includes SPECIAL OPTIONS.
- 3 Press **ENTER**. The screen display includes LINE USAGE.
- 4 Press **▼** until the screen display includes SCROLL RATE and the current setting.
- 5 Press **◀** or **▶** to change the setting (Very Slow, Slow, Medium, Fast, or Very Fast).
- 6 When the correct scroll rate is shown, press **▼** to save your choice. The screen display includes LCD BACKLIGHT.
- 7 Proceed to **Step 5** on page 35 to set the next feature (LCD Backlight)

— OR —

Press and hold **ENTER** to return to the idle screen.

NOTE: You can exit feature setup and return to the idle screen any time. Simply press and hold **ENTER**.

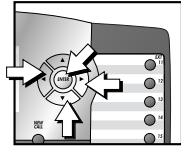

Turn Screen Backlight On or Off

- 1 Press **ENTER** to begin feature setup.
- 2 Press **▼** until the screen display includes SPECIAL OPTIONS.
- 3 Press **ENTER**. The screen display includes LINE USAGE.
- 4 Press **▼** until the screen display includes LCD BACKLIGHT and the current setting.
- 5 Press **◀** or **▶** to toggle between On and Off.
- 6 When the correct setting is shown, press **▼** to save your choice. The screen display includes COVM ON/OFF.
- 7 Proceed to **Step 5** on page 36 to set the next feature (COVM ON/OFF)
— OR —
 Press and hold **ENTER** to return to the idle screen.

NOTE: You can exit feature setup and return to the idle screen any time. Simply press and hold **ENTER**.

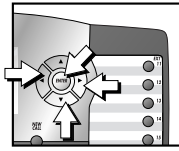

Turn COVM Indicators On or Off for Each Line

If you subscribe to Voice Mail service with your local telephone service provider, turn the COVM indicator on to have the screen display the appropriate line numbers when there are messages waiting. If you do not subscribe to Voice Mail service, turn the COVM indicators off for each line.

- 1 Press **ENTER** to begin feature setup.
 - 2 Press **▼** until the screen display includes SPECIAL OPTIONS.
 - 3 Press **ENTER**. The screen display includes LINE USAGE.
 - 4 Press **▼** until the screen display includes COVM ON/OFF.
 - 5 Press **ENTER**. The screen display includes L1 COVM ON/OFF and the current setting.
 - 6 Press **◀** or **▶** to toggle between On and Off for the line shown.
 - 7 When the correct setting is shown, press **▼** to save your choice. The screen display includes COVM ON/OFF for the next line and the current setting.
 - 8 Repeat **Steps 6** and **7** to turn the COVM indicator on or off for other lines at this extension.
 - 9 When you are finished setting the COVM indicators, press **▼** until the screen display includes DONE.
 - 10 Press **ENTER**. The screen display includes COVM ON/OFF.
 - 11 Press **▼** until the screen display includes COVM RESET, then proceed to **Step 5** on page 37 to clear the COVM indicators
- OR —
- Press and hold **ENTER** to return to the idle screen.

NOTE: You can exit feature setup and return to the idle screen any time. Simply press and hold **ENTER**.

Reset COVM Indicator

If a COVM indicator remains on when there are no messages on that line, you may have received a false signal from your local telephone service provider. You can clear the indicator manually.

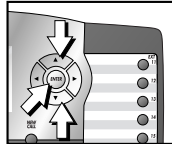

- 1 Press **ENTER** to begin feature setup.
 - 2 Press **▼** until the screen display includes SPECIAL OPTIONS.
 - 3 Press **ENTER**. The screen display includes LINE USAGE.
 - 4 Press **▼** until the screen display includes COVM RESET.
 - 5 Press **ENTER**. The screen display includes L1 COVM RESET.
 - 6 Press **▲** or **▼** to scroll through the COVM Reset menu (L1 COVM RESET...L4 COVM RESET, or ALL COVM RESET).
 - 7 When the line you want to reset is displayed, press **ENTER** to remove the message waiting indicator. You can clear all the lines at once by choosing ALL COVM RESET. The screen display includes Reset!.
 - 8 Press **▼** until the screen display includes DONE.
 - 9 Press **ENTER**. The screen display includes COVM RESET.
 - 10 Press **▼** until the screen display includes AREA CODES, then proceed to **Step 5** on page 38 to program the Home or Local Area Codes.
- OR —
- Press and hold **ENTER** to return to the idle screen.

NOTE: You can exit feature setup and return to the idle screen any time. Simply press and hold **ENTER**.

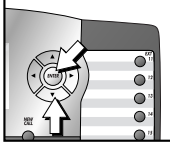

Program Home and Local Area Codes

You can program this phone to recognize one Home and up to five Local Area Codes. See “Home Area Code” and “Local Area Codes” on page 6 for definitions.

- 1 Press **ENTER** to begin feature setup.
- 2 Press **▼** until the screen display includes SPECIAL OPTIONS.
- 3 Press **ENTER**. The screen display includes LINE USAGE.
- 4 Press **▼** until the screen display includes AREA CODES.
- 5 Press **ENTER**. The screen display includes HOME AC and the current setting.
- 6 Use the dial pad keys to enter your Home Area Code, then press **▼**. The screen display includes LOCAL AC1 and the current setting.

If you need to enter any Local Area Codes, use the dial pad keys and then press **▼** to scroll to the next screen (LOCAL AC2, LOCAL AC3, LOCAL AC4, and LOCAL AC5).

NOTE: If you must dial the area code to place calls within your own area code, enter “000” for the Home Area Code and enter your area code as a Local Area Code.

- 7 When you are finished entering all of the area codes you need to program, press **▼** until the screen display includes DONE.
 - 8 Press **ENTER**. The screen display includes AREA CODES.
 - 9 Press **▼** until the screen display includes LINE GROUP, then proceed to **Step 5** on page 39 to assign the line group
- OR —
- Press and hold **ENTER** to return to the idle screen.

NOTE: You can exit feature setup and return to the idle screen any time. Simply press and hold **ENTER**.

Assign the Line Group for this Phone

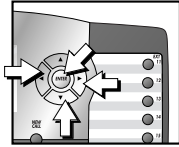

- 1 Press **ENTER** to begin feature setup.
- 2 Press **▼** until the screen display includes SPECIAL OPTIONS.
- 3 Press **ENTER**. The screen display includes LINE USAGE.
- 4 Press **▼** until the screen display includes LINE GROUP and the current setting.
- 5 Press **▶** or **◀** to scroll through the Line Group choices (Line 04...Line15, or PRV).
- 6 When the Line Group you want is shown, press **▼** to save your choice. The screen display includes RESET ALL.
- 7 Proceed to **Step 5** on page 40 to reset all feature settings to default values
— OR —
Press and hold **ENTER** to return to the idle screen.

NOTE: You can exit feature setup and return to the idle screen any time. Simply press and hold **ENTER**.

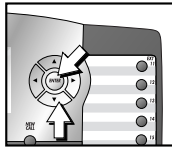

Erase All Settings and Return the Phone to Default Settings



If you reset all features to the default settings, all previous feature programming will be erased. You will need to program your preferences for every feature again. You cannot undo the RESET ALL command.

- 1 Press **ENTER** to begin feature setup.
- 2 Press **▼** until the screen display includes SPECIAL OPTIONS.
- 3 Press **ENTER**. The screen display includes LINE USAGE.
- 4 Press **▼** until the screen display includes RESET ALL.
- 5 Press **ENTER**. The screen display includes ENTER: Reset all?.
- 6 Press **ENTER** to confirm the command. The screen displays Reset!. A tone sounds and the screen returns to showing RESET ALL.
- 7 Press and hold **ENTER** to return to the idle screen.

NOTE: You can exit feature setup and return to the idle screen any time. Simply press and hold **ENTER**.

You will need to program the next two features if this phone is the designated Console Phone for your Centrex system.

Set This Phone to be the Centrex Console Phone

NOTE: This feature is for use with Centrex systems only.

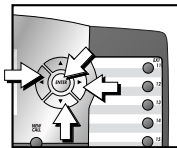

- 1 Press **ENTER** to begin feature setup.
- 2 Press **▼** until the screen display includes **CENTREX**.
- 3 Press **ENTER**. The screen display includes **CONSOLE** and the current setting.
- 4 Press **◀** or **▶** to toggle between **On** and **Off**.
- 5 Press **▼** to save your choice. The screen display includes **CSL DELAY RING**.
- 6 Proceed to **Step 5** of "Set the Centrex Console Delayed Ring Time" on page 42 to change the next feature (Console Delay Ring)
— OR —
 Press and hold **ENTER** to return to the idle screen.

NOTE: You can exit feature setup and return to the idle screen any time. Simply press and hold **ENTER**.

Set the Centrex Console Delayed Ring Time

NOTE: This feature is for use with Centrex systems only.

Set the length of time the phone will route your calls to the Centrex Console phone. One ring is about six seconds.

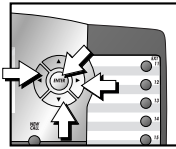

- 1 Press **ENTER** to begin feature setup.
- 2 Press **▼** until the screen display includes CENTREX.
- 3 Press **ENTER**. The screen display includes CONSOLE.
- 4 Press **▼** until the screen display includes CSL DELAY RING and the current setting.
- 5 Press **◀** or **▶** to scroll through the choices (Off, 02 sec...30 sec).
- 6 Press **▼** to save your choice. The screen display includes MAIN MENU.
- 7 Press and hold **ENTER** to return to the idle screen.

NOTE: You can exit feature setup and return to the idle screen any time. Simply press and hold **ENTER**.

Set the Display Language

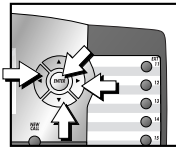

- 1 Press **ENTER** to begin feature setup.
- 2 Press **▼** until the screen display includes LANGUAGE and the current setting.
- 3 Press **◀** or **▶** to scroll through the language choices (English, Espanol, or Français). When the language you want to use is displayed, press **▼** to save your choice. The screen display includes EXIT.
- 4 Press **ENTER** to return to the idle screen.

NOTE: You can exit feature setup and return to the idle screen any time. Simply press and hold **ENTER**.

TELEPHONE OPERATION

NOTE: When you make a call, the phone selects the Prime Line you programmed (See “Assign the Prime Line” on page 32). When you answer a call, the phone automatically selects the ringing line.

Make or Answer a Call

NOTE: This phone will automatically make and answer calls in the mode (speakerphone or headset) you programmed (see “Set Automatic Mode” on page 33). Follow the directions below to choose a mode manually. If the phone is in use on one line, any other calls made or answered will use the same mode already in use.

NOTE: If you dial a phone number longer than 15 digits, the screen will display only the last 13 digits.

Handset

To make a call, lift the handset and dial the call.

To answer a call, lift the handset. Replace the handset to end the call.

To override automatic line selection, lift the handset, then press and release a LINE button

— OR —

Press the LINE button for the line you wish to select, then lift the handset.

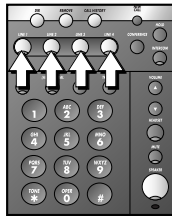

continued on page 44

Make or Answer a Call

continued from page 43

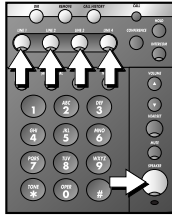
Speakerphone

To make a call, press and release the desired LINE button or **[SPEAKER]**. The SPEAKER light goes on. Wait for a dial tone, then dial the call. Press **[SPEAKER]** to end the call.

To answer a call, press **[SPEAKER]** or press the LINE button of the incoming call. Press **[SPEAKER]** again to end the call.

NOTE: If headset is programmed as the default mode (see “Set Automatic Mode” on page 33), you must press **[SPEAKER]** to activate the speakerphone.

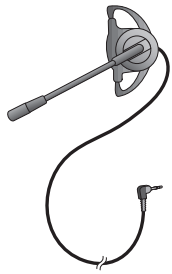
Headset

You can use this phone hands-free when you install any industry standard two-band 2.5mm headset (purchased separately). For best results use an AT&T two-band 2.5mm headset.

Make sure the headset is plugged into the headset jack. You will hear a double-beep if you press **[HEADSET]** when the headset is not plugged in.

NOTE: If headset is programmed as the default mode, (see “Set Automatic Mode” on page 33) but the headset is not plugged in, the phone will switch to speakerphone.

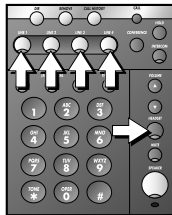

To make a call, press and release **[HEADSET]** or press the desired LINE button and then press **[HEADSET]**. The HEADSET light goes on. Wait for a dial tone, then dial the call. Press **[HEADSET]** to end the call.

To answer a call, press **[HEADSET]**. Press **[HEADSET]** again to end the call.

NOTE: If speakerphone is programmed as the default mode (See “Set Automatic Mode” on page 33), you must press **[HEADSET]** to activate the headset.

Switch Between Handset, Headset and Speakerphone

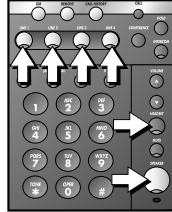

To switch from handset to headset or speakerphone, press **HEADSET** or **SPEAKER**, then replace the handset. (In order to use the headset, it must be plugged in.)

To switch from speakerphone to handset, lift the handset. (Do not press **SPEAKER** or the call will be disconnected.)

To switch from headset to handset when the handset is in the cradle, lift the handset.

To switch from headset to handset when the handset is off-hook, press **HEADSET** again.

To switch from headset to speakerphone, press **SPEAKER**.

To switch from speakerphone to headset, insert the headset plug into the jack, and press **HEADSET**.

To override automatic line selection, press and release a **LINE** button. This activates the speakerphone or headset, whichever is programmed as the default mode.

Timer

When you make or answer a call, the timer automatically starts. The screen displays the elapsed time in minutes and seconds for the first hour (up to 59:59) and then begins again. The timer stops automatically when you hang up and the recorded time is displayed for about 10 seconds. The timer also stops when you place a call on hold and resets to 00:00 when you release hold.

Call Privacy

To ensure call privacy, this phone allows only one set at a time to use a line.

Cancel Call Privacy

During the call, press the LINE button for the call. You'll hear a short beep. Others can now join the call.

Restore Call Privacy

Press the LINE button again during the call. You'll hear a double-beep. The other phones will be dropped from the call.

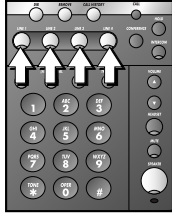

NOTE: Call privacy is automatically restored when you end the call.

NOTE: When a non-system phone answers a call, any other system phone can pick up the call by pressing the LINE button. Once a system phone picks up the call, Call Privacy is activated and no other system phones can listen to the call unless Call Privacy is canceled, but non-system phones which share that line can still join the call.

Do Not Disturb

When your phone is off-hook (i.e., you are on a call) you will hear a low volume ring when you receive an intercom call. In order to prevent even this audible signal, activate the Do Not Disturb (DND) feature. When you activate this feature you will not hear paging tones, voice paging, or incoming call rings. Instead, the LINE light flashes and the INTERCOM light goes on to signal an incoming call or page. If you receive an intercom call, the INTERCOM light flashes, and the number of the intercom extension calling you appears on the display.



- 1 Press **DND** to prevent interruptions. The DND light goes on and the screen display includes **DND**.
- 2 Press **DND** again to resume normal call alerts. The DND light goes off and the screen no longer shows **DND**.

When this feature is activated, callers from within your phone system will hear a short repeating tone (like a fast busy signal).

Volume

Handset/Speakerphone/Headset

Volume Control

When you are on a call, press VOLUME ▲ to increase call volume. Press VOLUME ▼ to decrease volume. You will hear a beep when you reach the minimum or maximum level.

Ringer Volume

When the phone is ringing, press VOLUME ▲ or VOLUME ▼ to adjust the ringer volume. This phone has four ringer volume levels. As you adjust the ringer, you will hear the ring change.

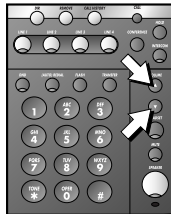

Turning Ringer Off

You may turn the ringer for each line on or off. For detailed instructions see “Turn the Ringer On/Off for Each Line” on page 25.

Redial

The last number dialed from this extension (up to 32 digits) is stored in redial memory until you dial another number.



Handset

To dial the same number again, lift the handset, listen for the dial tone, then press **(AUTO) REDIAL**. If there is no number stored in redial memory, the screen display briefly includes (empty) and then returns to the idle screen.

Speakerphone or Headset

To dial the same number again, press a LINE button, then press **(AUTO) REDIAL**. The phone automatically dials the last number. If there is no number stored in redial memory, the screen display briefly includes (empty) and then returns to the idle screen.

NOTE: You will experience a delay before the call is dialed when using the Redial feature. This is normal.

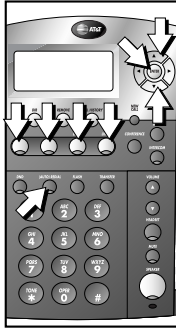

Redial Stack

The last six numbers dialed from this extension are automatically stored in the redial memory stack. You can review the numbers in the redial memory and dial one if you wish.

- 1 When the phone is not on a call, press **(AUTO) REDIAL**.
- 2 Press **▲** or **▼** to scroll through the last six numbers dialed at this extension.
- 3 When the number you want to call is displayed, press **ENTER** or a **LINE** button. The call is dialed automatically using the mode (headset or speakerphone) you programmed as the Automatic Mode. (See “Set Automatic Mode” on page 33.)

NOTE: If you do not place a call within 30 seconds, the screen returns to idle.

Auto Redial

This phone can automatically redial a number every 60 seconds up to ten times, or until the other line rings or you cancel Auto Redial.

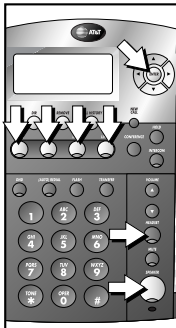

- 1 Follow the instructions under “Redial Stack” above to find the number you want to call.
- 2 Press a **LINE** button
— OR —
Press **ENTER**. The phone will dial the call.
- 3 When the other line rings or the other party answers, lift the handset
— OR —
Press **SPEAKER**
— OR —
Press **HEADSET** and speak with the other party.

NOTE: You will hear a double-beep if you press **HEADSET** when the headset is not plugged in.

To cancel Auto Redial, press any button except **VOLUME ▲** or **VOLUME ▼**.

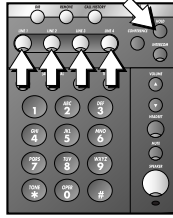

Hold

While on a call, press and release **HOLD**. The LINE light for the line on hold flashes slowly in green, and a double-beep sounds every 30 seconds to remind you the call is on hold. (To turn off the reminder beep, see “Turn Hold Reminder On or Off” on page 29.) You can replace the handset

in the cradle without disconnecting the call. The speakerphone is automatically turned off.

To release Hold, press and release the LINE button of the call on hold.

NOTE: The phone automatically disconnects a call on hold after 20 minutes. To keep a call on hold longer than 20 minutes, release Hold before 20 minutes and then place the call on hold again.

NOTE: You cannot put an intercom call on hold.

NOTE: If a line is in use, pressing **INTERCOM** will place the line on hold and activate the intercom.

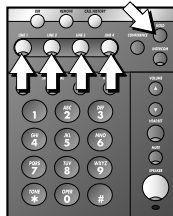

Switch Between Lines

- 1 Press and release **HOLD** to keep a call on the first line.
- 2 Press and release the LINE button of another line to make or answer another call.

NOTE: If you switch lines without pressing **HOLD** first, you will drop the call.

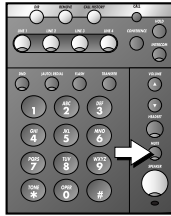

Mute

Mute allows you to hear the other party, but the other party can't hear you.

To activate this feature, press and release **MUTE**. The MUTE light goes on.

To return to the conversation, press and release **MUTE** again.

NOTE: Switching from handset to speakerphone or headset, or from speakerphone or headset to handset, changing lines, and putting a call on hold also cancels Mute.

Flash

Use **FLASH** instead of the switchhook to activate telephone company subscriber services such as Call Waiting or Three-Way Calling.



Temporary Tone Dialing

If you have dial pulse (rotary) service, you can change from dial pulse to touch tone dialing during a call by pressing **XTONE**.

- 1 Dial the number.
- 2 Press and release **XTONE**. Buttons pressed after this send touch tone signals.
- 3 After you hang up, the phone automatically returns to pulse service.



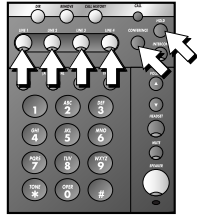

Conference Calls

This feature lets you set up a three-party call by using two lines at the same time. You can also join an intercom call with a call on an outside line. The outside line call must be established first because an intercom call cannot be placed on hold.

- 1 Make or answer a call.
- 2 Press and release **HOLD**.
- 3 Call someone on another line.
- 4 When this call is answered, press **CONFERENCE**. The three-party conference begins immediately.
- 5 To end a conference call, hang up. All parties will disconnect.

To talk privately with one party:

- 1 Press **HOLD** to place both lines on hold.
- 2 Press a **LINE** button to talk privately with the person on that line.
- 3 Press **CONFERENCE** to resume the conference call.

NOTE: An intercom call cannot be placed on hold. If one party is on the intercom, that party will be dropped from the call if you press **HOLD**.

To drop one line:

Press the **LINE** button of the party you want to keep. The other line will be dropped.

NOTE: Occasionally, the far-end parties on a conference call might not hear one another.

Transfer a Call

You can transfer a call you answer to any other system phone. Once you transfer a call, it can be picked up at any other system phone, not just at the extension you called. For information about using the display screen menus, see MENU OPERATION beginning on page 20.

NOTE: If a transferred call is not picked up within 20 minutes, the phone will automatically disconnect the call.

Blind Transfer

While on a call:

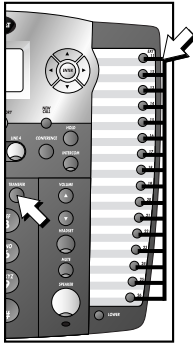

- 1 Press **TRANSFER**. The screen displays:

```
12:08 PM 12/26
EXT 11
Transfer
```

- 2 Press the **EXT** button for the extension where you're transferring the call

— OR —

Dial the extension number where you're transferring the call. The screen displays:

```
12:08 PM 12/26
EXT 11
Transfer 12
```

- 3 Hang up.

Your phone reminds you with a double-beep every 30 seconds when a transferred call has not been answered.

NOTE: If you do not dial an extension within 10 seconds, the transfer is automatically cancelled.

Transfer a Call and Speak to the Receiving Party

While on a call:

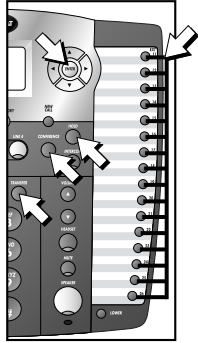

- 1 Press **HOLD**.
- 2 Press **INTERCOM**. The screen displays:

```
12:08 PM 12/26
EXT 11
INTERCOM TO_
PAGE
```

- 3 Press **ENTER**. The screen displays

```
12:08 PM 12/26
EXT 11
Paging
PAGE
```

- 4 Press the **EXT** button for the extension where you're transferring the call. The screen displays:

```
12:08 PM 12/26
EXT 11
PAGE 12
```

When the other party answers you can announce the call.

- 5 Press **TRANSFER**, then press the **EXT** button for the extension where you're transferring the call.

NOTE: If you do not dial an extension within 10 seconds, the transfer is automatically cancelled.

Answer a Transferred Call

When you hear a long transfer ring, pick up the handset or press the **LINE** button of the call to use the speakerphone or headset.

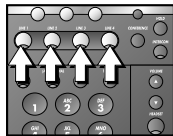

Low Battery Indicator

The screen displays **LOW BATT** when the battery needs to be replaced, or when no battery is installed.

Lights and What They Mean

LIGHT:	STATUS:	MEANS:
LINE	On steadily, green	This line is in use at this extension.
	On steadily, red	This line is in use at another extension.
	Flashing slowly, green	This line is on hold at this extension.
	Flashing slowly, red	This line is on hold at another extension.
	Flashing quickly, green	This line is ringing. — OR — You are transferring a call from this extension.
	Triple flash, red	A call on this line is being transferred at another extension.
INTERCOM	Flashing slowly	This intercom is in use at another extension.
	Flashing quickly	You have an incoming intercom call.
	On steadily	You are on an intercom call.
MUTE	On	This phone is muted.
SPEAKER	On	You are on a speakerphone call.
HEADSET	On	You are on a headset call.
DND	On	Do Not Disturb is turned on.
(AUTO)REDIAL	On steadily	The phone is waiting to redial an Auto Redial call.
	Flashing slowly	This phone is dialing Auto Redial call.

ONE TOUCH OPERATION

This telephone has 32 One Touch locations where you can store phone numbers you wish to dial using fewer keys than usual. You can store up to 24 digits in each location. The steps used to dial numbers stored in One Touch locations vary according to how you programmed the One Touch Preference. See “Set One Touch Preference” on page 23 and “Dial a One Touch Number” on page 59 for more details.

The first 16 locations can be accessed using only the EXT buttons. To access the remaining 16 locations, press **LOWER** and then the EXT button for the desired location.

NOTE: The EXT buttons are also used to place intercom calls. See INTERCOM OPERATION beginning on page 67 for details.

You may wish to write the names or telephone numbers of One Touch entries on the directory card, using the light gray spaces for the first 16 locations and the dark gray spaces for the second 16 locations.

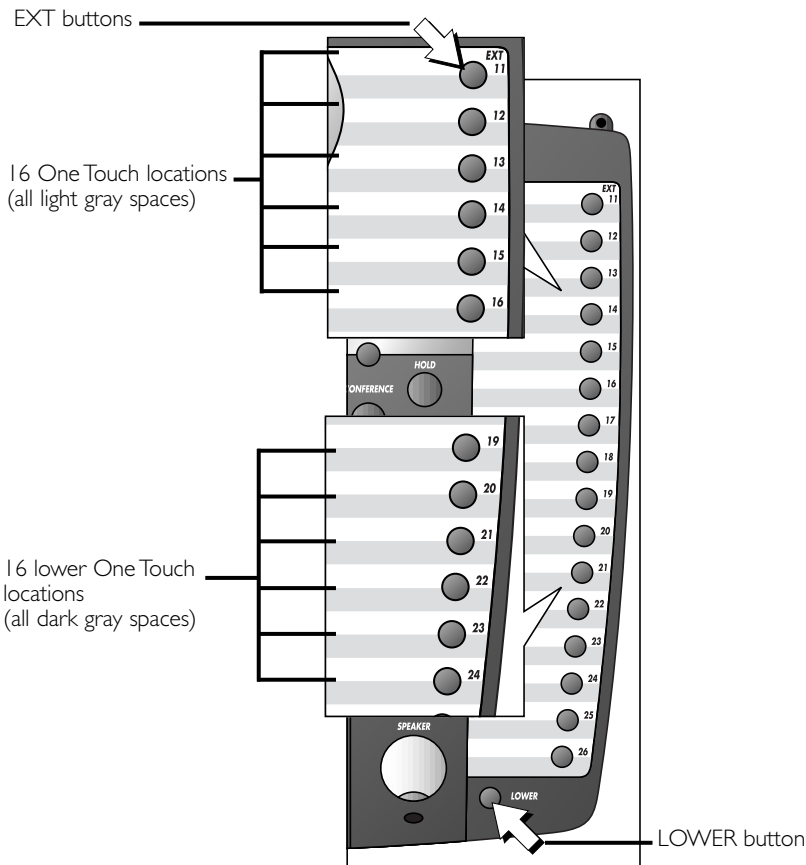

ONE TOUCH OPERATION

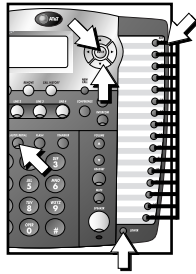

Store a Number in a One Touch Location

For information about using the display screen menus, see MENU OPERATION on page 20.

- 1 Press **ENTER** to enter the feature menu.
- 2 Press **ENTER**. The screen display includes PREFERENCE and the current setting.
- 3 Press **▼** until the screen display includes PROGRAM.
- 4 Press **ENTER**. The screen display includes Enter Number.
- 5 Enter the phone number using the dial pad
— OR —
 Press **(AUTO REDIAL)** to copy the last number dialed from this extension to this location.
 The screen will show the number as you enter it. You can press **◀** to backspace.
- 6 When you are finished entering the number, choose a One Touch location:
 Press the EXT button
— OR —
 Press **(LOWER)**, then press the EXT button.
 The screen displays the number entered and STORED!.

NOTE: Only the last number dialed from this extension can be copied to a One Touch location. The other numbers in the redial stack cannot be copied.

NOTE: You can exit storing a number at any time. Press **▼** until the screen shows CANCEL, then press **ENTER**.
— OR —
 Press and hold **ENTER**.

Store a Pause in a One Touch Entry

You can include a pause while storing a dialing sequence which requires one during actual dialing.

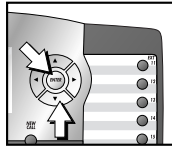

While you are entering the number to be stored, the screen display includes PAUSE.

Press **ENTER** where you want to store a pause. Each pause counts as one digit. Continue storing the number as usual.

Store Temporary Touch Tone Signals in a One Touch Entry

If you have dial pulse (rotary) service, you can store a dialing sequence which includes the touch tone signals required for some special services.

While you are entering the number to be stored, the screen display includes PAUSE.

When you want to begin storing temporary tone signals, press **▼** until the screen display includes TONE, then press **ENTER**. All numbers you enter after this will send touch tone signals during dialing.

Store a Flash in a One Touch Entry

You can store the flash signal required by some special services as part of a dialing sequence.

While you are entering the number to be stored, the screen display includes PAUSE.

When you want to enter a flash signal, press **▼** until the screen display includes FLASH, then press **ENTER**. Continue storing the number as usual.

ONE TOUCH OPERATION

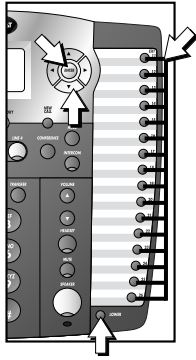

Review a One Touch Entry

For more information using the display screen menus, see MENU OPERATION on page 20.

- 1 Press **ENTER** to enter the feature menu.
- 2 Press **ENTER**. The screen display includes PREFERENCE.
- 3 Press **▼** until the screen display includes VIEW.
- 4 Press **ENTER**.
- 5 Press the EXT button

— OR —

Press **LOWER**, then the EXT button for the entry you want to review. The screen displays the number stored in that location.

If there is no number stored in this location, the screen display includes empty.

- 6 Press and hold **ENTER** to return to the idle screen.

NOTE: You can exit One Touch review at any time. Simply press and hold **ENTER**.

Dial a One Touch Number

The steps used to call a One Touch number depend on how you programmed the One Touch Preference (see “Set One Touch Preference” on page 23).

If One Touch Preference is set to INTERCOM:

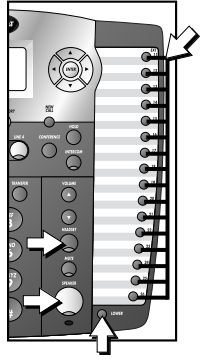

- 1 Lift the handset
— OR —
Press **SPEAKER**
— OR —
Press **HEADSET** and listen for the dial tone.
- 2 Press the EXT button
— OR —
Press **LOWER**, then press the EXT button for the number you want to call.
The screen displays the number as it is dialed.

If One Touch Preference is set to TELEPHONE, you do not need to go off hook and listen for a dial tone before you dial a One Touch number. You can simply:

- 1 Press the EXT button
— OR —
Press **LOWER**, then press the EXT button for the number you want to call.
The screen displays the number as it is dialed using the speakerphone or headset as programmed for Automatic Mode. (See “Set Automatic Mode” on page 33.)

DIRECTORY OPERATION

This phone can store up to 200 names and phone numbers in the directory. Names can be up to 16 characters long and numbers can be 24 digits long. Because directory entries are stored in alphabetical order, you may wish to enter names with the last name first in order to maintain consistency with the information stored automatically through the Caller ID function of this system.

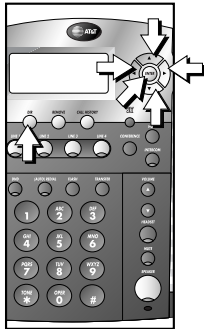

To enter directory mode, press **[DIR]**. The screen displays:

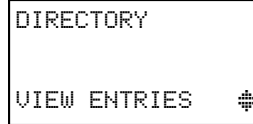

If there are already 200 stored entries, the screen display includes **DIRECTORY FULL!**. If there are no entries, the screen display includes **no entries**.

To work with the directory, press **[ENTER]**. The screen will display menu choices on the bottom line.

To exit directory mode at any time, press **[DIR]**.

Menu Structure

Use the navigation buttons (**[Left]**, **[Right]**, **[Up]**, **[Down]**, **[ENTER]**) to move through menu operations. See MENU OPERATION on page 20 for information about moving through menus in the screen display.

The menu structure for the directory is below.

VIEW ENTRIES	ADD ENTRY
DIAL	ENTER NUMBER
EDIT NAME	DONE
DONE	PAUSE
CANCEL	tone
EDIT NUMBER	FLASH
DONE	CANCEL
PAUSE	CANCEL
tone	
FLASH	
CANCEL	
MAIN MENU	

WRITERS NOTE:

Do we need
ENTER NAME
in the menu tree?

Store a Name and Number in the Directory

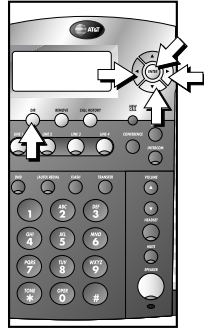

- 1 Press **DIR** to begin working with the directory.
- 2 Press **▼** until the screen display includes **ADD ENTRY**.
- 3 Press **ENTER**. The screen display includes **ENTER NAME**.
- 4 Use the dial pad keys and the chart below to enter the letters, digits or symbols you wish to store. Press the key repeatedly until the character you want is shown on the screen. For example, press **2** once for "A," twice for "B," three times for "C," and four times for "2." Press **▶** to move to the next character or space. Press **◀** to backspace. The name will appear on screen as you enter it.

PRESS:	ONCE	TWICE	3 TIMES	4 TIMES	5 TIMES	6 TIMES	7 TIMES	8 TIMES
1	,	-	'	&	.	()	!
2	A	B	C	2				
3	D	E	F	3				
4	G	H	I	4				
5	J	K	L	5				
6	M	N	O	6				
7	P	Q	R	S	7			
8	T	U	V	8				
9	W	X	Y	Z	9			
*	*							
0	0							
#	#							

- 5 When you are finished entering the name, press **ENTER** to move on to enter the phone number. The screen displays the name you entered and **<ENTER NUMBER>**.

continued on page 62

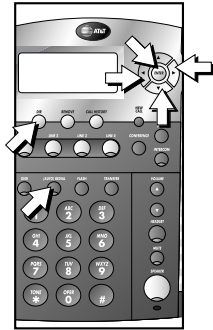

Store a Name and Number in the Directory

continued from page 61

- 6** Use the dial pad keys to enter the phone number you wish to store

— OR —

Press **(AUTO) REDIAL** to copy the last number dialed at this extension onto the screen.

Press **▶** to move to the next character or space. Press **◀** to backspace. The number will appear on the second line of the screen as you enter it.

- 7** When you are finished entering the number, press **ENTER** to store the name and number in the directory. The screen briefly displays the name and number you stored and **SAVED**. Then the screen will automatically return to include **ADD ENTRY**.

NOTE: You can exit the directory at any time without storing the entry. Simply press **DIR**.

Store a Pause in a Directory Number

You can include a pause in a number stored in the directory. When you reach the place in the dialing sequence where you wish to enter a pause, press **▼** until the screen displays:

```
JIM
555_
PAUSE
```

Press **ENTER** to store a two second pause. Then continue entering the number. Each pause counts as one digit.

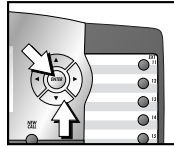

Store a Temporary Tone Signal in a Directory Number

If you have dial pulse (rotary) service, you can store tone signals in a directory number. When you reach the place in the dialing sequence where you wish tone dialing to begin, press **▼** until the screen displays:

```
JIM
555_
TONE
```

Press **ENTER**. All digits entered after this will send tone signals.

Store a Flash in a Directory Number

You can store the switchhook flash needed to access some custom-calling services in a directory number. When you reach the place in the dialing sequence where you wish to enter a flash, press **▼** until the screen displays:

```
JIM
555_
FLASH
```

Press **ENTER** to store the flash, then continue entering the number. Each flash counts as one digit.

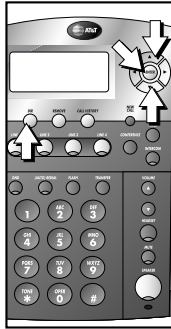

Review Directory Entries

- 1 Press **DIR** to begin working with the directory.
- 2 Press **▲** or **▼** to scroll through the directory entries

— OR —

Press the dial pad key for the first character of the entry you wish to review until the character you are looking for is displayed. Then press **▲** or **▼** to scroll through the entries beginning with this character. If there is no entry for the character you chose, the screen will display No Entries for "X".

— OR —

Press **ENTER**. The screen displays the first directory entry, for example:

```
ARRON  
0123456
```

Press **▲** or **▼** to scroll through the directory entries.

NOTE: You can exit the directory at any time. Simply press **DIR**.

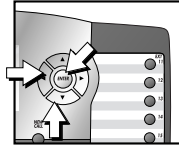

Edit a Directory Entry

- 1 Find the directory entry you wish to change by following the directions under “Review Directory Entries” on page 64.
- 2 When the entry you want to edit is displayed, press **ENTER**. The screen display includes DIAL.
- 3 Press **▼** until the screen display includes EDIT NAME.
- 4 Press **ENTER** and start to edit the name using the dial pad keys. (See the instructions in **Step 5** of “Store a Name and Number in the Directory” on page 61 for details.)
- 5 When you are finished editing the name, press **▼** until the screen display includes DONE.
- 6 Press **ENTER** to save the new name in the directory. The screen display briefly includes SAVED!. The screen automatically returns to showing the new name you stored and the number.
- 7 Press **ENTER** and then press **▼** until the screen display includes EDIT NUMBER
— OR —
Press **DIR** to save the new name and return to the idle screen without changing the number stored in this directory entry.
- 8 Press **ENTER** to begin editing the number using the dial pad keys. Press **◀** to backspace. The number will appear on the second line of the screen as you enter it.
- 9 Press **ENTER** to store the new number in the directory. The screen display briefly includes SAVED!. The screen automatically returns to showing the new name and number you stored.

NOTE: You can exit the directory at any time without storing the entry. Simply press **DIR**.

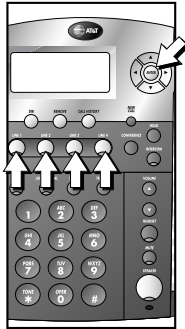

Dial a Number from the Directory

- 1 Find the entry for the number you wish to call by following the directions under “Review Directory Entries” on page 64.
- 2 Press **ENTER**. The screen display includes **DIAL**.
- 3 Press **ENTER**. The phone will automatically select an idle line and dial the call

— OR —

Press the **LINE** button for the line you wish to use, then press **ENTER** to place the call.

The call will be dialed in the mode (speakerphone or headset) you programmed (see “Set Automatic Mode” on page 33).



Remove a Name and Number from the Directory

- 1 Find the entry for the number you wish to call by following the directions under “Review Directory Entries” on page 64.
- 2 When the entry you wish to delete is displayed, press **REMOVE**. The screen display includes **REMOVED!**. The screen automatically returns to the first directory entry.

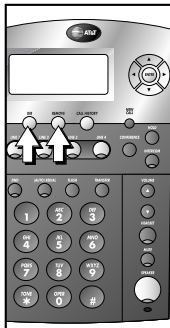

Remove All Entries from the Directory

- 1 Press **DIR** to begin working with the directory.
- 2 Press **REMOVE**. The screen display includes **REMOVE: ALL?**.
- 3 Press **REMOVE** again within three seconds to confirm the command and remove all directory entries. The screen briefly displays:

```
(empty)

All Removing!
```

The screen automatically returns to:

```
DIRECTORY

ADD ENTRY
```

INTERCOM OPERATION

This 974 telephone is fully compatible with any AT&T Four-Line Intercom Speakerphone 945 or 984 units you may have installed. You can use a total of 16 945/974/984 units together as extensions in your phone system.

This 974 telephone is also compatible with any AT&T 964/955/944 phones you have previously installed. This 974 telephone is **NOT** compatible with any 843, 853, 854, 874, or 954 telephones you may have previously installed.

 **NOTE:** If you have one or more 964, 955, or 944 phone(s) installed in the same phone system with this 974 telephone, you can only have 12 extensions in the phone system.

 Each individual phone in your telephone system **MUST** be assigned a unique extension number for the intercom feature to work. See "Assign an Extension Number to Your Phone" on page 24 for instructions.

 **NOTE:** If you subscribe to DSL service, please read "DSL Users" beginning on page 4 for information about minimizing problems with this phone caused by DSL signals.

This intercom features both a single-phone page and a system-wide page. A single-phone page alerts only one phone. A system-wide page alerts all system phones. Any phone with the Do Not Disturb (DND) feature activated will not receive a page.

An intercom call rings at the extension called with a repeating double-ring pattern.

A single-phone page automatically activates the speakerphone on the receiving phone. You can deactivate the speakerphone by lifting the handset.

 **NOTE:** If a line is in use, pressing  will place the line on hold and activate the intercom.

Basic Intercom Operations

OPERATION:	FUNCTION:
INTERCOM	Any two extensions connected to Line 1 can ring each other.
PAGE	Lets you “announce” over the speaker of the phone you’re calling. The person you’ve called can respond just by talking.
PAGE ALL	Lets you “announce” to all phones in the system at the same time (system-wide page).
CONFERENCE	Lets you connect another intercom call with an outside line.

Make an Intercom Call with the Handset

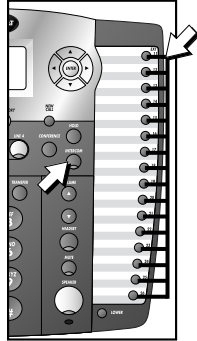

- 1 If One Touch Preference is set to INTERCOM, skip to **Step 2**
— OR —
If One Touch Preference is set to TELEPHONE, press **INTERCOM**.
- 2 Press the EXT button for the party you wish to call, then lift the handset. The screen display is similar to:

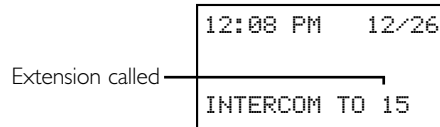

If the extension you called is idle, you will hear long beeps. If the other extension is on a call, you will hear a busy signal. If the other extension is set to Do Not Disturb, you will hear short beeps.

- ⊙ **NOTE:** The intercom call is automatically cancelled if you do not press an EXT button within 10 seconds.
- ⊙ **NOTE:** When you direct an intercom call to one extension, any extension in the system can answer the call by pressing **INTERCOM**.

Make an Intercom Call with the Speakerphone or Headset

With the handset in the cradle and the desired line idle:

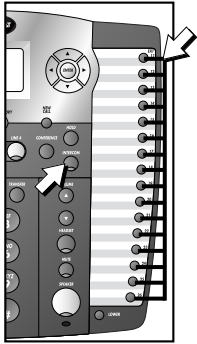

- 1 If One Touch Preference is set to INTERCOM, Skip to **Step 2**

— OR —

If One Touch Preference is set to TELEPHONE, press **INTERCOM**. The phone will automatically activate the line in the mode (headset or speakerphone) of the last call made.

- 2 Press the EXT button of the party you wish to reach. The screen display is similar to:

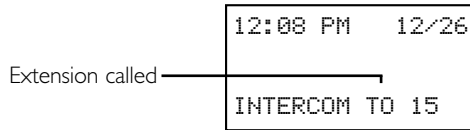

If the extension you called is idle, you will hear long beeps. If the other extension is busy, you will hear a busy signal. If the other extension is set to Do Not Disturb, you will hear short beeps.

NOTE: The intercom call is automatically cancelled if you do not press an EXT button within 10 seconds.

NOTE: When you direct an intercom call to one extension, any extension in the system can answer the call by pressing **INTERCOM**.

Answer an Intercom Call

NOTE: An intercom call can be answered at any extension in the phone system by pressing **INTERCOM**.

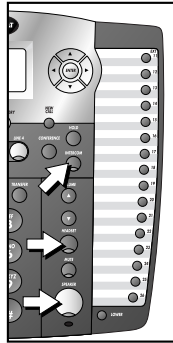

When you receive an intercom call you will hear a repeating double-ring pattern and your screen displays **INTERCOM FROM** with the extension number of the caller. Answer the intercom call by lifting the handset, or by pressing **INTERCOM**, **SPEAKER** or **HEADSET** to take the call hands-free.

NOTE: If you press **INTERCOM** to answer the call, the phone will automatically use the mode (speakerphone or headset) you programmed as the Automatic Mode (see "Set Automatic Mode" on page 33).

End an Intercom or Page Call

To end the intercom or page call, press **INTERCOM**
— OR —

Hang up or press **SPEAKER** or **HEADSET** again.

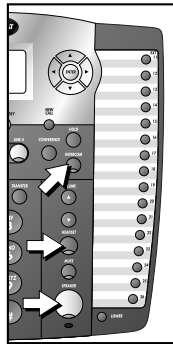

INTERCOM OPERATION

Page a Specific Extension (Single-phone Page)

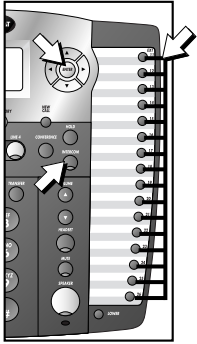

1 Press **INTERCOM**. The screen displays:

```
12:08 PM 12/26
EXT 11
INTERCOM TO_
PAGE #
```

2 Press **ENTER**. The screen displays:

```
12:08 PM 12/26
EXT 11
Paging
PAGE
```

3 Press the **EXT** button for the party you wish to page. The screen display is similar to:

```
12:08 PM 12/26
EXT 11
PAGE 15
```

Extension paged

Answer a Single-phone Page Auto-Mute Off

When your extension receives a page, the phone beeps and the speakerphone is automatically activated. Answer the call by simply speaking.

If you are on the headset, you can answer the page by pressing **HEADSET** and speaking through the headset.

Auto-Mute On

The **MUTE** light will be on. Lift the handset or press **MUTE** to temporarily deactivate Auto-Mute and answer the page.

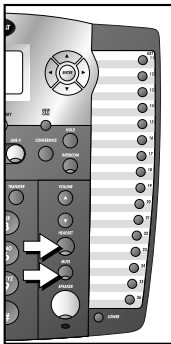

Page All System Phones

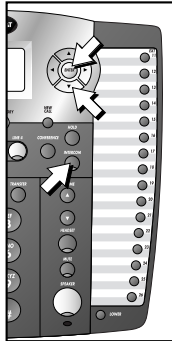

- 1 Press **INTERCOM**. The screen displays:

```
12:08 PM 12/26
EXT 11
INTERCOM TO_
PAGE #
```

- 2 Press **▼** until the screen displays:

```
12:08 PM 12/26
EXT 11
INTERCOM TO_
PAGE ALL #
```

- 3 Press **ENTER**. The screen displays:

```
12:08 PM 12/26
EXT 11
PAGE ALL
```

Once the page is answered at another extension, speak and your voice will be heard at all idle extensions in your phone system.

Answer a System-wide Page

NOTE: Only one extension can answer a system-wide page.

When you receive a system-wide page, your phone beeps and the screen shows the paging extension with a display similar to:

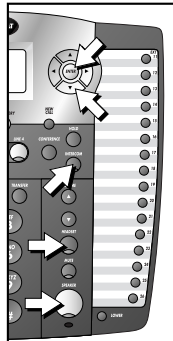

```
12:08 PM 12/26
ALL PAGE FROM 12
```

- 1 Press **INTERCOM** to answer the page. The screen display is similar to:

```
12:08 PM 12/26
INTERCOM TO 12
```

- 2 To end, press and release **SPEAKER** or **HEADSET**.

Make an Intercom Conference Call

A system phone on a two-way conversation on an outside line can invite a third party at an intercom extension into the conversation. Follow the directions under “Conference Calls” on page 51, making sure to establish the non-intercom call first.

NOTE: You cannot put an intercom conference call on hold.

Room Monitor

You can activate the speaker of another phone to monitor sounds in that room. The Auto-Mute feature must be turned off at the phone you want to monitor. (See “Turn Auto-Mute On or Off” on page 28 for instructions.)

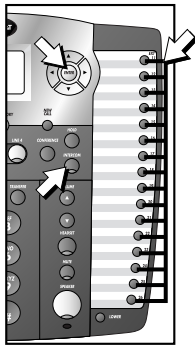

- 1 Press **INTERCOM**. The screen displays:

```
12:08 PM  12/26
EXT 11
INTERCOM TO_
PAGE
```

- 2 Press **ENTER**. The screen displays:

```
12:08 PM  12/26
EXT 11
Paging
PAGE
```

- 3 Press the **EXT** button for the telephone you want to monitor. The screen display is similar to:

```
12:08 PM  12/26
EXT 11
PAGE 15
```

The party at the extension being monitored will hear the intercom ring as with any page call, signaling that the speakerphone has been activated.

CALLER ID OPERATION

This telephone has a Caller ID feature that works with Caller Identification service provided by your local telephone company. There is a fee for this service, and it may not be available in all areas. This phone can provide information only if both you and the caller are in areas offering Caller Identification service, and if both telephone companies use compatible equipment.

When you use this phone with Caller ID service, you can see who's calling before you answer the phone. If you subscribe to Caller ID with Call Waiting, a **combined** service available through many local telephone companies, you can see who's trying to reach you even when you're on another call. This service may be called by different names (such as Caller ID with Visual Call Waiting) by different local telephone companies and may not be available in all areas.

NOTE: You must subscribe to combined Caller ID with Call Waiting as a single service to see Caller ID information for a Call Waiting call. Check with your telephone company for availability.

This phone assigns each incoming call a number from 1 to 200. The most recent call will have the highest number. (For example, if two calls have been received, call number 002 is the most recent.) When the call history is full, the oldest call information is automatically deleted to make room for new incoming call information.

The format of phone numbers displayed will depend on the Home and Local Area Codes you programmed. (See "Home Area Code" and "Local Area Codes" on page 6 for explanations of area codes. See "Program Home and Local Area Codes" on page 38 for programming instructions.) If the call came from within your Home Area Code, the screen displays only the seven digit number (without an area code). If the call came from one of your Local Area Codes, the screen displays 10 digits (area code plus the seven digit number). If the call did not come from any of the area codes you programmed, 1) phone numbers with 10 or more digits will automatically have a "1" inserted and displayed before the number and, 2) phone numbers with fewer than 10 digits will be displayed without a "1."

Caller ID Display

When you receive incoming Caller ID information, the screen display is similar to:

```
12:08PM 12/26 L2
SMITH, JOHN
5550123
```

The time and date of the call, the caller's name and phone number are included in the display if sent by the caller's telephone company. The incoming line number of the call also appears on screen (L2 in the above example). Other messages may appear on screen. See "Display Screen Messages" on page 78 for more information.

Caller ID information will appear on the screen for 30 seconds or until the caller hangs up, the call is answered at another extension in your phone system, or another extension which answered the call hangs up.

If you subscribe to Caller ID service, this phone automatically resets the time and date each time new call information is received. You can set the time and date yourself if you wish. (See "Set the Time and Date" on page 30.)

Call Waiting

If you subscribe to Caller ID with Call Waiting service and you receive a Call Waiting call, the screen displays call information for the call similar to:

```
L2 (CallWaiting)
SMITH, JOHN
5550123
```

- 1 Press **FLASH** to access the Call Waiting call.
- 2 To switch back to the original call, press **FLASH** again.



Calls Received on Two or More Lines Simultaneously

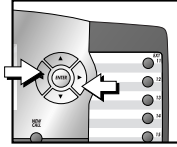

Your screen can display the Caller ID information for only one call at a time, but you can switch between the information for two or more ringing lines by pressing ◀ or ▶.

For example, if Line 3 of the phone is ringing, the screen displays the Caller ID information for Line 3:

```
12:08PM 12/26 L3
SMITH, JOHN
5551234
```

If the phone begins to ring on Line 1, the screen will display the new caller's information after it is received:

```
12:08PM 12/26 L1
BROWN, MARY
5550127
```

Press ◀ or ▶ to review the Caller ID information for the first call and the screen displays:

```
12:08PM 12/26 L3
SMITH, JOHN
5551234
```

Pressing ◀ or ▶ repeatedly will allow you to switch between all of the incoming call information. See "Display Screen Messages" on page 78 for information about other possible messages.

Display Screen Messages

DISPLAY:	MEANS:
PRIVATE NAME	The other party is blocking name information.
PRIVATE NUMBER	The other party is blocking telephone number information.
UNKNOWN NAME	Your phone company is unable to receive information about this caller's name.
UNKNOWN NUMBER	Your phone company is unable to receive information about this caller's number.
OUT OF AREA	The call information is unavailable.

CALLER ID OPERATION

Message Waiting and NEW CALL Light

This light stays on when you have received call information but have not yet reviewed it. If you subscribe to a voice mail service, this light flashes when you have unretrieved messages waiting. The screen also displays information about the number of new calls and voice mail messages waiting.

```
12:08PM L212/26
EXT 22
CID:100/198 COVM
1 34
```

CID:100/198 Indicates 100 **new** Caller ID messages and 198 **total** Caller ID messages.

COVM There is Voice Mail “message waiting” information on Lines 1, 3 and 4.
1 34

Call History

View Call History Summary

- 1 Press **CALL HISTORY**. The screen displays the numbers of total calls and new calls in call history:

```
CALL HISTORY
198 CALLS
115 NEW
```

- 2 Press **CALL HISTORY** again to exit Call History mode.

continued on page 80

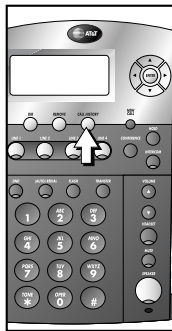

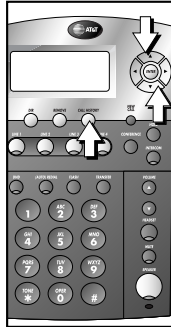

Call History

continued from page 79

Review Records in Call History

- 1 Press **CALL HISTORY**. The screen displays the numbers of total calls and new calls in call history:

```
CALL HISTORY
198 CALLS
115 NEW
```

- 2 Press **▼** to view the previous (most recent) caller's information

— OR —

Press **▲** to view the earliest caller's information.
The screen displays the caller information:

```
10:27AM 11/12 L3
SMITH, JOHN
5550123
CL#001 NEW
```

10:27AM 11/12	Time and date of the call
L3	The call came in on Line 3
SMITH, JOHN	Caller's name
5550123	Caller's phone number
CL#00	This is the first (earliest) record in call history
NEW	This is new, previously unreviewed call information

See "Display Screen Messages" on page 78 for information about other possible messages.

NOTE: To exit call history at any time without saving changes, press and hold **CALL HISTORY**.

Remove Calls from Call History

Remove a Specific Call Record from Call History



1 Locate the call record you wish to delete following the instructions under “Review Records in Call History” on page 80.

2 Press **REMOVE**. The screen display includes Removed!.

Then the screen displays the next record in call history. If there are no records in call history, the screen displays:

```
CALL HISTORY
000 CALLS
00 NEW
```

Remove All Calls from Call History

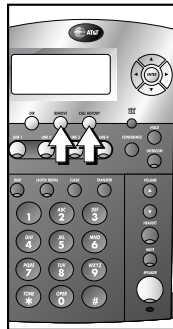

1 Press **CALL HISTORY**. The screen displays the numbers of total calls and new calls in call history.

2 Press **REMOVE**. The screen display includes REMOVE: ALL?.

3 Press **REMOVE** again within three seconds to confirm the command and delete all records from call history. The screen display includes removing....

The screen automatically returns to the call history summary.

NOTE: To exit call history at any time without saving changes, press and hold **CALL HISTORY**.

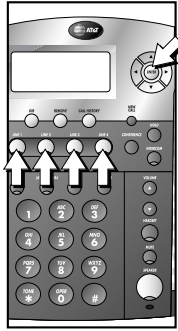

Dial a Number from Call History

As you review call history records you can dial a displayed phone number.

- 1 Locate the number you wish to call in call history (see “Review Records in Call History” on page 80). The screen display is similar to:

```
10:27AM 11/12 L3
SMITH, JOHN
5550123
CL#001          NEW
```

- 2 Press **ENTER**. The screen display includes DIAL.
- 3 Press **ENTER**. The phone will automatically select an idle line and dial the call

— OR —

Press the LINE button for the line you wish to use, then press **ENTER** to place the call.

The call will be dialed in the mode (speakerphone or headset) you programmed (see “Set Automatic Mode” on page 33).

Dial Options

You can change the format of a number in call history before you dial.

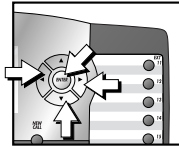

- 1 Follow the directions in **Steps 1** and **2** of “Dial a Number from Call History” above. The screen display includes DIAL.
- 2 Press **▼** until the screen display includes DIAL ALTERNATE.
- 3 Press **◀** or **▶** to scroll through the alternate dialing formats (seven digit number, area code + seven digit number, 1 + area code + seven digit number, or 1 + seven digit number). The screen displays the alternate formats on the third line.
- 4 When the format you want to use is displayed, dial the call as described in **Step 3** of “Dial a Number from Call History” above.

Save a Name and Number from Call History to the Directory

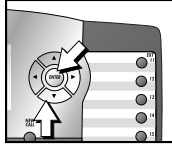

- 1 Locate the call history record number you wish to save (see “Review Records in Call History” on page 80). The screen display is similar to:

```
10:27AM 11/12 L3
SMITH, JOHN
5550123
CL#001          NEW
```

NOTE: If a call history record does not include a phone number, it cannot be saved to the directory.

- 2 Press **ENTER**. The screen display includes DIAL.
- 3 Press **▼** until the screen display includes COPY TO DIR.
- 4 Press **ENTER** to save the name and number to the directory. The screen displays the name, number and added to DIR!. The screen automatically returns to the call history summary.

NOTE: To exit call history at any time without saving changes, press and hold **CALL HISTORY**.

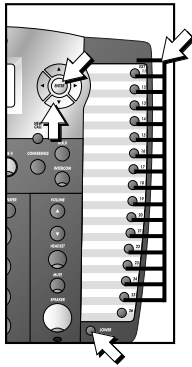

Save a Number from Call History to a One Touch Location

- 1 Locate the call history record you wish to save (see "Review Records in Call History" on page 80). The screen display is similar to:

```
10:27AM 11/12 L3
SMITH, JOHN
5550123
CL#001          NEW
```

Ⓢ **NOTE:** If a call history record does not include a phone number, it cannot be saved to the directory.

- 2 Press **ENTER**. The screen display includes DIAL.
- 3 Press **▼** until the screen display includes COPY TO 1-TOUCH.
- 4 Press **ENTER** to begin to save the number. The screen display includes PRESS 1-TOUCH .
- 5 Press the EXT button where you want to save the number

— OR —

Press **LOWER**, then press the EXT button.
The screen displays the number and Save to 1-TOUCH.
The screen automatically returns to the call history summary.

Ⓢ **NOTE:** To exit call history at any time without saving changes, press and hold **CALL HISTORY**.

ADDING A FAX MACHINE

Ⓢ NOTE: Do not connect a fax machine to Line 1. Doing so will interrupt the telephone's intercom data channel.

You may wish to use a fax machine with your phone. Choose Line 2, 3 or 4 for the fax machine, and connect it according to the manufacturer's instructions for installation and use.

- That line's telephone number is your fax number.
- The same line can be used for outgoing calls (incoming faxes will get a busy signal when the line is in use).
- Set your fax machine to answer on the first ring (follow manufacturer's instructions).
- To prevent the fax line from ringing at all the extensions, turn the ringer off for that line at other extensions (see "Turn the Ringer On or Off for Each Line" on page 25).

Ⓢ NOTE: If you are using a fax switch, or a fax machine with a built-in fax switch, see "Using a Fax Switch" below.

Using a Fax Switch

A fax switch lets the telephone know, before the phone rings, whether an incoming call is a voice call or a fax call. Some fax machines have a built-in fax switch. Using a fax switch may affect the operation of the LINE lights or other system features. If you have difficulty operating this phone, try the suggestions below.

GENERAL PRODUCT CARE

To keep your phone working and looking good, follow these guidelines:

- Avoid putting it near heating appliances and devices that generate electrical noise (for example, motors or fluorescent lamps).
- DO NOT expose it to direct sunlight or moisture.
- Avoid dropping the phone and/or other rough treatment.
- Clean with a soft cloth.
- Never use a strong cleaning agent or abrasive powder because this will damage the finish.
- Retain the original packaging in case you need to ship it at a later date.

GENERAL PRODUCT CARE

TECHNICAL SPECIFICATIONS

TECHNICAL SPECIFICATIONS

REN	0.2B
Power Adapter	Input: AC 120V, 60Hz Output: DC 12v, 500mA
Battery	One 9V alkaline battery required
Intercom Signal Frequency	Data 455 KHz

**Doug,
We need 974 additions**

TECHNICAL SPECIFICATIONS

IN CASE OF DIFFICULTY

If you have difficulty operating this phone, try the suggestions below. For Customer Service, visit our website at www.telephones.att.com or call **1 800 222-3111**. **Have the serial number, found on the underside of your phone, available when contacting Customer Service. Please retain your receipt as your proof of purchase.**

To purchase accessories or replacement parts contact Customer Service. Visit our website at www.telephones.att.com or call **1 800 222-3111**.

TELEPHONE OPERATION

PROBLEM

Telephone Does Not Work Properly

SOLUTION

- This 974 telephone is not compatible with any 843, 853, 854, 874, or 954 telephones you may have previously installed.

PROBLEM

No Dial Tone

SOLUTION

- Make sure all plugs are connected properly. Inspect the line cord connections at the modular jack(s) and at the telephone. Also inspect the coiled handset cord connection at both ends.
- Make sure a line is selected.
- Make sure Hold is not activated.
- If you do not hear a dial tone when you press **HEADSET**, make sure the headset is firmly connected at the jack.

PROBLEM

Telephone Does Not Ring

SOLUTION

- Make sure the Do Not Disturb (DND) feature is not activated.
- Make sure the ringers are turned on.
- If there are several non-system phones on the line that doesn't ring, disconnect some of them. Having too many phones connected can also result in low ringer volume for non-system telephones.
- If the INTERCOM light flashes but you don't hear a paging signal, make sure the Do Not Disturb feature is not activated.

TELEPHONE OPERATION

PROBLEM

A Repeating Short Ring (Error Ring) Sounds at All Extensions When You Assign an Extension Number to Your Phone

SOLUTION

The extension number you chose is already assigned. Begin again and choose a different extension number from 11 to 26 (see “Assign an Extension Number to Your Phone” on page 24). You **MUST** assign a different extension number to every phone in your system.

PROBLEM

Intercom Paging Signal Not Received

SOLUTION

Make sure you have programmed your intercom extension number correctly. Line 1 must be connected at all extensions, and must be the same telephone number/line for Page and Intercom to work properly.

PROBLEM

Cannot Join a Conversation in Progress

SOLUTION

The privacy feature prevents another set on the system from interrupting a conversation. Make sure you press the LINE button to release privacy.

PROBLEM

Error Tone (Fast Busy Signal) Heard When Making an Intercom Call

SOLUTION

The Do Not Disturb feature is activated at the extension you are calling.

PROBLEM

A Double Beep Sounds Every 30 Seconds

SOLUTION

There is a call on hold at this extension. Press and release the LINE button of the call to return to the call and turn off the reminder beep.

IN CASE OF DIFFICULTY

TELEPHONE OPERATION

PROBLEM

LINE Lights Remain On When No Line is Connected

SOLUTION

- Make sure the phone is programmed for that line to be absent. (See “Turn Line Usage On or Off for Each Line” on page 31.)
- Make sure that your Line Groups are programmed properly. (See “Assign the Line Group for this Phone” on page 39.)
- Disconnect all other devices (fax, modem, credit card reader, etc.) from any lines connected to your 974 phone. These devices can interfere with the telephone’s data links.
- Make sure the total length of telephone wiring used in your phone system is less than 600 feet. In some cases a Z800A filter can be used in a phone system with more than 600 feet of wire. AT&T highly recommends that a Z800A filter be installed by a professional. AT&T **CANNOT** guarantee that this telephone will work with such a filter, and **IS NOT** responsible for such installations. A Z800A filter can be obtained by calling **800 222-3111**. (See “DSL Users” beginning on page 4 for details.)

PROBLEM

Tone Signals Do Not Activate a Remote Device

SOLUTION

Tone signaling does not work during conference calls.

TELEPHONE OPERATION

PROBLEM

**Operation During
a Power Failure**

SOLUTION

This phone will operate during a power failure if a working battery has been installed. You will be able to answer calls with the handset or headset, and dial calls using the keypad and the One Touch or Redial features. No other features will work until power is restored.

PROBLEM

**The Screen Displays
Powerfail**

SOLUTION

The phone has been disconnected from AC power. When power is restored, a key is pressed, or the phone is taken off the hook, the screen will return to the usual display. One Touch and Redial numbers are retained until power is restored.

PROBLEM

**Display Screen
is Blank**

SOLUTION

Make sure the power cord is connected to both the phone and an electrical outlet not controlled by a wall switch.

PROBLEM

**Intercom, Hold, Line
Privacy or Other
Advanced Features Do
Not Work Properly**

SOLUTION

If you are a DSL customer, you may need to arrange for installation of a splitter and an AT&T Z800A filter. See "DSL Users" beginning on page 4 for details.

CALLER ID OPERATION

PROBLEM

**No Caller ID
Information While
on a Call**

SOLUTION

You must subscribe to **combined** Caller ID with Call Waiting as a **single** service to see Call Waiting information.

IN CASE OF DIFFICULTY

CALLER ID OPERATION

PROBLEM

No Caller ID Information is Received

SOLUTION

Caller ID information is transmitted by the telephone company between the first and second rings. Allow your phone to ring at least twice to receive Caller ID information.

PROBLEM

NEW CALL Light Flashes

SOLUTION

- Make sure you have reviewed all messages on all lines.
- You may have received a false signal from the Central Office. To clear, see “Reset COVM Indicator” on page 37 in FEATURE SETUP.

PROBLEM

Screen Displays COVM

SOLUTION

The screen displays COVM when the COVM indicator is turned on for at least one line, whether or not there are messages waiting, and whether or not you have Voice Mail service.

- If you subscribe to Voice Mail service with your local telephone company, but prefer not to display COVM on the screen, turn off the COVM indicator for each line.
- If you do not subscribe to Voice Mail service, turn off the COVM indicator for all lines.

See “Turn COVM Indicator On or Off for Each Line” on page 36 in FEATURE SETUP for detailed instructions.

PROBLEM

COVM Line Indicator Remains On

SOLUTION

- Make sure you have reviewed all messages on that line.
- You may have received a false signal from the Central Office. To clear, see “Reset COVM Indicator” on page 37 in FEATURE SETUP.

EXPANDING THE PHONE SYSTEM

When you combine two or more 945/974/984/944/955/964 phones you create an interacting system where phones share lines. If you have only 945/974/984 phones on your phone system, you can have up to 16 phones and up to 19 telephone lines. If you have one or more 944/955/964 phones in your phone system, you can have up to 12 phones and up to 15 telephone lines. The system can be expanded with or without Centrex service.

NOTE: All 974 features work as described earlier in this manual.

Line Groups

When phones share lines, the LINE lights let users at different extensions know when a specific line is in use. For accurate LINE lights, the same lines must be connected to each extension in the Line Group, and they must have the same incoming telephone number at each extension.

The chart below shows 16 extensions, each sharing the first three lines, but being assigned to different Line Groups based on other shared or private lines.

		Lines in System						
		L1	L2	L3	L4	L5	L6	L7
Intercom Extensions	EXT 11	✓	✓	✓	✓			
	EXT 12	✓	✓	✓		✓		
	EXT 13	✓	✓	✓	✓		✓	
	EXT 14	✓	✓	✓		✓		
	EXT 15	✓	✓	✓	✓		✓	
	EXT 16	✓	✓	✓		✓		
	EXT 17	✓	✓	✓	✓		✓	
	EXT 18	✓	✓	✓		✓		
	EXT 19	✓	✓	✓	✓		✓	
	EXT 20	✓	✓	✓		✓		
	EXT 21	✓	✓	✓	✓		✓	
	EXT 22	✓	✓	✓		✓		
	EXT 23	✓	✓	✓	✓		✓	
	EXT 24	✓	✓	✓		✓		
	EXT 25	✓	✓	✓	✓		✓	
	EXT 26	✓	✓	✓				✓

Private Lines

You can use the fourth line on each extension as a private line. A private line is a telephone number assigned to just one extension.

NOTE: You must program the lines you are using at each extension so that the phone knows which lines are shared and which are private. (You can physically wire lines with different telephone numbers into each unit for Line 4.)

The chart below shows 16 extensions, each sharing the first three lines.

		Lines in System																			
		L1	L2	L3	L4	L5	L6	L7	L8	L9	L10	L11	L12	L13	L14	L15	L16	L17	L18	L19	
Intercom Extensions	EXT 11	✓	✓	✓	✓																
	EXT 12	✓	✓	✓		✓															
	EXT 13	✓	✓	✓			✓														
	EXT 14	✓	✓	✓				✓													
	EXT 15	✓	✓	✓					✓												
	EXT 16	✓	✓	✓						✓											
	EXT 17	✓	✓	✓							✓										
	EXT 18	✓	✓	✓								✓									
	EXT 19	✓	✓	✓									✓								
	EXT 20	✓	✓	✓										✓							
	EXT 21	✓	✓	✓											✓						
	EXT 22	✓	✓	✓												✓					
	EXT 23	✓	✓	✓													✓				
	EXT 24	✓	✓	✓														✓			
	EXT 25	✓	✓	✓															✓		
	EXT 26	✓	✓	✓																✓	

CENTREX OPERATION

Setup Checklist

Before expanding your system or installing for Centrex, review the installation checklist. If you have Centrex, contact your local telephone company for further information about Centrex service.

- The phone number for Line 1 must be the same on all phones in order for the Intercom and Page features to work.
- Determine the number of phones that will be on the system.
- Identify the phone that will be the Console phone.
- Identify the private line for the Console phone. The Console phone must have its own private line. This line is not shared with any other phone.
- Follow the regular installation instructions in this manual.
- Enable the Console phone.
- Store the Centrex pickup codes and the seven-digit phone numbers in One Touch locations. (See ONE TOUCH OPERATION beginning on page 55.)

Enable the Console Phone

Determine which phone will be the Console phone for your system and program the Console following the directions to “Set This Phone to be the Centrex Console Phone” on page 41. It is recommended that Line 4 of the Console be programmed as a private line, to be sure a line is available for Centrex access.

Console Operation

Once another system phone has enabled its delayed ring, the Console phone will receive those calls. All the 974 features work in the same manner as described in this manual.

The Console phone can pick up other Centrex lines through Centrex switching. You can store the Centrex pickup codes and the seven-digit phone number of each station, except for the Console phone, in the One Touch locations.

Set Ring Delay Duration

This feature allows other system telephones' calls to ring at the Console phone. After a specified ring delay, the calls will ring at the Console phone. (See "Set the Centrex Console Delayed Ring Time" on page 42.)

Answer a Delayed Ring

The Console phone rings and the screen displays the extension number of the intercom sending the delayed ring.

- 1 Select a free line.
- 2 Enter the Centrex pickup code.
- 3 Enter the seven-digit phone number of the extension sending the delayed ring.

NOTE: If the Console is using another line and receives a delayed ring, the Console phone can put the other line on hold and follow Steps 1–3. If the Console is on an intercom call, the intercom call should be ended before picking up the ringing phone.

Pick Up Another Station's Line

- 1 Choose a free Centrex line.
- 2 Enter the Centrex pickup code.
- 3 Enter the seven-digit phone number of the line you want.

INDEX

▲ 6, 20, 22, 48, 60

▼ 6, 20, 22, 48, 60

⦿ 20

◀ 6, 20, 22, 60

▶ 6, 20, 22, 60

⦿ 20

A

A Double Beep Sounds Every
30 Seconds 89

A Repeating Short Ring (Error
Ring) Sounds at All Extensions
89

AM/PM 30

answer a call 43, 44

answer call 71

AREA CODES 8, 38

audible signal 46

Auto Redial 48

(AUTO) REDIAL 47, 48, 56

(AUTO)REDIAL 54

auto-mute 7, 28, 72, 74

automatic line selection 43, 45

automatic mode 8, 33, 48, 59, 71

Aux L3 jack 19

Aux L4 jack 19

B

Base 2, 11, 12

battery 11, 12, 14, 18, 53, 91

battery compartment 11, 12

Blind Transfer 52

C

call history 75, 79, 80, 81, 82, 83,
84

call information 75

call privacy 46

Call record 81

call volume 47

Call Waiting 50

Caller ID 5, 8, 60, 75, 79

Caller ID information 76, 77

Caller ID with Call Waiting 5, 75,
76

Caller Identification 5, 75

caller information 80

CANCEL 56

Cannot Join a Conversation
in Progress 89

Central Office Voice Mail 5

Centrex 1, 5, 41, 42, 93, 95

Centrex Console Delayed Ring 42

Centrex Console Phone 9, 41

Centrex pickup code 95, 96

conference 68

(CONFERENCE) 51

conference call 51, 90

console 9

Console phone 95, 96.

See also Centrex
Console Phone

Convenience Ports 19

COVM 5

COVM indicator 36, 37

INDEX

COVM INDICATOR 8
 COVM ON/OFF 8
 COVM RESET 37
 CSL DELAY RING 9

D

date 30
 day of the month 30
 day of the week 30
 default mode 44, 45
 default settings 40
 delay ring 7, 27
 delayed ring 27, 95, 96
 DIAL ALTERNATE 82
 dial mode 29
 dial options 82
 dial pad key 64
 dial pad keys 61, 62, 65
 dial pulse (rotary) 50, 57, 63
 dial tone 14, 16, 44, 47
 dialing sequence 57, 62, 63
 Digital Subscriber Line 4
 directory 60, 61, 62, 64, 65, 66, 83
 directory card 55
 DIRECTORY FULL! 60
 Display Screen is Blank 91
 DND 5, 10, 54
 DND light 46
 Do Not Disturb 5, 46, 54, 69, 70, 89
 Do Not Disturb (DND) 67, 88
 DSL 4, 91

98

DSL filters 4
 DSL service 4, 5, 67
 DSL service provider 4, 5
 DSL splitter 4, 5

E

English 22, 42
ENTER 6, 20, 48, 53, 60, 72–74
 erase all settings 40
 error ring 11
 Error Tone (Fast Busy Signal)
 Heard When Making a
 Intercom Call 89
 Espanol 22, 42
 EXT button 23, 52, 53, 55, 56, 58,
 59, 69, 70, 72, 74, 84
 extension 6, 11, 31, 46, 52–54, 67,
 69, 70–74, 89, 93, 94
 extension no 7
 extension number 3, 7, 10, 11, 52,
 67, 71, 89, 96
 extensions 3, 67, 85

F

fax 90
 fax machine 85
 fax switch 85
 feature setup 20, 21
 flash 50, 57, 63
FLASH 50
 Français 22, 42

H

hands-free 28, 44, 71
 handset 2, 14, 15, 33, 43, 45,
 47–49, 50, 53, 67, 69, 70, 71, 91
 handset cord 2, 14, 15
 handset tab 15
 headset 8, 33, 43–45, 47, 48, 50,
 53, 54, 59, 71, 72, 82, 91
HEADSET 6, 8, 44, 48, 59, 71–73
 headset jack 1, 44
 HEADSET light 44
 hearing aid 1
 hold 45, 50, 54, 74, 89, 91
HOLD 49, 51, 53
 hold reminder 29, 49
 Home Area Code 6, 8, 38, 75
 hour 30

I

incoming call 44, 46
 incoming calls 31
 incoming intercom call 54
 Initializing.. 14, 18
 Intercom 10, 23, 24, 31, 46, 67, 74,
 89, 91, 95.
 See also Centrex Console
 Phone
INTERCOM 49, 53, 69, 70–74
 intercom call 26, 49, 51, 54, 55,
 69–71
 intercom conference call 74
 INTERCOM light 46, 88

Intercom Paging Signal Not
 Received 89

L

L1/L2 jack 13
 L3/L4 jack 13
 Language 9, 22, 42
 LCD Backlight 8
 Lights 54
 Line 1 phone number 3
 LINE button 33, 43–49, 51, 53, 89
 line cords 2, 13
 Line Group 6, 39, 90, 93
 LINE light 46, 49
 LINE lights 85, 93
 Line Lights Remain On 90
 Line Preference 32
 Line Privacy 91. See also private
 line
 line usage 31, 90
 Local Area Code 6, 8, 38, 75
 LOW BATT 53
LOWER 55, 56, 58, 59
M
 make a call 43, 44
 Menu item 20
 menu operation 20, 21
 Message Waiting light 79
 microfilters 4
 minute 30
 month 30

INDEX

multi-phone system 6

Mute 50, 54

MUTE 50, 72

MUTE light 50, 72

N

Navigation buttons 6, 20

NEW CALL light 79

non-system phone 46, 88

O

One Touch 11, 23, 58, 91

One Touch (EXT) buttons 7

One Touch Location 56, 84

One Touch locations 55, 95

One Touch number 59

One Touch Preference 7, 55, 59,
69, 70

outgoing calls 85

outgoing or transfer calls 31

outside line 51

P

Page 3, 68, 72, 73, 89, 95.

See also Centrex Console
phone

page all 68

page call 74

paging only 31

pause 57, 62

phone system 3, 4, 6, 9, 46, 67, 71,
73, 90, 93

power adapter 2, 14, 16

100

power cord 14, 91

power failure 11, 14, 18, 91

POWER jack 14, 16

prime line 6, 8, 32, 43

privacy 28, 89

private line 93

PRIVATE NAME 78

PRIVATE NUMBER 78

PRV 39

Pulse 29

R

Rapid Scroll 8, 22, 34

Redial 11, 48, 91

redial memory 47

reminder beep 89

REMOVE:ALL? 81

Removed! 81

reset all 9

Reset! 37

return to the conversation 50

ring delay 96

ring pattern 7, 26

ring setting 27

ringer 25, 85, 88

ringer on /off 7

ringer type 7

Ringer Volume 47

room monitor 28, 74

S

Screen Backlight 35

screen display 20
 Screen Displays POWERFAIL 91
 scroll button 22
 scroll rate 8, 34
 single-phone page 67, 72
 speaker 74
SPEAKER 6, 8, 44, 48, 59, 71, 73
 SPEAKER light 44
 speakerphone 1, 8, 33, 43–45,
 48–50, 53, 54, 59, 67, 70–72,
 74, 82
 splitter 4
 Stored! 56
 switch lines 49
 Switchhook 15, 50
 system phone 6, 46, 52, 74
 system phones 6
 system-wide page 67, 73

T

Telephone Does Not Ring 88
 telephone lines 3
 telephone system 11, 24, 67
 telephone wiring 3, 90
 Temporary Tone 50, 57
 temporary tone signals 63
 Three-Party Call 51
 Three-Way Calling 50
 Time 30
 timer 45
X-TONE 50

Tone Signals Do Not Activate a
 Remote Device 90
 Tone 29
 touch tone 50, 57
 transfer 52, 53, 54
TRANSFER 52, 53
 transfer ring 53
 two-line adapter 13

U

UNKNOWN NAME 78
 UNKNOWN NUMBER 78
 unused lines 31

V

Voice Mail 36, 79
 Voice Mail service 27
 VOLUME ▲ 47
 VOLUME ▼ 47

Z

Z800A filter 3, 4, 5, 90