

**Lucent Technologies**  
Bell Labs Innovations



# ***CentreVu***<sup>®</sup> **Supervisor**

Version 8

Reports

585-210-929  
Comcode 108502188  
Issue 1  
December 1999

## Notice

Every effort was made to ensure that the information in this book was complete and accurate at the time of printing. However, information is subject to change.

## Your Responsibility for Your System's Security

Toll fraud is the unauthorized use of your telecommunications system by an unauthorized party, for example, persons other than your company's employees, agents, subcontractors, or persons working on your company's behalf. Note that there may be a risk of toll fraud associated with your telecommunications system and, if toll fraud occurs, it can result in substantial additional charges for your telecommunications services.

You and your system manager are responsible for the security of your system, such as programming and configuring your equipment to prevent unauthorized use. The system manager is also responsible for reading all installation, instruction, and system administration documents provided with this product in order to fully understand the features that can introduce risk of toll fraud and the steps that can be taken to reduce that risk. Lucent Technologies does not warrant that this product is immune from or will prevent unauthorized use of common-carrier telecommunication services or facilities accessed through or connected to it. Lucent Technologies will not be responsible for any charges that result from such unauthorized use.

## Lucent Technologies Fraud Intervention

If you *suspect that you are being victimized* by toll fraud and you need technical support or assistance, call Technical Service Center Toll Fraud Intervention Hotline at 1-800-643-2353.

## Federal Communications Commission Statement

**Part 15: Class A Statement.** This equipment has been tested and found to comply with the limits for a Class A digital device, pursuant to Part 15 of the FCC Rules. These limits are designed to provide reasonable protection against harmful interference when the equipment is operated in a commercial environment. This equipment generates, uses, and can radiate radio frequency energy and, if not installed and used in accordance with the instruction manual, may cause harmful interference to radio communications. Operation of this equipment in a residential area is likely to cause harmful interference, in which case the user will be required to correct the interference at his own expense.

**Part 15: Class B Statement.** This equipment has been tested and found to comply with the limits for a Class B digital device, pursuant to Part 15 of the FCC Rules. These limits are designed to provide reasonable protection against harmful interference in a residential installation. This equipment generates, uses, and can radiate radio-frequency energy and, if not installed and used in accordance with the instructions, may cause harmful interference to radio communications. However, there is no guarantee that interference will not occur in a particular installation. If this equipment does cause harmful interference to radio or television reception, which can be determined by turning the equipment off and on, the user is encouraged to try to correct the interference by one or more of the following measures:

- Reorient the receiving television or radio antenna where this may be done safely.
- To the extent possible, relocate the receiver with respect to the telephone equipment.
- Where the telephone equipment requires ac power, plug the telephone into a different ac outlet so that the telephone equipment and receiver are on different branch circuits.

**Part 15: Personal Computer Statement.** This equipment has been certified to comply with the limits for a Class B computing device, pursuant to Subpart J of Part 15 of FCC Rules. Only peripherals (computing input/output devices, terminals, printers, etc.) certified to comply with the Class B limits may be attached to this computer. Operation with noncertified peripherals is likely to result in interference to radio and television reception.

**Part 68: Answer-Supervision Signaling.** Allowing this equipment to be operated in a manner that does not provide proper answer-supervision signaling is in violation of Part 68 rules. This equipment returns answer-supervision signals to the public switched network when:

- Answered by the called station
- Answered by the attendant
- Routed to a recorded announcement that can be administered by the CPE user

This equipment returns answer-supervision signals on all DID calls forwarded back to the public switched telephone network. Permissible exceptions are:

- A call is unanswered
- A busy tone is received
- A reorder tone is received

## Canadian Department of Communications (DOC)

### Interference Information

This digital apparatus does not exceed the Class A limits for radio noise emissions set out in the radio interference regulations of the Canadian Department of Communications.

Le Présent Appareil Numérique n'émet pas de bruits radioélectriques dépassant les limites applicables aux appareils numériques de la class A prescrites dans le reglement sur le brouillage radioélectrique édicté par le ministère des Communications du Canada.

## Trademarks

- DEFINITY is a registered trademark of Lucent Technologies.
- CentreVu is a registered trademark of Lucent Technologies.
- CONVERSANT is a registered trademark of Lucent Technologies.
- Informix is a registered trademark of Informix Software, Inc.
- Intel is a registered trademark of Intel.
- Microsoft, MS, MS-DOS, Windows, Windows 95, Windows NT, and Access are registered trademarks of Microsoft Corporation.
- OpenLink is a trademark of OpenLink Software.
- Crystal Reports is a trademark of SeaGate Software.
- Solaris is a trademark of Sun Microsystems, Inc.
- SPARC trademarks, including the SCD compliant logo, are trademarks or registered trademarks of SPARC International, Inc. SPARCstation, SPARCserver, SPARCengine, SPARCworks, and SPARCcompiler are licensed exclusively to Sun Microsystems, Inc. Products bearing SPARC trademarks are based upon an architecture developed by Sun Microsystems, Inc.
- Sun and Sun Microsystems are trademarks or registered trademarks of Sun Microsystems, Inc.
- Ultra Enterprise 3000 and Ultra 5 are trademarks of Sun Microsystems, Inc.
- UNIX is a registered trademark in the United States and other countries, licensed exclusively through X/Open Company Limited.
- All other products mentioned herein are the trademarks of their respective owners.

**Ordering Information****Call:** Lucent Technologies Publications Center

Voice: 1-800-457-1235

International Voice: 317-322-6416

Fax: 1-800-457-1764

International Fax: 317-322-6699

**Write:** Lucent Technologies BCS Publications Center

2855 N. Franklin Road

Indianapolis, IN 46219

**Order:** Document No. 585-210-929

Comcode 108502188

Issue 1, December 1999

You can be placed on a Standing Order list for this and other documents you may need. Standing Order will enable you to automatically receive updated versions of individual documents or document sets, billed to account information that you provide. For more information on Standing Orders, or to be put on a list to receive future issues of this document, please contact the Lucent Technologies Publications Center.

**Warranty**

Lucent Technologies provides a limited warranty on this product. Refer to the "Limited use Software License Agreement" card provided with your package.

**European Union Declaration of Conformity**

Lucent Technologies Business Communications Systems declares that XXX equipment specified in this document conforms to the referenced European Union (EU) Directives and Harmonized Standards listed below:

EMC Directive 89/336/EEC

Low Voltage Directive 73/23/EEC



The "CE" mark affixed to the equipment means that it conforms to the above Directives.

**Heritage Statement**

Lucent Technologies—formed as a result of AT&T's planned restructuring—designs, builds, and delivers a wide range of public and private networks, communication systems and software, consumer and business telephone systems, and microelectronics components. The world-renowned Bell Laboratories is the research and development arm for the company.

**Comments**

To comment on this document, return the comment card at the front of the document.

**Acknowledgment**

This document was developed by Lucent Technologies Global Learning Solutions Organization.



# CentreVu® Supervisor Version 8 Reports

## Table of Contents

---

<b>Preface</b>	<b>P-1</b>
Conventions used	P-1
Report examples	P-2

---

<b>1 Introduction</b>	<b>1-1</b>
Overview	1-1
About CentreVu CMS and Supervisor	1-1
Interactions with switch features	1-5
How CentreVu CMS tracks ACD data	1-5
<b>Things to Know About the System</b>	<b>1-6</b>
Overview	1-6
Organization	1-6
Terminology	1-7
Terms	1-7
Prerequisite System Administration	1-9
Dictionary	1-9
Call Center Administration	1-9
User Permissions	1-9
System Setup	1-9
Relationships to Other Subsystems	1-10
Timetable	1-10
CMS	1-10
Dictionary	1-10
Exceptions	1-10
Scripting	1-10
User Permissions	1-11
<b>Things to Know About CentreVu Supervisor Reports</b>	<b>1-12</b>
Overview	1-12
Organization	1-12
Agent and Trunk States	1-13

Agent states	1-13
Trunk states	1-15
Refresh Rate for Real-Time and Integrated Reports	1-16
Fastest allowable refresh rate	1-16
Default refresh rate	1-16
Shortest refresh rate	1-16
Historical Data in Integrated Reports	1-16

---

## **2 Using CentreVu Supervisor Reports** **2-1**

Overview	2-1
How to access reports	2-1
How this chapter is organized	2-1

### **Selecting and Running Reports** **2-2**

Overview	2-2
Report Designer	2-2
Using the Scripting feature	2-3
CentreVu Supervisor Controller toolbar	2-3
Report Selector	2-3
Report output window	2-3
Script buttons	2-3
Selecting a Report	2-4
Running a Report	2-6
Types of input	2-6
Selecting Report Run Dates	2-8
Selecting Dates	2-8
Browse Date	2-8
Browse Dates	2-9
Browse Month	2-9
Browse Months	2-10
Selecting Report Run Times	2-11
Selecting times	2-11
Browse Time	2-11
Exiting and Restarting Reports	2-12
How to exit a report	2-12
How to restart a report	2-12

### **Report Menu Bar** **2-13**

Overview	2-13
Report	2-14
Report menu	2-14
Menu item functions	2-15

Save as HTML	2-17
Browsers	2-17
Selecting Save as HTML location	2-17
Output files	2-19
Templates	2-19
Not using templates	2-19
Using existing templates	2-20
Save as HTML template tags	2-20
Fonts	2-20
Print Preview	2-21
Access Print Preview	2-21
Print Preview dialog box	2-21
Print Preview fields	2-22
Edit	2-24
Edit menu	2-24
Menu item functions	2-24
Format	2-26
Format menu	2-26
Menu item functions	2-26
Tools	2-27
Tools menu	2-27
Menu item functions	2-27
Options	2-28
Options menu	2-28
Menu item functions	2-28
<b>Editing and Viewing Reports</b>	<b>2-29</b>
Overview	2-29
Organization	2-29
Report Layouts	2-30
Report types	2-30
What constitutes a report?	2-30
Tables	2-30
Charts	2-31
Formatting Table Reports	2-32
Accessing the Table Format Options window	2-32
General tab	2-32
General tab parameters	2-33
Sort tab	2-33
Using the Sort tab	2-34
Formatting Chart Reports	2-35
Accessing the Chart Format Options window	2-35
General tab	2-36
General tab input fields	2-36

3D Effects tab	2-37
3D Effects tab input fields	2-38
Axis tab	2-39
Axis tab input fields	2-39
Type tab	2-40
Type tab input fields	2-40
Title tab	2-41
Title tab input fields	2-41
Legend tab	2-42
Legend tab input fields	2-42
Data Labels tab	2-43
Data Labels tab input fields	2-43
Minimizing Report Output Windows	2-45
Icons associated with minimized report windows	2-45
Icons associated with minimized report thresholds	2-46
Right mouse button pop-up menus	2-47
Menus displayed	2-47
Rotating a 3D chart	2-49
Exporting Report Data	2-50
Defaults	2-50
Report format	2-50
Copying Chart Reports	2-53
Resizing Report Windows and Columns	2-54
Resizing a window	2-54
Standard Supervisor report window	2-54
Graphical report window	2-54
Changing a column width	2-54
Selecting a Printer	2-55
Print setup options	2-55
Setting Up a Page	2-57
Page setup options	2-57
Setting Report Threshold Highlights	2-59
Reports	2-59
Entities	2-59
Turn highlights on and off	2-59
Example	2-59
Set Report Threshold Highlights	2-60
Before you start	2-60
Tips for Setting Report Threshold Highlights	2-63
Tips for setting report threshold highlights	2-63
Available Agent Threshold Settings	2-65
Agent threshold settings	2-65
Available Split/Skill Threshold Settings	2-68
Split/skill threshold settings	2-68



Available VDN Threshold Settings	2-71
VDN threshold settings	2-71
Report Options	2-73
Functions	2-73
Options General Tab	2-74
Options general tab	2-74
Options Report Colors Tab	2-76
Options report colors tab	2-76
Options Threshold Colors Tab	2-78
Options threshold colors tab	2-78
Options Name Format Tab	2-79
Options name format tab	2-79
Create a New Report Color Scheme	2-81
Procedure	2-81
Create a New Threshold Color Scheme	2-84
Procedure	2-84
Create a New Name Format	2-87
Procedure	2-87

---

### **3 Real-Time Reports 3-1**

Overview	3-1
Introduction	3-1
Organization of Real-Time Reports	3-1
Presentation	3-2
Diagram of Real-Time reporting system	3-2

#### **Agent reports 3-4**

Overview	3-4
Organization	3-4
General Information About Agent Reports	3-5
What an Agent report contains	3-5
Organization of Agent reports	3-5
Agent report selector window	3-5
Agent Report Input Windows	3-6
Agent report input fields	3-6
Agent Group Report	3-7
Things to know about this report	3-7
Agent Group report example	3-7
Agent Group report input fields	3-7
Agent Group report description	3-8
Agent Report	3-10

Things to know about this report	3-10
Agent report example	3-10
Agent report input fields	3-10
Agent report description	3-11
Agent Information Report	3-13
Things to know about this report	3-13
Agent Information report example	3-14
Agent Information report description	3-14
Graphical Information Report	3-17
Things to know about this report	3-17
Graphical Information report example	3-18
Graphical Information report description	3-18
<b>Other Reports</b>	<b>3-22</b>
Overview	3-22
Organization of this section	3-22
General Information About Other Reports	3-23
What Other reports contain	3-23
Organization of Other reports	3-23
Other report selector window	3-23
Event Count Summary Report	3-24
Things to know about this report	3-24
Relationships to other subsystems	3-24
Event Count Summary input window	3-24
Event Count Summary input fields	3-25
Event Count Summary report example	3-25
Event Count Summary report description	3-26
Multi-ACD Report	3-27
Things to know about this report	3-27
Multi-ACD report input window	3-28
Multi-ACD report Input Fields	3-29
Multi-ACD report example	3-30
Multi-ACD report description	3-30
Multi-ACD Top Agent Report	3-35
Things to know about this report	3-35
Multi-ACD Top Agent report input window	3-36
Multi-ACD Top Agent report Input Fields	3-36
Multi-ACD Top Agent report example	3-37
Multi-ACD Top Agent report description	3-38
<b>Queue/Agent Reports</b>	<b>3-41</b>
Overview	3-41
Organization of this section	3-41
General Information About Queue/Agent Reports	3-42

What Queue/Agent reports contain	3-42
Organization of Queue/Agent reports	3-42
Queue/Agent Report Selector Window and Input Fields	3-43
Queue/Agent report selector window	3-43
Queue/Agent report input fields	3-44
Queue/Top Agent Status Report	3-45
Things to know about this report	3-45
Queue/Top Agent Status report example	3-45
Queue/Top Agent Status report description	3-46
Queue/Agent Status Report	3-50
Things to know about this report	3-50
Queue/Agent Status report example	3-50
Queue/Agent Status report description	3-51
Queue/Agent Summary Report	3-55
Things to know about this report	3-55
Queue/Agent Summary report example	3-55
Queue/Agent Summary report description	3-56
<b>Split/Skill Reports</b>	<b>3-58</b>
Overview	3-58
Organization of this section	3-58
General Information About Split/Skill Reports	3-59
Organization of split/skill reports	3-59
Split/Skill Report Selector Window and Input Fields	3-60
Split/Skill report selector window	3-60
Split/skill report input fields	3-60
Split/Skill Call Profile Report	3-62
Things to know about this report	3-62
Split/Skill Call Profile report example	3-62
Split/Skill Call Profile report description	3-63
Real-Time Graphical Active Agents Report	3-65
Things to know about this report	3-65
Graphical Active Agents report example	3-66
Graphical Active Agents report description	3-66
Real-Time Graphical Allocated Agents Report	3-69
Things to know about this report	3-69
Graphical Allocated Agents report example	3-70
Graphical Allocated Agents report description	3-71
Split/Skill Graphical AUX Agents Report	3-73
Things to know about this report	3-73
Report formats	3-73
Split/Skill Graphical AUX Agents report example	3-74
Split/Skill Graphical AUX Agents report description	3-74
Split/Skill Graphical AUX Top Agents Report	3-76

Things to know about this report	3-76
Split/Skill Graphical AUX Top Agents report example	3-77
Split/Skill Graphical AUX Top Agents report description	3-77
Split/Skill Graphical Call Profile Report	3-79
Things to know about this report	3-79
Split/Skill Graphical Call Profile report example	3-80
Split/Skill Graphical Call Profile report description	3-80
Split/Skill Graphical EWT Report	3-83
Things to know about this report	3-83
Split/Skill Graphical EWT report example	3-84
Split/Skill Graphical EWT report description	3-84
Split/Skill Graphical Queue Report	3-86
Things to know about this report	3-86
Split/Skill Graphical Queue report example	3-87
Split/Skill Graphical Queue report description	3-87
Split/Skill Graphical Skill Overload Report	3-89
Things to know about this report	3-89
Split/Skill Graphical Skill Overload report example	3-90
Split/Skill Graphical Skill Overload report description	3-90
Split/Skill Graphical Staffing Profile Report	3-91
Things to know about this report	3-91
Split/Skill Graphical Staffing Profile report example	3-92
Split/Skill Graphical Staffing Profile report description	3-92
Split/Skill Graphical Status Report	3-95
Things to know about this report	3-95
Split/Skill Graphical Status report example	3-96
Split/Skill Graphical Status report description	3-96
Split/Skill Graphical Top Skill Status Report	3-99
Things to know about this report	3-99
Split/Skill Graphical Top Skill Status report example	3-100
Split/Skill Graphical Top Skill Status report description	3-101
Reserve1 AUX Agents Report	3-104
Things to know about this report	3-104
Reserve1 AUX Agents report example	3-105
Reserve1 AUX Agents report description	3-105
Reserve2 AUX Agents Report	3-108
Things to know about this report	3-108
Reserve2 AUX Agents report example	3-109
Reserve2 AUX Agents report description	3-109
Skill AUX Report	3-112
Things to know about this report	3-112
Skill AUX report example	3-112
Skill AUX report description	3-113
Skill Status Report	3-114

Things to know about this reports	3-114
Skill Status report example	3-116
Skill Status report description	3-116
Skill Top Agent Report	3-120
Things to know about this report	3-120
Skill Top Agent report example	3-120
Skill Top Agent report description	3-121
Split Status Report	3-125
Things to know about this report	3-125
Split Status report example	3-127
Split Status report description	3-127
Split/Skill Report	3-130
Things to know about this report	3-130
Split/Skill report example	3-131
Split/Skill report description	3-131
Split/Skill by Location Report	3-134
Things to know about this report	3-134
Split/Skill by Location report example	3-134
Split/Skill by Location report description	3-135
Split/Skill Top Agent Status Report	3-136
Things to know about this report	3-136
Split/Skill Top Agent Status report example	3-136
Split/Skill Top Agent Status report description	3-137
Split/Skill Agent Status by Location Report	3-140
Things to know about this report	3-140
Split/Skill Agent Status by Location report example	3-141
Split/Skill Agent Status by Location report description	3-141
<b>Trunk Group Report</b>	<b>3-144</b>
Overview	3-144
Organization of this section	3-144
Trunk Group Report Selector Window and Input Fields	3-145
Trunk Group report selector window	3-145
Trunk Group report input fields	3-145
Trunk Group Report	3-146
Things to know about this report	3-146
Trunk Group report example	3-146
Trunk Group report description	3-146
<b>VDN Reports</b>	<b>3-148</b>
Overview	3-148
Organization of this section	3-148
General Information About VDN Reports	3-149
Organization of VDN reports	3-149

VDN Report Selector Window and Input Fields	3-150
VDN report selector window	3-150
VDN report input fields	3-150
VDN Call Profile Report	3-152
Things to know about this report	3-152
Prerequisite System Administration	3-152
VDN Call Profile report example	3-153
VDN Call Profile report description	3-153
VDN Graphical Call Profile Report	3-156
Things to know about this report	3-156
VDN Graphical Call Profile report example	3-157
VDN Graphical Call Profile report description	3-157
VDN Skill Preference Report	3-159
Things to know about this report	3-159
VDN Skill Preference report example	3-159
VDN Skill Preference report description	3-160
VDN Report	3-161
Things to know about this report	3-161
VDN report example	3-161
VDN report description	3-162
<b>Vector Report</b>	<b>3-164</b>
Overview	3-164
Organization of this section	3-164
Vector Selector Window and Input Fields	3-165
Vector report selector window	3-165
Vector report input fields	3-165
Vector Report	3-166
Things to know about this report	3-166
Vector report example	3-166
Vector report description	3-166
<b>Drill-Down Reports</b>	<b>3-168</b>
Overview	3-168
Organization of this section	3-168
General Information About Drill-Down Reports	3-169
Drill-down report access	3-169
Location ID as a report field	3-169
Finding drill-down information	3-169
Drill-Down report types	3-169
Modifying drill-down reports	3-169
Drill-Down Top Agent Work State Report	3-170
Accessing the report	3-170
Report contents	3-170

Report use	3-170
Database items	3-170
Drill-down Top Agent Work State report example	3-171
Drill-down Top Agent Work State report description	3-172
<b>Drill-Down Work State Report</b>	<b>3-174</b>
Accessing the report	3-174
Report contents	3-174
Report Use	3-174
Database Items	3-174
Drill-down Work State report example	3-175
Drill-down Work State report description	3-176

---

## **4 Historical Reports 4-1**

Overview	4-1
Introduction	4-1
Organization of Historical Reports	4-1
Presentation	4-1
Diagram of historical reporting system	4-2
Presentation of report information	4-3
How long does CMS store data?	4-3

### **Agent Reports 4-4**

Overview	4-4
Organization	4-4
General Information About Agent Reports	4-5
What an Agent report contains	4-5
Organization of Agent reports	4-5
Agent Report selector window	4-6
Agent Report Input Fields	4-7
Agent report input fields	4-7
Agent AUX Report	4-9
Things to know about this report	4-9
Agent AUX report example	4-9
Agent AUX report description	4-10
Agent Attendance Report	4-11
Things to know about this report	4-11
Agent Attendance report example	4-11
Agent Attendance report description	4-12
Agent Event Count Report	4-14
Things to know about this report	4-14
Agent Event Count report example	4-14
Agent Event Count report description	4-15
Agent Graphical Time Spent Daily Report	4-16

Things to know about this report	4-16
Agent Graphical Time Spent Daily report example	4-17
Agent Graphical Time Spent Daily report description	4-17
Agent Group Attendance Report	4-20
Things to know about this report	4-20
Agent Group Attendance report example	4-20
Agent Group Attendance report description	4-21
Agent Group AUX Report	4-23
Things to know about this report	4-23
Agent Group AUX report example	4-23
Agent Group AUX report description	4-24
Agent Group Summary Report	4-25
Things to know about this report	4-25
Agent Group Summary report example	4-25
Agent Group Summary report description	4-26
Agent Inbound/Outbound Report	4-29
Things to know about this report	4-29
Agent Inbound/Outbound report example	4-29
Agent Inbound/Outbound report description	4-30
Agent Login/Logout (Skill) Report	4-33
Things to know about this report	4-33
Agent Login/Logout (Skill) report example	4-34
Agent Login/Logout (Skill) report description	4-34
Agent Login/Logout (Split) Report	4-35
Things to know about this report	4-35
Agent Login/Logout (Split) report example	4-35
Agent Login/Logout (Split) report description	4-36
Agent Split/Skill Report	4-37
Things to know about this report	4-37
Agent Split/Skill report example	4-37
Agent Split/Skill report description	4-38
Agent Summary Report	4-40
Things to know about this report	4-40
Agent Summary report example	4-40
Agent Summary report description	4-40
Agent Trace by Location Report	4-44
Things to know about this report	4-44
Agent Trace by Location report example	4-44
Agent Trace by Location report description	4-44
<b>Other Reports</b>	<b>4-47</b>
Overview	4-47
Organization	4-47
General Information About Other Reports	4-48



What an Other Report contains	4-48
Organization of Other reports	4-48
Other report selector window	4-48
Call Records Report	4-49
Things to know about this report	4-49
Call Records report input fields	4-50
Call Records report example	4-50
Call Records report description	4-51
Call Work Code Report	4-54
Things to know about this report	4-54
Prerequisite system administration	4-54
Call Work Code report input fields	4-55
Call Work Code report example	4-55
Call Work Code report description	4-56
<b>Split/Skill Reports</b>	<b>4-57</b>
Overview	4-57
Organization	4-57
General Information About Split/Skill Reports	4-58
What a Split/Skill Report contains	4-58
Organization of Split/Skill reports	4-58
Split/Skill report selector window	4-58
Split/Skill Report Input Fields	4-59
Split/Skill report input fields	4-59
Split/Skill Call Profile Report	4-61
Things to know about this report	4-61
Split/Skill Call Profile report example	4-61
Split/Skill Call Profile report description	4-62
Split/Skill Graphical ASA Report	4-64
Things to know about this report	4-64
Split/Skill Graphical ASA report example	4-65
Split/Skill Graphical ASA report description	4-65
Split/Skill Graphical Average Positions Staffed Report	4-66
Things to know about this report	4-66
Split/Skill Graphical Average Positions Staffed report example	4-67
Split/Skill Graphical Average Positions Staffed report description	4-67
Split/Skill Graphical ASA Daily Report	4-68
Things to know about this report	4-68
Split/Skill Graphical ASA Daily report example	4-69
Split/Skill Graphical ASA report description	4-69
Split/Skill Graphical Call Profile Report	4-70
Things to know about this report	4-70
Split/Skill Graphical Call Profile report example	4-71
Split/Skill Graphical Call Profile report description	4-71

Split/Skill Graphical Multi-ACD Service Level Report	4-73
Things to know about this report	4-73
Split/Skill Graphical Multi-ACD Service Level report input window	4-73
Split/Skill Graphical Multi-ACD Service Level report input fields	4-74
Split/Skill Graphical Multi-ACD Service Level report example	4-75
Split/Skill Graphical Multi-ACD Service Level report description	4-75
Split/Skill Graphical Service Level Report	4-76
Things to know about this report	4-76
Split/Skill Graphical Service Level report example	4-76
Split/Skill Graphical Service Level report description	4-77
Split/Skill Graphical Skill Overload Report	4-78
Things to know about this report	4-78
Split/Skill Graphical Skill Overload report example	4-78
Split/Skill Graphical Skill Overload report description	4-79
Split/Skill Graphical Time Spent Report	4-80
Things to know about this report	4-80
Split/Skill Graphical Time Spent report example	4-81
Split/Skill Graphical Skill Time Spent report description	4-81
Split/Skill Outbound Report	4-83
Things to know about this report	4-83
Split/Skill Outbound report example	4-83
Split/Skill Outbound Report Description	4-84
Split/Skill Report	4-86
Things to know about this report	4-86
Split/Skill report example	4-86
Split/Skill report description	4-87
Split/Skill by Location Report	4-90
Things to know about this report	4-90
Split/Skill by Location report example	4-90
Split/Skill report description	4-91
Split/Skill Summary Report	4-95
Things to know about this report	4-95
Split/Skill Summary report example	4-96
Split/Skill Summary report description	4-96
<b>System Reports</b>	<b>4-101</b>
Overview	4-101
Organization	4-101
General Information About System Reports	4-102
What a System report contains	4-102
Organization of System reports	4-102
System Report selector window	4-102
System Graphical Maximum Delay Report	4-103
Things to know about this report	4-103

Graphical Maximum Delay report input window	4-103
System report input fields	4-104
System Graphical Maximum Delay report example	4-105
System Graphical Maximum Delay report description	4-105
System Multi-ACD by Split/Skill Report	4-107
Things to know about this report	4-107
Multi-ACD by Split/Skill report input window	4-108
Multi-ACD by Split/Skill report input fields	4-109
System Multi-ACD by Split/Skill report example	4-110
System Multi-ACD by Split/Skill report description	4-110
System Multi-ACD Report	4-113
Things to know about this report	4-113
Multi-ACD report input window	4-113
Multi-ACD report input fields	4-114
System Multi-ACD report example	4-115
System Multi-ACD report description	4-115
System Report	4-118
Things to know about this report	4-118
System report input window	4-118
System report input fields	4-119
System report example	4-120
System report description	4-120
<b>Trunk/Trunk Group Reports</b>	<b>4-124</b>
Overview	4-124
Organization	4-124
General Information About Trunk/Trunk Group Reports	4-125
What a Trunk/Trunk Group report contains	4-125
Organization of Trunk/Trunk Group reports	4-125
Trunk/Trunk Group report selector window	4-125
Trunk/Trunk Group Report Input Fields	4-126
Trunk Group report input fields	4-126
Trunk/Trunk Group Busy Hour Report	4-128
Things to know about this report	4-128
Trunk/Trunk Group Busy Hour report example	4-129
Trunk/Trunk Group Busy Hour report description	4-129
Trunk Report	4-131
Things to know about this report	4-131
Trunk report example	4-132
Trunk report description	4-132
Trunk Group Report	4-134
Things to know about this report	4-134
Trunk Group report example	4-135
Trunk Group report description	4-135

Trunk Group Summary Report	4-137
Things to know about this report	4-137
Trunk Group Summary report example	4-138
Trunk Group Summary report description	4-138
<b>VDN Reports</b>	<b>4-141</b>
Overview	4-141
Organization	4-141
General Information About VDN Reports	4-142
What a VDN Report contains	4-142
Organization of VDN reports	4-142
VDN report selector window	4-143
VDN Report Input Fields	4-144
VDN report input fields	4-144
VDN Busy Hour Report	4-145
Things to know about this report	4-145
VDN Busy Hour report example	4-145
VDN Busy Hour report description	4-146
VDN Call Profile Report	4-147
Things to know about this report	4-147
Prerequisite system administration	4-147
VDN Call Profile report example	4-148
VDN Call Profile report description	4-148
VDN Graphical Busy/Abandon/Disconnect Comparison Report	4-151
Things to know about this report	4-151
VDN Graphical Busy/Abandon/Disconnect Comparison report example	4-152
VDN Graphical Call Profile report description	4-153
VDN Graphical Call Profile Report	4-154
Things to know about this report	4-154
VDN Graphical Call Profile report example	4-155
VDN Graphical Call Profile report description	4-155
VDN Graphical Service Level Report	4-158
Things to know about this report	4-158
VDN Graphical Service Level report example	4-159
VDN Graphical Service Level report description	4-159
VDN Multi-ACD Flow Report	4-161
Things to know about this report	4-161
VDN Multi-ACD Flow report example	4-161
VDN Multi-ACD Flow report description	4-162
VDN Report	4-164
Things to know about this report	4-164
VDN Report example	4-164
VDN Report description	4-165

VDN Skill Preference Report	4-168
Things to know about this report	4-168
VDN Skill Preference report example	4-168
VDN Skill Preference report description	4-169

## **Vector Report** **4-172**

Overview	4-172
Organization	4-172
General Information About the Vector Report	4-173
Organization of the Vector Report	4-173
Vector Report selector window	4-173
Vector Report Input Fields	4-174
Vector report input fields	4-174
Vector Report	4-175
Things to know about this report	4-175
Vector report example	4-175
Vector report description	4-176

## **5 Integrated Reports** **5-1**

Overview	5-1
Introduction	5-1
Definition of integrated reports	5-1
How this chapter is organized	5-1
Diagram of integrated reporting system	5-1
Presentation of report information	5-1
Presentation of report information	5-2
Historical Data in Integrated Reports	5-2

## **Agent Reports** **5-3**

Overview	5-3
Organization of this section	5-3
General Information About Agent Reports	5-4
Organization of Agent reports	5-4
Agent Report Selector Window and Input Fields	5-5
Agent report selector window	5-5
Agent report input fields	5-6
Agent Graphical Information Report	5-7
Things to know about this report	5-7
DEFINITY ECS R5 and later information	5-8
Agent Graphical Information report example	5-8
Agent Graphical Information report description	5-8
Agent Information Report	5-13

Things to know about this report	5-13
Agent Information report example	5-14
Agent Information report description	5-14

## **Split/Skill Reports** **5-17**

Overview	5-17
General Information About Split/Skill Reports	5-18
Organization of this section	5-18
Organization of Split/Skill reports	5-18
Split/Skill Reports Selector Window and Input Fields	5-19
Split/Skill reports selector window	5-19
Split/Skill report input fields	5-19
Split/Skill Comparison Report	5-21
Things to know about this report	5-21
Split/Skill Comparison report example	5-21
Split/Skill Comparison report description	5-22
Graphical Skill Overload Report	5-24
Things to know about this report	5-24
Graphical Skill Overload report example	5-24
Graphical Skill Overload report description	5-25
Graphical Split/Skill View Report	5-26
Things to know about this report	5-26
Graphical Split/Skill View report example	5-26
Graphical Split/Skill View report description	5-27

## **VDN Report** **5-30**

Overview	5-30
Organization of this section	5-30
General Information About the VDN Report	5-31
VDN Report selector window	5-31
VDN Report input fields	5-32
VDN Graphical Call Handling Report	5-33
Things to know about this report	5-33
VDN Graphical Call Handling report example	5-34
VDN Graphical Call Handling report description	5-34

---

## **Appendix A:Database Items and Calculations** **A-1**

Overview	A-1
----------	-----

---

**GL**   **Glossary**

**GL-1**

---

**IN**   **Index**

**IN-1**





# Preface

**Purpose**

This book describes the Call Center reports that are generated through the *CentreVu*® Supervisor software.

The book includes:

- A description of each *CentreVu*® Supervisor report
- An example of each *CentreVu*® Supervisor report
- Definitions of all report fields
- Tips for customizing specific *CentreVu*® Supervisor reports.

**Reason for reissue**

This document is being reissued to comply with *CentreVu*® Call Management System (CMS) Release 3 Version 8 (R3V8) and *CentreVu*® Supervisor Release 8 (R8).

**Safety labels**

The following icon signifies a caution, warning, or danger condition.

**Intended-Audience**

The *CentreVu*® Supervisor Version 8 Reports (585-210-929) document is written for users who analyze the available reports and use them to efficiently run their call centers.

**How to use this document**

The following list describes the contents of each chapter and appendix in this document:

- Chapter 1, Introduction
- Chapter 2, Using *CentreVu*® Supervisor reports
- Chapter 3, Real-time reports: show snapshots of call center activity throughout the day
- Chapter 4, Historical reports: compile call center information in 15-, 30-, or 60-minute intervals. The interval information is then converted into daily, weekly, and monthly summary data.
- Chapter 5, Integrated reports: compile call center information from a specified start time in the past 24 hours up to and including the current interval.
- Appendix A, Database items and calculations

**Conventions used**

The following conventions are used throughout this document:

- A Book Title is italicized.
- An **Informix table name** is in monospaced type.
- A “Chapter Name” is always surrounded by quotes.

- A *File name* is in monospaced type.
- A Subsystem Reference is always in initial capital letters.
- A Window Title is always in initial capital letters.

**Related documentation** The following documents can help you use the CentreVu® CMS software to its maximum capability. Those most closely related to this document are the Administration and Report Designer documents.

- *CentreVu® Call Management System Release 3 Version 8 Administration (585-210-910)*
- *CentreVu® Advocate User Guide (585-210-927)*
- *CentreVu® CMS R3V5 Custom Reports (585-215-822, Issue 2)*
- *CentreVu® CMS R3V8 External Call History Interface (585-210-912)*
- *CentreVu® CMS R3V8 Upgrades and Migrations (585-210-913)*
- *CentreVu® CMS R3V6 Sun Microsystems, Inc. Sun® Sun Microsystems, Inc. Enterprise® Computers Hardware Installation and Setup (585-215-873, Issue 2)*
- *CentreVu® CMS R3V6 Sun Enterprise Computers Connectivity Diagram (585-215-877, Issue 2)*
- *CentreVu® Supervisor Version 8 Installation and Getting Started (585-210-928)*
- *Lucent Call Center Change Description (585-210-925)*
- *CentreVu® CMS R3V8 Database Items and Calculations (585-210-939)*
- *CentreVu® Report Designer Version 8 User Guide (585-210-930)*
- *CentreVu® CMS R3V8 Documentation CD-ROM (585-210-926)*

**Report examples** The report examples included in this document were taken from test lab machines and are not intended to emulate real data. Report data will vary dependent on your individual site.



# 1 Introduction

## Overview

---

**Purpose** This chapter is written for any *CentreVu* Supervisor Release 8 user who accesses the Real-Time, Historical, and Integrated reports subsystems. It outlines how reporting works and the reports that are available.

### About CentreVu CMS and Supervisor

Call Center reports are generated through the *CentreVu* Supervisor software. The *CentreVu* Supervisor software monitors the operations of and collects data from the switch. This data is then organized into reports that help you manage Call Center facilities and personnel. These reports may be displayed in real time, printed immediately, stored in a file, or scheduled for printing at a later time.

The data tracked includes caller identification, service parameters, internal call transfers, outgoing calls, and agent sales. Real-time reports can be updated as often as every three seconds and summarized as often as every 15 minutes. Historical reports are available in intervals of 15, 30, or 60 minutes; daily; weekly; and monthly summaries. Integrated reports include data for a specified start time in the past 24 hours up to and including the moment the report is generated.

One *CentreVu* CMS can manage up to 10,000 agent/split/skill or agent/skill pairs in up to eight switches Automatic Call Directories (ACDs) at different locations. This permits you to add agents in new locations while maintaining centralized supervision to control costs.

You can use *CentreVu* reports to do the following:

- Determine how many agents are needed
- Manage call volume fluctuations
- Configure the software to make changes automatically and to meet unexpected demands
- Change agent skill assignments
- Move agents between skills and/or initiate agent audit trails.
- Change Vector Directory Numbers (VDNs) to vector associations.

“[About CentreVu CMS and Supervisor \(1-1\)](#)” lists the CentreVu Supervisor reports that are available. The remaining chapters of this document give you an overview and an example of each report. The reports you see depend on your switch type, permissions, and system performance.

Table 1-1 CentreVu Reports

Report Name	Real-Time	Historical	Integrated
Agent Attendance		•	
Agent AUX		•	
Agent Event Count		•	
Agent Graphical Information			•
Agent Graphical Time Spent		•	
Agent Group Attendance		•	
Agent Group AUX		•	
Agent Group Summary		•	
Agent Group Report	•		
Agent Inbound/Outbound		•	
Agent Information			•
Agent Login/Logout (Skill)		•	
Agent Login/Logout (Split)		•	
Agent Split/Skill		•	
Agent Status by Location	•		
Agent Summary		•	
Agent Report	•		
Agent Trace by Location		•	
Busy Hour by Trunk Group		•	
Busy Hour by VDN		•	
Call Record		•	
Call Work Code		•	
Event Count Summary	•		
Graphical Active Agents	•		
Graphical Allocated Agents	•		
Graphical AUX Reserve1 Agents	•		
Graphical AUX Reserve2 Agents	•		
Graphical Average Positions Staffed		•	

Report Name	Real-Time	Historical	Integrated
Graphical Busy/Abandon/ Disconnect		•	
Graphical Maximum Delay		•	
Graphical Multi-ACD Service Level Daily		•	
Graphical Queue	•		
Graphical Split/Skill Call Profile	•		
Graphical Staffing Profile	•		
Graphical VDN Call Profile	•		
VDN Call Handling			•
Graphical Skill Overload			•
Graphical Split/Skill View			•
Multi-ACD	•	•	
Multi-ACD by Split/Skill		•	
Multi-ACD Call Flow by VDN		•	
Multi-ACD Top Agent	•		
Outbound Split/Skill		•	
Queue/Agent Status	•		
Queue/Top Agent Status	•		
Queue/Agent Summary	•		
Reserve1 AUX Agents	•		
Reserve2 AUX Agents		•	
Skill AUX Report	•		
Skill Status	•		
Skill Top Agent Report	•		
Split Status	•		
Split/Skill Report	•	•	
Split/Skill Average Speed of Answer		•	
Split/Skill by Location	•		
Split/Skill Call Profile	•	•	
Split/Skill Comparison			•

Report Name	Real-Time	Historical	Integrated
Split/Skill Graphical AUX Agents	•		
Split/Skill Graphical AUX Top Agents	•		
Split/Skill Graphical Call Profile	•	•	
Split/Skill Graphical EWT	•		
Split/Skill Graphical Service Level		•	
Split/Skill Graphical Status	•		
Split/Skill Graphical Time Spent		•	
Split/Skill Graphical Top Skill Status	•		
Split/Skill Outbound		•	
Split/Skill Queue	•		
Split/Skill Service Level		•	
Split/Skill Status		•	
Split/Skill Summary		•	
System		•	
System Multi-ACD		•	
System Multi-ACD by Split/Skill		•	
Top Agent Status	•		
Trunk		•	
Trunk Group	•	•	
Graphical Split/Skill	•		
Trunk Group Summary		•	
VDN Multi-ACD Flow		•	
VDN Report	•	•	
VDN Call Profile	•	•	
VDN Service Level		•	
VDN Skill Preference	•	•	
Vector	•	•	
Work State Report for Reserve1 Agents	•		
Work State Report for Reserve2 Agents	•		

---

**Interactions with switch features** See the *CentreVu® Call Management System R3V8 Database Items and Calculations (585-210-939)* document or the *CentreVu Call Management System R3V8 Administration (585-210-910)* document for the interactions with switch features.

**How CentreVu CMS tracks ACD data** Using the data in the real-time and historical databases, *CentreVu CMS* can generate standard reports which allow you to track your call center's activities. *CentreVu CMS* tracks the various agent, split/skill, trunk, trunk group, vector, and VDN activities at different points in the call process. See Chapter 1 in the *CentreVu Call Management System R3V8 Administration (585-210-910)* document for more information.



---

# Things to Know About the System

## Overview

---

**Purpose** This section introduces concepts and requirements that are relevant to reports.

**Organization** This section contains the following information:

- Terminology
- Prerequisite system administration
- Relationship to other subsystems





# Terminology

---

**Overview** The following terms are used throughout this book. For additional *CentreVu* CMS terms, see the Glossary.

**Terms** **Current Interval** The current intrahour interval which can be 15, 30, or 60 minutes. The current interval is part of the real-time database.

**Custom Reports** See the *CentreVu* CMS R3V5 Custom Reports document, Lucent Technologies (585-215-822), Issue 2, for more information.

**Designer Reports** Real-time or historical reports that have been customized from existing reports or designed according to your needs from Report Wizard or Report Designer. See the *CentreVu* Version 8 Report Designer (585-210-930) document for more information.

**Daily Data** Interval data that have been converted to a 1-day summary.

**Exception Reports** Display occurrences of unusual call-handling events.

**Historical Database** Contains intrahour records for up to 62 days in the past, daily records for up to 5 years in the past, and weekly or monthly records for up to 10 years for each *CentreVu* CMS-measured agent, split/skill, trunk, trunk group, vector, and Vector Directory Number (VDN).

**Historical Reports** Display past Automatic Call Distribution (ACD) data for various agent, split/skill, trunk, trunk group, vector, or VDN activities.

**Integrated Reports** Compile call center information from a specified start time in the past 24 hours up to and including the current interval.

**Monthly Data** Daily data that have been converted to a monthly summary.

**Multiuser Mode** Any administered *CentreVu* CMS user can log into CentreVu CMS. Data continues to be collected if data collection is “on.”

**Previous Interval** One intrahour interval. At the end of each intrahour interval, the contents of the current intrahour interval are copied to the previous intrahour interval portion of the real-time database.

**Real-Time Database** Current and previous intrahour data on each *CentreVu* CMS-measured agent, split/skill, trunk, trunk group, vector, and VDN.

**Real-Time Reports** Display current ACD call activity on agents, splits/skills, trunks, trunk groups, vectors, and VDNs.

**Single-User Mode** Only one person can log into CentreVu CMS. Data continues to be collected if data collection is “on.” This mode is required to change some *CentreVu* CMS administration.

**Subsystem** Each *CentreVu* Supervisor Controller selection. For example, Reports is referred to as a subsystem.

**Weekly Data** Daily data that has been converted to a weekly summary.



---

# Prerequisite System Administration

---

**Overview** The following system administration must be performed before you can fully use the real-time and historical reports subsystem.

**Dictionary** If you want names to appear on split/skill, trunk group, agent group, ACD, call work code, VDN, and vector reports, the names must first be entered in the Dictionary subsystem. If names are not assigned in the Dictionary subsystem, numbers appear as the default.

**Call Center Administration** To get Split/Skill Call Profile or VDN Call Profile reports, you must first define your acceptable service level and service level increments for the split(s)/skill(s) and VDN(s) in the Split/Skill Call Profile Setup and VDN Call Profile Setup window in the Call Center Administration subsystem.

To get an Agent Trace report, you must first start collecting agent trace data.

See the “Call Center Administration” chapter of the *CentreVu® CMS R3V8 Administration* (585-210-910) document for more information on setting call profiles and activating agent traces.

**User Permissions** For a report to display data, you must have read permission for the split/skill, trunk group, ACD, vector, or VDN. For example, if you have read permission for Splits 1, 2, and 4, and try to run a report on Splits 1, 4, and 5, you receive data for Splits 1 and 4 but not for Split 5, because you do not have read permission for that split.

For more information, see the “User Permissions” chapter of the *CentreVu® CMS R3V8 Administration* (585-210-910) document.

**System Setup** You need to specify how much of the data to save for later use by historical reports.

For more information, see the “System Setup” chapter of the *CentreVu® CMS R3V8 Administration* (585-210-910) document.



---

## Relationships to Other Subsystems

---

- Overview** Real-Time reports have the following relationships to other *CentreVu* CMS subsystems.
- Timetable** You cannot put a real-time report on a timetable. You can use shortcuts to display real-time reports. Scripting is used in R3V8 Supervisor. You must use the CMS terminal to use Timetable.  
See Appendix D, “Timetable,” in the *CentreVu® CMS R3V8 Administration* (585-210-910) document.
- CMS** If you cancel a report in *CentreVu* Supervisor, the data requests for the report do not cancel in CMS. Therefore, the report continues to run on the CMS side, even though it is canceled in *CentreVu* Supervisor. Until the data requests clear, *CentreVu* Supervisor and CMS may slow down as a result.
- Dictionary** For split/skill, VDN, vector, and ACD names to appear on reports, names must be defined and entered in the Dictionary subsystem.  
See Chapter 6, “Dictionary,” in the *CentreVu® CMS R3V8 Administration* (585-210-910) document.
- Exceptions** When an exception occurs, *CentreVu* CMS notifies you in three ways:
- The terminal beeps unless you have disabled the beep through the Supervisor Controller.
  - You can see information about exception conditions by looking at appropriate Real-Time reports.
  - The Commands: Exceptions menu item in *CentreVu* Supervisor allows you to view a running count of exceptions for Real-Time, Agents, Splits/Skills, VDNs, Vectors, and Trunk Groups. To be notified of these exceptions, you must have exception permission turned on for the specific split/skill, trunk group, ACD, VDN, and vector. Exception permissions are assigned through the *CentreVu* Supervisor Tools: User Permissions menu item.
  - The exception is entered in the real-time exceptions log.
- For more information, see the “Exceptions” and “User Permissions” chapters of the *CentreVu® CMS R3V8 Administration* (585-210-910) document.
- Scripting** The Scripting feature lets you create a script to run a specified report or run a report and export the data on schedule. The scripts require a customer-provided scheduler to be run at a later time.  
For more information on the Scripting feature, see Chapter 3, “Scripting,” in the *CentreVu® CMS R3V8 Administration* (585-210-910) document.

---

**User Permissions** The default real-time and integrated reports refresh rate is determined by your CMS System Administrator. The administrator then assigns each user a minimum refresh rate through the *CentreVu* Supervisor User Permissions menu item. If you enter a refresh rate that is less than your administrator-assigned refresh rate, an error message displays. For more information, see the “User Permissions” chapter of the *CentreVu® CMS R3V8 Administration* (585-210-910) document.



# Things to Know About *CentreVu* Supervisor Reports

---

## Overview

---

**Purpose** This section describes things to know about all *CentreVu* Supervisor reports.

**Organization** This section contains the following topics:

- Agent and Trunk States
- Refresh Rate for Real-Time and Integrated Reports
- Current Interval
- Service Level Increments for Call Profile Reports
- Items That Can Affect Real-Time and Integrated Report Data



# Agent and Trunk States

---

**Overview** Status changes of all ACD data (for splits/skills, trunk groups, vectors, VDNs, agents, and trunks) are sent from the switch. As a result, the states of agent extensions and trunks are what all other data are based on. Agent states appear on real-time reports as *CentreVu* CMS records the current status of the ACD, and trunk states appear on the *CentreVu* CMS real-time trunk report. The following list of agent states includes the default agent states. The names can be changed in the Dictionary.

**Agent states** **ACD** The agent logged into this extension is on a split/skill or direct agent call. For Generic 2.1 switches (not supported with R3V5, R3V6, or R3V8 CMS), the agent state is also ACD when a call is waiting on hold.

**Available (AVAIL)** The extension is able to accept an ACD call. An extension is AVAIL in AUTO-IN (AI) or MANUAL-IN (MI) work modes any time a station does not have a call active or on hold.

**After Call Work (ACW)** The agent is engaged in bookkeeping, data entry, or other work related to the previous call, and is not available to receive another call. The extension enters ACW after an ACD call in the MANUAL-IN mode completes. On the Enterprise Communications Server (ECS), the agent can select the state with the ACW key. If the agent presses the ACW button while on an ACD call, then the agent goes into ACW mode when the call is released. This ACW time is tracked as call-associated ACW. If the agent presses the ACW button while the agent is not on an ACD call, then the agent will be placed into the ACW mode, but this ACW will not be tracked as call-associated ACW. An agent's time in ACW includes time an agent is on incoming or outgoing calls while in ACW, as well as time in ACW when the agent is not connected to any calls.

**Auxiliary Work (AUX)** The agent is engaged in non-ACD work, is on break, in a meeting, at lunch, and so on. The agent presses the AUX WORK key when the agent wants *CentreVu* CMS to recognize the extension as staffed, but does not want the ACD to distribute calls to the voice terminal. An agent's time in AUX includes time an agent is on incoming or outgoing calls while in AUX, as well as time in AUX when the agent is not connected to any calls. Agents also accrue AUX time when they make or receive extension calls from AUTO-IN or MANUAL-IN mode. Reason codes describe the reasons you are in the AUX work mode (for example, you are on break).

**Direct Agent ACD (DACD)** The agent is on a direct agent ACD call.

**Direct Agent ACW (DACW)** The agent is in the after call work state for a direct agent ACD call.

**OTHER** The agent is doing other work. This may represent that an agent is in multiple splits or with multiple skills and is doing work for a split or skill other than this one, or that the agent has put a call on hold, or that the agent is dialing to place a call or activate a feature.

**UNKNOWN** *CentreVu* CMS does not recognize the current state. UNKNOWN remains until the condition is cleared (corrected) and/or the agent completes the current ACD call and any associated ACW, or a current agent state message is sent to *CentreVu* CMS from the switch.

**UNSTAF Unstaffed** The agent is not logged in and is not being tracked by *CentreVu* CMS.

**RINGING** The time a call rings at an agent's voice terminal after leaving the queue and before the agent answers the call. With this state, you can actually determine how long a call rings before an agent answers, and thereby determine the actual time a caller waits in queue and waits while the call is ringing to better analyze your call center's performance.



- 
- Trunk states**
- IDLE** The trunk is waiting for a call.
  - CONN** The caller and agent are connected on a call.
  - QUEUED** An ACD call has seized a trunk and is queued to a split or skill waiting for an agent to answer.
  - SEIZED** A call is using the trunk, either incoming or outgoing.
  - MBUSY** The trunk is maintenance busy, or out of service for maintenance purposes.
  - HOLD** The agent has put the caller on this trunk on hold.
  - UNKNOWN** *CentreVu* CMS does not recognize the state of the trunk.
  - DABN** The caller abandoned the call. The trunk quickly goes to idle.
  - FBUSY** Forced busy. The caller receives forced busy signal if you have an ECS or Generic 2 switch with Call Vectoring. For the ECS, you can receive busy calls if there is no call in queue for the split and no agents are available.
  - FDISC** The caller receives a forced disconnect. This appears only if you have the Vectoring feature.
  - RINGING** A call is ringing at the agent's voice terminal.



---

# Refresh Rate for Real-Time and Integrated Reports

---

**Overview** When you order a real-time or integrated report, you must specify a refresh rate for the report. This rate determines how often the report is updated to display new data.

**Fastest allowable refresh rate** Your fastest allowable refresh rate is defined in the User Permissions—User Data window as minimum refresh rate; see “User Permissions” in the *CentreVu® CMS R3V8 Administration* (585-210-910) document. For any user, the fastest rate that may be defined is every 3 seconds. However, the actual speed at which a report refreshes may be slower than the defined speed, since the number of active terminals, the number of active windows, and the number of real-time reports can have an impact on refresh rates.

**Default refresh rate** The default refresh rate when you bring up the report input window is your minimum refresh rate (defined by the CMS System Administrator) plus 15 seconds. You can change the refresh rate from the default at any time, with the minimum allowable refresh rate being three seconds. The minimum default refresh rate when a report is run as a script is user-defined.

**Shortest refresh rate** If you want to calculate the shortest refresh rates you can get in *CentreVu* CMS real-time reports for your configuration, go to the cmsadm Menu. The Real-Time Refresh program calculates the best (shortest) refresh rates you can get in *CentreVu* CMS reports.

**Historical Data in Integrated Reports** Once the historical CMS database is queried for an integrated report, the historical data in the report will not refresh unless you request the report again. The real-time data will continue to refresh at the end of each interval. Therefore, to see new historical data on an integrated report, you must request the report again to update the data.



# 2 Using *CentreVu* Supervisor Reports

## Overview

---

**Purpose** This chapter gives you general information about how to use *CentreVu* Supervisor reports. *CentreVu* Supervisor reports display, report, and summarize the performance of any measured subset of the Automatic Call Directory (ACD), including agents, splits/skills, trunks/trunk groups, Vector Directory Numbers (VDNs), and vectors.

**How to access reports** No matter where you run a report from, the way you select, run, edit, and view a report is the same.

You will find reports available under the following menus and tabs:

- Commands | Reports | Real-Time, Historical, or Integrated tab
- Commands | Dictionary | Reports tab
- Commands | Exceptions | Reports tab
- Commands | Agent Administration | Reports tab
- Commands | Call Center Administration | Reports tab
- Tools | Maintenance | Reports tab.

### More information

Procedures that apply to reports that are located in a specific Command or Tool are located in the appropriate chapter in the *CentreVu® CMS R3V8 Administration* (585-210-910) guide.

**How this chapter is organized** The chapter is divided into the following sections:

- Selecting and running reports
- Report menu bar
- Editing and viewing reports



---

# Selecting and Running Reports

## Overview

---

**Purpose** This section describes how to select and run reports through *CentreVu* Supervisor.

**Report Designer** If you have Report Designer and want to easily generate a new customized report, select the Report Wizard button in the Controller toolbar.

**More information**

For more information about the Report Designer, see the *CentreVu Report Designer Version 8 User Guide* (585-210-930).



## Using the Scripting feature

---

**Overview** The Scripting feature lets you create a script to run a specified report or run a report and export the data on schedule. The report can run in the current *CentreVu* Supervisor session and be displayed on the PC, or it can run in the background.

### More information

For more information on the Scripting feature, see Chapter 3, “Scripting,” in the *CentreVu® CMS R3V8 Administration* (585-210-910) document.

**CentreVu Supervisor Controller toolbar** The *CentreVu* Supervisor Controller toolbar lets you set options for scripting and organizing your scripts, as follows:

- **Options/Scripting** — selecting the Scripting tab in the Options window lets you set script execution as minimum, normal, or maximum. This window also lets you specify a name for the log file and view the contents of the log file.
- **Scripts/Organize Scripts** — selecting the Organize Scripts option from the Scripts drop-down menu displays the Organize Scripts window. This window displays all the logged-in user's scripts and script folders. Using these lists, you can add a new folder, move a script, delete a script, or rename a script.

**Report Selector** The Report Selector window lets you create a new script, as follows:  
Save as Script button—selecting this button in the Report Selector window displays the Save as Script dialog box, which enables you to create a new script for the selected report, but does not run the report. The script type is set to interactive and cannot be changed.

**Report output window** The Report Output Window menu bar lets you create a new script, as follows:

Report/Script—selecting the Script option from the Report drop-down menu displays the Save as Script window (only in run mode), which enables you to create a new script for the selected report and run the report. The script can be interactive or automatic.

**Script buttons** The Script button on the Data Export window displays the Save as Script dialog box, which lets you create a script, export the data from the report, and then exit the report.

The Script button on the Save as HTML window displays the Save as Script dialog box, which lets you create a new script for the selected report, run the report, and save it in HTML format. The report will exit after the save is complete.



## Selecting a Report

---

**Displaying the Report selector window** To display the Report Selector window, do the following:

- 1 In the Controller toolbar, select Commands to display the Commands drop-down menu.



- 2 Select one of the following windows:
  - Commands | Reports | Real-Time, Historical, or Integrated tab
  - Commands | Dictionary | Reports tab
  - Commands | Exceptions | Reports tab
  - Commands | Agent Administration | Reports tab
  - Commands | Call Center Administration | Reports tab
  - Tools | Maintenance | Reports tab.

END OF STEPS

---

**Result:**

A window displays from which you can select a report.

**Making selections** In the Select a Report window, do the following:

- 1 Select a category from the Category box.
- 2 Select a report from the Report box.

.....

**3** Select the ACD for which you want to run the report from the Run Report for ACD box.

.....

**4** Select OK , or double-click on the report you want to run.

**Result:** A report input window displays.

.....

**5** Go to Completing the Report Input Window.

.....

END OF STEPS



## Running a Report

---

**Types of input** The following example shows possible types of input that might be required to run a report. The inputs required will vary, depending on which report you are running.

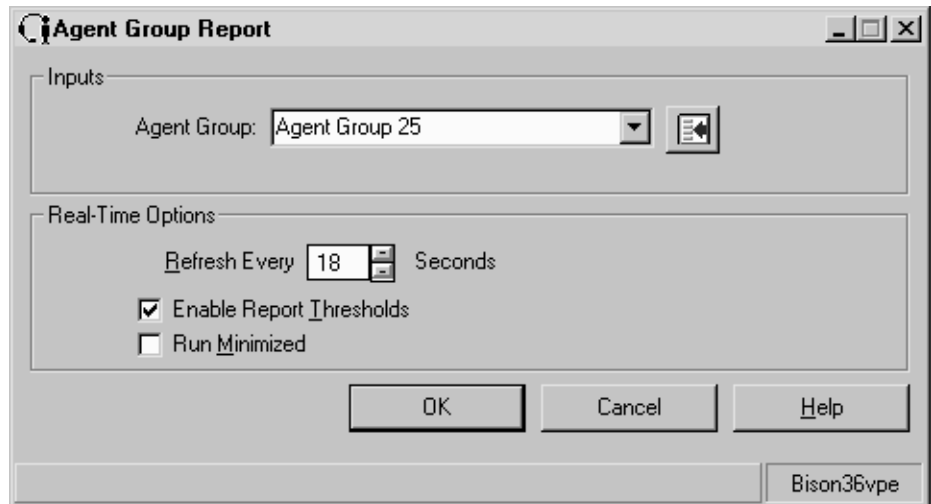

**Completing the report input window** Follow these steps in completing an input window:

- 1 Verify that the correct ACD is selected. The current ACD (selected on the selector window) is displayed at the bottom-right of the input window.

If the wrong ACD is displayed, press the Cancel button and then return to [Displaying the Report selector window \(2-4\)](#) to begin the report selection procedure again to select the correct ACD.

- 2 Fill in the input fields. For the Split/Skill Outbound Interval report input window, the input fields are: Split/Skill, Date, and Times.

To fill in an input field, do any of the following:

- Type in the name or number of the input requested
- Use the history list (pull-down menu)
- Press the Browse button to the right of the input field. This button will allow you to view all of the available inputs.



- 
- 3 For all reports other than Commands | Reports Real-Time and Integrated tabs, select the report destination. Reports can be viewed on screen or printed on any printer to which your PC is connected.

To select the report destination, do one of the following:

- Select the View Report on Screen destination.
- Select the Print Report on: destination and choose a printer (if you want to print on a printer other than the one displayed).

- 
- 4 Press the OK button.

**Result:** The report runs.

---

END OF STEPS



## Selecting Report Run Dates

**Selecting Dates** When you run historical reports, you need to select the date or dates for which to run the report.

To do this, you can do any of the following:

- Type the date or date range in the Date(s): input field.
- Type a relative date (for example, -2 for two days ago).
- Select the date(s) from the history list of previously used date(s) for this report.
- Select the Browse button. .

**Browse Date** If you press the Browse button and the input needed is a single date, the Browse Date window displays.

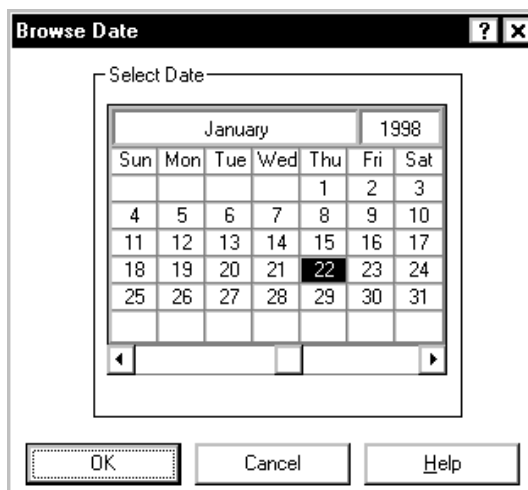

To select a specific date, use your mouse to point at a day and click. The day is highlighted.

If you want to choose a date that is not in the current month, use the arrow keys at the bottom of the window to scroll through the months.

**Browse Dates** If the input needed is for more than one date, the Browse Dates window displays.

The screenshot shows the 'Browse Dates' dialog box. It has a title bar with a question mark and a close button. The main area is titled 'Select Dates' and contains a 'Range' button and a 'Clear' button. Below these is a calendar grid for the months of January, February, and March 1998. The calendar grid shows days of the week (Sun, Mon, Tue, Wed, Thu, Fri, Sat) and dates. The date 22 is highlighted in the calendar. At the bottom of the dialog are 'OK', 'Cancel', and 'Help' buttons.

To select specific dates, use your mouse to point at a day and click. The day highlights. You can select as many days as you want.

To select a range of dates, select the Range button, point- and-click on the first day of the desired range, then point- and-click on the last day of the desired range. The dates selected highlight. You can select as many ranges as you want to, but you must select the Range button in order to define each range.

If you want to choose a date that is not currently displayed, use the arrow keys at the bottom of the window to scroll through the months.

To clear your current selections, select Clear.

**Browse Month** If the input needed is for one month, the Browse Month window displays.

The screenshot shows the 'Browse Month' dialog box. It has a title bar with a close button. The main area is titled 'Select Month' and contains a 'Month:' dropdown menu showing 'July' and a 'Year:' spinner control showing '1996'. At the bottom of the dialog are 'OK', 'Cancel', and 'Help' buttons.

This window is used in monthly reports where the data is for a single month. The form is initialized to the values in the input field or to the month previous to the current month when the input field is empty. Select a single month and year for the report. The minimum date is January 1980 and the maximum date is December 2037.

**Browse Months** If the input needed is for more than one month, the Browse Months window displays.

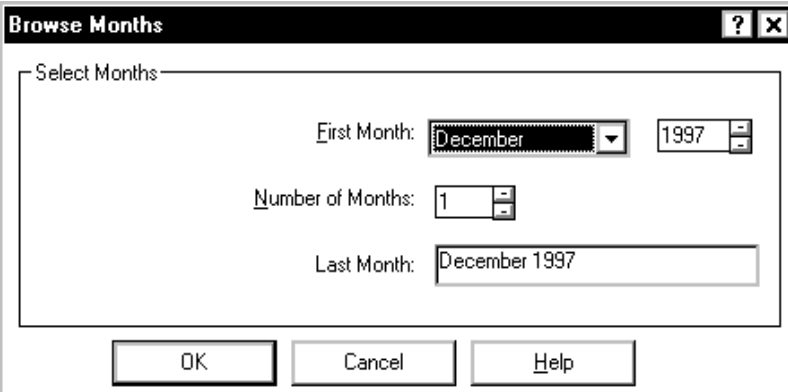

The screenshot shows a dialog box titled "Browse Months". It contains a "Select Months" section with the following fields:

- First Month:** A dropdown menu currently showing "December" and a year spinner set to "1997".
- Number of Months:** A spinner box set to "1".
- Last Month:** A text box containing "December 1997".

At the bottom of the dialog are three buttons: "OK", "Cancel", and "Help".

This window is available in monthly reports where the data is for one or more months. The report runs, beginning with the month entered in the First Month: field and going through as many months as are specified in the Number of Months: field.

The months are in calendar order in the drop-down box, with the minimum date being January 1980 and the maximum date December 2037.



## Selecting Report Run Times

---

**Selecting times** When you run interval historical reports, you need to select the time period for which to run the report.

To do this, do any of the following:

- Type the time range in the Times: input field.
- Select the times from the history list of previously used times for this report.
- Select the Browse button next to the Times input field.

**Browse Time** If you select the Browse button, the Browse Time window displays.

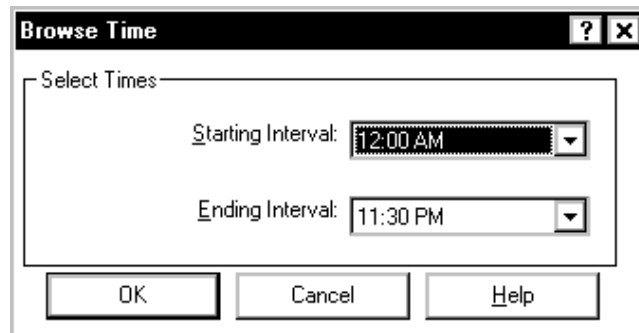

Complete the following fields:

- **Starting Interval:** select the time you want the report to begin with from the drop-down list. The report data will begin with the interval that begins immediately after the time you enter.
- **Ending Interval:** select the time you want the report to end with from the drop-down list. The report data will go through the interval during which the time you enter falls.



---

## Exiting and Restarting Reports

---

**How to exit a report** To exit a report (return to the Controller), do one of the following:

- Double click the System button.
- Select Close from the System button menu.
- Select Exit from the Report menu.

If the system shuts down due to an error, any changes you have made to the report(s) you are running are saved.

**How to restart a report** To restart a report (return to the report input window), do the following:

- Select Restart from the Report menu.

Work State drill-down reports and unsaved reports created in Report Wizard cannot be restarted.



---

# Report Menu Bar

## Overview

---

**Purpose** When you run a report, the menu bar at the top of the window has the following options:

- Report
- Edit
- Format
- Tools
- Options
- Help

This section describes the menu items that are available in each of these menus.



---

# Report

---

**Report menu** The Report menu has options that relate specifically to the report you are running.

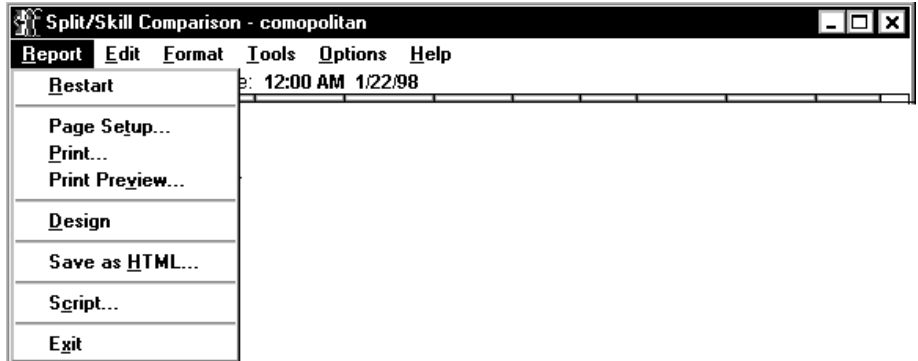



**Menu item functions** This table describes the action that each menu item performs:

Menu Item	Action
Restart	Closes the current report output window and displays the input window for the current report. This allows you to run the same report, changing inputs as needed. This is disabled for Drill-Down reports and if the report is an unsaved report created using the Report Wizard (this item is reenabled when the report is saved).
Page Setup	Displays the Page Setup window. See the <a href="#">Setting Up a Page (2-57)</a> in this chapter for more information on Page Setup.
Print	Displays the Print window. See <a href="#">Selecting a Printer (2-55)</a> for more information on the Print window. When you select Print from the Report menu, the report that is active will be printed according to the options you choose in the Print window. If the report is a real-time report, only one refresh of the report will be printed.
Print Preview	Displays the report so that you can see it before printing. See <a href="#">Print Preview (2-21)</a> for more information on the Print Preview window. Once you have selected Print Preview, you may print the report.
Design	If you have purchased the Report Designer software and your <i>CentreVu</i> CMS User ID is authorized to use the Report Designer, you can access the Report Designer Design Mode window from any report using this menu item. When you select Design from the Report menu, the report that is currently running remains visible, but you are placed in the Design Mode, where you can edit the report. For more information on the Design Mode, see the <i>CentreVu Report Designer Version 8 User Guide</i> (585-210-930). The Design menu item will be grayed out if you are currently running a drill-down report.
Save	Saves the report that you edited.
Save as	Saves the report you edited under a different file name.

Menu Item	Action
Save as HTML	Displays the Save as HTML window, which lets you save a snapshot of the report output as an HTML file. Selecting the Script button in this window displays the Save as Script dialog box, which lets you create a script to run the specified report and save the output as an HTML file.
Script	Displays the Save as Script dialog box, which enables you to create a script to run a specified report on schedule and display it on your computer. The script can be interactive or automatic.
Exit	Closes the active report output window. The location of the report output window is saved when the report is exited, and that is where the report will display the next time you run it.



---

## Save as HTML

---

**Overview** The Save as Hypertext Markup Language (HTML) function available with *CentreVu* Supervisor Version 8 allows the user to export a snapshot of a report running in *CentreVu* Supervisor and save it as an HTML file. Any report generated in *CentreVu* Supervisor can be converted to an HTML file. This file can then be stored on a web server for viewing on the Internet or an Intranet.

Things to note:

- Save as HTML does not automatically save the HTML file onto a web server. You must copy the HTML file and any associated graphics to the Internet server you want to use.
- Save as HTML does not automatically update the HTML for real-time reports.
- Save as HTML is found in the report pull-down menu on an open report.
- Save as HTML does not support 32-bit color mode for graphics saved using Save as HTML.

**Browsers** To view the HTML file, your Internet browser must support tables and .gif graphic files. For example, *Netscape* Navigator 3.0 or *Microsoft*™ Internet Explorer 3.0, or later versions of either, support tables and .gif graphic files.

**Selecting Save as HTML location** Save as HTML function can be found in the Report pull-down menu.

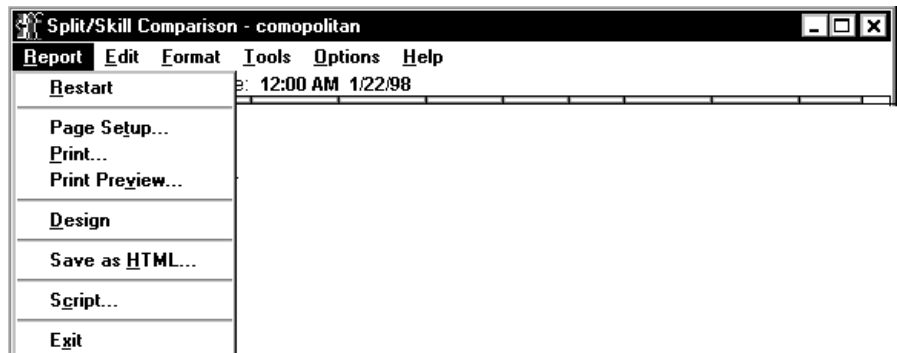

When you select Save as HTML, the Save as HTML dialog box displays.

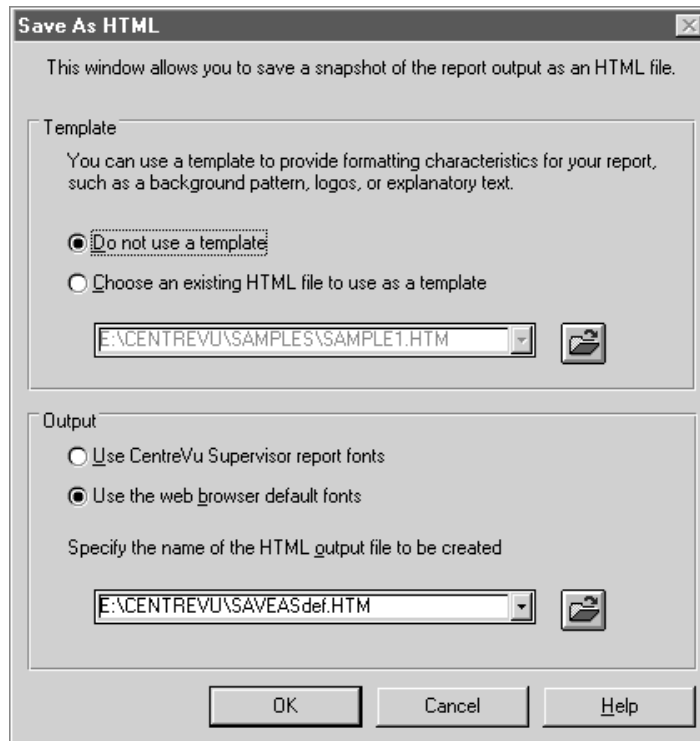

**Using Save as HTML** To save a report as an HTML file, use the following steps:

- 1 While running the report you want to save, select Save as HTML from the Report menu.
- 2 Select a template option.
  - Type the template file name in the template field, select the template from the pull-down history list, or select the Browse button and browse for a template.
  - If you do not want to use a template, select the Do not use a template radio button.
- 3 Select an output option.
  - Selecting Use *CentreVu* Supervisor report fonts preserves the report fonts as you see them in *CentreVu* Supervisor.
  - Selecting Use the web browser default fonts displays the output file using Internet browser default fonts.

- 
- 4 Type the name of the output file in the file name field, select the file name from the pull-down history list, or select the Browse button and browse for a file name.
  - 5 Select the OK button to save the report in HTML file format.
- 

END OF STEPS

---

**Results:**

The report is now saved as an HTML file for viewing with an Internet browser.

The HTML file that has been generated can be modified to fit your specific need using an HTML or text editor.

**Output files** You must select a name for the HTML file you are creating. You must specify the full file path (for example, c:\temp\myrpt.htm) to save the file in a directory other than the current directory.

If there are charts associated with the file, they are converted into .gif files and numbered in the order created. For example, c:\temp\myrpt1.gif and c:\temp\myrpt2.gif.

The output file is created using the templates and fonts you have specified. After the HTML is saved, you can move or copy it and all associated graphics files to a web server directory for viewing on the Internet or an Intranet.

**Templates** A template can be used to provide company logos, background color, specific fonts, or surrounding text to the HTML file. If you do not select a template, the HTML file displays only the report.

Note the following:

- Templates are HTML files that can be created or edited using an HTML or text editor.
- The templates are limited by what your web browser supports.

**Not using templates** If you choose not to use existing templates, Save as HTML generates basic HTML tags in order for your report to be converted to HTML.

Note the following:

- The standard surround tags <HTML> and <BODY> are generated.
- The background color is set to white and font color is set to black.
- The title of the page is the same as the report title.

**Using existing templates** *CentreVu* Supervisor provides you with Sample templates which can be found in the samples directory of the *CentreVu* Supervisor directory where the executable files were installed. Use these installed templates when saving a report as an HTML file.

**Save as HTML template tags** The following describes the tags used by Save as HTML and which can be used to create templates:

HTML Tag	Description
<CVSUP_TITLE>	This tag is replaced with the title of report in the HTML file. If this tag is used within the <TITLE> tags, the title of the report will be used as a heading to the page. Multiple uses of this tag are allowed.
<CVSUP_BODY>	This tag is replaced by the report body in the HTML file. However, only the first occurrence of this tag is replaced. If a template is used and the <CVSUP_BODY> tag is not in the template, an error occurs, and the Save as HTML operation is aborted.

**Fonts** If you choose to use the *CentreVu* Supervisor fonts, the font face and size are preserved in the HTML file.

- The fonts used in *CentreVu* Supervisor are Arial, Courier New and Times New Roman.
- In the event these fonts are not available on the computer viewing the HTML file, backup fonts are used. The backup fonts are Helvetica for Arial, Courier for Courier New, and Times for Times New Roman.
- If you choose to use the web browser's default fonts, the HTML file will not specify any fonts.
- Note the following:
  - If you choose not to preserve the *CentreVu* Supervisor fonts, the appearance of the report in the HTML file may change.
  - If you choose to use a template, do not preserve the *CentreVu* Supervisor fonts if the template specifies the fonts.



# Print Preview

**Overview** Print Preview displays the printed layout of a report on screen so that printed components, such as page breaks and headers and footers, may be viewed prior to actual printing.

**Access Print Preview** Print Preview is accessed from the Report menu of the output window of all generated reports. Select Print Preview to open the Print Preview dialog box

**Print Preview dialog box** The print preview dialog box displays one physical page of the generated report at a time.

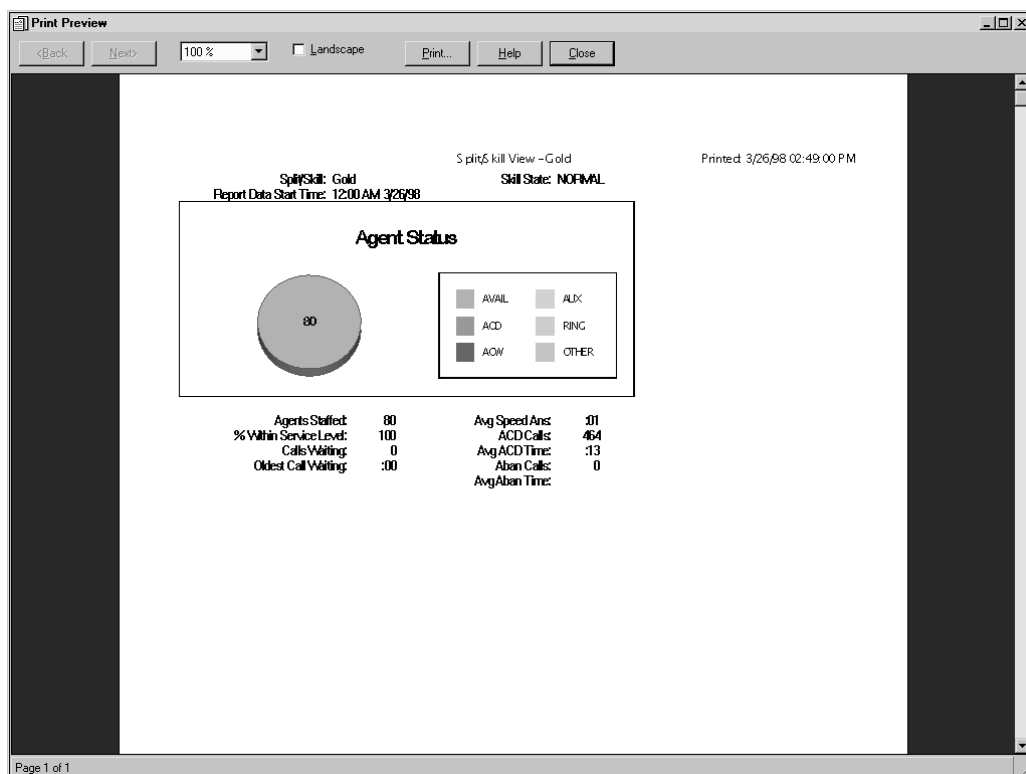

**Print Preview fields** The following table describes the fields and items on the Print Preview dialog box:

Field/Item	Description
Scroll bars	If the page does not fit within the Print Preview dialog box, scroll bars are available to view the entire page.
Status bar	A status bar at the bottom of the page lists which page of the report is being viewed; for example, "page 1 of 3."
Next button	If the generated report has more than one page in its final, printable version, the Next button moves you forward through the report a page at a time.
Back button	If the generated report has more than one page in its final, printable version, the Back button moves you backward through the report a page at a time.
Zoom In/Out	The Zoom In/Out drop-down list allows you to zoom in or out on a report in the Print Preview dialog box by a series of percentages in 25 percent increments. For example, you may view a report output in Print Preview at 100 percent, 125 percent, 150 percent, and so on. The default is based on screen size.
Landscape/Portrait	The Landscape check box allows you to view an output in either landscape mode (11" x 8.5") or in portrait mode (8.5" x 11") for printing purposes. The default is based on your default printer settings. To select Portrait mode, deselect the Landscape box.
Print	Select the Print button to display the Print Setup dialog box. The report that is active will be printed according to the options you choose on the Print Setup dialog box. You may choose the printer, the orientation, and the paper in this dialog box, or you can select Options to display printer-specific configuration information. If the report is a real-time report, only one refresh of the report will be printed.



Field/Item	Description
Help	Select Help (or press <b>F1</b> ) to display a standard <i>Windows</i> <sup>™</sup> Help page for the Print Preview dialog box.
Close	The Close button closes the Print Preview dialog box.



# Edit

**Edit menu** The Edit menu has standard *Windows* editing options.

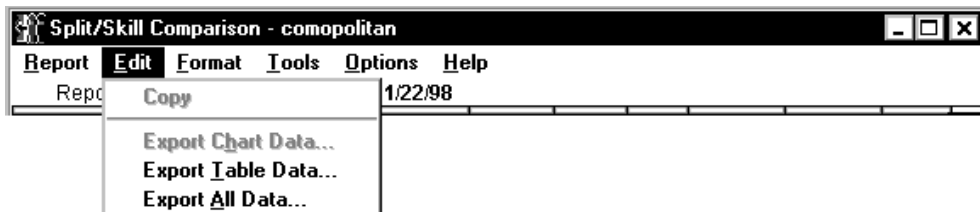

**Menu item functions** This table describes the action that each menu item performs.

Menu Item	Action
Copy	The image of the currently selected chart is copied to the clipboard in <i>Windows</i> metafile format. This allows you to paste the chart picture into most <i>Windows</i> applications, such as a word processor. You can also access Copy from the right mouse button pop-up menu. See <a href="#">Copying Chart Reports (2-53)</a> for instructions on using Copy.
Export Chart Data	The Data Export Options window is shown to allow you to export the data in the currently selected chart. If the report is a real-time report, only one refresh of the data will be exported. You can also access the Data Export Options window from the right mouse button pop-up menu. If there is more than one chart on this report, this option will be grayed out until you select a chart. For more information on exporting data, see the "Exporting Report Data" section in this chapter.
Export Table Data	The Data Export Options window is shown to allow you to export the table data. If the report is a real-time report, only one refresh of the data will be exported. You can also access the Data Export Options window from the right mouse button pop-up menu. If there is more than one table on the report, this option will be grayed out until you select a table. For more information on exporting data, see the "Exporting report Data" section in this chapter.

Menu Item	Action
Export All Data	The Data Export Options window is shown to allow you to export all data in the report. You will also be allowed to include labels and headers in the data that are exported. If the report is a real-time report, only one refresh of the data will be exported. You can also access the Data Export Options window from the right mouse button pop-up menu. For more information on exporting data, see the “Exporting Report Data” section in this chapter.



# Format

**Format menu** The Format menu contains actions for modifying the display format of the currently selected object. If one (or more) of the actions does not apply to the selected object, it will be grayed out.

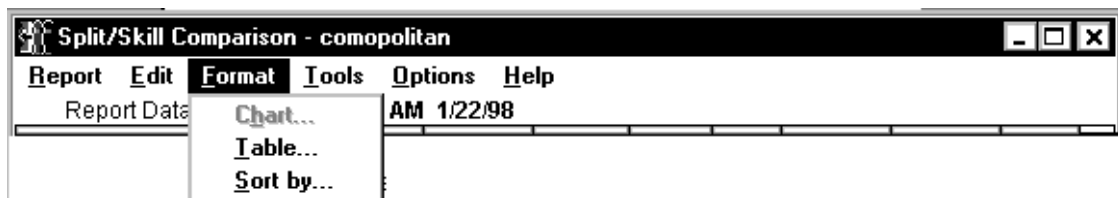

**Menu item functions** This table describes the action that each menu item performs.

Menu Item	Action
Chart	Allows you to format a chart. You can also access the Format Chart window from the right mouse button pop-up menu.
Table	Allows you to format a table. You can also access the Format Table window from the right mouse button pop-up menu.
Sort By	Allows you to sort the table by several parameters specific to the information in the selected table. You can also access the Sort by window from the right mouse button pop-up menu.



## Tools

**Tools menu** The Tools menu contains additional actions that affect the currently selected object. You can also access the Tools actions from the right mouse button.

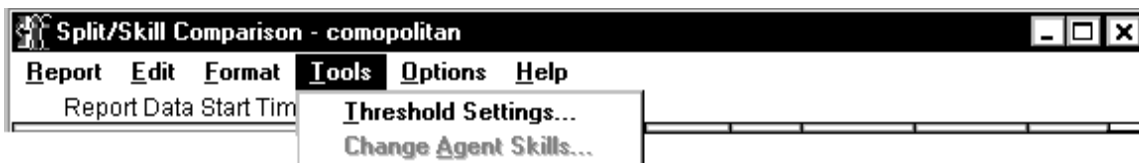

**Menu item functions** This table describes the action that each menu item performs.

Menu Item	Action
Available Drill-Down reports	If you are running a report that allows you to access one or more drill-down reports, the available drill-down reports will be accessible from the Tools menu.
Threshold settings	Opens a window that allows you to view or modify threshold highlight settings. Threshold highlight settings apply only to some real-time data items in real-time and integrated reports. For information on setting threshold highlights, see <a href="#">Setting Report Threshold Highlights (2-59)</a> .
Change Agent Splits/Skills	If the current ACD supports Expert Agent Selection (EAS), this menu item reads Change Agent Skills; otherwise, it reads Change Agent Splits. This menu item is enabled only when the selected table cell in a report is an agent name or agent login ID; otherwise, it is disabled. If you do not have write permission for Agent Administration, then this menu item is not shown. This action opens the Change Agent Skills window (EAS) or Change Agent Split Assignments window (non-EAS) for the selected agent. You can then modify the split/skill assignments for the agent. See the <i>CentreVu® CMS R3V8 Administration (585-210-910)</i> guide for more information.



# Options

**Options menu** The Options menu contains actions that affect the basic display of the report.



**Menu item functions** This table describes the action that each menu item performs.

Menu Item	Action
Thresholds	Turns threshold highlighting on or off for this real-time report. When threshold highlighting is on (there is a check by the menu item), the report shows the colors (icons if the report is minimized) specified in the Threshold Settings window. When threshold highlighting is off (there is no check by the menu item), the report shows none of the threshold highlights (or icons if the report is minimized).  See <a href="#">Setting Report Threshold Highlights (2-59)</a> for additional information on Threshold Highlights.
Status bar	Shows or hides the status bar. When the status bar is hidden, the window remains the same size but the contents are resized to fill the window. You would choose this to get a larger viewing area for the report. When the status bar is made visible, the window remains the same size but the contents are resized to fill the smaller window area. The status bar setting is saved in the report view.
Restore Original View	Restores the Report View to the original settings. All changes made to the format of this report are discarded.

---

# Editing and Viewing Reports

## Overview

---

**Purpose** This section describes the various formatting and display options for reports. It also includes some procedures for manipulating reports.

**Organization** The following topics are covered:

- Report layouts
- Formatting table reports
- Formatting chart reports
- Minimizing report output windows
- Right mouse-button pop-up menus
- Rotating a 3D chart
- Exporting report data
- Copying chart reports
- Resizing report windows
- Selecting a printer
- Setting Report Threshold Highlights
- Using Report Options



## Report Layouts

- Report types** There are two types of report layouts in *CentreVu* Supervisor:
- Tables — the *CentreVu* Supervisor presentation of standard reports.
  - Charts — the *CentreVu* Supervisor presentation of graphical reports.

**What constitutes a report?** A report can consist of only a table/tables, only a chart/charts, or a combination of tables and charts.

In addition to the tables and charts that make up the main body of reports, reports can include text and field names that are followed by single data items. Text and data fields are used on both table and chart reports.

**Tables** Most standard *CentreVu* Supervisor reports (reports that are not prefaced by "graphical") are displayed in tables.

The information on a standard report window is organized as follows:

Week	Split/Skill	ACD Calls	ACD Time	ACW Time	Extn In Calls	Extn In Time	Extn Out Calls	Extn Out Time	Assists	Held Calls	Hold Time	Trans Out
<b>Totals</b>		<b>1701334:43:18</b>		<b>:00:00</b>	<b>0</b>	<b>:00:00</b>	<b>0</b>	<b>:00:00</b>	<b>0</b>	<b>0</b>	<b>:00:00</b>	<b>0</b>
7/28/96	s53 ,+AbCd	0	:00:00	:00:00	0	:00:00	0	:00:00	0	0	:00:00	0
7/28/96	Skill 401	0	:00:00	:00:00	0	:00:00	0	:00:00	0	0	:00:00	0
7/28/96	Skill 402	0	:00:00	:00:00	0	:00:00	0	:00:00	0	0	:00:00	0
7/28/96	403	56	:06:52	:00:00	0	:00:00	0	:00:00	0	0	:00:00	0
7/28/96	tarts group 4	0	:00:07	:00:00	0	:00:00	0	:00:00	0	0	:00:00	0
7/28/96	Skill 405	0	:00:00	:00:00	0	:00:00	0	:00:00	0	0	:00:00	0
7/28/96	Skill 406	0	:00:00	:00:00	0	:00:00	0	:00:00	0	0	:00:00	0
7/28/96	Skill 407	0	:00:00	:00:00	0	:00:00	0	:00:00	0	0	:00:00	0
7/28/96	Skill 408	0	:00:00	:00:00	0	:00:00	0	:00:00	0	0	:00:00	0
7/28/96	Skill 409	0	:00:00	:00:00	0	:00:00	0	:00:00	0	0	:00:00	0
7/28/96	Skill 410	0	:00:00	:00:00	0	:00:00	0	:00:00	0	0	:00:00	0
7/28/96	Skill 411	0	:00:00	:00:00	0	:00:00	0	:00:00	0	0	:00:00	0
7/28/96	Skill 412	0	:00:00	:00:00	0	:00:00	0	:00:00	0	0	:00:00	0
7/28/96	Skill 413	1	:00:08	:00:00	0	:00:00	0	:00:00	0	0	:00:00	0
7/28/96	Skill 414	0	:00:00	:00:00	0	:00:00	0	:00:00	0	0	:00:00	0

### More information

Standard real-time reports can be sorted. See [Formatting Table Reports \(2-32\)](#).



**Charts** The graphical *CentreVu* Supervisor reports are displayed in charts.

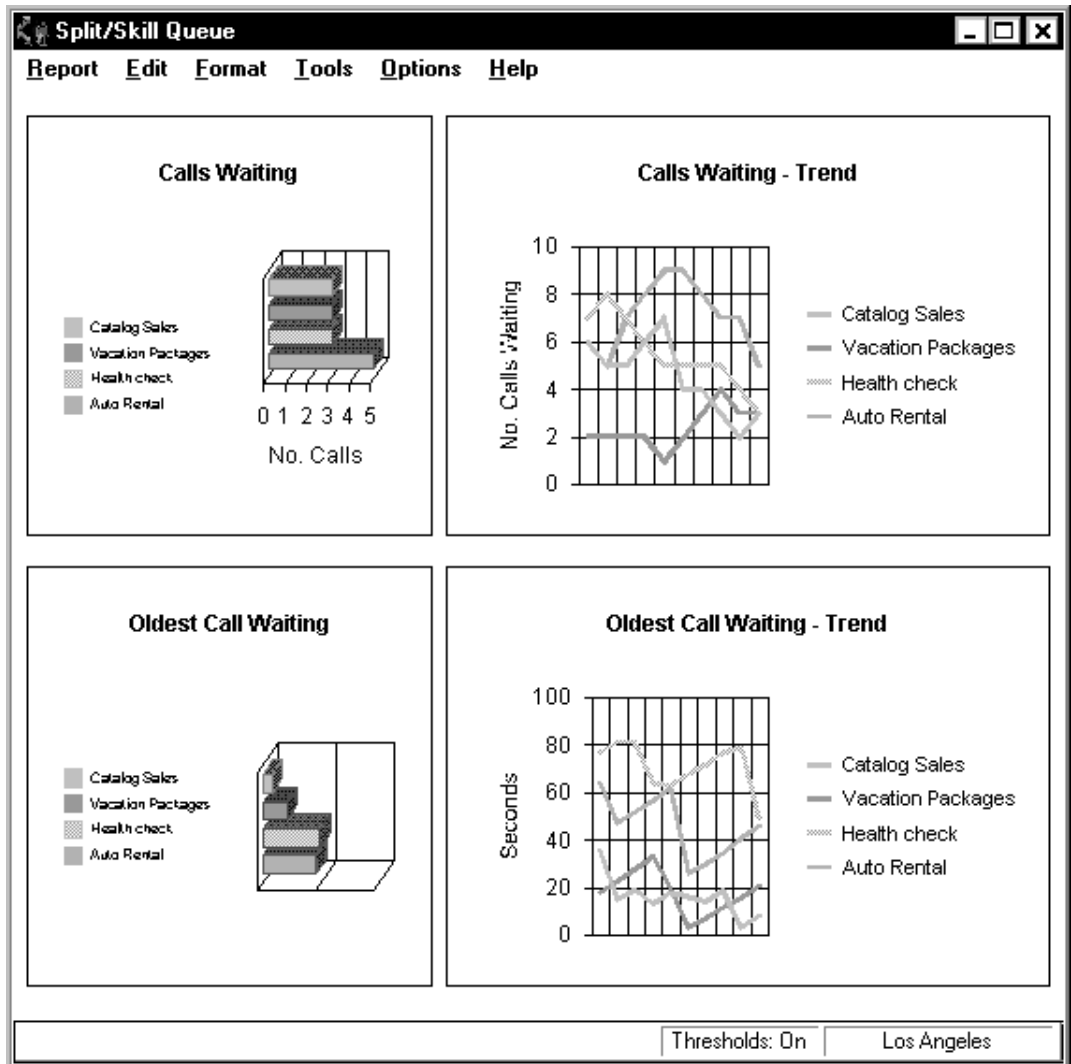

### More information

There are several options for formatting the appearance of the charts (graphical reports). See [Formatting Chart Reports \(2-35\)](#) for more information.



# Formatting Table Reports

**Overview** If you are in a report containing a table, you can format how the report is displayed using the Table Format Options window.

The changes you make to a report's format affect only your view of the report. The changes do not affect how other *CentreVu* Supervisor users see the report.

## Accessing the Table Format Options window

To access the Table Format Options window, use one of the following steps:

- Double click on a column heading in the report.
- Select Format Table or Sort by from the Format menu or the right mouse button pop-up menu.

If you select Sort by, the Table Format Options window displays with the Sort tab active. If you select Format Table, the Table Format Options window displays with the General tab active. Descriptions of these tabs follow.

The Table Format Options window allows you to make layout changes to a table. All changes you make are saved as part of the report view when the report exits.

**General tab** The General tab allows you to make format changes to a table.

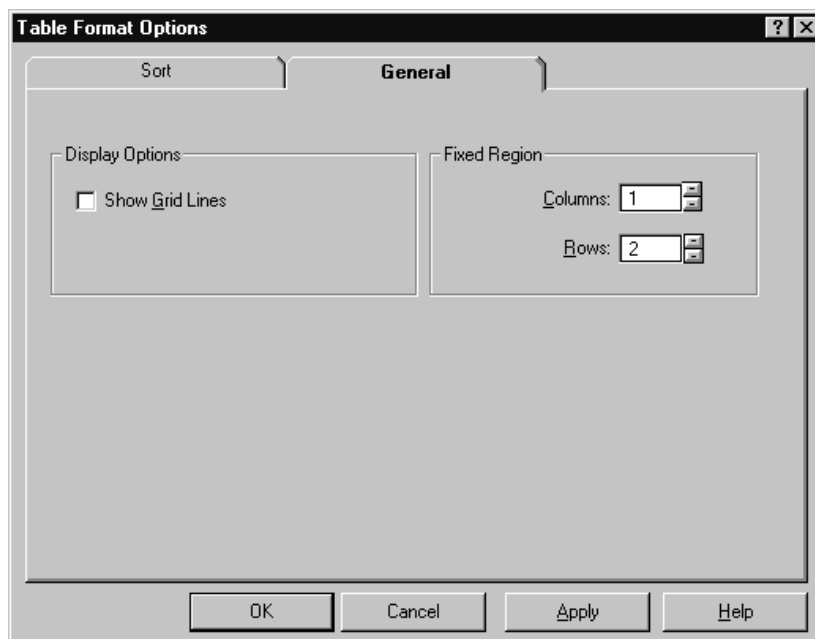

**General tab parameters** The following table parameters can be changed:

Parameter	Function
Show Gridlines	Specifies whether or not table lines are to be shown in the table.
Fixed Region, Columns	Specifies the number of columns from the left of the table that are fixed in place and do not scroll. Valid values are in the range of 0 through 99. You can use the spin boxes to select a valid value or type the value in.
Fixed Region, Rows	Specifies the number of rows from the top of the table that are fixed in place and do not scroll. Valid values are in the range of 0 through 99. You can use the spin boxes to select a valid value or type the value in.

**Sort tab** The Sort tab allows you to specify the order in which the information on the real-time table report is displayed.

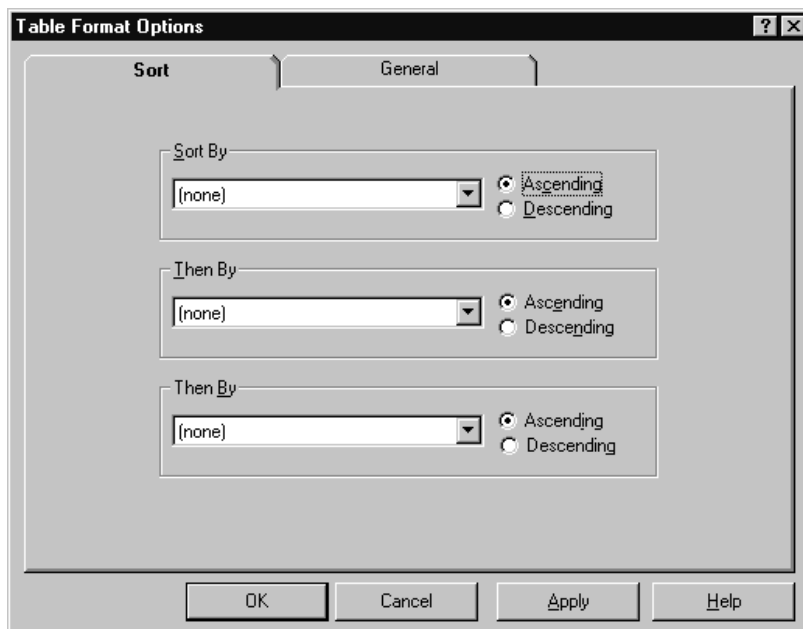

**Using the Sort tab** When you are setting up display order for a real-time report, specify the sort column ( Sort By) and the sort order (Ascending or Descending). The drop-down list for the Sort By lists all of the database table and item names used in the report.

Sorting may cause report refreshes to take longer. If you wish to speed up the refresh rate, turn off the sort options by selecting "(none)" for all of the Sort By criteria.

### Examples

Here are two examples of how you might use the Sort tab:

- Viewing a list of agents alphabetically — select "Agent Name" from the first Sort By drop-down list, select Ascending as the sort order, and leave the other two Then By boxes set to "(none)."
- Searching for agents who have been in a certain state for too long — select "State" from the first Sort By drop-down list, then select "Time" from the second Then By drop-down list, and then select Descending as the sort order for the second Then By.



# Formatting Chart Reports

---

**Overview** Charts (found in graphical reports) provide a graphical representation of data. Values or data points are displayed in formats such as bars, lines, filled areas, and pie charts. These data points are grouped into series that are identified with unique colors.

In many chart types, one data point from each series is grouped together by category across an axis. Categories are plotted along the x-axis, while values are plotted along the y-axis. A two-dimensional chart shows series next to each other, while a three-dimensional chart plots series along the z-axis. A chart can also have a title and a legend.

If you are in a graphical (chart) report, you can format how the report is displayed.

The changes you make to a report's format affect only your view of the report. The changes do not affect how other *CentreVu* Supervisor users see the report.

In general, if there is no value returned from the database by the query for a chart, the legends are displayed as dashes.

## Accessing the Chart Format Options window

To format a chart report, selecting Format Chart or Sort by from the Format menu list or the right mouse button pop-up menu. The Chart Format Options window appears.

The Chart Format Options window has seven tabs:,,,,,, and. Descriptions of these tabs follow.

- [General tab input fields \(2-36\)](#)
- [3D Effects tab input fields \(2-38\)](#)
- [Axis tab input fields \(2-39\)](#)
- [Type tab input fields \(2-40\)](#)
- [Title tab input fields \(2-41\)](#)
- [Legend tab input fields \(2-42\)](#)
- [Data Labels tab input fields \(2-43\)](#)

**General tab** The General tab allows you to specify several general options that apply to the chart.

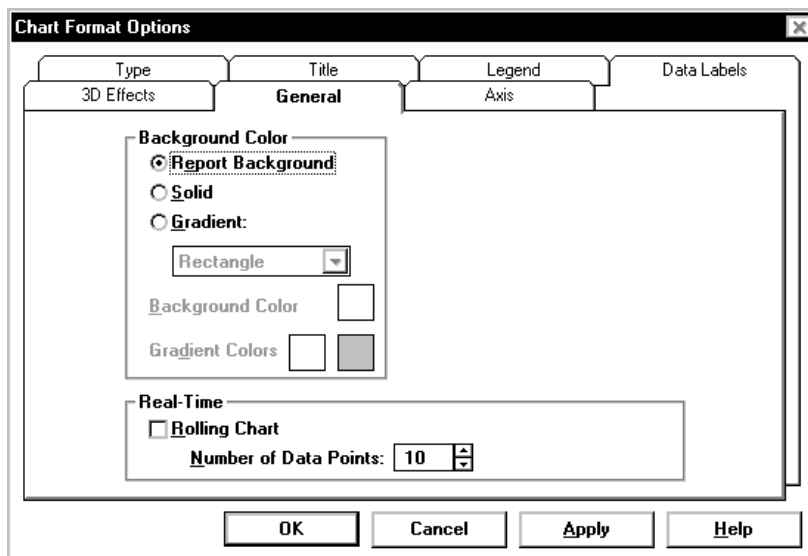

**General tab input fields** The following parameters can be changed:

Parameter	Function
Background Color	Specifies whether the backdrop of the chart is a solid color or whether it is displayed as a gradient, a smooth transition from one color to another. The gradient transition can be one of the following: Horizontal, Vertical, Rectangle, or Oval. The quality of the gradient effect will vary depending on the video card installed in the PC, or the capabilities of the printer for printed reports.

Parameter	Function
Real-Time	If the chart is a rolling chart, you can specify the number of data points to be displayed in the chart. Permitted values are 2 through 100, with 10 being the default. A rolling chart is a line chart that is initially displayed with no data points. For each refresh of the report, a data point is added. As data points are added, the chart “rolls” from left to right. When enough refreshes have occurred so that the chart is displaying the number of specified data points, at the next refresh, the oldest data point is dropped from the display and the newest data point is displayed.

**3D Effects tab** The 3D Effects tab allows you to control the 3D appearance of the chart. If the current chart is a 2D chart, this tab is disabled.

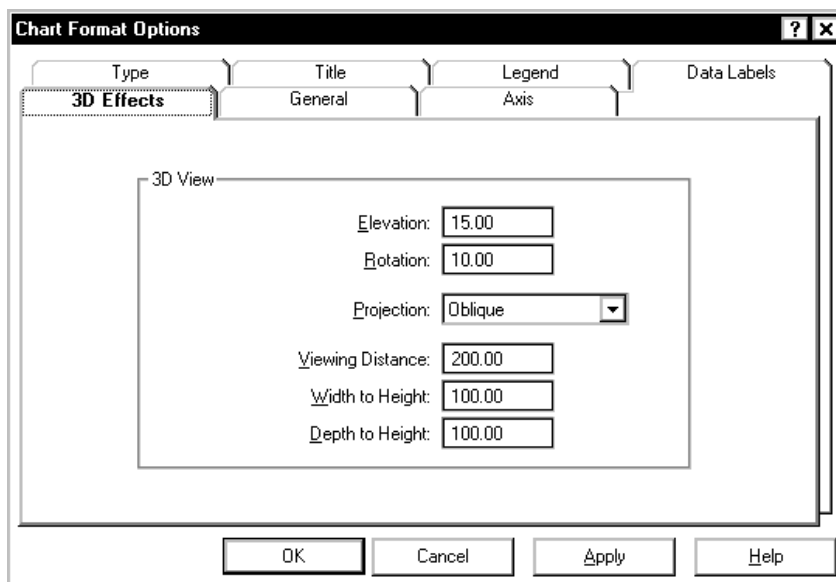

#### More information

See [Rotating a 3D chart \(2-49\)](#) for an easy way to change the elevation and rotation of a chart using the mouse.

**3D Effects tab input fields**

The following parameters can be changed:

Parameter	Function
Elevation	A number from 0 through 90 degrees that describes the relative height from which a chart is viewed. An elevation of 90 looks directly down on the top of the chart, while an elevation of 0 looks directly at the side of the chart. The example charts throughout this document use an elevation of 30 degrees.
Rotation	A number from -360 through 360 degrees that specifies the angle that the chart is turned relative to the viewing position. The example charts throughout this document use a rotation of 60 degrees. Rotation does not apply to 3D pie charts.
Projection	<p>Selects one of three mathematical algorithms used to give a 3D appearance on a 2D sheet of paper or computer screen.</p> <p>You can choose the following values:</p> <ul style="list-style-type: none"> <li>• <i>Oblique</i> — The chart has depth but the X-Y plane does not change when the chart is rotated or elevated.</li> <li>• <i>Orthogonal</i> — Perspective is not applied to the chart, resulting in less of a 3D effect. The advantage of using this type of projection is that vertical lines remain vertical, making some charts easier to read.</li> <li>• <i>Perspective</i> — This provides the most realistic 3D appearance. Objects farther away from you converge toward a vanishing point.</li> </ul>



Parameter	Function
Viewing Distance	A number from 50 through 1000 that represents the distance from which the chart is viewed as a percentage of the depth of the chart.
Width to Height	a number from 5 through 2000 that represents the percentage of the chart's height that is used to draw the chart's width.
Depth to Height	A number from 5 through 2000 that represents the percentage of the chart's height that is used to draw the chart's depth.

**Axis tab** The Axis tab allows you to specify the title that will display on each axis of the chart report.

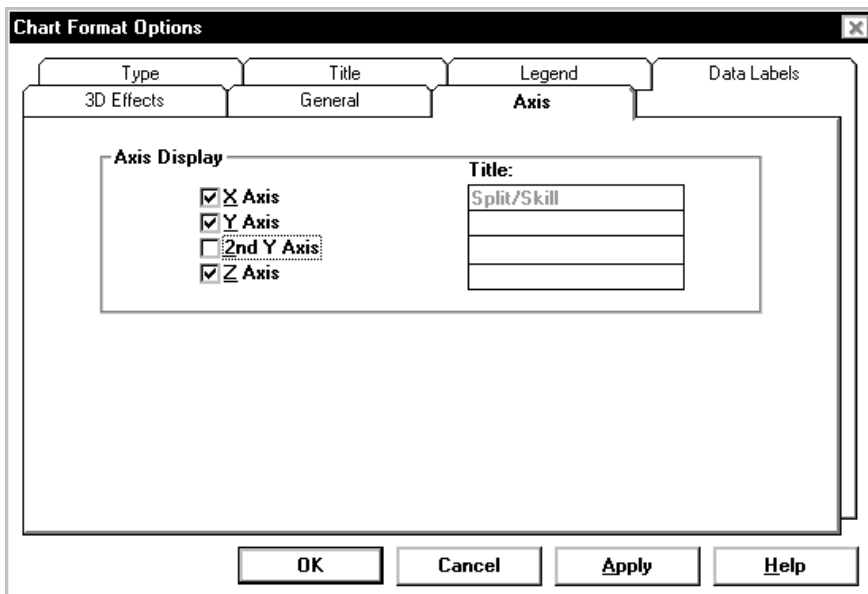

**Axis tab input fields** The following parameters can be changed:

Parameter	Function
Axis Display	Makes each of the axes visible or invisible. The choices are X Axis, Y Axis, 2nd Y Axis, and Z Axis.

**Type tab** The Type tab lets you change the chart type.

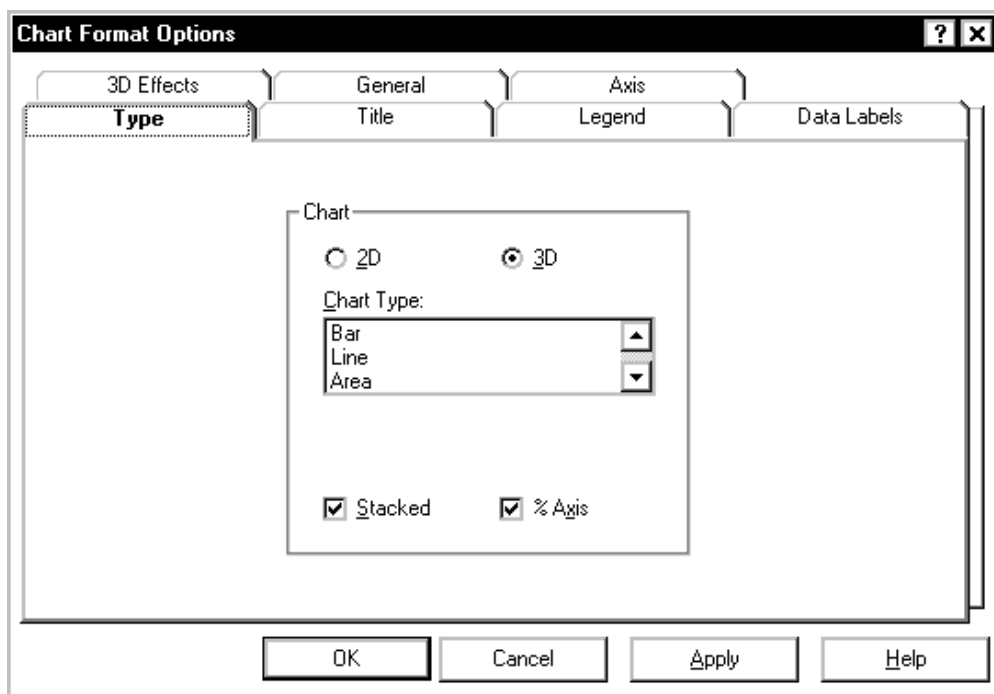

**Type tab input fields** The following parameters can be changed:

Parameter	Function
2D and 3D	Changes the chart between 2-dimensional and 3-dimensional views. 2D charts update faster than 3D charts, so if the drawing speed seems too slow, you may want to display charts as 2D.
Chart Type	<p>Specifies how the data is presented. You choose a chart type from the list. The types of charts available vary slightly depending on whether a 2D or 3D chart has been selected.</p> <p>All possible chart types are as follows:</p> <ul style="list-style-type: none"> <li>• Bar Chart (2D and 3D)</li> <li>• Line Chart (2D and 3D)</li> <li>• Area Chart (2D and 3D)</li> <li>• Step Chart (2D and 3D)</li> <li>• Horizontal Bar Chart (2D and 3D)</li> <li>• Clustered Bar Chart (3D only)</li> <li>• Pie Chart (2D and 3D)</li> </ul>

Parameter	Function
Stacked check box	Causes the data for all series to be stacked rather than shown separately. This check box is disabled for pie charts.
% Axis check box	Causes the value axis (y-axis) to be displayed as percentages rather than as actual data values. This can be combined with the stacked check box to produce a percentage stacked chart.

**Title tab** The Title tab allows you to control the location of the chart title.

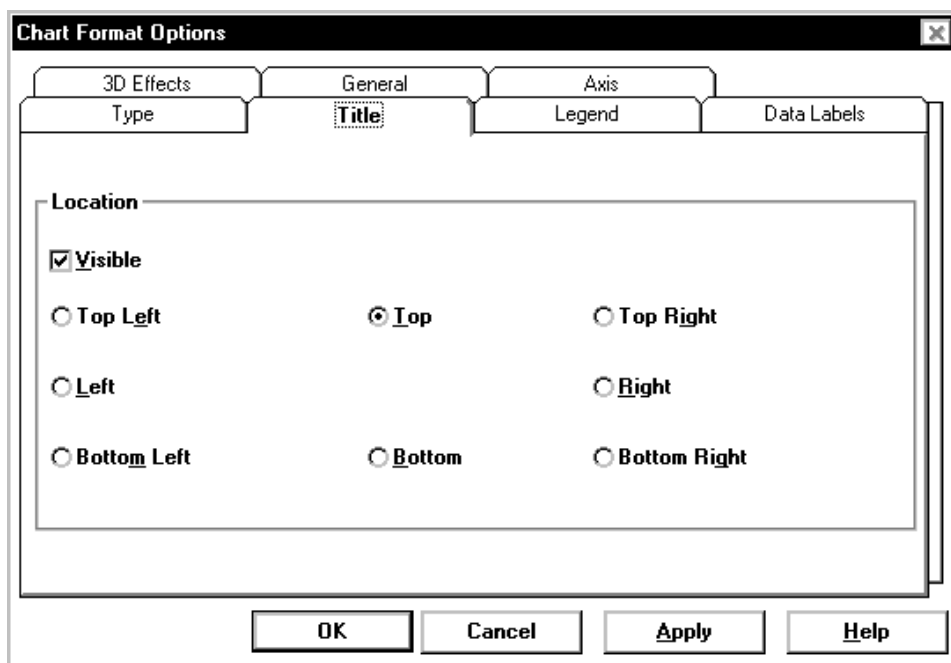

**Title tab input fields** The following parameters can be changed:

Parameter	Function
Visible check box	Allows you to display or not display report titles. Since the title takes up space, the drawn chart will be smaller if you have selected Visible. If you wish to increase the size of the chart, do not select the Visible option.

Parameter	Function
Location of title	If you elect to have report titles visible, you can select where the titles display. The available options are Top left , Top (center), Top right, Left , Right, Bottom left, Bottom (center), and Bottom right.

**Legend tab** The Legend tab allows you to control the location of the chart legend.

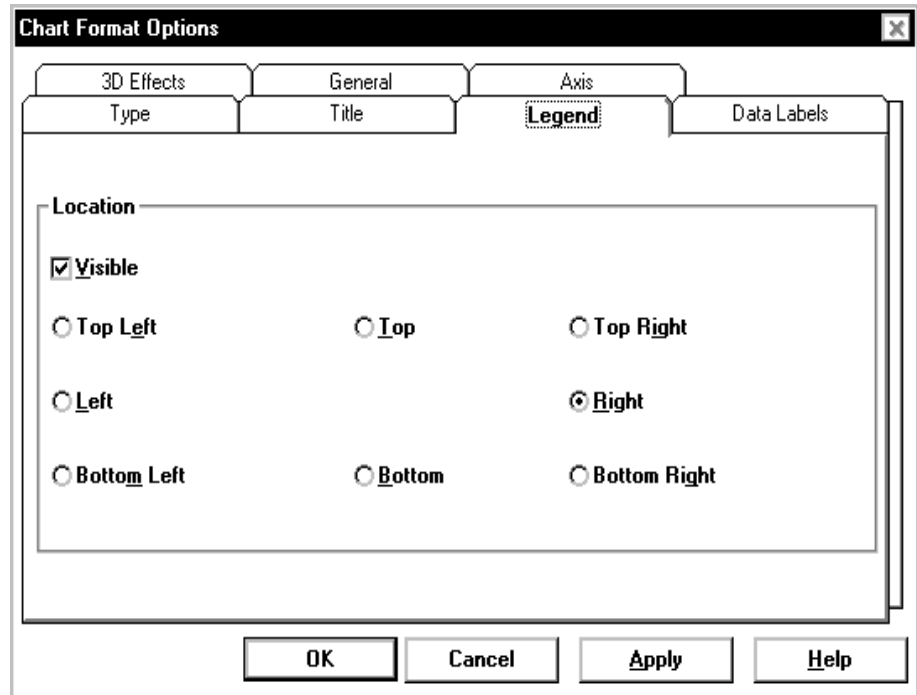

**Legend tab input fields** The following parameters can be changed:

Parameter	Function
Visible check box	Allows you to display or not display report legends. Since legends take up space, the drawn chart will be smaller if you have selected Visible. If you wish to increase the size of the chart, do not select the Visible option.
Location of legend	If you elect to have report legends visible, you can select where the legend displays. The available options are Top left , Top (center), Top right, Left , Right, Bottom left, Bottom (center), and Bottom right.

**Data Labels tab** The Data Labels tab allows you to control the location of the data point labels.

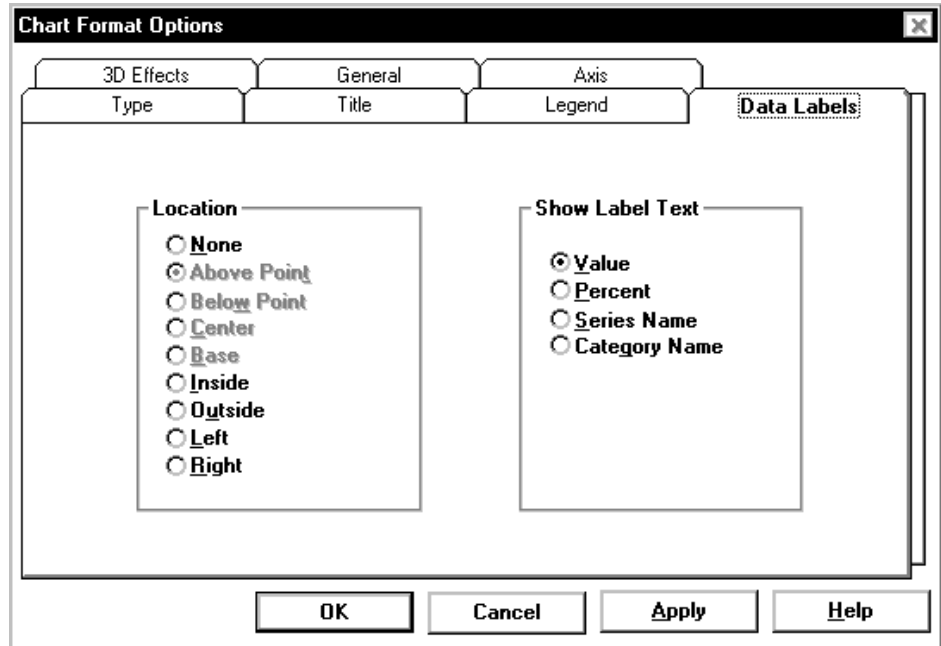

**Data Labels tab input fields** The position of data point labels can affect the readability of the chart. The label text may overlap in some situations, making it difficult or impossible to read the labels.

The following parameters can be changed:







<b>Parameter</b>	<b>Function</b>
None	Labels are not displayed.
Above Point	Displays the label above the data point. This location is valid only for bar, line, area, and step charts.
Below Point	Displays the label below the data point. This location is valid only for bar, line, area, and step charts.
Center	Displays the label centered on the data point. This location is valid only for bar, line, area, and step charts.
Base	Displays the label along the category axis, directly beneath the data point. This location is valid only for bar, line, area, and step charts.
Inside	Displays the label inside a pie slice. This location is valid only for pie charts.
Outside	Displays the label outside a pie slice. This location is valid only for pie charts.
Left	Displays the label at the left of a pie slice. This location is valid only for pie charts.
Right	Displays the label at the right of a pie slice. This location is valid only for pie charts.
Value	The value of the data point appears in the label.
Percent	The value of the data point appears in the label as a percentage.
Series Name	The series name is used to label the data point.
Category Name	The category name is used to label the data point.





## Minimizing Report Output Windows

**Overview** To minimize a report window, select the minimize button which is located in the upper right-hand corner of the window.

**Icons associated with minimized report windows** When a report output window is minimized, the report's icon is displayed. Depending on the category of the report, one of the following icons will be displayed:

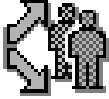

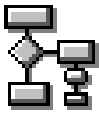
Report Type	Icon
Agent administration reports	
Call Center administration reports	
Agent real-time, historical, and integrated reports	
Dictionary reports	
Exceptions reports	
Maintenance reports	
Other, queue/agent, and custom real-time and historical reports	

Report Type	Icon
Split/skill real-time, historical, and integrated reports	
Trunk/trunk group real-time and historical reports	
VDN real-time, historical, and integrated reports	
Vector real-time and historical reports	

### Icons associated with minimized report thresholds

If Report Thresholds are enabled, real-time and integrated reports continue to update while they are minimized. If no Caution or Warning threshold condition is currently being met, the report's normal icon, as shown on the previous table, displays on the toolbar and in the system tray. If thresholds are being met, the report's icon on the toolbar remains the same, but the Caution or Warning threshold symbol appears in the system tray.

The threshold symbols are as follows:

Threshold Type	Icon
Caution Threshold	
Warning Threshold	





## Right mouse button pop-up menus



**Overview** The right mouse button pop-up menu is available only in running reports. When you click the right mouse button, a pop-up menu displays. The menu that displays is dependent on where your cursor is located. It can include options from the Edit, Format, and Tools menus on the Reports menu bar. The applicable menu items for the input field are enabled. If a report object is not selected, a menu is not displayed when you hold down the right mouse button.

To deselect a selected object, click anywhere else on the report.

The right mouse button pop-up menu is available when you do any of the following actions.

### Menus displayed

When you ...	This pop-up menu displays ...	And ...
Select a cell in a table and hold down the right mouse button.		A dotted border is drawn around the cell. If you select a cell that displays an agent name, agent number, or work mode, the available drill-down reports for that cell display at the top of the right mouse button menu. See examples of these later in this section.
Select an output field or label and hold down the right mouse button.		The data point is highlighted using selection handles (dots along the edges of the data point). If you selected a data point that allows report threshold highlighting to be set, the menu item will not be grayed out.
Select a data point in a chart and hold down the right mouse button.		A dotted border is drawn around the field. The Threshold Settings menu item is enabled if the highlighted field has related threshold settings.

When you ...	This pop-up menu displays ...	And ...
<p>Select an agent name or agent number in a table and hold down the right mouse button.</p>		<p>A dotted border is drawn around the agent name.</p> <p>If you do not have the EAS feature on your Enterprise Communications Server ( ECS) or switch, the drill-down reports available will be the Real-Time Agent Information report and the Integrated Agent Information report.</p> <p>From this menu, you can access either the Real-Time or the Integrated Agent Graphical Information report. If you double click on the agent name and you are running a real-time report, the default drill-down report is the Real-Time Agent Graphical Information report.</p> <p>You can change an agent's splits/skills while you are in a report using this method of selection. See the appropriate chapter in the <i>CentreVu® CMS R3V8 Administration</i> (585-210-910) guide for more information.</p>
<p>Select a cell on a table or a point on a chart that displays agent work state information and hold down the right mouse button.</p>		<p>The data point is highlighted using selection handles (dots along the edges of the data point).</p> <p>If you have the ECS or switch with the EAS feature, the Real-Time AUX Agent drill-down report will also be available.</p> <p>From this menu, you can access the Real-Time Split/Skill Top Agent Work State Report, which also displays when you double click on the work state in the report.</p>



---

## Rotating a 3D chart

---

**Overview** The rotation and elevation of any 3D chart can be changed interactively using the mouse. This is easier than using the 3D Effects tab of the Chart Format window (see [Formatting Chart Reports \(2-35\)](#) for information on using the 3D Effects tab).

**How to rotate a 3D chart** To change the rotation and elevation of a 3D chart, do the following steps:

- 1 Place the pointer over a 3D chart.
- 2 Press and hold the **CTRL** key. The pointer changes to indicate that the chart can be rotated.
- 3 Click and hold the left mouse button. A dotted 3D outline appears around the chart.
- 4 Move the pointer up and down to change the chart elevation, and left and right to change the chart rotation. The dotted 3D outline shows the position of the chart as you move the mouse.
- 5 When you find the rotation and elevation you want, release the mouse button. The chart is redrawn in the new position.

END OF STEPS

**Result:**

The 3D rotation and elevation of each chart is saved as part of the report view.



---

## Exporting Report Data

---

**Overview** You can export the data from both standard (table) and graphical (chart) reports, either to a file or to the *Windows* clipboard. Once you have exported report data, you can copy the report information into another application (for instance, a spreadsheet).

**Defaults** By default, only the data from the chart or table is exported. You can select the Include Labels and Headers check box on the Export Data window to include that information in the export of data.

**Report format** Reports are exported from *CentreVu* Supervisor in the following format:

- Data is exported as ASCII characters.
- For table reports, each row of data is written as one line, terminated by a carriage return (ASCII value 13).
- The field separator character is written between fields.
- The field separator does not follow the last character in the line.
- Text strings are delineated according to the specified text delimiter.

**How to export a data report**

To export the data from a report, do the following:

- 1 Click on the table or chart within a report.
- 2 Select Export Table Data or Export Chart Data or Export All Data, as appropriate, from the Edit menu or the right mouse button pop-up menu.

**Result:** The Export Data window appears. The Export Data window allows you to copy the data from a report to the clipboard or a file.

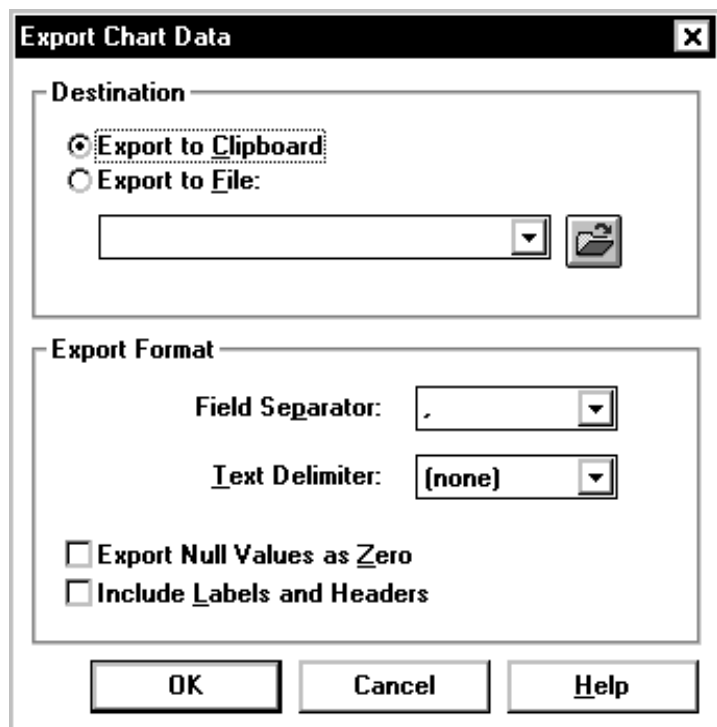

- 3 Complete the following parts of the Export Data window:
  - Destination selection box—choose to export the report to the clipboard or to a file. If you are exporting the report to a file, you need to type in a name for the file.  
You can select the File button to browse the files on your PC, or use the history list to select a file you previously used.
  - Export Format selection box—define the export format of the report. The character you choose from the drop-down list in the Field Separator text box is what will be placed between each field in the

report. The character you choose for the Text Delimiter determines what is used around text strings in the exported file. If a text delimiter is specified, no special checks are done to ensure that the data does not contain that character and the data is written unmodified.

If you want to export data to *Microsoft Excel*<sup>TM</sup>, choose “Tab” as the field separator and “None” as the text delimiter.

- **Export Null Values as Zero**—select this check box to include data that is null as a zero in the export of information. This is helpful if you are exporting a table report because a null value that is not included in the export of the data could disrupt the order of the rows/columns in the data.
- **Include Labels and Headers** check box—select this check box to include the text information (such as column headers in table reports) in the export of the report's data.
- **Export Time Durations in Seconds**—select this check box to include the time duration in the export of information.

---

**4** If you want to automatically export data on a schedule, select the **Script** button to display the **Save as Script** dialog box. This dialog box will create a script to export data from the report.

---

**5** Select **OK** in the **Export Data** window.

---

END OF STEPS



---

## Copying Chart Reports

---

**Overview** You can copy chart reports to the *Windows* clipboard. The copy of the selected chart report is copied to the clipboard in the *Windows* metafile (\*.wmf) format. This allows you to paste the chart image into any *Windows* application that can read the metafile format. For instance, you can copy chart reports and import the files into word processing files to be used as viewgraphs.

**How to copy chart reports** To copy a chart report to the metafile format, do the following steps:

- 1 Run a chart (graphical) report.
- 2 Select the image that you want to copy by clicking on it.
- 3 Select Copy from the Edit menu or use the right mouse button menu to select Copy.

END OF STEPS

**Results:**

The chart you selected is copied to the clipboard.



---

# Resizing Report Windows and Columns

---

**Resizing a window** You can resize report windows by moving the cursor to the edge of the window and, when the resize arrow appears, holding down the left mouse button and moving the mouse to size the window. When the window is the size you want it, release the mouse button.

You can also use the maximize and minimize buttons at the top of the window to size the window.

When you resize a *CentreVu* Supervisor report output window, the resulting effect depends on the type of report (standard or graphical) you are running. The following paragraphs outline the effects of resizing each type of report window.

**Standard Supervisor report window** When you resize the window of a standard report, the contents of the window do not change in size to reflect the new window size. If you made the window smaller than the size of the report, scroll bars will appear to allow you to view the entire contents of the report.

**Graphical report window** When you resize the window of a graphical report, the contents of the window will change in size to reflect the new window size. If a window is made too small, some elements may shrink in such a way to become unreadable. If this happens, resize the window to a more appropriate size. You may also choose to turn chart legends or data labels off to make more room for the chart itself. The window size is saved as part of the report view.

**Changing a column width** You can change the width of an individual table column in a table or chart report by positioning the mouse pointer between the column headers. The pointer will change to indicate that a resize is possible, and you can then drag the mouse to change the column size.





---

## Selecting a Printer

---

The Print setup window is a standard *Windows* Print window.

**Print setup options** The following options are available in the Print setup window:

- **Default Printer** — the default printer assigned by you in the *Windows* Control Panel will be used.
- **Specific Printer** — you can choose any printer that has been installed in the *Windows* Control Panel. All installed printers are included in the drop-down list. Depending on what printers are installed, non-printer devices such as files and fax may appear here.

Other entries in this window will vary depending on the capabilities of the chosen printer. The *Windows* system software determines what is available here and what happens if the Properties button is selected. These variations are not described here since *Windows* controls these options.

**How to select a printer** To access the Print setup window, do the following:

- 
- 1 Select a report (from Reports, Dictionary, Exceptions, Agent Administration, Call Center Administration, or Maintenance).

- 2 On the report input window, select the Print setup button.



**Result:** The Print setup window displays.

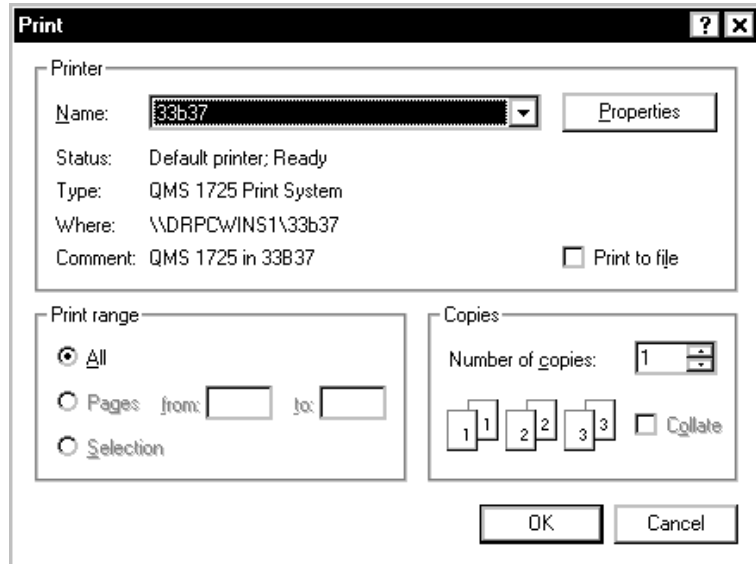

END OF STEPS



---

## Setting Up a Page

---

**Overview** The Page Setup window allows you to specify how each page of a report is positioned when printed. The changes you make in this window apply only to printed reports and do not affect reports displayed on-screen. The Page Setup window is a standard *Windows* print window.

- Page setup options** The following options are available in the Page Setup window:
- Margins — allows you to define the spaces at the edges of the page where nothing will be printed.
  - The margin settings are defined as follows:
    - Top — the margin is measured from the top of the page. The report is offset by this amount at the top of each page.
    - Bottom — the margin is measured from the bottom of the page. When a printed table reaches the bottom of the page, it will continue printing at the top of the next page, with the table titles repeated. If a chart would overlap the bottom margin, it will be scaled smaller so that it fits within the margin. Text that reaches the bottom of the page will be printed on the next page.
    - Left — the margin is measured from the left of the page. The report is offset by this amount on the left of each page.
    - Right — the margin is measured from the right of the page. Tables and text that are too wide to fit on the printed page are truncated at the right margin. Charts that would overlap the right margin are scaled smaller to fit within the margin.
  - Page Numbers — allows you to choose whether or not to display page numbers.
  - The following settings are valid:
    - Yes — page numbers will be displayed.
    - No — no page numbers will be displayed. This is equivalent to the way *CentreVu* Supervisor currently prints reports.
  - Box Around Tables — allows you to choose whether or not to display a box around report tables when printed.
  - The following settings are valid:
    - Box — boxes will be displayed.
    - No Box — boxes will not be displayed.

**How to set up a page** To access the Page Setup window, do the following steps:

- 1 Select a report (from Reports, Dictionary, Exceptions, Agent Administration, Call Center Administration, or Maintenance).
- 2 Complete the report input window, selecting View Report On Screen as the destination.
- 3 Select OK to run the report.
- 4 Once the report is running, select Page Setup from the Report menu.

END OF STEPS

**Result:**

The Page Setup window displays.



## Setting Report Threshold Highlights

---

**Overview** Report threshold highlights let you set visual flags to key you when a real-time data item is out of acceptable bounds. This feature enables you to run a minimized report and be notified (through color/icon changes) when an item has passed a specific threshold.

**Reports** You can set threshold highlights only for real-time data items in real-time or integrated reports. The threshold highlights you set will tell you when data for an entity (split/skill, agent, agent group, or VDN) has reached a certain level (threshold), as defined by you.

**Entities** Threshold highlight settings apply to a single entity on a specific ACD. For example, if you run a real-time split report for split 17 on ACD 1 and set the threshold highlights, the threshold settings apply to split 17 on ACD 1 for all reports you run for that split and ACD. Also, the threshold highlight settings are saved on the PC you are currently using. So, if you move to another PC, you need to set up the threshold highlights on that PC. If multiple users log into the same PC, each user's threshold highlight settings are saved individually.

**Turn highlights on and off** By default, the thresholds for each report are turned on, but the threshold highlight settings are empty and the sample size threshold is zero. Therefore, no threshold highlights show on any reports until you create them using the Threshold Settings window. You can turn thresholds on and off for each report by selecting/deselecting the Thresholds Settings check box in the report input window, or by selecting Threshold Settings from the Options menu in the report output window.

**Example** For example, set thresholds for Time on ACD Calls in the skill named Sales. You might set the High Caution threshold to 50 seconds and the High Warning threshold to 60 seconds. If an agent spends more than 50 seconds, but less than 60 seconds, on an ACD call in the Sales skill, the item on the report will highlight with the High Caution threshold color. If the time exceeds 60 seconds, the item on the report will highlight with the High Warning threshold color. However, if the agent spends more than 50 seconds on an ACD call in any other skill (that does not have the same thresholds), the item on the report will not display any threshold highlighting.

**Important!** Report threshold highlights are not the same as *CentreVu* CMS Exceptions Thresholds. The threshold highlighting you can do with this feature is available through the *CentreVu* Supervisor interface only.



## Set Report Threshold Highlights

**Before you start** The procedure in this section are used to set report threshold highlights.

**Important!** When a data item/items for which threshold highlights can be set is selected, the Threshold Settings menu item is enabled. When the data item that is selected does not allow thresholds, an error message will display. See the tables later in this section for a list of the report outputs that allow threshold highlighting.

Depending on which data item you have selected, the Sample Size box at the bottom of the Threshold Settings window may or may not be visible. If you selected a data item that is a percentage or an average, the Sample Size box is present.

**Set thresholds** The following is an example of the Threshold Settings window:

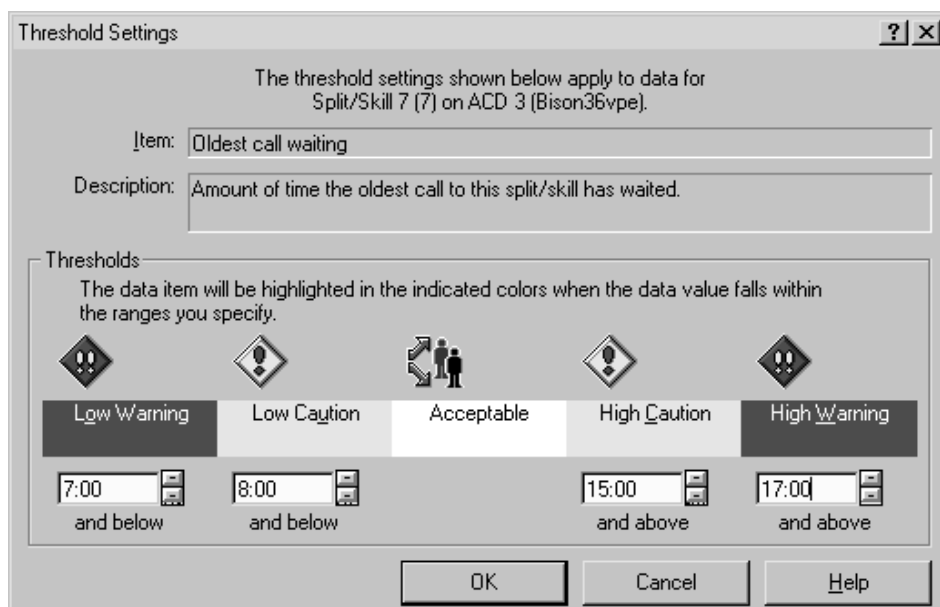

**Procedure** To set report threshold highlights do the following steps:

- 1 Run a report that contains real-time data (a real-time or integrated report).
- 2 Select on a data item in the report for which you can set threshold highlights.

- 
- 3 Select Threshold Settings from the right mouse button or from the Tools menu.
- 

- 4 Complete the Threshold Settings window.

The Threshold Settings window includes the following information and text boxes:

- **Item** — shows the name of the report threshold that applies to the selected data value. In most cases, this box contains a single entry. If the data value is agent “Time in State” or “Time in Workmode,” or agent group “Time in State” or “Time in Workmode,” then this list box contains multiple names, one for each possible agent state or workmode. Threshold highlights can be set for each individual state and workmode.
- **Description** — shows a description of the threshold currently selected.
- **Thresholds** — shows the colors (as defined in the Options Threshold Colors tab, accessed from the Tools menu), icons, and current numerical settings for the threshold highlights of this item. For thresholds that are time-related, the numbers you enter are in seconds. For example, if you are entering a High Caution threshold for three minutes, type 180 (for 180 seconds) in the High Caution field.
- **Sample Size** — contains the current value for the Sufficient Sample Size value. You can set this to any value from 0 to 999. When you set Sufficient Sample Size value, you are defining a minimum number of items that must be currently tracked before the threshold highlighting is enabled. You will only see Sample Size if the data item you selected is a percentage or an average.
- There are four types of thresholds available on the Threshold Settings window:
  - **Low Warning** — contains the current value for the Low Warning threshold for the selected data item. If no value is defined, the field is blank. You can set the value to any positive integer from 0 to 999,999,999 or leave it blank. If the field is blank, no threshold is set.
  - **Low Caution** — contains the current value for the Low Caution threshold for the selected data item. If no value is defined, the field is blank. You can set the value to any positive integer from 0 to 999,999,999 or leave it blank. If the field is blank, no threshold is set.

- 
- High Caution — contains the current value for the High Caution threshold for the selected data item. If no value is defined, the field is blank. You can set the value to any positive integer from 0 to 999,999,999 or leave it blank. If the field is blank, no threshold is set.
  - High Warning — contains the current value for the High Warning threshold for the selected data item. If no value is defined, the field is blank. You can set the value to any positive integer from 0 to 999,999,999 or leave it blank. If the field is blank, no threshold is set.
- 

**5** Select OK.

.....  
E N D O F S T E P S  
.....





## Tips for Setting Report Threshold Highlights

---

**Overview** Use the tips in this section when setting report threshold highlights.

- Tips for setting report threshold highlights** Keep the following tips in mind when you are setting report threshold highlights:
- Before you can administer threshold highlights for a data item, you must first click on the data item in the report to select it. When a data item is highlighted in a table (standard) report, it is outlined with a dotted line. When a data item is highlighted in a chart (graphical) report, it has “pull-bars” around the perimeter.
  - See the [Available Agent Threshold Settings \(2-65\)](#), [Available Split/Skill Threshold Settings \(2-68\)](#), and [Available VDN Threshold Settings \(2-71\)](#) sections in this chapter for more information on the real-time data items in reports for which you can set threshold highlights.
  - In standard reports, you can select items from the table or from the output information at the top of the report.
  - In chart reports, you can select items from the pie charts, bar charts, graphical reports, or tables.
  - When you set threshold highlights for an entity (split/skill, agent, agent group, or VDN), that set of threshold highlights applies to every report that is run specifically for that entity.
  - The report threshold highlights are updated with each refresh of the report, but not between report refreshes.
  - The numbers you define for the threshold highlights must increase from left to right (the number you use for Low Warning must be less than the number you use for High Warning).
  - You can set the label colors by choosing Options from the Tools menu on the Controller.
  - Depending on how you define the colors, the sample size threshold can behave in the following ways:
    - If you want to be alerted to the fact that a particular calculation is not statistically significant, set the Insufficient color to a different color than any other threshold condition. This causes data with insufficient sample size to be highlighted in a special color.
    - If you want to ignore values with insufficient sample sizes, set the Insufficient color to be black text on a gray background. This causes the value with insufficient sample size to not be highlighted.
  - You can set report thresholds to affect how report data is displayed.

- There are two ways data is affected:
  - If the data calculation contains a non-zero Sample Size threshold, the denominator of the specified calculation is compared to the Sample Size threshold. If the denominator is less than the Sample Size threshold, the value displays in the “Insufficient” color, indicating that the sample size is insufficient for the value to be significant.
  - If the sample size is sufficient or if there is no sample size associated with the data, then the data value is compared to the Low Warning, Low Caution, High Caution, and High Warning threshold values to determine which band applies. The value is displayed in the color associated with the appropriate threshold.



## Available Agent Threshold Settings

**Overview** Use the data items in this section when setting agent threshold highlights.

**Agent threshold settings** All of the data that *CentreVu* Supervisor uses for agent threshold highlights are retrieved from the **cagent** (current interval agent) database table. See the *CentreVu® CMS R3V8 Database Items and Calculations* (585-210-939) document for more information on the database tables.

The Average Talk Time data item includes Sample Size thresholds.

The agent threshold highlights you can set are as follows:

Threshold	Description/Database Item or Calculation
Time in AUX State	Description — Amount of time the agent is in the Auxiliary Work state. Measures — DURATION while AGSTATE = AUX
Time in AUX-IN State	Description — Amount of time the agent is on an incoming call while in the Auxiliary Work state. Measures — DURATION while AGSTATE = AUX-IN
Time in AUX-OUT State	Description — Amount of time the agent is on an outgoing call while in the Auxiliary Work state. Measures — DURATION while AGSTATE = AUX-OUT
Time in ACW State	Description — Amount of time the agent is in the After Call Work state. Measures — DURATION while AGSTATE = ACW
Time in ACW-IN State	Description — Amount of time the agent is on an incoming call while in the After Call Work state. Measures — DURATION while AGSTATE = ACW-IN
Time in ACW-OUT State	Description — Amount of time the agent is on an outgoing call while in the After Call Work state. Measures — DURATION while AGSTATE = ACW-OUT
Time in AVAIL State	Description — Amount of time the agent is in the AVAIL state. Measures — DURATION while AGSTATE = AVAIL
Time in ACD State	Description — Amount of time the agent is in the ACD state. Measures — DURATION while AGSTATE = ACD

Time in ACD-IN State	Description — Amount of time the agent is in the ACD-IN state. Measures — DURATION while AGSTATE = ACD-IN
Time in ACD-OUT State	Description — Amount of time the agent is in the ACD-OUT state. Measures — DURATION while AGSTATE = ACD-OUT
Time in DACD State	Description — Amount of time the agent is in the DACD state. Measures — DURATION while AGSTATE = DACD
Time in DACD-IN State	Description — Amount of time the agent is in the DACD-IN state. Measures — DURATION while AGSTATE = DACD-IN
Time in DACD-OUT State	Description — Amount of time the agent is in the DACD-OUT state. Measures — DURATION while AGSTATE = DACD-OUT
Time in DACW State	Description — Amount of time the agent is in the DACW state. Measures — DURATION while AGSTATE = DACW
Time in DACW-IN State	Description — Amount of time the agent is in the DACW-IN state. Measures — DURATION while AGSTATE = DACW-IN
Time in DACW-OUT State	Description — Amount of time the agent is in the DACW-OUT state. Measures — DURATION while AGSTATE = DACW-OUT
Time in RING State	Description — Amount of time the agent is in the RING state. Measures — DURATION while AGSTATE = RING
Time AUX Workmode	Description — Amount of time the agent is in the AUX workmode, including incoming and outgoing calls. This time measures the time the agent remains in AUX, regardless of any incoming or outgoing calls handled. Measures — AGTIME while WORKMODE = AUX.
Time in ACD Workmode	Description — Amount of time the agent is in the ACD workmode, including incoming and outgoing calls. This time measures the time the agent remains in ACD, regardless of any incoming or outgoing calls handled. Measures — AGTIME while WORKMODE = ACD

Time in ACW Workmode	Description — Amount of time the agent is in the ACW workmode, including incoming and outgoing calls. This time measures the time the agent remains in ACW, regardless of any incoming or outgoing calls handled. Measures — AGTIME while WORKMODE = ACW
Time in AVAIL Workmode	Description — Amount of time the agent is in the AVAIL workmode, including incoming and outgoing calls. This time measures the time the agent remains in AVAIL, regardless of any incoming or outgoing calls handled. Measures — AGTIME while WORKMODE = AVAIL
Time in DACD Workmode	Description — Amount of time the agent is in the DACD workmode. This time measures the time the agent remains in DACD, regardless of any incoming or outgoing calls handled. (Applies only to Generic 3 switches.) Measures — AGTIME while WORKMODE = DACD
Time in DACW Workmode	Description — Amount of time the agent is in the DACW workmode, including incoming and outgoing calls. This time measures the time the agent remains in DACW, regardless of any incoming or outgoing calls handled. Measures — AGTIME while WORKMODE = DACW
Calls in Direct Agent Queue	Description — Number of Direct Agent calls that are queued to the agent. DA_INQUEUE is the current number of Direct Agent calls waiting in any split/skill queue for a specific agent. (Applies only to Generic 3 switches.) Measures — DA_INQUEUE
Time call waiting in Direct Agent Queue	Description — Amount of time the caller has waited in the Direct Agent queue. DA_OLDESTCALL is the length of time that the oldest Direct Agent call has waited in any split/skill queue for this agent. (Applies only to Generic 3 switches.) Measures — DA_OLDESTCALL
Average Talk Time	Description — Average length of time the agent spends talking on ACD calls. Measures — AVG_AGENT_TALK_TIME calculation.

## Available Split/Skill Threshold Settings

**Overview** Use the data items in this section when setting split/skill threshold highlights.

**Split/skill threshold settings** All of the data that *CentreVu* Supervisor uses for split/skill threshold highlights are retrieved from the `csplit` (current interval split) database table. See the *CentreVu® CMS R3V8 Database Items and Calculations* (585-210-939) document for more information on the database tables.

The following data items include Sample Size thresholds:

- Average Speed of Answer
- Average Talk Time
- Average Time to Abandon
- Percent of Calls Answered in Service Level
- Percent of Calls Abandoned
- Percent of Calls Answered

The split/skill threshold highlights you can set are as follows:

Threshold	Description/Database Item or Calculation
Oldest Call Waiting	Description — Amount of time the oldest call to this split/skill has waited in queue. OLDESTCALL is the number of seconds the oldest split/skill ACD call has waited in queue or ringing. Measures — OLDESTCALL
Number of Calls Waiting in Queue	Description — Number of calls queued to this split/skill. The computation measures the number of calls in queue or ringing at an agent position. Measures — INQUEUE + INRING
Number of Calls Abandoned	Description — Number of calls that were queued to this split/skill and then abandoned. ABNCALLS is the number of calls offered to a split/queue which were subsequently abandoned by the caller. Measures — ABNCALLS
Average Speed of Answer	Description — Number of seconds, on average, before a call to this split/skill is answered. Average speed of answer is the ANSTIME (time spent by callers in queue or ringing before being answered) divided by the ACDCALLS (number of calls queued to the split/skill that were answered by an agent at this split/skill). Measures — AVG_ANSWER_SPEED

Average Talk Time	Description — Average length of time spent on ACD calls to the split/skill. Measures — AVG_ACD_TALK_TIME
Average Time to Abandon	Description — Average length of time callers waited before abandoning calls to the split/skill. Measures — AVG_ABANDON_TIME
Full Time Equivalent Agents Staffed	Description — Number of total full-time equivalent agents currently staffed for the skill. Measures — FTE_AGENTS
Number of Calls Forced Busy	Description — Number of calls to the split/skill that were given a busy signal by the switch. Measures — BUSYCALLS
Number of Calls Disconnected	Description — Number of calls to the split/skill that were disconnected by the switch. Measures — DISCCALLS
Percent of Calls Answered in Service Level	Description — Percentage of ACD calls to the split/skill that were answered within the service level. Measures — PERCENT_SERV_LVL_SPL
Percent of Calls Abandoned	Description — Percentage of ACD calls to the split/skill that were abandoned. Measures — PERCENT_CALL_ABAN
Number of Agents Staffed	Description — Number of agents logged into the split/skill. Measures — STAFFED
Percent of Calls Answered	Description — Percent of ACD calls offered to the split/skill that were answered. Measures — PERCENT_CALL_ANS
Call Profile Abandon per Service Level Increment	Description — Number of abandoned calls to the split/skill for any service level increment. A single report threshold applies to all of the values. If the number of abandoned calls for the split/skill reaches the threshold for any of the service level increments, the value for that service level increment is highlighted. Measures — ABNCALLS1 through ABNCALLS10
Rolling Average Speed of Answer	Description — Switch-based Rolling Average Speed of Answer for this split/skill. The Rolling Average Speed of Answer is the average speed of answer across intervals. Measures — ASA
Expected Wait Time (Low)	Description — Expected Wait Time for a call queued to this split/skill at a low priority level. Measures — EWTLOW

Expected Wait Time (Medium)	Description — Expected Wait Time for a call queued to this split/skill at medium priority level. Measures — EWTMEDIUM
Expected Wait Time (High)	Description — Expected Wait Time for a call queued to this split/skill at high priority level. Measures — EWTHIGH
Expected Wait Time (Top)	Description — Expected Wait Time for a call queued to this split/skill at top priority level. Measures — EWTTOP





## Available VDN Threshold Settings

**Overview** Use the data items in this section when setting VDN threshold highlights.

**VDN threshold settings** All of the data that *CentreVu* Supervisor uses for VDN threshold highlights are retrieved from the *c\_vdn* (current interval VDN) database table. See the *CentreVu® CMS R3V8 Database Items and Calculations* (585-210-939) document for more information on the database tables.

The following data items include Sample Size thresholds:

- Percent of Calls Answered in Service Level
- Percent of Calls Abandoned
- Percent of Calls Answered
- Average Speed of Answer
- Average Talk Time
- Average Time to Abandon

The VDN threshold highlights you can set are as follows:

Threshold	Description/Database Item or Calculation
Number of Calls Abandoned During the Interval	Description — Number of calls that were queued to this VDN and then abandoned. Measures — ABNCALLS
Number of Calls Forced Busy During the Interval	Description — Number of calls to the VDN that were given a busy signal by the switch. Measures — BUSYCALLS
Number of Calls Disconnected During the Interval	Description — Number of calls to the VDN that were disconnected by the switch via the vector “disconnect” command. Measures — DISCCALLS
Oldest Call Waiting	Description — Number of seconds the oldest call has waited in this VDN. Measures — OLDESTCALL
Number of Calls Waiting	Description — Number of calls queued to this VDN that have not been answered by an agent. Measures — INPROGRESS - ATAGENT
Percent of Calls Answered in Service Level	Description — Percentage of ACD calls to the VDN that were answered within the service level. Measures — $100 * (\text{ACCEPTABLE} / \text{INCALLS})$
Percent of Calls Abandoned	Description — Percentage of ACD calls to the VDN that were abandoned. Measures — $100 * (\text{ABNCALLS} / \text{INCALLS})$

Percent of Calls Answered	Description — Percentage of ACD calls offered to the VDN that were answered. Measures — $100 * [(ACDCALLS + CONNECTCALLS) / INCALLS]$
Call Profile Abandon per Service Level Increment	Description — Number of abandoned calls to this VDN for any service level increment. A single report threshold applies to all of the values. If the number of abandoned calls for the VDN reaches the threshold for any of the service level increments, the value for that service level increment is highlighted. Measures — ABNCALLS1 through ABNCALLS10
Average Speed of Answer	Description — Number of seconds, on average, before a call to this VDN is answered. This value is the time callers spent in queue or ringing before being answered divided by the number of calls queued to the VDN that were answered by an agent at this VDN. Measures — AVG_ANSWER_SPEED
Average Talk Time	Description — Average length of time spent on ACD calls to the VDN. Measures — AVG_ACD_TALK_TIME
Average Time to Abandon	Description — Average length of time callers waited before abandoning calls to the VDN. Measures — AVG_ABANDON_TIME
Rolling Average Speed of Answer	Description — Switch-based Rolling Average Speed of Answer for this VDN. The Rolling Average Speed of Answer is the average speed of answer across intervals. Measures — ASA



# Report Options

---

**Overview** This section describes what the Report Options tab can be used for.

**Functions** Use the Options tab to do the following actions:

- Set the ACD and other general options that *CentreVu* Supervisor will default to when you log in (General tab).
- Set up the colors that will be used in your graphical reports (Report Colors tab).
- Set up the colors that will be used in reports to tell you when threshold highlights (not exceptions thresholds) have been reached. See [Set Report Threshold Highlights \(2-60\)](#) for more information on threshold highlights.
- Choose or create a name format using {name} for Dictionary Name, {entity} for entity type, and {number} for entity number. The name format determines how items will be displayed in reports. For instance, if you select the name format of {entity}{number}, then all of the entities (splits/skills, ACDs, VDNs, vectors, trunks, trunk groups, call work codes, and AUX codes) that can be named in the Dictionary will display as the entity type and number instead of the Dictionary name. If you selected {name} as the name format, then the names that have been assigned to the entities in the Dictionary will display.



## Options General Tab

**Overview** This section describes the Options General tab.

### Options general tab

**Important!** The General tab is accessible when you *are* connected to a *CentreVu* CMS server.

Threshold highlighting does not use sound. It uses color only as an indicator of a threshold being met.

The following graphic shows the Options General tab (with default settings).

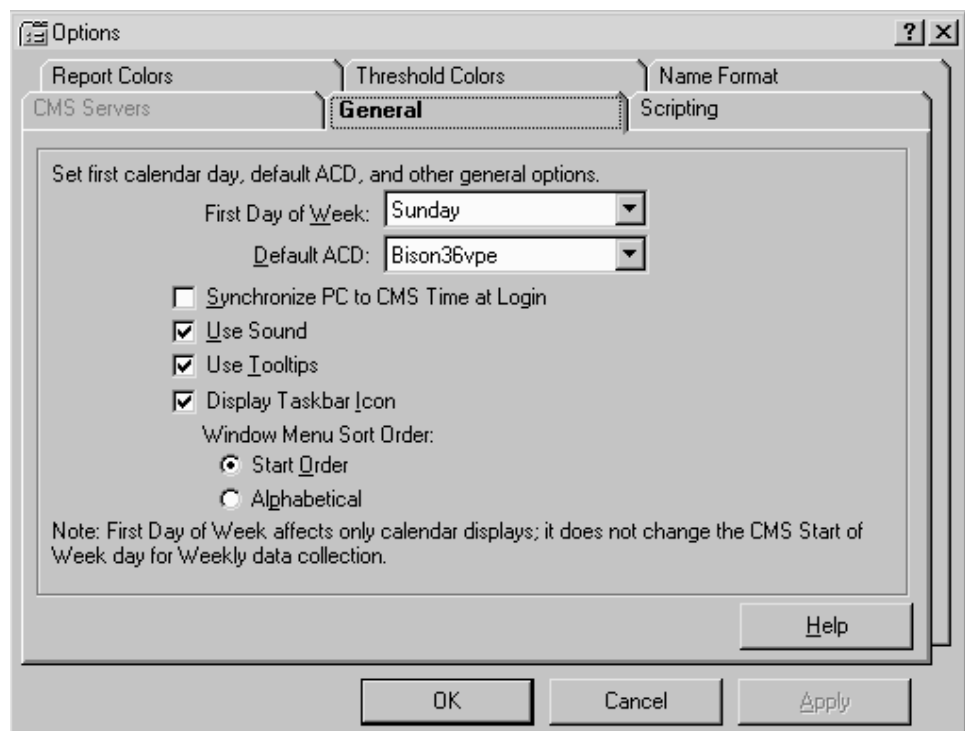

Use the General tab to set your first calendar day, default ACD, and other general options. The options are described below.

- **First Day of Week** — this option affects only how the calendar displays; it does not change the *CentreVu* CMS Start of Week day for weekly data collection (the *CentreVu* CMS Start of Week day is set through the System Setup: Storage Intervals window). For example, if you browse for a date, the calendar will start the week based on the day that you choose.  
Use the drop-down list to make your selection.
- **Default ACD** — when you select the ACD, this ACD will be the default listed in the functions windows and drop-down list options.  
Use the drop-down list to make your selection.

- Synchronize PC and CMS Time at Login — activate the check box for this selection to set the PC's clock to read the same time as the *CentreVu* CMS clock. If you do not activate this selection, your PC clock and the *CentreVu* CMS clock may not read the same time. This does not affect the *CentreVu* CMS clock.
- Use Sound — activate the check box for this selection to be alerted, by sound, when the Exceptions Indicator box is updated. The Exceptions Indicator box is on the Controller status bar. The sound you hear is the sound you have chosen for the exclamation event associated with your PC.
- Use Tooltips — activate the check box to make tooltips visible. For example, when you are working on the Controller window, you may place your mouse cursor over a toolbar button and a yellow box will appear with a brief description of that button.
- Use Taskbar Icon — activate the check box for this selection to use the *CentreVu* Supervisor system tray icon feature.
- Window Menu Sort Order —if you activate the Use Tray Icon, you need to determine how the items that display in the system tray icon menu will be sorted.
- The following sort options are available:
  - Start Order — select this radio button and the items in the system tray icon menu will display in the order in which you started them from *CentreVu* Supervisor.
  - Alphabetical — select this radio button and the items in the system tray icon menu will display in alphabetical order, regardless of the order in which you started them.



# Options Report Colors Tab

**Overview** This section describes the Options Report Colors tab.

## Options report colors tab

**Important!** The Report Colors tab is accessible when you *are* connected to a *CentreVu* CMS server.

The following graphic shows the Options Report Colors tab (with default settings).

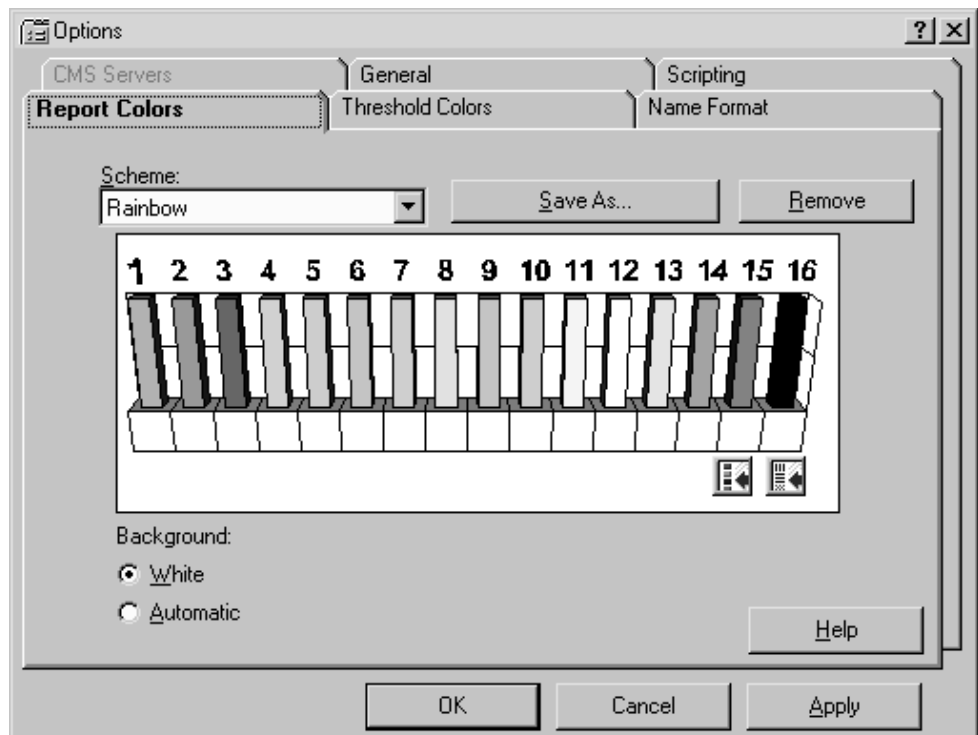

Use the Report Colors tab to set up the colors that will be used in your graphical reports.

- Scheme — You can select the report color scheme that you want to use for *CentreVu* Supervisor reports:
- Select one of the following two ways:
  - From a series of predefined color schemes, which are listed in the Scheme: field. Use the drop-down list to select a different scheme from the one that is currently displayed.
  - By creating a new color scheme. See the [Create a New Report Color Scheme \(2-81\)](#) section in this chapter for instructions on creating report color schemes.

- 
- Background — *CentreVu* Supervisor allows a choice of report background color:
  - Use one of the following two choices:
    - White — Select this radio button to make the background of all reports white.
    - Automatic — Select this radio button to make the background of all reports match the color that you have set up for your system in *Windows*.



## Options Threshold Colors Tab

**Overview** This section describes the Options Threshold Colors tab.

### Options threshold colors tab

**Important!** The Threshold Colors tab is accessible when you are connected to a *CentreVu* CMS server.

The following graphic shows the Options Threshold Colors tab (with default settings):

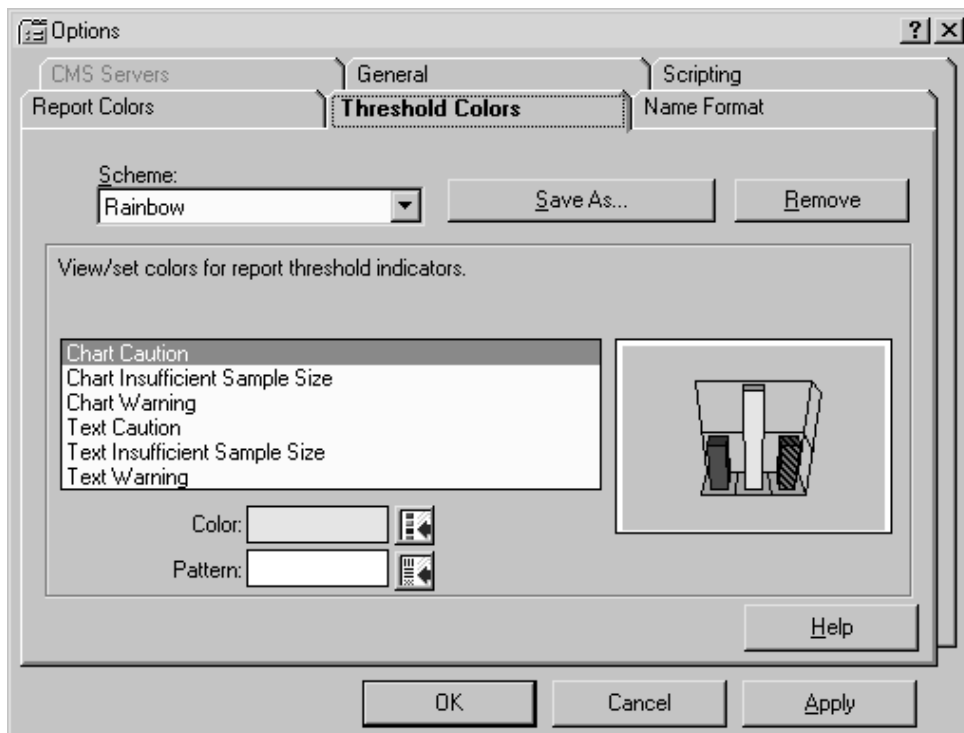

Use the Threshold Colors tab to set up the colors that will be used in reports to tell you when exceptions thresholds have been reached.

You can select report color schemes in the following ways:

- From a series of predefined color schemes, which are listed in the Scheme: field. Use the drop-down list to select a different scheme from the one that is currently displayed.
- By creating a new color scheme. See the [Create a New Threshold Color Scheme \(2-84\)](#) section in this chapter for instructions on creating report color schemes.





# Options Name Format Tab

**Overview** This sections describes the Options Name Format tab.

## Options name format tab

**Important!** The Name Format tab is accessible when you *are* connected to a *CentreVu* CMS server.

The following graphic shows the Options Name Format tab (with default settings):

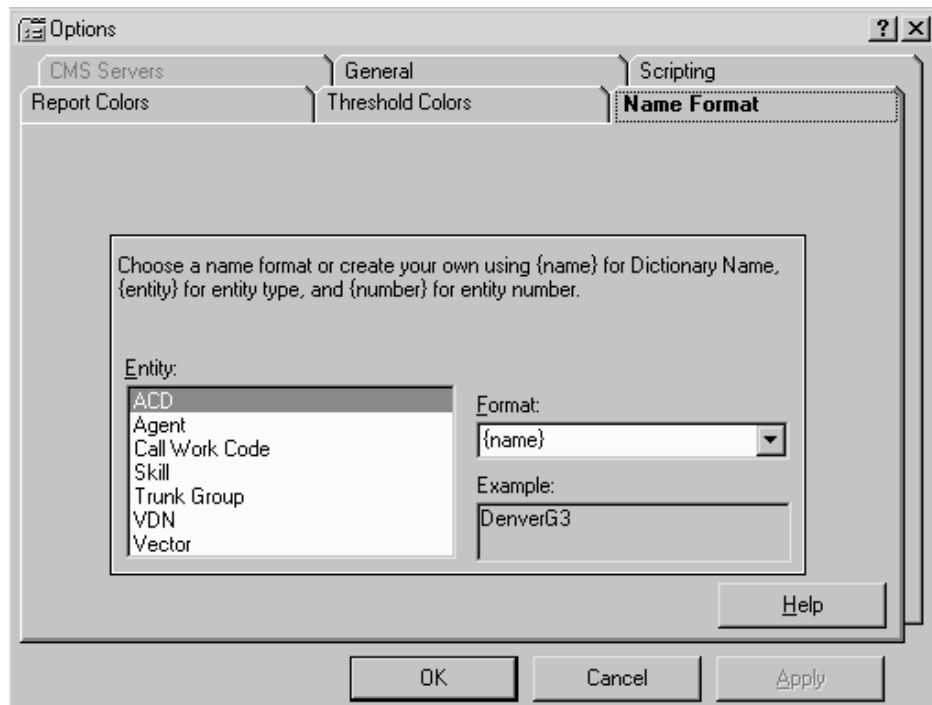

Use the Name Format tab to choose or create formats for how *CentreVu* CMS entities (splits/skills, ACDs, VDNs, vectors, trunks, trunk groups, call work codes, and AUX codes) will display in *CentreVu* Supervisor. The display can be set to any one or a combination of {name} for Dictionary Name, {entity} for entity type, and {number} for entity number.

To define the name format for entities, do the following steps:

1. Select the item for which you want to set formats from the Entity box.
2. In the Format text box:

3. Do either of the following actions:
  - Type the format that you want ({name}, {entity}, and/or {number}), or
  - Use the drop-down list to choose from a set of preformatted options.  
For example, if you want to display agent names and extension numbers on reports, enter {name} {number} in the Format box.  
The Example box provides an example of what the format will look like based on your current definition of the name format.
4. Select OK to save your changes. Select Cancel to clear your changes.

See [Create a New Name Format \(2-87\)](#) for information on creating a new report name format.



## Create a New Report Color Scheme

**Overview** The procedure in this section describes how to create a new report color scheme.

If you do not save the new color scheme using the Save As button, the changes that you made will overwrite the default color scheme that you modified.

### Procedure

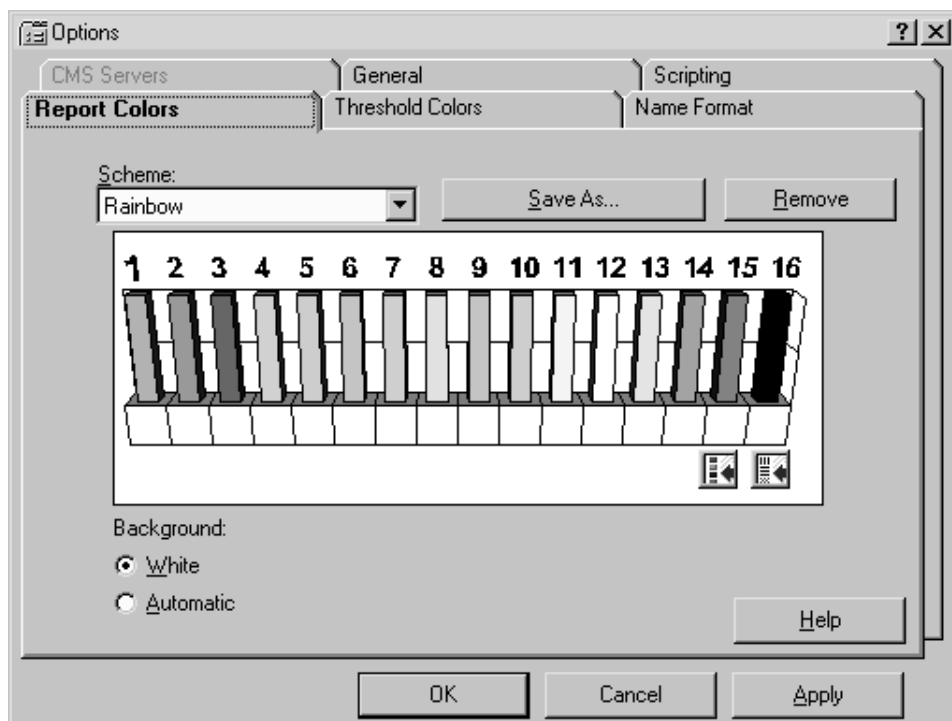

Use the following procedure to create a new report color scheme:

1. Choose Options from the Tools menu, or select the Options button from the toolbar.
2. Select the Report Colors tab.
3. Select the color scheme with which you want to begin from the Scheme: drop-down list.  
The view of the scheme displays.
4. Choose the Background color for reports by selecting White or Automatic.
5. Click on the color bar (1 through 16) you want to modify.
6. Select either the Color Selector or the Pattern Selector button.

If you select the Color Selector button, the following window displays:

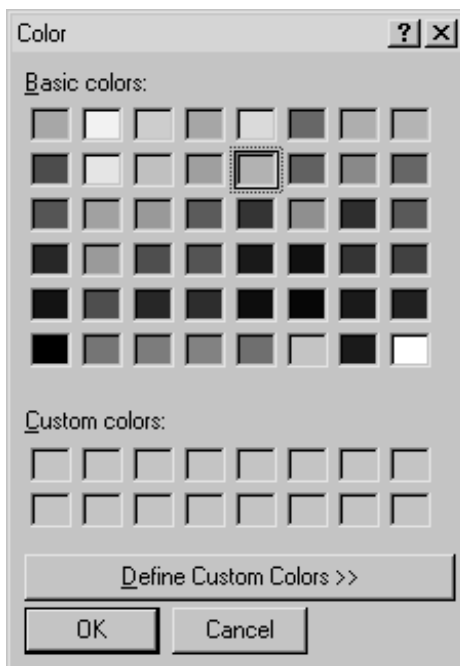

If you select the Pattern Selector button, the following selection box displays:

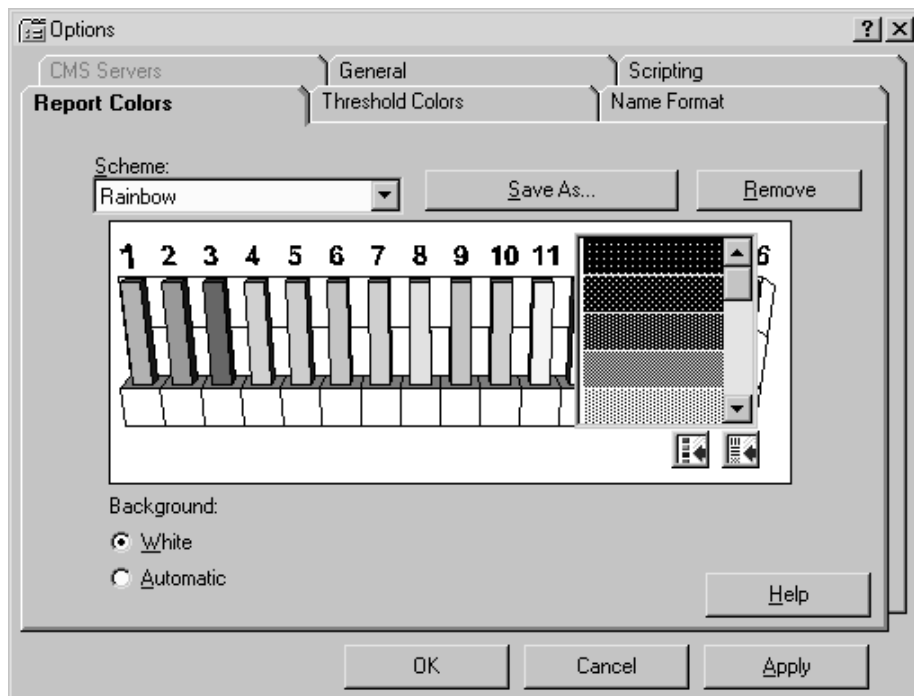

7. To select a new color, choose from the Basic colors palette, or create a custom color using standard *Windows* procedures.

8. To select a new pattern, click on the pattern you want to use.
9. Repeat steps 5 through 7 until you have updated all of the color bars that you want to modify.
10. When you are done modifying color bars, select Save As.  
The following window displays:

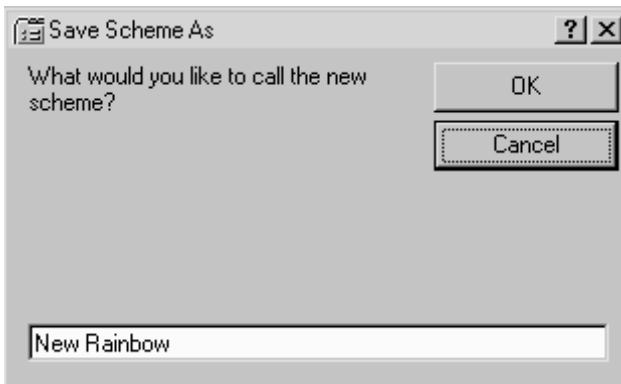

11. Type the name of the report color scheme that you created in the text box.
12. Select OK to save the scheme and the scheme name.

**Important!** You can view the changes that you made to a color scheme at any point in the modification by selecting Apply. When you do this, the current color scheme is applied to any reports that are running.



## Create a New Threshold Color Scheme

**Overview** The procedure in this section describes how to create a new threshold color scheme.

### Procedure

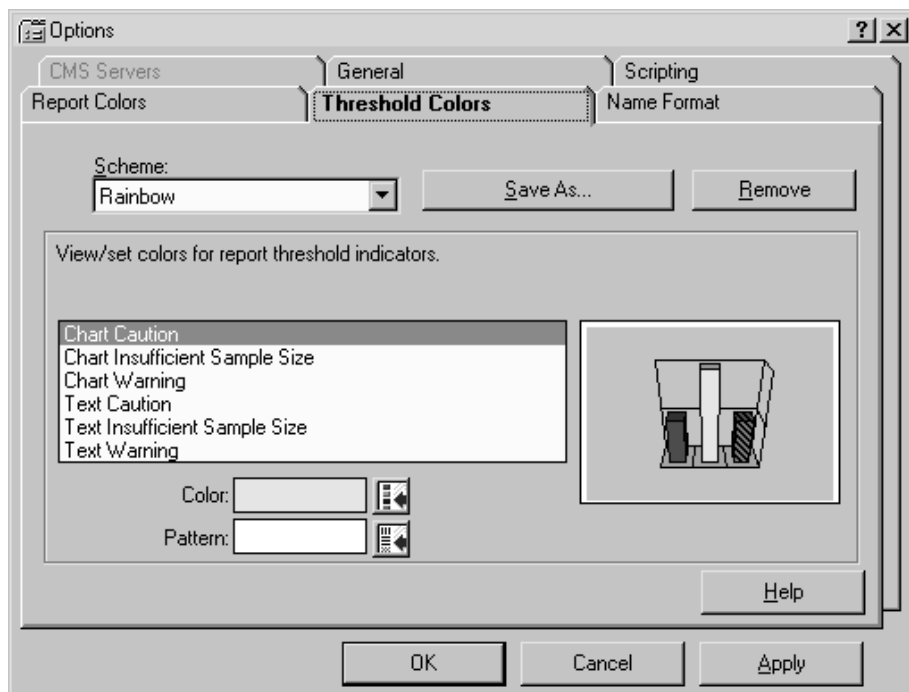

To create a new threshold color scheme for reports, do the following steps:

1. Choose Options from the Tools menu, or select the Options button on the toolbar.
2. Select the Threshold Colors tab.
3. Select the color scheme with which you want to begin from the Scheme: drop-down list.  
The view of the scheme displays.
4. Select the element of threshold highlighting that you want to modify colors for from the list box (Chart Caution, Chart Insufficient Sample Size, Chart Warning, Text Caution, Text Insufficient Sample Size, Text Warning).  
The current setting for the element displays to the right of the list box.
5. Set the color that will be displayed as text:

6. Use the following steps:
  - Select the Color Selector button next to the Text display box.  
The following window displays:

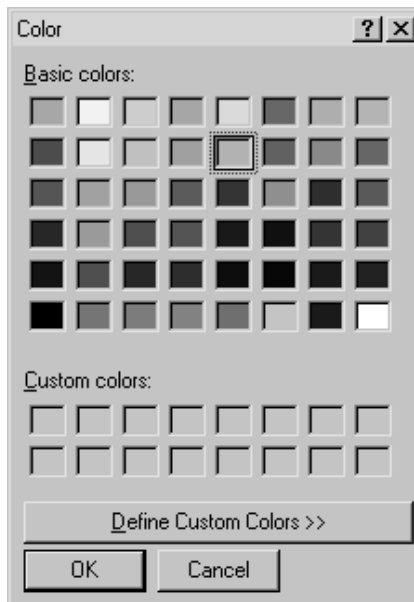

- Choose a color from the Basic colors palette, or create a custom color using standard *Windows* procedures.
  - Select OK when you are done.  
The Options window displays.
7. Set the color that will be displayed as the background on the threshold element:
  8. Use the following steps:
    - Select the Color Selector button next to the Background display box.  
The Color palette displays.
    - Choose a color from the Basic colors palette or create a custom color using standard *Windows* procedures.
    - Select OK when you are done.  
The Options window displays.
  9. Repeat steps 4 through 6 until you have updated all of the threshold element colors that you want to modify.
  10. When you are done modifying the threshold element colors, select Save As.

The following window displays:

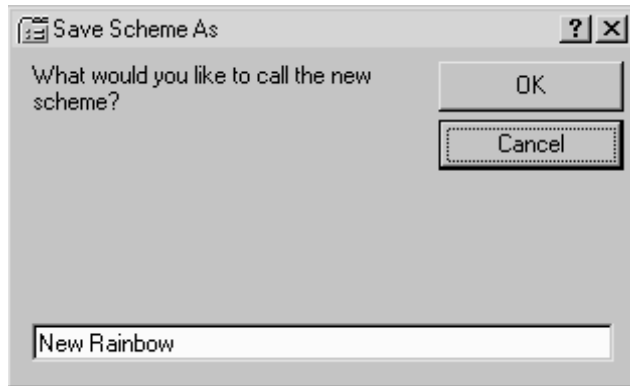

11. Type the name of the threshold color scheme that you created in the text box.
12. Select OK to save the scheme and the scheme name.

**Important!** You can view the changes that you made to a color scheme at any point in the modification by selecting Apply. When you do this, the current color scheme is applied to any threshold highlights that are displayed on running reports.





---

## Create a New Name Format

---

**Overview** The procedure in this section describes how to create a new report name format.

**Procedure** To create a new name format, do the following steps:

1. Choose Options from the Tools menu, or select the Options button on the toolbar.
2. Select the Name Format tab.
3. Select the Entity for which you want to change the name format.
4. In the Format text box, use the drop-down list to select one of the standard formats, or type in a name combination.
5. Select OK.

If you typed a nonstandard name format in Step 4, the format is not saved in the Format list as a standard option.

6. To select another name format, go to the Name Format tab, select the format, and then select OK.





# 3 Real-Time Reports

## Overview

---

**Purpose** This chapter is written for *CentreVu* Supervisor supervisors and administrators who use the real-time report subsystem to generate reports. Real-time reports can be displayed on your PC, printed, stored to a file, copied to a clipboard, run as a Script, or exported to HTML format through the Save as HTML feature.

**Introduction** This chapter gives you the information you need to understand every real-time report available on *CentreVu* Supervisor.

*CentreVu* Supervisor real-time reports give supervisors snapshots of the call center's performance and status. Abandoned calls, for example, can be monitored to determine the waiting-for-service tolerance of callers and compared to the number of calls in queue. Additionally, agent productivity can be compared at a glance to determine who may need help in speeding after call work.

Standard real-time reports:

- Show the current status of ACD activity. The types of data for reports are status, cumulative, and administrative. (See the *CentreVu® CMS R3V8 Database Items and Calculations (585-210-939)* document for a description of these data types.)
- Display data for the current interval for agent, split/skill, trunk/trunk group, vector, and VDN activities, such as number of ACD calls, abandoned calls, average talk time, and so on. All database items and calculations that are used for real-time reports are taken from the current interval tables.
- You assign the length of the current interval for real-time ACD data in the System Setup: Storage Intervals window. See the *CentreVu® CMS R3V8 Administration (585-210-910)* document for more information.

The Expert Agent Selection (EAS), Vectoring, and Graphics reports are also included in this chapter. If you do not have the Expert Agent Selection feature, Vectoring feature, or Graphics package, those report items do not appear on your menu. The reports you see depend on your switch type, permissions, and system performance.

### Organization of Real-Time Reports

The following topics are covered:

- [Agent reports \(3-4\)](#)
- [Other Reports \(3-22\)](#)
- [Queue/Agent Reports \(3-41\)](#)
- [Split/Skill Reports \(3-58\)](#)
- [Trunk Group Report \(3-144\)](#)

- [VDN Reports \(3-148\)](#)
- [Vector Report \(3-164\)](#)
- [Drill-Down Reports \(3-168\)](#).

**Presentation** This chapter gives a brief description of each available report and definitions of the input fields. It provides you with the information you need to complete any real-time report input screen.

Each report description has the following headings:

- **Things to Know About All Real-Time Reports:** gives you information on factors that affect the real-time reports.
- **Input Window:** includes input field definitions for each type of real-time report. The input window is shown at the beginning of each section of reports (agent, split/skill, and so on).
- **Sample Report:** provides an example of the report. A table provides report headings, field definitions, and the corresponding database item.

A short summary and example of each *CentreVu* Supervisor real-time report is included in this chapter. When you generate a real-time report, the totals for the report columns are on the top line of the report under the headings.

**Diagram of Real-Time reporting system** The following diagram shows how the Real-Time reporting system is structured. This section follows the report structure outlined in this diagram-agent reports are described first, followed by other reports, etc.

*Real-Time Reports*

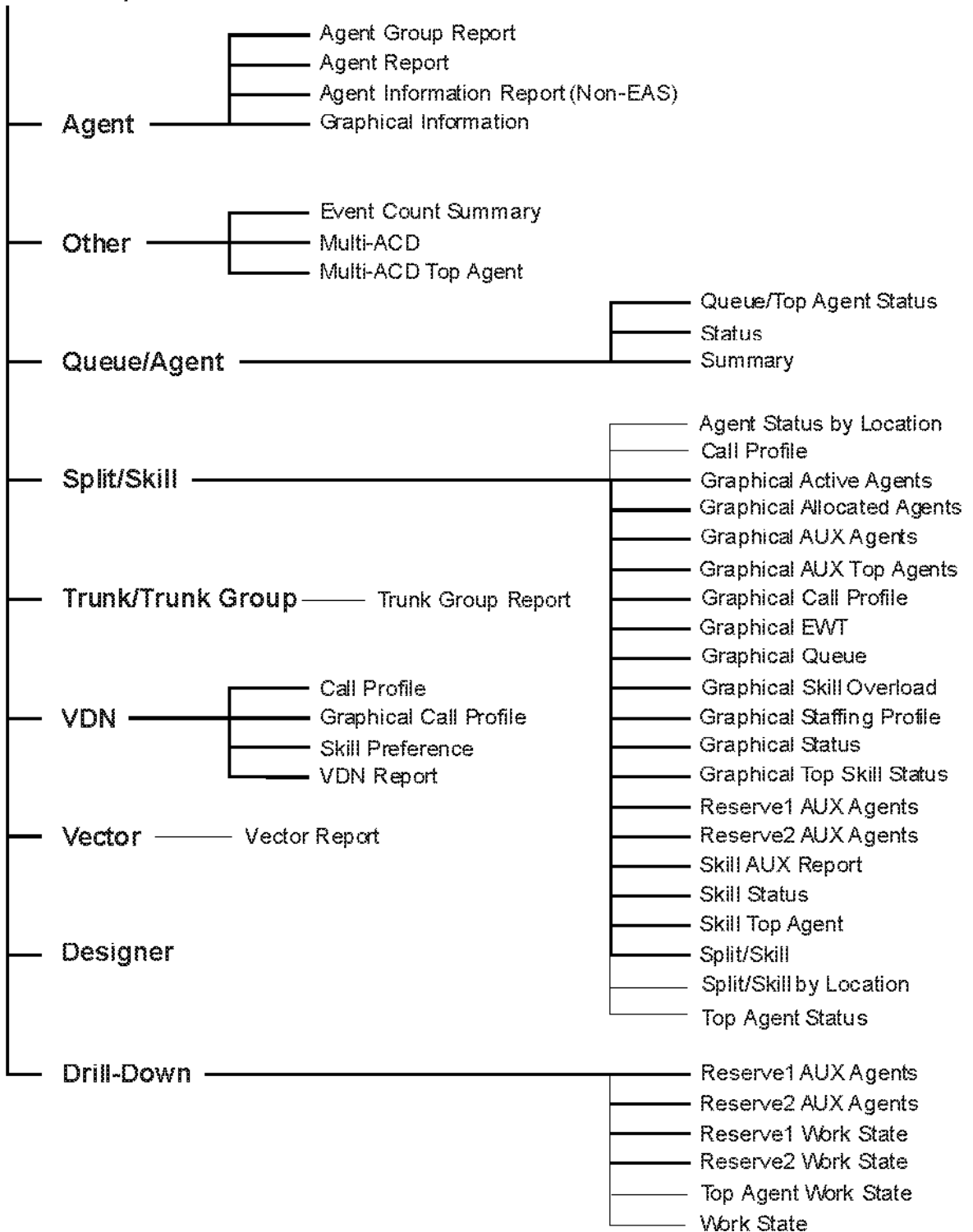

---

# Agent reports

## Overview

---

**Purpose** This section discusses agent reports.

**Organization** This following topics are described:

- [General Information About Agent Reports \(3-5\)](#)
- [Agent Report Input Windows \(3-6\)](#)
- [Agent Group Report \(3-7\)](#)
- [Agent Report \(3-10\)](#)
- [Agent Information Report \(3-13\)](#)
- [Graphical Information Report \(3-17\)](#).



# General Information About Agent Reports

- What an Agent report contains** The Agent reports give you the following specific information about agents:
- The agents according to groups you have created in the Dictionary subsystem.
  - The current activities of all agents assigned to a split or skill.
  - Real-time information and statistics for a specified agent.
- Organization of Agent reports** The following list shows how the Agent reports are organized in *CentreVu* Supervisor:
- Agent Group
  - Report
  - Agent Information (non-EAS)
  - Graphical Information
- Agent report selector window** The following figure is an example of the Agent Report selector window. The reports are explained in the same order as listed in the window.

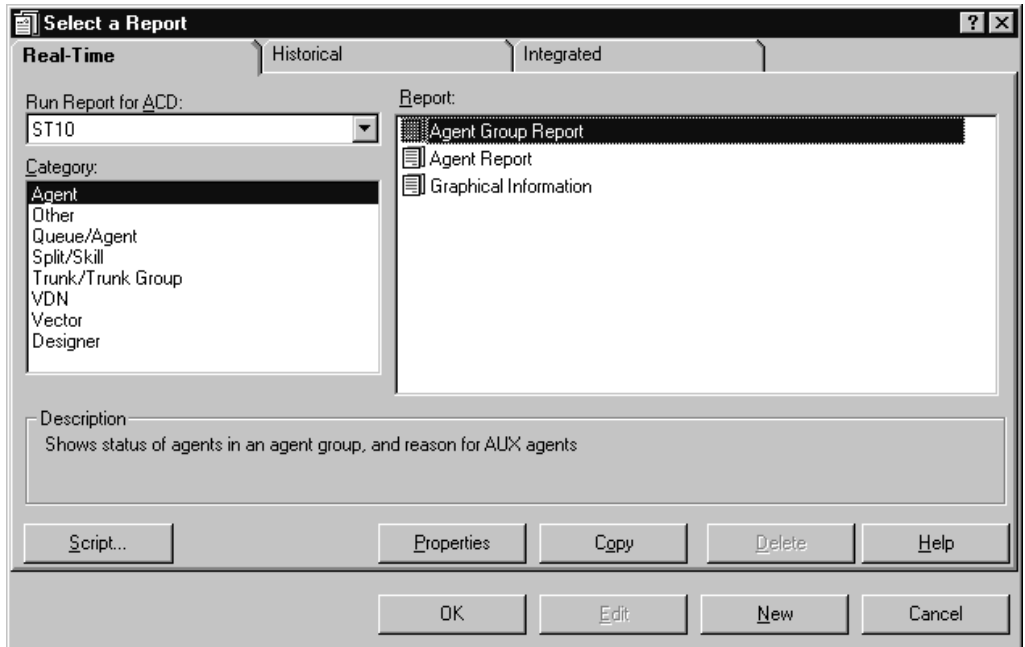

## Agent Report Input Windows

**Overview** The reports in this section use the Agent Report Input Windows. Specific input information is included with the reports.

**Agent report input fields** The following table describes the input fields on real-time Agent report input windows. Not all reports use all fields; refer to information for the specific report you are running to determine what you want to view. For example, you may enter an agent group, agent name or split/skill to run the report.

Field	Definition
Agent group:	Enter the name of the group that you want to view. Any name(s) that you want to appear on the report must have been previously defined and entered in the Dictionary subsystem.
Agent: or Agent Name:	Enter the name of the agent. The agent's name must be defined in the Dictionary subsystem; otherwise, you will see the agent Login IDs.
Split/Skill:	Enter the split or skill name or number that you want to view in this report. Any name(s) that you want to appear on the report must have been previously defined and entered in the Dictionary subsystem.
Refresh Every <#> Seconds:	Enter the number of seconds (3 to 600) to specify how rapidly CMS should update the report data. The default for the Refresh Every <#> Seconds field in this window is your assigned minimum refresh rate plus 15 seconds. To find out what your minimum refresh rate is, or to change it, check with your CMS administrator.
Enable Report Thresholds	Check the Enable Report Thresholds option to start the report with report thresholds running. Uncheck the option if you do not want to run report thresholds.
Run Minimized	Click the Run Minimized option to run the report in a minimized window. Uncheck the option to run the report at full size.





# Agent Group Report

**Overview** The Agent Group Report allows you to view agents according to groups you have created in the Dictionary subsystem. For example, these groups could be new agents, agents with specific extension numbers, or any grouping that fits your call center's needs.

- Things to know about this report** Here are some things you need to know about this report:
- Only one agent group displays on this report. If you want to compare groups, you can bring up two reports separately and toggle between the reports.
  - Only the agents logged in and assigned to the group display in the report.
  - The database items used for the Agent Group report are stored in the `cagent` table.
  - This report uses the Agent Group input window. Select an agent group to view on the report. See [Agent Report Input Windows \(3-6\)](#) for more information.

**Agent Group report example** The following figure provides an example of the Agent Group report:

The screenshot shows a window titled "Agent Group Report - Group1" with a menu bar (Report, Edit, Format, Tools, Options, Help). Below the menu bar, it says "Agent Group: Group1". The main area contains a table with the following data:

Agent Name	Login ID	Extn	AUX Reason	State	Split/Skill Time	VDN Name
agent5	50005	0005		AVAIL	11:25	
agent1	50001	0001		AVAIL	8:08	
agent4	50004	0004		AVAIL	6:54	
agent3	50003	0003		AVAIL	3:05	
agent6	50006	0006		AVAIL	2:25	
agent2	50002	0002		AVAIL	49:25	

At the bottom of the window, there is a status bar with the text "Double Click To Run Format Table" and "Thresholds: On r6\_dads1 eas".

**Agent Group report input fields** See agent input fields.

**Agent Group report description** The following table describes the report fields:

Field	Definition	Database Item, Calculation, or <Calculation Name>
Agent Group	The name of the group of agents. You can make this selection in the report input window.	No database item or calculation.
Agent Name	The name(s) of the agent(s) assigned to this split/skill and logged in (or their login IDs if names have not been assigned to them in Dictionary).	syn(LOGID)
Login ID	The login identification of the agent.	LOGID
Extn	The extension the agent logged in from.	EXTENSION
AUX Reason	The reason associated with the auxiliary work state of this agent (for example, lunch, break, meeting, or training). This field is blank if the agent is not in the AUX state.	AUXREASON
State	The current work mode (state) that the agent is in (AVAIL, ACD, ACW, AUX, DACD, DACW, RINGING, UNKNOWN, OTHER, UNSTAFF) and the call direction (blank, IN or OUT).	AWORKMODE and DIRECTION
Split/Skill	<p>When an agent is on a split/skill call, a direct agent call, or in After Call Work associated with the call or the ACW, WORKSKILL is the OLDEST_LOGON:</p> <ul style="list-style-type: none"> <li>When an agent is on an AUXIN/AUXOUT call from the available state, while in AUX or with an AUXIN/AUXOUT call on hold</li> <li>When an agent is on an AUXIN call with an ACD call on hold.</li> </ul> <p>When an agent is on an AUXOUT call with an ACD call on hold, this is the split/skill associated with the ACD call. When an agent is available, in AUX, or in OTHER, this is blank.</p>	WORKSKILL
Time	The elapsed time since the last agent WORKMODE change for any split/skill. This item is not reset if the DIRECTION changes, but WORKMODE remains the same. For example, if the agent goes from AUX to AUXOUT to AUX, AGTIME continues without resetting.	AGTIME

Field	Definition	Database Item, Calculation, or <Calculation Name>
VDN Name (Shows data only if you have the Vectoring feature)	The number or name of the VDN for which the report shows data. The Vector Directory Number (VDN) is associated with the ACD call in progress. If a name has been assigned to the VDN in the Dictionary, the name displays instead of the number.	syn(VDN)



# Agent Report

**Overview** The Agent report displays the current activities of all agents assigned to a split or skill. It shows the extension from which the agent logged in, the agent's work state, how long the agent has been in that work state, and the split or skill in which the agent is currently working. This report also gives you VDN information (if you have the Vectoring feature).

**Things to know about this report** Here are some things you need to know about this report:

- Only the agents currently assigned and logged into the split/skill display on this report.
- The database items used for the Agent Report are stored in the cagent table.
- This report uses the Agent Input Window. Select a split/skill that you want to view on the report. See [Agent Report Input Windows \(3-6\)](#) for more information.

**Agent report example** The following figure provides an example of the Agent report.

Agent Name	Login ID	Extn	AUX Reason	State	Split/Skill	Time	VDN Name
29039	29039	26039		AVAIL		*****	
29029	29029	26029		AVAIL		*****	
29055	29055	26055		AVAIL		*****	
29082	29082	26082		AVAIL		*****	
29080	29080	26080		AVAIL		*****	
29043	29043	26043		AVAIL		*****	
29040	29040	26040		AVAIL		*****	
29032	29032	26032		AVAIL		*****	
29031	29031	26031		AVAIL		*****	
29068	29068	26068		AVAIL		*****	

**Agent report input fields** See agent input fields.

**Agent report description** The following table describes the report fields:

Field	Definition	Database Item, Calculation, or <Calculation Name>
Split/Skill	The name or number of the split/skill selected for this report.	syn(SPLIT)
Agent Name	The name(s) of the agent(s) assigned to this split/skill and logged in (or their login IDs if names have not been assigned to them in Dictionary).	syn(LOGID)
Login ID	The login identification of the agent.	LOGID
Extn	The extension that the agent logged in from.	EXTENSION
AUX Reason	The reason associated with the auxiliary work state of this agent (for example, lunch, break, meeting, or training). This field is blank if the agent is not in the AUX state.	AUXREASON
State	The current work mode (state) that the agent is in (AVAIL, ACD, ACW, AUX, DACD, DACW, RINGING, UNKNOWN, OTHER, UNSTAFF) and the call direction (blank, IN or OUT).	AWORKMODE and DIRECTION
Split/Skill	<p>When an agent is on a split/skill call, a direct agent call, or in After Call Work associated with the call or the ACW. WORKSKILL is the OLDEST_LOGON:</p> <ul style="list-style-type: none"> <li>• When an agent is on an AUXIN/AUXOUT call from the available state, while in AUX or with an AUXIN/AUXOUT call on hold</li> <li>• When an agent is on an AUXIN call with an ACD call on hold.</li> </ul> <p>When an agent is on an AUXOUT call with an ACD call on hold, this is the split/skill associated with the ACD call. When an agent is available, in AUX, or in OTHER, this is blank.</p>	WORKSKILL

Field	Definition	Database Item, Calculation, or <Calculation Name>
Time	The elapsed time since the last agent WORKMODE change for any split/skill. This item is not reset if the DIRECTION changes, but WORKMODE remains the same. For example, if the agent goes from AUX to AUXOUT to AUX, AGTIME continues without resetting.	AGTIME
VDN Name (Shows data only if you have the Vectoring feature)	The number or name of the VDN for which the report shows data. The Vector Directory Number (VDN) associated with the ACD call in progress. If a name has been assigned to the VDN in the Dictionary, the name displays instead of the number.	VDN



---

# Agent Information Report

---

**Overview** The Agent Information report displays real-time information and statistics for the specified agent.

This version of the Agent Information report is for non-EAS users.

**Things to know about this report** Here are some things you need to know about this report:

- Whenever you drill down to the Real-Time Agent Information report, you can also drill down to the Integrated Agent Information report by clicking the right mouse button.
- This report includes a table that shows all the splits which the agent is logged into. If the agent is assigned to additional splits, but is not logged into those splits, these will not be reflected in this table.
- When this report is accessed from the report selector menu, you need to enter the Agent Name and Login ID input fields.
- When this report is accessed from another report by drilling down, the input fields will be defaulted from the report you are drilling down from.
- The database items used for the Agent Information report are stored in the cagent table.
- This report uses the Agent Information Input Window. Select an agent that you want to view on the report. See [Agent Report Input Windows \(3-6\)](#).

You can access this report as follows:

- From the Real-Time Agent Category selector menu.
- By drilling down from the Agent Name or Login ID fields on other reports (for example, Agent, Agent Group, Graphical AUX Agents Report, Graphical AUX Top Agents Report, or other Real-Time and Integrated reports).

**Agent Information report example** The following figure provides an example of the Agent Information report:

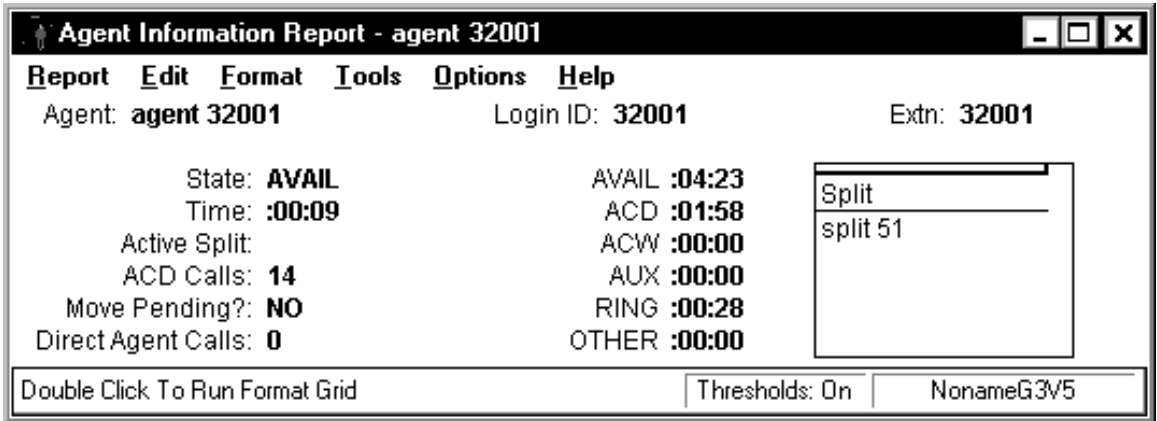

**Agent Information report description** The following table describes the report fields:

Field	Definition	Database Item, Calculation, or <Calculation Name>
Agent Name	The name(s) of the agent(s) assigned to this split/skill and logged in (or their login IDs if names have not been assigned to them in Dictionary).	syn (LOGID)
Login ID	The login identification of the agent.	LOGID
Extn	The extension that the agent logged in from.	EXTENSION
State	The current work mode (state) that the agent is in (AVAIL, ACD, ACW, AUX, DACD, DACW, RINGING, UNKNOWN, OTHER, UNSTAFF) and the call direction (blank, IN or OUT).	AWORKMODE and DIRECTION
Time	The elapsed time since the last agent WORKMODE change for any split/skill. This item is not reset if the DIRECTION changes, but WORKMODE remains the same. For example, if the agent goes from AUX to AUXOUT to AUX, AGTIME continues without resetting.	AGTIME



Field	Definition	Database Item, Calculation, or <Calculation Name>
Active Split	<p>The split is active when the agent is:</p> <ul style="list-style-type: none"> <li>On a split/skill, on a direct agent ACD call, or in ACW-this is the split/skill associated with the call or ACW.</li> <li>Available, in AUX or in OTHER states, this is null (blank).</li> <li>On an AUXIN/AUXOUT call-this is the OLDEST_LOGON split/skill.</li> <li>On an AUXIN/AUXOUT call from the available state, while in AUX or with an AUXIN/AUXOUT call from the available state, while in AUX or with an AUXIN/AUXOUT call on hold-this is the OLDEST_LOGON split/skill.</li> <li>On an AUXIN call with an ACD call on hold-this is the OLDEST_LOGON split/skill.</li> <li>On an AUXOUT call with an ACD call on hold-this is the split/skill associated with the ACD call.</li> </ul> <p>WORKSKILL differs from WORKSPLIT only in the case that the agent is available. In this case, WORKSKILL will be blank and WORKSPLIT will contain one of the splits/skills in which the agent is available.</p>	syn(WORKSKILL)
ACD Calls	The ACD calls that were queued to the split/skill and answered by an agent during the current interval. This does not include direct agent calls, but it does include ACD calls placed by an adjunct (also called outbound predictive dialing), for the Generic 3 with ASAI only.	sum(ACDCALLS)
Move Pending?	A move to a new split or skill or a change of skill is pending for this agent. This is available only for Generic 3 Version 4 and later switch releases with the "Move Agent While Staffed" feature. Values for MOVEPENDING are 0= NO, 1 = YES.	MOVEPENDING
Direct Agent Calls	The total number of split and direct agent calls (Generic 3 switches only) that have been answered by the agent during the current interval. This is the number of calls that the agent answered, not the number of calls for which the agent counted an event.	sum(DA_SKILL)
AVAIL	The time during the collection interval that the agent was in the available state for split or direct agent ACD calls in any split.	sum(TI_AVAILTIME)

Field	Definition	Database Item, Calculation, or <Calculation Name>
ACD	The time during the collection interval that the agent was talking on ACD calls for the SPLIT.	sum (<TOTAL_I_ACDTIME>)
ACW	The time during the collection interval that the agent was in after call work (ACW). This includes ACW for split ACD calls and ACW not associated with the call.	sum(<TOTAL_I_ACWTIME>)
AUX	The time during the collection interval that the agent was in the AUX work state in all splits/skills or on AUXINCALLS or AUXOUTCALLS.	sum(TI_AUXTIME)
RINGING	The time during the collection interval that the agent had split and direct agent ACD calls ringing.	sum(I_RINGTIME)
OTHER	The time during the collection interval that the agent was doing other work in all splits. For Generic 3 switches, while in Auto-in or Man-In: the agent put any call on hold and performed no further action, the agent dialed to place a call or to activate a feature, or an extension call rang with no other activity. For all switches, TI_OTHERTIME is collected for the time period after the switch comes up or after the agent logs in and before the CMS receives notification of the agent's state from the switch. The "TI_" time is stored only for the split/skill logged into the longest. "TI_" time needs to be summed across the splits/skills the agents may log into, in case the logon order changes during the collection interval.	sum(TI_OTHERTIME)
Split	The split number or name that this extension is assigned to or the split number or name that the agent logged into.	syn(SPLIT)



---

# Graphical Information Report

---

**Overview** The Graphical Information report displays real-time information and statistics for the specified agent.

**Things to know about this report** Here are some things you need to know about this report:

- Supervisors can use this report to access further information on one particular agent without having to execute several steps and several different reports to get the pertinent information. This report enables the supervisor to quickly make a more educated decision on whether an agent should be added to or removed from a skill.
- This report is available for all switch releases. The contents of this report depends upon the switch release for which it is being run.
- The database items used for the Graphical Information Report are stored in the cagent table.
- This report uses the Agent Information Input window. Select an agent that you want to view on the report. See [Agent Report Input Windows \(3-6\)](#).

You can access this report in the following ways:

- From the Real-Time Agent Category selector menu.
- By drilling down to this report from the Agent Name or Login ID fields on other reports (for example, Agent Information, Work State, or Graphic AUX Agent reports).

The following example of this report shows the information it will contain for the *DEFINITY* Enterprise Communications Server (ECS) Release 5 switch:

- Graphical information:  
A three-dimensional vertical bar chart, with time (in minutes) along the y-axis, and agent work states along the x-axis. The chart shows how much time (in minutes) during the current interval the agent spent in each of the work states. By default, no legend accompanies the chart.
- Table information:  
A table shows the skill that is assigned to the agent, and the skill level of 1-16 or R1 or R2 (if ECS switch with EAS) or the priority level with "1" representing the primary level, and "2" representing the secondary level (if using a pre-ECS switch with the EAS feature).  
A scroll bar is displayed only if the number of skills to which the agent is assigned exceeds what can be displayed in the table.
- Real-Time report status.

**Graphical Information report example**

The following figure provides an example of the Graphical Information report:

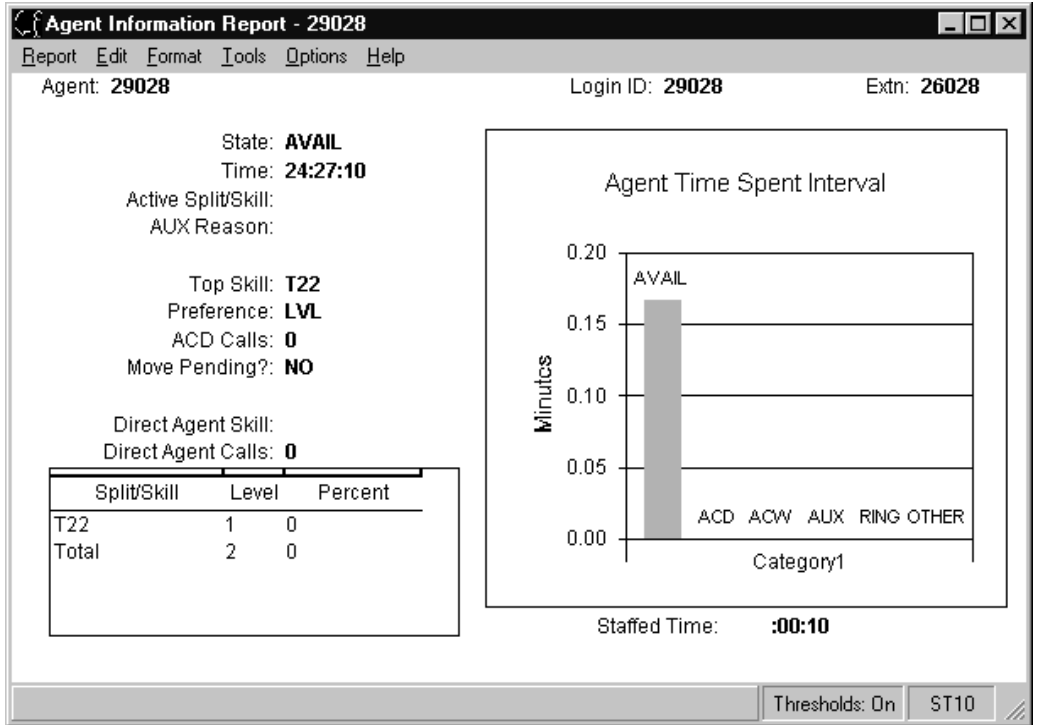

**Graphical Information report description**

The following table describes the report fields:

Field	Definition	Database Item, Calculation, or <Calculation Name>
Agent	The name(s) of the agent(s) assigned to this split/skill and logged in (or their login IDs if names have not been assigned to them in Dictionary).	syn(LOGID)
Login ID	The login identification of the agent.	LOGID
Extn	The extension that the agent logged in from.	EXTENSION
State	The current work mode (state) that the agent is in (AVAIL, ACD, ACW, AUX, DACD, DACW, RINGING, UNKNOWN, OTHER, UNSTAFF) and the call direction (blank, IN or OUT).	AWORKMODE and DIRECTION

Field	Definition	Database Item, Calculation, or <Calculation Name>
Time	The elapsed time since the last agent WORKMODE change for any split/skill. This item is not reset if the DIRECTION changes, but WORKMODE remains the same. For example, if the agent goes from AUX to AUXOUT to AUX, AGTIME continues without resetting.	AGTIME
Active Skill	<p>The skill is active when the agent is:</p> <ul style="list-style-type: none"> <li>• On a split/skill, on a direct agent ACD call, or in ACW. This is the split/skill associated with the call or ACW.</li> <li>• Available, in AUX or in OTHER states. This is null (blank).</li> <li>• On an AUXIN/AUXOUT call. This is the OLDEST_LOGON split/skill.</li> <li>• On an AUXIN/AUXOUT call from the available state, while in AUX or with an AUXIN/AUXOUT call from the available state, while in AUX or with an AUXIN/AUXOUT call on hold. This is the OLDEST_LOGON split/skill.</li> <li>• On an AUXIN call with an ACD call on hold. This is the OLDEST_LOGON split/skill.</li> <li>• On an AUXOUT call with an ACD call on hold. This is the split/skill associated with the ACD call.</li> </ul> <p>WORKSKILL differs from WORKSPLIT only in the case that the agent is available. In this case, WORKSKILL will be blank and WORKSPLIT will contain one of the splits/skills in which the agent is available.</p>	syn(WORKSKILL)
AUX Reason	For the <i>DEFINITY</i> ECS, this is the reason code associated with the auxiliary work state (on a break, in a meeting, and so on) of this agent. This field is blank if the agent is not in the AUX state.	syn(AUXREASON)
Top Skill	The agent's first-administered, highest-level, measured skill, where skill level 1 is the highest, skill level 16 is the lowest. The TOPSKILL of an agent will be 0 except when PREFERENCE is a skill level (LVL). This means that an agent will not have a top skill or be counted in any split table TOPSKILL items if their call handling preference is Greatest Need (NEED) or percent allocation (PCNT). In addition, agents who have skill level preference, but only reserve levels for all their skills, will not have a TOPSKILL.	syn(TOPSKILL)

Field	Definition	Database Item, Calculation, or <Calculation Name>
Call Handling Preference	The agent's call handling preference. Values are blank, skill level (LVL) or greatest need (NEED), or percent allocation (PCNT).	syn(PREFERENCE)
ACD Calls	The ACD calls that were queued to the split/skill and answered by an agent during the current interval. This does not include direct agent calls, but it does include ACD calls placed by an adjunct (also called outbound predictive dialing), for the Generic 3 with ASAI only.	sum(ACDCALLS)
Move Pending?	A move to a new split or skill or a change of skills is pending for this agent. This is available only for Generic 3 Version 4 and later switch releases with the "Move Agent While Staffed" feature. Values for MOVEPENDING are 0= NO, 1 = YES.	MOVEPENDING
Direct Agent Skill	The skill currently assigned as the agent's direct agent skill. Direct agent calls to the agent are queued to this skill.	syn(DA_SKILL)
Direct Agent Calls	The total number of split/skill and direct agent calls (Generic 3 switches only) that have been answered by this agent during the current interval. This is the number of calls that the agent answered, not the number of calls for which the agent counted an event.	sum(DA_ACDCALLS)
Skill	The name or number of the skill that is selected for this report.	syn(SPLIT)
Level	The skill level (1-16, R1 or R2) associated with the SKILL.	syn(LEVEL)
Percent	Agent's percent allocation for this SPLIT. Requires ECS R6 or later with <i>CentreVu Advocate</i> .	PERCENT
AVAIL	The time during the collection interval that the agent was in the available state for split/skill or direct agent ACD calls in any split/skill.	sum(TI_AVAILTIME)
ACD	The total time during the collection interval that the agent was talking on ACD calls for the split.	sum (<TOTAL_I_ACDTIME>)
ACW	The total time during the collection interval that the agent was in after call work (ACW). This includes ACW for split/skill ACD calls and ACW not associated with the call.	sum(<TOTAL_I_ACWTIME>)

Field	Definition	Database Item, Calculation, or <Calculation Name>
AUX	The total time during the collection interval that the agent was in the AUX work state in all splits/skills or on AUXINCALLS or AUXOUTCALLS.	sum(TI_AUXTIME)
RINGING	The time during the collection interval that the agent had split/skill and direct agent ACD calls ringing.	sum(I_RINGTIME)
OTHER	The time during the collection interval that the agent was doing other work in all splits/skills. For Generic 3 switches, while in Auto-in or Man-In: the agent put any call on hold and performed no further action, the agent dialed to place a call or to activate a feature, or an extension call rang with no other activity. For all switches, TI_OTHERTIME is collected for the time period after the link to the switch comes up or after the agent logs in and before the CMS receives notification of the agent's state from the switch. The "TI_" time is stored only for the split/skill logged into the longest. "TI_" time needs to be summed across the splits/skills the agents may log into, in case the logon order changes during the collection interval.	sum(TI_OTHERTIME)
Staffed Time	The time during the collection interval that the agent was staffed in any split/skill. "TI_" time is recorded only for the split/skill logged into the longest amount of time. "TI_" time needs to be summed across the splits/skills the agents may log into, in case the login order changes during the collection interval.	sum(TI_STAFFTIME)



---

# Other Reports

## Overview

---

**Purpose** This section discusses other reports.

**Organization of this section** This section contains the following topics:

- [General Information About Other Reports \(3-23\)](#)
- [Event Count Summary Report \(3-24\)](#)
- [Multi-ACD Report \(3-27\)](#)
- [Multi-ACD Top Agent Report \(3-35\)](#).





## General Information About Other Reports

- What Other reports contain** The Real-Time Other reports give you the following specific information about:
- A summary of the number of times during the current interval that an agent in a split/skill pressed any of the nine event count keys while on an ACD call or in call-related after call work.
  - Real-time call-handling information.
  - Skill information for skills from multiple ACDs.

- Organization of Other reports** The following list shows how the Other reports are structured in *CentreVu* Supervisor:
- Event Count
  - Multi-ACD
  - Multi-ACD Top Agent.

- Other report selector window** The following figure is an example of the Other Report Selector window. The reports are explained in the same order as listed in the window.

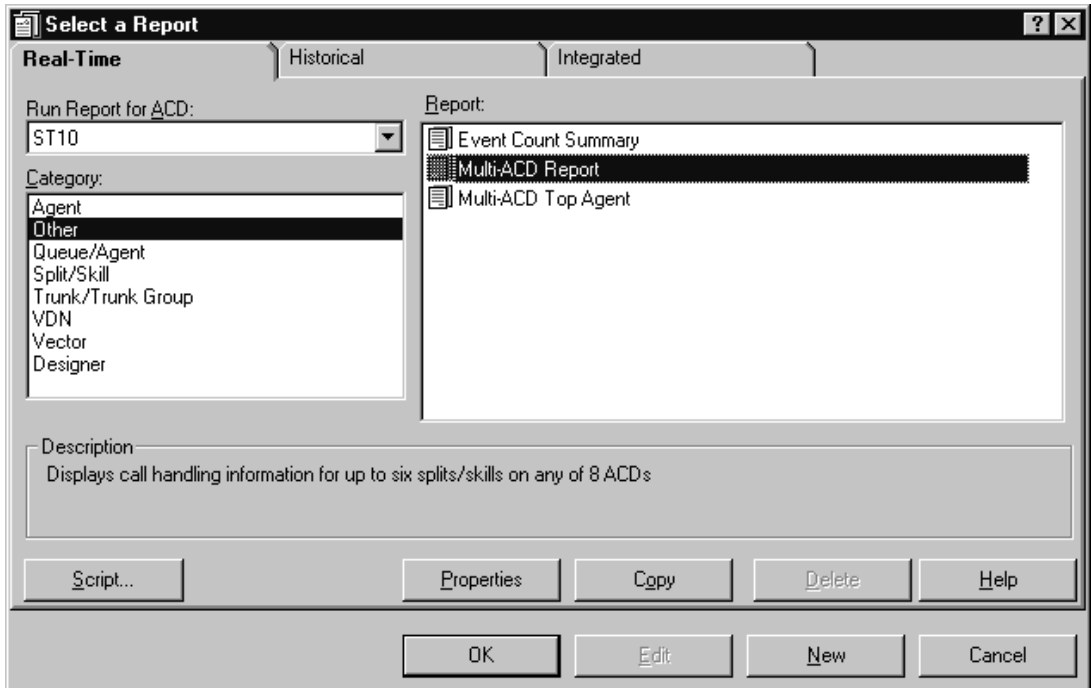

# Event Count Summary Report

---

**Overview** The Event Count Summary report displays the number of times during the current interval that an agent in a split/skill pressed any of the nine event count keys while on an ACD call or in call-related ACW.

- Things to know about this report** Here are some things you need to know about this report:
- You can define event keys to represent any kind of event you want (for example, the number of calls generated from an advertisement, promotion, or geographic area).
  - Event counts are only recorded while an agent is on an ACD call or in call-related ACW. If an agent is in AUTO-IN mode, the ACD call terminates when the caller hangs up, and an event count cannot be recorded after the caller hangs up. To track event counts, it is recommended that agents use the MANUAL-IN mode because the agent goes to ACW when the caller hangs up, allowing the agent to enter an event count.
  - This report is available with *DEFINITY* ECS Generic 3 switches only.
  - The database items used for the Trunk Group report are stored in the `cspLit` table

**Relationships to other subsystems** Event 0, audio difficulty, is used in the trunk and trunk group exception reports.

**Event Count Summary input window** The following figure shows an example of the Event Count Summary input window. You must fill in the report input window to run the report.

**Event Count Summary**

Inputs

Split/Skill: 1

Real-Time Options

Refresh Every 18 Seconds

Enable Report Thresholds

Run Minimized

OK Cancel Help

ST10

**Event Count Summary input fields**

The following table describes the input fields on real-time Event Count Summary report input windows:

Field	Definition
Split/Skill:	Fill in the split or skill name or number for which you want to run the report. You can enter a split/skill name only if the name has been defined in Dictionary.
Refresh Every <#> Seconds:	Enter the number of seconds (3 to 600) to specify how rapidly <i>CentreVu</i> CMS should update the report data. The default for the Refresh Every <#> Seconds: field in this window is your assigned minimum refresh rate plus 15 seconds. To find out what your minimum refresh rate is, or to change it, check with your <i>CentreVu</i> CMS administrator.
Enable Report thresholds	Check the Enable Report thresholds option to start the report with report thresholds running. Uncheck the option if you do not want to run report thresholds.
Run Minimized	Check the Run Minimized option to run the report in a minimized window. Uncheck the option to run the report at full size.

**Event Count Summary report example**

The following figure provides an example of the Event Count Summary report:

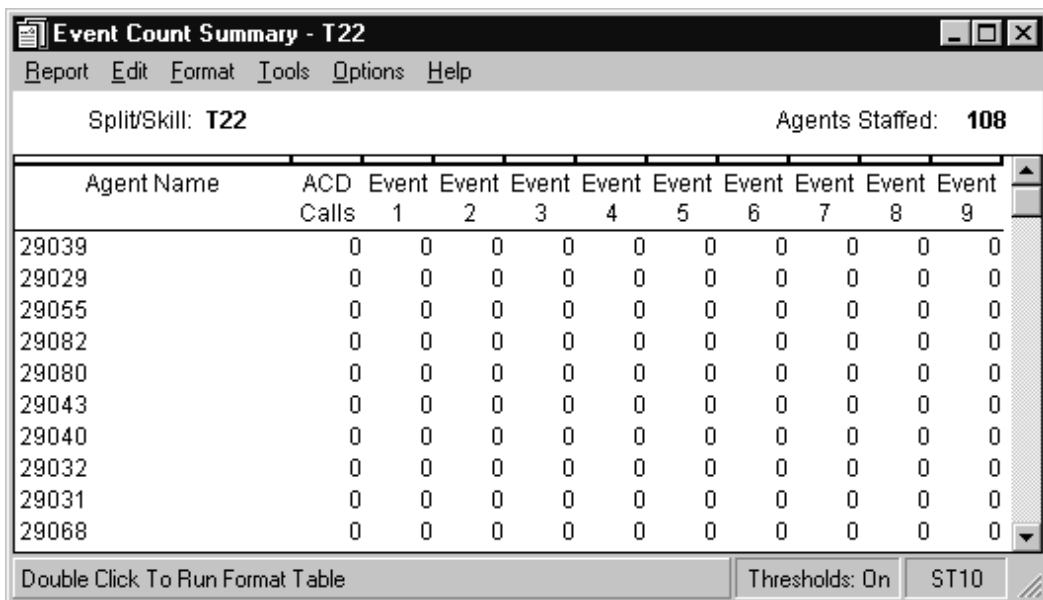

**Event Count Summary report description** The following table describes the report fields:

Report Heading	Description	Database Item, Calculation, or <Calculation Name>
Split/Skill	The name or number of the split(s)/skill(s) that is selected for this report.	syn(SPLIT)
Agents Staffed	The total number of agents that are logged into each split/skill.	STAFFED
Agent Name	The name(s) of the agent(s) assigned to this split/skill and logged in (or their login IDs if names have not been assigned to them in Dictionary).	syn(LOGID)
ACD Calls	The total number of split/skill and direct agent calls (Generic 3 switches only) that were answered by this agent. This is the number of calls that the agent answered, not the number of calls for which the agent counted an event.	ACDCALLS + DA_ACDCALLS <TOTAL_ACDCALLS>
Event 1 ... 9	The number of times during the specified time period that this agent entered each event count (1 - 9) while on ACD calls or in ACW associated with an ACD call for this split/skill recorded during this interval.	EVENT1 ... 9



---

# Multi-ACD Report

---

**Overview** This report displays real-time call-handling information. This information can be requested simultaneously for up to eight splits/skills and up to eight ACDs. This report allows you to evaluate and compare similar splits/skill information in different ACDs. With this information you can determine workload and call-handling performance, agent reassignment, or other ACD configuration alternatives to balance workloads and reduce abandoned calls

- Things to know about this report** Here are some things you need to know about this report:
- The Multi-ACD report appears on the real-time reports menu even if you have only one real ACD installed on your *CentreVu* CMS.
  - The database items used for the Multi-ACD Report are stored in the `csplit` table.
  - This report can include information on up to eight ACDs.

**Multi-ACD report input window**

The following figure shows an example of the Multi-ACD Report input window. You must fill in the report input window to run the report.

**Multi-ACD Report**

Inputs

ACD: ST10

Split/Skill: sp998

ACD(2): ST11

Split/Skill(2): BSR

ACD(3): ST10

Split/Skill(3): T26

ACD(4): (none)

Split/Skill(4):

ACD(5): (none)

Split/Skill(5):

ACD(6): (none)

Split/Skill(6):

ACD(7): (none)

Split/Skill(7):

Real-Time Options

Refresh Every 18 Seconds

Enable Report Thresholds

Run Minimized

OK Cancel Help

**Multi-ACD report Input Fields** The following table describes the input fields on real-time Multi-ACD report input windows:

Field	Definition
First through Eighth ACD:	Fill in the names or numbers of the First through Eighth ACD(s) for which you want to run the report. You can enter an ACD name only if the name has been defined in Dictionary.
Split/Skill:	Fill in the names or numbers of the Split/Skill(s) for which you want to run the report. You can enter a split/skill name only if the name has been defined in Dictionary.
Refresh Every <#> Seconds:	Enter the number of seconds from 3 to 600, to specify how rapidly <i>CentreVu</i> CMS should update the report data. The default for the Refresh Every <#> Seconds field in this window is your assigned minimum refresh rate plus 15 seconds. To find out what your minimum refresh rate is, or to change it, check with your <i>CentreVu</i> CMS administrator.
Enable Report Thresholds	Check the Enable Report thresholds option to start the report with report thresholds running. Uncheck the option if you do not want to run report thresholds.
Run Minimized	Check the Run Minimized option to run the report in a minimized window. Uncheck the option to run the report at full size.

**Multi-ACD report example**

The following figure provides an example of the Multi-ACD report:

ACD:	ST10	ST10	ST10	ST10	ST10	ST10	ST10
Split/Skill:	sp998	sp998	sp998	sp998	sp998	sp998	sp998
Skill State:	NORMAL	NORMAL	NORMAL	NORMAL	NORMAL	NORMAL	NORMAL
Calls Waiting:	0	0	0	0	0	0	0
Oldest Call Waiting:	:00	:00	:00	:00	:00	:00	:00
Avg Speed Ans:							
EWT Top:							
EWT High:							
EWT Medium:							
EWT Low:							
ACD Calls:	0	0	0	0	0	0	0
Avg ACD Time:							
Aban Calls:	0	0	0	0	0	0	0
Avg Aban Time:							
Agents Avail:	0	0	0	0	0	0	0
Agents Ringing:	0	0	0	0	0	0	0
Agents on ACD Calls:	0	0	0	0	0	0	0
Agents in ACW:	0	0	0	0	0	0	0
Agents in Other:	0	0	0	0	0	0	0
Agents in AUX:	0	0	0	0	0	0	0
Agents Staffed:	0	0	0	0	0	0	0

Thresholds: On ST10

**Multi-ACD report description**

The following table describes the report fields:

Report Heading	Description	Database Item, Calculation, or <Calculation Name>
Split/Skill	The name(s) or number(s) of the splits/skills selected for this report.	syn(SPLIT)
ACD	The name or number of the ACD for which the data was selected.	syn(ACD)
Skill State	The current state of the skill, compared to the administered thresholds. This displays as Normal, Overload 1, and Overload 2 on the report. Requires <i>DEFINITY</i> ECS R6 or later with <i>CentreVu</i> Advocate.	SKSTATE
Calls Waiting	The number of split/skill ACD calls waiting to be answered. This includes calls that are in queue and calls that are ringing at an agent voice terminal. It does not include direct agent calls for the <i>DEFINITY</i> ECS Generic 3 switch.	INQUEUE+ INRING



Report Heading	Description	Database Item, Calculation, or <Calculation Name>
Oldest Call Waiting	The length of time (in seconds) the oldest ACD call has waited in queue or ringing before being answered. This does not include direct agent calls.	OLDESTCALL
Avg Speed Answer	The average time calls waited in queue and ringing before an agent answered. This does not include direct agent calls, but it does include outbound ACD calls placed by an adjunct (also called outbound predictive dialing), for the Generic 3 with the ASAI only.	ANSTIME/ ACDCALLS <AVG_ANSWER_SPEED>
EWT Top	This heading contains EWT for the split/skill at top priority. EWT is the wait time for the call when it is queued to the split/skill at the top priority. EWT measures only the time it takes to deliver the call to an agent. It does not include ringing time. If <i>CentreVu</i> CMS is connected to a switch previous to the Generic 3 Version 4 or if vectoring is not activated, the EWT headings and columns are displayed, but the fields are blank. Exception thresholds for EWT can be set from the Exceptions command.	EWTTOP
EWT High	This heading contains EWT for the split/skill at high priority. EWT is the wait time for the call when it is queued to the split/skill at high priority. EWT measures only the time it takes to deliver the call to an agent. It does not include ringing time. If <i>CentreVu</i> CMS is connected to a switch previous to the Generic 3 Version 4 or if vectoring is not activated, the EWT headings and columns are displayed, but the fields are blank. Exception thresholds for EWT can be set from the Exceptions command.	EWTHIGH

Report Heading	Description	Database Item, Calculation, or <Calculation Name>
EWT Medium	This heading contains EWT for the split/skill at medium priority. EWT is the wait time for the call when it is queued to the split/skill at medium priority. EWT measures only the time it takes to deliver the call to an agent. It does not include ringing time. If <i>CentreVu</i> CMS is connected to a switch previous to the Generic 3 Version 4 or if vectoring is not activated, the EWT headings and columns are displayed, but the fields are blank. Exception thresholds for EWT can be set from the Exceptions command.	EWTMEDIUM
EWT Low	This heading contains EWT for the split/skill at low priority. EWT is the wait time for the call when it is queued to the split/skill at low priority. EWT measures only the time it takes to deliver the call to an agent. It does not include ringing time. If <i>CentreVu</i> CMS is connected to a switch previous to the Generic 3 Version 4 or if vectoring is not activated, the EWT headings and columns are displayed, but the fields are blank. Exception thresholds for EWT can be set from the Exceptions command.	EWTLOW
ACD Calls	The ACD calls that were queued to the split/skill and answered by an agent. This does not include direct agent calls, but it does include ACD calls placed by an adjunct (also called outbound predictive dialing), for the Generic 3 switches with the ASAI feature only.	ACDCALLS
Avg ACD Time	The average talk time for all ACD calls to this split/skill. This does not include hold time or time on direct agent calls, but it does include talk time of all outbound ACD calls placed by an adjunct (also called outbound predictive dialing) for the Generic 3 switches with the ASAI feature only.	ACDTIME/ ACDCALLS <AVG_ACD_TALK_TIME>

Report Heading	Description	Database Item, Calculation, or <Calculation Name>
Aban Calls	The total number of queued calls for each split/skill that abandoned before an agent answered. This includes calls that are ringing at a voice terminal but does not include direct agent calls. It also includes the number of outbound calls for each split/skill that abandoned at the far end before the agent answered, for the Generic 3 switches with the ASAI feature only.	ABNCALLS
Avg Aban Time	The average time a caller waited (in split/skill or VDN) before hanging up.	ABNTIME / ABNCALLS <AVG_ABANDON_TIME>
Agents Available:	The total number of agents who are available to receive ACD calls in each split/skill.	AVAILABLE
Agents Ringing:	The current number of agents that are available and have ACD calls (including direct agent calls) ringing at their voice terminal but have not yet answered. If the agent places a call or answers an extension call, the agent is shown in the AUX work state, rather than in the ringing state.	AGINRING
Agents on ACD Calls:	The total number of agents that are connected to inbound and outbound ACD calls in each split/skill. This does not include direct agent calls.	ONACD
Agents in ACW:	The number of agents who are in the after call work mode for each split/skill. This includes agents on ACWIN/ACWOUT calls and agents in ACW not associated with an ACD call.	INACW

Report Heading	Description	Database Item, Calculation, or <Calculation Name>
Agents in Other:	The current number of agent positions that are doing other work. Agent positions show up as OTHER directly after the link to the switch comes up and directly after the agents log in before the <i>CentreVu</i> CMS is notified of the agent's work state. For the Generic 3 switches with EAS, the agent did one of the following activities while in the Auto-in or Manual-In state: The agent put any call on hold and performed no further action. The agent is on a direct agent call or in ACW for a direct agent call. The agent is dialing to place a call or to activate a feature. The agent has a ringing personal call queued through another split or skill, with no other activity. For the Generic 3 switch without EAS, agents are logged into multiple splits and doing work for a split other than this one.	OTHER
Agents in Aux:	The current number of agents who are in the AUX work mode for all splits/skills including agents who are handling AUXIN or AUXOUT calls.	INAUX
Agents Staffed:	The number of agents logged into each split/skill.	STAFFED



# Multi-ACD Top Agent Report

---

**Overview** This report displays skill information for skills from multiple ACDs. Agent counts show top and backup agents. This report allows you to enter skills from multiple ACDs connected to the CMS.

The Multi-ACD report appears on the real-time reports menu even if you have only one real ACD installed on your *CentreVu* CMS.

## Things to know about this report

Here are some things you need to know about this report:

- This report shows the number of agents with this skill as their top skill for *DEFINITY* ECS G3 EAS switches.
- This report shows the number of agents with this split as *OLDEST\_LOGON* for Generic 3 non-EAS switches.
- The menu items for this report appear only if the current ACD is a Generic 3 switch and EAS is activated. The report can be run for any live ACD on the CMS (some of which may not be G3 switches with EAS activated).
- "Top Agents" are agents for whom the skill is their highest-level skill. If agents have more than one skill at the highest level, then the first one administered is the top skill.
- The database items used for the Multi-ACD Top Agent Report are stored in the *csplit* table.
- The standard report can only include information on six ACDs. This report must be customized with Report Designer to view information on eight ACDs.

**Multi-ACD Top Agent report input window**

The following figure shows an example of the Multi-ACD Top Agent input window. You must fill in the report input window to run the report.

The screenshot shows a dialog box titled "Multi-ACD Top Agent Report". It is divided into two sections: "Inputs" and "Real-Time Options".

**Inputs Section:**

- ACD: ST10
- Split/Skill: Total
- ACD(2): ST11
- Split/Skill(2): BSR
- ACD(3): ST10
- Split/Skill(3): T26
- ACD(4): [none]
- Split/Skill(4): [empty]
- ACD(5): [none]
- Split/Skill(5): [empty]
- ACD(6): [none]
- Split/Skill(6): [empty]

**Real-Time Options Section:**

- Refresh Every: 18 Seconds
- Enable Report Thresholds
- Run Minimized

Buttons at the bottom: OK, Cancel, Help.

**Multi-ACD Top Agent report Input Fields**

The following table describes the input fields on real-time Multi-ACD Top Agent report input windows:

Field	Definition
Skill: (for First through Sixth Skill)	Fill in the names or numbers of the First through Sixth Split/Skill(s) for which you want to run the report. You can enter a split/skill name only if the name has been defined in Dictionary.

Field	Definition
Refresh Every <#> Seconds	Enter the number of seconds from 3 to 600, to specify how rapidly <i>CentreVu</i> CMS should update the report data. The default for the Refresh Every <#> Seconds field in this window is your assigned minimum refresh rate plus 15 seconds. To find out what your minimum refresh rate is, or to change it, check with your <i>CentreVu</i> CMS administrator.
Enable Report Thresholds	Check the Enable Report thresholds option to start the report with report thresholds running. Uncheck the option if you do not want to fun report thresholds.
Run Minimized	Check the Run Minimized option to run the report in a minimized window. Uncheck the option to run the report at full size.

### Multi-ACD Top Agent report example

The following figure provides an example of the Multi-ACD Top Agent report:

The screenshot shows a window titled "Multi-ACD Top Agent Report" with a menu bar (Report, Edit, Format, Tools, Options, Help). The main content area displays a summary of call statistics for three skills: ST10, ST11, and ST10 T26. The statistics are organized into columns for each skill and rows for various metrics. The data is as follows:

	ACD: ST10	ST11	ST10
Split/Skill:	Total	BSR	T26
Skill State:	NORMA	UNKN	NORMA
Calls Waiting:	0	0	0
Oldest Call Waiting:	:00	:00	:00
Avg Speed Ans:			
ACD Calls:	0	0	0
Avg ACD Time:			
Aban Calls:	0	0	0
Avg Aban Time:			
Top Agents Avail:	0	0	79
Top Agents Ringing:	0	0	0
Top Agents on ACD Calls:	0	0	0
Top Agents in ACW:	0	0	0
Top Agents in Other:	0	0	0
Top Agents in AUX:	0	0	1
Top Agents Staffed:	0	0	80
Flex Agents Staffed:	189	24	0
Reserve1 Agents Staffed:	0	0	0
Reserve2 Agents Staffed:	0	0	0

At the bottom right of the window, there is a status bar that reads "Thresholds: On".

**Multi-ACD Top Agent report description** The following table describes the report fields:

Report Heading	Description	Database Item, Calculation, or <Calculation Name>
Skill	The name or number of the splits/skills selected for this report.	syn(SPLIT)
ACD	The name or number of the ACD for which the data was collected.	syn(ACD)
Skill State	The current state of the skill, compared to the administered thresholds. This displays as Normal, Overload 1, and Overload 2 on the report. Requires <i>DEFINITY</i> ECS R6 or later with <i>CentreVu Advocate</i> .	SKSTATE
Calls Waiting	The number of split or skill ACD calls waiting to be answered. This includes calls that are in queue and calls that are ringing at an agent voice terminal. It does not include direct agent calls for the Generic 3 switch.	INQUEUE+INRING
Oldest Call Waiting	The length of time (in seconds) that the oldest ACD call has waited in queue or ringing (at an agent voice terminal for each split/skill in the report) before being answered. This does not include direct agent calls.	OLDESTCALL
Avg Speed Ans	The average time that calls waited in queue and ringing before an agent answered. This does not include direct agent calls, but it does include outbound ACD calls placed by an adjunct (outbound predictive dialing) for the Generic 3 switches with ASAI only.	ANSTIME/ACDCALLS <AVG_ANSWER_SPEED>
ACD Calls	The ACD calls that were queued to the split/skill and answered by an agent in the split/skill. This does not include direct agent calls. It does include outbound ACD calls placed by an adjunct (outbound predictive dialing) for the Generic 3 switch with the ASAI feature only.	ACDCALLS
Avg ACD Time	The average talk time for all ACD calls to this split/skill. This does not include hold time or time on direct agent calls. It does include outbound ACD calls placed by an adjunct (outbound predictive dialing) for the Generic 3 switch with the ASAI feature only.	ACDTIME/ACDCALLS <AVG_ACD_TALK_TIME>



Report Heading	Description	Database Item, Calculation, or <Calculation Name>
Aban Calls	The number of calls that are abandoned by the caller when calls are in queue or when calls are ringing for this split/skill. This includes calls with talk times less than the phantom abandoned call timer value, if it is set. NOTE: When a call is queued to multiple splits/skills and abandons from the queue, only the primary split/skill increments ABNCALLS. (Calls that are ringing at an agent's voice terminal and then abandoned count as abandons for the split/skill for which they were ringing.)	ABNCALLS
Avg Aban Time	The average time a caller waited (in split/skill or VDN) before hanging up.	ABNTIME/ABNCALLS <AVG_ABANDON_TIME>
Top Agents Avail	The number of top agents that are logged into the skill who are available in the skill.	TAVAILABLE
Top Agents Ringing	The number of top agents that are logged into the skill who have ACD calls (including direct agent calls) ringing at their voice terminals.	TAGINRING
Top Agents on ACD Calls	The number of top agents connected to inbound and outbound ACD calls in each split/skill. This does not include direct agent calls.	TONACD
Top Agents in ACW	The number of top agents who are in the after call work state for each skill. This includes agents on ACWIN or ACWOUT calls and agents in ACW not associated with an ACD call.	TINACW
Top Agents in AUX	The number of top agents logged into the skill who are in the AUX work mode for all skills or are on AUXIN/AUXOUT calls. Does not apply to direct agents in ACW.	TINAUX

Report Heading	Description	Database Item, Calculation, or <Calculation Name>
Top Agents in Other	<p>For the Generic 3 switch, the agent did one of the following activities while in the Auto-in or Manual-In state:</p> <ul style="list-style-type: none"> <li>• The agent put any call on hold and performed no further action.</li> <li>• The agent was on a direct agent call or in ACW for a direct agent call.</li> <li>• The agent was dialing to place a call or to activate a feature.</li> <li>• The agent had a personal call ringing with no other activity.</li> </ul> <p>For the Generic 3 switch without EAS, agents are logged into multiple splits and doing work for a split other than this one (on an ACD call or in ACW). For the Generic 3, agents are logged into multiple skills and doing work for a skill other than this one (on an ACD call or in call-related ACW). Agent positions show up as OTHER directly after the link to the switch comes up and directly after the agents log in before the <i>CentreVu</i> CMS is notified of the agent's work state.</p>	TOTHER
Top Agents Staffed	Current number of top agents that are staffed in the skill.	TSTAFFED
Flex Agents Staffed	Number of agents who are staffing the skill, but are neither top or reserve agents. Requires ECS R6 or later with <i>CentreVu</i> Advocate.	FSTAFFED
Reserve1 Agents Staffed	Number of agents staffing this skill as reserve1. Requires ECS R6 or later with <i>CentreVu</i> Advocate.	R1STAFFED
Reserve2 Agents Staffed	Number of agents staffing this skill as reserve2. Requires ECS R6 or later with <i>CentreVu</i> Advocate.	R2STAFFED



# Queue/Agent Reports

---

## Overview

---

- Purpose** The Queue/Agent reports give you the following specific information about Queues and Agents:
- The overall skill information along with information about agents for whom the requested skill is the top skill.
  - The overall split/skill information such as the number of calls waiting, oldest call waiting, and percent answered within service level.
  - A summary of the split's/skill's queue status.

- Organization of this section** This section contains the following topics:
- [General Information About Queue/Agent Reports \(3-42\)](#)
  - [Queue/Agent Report Selector Window and Input Fields \(3-43\)](#)
  - [Queue/Top Agent Status Report \(3-45\)](#)
  - [Queue/Agent Status Report \(3-50\)](#)
  - [Queue/Agent Summary Report \(3-55\)](#).



---

## General Information About Queue/Agent Reports

---

**What Queue/Agent reports contain**

The Queue/Agent reports give you the following specific information about Queues and Agents:

- The overall skill information along with information about agents for whom the requested skill is the top skill.
- The overall split/skill information such as the number of calls waiting, oldest call waiting, and percent answered within service level.
- A summary of the split's/skill's queue status.

**Organization of Queue/Agent reports**

The following list shows how the Queue/Agent reports are structured in *CentreVu* Supervisor:

- Queue Top Agent Status
- Status
- Summary.



## Queue/Agent Report Selector Window and Input Fields

**Overview** The queue/agent report selector window and the queue report input window are used to run the queue/agent reports described in this section.

**Queue/Agent report selector window** The following figure is an example of the Queue/Agent report selector window. The reports are explained in the same order as listed in the window:

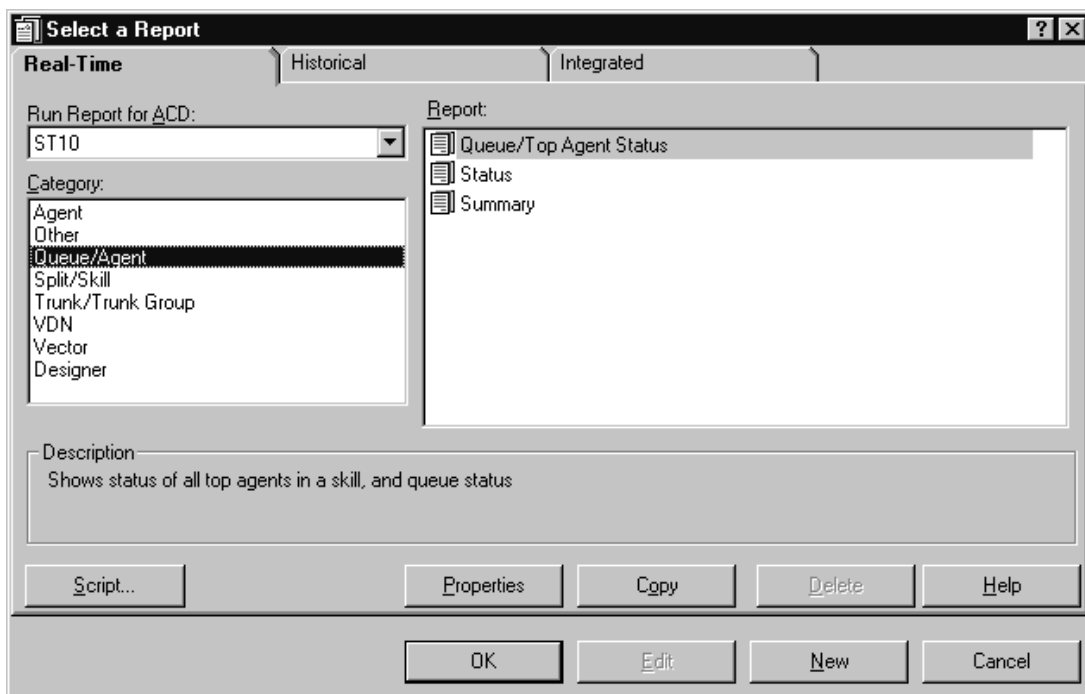

**Queue/Agent report  
input fields**

The following table describes the input fields on real-time Queue report input windows:

<b>Field</b>	<b>Definition</b>
Skill: or Split/Skill:	Enter the skill name or number that you want to view in this report. Any name(s) that you want to appear on the report must have been previously defined and entered in the Dictionary subsystem.
Refresh Every <#> Seconds	Enter the number of seconds (3 to 600) to specify how often you want the report to refresh. The default for the Refresh Every <#> Seconds field in this window is your assigned minimum refresh rate plus 15 seconds. To find out what your minimum refresh rate is, or to change it, check with your <i>CentreVu</i> CMS administrator
Enable Report Thresholds	Check the Enable Report Thresholds option to start the report with report thresholds running. Uncheck the option if you do not want to run report thresholds.
Run Minimized	Check the Run Minimized option to run the report in a minimized window. Uncheck the option to run the report at full size.



# Queue/Top Agent Status Report

**Overview** This report displays overall skill information along with information about agents for whom the requested skill is the top skill. This report resembles the Queue/Agent Status report, but this report also displays the number of top agents staffed, available, ringing, on ACD calls, in ACW, in AUX, and in Other, plus the number of flex agents staffed. The number of calls answered and abandoned also appear on the report.

## Things to know about this report

Here are some things you need to know about this report:

- This report is available only for Generic 3 switches with EAS.
- "Top Agents" are agents for whom the skill is their highest-level skill. If agents have more than one skill at the highest level, then the first one administered is the top skill.
- The database items used for the Queue/Top Status report are stored in csplit and cagent tables.
- This report uses the Queue Report input window. Select a skill that you want to view on the report. See [Queue/Agent Report Selector Window and Input Fields \(3-43\)](#) for more information.

## Queue/Top Agent Status report example

The following figure provides an example of a Queue/Top Agent Status report:

The screenshot shows a window titled "Queue/Top Agent Status - T26" with a menu bar (Report, Edit, Format, Tools, Options, Help). The summary statistics are as follows:

Split/Skill: <b>T26</b>	Top Agents Staffed: <b>80</b>
Skill State: <b>NORMAL</b>	Top Agents Avail: <b>79</b>
Calls Waiting: <b>0</b>	Top Agents Ringing: <b>0</b>
Oldest Call Waiting: <b>:00</b>	Top Agents on ACD Calls: <b>0</b>
Direct Agent Calls Waiting: <b>0</b>	Top Agents in ACW: <b>0</b>
% Within Service Level:	Top Agents in AUX: <b>1</b>
Service Level: <b>4</b>	Top Agents in Other: <b>0</b>
ACD Calls: <b>0</b>	Flex Agents Staffed: <b>0</b>
Aban Calls: <b>0</b>	Reserve1 Agents Staffed: <b>0</b>
	Reserve2 Agents Staffed: <b>0</b>

The agent list table below shows the following columns: Agent Name, Login ID, Extn, AUX Reason, State, Split/Skill, Level, Time, and VDN Name. The first 10 agents listed are:

Agent Name	Login ID	Extn	AUX Reason	State	Split/Skill	Level	Time	VDN Name
23019	23019	28019		AVAIL				
23022	23022	28022		AVAIL				
23021	23021	28021		AVAIL				
23031	23031	28031		AVAIL				
23024	23024	28024		AVAIL				
23032	23032	28032		AVAIL				
23033	23033	28033		AVAIL				
23025	23025	28025		AVAIL				
23026	23026	28026		AVAIL				

At the bottom right of the window, there are buttons for "Thresholds: On" and "ST10".

**Queue/Top Agent Status report description** The following table describes the report fields:

Report Heading	Description	Database Item, Calculation, or <Calculation Name>
Skill	Name or number of the skill selected for this report.	syn(SPLIT)
Skill State	The current state of the skill, compared to the administered thresholds. This displays as Normal, Overload 1, and Overload 2 on the report. Requires <i>DEFINITY</i> ECS R6 or later with <i>CentreVu</i> Advocate.	SKSTATE
Calls Waiting	The number of split or skill ACD calls waiting to be answered. This includes calls that are in queue and calls that are ringing at an agent voice terminal. It does not include direct agent calls for the Generic 3 switch.	INQUEUE+INRING
Oldest Call Waiting	The length of time (in seconds) the oldest ACD call has waited in queue or ringing (at an agent voice terminal for each split/skill in the report) before being answered. This does not include direct agent calls.	OLDESTCALL
Direct Agent Calls Waiting	The current number of direct agent calls (Generic 3 only) that are waiting in this skill's queue or ringing at agent positions.	DA_INQUEUE+DA_INRING
% Within Service Level	The percentage of skill ACD calls that were answered by an agent within the predetermined time.	100*(ACCEPTABLE/ CALLSOFFERED) <PERCENT_SERV_LVL_SPL>
Secs	Shows the current setting for the Acceptable Service Level, in seconds, as defined on the Call Center Administration Split/Skill Call Profile Setup window.	SERVICELEVEL
ACD Calls	The number of calls that were queued to the skill and answered by this agent in this skill (includes O_ACDCALLS).	ACDCALLS
Aban Calls	The number of calls that are abandoned by the caller when calls are in queue or when calls are ringing for this split/skill. This includes calls with talk times less than the phantom abandoned call timer value, if it is set.	ABNCALLS
Top Agents Staffed	The current number of top agents that are staffed in this skill.	TSTAFFED



Report Heading	Description	Database Item, Calculation, or <Calculation Name>
Top Agents Avail	The current number of top agents logged into the skill and available in the skill to take calls.	TAVAILABLE
Top Agents Ringing	The number of top agents logged into the skill who have ACD calls (including direct agent calls) ringing at their voice terminals.	TAGINRING
Top Agents on ACD Calls	The total number of top agents connected to inbound and outbound ACD calls in each skill. This does not include direct agent calls.	TONACD
Top Agents in ACW	The number of top agents who are in the after call work state for each skill. This includes agents on ACWIN/ACWOUT calls and agents in ACW not associated with an ACD call.	TINACW
Top Agents in AUX	The number of top agents logged into the skill who are in the AUX work mode for all skills or are on AUXIN/AUXOUT calls. Does not apply to direct agents in ACW.	TINAUX
Top Agents in Other	<p>The current number of top agent positions that are doing other work.</p> <p>For the Generic 3 switch the agent did one of the following activities while in the Auto-in or Manual-In state:</p> <ul style="list-style-type: none"> <li>• The agent put any call on hold and performed no further action.</li> <li>• The agent is on a direct agent call or in ACW for a direct agent call.</li> <li>• The agent is dialing to place a call or to activate a feature.</li> <li>• The agent has a personal call ringing with no other activity.</li> </ul> <p>For the Generic 3, agents are logged into multiple skills and doing work for a skill other than this one (on an ACD call or in call-related ACW). For the Generic 3 switches without EAS, agents are logged into multiple splits and doing work for a split other than this one (on an ACD call or in call-related ACW). Agent positions show up as OTHER directly after the link to the switch comes up and directly after the agents log in before the <i>CentreVu</i> CMS is notified of the agent's work state.</p>	TOTHER

Report Heading	Description	Database Item, Calculation, or <Calculation Name>
Flex Agents Staffed	Number of agents who are staffing the skill, but are neither top or reserve agents. Requires ECS R6 or later with <i>CentreVu Advocate</i> .	FSTAFFED
Reserve1 Agents Staffed	Number of agents staffing this skill as reserve1. Requires ECS R6 or later with <i>CentreVu Advocate</i> .	R1STAFFED
Reserve2 Agents Staffed	Number of agents staffing this skill as reserve2. Requires ECS R6 or later with <i>CentreVu Advocate</i> .	R2STAFFED
Agent Name	The name (or agent IDs if the names have not been assigned in the Dictionary) of the agents assigned to this split/skill and logged in.	syn(LOGID)
Login ID	The login identification of the agent	LOGID
Extn	The extension that the agent logged in from.	EXTENSION
AUX Reason	The reason associated with the auxiliary work state of this agent (for example, lunch, break, meeting, or training). This field is blank if the agent is not in the AUX state.	AUXREASON
State	The current work mode (state) that the agent is in (AVAIL, ACD, ACW, AUX, DACD, DACW, RINGING, UNKNOWN, OTHER, UNSTAFF) and the call direction (blank, IN or OUT).	AWORKMODE and DIRECTION
Skill/Level	<p>The skill and level associated with the split/skill or direct agent ACD call that the agent is on or the ACW session.</p> <p>WORKSKILL is the OLDEST_LOGON:</p> <ul style="list-style-type: none"> <li>When an agent is on an AUXIN/AUXOUT call from the available state, while in AUX or with an AUXIN/AUXOUT call on hold</li> <li>When an agent is on an AUXIN call with an ACD call on hold.</li> </ul> <p>When an agent is on an AUXOUT call with an ACD call on hold, this is the split/skill associated with the ACD call. When an agent is available, in AUX, or in OTHER, this is blank. The level is either a skill level (1-16) for a normal skill or a reserve level (R1 or R2) for a reserve skill. This WORKSKLEVEL applies to WORKSKILL.</p>	WORKSKILL/ syn(WORKSKLEVEL)

Report Heading	Description	Database Item, Calculation, or <Calculation Name>
Time	The elapsed time since the last agent WORKMODE change for any split/skill. This item is not reset if the DIRECTION changes, but WORKMODE remains the same. For example, if the agent goes from AUX to AUXOUT to AUX, AGTIME continues without resetting.	AGTIME
VDN Name (Shows data only if you have purchased the Vectoring feature)	The number or name of the VDN for which the report shows data. The Vector Directory Number is associated with the ACD call in progress.	VDN



# Queue/Agent Status Report

**Overview** This report is a combination of the Agent report and the Queue/Agent Summary report. It displays overall split/skill information such as the number of calls waiting, oldest call waiting, and percent answered within service level. It also shows the number of agents available, on ACD calls, staffed, with calls ringing, and on after call work. It also shows what each agent in the split/skill is currently doing.

- Things to know about this report** Here are some things you need to know about this report:
- Direct agent calls waiting are displayed in this report because direct agent calls occupy split/skill queue slots on Generic 3 switches.
  - The database items used for the Queue/Agent Status report are stored in `csplit` and `cagent` tables.
  - This report uses the Queue Report Input Window. Select a split/skill that you want to view on the report. See [Queue/Agent Report Selector Window and Input Fields \(3-43\)](#) for more information.

**Queue/Agent Status report example** The following figure provides an example of a Queue/Agent Status report:

Agent Name	Login ID	Extn	Role	Percent	AUX Reason	State	Direction	Split/Skill	Level	Time	VDN Name
29039	29039	26039			AVAIL	*****					
29029	29029	26029			AVAIL	*****					
29055	29055	26055			AVAIL	*****					
29082	29082	26082			AVAIL	*****					
29080	29080	26080			AVAIL	*****					
29043	29043	26043			AVAIL	*****					
29040	29040	26040			AVAIL	*****					
29032	29032	26032			AVAIL	*****					
29031	29031	26031			AVAIL	*****					
29068	29068	26068			AVAIL	*****					

**Queue/Agent Status report description** The following table describes the report fields:

Report Heading	Description	Database Item, Calculation, or <Calculation Name>
Split/Skill	The name or number of the split or skill selected for this report.	syn(SPLIT)
Skill State	Current state of this skill, compared to the administered thresholds. Requires ECS R6 or later with <i>CentreVu</i> Advocate.	syn(SKSTATE)
Calls Waiting	The total number of split or skill ACD calls waiting to be answered for each split/skill in the report. This includes calls that are in queue and are ringing at an agent's voice terminal. It also includes outbound ACD calls placed by an adjunct (also called outbound predictive dialing), for the the Generic 3 with ASAI only. For the Generic 3 switches, it does not include direct agent calls.	INQUEUE+INRING
Oldest Call Waiting	The length of time (in seconds) the oldest call has waited in queue or ringing (at an agent voice terminal for each split/skill in the report) before being answered. This does not include direct agent calls.	OLDESTCALL
Direct Agent Calls Waiting	The current number of direct agent calls (Generic 3 switches only) that are waiting in this split's/skill's queue or ringing at agent positions.	DA_INQUEUE+DA_INRING
% Within Service Level	The percentage of split/skill ACD calls that were answered by an agent within the predetermined time.	100*(ACCEPTABLE/ CALLSOFFERED) <PERCENT_SERV_LVL_SPL>
Secs	Shows the current setting for the Acceptable Service Level, in seconds, as defined on the Call Center Administration Split/Skill Call Profile Setup.	SERVICLEVEL
ACD Calls	The number of calls that were queued to this split/skill and answered by an agent in this split/skill (includes O_ACDCALLS).	ACDCALLS

Report Heading	Description	Database Item, Calculation, or <Calculation Name>
Aban Calls	The number of calls that are abandoned by the caller when calls are in queue or when calls are ringing for this split/skill. This includes calls with talk times less than the phantom abandoned call timer value, if it is set. NOTE: When a call is queued to multiple splits/skills and abandons from the queue, only the primary split/skill increments ABNCALLS. (Calls that are ringing at an agent's voice terminal and then abandon count as abandons for the split/skill for which they were ringing.)	ABNCALLS
Agents Staffed	The total number of agents logged into each split/skill.	STAFFED
Agents Avail	The current number of agents that are available to receive ACD calls in each split/skill.	AVAILABLE
Role	The Agent's service role for this SPLIT, as defined in the Dictionary. Requires <i>DEFINITY</i> ECS R6 or later with <i>CentreVu</i> Advocate.	syn(ROLE)
Percent	The Agent's percent allocation for this SPLIT. Requires <i>DEFINITY</i> ECS R6 or later with <i>CentreVu</i> Advocate.	PERCENT
Agents Ringing	The current number of agents that are available and have ACD calls (including direct agent calls) ringing at their voice terminal, but have not yet answered. If the agent places a call or answers an extension call, the agent is shown in the AUX work state, rather than in the ringing state.	AGINRING
Agents on ACD Calls	The total number of agents that are connected to inbound and outbound ACD calls in each split/skill. This does not include direct agent calls.	ONACD
Agents in ACW	The number of agents that are in the after call work mode for each split/skill. This includes agents on ACWIN/ACWOUT calls and agents in ACW not associated with an ACD call.	INACW
Agents in AUX	The current number of agents who are in the AUX work mode for all splits/skills, including agents who are handling AUXIN/AUXOUT calls.	INAUX

Report Heading	Description	Database Item, Calculation, or <Calculation Name>
Agents in Other	The current number of agent positions that are doing other work. For the Generic 3 switch, the agent did one of the following activities while in the Auto-in or Manual-In state: The agent put any call on hold and performed no further action. The agent is on a direct agent call or in ACW for a direct agent call. The agent is dialing to place a call or to activate a feature. The agent has a ringing personal call with no other activity. For the Generic 3 switches without EAS, agents are logged into multiple splits and doing work for a split other than this one. Agent positions show up as OTHER directly after the link to the switch comes up and directly after the agents log in before the <i>CentreVu</i> CMS is notified of the agent's work state.	OTHER
Agent Name	The name(s) of the agent(s) assigned to this split/skill and logged in (or their login IDs if names have not been assigned to them in Dictionary).	syn(LOGID)
Login ID	The login identification of the agent.	LOGID
Extn	The extension that the agent logged in from	EXTENSION
Role	The Agent's service role for this SPLIT, as defined in the Dictionary. Requires <i>DEFINITY</i> ECS R6 or later with <i>CentreVu</i> Advocate.	syn(ROLE)
Percent	The Agent's percent allocation for this SPLIT. Requires <i>DEFINITY</i> ECS R6 or later with <i>CentreVu</i> Advocate.	PERCENT
AUX Reason	The reason associated with the auxiliary work state of this agent (for example, lunch, break, meeting, or training). This field is blank if the agent is not in the AUX state.	AUXREASON
State	The current work mode (state) that the agent is in (AVAIL, ACD, ACW, AUX, DACD, DACW, RINGING, UNKNOWN, OTHER, UNSTAFF) and the call direction (blank, IN or OUT).	syn(WORKMODE) and syn(DIRECTION)

Report Heading	Description	Database Item, Calculation, or <Calculation Name>
Split/Skill	<p>The skill and level associated with the split/skill or direct agent ACD call that the agent is on or the ACW session.</p> <p>WORKSKILL is the OLDEST_LOGON:</p> <ul style="list-style-type: none"> <li>When an agent is on an AUXIN/AUXOUT call from the available state, while in AUX or with an AUXIN/AUXOUT call on hold</li> <li>When an agent is on an AUXIN call with an ACD call on hold.</li> </ul> <p>When an agent is on an AUXOUT call with an ACD call on hold, this is the split/skill associated with the ACD call. When an agent is available, in AUX, or in OTHER, this is blank. The level is either a skill level (1-16) for a normal skill or a reserve level (R1 or R2) for a reserve skill. This WORKSKLEVEL applies to WORKSKILL.</p>	syn(WORKSKLEVEL)
Level	<p>The skill level associated with the agent's current WORKSKILL, when WORKSKILL is not null. Requires a Generic 3 Version 2 or later switch with the EAS feature. For <i>CentreVu Advocate</i>, in the cagent table, WORKSKLEVEL contains either a skill level (1-16) for a normal skill, or a reserve level (1 or 2) for a reserve skill. This WORKSKLEVEL applies to WORKSKILL.</p>	syn(WORKSKLEVEL)
Time	<p>The elapsed time since the last agent WORKMODE change for any split/skill. This item is not reset if the DIRECTION changes, but WORKMODE remains the same. For example, if the agent goes from AUX to AUXOUT to AUX, AGTIME continues without resetting.</p>	AGTIME
VDN Name (Shows data only if you have purchased the Vectoring feature)	<p>The number or name of the VDN for which the report shows data. The Vector Directory Number (VDN) is associated with the ACD call in progress.</p>	VDN



## Queue/Agent Summary Report

**Overview** This report summarizes the split's/skill's queue status (for example, how many calls are waiting in queue). It also summarizes the status of all agents (for example, how many agents are currently staffed or in after call work for the split or skill).

**Things to know about this report** Here are some things you need to know about this report:

- Direct agent calls waiting are displayed in this report because direct agent calls occupy split/skill queue slots on Generic 3 or later switches.
- The database items used for the Queue/Agent Summary report are stored in the csplit and cagent tables.
- This report uses the Queue Report Input Window. Select a split/skill that you want to view on the report. See [Queue/Agent Report Selector Window and Input Fields \(3-43\)](#) for more information.

**Queue/Agent Summary report example**

The following figure provides an example of a Queue/Agent Summary report:

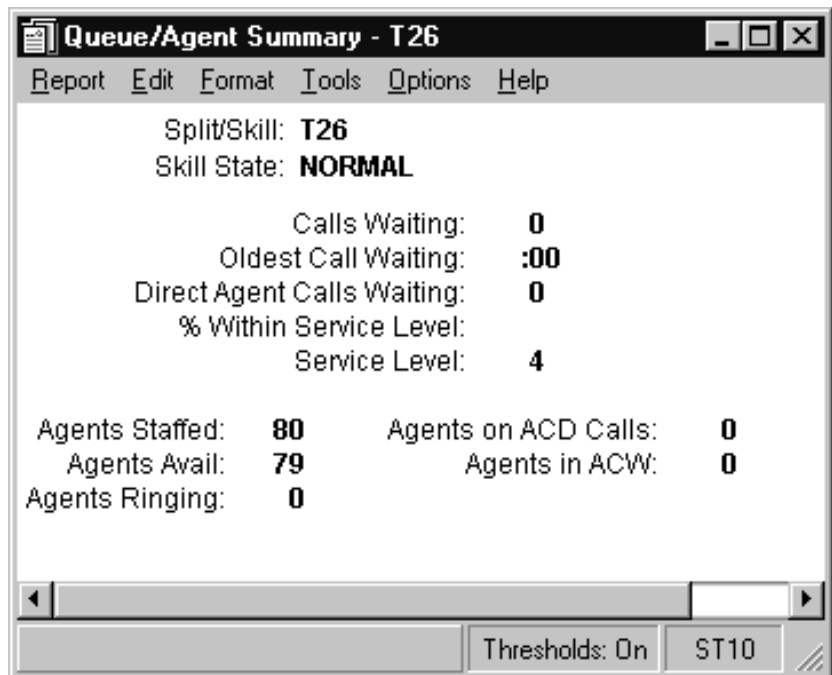

**Queue/Agent Summary report description** The following table describes the report fields:

Report Heading	Description	Database Item, Calculation, or <Calculation Name>
Split/Skill	The name or number of the splits/skills selected for this report.	syn(SPLIT)
Skill State	The current state of the skill, compared to the administered thresholds. This displays as Normal, Overload 1, and Overload 2 on the report. Requires <i>DEFINITY</i> ECS R6 or later with <i>CentreVu Advocate</i> .	SKSTATE
Calls Waiting	The number of split or skill ACD calls waiting to be answered. This includes calls that are in queue and calls that are ringing at an agent voice terminal. It does not include direct agent calls for the Generic 3 switch.	INQUEUE+INRING
Oldest Call Waiting	The length of time (in seconds) the oldest call has waited in queue or ringing (at an agent voice terminal for each split/skill in the report) before being answered. This does not include direct agent calls.	OLDESTCALL
Direct Agent Calls Waiting	The current number of direct agent calls (Generic 3 only) that are waiting in this split's/skill's queue or ringing at agent positions.	DA_INQUEUE+DA_INRING
% Within Service Level	The percentage of split/skill ACD calls that were answered by an agent within the predetermined time.	100*(ACCEPTABLE/ CALLSOFFERED) <PERCENT_SERV_LVL_SPL>
Secs.	The size of each service level increment is measured in seconds. Each increment of seconds represents a progressively longer wait time segment during which calls may be answered or abandoned, and each increment can be a different length. These increments are defined in the Call Center Administration - Split/Skill Call Profile Setup window or VDN Call Profile Setup window.	PERIOD1-9
Agents Staffed:	The total number of agents that are logged into each split/skill.	STAFFED
Agents Avail:	The current number of agents that are available to receive ACD calls in this split/skill.	AVAILABLE

Report Heading	Description	Database Item, Calculation, or <Calculation Name>
Agents Ringing:	The current number of agents that are available and have ACD calls (including direct agent calls) ringing at their voice terminal but have not yet answered. If the agent places a call or answers an extension call, the agent is shown in the AUX work state, rather than in the ringing state.	AGINRING
Agents on ACD Calls:	The total number of agents that are connected to inbound and outbound ACD calls in each split/skill. This does not include direct agent calls.	ONACD
Agents in ACW:	The number of agents who are in the after call work mode for each split/skill. This includes agents on ACW-IN/ACW-OUT calls and agents in ACW not associated with an ACD call.	INACW



# Split/Skill Reports

## Overview

---

**Purpose** From the Real-Time Split/Skill menu you can select Split Status (non-EAS) or Skill Status (EAS), Split/Skill Report, or Call Profile. Additionally, if you have the EAS feature, you can select Top Agent Status, Top Agent Report, and Skill AUX Report

The Split Status report or Skill Status report shows the status of one split or one skill. If you have the EAS feature, your system displays the Skill Status report. If you do not have the EAS feature, your system displays the Split Status report.

**Organization of this section** This section contains the following topics:

- [General Information About Split/Skill Reports \(3-59\)](#)
- [Split/Skill Report Selector Window and Input Fields \(3-60\)](#)
- [Split/Skill Call Profile Report \(3-62\)](#)
- [Real-Time Graphical Active Agents Report \(3-65\)](#)
- [Real-Time Graphical Allocated Agents Report \(3-69\)](#)
- [Split/Skill Graphical AUX Agents Report \(3-73\)](#)
- [Split/Skill Graphical AUX Top Agents Report \(3-76\)](#)
- [Split/Skill Graphical Call Profile Report \(3-79\)](#)
- [Split/Skill Graphical EWT Report \(3-83\)](#)
- [Split/Skill Graphical Queue Report \(3-86\)](#)
- [Split/Skill Graphical Skill Overload Report \(3-89\)](#)
- [Split/Skill Graphical Staffing Profile Report \(3-91\)](#)
- [Split/Skill Graphical Status Report \(3-95\)](#)
- [Split/Skill Graphical Top Skill Status Report \(3-99\)](#)
- [Reserve1 AUX Agents Report \(3-104\)](#)
- [Reserve2 AUX Agents Report \(3-108\)](#)
- [Skill AUX Report \(3-112\)](#)
- [Skill Status Report \(3-114\)](#)
- [Skill Top Agent Report \(3-120\)](#)
- [Split Status Report \(3-125\)](#)
- [Split/Skill Report \(3-130\)](#)
- [Split/Skill by Location Report \(3-134\)](#)
- [Split/Skill Top Agent Status Report \(3-136\)](#)
- [Split/Skill Agent Status by Location Report \(3-140\)](#)



---

## General Information About Split/Skill Reports

---

### Organization of split/skill reports

The following list shows how the Split/Skill reports are organized in *CentreVu* Supervisor:

- Call Profile
- Graphical Active Agents
- Graphical Allocated Agents
- Graphical AUX Agents Report
- Graphical AUX Top Agents Report
- Graphical Call Profile
- Graphical EWT
- Graphical Queue
- Graphical Skill Overload
- Graphical Staffing Profile
- Graphical Status
- Graphical Top Skill Status
- Reserve1 AUX Agents
- Reserve2 AUX Agents
- Skill AUX
- Skill Status
- Skill Top Agent
- Split Status
- Split/Skill Report
- Split/Skill by Location Report
- Top Agent Status Report
- Agent Status by Location Report



## Split/Skill Report Selector Window and Input Fields

**Overview** The split/skill report selector window and the split/skill report input window are used to run the split/skill reports described in this section.

**Split/Skill report selector window** The following figure is an example of the Split/Skill report selector window. The reports are explained in the same order as listed in the window:

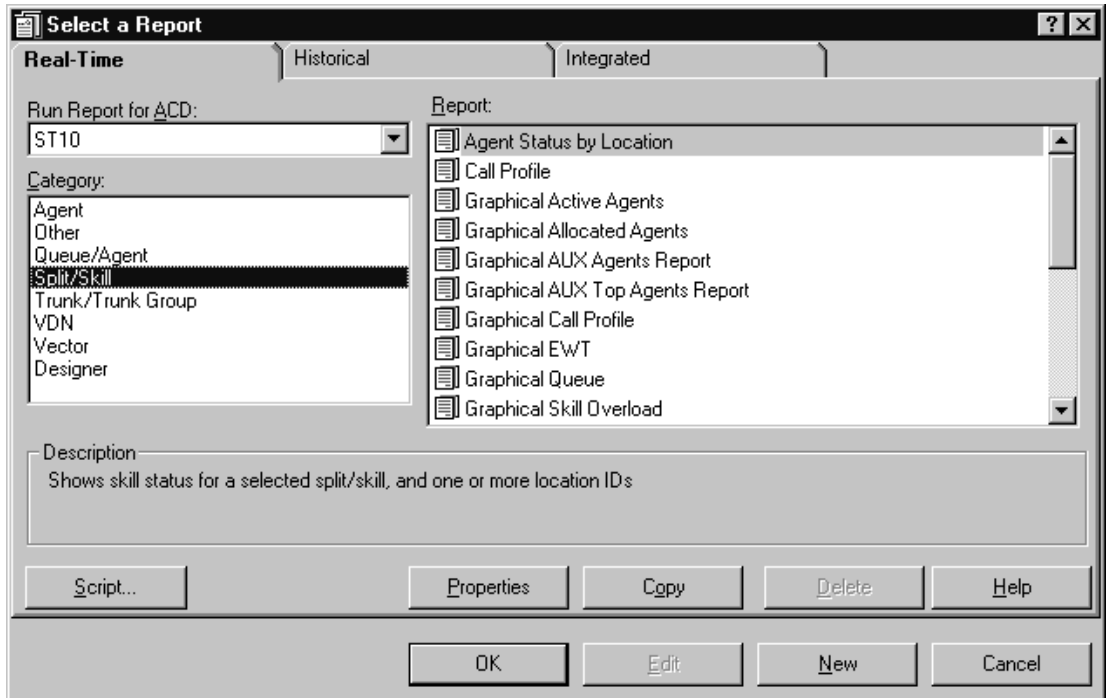

**Split/skill report input fields** The reports in this section use the Split/Skill Reports Input Window. The following table describes the input fields on real-time Split/Skill report input windows. Not all reports use all fields; refer to information for the specific report you are running to determine what you want to view. For example, you may enter a skill or split/skill to run the report.

All possible fields on this window are described here:

Field	Definition
Skill:, Split:, Split/Skill:, or Splits/Skills:	Fill in the Skill (or split) input name or number for which you want to run the report. You can enter a split/skill name only if the name has been defined in Dictionary.
Multi-Location ID	Select a location ID for which to run the report. The location ID is an ID number of 1 – 44 digits assigned to a <i>DEFINITY</i> port network location and the equipment assigned to that port location.

Field	Definition
Refresh Every <#> Seconds	Enter the number of seconds (3 to 600) to specify how rapidly <i>CentreVu</i> CMS should update the report data. The default for the Refresh Every <#> Seconds: field in this window is your assigned minimum refresh rate plus 15 seconds. To find out what your minimum refresh rate is, or to change it, check with your <i>CentreVu</i> CMS administrator.
Enable Report Thresholds	Check the Enable Report Thresholds option to start the report with report thresholds running. Uncheck the option if you do not want to run report thresholds.
Run Minimized	Check the Run Minimized option to run the report in a minimized window. Uncheck the option to run the report at full size.



# Split/Skill Call Profile Report

**Overview** This report shows the wait times of incoming calls that are answered and abandoned in a split or skill during the current interval.

- Things to know about this report** Here are some things you need to know about this report:
- Calls are displayed in ten columns, with each column representing a progressively longer wait time (increment).
  - The database items used for the Split/Skill Call Profile Report are stored in the csplit table.
  - You must have administered service level and wait time increments for this report to be meaningful.
  - This report uses the Split/Skill Report Input Window. Select a skill that you want to view on the report. See [Split/Skill Report Selector Window and Input Fields \(3-60\)](#) for more information.

**Split/Skill Call Profile report example** The following figure provides an example of a Split/Skill Call Profile report:

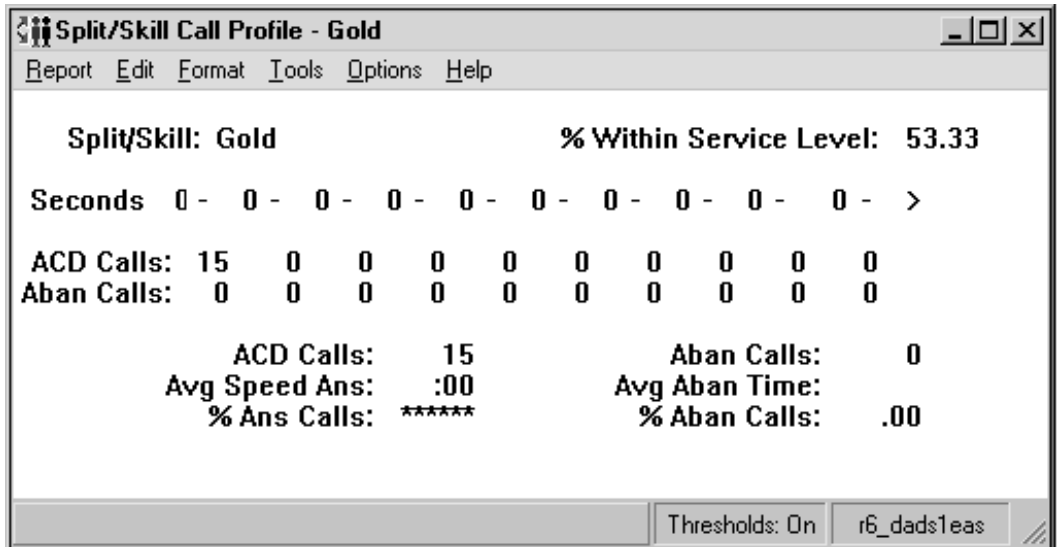



**Split/Skill Call Profile report description** The following table describes the report fields:

Report Heading	Description	Database Item, Calculation, or <Calculation Name>
Split/Skill	The name or number of the split/skill selected for this report.	syn(SPLIT)
% Within Service Level	The percentage of split/skill ACD calls that were answered by an agent within the predefined time. Calls offered to the split/skill include calls that were abandoned and calls that were not answered, but do not include direct agent calls. Calls that were not answered may include forced busy calls, forced disconnect calls, calls redirected to another destination, and calls queued to more than one split/skill and answered in another split/skill.	100*( ACCEPTABLE/ CALLSOFFERED) <PERCENT_SERV_LVL_SPL>
Seconds	The size of each increment is measured in seconds. Each increment of seconds represents a progressively longer wait time segment during which calls may be answered or abandoned, and each increment can be a different length. These increments are defined in the Call Center Administration Split/Skill Call Profile Setup window.	PERIOD1-9
ACD Calls	This is the number of calls that were sent to the split/skill that were answered by an agent within each increment. This includes outbound ACD calls placed by an adjunct (also called outbound predictive dialing), for the Generic 3 with ASAI only. For the Generic 3 switches it does not include direct agent calls.	ACDCALLS1-10
Aban Calls	The number of calls to the split/skill that were abandoned within each increment. If calls are queued to multiple splits/skills, only the first split/skill queued to records an abandon. This includes outbound ACD calls placed by an adjunct (also called outbound predictive dialing), for the Generic 3 with ASAI only. It does not include direct agent calls.	ABNCALLS

Report Heading	Description	Database Item, Calculation, or <Calculation Name>
(Total) ACD Calls	The total number of ACD calls that were sent to the split/skill that were answered by an agent in the split/skill. This includes outbound ACD calls placed by an adjunct (also called outbound predictive dialing), for the Generic 3 with ASAI only. For the Generic 3 switches, it does not include direct agent calls.	ACDCALLS
Avg Speed Ans	The average time calls waited in queue and ringing before an agent answered. This does not include direct agent calls, but it does include outbound ACD calls placed by an adjunct (also called outbound predictive dialing), for the Generic 3 with ASAI only.	ANSTIME/ ACDCALLS <AVG_ANSWER_SPEED>
% Ans Calls	The percentage of calls queued to the split/skill that were answered by an agent. Calls to the split/skill include abandoned calls and calls not answered. Calls not answered may include forced busy calls, forced disconnect calls, calls redirected to another destination, and calls queued to more than one split/skill and answered in another split/skill. For the Generic 3 switches, it does not include direct agent calls.	100*( ACDCALLS/ CALLSOFFERED) <PERCENT_CALL_ANS>
(Total) Aban Calls	The total number of calls queued for each split/skill that abandoned before an agent answered. This includes calls that abandon from ringing at a voice terminal. Direct agent calls are not included. For Generic 3 switches with ASAI, this includes outbound calls where the far end abandoned as well.	ABNCALLS
Avg Aban Time	The average time calls waited in split/skill before hanging up.	ABNTIME/ ABNCALLS <AVG_ABANDON_TIME>
% Aban Calls	The percentage of queued calls to the split/skill that were abandoned before being answered by an agent. For the Generic 3 switch with the ASAI feature only, calls to the split/skill include outbound ACD calls placed by an adjunct (outbound predictive dialing). For the Generic 3 switches, it does not include direct agent calls.	100*( ABNCALLS/ CALLSOFFERED) <PERCENT_CALL_ABAN>

---

# Real-Time Graphical Active Agents Report

---

**Overview** This report, which is available only for customers who have *DEFINITY* ECS R6 or later switches with EAS and have purchased *CentreVu* Advocate, displays how many agents of different types are active for a selected skill.

If *CentreVu* Advocate is not activated, the fields of the report which pertain to *CentreVu* Advocate will not be populated.

- Things to know about this report** Here are some things you need to know about this report:
- You can access this report from the Real-Time Split/Skill Category selector menu.
  - Call center supervisors can use this report to see the number of Top, Flex, Reserve1, and Reserve2 agents staffed. The supervisor will also be able to see the number of each of those categories of agents who are active for the skill.
  - This report consists of two charts, as well as individual data items and field labels.
  - This report has a two-dimensional bar chart.
  - The chart contains the following information:
    - The title of the chart is “Top Agents Active,” and is centered above the bar chart.
    - The x-axis contains the labels, “This Skill” and “Other Skills,” while the y-axis shows the number of agents.
  - This report has a three-dimensional pie chart,
  - The pie chart contains the following information for the number of agents active for the specified skill:
    - The title of the chart is “Active Agents for xxx,” where xxx is the specified skill, and is centered above the pie chart.
    - The pie chart's legend will be displayed by default, and shows Top, Flex, Reserve1, and Reserve2 agents.
    - The number of agents for each category are displayed.
  - The database items used in the Graphical Active Agents report are stored in the `csplit` table.
  - This report uses the Split/Skill Report Input Window. Select a skill that you want to view on the report. See [Split/Skill Report Selector Window and Input Fields \(3-60\)](#) for more information.

**Graphical Active Agents report example** The following figure provides an example of a Graphical Active Agents report:

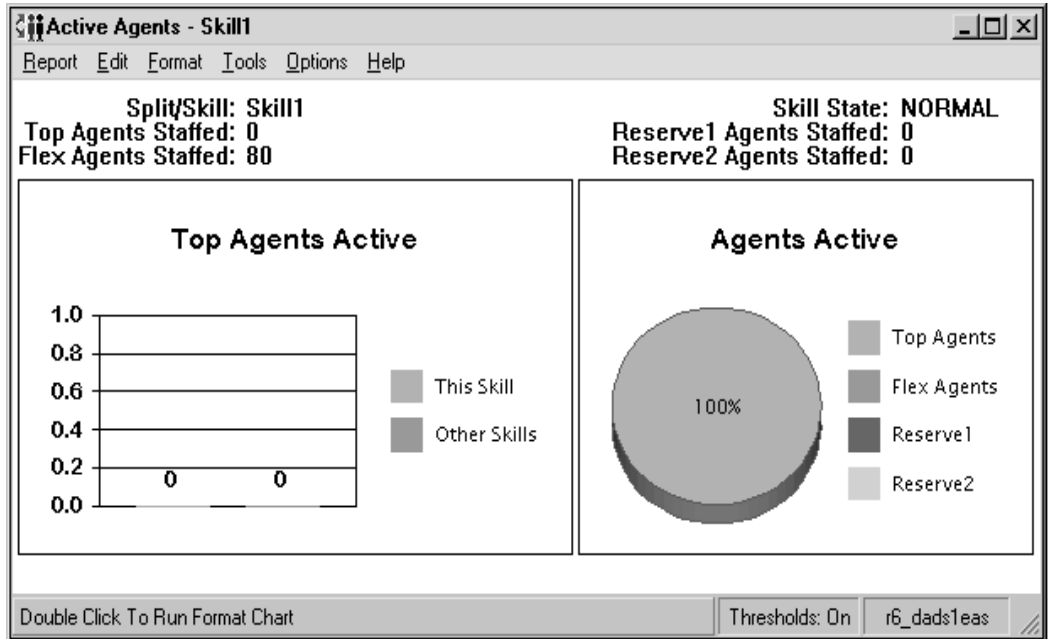

**Graphical Active Agents report description** The following table describes the report fields:

Report Heading	Description	Database Item, Calculation, or <Calculation Name>
Split/Skill	The name or number of the split/skill selected for this report.	syn(SPLIT)
Top Agents Staffed:	The current number of top agents that are staffed in SPLIT. Available with Generic 3 switches with the EAS feature. However, "top" database items are significant only for Generic 3 switches and the ECS with EAS. TSTAFFED = TAVAILABLE + TAGINRING	TSTAFFED
Flex Agents Staffed:	The number of agents who are staffing the skill, but are neither top or reserve agents. This field will contain backup agents if the <i>CentreVu Advocate</i> feature is not used, because the database item consists of agents whose roll in the skill is backup (regardless of the administration of <i>CentreVu Advocate</i> ), allocation, or roving. Requires <i>DEFINITY ECS R6</i> or later with <i>CentreVu Advocate</i> .	FSTAFFED

Report Heading	Description	Database Item, Calculation, or <Calculation Name>
Skill State	The current state of the skill, compared to the administered thresholds. Requires <i>DEFINITY</i> ECS R6 or later with <i>CentreVu</i> Advocate.	syn(SKSTATE)
Reserve1 Agents Staffed:	The number of agents staffing this skill as reserve1. Requires <i>DEFINITY</i> ECS R6 or later with <i>CentreVu</i> Advocate.	R1STAFFED
Reserve2 Agents Staffed:	The number of agents staffing this skill as reserve2. Requires <i>DEFINITY</i> ECS R6 or later with <i>CentreVu</i> Advocate.	R2STAFFED
—“Top Agents Active chart— “This Skill”	The number of top agents logged into the skill, who are on inbound and outbound ACD calls, plus the number of top agents who are in ACW for ACD calls, plus the number of top agents who have ACD calls ringing and are not doing anything else.	TONACD + TINACW + TAGINRING
—“Top Agents Active chart— “Other Skills”	The number of top agents that are doing other work. Agents are logged into multiple splits/skills other than this one (on an ACD call or in ACW, or ACD calls ringing). For Generic 3, while in Auto-in or Manual-in mode: the agent put any call on hold and has performed no further action; the agent is on a direct call or in ACW for a direct agent call; the agent is dialing to place a call or to activate a feature; an extension call or a direct agent ACD call is ringing with no other activity. For Generic 3 EAS with multiple call handling, agents are available for other, multiple call handling skills. Agent POSITIONS will show up in TOTHER directly after the link to the switch comes up and directly after the agents log in before the <i>CentreVu</i> CMS is notified of the agent's work state. Available with Generic 3 switches with the EAS feature. However, “top” database items are only significant for Generic 3 switches and ECS with EAS. TOTHER includes TDA_INACW and TDA_ONACD.	TOTHER

Report Heading	Description	Database Item, Calculation, or <Calculation Name>
—Agents Active chart—Top Agents	The number of top agents logged into the skill, who are on inbound and outbound ACD, plus the number of top agents who are in ACW for ACD calls, plus the number of top agents who have ACD calls ringing and are not doing anything else.	TONACD + TINACW + TAGINRING
—Agents Active chart—Flex Agents	The number of flex agents on ACD calls, plus the number of flex agents in ACW, plus the number of flex agents with this skill that have an ACD call ringing.	FONACD + FINACW + FAGINRING
—Agents Active chart—Reserve1 Agents	The number of reserve1 agents on ACD calls, plus the number of reserve1 agents in ACW, plus the number of reserve1 agents with this skill that have an ACD call ringing.	R1ONACD + R1INACW + R1AGINRING
—Agents Active chart—Reserve2 Agents	The number of reserve2 agents on ACD calls, plus the number of reserve2 agents in ACW, plus the number of reserve2 agents with this skill that have an ACD call ringing.	R2ONACD + R2INACW + R2AGINRING



---

# Real-Time Graphical Allocated Agents Report

---

**Overview** This report, which is available only for customers who have *DEFINITY* ECS R6 or later switches with Expert Agent Selection (EAS) and have purchased *CentreVu* Advocate, displays the number of active and staffed percent allocation agents who are staffing a selected skill.

If *CentreVu* Advocate is not activated, the fields of the report which pertain to *CentreVu* Advocate will not be populated.

## Things to know about this report

Here are some things you need to know about this report:

- You can access this report from the Real-Time Split/Skill Category selector menu.
- The Graphical Allocated Agents report will show the total number of active agents and full-time equivalent agents, for a selected skill. This report will also show the number of Standard, Reserve1, and Reserve2 agents staffed and the number of each of those categories of agents who are active for the skill.
- The Call Center manager or supervisor can use this report to determine how many agents are active from each agent pool and compare that to the number of total staffed agents.
- This report shows the following two-dimensional bar charts:
- The charts contain the following information:
  - The chart on the left side of the report displays the agents active for the specified skill, and has a bar for the number of standard agents active, a bar for the number of reserve1 agents active and a bar for the number of reserve 2 agents active.
  - The chart on the right side of the report displays staffed agents and has a bar each for the number of standard agents staffed, number of reserve1 agents staffed, and number of reserve2 agents staffed.
- The database items used in the report are stored in the `csplit` table.
- This report uses the Split/Skill Report Input Window. Select a skill that you want to view on the report. See [Split/Skill Report Selector Window and Input Fields \(3-60\)](#) for more information.

**Graphical Allocated Agents report example**

The following figure provides an example of a Graphical Allocated Agents report:

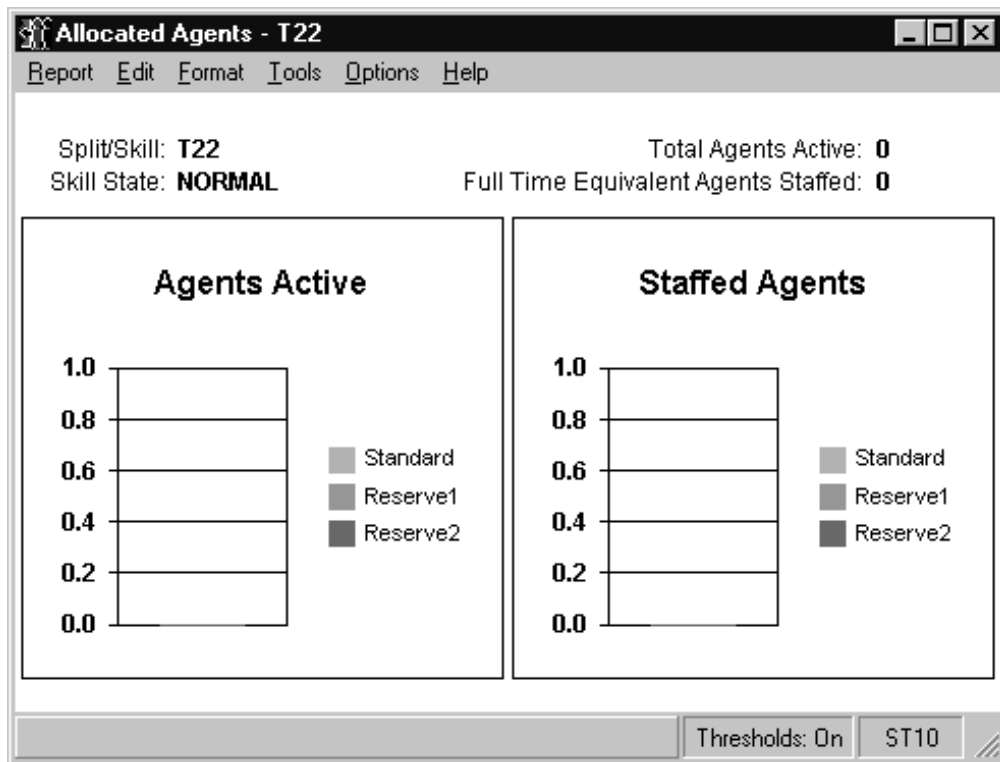



**Graphical Allocated Agents report description** The following table describes the report fields:

Report Heading	Description	Database Item, Calculation, or <Calculation Name>
Skill:	The name or number of the split/skill selected for this report.	syn(SPLIT)
Skill State	The current state of the skill, compared to the administered thresholds. Requires <i>DEFINITY</i> ECS R6 or later with <i>CentreVu</i> Advocate.	syn(SKSTATE)
Total Agents Active:	The current number of POSITIONS that are on inbound and outbound ACD calls; plus the current number of POSITIONS that are in after call work (ACW), including agents on ACWIN/ACWOUT calls as well as agents in ACW not associated with an ACD call; plus the current number of POSITIONS at which skill or direct agent calls are ringing.	ONACD + INACW + AGRING
Full Time Equivalent Agents Staffed:	<i>CentreVu</i> Advocate full-time equivalent number of agents staffed for this skill. Full Time Equivalent Agents Staffed = TOT_PERCENTS / 100.	FTE_AGENTS
Standard Agents (active)	The current number of POSITIONS that are on inbound and outbound ACD calls; plus the current number of POSITIONS that are in ACW, including agents on ACWIN/ACWOUT calls as well as agents in ACW not associated with an ACD call. This also includes the current number of POSITIONS at which skill or direct agent calls are ringing, minus the reserve1 agents (active); or the number of reserve1 agents on ACD calls, plus the number of reserve1 agents in ACW, plus the number of reserve1 agents with this skill that have an ACD call ringing. This field is minus the reserve2 agents (active); or the number of reserve2 agents on ACD calls, plus the number of reserve2 agents in ACW, plus the number of reserve2 agents with this skill that have an ACD call ringing.	(ONACD + INACW + AGINRING) - (R1ONACD + R1INACW + R1AGINRING) - (R2ONACD + R2INACW + R2AGINRING)

Report Heading	Description	Database Item, Calculation, or <Calculation Name>
Standard Agents (staffed)	The current number of POSITIONS that are staffed (logged in), minus the number of agents staffing this skill as reserve1, minus the number of agents staffing this skill as reserve2.	STAFFED - R1STAFFED - R2STAFFED
Reserve1 Agents (active)	The number of reserve1 agents on ACD calls, plus the number of reserve1 agents in ACW, plus the number of reserve1 agents with this skill that have an ACD call ringing.	(R1ONACD + R1INACW + R1AGINRING)
Reserve1 Agents Staffed:	The number of agents staffing this skill as reserve1. Requires <i>DEFINITY</i> ECS R6 or later with <i>CentreVu</i> Advocate.	R1STAFFED
Reserve2 Agents (active)	The number of reserve2 agents on ACD calls, plus the number of reserve2 agents in ACW, plus the number of reserve2 agents with this skill that have an ACD call ringing.	(R2ONACD + R2INACW + R2AGINRING)
Reserve2 Agents Staffed:	The number of agents staffing this skill as reserve2. Requires <i>DEFINITY</i> ECS R6 or later with <i>CentreVu</i> Advocate.	R2STAFFED



# Split/Skill Graphical AUX Agents Report

---

This report, which is available only with the *DEFINITY* ECS release, shows all agents with this skill who are in AUX, the reason, and the time in AUX.

## Things to know about this report

Here are some things to know about this report:

You can access this report in the following ways:

- From the Real-Time Split/Skill Category selector menu.
- By drilling down from the AUX work state fields on other reports to this report (only available with *DEFINITY* ECS). All other switch/EAS configuration drills down to the Work State Report.

## Report formats

This report shows the following two-dimensional pie chart information for the number of agents in AUX for each reason code for that skill:

- The pie chart's legend shows the synonym for each reason code and its corresponding color of the pie.
- The legend is sorted in ascending order by the reason code number, with the customer-defined synonym for reason code 0 at the bottom.
- The number of agents are shown inside each slice of the pie.

This report includes the following table information:

- A row for each agent currently in the AUX work state for that skill.
- The agent's name, login ID, reason code, and the time in AUX since the agent entered AUX for that reason code.
- You can specify how you want to sort the agent's name, login ID, reason code, and time.
- You can use the scroll bar to see additional agents who are in the AUX state.
- Call center supervisors can use this report to see which staffed agents are unavailable to take calls, and for what reason. The supervisor can also see how long each agent has been unavailable for each of the reason codes. This will help show the supervisor who can be pulled to answer calls if call volumes increase, and will also help to identify agents who are taking too long for breaks, lunch, etc.
- From this report, you can drill-down to the Agent Information report from the Agent Name field.
- The chart type can be changed. See Chapter 2: "Using Reports" in this document for more information.
- The database items used for the Split/Skill Graphical AUX Agents Report are stored in the `csplit` and `cagent` tables.
- This report uses the Split/Skill Report Input Window. Select a skill that you want to view on the report. See [Split/skill report input fields \(3-60\)](#) for more information.

This report shows the following two-dimensional pie chart information for the number of agents in AUX for each reason code for that skill:

- The pie chart's legend shows the synonym for each reason code and its corresponding color of the pie.
- The legend is sorted in ascending order by the reason code, with the customer-defined synonym for reason code 0 at the bottom.
- The number of agents are shown inside each slice of the pie.

**Split/Skill Graphical AUX Agents report example**

The following figure provides an example of a Split/Skill Graphical AUX Agents report:

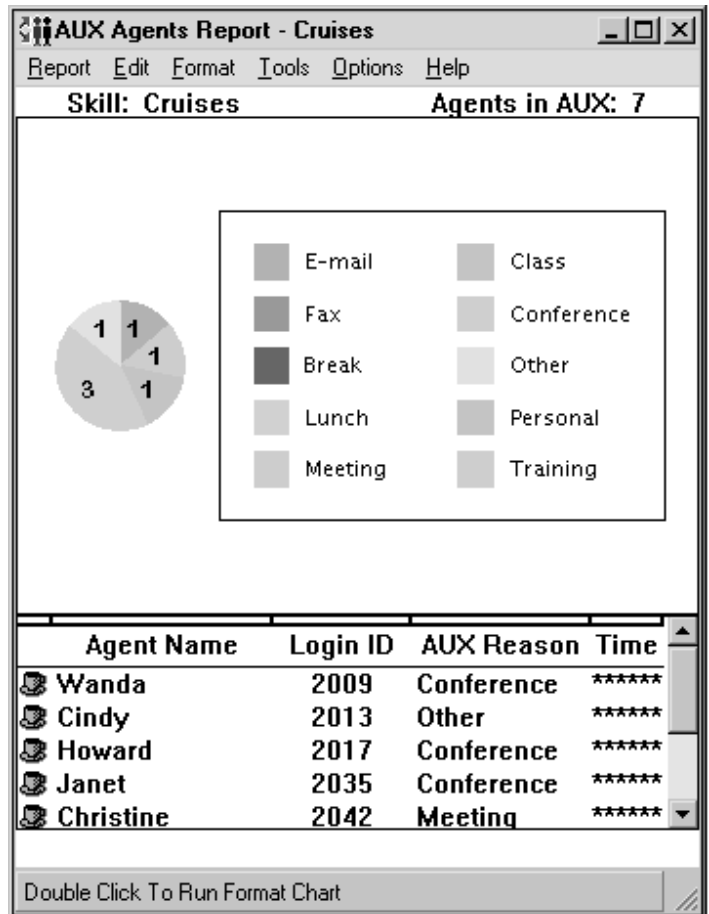

**Split/Skill Graphical AUX Agents report description**

The following table describes the report fields:

Report Heading	Description	Database Item, Calculation, or <Calculation Name>
Skill:	The name or number of the skill (up to 20 characters) that is selected for this report.	syn( SPLIT)

Report Heading	Description	Database Item, Calculation, or <Calculation Name>
Agents in AUX:	The current number of agent positions that are in AUX mode for this skill or on AUX-IN/AUX- OUT calls.	INAUX
Reason Code 0	The current number of positions that are in auxiliary work with reason code zero (0) for this skill or on AUXIN/AUXOUT calls. Reason code 0 is for "system" AUX work when reason codes are active ( <i>DEFINITY</i> ECS with EAS and later).	INAUX0
Reason Code 1-9	The current number of positions that are in auxiliary work with each of the reason codes 1-9 for this skill or on AUXIN/AUXOUT calls. ( <i>DEFINITY</i> ECS and later).	INAUX1-9
Agent Name	The names (or agent IDs if the names have not been assigned in Dictionary) of the agents assigned to this split/skill and logged in.	syn(LOGID)
Login ID	The login identification of the agent. LOGID	
Location ID	The location ID(s) associated with the agent. This ID is not associated with the agent personally, but rather with the terminal the agent is logged into. It is also associated with a port network location ID on <i>DEFINITY</i> . If the Agent Site Tracking feature is not available on your system, the field will not display meaningful data.	LOC_ID
AUX Reason	For the <i>DEFINITY</i> ECS, this is the reason associated with the auxiliary work state (on a break, in a meeting, and so on) of this agent. This field is blank if the agent is not in the AUX work state.	syn(AUXREASON)
Time	The elapsed time since the last agent WORKMODE change for any split/skill. This item is not reset if the DIRECTION changes, but WORKMODE remains the same. For example, if the agent goes from AUX to AUXOUT to AUX, AGTIME continues without resetting.	AGTIME



# Split/Skill Graphical AUX Top Agents Report

---

**Overview** This report, which is available only with the *DEFINITY* ECS release, shows top agents with this skill who are in AUX, the reason, and the time in AUX.

**Things to know about this report** Here are some things to know about this report:

- Call center supervisors can use this report to see which top agents are unavailable to take calls, and for what reason. The supervisor will also be able to see how long each top agent has been unavailable for each of the reason codes. This will help the supervisor figure out who could be pulled in to answer calls if call volumes increase, and will also help to identify top agents who are taking too long for breaks, lunch, etc.
- Top agents are agents for whom this measured skill is their highest priority. The skill level 1 is the highest priority and 16 is the lowest.
- The chart type can be changed. See Chapter 2: "Using Reports" in this document for more information.
- The database items used for the Split/Skill Graphical AUX Top Agents Report are stored in the `cspLit` and `cagent` tables.
- This report uses the Split/Skill Report Input Window. Select a skill that you want to view on the report. See [Split/skill report input fields \(3-60\)](#) for more information.

You can access this report in the following ways:

- From the Real-Time Split/Skill Category selector menu
- By drilling down from the AUX or Top Agent AUX (`cspLit.TINAUX`) work states on other top agent reports to this top agent report. This occurs only with *DEFINITY* ECS with EAS; otherwise, you drill down to the Work State report.

This report includes the following table information:

- A row for each top agent that is currently in the AUX work state for that skill.
- The top agent's name, login ID, reason code, and the time in AUX since the agent entered AUX for that reason code.
- You can specify how you want to sort the agent's name, login ID, reason code, and time.
- You can use the scroll bar to see additional top agents that are in the AUX state.

This report shows the following 2-D pie chart information for the number of agents in AUX for each reason code for that skill:

- The pie chart's legend shows the synonym for each reason code and its corresponding color of the pie.

- The number of agents are shown inside each slice of the pie.
- The legend is sorted in ascending order by reason code number, with the customer-defined synonym for reason code 0 at the bottom.

**Split/Skill Graphical AUX Top Agents report example**

The following figure provides an example of a Split/Skill Graphical AUX Top Agents report:

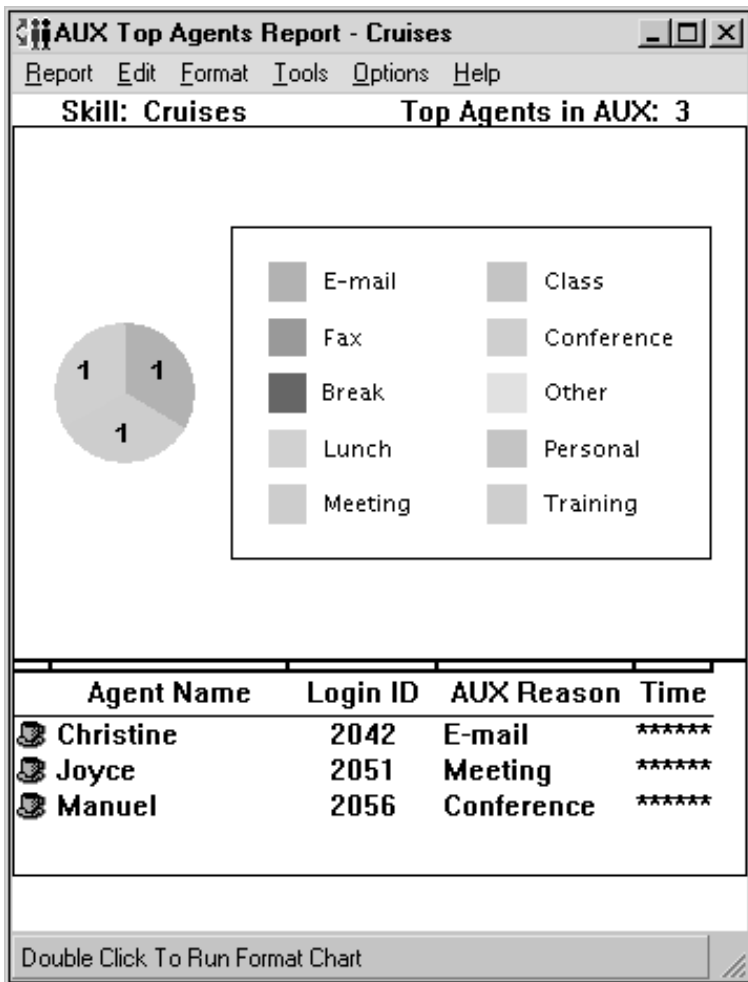

**Split/Skill Graphical AUX Top Agents report description**

The following table describes the report fields:

Report Heading	Description	Database Item, Calculation, or <Calculation Name>
Skill:	The name or number of the skill (up to 20 characters) that is selected for this report.	syn( SPLIT)

Report Heading	Description	Database Item, Calculation, or <Calculation Name>
Top Agents in AUX:	The number of top agents logged into the skill who are in the AUX work mode. This includes agents on AUXIN/AUXOUT calls.	INAUX
Reason Code 0	The current number of positions that are in auxiliary work with reason code zero (0) for this skill or on AUXIN/AUXOUT calls. Reason code "0" is for "system" AUX work when reason codes are active ( <i>DEFINITY</i> ECS with EAS and later).	NAUX0
Reason Code 1-9	The current number of positions that are in auxiliary work with each of the reason codes 1-9 for this skill or on AUXIN/AUXOUT calls ( <i>DEFINITY</i> ECS and later).	INAUX1-9
Agent Name	The names (or agent IDs if the names have not been assigned in Dictionary) of the agents assigned to this skill and logged in.	syn(LOGID)
Login ID	The login identification of the agent. LOGID	
Location ID	The location ID(s) associated with the agent. This ID is not associated with the agent personally, but rather with the terminal the agent is logged into. It is also associated with a port network location ID on <i>DEFINITY</i> . If the Agent Site Tracking feature is not available on your system, the field will not display meaningful data.	LOC_ID
AUX Reason	For the <i>DEFINITY</i> ECS, this is the reason code associated with the auxiliary work state (on a break, in a meeting, and so on) of this agent. This field is blank if the agent is not in the AUX state.	syn(AUXREASON)
Time	The elapsed time since the last agent WORKMODE change for any split/skill. This item is not reset if the DIRECTION changes, but WORKMODE remains the same. For example, if the agent goes from AUX to AUXOUT to AUX, AGTIME continues without resetting.	AGTIME



# Split/Skill Graphical Call Profile Report

---

**Overview** This report shows how well the split or skill you specify is performing compared to your call center's predefined acceptable service level.

**Things to know about this report** Here are some things to know about this report:

- You can access this report from the Real-Time Split/Skill Category selector menu.
- The split/skill selected for the report and the predefined acceptable service level are displayed above the top graph. Legends appear to the right of each chart.
- On the bottom graph, the horizontal axis represents the service interval in seconds, and the vertical axis represents the number of ACD calls answered/abandoned within the acceptable service level.
- The number displayed for each service interval is the upper limit of the interval. For example, if the first two intervals are "3" and "5," the first data point on the graph indicates the number of calls answered/abandoned within 0-3 seconds, and the second data point indicates the number of calls answered/abandoned within 4-5 seconds.
- The chart type can be changed. See Chapter 2: "Using Reports" in this document for more information.
- The database items used for this report are stored in the `csplit` table.
- This report uses the Split/Skill Report Input Window. Select a skill that you want to view on the report. See [Split/skill report input fields \(3-60\)](#) for more information.

This report has two charts:

- The top chart, a three-dimensional pie chart, shows the percentage of ACD calls answered within the predefined Acceptable Service Level and the percentage of ACD calls answered outside this level.
- The bottom chart, a stacked area graph, shows the number of ACD calls answered and abandoned within each service interval.

**Split/Skill Graphical Call Profile report example**

The following figure provides an example of a Split/Skill Graphical Call Profile report:

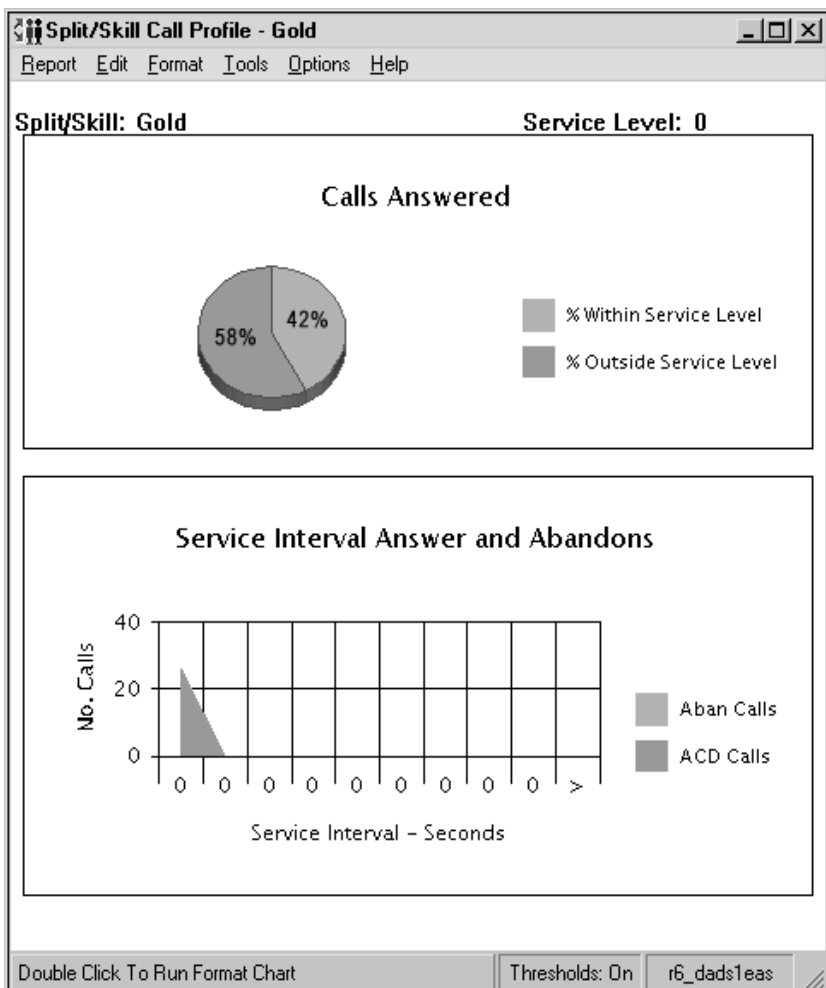

**Split/Skill Graphical Call Profile report description**

The following table describes the report fields:

Report Heading	Description	Database Item, Calculation, or <Calculation Name>
Split/Skill:	The name or number of the split/skill selected for this report.	syn( SPLIT)
Secs:	The size of each increment is measured in seconds. Each increment of seconds represents a progressively longer wait time segment during which calls may be answered or abandoned, and each increment can be a different length. These increments are defined in the Call Center Administration Split/Skill Call Profile Setup window.	PERIOD1-9

Report Heading	Description	Database Item, Calculation, or <Calculation Name>
% Within Service Level	<p>The percentage of split/skill ACD calls that were answered by an agent within the predefined service level. Calls offered to the split/skill include calls that were abandoned and calls that were not answered, but do not include direct agent calls. Calls that were not answered may include forced busy calls, forced disconnect calls, calls redirected to another destination, and calls queued to more than one split/skill and answered in another split/skill.</p> <p>For the call vectoring feature, calls that were not answered may include</p> <ul style="list-style-type: none"> <li>• Forced Busy calls</li> <li>• Forced disconnect calls</li> <li>• Calls redirected to another destination</li> <li>• Calls queued to more than one split/skill (Generic 3 only) and answered in another split/skill.</li> </ul>	$100 * (\text{ACCEPTABLE} / \text{CALLS-OFFERED})$ <PERCENT_SERV_LVL_SPL>
% Outside Service Level	<p>Percentage of split/skill ACD calls that were not answered by an agent within the predefined acceptable service level. Calls to the split/skill include abandoned calls, calls not answered, and outbound ACD calls placed by an adjunct (for example, Outbound predictive dialing - Generic 3 switches with the ASAI feature). Calls that were not answered may include forced busy calls, forced disconnect calls, calls redirected to another destination, and calls queued to more than one split and answered in another split/skill. For Generic 3 switches, Percent Within Service Level does not include direct agent calls.</p>	$< <100 - \text{PERCENT\_SERV\_LVL\_SPL}>$
Aban Calls	<p>The number of calls to the split/skill that were abandoned within each increment. If calls are queued to multiple splits/skills, only the first split/skill queued to records an abandon. This includes outbound ACD calls placed by an adjunct (also called outbound predictive dialing) for the Generic 3 with ASAI only. It does not include direct agent calls.</p>	ABNCALLS1-10

Report Heading	Description	Database Item, Calculation, or <Calculation Name>
ACD Calls	This is the number of calls that were sent to the split/skill that were answered by an agent within each increment. This includes outbound ACD calls placed by an adjunct (also called outbound predictive dialing), for the Generic 3 with ASAI only. For the Generic 3 switches it does not include direct agent calls.	ACDCALLS1



---

# Split/Skill Graphical EWT Report

---

**Overview** This report shows the current Expected Wait Time (EWT) for one or more of the splits or skills you specify.

- Things to know about this report** Here are some things you need to know about this report:
- This report is available only if you have a Generic 3 Version 4 or later version switch with the EWT option.
  - You can access this report from the Real-Time Split/Skill Category selector menu.
  - The vertical axis of the chart is labeled with the names or numbers of the splits or skills selected for the report.
  - A legend appears to the right of the chart.
  - The database items used for the report are stored in the `csplit` table.
  - The chart type can be changed. See Chapter 2: "Using Reports" in this document for more information.
  - This report uses the Split/Skill Report Input Window. Select a skill that you want to view on the report. See [Split/skill report input fields \(3-60\)](#) for more information.

**Split/Skill Graphical EWT report example**

The following figure provides an example of a Split/Skill Graphical EWT report:

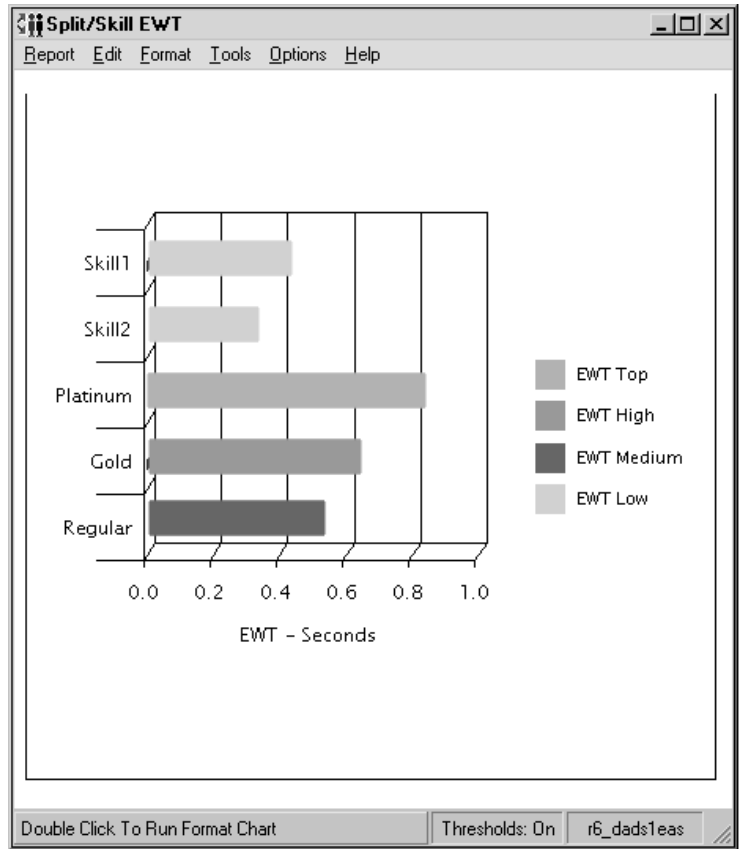

**Split/Skill Graphical EWT report description**

The following table describes the report fields:

Report Heading	Description	Database Item, Calculation, or <Calculation Name>
Skill	The name or number of the skill that is selected for this report.	syn( SPLIT)
Top	This heading contains EWT for the split/skill at top priority. EWT is the wait time for the call when it is queued to the split/skill at the top priority. EWT measures only the time it takes to deliver the call to an agent. It does not include ringing time. If <i>CentreVu</i> CMS is connected to a switch previous to the Generic 3 Version 4 or if vectoring is not activated, the EWT headings and columns are displayed, but the fields are blank. Exception thresholds for EWT can be set from the Exceptions command.	EWTTOP

Report Heading	Description	Database Item, Calculation, or <Calculation Name>
High	This heading contains EWT for the split/skill at high priority. EWT is the wait time for the call when it is queued to the split/skill at high priority. EWT measures only the time it takes to deliver the call to an agent. It does not include ringing time. If <i>CentreVu</i> CMS is connected to a switch previous to the Generic 3 Version 4 or if vectoring is not activated, the EWT headings and columns are displayed, but the fields are blank. Exception thresholds for EWT can be set from the Exceptions command.	EWTHIGH
Medium	This heading contains EWT for the split/skill at medium priority. EWT is the wait time for the call when it is queued to the split/skill at medium priority. EWT measures only the time it takes to deliver the call to an agent. It does not include ringing time. If <i>CentreVu</i> CMS is connected to a switch previous to the Generic 3 Version 4 or if vectoring is not activated, the EWT headings and columns are displayed, but the fields are blank. Exception thresholds for EWT can be set from the Exceptions command.	EWTMEDIUM
Low	This heading contains EWT for the split/skill at low priority. EWT is the wait time for the call when it is queued to the split/skill at low priority. EWT measures only the time it takes to deliver the call to an agent. It does not include ringing time. If <i>CentreVu</i> CMS is connected to a switch previous to the Generic 3 Version 4 or if vectoring is not activated, the EWT headings and columns are displayed, but the fields are blank. Exception thresholds for EWT can be set from the Exceptions command.	EWTLOW



---

# Split/Skill Graphical Queue Report

---

**Overview** This report shows the number of calls waiting in queue, the amount of time that the oldest call has waited in queue, and trending for one or more splits/skills.

- Things to know about this report** Here are some things you need to know about this report:
- You can access this report from the Real-Time Split/Skill Category selector menu.
  - You can use this report to view trends of calls waiting for several splits/skills.
  - The chart type can be changed. See Chapter 2: "Using Reports" in this document for more information.
  - This report has four graphs. The two graphs on the left side of the report show the number of Calls Waiting (upper left quadrant) and the Oldest Call Waiting (lower left quadrant). The two graphs on the right side of the report show the trends for the last ten refresh intervals for the same data items. The legend shows which line corresponds to which split/skill.
  - Each bar graph has a horizontal bar, on the left quadrant of the report, for each split/skill selected for the report. Each graph's x-axis dynamically scales to the largest value of the items being reported. The x-axis of the Calls Waiting bar graph displays the number of calls (No. Calls) waiting in the split/skill queue. The x-axis of the Oldest Call Waiting bar graph displays the number of seconds the oldest call in the split/skill queue has waited.
  - The database items used for this report are stored in the `csplit` table.
  - This report uses the Split/Skill Report Input Window. Select a skill that you want to view on the report. See [Split/skill report input fields \(3-60\)](#) for more information.



**Split/Skill Graphical Queue report example**

The following figure provides an example of a Split/Skill Graphical Queue report:

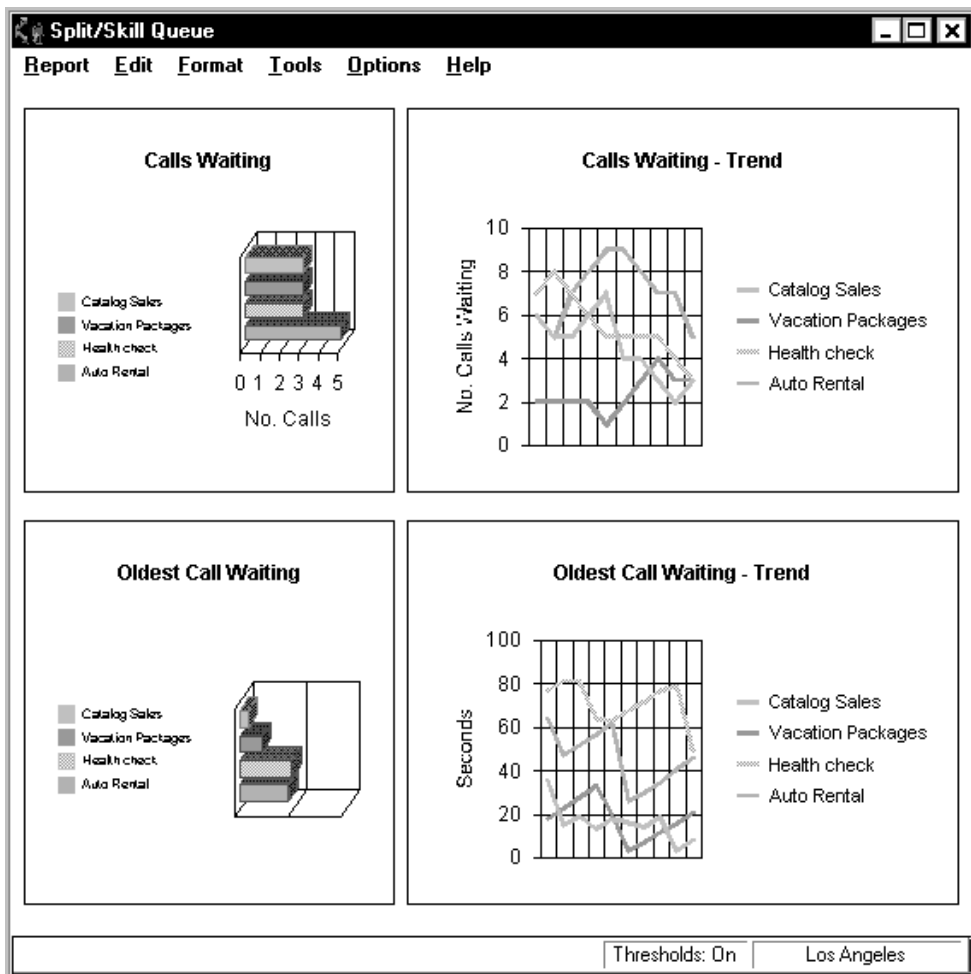

**Split/Skill Graphical Queue report description**

The following table describes the report fields:

Report Heading	Description	Database Item, Calculation, or <Calculation Name>
Split/Skill	The name or number of the splits/skills selected for this report.	syn( SPLIT)
Skill State	The current state of the skill, compared to the administered thresholds. This displays as Normal, Overload 1, and Overload 2 on the report. Requires <i>DEFINITY</i> ECS R6 or later with <i>CentreVu</i> Advocate.	SKSTATE

Report Heading	Description	Database Item, Calculation, or <Calculation Name>
Calls Waiting	The number of split or skill ACD calls waiting to be answered. This includes calls that are in queue and calls that are ringing at an agent voice terminal. It does not include direct agent calls for the Generic 3 switch.	INQUEUE + INRING
Oldest Call Waiting	The length of time (in seconds) the oldest ACD call has waited in queue or ringing (at an agent voice terminal for each split/skill in the report) before being answered. This does not include direct agent calls.	OLDESTCALL



---

## Split/Skill Graphical Skill Overload Report

---

**Overview** This report is only available for customers who have *DEFINITY* ECS R6 or later switches with Expert Agent Selection (EAS) and have purchased *CentreVu* Advocate. It shows the skill state (normal, unknown, overload1, overload 2) and trends for a selected skill.

If *CentreVu* Advocate is not activated, the fields of the report which pertain to *CentreVu* Advocate will not be populated.

- Things to know about this report** Here are some things you need to know about this report:
- You can access this report from the Real-Time Split/Skill Category selector menu.
  - The report caption displayed when the report is run reads “Skill Overload: xxx” where xxx is the skill name string specified by the Name Formats window of Tools/Options.
  - This report has two sections: a vertical bar chart and a rolling line chart.
  - The vertical bar chart consists of:
    - A vertical bar for each skill input for the report, showing the current skill state.
    - The y-axis of the report will display, from the bottom up, “Normal,” “Overload1,” and “Overload2.”
    - The title: Skill Overload Report
    - By default, a legend displays. The legend will show the synonym for every skill specified in the input, or the skill number if no skill name has been defined.
  - The rolling line chart consists of:
    - When the report is started, only one data point (whether unknown, normal, overload1 or overload2) is displayed for each skill. With each refresh, the new status will be added to the previous refresh. This continues for 20 refreshes, at which time the oldest data will roll off the chart.
    - The x-axis of the chart displays a tick mark for each report refresh.
    - The y-axis of the chart displays, from the bottom up, “Normal,” “Overload1,” and “Overload2.”
  - The database items used for this report are stored in the `csplit` table.
  - This report uses the Split/Skill Report Input Window. Select a skill that you want to view on the report. See [Split/skill report input fields \(3-60\)](#) for more information.

**Split/Skill Graphical Skill Overload report example**

The following figure is an example of a Graphical Skill Overload report:

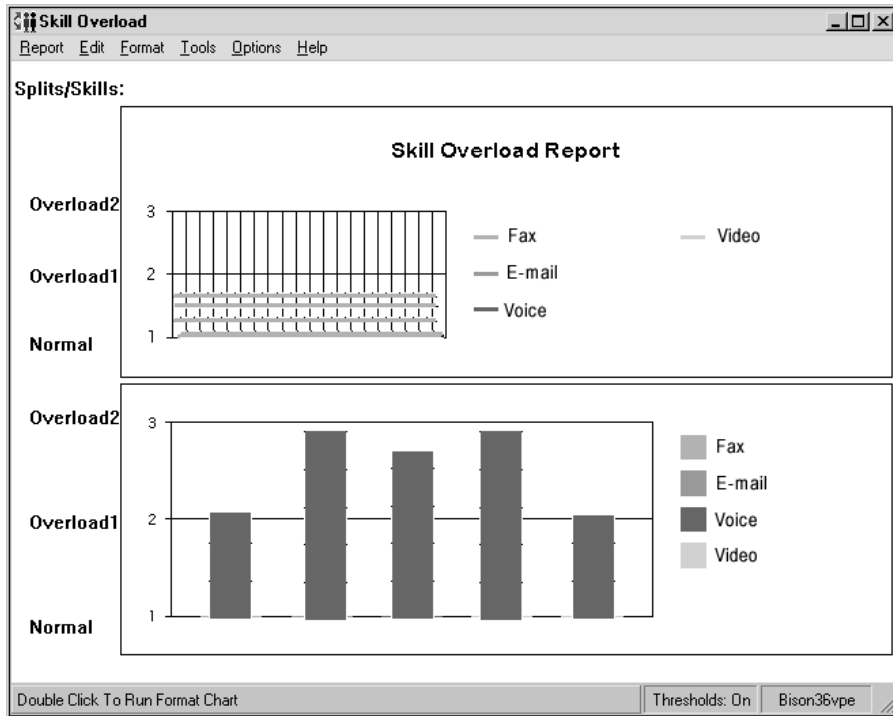

**Split/Skill Graphical Skill Overload report description**

The following table describes the report fields:

Report Heading	Description	Database Item, Calculation, or <Calculation Name>
Split/Skill	The name or number of the splits/skills selected for this report.	syn( SPLIT)
Skill State	The current state of the skill, compared to the administered thresholds. This displays as Normal, Overload 1, and Overload 2 on the report. Requires <i>DEFINITY</i> ECS R6 or later with <i>CentreVu</i> Advocate.	SKSTATE



---

## Split/Skill Graphical Staffing Profile Report

---

**Overview** This report is available only for customers who have *DEFINITY* ECS R6 or later switches with EAS and have purchased *CentreVu* Advocate. It shows how many of what type of agents are staffing a specified skill as Active, in Other, or in AUX.

If *CentreVu* Advocate is not activated, the fields of the report which pertain to *CentreVu* Advocate will not be populated.

- Things to know about this report** Here are some things you need to know about this report:
- You can access this report from the Real-Time Split/Skill Category selector menu.
  - Call center supervisors can use this report to see how many agents are active, in Other or in auxiliary work (AUX). This report will also show the supervisor what type of agents are in those fields.
  - This report has four charts.
  - The charts contain the following information:
    - The upper left quadrant chart shows Top agents staffed, active, in AUX, and in Other for the specified skill.
    - The upper right quadrant chart shows Flex agents staffed, active, in AUX, and in Other for the specified skill.
    - The lower right quadrant chart shows Reserve2 agents staffed, active, in AUX, and in Other for the specified skill.
    - The lower left quadrant chart shows Reserve1 agents staffed, active, in AUX, and in Other for the specified skill.
  - The database items used for this report are stored in the `csplit` table.
  - This report uses the Split/Skill Report Input Window. Select a skill that you want to view on the report. See [Split/skill report input fields \(3-60\)](#) for more information.
  - You may change the report in Report Designer to display information on agents who are available (AVAIL).

**Split/Skill Graphical Staffing Profile report example**

The following figure is an example of a Graphical Staffing Profile report:

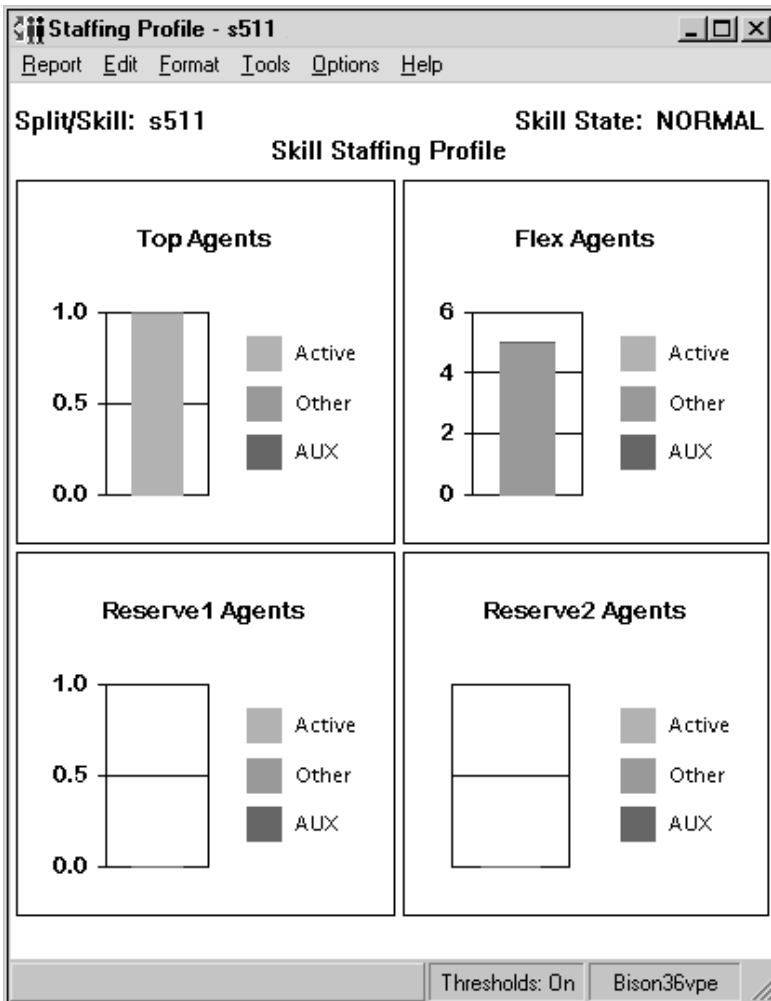

**Split/Skill Graphical Staffing Profile report description**

The following table describes the report fields:

Report Heading	Description	Database Item, Calculation, or <Calculation Name>
Split/Skill	The name or number of the splits/skills selected for this report.	syn( SPLIT)
Skill State	The current state of the skill, compared to the administered thresholds. This displays as Normal, Overload 1, and Overload 2 on the report. Requires <i>DEFINITY</i> ECS R6 or later with <i>CentreVu</i> Advocate.	SKSTATE

Report Heading	Description	Database Item, Calculation, or <Calculation Name>
Top Agents (AUX)	The number of top agents logged into the skill who are in the AUX work mode. This includes agents on AUXIN/AUXOUT calls. Available on Generic 3 switches with the EAS feature for top skills. However, "top" database items are only significant for Generic 3 switches and the ECS with EAS. TINAUX includes TINAUX0, TINAUX1-9, TONACDAUXOUT, TONAUXIN, and TONAUXOUT.	TINAUX
Top Agents (Other)	The number of top agents that are doing other work. Agents are logged into multiple skills and doing work for a skill other than this one (on an ACD call or in after call work [ACW], or ACD calls ringing). For Generic 3, while in Auto-in or Manual-in mode; the agent put any call on hold and has performed no further action; the agent is on a direct agent call or in ACW for a direct agent call; the agent is dialing to place a call or to activate a feature; an extension call or a direct agent ACD call is ringing with no other activity. For Generic 3 EAS with multiple call handling, agents are available for other, multiple call handling skills. Agent POSITIONS will show up in TOTHER directly after the link to the switch comes up and directly after the agents log in before the <i>CentreVu</i> CMS is notified of the agent's work state. Available with Generic 3 switches with the EAS feature. However, "top" database items are only significant for Generic 3 switches and the ECS with EAS. TOTHER includes TDA_INACW and TDA_ONACD.	TOTHER
Top Agents (Active)	The number of top agents logged into the skill, who are on inbound and outbound ACD calls, plus the number of top agents who are in ACW for ACD calls, plus the number of top agents who have ACD calls ringing and are not doing anything else.	TONACD + TINACW + TAGINRING
Flex Agents (AUX)	The number of flex agents in AUX. Requires <i>DEFINITY</i> ECS R6 or later with <i>CentreVu</i> Advocate.	FINAUX

Report Heading	Description	Database Item, Calculation, or <Calculation Name>
Flex Agents (Other)	The number of flex agents in the OTHER state. Requires <i>DEFINITY</i> ECS R6 or later with <i>CentreVu</i> Advocate.	FOTHER
Flex Agents (Active)	The number of flex agents on ACD calls, plus the number of flex agents in ACW, plus the number of flex agents with this skill that have an ACD call ringing.	FONACD + FINACW + FAGINRING
Reserve1 Agents (AUX)	The number of reserve1 agents in AUX. Requires <i>DEFINITY</i> ECS R6 or later with <i>CentreVu</i> Advocate.	R1INAUX
Reserve1 Agents (Other)	The number of reserve 1 agents in the OTHER state. Requires <i>DEFINITY</i> ECS R6 or later with <i>CentreVu</i> Advocate.	R1OTHER
Reserve1 Agents (Active)	The number of reserve1 agents on ACD calls, plus the number of reserve1 agents in ACW, plus the number of reserve1 agents with this skill that have an ACD call ringing.	R1ONACD + R1INACW + R1AGINRING
Reserve2 Agents (AUX)	The number of reserve2 agents in AUX. Requires <i>DEFINITY</i> ECS R6 or later with <i>CentreVu</i> Advocate.	R2INAUX
Reserve2 Agents (Other)	The number of reserve2 agents in the OTHER state. Requires <i>DEFINITY</i> ECS R6 or later with <i>CentreVu</i> Advocate.	R2OTHER
Reserve2 Agents (Active)	The number of reserve2 agents on ACD calls, plus the number of reserve2 agents in ACW, plus the number of reserve2 agents with this skill that have an ACD call ringing.	R2ONACD + R2INACW + R2AGINRING





---

# Split/Skill Graphical Status Report

---

**Overview** This report shows the status of the agent, the amount of time in an agent state, and the split/skill statistics for individual agents.

- Things to know about this report** Here are some things you need to know about this report:
- You can access this report from the Real-Time Split/Skill Category selector menu.
  - From this report, you can drill down to the Real-Time or Integrated Agent Information, Work State, and Graphical AUX Agent (for *DEFINITY* ECS with EAS) reports.
  - The chart type can be changed. See Chapter 2: "Using Reports" in this document for more information.
  - The database items used for the report are stored in the `csplit`, `hsplit`, and `cagent` tables.
  - This report is available in both graphical and tabular formats.
  - The table on the left side of the report lists the staffed (logged in) agents in the split/skill you specify, the state (workmode) each agent is currently in, the amount of time the agent has been in the current state, and the split/skill that the agent is in currently. If the Split/Skill column is empty, the agent is not currently on a call. The split/skill selected for the report is displayed above the table.
  - By default, agent names are sorted alphabetically. If there are more staffed agents than can be displayed, a scroll bar appears on the right side of the table. To the left of each agent name (or login id, if names are not assigned) is an icon representing the agent's state.
  - The three-dimensional pie chart in the upper-right quadrant shows the number of agents in each agent state (Avail, ACD, AUX, ACW, Ring, Other) for the selected split/skill. The number of agents in each agent state is displayed on the corresponding piece of pie. A legend is displayed to the right of the chart.
  - The fields in the lower-right quadrant of the report display real-time split/skill information.
  - This report uses the Split/Skill Report Input Window. Select a skill that you want to view on the report. See [Split/skill report input fields \(3-60\)](#) for more information.

### Split/Skill Graphical Status report example

The following figure provides an example of a Split/Skill Graphical Status report:

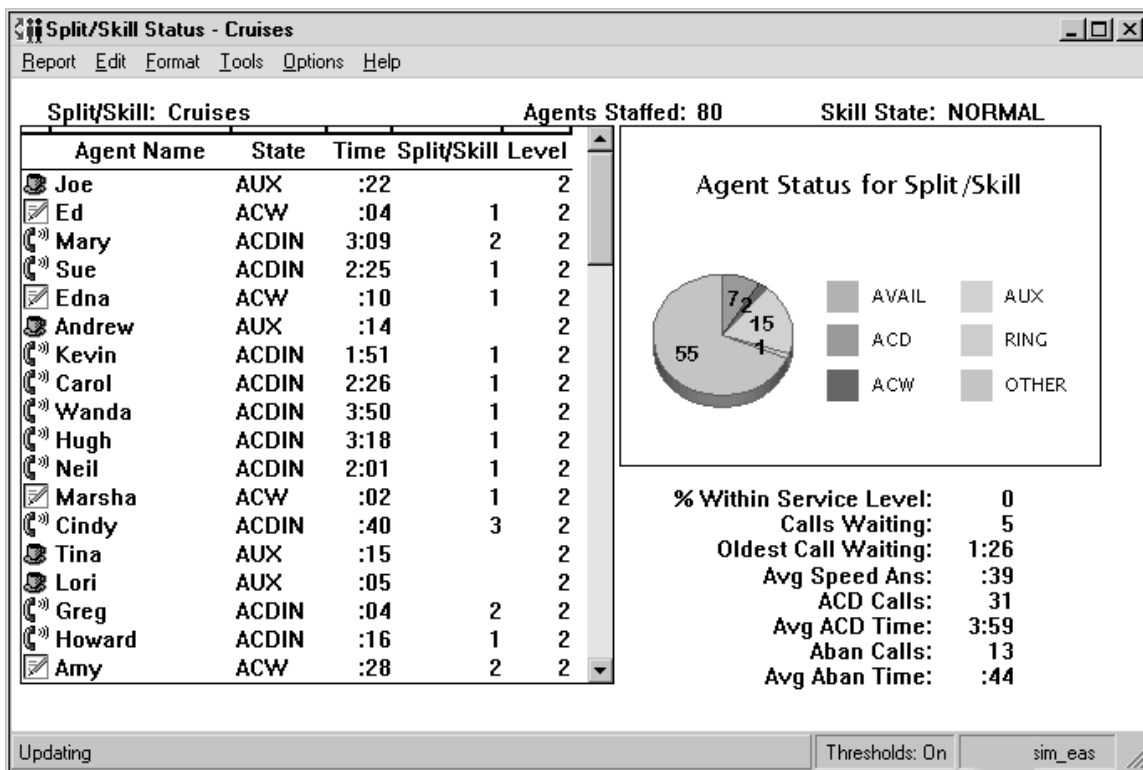

### Split/Skill Graphical Status report description

The following table describes the report fields:

Report Heading	Description	Database Item, Calculation, or <Calculation Name>
Split/Skill:	The name or number of the split(s)/skill(s) selected for this report.	syn(SPLIT)
Level	The skill level associated with the agent's current WORKSKILL, when WORKSKILL, is not null. Requires a Generic 3 Version 2 or later switch with the EAS feature. For CentreVu Advocate, in the cagent table, WORKSKLEVEL contains either a skill level (1-16) for a normal skill, or a reserve level (1 or 2) for a reserve skill. This WORKSKLEVEL applies to WORKSKILL.	syn(WORKSKLEVEL)
Agents Staffed:	The total number of agents that are logged into each split/skill.	STAFFED
Skill State	Current state of this skill, compared to the administered thresholds. Requires ECS R6 or later with CentreVu Advocate.	syn( SKSTATE)

Report Heading	Description	Database Item, Calculation, or <Calculation Name>
Agent Name	The name(s) of the agent(s) assigned to this split/skill and logged in (or their login IDs if names have not been assigned to them in Dictionary).	syn(LOGID)
State	The current work mode (state) the agent is in (AVAIL, ACD, ACW, AUX, DACD, DACW, RINGING, UNKNOWN, OTHER, UNSTAFF) and the call direction (blank, IN, or OUT).	syn( WORKMODE) and syn(DIRECTION)
Time	The elapsed time since the last agent WORKMODE change for any split/skill. This item is not reset if the DIRECTION changes, but WORKMODE remains the same. For example, if the agent goes from AUX to AUXOUT to AUX, AGTIME continues without resetting.	AGTIME
Split/Skill	The split associated with the call or the ACW state when an agent is either on a split or direct agent ACD call, or in the ACW state. If an agent puts an ACD call on hold and makes an AUX call, this is the split of the ACD call on hold. For AUXIN calls and AUXOUT calls made without an ACD call on hold, this is the split the agent has been logged into the longest. When the agent is available, all of the splits the agent is available in are listed.	WORKSPLIT, WORKSPLIT2...4 (Generic 3 Version 2 and later Generic 3 switches only)
% Within Service Level:	The percentage of split/skill ACD calls that were answered by an agent within the predefined time. Calls offered to the split/skill include calls that were abandoned and calls that were not answered, but do not include direct agent calls. Calls that were not answered may include forced busy calls, forced disconnect calls, calls redirected to another destination, and calls queued to more than one split/skill and answered in another split/skill.	100*( ACCEPTABLE/ CALLSOFFERED) <PERCENT_SERV_LVL_SPL>
Calls Waiting:	The number of split or skill ACD calls waiting to be answered. This includes calls that are in queue and calls that are ringing at an agent voice terminal. It does not include direct agent calls for the Generic 3 switches.	INQUEUE+ INRING

Report Heading	Description	Database Item, Calculation, or <Calculation Name>
Oldest Call Waiting:	The length of time (in seconds) the oldest ACD call has waited in queue or ringing (at an agent voice terminal for each split/skill in the report) before being answered. This does not include direct agent calls.	OLDESTCALL
Avg Speed Ans:	The average time calls waited in queue or ringing before an agent answered. This does not include direct agent calls, but it does include outbound ACD calls placed by an adjunct (also called outbound predictive dialing) for the Generic 3 with ASAI only.	ANSTIME / ACDCALLS <AVG_ANSWER_SPEED>
ACD Calls:	The ACD calls that were queued to the split/skill and answered by an agent. This does not include direct agent calls, but it does include ACD calls placed by an adjunct (also called outbound predictive dialing) for the Generic 3 with ASAI only.	ACDCALLS
Avg ACD Time:	The average talk time (does not include hold time) is calculated for all ACD calls to this split/skill. This does not include direct agent calls, but it does include talk time of all outbound ACD calls placed by an adjunct (also called outbound predictive dialing) for the Generic 3 with ASAI only.	ACDTIME / ACDCALLS <AVG_ACD_TALK_TIME>
Aban Calls:	The total number of queued calls for each split/skill that were abandoned before an agent answered. This includes calls that are ringing at a voice terminal but does not include direct agent calls. It also includes the number of outbound calls for each split/skill that abandoned at the far end before an agent answered (for the Generic 3 with the ASAI feature only).	ABNCALLS
Avg Aban Time:	The average time calls waited before hanging up.	ABNTIME / ABNCALLS <AVG_ABANDON_TIME>



---

# Split/Skill Graphical Top Skill Status Report

---

**Overview** This report, available only with EAS, contains a table of top agents and their work state, a pie chart showing the composite top agent status, and a pie chart showing the composite reason codes for top agents who are in AUX.

**Things to know about this report** Here are some things to know about this report:

- You can access this report from the Real-Time Split/Skill Category selector menu.
- The table on the left bottom half of the report contains a row for each staffed agent for whom this skill is their top skill. The row shows an icon representing agent state, the agent names as defined in the Dictionary, the agent state for this skill, time in current state, and a reason code (as defined in the Dictionary) for the AUX work state. The Reason column is blank except for those agents who are in AUX work. This table also contains the skill in which the agent is active. This field is blank if the agent is in AVAIL, AUX, or OTHER work modes.
- Call center supervisors can use this report for skill level distribution and to keep agents on ACD calls. In addition, this report shows what is happening with agents who are taking calls for this skill. This report is available for Generic 3 switch with EAS.
- From this report, you can drill down to the Real-Time and Integrated Agent Information, Top Agents Work State, and Graphical Top AUX Agent reports.
- Even though a skill may be staffed by many agents, it is likely that only those for whom this is their top skill will be available to answer calls to this skill.
- The database items used for the report are stored in the `csplit` and `cagent` tables.
- This report uses the Split/Skill Report Input Window. Select a skill that you want to view on the report. See [Split/skill report input fields \(3-60\)](#) for more information.

The two dimensional pie chart contains data only for the *DEFINITY* ECS with EAS. The two dimensional pie chart contains the following information:

- The composite status of top agents for the skill who are in AUX for each reason code.
- A legend displays the synonyms for reason codes that have been defined in the Dictionary. The legend is sorted in ascending order by reason code number, with the customer- defined synonym for reason code 0 at the bottom.

The three-dimensional pie chart contains the following information:

- The composite status of top agents for the skill in each of the work states.
- A legend in which a different color corresponds to each of the work states.
- Above the chart is the "Top Agents in AUX" heading.

**Split/Skill Graphical Top Skill Status report example**

The following figure provides an example of the Split/Skill Graphical Top Skill Status report:

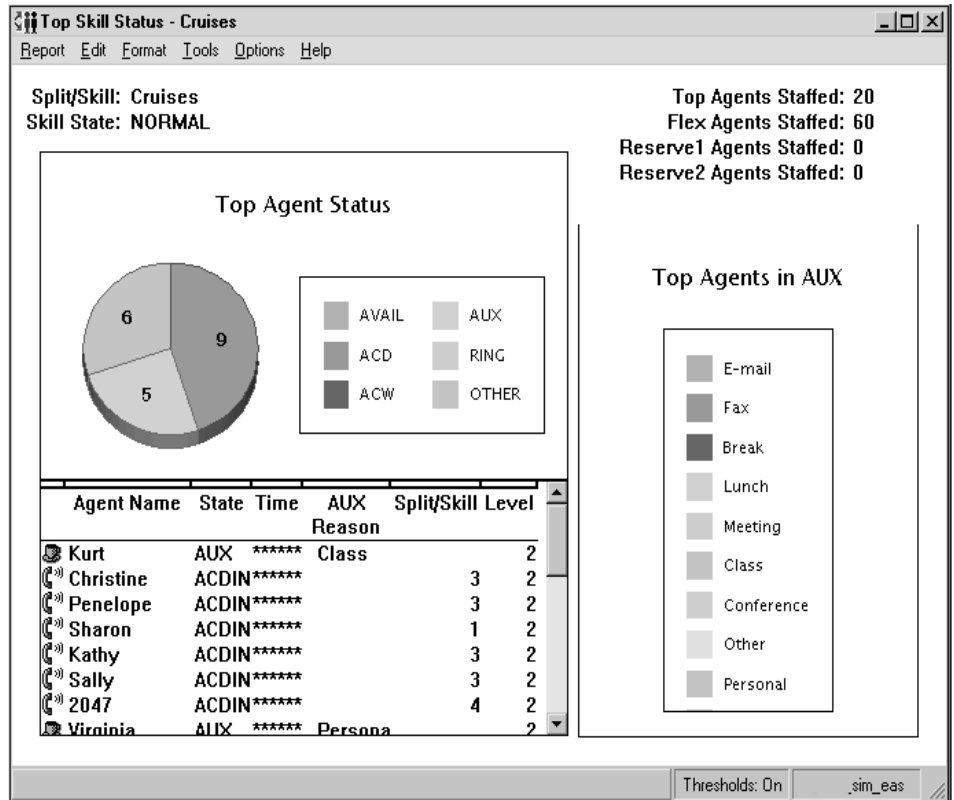

**Split/Skill Graphical Top Skill Status report description** The following table describes the report fields:

Report Heading	Description	Database Item, Calculation, or <Calculation Name>
Skill:	The name or number of the skill (up to 20 characters) that is selected for this report.	syn( SPLIT)
Skill State	The current state of the skill, compared to the administered thresholds. This displays as Normal, Overload 1, and Overload 2 on the report. Requires <i>DEFINITY</i> ECS R6 or later with <i>CentreVu</i> Advocate.	SKSTATE
Top Agents Staffed:	The current number of top agents that are staffed in this skill.	TSTAFFED
Flex Agents Staffed	Number of agents who are staffing the skill, but are neither top or reserve agents. Requires ECS R6 or later with <i>CentreVu</i> Advocate. This field will contain backup agents if the <i>CentreVu</i> Advocate feature is not used, since the database item consists of agents whose role in the skill is backup (applicable regardless of whether <i>CentreVu</i> Advocate is administered), allocation, or roving. FSTAFFED	
Reserve1 Agents Staffed	Number of agents staffing this skill as reserve1. Requires ECS R6 or later with <i>CentreVu</i> Advocate.	R1STAFFED
Reserve2 Agents Staffed	Number of agents staffing this skill as reserve2. Requires ECS R6 or later with <i>CentreVu</i> Advocate.	R2STAFFED
AVAIL	The current number of agents that are available to receive ACD calls in this split/skill.	AVAILABLE
ACD	The total time during the collection interval that the agent was talking on ACD calls for the Split.	sum(<TOTAL_I_ACDTIME>)
ACW	The total time during the collection interval that the agent was in after call work (ACW). This includes ACW for split/skill ACD Calls and ACW not associated with the call.	sum(<TOTAL_I_ACWTIME>)
AUX	The total time during the collection interval that the agent was in the AUX work state in all splits/skills or in AUXINCALLS or AUXOUTCALLS.	sum(TI_AUXTIME)

Report Heading	Description	Database Item, Calculation, or <Calculation Name>
RINGING	The time during the collection interval that the agent had split/skill and direct agent ACD calls ringing.	sum(I_RINGTIME)
OTHER	The time during the collection interval that the agent was doing other work in all split/skills. For Generic 3 switches, while in Auto-in or Man-in: the agent put any call on hold and performed no further action, the agent dialed to place a call or to activate a feature, or an extension call rang with no other activity. For all switches, TI_OTHERTIME is collected for the time period after the line to the switch comes up or after the agent logs in and before the CMS receives notification of the agent's state from the switch. The "TI_" time is only stored for the split/skill logged into the longest. "TI_" time needs to be summed across the split/skills the agents may log into, in case the logon order changes during the collection interval.	sum(TI_OTHERTIME)
Agent Name	The names (or agent IDs if the names have not been assigned in the Dictionary) of the top agents assigned to this skill and logged in.	syn( LOGID)
State	The current work mode (state) the agent is in (AVAIL, ACD, ACW, AUX, DACD, DACW, RINGING, UNKNOWN, OTHER, UNSTAFF) and the call direction (blank, IN, or OUT).	syn(WORKMODE) and syn(DIRECTION)
Time	The elapsed time since the last agent WORKMODE change for any split/skill. This item is not reset if the DIRECTION changes, but WORKMODE remains the same. For example, if the agent goes from AUX to AUXOUT to AUX, AGTIME continues without resetting.	AGTIME
AUX Reason	For the <i>DEFINITY</i> ECS, this is the reason code associated with the auxiliary work state (on a break, in a meeting, and so on) of this agent. This field is blank if the agent is not in the AUX state.	syn(AUXREASON)
Skill	The name or number of the skill (up to 20 characters) that is selected for this report.	syn(SPLIT)



Report Heading	Description	Database Item, Calculation, or <Calculation Name>
Level	The skill level associated with the agent's current WORKSKILL, when WORKSKILL, is not null. Requires a Generic 3 Version 2 or later switch with the EAS feature.	syn(WORKSKLEVEL)
Reason Code 0	The current number of positions that are in auxiliary work with reason code zero (0) for this skill or on AUXIN/AUXOUT calls. Reason code 0 is for "system "AUX work when reason codes are active ( <i>DEFINITY</i> ECS with EAS and later).	INAUX0
Reason Code 1...9	The current number of positions that are in auxiliary work with each of the reason codes 1-9 for this skill or on AUXIN/AUXOUT calls ( <i>DEFINITY</i> ECS and later).	TINAUX1-9



---

# Reserve1 AUX Agents Report

---

**Overview** This report, which is available only for customers who have *DEFINITY* ECS R6 or later switches with EAS and have purchased *CentreVu* Advocate, displays the Reserve1 agents who are in AUX and the time in AUX, for a specified skill. When this report is accessed from the report menu, it displays as the Reserve1 AUX Agents Report. When it is accessed by drilling down from the AUX work state or Agent Location ID, it displays as the Reserve1 AUX Work State Report.

When accessed as a drill-down report, this report will only contain Location ID if the report you drill-down from uses Location ID as an input.

## Things to know about this report

Here are some things you need to know about this report:

- You can access this report the following ways:
  - From the Real-Time Split/Skill Category selector menu
  - By drilling down to this report from the AUX work state of Reserve1 agents, or R1INAUX.
- Call center managers can use this report to see the Reserve1 agents in each AUX work state, for a specified skill. For each agent, the manager will also be able to see information such as the length of time in the AUX work state.
- This report consists of a table and two data fields. The report table contains a row for each agent who is in the specified state for the specified skill.
- The report caption will read “Reserve1 AUX Work State Report—xxx,” where xxx is the skill name string specified by the user.
- The database items used for the report are stored in the `csplit` and `cagent` table.
- This report uses the Agent Information Input window. Select an agent that you want to view on the report. See [Agent Report Input Windows \(3-6\)](#).

**Reserve1 AUX Agents  
report example**

The following figure provides an example of the Reserve1 AUX Agents report:

Agent Name	Login ID	Role	Active Split/Skill	Level	Time
44468	44468	BCKP			1:21:50
44466	44466	BCKP			1:21:50
44461	44461	BCKP			1:21:50
44465	44465	BCKP			1:21:50
44462	44462	BCKP			1:21:49
44463	44463	BCKP			1:21:49
44467	44467	BCKP			1:21:49
44476	44476	TOP			1:21:45
44478	44478	TOP			1:21:45
44471	44471	TOP			1:21:45
44472	44472	TOP			1:21:45
44475	44475	TOP			1:21:45
44477	44477	TOP			1:21:45
44473	44473	TOP			1:21:45
44474	44474	TOP			1:21:45

**Reserve1 AUX Agents  
report description**

The following table describes the report fields:

Field	Definition	Database Item, Calculation, or <Calculation Name>
Skill	The name or number of the skill (up to 20 characters) that is selected for this report.	syn(SPLIT)
Reserve1 Agents in AUX	The number of reserve1 agents in AUX. Requires <i>DEFINITY ECS R6</i> or later with <i>CentreVu Advocate</i> .	R11NAUX
Agent Name	The name of the agent.	syn(LOGID)
Login ID	The Login ID that was used to staff the EXTENSION. Agents in multiple splits/skills have one LOGID.	LOGID

Field	Definition	Database Item, Calculation, or <Calculation Name>
Location ID	The location ID(s) associated with the agent. This ID is not associated with the agent personally, but rather with the terminal the agent is logged into. It is also associated with a port network location ID on <i>DEFINITY</i> . If the Agent Site Tracking feature is not available on your system, the field will not display meaningful data..	LOC_ID
Role	Agent's service role for this SPLIT, as defined in the Dictionary. Requires <i>DEFINITY</i> ECS R6 or later with <i>CentreVu</i> Advocate.	syn(ROLE)
Active Split/Skill	<p>Use WORKSKILL for the following call conditions:</p> <ul style="list-style-type: none"> <li>• When an agent is on a skill or direct agent ACD call or in ACW (this is the skill associated with the call or ACW).</li> <li>• When an agent is available, in AUX or in OTHER (this is null [blank]).</li> <li>• When an agent is on an AUXIN/AUXOUT call (this is OLDEST_LOGON skill).</li> <li>• When an agent is on an AUXIN/AUXOUT call from the available state, while in AUX or with an AUXIN/AUXOUT call on hold (this is OLDEST_LOGON skill).</li> <li>• When an agent is on an AUXOUT call with an ACD call on hold (this is the skill associated with the ACD call).</li> </ul> <p>Note that WORKSKILL differs from WORKSPLIT only in the case that the agent is available. In this case, WORKSKILL will be blank and WORKSPLIT will contain one of the skills in which the agent is available. For releases with the EAS feature active, it is recommended to use WORKSKILL instead of WORKSPLIT in reports.</p> <p>Requires a Generic 3 Version 2 or later switch with the EAS feature.</p>	syn(WORKSKILL)

Field	Definition	Database Item, Calculation, or <Calculation Name>
Level	The skill level associated with the agent's current WORKSKILL, when WORKSKILL is not null. Requires a Generic 3 Version 2 or later switch with the EAS feature. For <i>CentreVu Advocate</i> , in the cagent table, WORKSKLEVEL contains either a skill level (1-16) for a normal skill, or a reserve level (1 or 2) for a reserve skill. This WORKSKLEVEL applies to WORKSKILL.	syn(WORKSKLEVEL)
Time	The elapsed time since the last agent WORKMODE change for any split/skill. This item is not reset if the DIRECTION changes, but WORKMODE remains the same. For example, if the agent goes from AUX to AUXOUT to AUX, AGTIME continues without resetting.	AGTIME



## Reserve2 AUX Agents Report

---

**Overview** This report, which is available only for customers who have *DEFINITY* ECS R6 or later switches with EAS and have purchased *CentreVu* Advocate, displays the Reserve2 agents who are in AUX and the time in AUX, for a specified skill. When this report is accessed from the report menu, it displays as the Reserve2 AUX Agents Report. When it is accessed by drilling down from the AUX work state or Agent Location ID, it displays as the Reserve2 AUX Work State Report.

When accessed as a drill-down report, this report will only contain Location ID if the report you drill-down from uses Location ID as an input.

**Things to know about this report** Here are some things you need to know about this report:

- You can access this report the following ways:
  - 
  - From the Real-Time Split/Skill Category selector menu
  - By drilling down to this report from the AUX work state of Reserve2 agents, or R2INAUX.
- Call center managers can use this report to see the Reserve2 agents in each AUX work state, for a specified skill. For each agent, the manager will also be able to see information such as the length of time in the AUX work state.
- This report consists of a table and two data fields. The report table contains a row for each agent who is in the specified state for the specified skill.
- The report caption will read “Reserve2 AUX Work State Report—xxx,” where xxx is the skill name string specified by the user.
- The database items used for the report are stored in the `csplit` and `cagent` table.
- This report uses the Agent Information Input window. Select an agent that you want to view on the report. See [Agent Report Input Windows \(3-6\)](#).

**Reserve2 AUX Agents  
report example**

The following figure provides an example of the Reserve2 AUX Agents report:

Agent Name	Login ID	Role	Active	Level	Time
44468	44468	BCKP			1:21:50
44466	44466	BCKP			1:21:50
44461	44461	BCKP			1:21:50
44465	44465	BCKP			1:21:50
44462	44462	BCKP			1:21:49
44463	44463	BCKP			1:21:49
44467	44467	BCKP			1:21:49
44476	44476	TOP			1:21:45
44478	44478	TOP			1:21:45
44471	44471	TOP			1:21:45
44472	44472	TOP			1:21:45
44475	44475	TOP			1:21:45
44477	44477	TOP			1:21:45
44473	44473	TOP			1:21:45
44474	44474	TOP			1:21:45

**Reserve2 AUX Agents  
report description**

The following table describes the report fields:

Field	Definition	Database Item, Calculation, or <Calculation Name>
Skill	The name or number of the skill (up to 20 characters) that is selected for this report.	syn(SPLIT)
Reserve2 Agents in AUX	The number of reserve2 agents in AUX. Requires <i>DEFINITY ECS R6</i> or later with <i>CentreVu Advocate</i> .	R2INAUX
Agent Name	The name of the agent.	syn(LOGID)
Login ID	The Login ID that was used to staff the EXTENSION. Agents in multiple splits/skills have one LOGID.	LOGID

Field	Definition	Database Item, Calculation, or <Calculation Name>
Location ID	The location ID(s) associated with the agent. This ID is not associated with the agent personally, but rather with the terminal the agent is logged into. It is also associated with a port network location ID on <i>DEFINITY</i> . If the Agent Site Tracking feature is not available on your system, the field will not display meaningful data..	LOC_ID
Role	Agent's service role for this SPLIT, as defined in the Dictionary. Requires <i>DEFINITY</i> ECS R6 or later with <i>CentreVu</i> Advocate.	syn(ROLE)
Active Split/Skill	<p>Use WORKSKILL for the following call conditions:</p> <ul style="list-style-type: none"> <li>• When an agent is on a skill or direct agent ACD call or in ACW (this is the skill associated with the call or ACW).</li> <li>• When an agent is available, in AUX or in OTHER (this is null [blank]).</li> <li>• When an agent is on an AUXIN/AUXOUT call (this is OLDEST_LOGON skill).</li> <li>• When an agent is on an AUXIN/AUXOUT call from the available state, while in AUX or with an AUXIN/AUXOUT call on hold (this is OLDEST_LOGON skill).</li> <li>• When an agent is on an AUXOUT call with an ACD call on hold (this is the skill associated with the ACD call).</li> </ul> <p>Note that WORKSKILL differs from WORKSPLIT only in the case that the agent is available. In this case, WORKSKILL will be blank and WORKSPLIT will contain one of the skills in which the agent is available. For releases with the EAS feature active, it is recommended to use WORKSKILL instead of WORKSPLIT in reports.</p> <p>Requires a Generic 3 Version 2 or later switch with the EAS feature.</p>	syn(WORKSKILL)



Field	Definition	Database Item, Calculation, or <Calculation Name>
Level	The skill level associated with the agent's current WORKSKILL, when WORKSKILL is not null. Requires a Generic 3 Version 2 or later switch with the EAS feature. For <i>CentreVu Advocate</i> , in the cagent table, WORKSKLEVEL contains either a skill level (1-16) for a normal skill, or a reserve level (1 or 2) for a reserve skill. This WORKSKLEVEL applies to WORKSKILL.	syn(WORKSKLEVEL)
Time	The elapsed time since the last agent WORKMODE change for any split/skill. This item is not reset if the DIRECTION changes, but WORKMODE remains the same. For example, if the agent goes from AUX to AUXOUT to AUX, AGTIME continues without resetting.	AGTIME



# Skill AUX Report

**Overview** This report shows, for one or more skills, the number of agents in AUX work with each reason code.

**Things to know about this report** Here are some things you need to know about this report:

- You must have an ECS Release 5 switch or later with the EAS feature.
- You must be using reason codes. You can run the report without using the reason codes, but all agents will be in reason code zero (0) when in AUX.
- The database items used for the Skill AUX report are stored in the **csplit** table.
- This report uses the Split/Skill Report Input Window. Select a skill that you want to view on the report. See [Split/skill report input fields \(3-60\)](#) for more information.

**Skill AUX report example** The following figure provides an example of the Skill AUX report:

Skill	T22	T23	T26	Total	sp998
Calls Waiting	0	0	0	0	0
Agents Staffed	197	0	81	279	0
Agents in AUX	5	0	2	7	0
0	5	0	2	7	0
1	0	0	0	0	0
2	0	0	0	0	0
3	0	0	0	0	0
4	0	0	0	0	0
5	0	0	0	0	0
6	0	0	0	0	0
7	0	0	0	0	0
8	0	0	0	0	0
9	0	0	0	0	0

Double Click To Run Format Table

Thresholds: On ST10

**Skill AUX report description** The following table describes the report fields:

Report Heading	Description	Database Item, Calculation, or <Calculation Name>
Skills:	The name(s) or number(s) of the skills selected for the report.	syn(SPLIT)
Calls Waiting	The number of skill ACD calls waiting to be answered. This includes calls that are in queue and calls that are ringing at an agent voice terminal. It does not include direct agent calls for the Generic 3 switch.	INQUEUE+INRING
Agents Staffed	The total number of agents that are logged into each skill.	STAFFED
Agents in AUX	The current number of agent positions that are either in AUX work mode for this skill or on AUX-IN/AUX- OUT calls.	INAUX
Reason Code 0... 9	The number of agents in each AUX reason code (0 to 9).	INAUX0...9



# Skill Status Report

---

**Overview** This report shows how long the oldest call has been waiting in queue, how many calls are currently waiting to be answered, the agent names, the agent states, the agent's skill level, and the number of the skill for which the agent is handling the call or is in after call work.

**Things to know about this reports** If you have a an ECS Release 5 switch with the EAS feature activated, you will see the report displayed in this section. This new report:

- Provides agent AUX reason codes.
- Provides the agent login identification and the agent name.
- Provides the level for the agent's currently active skill (ACD call or ACW session). This level can be any level from 1 to 16, or R1 or R2.
- The Login Skills columns have been removed from this report.

If you have a switch release earlier than ECS Release 5 with the EAS feature activated, a slightly different Skill Status Report than the one described in this section is displayed. This report:

- Provides the agent login skills, including whether a skill is *p* (primary) or *s* (secondary).
- Does not provide agent AUX reason codes.
- With the Generic 3 Version 2 through Version 4 switches, all the skills the agent is logged into are shown in the Login Skills column of the report. These skills are designated with a *p* or *s* to indicate if the skill is a primary or secondary skill.
- If you have the Generic 3 Version 3 switch or an earlier switch, the Expected Wait Time (EWT) fields are blank. EWT is only available on the Generic 3 Version 4 switch and later switches.
- All agents who are logged into a particular skill are displayed. You can page or scroll to view agents not shown in the window.
- The EWT value is updated whenever a call queues to the skill. If no call has queued for 2 minutes, CMS will request the switch to send the current EWT values for the skill.

The EWT fields may be blank for one of the following reasons:

- The EWT is unknown at this time.
- The EWT is infinity (for example, no agents are logged in).
- The priority is inactive, such as TOP, HIGH, MEDIUM, or LOW.
- The queue for the priority is full.

Expected Wait Time (EWT) may be different than you anticipate. The following factors can affect EWT:

- A low volume of calls are coming into a skill, or very few are coming in at one or more of the priorities. This causes EWT to show larger fluctuations than when there is heavier call volume.

- A skill has only one or two agents logged in.
- A combination of the low call volume and a small number of agents logged in.
- The number of agents logged into a given skill suddenly increases or decreases substantially. EWT adjusts immediately, and you will see a big jump or fall in the EWT.
- A significant percentage of callers who are queued drop from queue, either from hanging up or from being answered, and no new calls are queued. For example, in a vector with time-of-day routing, after a specified time, no more calls are routed to a particular skill. Calls in queue to this skill continue to be serviced, but no new calls are coming into the queue. The EWT remains unchanged until the specified time interval from the timer expires and the audit takes place.
- Calls may be queued to more than one skill.
- Agents may be logged into multiple skills.
- The switch may have the Multiple Call Handling feature enabled.
- A new skill is created or the switch reboots. No history exists, and 30 to 50 queued calls must accrue for an accurate EWT.
- The average handling times for calls changes suddenly.
- The call traffic is varying significantly.
- The queuing times are erratic.
- If calls are HIGH or MEDIUM priority call redirected, via intraflow to a skill that does not queue calls at this priority, the priority does not change.
- Agents are in multiple skills and distribution of calls for those agents changes suddenly.
- EWT's are displayed for the priorities for which calls are queuing. However, if you change the routing for a skill so that calls are not being queued at a priority, the EWT for that priority continues to be shown until all agents in the skill log out or until a translation pump-up is forced.
- The database items used for the Skill Status Report are stored in the `csplit` and `cagent` tables.
- This report uses the Split/Skill Report Input Window. Select a skill that you want to view on the report. See [Split/skill report input fields \(3-60\)](#) for more information.

**Skill Status report example**

The following figure provides an example of a Skill Status Report:

**Skill Status - Gold**

Report Edit Format Tools Options Help

Split/Skill: Gold  
Skill State: NORMA

Expected Wait Time  
EWT Top:  
EWT High:  
EWT Medium: :00:00  
EWT Low:

Calls Waiting: 0  
Oldest Call Waiting: :00

Agent Name	Login ID	AUX Reason	State	Split/Skill Level Time	VDN Name
50207	50207		AVAIL	18:53	
50214	50214		AVAIL	14:36	
50208	50208		AVAIL	15:19	
50213	50213		AVAIL	13:54	
50234	50234		AVAIL	44:11	
50233	50233		AVAIL	59:39	
50226	50226		AVAIL	18:01	
50224	50224		AVAIL	12:32	
50216	50216		AVAIL	13:03	
50221	50221		AVAIL	10:27	

Thresholds: On r6\_dads1eas

**Skill Status report description**

The following table describes the report fields:

Report Heading	Description	Database Item, Calculation, or <Calculation Name>
Skill	The name or number of the skill selected for the report.	syn(SPLIT)
Skill State	The current state of the skill, compared to the administered thresholds. This displays as Normal, Overload 1, and Overload 2 on the report. Requires <i>DEFINITY</i> ECS R6 or later with <i>CentreVu</i> Advocate.	SKSTATE
Calls Waiting	The number of skill ACD calls waiting to be answered. This includes calls that are in queue and calls that are ringing at an agent voice terminal. It does not include direct agent calls for the Generic 3 switch.	INQUEUE+ INRING
Oldest Call Waiting	The length of time (in seconds) the oldest ACD skill call has waited in queue or ringing before being answered. This does not include direct agent calls.	OLDESTCALL

Report Heading	Description	Database Item, Calculation, or <Calculation Name>
Expected Wait Time (Pri): Top	This heading contains EWT for the skill at top priority. EWT is the wait time for the skill when a call is queued to the skill at top priority. EWT measures only the time it takes to deliver the call to an agent. It does not include ringing time. If <i>CentreVu</i> CMS is connected to a switch previous to the Generic 3 Version 4 switch or if vectoring is not activated, the EWT headings and columns are displayed, but the fields are blank. Exception thresholds for EWT can be set from the Exception command.	EWTTOP
Expected Wait Time (Pri): High	This heading contains EWT for the skill at high priority. EWT is the wait time for the skill when a call is queued to the skill at high priority. EWT measures only the time it takes to deliver the call to an agent. It does not include ringing time. If <i>CentreVu</i> CMS is connected to a switch previous to the Generic 3 Version 4 switch or if vectoring is not activated, the EWT headings and columns are displayed, but the fields are blank. Exception thresholds for EWT can be set from the Exception command.	EWTHIGH
Expected Wait Time (Pri): Medium	Contains EWT for the skill at medium priority. EWT is the wait time for the skill when a call is queued to the skill at medium priority. EWT measures only the time it takes to deliver the call to an agent. It does not include ringing time. If <i>CentreVu</i> CMS is connected to a switch previous to the Generic 3 Version 4 switch or if vectoring is not activated, the EWT headings and columns are displayed, but the fields are blank. Exception thresholds for EWT can be set from the Exception command.	EWTMEDIUM

Report Heading	Description	Database Item, Calculation, or <Calculation Name>
Expected Wait Time (Pri): Low	This heading contains EWT for the skill at low priority. EWT is the wait time for the skill when a call is queued to the skill at low priority. EWT measures only the time it takes to deliver the call to an agent. It does not include ringing time. If <i>CentreVu</i> CMS is connected to a switch previous to the Generic 3 Version 4 switch or if vectoring is not activated, the EWT headings and columns are displayed, but the fields are blank. Exception thresholds for EWT can be set from the Exception command.	EWTLOW
Agent Name	The name(s) of the agent(s) assigned to this skill and logged in (or their login IDs if names have not been assigned to them in Dictionary).	syn(LOGID)
Login ID	The login identification of the agent.	LOGID
AUX Reason	The reason associated with the auxiliary work state of this agent, (for example, lunch, break, meeting, or training). This field is blank if the agent is not in the AUX state.	syn(AUXREASON)
State	The current work mode (state), that the agent is in (AVAIL, ACD, ACW, AUX, DACD, DACW, RINGING, UNKNOWN, OTHER, UNSTAFF), and the call direction (BLANK IN, or OUT).	syn(WORKMODE) syn(DIRECTION)
Skill/Level	<p>When an agent is on a skill call, a direct agent call, or in ACW mode, this is the skill associated with the call or the ACW, and the level associated with the skill.</p> <p>WORKSKILL is the OLDEST_LOGON:</p> <ul style="list-style-type: none"> <li>• When an agent is on an AUXIN/AUXOUT call from the available state, while in AUX or with an AUXIN/AUXOUT call on hold</li> <li>• When an agent is on an AUXIN call with an ACD call on hold.</li> </ul> <p>When an agent is on an AUXOUT call with an ACD call on hold, this is the skill associated with the ACD call. When an agent is available, in AUX, or in OTHER, this is blank.</p> <p>WORKSKLEVEL is the skill level (ranging from 1 to 16) or the reserve skill level (R1 or R2) associated with WORKSKILL.</p>	WORKSKILL/ syn(WORKSKLEVEL)



Report Heading	Description	Database Item, Calculation, or <Calculation Name>
Time	The elapsed time since the last agent WORKMODE change for any split/skill. This item is not reset if the DIRECTION changes, but WORKMODE remains the same. For example, if the agent goes from AUX to AUXOUT to AUX, AGTIME continues without resetting.	AGTIME
VDN Name (Shows data only if you have purchased the Vectoring feature.)	The number or name of the VDN for which the report shows data. the Vector Directory Number is associated with the ACD call in progress. If a name has been assigned to the VDN in the Dictionary, the name displays instead of the number.	VDN



# Skill Top Agent Report

**Overview** This report is similar to the Split/Skill Report, but shows counts of agents for whom the skill is the top skill. It also shows a count of agents for whom the skill is a backup skill.

## Things to know about this report

Here are some things you need to know about this report:

- You must have a Generic 3 switch with the EAS feature.
- The agent's top skill is the highest priority skill the agent is logged into. If the agent is logged into more than one skill that are listed as highest priority, then the top skill is the first skill listed.
- The database items used for the Skill Top Agent Report are stored in the csplit table.
- This report uses the Split/Skill Report Input Window. Select a skill that you want to view on the report. See [Split/skill report input fields \(3-60\)](#) for more information.

## Skill Top Agent report example

The following figure provides an example of a Skill Top Agent report:

Split/Skill	T22	T23	T26	Total	sp998
Skill State	NORMAL	NORMAL	NORMAL	NORMAL	NORMAL
Calls Waiting	0	0	0	0	0
Oldest Call Waiting	:00	:00	:00	:00	:00
Avg Speed Ans					
ACD Calls	0	0	0	0	0
Avg ACD Time					
Aban Calls	0	0	0	0	0
Avg Aban Time					
Top Agents Avail	192	0	79	0	0
Top Agents Ringing	0	0	0	0	0
Top Agents on ACD Calls	0	0	0	0	0
Top Agents in ACW	0	0	0	0	0
Top Agents in Other	0	0	0	0	0
Top Agents in AUX	5	0	2	0	0
Top Agents Staffed	197	0	81	0	0
Flex Agents Staffed	0	0	0	279	0
Reserve1 Agents Staffed	0	0	0	0	0
Reserve2 Agents Staffed	0	0	0	0	0

Double Click To Run Format Table

Thresholds: On ST10

**Skill Top Agent report description** The following table describes the report fields:

Report Heading	Description	Database Item, Calculation, or <Calculation Name>
Skills:	The name or number of the skill selected for this report.	syn(SPLIT)
Skill State	Current state of this skill, compared to the administered thresholds. Requires ECS R6 or later with <i>CentreVu</i> Advocate.	syn(SKSTATE)
Calls Waiting	This is the number of skill ACD calls waiting to be answered for each skill in the report. This includes calls that are in queue and ringing at an agent voice terminal. It also includes outbound ACD calls placed by an adjunct (also called outbound predictive dialing), for the Generic 3 with ASAI only. For the Generic 3 switches, it does not include direct agent calls.	INQUEUE+INRING
Oldest Call Waiting	The length of time (in seconds) the oldest call has waited in queue or ringing (at an agent voice terminal for each skill in the report) before being answered. This does not include direct agent calls.	OLDESTCALL
Avg Speed Ans	The average time calls waited in queue and ringing before an agent answered. This does not include direct agent calls, but it does include outbound ACD calls placed by an adjunct (also called outbound predictive dialing), for the Generic 3 with ASAI only.	ANSTIME/ ACDCALLS <AVG_ANSWER_SPEED>
ACD Calls	The ACD calls that were queued to the skill and answered by an agent. This does not include direct agent calls, but it does include ACD calls placed by an adjunct (also called outbound predictive dialing) for the Generic 3 switches with ASAI only.	ACDCALLS
Avg ACD Time	The average talk time (does not include hold time) is calculated for all ACD calls to this skill. This does not include direct agent calls, but it does include talk time of all outbound ACD calls placed by an adjunct (also called outbound predictive dialing), for the Generic 3 with ASAI only.	ACDTIME/ ACDCALLS <AVG_ACD_TALK_TIME>

Report Heading	Description	Database Item, Calculation, or <Calculation Name>
Aban Calls	The total number of queued calls for each skill that were abandoned before an agent answered. This includes calls that are ringing at a voice terminal but does not include direct agent calls. It also includes the number of outbound calls for each skill that abandoned at the far end before an agent answered. For the Generic 3 switches with the ASAI feature only.	ABNCALLS1-10
Avg Aban Time	The average time calls waited in split before hanging up.	ABNTIME / ABNCALLS <AVG_ABANDON_TIME>
Top Agents Avail	The number of top agents logged into the skill who are available in the skill to take calls.	TAVAILABLE
Top Agents Ringing	The current number of top agents logged into the skill who have ACD calls (including direct agent calls) ringing at their voice terminals.	TAGINRING
Top Agents on ACD Calls	The total number of top agents connected to inbound and outbound ACD calls in each skill. This does not include direct agent calls.	TONACD
Top Agents in ACW	The number of top agents who are in the after call work state for each skill. This includes agents on ACWIN or ACWOUT calls and agents in ACW not associated with an ACD call.	TINACW

Report Heading	Description	Database Item, Calculation, or <Calculation Name>
Top Agents in Other	<p>The current number of top agent positions that are doing other work.</p> <p>For the Generic 3 switch the agent did one of the following activities while in the Auto-in or Manual-In state:</p> <ul style="list-style-type: none"> <li>• The agent put any call on hold and performed no further action.</li> <li>• The agent is on a direct agent call or in ACW for a direct agent call.</li> <li>• The agent is dialing to place a call or to activate a feature.</li> <li>• The agent has a personal call ringing with no other activity.</li> </ul> <p>For the Generic 3 switches without EAS, agents are logged into multiple splits and doing work for a split other than this one (on an ACD call or in call-related ACW).</p> <p>For the Generic 3 switches with EAS, agents are logged into multiple skills and doing work for a skill other than this one (on an ACD call or in call-related ACW).</p> <p>Agent positions show up as OTHER directly after the link to the switch comes up and directly after the agents log in before the <i>CentreVu</i> CMS is notified of the agent's work state.</p>	TOTHER
Top Agents in Aux	The total number of top agents logged into the skill who are in the AUX Work mode for all skills or are on AUXIN/AUXOUT calls.	TINAUX
Top Agents Staffed	The current number of top agents that are staffed in the skill.	TSTAFFED
Flex Agents Staffed	Number of agents who are staffing the skill, but are neither top or reserve agents. Requires ECS R6 or later with <i>CentreVu</i> Advocate. This field will contain non-top agents if the <i>CentreVu</i> Advocate feature is not used, since the database item consists of agents whose role in the skill is backup (applicable regardless of whether <i>CentreVu</i> Advocate is administered), allocation, or roving.	FSTAFFED

Report Heading	Description	Database Item, Calculation, or <Calculation Name>
Reserve1 Agents Staffed	Number of agents staffing this skill as reserve1. Requires ECS R6 or later with <i>CentreVu</i> Advocate.	R1STAFFED
Reserve2 Agents Staffed	Number of agents staffing this skill as reserve2. Requires ECS R6 or later with <i>CentreVu</i> Advocate.	R2STAFFED



# Split Status Report

---

**Overview** This report shows how long the oldest call in queue has been waiting, how many calls are currently waiting to be answered, the agent names, the agent states, the length of time an agent has been in the state, and the split associated with the call the agent is currently handling.

*Note:* The Split Status report is available on switches that do not have the EAS feature. If you have the EAS Feature, this report is replaced with the Skill Status Report.

**Things to know about this report** Here are some things to know about this report:

**this report**

- All agents logged into the selected split are displayed. You can scroll to view agents that you cannot see on the report.
- If an agent is on an ACD call or in the ACW state, a single split is displayed that corresponds to the ACD call or ACW.
- If the agent is available, all of the splits are displayed.
- If the agent is in AUX in all splits, all splits are displayed.
- For a Generic 3 Version 2 or later version switch without the Expert Agent Selection (EAS) feather, an agent can be logged into a total of four splits.
- If you have a Generic 3 Version 3 switch or an earlier switch, the Expected Wait Time (EWT) fields are blank. EWT is only available on the Generic 3 Version 4 switch and later Generic 3 switches.
- The EWT value is updated whenever a call queues to the split. If no call has queued for 2 minutes, CMS will request the switch to send the current EWT values for the split.

The EWT fields may be blank for one of the following reasons:

- The EWT is unknown at this time.
- The EWT is infinity (for example, no agents are logged in).
- The priority (TOP, HIGH, MEDIUM, LOW) is inactive.
- The queue for this split is full.
- Please refer to the Generic 3 Version 4 Vectoring/EAS Guide for more information on EWT and causes of the field blanking out.

EWT may not be what you anticipate. These factors can affect EWT:

- A low volume of calls coming into a split, or very few coming in at one or more of the priorities. This causes EWT to show larger fluctuations than when there is heavier call volume.
- A split has only one or two agents logged in.
- A combination of the low call volume and a small number of agents logged in.

- The number of agents logged into a given split suddenly increases or decreases substantially. EWT adjusts immediately, and you will see a big jump or fall in the EWT.
- A significant percentage of callers who are queued drop from queue, either from hanging up or from being answered, and no new calls are queued. For example, in a vector with time-of-day routing, after a specified time no more calls are routed to a particular split. Calls in queue to this split continue to be serviced, but no new calls are coming into the queue. The EWT remains unchanged until the specified time interval from the timer has expired and the audit has taken place.
- Calls may be queued to more than one split.
- Agents may be logged into multiple splits.
- The switch may have the Multiple Call Handling (MCH) feature enabled.
- A new split is created or the switch reboots. No history exists, and 30 to 50 queued calls must accrue for an accurate EWT.
- The average handling time for calls changes suddenly.
- The call traffic is varying significantly.
- The queuing times are erratic.
- EWT's are displayed only for the priorities for which calls are queuing. However, if you change the routing for a split so that calls are not being queued at a priority, the EWT for that priority continues to be shown until all agents in the split log out or a translation pump-up is forced.
- The database items used for the Split Status Report are stored in the `csplit` and `cagent` tables.
- This report uses the Split/Skill Report Input Window. Select a skill that you want to view on the report. See [Split/skill report input fields \(3-60\)](#) for more information.



**Split Status report example**

The following figure provides an example of the Split Status report:

Split: s1		Expected Wait Time	
Calls Waiting:	14	EWT Top:	
Oldest Call Waiting:	1:54	EWT High:	
		EWT Medium:	
		EWT Low:	

Agent Name	State	Split 1	Split 2	Split 3	Split 4	Time	VDN Name
a2001	ACW	1				1:59	v1005
a2002	ACDIN	1				1:57	v1005
a2003	ACDIN	1				1:35	v1007
a2004	ACW	1				2:29	v1005
a2005	ACW	1				:44	v1007
a2006	ACW	1				1:18	v1005
a2007	ACW	1				2:35	v1006
a2008	ACW	1				1:10	v1005
a2009	ACW	1				2:18	v1007
a2010	ACW	1				2:49	v1005

**Split Status report description**

The following table describes the report fields:

Report Heading	Description	Database Item, Calculation, or <Calculation Name>
Split	The name or number of the split selected for the report.	syn(SPLIT)
Calls Waiting	The number of split ACD calls waiting to be answered. This includes calls that are in queue and calls that are ringing at an agent voice terminal. It does not include direct agent calls for the Generic 3 switch.	INQUEUE+ INRING
Oldest Call Waiting	The length of time (in seconds) the oldest ACD call has waited in queue or ringing (at an agent voice terminal) before being answered. This does not include direct agent calls.	OLDESTCALL

Report Heading	Description	Database Item, Calculation, or <Calculation Name>
Expected Wait Time (Pri): Top	<p>This heading contains EWT for the split at top priority. EWT is the expected wait time for the split when a new call is queued to the split at top priority. EWT measures only the time it takes to deliver the call to an agent. It does not include ringing time.</p> <p>If <i>CentreVu</i> CMS is connected to a switch previous to the Generic 3 Version 4 switch or if vectoring is not activated, the EWT headings and columns are displayed, but the fields are blank.</p>	EWTTOP
Expected Wait Time (Pri): High	<p>This heading contains EWT for the split at high priority. EWT is the expected wait time for the split when a new call queued to the split at high priority. EWT measures only the time it takes to deliver the call to an agent. It does not include ringing time. If <i>CentreVu</i> CMS is connected to a switch previous to the Generic 3 Version 4 switch or if vectoring is not activated, the EWT headings and columns are displayed, but the fields are blank.</p>	EWTHIGH
Expected Wait Time (Pri): Medium	<p>This heading contains EWT for the split at medium priority. EWT is the expected wait time for the split when a new call is queued to the split at medium priority. EWT measures only the time it takes to deliver the call to an agent. It does not include ringing time. If <i>CentreVu</i> CMS is connected to a switch previous to the Generic 3 Version 4 switch or if vectoring is not activated, the EWT headings and columns are displayed, but the fields are blank.</p>	EWTMEDIUM
Expected Wait Time (Pri): Low	<p>This heading contains EWT for the split at low priority. EWT is the wait time for teh split when a new call is queued to the split at low priority. EWT measures only the time it takes to deliver the call to an agent. It does not include ringing time. If <i>CentreVu</i> CMS is connected to a switch previous to the Generic 3 Version 4 switch or if vectoring is not activated, the EWT headings and columns are displayed, but the fields are blank.</p>	EWTLOW

Report Heading	Description	Database Item, Calculation, or <Calculation Name>
Agent Name	The name(s) of the agent(s) assigned to the split and logged in (or their login IDs if names have not been assigned to them in Dictionary).	syn(LOGID)
State	The current work mode (state) the agent is in, such as AVAIL, ACD, ACW, AUX, DACD, DACW, RINGING, UNKNOWN, OTHER, or UNSTAFF, and the call direction (BLANK, IN, or OUT).	WORKMODE and DIRECTION
Split(s)	The split associated with the call or the ACW state when an agent is either on a split or direct agent ACD call, or in the ACW state. If an agent puts an ACD call on hold and makes an AUX call, this is the split of the ACD call on hold. For AUXIN calls and for AUXOUT calls made without an ACD call on hold, this is the split the agent has been logged into the longest. When the agent is available, all of the splits the agent is available in are listed.	WORKSPLIT WORKSPLIT2 WORKSPLIT3 WORKSPLIT4 ((Generic 3 Version 2 and later Generic 3 switches only)
Time	The elapsed time since the last agent WORKMODE change for any split/skill. This item is not reset if the DIRECTION changes, but WORKMODE remains the same. For example, if the agent goes from AUX to AUXOUT to AUX, AGTIME continues without resetting.	AGTIME
VDN (Shows data only if you have purchased the Vectoring feature.)	The vector directory number is associated with the ACD call in progress. If a name has been assigned to the VDN in the Dictionary, the name displays instead of the number.	VDN



# Split/Skill Report

---

**Overview** The Split/Skill report simultaneously displays real-time call-handling information on a number of splits or skills. It allows the supervisor to evaluate and compare the workload and call-handling performance between splits/skills, and to determine agent reassignment. Additionally, the supervisor can evaluate other ACD configuration alternatives which can be used to balance workloads and reduce abandoned calls.

- Things to know about this report** Here are some things you need to know about this report:
- You can enter a range or a list of splits/skills which the report will cover. If you only want to view one split or skill, you may size the window smaller.
  - In this report, the OTHER state displays for agents who are on calls or in after call work state for other splits or skills.
  - For agents in split/skills with the many forced option of Multiple Call Handling for Generic 3 Version 4 and later switches, a queued call is not delivered to an agent position if there is no available call appearance. If the agent has no available call appearance, then the agent is either on a call or has all calls on hold. In either case, the agent is not available.
  - The database items used for the Report are stored in the **csplit** table.
  - This report uses the Split/Skill Report Input Window. Select a skill that you want to view on the report. See [Split/skill report input fields \(3-60\)](#) for more information.

**Split/Skill report example** The following figure provides an example of the Split/Skill report:

Split/Skill	T22	T23	T26	Total	sp998
Skill State	NORMAL	NORMAL	NORMAL	NORMAL	NORMAL
Calls Waiting	0	0	0	0	0
Oldest Call Waiting	:00	:00	:00	:00	:00
Avg Speed Ans					
ACD Calls	0	0	0	0	0
Avg ACD Time					
Aban Calls	0	0	0	0	0
Avg Aban Time					
Agents Avail	192	0	79	272	0
Agents Ringing	0	0	0	0	0
Agents on ACD Calls	0	0	0	0	0
Agents in ACW	0	0	0	0	0
Agents in Other	0	0	0	0	0
Agents in AUX	5	0	2	7	0
Agents Staffed	197	0	81	279	0

Double Click To Run Format Table      Thresholds: On      ST10

**Split/Skill report description** The following table describes the report fields:

Report Heading	Description	Database Item, Calculation, or <Calculation Name>
Splits/Skills	The name or number of the split(s)/(skill(s) selected for the report.	syn(SPLIT)
Skill State	The current state of the skill, compared to the administered thresholds. This displays as Normal, Overload 1, and Overload 2 on the report. Requires <i>DEFINITY</i> ECS R6 or later with <i>CentreVu</i> Advocate.	SKSTATE
Calls Waiting	The number of split or skill ACD calls waiting to be answered. This includes calls that are in queue and ringing at an agent voice terminal. It does not include direct agent calls for the Generic 3 switch.	INQUEUE+ INRING
Oldest Call Waiting	The length of time (in seconds) the oldest ACD call has waited in queue or ringing (at an agent voice terminal for each split/skill in the report) before being answered. This does not include direct agent calls.	OLDESTCALL

Report Heading	Description	Database Item, Calculation, or <Calculation Name>
Avg Speed Ans	The average time calls waited in queue and ringing before an agent answered. This does not include direct agent calls, but it does include outbound ACD calls placed by an adjunct (also called outbound predictive dialing), for the <i>DEFINITY</i> ECS Generic 3 with ASAI only.	ANSTIME/ ACDCALLS <AVG_ANSWER_SPEED>
ACD Calls	The ACD calls that were queued to the split/skill and answered by an agent. This does not include direct agent calls, but it does include ACD calls placed by an adjunct (also called outbound predictive dialing), for the Generic 3 with ASAI only.	ACDCALLS
Avg ACD Time	The average talk time (does not include hold time) is calculated for all ACD calls to this split/skill. This does not include talk time on direct agent calls, but it does include talk time of all outbound ACD calls placed by an adjunct (also called outbound predictive dialing), for the Generic 3 with ASAI only.	ACDTIME/ ACDCALLS <AVG_ACD_TALK_TIME>
Aban Calls	The total number of queued calls for each split/skill that abandoned before an agent answered. This includes calls that are ringing at a voice terminal but does not include direct agent calls. It also includes the number of outbound calls for each split/skill that abandoned at the far end before an agent answered. (For the Generic 3 with the ASAI feature only).	ABNCALLS1-10
Avg Aban Time	The average time a caller waited (in split/skill) before hanging up.	ABNTIME / ABNCALLS <AVG_ABANDON_TIME>
Agents Avail	The current number of agents that are available to receive ACD calls in each split/skill.	AVAILABLE
Agents Ringing	The current number of agents that are available and have ACD calls (including direct agent calls) ringing at their voice terminal but have not yet answered. If the agent places a call or answers an extension call, the agent is shown in the AUX work state, rather than in the ringing state.	AGINRING
Agents on ACD Calls	The total number of agents that are connected to inbound and outbound ACD calls in each split/skill. This does not include agents on direct agent calls.	ONACD

Report Heading	Description	Database Item, Calculation, or <Calculation Name>
Agents in ACW	The number of agents who are in the after call work state for each split/skill. This includes agents on ACWIN or ACWOUT calls and agents in ACW not associated with an ACD call.	INACW
Agents in Other	<p>The current number of agent positions that are doing other work.</p> <p>For the Generic 3 switches with EAS, the agent did one of the following activities while in the Auto-in or Manual-In state:</p> <ul style="list-style-type: none"> <li>• The agent put any call on hold and performed no further action.</li> <li>• The agent is on a direct agent call or in ACW for a direct agent call.</li> <li>• The agent is dialing to place a call or to activate a feature.</li> <li>• The agent has a ringing personal call, with no other activity.</li> </ul> <p>For the Generic 3 switches without EAS, agents are logged into multiple splits and doing work for a split other than this one.</p> <p>Agent positions show up as OTHER directly after the link to the switch comes up and directly after the agents log in before the <i>CentreVu</i> CMS is notified of the agent's work state.</p>	OTHER
Agents in AUX	The current number of agents who are in the AUX work mode for all splits/skills including agents who are handling AUXIN or AUXOUT calls.	INAUX
Agents Staffed	The total number of agents that are logged into each split/skill.	STAFFED



## Split/Skill by Location Report

**Overview** The Split/Skill by Location report supports the Agent Site Tracking feature introduced with R3V8 CMS and R8 Supervisor. This report tracks agents by their split/skill location ID.

The Split/Skill by Location report displays real-time agent call-handling information on a single split or skill. It allows the supervisor to evaluate the workload and call-handling performance on the split/skill, and to determine agent reassignment.

**Things to know about this report** Here are some things you need to know about this report:

- This report displays information on a single split/skill. Select the split/skill location ID through the input window.
- This report shows the agents logged into a single split/skill.
- The database items used for the Report are stored in the **cagent** table.
- This report is in table format.
- This report uses the Split/Skill Report Input Window. Select a skill that you want to view on the report. See [Split/skill report input fields \(3-60\)](#) for more information.

**Split/Skill by Location report example** The following figure provides an example of the Split/Skill by Location report:

Location	Agent Name	Login ID
New York	23019	23019
New York	23022	23022
New York	23021	23021
New York	23031	23031
New York	23024	23024
New York	23032	23032
New York	23033	23033
New York	23025	23025



**Split/Skill by Location report description** The following table describes the report fields:

Report Heading	Description	Database Item, Calculation, or <Calculation Name>
Location ID	The location ID(s) associated with the agent. This ID is not associated with the agent personally, but rather with the terminal the agent is logged into. It is also associated with a port network location ID on <i>DEFINITY</i> . If the Agent Site Tracking feature is not available on your system, the field will not display meaningful data.	LOC_ID
Agent Name	The names or login IDs of the agents that logged into the split/skill selected in the report input window.	syn(LOGID)
Login ID	The login ID of the agent.	LOGID



# Split/Skill Top Agent Status Report

**Overview** This report is the same as the Skill Status Report, except that it only shows status for agents for whom the selected skill is the top skill.

**Things to know about this report** Here are some things you need to know about this report:

- This report shows information for agents with this skill as top skill only.
- "Top Agents" are agents for whom the skill is their highest-level skill. If agents have more than one skill at the highest level, then the first one administered is the top skill.
- The EWT value is updated whenever a call queues to the skill. If no call has queued for 2 minutes, CMS will request the switch to send the current EWT values for the skill.
- You must have a Generic 3 switch with the EAS feature.
- The database items used for the Split/Skill Top Agent Status Report are stored in the `csp1it` and `cagent` tables.
- This report uses the Split/Skill Report Input Window. Select a skill that you want to view on the report. See [Split/skill report input fields \(3-60\)](#) for more information.

## Split/Skill Top Agent Status report example

The following figure provides an example of the Split/Skill Top Agent Status report:

Agent Name	Login ID	AUX Reason	State	Split/Skill Level	Time	VDN Name
44477	44477		AVAIL		1:05:45	
44475	44475		AVAIL		1:05:45	
44471	44471		AVAIL		1:05:45	
44473	44473		AVAIL		1:05:45	
44478	44478		AVAIL		1:05:45	
44474	44474		AVAIL		1:05:45	
44472	44472		AVAIL		1:05:45	
44476	44476		AVAIL		1:05:45	

**Split/Skill Top Agent Status report description** The following table describes the report fields:

Report Heading	Description	Database Item, Calculation, or <Calculation Name>
Skill:	The name or number of the skill selected for this report.	syn(SPLIT)
Skill State	The current state of the skill, compared to the administered thresholds. This displays as Normal, Overload 1, and Overload 2 on the report. Requires <i>DEFINITY</i> ECS R6 or later with <i>CentreVu</i> Advocate.	SKSTATE
Calls Waiting	The number of skill ACD calls waiting to be answered. This includes calls that are in queue and ringing at an agent voice terminal. It also includes outbound ACD calls placed by an adjunct (also called outbound predictive dialing), for the Generic 3 with ASAI only. For the Generic 3 switches, it does not include direct agent calls.	INQUEUE+INRING
Oldest Call Waiting	The length of time (in seconds) the oldest ACD call has waited in queue or ringing (at an agent voice terminal for each split/skill in the report) before being answered. This does not include direct agent calls.	OLDESTCALL
Expected Wait Time (Pri): Top:	This heading contains EWT for the skill at top priority. EWT is the wait time for the skill when a call is queued to the split/skill at top priority. EWT measures only the time it takes to deliver the call to an agent. It does not include ringing time. If <i>CentreVu</i> CMS is connected to a switch previous to the Generic 3 Version 4 switch or if vectoring is not activated, the EWT headings and columns are displayed, but the fields are blank. Exception thresholds for EWT can be set from the Exception command.	EWTTOP

Report Heading	Description	Database Item, Calculation, or <Calculation Name>
Expected Wait Time (Pri): High:	This heading contains EWT for the skill at high priority. EWT is the wait time for the skill when a call is queued to the split/skill at high priority. EWT measures only the time it takes to deliver the call to an agent. It does not include ringing time. If <i>CentreVu</i> CMS is connected to a switch previous to the Generic 3 Version 4 switch or if vectoring is not activated, the EWT headings and columns are displayed, but the fields are blank. Exception thresholds for EWT can be set from the Exception command	EWTHIGH
Expected Wait Time(Pri): Medium:	This heading contains EWT for the skill at medium priority. EWT is the wait time for the skill when a call is queued to the split/skill at medium priority. EWT measures only the time it takes to deliver the call to an agent. It does not include ringing time. If <i>CentreVu</i> CMS is connected to a switch previous to the Generic 3 Version 4 switch or if vectoring is not activated, the EWT headings and columns are displayed, but the fields are blank. Exception thresholds for EWT can be set from the Exception command	EWTMEDIUM
Expected Wait Time (Pri): Low:	This heading contains EWT for the skill at low priority. EWT is the wait time for the skill when a call is queued to the split/skill at low priority. EWT measures only the time it takes to deliver the call to an agent. It does not include ringing time. If <i>CentreVu</i> CMS is connected to a switch previous to the Generic 3 Version 4 switch or if vectoring is not activated, the EWT headings and columns are displayed. Exception thresholds for EWT can be set from the Exception command, but the fields are blank.	EWTLOW
Agent Name	The name(s) of the top agent(s) assigned to this split/skill and logged in (or their login IDs if names have not been assigned to them in Dictionary).	syn(LOGID)
Login ID	The login identification of the agent.	LOGID

Report Heading	Description	Database Item, Calculation, or <Calculation Name>
AUX Reason	The reason associated with the auxiliary work state of this agent (for example, lunch, break, meeting, or training). This field is blank if the agent is not in the AUX state.	syn(AUXREASON)
State	The current work mode (state) the agent is in (AVAIL, ACD, ACW, AUX, DACD, DACW, RINGING, UNKNOWN, OTHER, UNSTAFF) and the call direction (blank, IN, or OUT).	syn(WORKMODE) and syn(DIRECTION)
Skill/Level	<p>When an agent is on a skill call, a direct agent call, or in ACW mode, this is the skill associated with the call or the ACW, and the level associated with the skill.</p> <p>WORKSKILL is the OLDEST_LOGON:</p> <ul style="list-style-type: none"> <li>• When an agent is on an AUXIN/AUXOUT call from the available state, while in AUX, or with an AUXIN/AUXOUT call on hold</li> <li>• When an agent is on an AUXIN call with an ACD call on hold.</li> <li>• When an agent is on an AUXOUT call with an ACD call on hold, this is the skill associated with the ACD call.</li> <li>• When an agent is available, in AUX, or in OTHER, this is blank.</li> </ul> <p>WORKSKLEVEL is the skill level (ranging from 1 to 16) or the reserve level (R1 or R2) associated with WORKSKILL.</p>	WORKSKILL/ syn(WORKSKLEVEL)
Time	The elapsed time since the last agent WORKMODE change for any split/skill. This item is not reset if the DIRECTION changes, but WORKMODE remains the same. For example, if the agent goes from AUX to AUXOUT to AUX, AGTIME continues without resetting.	AGTIME
VDN Name (Shows data only if you have purchased the Vectoring feature.)	The number or name of the VDN for which the report shows data. The Vector Directory Number is associated with the ACD in progress. If a name has been assigned to the VDN in the Dictionary, the name displays instead of the number.	syn(VDN)

---

## Split/Skill Agent Status by Location Report

---

**Overview** This report shows the agent status on a selected skill, by location ID. This report supports the agent site tracking feature, and this feature must be enabled to view meaningful data on the report

- Things to know about this report** Here are some things you need to know about this report:
- This report shows information for agents in this skill by their terminal location ID.
  - This report includes information on agent roles, skill state, agent extensions, location IDs, and skill level or percent allocation per agent.
  - You must have a Generic 3 switch with the EAS feature.
  - The database items used for the Split/Skill Top Agent Status Report are stored in the **cagent** tables.
  - This report uses the Split/Skill Report Input Window. Select a skill that you want to view on the report and a location ID to sort by. See [Split/skill report input fields \(3-60\)](#) for more information.

### Split/Skill Agent Status by Location report example

The following figure provides an example of the Split/Skill Agent Status by Location report:

Agent Name	Location	Login ID	Extn	Role	Percent	AUX Reason	State	Direction	Split/Skill	Level	Time
29039	29039	26039		AVAIL		*****					
29029	29029	26029		AVAIL		*****					
29055	29055	26055		AVAIL		*****					
29082	29082	26082		AVAIL		*****					
29080	29080	26080		AVAIL		*****					
29043	29043	26043		AVAIL		*****					
29040	29040	26040		AVAIL		*****					
29032	29032	26032		AVAIL		*****					
29031	29031	26031		AVAIL		*****					
29068	29068	26068		AVAIL		*****					

### Split/Skill Agent Status by Location report description

The following table describes the report fields for the time period covered by the report.

Report Heading	Description	Database Item, Calculation, or <Calculation Name>
Split/Skill	The name or number of the split/skill that is selected for this report. You can make these selections in the report input window.	syn(SPLIT)
Location ID	The location ID(s) associated with the agent. This ID is not associated with the agent personally, but rather with the terminal the agent is logged into. It is also associated with a port network location ID on <i>DEFINITY</i> . If the Agent Site Tracking feature is not available on your system, the field will not display meaningful data.	LOC_ID
Agents in ACW	The total number of agents currently in ACW for this skill.	select count(*) where split = \$input and LOC_ID = \$input and WORKMODE = ACW

Report Heading	Description	Database Item, Calculation, or <Calculation Name>
Agents on ACD Calls	The total agents currently on ACD calls in this skill.	select count(*) where split = \$input and LOC_ID = \$input and WORKMODE = ACD
Agents in AUX	The total agents currently in AUX work in this skill.	select count(*) where split = \$input and LOC_ID = \$input and WORKMODE = AUX
Agents in Other	The total number of agents doing other work in this skill. For all switches "other" time is accumulated when: <ul style="list-style-type: none"> <li>An agent first logs into the switch. <i>CentreVu</i> CMS tracks the agent time as "other" time until the switch notifies <i>CentreVu</i> CMS of the agent's state</li> <li>The link between CMS and the switch becomes operational. The switch notifies CMS of all agents who are logged in. CMS assumes these agents are in the "other" state until the switch sends it notification of each agent's current state.</li> </ul>	select count(*) where split = \$input and LOC_ID = \$input and WORKMODE = OTHER
Agents in Other (Contd.)	For Generic 3 switches, "other" time is accumulated when agents in Auto-In or Manual-In: <ul style="list-style-type: none"> <li>Put any call on hold while not doing any other activity</li> <li>Dialed to place a call or to activate a feature</li> <li>Had a personal call ringing with no other activity</li> <li>Were available for other, multiple call handling skills, but not for this skill</li> <li>Were logged into multiple splits/skills and were doing work for a split/skill other than this split/skill (on an ACD call or in call-related ACW).</li> </ul>	select count(*) where split = \$input and LOC_ID = \$input and WORKMODE = OTHER
Agents Staffed	The total number of agents currently staffed for this skill.	select count(*) where split = \$input and LOC_ID = \$input
Agents Avail	The total number of agents currently available in this split/skill	select count(*) where split = \$input and LOC_ID = \$input and WORKMODE = AVAIL
Agents Ringing	The total number of agents in this skill with calls currently ringing.	select count(*) where split = \$input and LOC_ID = \$input and WORKMODE = RING
Agent Name	The names or login IDs of the agents that logged into the split/skill selected in the report input window.	syn(LOGID)
Login ID	The login ID of the agent.	LOGID
Extn	The agent's terminal extension number.	EXTENSION



Report Heading	Description	Database Item, Calculation, or <Calculation Name>
Role	The Agent's service role for this SKILL, based on call handling preference and skill level.	ROLE
Percent	The Agent's percent allocation for this SPLIT. Requires <i>DEFINITY ECS R6</i> with <i>CentreVu Advocate</i> .	PERCENT
AUX Reason	The reason the agent is in AUX on this skill.	AUXREASON
State	The agent's state on this skill; for example, in AUX, in ACW, in OTHER.	AWORKMODE, WORKSKILL
Direction	The agent's direction on this skill, IN or OUT.	DIRECTION
Split/Skill	The name or number of the split/skill that is selected for this report. You can make these selections in the report input window.	syn(SPLIT)
Level	The agent's skill level on this skill, 1–16, r1 or r2.	WORKSKLEVEL
Time	The elapsed time since the last agent WORKMODE change for any split/skill. This item is not reset if the DIRECTION changes, but WORKMODE remains the same. For example, if the agent goes fromAUX to AUXOUT to AUX, AGTIME continues without resetting.	AGTIME



---

# Trunk Group Report

## Overview

---

**Purpose** The Trunk Group Report gives you the current status of each trunk in a selected trunk group.

**Organization of this section** This section contains the following topics:

- [Trunk Group Report Selector Window and Input Fields \(3-145\)](#)
- [Trunk Group Report \(3-146\)](#).



# Trunk Group Report Selector Window and Input Fields

**Overview** The trunk/trunk group selector window is where you specify which trunks or trunk groups will appear in the report

**Trunk Group report selector window** This figure is an example of the Trunk Group Report selector window:

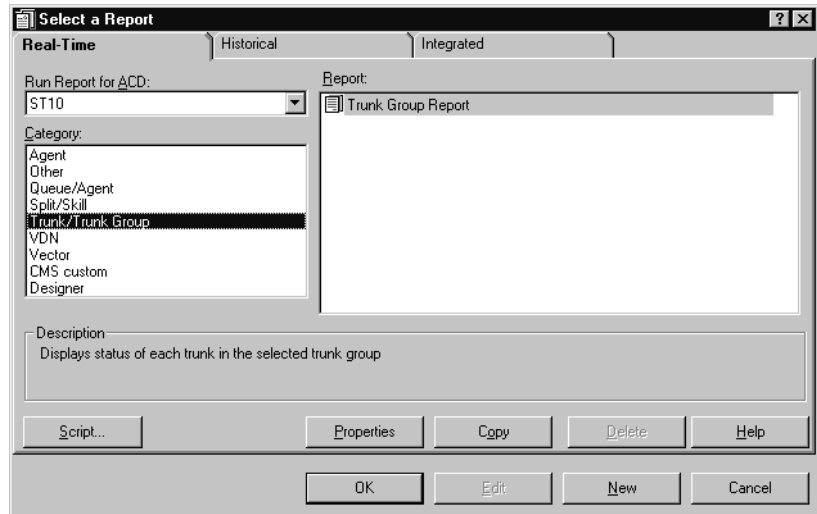

**Trunk Group report input fields** The following table describes the input fields on real-time Trunk Group report input windows. The report input window must be filled in to run the report:

Field	Definition
Trunk group:	Enter the trunk group name or number that you want to view in this report. Any name(s) that you want to appear on the report must have been previously defined and entered in the Dictionary subsystem.
Refresh Every <#> seconds:	Enter the number of seconds (3 to 600) to specify how rapidly <i>CentreVu</i> CMS should update the report data. The default for the Refresh Every <#> Seconds field in this window is your assigned minimum refresh rate plus 15 seconds. To find out what your minimum refresh rate is, or to change it, check with your <i>CentreVu</i> CMS administrator.
Enable Report Thresholds	Check the Enable Report Thresholds option to start the report with report thresholds running. Uncheck the option if you do not want to run report thresholds.
Run Minimized	Check the Run Minimized option to run the report in a minimized window. Uncheck the option to run the report at full size.

# Trunk Group Report

**Overview** The Trunk Group report displays the current status of each trunk in a selected trunk group. This information is useful in identifying overused or underused facilities and in general troubleshooting.

- Things to know about this report** Here are some things you need to know about this report:
- The database items used for the Trunk Group report are stored in the `ctkgrp` table.
  - This report uses the Trunk Group input window. See [Trunk Group report input fields \(3-145\)](#) for more information.

**Trunk Group report example** The following figure provides an example of a Trunk Group report:

Trunk	State	Direction	Time	Agent Name	Extn	Split/Skill	VDN Name
Tkgrp 1	IDLE	OUT	1:40	Agent 1	2001	Skill1	Orders
Tkgrp 2	CONN	IN	1:24	Agent 12	2012	Skill2	Orders
Tkgrp 3	CONN	IN	:30	Agent 32	2032	Regular	Orders
Tkgrp 4	HOLD	IN	1:07	Agent 16	2016	Gold	Orders
Tkgrp 5	RINGING	IN	1:32	Agent 3	2003	Platinum	Orders

**Trunk Group report description** The following table describes the report fields:

Report Heading	Description	Database Item, Calculation, or <Calculation Name>
Trunk Group Name	The trunk group name or number for which the report was requested.	syn(TKGRP)
Trunk	The trunk equipment location assigned to this trunk.	EQLOC
State	The current state of the trunk (IDLE, CONN, QUEUED, SEIZED, MBUSY, HOLD, UNKNOWN, DABN, FBUSY, FDISC, RING).	TKSTATE

Report Heading	Description	Database Item, Calculation, or <Calculation Name>
Direction	The direction in which the trunk is carrying the current call (in or out).	DIRECTION
Time	The time that the trunk has spent in the current state.	DURATION
Agent Name	The name of the agent handling the current call on the trunk.	syn(LOGID)
Extn	The extension number that is associated with the current call on the trunk.	EXTENSION
Split/Skill	The split/skill number that is associated with the current call on the trunk.	SPLIT
VDN Name (Shows data only if you have the Vectoring feature)	The number or name of the VDN for which the report shows data. The Vector Directory Number is associated with the ACD call in progress. If a name has been assigned to the VDN in the Dictionary, the name displays instead of the number.	VDN



# VDN Reports

---

## Overview

---

- Purpose** The VDN reports give you the following specific information about VDNs:
- The wait times of incoming calls answered/connected and abandoned for a VDN during the current interval.
  - How calls to the specified VDN are being handled.
  - The number of calls handled by each of the VDN skill preferences and information about call handling.
  - The current overall status of the VDNs you select.

- Organization of this section** This section contains the following topics:
- [General Information About Split/Skill Reports \(3-59\)](#)
  - [VDN Report Selector Window and Input Fields \(3-150\)](#)
  - [VDN Call Profile Report \(3-152\)](#)
  - [VDN Graphical Call Profile Report \(3-156\)](#)
  - [VDN Skill Preference Report \(3-159\)](#)
  - [VDN Report \(3-161\)](#).



---

## General Information About VDN Reports

---

**Organization of VDN reports**

The following list shows how the VDN reports are organized in *CentreVu* Supervisor:

- Call Profile
- Graphical Call Profile
- Skill Preference
- Report.



## VDN Report Selector Window and Input Fields

**Overview** The VDN report selector window and the VDN report input window are used to run the VDN reports described in this section.

**VDN report selector window** The following figure is an example of the VDN Report Selector window. The reports are explained in the same order as listed in the window:

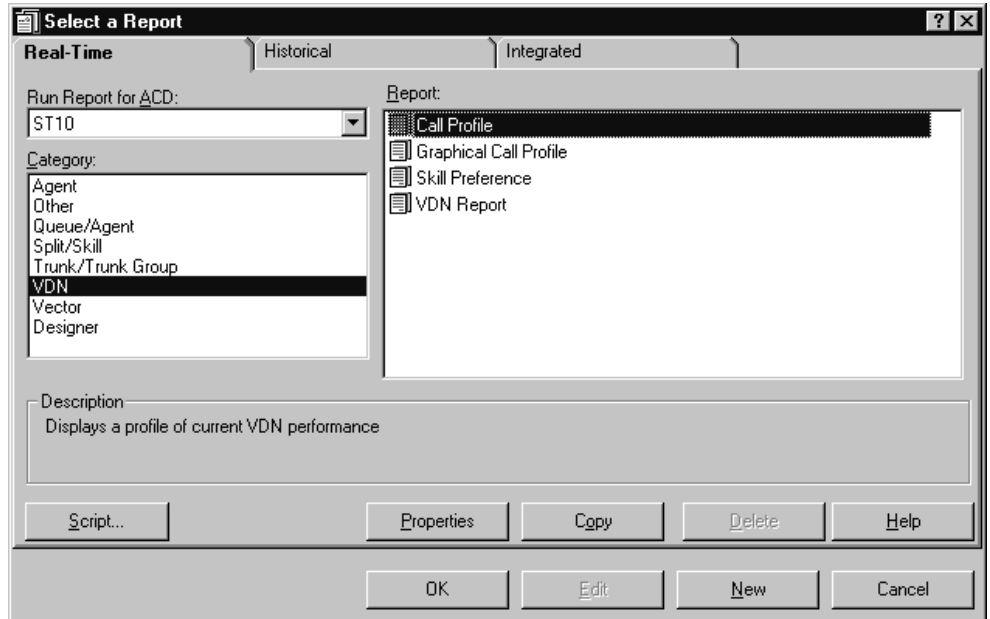

**VDN report input fields** The reports in this section use the VDN Reports Input Window. Specific input information is included with the reports. The report input window must be filled in to run the report. The following table describes the input fields on real-time VDN report input windows:

Field	Definition
VDN:	Fill in the VDN(s) names(s) or number(s) for which you want to run the report. You can enter a VDN name only if the name has been defined in the Dictionary.
Refresh Every <#> seconds:	Enter the number of seconds (3 to 600) to specify how frequently <i>CentreVu</i> CMS should update the report data. The default for the Refresh Every <#> Seconds field in this window is your assigned minimum refresh rate plus 15 seconds. To find out what your minimum refresh rate is, or to change it, check with your <i>CentreVu</i> CMS administrator.



Field	Definition
Enable Report Thresholds	Check the Enable Report Thresholds option to start the report with report thresholds running. Uncheck the option if you do not want to run report thresholds.
Run Minimized	Check the Run Minimized option to run the report in a minimized window. Uncheck the option to run the report at full size.



# VDN Call Profile Report

---

**Overview** This report, which is available only for customers who have the Vectoring feature, displays the numbers of answered/connected and abandoned calls to the specified VDN within the administered service level increments. It also displays the percentage of calls answered or connected within the acceptable service level.

In order to run this report the Vectoring feature must be enabled.

**Things to know about this report** Here are some things you need to know about this report:

- Calls are displayed in ten separate columns, with each column representing a progressively longer wait time for the call. For example, the first field shows calls that were answered in less than or equal to PERIOD1 seconds, the second field shows calls that were answered in less than or equal to PERIOD2 seconds, but greater than PERIOD1 seconds, and so on.
- You can only run this report if the Vectoring feature has been purchase and authorized for you to use.
- The database items used for the VDN Call Profile report are stored in the `cvdn` table.
- This report uses the VDN Report Input Window. Select a VDN that you want to view on the report. See [VDN report input fields \(3-150\)](#) for more information.

**Prerequisite System Administration** You must first define your acceptable service level and service level increments for this VDN in the VDN Call Profile Setup window. If you do not define your service level and increments, zero (0) is used for all increments (therefore, all calls appear in the first increment).

## Reference

For more information, see the "Call Center Administration" chapter of the *CentreVu Call Management System Release 3 Version 8 Administration 585-210-910* document.

**VDN Call Profile report example** The following figure provides an example of a VDN Call Profile report:

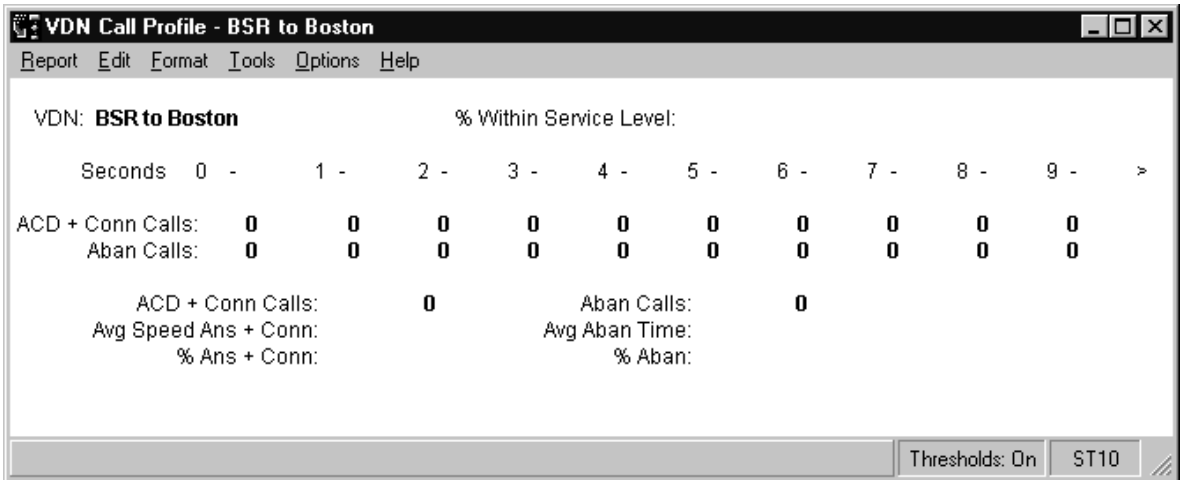

**VDN Call Profile report description** This table describes the report fields:

Report Heading	Description	Database Item, Calculation, or <Calculation Name>
VDN (Shows data only if you have purchased the Vectoring feature.)	The number or name of the VDN for which the report shows data (selected in the report input window).	VDN
% Within Service Level	Percentage of calls to the VDN that were answered/connected within the service level (as specified in the VDN Call Profile Setup window). Calls to the VDN may result in ACD calls, direct agent calls, and non-ACD calls.	100 * ( ACCEPTABLE / INCALLS) <PERCENT_SERV_LVL_VDN>
Seconds	The size of each service level increment is measured in seconds. Each increment of seconds represents a progressively longer wait time segment during which calls may be answered or abandoned, and each increment can be a different length. These increments are defined in the Call Center Administration VDN Call Profile Setup window.	PERIOD1-9

Report Heading	Description	Database Item, Calculation, or <Calculation Name>
ACD + Conn Calls:	Number of calls to the VDN that were answered by an agent or connected to a non-ACD destination within each of the service level increments. this includes direct agent calls. With Generic 3 switches, connected means calls that are answered at a non-ACD destination.	ANSCONNCALLS1-10
Aban Calls:	Number of calls to the VDN that were abandoned within each of the service level increments. This includes direct agent calls and calls that were abandoned while queued to a split/skill or while ringing a voice terminal. For Generic 3 switches, this includes all VDN calls abandoned. For Generic 3 with the ASAI feature switches, this also includes the number of outbound calls for each split/skill that abandoned before an agent answered at the far end.	ABNCALLS1-10
ACD + Conn Calls (total):	Total number of calls to the VDN (including direct agent calls) that were answered by an agent or were connected to a non-ACD destination. With Generic 3 switches, connected means calls that are answered at a non-ACD destination.	ACDCALLS + CONNECTCALLS
Avg Speed of Ans + Conn:	The average time, in minutes and seconds, that calls to the VDN completed during this interval waited before being answered by an agent or connected (to a non-ACD destination). This includes direct agent calls (Generic 3 only), non-ACD calls, and calls answered by AUDIX and Message Center agents, but only includes calls that were processed by the VDN. This includes ringing time for all calls.	( ANSTIME + CONNECTTIME) / ( ACDCALLS + CONNECTCALLS)
% Ans + Conn:	Percentage of calls (which may includes direct agent calls) to the VDN completed during this interval that were answered or connected within the administered service level increments. This includes direct agent calls. With Generic 3 switches, connected means calls that are answered at a non-ACD destination.	100*(( ACDCALLS + CONNECTCALLS) / INCALLS

Report Heading	Description	Database Item, Calculation, or <Calculation Name>
Aban Calls (total):	Total number of calls to the VDN that were abandoned. This includes direct agent calls and calls that were abandoned while queued to a split/skill or while ringing a voice terminal.	ABNCALLS
Avg Aban Time:	The average time calls waited in VDN before hanging up.	ABNTIME / ABNCALLS <AVG_ABANDON_TIME>
% Aban:	Percentage of calls to the VDN that were abandoned.	100*( ABNCALLS / INCALLS)



# VDN Graphical Call Profile Report

---

**Overview** This report shows how calls to the VDN you specify are being handled compared to your call center's predefined acceptable service level. Call center supervisors can use this report to look at VDN calls answered within the acceptable service level and service interval answer and abandons.

This report is available on switches with the Call Vectoring feature.

**Things to know about this report** Here are some things to know about this report:

- You can access this report from the Real-Time VDN Category selector menu.
- This report contains two charts, a three-dimensional pie chart and a stacked area graph. A legend is located to the right of each chart. The three-dimensional pie chart contains the percentage of ACD calls answered within the predefined acceptable service level and the percentage of ACD calls answered outside this level. The VDN selected for the report and the predefined acceptable service level are displayed above this chart.

The stacked area graph contains the following information:

- The number of ACD calls answered and abandoned within each service interval.
- The x-axis represents each of the defined service intervals in seconds, and the y-axis represents the number of ACD calls answered/abandoned within each of the defined service levels.
- The number displayed for each service interval is the upper limit of the interval. For example, if the first two intervals are "5" and "10," the first data point on the graph shows the number of calls answered/abandoned within 0-5 seconds, and the second data point shows the number of calls answered/abandoned within 6-10 seconds.
- The chart type can be changed. See Chapter 2: "Using Reports" in this document for more information.
- The database items used for the VDN Graphical Call Profile report are stored in the `cvdn` table.
- This report uses the VDN Report Input Window. Select a VDN that you want to view on the report. See [VDN report input fields \(3-150\)](#) for more information.

**VDN Graphical Call Profile report example**

The following figure provides an example of the VDN Graphical Call Profile Report:

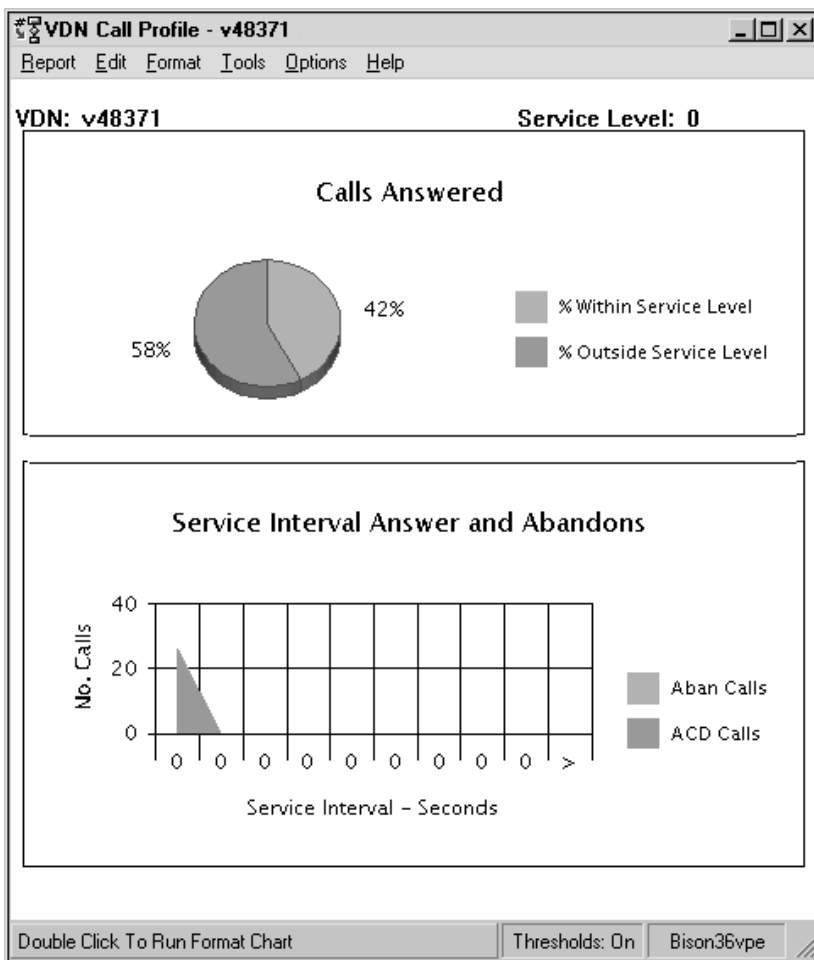

**VDN Graphical Call Profile report description**

The following table describes the report fields:

Report Heading	Description	Database Item, Calculation, or <Calculation Name>
VDN: (Shows data only if you have purchased the vectoring feature.)	The number or name of the VDN for which the report shows data.	VDN or syn(VDN)
% Within Service Level	Percentage of calls to the VDN that were answered/connected within the service level (as specified in the VDN Call Profile Setup window). Calls to the VDN may result in ACD, direct agent calls, and non-ACD calls.	<PERCENT_SERV_LVL_VDN

Report Heading	Description	Database Item, Calculation, or <Calculation Name>
% Outside Service Level	Percentage of VDN ACD calls that were not answered by an agent within the predefined acceptable service level. Calls that were not answered may include forced busy calls, forced disconnect calls, calls redirected to another destination, and calls queued to more than one VDN and answered in another VDN.	< <100--PERCENT_SERV_LVL_VDN>
Service Interval - Seconds	The size of each service level increment is measured in seconds. Each increment of seconds represents a progressively longer wait time segments during which calls may be answered or abandoned, and each increment can be a different length. These increments are defined in the call Center Administration VDN Call Profile Setup window.	PERIOD1-9
ACD + Conn Calls:	The number of calls to the VDN that were answered by an agent or connected to a non-ACD destination within each of the service level increments. Calls in each increment are represented by color-coded area (see legend).	ANSCONNCALLS1-10
Seconds:	Shows the current setting for the Acceptable Service Level, in seconds, as defined on the Call Center Administration: VDN Call Profile Setup window)	SERVICELEVEL
Aban Calls:	The number of calls to the VDN that were abandoned within each of the service level increments. This includes direct agent calls and calls that were abandoned while queued to a split/skill or while ringing a voice terminal. For all Generic 3 switches, this is all VDN calls abandoned. For Generic 3 with the ASAI feature switches, this also includes the number of outbound calls for each split/skill that abandoned before an agent answered at the far end.	ABNCALLS1-10





# VDN Skill Preference Report

**Overview** This report, which is only available for customers who have the Vectoring and EAS features, displays information about call handling for the VDN as a whole and lists the number of calls handled by each of the VDN skill preferences.

In order to run this report, the Vectoring and EAS features must be enabled.

**Things to know about this report** Here are some things you need to know about this report:

- This report is only available if the Vectoring and EAS features have been purchased and authorized for you to use.
- This report displays data on the handling of calls to the VDNs by VDN skill preference.
- If a specific skill in the vector is also administered as a VDN skill preference for the associated VDN, data for that skill preference shows in this report.
- The database items used for the VDN Skill Preference report are stored in the cvdn table.
- This report uses the VDN Report Input Window. Select a VDN that you want to view on the report. See [VDN report input fields \(3-150\)](#) for more information.

**VDN Skill Preference report example** The following figure provides an example of the real-time VDN Skill Preference report:

The screenshot shows a window titled "VDN Skill Preference" with a menu bar (Report, Edit, Format, Tools, Options, Help) and a table of data. The table has columns for VDN Name, Inbound Calls, ACD Calls, Avg Speed Ans, Avg ACD Time, Avg ACW Time, Aban Calls, Avg Aban Time, 1st Skill ACD Calls, 2nd Skill ACD Calls, and 3rd Skill ACD Calls. The data rows show Design and BSR to VDNs with zero values for all metrics.

VDN Name	Inbound Calls	ACD Calls	Avg Speed Ans	Avg ACD Time	Avg ACW Time	Aban Calls	Avg Aban Time	1st Skill ACD Calls	2nd Skill ACD Calls	3rd Skill ACD Calls
Design	0	0				0		0	0	0
BSR to	0	0				0		0	0	0

At the bottom right of the window, there are two buttons: "Thresholds: On" and "ST10".

**VDN Skill Preference report description** The following table describes the report fields:

Report Heading	Description	Database Item, Calculation, or <Calculation Name>
VDN Name (Shows data only if you have purchased the Vectoring Feature.)	The number or name of the VDN for which the report shows data.	VDN
Inbound Calls	Number of calls offered to the VDN since the start of the interval and that completed during the interval.	INCALLS
ACD Calls	The number of split/skill and direct agent ACD calls to the VDN completed during the reporting period that were answered by an agent. This includes calls from "queue to main," "check backup," "messaging split/skill," "route to" split/skill, and "adjunct routing" to split/skill or direct agent.	ACDCALLS
Avg Speed Ans	The average speed of the answer for split/skill and direct agent ACD calls to the VDN that were completed during the reporting period.	ANSTIME / ACDCALLS <AVG_ANSWER_SPEED>
Avg ACD Time	The average talk time (not including hold time) for all ACD calls (which may included direct agent calls) completed during this interval that were processed by the VDN.	ACDTIME / ACDCALLS <AVG_ACD_TALK_TIME>
Avg ACW Time	Average time agents spent in after call work associated with ACD calls to this VDN that were completed during this interval. (This does not include after call work time not associated with ACD calls.	ACWTIME/ ACDCALLS <AVG_ACW_TIME>
Aban Calls	Number of calls to the VDN during this interval that hung up during this interval.	ABNCALLS
Avg Aban Time	The average time calls waited (in VDN) before hanging up.	ABNTIME / ABNCALLS <AVG_ABANDON_TIME>
(1st., 2nd., 3rd.) Skill ACD Calls	Number of completed ACD calls to the VDN answered by agents in each of the three VDN skill preferences.	SKILLCALLS1 SKILLCALLS2 SKILLCALLS3

## VDN Report

**Overview** This report, which is only available for customers who have the Vectoring feature, displays information about how calls to the specified VDNs are being handled during the current interval.

In order to run this report, the Vectoring feature must be enabled.

**Things to know about this report** Here are some things you need to know about this report:

- You can only run this report if the Vectoring feature has been purchased and authorized for you to use.
- The database items used for the VDN Report are stored in the `cvdn` table.
- This report uses the VDN Reports Input Window. See [VDN report input fields \(3-150\)](#) for more information.

**VDN report example** The following figure provides an example of a VDN Report:

VDN Name	Calls Waiting	Oldest Call Waiting	Avg Speed Ans	Aban Calls	Avg Aban Time	ACD Calls	Avg ACD Time	Busy + Disc Calls	Flow In	Flow Out	Active VDN Calls
Design	0	:00		0		0		0	0	0	
Electroi	0	:00		0		0		0	0	0	
Security	0	:00		0		0		0	0	0	14
BSR to	0	:00		0		0		0	0	0	

Thresholds: On ST10

**VDN report description** The following table describes the report fields:

Report Heading	Description	Database Item, Calculation, or <Calculation Name>
VDN	The number or name of the VDN for which the report shows data.	VDN
Calls Waiting	Number of calls (which may include non-ACD and direct agent calls) to the VDN that are currently being processed by the vector, are in queue, or are ringing at an agent's voice terminal.	INPROGRESS - ATAGENT
Oldest Call Waiting	Length of time the oldest call currently waiting in the VDN has been waiting.	OLDESTCALL
Avg Speed Ans	The average speed of answer for split/skill and direct agent ACD calls to the VDN that were completed during the reporting period.	ANSTIME / ACDCALLS <AVG_ANSWER_SPEED>
Aban Calls	The number of calls to the VDN that hung up during this interval.	ABNCALLS
Avg Aban Time	The average time calls waited (in split/skill or VDN) before hanging up.	ABNTIME / ABNCALLS <AVG_ABANDON_TIME>
ACD Calls	The number of calls to the VDN completed during the interval that were answered by an agent. This includes calls from "queue to main," "check backup," "messaging split/skill," "route to split skill," and "adjunct routing" to split/skill or direct agent.	ACDCALLS
Avg ACD Time	The average talk time (not including hold time) for all ACD calls (which may include direct agent calls) completed during the interval that were processed by the VDN.	ACDTIME / ACDCALLS <AVG_ACD_TALK_TIME>
Busy + Disc Calls	Number of calls offered to the VDN that received a forced busy signal or forced disconnect.	BUSYCALLS + DISCCALLS <BUSY_DISCONNECT>
Flow In	Number of calls that were redirected to this VDN via a "route to" VDN. Calls are counted regardless of whether they remained connected to the VDN, were abandoned, or were routed to some other destination.	INFLOWCALLS

Report Heading	Description	Database Item, Calculation, or <Calculation Name>
Flow Out	The number of calls to this VDN that were redirected to another VDN or a destination outside the switch by way of a "route to" or "adjunct routing" command (Generic 3 switches only). This does not include calls redirected to another vector by way of a "go to vector" command, because those calls stay in the same VDN.	OUTFLOWCALLS
Active VDN Calls	Number of calls currently active in a VDN. This only includes incoming trunk calls directly to the VDN, but it does not include internal calls, transfers, or calls routed or redirected to the VDN through another VDN. A call is considered active in a VDN from the time that the call routes to the VDN until all parties on the call have been dropped and the call is released. If <i>CentreVu</i> CMS is connected to a switch release earlier than Generic 3 Version 4 or the vectoring feature is not enabled, then the Active VDN Calls column is displayed, but the fields are blank.	ACTIVECALLS



---

# Vector Report

## Overview

---

**Purpose** The Vector report displays the information about how calls to the specified vectors are being handled during the current interval.

**Organization of this section** This section contains the following topics:

- [Vector Selector Window and Input Fields \(3-165\)](#)
- [Vector Report \(3-166\)](#).



# Vector Selector Window and Input Fields

**Overview** The vector selector window is where you specify which vectors will appear in the report

**Vector report selector window** The following figure is an example of the Vector Report selector window:

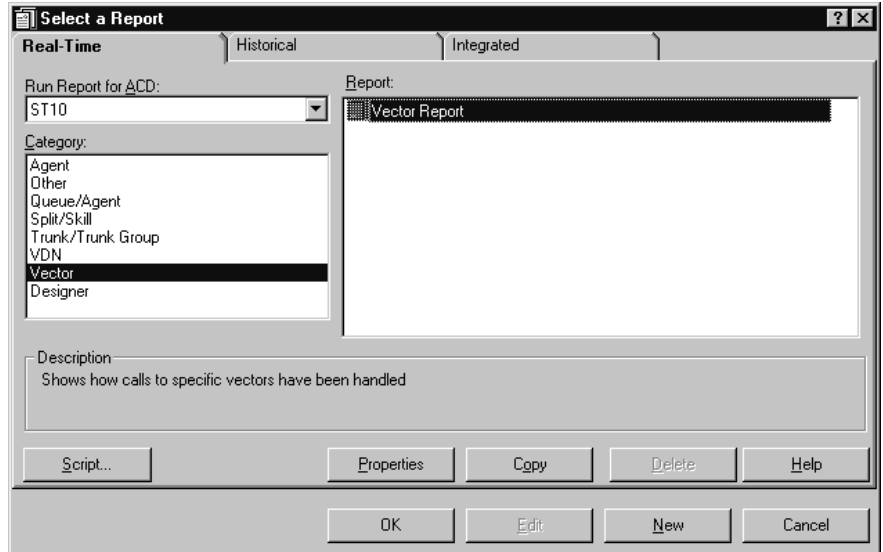

**Vector report input fields** The following table describes the input fields on real-time Vector report input windows. The report input window must be filled in to run the report:

Field	Definition
Vector(s):	Enter the name(s) or number(s) of the vector(s) for which you want to run the report. You can enter a vector name only if the name has been defined in the Dictionary.
Refresh Every <#> seconds:	Enter the number of seconds (3 to 600) to specify how frequently <i>CentreVu</i> CMS should update the report data. The default for the Refresh Every <#> seconds: field in this window is your assigned minimum refresh rate plus 15 seconds. To find out what your minimum refresh rate is, or to change it, check with your <i>CentreVu</i> CMS administrator.
Enable Report thresholds	Check the Enable Report Thresholds option to start the report with report thresholds running. Uncheck the option if you do not want to run report thresholds.
Run Minimized	Check the Run Minimized option to run the report in a minimized window. Uncheck the option to run the report at full size.

# Vector Report

**Overview** The Vector report displays information about how calls to the specified vectors are being handled during the current interval.

**Things to know about this report** Here are some things you need to know about this report:

- The database items used for the Vector Report are stored in the `cvector` table.
- This report uses the Vector Report Input window. Select the vectors that you want to view on the report. See [Vector Selector Window and Input Fields \(3-165\)](#) for more information.

**Vector report example** The following figure provides an example of a Vector Report:

Vector Name	Calls Waiting	Avg Speed Ans	Aban Calls	Avg Aban Time	ACD Calls	Busy + Disc Calls	Flow In	Flow Out
Vector1	0	:01	0		5	0	0	0
Vector2	0	:01	0		7	0	0	0
Vector3	0	:01	0		16	0	0	0

**Vector report description** The following table describes the report fields:

Report Heading	Description	Database Item, Calculation, or <Calculation Name>
Vector or Vector Name	Number or name of the vector for which the report shows data (selected in the report input window).	VECTOR
Calls Wait	Number of calls (which may include ACD and direct agent calls) that are currently being processed by the vector. This includes calls ringing a voice terminal.	INPROGRESS



Report Heading	Description	Database Item, Calculation, or <Calculation Name>
Avg Speed Ans	The average time, in minutes and seconds, that split/skill and direct agent ACD calls waited before they were answered by an agent. This item includes only calls that were answered as a result of processing by this vector. It does not include hold time.	ANSTIME / ACDCALLS <AVG_ANSWER_SPEED>
Aban Calls	Number of calls that were abandoned while being processed by this vector. This includes direct agent calls and calls that were abandoned while queued to a split/skill or while ringing a voice terminal.	ABNCALLS
Avg Aban Time	The average time a caller waited before hanging up.	ABNTIME / ABNCALLS <AVG_ABANDON_TIME>
ACD Calls	The number of calls that were processed by the vector and answered by an agent. This includes direct agent calls for Generic 3 switches and the ECS, and it does includes ACD calls placed by an adjunct (also called outbound predictive dialing), for the Generic 3 switches with the ASAI feature only.	ACDCALLS
Busy + Disc Calls	Number of calls offered to the vector that received a forced busy signal or forced disconnect.	BUSYCALLS + DISCCALLS <BUSY_DISCONNECT>
Flow In	Number of calls that were redirected from within the switch to this vector . Calls are counted regardless of whether they were answered while being processed by the vector, were abandoned, or were routed to some other destination.	INFLOWCALLS
Flow Out	The number of calls to this vector that were redirected to another vector or a destination by way of a "route to", "go to vector" or "adjunct routing" command (Generic 3 switches only). This includes calls routed to destinations within and outside the switch. Calls that route to a split/skill are not considered vector flow out calls, but are still tracked in the vector.	OUTFLOWCALLS

# Drill-Down Reports

---

## Overview

---

**Purpose** Supervisor reports allow you to "drill-down" to very detailed information from a variety of places. A "drill-down" report is a report that gives you very specific information on an agent or a work state in a split/skill.

**Organization of this section** This section contains the following topics:

- [General Information About Drill-Down Reports \(3-169\)](#)
- [Drill-Down Top Agent Work State Report \(3-170\)](#)
- [Drill-Down Work State Report \(3-174\)](#).



---

# General Information About Drill-Down Reports

---

- Drill-down report access** You can access drill-down reports in the following ways:
- Double click on an element in a report that allows you to access a drill-down report
  - Single click on an element in a report that allows you to access a drill-down report and then using the right mouse button menu to select a specific drill-down report
  - Use the Tools menu to select any of the drill-down reports that are accessible from the currently running report.
- Location ID as a report field** If you use a customer-created drill-down report to view information related to *CentreVu Advocate* and that report uses Location ID as an input field, a completely new drill-down report will display. This report will differ from the current set of drill-down reports and will include agent location ID as a report field.
- Drill-down reports will only contain Location ID if the report you drilled down from uses Location ID as an input.
- Finding drill-down information** You can tell if the report you are currently running accesses a drill-down report(s) (and which drill-down reports are available) by moving the mouse cursor over information on the report and reading the status bar at the bottom left-hand side of the report window.
- Drill-Down report types** There are two basic elements on reports from which you can access drill-down reports:
- Agent names, Login IDs or Location IDs- drill-down to agent-specific information reports
  - Work states (AUX, Avail, ACD, ACW, Ring, Other) - drill-down to work state reports or AUX Agents reports (ECS only).
- Modifying drill-down reports** Drill-down reports can only be modified if they are run from the Reports Selector window. They cannot be modified if they are accessed from another report or agent work state.



---

# Drill-Down Top Agent Work State Report

---

**Overview** This report shows top agents who are in the specified work state and the time in the state. In addition, this report shows all of the agents that are staffed even if they are not in a particular state for the specified split/skill. This report is available on all *DEFINITY* ECS or later switch releases with EAS.

**Accessing the report** You can only access this report by drilling down from work states (AVAIL, ACD, ACW, RINGING, and OTHER) or Location ID on other Real-Time Top Agent reports (for example, from the Real-Time Graphical Top Skill Status report) except for the AUX work state which requires *DEFINITY* ECS with EAS.

This report will only contain Location ID if the report you drilled down from uses Location ID as an input.

When you drill down to this report from another report, this report shows all of the top agents in that particular work state for that split or skill only.

**Report contents** This report contains:

- A table with a row for each top agent currently in the selected work state.
- Top agent name, login ID, time in state, split/skill, and the skill level and role in the skill in which the agent is active in each row of the table.
- The user will be able to specify sort by agent name, login ID, time in state, split/skill, skill level and role.
- The user will be able to specify a primary and a secondary sort key.

By default, the table will be sorted by split/skill for the primary sort, then by time in state (in descending order) for the secondary sort.

**Report use** From this report, you can drill down to Real-Time or Integrated Agent Information reports.

Call Center Supervisors can use this report to look at all the top agents in a particular work state, and to see how long an agent has been in this work state, the skill for which they are occupied, the skill level assigned to the agent for this skill, and the role the agent has in this skill.

You cannot customize this report.

**Database items** The database items used for this report are stored in the `csplit` and `cagent` tables.

### Drill-down Top Agent Work State report example

The following figure provides an example of the Top Agent Work State report:

The screenshot shows a window titled "Work State Report - s511" with a menu bar (Report, Edit, Format, Tools, Options, Help) and a status bar (Double Click To Run Format Table, Thresholds: On, Bison36vpe). The main content is a table with the following data:

Split/Skill: s511		Skill State: NORMAL		Agent State: AVAIL	
Agent Name	Login ID	Role	Active	Level	Time
			Split/Skill		
44468	44468	BCKP			1:17:11
44466	44466	BCKP			1:17:11
44461	44461	BCKP			1:17:11
44465	44465	BCKP			1:17:11
44462	44462	BCKP			1:17:10
44463	44463	BCKP			1:17:10
44467	44467	BCKP			1:17:10
44476	44476	TOP			1:17:06
44478	44478	TOP			1:17:06
44471	44471	TOP			1:17:06
44472	44472	TOP			1:17:06
44475	44475	TOP			1:17:06
44477	44477	TOP			1:17:06
44473	44473	TOP			1:17:06
44474	44474	TOP			1:17:06

**Drill-down Top Agent Work State report description** The following table describes the report fields:

Report Heading	Description	Database Item, Calculation, or <Calculation Name>
Skill:	The name or number of the skill (up to 20 characters) that is selected for this report.	syn( SPLIT)
Skill State	The current state of the skill, compared to the administered thresholds. This displays as Normal, Overload 1, and Overload 2 on the report. Requires <i>DEFINITY</i> ECS R6 or later with <i>CentreVu</i> Advocate.	SKSTATE
Agent state	The current work mode for this agent. Values include Avail, ACD, ACW, AUX, DACD, DACW, RINGING, UNKNOWN, OTHER, AND UNSTAFF.	AWORKMODE + DIRECTION
Agent Name	The name (or agent IDs if the names have not been assigned in the Dictionary) of the agents assigned to this split/skill and logged in.	syn(LOGID)
Login ID	The login identification of the agents.	LOGID
Location ID	The location ID(s) associated with the agent. This ID is not associated with the agent personally, but rather with the terminal the agent is logged into. It is also associated with a port network location ID on <i>DEFINITY</i> . If the Agent Site Tracking feature is not available on your system, the field will not display meaningful data.	LOC_ID
Role	Agent's service role for this SPLIT, as defined in the Dictionary. Requires ECS R6 or later with <i>CentreVu</i> Advocate.	syn(ROLE)

Report Heading	Description	Database Item, Calculation, or <Calculation Name>
Active Skill	<p>This skill is active when the agent is:</p> <ul style="list-style-type: none"> <li>• On a split/skill, on a direct agent ACD call, or in ACW. This is the split/skill associated with the call or ACW.</li> <li>• Available, in AUX or in OTHER state. This is null (blank).</li> <li>• On an AUXIN/AUXOUT call. This is the OLDEST_LOGIN split/skill.</li> <li>• On an AUXIN/AUXOUT call from the available state, while in AUX or with an AUXIN/AUXOUT call from the available state, while in AUX or with an AUXIN/AUXOUT call on hold. This is the OLDEST_LOGON split/skill.</li> <li>• On an AUXIN call with an ACD call on hold. This is the OLDEST_LOGON split/skill.</li> <li>• On an AUXOUT call with an ACD call on hold. This is the split/skill associated with the ACD call.</li> </ul> <p>WORKSKILL differs from WORKSPLIT only in the case that the agent is available. In this case, WORKSKILL will be blank AND WORKSPLIT will contain one of the split/skills in which the agent is available.</p>	syn(WORKSKILL)
Level	The skill level (1-16, R1 or R2) associated with the SKILL.	syn(LEVEL)
Time	The elapsed time since the last agent WORKMODE change for any split/skill. This item is not reset if the DIRECTION changes, but WORKMODE remains the same. For example, if the agent goes from AUX to AUXOUT to AUX, AGTIME continues without resetting.	AGTIME



---

# Drill-Down Work State Report

---

**Overview** This report shows all of the agents who are in the specified work state and the time in state.

This report is available on all switches.

**Accessing the report** You can only access this report by drilling down from work states (AVAIL, ACD, ACW, AUX, RINGING, and OTHER) or Location ID on other Real-Time reports (for example, from the Real-Time Graphical Status report).

This report will only contain Location ID if the report you drilled down from uses Location ID as an input.

From this report, you can drill down to Real-Time or Integrated Agent Information reports.

**Report contents** This report contains:

- A table with a row for each top agent currently in the selected work state.
- Agent name, login ID, time in state, split/skill, and the skill level and role for the skill in which the agent is active in each row of the table.
- The user will be able to specify sort by agent name, login ID, time in state, split/skill, and skill level.
- The user will be able to specify a primary and a secondary sort key.

By default, the table will be sorted by split/skill for the primary sort, then by time in state (in descending order) for the secondary sort.

**Report Use** When you drill down to this report from another report, this report shows all of the agents in that work state for that split or skill only.

Call Center Supervisors can use this report to look at all agents in a particular work state, and to see how long an agent has been in this work state, the split/skill for which they are occupied, the skill level assigned to the agent for this skill, and the role the agent has in this skill.

You cannot customize this report.

**Database Items** The database items used for this report are stored in the `csplit` and `cagent` tables.



### Drill-down Work State report example

The following figure provides an example of the Work State report:

Work State Report - s511					
Report Edit Format Tools Options Help					
Split/Skill: s511			Skill State: NORMAL Agent State: AVAIL		
Agent Name	Login ID	Role	Active Split/Skill	Level	Time
44468	44468	BCKP			1:21:50
44466	44466	BCKP			1:21:50
44461	44461	BCKP			1:21:50
44465	44465	BCKP			1:21:50
44462	44462	BCKP			1:21:49
44463	44463	BCKP			1:21:49
44467	44467	BCKP			1:21:49
44476	44476	TOP			1:21:45
44478	44478	TOP			1:21:45
44471	44471	TOP			1:21:45
44472	44472	TOP			1:21:45
44475	44475	TOP			1:21:45
44477	44477	TOP			1:21:45
44473	44473	TOP			1:21:45
44474	44474	TOP			1:21:45

Updating Thresholds: On    Bison36vpe

**Drill-down Work State report description** The following table describes the report fields:

Report Heading	Description	Database Item, Calculation, or <Calculation Name>
Split/Skill	The name or number of the skill that is selected for this report.	syn( SPLIT)
Skill State	The current state of the skill, compared to the administered thresholds. This displays as Normal, Overload 1, and Overload 2 on the report. Requires <i>DEFINITY</i> ECS R6 or later with <i>CentreVu</i> Advocate.	SKSTATE
Agent state	The current work mode for this agent. Values include AVAIL, ACD, ACW, AUX, DACD, DACW, RINGING, UNKNOWN, OTHER, AND UNSTAFF.	AWORKMODE + DIRECTION
Agent Name	The name (or agent IDs if the names have not been assigned in the Dictionary) of the agents assigned to this split/skill and logged in.	syn(LOGID)
Login ID	The login identification of the agents.	LOGID
Location ID	The location ID(s) associated with the agent. This ID is not associated with the agent personally, but rather with the terminal the agent is logged into. It is also associated with a port network location ID on <i>DEFINITY</i> . If the Agent Site Tracking feature is not available on your system, the field will not display meaningful data.	LOC_ID
Role	Agent's service role for this SPLIT, as defined in the Dictionary. Requires ECS R6 or later with <i>CentreVu</i> Advocate.	syn(ROLE)

Report Heading	Description	Database Item, Calculation, or <Calculation Name>
Active Split/Skill	<p>This skill is active when the agent is:</p> <ul style="list-style-type: none"> <li>• On a split/skill, on a direct agent ACD call, or in ACW. This is the split/skill associated with the call or ACW.</li> <li>• Available, in AUX or in OTHER state. This is null (blank).</li> <li>• On an AUXIN/AUXOUT call from the available state, while in AUX or with an AUXIN/AUXOUT call on hold. This is the OLDEST_LOGIN split/skill.</li> <li>• On an AUXIN call with an ACD call on hold. This is the split/skill associated with the ACD call.</li> </ul> <p>WORKSKILL differs from WORKSPLIT only in the case that the agent is available. In this case, WORKSKILL will be blank AND WORKSPLIT will contain one of the split/skills in which the agent is available.</p>	syn(WORKSKILL)
Level	The skill level (1-16, R1or R2) associated with the SKILL.	syn(LEVEL)
Time	The elapsed time since the last agent WORKMODE change for any split/skill. This item is not reset if the DIRECTION changes, but WORKMODE remains the same. For example, if the agent goes fro AUX to AUXOUT to AUX, AGTIME continues without resetting.	AGTIME





# 4 Historical Reports

## Overview

---

**Purpose** This chapter is written for supervisors who use *CentreVu* Supervisor historical reports to effectively run the call center. Historical reports can be displayed on your PC, printed, stored to a file, copied to a clipboard, run as a script, or exported to HTML format through the Save as HTML feature.

**Introduction** This chapter gives you the information you need to understand every historical report available.

Historical reports display, report, and summarize the past performance of any measured subset of the ACD. Historical reports display past data for various agent, split/skill, trunk/trunk groups, VDN, and vector activities, such as number of ACD calls, abandoned calls, average talk time, and average speed of answer.

The information in historical reports will give you a sound basis for decisions concerning the following:

- Mix of trunk facilities
- Split or skill size
- Agent assignments
- Consistent and objective performance standards
- Performance evaluations.

The Expert Agent Selection (EAS), Vectoring, and Graphics reports are also included in this chapter. If you do not have the Expert Agent Selection feature, Vectoring feature, or Graphics package, those report items do not appear on your menu. The reports you see depend on your switch type, permissions, and system performance.

**Organization of Historical Reports**

The following topics are covered:

- [Agent Reports \(4-4\)](#)
- [Other Reports \(4-47\)](#)
- [Split/Skill Reports \(4-57\)](#)
- [System Reports \(4-101\)](#)
- [Trunk/Trunk Group Reports \(4-124\)](#)
- [VDN Reports \(4-141\)](#)
- [Vector Report \(4-172\)](#).

**Presentation**

This chapter gives a brief description of each available report, examples of the report input windows, and definitions of the input fields. It provides you with the information you need to complete any historical report input window.

Each report description has the following headings:

- Things to Know About All Historical Reports - gives you information on factors that affect the historical reports.

- Input Window - includes input field definitions specific to each report.
- Sample Report - provides an example of the report. A table provides report headings, field definitions, and the corresponding database item.

A short summary and example of each historical report is included in this chapter.

**Diagram of historical reporting system**

The following diagram shows how the Historical reporting system is structured. This section follows the report structure outlined in this diagram-agent reports are described first, followed by other reports, such as call records and call work code reports.

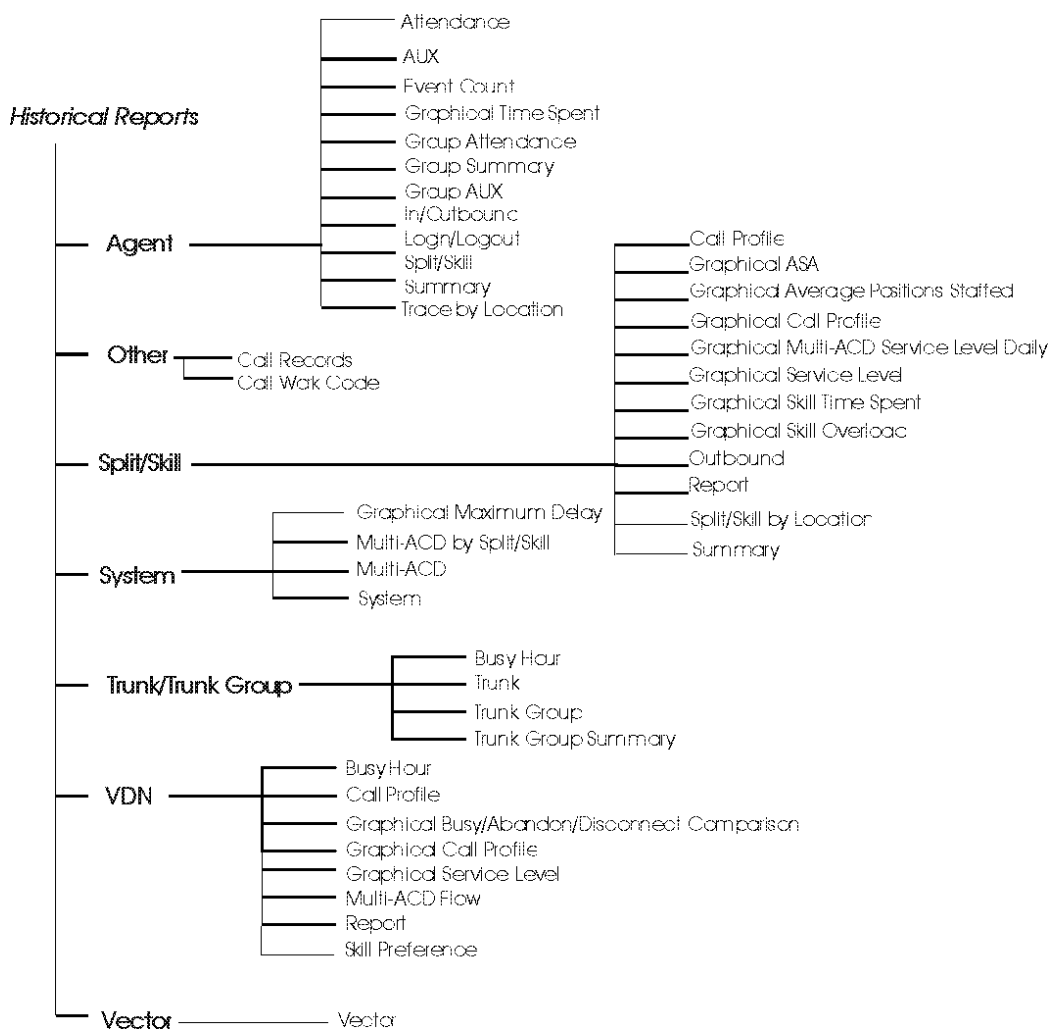

**Presentation of report information**

When you generate a historical report, the totals for the report columns are on the top line of the report under the headings.

There are four types of historical reports:

- Interval reports contain breakdowns of data by the interval you have defined. The report intervals can be 15, 30, or 60 minutes. Interval reports can help you identify your high and low call volumes, and thereby manage your call center more easily.
- Daily reports display summarized interval data, one line for each day.
- Weekly reports display summarized daily data for the week(s) specified, one line for each week.
- Monthly reports display summarized daily data for the month(s) specified, one line for each month.

All four types are not available for each report. The Select a Report window lists reports based on which types are available (for example: Call Profile Daily, Call Profile Weekly, Call Profile Monthly).

**How long does CMS store data?**

*CentreVu* CMS can store intrahour data for up to 62 days, daily summary data for 5 years, and weekly/monthly summary data for 10 years. Disk storage space can quickly become an issue, as the volume of data you wish to store increases.



---

# Agent Reports

## Overview

---

**Purpose** This section describes agent reports.

**Organization** This following topics are described:

- General Information About Agent Reports
- Agent Report Selector Window
- Agent Report Input Fields
- Agent AUX Report
- Agent Attendance Report
- Agent Event Count Report
- Agent Graphical Time Spent Report
- Agent Group Attendance Report
- Agent Group AUX Report
- Agent Group Summary Report
- Agent Inbound/Outbound Report
- Agent Login/Logout (Skill) Report
- Agent Login/Logout (Split) Report
- Agent Split/Skill Report
- Agent Summary Report
- Agent Trace by Location Report





---

## General Information About Agent Reports

---

- What an Agent report contains** The Agent reports give you the following specific information about agents:
- Every agent activity and the time it occurred for a particular agent in the Agent Trace by Location report.
  - An individual agent's performance by split or skill in the Agent Split/Skill report.
  - How a group of agents is performing in the Group Summary report.
- Organization of Agent reports** The following list shows how the Historical Agent reports are organized in *CentreVu* Supervisor:
- AUX: Interval, Daily, Weekly, Monthly
  - Attendance: Daily, Weekly, Monthly
  - Event Count: Interval
  - Graphical Time Spent: Interval, Daily, Weekly, Monthly
  - Group AUX: Daily, Weekly, Monthly
  - Group Summary: Daily, Weekly, Monthly
  - Group Attendance: Daily, Weekly, Monthly
  - In/Outbound: Interval, Daily, Weekly, Monthly
  - Login/Logout (Skill): Interval
  - Login/Logout (Split): Daily
  - Split/Skill: Interval, Daily, Weekly, Monthly
  - Summary: Interval, Daily, Weekly, Monthly
  - Trace by Location

**Agent Report selector window**

The following figure is an example of the Agent Report selector window. The reports are explained in the same order as listed in the window.

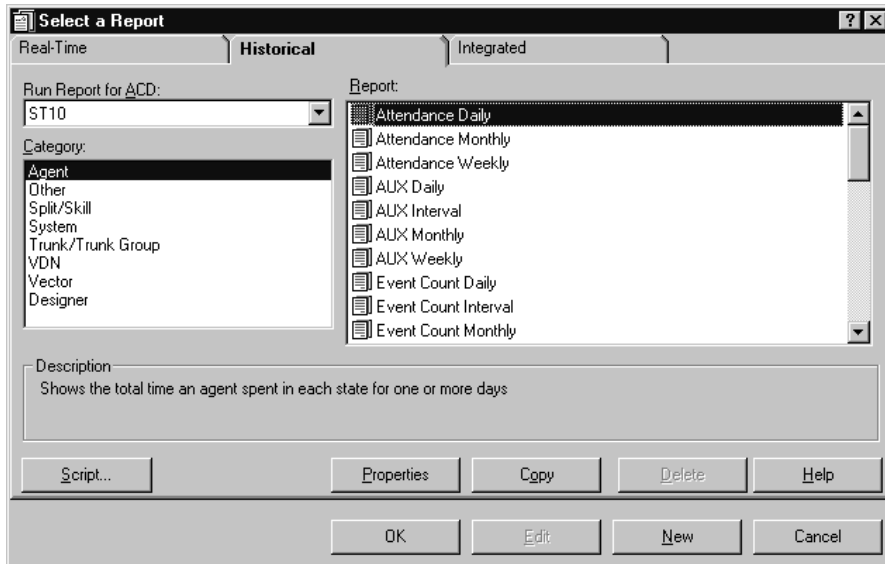

## Agent Report Input Fields

---

**Overview** The reports in this section use the Agent Report Input Windows. Specific input information is included with the reports.

**Agent report input fields** The following table describes the input fields on historical Agent report input windows. Not all reports use all fields; refer to information for the specific report you are running to determine what you want to view. For example, you may enter an agent group, agent name or split/skill to run the report.

All possible fields on this window are described here:

Field	Definition
Agent:	Enter the name of the agent. The agent's name must be defined in the Dictionary subsystem; otherwise, you will see the agent's ID number.
Agent group:	Enter the appropriate group name. It is important to enter the agent group name correctly, because <i>CentreVu</i> CMS does not check to see if the group name you entered exists in the Dictionary subsystem. Therefore, if you enter a name that is misspelled, the report runs but does not contain data because the group does not exist. You should enter the correct group name and run the report again.
Date: (Interval)	Enter the date you would like the report to cover. <ul style="list-style-type: none"> <li>You can use the month/day/year (for example, 3/21/95).</li> <li>You can use a "-" offset based on today's date (for example, -1 for yesterday).</li> </ul>
Login Date:	Enter the date that you would like the report to cover. This is the date on which agents in the skill logged in. <ul style="list-style-type: none"> <li>You can use the month/day/year (for example, 3/21/95).</li> <li>You can use a "-" offset based on today's date (for example, -1 for yesterday).</li> </ul>

Field	Definition
Date: (daily, weekly, and monthly)	<p>Enter the dates for the days or the start dates for the weeks or the months that you would like the report to cover.</p> <ul style="list-style-type: none"> <li>• You can use the month/day/year (for example, 3/21/95).</li> <li>• You can use a "-" offset based on today's date (for example, -1 for yesterday). You can also specify a range of dates (for example, 0 through - 7).</li> <li>• You can separate individual data entry items using a semicolon (for example, 3/21/95;3/23/95;3/25/95), and you can enter ranges by placing a hyphen between entries (for example, 3/21/95-3/25/95). For weekly and monthly reports, specifying a range produces all weeks and/or months that begin in the range. When you specify a date for a weekly report, that date or range of dates must correspond to the week start day selected in the System Setup-Storage Intervals window. If the date and day do not match, the message No records found displays in the status line. The month start date must be the first day of the month.</li> </ul>
Times: (Interval)	<p>Enter the times you would like the report to cover.</p> <ul style="list-style-type: none"> <li>• You can use AM/PM format (for example, 7:30AM-5:00PM).</li> <li>• You can use military time format (for example, 7:30-17:00).</li> <li>• You can separate individual data entry items using a semicolon (for example, 3/21/95;3/23/95;3/25/95), and you can enter ranges by placing a hyphen between entries (for example, 3/21/95-3/25/95). For weekly and monthly reports, specifying a range produces all weeks and/or months that begin in the range.</li> </ul>
Destination:	<p>Choose a report destination. You can select View Report on Screen or Print Report on: and then use the Select Printer button to print the report on any Windows printer. The default printer is shown.</p>



# Agent AUX Report

**Overview** The Agent AUX (Auxiliary Work) report is based on the Agent Summary and Agent Attendance reports. This report shows the total staffed time, total AUX time, and AUX time for each reason code for an agent.

**Things to know about this report**

Here are some things you need to know about this report:

- The Agent AUX report is available in interval, daily, weekly, and monthly versions.
- The database items for the Agent AUX report are stored in the **hagent** (interval), **dagent** (daily), **wagent** (weekly), and **magent** (monthly) tables.
- This report is only available when the Automatic Call Distribution (ACD) and Expert Agent Selection (EAS) features have been enabled on a *DEFINITY* ECS or greater.
- You must be using AUX Reason Codes on the switch for this report to be meaningful.
- This report uses the Agent Report Input Window. Select an agent who you want to view on the report. See [Agent Report Input Fields \(4-7\)](#) for more information.

**Agent AUX report example**

The following figure provides an example of an Agent AUX report.

Time	Staffed Time	AUX Time	Time in a0	Time in a1	Time in a2
<b>Totals</b>	22:56:07	:02:13	:00:01	:02:12	:00:00
12:00 - *****	:30:00	:00:00	:00:00	:00:00	:00:00
12:30 - 1:00AM	:30:00	:00:00	:00:00	:00:00	:00:00
1:00 - 1:30AM	:30:00	:00:00	:00:00	:00:00	:00:00
1:30 - 2:00AM	:30:00	:00:00	:00:00	:00:00	:00:00
2:00 - 2:30AM	:30:00	:00:00	:00:00	:00:00	:00:00
2:30 - 3:00AM	:30:00	:00:00	:00:00	:00:00	:00:00
3:00 - 3:30AM	:30:00	:00:00	:00:00	:00:00	:00:00
3:30 - 4:00AM	:30:00	:00:00	:00:00	:00:00	:00:00
4:00 - 4:30AM	:30:00	:00:00	:00:00	:00:00	:00:00
4:30 - 5:00AM	:30:00	:00:00	:00:00	:00:00	:00:00
5:00 - 5:30AM	:30:00	:00:00	:00:00	:00:00	:00:00
5:30 - 6:00AM	:30:00	:00:00	:00:00	:00:00	:00:00
6:00 - 6:30AM	:06:35	:00:00	:00:00	:00:00	:00:00

**Agent AUX report description** The following table describes the report fields:

Field	Description	Database Item, Calculation, or <Calculation name>
Date, Week Starting, or Month Starting	The day, week, or month for which the report ran. You can make these selections in the report input window.	ROW_DATE
Agent Name:	The name or login ID of the agent. You can make this selection in the report input window.	syn(LOGID)
ACD:	The ACD name or number for which the data was collected.	syn(ACD)
Time (for interval reports only)	The intrahour intervals for which the report shows data. You can make these selections in the report input window.	STARTTIME, STARTTIME + INTRVL
Staffed Time	The total time that the agent was logged in (staffed) for the specified time period in any split/skill. (This does not include time that the link was down.)	sum(TI_STAFFTIME)
AUX Time	The total time that the agent spent in AUX work in all splits/skills and on AUXIN/AUXOUT calls for the specified time period.	sum(TI_AUXTIME)
Time in 0	The time that the agent spent in AUX with the reason code of 0 (zero). This is the time in the "system" AUX for the switches using AUX reason codes. It is the same as TI_AUXTIME for switches not using AUX reason codes.	sum(TI_AUXTIME0)
Time in 1...9	The time that the agent spent in AUX with each of the reason codes 1–9.	sum(TI_AUXTIME1) ... sum(TI_AUXTIME9)



# Agent Attendance Report

**Overview** The Agent Attendance report gives the total staffed time, ACD time, ACW time, AUX time, time in the ringing state, extension time, available time, and the number of calls handled by an agent for the specified time period for all splits or skills the agent was logged into.

**Things to know about this report** Here are some things you need to know about this report:

- The Agent Attendance report is available in daily, weekly, and monthly versions.
- The database items for the Agent Attendance report are stored in the **hagent** (interval), **dagent** (daily), **wagent** and **magent** (monthly) tables.
- The report item Total Staff Time contains other time (TI\_OTHERTIME) which is not shown in the report but can cause the numbers to not add up.
- This report uses the Agent Report Input Window. Select an agent who you want to view on the report. See [Agent Report Input Fields \(4-7\)](#) for more information.

**Agent Attendance report example**

The following figure provides an example of an Agent Attendance report.

Date	Staffed Time	ACD Time	ACW Time	Agent Ring Time	Extn In Time	Extn Out Time	Avail Time	AUX Time	ACD Calls	Extn In Calls	Extn Out Calls
<b>Totals</b>	<b>36:21:15</b>	<b>26:27:04</b>	<b>:00:00</b>	<b>1:34:40</b>	<b>:00:00</b>	<b>:00:00</b>	<b>8:17:28</b>	<b>:00:12</b>	<b>5718</b>	<b>0</b>	<b>0</b>
8/9/99	12:25:41	4:43:01	:00:00	:24:32	:00:00	:00:00	7:16:25	:00:08	1743	0	0
8/16/99	23:55:34	21:44:03	:00:00	1:10:08	:00:00	:00:00	1:01:03	:00:04	3975	0	0

**Agent Attendance report description** The following table describes the report fields:

Field	Description	Database Item, Calculation, or <Calculation name>
Agent Name:	The name or login ID of the agent. You can make this selection in the report input window.	syn(LOGID)
ACD:	The ACD name or number for which the data was collected.	syn(ACD)
Date, Week, or Month Starting	The day, week, or month for which the report ran. You can make these selections in the report input window.	ROW_DATE
Staffed Time	The total time that the agent was logged in (staffed) for the specified time period in any split/skill. (This does not include time that the link was down.)	sum(TI_STAFFTIME)
ACD Time	The total time that the agent spent on all split/skill and direct agent ACD calls for the specified time period in any split/skill.	sum(I_DA_ACDDTIME), sum(<TOTAL_I_ACDDTIME>)
ACW Time	The total time that the agent spent in ACW for the specified time period in any split/skill for ACD calls and direct agent calls as well as time in ACW not associated with a call. Time on extension calls is also included.	sum(I_DA_ACWTIME), sum(<TOTAL_I_ACWTIME>)
Agent Ring Time	The total time during the collection interval that the agent had split/skill and direct agent ACD calls ringing. If the agent answers or makes another call instead of answering the ringing call, I_RINGTIME stops accumulating. RINGTIME is the time that the caller spends ringing and is independent of agent activity. Time ringing is only tracked for Generic 3 and <i>DEFINITY</i> ECS switches.	sum(I_RINGTIME)
Extn In Time	The total time that the agent spent talking on inbound extension calls for the specified time period.	sum(I_ACWINTIME + I_AUXINTIME), sum(<EXT_IN_TIME>)
Extn Out Time	The total time that the agent spent talking on outbound extension calls for the specified time period.	sum(I_ACWOUTTIME + I_AUXOUTTIME), sum <EXT_OUT_TIME>
Avail Time	The total time for the specified time period that the agent was available to take ACD calls in any split/skill.	sum(TI_AVAILTIME)



Field	Description	Database Item, Calculation, or <Calculation name>
AUX Time	The total time that the agent spent in AUX work in all splits/skills and on AUXIN/AUXOUT calls for the specified time period.	sum(TI_AUXTIME)
ACD Calls	The total number of split/skill and direct agent ACD calls answered by the agent.	sum(ACDCALLS + DA_ACDCALLS), sum(<TOTAL_ACDCALLS>)
Extn In Calls	<p>The number of inbound extension calls completed by the agent during the period covered. This includes calls received while the agent was in the following work modes:</p> <ul style="list-style-type: none"> <li>• Auto-In or Manual-In</li> <li>• ACW mode for ACD calls</li> <li>• ACW mode that was not associated with a call</li> <li>• AUX work mode.</li> </ul>	sum(ACWINCALLS + AUXINCALLS) and sum(<EXT_CALL_IN>)
Extn Out Calls	<p>The number of outbound extension calls that were completed by the agent during the period covered. This includes calls originated by the agent while the agent was in the following work modes:</p> <ul style="list-style-type: none"> <li>• Auto-In or Manual-In</li> <li>• ACW mode for ACD calls</li> <li>• ACW mode that was not associated with a call</li> <li>• AUX work mode.</li> </ul>	sum(ACWOUTCALLS) + sum(AUXOUTCALLS), <EXT_CALL_OUT>, sum <EXT_CALL_OUT>



# Agent Event Count Report

**Overview** The Agent Event Count report shows the total number of times that an individual agent pressed an Event Count (sometimes referred to as Stroke Count) key for all splits/skills. An Event Count key can represent any call event, including a successful sale, a call from a demographic category, or a response to a promotion. *CentreVu* CMS records an event occurrence each time that an agent presses an Event Count key on his or her voice terminal while the agent is on an ACD call or in call-related ACW. This feature's operations is dependent on Stroke Count administration on the switch.

- Things to know about this report** Here are some things you need to know about this report:
- This report is available with *DEFINITY* ECS Generic 3 switches only.
  - The Event Count report is available in interval, daily, weekly, and monthly versions.
  - The database items for the Agent Event Count report are stored in the **hagent** (interval), **dagent** (daily), **wagent** and **magent** (monthly) tables.
  - This report uses the Agent Report Input Window. Select an agent who you want to view on the report. See [Agent Report Input Fields \(4-7\)](#) for more information.

**Agent Event Count report example** The following figure provides an example of an Agent Event Count report.

Agent: Georgia Gillian										
Date	ACD Calls	Event 1	Event 2	Event 3	Event 4	Event 5	Event 6	Event 7	Event 8	Event 9
<b>Totals</b>	<b>5718</b>	<b>0</b>	<b>0</b>	<b>0</b>	<b>0</b>	<b>0</b>	<b>0</b>	<b>0</b>	<b>0</b>	<b>0</b>
8/9/99	1743	0	0	0	0	0	0	0	0	0
8/16/99	3975	0	0	0	0	0	0	0	0	0

Double Click To Run Format Table ST10

**Agent Event Count report description** The following table describes the report fields:

Field	Description	Database Item, Calculation, or <Calculation name>
Date, Week Starting, or Month Starting	The day, week, or month for which the report ran. You can make these selections in the report input window.	ROW_DATE
Agent Name	The name or login ID of the agent. You can make this selection in the report input window.	syn(LOGID)
ACD	The ACD name or number for which the data was collected.	syn(ACD)
Time (interval reports only)	The intrahour intervals for which the report shows data. You can make these selections in the report input window. NOTE: This is the interval for which counts were summed.	STARTTIME, STARTTIME + INTRVL
ACD Calls	The number of split/skill and direct agent ACD calls that were answered by this agent during the specified time period.	ACDCALLS + DA_ACDCALLS), sum(<TOTAL_ACDCALLS>)
Event Count 1...9	The number of key presses of the various Event Count keys by this agent during the specified time period.	sum(EVENT1)...sum(EVENT9)



---

# Agent Graphical Time Spent Daily Report

---

**Overview** This report shows historical information and statistics for the specified agent.

- Things to know about this report** Here are some things you need to know about this report:
- This report is available in daily version only.
  - This report is available for all switch releases. The contents of this report depends upon the switch release for which it is being run.
  - The database items for the Agent Graphical Time Spent Daily report are stored in the `cagent` (daily) table.
  - Call center supervisors can use this report to get an idea of how much time an agent spent on ACD calls, in available state, in ACW, in AUX, and so on, for a particular day. This report enables the supervisor to tell how much time the agent spent in AUX work state for each of the reason codes defined for this Call Center.
  - The following example of this report shows the information it will contain for the *DEFINITY* ECS Release 6 switch with EAS.
  - This report is available only through the *CentreVu* Supervisor interface.
  - This report uses the Agent Report Input Window. Select an agent who you want to view on the report. See [Agent Report Input Fields \(4-7\)](#) for more information.

**Agent Graphical Time Spent Daily report example**

The following figure provides an example of an Agent Graphical Time Spent report.



**Agent Graphical Time Spent Daily report description**

The following table describes the report fields:

Field	Description	Database Item, Calculation, or <Calculation name>
Agent:	The name (or agent login ID if the names have not been assigned in Dictionary) of the agent.	syn(LOGID)
Date:	The day for which the report was run (selected in the report input window).	ROW_DATE
AVAIL	The time during the collection interval that the agent was in the available state for split/skill or direct agent ACD calls in any split/skill.	sum(TI_AVAILTIME)
ACD	The time during the collection interval that the agent was talking on ACD calls for the SPLIT.	sum (<TOTAL_I_ACDTIME>)

Field	Description	Database Item, Calculation, or <Calculation name>
ACW	The time during the collection interval that the agent was in after call work (ACW). This includes ACW for split/skill ACD calls and ACW not associated with the call.	sum(<TOTAL_I_ACWTIME>)
AUX	The time during the collection interval that the agent was in the AUX work state in all splits/skills or on AUXINCALLS or AUXOUTCALLS.	sum(TI_AUXTIME)
RINGING	The time during the collection interval that the agent had split/skill and direct agent ACD calls ringing.	sum(I_RINGTIME)
Reason Code 0	The time that the agent spent in AUX with reason code 0. This is the time in "system" AUX for the switches using AUX reason codes. It is the same as TI_AUXTIME for switches not using AUX reason codes. The "TI_" stands for the time that is stored only for the split or skill that the agent is logged into for the longest amount of time. "TI_" time needs to be summed across the skills the agents may log into, in case the login order changes during the collection interval.	sum(TI_AUXTIME)
Reason Codes 1-9	The time that the agent spent in AUX with each of the reason codes 1-9. The "TI_" stands for the time that is stored only for the split or skill that the agent is logged into for the longest amount of time. "TI_" time needs to be summed across the skills the agents may log into, in case the login order changes during the collection interval.	sum(TI_AUXTIME1-9)

Field	Description	Database Item, Calculation, or <Calculation name>
OTHER	<p>The time during the collection interval that the agent was doing other work in all splits/skills. For Generic 3 switches, while in Auto-in or Man-In: the agent put any call on hold and performed no further action, the agent dialed to place a call or to activate a feature, or an extension call rang with no other activity. For all switches, TI_OTHERTIME is collected for the time period after the line to the switch comes up or after the agent logs in and before the CMS receives notification of the agent's state from the switch. The TI_ stands for the time that is stored only for the split/skill that the agent is logged into for the longest amount of time. TI_ time needs to be summed across the splits/skills the agents may log into, in case the logon order changes during the collection interval.</p>	sum(TI_OTHERTIME)



# Agent Group Attendance Report

**Overview** The Agent Group Attendance report summarizes staffed time, ACD time, ACW time, AUX time, time in the ringing state, extension time, available time, and number of calls handled for each agent in an agent group for the specified time period.

**Things to know about this report** Here are some things you need to know about this report:

- The Agent Group Attendance report is available in daily, weekly, and monthly versions.
- The database items for the Agent Group Attendance report are stored in the **dagent** (daily), **wagent** (weekly), and **magent** (monthly) tables.
- The Totals column in the report(s) displays the totals for all agents in the group you have selected. Individual agent entries in this report show the totals for a particular agent.
- This report uses the Agent Report Input Window. Select an agent who you want to view on the report. See [Agent Report Input Fields \(4-7\)](#) for more information.

**Agent Group Attendance report example** The following figure provides an example of an Agent Group Attendance report.

Agent Name	Login ID	Staffed Time	ACD Time	ACW Time	Agent Ring Time	Extn In Time	Extn Out Time	Avail Time	AUX Time	ACD Calls	Extn In Calls	Extn Out Calls
<b>Totals</b>		<b>384:00:00</b>	<b>192:15:46</b>	<b>:00:00</b>	<b>22:12:07</b>	<b>:00:00</b>	<b>:00:00</b>	<b>169:30:52</b>	<b>:00:00</b>	<b>31305</b>	<b>0</b>	<b>0</b>
29730	29730	24:00:00	:00:00	:00:00	:00:00	:00:00	:00:00	24:00:00	:00:00	0	0	0
29731	29731	24:00:00	:00:00	:00:00	:00:00	:00:00	:00:00	24:00:00	:00:00	0	0	0
Joseph Rich	29732	24:00:00	21:40:18	:00:00	1:12:15	:00:00	:00:00	1:07:19	:00:00	3541	0	0
Georgia Gillian	29733	24:00:00	21:43:31	:00:00	1:12:29	:00:00	:00:00	1:03:44	:00:00	3573	0	0
29734	29734	24:00:00	:00:00	:00:00	:00:00	:00:00	:00:00	24:00:00	:00:00	0	0	0
Sandy Minner	29735	24:00:00	21:34:19	:00:00	1:15:00	:00:00	:00:00	1:10:30	:00:00	3496	0	0
Gregory Jones	29736	24:00:00	21:31:05	:00:00	1:17:00	:00:00	:00:00	1:11:45	:00:00	3498	0	0
Michael Mansfield	29737	24:00:00	2:51:48	:00:00	:04:18	:00:00	:00:00	21:03:54	:00:00	544	0	0
29739	29739	24:00:00	2:47:41	:00:00	:04:24	:00:00	:00:00	21:07:54	:00:00	533	0	0
Jennifer Davis	29741	24:00:00	19:26:05	:00:00	3:25:54	:00:00	:00:00	1:07:54	:00:00	3088	0	0
29743	29743	24:00:00	19:30:46	:00:00	3:20:29	:00:00	:00:00	1:08:37	:00:00	3109	0	0
29745	29745	24:00:00	:00:00	:00:00	:00:00	:00:00	:00:00	24:00:00	:00:00	0	0	0
Harold Edwards	29746	24:00:00	19:24:12	:00:00	3:25:19	:00:00	:00:00	1:10:25	:00:00	3108	0	0
McKee Ellen	29747	24:00:00	19:27:06	:00:00	3:25:45	:00:00	:00:00	1:07:06	:00:00	3151	0	0
Ordendahl Anna	29748	24:00:00	2:49:53	:00:00	:04:26	:00:00	:00:00	21:05:40	:00:00	539	0	0



**Agent Group Attendance report description** The following table describes the report fields:

Field	Description	Database Item, Calculation, or <Calculation name>
Date, Week Starting, or Month Starting	The day, week, or month for which the report ran. You can make these selections in the report input window.	ROW_DATE
Agent Group	The name of the group of agents. You can make this selection in the report input window.	No database item or calculation.
ACD	The ACD name or number for which the data was collected.	syn(ACD)
Agent Name	The name or login ID of the agent.	syn(LOGID)
Login ID	The login ID assigned to each agent.	LOGID
Agent	The name or login ID of the agent.	LOGID
Staffed Time	The total time that the agents were logged in (staffed) for the specified time period in any split/skill. This does not include time the link was down.	sum(TI_STAFFTIME)
ACD Time	The total time that the agents in the group talked on all split/skill and direct agent ACD calls for the specified time period.	I_ACDTIME + I_DA_ACDTIME), sum(<TOTAL_I_ACDTIME>)
Agent Ring Time	The total time during the collection interval that agents had split/skill and direct agent ACD calls ringing. If the agent answers or makes another call instead of answering the ringing call, I_RINGTIME stops accumulating. RINGTIME is the time that the caller spends ringing and is independent of agent activity.	sum(I_RINGTIME)
Extn In Time	The total time that the agents in the group spent talking on inbound extension calls for the specified time period.	I_ACWINTIME + I_AUXINTIME), sum(<EXT_IN_TIME>)
Extn Out Time	The total time that the agents spent talking on outbound extension calls for the specified time period.	I_ACWOUTTIME + I_AUXOUTTIME), sum(<EXT_OUT_TIME>)
Avail Time	The total time that the agents were available to take ACD calls for any split/skill during the specified time period.	sum(TI_AVAILTIME)
AUX Time	The total time that the agents spent in AUX work in all splits/skills or on AUXIN/AUXOUT calls for the specified time period.	sum(TI_AUXTIME)

Field	Description	Database Item, Calculation, or <Calculation name>
ACD Calls	The total number of split/skill and direct agent ACD calls answered by the agents in this group that completed during the specified time period.	sum(ACDCALLS + DA_ACDCALLS), sum(<TOTAL_ACDCALLS>)
Extn In Calls	The number of inbound extension calls that were completed by the agent during the period covered. This includes calls received while the agent was in the following work modes: <ul style="list-style-type: none"> <li>• Auto-In or Manual-In</li> <li>• ACW mode for ACD calls</li> <li>• ACW mode that was not associated with a call</li> <li>• AUX work mode.</li> </ul>	sum(ACWINCALLS + <EXT_CALL_IN>)
Extn Out Calls	The number of outbound extension calls that were placed by the agent during the period covered. This includes calls originated by the agent while the agent was in the following work modes: <ul style="list-style-type: none"> <li>• Auto-In or Manual-In</li> <li>• ACW mode for ACD calls</li> <li>• ACW mode that was not associated with a call</li> <li>• AUX work mode.</li> </ul>	sum(ACWOUTCALLS + AUXOUTCALLS) sum(<EXT_CALL_OUT>)





**Agent Group AUX report description** The following table describes the report fields:

Field	Description	Database Item, Calculation, or <Calculation name>
Date, Week Starting, or Month Starting	The day, week, or month for which the report ran. You can make these selections in the report input window.	ROW_DATE
Date:	The day for which the report was run (selected in the report input window).	ROW_DATE
Agent Group	The name of the group of agents. You can make this selection in the report input window.	No database item or calculation.
ACD	The ACD name or number for which the data was collected.	syn(ACD)
Agent	The name or login ID of the agent.	syn(LOGID)
Login ID	The name or login ID of the agent.	LOGID
Staffed Time	The total time that the agents were logged in (staffed) for the specified time period in any split/skill. This does not include time the link was down.	sum(TI_STAFFTIME)
AUX Time	The total time that the agents spent in AUX work in all splits/skills for the specified time period.	sum(TI_AUXTIME)
Time in 0	The time that the agent spent in AUX with the reason code of 0 (zero). This is the time in the "system" AUX for the switches using AUX reason codes. It is the same as TI_AUXTIME for switches not using AUX reason codes.	sum(TI_AUXTIME0)
Time in 1...9	The time that the agent spent in AUX with each of the reason codes 1-9.	sum(TI_AUXTIME1)... sum(TI_AUXTIME9)



# Agent Group Summary Report

**Overview** The Agent Group Summary report summarizes the daily activities of every agent within a specific group. Agents in a group may share common characteristics, such as being newly hired or top performers, or they may simply be part of a more manageable subdivision of a skill. You can use this report to compare individuals within a group. This report lists the totals for each agent in the group summed over all splits/skills that the agent was logged into during the time period covered in the report. This report also contains information on the overall occupancy of the selected agent group, expressed as a percentage, both with and without ACW included.

- Things to know about this report** Here are some things you need to know about this report:
- The Agent Group Summary report is available in daily, weekly, and monthly versions.
  - The database items for the Agent Group Summary report are stored in the **dagent** (daily), **wagent** (weekly), and **magent** (monthly) tables.
  - This report uses the Agent Report Input Window. Select an agent who you want to view on the report. See [Agent Report Input Fields \(4-7\)](#) for more information.

**Agent Group Summary report example** The following figure provides an example of an Agent Group Summary report.

Agent Name	ACD Calls	Avg ACD Time	Avg ACW Time	% Agent w/ ACW	% Agent w/o ACW	Extn In Calls	Avg Extn In Time	Extn Out Calls	Avg Extn Out Time	ACD Time	ACW Time	Agent Ring Time	Other Time	AUX Time	Avail Time	Staffed Time
<b>Totals</b>	<b>31305</b>	<b>:22</b>	<b>:00</b>	<b>56</b>	<b>56</b>	<b>0</b>	<b>0</b>	<b>0</b>	<b>0</b>	<b>*****</b>	<b>:00:00</b>	<b>22:12:07</b>	<b>:01:15</b>	<b>:00:00</b>	<b>*****</b>	<b>*****</b>
29730	0			0	0	0	0	0	0	:00:00	:00:00	:00:00	:00:00	:00:00	:00:00	*****
29731	0			0	0	0	0	0	0	:00:00	:00:00	:00:00	:00:00	:00:00	:00:00	*****
Joseph Rich	3541	:22	:00	95	95	0	0	0	0	*****	:00:00	1:12:15	:00:08	:00:00	1:07:19	*****
Georgia Gillian	3573	:22	:00	96	96	0	0	0	0	*****	:00:00	1:12:29	:00:16	:00:00	1:03:44	*****
29734	0			0	0	0	0	0	0	:00:00	:00:00	:00:00	:00:00	:00:00	:00:00	*****
Sandy Minner	3496	:22	:00	95	95	0	0	0	0	*****	:00:00	1:15:00	:00:11	:00:00	1:10:30	*****
Gregory Jones	3498	:22	:00	95	95	0	0	0	0	*****	:00:00	1:17:00	:00:10	:00:00	1:11:45	*****
Micheal Mansfield	544	:19	:00	12	12	0	0	0	0	2:51:48	:00:00	:04:18	:00:00	:00:00	*****	*****
29739	533	:19	:00	12	12	0	0	0	0	2:47:41	:00:00	:04:24	:00:01	:00:00	*****	*****
Jennifer Davis	3088	:23	:00	95	95	0	0	0	0	*****	:00:00	3:25:54	:00:07	:00:00	1:07:54	*****
29743	3109	:23	:00	95	95	0	0	0	0	*****	:00:00	3:20:29	:00:08	:00:00	1:08:37	*****
29745	0			0	0	0	0	0	0	:00:00	:00:00	:00:00	:00:00	:00:00	:00:00	*****
Harold Edwards	3108	:22	:00	95	95	0	0	0	0	*****	:00:00	3:25:19	:00:04	:00:00	1:10:25	*****
McKee Ellen	3151	:22	:00	95	95	0	0	0	0	*****	:00:00	3:25:45	:00:03	:00:00	1:07:06	*****
Odendahl Anna	539	:19	:00	12	12	0	0	0	0	2:49:53	:00:00	:04:26	:00:01	:00:00	*****	*****
Glen Keith	3125	:22	:00	95	95	0	0	0	0	*****	:00:00	3:24:48	:00:06	:00:00	1:06:04	*****

**Agent Group Summary report description** The following table describes the report fields.

Report Heading	Description	Database Item, Calculation, or <Calculation Name>
Date, Week Starting, or Month Starting	The day, week, or month that the report was run (selected in the report input window).	ROW_DATE
Agent Group	The name of the group of agents. You can make this selection in the report input window.	No database item or calculation.
ACD	The ACD name or number for which the data was collected.	syn(ACD)
Agent Name	The name or login ID of the agent.	syn(LOGID)
ACD Calls	The number of split/skill and direct agent ACD calls that were answered by the agent that completed during the interval. This total also includes O_ACDCALLS if you have the Outgoing Call Management application of ASAI. (O_ACDCALLS is the number of ACDCALLS that were placed by an adjunct [predictive dialing].)	sum( ACDCALLS + DA_ACDCALLS), sum<TOTAL_ACDCALLS>
Avg ACD Time	The average time that the agent spent talking on ACD calls (including direct agent calls) that completed during the period covered.	sum( TOTAL_ACDDTIME)/ sum (TOTAL_ACDCALLS), <AVG_AGENT_TALK_SUM>
Avg ACW Time	The average time that the agent spent in ACW for ACD calls during the period covered. This includes direct agent call activities.	sum( TOTAL_ACWTIME)/ sum (TOTAL_ACDCALLS), <AVG_AGENT_ACW_SUM>
% Agent Occup w/ACW	The overall occupancy of the selected agent group, expressed as a percent, and including the group's time in after call work.	100 * (sum(I_RINGTIME + I_ACDDTIME + I_ACDDOTHERTIME + I_ACD_AUXOUTTIME + I_ACDAUXINTIME + I_ACWTIME) / (sum(TI_STAFFTIME – TI_AUXTIME + I_ACDAUX_OUTTIME + I_ACDAUXINTIME)

Report Heading	Description	Database Item, Calculation, or <Calculation Name>
% Agent Occup w/o ACW	The overall occupancy of the selected agent group, expressed as a percent, not including the group's time in after call work.	100 * (sum(I_RINGTIME + I_ACDTIME + I_ACDOTHERTIME + I_ACD_AUXOUTTIME + I_ACDAUXINTIME) / (sum(TI_STAFFTIME - TI_AUXTIME + I_ACDAUX_OUTTIME + I_ACDAUXINTIME))
Extn In Calls	<p>The number of inbound extension calls that were completed by the agent during the period covered.</p> <p>This includes calls received while the agent was in the following work modes:</p> <ul style="list-style-type: none"> <li>• Auto-In or Manual-In</li> <li>• ACW mode for ACD calls</li> <li>• ACW mode that was not associated with a call</li> <li>• AUX work mode.</li> </ul>	sum(ACWINCALLS + AUXINCALLS), sum<EXT_CALL_IN>
Avg Extn In Time	The average time of the agent's inbound extension calls.	sum( ACWINTIME+ AUXINTIME)/ sum( ACWINCALLS + AUXINCALLS), <AVG_TALK_TIME_IN_SUM>
Extn Out Calls	<p>The number of outbound extension calls that were completed by the agent during the period covered.</p> <p>This includes calls originated by the agent while the agent was in the following work modes:</p> <ul style="list-style-type: none"> <li>• Auto-In or Manual-In</li> <li>• ACW mode for ACD calls</li> <li>• ACW mode that was not associated with a call</li> <li>• AUX work mode.</li> </ul>	sum( ACWOUTCALLS + AUXOUTCALLS), sum<EXT_CALL_OUT>
Avg Extn Out Time	The average length of the agent's outbound extension calls.	sum( ACWOUTTIME+ AUXOUTTIME) / sum (ACWOUTCALLS + AUXOUTCALLS), <AVG_TALK_TIM_OUT_SUM>

Report Heading	Description	Database Item, Calculation, or <Calculation Name>
ACD Time	The total time that the agent spent talking on all ACD calls during the time period.	sum( I_ACDTIME + I_DA_ACDTIME), sum(<TOTAL_I_ACDTIME>)
ACW Time	The total time that the agent spent in ACW for split/skill and direct agent ACD calls, as well as time in ACW not associated with a call. Includes time on extension calls.	sum( I_ACWTIME + I_DA_ACWTIME) sum(<TOTAL_I_ACWTIME>)
Agent Ring Time	The total time that the agent spent with split/skill and direct agent ACD calls ringing. This only applies to <i>DEFINITY</i> ECS Generic 3 switches.	sum( I_RINGTIME)
Other Time	The time that the agent spent doing other work in all splits/skills.  For <i>DEFINITY</i> ECS Generic 3 switches, agents are doing other work while in Auto-in or Manual-In if they: <ul style="list-style-type: none"> <li>Put any call on hold while not doing any other activity.</li> <li>Dial to place a call or to activate a feature</li> <li>Have a personal call ringing with no other activity.</li> </ul> Agent positions show up as OTHER directly after the link to the switch comes up and directly after the agents log in before the <i>CentreVu</i> CMS is notified of the agent's work state.	sum(TI_OTHERTIME)
AUX Time	The total time that the agents spent in AUX work in all splits/skills or on AUXIN/AUXOUT calls for the specified time period.	sum( TI_AUXTIME)
Avail Time	The total time that the agent spent waiting for an ACD call in any split/skill.	sum( TI_AVAILTIME)
Staffed Time	The total time that the agents were logged in (staffed) for the specified time period in any split/skill. This does not include time the link was down.	sum( TI_STAFFTIME)



# Agent Inbound/Outbound Report

**Overview** The Agent Inbound/Outbound Call report is a detailed breakdown of the inbound and outbound calls handled by an agent. The report sums the total over all the splits or skills the agent was logged into for the specific period covered.

**Things to know about this report** Here are some things you need to know about this report:

- This report is available in interval, daily, weekly, and monthly versions.
- The database items for the Agent Inbound/Outbound report are stored in the **hagent** (interval), **dagent** (daily), **wagent** (weekly), and **magent** (monthly) tables.
- You must have the Outgoing Call Management application of ASAI for data to appear in the Outbound ACD columns.
- This report uses the Agent Report Input Window. Select an agent who you want to view on the report. See [Agent Report Input Fields \(4-7\)](#) for more information.

**Agent Inbound/Outbound report example** The following figure provides an example of an Agent Inbound/Outbound Report.

Date	Inbound ACD Calls	Avg Inbound ACD Time	Avg ACW (Inbound ACD) Time	Outbound ACD Calls	Avg Outbound ACD Time	Avg ACW (Outbound ACD) Time	Extn In Calls	Avg Extn In Time	Extn Out Calls	Avg Extn Out Time	External Extn Calls	Avg External Extn Out Time	Assists	Trans Out
<b>Totals</b>	<b>5718</b>	<b>:17</b>	<b>:00</b>	<b>0</b>			<b>0</b>		<b>0</b>		<b>0</b>		<b>0</b>	<b>0</b>
8/9/99	1743	:10	:00	0			0		0		0		0	0
8/16/99	3975	:20	:00	0			0		0		0		0	0

**Agent Inbound/  
Outbound report  
description** The following table describes the report fields.

Report Heading	Description	Database Item, Calculation, or <Calculation Name>
Agent	The name or login ID of the agent. You can make this selection in the report input window.	syn(LOGID)
ACD	The ACD name or number for which the data was collected.	sum(ACD)
Time (interval reports only)	The intrahour intervals for which the report shows data. You can make these selections in the report input window.	STARTTIME, STARTTIME + INTRVL
Date, Week Starting, or Month Starting	The day, week, or month for which the report ran. You can make these selections in the report input window.	ROW_DATE
Inbound ACD Calls	The total number of all inbound ACD calls answered by this agent that completed during the specified time period.	(sum( ACDCALLS + DA_ACDCALLS - O_ACDCALLS)), <INBOUND_ACDCALLS>
Avg Inbound ACD Time	The average length of all inbound ACD calls answered by this agent that completed during the specified time period.	sum( ACDDTIME+ DA_ACDDTIME- O_ACDDTIME)/ sum( ACDCALLS+ DA_ACDCALLS- O_ACDCALLS)
Avg ACW Time (Inbound ACD)	The average length of all ACW sessions by this agent for inbound ACD calls completed during the specified time period. This includes direct agent call activities.	sum( ACWTIME + DA_ACWTIME - O_ACWTIME)/ sum( ACDCALLS+ DA_ACDCALLS- OACDCALLS)
Outbound ACD Calls	The total number of all outbound ACD calls for this agent that completed during the specified time period.	sum( O_ACDCALLS)
Avg Outbound ACD Time	The average length of all outbound ACD calls for this agent that completed during the specified time period.	sum( O_ACDDTIME) / sum( O_ACDCALLS)
Avg ACW Time (Outbound ACD)	The average length of all ACW sessions by this agent for outbound ACD calls that completed during the specified time period. This includes direct agent call activities.	sum( O_ACWTIME) / sum( O_ACDCALLS)

Report Heading	Description	Database Item, Calculation, or <Calculation Name>
Extn In Calls	<p>The number of inbound extension calls that were completed by the agent during the period covered.</p> <p>This includes calls received while the agent was in the following work modes:</p> <ul style="list-style-type: none"> <li>• Auto-In or Manual-In</li> <li>• ACW mode for ACD calls</li> <li>• ACW mode that was not associated with a call</li> <li>• AUX work mode.</li> </ul>	$\text{sum( ACWINCALLS + AUXINCALLS),}$ $\text{sum<EXT_CALL_IN>}$
Avg Extn In Time	<p>The average length of this agent's inbound extension calls.</p>	$\text{sum(( ACWINTIME + AUXINTIME) / sum( ACWINCALLS + AUXINCALLS))}$
Extn Out Calls	<p>The number of outbound extension calls that were completed by the agent during the period covered.</p> <p>This includes calls originated by the agent while the agent was in the following work modes:</p> <ul style="list-style-type: none"> <li>• Auto-In or Manual-In</li> <li>• ACW mode for ACD calls</li> <li>• ACW mode that was not associated with a call</li> <li>• AUX work mode.</li> </ul>	$\text{sum( ACWOUTCALLS + AUXOUTCALLS),}$ $\text{sum<EXT_CALL_OUT>}$
Avg Extn Out Time	<p>The average length of this agent's outbound extension calls.</p>	$\text{sum( ACWOUTTIME + AUXOUTTIME) / sum( ACWOUTCALLS + AUXOUTCALLS)}$
External Calls Extn Out	<p>The number of outbound extension calls that were made by this agent to a location outside the switch during ACW sessions and AUX work. (Does not include DA_ACWOFFCALLS.)</p>	$\text{sum( ACWOUTOFFCALLS + AUXOUTOFFCALLS)}$
Avg External Extn Out Time	<p>The average length of this agent's calls to a location outside the switch during ACW sessions or AUX work.</p>	$\text{sum( ACWOUTOFFTIME + AUXOUTOFFTIME) / sum( ACWOUTOFFCALLS + AUXOUTOFFCALLS)}$

Report Heading	Description	Database Item, Calculation, or <Calculation Name>
Assists	The number of calls that were referred to the supervisor by this agent during the specified time period.	sum( ASSISTS)
Trans Out	The number of calls that were transferred by this agent to another destination during the specified time period (for Generic 3, any call transferred).	sum( TRANSFERRED)



---

## Agent Login/Logout (Skill) Report

---

**Overview** The Agent Login/Logout (Skill) report shows the times that agents in a given skill logged in and logged out, the reason codes associated with the logout (if there is one), and the skills with which the agents logged in and out.

**Things to know about this report** If you have the *DEFINITY* ECS with EAS feature activated, you will see the report displayed in this section. Here are some things to know about this report:

- This new report provides logout reason codes.
- This new report shows up to 15 skills.
- This new report can be customized to show more or fewer skills and to add the skill levels directly on the CMS server.
- If you have a switch release earlier than *DEFINITY* ECS with EAS feature activated, a different Agent Login/Logout (Skill) report than the one described in this section is displayed. This report does not show the logout reason codes.
- The Login/Logout (Skill) report is available in daily version only.
- The database items for the Agent Group Summary report are stored in the `hagLog` table.
- This report uses the Agent Report Input Window. Select an agent who you want to view on the report. See [Agent Report Input Fields \(4-7\)](#) for more information.

**Agent Login/Logout (Skill) report example**

The following figure provides an example of an Agent Login/Logout (Skill) Report.

Agent Name	Extn	Login Time	Logout Time	Logout Date	Logout Reason	Skill 1	Skill 2	Skill 3	Skill 4	Skill 5	Skill 6	Skill 7
44461	42151	7:10AM	4:10PM	2/19/98	IO	510	511	512	513	515		
44462	42152	7:10AM	4:12PM	2/19/98	IO	510	511	512	513	515		
44463	42153	7:10AM	4:00PM	2/19/98	IO	510	511	512	513	515		
44464	42154	7:10AM	4:15PM	2/19/98	IO	510	511	512	513	515		
44465	42155	7:10AM	4:10PM	2/19/98	IO	510	511	512	513	515		
44466	42156	7:10AM	4:30PM	2/19/98	IO	510	511	512	513	515		
44467	42157	7:10AM	4:12PM	2/19/98	IO	510	511	512	513	515		
44468	42158	7:10AM	4:15PM	2/19/98	IO	510	511	512	513	515		
44471	42161	7:10AM	4:00PM	2/19/98	IO	511	512	513	514	515		
44472	42162	7:10AM	4:28PM	2/19/98	IO	511	512	513	514	515		
44473	42163	7:10AM	4:20PM	2/19/98	IO	511	512	513	514	515		
44474	42164	7:10AM	4:15PM	2/19/98	IO	511	512	513	514	515		
44475	42165	7:10AM	4:10PM	2/19/98	IO	511	512	513	514	515		
44476	42166	7:10AM	4:12PM	2/19/98	IO	511	512	513	514	515		
44477	42167	7:10AM	4:30PM	2/19/98	IO	511	512	513	514	515		
44478	42168	7:10AM	4:15PM	2/19/98	IO	511	512	513	514	515		

**Agent Login/Logout (Skill) report description**

The following table describes the report fields.

Report Heading	Description	Database Item, Calculation, or <Calculation Name>
Date	The date for which the report was run. The report shows data for agents who logged in on this date.	ROW_DATE
Skill	The name or number of the skill (selected in the report input window).	syn(SPLIT)
Extn	The extension where the agent logged in.	EXTN
Login Time	The time that the agent logged in with the given set of skills.	LOGIN
Logout Time	The time that the agent logged out or was logged out from the given set of skills.	LOGOUT
Logout Date	The date that the agent logged out from the given set of skills.	LOGOUT_DATE
Logout Reason	The reason for logging out.	LOGOUTREASON
Skills 1–15	The first 15 skills with which the agent logged in.	SPLIT, LOGONSKILL2-15



## Agent Login/Logout (Split) Report

**Overview** The Agent Split Login/Logout report shows the agent login and logout times for agents in a split on a specified day.

**Things to know about this report** Here are some things to know about this report:

- This report is available in the daily version only.
- The database items for the Agent Login/Logout (Split) report are stored in the haglog table.
- This report appears for *DEFINITY* ECS Generic 3 switches without EAS.
- This report accepts split numbers from 1-600 when the switch type is *DEFINITY* ECS or later.
- This report uses the Agent Report Input Window. Select an agent who you want to view on the report. See [Agent Report Input Fields \(4-7\)](#) for more information.

**Agent Login/Logout (Split) report example** The following figure provides an example of an Agent Login/Logout (Split) Report.

The screenshot shows a window titled "Agent Split Login/Logout - s1" with a menu bar (Report, Edit, Format, Tools, Options, Help). The report content includes the date "Date: 2/19/98" and split "Split: s1". Below this is a table with the following columns: Agent Name, Extn, Login Time, Logout Time, and Logout Date. The table lists 18 agents with their respective extension numbers, login times (all at 7:10AM), and logout times and dates (all on 2/19/98). At the bottom of the window, there is a status bar with the text "Double Click To Run Format Table" and the user name "Jaeger1G32".

Agent Name	Extn	Login Time	Logout Time	Logout Date
44461	42151	7:10AM	4:10PM	2/19/98
44462	42152	7:10AM	4:12PM	2/19/98
44463	42153	7:10AM	4:00PM	2/19/98
44464	42154	7:10AM	4:15PM	2/19/98
44465	42155	7:10AM	4:10PM	2/19/98
44466	42156	7:10AM	4:30PM	2/19/98
44467	42157	7:10AM	4:12PM	2/19/98
44468	42158	7:10AM	4:15PM	2/19/98
44471	42161	7:10AM	4:00PM	2/19/98
44472	42162	7:10AM	4:28PM	2/19/98
44473	42163	7:10AM	4:20PM	2/19/98
44474	42164	7:10AM	4:15PM	2/19/98
44475	42165	7:10AM	4:10PM	2/19/98
44476	42166	7:10AM	4:12PM	2/19/98
44477	42167	7:10AM	4:30PM	2/19/98
44478	42168	7:10AM	4:15PM	2/19/98

**Agent Login/Logout (Split) report description** The following table describes the report fields:

Field	Description	Database Item, Calculation, or <Calculation name>
Date:	The day for which the report shows data. You can make these selections in the report input window.	ROW_DATE
Split:	The name or number of the split (selected in the report input window).	syn(SPLIT)
ACD	The ACD name or number for which the data was collected.	syn(ACD)
Agent Name	The name or login ID of the agent.	syn(LOGID)
Extn	The measured extension where the agent logged in.	EXTN
Login Time	The time that the agent logged into this split.	LOGIN
Logout Time	The time that the agent logged out of this split.	LOGOUT
Logout Date	The date that the agent logged out of this split.	LOGOUT_DATE





# Agent Split/Skill Report

**Overview** The Agent Split/Skill report shows an individual agent's performance by split or skill.

**Things to know about this report** Here are some things to know about this report:

- The Agent Split/Skill report is available in interval, daily, weekly, and monthly versions.
- The database items for the Agent Split/Skill Report are stored in the **hagent** (interval), **dagent** (daily), **wagent** (weekly), and **magent** (monthly) tables.
- Each row in the report shows the total for the specified time for a particular split/skill the agent was logged into. However, the **Totals**:row shows the totals over the day for all splits or skills for this agent.
- Talk times are shown as totals, not as averages.
- This report uses the Agent Report Input Window. Select an agent who you want to view on the report. See [Agent Report Input Fields \(4-7\)](#) for more information.

**Agent Split/Skill report example** The following figure provides an example of an Agent Split/Skill Report.

Date	Split/Skill	ACD Calls	ACD Time	ACW Time	Extn In Calls	Extn In Time	Extn Out Calls	Extn Out Time	Assists	Held Calls	Hold Time	Trans Out
<b>Totals</b>		<b>5718</b>	<b>26:27:04</b>	<b>:00:00</b>	<b>0</b>	<b>:00:00</b>	<b>0</b>	<b>:00:00</b>	<b>0</b>	<b>0</b>	<b>:00:00</b>	<b>0</b>
8/9/99	6	248	:40:07	:00:00	0	:00:00	0	:00:00	0	0	:00:00	0
8/9/99	Total	0	:00:00	:00:00	0	:00:00	0	:00:00	0	0	:00:00	0
8/9/99	sp998	1495	4:02:54	:00:00	0	:00:00	0	:00:00	0	0	:00:00	0
8/16/99	Total	0	:00:00	:00:00	0	:00:00	0	:00:00	0	0	:00:00	0
8/16/99	sp998	3975	21:44:03	:00:00	0	:00:00	0	:00:00	0	0	:00:00	0

**Agent Split/Skill report description** The following table describes the report fields.

Report Heading	Description	Database Item, Calculation, or <Calculation Name>
Date, Week Starting, or Month Starting	The day, week, or month for which the report ran. You can make these selections in the report input window.	ROW_DATE
Agent	The name or login ID of the agent. You can make this selection in the report input window.	syn(LOGID)
ACD	The ACD name or number for which the data was collected.	syn(ACD)
Time (for interval reports only)	The intrahour intervals for which the report shows data. You can make these selections in the report input window.	STARTTIME, STARTTIME + INTRVL
Split/Skill	The name or number of the split(s)/skill(s) that the agent logged into during the specified time period and for which data are shown.	syn(SPLIT)
ACD Calls	The number of split/skill and direct agent ACD calls that were answered by the agent. This total also includes outbound ACD calls (O_ACDCALLS) if you have the Outgoing Call Management application on ASAI. (O_ACDCALLS is the number of ACDCALLS that were placed by an adjunct [predictive dialing].)	( ACDCALLS+ DA_ACDCALLS), <TOTAL ACDCALLS>
ACD Time	The total time an agent talked on split/skill and direct agent ACD calls for the split/skill.	( I_ACDCALLS* I_ACDCALLS+ I_DA_ACDTIME), <TOTAL I_ACDCALLS* I_ACDCALLS+ I_DA_ACDTIME>
ACW Time	The total time that the agent spent in ACW associated with split/skill and direct agent ACD calls and ACW not associated with a call during the report interval.	( I_ACWTIME + I_DA_ACWTIME), <TOTAL_ACWTIME>
Extn In Calls	The number of inbound extension calls that were completed by the agent during the period covered. This includes calls received while the agent was in the following work modes: <ul style="list-style-type: none"> <li>• Auto-In or Manual-In</li> <li>• ACW mode for ACD calls</li> <li>• ACW mode that was not associated with a call</li> <li>• AUX work mode.</li> </ul>	ACWINCALLS+ AUXINCALLS, <EXT_CALL_IN>

Report Heading	Description	Database Item, Calculation, or <Calculation Name>
Extn In Time	The total time that the agent spent talking on inbound extension calls during the report period.	I_ACWINTIME+ I_AUXINTIME, <EXT_IN_TIME>
Extn Out Calls	The number of outbound extension calls that were completed by the agent during the period covered. This includes calls originated by the agent while the agent was in the following work modes: <ul style="list-style-type: none"> <li>• Auto-In or Manual-In</li> <li>• ACW mode for ACD calls</li> <li>• ACW mode that was not associated with a call</li> <li>• AUX work mode.</li> </ul>	ACWOUTCALLS + AUXOUTCALLS, <EXT_CALL_OUT>
Extn Out Time	The total time that the agent spent on outbound extension calls during the report period.	I_ACWOUTTIME + I_AUXOUTTIME, <EXT_OUT_TIME>
Assists	The number of times that the split/skill supervisor was called by the agent who was on a split/skill or a direct agent ACD call or in call-related ACW.	ASSISTS
Held Calls	The number of calls that the agent placed on hold. For <i>DEFINITY</i> ECS Generic 3 switches, this is all calls the agent put on hold.	HOLDCALLS
Total Hold Time	The total time that calls were on hold for this agent. This includes all callers for Generic 3 switches.	HOLDTIME
Trans Out	The number of times that an agent completed a transfer (for <i>DEFINITY</i> ECS Generic 3 switches, any call transferred).	TRANSFERRED



# Agent Summary Report

**Overview** The Agent Summary report shows the activities and performance of an individual agent for all splits or skills of which the agent is a member. It represents the totals over the specified time period for all splits or skills the agent was logged into. This report also includes information on agent occupancy, expressed as a percentage of total work time, both with and without ACW.

- Things to know about this report** Here are some things to know about this report:
- The Agent Summary report is available in interval, daily, weekly, and monthly versions.
  - The database items for the Agent Summary report are stored in the **hagent** (interval), **dagent**(daily), **wagent** (weekly), and **magent** (monthly) tables.
  - This report uses the Agent Report Input Window. Select an agent who you want to view on the report. See [Agent Report Input Fields \(4-7\)](#) for more information.

**Agent Summary report example** The following figure provides an example of an Agent Summary Report.

ACD Calls	Avg ACD Time	Avg ACW Time	% Agent Occup w/ ACW	% Agent Occup w/o ACW	Extn In Calls	Avg Extn In Time	Extn Out Calls	Avg Extn Out Time	ACD Time	ACW Time	Agent Ring Time	Other Time	AUX Time	Avail Time	Staffed Time	Trans Out
<b>5718</b>	<b>:17</b>	<b>:00</b>	<b>77</b>	<b>77</b>	<b>0</b>		<b>0</b>		<b>26:27:04</b>	<b>:00:00</b>	<b>1:34:40</b>	<b>:01:51</b>	<b>:00:12</b>	<b>8:17:28</b>	<b>36:21:15</b>	<b>0</b>
1743	:10	:00	41	41	0		0		4:43:01	:00:00	:24:32	:01:35	:00:08	7:16:25	12:25:41	0
3975	:20	:00	96	96	0		0		21:44:03	:00:00	1:10:08	:00:16	:00:04	1:01:03	23:55:34	0

**Agent Summary report description** The following table describes the report fields:

Field	Description	Database Item, Calculation, or <Calculation name>
Date, Week Starting, or Month Starting	The day, week, or month for which the report ran. You can make these selections in the report input window.	ROW_DATE
Agent:	The name or login ID of the agent. You can make this selection in the report input window.	syn(LOGID)

Field	Description	Database Item, Calculation, or <Calculation name>
Time (for interval reports only)	The intrahour intervals for which the report shows data. You can make these selections in the report input window. The time displays in hh:mm:ss (hour/minute/second) format.	STARTTIME, STARTTIME + INTRVL
ACD Calls	The number of ACD calls and direct agent calls that were answered by the agent. This total also includes O_ACDCALLS if you have the Outgoing Call Management application of ASAI. (O_ACDCALLS is the number of ACDCALLS that were placed by an adjunct [predictive dialing].)	sum(ACDCALLS + DA_ACDCALLS), sum(<TOTAL_ACDCALLS>)
Avg ACD Time	The average length of this agent's ACD calls (including direct agent calls) during the period covered.	sum(TOTAL_ACDDTIME)/ sum(TOTAL_ACDCALLS), <AVG_AGENT_TALK_SUM>
Avg ACW Time	The average length of After Call Work (ACW) sessions for this agent. This includes direct agent call activities.	sum(TOTAL_ACWTIME)/ sum(TOTAL_ACDCALLS), <AVG_AGENT_ACW_SUM>
% Agent Occup w/ACW	The percentage of agent occupancy in which the agent's time in after call work is considered as work time.	100 * (sum(I_RINGTIME + I_ACDDTIME + I_ACDDOTHERTIME + I_ACDDAUX_OUTTIME + I_ACDDAUXINTIME + I_ACDDWTIME) / (sum(TI_STAFFTIME - TI_AUXTIME + I_ACDDAUX_OUTTIME + I_ACDDAUXINTIME)))
% Agent Occup w/o ACW	The percentage of agent occupancy in which the agent's time in after call work time is considered idle.	100 * (sum(I_RINGTIME + I_ACDDTIME + I_ACDDOTHERTIME + I_ACDDAUX_OUTTIME + I_ACDDAUXINTIME) / (sum(TI_STAFFTIME - TI_AUXTIME + I_ACDDAUX_OUTTIME + I_ACDDAUXINTIME)))

Field	Description	Database Item, Calculation, or <Calculation name>
Extn In Calls	The number of inbound extension calls that were completed by the agent during the period covered. This includes calls received while the agent was in the following work modes: <ul style="list-style-type: none"> <li>• Auto-In or Manual-In</li> <li>• ACW mode for ACD calls</li> <li>• ACW mode that was not associated with a call</li> <li>• AUX work mode.</li> </ul>	sum(ACWINCALLS + <EXT_CALL_IN>)
Avg Extn In Time	The average length of this agent's inbound extension calls.	sum(ACWINTIME + AUXINTIME)/ sum(ACWINCALLS + AUXINCALLS), <AVG_TALK_TIME_IN_SUM>
Extn Out Calls	The number of outbound extension calls that were placed by the agent during the period covered. This includes calls originated by the agent while the agent was in the following work modes: <ul style="list-style-type: none"> <li>• Auto-In or Manual-In</li> <li>• ACW mode for ACD calls</li> <li>• ACW mode that was not associated with a call</li> <li>• AUX work mode.</li> </ul>	sum(ACWOUTCALLS + AUXOUTCALLS) sum(<EXT_CALL_OUT>)
Avg Extn Out Time	The average length of this agent's outbound extension calls.	sum(ACWOUTTIME + AUXOUTTIME)/ sum(ACWOUTCALLS + AUXOUTCALLS), <AVG_TALK_TIME_OUT_SUM >
ACD Time	Time this agent spent on ACD calls (including direct agent calls) during the report interval.	sum(I_ACDTIME + I_DA_ACDTIME), sum(<TOTAL_I_ACDTIME>)
ACW Time	The amount of time the agent spent working on call-related activities (that is, ACW activities). This includes direct agent ACW activities during the report interval.	sum(I_ACWTIME + I_DA_ACWTIME), sum(<TOTAL_I_ACWTIME>)
Agent Ring Time	The time the agent had split/skill and direct agent ACD calls ringing. If the agent answers or makes another call instead of answering the ringing call, the I_RINGTIME is stopped. This applies only to switches with ring state.	sum(I_RINGTIME)

Field	Description	Database Item, Calculation, or <Calculation name>
Other Time	<p>The time the agent spent doing other work in all splits/skills. For <i>DEFINITY</i> ECS switches, agents are doing other work while in Auto-In or Manual-In if they:</p> <ul style="list-style-type: none"> <li>Put any call on hold while not doing any other activity.</li> <li>Dial to place a call or to activate a feature.</li> <li>Have a personal call ringing with no other activity.</li> </ul> <p>Agent positions show up as OTHER directly after the link to the switch comes up and directly after the agents log in before the <i>CentreVu</i> CMS is notified of the agent's work state.</p>	sum(TI_OTHERTIME)
AUX Time	The total time that the agents spent in AUX work in all splits/skills or on AUXIN/AUXOUT calls for the specified time period.	sum(TI_AUXTIME)
Avail Time	The total time that the agents were available to take ACD calls for any split/skill during the specified time period.	sum(TI_AVAILTIME)
Staffed Time	The total time the agents were logged in (staffed) for the specified time period in any split/skill. This does not include time the link was down.	sum(TI_STAFFTIME)
Trans Out	The number of calls transferred by this agent to another destination. For <i>DEFINITY</i> ECS switches, this records all calls that were transferred.	sum(TRANSFERRED)
Held Calls	The number of calls the agent put on hold. For <i>DEFINITY</i> ECS switches, this is all calls the agent put on hold.	sum(HOLDCALLS)
Avg Hold Time	The average length of time calls were on hold.	sum(HOLDTIME) / sum(HOLDCALLS), <AVG_HOLD_TIME_SUM>



# Agent Trace by Location Report

**Overview** The Agent Trace by Location report lists each agent activity and the time it occurred, by agent location ID. This information could be useful when evaluating how well agents are using their time. This report is only available through Release 8 *CentreVu* Supervisor.

**Things to know about this report** Here are some things to know about this report:

- Refer to the "Agent and Trunk States" section of Chapter 1, "Introduction" in this book for a list of the agent states.
- The database items for the Agent Trace by Location report are stored in the `ag_actv` table.
- This report uses the Agent Report Input Window. Select an agent who you want to view on the report. See [Agent Report Input Fields \(4-7\)](#) for more information.

**Agent Trace by Location report example** The following figure provides an example of an Agent Trace by Location Report.

Date	Time	Seq	Logout Reason	AUX Reason	State	Split/Skill	Time Hold	Rec Malicious Call	Rls	Calling Party	Call Work Code	Dialed Digits	Asst	Conf
3/31/98	4:15:06PM	1	3	2	RINGING	Gold					4		n	n
3/31/98	4:15:06PM	1	5	4	AVAIL	Platinum					3		n	n
3/31/98	4:15:06PM	1	2	6	AVAIL	Regular					3		n	n
3/31/98	4:15:06PM	1	5	5	RINGING	Gold					4		n	n
3/31/98	4:15:06PM	1	3	4	ACD	Gold					1		n	n

**Agent Trace by Location report description** The following table describes the report fields.

Report Heading	Description	Database Item, Calculation, or <Calculation Name>
Agent	The name or login ID of the agent. You can make this selection in the report input window.	syn(LOGID)
ACD	The ACD name or number for which the data was collected.	syn(ACD)



Report Heading	Description	Database Item, Calculation, or <Calculation Name>
Date	The day that the event (state change) was recorded.	ROW_DATE
Time	The time of day that the event started.	EVENT_TIME
Seq	The sequence number of the event. Agent events which occur in the same second are assigned increasing sequence numbers, so the order in which they occurred can be determined.	WMODE_SEQ
Location ID	The location ID(s) associated with the agent. This ID is not associated with the agent personally, but rather with the terminal the agent is logged into. It is also associated with a port network location ID on <i>DEFINITY</i> . If the Agent Site Tracking feature is not available on your system, the field will not display meaningful data.	LOC_ID
Logout Reason	The reason code that the agent entered when logging out. Reason code 0 (zero) indicates that the agent forced a logout without entering a reason code, or the system logged the agent out.	syn(LOGOUTREASON)
AUX Reason	The reason code that the agent entered when changing to AUX work mode. Reason code 0 (zero) indicates that the agent did not enter a reason code, or the system put the agent into AUX work mode.	syn(AUXREASON)
State	The current work state of the agent. An agent can be in any one of the following states: LOGON, LOGOFF, ACDIN, ACDOUT, ACW, ACWIN, ACWOUT, AUX, AUXIN, AUXOUT, AVAILABLE, DACDIN, DACDOUT, DACW, DACWIN, DACWOUT, or UNKNOWN.	WORKMODE and DIRECTION
Split/Skill	The name or number of the split/skill which the agent logged into or for which the agent handled a call.	syn( SPLIT)
Time	The length of time spent in the state. Shown in minutes and seconds (mm:ss).	DURATION
Hold	The agent put the current call on hold. For <i>DEFINITY</i> ECS Generic 3 switches, this is all calls the agent put on hold.	CALLER_HOLD

Report Heading	Description	Database Item, Calculation, or <Calculation Name>
Rec	This indicates whether the agent reconnected to the call (for example, the agent put a call on hold and then retrieved the call from hold).	RECONNECT
Malicious Call	The agent activated malicious call trace. This applies to <i>DEFINITY</i> ECS Generic 3.	MCT
Rls	The agent released the ACD call. This is always true for ACD calls the agent transferred or conferenced. This only applies to <i>DEFINITY</i> ECS and Generic 3 switches.	AGT_RELEASED
Calling Party	The identification of the caller. This is the ANI/SID for Generic 3 Version 4 and later <i>DEFINITY</i> ECS with ISDN ANI delivery. Otherwise, it is the extension or trunk equipment location identifying the originator of the call.	CALLING_PTY
Call Work Code	The call work code that the agent entered for the call. This applies to <i>DEFINITY</i> ECS Generic 3 switches.	WORKCODE
Dialed Digits	The digits that the agent dialed to originate a call. Trunk access codes, feature access codes, account and authorization codes are not included. This applies to <i>DEFINITY</i> ECS Generic 3 switches.	DIGITS_DIALED
Asst	The agent requested supervisor assistance. This is activated by pressing the ASSIST button.	ASSIST_ACTV
Conf	The agent activated a conference. This applies to <i>DEFINITY</i> ECS Generic 3 switches.	CONFERENCE
Trans Out	The agent transferred the call. ( <i>DEFINITY</i> ECS Generic 3 = all calls transferred.)	TRANSFERRED



---

# Other Reports

## Overview

---

**Purpose** This section describes Other reports.

**Organization** This following topics are described:

- General Information About Other Reports
- Call Records Report
- Call Work Codes Report



# General Information About Other Reports

**What an Other Report contains** *CentreVu* Supervisor Other reports give you access to specific information on call records and call work codes.

**Organization of Other reports** The following list shows how the Call Records and Call Work Code reports are organized in *CentreVu* Supervisor .

- Call Records
- Call Work Code: Daily, Weekly, Monthly

**Other report selector window** The following figure is an example of the Other Report Selector window. The reports are explained in the same order as listed in the window.

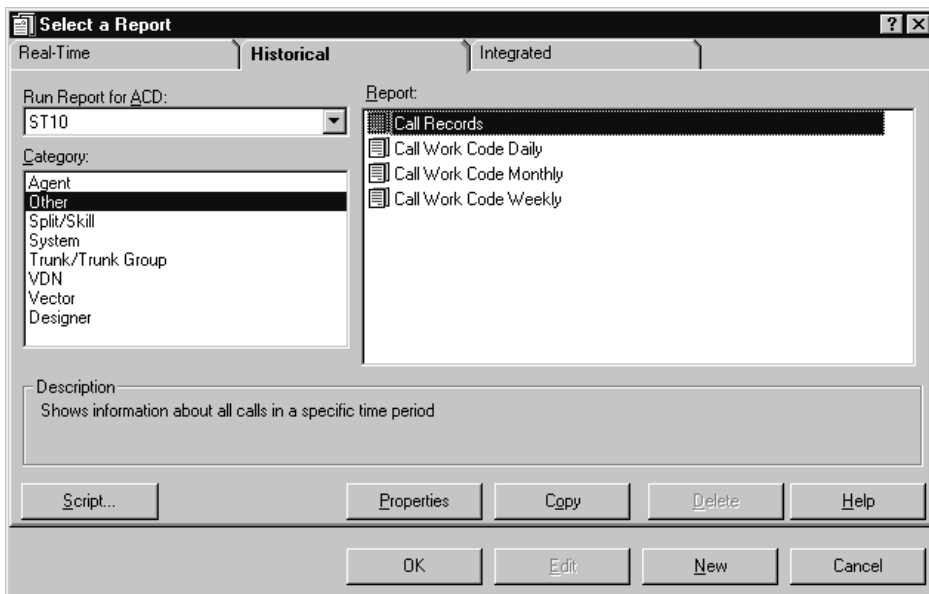

## Call Records Report

---

**Overview** The Call Records report allows you to view selected information about each call. For example, you might have a caller that complained about being put on hold three times and then transferred. This report gives you this type of information about a call.

**Things to know about this report** Here are some things to know about this report:

- Call Records allow you to view information about particular calls. Each call is represented by one or more records, because a new record is created whenever the call is conferenced or transferred. However, all records for a particular call will have the same call ID, so that you know the records represent the same call.
- With call records, the call is tracked up until it is transferred or conferenced. At the point of a conference or transfer, a new call record is generated for the call.
- The standard Call Records report is provided as a model for customized call record reports. Most call record reporting will need to be done from Designer reports tailored to your needs.
- If you are customizing the Historical Call Record Report with *CentreVu* Report Designer, the Disposition report field will display the numerical values for DISPOSITION, and not the state names. See the *CentreVu CMS R3V8 Database Items and Calculations* (585-210-939) document for more information.
- See the *CentreVu CMS R3V8 Database Items and Calculations* (585-210-939) document for a complete listing of the call record historical database items.
- Call records are limited to 5000 records.
- To protect the real-time processing on *CentreVu* CMS, internal call records can only be collected if your call center's traffic is under 400 calls in 20 minutes.
- The `call_rec` table includes may items that are not displayed in the standard report.
- This report gives you information on specific calls. It is based only on the start and stop dates and times that you enter.
- The database items for the Call Records report are stored in the `call_rec` table.

**Call Records report input fields** The following table describes the fields on the input window. You must fill in the window to run the report.

Field	Definition
Start date:	Enter the date from which you want the reporting period to start. The report runs for all calls answered by the ACD from the Start date and Start time through the Stop date and Stop time.
Start time:	Enter the time from which you want the reporting period to start. Use any of the following formats: <ul style="list-style-type: none"> <li>• AM/PM (for example, 7:30AM or 5:00PM)</li> <li>• 24-hour notation (for example, 7:30 or 17:00).</li> </ul>
Stop date:	Enter the date you want the report to run through. The report will be run for all calls answered by the ACD from the Start date and Start time through the Stop date and Stop time.
Stop time:	Enter the time that you want the report to stop. Use any of the following formats: <ul style="list-style-type: none"> <li>• AM/PM (for example, 7:30AM or 5:00PM)</li> <li>• 24-hour notation (for example, 7:30 or 17:00).</li> </ul>
Destination:	Choose a report destination. You can select View Report on Screen or Print Report on: and then use the Select Printer button to print the report on any Windows printer. The default printer is shown.

**Call Records report example** The following figure provides an example of a Call Records Report.

The screenshot shows a window titled 'Call Records' with a menu bar (Report, Edit, Format, Tools, Options, Help) and a status bar (Double Click To Run Format Table, ST10). The report content includes a date filter 'Date: 10/4/99' and a table with the following data:

Call ID	Segment	Date	Start Time	Calling Party	Dialed Number	Disposition	Disposition Time	Split/Skill	Ans Logid	Talk Time	Hold Time	ACW Time	Trans Out	Conf	Assist	Last Call Work Code
12967579	01	3/31/98	4:15:09PM		3035551947			Gold	50001	03:12	00:34	00:08		n	n	4
10928547	01	3/31/98	4:15:11PM		3035557683			Regular	50034	02:15	00:12	00:12		n	n	1
21047019	02	3/31/98	3:21:08PM		3035559807			Gold	50021	04:32	00:45	00:05		n	n	1
46289105	01	3/31/98	3:12:34PM		3035556724			Gold	50012	01:45	00:18	00:15		n	n	2

**Call Records report description** The following table describes the report fields for the time period covered by the report.

<b>Report Heading</b>	<b>Description</b>	<b>Database Item, Calculation, or &lt;Calculation Name&gt;</b>
Date:	The day, week, or month for which the report ran. You can make these selections in the report input window.	ROW_DATE
ACD	The number of the ACD that handled this call.	syn(ACD)
Call ID	A unique number assigned to this call and all its segments. Note that in the case of a conference or transfer, when the data for the conference/transfer is recorded, the same call ID will be recorded for all call segments of the conference/transfer. In the case of "meet-me" conferences, this may result in higher-numbered segments of the call starting before the first segment on the call. Call IDs are not necessarily strictly sequential, but will be unique for calls over a day.	CALLID
Segment	The number of the call segment. Segment numbers are from 1 up to the number of segments in the call.	SEGMENT
Date	The starting date for the segment.	ROW_DATE
Start Time	The starting time for the segment.	ROW_TIME
Calling Party	The Automatic Number Identification (ANI)/Station Identification (SID) (Generic 3 Version 4 switches or the ECS with ANI delivery), extension or trunk equipment location identifying the originator of the call This field is blank if the trunk is not measured or, for internal calls, if the originating extension is not measured.	CALLING_PTY
Dialed Number	The number the caller dialed. This will be the VDN for inbound vectoring calls and dialed digits for outbound calls. This will be blank for inbound calls without vectoring.	DIALED_NUM

Report Heading	Description	Database Item, Calculation, or <Calculation Name>
Disposition	<p>Indicates what happened to the call in the call segment. The possibilities are: 1=connected (CONN), 2=answered (ANS), 3=abandoned (ABAN), 4=interflowed (IFLOW), 5=forced busy (FBUSY), 6=forced disconnect (FDISC), and 7=other (OTHER).</p> <ul style="list-style-type: none"> <li>• A connected call is a non-ACD call to a measured agent for which CMS receives an indication that the call was connected.</li> <li>• An answered call is any split/skill or direct agent ACD call for which CMS receives an indication that the call was answered by an agent.</li> <li>• An abandoned call is any call for which CMS receives notification that the caller abandoned. This includes calls with talk times shorter than the phantom abandoned call timer.</li> <li>• An interflowed call is a call that was redirected to an off-switch destination.</li> <li>• Forced busy calls are calls that CMS records as BUSYCALLS for the trunk group that carried them. For switches with vectoring, these are VDN calls that received a forced busy from the “busy” vector command. For the ECS , calls that receive a busy indication because the split queue was full (or there was no queue) are recorded here.</li> <li>• Forced disconnect calls are VDN calls that are disconnected by the switch due to the execution of a disconnect vector command (Generic 3 Version 2, later Generic 3 switches, and the ECS ). For the ECS , Generic 3 Version 2 and later Generic 3 releases, forced disconnect calls also include calls disconnected because of the disconnect vector timer or because they reached the end of vector processing without being queued.</li> </ul>	DISPOSITION
Disposition Time	<p>The amount of time the call waited until its disposition (in the vector, in queue, and ringing). For extension calls made directly to agents (not through a VDN), this will always be zero.</p>	DISPTIME
Split/Skill	<p>The number of the split or skill associated with the call at its disposition in this call segment. Calls that were not queued to a split or skill at the time of disposition will have this item set to blank. Calls that were queued to an unmeasured split or skill at the time of disposition will have this item set to zero.</p>	DISPSPLIT



Report Heading	Description	Database Item, Calculation, or <Calculation Name>
Ans Logid	The login ID of the agent who answered the call in this segment. This field is blank for unmeasured extensions when EAS is not active.	ANSLOGIN
Talk Time	The time an agent spends talking on a call. This does not include the time the caller is on hold.	TALKTIME
Hold Time	<p>The total time the call was put on hold by the answering agent, in seconds, in this call segment. Note that in agent-to-agent calls, Hold Time is accrued for the answering agent if the agent puts the call on hold, but not for the other agent (who continues to accrue talk time).</p> <p>For the <i>DEFINITY</i> ECS switches, Hold Time includes all calls held.</p>	ANSHOLDTIME
ACW Time	The time spent, in seconds, in After Call Work (ACW) related to this call by the answering agent in this segment.	ACWTIME
Trans Out	<p>This indicates whether or not the answering agent initiated a transfer on this call segment. Valid values for Trans Out are 0=NO, 1=YES.</p> <p>For the ECS and Generic 3 switches Trs is set for any call transferred.</p>	TRANSFERRED
Conf	<p>This indicates whether or not this call segment represents part of a conference (0= NO, 1=YES).</p> <p>Available on the ECS and Generic 3 switches.</p>	CONFERENCE
Assist	This indicates if the answering agent in this segment requested supervisor assistance on this call (0= NO, 1=YES).	ASSIST
Last Call Work Code	The last call work code entered by the answering agent in this segment. This database item applies to <i>DEFINITY</i> ECS switches.	LASTCWC

# Call Work Code Report

---

**Overview** Use the Call Work Code report to track certain call activities of your call center, such as special sale items, complaints, or how many times a customer made a purchase based on a special sales campaign. Agents enter a specific call work code that is associated with a particular call activity when the activity occurs. Those entries are tracked on this report. To produce data in this report, you must have the Call Work Codes feature on a *DEFINITY* ECS Generic 3 switch.

**Things to know about this report** Here are some things to know about this report:

- The Call Work Code report is available in daily, weekly, and monthly versions.
- The database items for the Call Work Code reports are stored in the `dcwc` (daily), `wcwc` (weekly), and `mcwc` (monthly) tables.
- The range of call work codes that may be reported on cannot exceed 1000.
- Because call work codes directly affect the amount of storage space required for each file system and the disk space, you must allocate the number of call work codes to be saved by the CMS in the System Setup-Data Storage Allocation window.
- You must identify and specify where you want to store call work code data in the System Setup-Free Space Allocation window.
- You must assign the call work codes for which the CMS collects data in the Call Center Administration-Call Work Codes window.
- Call Work Codes can only be nine or fewer digits in each code if you want to assign names to the codes in the Dictionary.

**Prerequisite system administration** If you wish to run this report, you must do the following:

- Allocate the number of call work codes to be saved by *CentreVu* CMS in the System Setup-Data Storage Allocation window. See Chapter 9, "CMS System Setup" in the *CentreVu Call Management System Release 3 Version 8 Administration 585-210-910* document for more information.
- Identify and specify where you want to store call work code data in the System Setup-Free Space Allocation window. See Chapter 9, "CMS System Setup" in the *CentreVu Call Management System Release 3 Version 8 Administration 585-210-910* document for more information.
- Assign the call work codes for which *CentreVu* CMS collects data in the Call Center Administration-Call Work Codes window. See Chapter 7, "Call Center Administration" in the *CentreVu Call Management System Release 3 Version 8 Administration 585-210-910* document for more information.

**Call Work Code report input fields** The following table describes the fields on the input window. You must fill in the window to run the report.

Field	Definition
Call work code(s):	Enter the call work code name(s) or number(s) that you want to view in this report.
Date:	Enter the date for the day or the start date for the week or the month you would like the report to cover. <ul style="list-style-type: none"> <li>You can use the month/day/year (for example, 3/21/95).</li> <li>You can use a "-" offset based on today's date (for example, -1 for yesterday).</li> <li>When you specify a date for a weekly report, that date must correspond to the week start day selected in the System Setup- Storage Intervals window. If the date and day do not match, the message <b>No records found</b> displays in the status line. The month start date must be the first day of the month.</li> </ul>
Destination:	Choose a report destination. You can select View Report on Screen or Print Report on: and then use the Select Printer button to print the report on any Windows printer. The default printer is shown.

**Call Work Code report example** The following figure provides an example of a Call Work Code Report.

Call Work Code	Call Work Code Name	ACD Calls	ACD Time	ACW Time	Avg ACD Time	Avg ACW Time
<b>Totals</b>						
1	Sales	157	10:46:34	00:39:25	04:13	00:15
2	Purchases	198	05:39:28	00:39:58	03:38	00:12
3	Returns	86	07:16:15	00:30:01	05:14	00:21
4	Fraud	21	02:10:47	00:11:12	06:24	00:32

**Call Work Code report description** The following table describes the report fields for the time period covered by the report.

Report Heading	Description	Database Item, Calculation, or <Calculation Name>
Date, Week Starting, Month Starting	The day, week, or month for which the report ran. You can make these selections in the report input window.	ROW_DATE
ACD	ACD name or number associated with the call work code(s).	syn( ACD)
Call Work Code	Call work code number.	CWC
Call Work Code Name	Name associated with the call work code number.	syn( CWC)
ACD Calls	Number of times the call work code was entered while agents were on ACD calls or in ACW associated with an ACD call.	ACDCALLS
ACD Time	Total talk time associated with ACDCALLS that have this call work code.	ACDTIME
ACW Time	Total after call work time associated with ACDCALLS with this call work code.	ACWTIME
Avg ACD Time	Average talk time associated with the call work code.	ACDTIME/ ACDCALLS, <AVG_ACD_TALK_TIME>
Avg ACW Time	Average after call work time associated with the call work code.	ACWTIME/ ACDCALLS, <AVG_ACW_TIME>



# Split/Skill Reports

---

## Overview

---

**Purpose** This section describes split/skill reports.

- Organization** The following topics are described:
- General Information About Split/Skill Reports
  - Split/Skill Report Selector Window
  - Split/Skill Report Input Fields
  - Split/Skill Call Profile Report
  - Split/Skill Graphical ASA Report
  - Split/Skill Graphical ASA Daily
  - Split/Skill Graphical Average Positions Staffed Report
  - Split/Skill Graphical Call Profile Report
  - Split/Skill Graphical Multi-ACD Service Level Daily
  - Split/Skill Graphical Service Level Report
  - Split/Skill Graphical Skill Overload Report
  - Split/Skill Graphical Time Spent Report
  - Split/Skill Outbound Report
  - Split/Skill Report
  - Split/Skill by Location Report
  - Split/Skill Summary Report



## General Information About Split/Skill Reports

### What a Split/Skill Report contains

*CentreVu* Supervisor Split/Skill reports give you access to information on your splits or skills. This information includes looking at the percentage of calls answered within set service levels by split/skill, how many calls were handled by each agent in a split/skill, and summarizing the activity for an entire split/skill.

### Organization of Split/Skill reports

The following list shows how the Split/Skill reports are structured in *CentreVu* Supervisor.

- Call Profile: Daily, Weekly, Monthly
- Split/Skill Graphical Multi-ACD Service Level Daily: Daily
- Graphical ASA
- Graphical Average Positions Staffed
- Graphical Service Level: Interval
- Graphical Call Profile: Daily
- Graphical Skill Overload
- Graphical Time Spent: Interval
- Outbound: Interval, Daily, Weekly, Monthly
- Report: Daily, Weekly, Monthly
- Split/Skill by Location: daily
- Summary: Interval, Daily, Weekly, Monthly

### Split/Skill report selector window

The following figure is an example of the Split/Skill Report selector window. The reports are explained in the same order as listed in the window.

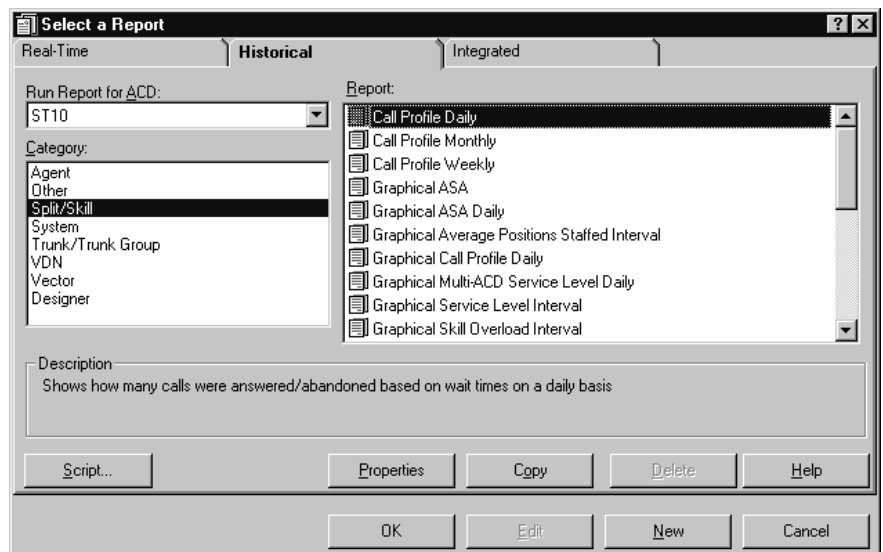

## Split/Skill Report Input Fields

**Overview** The reports in this section use the Split/Skill Report Input Windows. Specific input information is included with the reports. The following figure shows an example of the Split/Skill Report input window. You must fill in the report input window to run the report.

**Split/Skill report input fields** The following table describes the input fields on historical Split/Skill report input windows. Not all reports use all fields; refer to information for the specific report you are running to determine what you want to view. For example, you may enter an agent group, agent name, location ID, or split/skill to run the report.

All possible fields on this window are described here:

Field	Definition
Split/Skill:	Enter the appropriate split/skill name or number that you want to view in this report. Any name(s) you want to appear on the report must have been previously defined and entered in the Dictionary subsystem.
Date: (interval)	Enter the date you would like the report to cover. Use any of the following formats: <ul style="list-style-type: none"> <li>• A month/day/year (for example, 3/21/96).</li> <li>• A minus (-) offset based on today's date (for example, -1 for yesterday).</li> </ul>
Dates: (daily, weekly, monthly)	Enter the date(s) you would like the report to cover: <ul style="list-style-type: none"> <li>• Daily - enter the day(s).</li> <li>• Weekly - enter the start date for the week(s). When you specify a date for a weekly report, that date must correspond to the week start day selected in the System Setup-Storage Intervals window. If the date and day do not match, the message No records found displays in the status line.</li> <li>• Monthly - enter the first day of the month(s).</li> </ul> Use any of the following formats: <ul style="list-style-type: none"> <li>• A month/day/year (for example, 3/21/96).</li> <li>• A minus (-) offset based on today's date (for example, -1 for yesterday).</li> <li>• A semicolon (;) to separate individual data entry items (for example, 3/21/96;3/23/96;3/25/96)</li> <li>• A hyphen (-) to designate a range of dates (for example, 3/21/96-3/25/96). For the weekly and monthly versions, the report includes any weeks or months that begin in the range.</li> </ul>

Field	Definition
Times: (interval)	<p>Enter the time you would like the report to cover. Use any of the following formats:</p> <ul style="list-style-type: none"><li>• AM/PM (for example, 7:30AM-5:00PM)</li><li>• Military time (for example, 7:30-17:00).</li><li>• You can use a "-" offset based on today's date (for example, -1 for yesterday).</li></ul>
Destination:	<p>Choose a report destination. You can select View Report on Screen or Print Report on: and then use the Select Printer button to print the report on any Windows printer. The default printer is shown.</p>
Location	<p>Select a location ID for which to run the report. The location ID is an ID number of 1 – 44 digits assigned to a <i>DEFINITY</i> port network location and the equipment assigned to that port location.</p>





# Split/Skill Call Profile Report

**Overview** The Split/Skill Call Profile report shows the number of calls answered and abandoned in time increments that you administer. This report also displays your acceptable service level. See “Call Center Administration—Split/Skill Call Profile Setup,” in the *CentreVu Call Management System Release 3 Version 8 Administration 585-210-910* document for both the time increments and acceptable service levels. Since this report shows you how long it takes for calls to be answered or abandoned, you can determine how long a caller is willing to wait for an agent before hanging up. With this information, you can determine the appropriate answering speed required to reduce abandoned calls.

- Things to know about this report** Here are some things to know about this report:
- Calls are displayed in ten columns, with each column representing a progressively longer wait time.
  - The Split/Skill Call Profile report is available in daily, weekly, and monthly versions.
  - The database items for the Split/Skill Call Profile Report are stored in the `dsplit` (daily), `wsplit` (weekly), and `msplit` (monthly) tables.
  - This report uses the Split/Skill report input window. Select a split/skill that you want to view on the report. See [Split/Skill Report Input Fields \(4-59\)](#) for more information.

**Split/Skill Call Profile report example** The following figure provides an example of a Split/Skill Call Profile report.

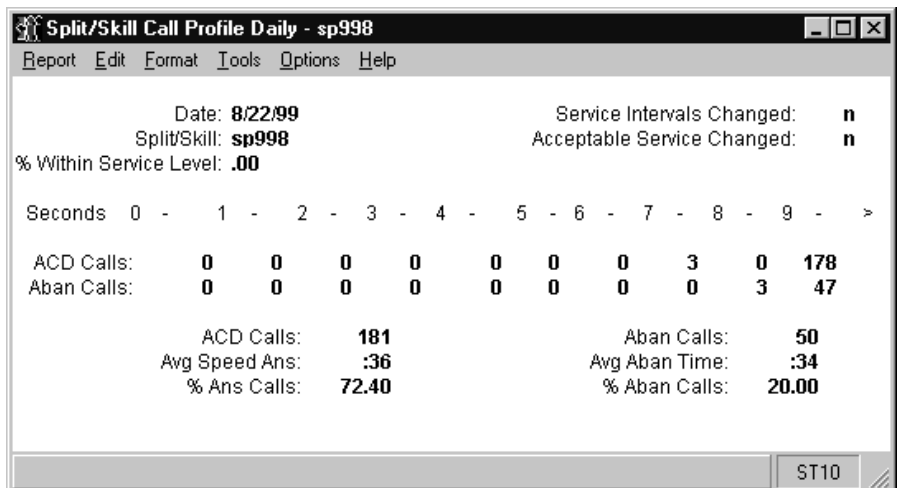

**Split/Skill Call Profile report description** The following table describes the report fields for the time period covered by the report.

Report Heading	Description	Database Item, Calculation, or <Calculation Name>
Date, Week Starting, Month Starting	The day, week, or month for which the report ran. You can make these selections in the report input window.	ROW_DATE
Split/Skill	The name or number of the split/skill that is selected for this report. You can make these selections in the report input window.	syn(SPLIT)
% Within Service Level	The percentage of split/skill ACD calls that were queued to this split/skill and answered within your administered service level.	100*( ACCEPTABLE/ CALLSOFFERED), <PERCENT_SERV_LVL_SPL>
ACD	The ACD name or number for which the data was collected.	syn(ACD)
Service Intervals Changed	A YES appears if you changed your service interval increments during the time period covered by the report. A NO appears if you have not changed your service interval increments. The words displayed for YES or NO represent the values defined in the Dictionary subsystem.	syn(YES_NO)
Acceptable Service Changed	A YES appears if you changed your acceptable service level during the period covered by the report. A NO appears if you have not changed your acceptable service level. The words displayed for YES or NO represent the values defined in the Dictionary subsystem.	syn(YES_NO)
Seconds	The values administered for the service level increments. Each Secs (seconds) interval represents a progressively longer wait time for a call, and each interval can be a different length.	PERIOD1-9
ACD Calls	The number of split/skill ACD calls answered within each service level increment.	ACDCALLS1-10
Aban Calls	The number of split/skill ACD calls that abandoned within each service level increment.	ABNCALLS1-10

Report Heading	Description	Database Item, Calculation, or <Calculation Name>
ACD Calls	The number of split/skill ACD calls that were queued to this split/skill and answered by an agent for this split/skill. This total also includes O_ACDCALLS if you have the Outgoing Call Management (OCM) application of ASAI. The O_ACDCALLS is the number of ACDCALLS that were placed by an adjunct; this is also referred to as predictive dialing.	ACDCALLS
Avg Speed Ans	The average time the split/skill ACD calls were waiting in queue and ringing before being answered by an agent.	ANSTIME/ ACDCALLS, <AVG_ANSWER_SPEED>
% Ans Calls	The percentage of calls queued to the split/skill that were answered by agents for this split/skill.	100*( ACDCALLS/ CALLSOFFERED), <PERCENT_CALL_ANS>
Aban Calls	The number of ACD calls to the split/skill that disconnected while either waiting in queue (if this was the first split/skill the call was queued to), or while ringing. This total includes calls with talk time less than the phantom abandoned call timer value, if it is set. This total also includes O_ABNCALLS if you have OCM. The O_ABNCALLS is the number of outbound ACD calls that were abandoned by the far end.	ABNCALLS
Avg Aban Time	The average time the split/skill ACD calls were waiting in queue or ringing before abandoning.	ABNTIME/ ABNCALLS, <AVG_ABANDON_TIME>
% Aban Calls	The percentage of calls queued to the split/skill that abandoned before being answered by an agent.	100*( ABNCALLS/ ( CALLSOFFERED)), <PERCENT_CALL_ABAN>



---

# Split/Skill Graphical ASA Report

---

**Overview** The Split/Skill Graphical ASA (Average Speed of Answer) report shows the average speed of answer for ACD calls answered in each selected split/skill for each selected interval.

**Things to know about this report** Here are some things to know about this report:

- The database items for the Split/Skill Graphical ASA report are stored in the `dsplit` (current interval) and `hsplit` (intrahour interval) tables.
- The chart type can be changed. See Chapter 2, “Using Reports”, for more information.
- This report is only available through the *CentreVu* Supervisor interface.
- This report uses the Split/Skill report input window. Select a split/skill that you want to view on the report. See [Split/Skill Report Input Fields \(4-59\)](#) for more information.
- This report is only available for *DEFINITY* R8 ACDs.

**Split/Skill Graphical ASA report example**

The following figure provides an example of a Split/Skill Graphical ASA report.

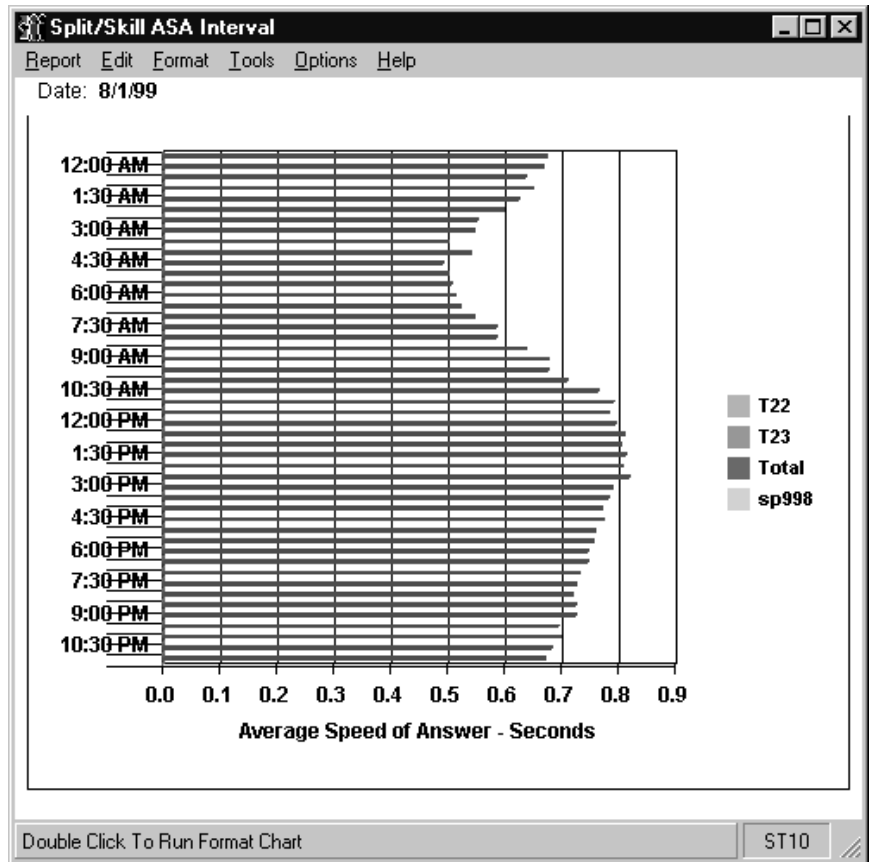

**Split/Skill Graphical ASA report description**

The following table describes the report fields for the time period covered by the report.

Report Heading	Description	Database Item, Calculation, or <Calculation Name>
Date:	The day for which the report was run (selected in the report input window).	ROWDATE
Start Time (Interval)	The start time of the interval for which the data was collected. (This field displays only for the Interval report.)	STARTTIME
Split/Skill	The name or number of the split/skill you are currently viewing.	syn(SPLIT)
Average Speed of Ans - Seconds	The value in seconds of the average speed of answer for the split/skill during the time period covered in the report.	<AVG_ANSWER_SPEED>

# Split/Skill Graphical Average Positions Staffed Report

---

**Overview** This report is available for customers who have purchased *CentreVu Advocate* and the *DEFINITY ECS R6* or later. This report shows, for a specified skill, the maximum agent positions allocated for the skill, as well as the average positions staffed. This allows call center supervisors to see historically how many agents were counted on for a skill in comparison to how many agents were actually available on the skill.

**Things to know about this report** Here are some things to know about this report:

**this report**

- This report is available only on the *DEFINITY*, ECS R6 or later with EAS. If *CentreVu Advocate* is not activated, then the fields on the report that pertain to *CentreVu Advocate* will not populate.
- This report is accessed from the historical folder of the report selector window, via the Split/Skill category, under “Graphical Average Positions Staffed.”
- The report input window allows the user to specify a skill name or number, the time intervals, and the report destination.
- The caption displayed on the report is “Average Positions Staffed - xxx” where xxx is the skill string name specified by the user in the Name Format window.
- The date for which the report is run displays at the top right of the report.
- The primary component of this report is a 2-D vertical bar chart.
- The chart contains the following components:
  - The y-axis of the chart has gradients for the number of agents.
  - The x-axis of the chart displays the specified time intervals.
  - The legend displays “Max Post Allocated” and “Avg Pos Staffed.”
- The database items for the Split/Skill Graphical ASA report are stored in the `dsplit` (current interval) and `hsplit` (intrahour interval) tables.
- This report uses the Split/Skill report input window. Select a split/skill that you want to view on the report. See [Split/Skill Report Input Fields \(4-59\)](#) for more information.

**Split/Skill Graphical Average Positions Staffed report example**

The following figure provides an example of a Split/Skill Graphical Average Positions Staffed report.

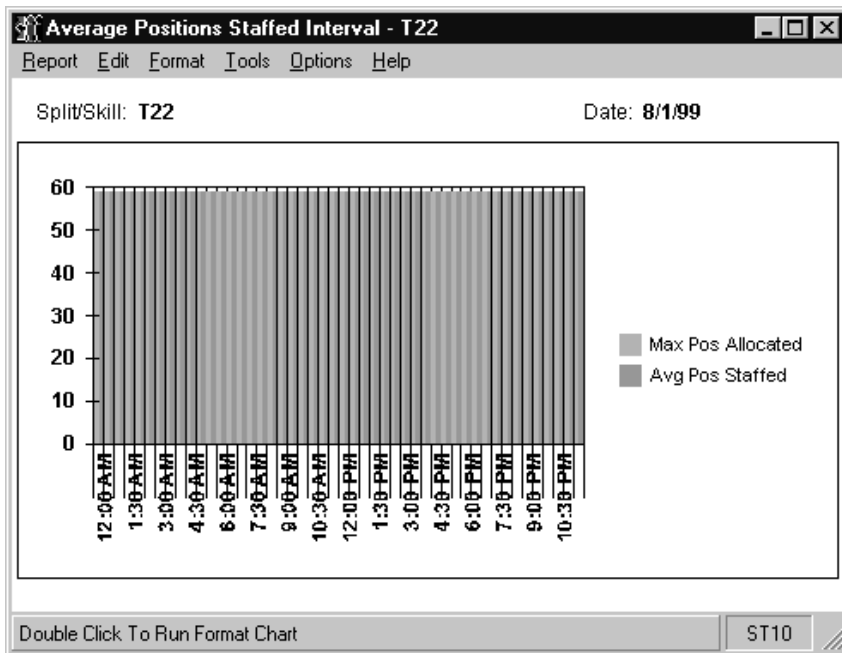

**Split/Skill Graphical Average Positions Staffed report description**

The following table describes the report fields for the time period covered by the report.

Report Heading	Description	Database Item, Calculation, or <Calculation Name>
Date:	The day for which the report was run (selected in the report input window).	ROWDATE
Split/Skill	The name or number of the split/skill you are currently viewing.	syn(SPLIT)
Max Pos Allocated	The maximum agent positions allocated for this skill.	MAX_DEDICATED_AGT
Avg Pos Staffed	The average positions staffed for this skill.	AVG_EQV_AG_STFD



---

# Split/Skill Graphical ASA Daily Report

---

**Overview** The Split/Skill Graphical ASA (Average Speed of Answer) Daily report shows the average speed of answer for ACD calls answered in selected splits/skills for selected days.

**Things to know about this report** Here are some things to know about this report:

- The database items for the Split/Skill Graphical ASA Daily report are stored in the `dsplit` (current interval) tables.
- The chart type can be changed. See Chapter 2, “Using Reports”, for more information.
- The bottom right of the report contains a status bar that displays the name of the ACD chosen through the Report Selector dialog box. A legend on the right side of the report shows the names of the selected splits/skills.
- This report is only available through the *CentreVu* Supervisor interface.
- This report uses the Split/Skill report input window. Select the splits/skills that you want to view on the report and the days for which you want to view ASA. See [Split/Skill Report Input Fields \(4-59\)](#) for more information.



**Split/Skill Graphical ASA Daily report example**

The following figure provides an example of a Split/Skill Graphical ASA Daily report.

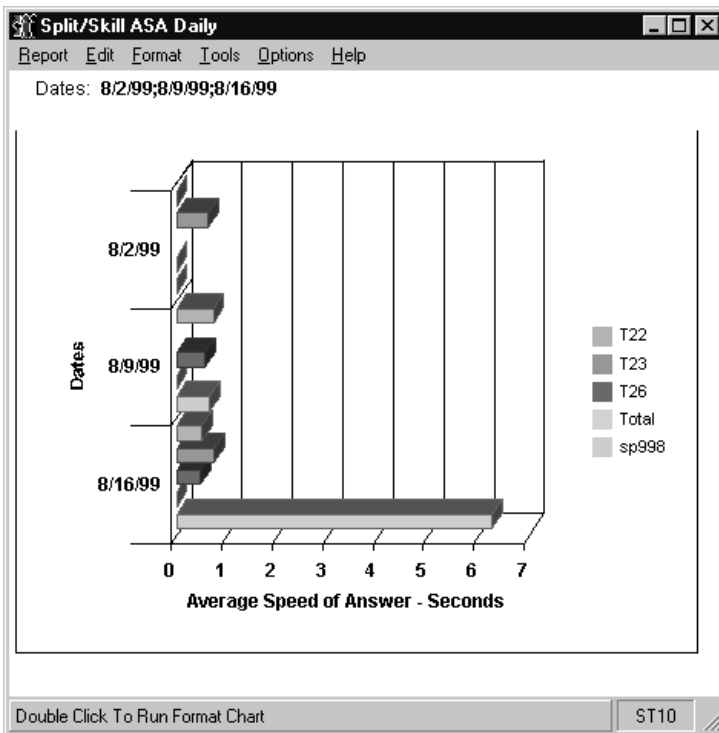

**Split/Skill Graphical ASA report description**

The following table describes the report fields for the time period covered by the report.

Report Heading	Description	Database Item, Calculation, or <Calculation Name>
Dates	The days for which the report was run (selected in the report input window).	ROWDATE
Split/Skill	The name of the split/skill you are currently viewing.	syn(SPLIT)
Average Speed of Ans - Seconds	The value in seconds of the average speed of answer for the split/skill during the time period covered in the report.	<AVG_ANSWER_SPEED>



# Split/Skill Graphical Call Profile Report

---

**Overview** This report shows how well the split or skill you specify performed compared to your call center's predefined service levels for the date you specify.

**Things to know about this report**

Here are some things to know about this report:

- This report has four charts and displays a collection of split/skill call profile related data items at the top of the report. A legend appears to the right of each chart.
- The three-dimensional pie chart in the upper-left quadrant shows the percentage of ACD calls answered within the Acceptable Service Level and the percentage of ACD calls answered outside this level. The numerical value represented by each pie piece is shown inside the pie chart, and the boxes to the right of each graph are a legend.
- The three-dimensional pie charts on the right side of the report show the Percentage Answered Distribution (upper right quadrant) and the Percentage Abandoned Distribution (lower right quadrant) for each service level increment. The numerical value represented by each pie piece is shown inside the pie chart.
- The horizontal bar chart in the lower-left quadrant shows the actual number of ACD calls answered within each service interval. The horizontal axis represents the number of calls answered or abandoned. The vertical axis represents the customer's service intervals. For each of these intervals, two horizontal bars are displayed. One bar shows the number of answered ACD calls, and the other bar shows the number of abandoned calls.
- The number displayed for each service interval is the upper limit of the interval. For example, if the first two intervals are 5 and 10, the first data point on the graph indicates the number of calls answered/abandoned within 0-5 seconds, the second data point indicates the number of calls answered/abandoned within 6-10 seconds.
- Other chart styles are available and can be changed.
- The database items for the Split/Skill Call Profile report are stored in the `dsplit` table.
- This report is only available through the *CentreVu* Supervisor interface.
- This report uses the Split/Skill report input window. Select a split/skill that you want to view on the report. See [Split/Skill Report Input Fields \(4-59\)](#) for more information.

**Split/Skill Graphical Call Profile report example**

The following figure provides an example of a Split/Skill Graphical Call Profile report.

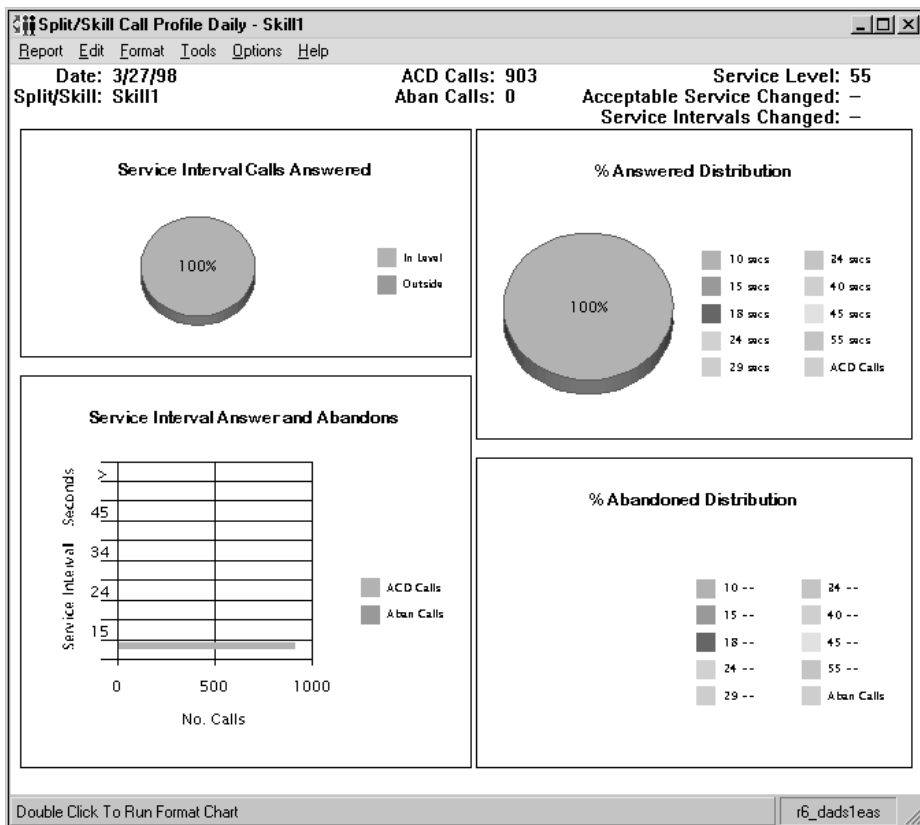

**Split/Skill Graphical Call Profile report description**

The following table describes the report fields for the time period covered by the report.

Report Heading	Description	Database Item, Calculation, or <Calculation Name>
Date:	The day for which the report was run (selected in the report input window).	ROW_DATE
ACD Calls:	The number of calls answered within the split/skill for that day.	ACDCALLS
Service Level	The number of seconds defined by the customer as acceptable for answering calls.	SERVICELLEVEL
Split/Skill:	The name or number of the split/skill.	syn( SPLIT)
Aban Calls:	The number of split/skill calls abandoned for that day.	ABNCALLS

Report Heading	Description	Database Item, Calculation, or <Calculation Name>
Acceptable Service Changed:	Shows whether or not the acceptable service level was changed. A "YES" appears if the acceptable service level changed during the period covered by the report. Otherwise, a "NO" appears.	syn( SVCLEVELCHG)
Service Intervals Changed:	A "YES" appears if service intervals were changed during the period covered by the report.	syn( PERIODCHG)
Service Interval Calls Answered	Percentage of split/skill ACD calls that were answered by an agent within the predefined acceptable service level. Calls to the split/skill include abandoned calls, calls not answered, and outbound ACD calls placed by an adjunct (for example, outbound predictive dialing—Generic 3 switches with the ASAI feature). Calls that were not answered may include forced busy calls, forced disconnect calls, calls redirected to another destination, and calls queued to more than one split and answered in another split/skill. For Generic 3 switches, Percent Within Service Level does not include direct agent calls.	< <PERCENT_SERV_LVL_SPL>
Service Interval Answers and Abandons	Percentage of split/skill ACD calls that were answered by an agent within the predefined acceptable service level. Calls to the split/skill include abandoned calls, calls not answered, and outbound ACD calls placed by an adjunct. Outbound predictive dialing—Generic 3 switches with the ASAI feature only. Calls that were not answered may include forced busy calls, forced disconnect calls, calls redirected to another destination, and calls queued to more than one split and answered in another split/skill. For Generic 3 switches, Percent Within Service Level does not include direct agent calls.	< <100-PERCENT_SERV_LVL_SPL>
% Answered Distribution	Graphically displays the distribution of all of the incoming calls that were answered within each of the defined service levels.	ACDCALLS1-10
% Abandoned Distribution	Graphically displays the distribution of all of the incoming calls that were abandoned within each of the defined service levels.	ABNCALLS1-10

# Split/Skill Graphical Multi-ACD Service Level Report

**Overview** The Split/Skill Graphical Multi-ACD Service Level Report shows the Percent in Service Level achieved for a skill selected from one or more ACDs for each day. You can compare a split/skill in different ACDs and use the information to:

- Determine workload
- Review Percent in Service Level for each ACD
- Evaluate call-handling performance
- Reassign agents
- Perform other ACD configuration alternatives for balancing workloads and/or reducing abandoned calls.

## Things to know about this report

Here are some things to know about this report:

- You can specify a single split/skill across ACDs.
- The Split/Skill Graphical Multi-ACD Service Level report is only available in a daily version.
- The database items used for the Split/Skill Graphical Multi-ACD Service Level report are stored in the `dsplit` (daily) tables.
- The Split/Skill Graphical Multi-ACD Service Level report can include information on up to eight ACDs.
- This report is only available for *DEFINITY* R8 ACDs.

## Split/Skill Graphical Multi-ACD Service Level report input window

The following figure provides an example of a Split/Skill Graphical Multi-ACD Service Level report input window. The report input window must be filled in to run the report.

**Split/Skill Graphical  
Multi-ACD Service Level  
report input fields**

The following table describes the fields on the input window.

Field	Definition
Dates: (daily)	<p>Enter the date(s) you would like the report to cover.</p> <p>Use any of the following formats:</p> <ul style="list-style-type: none"> <li>• A month/day/year (for example, 3/21/96).</li> <li>• A minus (-) offset based on today's date (for example, -1 for yesterday).</li> <li>• A semicolon (;) to separate individual data entry items (for example, 3/21/96;3/23/96;3/25/96)</li> <li>• A hyphen (-) to designate a range of dates (for example, 3/21/96-3/25/96).</li> </ul>
First through Eighth ACD:	Enter the ACD name(s) or number(s) that corresponds to the following Split(s)/Skill(s) field.
First through Eighth Split(s)/Skill(s):	Enter the appropriate split/skill name(s) or number(s) that you want to view in this report. Any name(s) you want to appear on the report must have been previously defined and entered in the Dictionary subsystem. You can enter more than one split/ skill by using a semicolon (;) to separate individual entries or using a hyphen (-) for a range of values.
Destination:	Choose a report destination. You can select View Report on Screen or Print Report on: and then use the Select Printer button to print the report on any Windows printer. The default printer is shown.

**Split/Skill Graphical Multi-ACD Service Level report example**

The following figure provides an example of a Split/Skill Graphical Multi-ACD Service Level report.

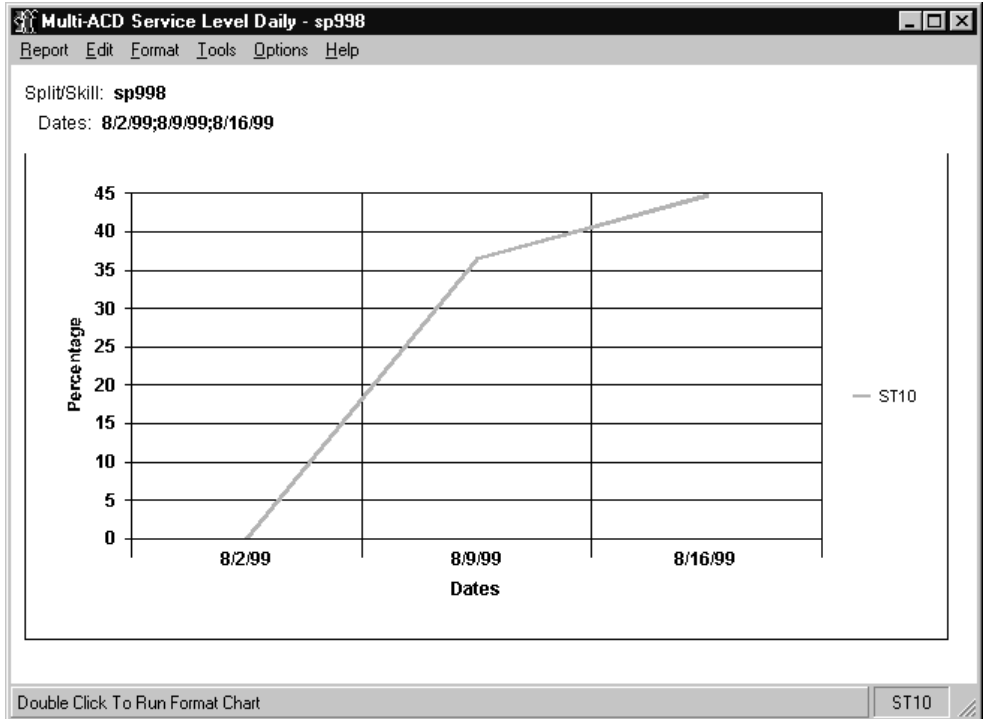

**Split/Skill Graphical Multi-ACD Service Level report description**

The following table describes the report fields for the time period covered by the report.

Report Heading	Description	Database Item, Calculation, or <Calculation Name>
ACD	The ACD name or number for which the data was collected.	syn(ACD)
Split/Skill	The name or number of the split/skill that is selected for this report. You can make these selections in the report input window.	syn(SPLIT)
Date, Week Starting, Month Starting	The day, week, or month for which the report ran. You can make these selections in the report input window.	ROW_DATE
Seconds	The seconds in Service Level for the ACD.	<100 * ACCEPTABLE/ CALLSOFFERED>

# Split/Skill Graphical Service Level Report

**Overview** This report shows the percentage of ACD calls answered within the predefined acceptable service level and the percentage of ACD calls abandoned for the date and split or skill you specify.

**Things to know about this report**

Here are some things to know about this report:

- The chart type can be changed. See Chapter 2, "Using Reports", for more information.
- Each set of vertical bars is labeled with the start time for the service interval. The box below the chart is a legend.
- The database items for the Split/Skill Service Level report are stored in the `hsplit` (intrahour interval) table.
- This report is only available through the *CentreVu* Supervisor interface.
- This report uses the Split/Skill report input window. Select a split/skill that you want to view on the report. See [Split/Skill Report Input Fields \(4-59\)](#) for more information.

**Split/Skill Graphical Service Level report example**

The following figure provides an example of a Split/Skill Graphical Service Level report.

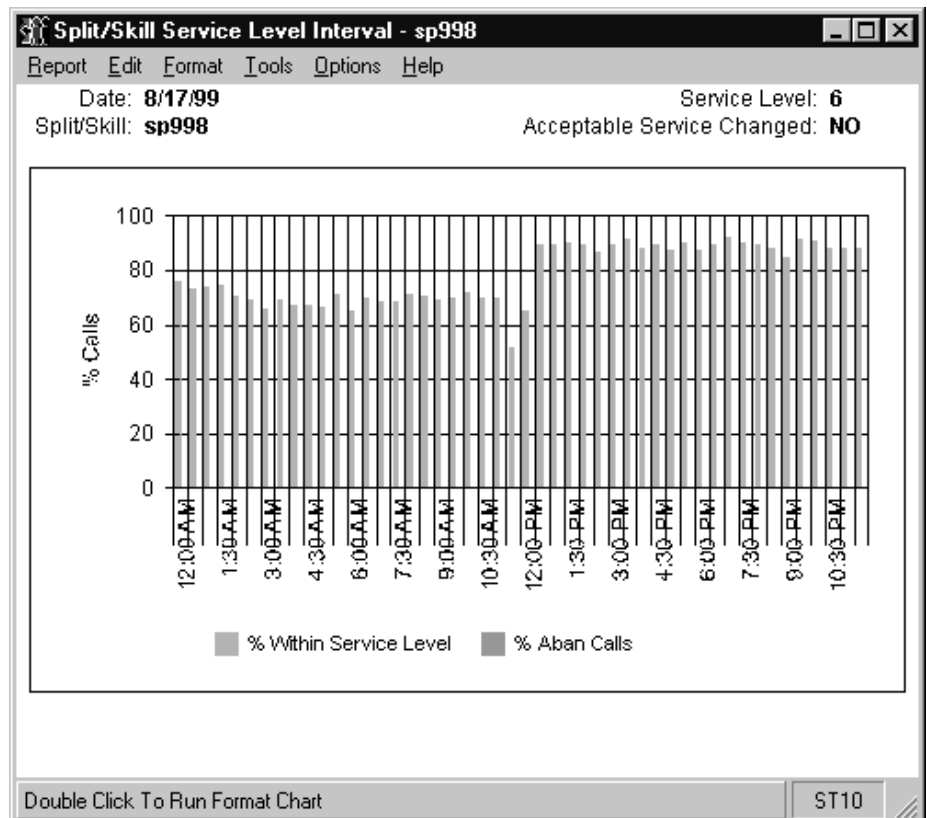



**Split/Skill Graphical Service Level report description** The following table describes the report fields for the time period covered by the report.

Report Heading	Description	Database Item, Calculation, or <Calculation Name>
Date:	The day for which the report was run (selected in the report input window).	ROW_DATE
Secs.:	Shows actual administered service level.	SERVICLEVEL
Split/Skill:	The name or number of the split/skill that you are currently viewing.	syn(SPLIT)
Acceptable Service Changed:	Shows whether or not the service level was changed. A "YES" appears if the acceptable service level changed during the period covered by the report. Otherwise, a "NO" appears.	syn(SVCLEVELCHG)
% Within Service Level	Percentage of ACD calls that were answered by an agent within the predefined acceptable service level for the time period shown in the report.	<PERCENT_SERV_LVL_SPL>
% Aban Calls	Percentage of ACD calls that were abandoned for the time period shown in the report.	<PERCENT_CALL_ABAN>



# Split/Skill Graphical Skill Overload Report

**Overview** The Graphical Skill Overload report shows how much time each skill has spent in normal versus overload condition for the intervals specified for a particular day.

If *CentreVu Advocate* is not activated, the fields of the report which pertain to *CentreVu Advocate* will not be populated.

**Things to know about this report**

Here are some things you need to know about this report:

- You can access this report from the Historical Split/Skill Category selector menu.
- The Graphical Skill Overload report is available in a daily version.
- This report displays a horizontal bar chart with a horizontal bar for each skill.
- If you notice a trend toward increased time in overload state, you may need to train or hire additional agents for that skill.
- The database items used for this report are stored in the `dsplit` table.
- This report uses the Split/Skill Report Input Window. Select a skill that you want to view on the report. See [Split/Skill Report Input Fields \(4-59\)](#) for more information.

**Split/Skill Graphical Skill Overload report example**

The following figure is an example of a Graphical Skill Overload report:

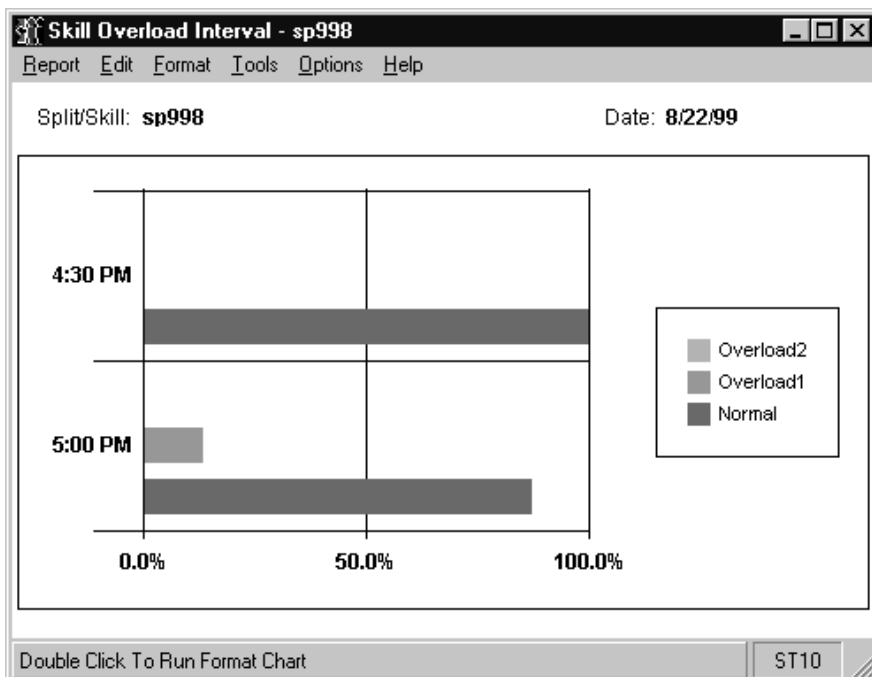

**Split/Skill Graphical Skill Overload report description** The following table describes the report fields:

Report Heading	Description	Database Item, Calculation, or <Calculation Name>
Date	The day for which the report was run (selected in the report input window).	ROW_DATE
Split/Skill	The name or number of the splits/skills selected for this report.	syn( SPLIT)
Normal	The time the skill spent under all of the thresholds.	I_NORMTIME
Overload1	The time the skill spent over threshold 1 and under threshold 2.	I_OL1TIME
Overload2	The time the skill spent over threshold 2.	I_OL21TIME



# Split/Skill Graphical Time Spent Report

---

**Overview** This report shows how much time the agents staffed in the specified split or skill spent in each work state. It also shows the composite time spent in the AUX work state for each of the reason codes defined for this Call Center.

**Things to know about this report** Here are some things to know about this report:

- Call center supervisors can use this report to estimate how much time agents in this split/skill spent on ACD calls, in available state, in ACW, in AUX, etc. for a particular day. This report enables supervisors to tell how much time the agents in this split/skill spent in AUX work state for each of the reason codes defined for this call center.
- This report can display a three-dimensional pie chart that shows the amount of time (in hours and minutes) that the agent spent in each work state.
- By default, the percentage is shown inside of each section of the pie chart.
- A legend displays a different color for each of the agent work states (dictionary-defined synonym for each work state).
- This report displays a three-dimensional pie chart that shows the reason codes for the time that the agents spent in AUX work mode.
- The percentage of AUX time (in hours and minutes) agents spent in AUX for each reason code is displayed inside the slice of the pie chart.
- A legend to the right of the pie chart shows a different color for each of the reason codes. This legend contains the dictionary-defined reason codes or numbers (if the reason codes have not been defined in Dictionary).
- The database items used for the Split/Skill Graphical Skill Time Spent report are stored in the `hsplit` (intrahour) and `dsplit` (daily) tables.
- This report is only available through the *CentreVu* Supervisor interface.
- This report uses the Split/Skill report input window. Select a split/skill that you want to view on the report. See [Split/Skill Report Input Fields \(4-59\)](#) for more information.

**Split/Skill Graphical Time Spent report example**

The following figure provides an example of a Split/Skill Graphical Skill Time Spent report.



**Split/Skill Graphical Skill Time Spent report description**

The following table describes the report fields for the time period covered by the report.

Report Heading	Description	Database Item, Calculation, or <Calculation Name>
Split/Skill:	The name or number of the split/skill you are currently viewing.	syn( SPLIT)
Date:	The day for which the report was run (selected in the report input window).	ROW_DATE
AVAIL	The time during the collection interval that POSITIONS were available for calls from this split/skill.	I_AVAILTIME
ACW	The time during the collection interval that POSITIONS were in AUX in this split/skill. This includes I_AUXINTIME and I_AUXOUTTIME.	<I_ACWTIME>

Report Heading	Description	Database Item, Calculation, or <Calculation Name>
RINGING	The time during the collection interval that agents were in the ringing state for calls to this split/skill. If the agent changes work modes or answers/makes another call instead of answering the ringing call, I_RINGTIME will stop accumulating. RINGTIME is the time that the caller spends ringing and is independent of agent activity.	I_RINGTIME
ACD	The time during the collection interval that POSITIONS were on split/skill ACD calls for this split/skill.	<I_ACDDTIME>
AUX	The time during the collection interval that POSITIONS are in AUX in this split/skill.	I_AUXTIME
OTHER	The time during the collection interval that POSITIONS were doing other work.	I_OTHERTIME
Reason Code 0	The time during the collection interval that POSITIONS were in AUX for reason code 0 in this split/skill. This includes time on extension calls from this AUX state.  For switches using AUX reason codes, this represents the time agents spent in "system" AUX.  For switches not using AUX reason codes, I_AUXTIME0 is the same as I_AUXTIME.	I_AUXTIME0
Reason Code 1-9	The time during the collection interval that POSITIONS were in AUX for each reason code 1-9 in this skill. This includes the time on extension calls from each AUX state.	I_AUXTIME1-9



# Split/Skill Outbound Report

**Overview** The Split/Skill Outbound report displays the numbers and average talk times for each type of outbound call for a given split/skill. It is useful primarily for splits/skills that use an adjunct to deliver outbound ACD calls or to dial outbound extension calls.

**Things to know about this report** Here are some things to know about this report:

- This report requires the Outgoing Call Management application of ASAI.
- The Split/Skill Outbound report is available in interval, daily, weekly, and monthly versions.
- The database items for the Split/Skill Outbound report are stored in the **hsplit** (interval), **dsplit** (daily), **wsplit** (weekly), and **msplit** (monthly) tables.
- This report uses the Split/Skill report input window. Select a split/skill that you want to view on the report. See [Split/Skill Report Input Fields \(4-59\)](#) for more information.

**Split/Skill Outbound report example** The following figure provides an example of a Split/Skill Outbound report.

Date	Outbound ACD Calls	Avg Outbound ACD Time	Avg ACW (Outbound ACD)	Extn Out Calls	Avg Extn Out Time	Adjunct Dialed Extn Calls
<b>Totals</b>	<b>0</b>			<b>8</b>	<b>:05</b>	<b>0</b>
8/2/99	0			0		0
8/9/99	0			8	:05	0
8/16/99	0			0		0

**Split/Skill Outbound Report Description** The following table describes the report fields for the time period covered by the report.

Report Heading	Description	Database Item, Calculation, or <Calculation Name>
Split/Skill:	The name or number of the split/skill that is selected for this report. You can make these selections in the report input window.	syn(SPLIT)
Time (for interval reports only)	The intrahour intervals for which the report shows data, as selected in the report input window.	STARTTIME, STARTTIME+INTRVL
Date, Week Starting, Month Starting	The day, week, or month for which the report ran. You can make these selections in the report input window.	ROW_DATE
Outbound ACD Calls	The number of outbound ACD calls placed by an adjunct processor and queued to this split/skill and answered by agents for this split/skill.	O_ACDCALLS
Avg Outbound ACD Time	The average time the agents spent talking on outbound ACD calls placed by an adjunct for this split/skill.	O_ACDCALLS/O_ACDCALLS
Avg ACW Time (Outbound ACD)	The average time the agents spent in after call work associated with outbound ACD calls placed by an adjunct for this split/skill.	O_ACWTIME/O_ACDCALLS
Extn Out Calls	<p>The number of outbound extension calls made by agents logged into this split/skill during the period covered. Direct agent ACW out calls are not included.</p> <p>For agents in multiple splits/skills, outbound AUX extension calls are included here if this split/skill is the first one that the agent logged into, unless the agent has an ACD call on hold. In this case the outbound call is recorded for the split/skill associated with the ACD call.</p>	ACWOUTCALLS+ AUXOUTCALLS <EXT_CALL_OUT>



Report Heading	Description	Database Item, Calculation, or <Calculation Name>
Avg Extn Out Time	<p>The average time agents in this split/skill spent talking on outbound extension calls.</p> <p>For agents in multiple splits/skills, time spent on outbound AUX extension calls are included here if this split/skill is the first one that the agent logged into, unless the agent has an ACD call on hold. In this case the outbound call is recorded for the split/skill associated with the ACD call.</p>	<p>(ACWOUTTIME+ AUXOUTTIME)/ (ACWOUTCALLS+ AUXOUTCALLS)</p>
Adjunct Dialed Extn Calls	<p>The number of outbound extension calls for this split/skill that were placed by an adjunct for an agent; these are also referred to as keyboard-dialed calls.</p>	<p>ACWOUTADJCALLS + AUXOUTADJCALLS</p>



# Split/Skill Report

**Overview** The Split/Skill Report shows the calls handled, agent time and assists, and transfers and holds for each agent in a split/skill. This report shows only the time each agent worked in this particular split/skill. An agent could have worked in other splits/skills during the day.

**Things to know about this report** Here are some things to know about this report:

- The Split/Skill Report is available in daily, weekly, and monthly versions.
- The database items for the Split/Skill Report are stored in the **dagent** (daily), **wagent** (weekly), and **magent** (monthly) tables.
- This report uses the Split/Skill report input window. Select a split/skill that you want to view on the report. See [Split/Skill Report Input Fields \(4-59\)](#) for more information.

**Split/Skill report example** The following figure provides an example of a Split/Skill report.

Agent Name	ACD Calls	Avg ACD	Avg ACW	ACD Time	ACW Time	Agent Ring Time	Other Time	AUX Time	Avail Time	Staffed Time	Assists	Trans Out	Held Calls	Avg Hold Time
<b>Totals</b>	<b>181</b>	<b>:08</b>	<b>:00</b>	<b>:24:40</b>	<b>:00:00</b>	<b>:12:39</b>	<b>:39:15</b>	<b>:00:39</b>	<b>:00:02</b>	<b>1:17:15</b>	<b>0</b>	<b>0</b>	<b>0</b>	
29665	20	:07	:00	:02:25	:00:00	:01:33	:04:27	:00:05	:00:01	:08:31	0	0	0	
29670	21	:08	:00	:02:39	:00:00	:01:33	:04:21	:00:04	:00:00	:08:37	0	0	0	
29677	21	:08	:00	:02:49	:00:00	:01:20	:04:18	:00:04	:00:00	:08:31	0	0	0	
29684	22	:08	:00	:02:58	:00:00	:01:19	:04:18	:00:04	:00:00	:08:39	0	0	0	
29685	19	:08	:00	:02:40	:00:00	:01:30	:04:18	:00:04	:00:01	:08:33	0	0	0	
29716	15	:09	:00	:02:21	:00:00	:01:43	:04:23	:00:04	:00:00	:08:31	0	0	0	
29718	24	:07	:00	:02:49	:00:00	:01:20	:04:24	:00:04	:00:00	:08:37	0	0	0	
29723	20	:09	:00	:03:09	:00:00	:01:01	:04:23	:00:05	:00:00	:08:38	0	0	0	
29726	19	:09	:00	:02:50	:00:00	:01:20	:04:23	:00:05	:00:00	:08:38	0	0	0	

**Split/Skill report description** The following table describes the report fields for the time period covered by the report.

Report Heading	Description	Database Item, Calculation, or <Calculation Name>
Date, Week Starting, Month Starting:	The day, week, or month for which the report ran. You make these selections in the report input window.	ROW_DATE
Split/Skill	The name or number of the split/skill that is selected for this report. You can make these selections in the report input window.	syn(SPLIT)
ACD	The ACD name or number for which the data was collected.	syn( ACD)
Agent Name	The names or login IDs of the agents that logged into the split/skill selected in the report input window.	syn(LOGID)
ACD Calls	The number of split/skill and direct agent ACD calls answered by the agent that connected during interval. Direct agent calls are included if this is the direct agent skill, or the direct agent skill is not measured by CMS and this is the first skill the agent logged into. This total also includes O_ACDCALLS if you have the Outgoing Call Management application on ASAI. The O_ACDCALLS is the number of ACDCALLS that were placed by an adjunct on behalf of a split/skill; this is also referred to as predictive dialing.	ACDCALLS + DA_ACDCALLS, <TOTAL_ACDCALLS>
Avg ACD Time	<p>The average time the agent spent talking on ACD calls for this split/skill that completed during the period covered.</p> <p>Direct agent time is included:</p> <ul style="list-style-type: none"> <li>• if this is the direct agent skill</li> <li>• if the direct agent skill is not measured by CMS and this is the first skill the agent logged into.</li> <li>• if the Direct Agent skill is not assigned, but the agent receives Direct Agent calls.</li> </ul> <p>This average includes O_ACDTIME if you have Outgoing Call Management (OCM).</p>	( ACDTIME+ DA_ACDTIME)/ ( ACDCALLS+ DA_ACDCALLS), <AVG_AGENT_TALK_TIME>

Report Heading	Description	Database Item, Calculation, or <Calculation Name>
Avg ACW Time	<p>The average time the agent spent in ACW for ACD and direct agent calls for this split/skill during the time period covered by the report.</p> <p>Direct agent calls are included:</p> <ul style="list-style-type: none"> <li>• if this is the direct agent skill</li> <li>• if the direct agent skill is not measured by CMS and this is the first skill the agent logged into.</li> <li>• if the Direct Agent skill is not assigned, but the agent receives Direct Agent calls.</li> </ul> <p>This average includes O_ACWTIME if you have Outgoing Call Management (OCM).</p>	<p>( ACWTIME+ DA_ACWTIME)/ (ACDCALLS+ DA_ACDCALLS), &lt;AVG_AGENT_ACW_TIME&gt;</p>
ACD Time	<p>The total time the agent spent on split/skill ACD calls for this split/skill during the period.</p> <p>Direct agent time is included:</p> <ul style="list-style-type: none"> <li>• if this is the direct agent skill</li> <li>• if the direct agent skill is not measured by CMS and this is the first skill the agent logged into.</li> <li>• if the Direct Agent skill is not assigned, but the agent receives Direct Agent calls.</li> </ul>	<p>I_ACDDTIME+ I_DA_ACDDTIME, &lt;TOTAL_I_ACDDTIME&gt;</p>
ACW Time	<p>The total time the agent spent working in after call work activities for this split/skill and direct agent ACD calls attributed to this split/skill.</p>	<p>I_ACWTIME+ I_DA_ACWTIME, &lt;TOTAL_I_ACWTIME&gt;</p>
Agent Ring Time	<p>The total time split/skill and direct agent calls rang before the agent answered. Ring applies to <i>DEFINITY</i> ECS Generic 3 switches only.</p>	<p>I_RINGTIME</p>

Report Heading	Description	Database Item, Calculation, or <Calculation Name>
Other Time	<p>The time agents spent doing other work.</p> <p>For all switches "other" time is accumulated when:</p> <ul style="list-style-type: none"> <li>• An agent first logs into the switch. <i>CentreVu</i> CMS tracks the agent time as "other" time until the switch notifies <i>CentreVu</i> CMS of the agent's state</li> <li>• The link between CMS and the switch becomes operational. The switch notifies CMS of all agents who are logged in. CMS assumes these agents are in the "other" state until the switch sends it notification of each agent's current state.</li> </ul> <p>For Generic 3 switches, "other" time is accumulated when agents in Auto-In or Manual-In:</p> <ul style="list-style-type: none"> <li>• Put any call on hold while not doing any other activity</li> <li>• Dialed to place a call or to activate a feature</li> <li>• Had a personal call ringing with no other activity</li> <li>• Were available for other, multiple call handling skills, but not for this skill</li> <li>• Were logged into multiple splits/skills and were doing work for a split/skill other than this split/skill (on an ACD call or in call-related ACW).</li> </ul>	I_OTHERTIME
AUX Time	The total time the agent spent in auxiliary work for the split/skill.	I_AUXTIME
Avail Time	The total time the agent spent waiting for an ACD call in the split/skill.	I_AVAILTIME
Staffed Time	The total time the agent was logged into the split/skill for the period covered.	I_STAFFTIME
Assists	The number of calls for which an agent requested supervisor assistance for the split/skill. Assists for direct agent calls are included here.	ASSISTS
Trans Out	The number of calls transferred by this agent to another destination during the specified time period. For <i>DEFINITY</i> ECS Generic 3 switches, any call transferred.	TRANSFERRED
Held Calls	The number of calls the agent put on hold. This is any type of call for <i>DEFINITY</i> ECS Generic 3 switches.	HOLDCALLS
Avg Hold Time	The average time callers spent on hold at the agent. This is any type of call for <i>DEFINITY</i> ECS Generic 3 switches.	HOLDTIME/ HOLDCALLS, <AVG_HOLD_TIME>

# Split/Skill by Location Report

**Overview** The Split/Skill by Location Report shows the calls handled, agent time, location ID for the agent terminal, and work, AUX, and other time for each agent in a split/skill. This report shows only the time each agent worked in this particular split/skill. An agent could have worked in other splits/skills during the day. This report supports the Agent Site Tracking feature, which must be enabled to see meaningful data on the report.

- Things to know about this report** Here are some things to know about this report:
- The Split/Skill by Location Report is available in a daily version only.
  - The database items for the Split/Skill by Location Report are stored in the `dagent` (daily) tables.
  - This report uses the Split/Skill report input window. Select a split/skill that you want to view on the report. See [Split/Skill Report Input Fields \(4-59\)](#) for more information.

**Split/Skill by Location report example** The following figure provides an example of a Split/Skill by Location report.

Agent Name	Location	ACD Calls	Avg ACD Time	Avg ACW Time	ACD Time	ACW Time	Agent Ring Time	Other Time	AUX Time	Avail Time	Staffed Time
<b>Totals</b>											

Double Click To Run Format Table ST10

**Split/Skill report description** The following table describes the report fields for the time period covered by the report.

Report Heading	Description	Database Item, Calculation, or <Calculation Name>
Date Starting:	The day for which the report ran. You make these selections in the report input window.	ROW_DATE
Split/Skill	The name or number of the split/skill that is selected for this report. You can make these selections in the report input window.	syn(SPLIT)
Location IDs	The location ID(s) associated with the agents. These IDs is not associated with the agents personally, but rather with the terminal the agents are logged into. It is also associated with a port network location ID on <i>DEFINITY</i> . If the Agent Site Tracking feature is not available on your system, the field will not display meaningful data.	LOC_ID
Agent Name	The names or login IDs of the agents that logged into the split/skill selected in the report input window.	syn(LOGID)
Location ID	The location ID associated with the agent. This ID is not associated with the agent personally, but rather with the terminal the agent is logged into. It is also associated with a port network location ID on <i>DEFINITY</i> . If the Agent Site Tracking feature is not available on your system, the field will not display meaningful data.	LOC_ID
ACD Calls	The number of split/skill and direct agent ACD calls answered by the agent that connected during interval. Direct agent calls are included if this is the direct agent skill, or the direct agent skill is not measured by CMS and this is the first skill the agent logged into. This total also includes O_ACDCALLS if you have the Outgoing Call Management application on ASAI. The O_ACDCALLS is the number of ACDCALLS that were placed by an adjunct on behalf of a split/skill; this is also referred to as predictive dialing.	ACDCALLS + DA_ACDCALLS, <TOTAL_ACDCALLS>

Report Heading	Description	Database Item, Calculation, or <Calculation Name>
Avg ACD Time	<p>The average time the agent spent talking on ACD calls for this split/skill that completed during the period covered.</p> <p>Direct agent time is included:</p> <ul style="list-style-type: none"> <li>if this is the direct agent skill</li> <li>if the direct agent skill is not measured by CMS and this is the first skill the agent logged into.</li> <li>if the Direct Agent skill is not assigned, but the agent receives Direct Agent calls.</li> </ul> <p>This average includes O_ACDTIME if you have Outgoing Call Management (OCM).</p>	<p>( ACDTIME+ DA_ACDTIME)/ ( ACDCALLS+ DA_ACDCALLS), &lt;AVG_AGENT_TALK_TIME&gt;</p>
Avg ACW Time	<p>The average time the agent spent in ACW for ACD and direct agent calls for this split/skill during the time period covered by the report.</p> <p>Direct agent calls are included:</p> <ul style="list-style-type: none"> <li>if this is the direct agent skill</li> <li>if the direct agent skill is not measured by CMS and this is the first skill the agent logged into.</li> <li>if the Direct Agent skill is not assigned, but the agent receives Direct Agent calls.</li> </ul> <p>This average includes O_ACWTIME if you have Outgoing Call Management (OCM).</p>	<p>( ACWTIME+ DA_ACWTIME)/ ( ACDCALLS+ DA_ACDCALLS), &lt;AVG_AGENT_ACW_TIME&gt;</p>
ACD Time	<p>The total time the agent spent on split/skill ACD calls for this split/skill during the period.</p> <p>Direct agent time is included:</p> <ul style="list-style-type: none"> <li>if this is the direct agent skill</li> <li>if the direct agent skill is not measured by CMS and this is the first skill the agent logged into.</li> <li>if the Direct Agent skill is not assigned, but the agent receives Direct Agent calls.</li> </ul>	<p>I_ACDTIME+ I_DA_ACDTIME, &lt;TOTAL_I_ACDTIME&gt;</p>
ACW Time	<p>The total time the agent spent working in after call work activities for this split/skill and direct agent ACD calls attributed to this split/skill.</p>	<p>I_ACWTIME+ I_DA_ACWTIME , &lt;TOTAL_I_ACWTIME&gt;</p>
Agent Ring Time	<p>The total time split/skill and direct agent calls rang before the agent answered. Ring applies to <i>DEFINITY</i> ECS Generic 3 switches only.</p>	<p>I_RINGTIME</p>



Report Heading	Description	Database Item, Calculation, or <Calculation Name>
Other Time	<p>The time agents spent doing other work.</p> <p>For all switches "other" time is accumulated when:</p> <ul style="list-style-type: none"> <li>• An agent first logs into the switch. <i>CentreVu</i> CMS tracks the agent time as "other" time until the switch notifies <i>CentreVu</i> CMS of the agent's state</li> <li>• The link between CMS and the switch becomes operational. The switch notifies CMS of all agents who are logged in. CMS assumes these agents are in the "other" state until the switch sends it notification of each agent's current state.</li> </ul> <p>For Generic 3 switches, "other" time is accumulated when agents in Auto-In or Manual-In:</p> <ul style="list-style-type: none"> <li>• Put any call on hold while not doing any other activity</li> <li>• Dialed to place a call or to activate a feature</li> <li>• Had a personal call ringing with no other activity</li> <li>• Were available for other, multiple call handling skills, but not for this skill</li> <li>• Were logged into multiple splits/skills and were doing work for a split/skill other than this split/skill (on an ACD call or in call-related ACW).</li> </ul>	I_OTHERTIME
AUX Time	The total time the agent spent in auxiliary work for the split/skill.	I_AUXTIME
Avail Time	The total time the agent spent waiting for an ACD call in the split/skill.	I_AVAILTIME
Staffed Time	The total time the agent was logged into the split/skill for the period covered.	I_STAFFTIME
Total ACD Calls	The total number of ACD calls received on the skill for the selected date.	sum (TOTAL_ACDCALLS)
Total Avg ACD Time	The total average ACD time on the skill for the selected date.	AVG_AGENT_TALK_SUM
Total Avg ACW Time	The total average ACW time on the skill for the selected date.	AVG_AGENT_ACW_TIME
Total ACD Time	The total ACD time for the skill for the selected date.	sum(TOTAL_I_ACD_TIME)
Total ACW Time	The total ACW time for the skill for the selected date.	sum(TOTAL_I_ACW_TIME)
Total Agent Ring Time	The total agent ring time for the skill for the selected date.	sum(I_RINGTIME)

Report Heading	Description	Database Item, Calculation, or <Calculation Name>
Total Agent Other Time	The total agent other time for the skill for the selected date.	sum(I_OTHERTIME)
Total Agent AUX Time	The total agent AUX time for the skill for the selected date.	sum(I_AUXTIME)
Total Agent Avail Time	The total agent avail time for the skill for the selected date.	sum(I_AVAILTIME)
Total Agent Staffed Time	The total agent staffed time for the skill for the selected date.	sum(I_STAFFTIME)



# Split/Skill Summary Report

---

**Overview** The Split/Skill Summary report summarizes the activity for an entire split or skill by time. You could use this report to analyze the overall performance of a split/skill or to compare two or more comparable splits/skills.

**Things to know about this report** Here are some things to know about this report:

- For *DEFINITY* ECS /Generic 3 switches with vectoring, calls that queued to this split or skill as the second or third split/skill in the VDN, but the disposition of the call (answered, abandoned, outflowed) was recorded for another split/skill.
- Direct agent call data are not included in any of the Split/Skill Summary reports. Direct agent calls are considered calls to the agent instead of calls to the split/skill. If you wish to include direct agent calls as split/skill calls, you can create a Designer report using the agent table data.
- The Split/Skill Summary report is available in interval, daily, weekly, and monthly versions.
- The database items for the Split/Skill Summary Report are stored in the `hsplit` (interval), `dsplit` (daily), `wsplit` (weekly), and `msplit` (monthly) tables.
- This report uses the Split/Skill report input window. Select a split/skill that you want to view on the report. See [Split/Skill Report Input Fields \(4-59\)](#) for more information.

**Split/Skill Summary report example**

The following figure provides an example of a Split/Skill Summary report.

Date	Avg Speed Ans	Avg Aban Time	ACD Calls	Avg ACD Time	Avg ACW Time	Aban Calls	Max Delay	Flow In	Flow Out	Extn Out Calls	Avg Extn Out Time	Dequeued Calls	Avg Time to Dequeue	% ACD Time	% Ans Calls
<b>Totals</b>	:00		1088	:09	:02	0	:01	0	0	212	:02	0		.18	100.00
3/27/98	:01		903	:09	:02	0	:01	0	0	176	:02	0		.14	100.00
3/28/98	:00		185	:09	:02	0	:01	0	0	36	:01	0		.04	100.00

**Split/Skill Summary report description**

The following table describes the report fields for the time period covered by the report.

Report Heading	Description	Database Item, Calculation, or <Calculation Name>
Split/Skill:	The name or number of the split/skill that is selected for this report. You can make these selections in the report input window.	syn(SPLIT)
Time (for interval reports only)	The intrahour intervals for which the report shows data, selected in the report input window.	STARTTIME, STARTTIME + INTRVL
Date, Week Starting, Month Starting	The day, week, or month for which the report ran. You can make these selections in the report input window.	ROW_DATE
Avg Speed Ans	The average time the completed split/skill ACD calls were waiting in queue and ringing before being answered by an agent.	ANSTIME/ACDCALLS <AVG_ANSWER_SPEED>

Report Heading	Description	Database Item, Calculation, or <Calculation Name>
Avg Aban Time	The average time the split/skill ACD calls were waiting in queue or ringing before abandoning.	ABNTIME/ ABNCALLS <AVG_ABANDON_TIME>
ACD Calls	The number of split/skill ACD calls that were queued to this split/skill and answered by an agent for this split/skill. This total also includes O_ACDCALLS if you have the Outgoing Call Management application of ASAI (OCM). The O_ACDCALLS is the number of ACDCALLS that were placed by an adjunct; this is also referred to as predictive dialing.	ACDCALLS
Avg ACD Time	The average time the agents spent talking on ACD calls for this split/skill that completed during the interval. This average includes O_ACDTIME if you have OCM.	ACDTIME/ ACDCALLS <AVG_ACD_TALK_TIME>
Avg ACW Time	The average time the agents spent in after call work associated with ACD calls for this split/skill. This average includes O_ACWTIME if you have OCM.	ACWTIME/ ACDCALLS <AVG_ACW_TIME>
Aban Calls	The number of ACD calls to the split/skill that abandoned while either waiting in queue (if this was the first split/skill the call was queued to), or while ringing. This total includes calls with talk time less than the phantom abandoned call timer value, if it is set. This total also includes O_ABNCALLS if you have OCM. The O_ABNCALLS is the number of outbound ACD calls that were abandoned by the far end.	ABNCALLS
Max Delay	<p>The maximum time that a caller waited in queue and ringing before:</p> <ul style="list-style-type: none"> <li>• being answered</li> <li>• abandoning</li> <li>• being redirected</li> <li>• receiving a busy signal</li> <li>• being disconnected.</li> </ul> <p>The value shown in the Totals line for this column is the maximum of the Max Delay values shown in the individual intervals.</p>	MAXOCWTIME

Report Heading	Description	Database Item, Calculation, or <Calculation Name>
Flow In	<p>The number of calls that were redirected to this split/skill queue from another queue. The following calls are considered inflows:</p> <ul style="list-style-type: none"> <li>• For switches without vectoring, calls that intraflow from another split's queue to this split's queue.</li> <li>• With multiple split/skill queuing ( <i>DEFINITY</i> ECS switches with vectoring), calls that queue to this split/skill as a nonprimary split/skill and are either answered by an agent in this split/skill or abandoned from ringing in this split/skill.</li> <li>• For <i>DEFINITY</i> ECS Generic 3 Version 2 and later Generic 3 switches, calls that ring at an agent in this split/skill and then requeue to the same split/skill by the "Redirection on No Answer to a Split/Skill" feature.</li> <li>• When a call leaves a VDN (for example by routing to a VDN) or leaves vector processing (for example by routing to a split/skill), the next split/skill to which the call queues is not credited with an inflow.</li> </ul>	INFLOWCALLS
Flow Out	<p>The number of calls offered to this split/skill that were redirected to another destination.</p> <p>For switches without vectoring, calls that intraflow or interflow to another destination are counted as outflows.</p> <p>For switches with vectoring, an outflow is counted:</p> <ul style="list-style-type: none"> <li>• If the call routes to another VDN.</li> <li>• If the call routes to a number or digits.</li> </ul> <p>For <i>DEFINITY</i> ECS switches with vectoring, an outflow is also counted:</p> <ul style="list-style-type: none"> <li>• If the call queues to this split/skill as the primary split/skill and is redirected by the Redirection on No Answer feature (Generic 3 Version 2 and <i>DEFINITY</i> ECS switches)</li> <li>• If the call queues to a messaging split/skill</li> <li>• If the call rang at an agent in this split/skill and was answered using call pickup</li> <li>• If the call queued to this split/skill as primary and was either answered by an agent in a nonprimary split/skill or abandons from ringing at an agent in a nonprimary split/skill.</li> </ul>	OUTFLOWCALLS

Report Heading	Description	Database Item, Calculation, or <Calculation Name>
Extn Out Calls	<p>The number of outbound extension calls made by agents logged into this split/skill. Direct agent ACW out calls are not included.</p> <p>For agents in multiple splits/skills, outbound AUX extension calls are included here if this split/skill is the first one that the agent logged into, unless the agent has an ACD call on hold. In this case, the outbound call is recorded for the split/skill associated with the ACD call.</p>	<p>ACWOUTCALLS+ AUXOUTCALLS &lt;EXT_CALL_OUT&gt;</p>
Avg Extn Out Time	<p>The average time agents in this split/skill spent talking on outbound extension calls.</p> <p>For agents in multiple splits/skills, time spent on outbound AUX extension calls is included here if this split/skill is the first one that the agent logged into, unless the agent has an ACD call on hold. In this case the outbound call is recorded for the split/skill associated with the ACD call.</p>	<p>(ACWOUTTIME+ AUXOUTTIME)/ (ACWOUTCALLS+ AUXOUTCALLS) &lt;AVG_TALK_TIME_OUT&gt;</p>
Dequeued Calls	<p>For switches with multiple split/skill queuing, the number of calls queued to this split/skill as a nonprimary split/skill (that is, this was not the first split/skill to which the call queued) for which the disposition (answered, outflowed, abandoned, busy, forced disconnect) was recorded in another split/skill.</p>	<p>DEQUEECALLS</p>
Avg Time to Dequeue	<p>For switches with multiple split/skill queuing, average time the dequeued calls spent queued to this split/skill before leaving the queue.</p>	<p>DEQUETIME/ DEQUEECALLS</p>
% ACD Time	<p>The percentage of staffed time that agents in this split/skill spent on ACD calls and in after call work for this split/skill.</p>	<p>100*(I_ACDDTIME+ I_ACWTIME)/ I_STAFFTIME) &lt;PERCENT_ACD_TIME&gt;</p>
% Ans Calls	<p>The percentage of calls queued to this split/skill that were answered by agents for this split/skill.</p>	<p>100*(ACDCALLS/ CALLSOFFERED) &lt;PERCENT_CALL_ANS&gt;</p>

Report Heading	Description	Database Item, Calculation, or <Calculation Name>
Avg Pos Staff (Interval report only)	The average number of positions staffed in this split/skill during the interval.	I_STAFFTIME/ (INTRVL*60)<AVG_POS_STAFF>
Calls Per Pos (Interval report only)	The average number of calls answered by each position staffed during the interval. (If an agent is staffed for part of an interval, the calculation reports what the agent would have handled had the agent been staffed during the entire interval.)	(60 * INTRVL * ACDCALLS)/ I_STAFFTIME <CALLS_PER_POS>





---

# System Reports

## Overview

---

**Purpose** This section describes system reports.

**Organization** This following topics are described:

- General Information About System Reports
- System Report Selector Window
- Graphical Maximum Delay
- Multi-ACD by Split/Skill Report
- Multi-ACD Report
- System Report



## General Information About System Reports

### What a System report contains

*CentreVu* Supervisor system reports allow you to access summary data on a set of measured splits/skills for a particular ACD, the summary data over all splits/skills for a particular ACD, and the call data on similar splits/skills for different ACDs.

### Organization of System reports

The following list shows how the System reports are structured in *CentreVu* Supervisor.

- Multi-ACD by Split/Skill: Daily, Weekly, Monthly
- Graphical Maximum Delay: Daily
- Multi-ACD: Daily, Weekly, Monthly
- System: Daily, Weekly, Monthly

### System Report selector window

The following figure is an example of the System Report Selector window. The reports are explained in the same order as listed in the window.

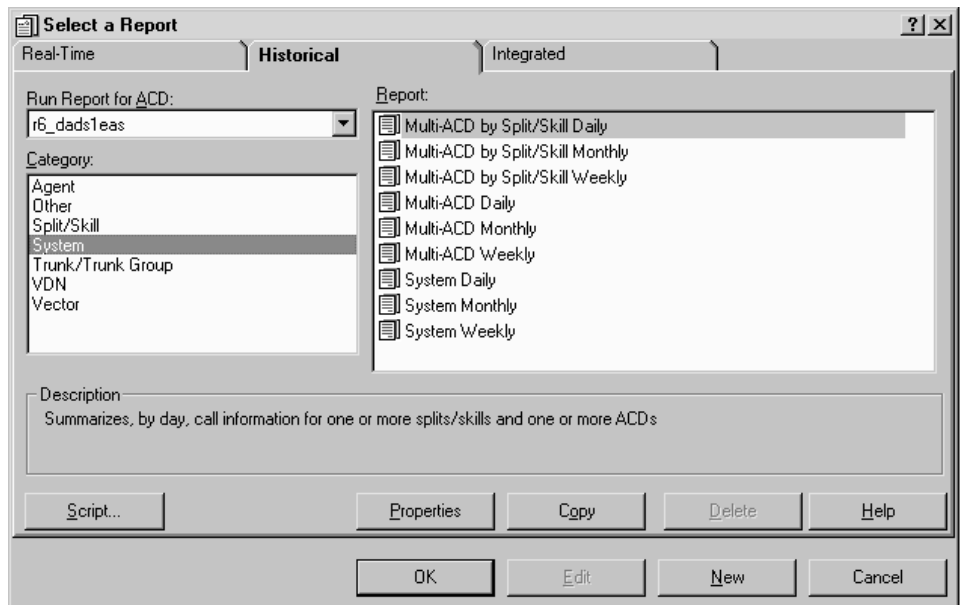

# System Graphical Maximum Delay Report

**Overview** The System Graphical Maximum Delay report shows the maximum delay for one split/skill in one or more ACDs for each day selected. You can compare the split/skill across ACDs and use the information to determine which ACD has the longest delay in answering calls.

## Things to know about this report

Here are some things to know about this report:

- You can specify one split/skill available across ACDs.
- The System Graphical Maximum Delay report is available in a daily version.
- The database items used for the System Graphical Maximum Delay report are stored in the `dsplit` (daily) tables.
- Standard multi-ACD reports can include information on up to eight ACDs.
- This report is only available for *DEFINITY* R8 ACDs.

## Graphical Maximum Delay report input window

The following figure provides an example of a System Graphical Maximum Delay input window. The report input window must be filled in to run the report.

Maximum Delay

Inputs

Split/Skill: T26

Dates: 8/3/1999-8/17/1999

ACDs: ST10;ST11;ST12;ST13

Destination

View Report on Screen

Print Report on: \\DRPRINT2\33b37

OK Cancel Help

**System report input fields** The following table describes the fields on the input window.

Field	Definition
Split/Skill:	Enter the appropriate split/skill name or number that you want to view in this report. Any name(s) you want to appear on the report must have been previously defined and entered in the Dictionary subsystem.
Dates: (daily, weekly, monthly)	Enter the date(s) you would like the report to cover: Use any of the following formats: <ul style="list-style-type: none"> <li>• A month/day/year (for example, 3/21/96).</li> <li>• A minus (-) offset based on today's date (for example, -1 for yesterday).</li> <li>• A semicolon (;) to separate individual data entry items (for example, 3/21/96;3/23/96;3/25/96)</li> <li>• A hyphen (-) to designate a range of dates (for example, 3/21/96-3/25/96). For the weekly and monthly versions, the report includes any weeks or months that begin in the range.</li> </ul>
First through Eighth ACD:	Enter the ACD name or number that corresponds to the following Split(s)/Skill(s) field.
Destination:	Choose a report destination. You can select View Report on Screen or Print Report on: and then use the Select Printer button to print the report on any Windows printer. The default printer is shown.

**System Graphical  
Maximum Delay report  
example**

The following figure provides an example of a System Multi-ACD by Split/Skill report.

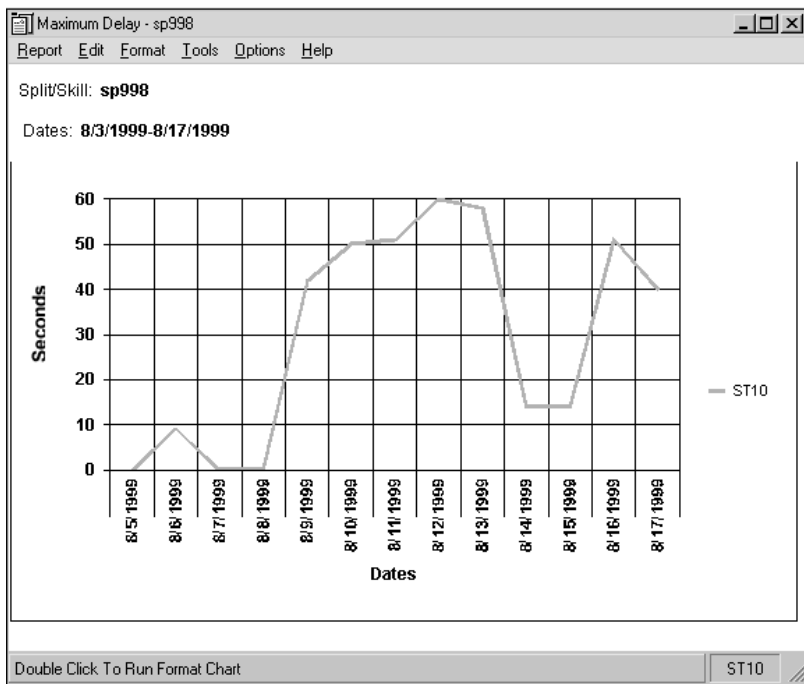

**System Graphical  
Maximum Delay report  
description**

The following table describes the report fields for the time period covered by the report.

Report Heading	Description	Database Item, Calculation, or <Calculation Name>
ACD	The ACD name or number for which the data was collected.	syn(ACD)
Split/Skill	The name or number of the split/skill that is selected for this report. You can make these selections in the report input window.	syn(SPLIT)
Dates	The dates for which the report ran. You can make these selections in the report input window.	ROW_DATE

Report Heading	Description	Database Item, Calculation, or <Calculation Name>
—Max Delay — Seconds	<p>The maximum time that a caller waited in queue and ringing before:</p> <ul style="list-style-type: none"> <li>• Being serviced</li> <li>• Abandoning</li> <li>• Being redirected</li> <li>• Receiving a busy signal</li> <li>• Being disconnected.</li> </ul> <p>The value shown in the Totals line is the maximum of the Max Delay values shown for the individual splits/skills.</p>	MAXOCWTIME



---

## System Multi-ACD by Split/Skill Report

---

**Overview** The System Multi-ACD by Split/Skill report displays call-handling information on different splits/skills for different ACDs. You can compare similar splits/skills in different ACDs and use the information to:

- Determine workload
- Evaluate call-handling performance
- Reassign agents
- Perform other ACD configuration alternatives for balancing workloads and/or reducing abandoned calls.

**Things to know about this report** Here are some things to know about this report:

- You can specify a list of splits/skills available for each ACD desired.
- The System Multi-ACD Report by Split/Skill report is available in daily, weekly, and monthly versions.
- The database items used for the System Multi-ACD by Split/Skill report are stored in the `dsplit` (daily), `wsplit`(weekly), and `msplit` (monthly) tables.
- Standard Multi-ACD reports can include information on up to eight ACDs.

**Multi-ACD by Split/Skill report input window**

The following figure provides an example of a System Multi-ACD by Split Skill input window. The report input window must be filled in to run the report.

**System Multi-ACD by Split/Skill Daily**

**Inputs**

Date: 8/22/99

ACD: ST10

Splits/Skills: sp998

ACD(2): ST11

Splits/Skills(2): BSR

ACD(3): (none)

Splits/Skills(3):

ACD(4): (none)

Splits/Skills(4):

**Destination**

View Report on Screen

Print Report on: \\DRPRINT2\33b37

OK Cancel Help



**Multi-ACD by Split/Skill report input fields** The following table describes the fields on the input window.

Field	Definition
Dates: (daily, weekly, monthly)	<p>Enter the date(s) you would like the report to cover:</p> <ul style="list-style-type: none"> <li>• Daily - enter the day(s).</li> <li>• Weekly - enter the start date for the week(s). When you specify a date for a weekly report, that date must correspond to the week start day selected in the System Setup-Storage Intervals window. If the date and day do not match, the message No records found displays in the status line.</li> <li>• Monthly - enter the first day of the month(s).</li> </ul> <p>Use any of the following formats:</p> <ul style="list-style-type: none"> <li>• A month/day/year (for example, 3/21/96).</li> <li>• A minus (-) offset based on today's date (for example, -1 for yesterday).</li> <li>• A semicolon (;) to separate individual data entry items (for example, 3/21/96;3/23/96;3/25/96)</li> <li>• A hyphen (-) to designate a range of dates (for example, 3/21/96-3/25/96). For the weekly and monthly versions, the report includes any weeks or months that begin in the range.</li> </ul>
First through Eighth ACD:	Enter the ACD name or number that corresponds to the following Split(s)/Skill(s) field.
First through Eighth Split(s)/Skill(s):	Enter the appropriate split/skill name(s) or number(s) that you want to view in this report. Any name(s) you want to appear on the report must have been previously defined and entered in the Dictionary subsystem. You can enter more than one split/ skill by using a semicolon (;) to separate individual entries or using a hyphen (-) for a range of values.
Destination:	Choose a report destination. You can select View Report on Screen or Print Report on: and then use the Select Printer button to print the report on any Windows printer. The default printer is shown.

**System Multi-ACD by Split/Skill report example**

The following figure provides an example of a System Multi-ACD by Split/Skill report.

Split/Skill	ACD	Avg Speed Ans	Avg Aban Time	ACD Calls	Avg ACD Time	Avg ACW Time	Aban Calls	Max Delay	Flow In	Flow Out	Extn Out Calls	Avg Extn Out Time	% ACD	% Ans Calls
<b>Totals</b>		<b>:01</b>	<b>:34</b>	<b>41903</b>	<b>:11</b>	<b>:00</b>	<b>50</b>	<b>1:07</b>	<b>0</b>	<b>0</b>	<b>0</b>		<b>4.02</b>	<b>99.84</b>
T22	ST10	:00		27744	:12	:00	0	:37	0	0	0		9.19	100.00
BSR	ST11	:01		13978	:10	:00	0	:04	0	0	0		9.40	100.00
T23	ST10			0			0	:00	0	0	0		.00	
T26	ST10			0			0	:00	0	0	0		.00	
Total	ST10			0			0	:00	0	0	0		.00	
sp998	ST10	:36	:34	181	:08	:00	50	1:07	0	0	0		31.93	72.40

**System Multi-ACD by Split/Skill report description**

The following table describes the report fields for the time period covered by the report.

Report Heading	Description	Database Item, Calculation, or <Calculation Name>
Date, Week Starting, Month Starting	The day, week, or month for which the report ran. You can make these selections in the report input window.	ROW_DATE
Split/Skill	The name or number of the split/skill that is selected for this report. You can make these selections in the report input window.	syn(SPLIT)
ACD	The ACD name or number for which the data was collected.	syn(ACD)
Avg Speed Ans	The average time the split/skill ACD calls were waiting in queue and ringing before being answered by an agent.	ANSTIME/ ACDCALLS <AVG_ANSWER_SPEED>
Avg Aban Time	The average time the split/skill ACD calls were waiting in queue or ringing before abandoning.	ABNTIME/ ABNCALLS <AVG_ABANDON_TIME>

Report Heading	Description	Database Item, Calculation, or <Calculation Name>
ACD Calls	The number of split/skill ACD calls that were queued to this split/skill and answered by an agent for this split/skill. This total also includes O_ACDCALLS if you have the Outgoing Call Management application (OCM) of ASAI. The O_ACDCALLS is the number of ACDCALLS that were placed by an adjunct; this is also referred to as predictive dialing.	ACDCALLS
Avg ACD Time	The average time the agents spent talking on ACD calls for this split/skill. This average time includes O_ACDTIME if you have OCM.	ACDTIME/ACDCALLS, <AVG_ACD_TALK_TIME>
Avg ACW Time	The average time the agents spent in after call work associated with ACD calls for this split/skill. This average time includes O_ACWTIME if you have the OCM.	ACWTIME/ ACDCALLS, <AVG_ACW_TIME>
Aban Calls	The number of ACD calls to the split/skill that abandoned while either waiting in queue (if this was the first split/skill the call was queued to), or while ringing. This total includes calls with talk time less than the phantom abandoned call timer value, if it is set. This total also includes O_ABNCALLS if you have OCM. The O_ABNCALLS is the number of outbound ACD calls that were abandoned by the far end.	ABNCALLS
Max Delay	<p>The maximum time that a caller waited in queue and ringing before:</p> <ul style="list-style-type: none"> <li>• Being serviced</li> <li>• Abandoning</li> <li>• Being redirected</li> <li>• Receiving a busy signal</li> <li>• Being disconnected.</li> </ul> <p>The value shown in the Totals line is the maximum of the Max Delay values shown for the individual splits/skills.</p>	MAXOCWTIME

Report Heading	Description	Database Item, Calculation, or <Calculation Name>
Extn Out Calls	The number of outbound extension calls made by agents logged into this split/skill. Direct agent ACW out calls are not included. For agents in multiple splits/skills, outbound AUX extension calls are included here if this split/skill is the first one that the agent logged into, unless the agent has an ACD call on hold. In this case the outbound call is recorded for the split/skill associated with the ACD call.	( ACWOUTCALLS + AUXOUTCALLS), <EXT_CALL_OUT>
Avg Extn Out Time	The average time agents in this split/skill spent talking on outbound extension calls. For agents in multiple splits/skills, time spent on outbound AUX extension calls is included here if this split/skill is the first one that the agent logged into, unless the agent has an ACD call on hold. In this case the outbound call is recorded for the split/skill associated with the ACD call.	( ACWOUTTIME+ AUXOUTTIME)/( ACWOUTCALLS + AUXOUTCALLS), <AVG_TALK_TIME_OUT>
% ACD Time	The percentage of staffed time that agents for this split/skill spent on ACD calls and in after call work for this split/skill.	100*(( I_ACDDTIME+ I_ACWTIME)/ I_STAFFTIME), <PERCENT_ACD_TIME>
% Ans Calls	The percentage of calls queued to this split/skill that were answered by agents for this split/skill.	100*( ACDCALLS/ CALLSOFFERED), <PERCENT_CALL_ANS>



# System Multi-ACD Report

**Overview** The System Multi-ACD report summarizes data over all splits/skills in the ACD for each ACD requested. This allows you to evaluate and compare different ACD configurations to determine workload and call-handling performance. After reviewing this report, you could choose different ACD configurations to balance workloads and/or reduce abandoned calls. If you have vectoring, you may want to create a Designer report that summarizes data over all VDNs instead of over all splits/skills.

- Things to know about this report** Here are some things to know about this report:
- The System Multi-ACD report is available in daily, weekly, and monthly versions.
  - The database items used for the System Multi-ACD report are stored in the `dsplit` (daily), `wsplit` (weekly), and `msplit`(monthly) tables.
  - Standard Multi-ACD reports can include information on up to eight ACDs.

**Multi-ACD report input window** The following figure provides an example of a System Multi-ACD Input window. The report input window must be filled in to run the report.

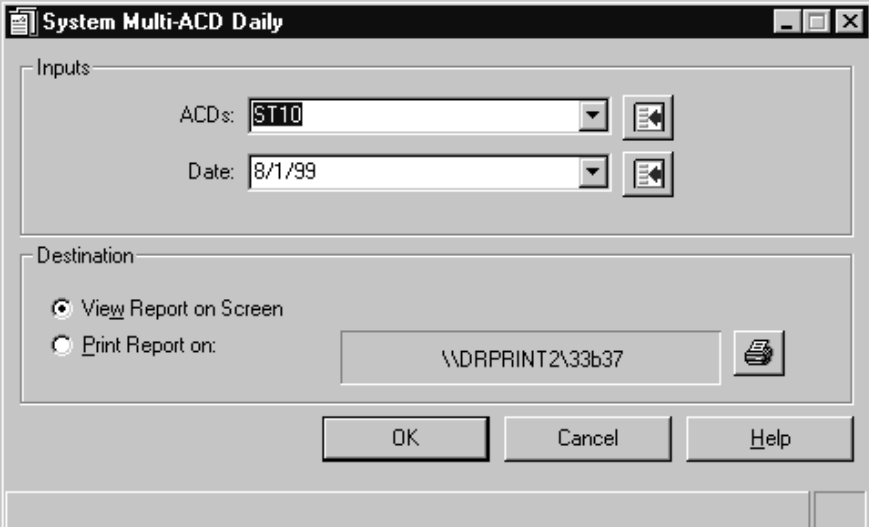

The screenshot shows a dialog box titled "System Multi-ACD Daily". It has two main sections: "Inputs" and "Destination".

**Inputs:**

- ACDs: A dropdown menu with "ST10" selected and a list icon to its right.
- Date: A dropdown menu with "8/1/99" selected and a list icon to its right.

**Destination:**

- View Report on Screen
- Print Report on: A text box containing "\\DRPRINT2\33b37" and a printer icon to its right.

At the bottom, there are three buttons: "OK", "Cancel", and "Help".

**Multi-ACD report input fields** The following table describes the fields on the input window.

Field	Definition
Date:	<p>Enter the date you would like the report to cover.</p> <ul style="list-style-type: none"> <li>• Daily - enter the day.</li> <li>• Weekly - enter the start date for the week. When you specify a date for a weekly report, that date must correspond to the week start day selected in the System Setup-Storage Intervals window. If the date and day do not match, the message No records found displays in the status line.</li> <li>• Monthly - enter the first day of the month.</li> </ul>
Dates: (daily, weekly, monthly)	<p>Enter the date(s) you would like the report to cover:</p> <ul style="list-style-type: none"> <li>• Daily - enter the day(s).</li> <li>• Weekly - enter the start date for the week(s). When you specify a date for a weekly report, that date must correspond to the week start day selected in the System Setup-Storage Intervals window. If the date and day do not match, the message No records found displays in the status line.</li> <li>• Monthly - enter the first day of the month(s).</li> </ul> <p>Use any of the following formats:</p> <ul style="list-style-type: none"> <li>• A month/day/year (for example, 3/21/96).</li> <li>• A minus (-) offset based on today's date (for example, -1 for yesterday).</li> <li>• A semicolon (;) to separate individual data entry items (for example, 3/21/96;3/23/96;3/25/96)</li> <li>• A hyphen (-) to designate a range of dates (for example, 3/21/96-3/25/96). For the weekly and monthly versions, the report includes any weeks or months that begin in the range.</li> </ul>
ACDs (1 - 8):	<p>Enter the appropriate ACD name(s) or number(s). You can enter more than one ACD by using a semicolon (;) to separate individual entries or using a hyphen (-) for a range of values.</p>
Destination:	<p>Choose a report destination. You can select View Report on Screen or Print Report on: and then use the Select Printer button to print the report on any Windows printer. The default printer is shown.</p>

**System Multi-ACD report example** The following figure provides an example of a System Multi-ACD report.

Split/Skill	ACD	Avg Speed Ans	Avg Aban Time	ACD Calls	Avg ACD Time	Avg ACW Time	Aban Calls	Max Delay	Flow In	Flow Out	Extn Out Calls	Avg Extn Out Time	% ACD Time	% Ans Calls
<b>Totals</b>		:01		2115	:11	:02	0	:01	0	0	549	:03	.10	100.00
<b>Skill1</b>	r6_dads1eas	:01		903	:09	:02	0	:01	0	0	176	:02	.14	100.00
<b>Skill2</b>	r6_dads2eas			0			0	:00	0	0	0		.00	
<b>Gold</b>	r6_dads3eas	:01		1212	:13	:01	0	:01	0	0	373	:04	.26	100.00
<b>Regular</b>	r6_dads4eas			0			0	:00	0	0	0		.00	

**System Multi-ACD report description** The following table describes the report fields for the time period covered by the report.

Report Heading	Description	Database Item, Calculation, or <Calculation Name>
Date, Week Starting, Month Starting	The day, week, or month for which the report ran. You make these selections in the report input window.	ROW_DATE
Split/Skill	The name or number of the split/skill that is selected for this report. You can make these selections in the report input window.	syn(SPLIT)
ACD	The ACD name or number for which the data was collected.	syn(ACD)
Avg Speed Ans	The average time the split/skill ACD calls were waiting in queue and ringing before being answered by an agent.	sum(ANSTIME)/ sum(ACDCALLS) <AVG_ANSWER_SPEED_SUM >
Avg Aban Time	The average time the split/skill ACD calls were waiting in queue or ringing before abandoning.	sum(ABNTIME)/ sum(ABNCALLS) <AVG_ABANDON_TIME_SUM>

Report Heading	Description	Database Item, Calculation, or <Calculation Name>
ACD Calls	The number of split/skill ACD calls that were queued to splits/skills in the ACD and answered by an agent for those splits/skills. This total also includes O_ACDCALLS if you have the Outgoing Call Management application (OCM) of ASAI. The O_ACDCALLS is the number of ACDCALLS that were placed by an adjunct; this is also referred to as predictive dialing.	sum(ACDCALLS)
Avg ACD Time	The average time the agents spent talking on ACD calls for this ACD. The average time includes O_ACDTIME if you have OCM.	sum(ACDTIME)/ sum(ACDCALLS) <AVG_ACD_TALK_TIM_SUM>
Avg ACW Time	The average time the agents spent in after call work for ACD calls to this ACD. This average time includes O_ACWTIME if you have OCM.	sum(ACWTIME)/ sum(ACDCALLS) <AVG_ACW_TIME_SUM>
Aban Calls	The number of ACD calls queued to split/skills in the ACD that abandoned while waiting in queue or ringing. This total includes calls with talk time less than the phantom abandoned call timer value, if it is set. This total also includes O_ABNCALLS if you have OCM. The O_ABNCALLS is the number of outbound ACD calls that were abandoned by the far end.	sum(ABNCALLS)
Max Delay	<p>The maximum time that a caller waited in queue and ringing before:</p> <ul style="list-style-type: none"> <li>• Being serviced</li> <li>• Abandoning</li> <li>• Being redirected</li> <li>• Receiving a busy signal</li> <li>• Being disconnected.</li> </ul> <p>The value shown in the Totals line is the maximum of the Max Delay values shown for the individual ACDs.</p>	max(MAXOCWTIME)
Extn Out Calls	The number of outbound extension calls made by agents logged into this ACD. Direct agent ACW out calls are not included.	sum(ACWOUTCALLS+ AUXOUTCALLS) <EXT_CALL_OUT>



Report Heading	Description	Database Item, Calculation, or <Calculation Name>
Avg Extn Out Time	The average time agents in this ACD spent talking on outbound extension calls.	$\frac{\text{sum}(\text{ACWOUTTIME} + \text{AUXOUTTIME})}{\text{sum}(\text{ACWOUTCALLS} + \text{AUXOUTCALLS})}$ <AVG_TALK_TIME_OUT_SUM >
% ACD Time	The percentage of staffed time that agents for the splits/skills in this ACD spent on ACD calls and in after call work.	$100 * \left( \frac{\text{sum}(\text{I\_ACD\_TIME} + \text{I\_ACW\_TIME})}{\text{sum}(\text{I\_STAFF\_TIME})} \right)$ <PERCENT_ACD_TIME_SUM>
% Ans Calls	The percentage of calls queued to the splits/skills in this ACD that were answered by agents for the splits/skills.	$100 * \left( \frac{\text{sum}(\text{ACD\_CALLS})}{\text{sum}(\text{CALLS\_OFFERED})} \right)$ <PERCENT_CALL_ANS_SUM>



# System Report

**Overview** The System report summarizes the activity for a set of splits/skills for the same ACD. You can use this report to compare split/skill performance for splits/skills performing similar functions for the same ACD.

**Things to know about this report** Here are some things to know about this report:

- If you have a switch without vectoring, Flow Out represents the number of calls redirected (by call forwarding or call coverage) from this split to another destination. In many cases, the summary numbers for Flow Out of one split may not match Flow In numbers for another split. These numbers may not match because calls were intraflowed into unmeasured splits, extensions within the ACD, or elsewhere. Also, the Flow In and Flow Out for a given split are typically not equal.
- Statistics in the report such as % AUX (percent auxiliary work) and Number of Extension-Out Calls are indicators of activities not directly related to ACD traffic.
- The System report is available in daily, weekly, and monthly versions.
- The database items used for the System report are stored in the **dsplit** (daily), **wsplit** (weekly), and **msplit** (monthly) tables.

**System report input window** The following figure provides an example of a System Report Input window. The report input window must be filled in to run the report.

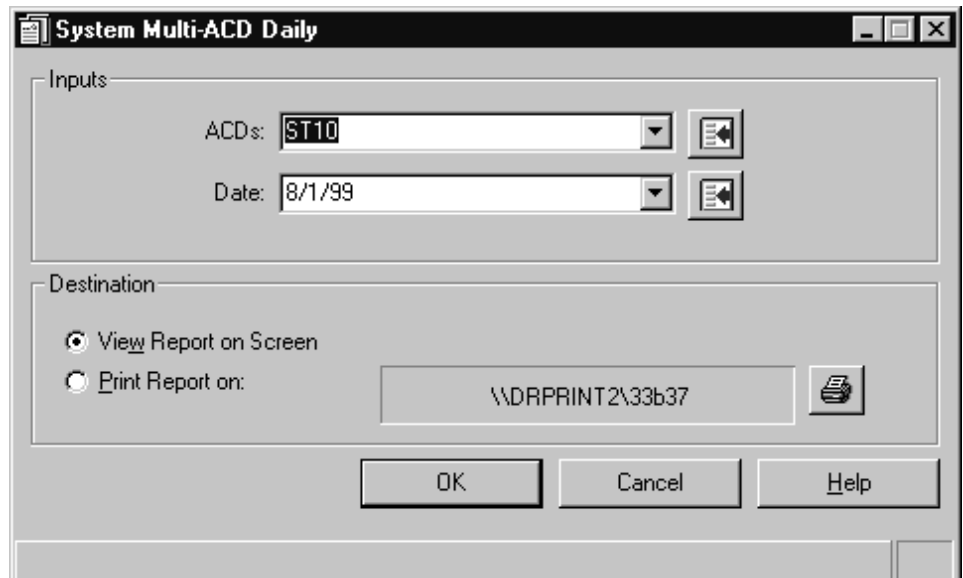

The screenshot shows a dialog box titled "System Multi-ACD Daily". It has two main sections: "Inputs" and "Destination".

**Inputs:**

- ACDs: A dropdown menu with "ST10" selected and a list icon to its right.
- Date: A dropdown menu with "8/1/99" selected and a list icon to its right.

**Destination:**

- View Report on Screen
- Print Report on: A text box containing "\\DRPRINT2\33b37" and a printer icon to its right.

At the bottom of the dialog are three buttons: "OK", "Cancel", and "Help".

**System report input fields** The following table describes the fields on the input window:

Field	Definition
Date:	<p>Enter the date you would like the report to cover:</p> <ul style="list-style-type: none"> <li>• Daily — enter the day.</li> <li>• Weekly — enter the start date for the week. When you specify a date for a weekly report, that date must correspond to the week start day selected in the System Setup—Storage Intervals window. If the date and day do not match, the message No records found displays in the status line.</li> <li>• Monthly — enter the first day of the month.</li> </ul> <p>Use any of the following formats:</p> <ul style="list-style-type: none"> <li>• A month/day/year (for example, 3/21/96).</li> <li>• A minus (-) offset based on today's date (for example, -1 for yesterday).</li> <li>• A semicolon (;) to separate individual data entry items (for example, 3/21/96;3/23/96;3/25/96).</li> </ul>
Destination:	<p>Choose a report destination. You can select View Report on Screen or Print Report on: and then use the Select Printer button to print the report on any Windows printer. The default printer is shown.</p>

**System report example** The following figure provides an example of a System report.

Split/Skill	Avg Speed Ans	Avg Aban Time	ACD Calls	Avg ACD Time	Avg ACW Time	Aban Calls	Max Delay	Flow In	Flow Out	Extn Out Calls	Avg Extn Out Time	% ACD	% Ans Calls
<b>Totals</b>	<b>:01</b>		<b>95962</b>	<b>:08</b>	<b>:00</b>	<b>0</b>	<b>:02</b>	<b>0</b>	<b>0</b>	<b>137</b>	<b>:02</b>	<b>3.77</b>	<b>100.00</b>
T22			0			0	:00	0	0	137	:02	.00	
T23	.01		95962	:08	:00	0	:02	0	0	0		16.23	100.00
Total			0			0	:00	0	0	0		.00	
sp998			0			0	:00	0	0	0		.00	

**System report description** The following table describes the report fields for the time period covered by the report.

Report Heading	Description	Database Item, Calculation, or <Calculation Name>
Date, Week Starting, Month Starting	The day, week, or month for which the report ran. You can make these selections in the report input window.	ROW_DATE
ACD	The ACD name or number for which the data was collected.	syn(ACD)
Split/Skill	The name or number of the split/skill that is selected for this report. You can make these selections in the report input window.	syn(SPLIT)
Avg Speed Ans	The average time the split/skill ACD calls were waiting in queue and ringing before being answered by an agent.	ANSTIME/ ACDCALLS, <AVG_ANSWER_S PEED>

Report Heading	Description	Database Item, Calculation, or <Calculation Name>
Avg Aban Time	The average time the split/skill ACD calls were waiting in queue or ringing before abandoning.	ABNTIME/ ABNCALLS <AVG_ABANDON_TIME>
ACD Calls	The number of split/skill ACD calls that were queued to this split/skill and answered by an agent for this split/skill. This total also includes O_ACDCALLS if you have the Outgoing Call Management (OCM) application of ASAI. The O_ACDCALLS is the number of ACDCALLS that were placed by an adjunct; this is also referred to as predictive dialing.	ACDCALLS
Avg ACD Time	The average time the agents spent talking on ACD calls for the split/skill. This average time includes O_ACDTIME if you have OCM.	ACDTIME/ ACDCALLS, <AVG_ACD_TALK_TIME>
Avg ACW Time	The average time the agent spent in after call work associated with ACD calls for the split/skill. This average time includes O_ACWTIME if you have OCM.	ACWTIME/ ACDCALLS, <AVG_ACW_TIME>
Aban Calls	The number of ACD calls to the split/skill that abandoned while either waiting in queue (if this was the first split/skill the call was queued to), or while ringing. This total includes calls with talk time less than the phantom abandoned call timer value, if it is set. This total also includes O_ABNCALLS if you have OCM. The O_ABNCALLS is the number of outbound ACD calls that were abandoned by the far end.	ABNCALLS
Max Delay	<p>The maximum time that a caller waited in queue and ringing before:</p> <ul style="list-style-type: none"> <li>• Being answered</li> <li>• Abandoning</li> <li>• Being redirected</li> <li>• Receiving a busy signal</li> <li>• Being disconnected.</li> </ul> <p>The value shown in the Totals line is the maximum of the Max Delay values shown in the individual intervals.</p>	MAXOCWTIME

Report Heading	Description	Database Item, Calculation, or <Calculation Name>
Flow In	<p>The number of calls that were redirected to the split/skill queue from another queue. The following calls are considered inflows:</p> <ul style="list-style-type: none"> <li>• For switches without vectoring, calls that intraflow from another split's queue to this split's queue</li> <li>• With multiple split/skill queuing ( <i>DEFINITY</i> ECS Generic 3 switches with vectoring), calls that queue to this split/skill as a nonprimary split/skill and are either answered by an agent in this split/skill or abandoned from ringing in this split/skill</li> <li>• For <i>DEFINITY</i> ECS Generic 3 Version 2 and later Generic 3 switches, calls that ring at an agent in this split/skill and then requeue to the same split/skill by the "Redirection on No Answer to a split/skill" feature.</li> <li>• When a call leaves a VDN (for example by routing to a VDN) or leaves vector processing (for example by routing to a split/skill), the next split/skill to which the call queues is not credited with an inflow.</li> </ul>	INFLOWCALLS
Flow Out	<p>The number of calls offered to this split/skill that were redirected to another destination. For switches without vectoring, calls that intraflow or interflow to another destination are counted as outflows.</p> <p>For switches with vectoring, an outflow is counted:</p> <ul style="list-style-type: none"> <li>• If the call routes to another VDN</li> <li>• If the call routes to a number or digits</li> </ul> <p>For <i>DEFINITY</i> ECS Generic 3 switches with vectoring, an outflow is also counted:</p> <ul style="list-style-type: none"> <li>• If the call queues to this split/skill as the primary split/skill and is redirected by the Redirection on No Answer feature (Generic 3 Version 2 and later <i>DEFINITY</i> ECS Generic 3 switches).</li> <li>• If the call queues to a messaging split/skill</li> <li>• If the call rang at an agent in this split/skill and was answered using call pickup</li> <li>• If the call queued to this split/skill as primary and was either answered by an agent in a nonprimary split/skill or abandoned from ringing at an agent in a nonprimary split/skill.</li> </ul>	OUTFLOWCALLS

Report Heading	Description	Database Item, Calculation, or <Calculation Name>
Extn Out Calls	The number of outbound extension calls made by agents logged into this split/skill. The direct agent ACW out calls are not included. For agents in multiple splits/skills, outbound AUX extension calls are included here if this split/skill is the first one that the agent logged into, unless the agent has an ACD call on hold. In this case, the outbound call is recorded for the split/skill associated with the ACD call.	( ACWOUTCALLS+ AUXOUTCALLS) <EXT_CALL_OUT>
Avg Extn Out Time	The average time agents in this split/skill spent talking on outbound extension calls. For agents in multiple splits/skills, time spent on outbound AUX extension calls is included here if this split/skill is the first one that the agent logged into, unless the agent has an ACD call on hold. In this case, the outbound call is recorded for the split/skill associated with the ACD call.	( ACWOUTTIME+ AUXOUTTIME)/ ( ACWOUTCALLS+ AUXOUTCALLS) <AVG_TALK_TIME_OUT>
% ACD Time	The percentage of staffed time that agents for this split/skill spent on ACD calls and in after call work for this split/skill.	100*(( I_ACDTIME+ I_ACWTIME)/ I_STAFFTIME), <PERCENT_ACD_TIME>
% Ans Calls	The percentage of calls queued to this split/skill that were answered by agents for this split/skill.	100*( ACDCALLS / CALLSOFFERED), <PERCENT_CALL_ANS>



---

# Trunk/Trunk Group Reports

## Overview

---

**Purpose** This section describes trunk and trunk group reports.

**Organization** This following topics are described:

- General Information About Trunk/Trunk Group Reports
- Trunk/Trunk Group Reports Selector Window
- Trunk/Trunk Group Reports Input Fields
- Busy Hour Report
- Trunk Report
- Trunk Group Report
- Trunk Group Summary Report





## General Information About Trunk/Trunk Group Reports

### What a Trunk/Trunk Group report contains

Trunk and Trunk Group reports display traffic data for a single trunk, summarize the incoming and outgoing traffic of every trunk in a trunk group for a specific time period, display the level of incoming and outgoing call traffic for an individual trunk group, or display the busiest hour of the day for each trunk group you select.

### Organization of Trunk/Trunk Group reports

The following list shows how the Trunk and Trunk Group reports are structured in *CentreVu* Supervisor.

- Busy Hour
- Trunk: Interval, Daily, Weekly, Monthly
- Trunk Group: Daily, Weekly, Monthly
- Trunk Group Summary: Interval, Daily, Weekly, Monthly

### Trunk/Trunk Group report selector window

The following figure is an example of the Trunk/Trunk Group report selector window. The reports are explained in the same order as listed in the window.

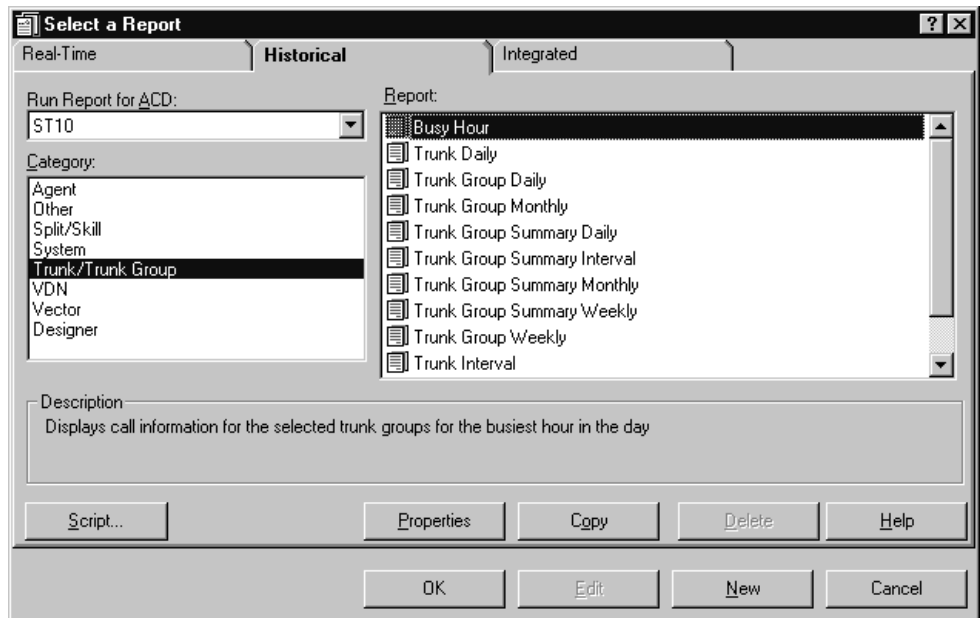

## Trunk/Trunk Group Report Input Fields

**Overview** The reports in this section use the Trunk/Trunk Group/Busy Hour Report Input Windows. Specific input information is included with the reports. The following figure shows an example of the Trunk/Trunk Group/Busy Hour Report input window. You must fill in the report input window to run the report.

**Trunk Group report input fields** The following table describes the input fields on historical Trunk/Trunk Group/Busy Hour report input windows. Not all reports use all fields; refer to information for the specific report you are running to determine what you want to view. For example, you may enter an a trunk or trunk group to run the report.

All possible fields on this window are described here:

Field	Definition
Trunk group: (daily, weekly, and monthly)	Enter the appropriate trunk group name or number. See on-line help for the valid numerical entries for your particular switch.
Date:	Enter the date you would like the report to cover: <ul style="list-style-type: none"> <li>A month/day/year (for example, 3/21/96).</li> <li>A minus (-) offset based on today's date (for example, -1 for yesterday).</li> </ul>
Dates: (daily, weekly, monthly)	Enter the date(s) for the day(s) or the start date(s) for the week(s) or the month(s) you would like the report to cover. <ul style="list-style-type: none"> <li>Daily - enter the day(s).</li> <li>Weekly - enter the start date for the week(s). When you specify a date for a weekly report, that date must correspond to the week start day selected in the System Setup-Storage Intervals window. If the date and day do not match, the message No records found displays in the status line.</li> <li>Monthly - enter the first day of the month(s).</li> </ul> Use any of the following formats: <ul style="list-style-type: none"> <li>A month/day/year (for example, 3/21/96).</li> <li>A minus (-) offset based on today's date (for example, -1 for yesterday).</li> <li>A semicolon (;) to separate individual data entry items (for example, 3/21/96;3/23/96;3/25/96)</li> <li>A hyphen (-) to designate a range of dates (for example, 3/21/96-3/25/96). For the weekly and monthly versions, the report includes any weeks or months that begin in the range.</li> <li>When you specify a date for a weekly report, that date must correspond to the week start day selected in the System Setup-Storage Intervals window. If the date and day do not match, the message No records found displays in the status line. The month start date must be the first day of the month.</li> </ul>

Field	Definition
Times: (interval)	<p>Enter the time you would like the report to cover. Use any of the following formats:</p> <ul style="list-style-type: none"><li>• AM/PM (for example, 7:30AM-5:00PM)</li><li>• Military time (for example, 7:30-17:00).</li><li>• You can use a "-" offset based on today's date (for example, -1 for yesterday).</li></ul>
Destination:	<p>Choose a report destination. You can select View Report on Screen or Print Report on: and then use the Select Printer button to print the report on any Windows printer. The default printer is shown.</p>



---

# Trunk/Trunk Group Busy Hour Report

---

**Overview** The Trunk/Trunk Group Busy Hour report displays the busiest hour of the day for each trunk group you select. The busiest hour is calculated as a set of contiguous intervals that make up an hour (one 60-minute interval, two 30-minute intervals, or four 15-minute intervals) in which the total holding time for the trunks in the trunk group was the maximum for the day.

**Things to know about this report** Here are some things to know about this report:

**this report**

- The Trunk/Trunk Group Busy Hour is available in daily version only.
- The busiest hour is calculated as a set of contiguous intervals that make up an hour (one 60-minute interval, two 30-minute intervals, or four 15-minute intervals) in which the total holding time for the trunks in the trunk group was the maximum for the day.
- The database items for the Trunk/Trunk Group Busy Hour report are stored in the `dtkgrp` (daily) table.
- You cannot customize this report.
- This report uses the Trunk/Trunk Group/Busy Hour report input window. Select a trunk group that you want to view on the report. See [Trunk/Trunk Group Report Input Fields \(4-126\)](#) for more information.

**Trunk/Trunk Group Busy Hour report example** The following figure provides an example of the Trunk/Trunk Group Busy Hour report.

Trunk Group Name	Busy Hour	Avg Trunk Holding Time	Calls Carried	Inbound Calls	Outbound Calls	ACD Calls	Aban Calls	Other Calls	% All Trunks Busy	% Occupancy
Tkgrp1	1:00 PM	:00:35	2219	664	524	524	401	1294	30:08	94.68
Tkgrp2	2:00 PM	:00:24	2406	704	602	400	300	400	32:04	96.87

**Trunk/Trunk Group Busy Hour report description** The following table describes the report fields.

Report Heading	Description	Database Item, Calculation, or <Calculation Name>
Date	Day for which the report was run (selected in the report input window).	ROW_DATE
Trunk Group Name	Trunk group name or number for which the report was requested.	syn(TKGRP)
Busy Hour	Start time of the hour in which the trunk group was the busiest.	BH_STARTTIME
Avg Trunk Holding Time	Average holding time for all incoming and outgoing calls in the trunk group that completed during the busy hour.	(BH_INTIME+BH_OUTTIME)/ (BH_INCALLS+BH_OUTCALLS)
Calls Carried	Total number of all incoming and outgoing calls carried by this trunk group that completed during the busy hour.	BH_INCALLS+BH_OUTCALLS
Inbound Calls	Total number of all incoming calls carried by this trunk group that completed during the busy hour.	BH_INCALLS

Report Heading	Description	Database Item, Calculation, or <Calculation Name>
Outbound Calls	Total number of all outgoing calls carried by this trunk group that completed during the busy hour.	BH_OUTCALLS
ACD Calls	Total number of all ACD calls carried by this trunk group and answered by an agent that completed during the busy hour.	BH_ACDCALLS + BH_OACDCALLS
Aban Calls	Total number of all calls abandoned by callers on this trunk group during the busy hour. With vectoring, this includes calls that were abandoned from vector processing. With <i>DEFINITY</i> ECS switches, this includes all calls carried by the trunk group that were abandoned, except for calls directly to unmeasured stations that did not go through a measured VDN or split/skill.	BH_ABNCALLS + BH_OABNCALLS
Other Calls	Number of calls that received a busy signal, calls disconnected, extension calls, short calls, and calls of unknown disposition.	BH_OTHERCALLS + BH_OOTHERCALLS
% All Trunks Busy	Percentage of time during the hour that all trunks were busy.	BH_ALLINUSETIME/36
% Occupancy	Percentage of time during the hour that trunks were occupied by incoming and outgoing calls.	(BH_INTIME + BH_OUTTIME)/ 100



---

# Trunk Report

---

**Overview** The Trunk report displays call traffic data for a single trunk. With this report, you can review trunks in any measured trunk group. You can use this report to verify that call traffic levels for a trunk are appropriate throughout the time period specified. You can also monitor outgoing calls made throughout the day.

- Things to know about this report** Here are some things to know about this report:
- The Trunk report is available in interval, daily, weekly, and monthly versions.
  - The database items for the Trunk report are stored in the **htrunk**(interval), **dtrunk** (daily), **wtrunk** (weekly), and **mtrunk** (monthly) tables.
  - The report item Centum Call Seconds (CCS) is the number of 100-second increments in which the trunk was busy during the intrahour interval. A trunk is "seized" while the call is both in queue and connected to an agent. Therefore, wait time for abandoned calls is figured into the CCS figures. For example, since a half-hour has 1800 seconds, the maximum CCS for each trunk in a trunk group is 18 CCS. Multiplying 18 CCS by the number of trunks in a trunk group gives you the maximum occupancy for the trunk group, which you can then compare with your actual CCS. If your intrahour interval is 15- or 60-minutes, your number will be different.
  - This report uses the Trunk/Trunk Group/Busy Hour report input window. Select a trunk group that you want to view on the report. See [Trunk/Trunk Group Report Input Fields \(4-126\)](#) for more information.

**Trunk report example** The following figure provides an example of the Trunk report.

The screenshot shows a window titled "Trunk Daily - tkgrp1" with a menu bar (Report, Edit, Format, Tools, Options, Help). Below the menu, it displays "Date: 3/27/98" and "Trunk Group Name: tkgrp1". The main content is a table with the following data:

Trunk	Inbound Calls	Aban Calls	Avg Inbound Trunk Hold Time	Inbound CCS	Outbound Calls	Outbound Aban Calls	Avg Outbound Trunk Hold Time	Outbound CCS	Maint Busy Time
<b>Totals</b>	17499	7633	:22	5341.26	22823	0	:44	11428.20	
0001E1701	611	332	:16	100.58	1142	0	:44	505.50	
0001E1702	600	319	:18	109.45	1118	0	:44	494.80	
0001E1703	662	336	:18	117.12	1095	0	:44	485.92	
0001E1704	613	292	:19	115.97	1095	0	:44	485.59	
0001E1705	623	314	:20	122.08	1083	0	:44	480.87	

The window title bar includes a standard OS icon and window controls. The bottom right corner of the window shows the text "r6\_dads1eas".

**Trunk report description** The following table describes the report fields.

Report Heading	Description	Database Item, Calculation, or <Calculation Name>
Date, Week Starting, Month Starting	Day, week, or month for which the report was run (selected in the report input window).	ROW_DATE
Trunk Group Name	Trunk group name or number for which the report was requested.	syn(TKGRP)
Trunk	Trunk number (physical equipment location) of the trunk.	EQLOC
ACD	ACD name or number associated with the trunk group.	syn(ACD)
Time (Interval only)	Intrahour intervals for which the report shows data (selected in the report input window).	STARTTIME, STARTTIME + INTRVL
Inbound Calls	Total number of all incoming calls carried by this trunk that completed during the specified time period.	INCALLS
Aban Calls	Total number of inbound calls abandoned by the caller during the specified time period.	ABNCALLS



Report Heading	Description	Database Item, Calculation, or <Calculation Name>
Avg Inbound Trunk Hold Time	Average holding time for all incoming calls that completed during the specified time period. Average holding time includes time in vector processing, in queue, ringing, talking, and holding.	INTIME / INCALLS; <AVG_TRK_HOLD_TIME_IN>
Inbound CCS	Total trunk occupancy by incoming calls during the specified time period.	I_INOCC / 100
Outbound Calls	Total number of all outgoing calls carried by this trunk that completed during the specified time period.	OUTCALLS
Outbound Aban Calls	Number of outbound ACD calls (if you have the outgoing call management application on ASAI) abandoned at the far end. ( <i>DEFINITY</i> ECS switches with ASAI).	O_ABNCALLS
Avg Outbound Trunk Hold Time	Average holding time of all outgoing calls that completed during the specified time period.	OUTTIME / OUTCALLS; <AVG_TRK_HOLD_TIM_OUT>
Outbound CCS	Total trunk occupancy of outgoing calls during the specified time period.	I_OUTOCC/100
Maint Busy Time	Total time of all maintenance-busy periods for this trunk for the time period.	MBUSYTIME



---

# Trunk Group Report

---

**Overview** The Trunk Group report summarizes the incoming and outgoing traffic of every trunk in a trunk group for the specified time period. You could use this report to verify that the number of trunks available to your splits/skills is appropriate and to monitor the number of outgoing calls.

Also, because it lists trunks by physical location on the switch and totals trunk failures, the Trunk Group report can be useful for troubleshooting problems with trunks.

**Things to know about this report** Here are some things to know about this report:

- The Trunk Group report is available in daily, weekly, and monthly versions.
- The database items for the Trunk Group report are stored in the **dtrunk** (daily), **wtrunk** (weekly), and **mtrunk** (monthly) tables.
- The report item Centum Call Seconds (CCS) is the number of 100-second increments in which the trunk was busy during the intrahour interval. A trunk is "seized" while the call is both in queue and connected to an agent. Therefore, wait time for abandoned calls is figured into the CCS figures. For example, since a half-hour has 1800 seconds, the maximum CCS for each trunk in a trunk group is 18 CCS. Multiplying 18 CCS by the number of trunks in a trunk group gives you the maximum occupancy for the trunk group, which you can then compare with your actual CCS. If your intrahour interval is 15 or 60 minutes, your number will be different.
- For the *DEFINITY* ECS and Generic 3 switches, trunks that fail are immediately put in the Maintenance Busy State.
- This report uses the Trunk/Trunk Group/Busy Hour report input window. Select a trunk group that you want to view on the report. See [Trunk/Trunk Group Report Input Fields \(4-126\)](#) for more information.

**Trunk Group report example** The following figure provides an example of the Trunk Group report.

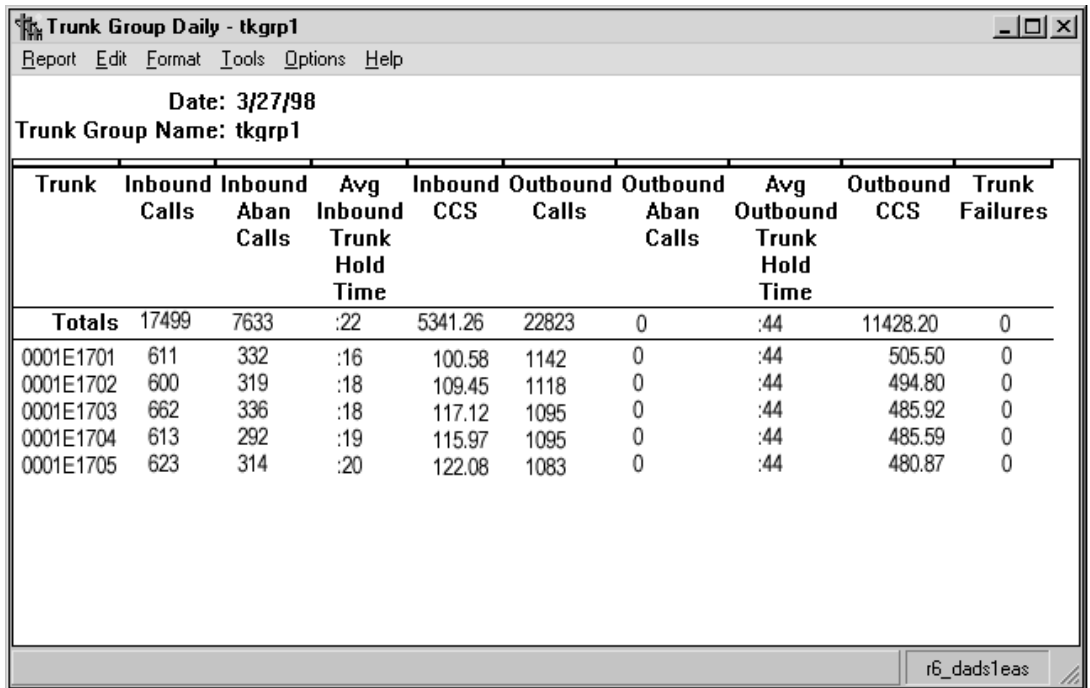

Trunk	Inbound Calls	Inbound Aban Calls	Avg Inbound Trunk Hold Time	Inbound CCS	Outbound Calls	Outbound Aban Calls	Avg Outbound Trunk Hold Time	Outbound CCS	Trunk Failures
<b>Totals</b>	17499	7633	:22	5341.26	22823	0	:44	11428.20	0
0001E1701	611	332	:16	100.58	1142	0	:44	505.50	0
0001E1702	600	319	:18	109.45	1118	0	:44	494.80	0
0001E1703	662	336	:18	117.12	1095	0	:44	485.92	0
0001E1704	613	292	:19	115.97	1095	0	:44	485.59	0
0001E1705	623	314	:20	122.08	1083	0	:44	480.87	0

**Trunk Group report description** The following table describes the report fields.

Report Heading	Description	Database Item, Calculation, or <Calculation Name>
Date, Week starting, Month starting	Day, week, or month for which the report was run (selected in the report input window).	ROW_DATE
Trunk Group Name	Trunk group name or number for which the report was requested.	syn(TKGRP)
ACD	ACD name or number associated with the trunk group.	syn(ACD)
Trunk	Trunk number (physical equipment location) of the trunk.	EQLOC
Inbound Calls	Total number of inbound calls carried by this trunk that completed during the specified time period.	sum(INCALLS)
Aban Calls	Total number of inbound calls abandoned by the caller during the specified time period.	sum(ABNCALLS)

Report Heading	Description	Database Item, Calculation, or <Calculation Name>
Avg Inbound Trunk Hold Time	Average holding time for all incoming calls that completed during the time period. Average holding time includes time in vector processing, in queue, ringing, talking, and on hold.	sum( INTIME)/sum( INCALLS) <AVG_TRK_HOLD_IN_SUM>
Inbound CCS	Total trunk occupancy by incoming calls during the specified time period.	sum(I_INOCC)/100
Outbound Calls	Number of outbound calls that were carried by this trunk that completed during the specified time period.	sum(OUTCALLS)
Outbound Aban Calls	Number of outbound ACD calls (if you have the Outgoing Call Management application on ASAI) that abandoned at the far end.	sum(O_ABNCALLS)
Avg Outbound Trunk Hold Time	Average holding time of all outgoing calls on this trunk that completed during the specified time period.	sum(OUTTIME)/ sum( OUTCALLS) <AVG_TRK_HOLD_OUT_SUM>
Outbound CCS	Total trunk occupancy of outgoing calls during the specified time period.	sum(I_OUTOCC) / 100
Trunk Failures	Number of trunk failures for this trunk or total for the trunk group.	sum(FAILURES)



---

# Trunk Group Summary Report

---

**Overview** The Trunk Group Summary report shows the level of incoming and outgoing call traffic for an individual trunk group. You could use this report to verify that the number of trunks available to your splits is appropriate and to monitor the number of outgoing calls.

**Things to know about this report** Here are some things to know about this report:

- The Trunk Group Summary report is available in interval, daily, weekly, and monthly versions.
- The database items for the Trunk Group Summary report are stored in the `htkgrp` (interval), `dtkgrp` (daily), `wtkgrp` (weekly), and `mtkgrp` (monthly) tables.
- For both inbound and outbound calls, Call Carried = Calls Answered + Calls Abandoned + Other Calls. Also, Other Calls = Calls Given a Busy Signal + Calls Disconnected by the Switch + Calls Answered by an Unmeasured Agent.
- The report item Centum Call Seconds (CCS) is the number of 100-second increments in which the trunk was busy during the intrahour interval. A trunk is "seized" while the call is both in queue and connected to an agent. Therefore, wait time for abandoned calls is figured into the CCS figures. For example, since a half-hour has 1800 seconds, the maximum CCS for each trunk in a trunk group is 18 CCS. Multiplying 18 CCS by the number of trunks in a trunk group gives you the maximum occupancy for the trunk group, which you can then compare with your actual CCS. If your intrahour interval is 15 or 60 minutes, your number will be different.
- A Trunk Group Summary can have two entries for one interval if the trunk group termination changed during that interval. For example, at the start of the interval, trunk group 2 terminates at VDN58803. During the interval the termination is changed to VDN58804. The system shows two trunk group records for reports (interval, daily, weekly, and monthly) containing the interval in which the termination was changed.
- The report item % Time All Trunks Busy, which is a good indicator of how many callers being blocked (getting a busy signal), should be a relatively low figure in most call centers.
- This report uses the Trunk/Trunk Group/Busy Hour report input window. Select a trunk group that you want to view on the report. See [Trunk/Trunk Group Report Input Fields \(4-126\)](#) for more information.

**Trunk Group Summary report example**

The following figure provides an example of the Trunk Group Summary report.

Date	Inbound Calls	ACD Calls	Inbound Aban Calls	Other Calls	Avg Inbound Trunk Hold Time	Inbound CCS	Outbound Calls	Outbound ACD Calls	Outbound Aban Calls	Outbound Other Calls	Avg Outbound Trunk Hold Time	Outbound CCS	Outbound Far End Comp	Outbound Blocked Calls	% All Trunks Busy	% Main Bus
<b>Totals</b>	17499	9861	7633	5	:22	5341.26	22823	0	0	22823	:44	11428.20	1199	0	19.47	0.00
12:00-12:30AM	602	463	138	1	:15	89.51	715	0	0	715	:40	288.53	294	0	18.72	0.00
12:30-1:00AM	592	462	130	0	:15	90.92	722	0	0	722	:40	290.91	275	0	18.17	0.00
1:00-1:30AM	535	406	129	0	:15	80.65	709	0	0	709	:42	297.09	176	0	16.56	0.00
1:30-2:00AM	509	385	124	0	:16	81.28	719	0	0	719	:43	306.03	144	0	24.00	0.00
2:00-2:30AM	558	424	134	0	:14	79.78	714	0	0	714	:43	306.27	138	0	21.39	0.00

**Trunk Group Summary report description**

The following table describes the report fields.

Report Heading	Description	Database Item, Calculation, or <Calculation Name>
Trunk Group Name:	Name or number of the trunk group for which the report was requested.	syn(TKGRP)
Number of trunks:	Number of trunks in the trunk group.	TRUNKS
Time (for interval reports only)	Intrahour intervals for which the report shows data (selected in the report input window).	STARTTIME, STARTTIME + INTRVL
Date, Week starting, Month starting	Day, week, or month for which the report was run (selected in the report input window).	ROW_DATE
Inbound Calls	Total number of inbound calls carried by this trunk group that completed during the specified time period.	sum(INCALLS)
ACD Calls	Total number of inbound split/skill or direct agent calls answered by agents that completed during the specified time period.	sum(ACDCALLS)
Inbound Aban Calls	Total number of inbound calls abandoned by the caller during the specified time period.	sum(ABNCALLS)

Report Heading	Description	Database Item, Calculation, or <Calculation Name>
Other Calls	Number of inbound calls that were not answered as ACD calls or abandoned. This includes calls that were forced busy, disconnected, answered extension-in calls, calls outflowed off the switch, short inbound calls, and calls with unknown dispositions.	sum(OTHERCALLS)
Avg Inbound Trunk Hold Time	Average trunk holding time for all incoming calls that completed during the period. This is the average length of time a typical incoming call made use of a trunk (the trunk could not be used for another call during that time).	sum(INTIME)/sum(INCALLS) <AVG_TRK_HOLD_IN_SUM>
Inbound CCS	Total trunk occupancy by incoming calls during the specified time period.	sum(I_INOCC) (in seconds)/100
Outbound Calls	Number of outbound calls that were carried by this trunk group that completed during the specified time period.	sum(OUTCALLS)
Outbound ACD Calls	Total number of outbound calls (if you have the Outgoing Call Management application on ASAI) that were offered to one or more splits/skills and handled by an agent in one of those splits/skills.	sum(O_ACDCALLS)
Outbound Aban Calls	Number of outbound ACD calls (if you have the Outgoing Call Management application on ASAI) that abandoned at the far end.	sum(O_ABNCALLS)
Outbound Other Calls	Number of outbound calls that were not answered or abandoned as ACD calls. This includes calls that were given a busy or disconnect by the switch, extension-out calls, short outgoing calls, and calls of unknown disposition.	sum(O_OTHERCALLS)
Avg Outbound Trunk Hold Time	Average trunk holding time for outgoing calls carried by this trunk group that completed during the specified time period.	sum(OUTTIME)/ sum(OUTCALLS) <AVG_TRK_HOLD_OUT_SUM>
Outbound CCS	Total trunk occupancy of outgoing calls during the specified time period.	sum(I_OUTOCC) / 100
Outbound Far End Comp	Number of outbound calls that were answered at the far end ( <i>DEFINITY</i> ECS switch only).	sum(COMPLETED)
Outbound Blocked Calls	The number of outbound call attempts that were blocked because all the trunks were busy.	sum(BLOCKAGE)

Report Heading	Description	Database Item, Calculation, or <Calculation Name>
% All Trunks Busy	Percentage of time that all trunks were busy during the specified time period.	For interval $100 * \text{sum}(\text{ALLINUSETIME}) / \text{sum}(\text{INTRVL} * 60)$ For daily: <PERCENT_AL_BSY_SUM_D> For weekly: <PERCENT_AL_BSY_SUM_W> For monthly: <PERCENT_AL_BSY_SUM_M>
% Maint Busy	Percentage of time that trunks were out of service for maintenance during the specified time period.	for interval: $100 * \text{sum}(\text{MBUSYTIME}) / (\text{avg}(\text{INTRVL} * 60) * \text{sum}(\text{TRUNKS}))$ For daily: <PERCENT_MBUSY_SUM_D> For weekly: <PERCENT_MBUSY_SUM_W> For monthly: <PERCENT_MBUSY_SUM_M>





# VDN Reports

---

## Overview

---

**Purpose** This section describes VDN reports.

**Organization** This following topics are described:

- General Information About VDN Reports
- VDN Reports Selector Window
- VDN Reports Input Fields
- VDN Busy Hour Report
- VDN Call Profile Report
- VDN Graphical Busy/Abandon/Disconnect Comparison Report
- VDN Graphical Call Profile Report
- VDN Graphical Service Level Report
- VDN Multi-ACD Flow Report
- VDN Report
- VDN Skill Preference Report



---

## General Information About VDN Reports

---

- What a VDN Report contains** The VDN reports give you the following specific information about VDNs and vectors:
- A summary of incoming ACD call-handling performance for a specified VDN
  - Specific call data for a single VDN
  - The number of calls answered by a measured agent or calls connected to a non-ACD destination (like an attendant) and the abandoned calls that were processed by a VDN in a selected time period
  - For the busiest hour in a selected day, call-handling data for selected VDNs
  - Call-handling data for several VDNs and ACDs.
- Organization of VDN reports** The following list shows how the VDN reports are structured in *CentreVu* Supervisor :
- Busy Hour
  - Call Profile: Daily, Weekly, Monthly
  - Graphical Call Profile: Daily
  - Graphical Busy/Abandon/Disconnect: Daily
  - Graphical Service Level: Interval
  - Multi-ACD Flow: Daily, Weekly, Monthly
  - Report: Interval, Daily, Weekly, Monthly
  - Skill Preference Report: Interval, Daily, Weekly, Monthly

**VDN report selector window** The following figure is an example of the VDN Reports selector window. The reports are explained in the same order as listed in the window.

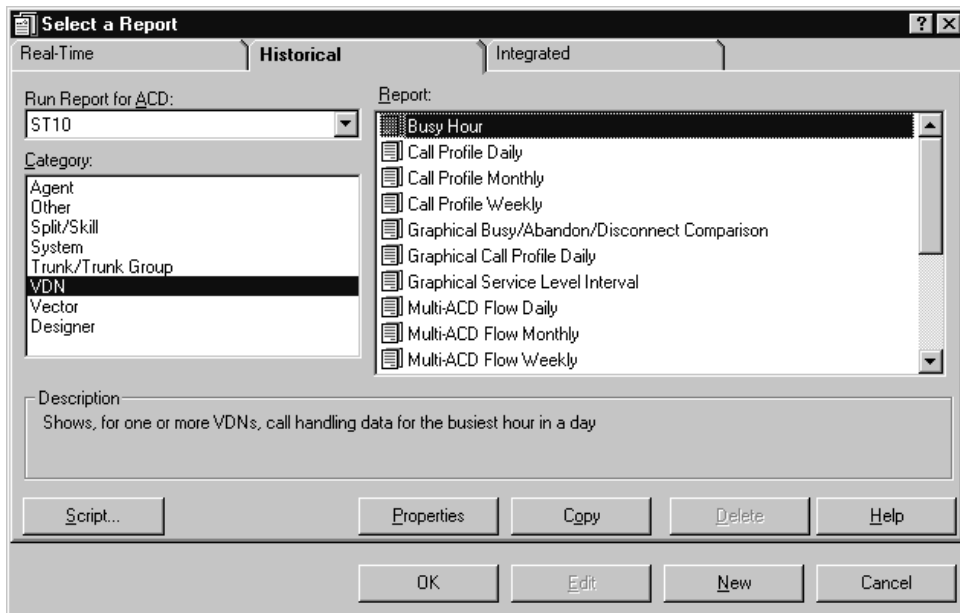

## VDN Report Input Fields

---

**VDN report input fields** The following table describes the input fields on historical VDN report input windows. Not all reports use all fields; refer to information for the specific report you are running to determine what you want to view. You will generally select a VDN to run the report.

All possible fields on this window are described here:

Field	Definition
VDN:	Enter the name or number of the VDN you want to include in the report.
Date:	Enter the date you would like the report to cover: <ul style="list-style-type: none"> <li>• A month/day/year (for example, 3/21/96).</li> <li>• A minus (-) offset based on today's date (for example, -1 for yesterday).</li> </ul>
Times: (interval)	Enter the time you would like the report to cover. Use any of the following formats: <ul style="list-style-type: none"> <li>• AM/PM (for example, 7:30AM-5:00PM)</li> <li>• Military time (for example, 7:30-17:00).</li> <li>• You can use a "-" offset based on today's date (for example, -1 for yesterday).</li> <li>• Select the information from the pull-down list of previously used items. During each CMS session, Supervisor recalls the items you have selected for each input field. You can use the pull-down list to select an item for the input field.</li> <li>• Use the Browse button to view all available items for the input field, and then select a item(s) for the input field. When you select the Browse button, a window opens that lets you select items for the input field.</li> </ul>
Destination:	Choose a report destination. You can select View Report on Screen or Print Report on: and then use the Select Printer button to print the report on any Windows printer. The default printer is shown.



# VDN Busy Hour Report

**Overview** The VDN Busy Hour report shows call handling data for the busiest hour in the selected day for each selected VDN.

The busiest hour is the set of contiguous intervals, totaling an hour, that had the highest number of incoming calls for the VDN. For example, if your system stores data in 15-minute intervals, the busiest hour might be the four intervals from 10:15 a.m. to 11:15 a.m. or the four intervals from 4:30 p.m. to 5:30 p.m.

**Things to know about this report** Here are some things to know about this report:

- The "Calls Offered" report item includes all calls that entered the VDN.
- The VDN Busy Hour report is available in interval version only.
- The database items used in the VDN Busy Hour are stored in the `hvdn` (interval) table.
- This report uses the VDN report input window. Select a VDN that you want to view on the report. See [VDN Report Input Fields \(4-144\)](#) for more information.

**VDN Busy Hour report example** The following figure provides an example of the VDN Busy Hour report.

VDN Name	Busy Hour	Inbound Calls	ACD Calls	Avg ACD Time	Aban Calls	Forced Busy Calls	Forced Disc Calls	Other Calls
Design Dynamics	1:30AM	2	1	:17	1	0	0	0
Electronics Inc.	5:30AM	4001	4001	:08	0	0	0	0

**VDN Busy Hour report description** The following table describes the report fields.

Report Heading	Description	Database Item, Calculation, or <Calculation Name>
Date	Day for which the report was run (selected in the report input window).	ROW_DATE
ACD	ACD associated with the VDNs in the report. This ACD is always the current ACD.	syn(ACD)
VDN Name	Number or name of each VDN for which the report shows data (selected in the report input window).	syn( VDN)
Busy Hour	Busiest hour is the set of contiguous intervals totaling an hour that had the highest number of completed incoming calls to the associated VDN.	BH_STARTTIME
Inbound Calls	Number of calls to the VDN that were completed in the busy hour.	BH_VDNCALLS
ACD Calls	Number of calls to the VDN completed during the busy hour that were answered by an agent as split/skill or direct agent calls.	BH_ACDCALLS
Avg ACD Time	Average time that agents spent talking to callers on split/skill and direct agent ACD calls that completed during the busy hour to the VDN. This does not include HOLDTIME.	BH_ACDDTIME/ BH_ACDCALLS
Aban Calls	Number of calls to the VDN that were abandoned during the busy hour.	BH_ABNCALLS
Forced Busy Calls	Number of calls that received a forced busy signal while being processed by the VDN (in the busy hour).	BH_BUSYCALLS
Forced Disc Calls	Number of calls that received a forced disconnect while being processed by the VDN (in the busy hour).	BH_DISCCALLS
Other Calls	Number of calls that connected to a non-ACD destination while being processed by the VDN (in the busy hour).	BH_OTHERCALLS - BH_BUSYCALLS - BH_DISCCALLS



# VDN Call Profile Report

---

**Overview** The VDN Call Profile report displays the numbers of answered/connected and abandoned calls within each of the administered service level increments for the VDN during the selected time period. The VDN Call Profile report also displays the acceptable service level administered for the VDN and the percentage of calls completed during the reporting period that were answered/connected within that service level. Because this report shows you how long it takes for calls to be answered or abandoned, you can determine how long callers are willing to wait for agents before hanging up. With this information, you can determine the answering speed required to reduce the number of abandoned calls.

- Things to know about this report** Here are some things to know about this report:
- The VDN Call Profile report is available only if the Vectoring feature has been purchased and authorized for you to use.
  - Each of the ten columns represents a progressively longer wait time. For example, the first column shows calls answered/connected in less than or equal to PERIOD1 seconds, the second column shows calls answered/connected in less than or equal to PERIOD2 seconds, but greater than PERIOD1 seconds, and so on.
  - Calls receiving a forced busy or disconnect and calls that outflow (for example, routed to another VDN) are not considered in the VDN Call Profile report.
  - The VDN Call Profile report is available in daily, weekly, and monthly versions.
  - The database items used in the VDN Call Profile report are stored in the `dvdn` (daily), `wvdn` (weekly), and `mvdn` (monthly) tables.
  - This report uses the VDN report input window. Select a VDN that you want to view on the report. See [VDN Report Input Fields \(4-144\)](#) for more information.

**Prerequisite system administration** You must define your acceptable service level and service level increments for this VDN in the VDN Call Profile Setup window. If you do not define your service level and increments, zero (0) is used for all increments, and all calls appear in the first increment. See Chapter 7, "Call Center Administration" in the *CentreVu Call Management System Release 3 Version 8 Administration 585-210-910* document for more information.

**VDN Call Profile report example** The following figure provides an example of the VDN Call Profile report.

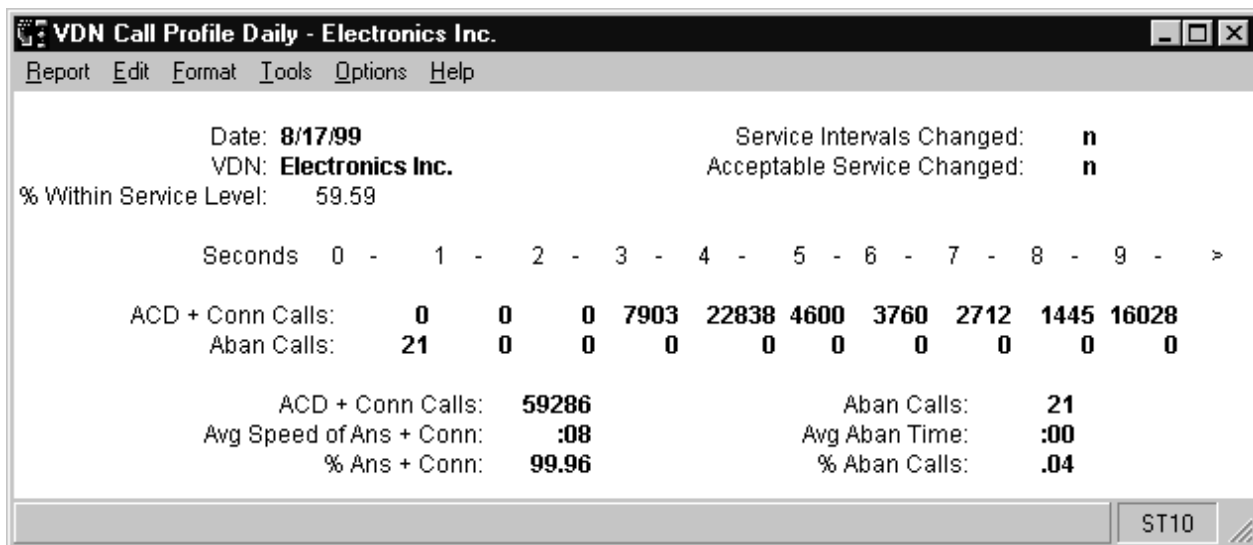

**VDN Call Profile report description** The following table describes the report fields.

Report Heading	Description	Database Item, Calculation, or <Calculation Name>
Date, Week Starting, Month Starting	Day, week, or month for which the report was run (selected in the report input window).	ROW_DATE
VDN	Number or name of the VDN for which the report shows data (selected in the report input window).	syn( VDN)
ACD	ACD name or number for which the report was run.	syn( ACD)
% Within Service Level	Percentage of incoming calls to the VDN that were answered by a measured agent or connected to a non-ACD destination within the service level (as specified in the VDN Call Profile Setup window).	100*(sum( ACCEPTABLE)/sum( INCALLS)), <PERCENT_SERV_LVL_VDN >
Service Intervals Changed	Indication (YES/NO) as to whether the call profile increments (in the VDN Call Profile window) were changed within the time frame of the report.	syn(YES_NO)
Acceptable Service Changed	Indication (YES/NO) as to whether the acceptable service level (in the VDN Call Profile Setup window) was changed within the time frame of the report.	syn(YES_NO)



Report Heading	Description	Database Item, Calculation, or <Calculation Name>
Seconds	Lower and upper limits in seconds of each service level increment (as defined in the VDN Call Profile Setup window). These increments represent progressively longer wait time segments in which calls may be answered by a measured agent, connected to a non-ACD destination, or abandoned.	PERIOD1-9
ACD+Conn Calls	Number of calls that, while carried by this VDN, were answered by a measured agent or were connected to a non-ACD destination within each of the service level increments. With <i>DEFINITY</i> ECS Generic 3 switches, connected means calls answered at a non-ACD destination.	sum( ANSCONNCALLS1), sum( ANSCONNCALLS2), through sum(ANSCONNCALLS10)
Aban Calls	Number of incoming calls to the VDN that hung up before they could be answered within each of the service level increments.	sum( ABNCALLS1), sum( ABNCALLS2), through sum(ABNCALLS10)
ACD+Conn Calls (total)	Number of calls that, while being carried by this VDN, were answered by an agent or were connected (to a non-ACD destination). With <i>DEFINITY</i> ECS Generic 3 switches, "connected" means calls answered at a non-ACD destination.	sum( ACDCALLS + CONNECTCALLS)
Avg Speed of Ans+Conn	Average time, in minutes and seconds, that calls completed in this interval waited before they were answered by an agent or were connected (to a non-ACD destination). This average includes direct agent calls (Generic 3 switches only). With <i>DEFINITY</i> ECS Generic 3 switches, "connected" means calls answered at a non-ACD destination.	sum( ANSTIME + CONNECTTIME) / sum ( ACDCALLS + CONNECTCALLS)
% Ans+Conn	Percentage of calls to the VDN answered by a measured agent or connected to a non-ACD destination within the service level. With <i>DEFINITY</i> ECS Generic 3 switches, "connected" means calls answered at a non-ACD destination.	100*(sum( ACDCALLS + CONNECTCALLS) / sum( INCALLS)), <PERCENT_VDN_ANSCONN >
Aban Calls	Number of calls that were abandoned while being carried by the VDN.	sum( ABNCALLS)
Avg Aban Time	Average time that calls waited before the callers abandoned them.	sum( ABNTIME)/ sum( ABNCALLS), <AVG_ABANDON_ TIME_SUM>

Report Heading	Description	Database Item, Calculation, or <Calculation Name>
% Aban	Percentage of calls that abandoned while carried by this VDN.	100*(sum( ABNCALLS) / sum( INCALLS)), <PERCENT_VDN_ABAN>



# VDN Graphical Busy/Abandon/Disconnect Comparison Report

---

**Overview** This report shows the percent of busy, abandon, and disconnect for summarized VDNs in one ACD for the date you specify.

**Things to know about this report**

Here are some things to know about this report:

- The selected ACD is displayed at the bottom right of the report.
- A legend on the right side of the report shows the color scheme for % Busy, % Abandon, and % Disconnect.
- % Busy refers to the percentage of the total calls that are busy for all VDNs on the ACD.
- % Abandon refers to the percentage of the total calls that abandoned for all VDNs on the ACD.
- % Disconnect refers to the percentage of the total calls that are disconnected for all VDNs on the ACD.
- The chart type can be changed. See Chapter 2, “Using Reports”, for more information.
- The database items are stored in the `dvdn` (daily) table.
- This report is only available through the *CentreVu* Supervisor interface.
- This report uses the VDN report input window. Select a VDN that you want to view on the report. See [VDN Report Input Fields \(4-144\)](#) for more information.
- This report is only available for *DEFINITY* R8 ACDs.

**VDN Graphical Busy/  
Abandon/Disconnect  
Comparison report  
example**

The following figure provides an example of the VDN Graphical Call Profile report.

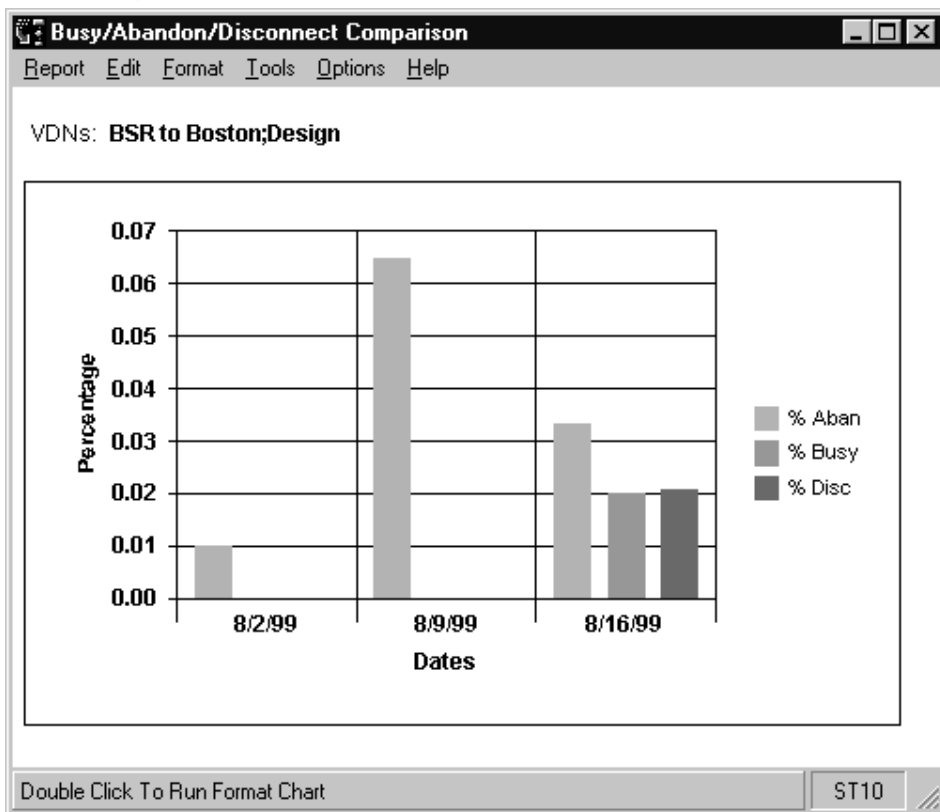

**VDN Graphical Call Profile report description** The following table describes the report fields.

Report Heading	Description	Database Item, Calculation, or <Calculation Name>
Date:	The day for which the report was run (selected in the report input window).	ROW_DATE
VDN:	The number or name of the VDN for which the report shows data (selected in the report input window).	VDN or syn(VDN)
ACD	ACD name or number that is sending calls to the VDN.	syn( ACD)
Abandon	The percentage of the total number of calls in all VDNs in the selected ACD that abandoned on the selected date.	$100 * (\text{sum}(\text{ABNCALLS}) / \text{sum}(\text{INCALLS}))$ . Note that this calculation is not a standard CMS calculation — it is only available through reports.
Busy	The percentage of the total number of calls in all VDNs in the selected ACD that were busy for the selected date.	$100 * (\text{sum}(\text{BUSYCALLS}) / \text{sum}(\text{INCALLS}))$ . Note that this calculation is not a standard CMS calculation — it is only available through reports.
Disconnect	The percentage of the total number of calls in all VDNs in the selected ACD that disconnected on the selected date.	$100 * (\text{sum}(\text{DISCCALLS}) / \text{sum}(\text{INCALLS}))$ . Note that this calculation is not a standard CMS calculation — it is only available through reports.



# VDN Graphical Call Profile Report

---

**Overview** This report shows how calls to the VDN you specify are being handled compared to your call center's predefined Acceptable Service Level for the date you specify.

- Things to know about this report** Here are some things to know about this report:
- This report has four charts and displays a collection of VDN call profile related data items at the top of the report. The box to the right of each chart is a legend.
  - The three-dimensional pie chart in the upper-left quadrant shows the percentage of ACD calls answered within the predefined Acceptable Service Level and the percentage of ACD calls answered outside this level. The numerical value represented by each pie piece is shown inside the pie chart.
  - The stacked area graph in the lower-left quadrant shows the number of ACD calls answered and abandoned within each service level. Note that the number displayed for each service interval is the upper limit of the interval. (For example, if the first two intervals are "5" and "10," the first data point shows answers/abandons within 0-5 seconds, and the second data point shows answers/abandons within 6-10 seconds.)
  - The three-dimensional pie charts on the right side of the report show the Percentage Answered Distribution and the Percentage Abandoned Distribution. The numerical value represented by each pie piece is shown inside the pie chart.
  - The chart type can be changed. See Chapter 2, "Using Reports", for more information.
  - The database items are stored in the `dvdn` (daily) table.
  - This report is only available through the *CentreVu* Supervisor interface.
  - This report uses the VDN report input window. Select a VDN that you want to view on the report. See [VDN Report Input Fields \(4-144\)](#) for more information.

**VDN Graphical Call Profile report example**

The following figure provides an example of the VDN Graphical Call Profile report.

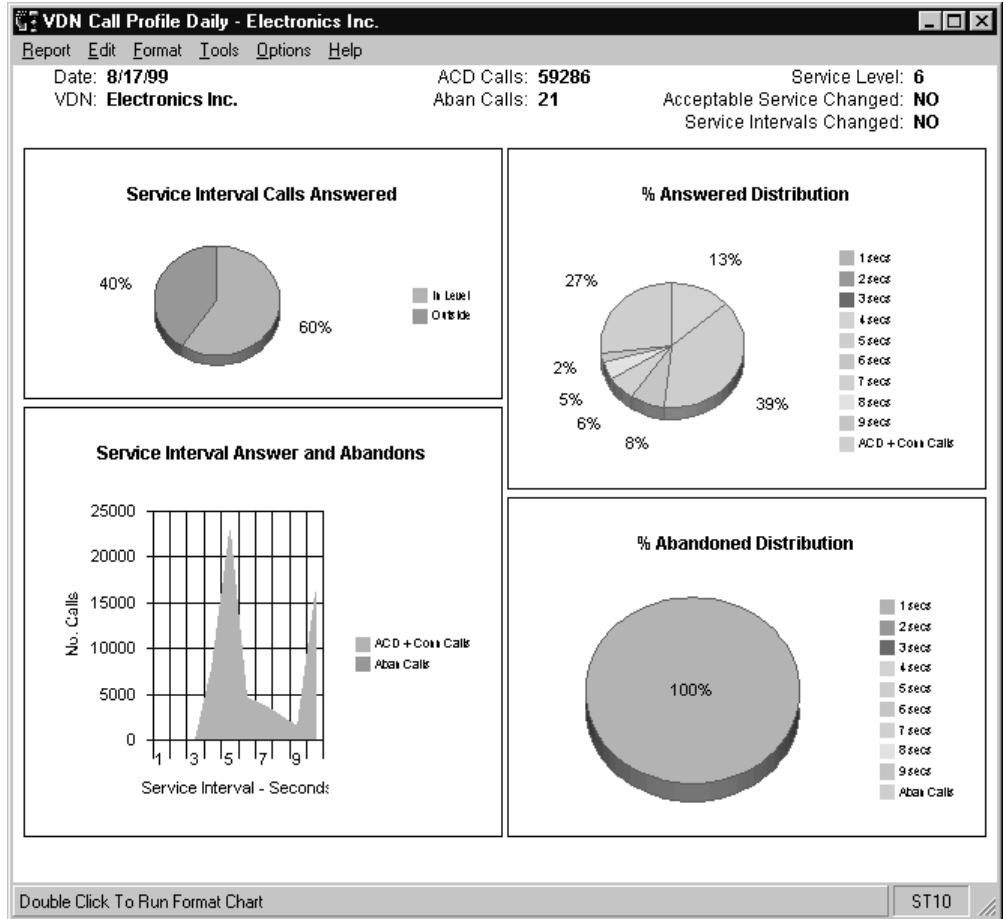

**VDN Graphical Call Profile report description**

The following table describes the report fields.

Report Heading	Description	Database Item, Calculation, or <Calculation Name>
Date:	The day for which the report was run (selected in the report input window).	ROW_DATE
VDN:	The number or name of the VDN for which the report shows data (selected in the report input window).	VDN or syn(VDN)
ACD Calls:	The total number of calls answered within the VDN for that day.	ACDCALLS
Aban Calls:	The total number of VDN calls abandoned for that day.	ABNCALLS
Service Level	Shows administered acceptable service level.	SERVICELEVEL

Report Heading	Description	Database Item, Calculation, or <Calculation Name>
Service Intervals Changed	Shows whether or not the service level was changed. A "YES" appears if the acceptable service level changed during the period covered by the report. Otherwise, a "NO" appears.	syn( SVCLEVELCHG)
Service Interval Calls Answered	The number of calls that, while connected to this VDN, were answered by an agent or were connected to a non-ACD destination within each of the service level increments. With Generic 3 switches, connected means calls that were answered at a non-ACD destination.	sum (ANSCONNCALLS1), sum (ANSCONNCALLS2 through 10)
Service Interval Calls Answered	Percentage of split/skill ACD calls that were answered by an agent within the predefined acceptable service level. Calls to the split/skill include abandoned calls, calls not answered, and outbound ACD calls placed by an adjunct (for example, outbound predictive dialing—Generic 3 switches with the ASAI feature). Calls that were not answered may include forced busy calls, forced disconnect calls, calls redirected to another destination, and calls queued to more than one split and answered in another split/skill. For Generic 3 switches, Percent Within Service Level does not include direct agent calls.	<PERCENT_SERV_LVL_SPL>
Service Interval Answers and Abandons	Percentage of split/skill ACD calls that were answered by an agent within the predefined acceptable service level. Calls to the split/skill include abandoned calls, calls not answered, and outbound ACD calls placed by an adjunct. Outbound predictive dialing—Generic 3 switches with the ASAI feature only. Calls that were not answered may include forced busy calls, forced disconnect calls, calls redirected to another destination, and calls queued to more than one split and answered in another split/skill. For Generic 3 switches, Percent Within Service Level does not include direct agent calls.	< <100-PERCENT_SERV_LVL_SPL>
Service Interval - seconds	The lower and upper limit in seconds of each service level increment (as defined in the VDN Call Profile Setup window). These increments represent progressively longer wait time segments in which calls may be answered or abandoned.	PERIOD1-9



Report Heading	Description	Database Item, Calculation, or <Calculation Name>
% Answered Distribution	A chart displaying the distribution of the percent of calls answered for the day across all intervals.	None.
% Abandoned Distribution	A chart displaying the distribution of the percent of calls abandoned for the day across all intervals.	None.



---

# VDN Graphical Service Level Report

---

**Overview** This report shows the percentage of ACD calls answered within the predefined Acceptable Service Level and the percentage of ACD calls abandoned for the date and VDN that you specify.

- Things to know about this report** Here are some things to know about this report:
- Each set of vertical bars is labeled with the start time for the service interval. The box below the graph is a legend.
  - The chart type can be changed. See Chapter 2, “Using Reports”, for more information.
  - The database items used for the report are stored in the `hvdn` (intrahour interval) table.
  - This report is only available through the *CentreVu* Supervisor Interface.
  - This report is only available through the *CentreVu* Supervisor interface.
  - This report uses the VDN report input window. Select a VDN that you want to view on the report. See [VDN Report Input Fields \(4-144\)](#) for more information.

**VDN Graphical Service Level report example**

The following figure provides an example of the VDN Graphical Service Level report.

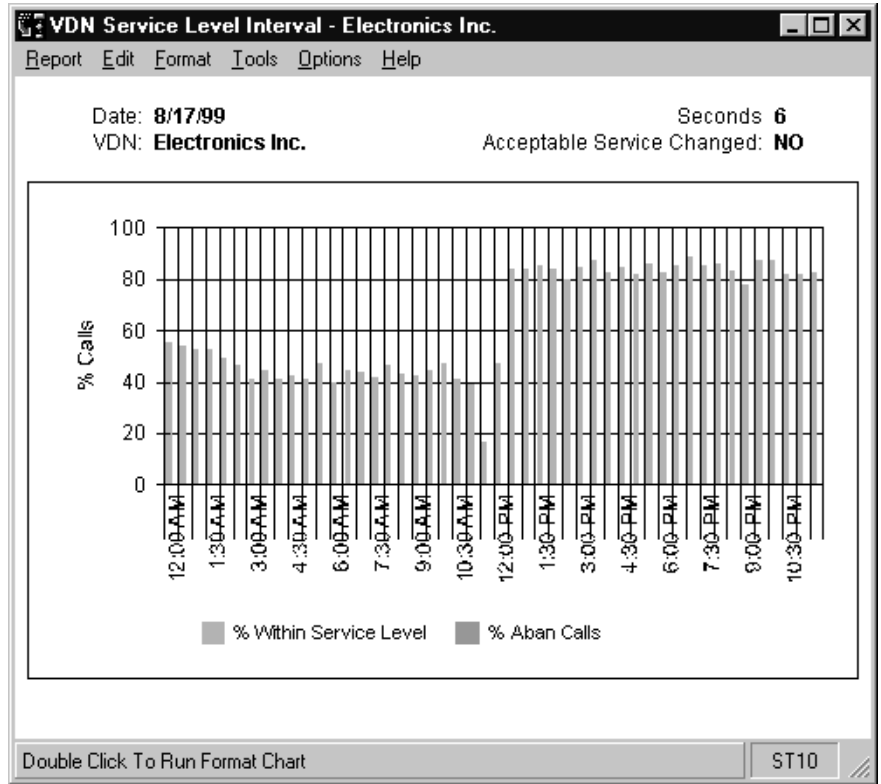

**VDN Graphical Service Level report description**

The following table describes the report fields.

Report Heading	Description	Database Item, Calculation, or <Calculation Name>
Date:	The day for which the report was run (selected in the report input window).	ROW_DATE
VDN:	The number or name of the VDN for which the report shows data (selected in the report input window).	VDN
Seconds	Shows actual administered service level.	SERVICELEVEL
Acceptable Service Changed	Shows whether or not the service level was changed. A "YES" appears if the acceptable service level changed during the period covered by the report. Otherwise, a "NO" appears.	syn(SVCLEVELCHG)

Report Heading	Description	Database Item, Calculation, or <Calculation Name>
% Within Service Level	The percentage of incoming calls to the VDN that were answered by a measured agent or connected to a non-ACD destination within the service level (as specified in the VDN Call Profile Setup window). Data are for each specified intrahour interval or day (selected in the report input window).	<PERCENT_SERV_LVL_VDN>
% Aban Calls	The percentage of incoming calls that were abandoned in the VDN.	<PERCENT_VDN_ABAN>
Times	Intrahour intervals for which the report shows data (as selected in the report input window).	STARTTIME or STARTTIME + INTRVL



# VDN Multi-ACD Flow Report

**Overview** The VDN Multi-ACD Call Flow report shows call-handling data for the VDNs and the ACDs you select. This report can display information on up to eight ACDs.

**Things to know about this report**

Here are some things to know about this report:

- This report is only available if the Vectoring feature has been purchased and authorized for you to use.
- You must have the Lookahead Interflow feature active on your ACD to get Lookahead Attempts and Completions data.
- You must have a *DEFINITY* ECS/Generic 3 switch to get adjunct routing data.
- The VDN Flow Out report item includes only calls that route to another VDN and route to an external (off-switch) destination.
- The VDN Flow Interflow report item includes both Lookahead Interflow and non-Lookahead Interflow call completions.
- The VDN Multi-ACD Call Flow is available in daily, weekly, and monthly versions.
- The database items used in the VDN Multi-ACD Call Flow are stored in the `dvdn` (daily), `wvdn` (weekly), and `mvdn` (monthly) tables.
- You cannot customize this report.
- This report uses the VDN report input window. Select a VDN that you want to view on the report. This report can display information on up to eight ACDs. See [VDN Report Input Fields \(4-144\)](#) for more information.

**VDN Multi-ACD Flow report example**

The following figure provides an example of the VDN Multi-ACD Flow report.

VDN Name	ACD	Inbound Calls	ACD Calls	Aban Calls	Busy + Disc Calls	Backup ACD Calls	Flow In	Flow Out	VDN Interflow	Lookahead Interflow Attempts	Lookahead Interflow Completions	Adjunct Routing Attempts	Adjunct Routing Completions
<b>Totals</b>		<b>367647</b>	<b>352967</b>	<b>2619</b>	<b>0</b>	<b>0</b>	<b>0</b>	<b>12061</b>	<b>12061</b>	<b>12061</b>	<b>12061</b>	<b>0</b>	<b>0</b>
Design Dynamics	ST10	142197	139650	2547	0	0	0	0	0	0	0	0	0
Electronics Inc.	ST10	59307	59286	21	0	0	0	0	0	0	0	0	0
Security Products	ST10	142181	142139	42	0	0	0	0	0	0	0	0	0
BSR to Boston	ST10	23962	11892	9	0	0	0	12061	12061	12061	12061	0	0

**VDN Multi-ACD Flow report description** The following table describes the report fields.

Report Heading	Description	Database Item, Calculation, or <Calculation Name>
Date, Week Starting, Month Starting	Day, week, or month for which the report was run (selected in the report input window).	ROW_DATE
VDN Name	Number or name of each VDN for which the report shows data (selected in the report input window). If the same VDN name or number is used on two or more ACDs, that name or number will be repeated for each ACD.	syn( VDN)
ACD	ACD that contains the associated VDN in the report.	syn( ACD)
Inbound Calls	Number of calls to the VDN that were completed in the specified time period.	INCALLS sum(INCALLS) (for the "Totals" line)
ACD Calls	Number of split/skill and direct agent ACD calls to the VDN completed during the specified time period that were answered by an agent.	ACDCALLS sum(ACDCALLS) (for the "Totals" line)
Aban Calls	Number of ACD calls to the VDN that hung up before being answered during the specified time period.	ABNCALLS sum(ABNCALLS) (for the "Totals" line)
Busy+Disc Calls	Number of calls to the VDN that, during the specified time period, received a forced busy signal or disconnect.	BUSYCALLS+ DISCCALLS, <BUSY_DISCONNECT> sum(BUSY+DISCCALLS) (for the "Totals" line)
ACD Calls	Number of calls that, in the specified time period, were answered by an agent in a backup split/skill (split/skill other than the main split/skill) while carried by the VDN. This report item includes messaging split/skill calls, check backup calls, route to split/skill calls, and direct agent calls.	BACKUPCALLS sum(BACKUPCALLS) (for the "Totals" line)
Flow In	Number of calls that, in the specified time period, were redirected to this VDN via a "route to" VDN. Calls are counted regardless of whether they remained connected to the VDN, were abandoned, or were subsequently routed to some other destination.	INFLOWCALLS sum(INFLOWCALLS) (for the "Totals" line)

Report Heading	Description	Database Item, Calculation, or <Calculation Name>
Flow Out	Number of calls that, in the specified time period, were routed to another destination via a "route to" VDN or external destination. It does not include calls routed to another vector via a "go to vector" step.	OUTFLOWCALLS sum(OUTFLOWCALLS) (for the "Totals" line)
VDN Interflow	Number of calls that, in the specified time period, were routed from this VDN to a destination outside the switch. This report item includes Lookahead Interflow calls.	INTERFLOWCALLS sum(INTERFLOWCALLS) (for the "Totals" line)
Lookahead Interflow Attempts	Number of times that, in the specified time period, the switch attempted to route from this VDN using the Lookahead Interflow feature.	LOOKATTEMPTS sum(LOOKATTEMPTS) (for the "Totals" line)
Lookahead Interflow Completions	Number of calls that, in the specified time period, the switch successfully routed from this VDN using the Lookahead Interflow feature.	LOOKFLOWCALLS sum(LOOKFLOWCALLS) (for the "Totals" line)
Adjunct Routing Attempts	Number of times that, in the specified time period, a VDN ( <i>DEFINITY</i> ECS Generic 3 switches only) attempted to request routing from an adjunct. This report item includes unsuccessful adjunct routing attempts, which means the adjunct was not able, within the given amount of time established in the vector, to route the call.	ADJATTEMPTS sum(ADJATTEMPTS) (for the "Totals" line)
Adjunct Routing Completions	Number of calls that, in the specified time period, were successfully routed by an adjunct via an "adjunct routing" command in a vector. This report item includes direct agent calls completed via the adjunct.	ADJROUTED sum(ADJROUTED) (for the "Totals" line)



# VDN Report

**Overview** The VDN Report gives you historical information for a specified VDN and period of time. The interval, daily, weekly, and monthly VDN Reports display, for a particular VDN, various types of data that show how well calls to that VDN were handled.

**Things to know about this report** Here are some things to know about this report:

- This report is only available if the Vectoring feature has been purchased and authorized for you to use.
- If you have Expert Agent Selection (EAS), the VDN report includes three VDN Skill Preference columns on the right-hand side of the report.
- On a Generic 3 switch, the "go to vector" command allows the ACD to process calls using more than one vector, even though those calls remain connected to the original VDN. Thus, for a report item like "Calls Ans in Main," the main splits in which calls are answered may be referenced in a vector other than the first vector to which the VDN is assigned.
- The VDN Report is available in interval, daily, weekly, and monthly versions.
- The database items used in the VDN report are stored in the **hvdn**(interval), **dvdn** (daily), **wvdn** (weekly), and **mvdn** (monthly) tables.
- This report uses the VDN report input window. Select a VDN that you want to view on the report. See [VDN Report Input Fields \(4-144\)](#) for more information.

**VDN Report example** The following figure provides an example of the VDN report.

Date	Vector	Inbound Calls	Flow In	ACD Calls	Avg Speed	Avg ACD	Avg ACW	Main ACD	Backup ACD	Connect Calls	Avg Connect Time	Aban Calls	Avg Aban Time	Forced Busy Calls	Forced Disc Calls	Flow Out	Avg VDN Time	1st Skill Pref	2nd Skill Pref	3rd Skill Pref
<b>Totals</b>		9841	808	4735	:03	:07	:00	0	4735	0		5106	:40	0	0	0	:26			
3/27/98	1968	161	947	:03	:07	:01	0	947	0	0		1021	:40	0	0	0	:26	01	02	03
3/28/98	1960	164	940	:02	:06	:00	0	940	0	0		1000	:38	0	0	0	:25	02	04	05
3/29/98	1976	158	954	:03	:06	:02	0	954	0	0		1042	:42	0	0	0	:27	01	02	03
3/30/98	1962	172	950	:03	:07	:00	0	950	0	0		1030	:40	0	0	0	:26	04	05	02
3/31/98	1966	152	944	:02	:08	:00	0	944	0	0		1012	:40	0	0	0	:26	05	01	03



**VDN Report description** The following table describes the report fields.

Report Heading	Description	Database Item, Calculation, or <Calculation Name>
Date, Week Starting, Month Starting	Day(s), week(s), or month(s) for which the report was run (selected in the report input window).	ROW_DATE
VDN Name	Number or name of the VDN for which the report shows data (selected in the report input window).	syn( VDN)
ACD	ACD name or number that is sending calls to the VDN.	syn( ACD)
Time (for Interval reports only)	Intrahour intervals for which the report shows data (selected in the report input window).	STARTTIME, STARTTIME + INTRVL
Vector	Number of the vector to which the VDN is assigned. If the VDN-vector association changed during the reporting period, two rows appear in the report for that period, one for each vector associated with the VDN.	VECTOR
Inbound Calls	Number of calls to the VDN within the specified time period. Calls are counted regardless of whether they were answered in the VDN, were abandoned, or were routed to some other destination.	INCALLS sum(INCALLS)
Flow In	Number of calls that, in the specified time period, were redirected to this VDN via the "route to VDN" vector command. Calls are counted regardless of whether they were answered in the VDN, were abandoned, or were routed to some other destination.	INFLOWCALLS sum(INFLOWCALLS)
ACD Calls	Number of split/skill and direct agent ACD calls completed during the reporting period that were answered while carried by the VDN. This includes calls from "queue to main," "check backup," "route to split/skill, and "adjunct routing" to a split/skill or direct agent.	ACDCALLS sum(ACDCALLS)
Avg Speed Ans	Average time, in minutes and seconds, split/skill and direct agent ACD calls waited before they were answered by an agent.	ANSTIME/ ACDCALLS, <AVG_ANSWER_SPEED> <AVG_ANSWER_SPEED_SUM>
Avg ACD Time	Average talk time, in minutes and seconds, for split/skill and direct agent ACD calls for this VDN. This does not include HOLDTIME.	ACDTIME/ ACDCALLS, <AVG_ACD_TALK_TIME> <AVG_ACD_TALK_TIM_SUM>

Report Heading	Description	Database Item, Calculation, or <Calculation Name>
Avg ACW Time	Average amount of time, in the specified time period, that agents spent in after-call work for split/skill and direct agent ACD calls to this VDN.	ACWTIME/ ACDCALLS <AVG_ACW_TIME> <AVG_ACW_TIME_SUM>
Main ACD Calls	Number of calls to the VDN completed during the specified time period that were answered by an agent in a main split/skill. The calls are directed to the main split/skill by the "queue to main" vector command. This item does not include direct agent calls.	ACDCALLS- BACKUPCALLS sum( ACDCALLS) - sum( BACKUPCALLS)
Backup ACD Calls	Number of calls to the VDN completed during the specified time period that were answered by an agent in a backup split/skill (split/skill other than the main split/skill). The calls can be directed to a backup split/skill by a "check backup," "messaging split/skill," or "route to split/skill" or direct agent vector command. This item does include direct agent calls.	BACKUPCALLS sum(BACKUPCALLS)
Connect Calls	Number of calls to the VDN that were connected to a non-ACD destination. With Generic 3 switches, "connected" means calls answered at a non-ACD destination. With the switch, "connected" means calls rang at the non- ACD destination.	CONNECTCALLS
Avg Connect Time	Average time, in minutes and seconds, that calls to the VDN waited before connecting to a non- ACD destination. <i>CentreVu</i> CMS tracks time starting from the moment a call connects to the VDN and ending the moment the call connects to the destination. With <i>DEFINITY</i> ECS/Generic 3 switches, "connected" means calls answered at a non-ACD destination.	CONNECTTIME / CONNECTCALLS, <AVG_CONNECT_ TIME> <AVG_CONNECT_TIME _SUM>
Aban Calls	Number of calls to the ACD that hung up while being carried by this VDN. The number of calls applies to the specified time period.	ABNCALLS sum(ABNCALLS) (for the "Totals" line)
Avg Aban Time	Average time, in minutes and seconds, that abandoned calls waited in this VDN before they were abandoned. This average, which applies to the specified time period, includes direct agent calls ( <i>DEFINITY</i> ECS/Generic 3 switches only).	ABN TIME/ ABNCALLS, <AVG_ABANDON_ TIME> <AVG_ABANDON_TIME _SUM> (for the "Totals" line)

Report Heading	Description	Database Item, Calculation, or <Calculation Name>
% Aban	The percentage of calls offered to the VDN that abandoned.	100 * ABNCALLS/ INCALLS
Forced Busy Calls	Number of calls that, for the specified time period, received a forced busy signal while being carried by the VDN.	BUSYCALLS sum(BUSYCALLS) (for the "Totals" line)
Forced Disc Calls	Number of calls that, in the specified time period, received a forced disconnect while being carried by the VDN.	DISCCALLS sum(DISCCALLS) (for the "Totals" line)
% Busy	The percentage of total calls offered to the VDN that were forced busy by a vector step.	100 * BUSYCALLS/ INCALLS
Flow Out	Number of calls that, for the specified time period, were routed to another VDN or external destination via a "route to" step or "adjunct routing" command ( <i>DEFINITY</i> ECS/Generic 3 switches only). It does not include calls routed to a new vector via a "go to vector" command.	OUTFLOWCALLS sum(OUTFLOWCALLS) (for the "Totals" line)
% Flow Out	The percentage of total calls offered to the VDN that were directed to another VDN.	100 * OUTFLOWCALLS/ INCALLS
Avg VDN Time	Average time, in minutes and seconds, that calls were carried by the VDN, including talk time. This average, which applies to the specified time period, is for all calls, including direct agent calls ( <i>DEFINITY</i> ECS/ Generic 3 switches only), abandoned calls, disconnected calls, interflowed calls, and so on.	INTIME/INCALLS, <AVG_VDN_TIME> <AVG_VDN_TIME_ SUM> (for the "Totals" line)
1st Skill Pref	For switches with EAS only, the first skill assigned to this VDN.	SKILL1
2nd Skill Pref	For switches with EAS only, the second skill assigned to this VDN.	SKILL2
3rd Skill Pref	For switches with EAS only, the third skill assigned to this VDN.	SKILL3



# VDN Skill Preference Report

**Overview** The VDN Skill Preference report shows the number of calls answered, average talk time, and average after call work time for calls to the VDN by skill preference for which they were answered. The report lists information for the first, second, and third VDN skill preferences.

**Things to know about this report** Here are some things to know about this report:

- If the VDN skill preferences are referred to explicitly in the vector (for example, "queue to main skill xx" instead of "queue to main skill 1st"), the calls answered for that skill are included in this report.
- The VDN Skill Preference report is available in interval, daily, weekly, and monthly versions.
- The database items used in the VDN Skill Preference report are stored in the **hvdn** (interval), **dvdn** (daily), **wvdn** (weekly), and **mvdn** (monthly) tables.
- This report uses the VDN report input window. Select a VDN that you want to view on the report. See [VDN Report Input Fields \(4-144\)](#) for more information.

**VDN Skill Preference report example** The following figure provides an example of the VDN Skill Preference report.

Date	Vector	Inbound Calls	Avg Speed Ans	Aban Calls	Avg Aban Time	ACD Calls	Avg ACD Time	Avg ACW Time	1st Skill Pref	1st Skill ACD	1st Skill Avg	1st Skill ACW	2nd Skill Pref	2nd Skill ACD	2nd Skill Avg	2nd Skill ACW	3rd Skill Pref	3rd Skill ACD	3rd Skill Avg	3rd Skill ACW
<b>Totals</b>		<b>191100</b>	<b>:08</b>	<b>75</b>	<b>:09*****</b>		<b>:16</b>	<b>:02</b>	<b>0</b>				<b>0</b>					<b>0</b>		
8/2/99	2	50304	:05	5	:01	50299	:08	:00	0	0			0	0			0	0		
8/9/99	2	5816	:05	9	:01	5807	:10	:00	0	0			0	0			0	0		
8/9/99	998	24712	:05	35	:00	24677	:10	:00	0	0			0	0			0	0		
8/16/99	2	110268	:09	26	:24*****		:21	:03	0	0			0	0			0	0		

**VDN Skill Preference report description** The following table describes the report fields.

Report Heading	Description	Database Item, Calculation, or <Calculation Name>
VDN	Name or number of the VDN for which the report was run.	syn(VDN)
ACD	Name or number of the ACD for which the report was run.	syn(ACD)
Date, Week Starting, Month Starting	Dates for which the report was run. For weekly and monthly reports, these dates are the starting dates of the weeks or months.	ROW_DATE
Time (for interval reports only)	Intervals which the report covers.	STARTTIME, STARTTIME + INTRVL
Vector	Number of the vector to which the VDN is assigned. If the VDN-vector association changes during the reporting period, two rows will appear in the report for that period, one for each vector associated with the VDN.	VECTOR
Inbound Calls	Number of inbound calls that were directed to the VDN.	INCALLS sum(INCALLS)
Avg Speed Ans	Average speed of answer for split/skill and direct agent ACD calls to the VDN that were completed during the reporting period.	ANSTIME / ACDCALLS <AVG_ANSWER_SPEED> <AVG_ANSWER_SPEED_SUM>
Aban Calls	Number of calls to the VDN during the reporting period that hung up before they could be answered.	ABNCALLS sum(ABNCALLS)
Avg Aban Time	Average time callers to the VDN waited before abandoning.	ABNTIME / ABNCALLS <AVG_ABANDON_TIME> <AVG_ABANDON_TIME_SUM>
ACD Calls	Number of skill and direct agent ACD calls to the VDN completed during the reporting period that were answered by an agent. This includes calls from "queue to main," "check backup," "messaging skill," "route to skill, and "adjunct routing" to a skill or direct agent.	ACDCALLS sum(ACDCALLS)

Report Heading	Description	Database Item, Calculation, or <Calculation Name>
Avg ACD Time	Average time agents spent talking on skill and direct agent ACD calls to this VDN that were completed during the reporting period. This does not include HOLDTIME.	ACDTIME / ACDCALLS <AVG_ACD_TALK_TIME> <AVG_ACD_TALK_TIM_SUM>
Avg ACW	Average time agents spent in after call work associated with skill and direct agent calls to this VDN that were completed during the reporting period.	ACWTIME / ACDCALLS <AVG_ACW_TIME> <AVG_ACW_TIME_SUM>
1st Skill Pref.	First VDN skill assigned to this VDN.	SKILL1
1st Skill ACD Calls	Number of ACD calls to the VDN completed during the reporting period that were answered by an agent in the first VDN skill.	SKILLCALLS1 sum(SKILLCALLS1)
1st Skill Avg ACD Time	Average talk time for calls to this VDN answered by agents in the first VDN skill preference. This does not include HOLDTIME.	SKILLTIME1 / SKILLCALLS1 sum(SKILLTIME1) / sum(SKILLCALLS1)
1st Skill Avg ACW	Average after call work time for calls to this VDN answered by agents in the first VDN skill preference.	SKILLACWTIME1 / SKILLCALLS1 sum(SKILLACWTIME1) / sum(SKILLCALLS1)
2nd Skill Pref.	Second VDN skill assigned to this VDN.	SKILL2
2nd Skill ACD Calls	Number of ACD calls to the VDN completed during the reporting period that were answered by an agent in the second VDN skill preference.	SKILLCALLS2 sum(SKILLCALLS2)
2nd Skill Avg ACD Time	Average talk time for calls to this VDN answered by agents in the second VDN skill. This does not include HOLDTIME.	SKILLTIME2 / SKILLCALLS2 sum(SKILLTIME2) / sum(SKILLCALLS2)
2nd Skill Avg ACW	Average after call work time for calls to this VDN answered by agents in the second VDN skill.	SKILLACWTIME2 / SKILLCALLS2 sum(SKILLACWTIME2) / sum(SKILLCALLS2)
3rd Skill Pref.	Third VDN skill assigned to this VDN.	SKILL3
3rd Skill ACD Calls	Number of ACD calls to the VDN completed during the reporting period that were answered by an agent in the third VDN skill.	SKILLCALLS3 sum(SKILLCALLS3)

Report Heading	Description	Database Item, Calculation, or <Calculation Name>
3rd Skill Avg ACD	Average talk time for calls to this VDN answered by agents in the third VDN skill. This does not include HOLDTIME.	SKILLTIME3 / SKILLCALLS3 sum(SKILLTIME3) / sum(SKILLCALLS3) (for the "Totals" line)
3rd Skill Avg ACW	Average after call work time for calls to this VDN answered by agents in the third VDN skill.	SKILLACWTIME3/ SKILLCALLS3 sum(SKILLACWTIME3)/ sum(SKILLCALLS3) (for the "Totals" line)



---

# Vector Report

## Overview

---

**Purpose** This section describes the vector report.

**Organization** This section contains the following topics:

- General Information About the Vector Report
- Vector Report Selector Window
- Vector Report Input Fields
- Vector Report





## General Information About the Vector Report

**Organization of the Vector Report** The Vector Report is available in Interval, Daily, Weekly, and Monthly versions.

**Vector Report selector window** The following figure is an example of the Vector Report Selector window.

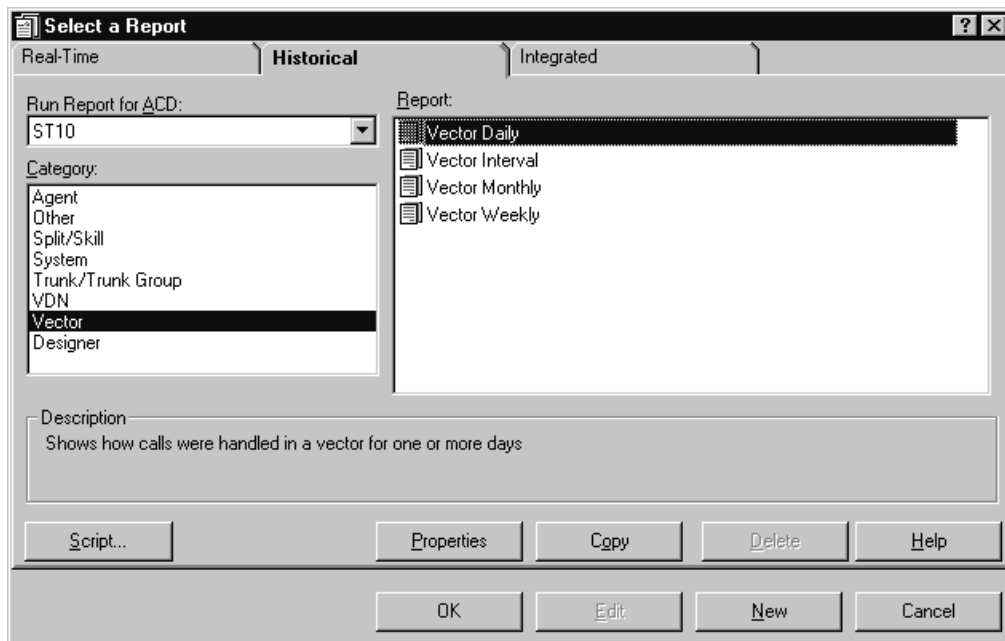

## Vector Report Input Fields

**Vector report input fields** The following table describes the fields on the input window.

Field	Definition
Vector:	Enter the name or number of the vector you want to include in the report.
Date: (for interval report only)	<p>Enter the date(s) you would like the report to cover:</p> <ul style="list-style-type: none"> <li>You can use the month/day/year (for example, 3/21/95).</li> <li>You can use a "-" offset based on today's date (for example, -1 for yesterday).</li> </ul>
Date: (for daily, weekly, and monthly reports)	<p>Enter the date(s) you would like the report to cover:</p> <ul style="list-style-type: none"> <li>Daily - enter the day(s).</li> <li>Weekly - enter the start date for the week(s). When you specify a date for a weekly report, that date must correspond to the week start day selected in the System Setup-Storage Intervals window. If the date and day do not match, the message No records found displays in the status line.</li> <li>Monthly - enter the first day of the month(s).</li> </ul> <p>Use any of the following formats:</p> <ul style="list-style-type: none"> <li>A month/day/year (for example, 3/21/96).</li> <li>A minus (-) offset based on today's date (for example, -1 for yesterday).</li> <li>A semicolon (;) to separate individual data entry items (for example, 3/21/96;3/23/96;3/25/96)</li> <li>A hyphen (-) to designate a range of dates (for example, 3/21/96-3/25/96). For the weekly and monthly versions, the report includes any weeks or months that begin in the range.</li> </ul>
Times:	<p>Enter the time you would like the report to cover.</p> <ul style="list-style-type: none"> <li>You can use AM/PM format (for example, 7:30AM- 5:00PM).</li> <li>You can use military time format (for example, 7:30- 17:00).</li> </ul>
Destination:	Choose a report destination. You can select View Report on Screen or Print Report on: and then use the Select Printer button to print the report on any Windows printer. The default printer is shown.



# Vector Report

**Overview** The Vector report displays, for a single vector, various types of data that show how calls were handled by the vector.

This menu item is available only if you have purchased the *CentreVu* CMS Vectoring feature and that feature has been authorized for you to use.

**Things to know about this report** Here are some things to know about this report:

- The Vector report is available in interval, daily, weekly, and monthly versions.
- The database items for the Vector reports are stored in the `hvector` (interval), `dvector` (daily), `wvector` (weekly), and `mvector` (monthly) tables.

**Vector report example** The following figure provides an example of a Vector report.

Date	Inbound Calls	Avg Speed Ans	Main ACDCalls	Backup ACDCalls	Aban Calls	Avg Time	Forced Busy Calls	Forced Disc Calls	Flow In	Flow Out	Other Calls	Avg Vector Time
Totals	185	:00	185	0	0		0	0	0	0	0	:00
3/28/98	185	:00	185	0	0		0	0	0	0	0	:00

**Vector report description** The following table describes the report fields for the time period covered by the report.

Report Heading	Description	Database Item, Calculation, or <Calculation Name>
Vector:	Number or name of the vector for which the report shows data (selected in the report input window).	syn(VECTOR)
Date, Week Starting, Month Starting:	Day (for interval report) or dates (for daily, weekly, and monthly reports) for which the report was run (selected in the report input window).	ROW_DATE
Time (for Interval reports only)	Intrahour intervals for which the report shows data (selected in the report input window).	STARTTIME, STARTTIME+INTRVL
Inbound Calls	Number of calls processed by the vector that completed in the specified time period.	INCALLS sum(INCALLS) (for the "Totals" line)
Avg Speed Ans	Average time, in minutes and seconds, that split/skill and direct agent ACD calls waited before they were answered by an agent. This item includes only calls that were answered as a result of processing by this vector.	ANSTIME/ACDCALLS <AVG_ANSWER_SPEED> <AVG_ANSWER_SPEED_SUM > (for the "Totals" line)
Main ACD Calls	Number of calls completed during the specified time period that were answered by an agent in a main split/skill because of processing by this vector. The calls are directed to the main split/skill by the "queue to main" vector command. This item does not include direct agent calls.	ACDCALLS-BACKUPCALLS sum(ACDCALLS) - sum(BACKUPCALLS) (for the "Totals" line)
Backup ACD Calls	Number of calls completed during the specified time period that were answered by an agent in a backup split/skill using a vector command other than "queue to main." This report item includes messaging split/skill calls, check backup calls, route to split/skill calls, and direct agent calls.	BACKUPCALLS sum(BACKUPCALLS) (for the "Totals" line)
Aban Calls	The number of calls that were abandoned by the caller while in vector processing. This item includes calls that abandoned either while in a split/skill or direct agent queue or while ringing at agent voice terminals or while in vector processing (call need not have queued yet). The number of calls applies for the specified time period.	ABNCALLS sum(ABNCALLS) (for the "Totals" line)

Report Heading	Description	Database Item, Calculation, or <Calculation Name>
Avg Aban Time	The average time, in minutes and seconds, that calls waited in the vector before they were abandoned.	ABNTIME/ABNCALLS <AVG_ABANDON_TIME> <AVG_ABANDON_TIME_SUM > (for the "Totals" line)
Forced Busy Calls	The number of calls that, in the specified time period, received a forced busy signal as a result of processing by this vector.	BUSYCALLS sum(BUSYCALLS) (for the "Totals" line)
Forced Disc Calls	The number of calls that, in the specified time period, received a forced disconnect as a result of processing by the vector.	DISCCALLS sum(DISCCALLS) (for the "Totals" line)
Flow In	The number of calls that, in the specified time period, were redirected to this vector from within the switch via "route to VDN" and "go to vector" commands.	INFLOWCALLS sum(INFLOWCALLS) (for the "Totals" line)
Flow Out	Number of calls that, in the specified time period, were redirected to another destination by way of a "go to vector," "route to," or "adjunct routing" command to a destination other than a split/skill or direct agent. (Calls that route to a split/skill or direct agent by way of a "route to," "adjunct routing," or "messaging split/skill" command are still tracked in the vector.)	OUTFLOWCALLS sum(OUTFLOWCALLS) (for the "Totals" line)
Other Calls	This includes forced busy calls, forced disconnect calls and outflow calls.  OTHERCALLS = INCALLS - ACDCALLS - ABNCALLS.	OTHERCALLS

Report Heading	Description	Database Item, Calculation, or <Calculation Name>
Avg Vector Time	<p>The average time, in minutes and seconds, that calls were being processed by the vector. This average, which applies to the specified time period of the report, is for all calls to the vector. The item includes calls that were abandoned, disconnected calls, interflowed calls, and so on. Talk time is not included because calls are removed from the vector when the calls connect to agent voice terminals. Vector processing stops when the “stop” step or the “go to vector” step is processed or the “route to” completes successfully; or at the completion of the last step in the vector, when busy or disconnect is sent, when the call abandons, or when a messaging split/skill or adjunct routing command succeeds.</p>	INTIME/INCALLS <AVG_VEC_TIME> <AVG_VEC_TIME_SUM> (for the “Totals” line)



# 5 Integrated Reports

## Overview

---

**Purpose** This chapter is written for supervisors who use *CentreVu* Supervisor integrated reports to effectively run the call center. Integrated reports can be displayed on your PC, printed, stored to a file, copied to a clipboard, run as a script, or exported to HTML format through the Save as HTML feature.

**Introduction** This chapter explains every integrated report available through *CentreVu* Supervisor.

**Definition of integrated reports** At the Integrated Reports tab, reports that refresh in real-time can be selected to display information accumulated from any interval beginning in the past 24 hours until the time the report is generated. Standard integrated reports show data for ACD, agent, split/skill, trunks/trunk group, vector, and VDN activities. The reports you see depend on your switch type, permissions, and system performance.

**How this chapter is organized** This chapter gives a brief description of each available report and definitions of the input fields. It provides the information needed to complete any integrated report input screen.

Each report section contains the following headings:

- *Things to know about this report*—gives you information on factors that affect the integrated report discussed in each section.
- *Report example*—provides an example of the report. A table provides report headings, field definitions, and the corresponding database item.

**Diagram of integrated reporting system** The following diagram shows how the Integrated reporting system is structured. This section follows the report structure outlined in the diagram—agent reports are described first, followed by split/skill reports, then V

**Presentation of report information** The Integrated reports are available only when you are using the Supervisor application (they are not available through Terminal or standard CMS).

Only reports that are available exclusively through Supervisor are described in this chapter. An Integrated report combines real-time and historical data for a current view of the day. For general information about Integrated reports, see Chapter 2, *Using Reports*, in this document.

Designer reports are described in the *CentreVu® Report Designer Version 8 User Guide* 585-210-930.

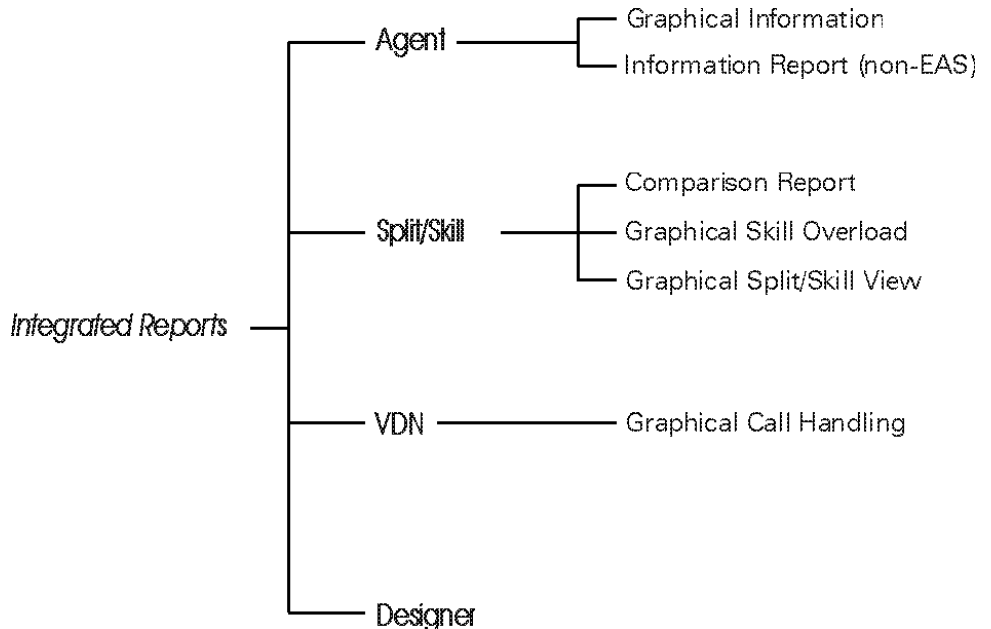

#### **Presentation of report information**

The Integrated reports are available only when you are using the Supervisor application (they are not available through Terminal or standard CMS).

Only reports that are available exclusively through Supervisor are described in this chapter. An Integrated report combines real-time and historical data for a current view of the day. For general information about Integrated reports, see Chapter 2, *Using Reports*, in this document.

#### **Historical Data in Integrated Reports**

Once the historical CMS database is queried for an integrated report, the historical data in the report will not refresh unless you request the report again. The real-time data will continue to refresh at the end of each interval. Therefore, to see new historical data on an integrated report, you must request the report again to update the data.





---

# Agent Reports

## Overview

---

**Purpose** *CentreVu* Supervisor Agent reports allow for access to information and statistics for each agent from specified start times.

**Organization of this section** This section contains the following topics:

- [General Information About Agent Reports \(5-4\)](#)
- [Agent Report Selector Window and Input Fields \(5-5\)](#)
- [Agent Graphical Information Report \(5-7\)](#)
- [Agent Information Report \(5-13\)](#)



---

## General Information About Agent Reports

---

- Organization of Agent reports** The following list shows how the Integrated Agent reports are organized in Supervisor. Depending on your switch type, you will see either the Information or Graphical Information report.
- Graphical information (with Expert Agent Selection)
  - Information (without Expert Agent Selection)



## Agent Report Selector Window and Input Fields

**Agent report selector window** This figure is an example of the Agent report selector window. The reports are explained in the same order as listed in the window.

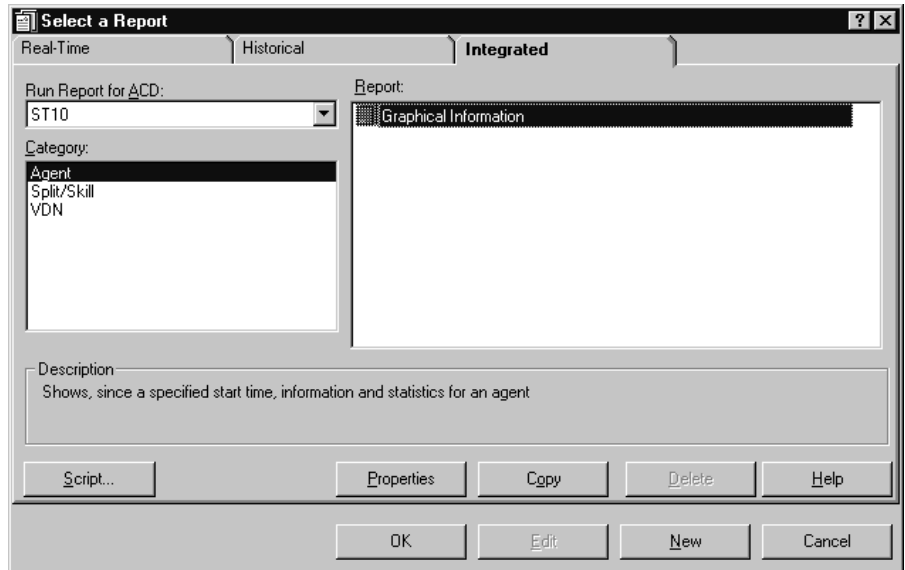

**Agent report input fields** The following describes the input fields on Integrated Agent report input windows. The report input window must be filled in to run the report. These fields are the same for all Agent report input windows.

Field	Description
Agent:	Enter the name of the agent. The agent's name must be defined in the Dictionary subsystem; otherwise, you will see the agent login IDs.
Report Data Start Time:	Enter the day and time (either in military time or with AM/PM specified) you want the report to start collecting data. The time entered (or the time adjusted to the nearest previous interval start time relative to the entered time) is used to populate the Report Data Start Time field on the report. NOTE: If no report start time is available, the start time will be midnight of the current day. The report start time must be less than 24 hours before the current time.
Refresh Every <#> Seconds	Enter the number of seconds (3 to 600) to specify how rapidly <i>CentreVu</i> CMS should update the report data. The default value for the Refresh rate in seconds: field in this window is your assigned minimum refresh rate plus 15 seconds. To find out what your minimum refresh rate is, or to change it, check with your <i>CentreVu</i> CMS administrator.
Enable Report Thresholds	Check this box to turn on the thresholds for the report.
Run Minimized	Check this box to minimize the report.



# Agent Graphical Information Report

---

**Overview** The Agent Graphical Information Report shows information and statistics for an agent from a specified interval start time, within the past 24 hours.

**Things to know about this report** Here are some things to know about this report:

- This report can be accessed in the following ways:
- From the Integrated Agent Category selector menu.
- By drilling down to this report from the Agent Name or Login ID fields on other reports (for example, Work State, Graphic AUX Agent reports or Call Center Administration windows).
- If the system is a switch that does not have the EAS feature, see the section, “Agent Information report,” in this chapter for details.
- This report is available for all switch releases. Contents of this report will vary depending upon the switch release for which it is being run.
- Supervisors can use this report to access further information on one particular agent without having to execute several steps and several different reports to get the pertinent information. This report enables supervisors to quickly evaluate agent performance and decide whether an agent should be added to or removed from a skill.
- If an agent logs off while an Integrated Agent Report is being displayed, the staffed time and AUX time for that agent may drop, because the real-time component of the times is no longer present. Restarting the report will cause the integrated times to be displayed once again.
- The database items for the Agent Graphical Information Report are stored in the **cagent** (current interval) and **hagent** (intrahour interval) tables.
- This report uses the Agent Graphical Information Report input window. See [Agent Report Selector Window and Input Fields \(5-5\)](#) for input field definitions.

This report is available in two forms:

- *DEFINITY* Enterprise Communications Server (ECS) with the EAS feature.
- Generic 3 Version 4 and earlier switches with the EAS feature.

**DEFINITY ECS R5 and later information**

The following list describes the information this report will contain for the DEFINITY ECS Release 5 and later switch:

- A two-dimensional bar chart shows the time the agent has spent in each of the work states since the report data start time. Above the bar chart is the text “Agent Time Spent.”
- A table show the skills assigned to the agent and the corresponding skill level. A scroll bar is provided if the number of skills to which the agent is assigned exceeds the default size of this table.

**Agent Graphical Information report example**

This figure provides an example of an Agent Graphical Information report.

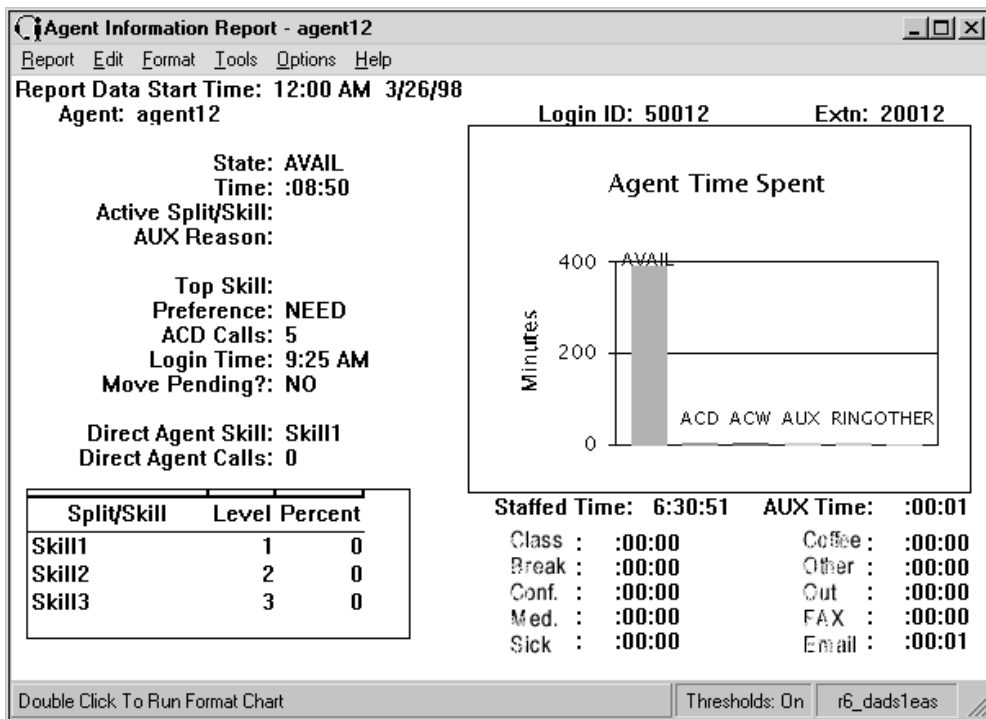

**Agent Graphical Information report description**

This table describes the report fields:

Report Heading	Description	Database Item, Calculation, or <Calculation Name>
Report Data Start Time:	The day and time that the report started collecting data.	No database item.
Agent:	The names (or agent IDs if the names have not been assigned in Dictionary) of the agents assigned and logged into this split/skill.	syn(LOGID)

Report Heading	Description	Database Item, Calculation, or <Calculation Name>
Login ID:	The login identification of the agent.	LOGID
Extn:	The extension that the agent logged in from.	EXTENSION
State:	The current work mode (state) that the agent is in (AVAIL, ACD, ACW, AUX, DACD, DACW, RINGING, UNKNOWN, OTHER, UNSTAFF) and the call direction (blank, IN or OUT).	syn(AWORKMODE) and syn(DIRECTION)
Time:	The elapsed time since the last agent WORKMODE change for any split/skill. This item is not reset if the DIRECTION changes, but WORKMODE remains the same. For example, if the agent goes from AUX to AUXOUT to AUX, AGTIME continues without resetting.	AGTIME
Active Split/Skill:	When an agent is on a split/skill or direct agent ACD call or in ACW, this is the split/skill associated with the call or ACW. When an agent is available, in AUX or in OTHER, this is null (blank). When an agent is on an AUXIN/AUXOUT call, this is the OLDEST_LOGON split/skill. When an agent is on an AUXIN/AUXOUT call from the available state, while in AUX or with an AUXIN/AUXOUT call on hold, this is the OLDEST_LOGON split/skill. When an agent is on an AUXIN call with an ACD call on hold, this is the OLDEST_LOGON split/skill. When an agent is on an AUXOUT call with an ACD call on hold, this is the split/skill associated with the ACD call.	syn(WORKSKILL)
AUX Reason:	The reason code associated with the agent's current state. This is blank if the agent is not in the AUX state. For agents in AUX on switch releases that are earlier than the ECS or that do not have EAS and reason codes active, this will only be 0 (zero).	syn(AUXREASON)
Top Skill:	The agent's first-administered, highest-level, measured skill, where skill level 1 is the highest, and skill level 16 is the lowest.	syn(TOPSKILL)
Call Handling Preference:	The agent's call handling preference. Values are blank, skill level (LVL), percent (PCNT) or greatest need (NEED).	syn(PREFERENCE)

Report Heading	Description	Database Item, Calculation, or <Calculation Name>
ACD Calls:	The queued ACD calls to the split/skill that were answered by an agent in the split/skill. This does not include direct agent calls, but it does include ACD calls placed by an adjunct (outbound predictive dialing—Generic switches with ASAI only).	sum(ACDCALLS)
Login Time:	The time of the day that the agent logged into this SPLIT. This field is not set unless the agent is logged in. Values include NULL and time-of- day.	LOGONSTART
Move Pending?:	A move to a new split or skill or a change of skills is pending for this agent. This is available only for Generic 3 Version 4 and later switch releases with the “Move Agent While Staffed” feature.	MOVEPENDING
Direct Agent Skill:	The skill that is currently assigned as the agent's direct agent skill. Direct agent calls to the agent are queued to this skill.	syn(DA_SKILL)
Direct Agent Calls:	The number of direct agent ACD calls that the agent answered.	DA_ACDCALLS
Split/Skill:	The split/skill number for which the data was collected.	syn(SPLIT)
Level:	The skill level (1-16) or reserve skill level (1 or 2) that is associated with the SPLIT.	syn(LEVEL)
Percent	Agents's percent allocation for this SPLIT. Requires <i>DEFINITY</i> ECS R6 or higher with <i>CentreVu Advocate</i> .	PERCENT
AVAIL	The time since the report start time that the agent was in the available state for split/skill or direct agent ACD calls in any split/skill. TI_AVAILTIME is recorded for the split/skill that was the OLDEST_LOGON. For non-EAS operation, if an agent logged into multiple splits in AUX mode in one split and is available for ACD calls in another split. The agent accrues I_AVAILTIME for the split in which the agent is available and TI_AVAILABLE in the split logged into the longest.	sum(TI_AVAILTIME)
ACD	The time during the collection interval that the agent was talking on ACD calls for the SPLIT.	sum(I_ACDDTIME + I_DA_ACDDTIME)



Report Heading	Description	Database Item, Calculation, or <Calculation Name>
ACW	The total time during the collection interval that the agent was in after call work (ACW). This includes ACW for split/skill ACD calls and ACW not associated with the call.	sum (I_ACWTIME + I_DA_ACWTIME)
AUX	The time during the collection interval that the agent was in AUX in all splits/skills or on AUXINCALLS or AUXOUTCALLS. "TI_" stands for the time that is stored for the split/skill logged into the longest.	sum(TI_AUXTIME)
RINGING	The time during the collection interval that the agent had split/skill and direct agent ACD calls ringing. If the agent changes work modes or answers/makes another call instead of answering the ringing call, I_RINGTIME will stop accumulating. RINGTIME is the time the caller spends ringing and is independent of agent activity.	sum(I_RINGTIME)
OTHER	The time during the collection interval that the agent was doing other work in all splits/skills. For Generic 3 switches, while in Auto-in or Man-In: the agent put any call on hold and performed no further action, the agent dialed to place a call or to activate a feature, or an extension call rang with no other activity. For all switches, TI_OTHERTIME is collected for the time period after the link to the switch comes up or after the agent logs in and before the CMS receives notification of the agent's state from the switch.	sum(TI_OTHERTIME)
Staffed Time:	The time during the collection interval that the agent was staffed in any split/skill. The "TI_" stands for the time that is stored only for the split or skill that the agent is logged into for the longest amount of time.	sum(TI_STAFFTIME)

Report Heading	Description	Database Item, Calculation, or <Calculation Name>
AUX Time:	The time during the collection interval that the agent was in AUX in all splits/skills or on AUXINCALLS or AUXOUTCALLS. The "TI_" stands for the time that is stored only for the split or skill that the agent is logged into for the longest amount of time.	sum(TI_AUXTIME)
Reason Code	The time that the agent spent in active AUX reason codes. It is the same as TI_AUXTIME for switches without AUX reason codes active. The "TI_" stands for the time that is stored only for the skill that the agent is logged into for the longest amount of time.	sum(TI_AUXTIME0)



# Agent Information Report

---

**Overview** The Agent Information report shows information and statistics for an agent from a specified start time.

**Things to know about this report** Here are some things to know about this report:

- This report is not available with the EAS feature.
- This report uses the Agent Graphical Information Report Input Window. See [Agent Report Selector Window and Input Fields \(5-5\)](#) for input field definitions.
- When a Supervisor user drills down from an agent name to an Agent Information report and selects an integrated report, the report data start time defaults to the start time specified in the last integrated report input window. If no integrated report has ever been entered, the default is set to midnight. Supervisor users have the ability to restart this report just as any other Supervisor report can be restarted, and a different report start time can be specified when the report is restarted.
- The database items for the Agent Information report are stored in the `cagent` (current interval) and `hagent` (intrahour interval) tables.

This report can be accessed in the following ways:

- From the Integrated Agent Category selector menu.
- By drilling down to this report from the Agent Name or Login ID fields on other reports (for example, Agent Information, Work State, Graphic AUX Agent reports or from Call Center Administration windows).
- If an agent logs off while an Integrated Agent Report is being displayed, the staffed time and AUX time for that agent may drop, because the real-time component of the times is no longer present. Restarting the report will cause the integrated times to be displayed once again.

**Agent Information report example** This figure provides an example of an Agent Information report:

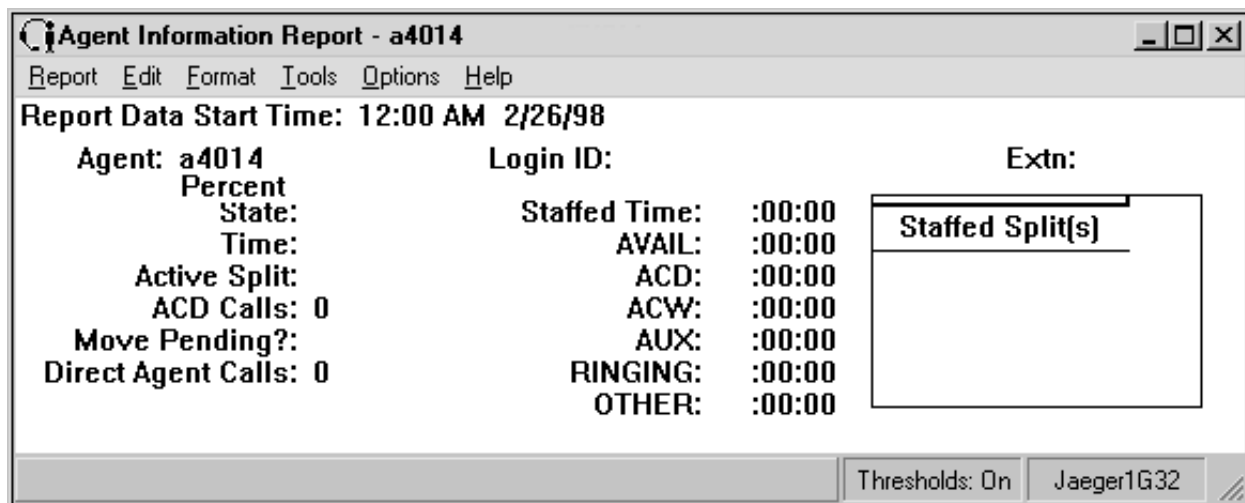

**Agent Information report description** This table describes the report fields.

Report Heading	Description	Database Item, Calculation, or <Calculation Name>
Report Data Start Time:	The day and time that the report started collecting data.	No database item.
Agent:	The names (or agent IDs if the names have not been assigned in Dictionary) of the agents assigned and logged into this split/skill.	syn(LOGID)
Login ID:	The login identification of the agent.	LOGID
Extn:	The extension that the agent logged in from.	EXTENSION
Percent	The agent's percent allocation.	PERCENT
State:	The current work mode (state) that the agent is in (AVAIL, ACD, ACW, AUX, DACD, DACW, RING, UNKNOWN, OTHER, UNSTAFF) and the call direction (blank, IN or OUT).	syn(AWORKMODE) and syn(DIRECTION)
Time:	The elapsed time since the last agent WORKMODE change for any split/skill. This item is not reset if the DIRECTION changes, but WORKMODE remains the same. For example, if the agent goes from AUX to AUXOUT to AUX, AGTIME continues without resetting.	AGTIME

Report Heading	Description	Database Item, Calculation, or <Calculation Name>
Active Split:	When an agent is on a split or direct agent ACD call or in ACW, this is the split associated with the call or ACW. When an agent is available, in AUX or in OTHER, this is null (blank). When an agent is on an AUXIN/AUXOUT call, this is the OLDEST_LOGON split. When an agent is on an AUXIN/AUXOUT call from the available state, while in AUX or with an AUXIN/AUXOUT call on hold, this is the OLDEST_LOGON split/skill. When an agent is on an AUXIN call with an ACD call on hold, this is the OLDEST_LOGON split. When an agent is on an AUXOUT call with an ACD call on hold, this is the split associated with the ACD call.	syn(WORKSKILL)
ACD Calls:	The queued ACD calls to the split/skill that were answered by an agent in the split/skill. This does not include direct agent calls, but it does include ACD calls placed by an adjunct (outbound predictive dialing—Generic switches with ASAI only).	sum(ACDCALLS)
Move Pending?:	A move to a new split or skill or a change of skills is pending for this agent. This is available only for Generic 3 Version 4 and later switch releases with the “Move Agent While Staffed” feature.	MOVEPENDING
Direct Agent Calls:	The number of direct agent ACD calls that the agent answered.	sum(DA_ACDCALLS)
Staffed Time:	Current number of top agents that are staffed in the skill.	sum(TI_STAFFTIME)
AVAIL	The time since the report start time that the agent was in the available state for split/skill or direct agent ACD calls in any split/skill. TI_AVAILTIME is recorded for the split/skill. For non-EAS operation, if an agent logged into multiple splits in AUX mode in one split and is available for ACD calls in another split. The agent will accrue I_AVAILTIME for the split in which the agent is available and TI_AVAILABLE in the split logged into the longest.	sum(TI_AVAILTIME)
ACD	The time during the collection interval that the agent was talking on ACD calls for the SPLIT.	sum(I_ACDDTIME + I_DA_ACDDTIME)

Report Heading	Description	Database Item, Calculation, or <Calculation Name>
ACW	The time during the collection interval that the agent was in after call work (ACW). This includes ACW for split/skill ACD calls and ACW not associated with the call.	sum(I_ACWTIME + I_DA_ACWTIME)
AUX	The time during the collection interval that the agent was in AUX in all splits/skills or on AUXINCALLS or AUXOUTCALLS. The "TI_" stands for the time that is stored only for the split or skill that the agent is logged into for the longest amount of time.	sum(TI_AUXTIME)
RINGING	The time during the collection interval that the agent had split/skill and direct agent ACD calls ringing. If the agent changes work modes or answers/makes another call instead of answering the ringing call, I_RINGTIME will stop accumulating. RINGTIME is the time the caller spends ringing and is independent of agent activity.	sum(I_RINGTIME)
OTHER	The time during the collection interval that the agent was doing other work in all splits/skills. For Generic 3 switches, while in Auto-in or Man-In: the agent put any call on hold and performed no further action, the agent dialed to place a call or to activate a feature, or an extension call rang with no other activity. For all switches, TI_OTHERTIME is collected for the time period after the link to the switch comes up or after the agent logs in and before the CMS receives notification of the agent's state from the switch.	sum(TI_OTHERTIME)
Staffed Split(s)	Split/Skill number for which data was collected.	syn(SPLIT)



---

# Split/Skill Reports

## Overview

---

- Purpose** *CentreVu* Supervisor Split/Skill reports allow access to the following specific information about splits and skills:
- The current status and cumulative data for one or more splits or skills.
  - The status of agents in the split/skill and cumulative split/skill statistics.
  - The time each specified skill has spent in normal versus overload conditions.



---

## General Information About Split/Skill Reports

---

**Organization of this section** This section contains the following topics:

- [Organization of Split/Skill reports \(5-18\)](#)
- [Split/Skill Reports Selector Window and Input Fields \(5-19\)](#)
- [Split/Skill Reports Selector Window and Input Fields \(5-19\)](#)
- [Split/Skill Comparison Report \(5-21\)](#)
- [Graphical Skill Overload Report \(5-24\)](#)
- [Graphical Split/Skill View Report \(5-26\)](#)

**Organization of Split/Skill reports** The following list shows how the Integrated Split/Skill reports are organized in *CentreVu* Supervisor:

- Comparison
- Graphical Skill Overload
- Graphical Split/Skill View
- Graphical Skill Overload





# Split/Skill Reports Selector Window and Input Fields

## Split/Skill reports selector window

The following figure is an example of the Split/Skill report selector window. The reports are explained in the same order as listed in the window.

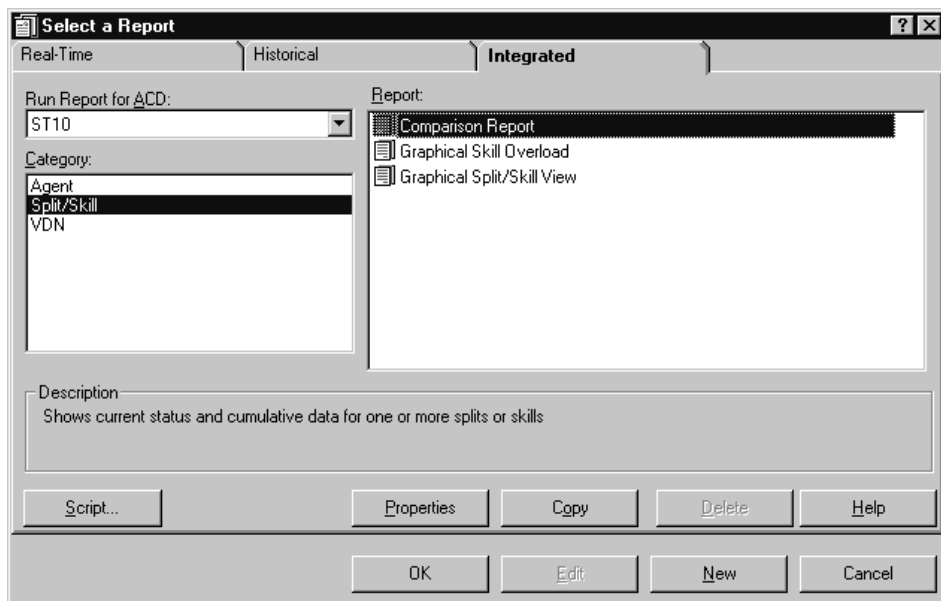

## Split/Skill report input fields

The following describes the input fields on integrated Split/Skill report input windows. The report input window must be filled in to run the report. These fields are the same for all integrated split/skill reports:

Field	Description
Splits/Skills:	Enter the appropriate split/skill name(s). Any name you want to appear on the report must have been previously defined and entered in the Dictionary subsystem.
Report Data Start Time:	Enter the day and time (either in military time or with AM/PM specified) you want the report to start collecting data. The time entered (or the time adjusted to the nearest previous interval start time relative to the entered time) is used to populate the Report Data Start Time field on the report. NOTE: If no report start time is available, the start time will be midnight of the current day. The report start time must be less than 24 hours before the current time.

Field	Description
Refresh Every <#> Seconds	Enter the number of seconds (3 to 600) to specify how rapidly <i>CentreVu</i> CMS should update the report data. The default value for the Refresh rate in seconds: field in this window is your assigned minimum refresh rate plus 15 seconds. To find out what your minimum refresh rate is, or to change it, check with your <i>CentreVu</i> CMS administrator.
Enable Report Thresholds	Check this box to turn on the thresholds for the report.
Run Minimized	Check this box to minimize the report.



# Split/Skill Comparison Report

**Overview** This report shows the current status and cumulative data for one or more splits or skills.

**Things to know about this report** Here are some things to know about this report:

- Call center supervisors or administrators who are responsible for several splits/skill can use this report to see if splits/skills have comparable talk times, abandon rates, and average speed of answer figures that are comparable up until a certain point in the day.
- The database items for the Split/Skill Comparison report are stored in the `csplit` (current interval) and `hsplit` (intrahour interval) table.
- This report uses the Split/Skill Comparison Report Input Window. See [Split/Skill Reports Selector Window and Input Fields \(5-19\)](#) for input field definitions.

**Split/Skill Comparison report example** This figure provides an example of a Split/Skill Comparison report.

Split/Skill	Skill State	Agents Staffed	Calls Waiting	Oldest Call Waiting	ACD Calls	Avg ACD Time	Aban Calls	Avg Aban Time	Avg Speed Ans
T22	NORMAL	0	0	:00	0		0		
T23	NORMAL	0	0	:00	0		0		
T26	NORMAL	0	0	:00	0		0		
Total	NORMAL	0	0	:00	0		0		
sp998	NORMAL	0	0	:00	0		0		

Report Data Start Time: 12:00 AM 8/23/99

Double Click To Run Format Table      Thresholds: On      ST10

**Split/Skill Comparison report description** This table describes the report fields:

Report Heading	Description	Database Item, Calculation, or <Calculation Name>
Report Data Start Time:	The day and time that the report started collecting data.	No database item.
Split/Skill:	The name or number of the split(s)/skill(s) selected for the report.	syn(SPLIT)
Skill State	Current state of this skill, compared to the administered thresholds. Requires ECS R6 or later with <i>CentreVu</i> Advocate.	SKSTATE
Agents Staffed	The login identification of the agent.	STAFFED
Calls Waiting	The total number of ACD calls waiting to be answered for each split/skill in the report. This includes calls that are in queue and ringing at an agent voice terminal. It also includes outbound ACD calls placed by an adjunct (also called outbound predictive dialing), for the Generic 3 with ASAI only. For the Generic 3 switches, it does not include direct agent calls.	INQUEUE + INRING
Oldest Call Waiting	The number of seconds that the oldest call has waited in queue or ringing at an agent voice terminal for each split/skill in the report. This does not include direct agent calls.	OLDESTCALL
ACD Calls	The ACD calls that were queued to the split/skill and answered by an agent. This does not include direct agent calls, but it does include ACD calls placed by an adjunct (also called outbound predictive dialing), for the Generic 3 with ASAI only.	ACDCALLS
Avg ACD Time	The average talk time for all ACD calls to the split. This does not include hold time on direct agent calls, but it does include talk time of all outbound ACD calls placed by an adjunct (also called outbound predictive dialing), for the Generic 3 with ASAI only.	ACDTIME / ACDCALLS, <AVG_ACD_TALK_TIME>

Report Heading	Description	Database Item, Calculation, or <Calculation Name>
Aban Calls	The total number of queued calls for each split/skill that abandoned before an agent answered. This includes calls that are ringing at a voice terminal but does not include direct agent calls. It also includes the number of outbound calls for each split/skill that abandoned at the far end before an agent answered. For the Generic 3 with the ASAI feature only.	ABNCALLS
Avg Aban Time	The average time a caller waited before hanging up.	ABNTIME / ABNCALLS
Avg Speed Ans	The average time calls waited in queue and ringing before an agent answered. This does not include direct agent calls, but it does include outbound ACD calls placed by an adjunct (also called outbound predictive dialing), for the Generic 3 with ASAI only.	ANSTIME / ACDCALLS, <AVG_ANSWER_SPEED>



# Graphical Skill Overload Report

**Overview** This report shows the amount of time each specified skill has spent in normal versus overload conditions from the report start time until the report generation time since a specified start time in the last 24 hours. This report is available only if you have purchased the Expert Agent Select (EAS) feature.

## Things to know about this report

Here are some things to know about this report:

- The Graphical Skill Overload report is a vertical bar graph.
- The database items for the report are stored in the `csplit` (current interval) and `hsplit` (intrahour interval) table.
- This report uses the Split/Skill Comparison Report Input Window. See [Split/Skill Reports Selector Window and Input Fields \(5-19\)](#) for input field definitions.

## Graphical Skill Overload report example

This figure provides an example of a Graphical Skill Overload report.

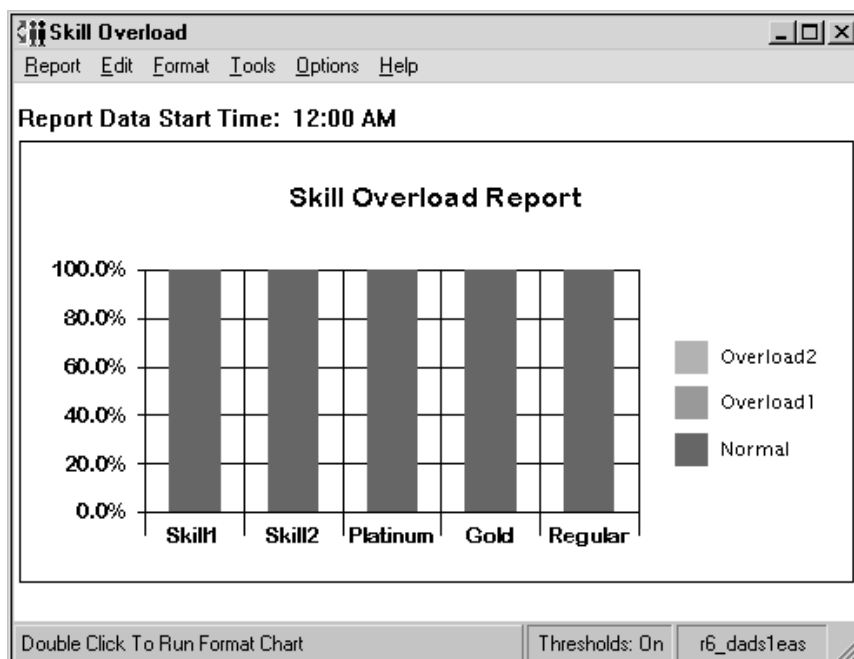

**Graphical Skill Overload report description** This table describes the report fields:

Report Heading	Description	Database Item, Calculation, or <Calculation Name>
Split/Skill:	The name or number of the split(s)/skill(s) selected for the report.	syn(SPLIT)
Normal	The time the skill spent under all of the thresholds.	I_NORMTIME
Overload1	The time the skill spent over threshold 1 and under threshold 2.	I_OL1TIME
Overload2	The time the skill spent over threshold 2.	I_OL2TIME



# Graphical Split/Skill View Report

**Overview** This report shows the status of agents in the split/skill and cumulative split/skill statistics.

**Things to know about this report**

Here are some things to know about this report:

- Call center managers can use this report for large numbers of agents in one split or skill, and need split/skill status but do not want to consume the PC resources required to display individual agent status of many agents. Call center managers can use this report to see the totals and averages for a specific split or skill up to a certain point in the day.
- The database items for the Graphical Split/Skill view report are stored in the `csplit` (current interval) and `hsplit` (intrahour interval) table.
- This report uses the Split/Skill View Input Window. See [Split/Skill Reports Selector Window and Input Fields \(5-19\)](#) for input field definitions.

**Graphical Split/Skill View report example**

This figure provides an example of a Graphical Split/Skill view report.

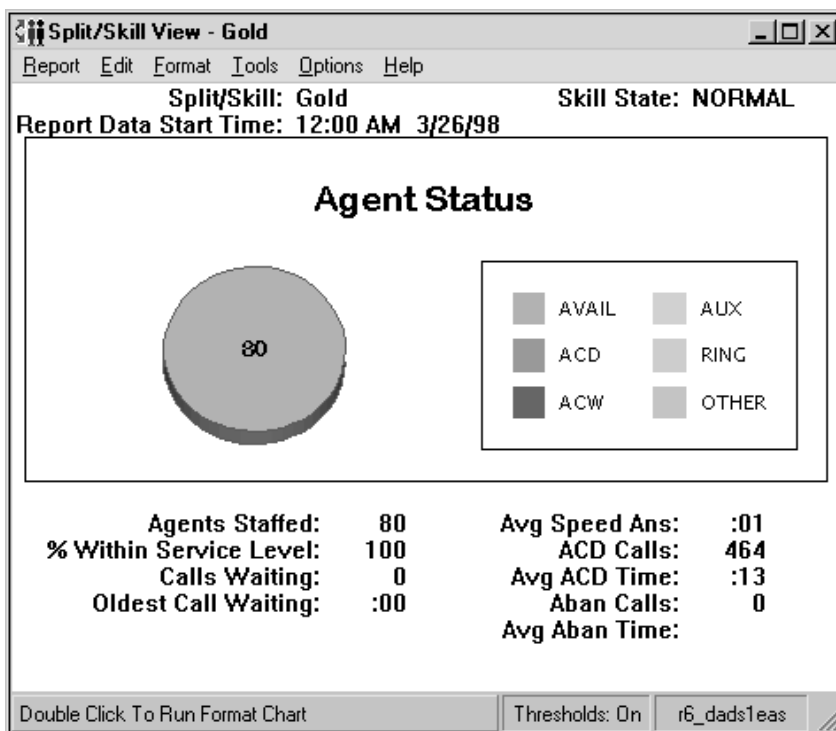



**Graphical Split/Skill View report description** This table describes the report fields:

Report Heading	Description	Database Item, Calculation, or <Calculation Name>
Report Data Start Time:	The day and time that the report started collecting data.	No database item.
Skill State	Current state of this skill, compared to the administered thresholds. Requires ECS R6 or later with <i>CentreVu Advocate</i> .	syn(SKSTATE)
AVAIL	The current number of agents that are available to receive ACD calls in this split/skill.	AVAILABLE
ACD	The total number of agents connected to inbound and outbound ACD calls in each split/skill. This does not include direct agent calls.	ONACD
ACW	The current number of POSITIONS that are in after call work for this split/skill. This includes agents on ACWIN/ACWOUT calls as well as agents in ACW not associated with an ACD call. It does not include agents in ACW for direct agent ACD calls.	INACW
AUX	The current number of POSITIONS that are in auxiliary work for all splits/skills or on AUXIN/AUXOUT calls.	INAUX
RINGING	The current number of POSITIONS that are in the “ring” state, for this split/skill. For example, the positions that have a split/skill or direct agent ACD call ring for this split/skill and are not doing anything else. Note: When an agent makes or answers an extension call while an ACD call is ringing, that position is no longer counted in AGINRING (because the agent is then on an AUXIN/OUT call). Agents talking on ACD calls who receive a forced MCH call (for Generic 3 Version 4 switches and later) are not counted in AGINRING (they are counted in ONACD).	AGINRING
OTHER	The current number of POSITIONS that are doing other work.	OTHER
Agents Staffed:	The number of agents logged into the split/skill.	STAFFED

Report Heading	Description	Database Item, Calculation, or <Calculation Name>
% Within Service Level:	The percentage of split/skill ACD calls that were answered by an agent within the predefined acceptable service level. Calls to the split/skill include abandoned calls, calls not answered, and outbound ACD calls placed by an adjunct (for example, outbound predictive dialing—Generic 3 switches with the ASAI feature). Calls that were not answered may include forced busy calls, forced disconnect calls, calls redirected to another destination, and calls queued to more than one split and answered in another split/skill. For Generic 3 switches, Percent Within Service Level does not include direct agent calls.	100*(ACCEPTABLE/ CALLSOFFERED); sum(PERCENT_SERV_ LVL_SPL); <PERCENT_SERV_LVL>
Calls Waiting	The total number of split/skill ACD calls waiting to be answered. This includes calls that are in queue and ringing at an agent voice terminal and outbound ACD calls placed by an adjunct (for example, outbound predictive dialing—Generic 3 switches with the ASAI feature). It does not include direct agent calls (Generic 3 switches only).	INQUEUE + INRING
Oldest Call Waiting:	The number of seconds that the oldest ACD call has waited in queue or ringing before being answered. This does not include direct agent calls.	OLDESTCALL
Avg Speed Ans:	The average time that calls waited in queue or ringing before an agent answered. This does not include direct agent calls, but it does include outbound ACD calls placed by an adjunct (outbound predictive dialing—Generic 3 with the ASAI feature only).	ANSTIME / ACDCALLS; <AVG_ANSWER_SPEED>
ACD Calls:	The queued ACD calls to the split/skill that were answered by an agent. This does not include direct agent calls, but it does include ACD calls placed by an adjunct (outbound predictive dialing—Generic 3 with ASAI only).	ACDCALLS
Avg ACD Time:	The average talk time (does not include hold time) for all ACD calls to this split/skill. This does not include direct agent calls, but it does include talk time of all ACD calls placed by an adjunct (outbound predictive dialing—Generic 3 with the ASAI feature only).	<AVG_ACD_TALK_TIME>

Report Heading	Description	Database Item, Calculation, or <Calculation Name>
Aban Calls:	The total number of queued calls for each split/skill that abandoned before an agent answered. This includes calls that are ringing at a voice terminal but does not include direct agent calls. It also includes the number of outbound calls for each split/skill that abandoned at the far end before an agent answered (Generic 3 with the ASAI feature only).	ABNCALLS
Avg Aban Time:	The average time a caller waited before hanging up.	ABNTIME / ABNCALLS; <AVG_ABANDON_TIME>



---

# VDN Report

## Overview

---

**Purpose** The *CentreVu* Supervisor VDN Graphical Call Handling report allows access to specific information on answered, abandoned, and outflow calls.

**Organization of this section** This section contains the following topics:

- [General Information About the VDN Report \(5-31\)](#)
- [VDN Graphical Call Handling Report \(5-33\)](#)



# General Information About the VDN Report

## VDN Report selector window

The following figure is an example of the VDN report selector window.

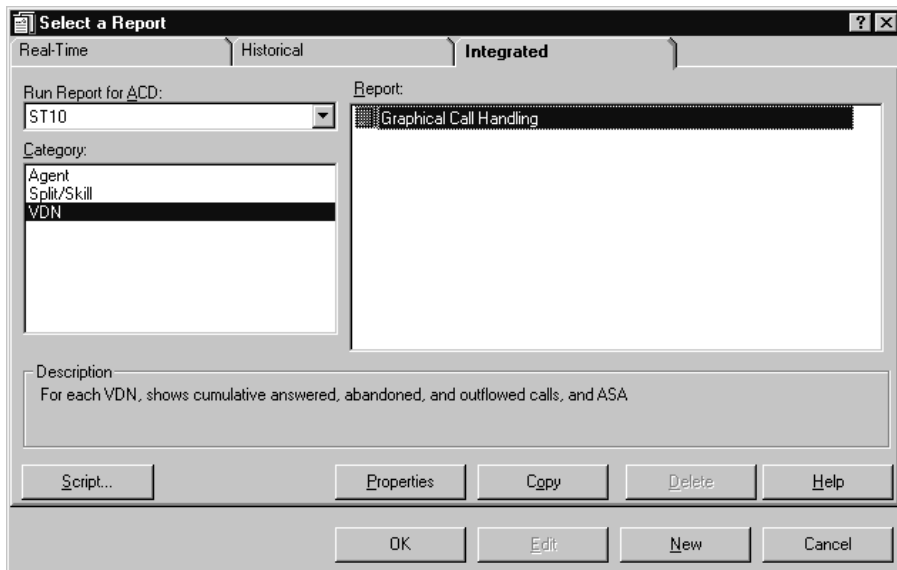

**VDN Report input fields** This table describes the input fields on integrated VDN Report Input windows. You must fill in the report input window to run the report:

Field	Description
VDNs:	<p>Enter the number(s) or name(s) (if they have been defined in the Dictionary) of the VDN(s) that you want to include in the report. You can enter a name only if it has been previously defined in the Dictionary subsystem.</p> <p>To complete the input field, do the following:</p> <ul style="list-style-type: none"> <li>• Type in the information requested.</li> <li>• Select the information from the pull-down list of previously used items. During each CMS session, Supervisor recalls the items you have selected for each input field. You can use the pull-down list to select an item for the input field.</li> <li>• Use the Browse button to view all available items for the input field, and then select item(s) for the input field. When you click on the Browse button, a window opens that lets you select items for the input field.</li> </ul>
Report Data Start Time:	<p>Enter the day and time (either in military time or with AM/PM specified) you want the report to start collecting data. The time entered (or the time adjusted to the nearest previous interval start time relative to the entered time) is used to populate the Report Data Start Time field on the report. NOTE: If no report start time is available, the start time will be midnight of the current day. The report start time must be less than 24 hours before the current time.</p>
Refresh Every <#> Seconds	<p>Enter the number of seconds (3 to 600) to specify how rapidly <i>CentreVu</i> CMS should update the report data. The default value for the Refresh rate in seconds: field in this window is your assigned minimum refresh rate plus 15 seconds. To find out what your minimum refresh rate is, or to change it, check with your <i>CentreVu</i> CMS administrator.</p>
Enable Report Thresholds	<p>Check this box to turn on the thresholds for the report.</p>
Run Minimized	<p>Check this box to minimize the report.</p>



# VDN Graphical Call Handling Report

---

**Overview** This report shows, for each VDN, the cumulative number of calls that are answered, abandoned, and considered outflow calls. The report also includes the average speed of answer.

**Things to know about this report** Here are some things to know about this report:

- This report shows in chart format how many ACD calls for each specified VDN were answered, abandoned, or outflowed. It also shows the switch-based ASA.

This report consists of two charts, with a legend to the right of each.

- The top chart is a three-dimensional, horizontal, color-coded bar chart showing the numbers of ACD calls answered, abandoned, and outflowed.
- The bottom chart is a line graph, where the Rolling ASA for each specified VDN is represented by each color-coded line.
- If the system is a switch that does not have the EAS feature, see the section, “Agent Information report,” in this chapter for details.
- The chart type can be changed. See Chapter 2, “Using Reports”, for more information.
- The database items used for the VDN Graphical Call Handling report are stored in the **cvdn** (current interval) and **hvdn** (intrahour interval) tables.
- This report uses the VDN Graphical Call Handling Report Input Window. See [General Information About the VDN Report \(5-31\)](#) for input field definitions.

**VDN Graphical Call Handling report example**

This figure provides an example of a VDN Graphical Call Handling report.

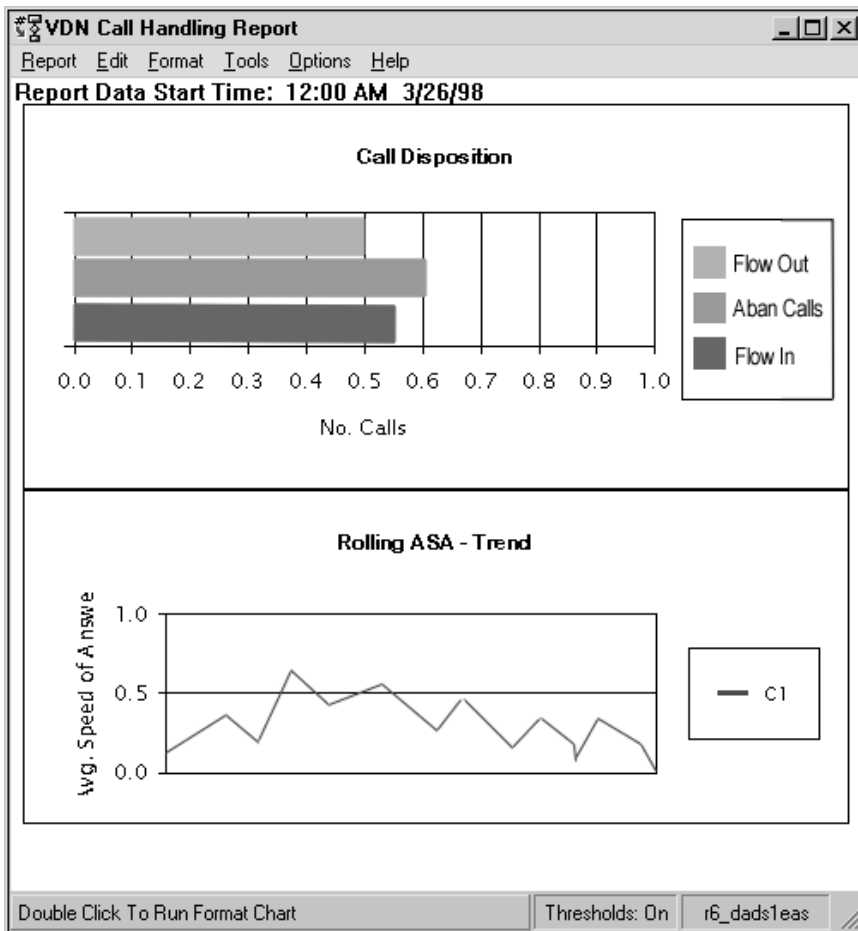

**VDN Graphical Call Handling report description**

This table describes the report fields:

Report Heading	Description	Database Item, Calculation, or <Calculation Name>
Report Data Start Time:	The day and time that the report started collecting data.	No database item.
VDN	The number or name of the VDN for which the report shows data (selected in the report input window).	syn(VDN)
Rolling ASA	The switch-provided rolling average speed of answer for this VDN. This value is sent to <i>CentreVu</i> CMS whenever it changes (for example, when a call is answered) on the Generic 3 Version 4 or later switch with the call vectoring enhancements.	ASA



Report Heading	Description	Database Item, Calculation, or <Calculation Name>
Flow Out	The number of calls that were redirected to another VDN or off-switch destination via a “route to” step or “adjunct routing” command, or were redirected to a VDN by redirection on no answer. Calls in the VDN that are routed to other switch destinations, such as splits/skills or extensions, are not counted as outflows from the VDN.	OUTFLOWCALLS
Aban Calls	The number of calls to the ACD during the reporting period that hung up while being carried by this VDN.	ABNCALLS
ACD Calls	The number of split/skill and direct agent ACD calls completed during the reporting period that were answered while carried by the VDN. This includes calls from “queue to main,” “check backup,” “route to” split/skill, and “adjunct routing” to a split/skill or direct agent.	ACDCALLS





---

# Appendix A: Database Items and Calculations

## Overview

---

**Purpose** For complete descriptions of all Database items and calculations available with Release 3 Version 8 CMS, refer to the *CentreVu® CMS R3V8 Database Items and Calculations* document, 585-210-939.





# Glossary

**% Agent Occupancy with ACW**

Agent occupancy, displayed as a percentage, including agent after call work (ACW) time as work time.

**% Agent Occupancy without ACW**

Agent occupancy, displayed as a percentage, not including agent ACW time as work time.

**% Agent Group Occupancy with ACW**

Agent group occupancy, displayed as a percentage, including agent ACW time as work time.

**% Agent Group Occupancy without ACW**

Agent group occupancy, displayed as a percentage, not including agent ACW time as work time.

**% Flow Out**

The percentage of inbound calls on the VDN that are directed (flowed out) to other VDNs.

**Abandoned Call**

A call in which a caller hangs up before receiving an answer from an agent. The call could be queued to a split or in a vector/VDN before it is abandoned.

**Abandoned Call Search**

An ACD capability that enables the system to make sure that the caller is on the line before passing the call to an agent.

**Acceptable Service Level**

A target value set to define the acceptable amount of time for an agent to answer a call. Target values are normally set as objectives by management.

A percentage of calls answered within a set amount of time (for example, 80% of calls answered within 20 seconds).

**Access Permissions**

Permissions assigned to a CMS user so that the user can access different subsystems in CMS or administer specific elements (splits/skills, trunks, vectors, etc.) of the ACD. Access permissions are specified as read or write permission. Read permission means the CMS user can access and view data (for example, run reports or view the Dictionary subsystem). Write permission means the CMS user can add, modify, or delete data and execute processes.

**ACD**

See Automatic Call Distribution.

**ACD Call**

A call that queued to a split/skill and was answered by an agent in that split/skill, or a call that queued as a direct agent call and was answered by the agent for whom it was queued.

**Acknowledgment**

A window that requires you to confirm an action or to acknowledge a system message (for example, system going down, warning, or fatal error for the user window). This window cannot be moved, sized, or scrolled and disappears only when you confirm the message.

**Activate Agent Trace**

From this window you can start CMS tracing of agent activities. These activities include all agent state changes until the trace is turned off. You must activate an agent trace to obtain an Agent Trace report.

**Active VDN Calls**

The number of calls currently active in a VDN. The G3V4 vector enhancement "VDN Calls Routing" refers to the ability to program a vector step according to the number of active VDN calls. The number of active calls is referred to as "counted-calls" in the vector step.

**ACW**

See After Call Work.

**Adjunct/Switch Applications Interface (ASAI)**

An AT&T recommendation for interfacing adjuncts and communications systems, based on the CCITT Q.932 specification for layer 3. ASAI supports activities such as event notification and call control.

**After Call Work (ACW)**

An agent state generally representing work related to the preceding ACD call. Going on-hook after an ACD call during MANUAL-IN operation places the call in ACW. With Generic 1 and Generic 3, ACW is accessible by a key on the agent's set and may not be related to an ACD call.

**Agent**

A person who answers calls to an extension in an ACD split/skill. The agent is known to CMS by a login identification keyed into a voice terminal.

**Agent Login ID**

A 1- to 9-digit number (Generic 3) entered by an ACD agent from a voice terminal to activate the agent position. Agent logins are required for all CMS-measured ACD agents.

**Agent Occupancy**

The average percentage of time that you are expecting or targeting for each split/skill agent to spend, while logged in, on ACD calls and in ACW.

**Agent Position(Non-EAS)**

The combination of agent login ID and split the agent logged into. Agents logged into multiple splits have multiple positions associated with them. Call data are collected separately for each agent/split combination.

**Agent Position (EAS)**

The combination of agent login ID and the skills the agent is assigned. Data are collected for the agent by skill, so the total work for the agent must be summed over all skills in which the agent worked.

**Agent Role**

A description of the kind of service an agent in multiple skills gives to one of their skills. This is a combination of call handling preference and skill/reserve levels.

The five roles are:

- Top: top agents logged into their highest priority skill
- Allocated: agents with percent allocation call handling preference administered (see the *CentreVu® Advocate User Guide*, 585-210-927)
- Backup: agent is assigned to a skill, but not as the top skill
- Roving: an agent answers the skill's calls when this skill has the greatest need
- Reserve: an agent who normally does not answer call for this skill answers calls in the skill because the skill has surpassed its pre-set over-threshold conditions (see the *CentreVu® Advocate User Guide*, 585-210-927)

**Agent Skill**

An attribute that is associated with an ACD agent. Agent Skills can be thought of as the ability for an agent with a particular set of skills to handle a call that requires one of a set of skills. An agent can be assigned up to 20 skills. The meaning of each Agent Skill is defined by the customer. Examples are the ability to speak a particular language or the expertise to handle a certain product.

See also Primary Skill and Secondary Skill.

**Agent State**

A feature of agent call handling. Agent states are the different call work modes an agent can be in (ACD, ACW, AVAIL, AUX, UNSTAFF, DACD, DACW, OTHER, UNKNOWN, RINGING). Data about these states is displayed in real-time and historical reports.

See the definition of each state for additional information.

**Agent Terminal**

The voice terminal used by a call-center agent.



**Agent Trace**

You must start an agent trace before you can obtain an Agent Trace report. You can activate traces for a maximum of 25 agents at any one time. You can select the dates in which the trace will receive information. This report lists each agent activity and the time it occurred. The Agent Trace report can be helpful when evaluating how well individual agents are using their time.

**AI**

See Auto-In.

**Algorithm**

A prescribed set of well-defined rules or instructions for the solution of a problem; for example, the performance of a calculation, in a finite number of steps. Expressing an algorithm in a formal notation is one of the main parts of a software program.

**ANI**

See Automatic Number Identification.

**Announcement**

A recorded message that normally tells the caller what destination the call has reached. The announcement also often tries to persuade the caller to stay on the line. With Call Vectoring, announcements can be part of a vector's call processing. An announcement is assigned to a vector by entering an announcement number.

**ASA**

See Average Speed of Answer.

**ASAI**

See Adjunct/Switch Applications Interface.

**Auto-Available Split**

An ACD capability that ensures that after a power failure or a system restart, Voice Response Units (for example, the CONVERSANT™ Voice Information System) are brought on line again immediately, without time-consuming reprogramming.

**Auto-In (AI)**

An ACD work mode that makes the agent available to receive calls and allows the agent to receive a new ACD call immediately after disconnecting from the previous call.

**Automatic Call Distribution (ACD)**

A switch feature. Automatic Call Distribution (ACD) is software that channels high-volume incoming call traffic to agent groups (splits or skills).

Also an agent state where the extension is engaged in an ACD call (with the agent either talking to the caller or the call waiting on hold).

See also Redirect on no Answer and Auto-Available Split.

**Automatic Number Identification (ANI)**

A general industry term referring to knowledge of the calling party number (CPN). When the calling party is behind a switch, the number provided can be either a billing number for the switch or the station identification number.

**AUX**

See Auxiliary Work.

**Auxiliary Work (AUX)**

An agent state. For example, the agent is engaged in non-ACD work, is on break, in a meeting, or at lunch. An agent can reach this state by pressing the AUX WORK button or dialing the proper access code from the voice terminal. The agent can also reach the state by going off-hook to make or answer an extension call while in AVAIL or with a call on hold.

**AVAIL**

See Available.

**Available (AVAIL)**

An agent state. The extension is able to accept an ACD call.

**Average Agent Service Time**

The average time you are expecting or targeting for each agent to spend on an ACD call, including talk time and after-call-work time.

---

**Average Speed of Answer (ASA)**

The average amount of time a caller waits in queue before connecting to an agent. ASA is usually an objective set by your call center's management.

The ASA for a split/skill includes the time spent in queue and the time ringing an agent. ASA for a VDN includes the time spent in vector processing (including the time spent in queue and the time ringing) for the VDN that the call was answered in.

Interval ASA has been used for BCMS and pre-R3V4 CMS reporting where the ASA is calculated on reporting interval boundaries and the ASA is cleared to zero at the start of each reporting interval. Rolling ASA is used, beginning with R3V4 CMS, for vector routing. Rolling ASA is a running weighted average calculation without regard to any interval boundaries. Rolling ASA is calculated on the G3V4 switch and sent to R3V4 CMS.

**Calculation**

A menu selection in the CMS Dictionary subsystem which gives the abbreviated name (calculation name) for the calculation that generates the data for a field in a report.

**Call-Based Items**

The category of database items in CMS that are committed to the database after the call completes. If a call starts and ends in different intrahour intervals, all of the call-based data is recorded in the interval in which the call completed. Most database items are call-based.

**Call Handling Preference**

A parameter of agent administration in the EAS environment that specifies how calls are selected for the agent.

**Call-Handling Profile**

A set of objectives describing how you want a split/skill to handle calls.

**Call Management System (CMS)**

A software product used by business customers that have AT&T telecommunications switches and receive a large volume of telephone calls that are processed through the Automatic Call Distribution (ACD) feature of the switch. The CMS collects call-traffic data, formats management reports, and provides an administrative interface to the ACD feature in the switch.

**Call Prompting**

A switch feature that routes incoming calls based on information entered by the calling party, such as an account number. The caller receives an announcement and is prompted to select an option from those listed in the announcement.

**Call Vectoring**

A switch feature that provides a highly flexible method for processing ACD calls using VDNs and vectors as processing points between trunk groups and splits. Call vectoring permits treatment of calls that is independent of splits.

Similar to a computer program, a call vector is a set of instructions that control the routing of incoming calls based on conditions that occur in a call center environment. Examples of call vector conditions include time of day and the number of calls in queue.

**Call Work Code (CWC)**

An ACD capability that makes sure that during or after the call, the agent can enter a string of digits and send these digits to the *DEFINITY*® Call Management System for management reporting.

**Calls Carried**

Trunk data. The number of inbound/outbound calls carried.

***CentreVu* Advocate**

A set of features designed to enhance call and agent selection within a call center. *CentreVu*® Advocate requires Version 6 *CentreVu*® Supervisor, a *DEFINITY*® ECS Release 6, and Expert Agent Selection. See the *CentreVu*® Advocate User Guide (585-210-927) for more information.

***CentreVu* Supervisor**

The Call Management System application for the Microsoft Windows operating environment.

**Change Agent Skills**

An agent's skills may be changed from CMS by using the Change Agent Skills Window. The Change Agent Skills Window allows the user to change the skill assignments for one agent. Through this window a user can quickly see what skills are currently assigned to an agent and the user can easily change the agent's skill assignment or apply an agent template to up to 50 agents.

**CMS**

See Call Management System.

**CONN**

See Connected.

**Connected (CONN)**

A trunk state. A caller and an agent are connected on an ACD call.

**Connected Call**

A non-ACD call is considered to be connected to an extension (not a VDN or direct agent) when the call rings at the station and the caller does not abandon.

**Current**

A CMS action that displays data from the current interval.

**Current Interval**

Represents the current intrahour interval, which can be 15, 30, or 60 minutes. The current interval is part of the real-time database.

**Current Wait Time**

The time a call has waited for service in a call queue adjusted for queue priority.

**Custom Reports**

Real-time or historical reports that have been customized from standard reports or created from scratch. See the *CentreVu*™ *CMS R3V5 Custom Reports* document, 585-215-822, Issue 2.

**CWC**

See Call Work Code

**DABN**

See Direct Abandon.

**DACD**

See Direct Agent ACD.

**DACW**

See Direct Agent ACW.

**Daily Data**

Interval data that has been converted to a 1-day summary.

**Data Collection Off**

CMS is not collecting ACD data. If you turn off data collection, CMS will not void data on current call activity.

**Data Collection On**

CMS is collecting ACD data.

**Data Points**

Points of historical data. A data point should include data for each interval of the working day.

**Database**

A group of tables that store ACD data according to a specific time frame: current and previous intrahour real-time data and intrahour, daily, weekly, and monthly historical data.

**Database Item**

A name for a specific type of data stored in one of the CMS databases. A database item may store ACD identifiers (split numbers or names, login IDs, VDNs, etc.) or statistical data on ACD performance (number of ACD calls, wait time for calls in queue, current states of individual agents, etc.).

**Database Tables**

CMS uses these tables to collect, store, and retrieve ACD data. Standard CMS items (database items) are names of columns in the CMS database tables.

**Date Format**

The standard format for entering dates on Supervisor reports.

Acceptable formats are:

- Month/day/year (for example, 3/21/93).
- A "-" offset based on today's date (for example, -1 for yesterday). You can also enter a range of numbers (for example, 0 through -7).
- Separating individual data entry items using a semicolon (for example, 3/21/93;3/23/93;3/25/93)
- Entering ranges by placing a hyphen between entries (for example, 3/21/93-3/25/93).

When you specify a date for a weekly report, that date or range of dates must correspond to the week start day selected in the System Setup-Storage Intervals window. If the date and day do not match, the message No records found displays in the status line.

The month start date must be the first day of the month.

**Delete**

A CMS action that removes the entry on the window from the database.

**Designer Reports**

Customized reports that can be created using *CentreVu*® Supervisor's Report Designer feature, and which are run from *CentreVu*® Supervisor.

**Dictionary**

A CMS subsystem that can be used to assign names to various call center elements such as login IDs, splits/skills, trunk groups, VDNs and vectors. These names appear on reports, making them easier to interpret.

**Dictionary Location**

The location ID is a number associated with one or more port networks on a *Definity* R7.1 or later. Any hardware residing on a port network is assigned the port network's location ID and identified by that ID number. The hardware tracked with this number includes the voice terminals agents use and trunks.

The location ID assigned to voice terminals can be used to track individual agents. The location ID assigned to trunks can be used to track groups of agents by location. VDNs, hunt groups, and vectors do not have location IDs associated with them because they operate independently of locations.

**Direct Abandon (DABN)**

A trunk state. The caller abandoned the call, and the trunk quickly goes to idle.

**Direct Agent ACD (DACD)**

An agent state. The agent is on a direct agent ACD call.

**Direct Agent ACW (DACW)**

An agent state. The agent is in the after call work state for a direct agent ACD call.

**Direct Agent Calling**

An EAS capability that makes it possible for a caller to reach the same agent every time and still include the call in the management tracking of the call center. This is ideal for claims processing, where a client needs to speak with the agent handling the claim. This flexibility ensures a high level of customer service without reducing management control.

**EAD**

See Expert Agent Distribution.

**EAS**

See Expert Agent Selection.

**Entity**

A generic term that refers to one of the following: Agent, Agent Group, Split/Skill, Trunk, Trunk Group, VDN, Vector, or Call Work Code.



**Error Message**

A response from a program indicating that a problem has arisen or something unexpected has happened, requiring your attention.

**EWT**

See Expected Wait Time.

**Exception**

A type of activity on the ACD which falls outside of the limits you have defined. An exceptional condition is defined in the CMS Exceptions subsystem, and usually indicates abnormal or unacceptable performance on the ACD (by agents, splits/skills, VDNs, vectors, trunks, or trunk groups).

**Exception Reports**

Display occurrences of unusual call-handling events.

**Expected Wait Time (EWT)**

An estimate of how long a caller will have to wait to be served by a call center while in queue considering the current and past traffic, handling time, and staffing conditions. Time spent in vector processing before being queued and the time spent ringing an agent with manual answering operation is not included in the EWT prediction. With the G3V5 and R3V5 CMS, the EWT is a switch-based calculation.

**Expert Agent Distribution (EAD)**

A call queued for a skill will go to the most idle agent (primary skill agent). Agents who are idle and have secondary agent skills will receive the call queued for a skill if there are no primary agents available.

**Expert Agent Selection (EAS)**

Expert Agent Selection (EAS) is an optional switch feature that builds on the power of the Call Vectoring and ACD features of the switch to match the skills required to handle a particular call to an agent who has at least one of the skills that a caller requires. The ACD queuing and the vector commands Queue-to-Main and Check-Backup are used to route a call to an agent with the appropriate skill to handle that call. With EAS call distribution is based on skill. You can match the skills required to handle a particular call to an agent who has at least one of the skills that a caller requires.

CMS collects data on skills in the same manner as it collects data on splits. Real-Time agent reports generally indicate which skills the agents have, and in which skill they are currently working. Skill reports show the performance of the skill overall, displaying such items as the ASA, the number of calls, and the percentage of calls answered within the target service level for the skill.

CMS also reports VDN data by VDN skill preference, so that customers can assess the call center performance relative to calls requiring particular skills. CMS reports how many calls were handled, how long these calls waited for service, and the average talk time for calls queued to a particular skill preference in a particular VDN.

**Extension Call**

Extension calls are any calls originated by agents and non-ACD calls received by agents. For the Generic 3 switches, these include calls an agent makes to set up a conference or transfer.

**FBUSY**

See Forced Busy.

**FDISC**

See Forced Disconnect.

**Find One**

A CMS action that searches the database for entries that match the input value.

**Flex Agents**

Agents who have a role of Roving, Backup, or Allocated. Top and Reserve agents are not Flex agents. See the *CentreVu® Advocate User Guide*, 585-210-927.

**Flexible Routing**

An ACD capability that allows customers to choose how incoming calls should be routed to agents within a split. Calls can be routed to the first available agent or to the most idle agent.

**Flow Out**

For a split/skill, this is the number of calls offered to a split/skill that were redirected to another destination while queued to the split/skill. This can happen under different circumstances, depending on the switch release and on whether vectoring is active or not. For Generic 3 switches without vectoring, this is the number of CALLSOFFERED that were redirected to another destination while queued to this split/skill.

This can happen if:

- the call intraflowed or interflowed.
- the split/skill call forwarding was active.
- a ringing ACD call was answered using call pickup.
- a ringing ACD call redirected on no answer.

For Generic 3 switches with vectoring, the number of outflow calls are counted if:

- a ringing ACD call redirected on no answer.
- the call rang at an agent in this split/skill and was answered using call pickup.
- the call was routed to another VDN.
- the call routed to a number or digits.
- the call queued to a messaging split/skill.
- the call queued to this split/skill as the primary split/skill and was answered by an agent in another split/skill, rang at an agent in another split/skill and then abandoned or was redirected by the Redirection on No Answer feature (for Generic 3 Version 2 and later switch releases).

For Generic 3 Version 2 switches, this is the number of CALLSOFFERED that were redirected to another destination while queued to this split/skill. This can happen by requeueing to the same split/skill via the Redirect on No Answer feature.

For vectors, this is the number of calls to the vector that were redirected to another destination by way of a "go to vector" command or by a "route to" or "adjunct routing" command to a destination other than a split/skill or direct agent. (Calls that route to a split/skill or direct agent by way of a "route to," "adjunct routing," or "messaging split/skill" command are still tracked in the vector.)

Fro VDNs, this is the number of calls to the VDN that were redirected to another VDN or to a destination outside the switch by way of a "route to" or "adjunct routing" command, or were redirected to another VDN by the Redirect on No Answer feature. Note that calls are only counted as outflows from the VDN when they are redirected to another VDN or to an off-switch destination. Calls in the VDN that route to other destinations, such as split/skills or extensions, are not counted as outflows from the VDN.

**FMCH**

See Forced Multiple Call Handling.

**Forced Busy (FBUSY)**

A trunk state. The caller receives a forced busy signal.

**Forced Disconnect (FDISC)**

A trunk state. The caller receives a forced disconnect.

**Forced Multiple Call Handling (FMCH)**

A feature available with G3V4 or later switches that, when activated for a split/skill, allows calls to be automatically delivered to an idle line appearance, if the agent is in the Auto-In/Manual-In work mode and an unrestricted line appearance is available on the voice terminal.

**Historical Database**

Contains intrahour records for up to 62 days, daily records for up to 5 years, and weekly/monthly records for up to 10 years for each CMS-measured agent, split/skill, trunk, trunk group, vector, and VDN.

**Historical Reports**

Display past ACD data for various agent, split/skill, trunk, trunk group, vector, or VDN activities. A report summary of call data into daily, weekly or monthly totals.

**HOLD**

A trunk state. The agent has put the call on this trunk on hold.

**IDLE**

A trunk state. The trunk is not in use and waiting for a call.

**II**

See Information Indicator.

**Information Indicator (II)**

A two-digit code that identifies the type of originating line (for example: hotel or pay phone) for incoming ISDN PRI calls.

**INFORMIX**

A relational database management system used to organize CMS data.

**INFORMIX SQL**

The interactive interface typically used to view the INFORMIX database. For CMS purposes, CMS QL is used instead of INFORMIX SQL.

**Integrated Services Digital Network (ISDN)**

A digital standard for telephony that enables, among other things, telephone, television, and computer signals on the same lines. This system may someday replace our existing telephone lines.

**Interval-Based Items**

A category of database items. These items represent the amount of time during a collection interval spent doing a particular activity. Interval-based items are updated throughout the collection interval and timing is restarted at the end of the interval. Interval-based items should only be used to show amount of time in an interval for an activity or to calculate percentages of time spent in an interval. Interval-based items should not be used to calculate averages (such as average hold time).

**Intrahour Interval**

A 15, 30, or 60 minute segment of time starting on the hour. An intrahour interval is the basic unit of CMS report time.

**Location**

A location, or site, refers to a physical location. This can be a building, a section of a building, or it can be what was once a separate ACD before the ATM WAN capability was used to merge separate ACDs with other ACDs into one large call center. A location will typically be assigned one (or more) location IDs. A location, despite being part of a larger call center, may continue to have sole responsibility for handling certain 800 numbers. A location may also share responsibility for handling an 800 number by having some of its agents be part of a larger split/skill that includes agents from other locations.

**Location ID for Agents**

An agent location ID is the ID of the agent terminal the agent is logged into. It is associated with the *DEFINITY* port network ID to which the agent terminal is attached. An agent cannot be assigned a location ID for reporting purposes until he or she logs into the ACD. Available on the *DEFINITY* ECS R7.1 with ATM and later.

**Location ID for Trunks**

The *DEFINITY* network location ID (1-44) associated with a trunk. A Location ID is not directly assigned to a trunk, instead, it is assigned to a port network (via the *chcabinetx* form). Therefore, each trunk whose equipment location belongs to that port network will be associated with that port network's location ID.

**Logical Agent**

An EAS feature that associates the agent's login ID with the physical extension when the agent logs in. Properties such as the assigned skills, class of restriction, and coverage path are associated with the login ID rather than the physical extension. This allows agents to log in at any available set.

Agents are assigned a single set of work mode buttons, rather than one set per skill. This simplifies the agent's interface to the work mode buttons. When the "MI" or "AI" button is lit, the agent is available to take a call in any assigned skills.

The Logical Agent capability allows calling agents to connect by dialing into their login IDs. Calls to login IDs may be treated as direct agent ACD calls, given the proper class of restriction, or may be treated as extension (personal) calls. Treating the calls as direct agent calls can be used to help distinguish business-related from personal calls.

**LOGOFF**

An agent trace work mode. An agent is logged out and not available to take ACD calls.

**LOGON**

An agent trace work mode. An agent is logged in and available to take ACD calls.

**Maintenance Busy (MBUSY)**

A trunk state. The trunk is maintenance busy, out of service for maintenance purposes.

**Manual In (MI)**

An ACD work mode. MI makes the agent available to receive an ACD call and automatically places the agent into the ACW state upon release from the call.

**MBUSY**

See Maintenance Busy.

**MCH**

See Multiple Call Handling.

**Measured**

A term that means an ACD element (agent, split/skill, trunk, trunk group, vector, VDN) has been identified to CMS for collection of data. If the ACD element is not measured, no data is collected.

**MI**

See Manual In.

**MIA**

See Most Idle Agent.

**Modify**

A CMS action that changes the database entry to reflect the new values entered in the current primary window.

**Monthly Data**

Daily data that has been converted to a Monthly summary.

**Most Idle Agent (MIA)**

An ACD distribution method that maintains a queue of idle agents. An agent is put at the end of the list for a particular split when the agent completes an ACD call for that split. The agent continues to advance in the list as long as the agent remains staffed and in ACW, available, or on AUXIN/OUT extension calls from the available state. In G3V2, if the agent is in ACW or is on an AUXIN/OUT extension call from the available state, then the agent is marked as unavailable to take an ACD call but remains in the list, moving up. An agent in the AUX mode (either by pressing the AUX button or by logging in) is not in the list of eligible agents.

Agents in multiple splits/skills are in multiple "eligible agent" lists, one list for each split/skill. An agent who is in ACW, on an AUXIN/OUT extension call from the AVAIL state, or on an ACD call for another split/skill continues to move up the list of eligible agents for other split/skills.

With EAS, if there are no calls waiting in queue for an agent's primary skill(s), the agent is put into the MIA queue for primary and secondary skills, and then receives the next call for any of the skills logged into.

**Multi-Agent Skill Change Window**

This window allows the user to perform the following administration actions: add one or more agents to a skill; move one or more agents from one skill to another; and remove one or more agents from a skill.

**Multiple Call Handling (MCH)**

Allows an agent to receive an ACD call while other calls are active on the agent's station. The agent must put the current call on hold and press AI/MI in order to receive another ACD call.



**Multiple Split Queuing**

With Call Vectoring, a call can be directed to up to four splits at the same time, with the first agent who is free getting the call.

**Multiuser Mode**

Any administered CMS user can log into CMS. Data continues to be collected if data collection is "on."

**Name (Synonym) Fields**

Fields in which you may enter a name (synonym) that has been entered in the Dictionary subsystem (for example, names of agents, splits/skills, agent groups, trunk groups, vectors, VDNs).

**Nonprimary Split/Skill**

When a call is queued to multiple splits/skills, the second and third splits/skills to which the call queues in a VDN are called nonprimary splits/skills. They are also referred to as secondary and tertiary splits/skills, respectively.

**Only Me Report**

A custom report that only the creator and the *CentreVu*® CMS administrator(s) can access.

**OTHER**

An agent state. The agent is working on a direct agent call, working on a call for another split or skill, or has put a call on hold and has not chosen another work mode.

**Percent (%) Within Service Level**

The percentage of calls that you are expecting or targeting to be answered by an agent within a specific number of seconds.

**Phantom Abandon Call Timer**

A CMS capability that tracks information about abandoned calls. When the capability is enabled, calls with a duration shorter than the administered value (zero to ten seconds) are counted as phantom abandon calls. Setting the timer to zero disables it.

**Previous Interval**

Represents one intrahour interval and is part of the real-time database. At the end of each intrahour interval, the contents of the current intrahour interval are copied to the previous intrahour interval portion of the real-time database.

**Primary Skill**

Skills assigned to an agent. Primary skills are the areas in which the agent has the most expertise.

See also Agent Skill.

**Queue**

A holding area for calls waiting to be answered in the order in which they were received. Calls in a queue may have different priority levels, in which case, calls with a higher priority are answered first.

**QUEUED**

A trunk state. An ACD call has seized the trunk and is queued to a split/skill waiting for an agent to answer.

**Read Permission**

The CMS user can access and view data (for example, run reports or view the Dictionary subsystem). Read permission is granted from the User Permissions subsystem.

**Real-Time Database**

Consists of the current and previous intrahour data on each CMS-measured agent, split, trunk, trunk group, vector, and Vector Directory Number (VDN).

**Real-Time Reports**

Display current ACD call activity on agents, splits/skills, trunks, trunk groups, vectors, and VDNs for the current or previous intrahour interval. Current intrahour interval real-time reports are constantly updated as data changes during the interval. Previous intrahour interval real-time reports show data totals for activity that occurred in the previous intrahour interval.

**Redirect On No Answer**

An ACD capability that assists the user if a call is not answered in a specified number of rings (preset by the call center Manager). The terminal extension, including ports with VRUs, is busied out and the call goes back into the queue at top priority.

**Refresh Rate**

The number of seconds CMS should wait for each update of the real-time report data. A user's fastest allowable refresh rate is defined in the User Permissions - User Data window as a minimum refresh rate. The default refresh rate when a user brings up the report input window is the administered minimum refresh rate plus 15 seconds.

R3V6 can refer to a software version of *CentreVu*® CMS.

**RINGING**

An agent state. The time a call rings at an agent's voice terminal after leaving the queue and before the agent answers the call. Available only with Generic 3.

A trunk state. A call is ringing at the agent's voice terminal.

**Rolling ASA**

See Average Speed of Answer (ASA).

**Scripting**

The Scripting feature lets you create a script to run a specified report or run a report and export the data on schedule. The scripts require a customer- provided scheduler to be run at a later time.

**Secondary Skill**

Skills assigned to an agent. Secondary skills are the areas in which the agent does not have extensive expertise. (Used in G3V2 through G3V4 with EAS.)

See also Agent Skill, Skill Level.

**SEIZED**

A trunk state. A call is using the trunk either incoming or outgoing.

**Service Level**

A time specified in seconds within which all calls should be answered. Normally set as an objective by management. Usually referred to as Acceptable Service Level (ASA).

**Service Observing- VDNs**

A feature available with G3V4 or later switches that gives a voice terminal user the ability to monitor the treatment a call receives as it is processed by a VDN.

**Single-User Mode**

Only one person can log into CMS. Data continues to be collected if data collection is "on." This mode is required to change some CMS administration.

**Skill**

An attribute that is assigned to an ACD Agent. Agent Skills can be thought of as the ability for an Agent with a particular set of skills to handle a call which requires one of those skills. In relationship to your call center, think of skill as a specific customer need/ requirement or perhaps a business need of your call center. You will be defining your skills based on the needs of your customers and your call center.

**Skill Level**

A priority level from 1 (highest) to 16 (lowest) indicating an agent's level of expertise or ability to handle calls to the given skill. (ECS Version 5 and later.)

**Split**

A group of extensions that receives special-purpose calls in an efficient, cost- effective manner. Normally, calls to a split arrive primarily over one or a few trunk groups.

**Staffed Agent**

An Agent who is currently logged in to the switch.

**Standard Reports**

The set of reports that are delivered with the CMS or *CentreVu*® Supervisor software.

**Station**

An unmeasured extension. An extension that is not currently staffed by an agent or that is a member of an unmeasured split/skill or hunt group.

**Subsystem**

Each CMS Controller selection (for example, Reports, Dictionary, System Setup, Exceptions, etc.) along with Timetable and Shortcut is referred to as a subsystem of the Call Management System throughout this document.

**Switch**

A private switching system providing voice-only or voice and data communications services (including access to public and private networks) for a group of terminals within a customer's premises.

**System AUX**

The *DEFINITY*® switches use the reason code 0 as the default code for situations in which the switch places the agent in the AUX mode automatically (for example, on login, when agents make or receive extension calls from AI/MI mode, when the agent is taken out of service due to failure to answer a ringing call) or logs the agent out (for example, during a Move Agent while Staffed operation). ASAI applications that change the agent's work mode to AUX or log the agent out without specifying a reason code will result in change to AUX or logout with the default reason code.

**Tertiary Split/Skill**

Generic 3 and ECS with vectoring only. When a call is queued to multiple splits/skills, the third split/skill the call queued to in a VDN is called the tertiary split/skill.

**Thresholds**

Supervisor thresholds are defined as Caution or Warning.

Threshold highlight settings apply only to some real-time data items in real-time and integrated reports. For information on setting threshold highlights, see the *CentreVu® Call Management System Release 3 Version 8 Administration 585-210-910* document.

**Time Format**

The standard format for entering times on CMS reports.

Acceptable formats are:

- AM/PM format (for example, 7:30AM-5:00PM).
- Military time format (for example, 7:30-17:00).

**Timetable**

An activity task or group of activities tasks (like reports) scheduled for completion at a time that is convenient and nondisruptive for your call center's operation.

**Trunk**

A telephone circuit that carries calls between two switches, between a Central Office (CO) and a switch, or between a CO and a phone.

**Trunk Group**

A group of trunks that are assigned the same dialing digits - either a phone number or a Direct Inward Dialed (DID) prefix.

**Uniform Call Distribution (UCD)**

The most idle agent for the skill will receive the call (if the agent is available).

**Universal Call Identifier (UCID)**

A number that uniquely identifies a call in a network of nodes that support UCID. This number will be a part of the records in the Call History feature of CMS.

**UNKNOWN**

An agent state. CMS does not recognize the current state.

A trunk state. CMS does not recognize the state of the trunk.

**UNSTAF (non-EAS)**

Unstaffed, an agent state. The agent is not logged in and, therefore is not being tracked by CMS.

**User ID**

The login ID for a CMS user.

**User Permissions**

A CMS subsystem that allows the CMS administrator to define user access permissions.

**VDN**

See Vector Directory Number.

**VDN Calls-Counted**

Also known as counted-calls to VDN and active VDN calls. A Call Vectoring capability available with G3V4 or later switches. Counted-calls to VDN is a parameter of the "go to step" and "go to vector" commands that provides conditional branching (to a different step in the same vector or to a different vector) based on the number of incoming trunk calls a VDN is currently processing.

**VDN of Origin Announcement (VOA)**

A short announcement that is assigned to a VDN through switch administration. The VOA identifies the origin or purpose of a call for the call center agent who answers the call.

**VDN Skill Preference**

Up to three skill(s) can be assigned to a VDN. Calls use VDN skills for routing based on your preference (as you administer it in the vector). VDN skill preferences are referred to in the vector as "1st," "2nd," or "3rd."

A prioritized list of agent skills administered for a VDN that are required or preferred for the answering agent. VDN Skill Preferences represent the requirement that a call be routed to an ACD agent with a particular ability or set of abilities.

**Vector**

A list of steps that process calls in a user-defined manner. Vector steps can send calls to splits, play announcements and music, disconnect calls, give calls a busy signal, or route calls to other destinations. Calls enter vector processing via VDNs, which may have received calls from assigned trunk groups, from other vectors, or from extensions connected to the switch.

**Vector Directory Number (VDN)**

An extension number that enables calls to connect to a vector for processing. A VDN is not assigned an equipment location. It is assigned to a vector. A VDN can connect calls to a vector when the calls arrive over an assigned automatic-in trunk group or when calls arrive over a dial-repeating (DID) trunk group and the final digits match the VDN. The VDN by itself may be dialed to access the vector from any extension connected to the switch.

**Voice Terminal**

A telephone set, usually with buttons, that gives an agent some control over the way calls are handled.

**Weekly Data**

Daily data that have been converted to a weekly summary.

**Write Permission**

The CMS user can add, modify, or delete data and execute processes. Write permission is granted from the User Permissions subsystem.



# Index

## Symbols

- % Aban, [4-150](#), [4-167](#)
- % Aban Calls, [4-63](#), [4-77](#), [4-160](#)
- % Abandoned Distribution, [4-72](#), [4-157](#)
- % ACD Time, [4-112](#), [4-117](#), [4-123](#)
- % Agent Group Occupancy with ACW, [GL-1](#)
- % Agent Group Occupancy without ACW, [GL-1](#)
- % Agent Group w/ACW, [4-26](#)
- % Agent Group w/o ACW, [4-27](#)
- % Agent Occup w/ACW, [4-40](#)
- % Agent Occup w/o ACW, [4-40](#)
- % Agent Occupancy with ACW, [GL-1](#)
- % Agent Occupancy without ACW, [GL-1](#)
- % Ans Calls, [4-63](#), [4-112](#), [4-117](#), [4-123](#)
- % Ans+Conn, [4-149](#)
- % Answered Distribution, [4-72](#), [4-157](#)
- % Busy, [4-167](#)
- % Flow Out, [4-167](#), [GL-1](#)
- % Outside Service Level, [3-81](#), [3-158](#)
- % Within Service Level, [3-63](#), [3-81](#), [3-97](#), [3-153](#), [3-157](#), [4-62](#), [4-77](#), [4-148](#), [4-160](#)

## Numerics

- 100 \* (sum(ABNCALLS/sum(INCALLS))), [4-153](#)
- 100 \* (sum(BUSYCALLS)/sum(INCALLS)), [4-153](#)
- 100 \* (sum(DISCCALLS)/sum(INCALLS)), [4-153](#)
- 100 \* ABNCALLS/INCALLS, [4-167](#)
- 100 \* BUSYCALLS/INCALLS, [4-167](#)
- 100 \* OUTFLOWCALLS/INCALLS, [4-167](#)
- 100- PERCENT\_SERV\_LVL\_VDN>, [3-158](#)
- 100-PERCENT\_SERV\_LVL\_SPL>, [3-81](#), [4-72](#), [4-156](#)
- 1st Skill ACD Calls, [4-170](#)
- 1st Skill Avg ACD Time, [4-170](#)
- 1st Skill Avg ACW, [4-170](#)
- 1st Skill Pref, [4-170](#)
- 1st Skill Preference, [4-167](#)

- 2nd Skill ACD Calls, [4-170](#)
- 2nd Skill Avg ACD Time, [4-170](#)
- 2nd Skill Avg ACW, [4-170](#)
- 2nd Skill Pref, [4-170](#)
- 2nd Skill Preference, [4-167](#)
- 3D Chart
  - Rotating, [2-49](#)
  - Rotating procedure, [2-49](#)
- 3rd Skill ACD Calls, [4-170](#)
- 3rd Skill Avg ACD, [4-171](#)
- 3rd Skill Avg ACW, [4-171](#)
- 3rd Skill Pref, [4-170](#)
- 3rd Skill Preference, [4-167](#)

## A

- Aban, [3-158](#)
- Aban Calls, [3-39](#), [3-81](#), [4-62](#), [4-63](#), [4-71](#), [4-111](#), [4-121](#), [4-135](#), [4-146](#), [4-149](#), [4-155](#), [4-162](#), [4-166](#), [4-169](#)
- Abandon, [4-153](#)
- Abandoned, [3-63](#)
- Abandoned Call, [GL-1](#)
- Abandoned Call Search, [GL-1](#)
- Abandoned Calls, [3-33](#), [3-98](#), [3-122](#), [3-132](#)
- ABNCALLS, [3-33](#), [3-64](#), [3-98](#), [3-122](#), [3-132](#), [3-155](#), [3-160](#), [3-162](#), [3-167](#), [4-63](#), [4-71](#), [4-110](#), [4-111](#), [4-121](#), [4-135](#), [4-149](#), [4-150](#), [4-162](#), [4-166](#), [4-169](#), [5-22](#), [5-27](#), [5-34](#)
- ABNCALLS1, [3-81](#), [4-149](#)
- ABNCALLS1-10, [3-63](#), [3-154](#), [3-158](#), [4-62](#), [4-72](#), [4-155](#)
- ABNCALLS2-10, [4-149](#)
- ABNTIME, [3-33](#), [3-64](#), [3-98](#), [3-122](#), [3-132](#), [3-155](#), [3-160](#), [3-162](#), [3-167](#), [4-63](#), [4-110](#), [4-121](#), [4-149](#), [4-166](#), [4-169](#), [5-22](#), [5-27](#)
- About Graphical Reports, [5-7](#)
- ACCEPTABLE, [3-63](#), [3-97](#), [3-153](#), [4-62](#), [4-75](#), [4-148](#), [5-27](#)
- Acceptable Service Changed, [4-62](#), [4-72](#), [4-77](#), [4-148](#), [4-159](#)
- Acceptable Service Level, [GL-1](#)
- Access Permissions, [GL-2](#)

- Accessing Reports, 2-1
- ACD, 3-14, 3-20, 3-30, 3-38, 3-101, 4-10, 4-12, 4-15, 4-17, 4-21, 4-24, 4-26, 4-30, 4-36, 4-38, 4-44, 4-56, 4-62, 4-75, 4-82, 4-87, 4-105, 4-110, 4-120, 4-135, 4-146, 4-148, 4-153, 4-162, 4-165, 4-169, GL-2
- ACD Call, GL-2
- ACD Calls, 3-14, 3-18, 3-32, 3-33, 3-38, 3-82, 3-98, 3-121, 3-122, 3-132, 3-162, 3-167, 4-12, 4-15, 4-26, 4-38, 4-40, 4-56, 4-62, 4-63, 4-71, 4-87, 4-91, 4-111, 4-121, 4-146, 4-155, 4-162, 4-165, 4-169
- ACD Calls Ans, 3-160
- ACD Time, 4-12, 4-21, 4-28, 4-38, 4-40, 4-56, 4-88, 4-92
- ACD+Conn Calls, 4-149
- ACD+Conn Calls (total), 4-149
- ACDCALLS, 3-31, 3-32, 3-64, 3-98, 3-121, 3-132, 3-154, 3-160, 3-162, 3-167, 4-12, 4-15, 4-26, 4-30, 4-38, 4-56, 4-63, 4-71, 4-87, 4-88, 4-92, 4-110, 4-111, 4-112, 4-120, 4-121, 4-123, 4-149, 4-162, 4-165, 4-166, 4-169, 4-170, 5-8, 5-14, 5-22, 5-27, 5-34
- ACDCALLS + DA\_ACDCALLS, 4-87, 4-91
- ACDCALLS1, 3-82
- ACDCALLS1-10, 3-63, 4-62, 4-72, 4-155
- ACDs, 3-30
- ACDTIME, 3-32, 3-98, 3-121, 3-132, 3-160, 3-162, 4-30, 4-56, 4-87, 4-92, 4-111, 4-121, 4-165, 4-170, 5-22
- Acknowledgment, GL-2
- Activate Agent Trace, GL-2
- Active Skill, 3-18
- Active Split, 3-14
- Active Split/Skill, 3-105, 3-109
- Active VDN Calls, 3-163, GL-2
- ACTIVECALLS, 3-163
- ACW, 3-14, 3-20, 3-101, 4-81, GL-2
- ACW Time, 4-12, 4-21, 4-28, 4-38, 4-40, 4-56, 4-88, 4-92
- ACWINCALLS, 4-12, 4-27, 4-31, 4-38
- ACWINTIME, 4-27, 4-31
- ACWOUTCALLS, 4-27, 4-31, 4-39, 4-112, 4-123
- ACWOUTOFFCALLS, 4-31
- ACWOUTOFFTIME, 4-31
- ACWOUTTIME, 4-27, 4-31, 4-112, 4-123
- ACWTIME, 3-160, 4-30, 4-56, 4-88, 4-92, 4-111, 4-121, 4-166, 4-170
- ADJATTEMPTS, 4-163
- ADJROUTED, 4-163
- Adjunct Routing Attempts, 4-163
- Adjunct Routing Completions, 4-163
- Adjunct/Switch Applications Interface (ASAI), GL-3
- After Call Work, 3-133
- After Call Work (ACW), GL-3
- Agent, 3-18, 3-118, 3-129, 4-12, 4-17, 4-30, 4-38, 4-40, 4-44, GL-3
- Agent Attendance Report, 4-11
- Agent AUX Report, 4-9
- Agent Graphical Information Report, 3-17
- Agent Group, 3-8, 4-21, 4-24, 4-26
- Agent Group Report, 3-7
- Agent ID, 4-21
- Agent Information Report, 3-13, 5-7, 5-13
- Agent Login ID, GL-3
- Agent Name, 3-8, 3-11, 3-14, 3-26, 3-48, 3-53, 3-75, 3-78, 3-97, 3-102, 3-105, 3-109, 3-135, 3-142, 3-172, 4-10, 4-15, 4-21, 4-24, 4-26, 4-36, 4-87, 4-91
- Agent Occupancy, GL-3
- Agent Position
  - EAS, GL-3
  - Non-EAS, GL-3
- Agent Report, 3-10
- Agent Report Input Fields, 4-7
- Agent report input fields, 5-6
- Agent report input window, 3-6
- Agent report selector window, 3-5, 5-5
- Agent Reports, 3-5, 5-4
  - Agent Group Report, 3-7
  - Agent Information Report, 3-13
  - Agent Report, 3-10
  - Attendance, 4-11
  - AUX, 4-9
  - Event Count, 4-14

- Agent Reports, (continued)
  - general information, [3-5](#), [4-5](#)
  - Graphical Information Report, [3-17](#)
  - Graphical Time Spent, [4-16](#)
  - Group Attendance, [4-20](#)
  - Group AUX, [4-23](#)
  - Group Summary, [4-25](#)
  - Inbound/Outbound, [4-29](#)
  - Information, [5-7](#), [5-13](#)
  - Login/Logout (Skill), [4-33](#)
  - Login/Logout (Split), [4-35](#)
  - organization, [3-4](#), [4-4](#), [4-5](#), [5-3](#)
  - Overview, [3-4](#)
  - overview, [5-3](#)
  - Roadmap, [3-5](#)
  - selector window, [4-6](#)
  - Split/Skill Report, [4-37](#)
  - Summary Report, [4-40](#)
  - Trace by Location Report, [4-44](#)
- Agent Reports Selector Window, [4-6](#)
- Agent Reports, general information, [3-5](#)
- Agent Reports, organization, [3-4](#), [4-4](#)
- Agent Ring Time, [4-12](#), [4-21](#), [4-28](#), [4-40](#), [4-88](#), [4-92](#)
- Agent Role, [GL-4](#)
- Agent Skill, [GL-4](#)
- Agent State, [GL-4](#)
- Agent state, [3-172](#)
- Agent Summary Report, [4-40](#)
- Agent Terminal, [GL-4](#)
- Agent threshold settings, [2-65](#)
- Agent Trace, [GL-5](#)
- Agent Trace by Location Report, [4-44](#)
- Agents Active chartFlex Agents, [3-68](#)
- Agents Active chartReserve1 Agents, [3-68](#)
- Agents Active chartReserve2 Agents, [3-68](#)
- Agents Active chartTop Agents, [3-68](#)
- Agents Avail, [3-142](#)
- Agents in ACW, [3-141](#)
- Agents in AUX, [3-75](#), [3-142](#)
- Agents in Other, [3-142](#)
- Agents on ACD Calls, [3-142](#)
- Agents Ringing, [3-142](#)
- Agents Staffed, [3-26](#), [3-96](#), [3-113](#), [3-142](#)
- AGINRING, [3-33](#), [3-122](#), [3-132](#), [5-27](#)
- AGRING, [3-71](#)
- AGTIME, [3-75](#), [3-78](#), [3-97](#), [3-102](#), [3-119](#), [3-129](#), [3-143](#), [5-8](#), [5-14](#)
- AI, [GL-5](#)
- Algorithm, [GL-5](#)
- ANI, [GL-5](#)
- Announcement, [GL-5](#)
- Ans/Conn, [3-158](#)
- ANSCONNCALLS1, [4-149](#), [4-156](#)
- ANSCONNCALLS10, [4-156](#)
- ANSCONNCALLS1-10, [3-154](#), [3-158](#)
- ANSCONNCALLS2, [4-156](#)
- ANSCONNCALLS2-10, [4-149](#)
- ANSTIME, [3-31](#), [3-64](#), [3-98](#), [3-121](#), [3-132](#), [3-154](#), [3-160](#), [3-162](#), [3-167](#), [4-63](#), [4-110](#), [4-120](#), [4-149](#), [4-165](#), [4-169](#), [5-22](#), [5-27](#)
- ASA, [5-34](#), [GL-5](#)
- ASAI, [GL-5](#)
- ASSISTS, [4-32](#), [4-39](#), [4-89](#)
- Assists, [4-32](#), [4-39](#), [4-89](#)
- Asst, [4-46](#)
- ATAGENT, [3-162](#)
- Attendance Report, [4-11](#)
- Auto-Available Split, [GL-5](#)
- Auto-In (AI), [GL-6](#)
- Automatic Call Distribution (ACD), [GL-6](#)
- Automatic Number Identification (ANI), [GL-6](#)
- AUX, [3-14](#), [3-21](#), [3-101](#), [4-82](#), [GL-6](#)
- AUX Reason, [3-8](#), [3-11](#), [3-18](#), [3-48](#), [3-53](#), [3-75](#), [3-78](#), [3-102](#), [3-143](#), [4-45](#)
- AUX Report, [4-9](#)

- AUX Time, [4-12](#), [4-21](#), [4-24](#), [4-28](#), [4-40](#), [4-89](#), [4-93](#)
- AUX Time 0, [4-10](#), [4-24](#)
- AUX Time 1...9, [4-10](#), [4-24](#)
- Aux Work, [3-34](#), [3-123](#), [3-133](#)
- Auxiliary Work (AUX), [GL-6](#)
- AUXINCALLS, [4-12](#), [4-27](#), [4-31](#), [4-38](#)
- AUXINTIME, [4-27](#), [4-31](#)
- AUXOUTCALLS, [4-12](#), [4-27](#), [4-31](#), [4-39](#), [4-112](#), [4-123](#)
- AUXOUTOFFCALLS, [4-31](#)
- AUXOUTOFFTIME, [4-31](#)
- AUXOUTTIME, [4-27](#), [4-31](#), [4-112](#), [4-123](#)
- AUXREASON, [3-75](#), [3-78](#), [3-102](#), [3-143](#), [5-8](#)
- AVAIL, [3-14](#), [3-20](#), [3-101](#), [4-17](#), [4-81](#), [GL-6](#)
- Avail Time, [4-12](#), [4-28](#), [4-40](#), [4-89](#), [4-93](#)
- AVAILABLE, [3-33](#), [3-122](#), [3-132](#), [5-27](#)
- Available, [3-33](#), [3-122](#), [3-132](#)
- Available (AVAIL), [GL-6](#)
- Average Agent Service Time, [GL-6](#)
- Average Speed of Ans - Seconds, [4-65](#), [4-69](#)
- Average Speed of Answer, [3-64](#)
- Average Speed of Answer (ASA), [GL-7](#)
- Average Time to Abandon, [3-64](#), [4-63](#)
- Avg Aban Time, [3-39](#), [3-160](#), [3-162](#), [4-110](#), [4-121](#), [4-149](#), [4-166](#), [4-169](#)
- Avg ACD Talk, [3-162](#)
- Avg ACD Talk Time, [3-32](#), [3-121](#), [3-132](#)
- Avg ACD Time, [3-38](#), [4-40](#), [4-56](#), [4-87](#), [4-92](#), [4-111](#), [4-116](#), [4-121](#), [4-146](#), [4-165](#), [4-170](#)
- Avg ACW, [4-170](#)
- Avg ACW Call, [4-26](#)
- Avg ACW Time, [4-40](#), [4-56](#), [4-111](#), [4-116](#), [4-121](#), [4-166](#)
- Avg ACW Time (Inbound ACD), [4-30](#)
- Avg ACW Time (Outbound ACD), [4-30](#)
- Avg After Call, [3-160](#), [4-88](#), [4-92](#)
- Avg Connect Time, [4-166](#)
- Avg External Extn Out Time, [4-31](#)
- Avg Extn In Time, [4-27](#), [4-40](#)
- Avg Extn Out Time, [4-27](#), [4-31](#), [4-40](#), [4-112](#), [4-117](#), [4-123](#)
- Avg Hold Time, [4-40](#), [4-89](#)
- Avg Inbound ACD Time, [4-30](#)
- Avg Inbound Trunk Hold Time, [4-136](#)
- Avg Outbound ACD Time, [4-30](#)
- Avg Outbound Trunk Hold Time, [4-136](#)
- Avg Pos Staffed, [4-67](#)
- Avg Speed Ans, [3-38](#), [3-121](#), [4-63](#), [4-110](#), [4-120](#), [4-169](#)
- Avg Speed Answer, [3-160](#), [3-162](#), [3-167](#)
- Avg Speed of Ans+Conn, [4-149](#)
- Avg Speed of Answer, [3-31](#), [3-132](#), [4-165](#)
- Avg Talk Time, [3-160](#), [4-26](#), [4-31](#)
- Avg Time to Abandon, [3-33](#), [3-122](#), [3-132](#), [3-167](#)
- Avg VDN Time, [4-167](#)
- Avg. ACD Talk Time, [3-98](#)
- Avg. Speed of Answer, [3-98](#)
- Avg. Time to Abandon, [3-98](#)
- AVG\_ABANDON\_TIME, [5-27](#)
- AVG\_ACD\_TALK\_TIME, [3-98](#), [5-22](#), [5-27](#)
- AVG\_AGENT\_ACW\_TIME, [4-93](#)
- AVG\_AGENT\_TALK\_SUM, [4-93](#)
- AVG\_ANSWER\_SPEED, [3-98](#), [4-65](#), [4-69](#), [5-22](#), [5-27](#)
- AVG\_EQV\_AG\_STFD, [4-67](#)
- AWORKMODE, [3-102](#), [3-143](#), [5-8](#), [5-14](#)

## B

- Backup ACD Calls, [4-166](#)
- BACKUPCALLS, [4-162](#), [4-166](#)
- BH\_ABNCALLS, [4-146](#)
- BH\_ACDCALLS, [4-146](#)
- BH\_ACDTIME, [4-146](#)
- BH\_BUSYCALLS, [4-146](#)
- BH\_DISCCALLS, [4-146](#)
- BH\_OTHERCALLS, [4-146](#)
- BH\_STARTTIME, [4-146](#)
- BH\_VDNCALLS, [4-146](#)
- Browse Date dialog box, [2-8](#)

Browse Dates dialog box, [2-9](#)  
 Browse Month dialog box, [2-9](#)  
 Browse Months dialog box, [2-10](#)  
 Browse Time dialog box, [2-11](#)  
 Busy, [4-153](#)  
 Busy Hour, [4-146](#)  
 Busy+Disc Calls, [4-162](#)  
 Busy/Disc, [3-167](#)  
 BUSYCALLS, [3-162](#), [3-167](#), [4-162](#), [4-167](#)

## C

Calculation, [GL-7](#)  
 Call Handling Preference, [3-18](#), [GL-7](#)  
 Call Management System (CMS), [GL-8](#)  
 Call Profile Report, [3-62](#)  
 Call Prompting, [GL-8](#)  
 Call Records Report, [4-49](#)  
 Call Records Report Input Fields, [4-50](#)  
 Call Vectoring, [GL-8](#)  
 Call Work Code, [4-55](#), [4-56](#)  
 Call Work Code (CWC), [GL-8](#)  
 Call Work Code Name, [4-56](#)  
 Call Work Code Report, [4-54](#)  
 Call Work Code Report Input Fields, [4-55](#)  
 Call-Based Items, [GL-7](#)  
 Call-Handling Profile, [GL-7](#)  
 Calling Party, [4-46](#)  
 Calls, [4-30](#)  
 Calls Aban, [3-167](#)  
 Calls Carried, [GL-8](#)  
 Calls Wait, [3-162](#), [3-166](#)  
 Calls Waiting, [3-30](#), [3-38](#), [3-56](#), [3-88](#), [3-97](#), [3-113](#), [3-116](#),  
[3-121](#), [3-127](#), [3-131](#)  
 CALLSOFFERED, [3-63](#), [3-64](#), [3-97](#), [4-62](#), [4-63](#), [4-75](#), [4-112](#), [4-123](#), [5-27](#)  
 CentreVu Advocate, [GL-8](#)  
 CentreVu Supervisor, [GL-8](#)  
 Change Agent Skills, [GL-9](#)

Chart Reports  
     3D Effects Tab, [2-37](#)  
     3D Effects Tab Parameters, [2-38](#)  
     Accessing Options, [2-35](#)  
     Axis Tab, [2-39](#)  
     Axis Tab Parameters, [2-39](#)  
     Data Labels Tab, [2-43](#)  
     Data Labels Tab Parameters, [2-43](#)  
     Formatting, [2-35](#)  
     General Tab, [2-36](#)  
     General Tab Parameters, [2-36](#)  
     Legend Tab, [2-42](#)  
     Legend Tab Parameters, [2-42](#)  
     Title Tab, [2-41](#)  
     Title Tab Parameters, [2-41](#)  
     Type Tab, [2-40](#)  
     Type Tab Parameters, [2-40](#)  
 CMS, [GL-9](#)  
 Conf, [4-46](#)  
 Connect Calls, [4-166](#)  
 CONNECTCALLS, [3-154](#), [4-149](#), [4-166](#)  
 Connected (CONN), [GL-9](#)  
 Connected Call, [GL-9](#)  
 CONNECTTIME, [3-154](#), [4-149](#), [4-166](#)  
 Copying Chart Reports, [2-53](#)  
     Procedure, [2-53](#)  
 Current, [GL-9](#)  
 Current Interval, [GL-9](#)  
 Current Interval, Definition, [1-7](#)  
 Current Wait Time, [GL-9](#)  
 Custom Reports, [GL-9](#)  
 Custom Reports, Reference, [1-7](#)  
 CWC, [4-56](#), [GL-9](#)

## D

DA\_ACDCALLS, [4-12](#), [4-15](#), [4-26](#), [4-30](#), [4-38](#), [4-87](#), [4-88](#), [4-92](#), [5-8](#), [5-14](#)  
 DA\_ACDTIME, [4-30](#), [4-87](#), [4-92](#)

DA\_ACWTIME, [4-30](#), [4-88](#), [4-92](#)  
DA\_SKILL, [5-8](#)  
DABN, [GL-10](#)  
DACD, [GL-10](#)  
DACW, [GL-10](#)  
Daily Data, [GL-10](#)  
Daily Data, Definition, [1-7](#)  
Daily Reports, [4-3](#)  
Data Collection Off, [GL-10](#)  
Data Collection On, [GL-10](#)  
Data Points, [GL-10](#)  
Database, [GL-10](#)  
Database Item, [GL-10](#)  
Database Tables, [GL-10](#)  
Date, [4-10](#), [4-12](#), [4-15](#), [4-17](#), [4-21](#), [4-26](#), [4-30](#), [4-36](#), [4-38](#),  
[4-40](#), [4-45](#), [4-55](#), [4-62](#), [4-65](#), [4-67](#), [4-71](#), [4-75](#), [4-77](#), [4-79](#),  
[4-81](#), [4-87](#), [4-91](#), [4-110](#), [4-120](#), [4-135](#), [4-146](#), [4-148](#), [4-153](#), [4-155](#), [4-159](#), [4-162](#), [4-165](#), [4-169](#)  
Date Format, [GL-11](#)  
Date, Week Starting, Month Starting, [4-56](#)  
Dates, [4-69](#), [4-105](#)  
Delete, [GL-11](#)  
Designer Reports, [GL-11](#)  
Designer Reports, Definition, [1-7](#)  
Dialed Digits, [4-46](#)  
Dialed Number Identification Service (DNIS), [GL-11](#)  
Dictionary, [GL-11](#)  
Dictionary Location, [GL-12](#)  
Direct Abandon (DABN), [GL-12](#)  
Direct Agent ACD (DACD), [GL-12](#)  
Direct Agent ACW (DACW), [GL-12](#)  
Direct Agent Calling, [GL-12](#)  
Direct Agent Calls, [3-14](#), [3-18](#)  
Direct Agent Skills, [3-18](#)  
DIRECTION, [3-97](#), [3-102](#), [3-129](#), [3-143](#), [4-45](#), [5-8](#), [5-14](#)  
Direction, [3-143](#)  
DISCCALLS, [3-162](#), [3-167](#), [4-162](#), [4-167](#)  
Disconnect, [4-153](#)

Drill-Down Reports, [3-168](#)  
    Drill-Down Top Agent Work State Report, [3-170](#)  
    Drill-Down Work State Report, [3-174](#)  
    General Information, [3-168](#)  
Drill-Down Top Agent Work State Report, [3-170](#)  
Drill-Down Work State Report, [3-174](#)  
DURATION, [4-45](#)

## E

EAD, [GL-12](#)  
EAS, [GL-12](#)  
Entity, [GL-12](#)  
EQLOC, [4-135](#)  
Error Message, [GL-13](#)  
Event Count, [3-26](#)  
Event Count 1-9, [4-15](#)  
Event Count Report, [4-14](#)  
Event Count Summary Report, [3-24](#)  
Event counts, [3-24](#)  
EVENT\_TIME, [4-45](#)  
EVENT1-9, [3-26](#)  
EWT, [GL-13](#)  
EWT High, [3-31](#)  
EWT Low, [3-32](#)  
EWT Medium, [3-32](#)  
EWT Top, [3-31](#)  
EWTHIGH, [3-31](#), [3-85](#), [3-117](#), [3-128](#), [3-138](#)  
EWTLOW, [3-32](#), [3-85](#), [3-118](#), [3-128](#), [3-138](#)  
EWTMEDIUM, [3-32](#), [3-85](#), [3-117](#), [3-128](#), [3-138](#)  
EWTTOP, [3-31](#), [3-84](#), [3-117](#), [3-128](#), [3-137](#)  
Exception, [GL-13](#)  
Exception Reports, [GL-13](#)  
    Definition, [1-7](#)  
Exceptions  
    Audio difficulty, [3-24](#)  
Exiting and Restarting Reports, [2-12](#)  
Exiting Reports, procedure, [2-12](#)

Expected Wait Time (EWT), [GL-13](#)  
Expected Wait Time High, [3-117](#), [3-128](#), [3-138](#)  
Expected Wait Time Low, [3-118](#), [3-128](#), [3-138](#)  
Expected Wait Time Medium, [3-117](#), [3-128](#), [3-138](#)  
Expected Wait Time Top, [3-117](#), [3-128](#), [3-137](#)  
Expert Agent Distribution (EAD), [GL-13](#)  
Expert Agent Selection (EAS), [GL-14](#)  
Exporting Report Data, [2-50](#)  
    Defaults, [2-50](#)  
    Procedure, [2-51](#)  
    Report Format, [2-50](#)  
EXT\_CALL\_IN, [4-12](#)  
EXT\_CALL\_OUT, [4-12](#)  
EXT\_IN\_TIME, [4-12](#)  
EXT\_OUT\_TIME, [4-12](#)  
EXTENSION, [3-142](#), [5-8](#), [5-14](#)  
Extension Call, [GL-14](#)  
External Extn Out Calls, [4-31](#)  
EXTN, [4-34](#), [4-36](#)  
Extn, [3-8](#), [3-11](#), [3-14](#), [3-18](#), [3-48](#), [3-53](#), [3-142](#), [4-34](#), [4-36](#)  
Extn In Calls, [4-12](#), [4-27](#), [4-31](#), [4-38](#), [4-40](#)  
Extn In Time, [4-12](#), [4-21](#), [4-39](#)  
Extn Out Calls, [4-12](#), [4-27](#), [4-31](#), [4-39](#), [4-40](#), [4-112](#), [4-116](#),  
    [4-123](#)  
Extn Out Time, [4-12](#), [4-39](#)

## F

FAGINRING, [3-68](#), [3-94](#)  
FAILURES, [4-136](#)  
FBUSY, [GL-14](#)  
FDISC, [GL-14](#)  
FINACW, [3-68](#), [3-94](#)  
FINAUX, [3-93](#)  
Find One, [GL-14](#)  
Flex Agents, [GL-15](#)  
Flex Agents (Active), [3-94](#)  
Flex Agents (AUX), [3-93](#)  
Flex Agents (Other), [3-94](#)

Flex Agents Staffed, [3-40](#), [3-48](#), [3-66](#)  
Flexible Routing, [GL-15](#)  
Flow In, [4-122](#), [4-162](#), [4-165](#)  
Flow Out, [4-122](#), [4-163](#), [4-167](#), [GL-15](#)  
FMCH, [GL-16](#)  
FONACD, [3-68](#), [3-94](#)  
Forced Busy (FBUSY), [GL-16](#)  
Forced Busy Calls, [4-146](#), [4-167](#)  
Forced Disc Calls, [4-146](#), [4-167](#)  
Forced Disconnect (FDISC), [GL-16](#)  
Forced Multiple Call Handling (FMCH), [GL-16](#)  
FOTHER, [3-94](#)  
FSTAFFED, [3-40](#), [3-66](#), [3-101](#)  
FTE\_AGENTS, [3-71](#)  
Full Time Equivalent Agents Staffed, [3-71](#)

## G

Graphical Active Agents Report, [3-65](#)  
Graphical Allocated Agents Report, [3-69](#)  
Graphical Reports  
    Introduction, [5-7](#)  
Graphical Skill Overload Report, [3-89](#), [4-78](#)  
Graphical Staffing Profile Report, [3-91](#)  
Graphical Time Spent Report, [4-16](#)  
Group Attendance Report, [4-20](#)  
Group AUX Report, [4-23](#)  
Group Summary Report, [4-25](#)

## H

Held Calls, [4-39](#), [4-40](#), [4-89](#)  
High, [3-85](#)  
Historical Agent Reports, organization, [4-5](#)  
Historical Agent Reports, overview, [4-4](#)  
Historical Database, [GL-16](#)  
Historical Database, Definition, [1-7](#)  
Historical Other Reports, organization, [4-47](#)  
Historical Other Reports, overview, [4-47](#)

- Historical Reports, [4-57](#), [GL-16](#)
  - Agent Attendance, [4-11](#)
  - Agent AUX, [4-9](#)
  - Agent Event Count, [4-14](#)
  - Agent Graphical Time Spent, [4-16](#)
  - Agent Group Attendance, [4-20](#)
  - Agent Group AUX, [4-23](#)
  - Agent Group Summary, [4-25](#)
  - agent reports, [4-4](#)
  - Agent Summary Report, [4-40](#)
  - Agent Trace by Location Report, [4-44](#)
  - Call Records Report, [4-49](#)
  - Call Work Code Attendance, [4-54](#)
  - Daily Reports, [4-3](#)
  - Graphical Skill Overload Report, [4-78](#)
  - Inbound/Outbound Summary, [4-29](#)
  - Interval Reports, [4-3](#)
  - introduction, [4-1](#)
  - Login/Logout (Skill), [4-33](#)
  - Login/Logout (Split), [4-35](#)
  - Monthly Reports, [4-3](#)
  - organization, [4-1](#)
  - overview, [4-1](#)
  - presentation, [4-1](#)
  - roadmap, [4-2](#)
  - Split/Skill by Location Report, [4-90](#)
  - Split/Skill Call Profile Report, [4-61](#)
  - Split/Skill Graphical ASA Daily Report, [4-68](#)
  - Split/Skill Graphical ASA Report, [4-64](#)
  - Split/Skill Graphical Average Positions Staffed Report, [4-66](#)
  - Split/Skill Graphical Call Profile Report, [4-70](#)
  - Split/Skill Graphical Multi-ACD Service Level Report, [4-73](#)
  - Split/Skill Graphical Service Level Report, [4-76](#)
  - Split/Skill Graphical Time Spent Report, [4-80](#)
  - Split/Skill Outbound Report, [4-83](#)
- Historical Reports, (continued)
  - Split/Skill Report, [4-37](#), [4-86](#)
  - Split/Skill Summary Report, [4-95](#)
  - System Graphical Maximum Delay Report, [4-103](#)
  - System Multi-ACD by Split/Skill Report, [4-107](#)
  - System Multi-ACD Report, [4-113](#)
  - System Report, [4-118](#)
  - System Reports, [4-101](#)
  - Trunk Group Report, [4-134](#)
  - Trunk Group Summary Report, [4-137](#)
  - Trunk Report, [4-131](#)
  - Trunk/Trunk Group Busy Hour Report, [4-128](#)
  - Trunk/Trunk Group Reports, [4-124](#)
  - VDN Busy Hour Report, [4-145](#)
  - VDN Call Profile Report, [4-147](#)
  - VDN Graphical Busy/Abandon/Disconnect Comparison Report, [4-151](#)
  - VDN Graphical Call Profile Report, [4-154](#)
  - VDN Graphical Service Level Report, [4-158](#)
  - VDN Multi-ACD Flow Report, [4-161](#)
  - VDN Report, [4-164](#)
  - VDN Reports, [4-141](#)
  - VDN Skill Preference Report, [4-168](#)
  - Vector Report, [4-172](#), [4-175](#)
  - Weekly Reports, [4-3](#)
- Historical Reports, Definition, [1-7](#)
- Historical Reports, introduction, [4-1](#)
- Historical Reports, organization, [4-1](#)
- Historical Reports, overview, [4-1](#)
- Historical Reports, presentation, [4-1](#)
- Historical Reports, roadmap, [4-2](#)
- Historical System Reports, general information, [4-102](#)
- Historical System Reports, organization, [4-101](#)
- Historical System Reports, selector window, [4-102](#)
- Historical Trunk/Trunk Group Reports, general information, [4-125](#)
- Historical Trunk/Trunk Group Reports, organization, [4-124](#)



Historical Trunk/Trunk Group Reports, selector window, [4-125](#)

Historical VDN Reports, general information, [4-142](#)

Historical VDN Reports, organization, [4-141](#)

Historical VDN Reports, selector window, [4-143](#)

Historical Vector Report, general information, [4-173](#)

Historical Vector Report, organization, [4-172](#)

Historical Vector Report, selector window, [4-173](#)

HOLD, [GL-17](#)

Hold, [4-45](#)

HOLDCALLS, [4-39](#), [4-89](#)

HOLDTIME, [4-39](#), [4-89](#)

**I**

I\_ACDTIME, [4-12](#), [4-21](#), [4-28](#), [4-38](#), [4-88](#), [4-92](#), [4-112](#), [4-123](#), [5-8](#), [5-14](#), [5-34](#)

I\_ACWINTIME, [4-12](#), [4-21](#), [4-39](#)

I\_ACWOUTTIME, [4-12](#), [4-39](#)

I\_ACWTIME, [4-12](#), [4-21](#), [4-28](#), [4-38](#), [4-88](#), [4-92](#), [4-112](#), [4-123](#), [5-8](#), [5-14](#)

I\_AUXINTIME, [4-12](#), [4-21](#), [4-39](#)

I\_AUXOUTTIME, [4-12](#), [4-39](#)

I\_AUXTIME, [4-82](#), [4-93](#)

I\_AUXTIME0, [4-82](#)

I\_AUXTIME1-9, [4-82](#)

I\_AVAILTIME, [4-81](#), [4-89](#), [4-93](#)

I\_DA\_ACDTIME, [4-12](#), [4-21](#), [4-28](#), [4-38](#), [4-88](#), [4-92](#), [5-8](#), [5-14](#)

I\_DA\_ACWTIME, [4-12](#), [4-21](#), [4-28](#), [4-38](#), [4-88](#), [4-92](#), [5-8](#), [5-14](#)

I\_INOCC, [4-136](#)

I\_NORMTIME, [4-79](#), [5-25](#)

I\_OL1TIME, [4-79](#), [5-25](#)

I\_OL2TIME, [4-79](#), [5-25](#)

I\_OTHERTIME, [4-82](#), [4-89](#), [4-93](#)

I\_OUTOCC, [4-136](#)

I\_RINGTIME, [3-21](#), [4-12](#), [4-21](#), [4-28](#), [4-82](#), [4-88](#), [4-92](#), [5-14](#)

I\_STAFFTIME, [4-89](#), [4-93](#), [4-112](#), [4-123](#)

IDLE, [GL-17](#)

II, [GL-17](#)

INACW, [3-33](#), [3-71](#), [3-122](#), [3-133](#), [5-27](#)

INAUX, [3-34](#), [3-75](#), [3-123](#), [3-133](#), [5-27](#)

INAUX0, [3-75](#)

INAUX1-9, [3-75](#)

Inbound Calls, [4-135](#), [4-146](#), [4-162](#), [4-165](#), [4-169](#)

Inbound CCS, [4-136](#)

Inbound/Outbound Report, [4-29](#)

INCALLS, [3-153](#), [3-154](#), [3-155](#), [3-160](#), [4-135](#), [4-136](#), [4-148](#), [4-149](#), [4-150](#), [4-162](#), [4-165](#), [4-169](#)

INFLOWCALLS, [3-162](#), [3-167](#), [4-122](#), [4-162](#), [4-165](#)

Information Indicator (II), [GL-17](#)

Information Report, [5-7](#), [5-13](#)

INFORMIX, [GL-17](#)

INFORMIX SQL, [GL-17](#)

INPROGRESS, [3-162](#), [3-166](#)

INQUEUE, [3-30](#), [3-88](#), [3-97](#), [3-116](#), [3-127](#), [3-131](#), [5-22](#), [5-27](#)

INRING, [3-30](#), [3-88](#), [3-97](#), [3-116](#), [3-127](#), [3-131](#), [5-22](#), [5-27](#)

Integrated Agent Reports, [5-4](#)

Integrated Agent Reports, organization, [5-3](#)

Integrated Agent Reports, overview, [5-3](#)

Integrated Reports

- Agent Information, [5-7](#), [5-13](#)
- Agent input fields, [5-6](#)
- Agent Reports, [5-4](#)
- Agent selector window, [5-5](#)
- Graphical Call Handling, [5-33](#)
- Graphical Skill Overload, [5-24](#)
- Graphical Split/Skill View, [5-26](#)
- Split/Skill Comparison, [5-21](#)
- Split/Skill report input fields, [5-19](#)
- Split/Skill report selector window, [5-19](#)
- Split/Skill Reports, [5-17](#)
- VDN Report, [5-30](#), [5-31](#)
- VDN Report input fields, [5-32](#)

Integrated Reports, (continued)  
 VDN Report selector window, [5-31](#)

Integrated Reports, Definition, [1-7](#), [5-1](#)

Integrated Reports, roadmap, [5-1](#)

Integrated Services Digital Network (ISDN), [GL-17](#)

Integrated Split/Skill Reports, [5-17](#)

Integrated Split/Skill Reports, general information, [5-18](#)

Integrated Split/Skill Reports, organization, [5-18](#)

Integrated VDN Report, general information, [5-31](#)

INTERFLOWCALLS, [4-163](#)

Interval Reports, [4-3](#)

Interval-Based Items, [GL-17](#)

INTIME, [4-136](#), [4-167](#)

Intrahour Interval, [GL-17](#)

INTRVL, [4-15](#), [4-169](#)

## L

LEVEL, [5-8](#)

Level, [3-18](#), [3-54](#), [3-96](#), [3-103](#), [3-105](#), [3-109](#), [3-143](#)

LOC\_ID, [3-75](#), [3-78](#), [3-106](#), [3-110](#), [3-135](#), [3-141](#), [3-172](#), [3-176](#), [4-45](#), [4-91](#)

Location, [GL-18](#)

Location ID, [3-75](#), [3-78](#), [3-106](#), [3-110](#), [3-135](#), [3-141](#), [3-172](#), [3-176](#), [4-45](#), [4-91](#)

Location ID for Agents, [GL-18](#)

Location ID for Trunks, [GL-18](#)

Logical Agent, [GL-18](#)

LOGID, [3-26](#), [3-75](#), [3-78](#), [3-96](#), [3-102](#), [3-118](#), [3-129](#), [3-135](#), [3-142](#), [4-12](#), [4-15](#), [4-17](#), [4-21](#), [4-26](#), [4-30](#), [4-38](#), [4-40](#), [4-44](#), [4-87](#), [4-91](#), [5-8](#), [5-14](#), [5-22](#), [5-27](#)

LOGIN, [4-34](#), [4-36](#)

Login ID, [3-8](#), [3-11](#), [3-14](#), [3-18](#), [3-48](#), [3-53](#), [3-75](#), [3-78](#), [3-105](#), [3-109](#), [3-135](#), [3-142](#), [3-172](#)

Login Skill(s), [3-118](#)

Login Time, [4-34](#), [4-36](#)

Login/Logout (Skill) Report, [4-33](#)

Login/Logout (Split) Report, [4-35](#)

LOGOFF, [GL-19](#)

LOGON, [GL-19](#)

LOGONSTART, [5-8](#)

LOGOUT, [4-34](#), [4-36](#)

Logout Date, [4-34](#), [4-36](#)

Logout Reason, [4-45](#)

Logout Time, [4-34](#), [4-36](#)

LOGOUT\_DATE, [4-36](#)

Lookahead Interflow Attempts, [4-163](#)

Lookahead Interflow Completions, [4-163](#)

LOOKATTEMPTS, [4-163](#)

LOOKFLOWCALLS, [4-163](#)

Low, [3-85](#)

## M

Main ACD Calls, [4-166](#)

Maintenance Busy (MBUSY), [GL-19](#)

Malicious Call, [4-46](#)

Manual In (MI), [GL-19](#)

Max Delay, [4-111](#), [4-121](#)

Max Delay Seconds, [4-106](#)

Max Pos Allocated, [4-67](#)

MAX\_DEDICATED\_AGT, [4-67](#)

MAXOCWTIME, [4-106](#), [4-111](#), [4-121](#)

MBUSY, [GL-19](#)

MCH, [GL-19](#)

Measured, [GL-19](#)

Medium, [3-85](#)

MI, [GL-19](#)

MIA, [GL-19](#)

Modify, [GL-20](#)

Month, [4-10](#)

Month Starting, [4-12](#), [4-15](#), [4-21](#), [4-30](#), [4-38](#), [4-40](#), [4-62](#), [4-87](#), [4-148](#)

Month starting, [4-120](#), [4-135](#), [4-162](#), [4-165](#), [4-169](#)

Monthly Data, [GL-20](#)

Monthly Data, Definition, [1-7](#)

Monthly Reports, [4-3](#)

Most Idle Agent (MIA), [GL-20](#)

Move Pending?, [3-14](#), [3-18](#)

MOVEPENDING, [5-8](#), [5-14](#)

Multi-ACD Report, [3-27](#)

Multi-ACD Top Agent Report, [3-35](#)

Multi-Agent Skill Change Window, [GL-20](#)

Multiple Call Handling (MCH), [GL-20](#)

Multiple Split Queuing, [GL-21](#)

Multiuser Mode, [GL-21](#)

Multiuser Mode, Definition, [1-7](#)

## N

Name (Synonym) Fields, [GL-21](#)

Nonprimary Split/Skill, [GL-21](#)

Normal, [4-79](#)

## O

O\_ABNCALLS, [4-136](#)

O\_ACDCALLS, [4-30](#)

O\_ACDTIME, [4-30](#)

O\_ACWTIME, [4-30](#)

OACDCALLS, [4-30](#)

Oldest Call Waiting, [3-31](#), [3-38](#), [3-56](#), [3-88](#), [3-98](#), [3-116](#), [3-121](#), [3-127](#), [3-131](#), [3-162](#)

OLDESTCALL, [3-31](#), [3-88](#), [3-98](#), [3-116](#), [3-127](#), [3-131](#), [3-162](#), [5-22](#), [5-27](#)

ONACD, [3-33](#), [3-71](#), [3-122](#), [3-132](#), [5-27](#)

Only Me Report, [GL-21](#)

Options

Reports, [2-73](#)

Options Menu, [2-28](#)

Menu Item Functions, [2-28](#)

OTHER, [3-21](#), [3-34](#), [3-102](#), [3-123](#), [3-133](#), [4-17](#), [4-82](#), [5-27](#), [GL-21](#)

Other, [3-14](#), [3-34](#), [3-123](#), [3-133](#)

Other Calls, [4-146](#)

Other Reports, [3-22](#)

Call Records Report, [4-49](#)

Call Work Code, [4-54](#)

Event Count Summary Report, [3-24](#)

Other Reports, (continued)

general information, [4-48](#)

Multi-ACD Report, [3-27](#)

Multi-ACD Top Agent Report, [3-35](#)

organization, [3-22](#), [4-47](#)

Overview, [3-22](#)

overview, [4-47](#)

Roadmap, [3-22](#)

selector window, [3-23](#), [4-48](#)

Other Reports Selector Window, [4-48](#)

Other Reports, organization, [3-22](#)

Other Reports, selector window, [3-23](#)

Other Time, [4-28](#), [4-40](#), [4-89](#), [4-93](#)

Outbound Aban Calls, [4-136](#)

Outbound ACD Calls, [4-30](#)

Outbound Calls, [4-136](#)

Outbound CCS, [4-136](#)

OUTCALLS, [4-136](#)

OUTFLOWCALLS, [3-163](#), [3-167](#), [4-122](#), [4-163](#), [4-167](#), [5-34](#)

OUTTIME, [4-136](#)

Overload1, [4-79](#)

Overload2, [4-79](#)

## P

PERCENT, [3-143](#)

Percent, [3-18](#), [3-53](#), [3-143](#)

Percent (%) Within Service Level, [GL-21](#)

PERCENT\_CALL\_ABAN, [4-77](#)

PERCENT\_SERV\_LVL\_VDN, [4-160](#)

PERCENT\_SERV\_LVL\_SPL>, [4-72](#)

PERCENT\_VDN\_ABAN, [4-160](#)

PERCENT\_SERV\_LVL\_SPL, [5-27](#)

Percentage, [4-75](#)

Percentage Abandoned, [3-64](#)

Percentage Answered, [3-64](#)

PERIOD1-9, [3-63](#), [3-153](#), [3-158](#), [4-62](#), [4-149](#), [4-156](#)

PERIODCHG, [4-62](#), [4-72](#)

Phantom Abandon Call Timer, [GL-21](#)

Pop-Up Menus, [2-47](#)

    Displayed Menus, [2-47](#)

PREFERENCE, [5-8](#)

Previous Interval, [GL-22](#)

Previous Interval, Definition, [1-7](#)

Primary Skill, [GL-22](#)

Print Preview, [2-21](#)

    Accessing, [2-21](#)

    Dialog Box, [2-21](#)

    Fields, [2-22](#)

Printed, [4-10](#), [4-12](#), [4-15](#), [4-21](#), [4-24](#)

## Q

Queue, [GL-22](#)

Queue Agent Status Report, [3-50](#)

Queue Agent Summary Report, [3-55](#)

Queue/Agent Reports, [3-41](#)

    general information, [3-42](#)

    input fields, [3-44](#)

    organization, [3-41](#)

    Queue Agent Status Report, [3-50](#)

    Queue Agent Summary Report, [3-55](#)

    Queue/Top Agent Status Report, [3-45](#)

    Roadmap, [3-41](#)

    selector window, [3-43](#)

Queue/Agent Reports input fields, [3-44](#)

Queue/Agent Reports selector window, [3-43](#)

Queue/Agent Reports, general information, [3-42](#)

Queue/Agent Reports, organization, [3-41](#)

Queue/Top Agent Status Report, [3-45](#)

QUEUED, [GL-22](#)

## R

R1AGINRING, [3-68](#), [3-94](#)

R1INACD, [3-94](#)

R1INACW, [3-68](#), [3-94](#)

R1INAUX, [3-94](#)

R1ONACD, [3-68](#)

R1OTHER, [3-94](#)

R1STAFFED, [3-40](#), [3-67](#), [3-72](#)

R21AGINRING, [3-68](#)

R2AGINRING, [3-94](#)

R2INACD, [3-94](#)

R2INACW, [3-68](#), [3-94](#)

R2INAUX, [3-94](#)

R2ONACD, [3-68](#)

R2OTHER, [3-94](#)

R2STAFFED, [3-40](#), [3-67](#), [3-72](#)

Read Permission, [GL-22](#)

Real-Time Agent Reports, overview, [3-4](#)

Real-Time Database, [GL-22](#)

Real-Time Database, Definition, [1-7](#)

Real-Time Reports, [GL-22](#)

    Agent Graphical Information Report, [3-17](#)

    Agent Group Report, [3-7](#)

    Agent Information Report, [3-13](#)

    Agent Report, [3-10](#)

    Agent report input window, [3-6](#)

    Agent report selector window, [3-5](#)

    Agent Reports, [3-4](#), [3-5](#)

    Call Profile, [3-62](#)

    Drill-Down Reports, [3-168](#)

    Drill-Down Top Agent Work State Report, [3-170](#)

    Drill-Down Work State Report, [3-174](#)

    Event Count Summary Report, [3-24](#)

    Graphical Active Agents, [3-65](#)

    Graphical Allocated Agents, [3-69](#)

    Graphical Call Profile Report, [3-79](#)

    Graphical EWT Report, [3-83](#)

    Graphical Queue Report, [3-86](#)

    Graphical Skill Overload Report, [3-89](#)

    Graphical Staffing Profile Report, [3-91](#)

    Graphical Status Report, [3-95](#)

    Graphical Top Skill Status Report, [3-99](#)

## Real-Time Reports, (continued)

- Multi-ACD Report, [3-27](#)
  - Multi-ACD Top Agent Report, [3-35](#)
  - organization, [3-1](#)
  - Other Reports, [3-22](#)
  - overview, [3-1](#)
  - presentation, [3-2](#)
  - Queue Agent Status Report, [3-50](#)
  - Queue Agent Summary Report, [3-55](#)
  - Queue/Agent Reports, [3-41](#)
  - Queue/Top Agent Status Report, [3-45](#)
  - Reserve1 AUX Agents Report, [3-104](#)
  - Reserve2 AUX Agents Report, [3-108](#)
  - roadmap, [3-2](#)
  - Skill AUX Report, [3-112](#)
  - Skill Status Report, [3-114](#)
  - Skill Top Agent Report, [3-120](#)
  - Split Status Report, [3-125](#)
  - Split/Skill Agent Status by Location Report, [3-140](#)
  - Split/Skill by Location Report, [3-134](#)
  - Split/Skill Graphical AUX Agents Report, [3-73](#)
  - Split/Skill Graphical AUX Top Agents Report, [3-76](#)
  - Split/Skill Report, [3-130](#)
  - Split/Skill Reports, [3-58](#)
  - Split/Skill Top Agent Status Report, [3-136](#)
  - Trunk Group Report, [3-144](#)
  - VDN Call Profile Report, [3-152](#)
  - VDN Graphical Call Profile Report, [3-156](#)
  - VDN Report, [3-161](#)
  - VDN Reports, [3-148](#)
  - VDN Skill Preference Report, [3-159](#)
  - Vector Report, [3-164](#)
- Real-Time Reports, Definition, [1-7](#)
- Real-Time Reports, organization, [3-1](#)
- Real-Time Reports, overview, [3-1](#)
- Real-Time Reports, presentation, [3-2](#)
- Real-Time Reports, roadmap, [3-2](#)
- Reason Code 0, [3-75](#), [3-78](#), [3-103](#), [4-82](#)
  - Reason Code 1...9, [3-103](#)
  - Reason Code 1-9, [3-75](#), [3-78](#), [4-82](#)
  - RECONNECT, [4-46](#)
  - Reconnect, [4-46](#)
  - Redirect On No Answer, [GL-23](#)
  - Refresh Rate, [GL-23](#)
  - Report Charts, [2-31](#)
  - Report color scheme, create, [2-81](#)
  - Report Input Information, Types, [2-6](#)
  - Report Input Information, Window, [2-6](#)
  - Report Intervals, [4-3](#)
  - Report Menu Bar, [2-13](#)
  - Report Menu Bar, options, [2-13](#)
  - Report Menu Bar, report menu, [2-14](#)
  - Report Menu Bar, Save as HTML, [2-17](#)
  - Report name format, create, [2-87](#)
  - Report Options, [2-73](#)
    - create a name format, [2-87](#)
    - create a report color scheme, [2-81](#)
    - create a threshold color scheme, [2-84](#)
    - general tab, description, [2-74](#)
    - name format tab, description, [2-79](#)
    - Overview, [2-73](#)
    - report colors tab, description, [2-76](#)
    - threshold colors tab, description, [2-78](#)
    - using the general tab, [2-74](#)
    - using the name format tab, [2-79](#)
    - using the report colors tab, [2-76](#)
    - using the threshold colors tab, [2-78](#)
  - Report Output Window, [2-3](#)
  - Report Run Dates, Browse Date, [2-8](#)
  - Report Run Dates, Browse Dates, [2-9](#)
  - Report Run Dates, Browse Month, [2-9](#)
  - Report Run Dates, Browse Months, [2-10](#)
  - Report Run Dates, Selecting, [2-8](#)
  - Report Run Times, Browse Time, [2-11](#)

- Report Run Times, Selecting, [2-11](#)
- Report Selector, [2-3](#)
- Report Selector Window, Displaying, [2-4](#)
- Report Selector Window, Fields, [2-4](#)
- Report Tables, [2-30](#)
- Report threshold color scheme, create, [2-84](#)
- Report threshold highlights, [2-59](#)
- Report Types, [2-30](#)
- Report Windows
  - Changing Column Widths, [2-54](#)
  - Graphical Report Window, [2-54](#)
  - Resizing, [2-54](#)
  - Standard Windows, [2-54](#)
- Report, Editing and Viewing, [2-29](#)
- Reports, Copying Charts, [2-53](#)
- Reports, Editing, [2-24](#)
  - Menu, [2-24](#)
  - Menu Item Functions, [2-24](#)
- Reports, Exporting Data, [2-50](#)
- Reports, Formatting
  - Menu, [2-26](#)
  - Menu Item Functions, [2-26](#)
- Reports, Layouts, [2-30](#)
- Reports, Minimized, [2-45](#)
  - Icons, [2-45](#)
  - Threshold Icons, [2-46](#)
- Reports, Options, [2-28](#)
- Reports, Page Setup, [2-57](#)
  - Options, [2-57](#)
  - Procedure, [2-58](#)
- Reports, Resizing Windows and Columns, [2-54](#)
- Reports, Running, [2-6](#)
- Reports, Selecting, [2-4](#)
- Reports, Selecting a Printer, [2-55](#)
- Reports, Tools
  - Menu, [2-27](#)
  - Menu Item Functions, [2-27](#)
- Reserve1 Agents (Active), [3-94](#)
- Reserve1 Agents (active), [3-72](#)
- Reserve1 Agents (AUX), [3-94](#)
- Reserve1 Agents (Other), [3-94](#)
- Reserve1 Agents in AUX, [3-105](#)
- Reserve1 Agents Staffed, [3-40](#), [3-48](#)
  - , [3-67](#), [3-72](#)
- Reserve1 AUX Agents Report, [3-104](#)
- Reserve2 Agents (Active), [3-94](#)
- Reserve2 Agents (active), [3-72](#)
- Reserve2 Agents (AUX), [3-94](#)
- Reserve2 Agents (Other), [3-94](#)
- Reserve2 Agents in AUX, [3-109](#)
- Reserve2 Agents Staffed, [3-40](#), [3-48](#), [3-67](#), [3-72](#)
- Reserve2 AUX Agents Report, [3-108](#)
- Resizing Report Windows and Columns, [2-54](#)
- Restarting Reports, procedure, [2-12](#)
- RINGING, [3-14](#), [3-21](#), [3-102](#), [4-82](#), [GL-23](#)
- Ringling, [3-33](#), [3-122](#), [3-132](#)
- Rls, [4-46](#)
- Roadmap
  - Historical Split/Skill Reports, [4-57](#)
  - Historical System Reports, [4-101](#)
  - Historical Trunk/Trunk Group Reports, [4-124](#)
  - Historical VDN Reports, [4-141](#)
  - Historical Vector Report, [4-172](#)
  - Real-Time Agent Reports, [3-5](#)
  - Real-Time Other Reports, [3-22](#)
  - Real-Time Queue/Agent Reports, [3-41](#)
  - Real-Time Split/Skill Reports, [3-58](#)
- ROLE, [3-143](#)
- Role, [3-53](#), [3-105](#), [3-109](#), [3-143](#)
- Rolling ASA, [GL-23](#)
- ROW\_DATE, [4-10](#), [4-12](#), [4-15](#), [4-17](#), [4-21](#), [4-26](#), [4-30](#), [4-34](#), [4-36](#), [4-38](#), [4-40](#), [4-45](#), [4-56](#), [4-62](#), [4-65](#), [4-67](#), [4-69](#), [4-71](#), [4-75](#), [4-77](#), [4-79](#), [4-81](#), [4-87](#), [4-91](#), [4-105](#), [4-110](#), [4-120](#), [4-135](#), [4-146](#), [4-148](#), [4-153](#), [4-155](#), [4-159](#), [4-162](#), [4-165](#), [4-169](#)

Running Reports, [2-2](#)

## S

Save as HTML, [2-17](#)

Browsers, [2-17](#)

Fonts, [2-20](#)

Not Using Templates, [2-19](#)

Output Files, [2-19](#)

Save as location, [2-17](#)

Template Tags, [2-20](#)

Templates, [2-19](#)

Using, [2-18](#)

Using Existing Templates, [2-20](#)

Script Buttons, [2-3](#)

Scripting, [GL-23](#)

Scripting, Using, [2-3](#)

Secondary Skill, [GL-23](#)

Seconds, [4-62](#), [4-149](#), [4-159](#)

Secs, [3-63](#), [3-80](#), [3-158](#), [4-77](#)

Secs., [3-153](#), [3-158](#)

SEIZED, [GL-23](#)

Selecting a Printer

Print Setup Options, [2-55](#)

Procedure, [2-55](#)

Selecting Report Run Times, [2-11](#)

Selecting Reports, [2-2](#)

Seq, [4-45](#)

Service Interval - Seconds, [4-156](#)

Service Interval Answers and Abandons, [4-72](#), [4-156](#)

Service Interval Calls Answered, [4-72](#), [4-156](#)

Service Intervals Changed, [4-62](#), [4-72](#), [4-148](#), [4-156](#)

Service Level, [4-71](#), [4-155](#), [GL-24](#)

Service ObservingVDNs, [GL-24](#)

SERVICELEVEL, [3-80](#), [3-158](#), [4-71](#), [4-77](#)

SERVLEVEL, [4-155](#), [4-159](#)

Single-User Mode, [GL-24](#)

Single-User Mode, Definition, [1-7](#)

Skill, [3-18](#), [3-38](#), [3-71](#), [3-74](#), [3-77](#), [3-80](#), [3-101](#), [3-102](#), [3-105](#), [3-109](#), [3-116](#), [3-172](#), [4-34](#), [GL-24](#)

Skill Level, [GL-24](#)

Skill State, [3-30](#), [3-38](#), [3-46](#), [3-56](#), [3-67](#), [3-71](#), [3-87](#), [3-90](#), [3-92](#), [3-96](#), [3-101](#), [3-116](#), [3-131](#), [3-137](#), [3-172](#), [3-176](#)

Skill Top Agent Report, [3-120](#)

SKILL1, [4-167](#), [4-170](#)

SKILL2, [4-167](#), [4-170](#)

SKILL3, [4-167](#), [4-170](#)

SKILLACWTIME1, [4-170](#)

SKILLACWTIME2, [4-170](#)

SKILLACWTIME3, [4-171](#)

SKILLCALLS1, [3-160](#), [4-170](#)

SKILLCALLS2, [3-160](#), [4-170](#)

SKILLCALLS3, [3-160](#), [4-170](#)

Skills, [3-121](#)

Skills 1-15, [4-34](#)

SKILLTIME1, [4-170](#)

SKILLTIME2, [4-170](#)

SKILLTIME3, [4-171](#)

SKSTATE, [3-30](#), [3-38](#), [3-46](#), [3-56](#), [3-67](#), [3-71](#), [3-87](#), [3-90](#), [3-92](#), [3-96](#), [3-101](#), [3-116](#), [3-131](#), [3-137](#), [3-172](#), [3-176](#), [5-22](#), [5-27](#)

SPLIT, [3-26](#), [3-30](#), [3-63](#), [3-66](#), [3-71](#), [3-74](#), [3-77](#), [3-80](#), [3-84](#), [3-87](#), [3-90](#), [3-92](#), [3-96](#), [3-101](#), [3-113](#), [3-116](#), [3-127](#), [3-131](#), [3-141](#), [3-143](#), [3-172](#), [3-176](#), [4-34](#), [4-38](#), [4-45](#), [4-62](#), [4-65](#), [4-67](#), [4-69](#), [4-71](#), [4-75](#), [4-79](#), [4-81](#), [4-87](#), [4-91](#), [4-105](#), [4-110](#), [4-115](#), [4-120](#), [5-8](#), [5-14](#), [5-22](#), [5-25](#), [5-27](#)

Split, [3-14](#), [3-84](#), [3-127](#), [4-36](#), [GL-24](#)

Split Status Report, [3-125](#)

Split(s), [3-129](#)

Split/Skill, [3-8](#), [3-11](#), [3-26](#), [3-54](#), [3-56](#), [3-63](#), [3-66](#), [3-87](#), [3-90](#), [3-92](#), [3-96](#), [3-97](#), [3-113](#), [3-141](#), [3-143](#), [4-38](#), [4-45](#), [4-62](#), [4-65](#), [4-67](#), [4-69](#), [4-71](#), [4-75](#), [4-77](#), [4-79](#), [4-81](#), [4-87](#), [4-91](#), [4-105](#), [4-110](#), [4-115](#), [4-120](#)

Split/Skill Agent Status by Location Report, [3-140](#)

Split/Skill by Location Report, [3-134](#), [4-90](#)

Split/Skill Call Profile Report, [4-61](#)

Split/Skill Graphical ASA Daily Report, [4-68](#)

Split/Skill Graphical ASA Report, [4-64](#)

- Split/Skill Graphical AUX Agents Report, [3-73](#)
- Split/Skill Graphical AUX Top Agents Report, [3-76](#)
- Split/Skill Graphical Average Positions Staffed Report, [4-66](#)
- Split/Skill Graphical Call Profile Report, [3-79](#), [4-70](#)
- Split/Skill Graphical EWT Report, [3-83](#)
- Split/Skill Graphical Multi-ACD Service Level Report, [4-73](#)
- Split/Skill Graphical Multi-ACD Service Level Report Input Fields, [4-74](#)
- Split/Skill Graphical Queue Report, [3-86](#)
- Split/Skill Graphical Service Level Report, [4-76](#)
- Split/Skill Graphical Status Report, [3-95](#)
- Split/Skill Graphical Time Spent Report, [4-80](#)
- Split/Skill Graphical Top Skill Status Report, [3-99](#)
- Split/Skill Outbound Report, [4-83](#)
- Split/Skill Report, [3-130](#), [4-37](#), [4-86](#)
- Split/Skill Report Input Fields, [4-59](#)
- Split/Skill report input fields, [5-19](#)
- Split/Skill report selector window, [5-19](#)
- Split/Skill Reports, [3-58](#), [4-57](#), [5-17](#)
  - Call Profile, [3-62](#)
  - Call Profile Report, [4-61](#)
  - Comparison, [5-21](#)
  - general information, [3-59](#), [4-58](#), [5-18](#)
  - Graphical Active Agents, [3-65](#)
  - Graphical Allocated Agents, [3-69](#)
  - Graphical ASA Daily Report, [4-68](#)
  - Graphical ASA Report, [4-64](#)
  - Graphical Average Positions Staffed Report, [4-66](#)
  - Graphical Call Profile Report, [3-79](#), [4-70](#)
  - Graphical EWT Report, [3-83](#)
  - Graphical Multi-ACD Service Level Report, [4-73](#)
  - Graphical Queue Report, [3-86](#)
  - Graphical Service Level Report, [4-76](#)
  - Graphical Skill Overload, [5-24](#)
  - Graphical Skill Overload Report, [3-89](#), [4-78](#)
  - Graphical Staffing Profile Report, [3-91](#)
  - Graphical Status Report, [3-95](#)
- Split/Skill Reports, (continued)
  - Graphical Time Spent Report, [4-80](#)
  - Graphical Top Skill Status Report, [3-99](#)
  - Graphical View, [5-26](#)
  - input fields, [3-60](#), [4-59](#)
  - organization, [3-58](#), [4-58](#), [5-18](#)
  - Outbound Report, [4-83](#)
  - Report, [4-86](#)
  - Reserve1 AUX Agents Report, [3-104](#)
  - Reserve2 AUX Agents Report, [3-108](#)
  - Roadmap, [3-58](#), [4-57](#)
  - selector window, [3-60](#), [4-58](#)
  - Skill AUX Report, [3-112](#)
  - Skill Status Report, [3-114](#)
  - Skill Top Agent Report, [3-120](#)
  - Split Status Report, [3-125](#)
  - Split/Skill Agent Status by Location Report, [3-140](#)
  - Split/Skill by Location Report, [3-134](#), [4-90](#)
  - Split/Skill Graphical AUX Agents Report, [3-73](#)
  - Split/Skill Graphical Top AUX Agents Report, [3-76](#)
  - Split/Skill Report, [3-130](#)
  - Split/Skill Top Agent Status Report, [3-136](#)
  - Summary Report, [4-95](#)
  - VDN Report, [5-30](#)
- Split/Skill Reports selector window, [3-60](#)
- Split/Skill Reports, general information, [3-59](#)
- Split/Skill Reports, input fields, [3-60](#)
- Split/Skill Reports, organization, [3-58](#)
- Split/Skill Skill AUX Report, [3-112](#)
- Split/Skill Skill Status Report, [3-114](#)
- Split/Skill Summary Report, [4-95](#)
- Split/Skill threshold settings, [2-68](#)
- Split/Skill Top Agent Status Report, [3-136](#)
- Splits/Skills, [3-30](#), [3-131](#)
- STAFFED, [3-26](#), [3-34](#), [3-123](#), [3-133](#), [5-22](#), [5-27](#)
- Staffed, [3-34](#), [3-123](#), [3-133](#)
- Staffed Agent, [GL-24](#)



Staffed Time, [3-21](#), [4-10](#), [4-12](#), [4-21](#), [4-24](#), [4-28](#), [4-40](#), [4-89](#), [4-93](#)

Standard Agents (active), [3-71](#)

Standard Agents (staffed), [3-72](#)

Standard Reports, [GL-24](#)

Start, [4-50](#)

Start Time (Interval), [4-65](#)

STARTTIME, [4-10](#), [4-12](#), [4-15](#), [4-30](#), [4-38](#), [4-165](#), [4-169](#)

State, [3-8](#), [3-11](#), [3-14](#), [3-18](#), [3-53](#), [3-97](#), [3-102](#), [3-118](#), [3-129](#), [3-143](#), [4-45](#)

Station, [GL-25](#)

Stop, [4-50](#)

Stroke Count, [4-14](#)

Stroke counts, [3-24](#)

Subsystem, [GL-25](#)

Subsystem, Definition, [1-7](#)

sum (TOTAL\_ACDCALLS), [4-93](#)

sum(I\_AUXTIME), [4-94](#)

sum(I\_AVAILTIME), [4-94](#)

sum(I\_OTHERTIME), [4-94](#)

sum(I\_RINGTIME), [4-93](#)

sum(I\_STAFFTIME), [4-94](#)

sum(TOTAL\_I\_ACD\_TIME), [4-93](#)

sum(TOTAL\_I\_ACW\_TIME), [4-93](#)

Supervisor Controller Toolbar, [2-3](#)

SVCLEVELCHG, [4-62](#), [4-72](#), [4-148](#), [4-156](#), [4-159](#)

Switch, [GL-25](#)

syn(SPLIT), [4-36](#)

System Graphical Maximum Delay Report, [4-103](#)

System Graphical Maximum Delay Report Input Fields, [4-104](#)

System Multi-ACD by Split/Skill Report, [4-107](#)

System Multi-ACD by Split/Skill Report Input Fields, [4-109](#)

System Multi-ACD Report, [4-113](#)

System Multi-ACD Report Input Fields, [4-114](#)

System Multi-ACD Report Input Window, [4-113](#)

System Report, [4-118](#)

System Reports, [4-101](#)

- general information, [4-102](#)
- Graphical Maximum Delay Report, [4-103](#)
- Multi-ACD by Split/Skill Report, [4-107](#)
- Multi-ACD Report, [4-113](#)
- organization, [4-101](#)
- Roadmap, [4-101](#)
- selector window, [4-102](#)
- System Report, [4-118](#)

System Setup, [GL-25](#)

## T

Table Reports

- Accessing Options Window, [2-32](#)
- Formatting, [2-32](#)
- General Tab, [2-32](#)
- General Tab Parameters, [2-33](#)
- Sort Tab, [2-33](#)
- Using Sort Tab, [2-34](#)

TAGINRING, [3-67](#), [3-68](#), [3-93](#), [3-102](#)

TAVAILABLE, [3-101](#)

Terminology, [1-7](#)

Tertiary Split/Skill, [GL-25](#)

Threshold, [GL-25](#)

Threshold highlight

- overview, [2-59](#)

Threshold highlights

- agent threshold settings, [2-65](#)
- entities, [2-59](#)
- example, [2-59](#)
- reports, [2-59](#)
- set, [2-60](#)
- setting, [2-59](#)
- split/skill threshold settings, [2-68](#)
- threshold settings window, [2-60](#)
- tips for setting, [2-63](#)
- turn on and off, [2-59](#)

- Threshold highlights, (continued)
  - VDN threshold settings, [2-71](#)
- Threshold Settings window, [2-60](#)
- TI\_AUXTIME, [3-21](#), [4-12](#), [4-28](#), [4-89](#), [5-8](#), [5-14](#)
- TI\_AUXTIME0, [5-8](#)
- TI\_AVAILTIME, [3-20](#), [4-12](#), [4-17](#), [4-28](#), [5-8](#), [5-14](#)
- TI\_OTHERTIME, [3-21](#), [4-17](#), [5-8](#), [5-14](#)
- TI\_STAFFTIME, [3-21](#), [4-12](#), [4-21](#), [4-28](#), [5-8](#), [5-14](#)
- Time, [3-8](#), [3-11](#), [3-14](#), [3-18](#), [3-54](#), [3-75](#), [3-78](#), [3-97](#), [3-102](#), [3-105](#), [3-109](#), [3-119](#), [3-129](#), [3-143](#), [4-10](#), [4-12](#), [4-15](#), [4-30](#), [4-38](#), [4-45](#), [4-165](#), [4-169](#)
- Time Format, [GL-26](#)
- Times, [4-160](#)
- Timetable, [GL-26](#)
- TINACW, [3-67](#), [3-68](#), [3-93](#), [3-101](#)
- TINAUX, [3-78](#), [3-93](#), [3-101](#)
- TINAUX0, [3-78](#)
- TINAUX1-9, [3-78](#), [3-103](#)
- TKGRP, [4-135](#)
- TONACD, [3-67](#), [3-68](#), [3-93](#), [3-101](#)
- Top, [3-84](#)
- Top Agents (Active), [3-93](#)
- Top Agents (AUX), [3-93](#)
- Top Agents (Other), [3-93](#)
- Top Agents Active chart Other Skills, [3-67](#)
- Top Agents Active chartThis Skill, [3-67](#)
- Top Agents Avail, [3-39](#)
- Top Agents in ACW, [3-39](#)
- Top Agents in AUX, [3-39](#), [3-78](#)
- Top Agents in Other, [3-40](#)
- Top Agents on ACD Calls, [3-39](#)
- Top Agents Ringing, [3-39](#)
- Top Agents Staffed, [3-40](#), [3-66](#), [3-101](#)
- Top Skill, [3-18](#)
- TOPSKILL, [5-8](#)
- Total ACD Calls, [4-93](#)
- Total ACD Time, [4-93](#)
- Total ACW Time, [4-93](#)
- Total Agent AUX Time, [4-94](#)
- Total Agent Avail Time, [4-94](#)
- Total Agent Other Time, [4-94](#)
- Total Agent Ring Time, [4-93](#)
- Total Agent Staffed Time, [4-94](#)
- Total Agents Active, [3-71](#)
- Total AUX Time, [4-10](#)
- Total Avg ACD Time, [4-93](#)
- Total Avg ACW Time, [4-93](#)
- Total Calls Abandoned, [3-64](#)
- Total Calls Answered, [3-64](#)
- Total Hold Time, [4-39](#)
- TOTAL\_ACDCALLS, [3-26](#), [4-12](#), [4-26](#)
- TOTAL\_ACDTIME, [4-26](#)
- TOTAL\_ACWTIME, [4-26](#)
- TOTAL\_I\_ACDTIME, [4-12](#), [4-15](#), [4-21](#)
- TOTAL\_I\_ACWTIME, [4-12](#), [4-21](#)
- TOTHER, [3-67](#), [3-93](#), [3-102](#)
- Trans Out, [4-32](#), [4-39](#), [4-40](#), [4-46](#), [4-89](#)
- TRANSFERRED, [4-32](#), [4-39](#), [4-89](#)
- Trunk, [4-135](#), [GL-26](#)
- Trunk Failures, [4-136](#)
- Trunk Group, [GL-26](#)
- Trunk Group Name, [4-135](#)
- Trunk Group Report, [3-144](#), [4-134](#)
- Trunk Group Reports
  - General Information, [3-144](#)
  - Input Fields, [3-144](#)
  - Selector Window, [3-144](#)
  - Trunk Group Report, [3-144](#)
- Trunk Group Summary Report, [4-137](#)
- Trunk Report, [4-131](#)
- Trunk/Trunk Group Busy Hour Report, [4-128](#)
- Trunk/Trunk Group Report Input Fields, [4-126](#)

Trunk/Trunk Group Reports, [4-124](#)

    Busy Hour Report, [4-128](#)

    general information, [4-125](#)

    organization, [4-124](#)

    Roadmap, [4-124](#)

    selector window, [4-125](#)

    Trunk Group Report, [4-134](#)

    Trunk Group Summary Report, [4-137](#)

    Trunk Report, [4-131](#)

TSTAFFED, [3-66](#), [3-101](#)

## U

Uniform Call Distribution (UCD), [GL-26](#)

Universal Call Identifier (UCID), [GL-26](#)

UNKNOWN, [GL-26](#)

UNSTAF, [GL-26](#)

User ID, [GL-26](#)

User Permissions, [GL-27](#)

## V

VDN, [3-119](#), [3-129](#), [3-153](#), [3-157](#), [3-160](#), [3-162](#), [4-146](#), [4-148](#), [4-153](#), [4-155](#), [4-159](#), [4-162](#), [4-165](#), [4-169](#), [5-34](#), [GL-27](#)

VDN Busy Hour Report, [4-145](#)

VDN Call Profile Report, [3-152](#), [4-147](#)

    Acceptable service level, [3-152](#)

    Caution, [4-147](#)

    Service level increments, [3-152](#)

VDN Calls-Counted, [GL-27](#)

VDN Graphical Busy/Abandon/Disconnect Comparison Report, [4-151](#)

VDN Graphical Call Handling Report, [5-33](#)

VDN Graphical Call Profile Report, [3-156](#), [4-154](#)

VDN Graphical Service Level Report, [4-158](#)

VDN Interflow, [4-163](#)

VDN Multi-ACD Flow Report, [4-161](#)

VDN Name, [3-8](#), [3-11](#), [4-146](#), [4-162](#), [4-165](#)

VDN of Origin Announcement (VOA), [GL-27](#)

VDN Report, [3-161](#), [4-164](#)

VDN Report Input Fields, [4-144](#)

VDN Report input fields, [5-32](#)

VDN Report selector window, [5-31](#)

VDN Reports, [3-148](#), [4-141](#)

    Busy Hour Report, [4-145](#)

    Call Profile Report, [4-147](#)

    General Information, [3-148](#)

    general information, [4-142](#)

    Graphical Busy/Abandon/Disconnect Comparison Report, [4-151](#)

    Graphical Call Handling, [5-33](#)

    Graphical Call Profile Report, [4-154](#)

    Graphical Service Level Report, [4-158](#)

    Input Fields, [3-148](#)

    Multi-ACD Flow Report, [4-161](#)

    organization, [4-141](#)

    Report, [4-164](#)

    Roadmap, [3-148](#), [4-141](#)

    Selector Window, [3-148](#)

    selector window, [4-143](#)

    Skill Preference Report, [4-168](#)

    VDN Call Profile Report, [3-152](#)

    VDN Graphical Call Profile Report, [3-156](#)

    VDN Report, [3-161](#)

    VDN Skill Preference Report, [3-159](#)

VDN Skill Preference, [GL-27](#)

VDN Skill Preference Report, [3-159](#), [4-168](#)

VDN threshold settings, [2-71](#)

VECTOR, [3-166](#), [4-165](#), [4-169](#)

Vector, [3-166](#), [4-165](#), [4-169](#), [GL-27](#)

Vector Directory Number (VDN), [GL-28](#)

Vector Flow In, [3-167](#)

Vector Flow Out, [3-167](#)

Vector Report, [3-164](#), [4-172](#), [4-175](#)

    General Information, [3-164](#)

    general information, [4-173](#)

    Input Fields, [3-164](#)

    organization, [4-172](#)

    Roadmap, [3-164](#), [3-168](#), [4-172](#)

    Selector Window, [3-164](#)

    selector window, [4-173](#)

Vector Report Input Fields, [4-174](#)

Voice Terminal, [GL-28](#)

## W

Week, [4-10](#)

Week Starting, [4-12](#), [4-15](#), [4-21](#), [4-30](#), [4-38](#), [4-40](#), [4-62](#), [4-87](#), [4-148](#)

Week starting, [4-120](#), [4-135](#), [4-162](#), [4-165](#), [4-169](#)

Weekly Data, [GL-28](#)

Weekly Data, Definition, [1-7](#)

Weekly Reports, [4-3](#)

WMODE\_SEQ, [4-45](#)

WORKMODE, [3-97](#), [3-118](#), [3-129](#), [3-141](#), [3-142](#), [4-45](#)

WORKSKILL, [3-102](#), [3-143](#), [5-8](#), [5-14](#)

WORKSKLEVEL, [3-143](#)

WORKSPLIT, [3-129](#)

WORKSPLIT2, [3-129](#)

WORKSPLIT3, [3-129](#)

WORKSPLIT4, [3-129](#)

Write Permission, [GL-28](#)

# How Are We Doing?

Document Title: **CentreVu® Supervisor Version 8**

Reports

Document No.: 585-210-929

Issue 1

Date: December 1999

Lucent Technologies welcomes your feedback on this document. Your comments are of great value in helping us to improve our documentation.

1. Please rate the effectiveness of this document in the following areas:

	Excellent	Good	Fair	Poor	Not Applicable
Ease of Use					////////////////////
Clarity					////////////////////
Completeness					////////////////////
Accuracy					////////////////////
Organization					////////////////////
Appearance					////////////////////
Examples					////////////////////
Illustration					
Overall Satisfaction					////////////////////

2. Please check the ways you feel we could improve this document:

- |  |   |
|--|---|
| <input type="checkbox"/> Improve the overview/introduction | <input type="checkbox"/> Make it more concise/brief                 |
| <input type="checkbox"/> Improve the table of contents     | <input type="checkbox"/> Add more step-by-step procedures/tutorials |
| <input type="checkbox"/> Improve the organization          | <input type="checkbox"/> Add more troubleshooting information       |
| <input type="checkbox"/> Include more figures              | <input type="checkbox"/> Make it less technical                     |
| <input type="checkbox"/> Add more examples                 | <input type="checkbox"/> Add more/better quick reference aids       |
| <input type="checkbox"/> Add more detail                   | <input type="checkbox"/> Improve the index                          |

Please provide details for the suggested improvement. \_\_\_\_\_  
 \_\_\_\_\_

3. What did you like most about this document?

\_\_\_\_\_  
 \_\_\_\_\_

4. Feel free to write any comments below or on an attached sheet.

\_\_\_\_\_  
 \_\_\_\_\_  
 \_\_\_\_\_

If we may contact you concerning your comments, please complete the following:

Name: \_\_\_\_\_ Telephone Number: (\_\_\_\_) \_\_\_\_\_

Company/Organization: \_\_\_\_\_ Date: \_\_\_\_\_

When you have completed this form, please fold, tape, and return to address on back or you can fax the form to: 303-538-2195.

