

Lucent Technologies
Bell Labs Innovations



MERLIN LEGEND®
Communications System

Release 6.0

System Manager's Guide

555-660-118
Comcode 108136045
Issue 1
February 1998

Notice

Every effort was made to ensure that the information in this book was complete and accurate at the time of printing. However, information is subject to change. See Appendix A, “*Customer Support Information*,” for important information.

Your Responsibility for Your System’s Security

Toll fraud is the unauthorized use of your telecommunications system by an unauthorized party, for example, persons other than your company’s employees, agents, subcontractors, or persons working on your company’s behalf. Note that there may be a risk of toll fraud associated with your telecommunications system, and if toll fraud occurs, it can result in substantial additional charges for your telecommunications services.

You and your System Manager are responsible for the security of your system, such as programming and configuring your equipment to prevent unauthorized use. The System Manager is also responsible for reading all installation, instruction, and system programming documents provided with this product in order to fully understand the features that can introduce risk of toll fraud and the steps that can be taken to reduce that risk.

Lucent Technologies does not warrant that this product is immune from or will prevent unauthorized use of common-carrier telecommunication services or facilities accessed through or connected to it. Lucent Technologies will not be responsible for any charges that result from such unauthorized use. For important information regarding your system and toll fraud, see Appendix A, “*Customer Support Information*.”

Federal Communications Commission Statement

This equipment has been tested and found to comply with the limits for a Class A digital device, pursuant to Part 15 of the FCC Rules. These limits are designed to provide reasonable protection against harmful interference when the equipment is operated in a commercial environment. This equipment generates, uses, and can radiate radio frequency energy and, if not installed and used in accordance with the instruction manual, may cause harmful interference to radio communications. Operation of this equipment in a residential area is likely to cause harmful interference, in which case the user will be required to correct the interference at his own expense. For further FCC information, see Appendix A, “*Customer Support Information*.”

Canadian Department of Communications (DOC) Interference Information

This digital apparatus does not exceed the Class A limits for radio noise emissions set out in the radio interference regulations of the Canadian Department of Communications.

Le Présent Appareil Numérique n’ émet pas de bruits radioélectriques dépassant les limites applicables aux appareils numériques de la classe A prescrites dans le règlement sur le brouillage radioélectrique édicté par le ministère des Communications du Canada.

Trademarks

5ESS, AUDIX, DEFINITY, HackerTracker, CONVERSANT, Lucent Technologies Attendant, Fax Attendant System, MERLIN, MERLIN LEGEND, MERLIN MAIL, MERLIN PFC, MLX-10, MLX-10D, MLX-10DP, MLX-16DP, MLX-20L, MLX-28D, PassageWay, PARTNER, and Voice Power are registered trademarks and 4ESS, Intuity, Lucent Technologies, MLX-5, MLX-5D, and ExpressRoute 1000 are trademarks of Lucent Technologies in the US and other countries. NetPROTECT is a service mark of Lucent Technologies in the US and other countries.

Supra, StarSet, and Mirage are registered trademarks of Plantronics, Inc.

MEGACOM, ACCUNET, AT&T, Magic on Hold, and MultiQuest are registered trademarks of AT&T.

Pipeline is a trademark of Ascend Communications, Inc.

Intel and Pentium are registered trademarks of Intel Corporation.

PagePac is a registered trademark and PagePal a trademark of DRACON, a division of Harris Corporation.

UNIX is a registered trademark of UNIX System Laboratories, Inc

NORTEL is a registered trademark and DMS a trademark of Northern Telecom.

MCI, Prism, and Vnet are registered trademarks of MCI Communications Corp.

Apple and Macintosh are registered trademarks of Apple Computer, Inc.

Microsoft and Windows are registered trademarks of Microsoft Corporation.

Ordering Information

Call: BCS Publications Center
Voice 1 800 457-1235 International Voice 317-322-6791
Fax 1 800 457-1764 International Fax 317-322-6849

Write: BCS Publications Center
P.O. Box 4100
Crawfordsville, IN 47933

Order: Document No. 555-660-118
Comcode: 10800136045
Issue 1, February 1998

For more information about Lucent Technologies documents, refer to the section entitled, “[Related Documents](#)” on page xlii.

Support Telephone Number

In the continental US, Lucent Technologies provides a toll-free customer helpline 24 hours a day. Call the Lucent Technologies Helpline at **1 800 628-2888** or your Lucent Technologies authorized dealer if you need assistance when installing, programming, or using your system. Consultation charges may apply. Outside the continental US, contact your local Lucent Technologies authorized representative.

Lucent Technologies Fraud Intervention

If you *suspect you are being victimized* by toll fraud and you need technical support or assistance, call BCS National Service Assistance Center at **1 800 628-2888**.

Warranty

Lucent Technologies provides a limited warranty on this product. Refer to “Limited Warranty and Limitation of Liability” in Appendix A, “*Customer Support Information*.”

MERLIN LEGEND[®] Communications System

Release 6.0

System Manager's Guide

System Information Sheet

If you have a problem with your system, you may be able to resolve it quickly and easily by following the appropriate troubleshooting procedure in this guide. If the problem persists or is not listed in this guide, call the Lucent Technologies Helpline at 1 800 628-2888 for further assistance.

When you call the Helpline, the Lucent Technologies representatives can better help you if you have available the following system information and troubleshooting information. Also, obtain system planning Form 2a, System Numbering: Extension Jacks and Form 2c, System Numbering: Line/Trunk Jacks.

System Information

Company Name
(as on the equipment order) _____

Account Number
(if known) _____

Customer Identification Number _____

Main Listed Telephone Number
(for this location) _____

Lucent Technologies Contact's
Name and Phone Number _____

Troubleshooting Information

Type of equipment experiencing the problem (for example, MERLIN LEGEND Communications System, MERLIN LEGEND MAIL, or a particular system component):

A description of the problem:

Has this problem occurred before?

Have you attempted to troubleshoot the problem?

Contents

<u>IMPORTANT SAFETY INSTRUCTIONS</u>	<u>xv</u>
<u>New Features and Enhancements</u>	<u>xvii</u>
■ <u>Release 6.0 Enhancements</u>	<u>xvii</u>
<u>Prior Releases: Features and Enhancements</u>	<u>xxiii</u>
■ <u>Release 3.1 Enhancements</u>	<u>xxiii</u>
■ <u>Release 4.0 Enhancements</u>	<u>xxvi</u>
■ <u>Release 4.1 Enhancements</u>	<u>xxix</u>
■ <u>Release 4.2 Enhancements</u>	<u>xxxi</u>
■ <u>Release 5.0 Enhancements</u>	<u>xxxiii</u>
<u>About This Book</u>	<u>xxxix</u>
■ <u>Intended Audience</u>	<u>xxxix</u>
■ <u>How to Use This Book</u>	<u>xxxix</u>
■ <u>Terms and Conventions Used</u>	<u>xl</u>
■ <u>Security</u>	<u>xli</u>
■ <u>Related Documents</u>	<u>xlii</u>
■ <u>How to Comment on This Book</u>	<u>xliii</u>
<u>1 Read This First</u>	<u>1-1</u>
■ <u>Overview</u>	<u>1-1</u>
■ <u>Your Role as System Manager</u>	<u>1-4</u>
■ <u>The System Planning Forms</u>	<u>1-5</u>
■ <u>Upgrading the System</u>	<u>1-6</u>
■ <u>Environmental Requirements</u>	<u>1-6</u>
<u>2 About the System</u>	<u>2-1</u>
■ <u>Background</u>	<u>2-2</u>
■ <u>System Overview</u>	<u>2-9</u>
■ <u>Incoming Trunks</u>	<u>2-12</u>
■ <u>Modes of Operation</u>	<u>2-16</u>
■ <u>Components</u>	<u>2-18</u>
■ <u>Features</u>	<u>2-22</u>
■ <u>Applications</u>	<u>2-22</u>
■ <u>Programming the System</u>	<u>2-25</u>

■ System Capacities	2-25
■ Auxiliary Components	2-26
■ Data Communications Capabilities	2-29
3 System Components	3-1
■ Control Unit	3-1
■ Telephones	3-14
■ Operator Consoles	3-30
■ Adapters	3-34
■ Adjuncts	3-36
■ Power-Related Hardware	3-46
4 Features and Applications	4-1
■ Features	4-1
■ Applications	4-60
5 Putting the System to Work	5-1
■ Scenario 1: A Small Office	5-2
■ Scenario 2: A Professional Office	5-7
■ Optimizing Your System	5-22
6 Managing the System	6-1
■ Using the Task Descriptions	6-2
■ Using the Programming Procedures	6-3
■ Introduction to System Programming	6-5
■ Programming from the Console	6-13
■ Programming from a PC with SPM	6-18
■ Centralized Telephone Programming	6-24
■ Using Reports	6-34
■ Setting System Date and/or Time	6-38
■ Backing Up the System	6-39
■ Adding an Extension	6-40
■ Moving an Extension	6-43
■ Removing an Extension	6-44
■ Assigning a HotLine Extension	6-46
■ Changing Calling Restrictions	6-48
■ Changing Trunk-to-Trunk Transfer Status	6-49
■ Changing Coverage Delay Options	6-51

■ Adding/Removing a Line	6-57
■ Adding a DLC Operator Position	6-58
■ Adding a QCC Operator Position	6-61
■ Adding Operator Features	6-64
■ Connecting Auxiliary Equipment	6-66
■ Changing Calling Group Assignments	6-69
■ Revising Allowed Lists	6-71
■ Assigning Allowed Lists to Extensions	6-73
■ Revising Disallowed Lists	6-74
■ Assigning Disallowed Lists to Extensions	6-76
■ Changing Group Coverage Assignments	6-77
■ Revising Night Service with Group Assignment	6-79
■ Revising Night Service with Coverage Control	6-81
■ Changing Extension Directory Labels	6-83
■ Changing Trunk Labels	6-84
■ Changing Posted Message Labels	6-85
■ Changing Calling Group Labels	6-87
■ Changing System Directory Labels	6-88
■ Adding a CTI Link	6-89
■ Removing a CTI Link	6-93
7 Learning More	7-1
■ Guides	7-1
■ System Guides Information Finder	7-13
8 Troubleshooting the System	8-1
■ All Phones Are Dead (No Dial Tone or Lights)	8-2
■ Some Phones Are Dead (No Dial Tone or Lights)	8-3
■ Difficulty Making Outside Calls	8-5
■ Phone Does Not Ring	8-8
■ DLC Console Not Ringing for Incoming Calls	8-11
■ QCC Console Not Ringing for Incoming Calls	8-12
■ Single-Line Phones Ring Back after Completed Call	8-13
■ Cannot Transfer Call after Answer on an Outside Line	8-14
■ Night Service Not Working	8-15
■ Calls Not Going to Voice Mail	8-17
■ Callers Getting Incorrect Response from Voice Mail	8-19

■ Calls Not Going to Coverage	8-20
■ Trouble Hearing Called Party	8-21
■ Programmed Button Fails	8-21
■ Reminder Messages Received with the Wrong Time	8-22
■ Recall/Switchhook Does Not Work	8-23
■ Calling Group Members Not Receiving Calls	8-24
■ Calls Not Receiving Screen Pop	8-25
■ Calling Group Overflow Calls Not Receiving Screen Pop	8-27
■ Secondary Announcements Not Playing as Programmed	8-27
■ Other or Unresolved Problems	8-30
A Customer Support Information	A-1
■ Support Telephone Number	A-1
■ Federal Communications Commission (FCC) Electromagnetic Interference Information	A-1
■ Canadian Department of Communications (DOC) Interference Information	A-2
■ FCC Notification and Repair Information	A-2
■ Installation and Operational Procedures	A-3
■ DOC Notification and Repair Information	A-5
■ Renseignements sur la notification du ministère des Communications du Canada et la réparation	A-6
■ Security of Your System: Preventing Toll Fraud	A-9
■ Toll Fraud Prevention	A-10
■ Other Security Hints	A-16
■ Limited Warranty and Limitation of Liability	A-20
■ Remote Administration and Maintenance	A-21
B About Telecommunications	B-1
■ Telephone Extension Equipment	B-2
■ Transmission Facilities	B-3
■ Switching Equipment	B-5
■ Signaling	B-8

<u>C</u>	<u>System Capacities</u>	<u>C-1</u>
<u>D</u>	<u>System Planning Forms</u>	<u>D-1</u>
<u>E</u>	<u>Removing/Reinstalling the Control Unit Cover</u>	<u>E-1</u>
	<u>■ Removing the Control Unit Housing</u>	<u>E-2</u>
	<u>■ Installing the Control Unit Housing</u>	<u>E-2</u>
<u>GL</u>	<u>Glossary</u>	<u>GL-1</u>
<u>IN</u>	<u>Index</u>	<u>IN-1</u>

Figures

2	About the System	2-1
2-1	The Local Loop	2-3
2-2	The Telephone Network	2-4
2-3	The Evolution of Switches	2-7
2-4	The Switching Office Hierarchy	2-8
2-5	System Overview	2-11
2-6	Incoming Trunks	2-13
2-7	System Components	2-20
2-8	408 GS/LS-MLX Module	2-21
2-9	Applications	2-24
2-10	Auxiliary System Components	2-28

3	System Components	3-1
3-1	Processor Module	3-3
3-2	Power Supply Module	3-4
3-3	Line/Trunk and Extension Modules	3-11
3-4	MLX-28D Telephone	3-16
3-5	MLX-20L Telephone	3-17
3-6	MLX-16DP Telephone	3-18
3-7	MLX-10D Telephone	3-19
3-8	MLX-10 Telephone	3-20
3-9	MLX-5D Telephone	3-21
3-10	Direct Station Selector	3-23

5	Putting the System to Work	5-1
5-1	Medical Office Floor Plan	5-4
5-2	Law Firm Floor Plan	5-8
5-3	Law Firm Equipment	5-16
5-4	Law Firm Call Coverage	5-20
5-5	CTI Link Overview	5-24

6	Managing the System	6-1
6-1	Information Screen	6-7
6-2	Menu Selection Screen	6-7
6-3	Data Entry Screen	6-8
6-4	System Programming Menu Screens	6-8
6-5	Screen Keys	6-10
6-6	Station Busy Screen	6-11
6-7	MLX-20L Telephone with Direct Station Selector (DSS)	6-14
6-8	Display Buttons and Main Menu	6-15
6-9	Console Overlay	6-16

E	Removing/Reinstalling the Control Unit Cover	E-1
E-1	Removing the Control Unit Housing	E-2
E-2	Installing the Top Cover	E-3
E-3	Installing the Front Cover	E-4

Tables

2	About the System	2-1
2-1	Modes of Operation	2-17

3	System Components	3-1
3-1	Line/Trunk and Extension Modules	3-12
3-2	Analog Multiline Telephones	3-24
3-3	Single-Line Telephones	3-25
3-4	Maximum Number of System Operator Positions	3-30
3-5	Adjunct Summary	3-44

4	Features and Applications	4-1
4-1	Feature Finder: Basic Calling and Answering (Non-Networked Systems)	4-5
4-2	Feature Finder: Covering Calls and Having Calls Covered (Non-Networked Systems)	4-13
4-3	Feature Finder: Calling Privileges and Restrictions (Non-Networked Systems)	4-16
4-4	Feature Finder: Customizing Phones (Non-Networked Systems)	4-19
4-5	Feature Finder: Messaging (Non-Networked Systems)	4-21
4-6	Feature Finder: Timekeeping	4-23
4-7	Feature Finder: System Manager's Functions and Features (Non-Networked Systems)	4-24
4-8	Feature Finder: Special Operator and Supervisor Features (Non-Networked Systems)	4-31
4-9	Selective Coverage Features	4-39
4-10	Features for Covering Calls (Non-Networked Systems)	4-41
4-11	Facility Restriction Levels	4-49
4-12	Application Descriptions and Modes of Operation	4-62
4-13	Voice Messaging Systems	4-66

5	Putting the System to Work	5-1
5-1	Medical Office Needs	5-3
5-2	Executive Staff Needs	5-9
5-3	Secretarial Staff Needs	5-10
5-4	Administrative/Support Staff Needs	5-11
5-5	Other Needs	5-12
5-6	Law Firm Call Coverage and Call-Handling	5-17
5-7	Law Firm Calling Restrictions	5-21

6	Managing the System	6-1
6-1	Typefaces Used in Summary Programming Procedures	6-5
6-2	System Programming Menu Options	6-9
6-3	Screen Keys	6-10
6-4	Idle States	6-12
6-5	Exiting System Programming	6-18
6-6	Features That Can Be Copied: All Telephones	6-30
6-7	Features That Can Be Copied: Direct-Line Consoles Only	6-32
6-8	Ring Delays Affecting Coverage	6-52
6-9	Group Coverage Call Delivery Rules (Release 4.1 and Later Systems)	6-54
6-10	Maximum Number of Operator Positions	6-58
6-11	Maximum Number of Operator Positions	6-62

7	Learning More	7-1
7-1	System Reference Guides Overview	7-4
7-2	Information Finder: Features	7-14
7-3	Information Finder: Programming	7-17

8	Troubleshooting the System	8-1
8-1	Checking the Effectiveness of Delay Announcements	8-28

C	System Capacities	C-1
C-1	Hardware and Software Capacities	C-2

D	System Planning Forms	D-1
D-1	System Planning Forms	D-1

IMPORTANT SAFETY INSTRUCTIONS



The exclamation point in an equilateral triangle is intended to alert the user to the presence of important operating and maintenance (servicing) instructions in the literature accompanying the product.

When installing telephone equipment, always follow basic safety precautions to reduce the risk of fire, electrical shock, and injury to persons, including:

- Read and understand all instructions.
- Follow all warnings and instructions marked on or packed with the product.
- Never install telephone wiring during a lightning storm.
- Never install a telephone jack in a wet location unless the jack is specifically designed for wet locations.
- Never touch uninsulated telephone wires or terminals unless the telephone wiring has been disconnected at the network interface.
- Use caution when installing or modifying telephone lines.
- Use only Lucent Technologies-manufactured MERLIN LEGEND Communications System circuit modules, carrier assemblies, and power units in the MERLIN LEGEND Communications System control unit.
- Use only Lucent Technologies-recommended/approved MERLIN LEGEND Communications System accessories.
- If equipment connected to the analog extension modules (008, 408, 408 GS/LS) or to the MLX telephone modules (008 MLX, 408 GS/LS-MLX) is to be used for in-range out-of-building (IROB) applications, IROB protectors are required.
- Do not install this product near water, for example, in a wet basement location.
- Do not overload wall outlets, as this can result in the risk of fire or electrical shock.
- The MERLIN LEGEND Communications System is equipped with a 3-wire grounding-type plug with a third (grounding) pin. This plug will fit only into a grounding-type power outlet. This is a safety feature. If you are unable to insert the plug into the outlet, contact an electrician to replace the obsolete outlet. Do not defeat the safety purpose of the grounding plug.
- The MERLIN LEGEND Communications System requires a supplementary ground.

- Do not attach the power supply cord to building surfaces. Do not allow anything to rest on the power cord. Do not locate this product where the cord will be abused by persons walking on it.
- Slots and openings in the module housings are provided for ventilation. To protect this equipment from overheating, do not block these openings.
- Never push objects of any kind into this product through module openings or expansion slots, as they may touch dangerous voltage points or short out parts, which could result in a risk of fire or electrical shock. Never spill liquid of any kind on this product.
- Unplug the product from the wall outlet before cleaning. Use a damp cloth for cleaning. Do not use cleaners or aerosol cleaners.
- Auxiliary equipment includes answering machines, alerts, modems, and fax machines. To connect one of these devices, you must first have a Multi-Function Module (MFM).
- Do not operate telephones if chemical gas leakage is suspected in the area. Use telephones located in some other safe area to report the trouble.



WARNING:

- *For your personal safety, DO NOT install an MFM yourself.*
- *ONLY an authorized technician or dealer representative shall install, set options, or repair an MFM.*
- *To eliminate the risk of personal injury due to electrical shock, DO NOT attempt to install or remove an MFM from your MLX telephone. Opening or removing the module cover of your telephone may expose you to dangerous voltages.*

SAVE THESE INSTRUCTIONS

New Features and Enhancements

Release 6.0 Enhancements

Release 6.0 includes all Release 5.0 functionality, plus the enhancements listed below.

Private Networks

In Hybrid/PBX mode systems only, MERLIN LEGEND Communications Systems can be networked with one another or with DEFINITY[®] Enterprise Communications Server (ECS) and ProLogix[™] Communications Systems in private networks. In previous releases, this functionality is available using tie lines, but users handle calls between networked switches as outside calls. In this release, dialing the pool access code is not necessary for a call going from one networked switch to another. Also, delay-start tie trunks or T1 trunks administered as PRI can act as *tandem trunks* to connect networked systems.

Available for Hybrid/PBX mode systems, the private network features of the MERLIN LEGEND Communications System Release 6.0 provide the following advantages for geographically dispersed organizational sites:

- **Intersystem Calling.** In a private network, users on one local system can call extensions on other systems in the network. Release 6.0 can support 2-, 3-, 4-, or 5-digit dial plans. They dial these extensions as inside calls. To implement this function, the system manager programs the extension ranges of remote networked switches to create a non-local dial plan. This programming does not actually affect numbering on the remote system. To correctly set up systems for transparent calling among non-local dial plan extensions, the system manager assigns networking tie and/or PRI tandem trunks to pools. Then he or she programs as many as 20 patterns, associates with routes, Facility Restriction Levels (FRLs), digit absorption, and digit prepending. This allows ARS-like routing of non-local dial plan

calls. In addition, system managers can control whether calling name, calling number, or both are shown at MLX display telephone for incoming calls across PRI tandem trunks.

- **Toll Savings.** Private networked trunks may allow you to realize significant cost savings on long-distance and toll calls by performing tandem switching in the following two ways:
 - Callers on a local system, or individuals dialing in to remote access at a local system, can reach the public switched telephone network (PSTN) via outside trunks connected to other systems in a private network, avoiding toll charges or decreasing the cost of toll calls. No special dialing is required. For example, an organization might have a main office in Boston and a subsidiary office in New Jersey, connected by networked private tandem trunks between two systems. A user in the New Jersey office who wishes to make an outside call to the 617 area code (Boston) can do so through a line/trunk connected to the system in Boston. For example, he or she might dial, ~~916175551211~~. The local ARS tables would route this call over the private network trunks and use the ARS tables of the remote system in Boston to route this call. The system managers at each end of a private network set up ARS and Remote Access features to implement this functionality.
 - In addition, local organizations or incoming DID calls use private networked trunks to make intersystem calls between networked systems, which may be geographically distant from one another, also resulting in toll savings.
- **Service Cost Savings.** In addition to toll call saving, there are two ways that organizations can save on service costs incurred from telecommunications providers that provide public switched telephone network access:
 - You order a point to point T1 facility from a service provider, then use system programming to set it up for PRI signalling. As necessary, a service provider can provide amplification on the T1 facility, but does not supply switching services.
 - You can tailor your use of PRI B-channels with drop-and-insert equipment that allows fractional use of B-channels for dedicated data/video communications between systems at speeds greater than 64kbps per channel or 128 kbps for 2B data, while keeping the remaining B-channels for PRI voice traffic. The PRI D-channel must remain active.
 - You can tailor use of T1 channels to support both T1-emulated tandem tie service and T1 Switched 56 service for data communications at 56 kbps per channel, allowing 2B data transfers at 112 kbps. You can also use drop-and-insert equipment to provide fractional T1 use.

- **Voice Mail and Auto Attendant.** Networked systems should have their own local voice mail and/or auto attendant applications as well as their own external alerts and Music On Hold sources. However, a single auto attendant can transfer calls throughout the network. It can answer only those calls that arrive on the PSTN facilities of the system where it is connected.

Although many features are available using tie trunks for network connectivity, PRI tandem trunks provide greatly enhanced features and faster call setup. For this reason, PRI is recommended over tie functionality in private networks.

Group Calling Enhancements

Release 6.0 and later systems include Group Calling features that enhance group calling operations.

Queue Control

The system manager can control the maximum number of calls allowed in the primary calling group queue for calls that arrive on certain facilities often assigned to calling groups. When the number of the calls in queue reaches the programmed maximum, subsequent callers receive a busy signal.

Queue control applies to calls received on the following types of facilities:

- DID (Direct Inward Dialing)
- PRI facilities programmed for dial-plan routing
- All calls transferred from a VMI (voice messaging interface) port
- Dial-in Tie

Queue control also applies to internal calls to a DGC group and calls to a calling group through the QCC.

Internal calls that dial #0 or #800 and are directed to a calling group administered as Position-Busy Backup are eligible for queue control. Calls that come in on a trunk assigned to the Queued Call Console (QCC) are not eligible for queue control if the call is directed to a calling group designated as Position-Busy Backup.

Remote-access calls to a calling group, coverage calls directed to a calling group, calls directed to calling group through QCC Position-Busy backup, and all other outside calls are not eligible for queue control.

Prompt-Based Overflow

System managers can activate the Prompt-Based Overflow option. This option allows callers waiting in queue and listening to a delay announcement to press the # key in order to reach the overflow receiver for the group, which may be the QCC queue or another calling group (including a calling group assigned for a voice mail system).

All three overflow distribution options—based on the number of calls, the time a caller has waited, and according to the caller's prompt—may be used at one time. In this case, time-based and number-of-calls based options take precedence over overflow distribution based on the caller's prompt.

When prompt-based overflow distribution is used, an extra TTR must be provided for each delay announcement device assigned to the associated calling group. The delay announcement informs the caller of the # key option to exit the queue and leave rather than waiting for an agent. If no TTR is available when a calling group call arrives, the call is not sent to a delay announcement extension.

Centrex Transfer via Remote Call Forwarding

Centrex Transfer via Remote Call Forwarding can be used in all system modes of operation to send outside calls to a remote telephone number or another Centrex station. In this context, the term *outside calls* refers to calls from outside the communications system, which may originate at extensions in the Centrex system but not connected to the local MERLIN LEGEND Communications System.

An outside call that uses this feature is defined as a call that arrives on an analog Centrex loop-start line at the MERLIN LEGEND Communications System. It may arrive directly or be transferred without consultation or without transfer supervision (in the case of an automated attendant). The forwarding call to the outside number is made on the same line/trunk on which the call arrived, conserving system facilities. The following considerations and rules apply:

- Only outside Centrex calls are forwarded using this feature.
- The system must be equipped with analog loop-start Centrex lines and *all* loop-start lines in the system must be Centrex facilities. Loop-start lines do not have to provide reliable disconnect for use by the Centrex Transfer via Remote Call Forwarding feature.
- To transfer calls outside the Centrex system, the organization must subscribe to a Centrex trunk-to-trunk transfer feature.

Activating Centrex Transfer via Remote Call Forwarding is just like activating regular Remote Call Forwarding and requires that Remote Call Forwarding be enabled for the extension. However, the user dials * instead of a dial-out code, and a Pause character may be required after the *. The Centrex service provider determines whether the Pause is needed.

Pause cannot be originated from a single-line telephone or a remote access user. A multiline telephone user in the local system must enter an authorization code to activate the feature.

A remote access user may activate the feature without using an authorization code. Barrier code requirements do apply, however.

Authorization Codes and Remote Call Forwarding

In Release 6.0 and later Key or Hybrid/PBX mode systems, forwarding features, including Centrex Transfer via Remote Call Forwarding, but excluding Follow Me, can be activated or deactivated at a multiline telephone by entering the authorization code for the extension from which calls are to be forwarded. The user enters the authorization code, then activates or deactivates the forwarding feature in the normal fashion. This is especially useful for a single-line telephone user who must include a Pause character in a Centrex Transfer via Remote Call Forwarding dialing sequence, because the character cannot be dialed at a single-line telephone. It is also useful when activating Call Forwarding or Remote Call Forwarding at phantom stations, or via remote access (e.g. from another switch in the network). No other features can be used by entering an authorization code in this fashion.

Prior Releases: Features and Enhancements

Release 3.1 Enhancements

Release 3.1 includes all Release 3.0 functionality, plus the enhancements listed below.

Call Restriction Checking for Star Codes

Beginning with Release 3.1, a system manager can add star (*) codes to Allowed and Disallowed Lists to help prevent toll fraud. Star codes, typically dialed before an outgoing call, enable telephone users to obtain special services provided by the central office (CO). For example, in many areas, a telephone user can dial *67 before a telephone number to disable central office-supplied caller identification at the receiving party's telephone. You must contract with your telephone service provider to have these codes activated.

When users dial star codes, the system's calling restrictions determine whether the codes are allowed. If they are allowed, the system's calling restrictions are reset and the remaining digits that the users dial are checked against the calling restrictions.

Trunk-to-Trunk Transfer Set for Each Extension

This enhancement to the Transfer feature enables the system manager to allow or disallow trunk-to-trunk transfer on a per-extension basis. In Release 3.1 and later systems, the default setting for all extensions is restricted.

Programmable Second Dial Tone Timer

The system manager can assign a second dial tone timer to lines/trunks, in order to help prevent toll fraud (for example, when star codes are used). After receiving certain digits dialed by a user, the CO may provide a second dial tone, prompting the user to enter more digits. If this second dial tone is delayed, and the user dials digits before the CO provides the second dial tone, there is a risk of toll fraud or misrouting the call. The second dial tone timer enables the system manager to make sure that the CO is ready to receive more digits from the caller.

Security Enhancements

The sections below outside security measures that are implemented in Release 3.1 and later systems.

Disallowed List Including Numbers Often Associated with Toll Fraud

A factory-set Disallowed List 7 contains default entries, which are numbers frequently associated with toll fraud. By default, Disallowed List 7 is automatically assigned to both generic and integrated VMI (voice messaging interface) ports used by voice messaging systems. The system manager can manually assign this list to other extensions.

Default Pool Dial-Out Code Restriction for All Extensions

The default setting for the pool dial-out code restriction (Hybrid/PBX mode only) is restricted. No extension or remote access user with a barrier code has access to pools until the restriction is removed by the system manager.

Default Outward Restrictions for VMI Ports

Ports assigned for use by voice messaging systems (generic or integrated VMI ports) are now assigned outward restrictions by default. If a voice messaging system must be allowed to call out (for example, to send calls to a user's home office), the system manager must remove these restrictions.



SECURITY ALERT:

Before removing restrictions, it is strongly recommended that you read Appendix A, "Customer Support Information."

Default Facility Restriction Level (FRL) for VMI Ports

The default Automatic Route Selection (ARS) FRL for VMI ports is 0, restricting all outcalling.

Default for the Default Local Table

The default Automatic Route Selection (ARS, Hybrid/PBX mode only) FRL has changed to 2 for the Default Local table. System managers can easily change an extension default of 3 to 2 or lower in order to restrict calling. No adjustment to the route FRL is required.

New Maintenance Procedure for Testing Outgoing Trunks

Technicians must enter a password in order to perform trunk tests.



SECURITY ALERT:

The enhancements in Release 3.1 help increase the security of the MERLIN LEGEND System. To fully utilize these security enhancements, be sure to read and understand the information in these upgrade notes and in the relevant system guides.

Release 4.0 Enhancements

Release 4.0 includes all Release 3.1 functionality, plus the enhancements listed below.

Support for Up to 200 Extensions

An expanded dial plan supports up to 200 tip/ring devices.

Support for National ISDN BRI Service

This service (Hybrid/PBX and Key modes) provides an alternative to loop-start and ground-start lines/trunks for voice and digital data connectivity to the central office. Each of the two B-channels (*bearer channels*) on a BRI line can carry one voice and one data call at any given time. The data speeds on a B-channel are up to 28.8 kbps for analog data and up to 64 kbps for digital data, which is necessary for videoconferencing and other high-speed applications. Release 4.0 supports the IOC Package "S" (basic call handling) service configuration and Multiline Hunt service configuration on designated CO switches.

New Control Unit Modules

Release 4.0 supports a new NI-BRI line/trunk module and a higher-capacity tip/ring module.

800 NI-BRI Module

This new module connects NI-BRI trunks to the MERLIN LEGEND system for voice, high-speed data, and video transmission.

016 Tip/Ring Module

This new module supports a 200-extension dial plan by providing 16 ports for tip/ring devices. Applications that use a tip/ring interface can connect to this board. All 16 ports can ring simultaneously. Four touch-tone receivers (TTRs) are included on the module as well. The module's ringing frequency (default 20 Hz) can be changed through programming to 25 Hz for those locations that require it.

Downloadable Firmware for the 016 and NI-BRI Modules

The Personal Computer Memory Card International Association (PCMCIA) technology introduced in Release 3.0 continues to support these two new boards for installation and upgrade in Release 4.0. A Release 3.0 or later processor is required for PCMCIA technology.

Support for 2B Data Applications

A Lucent Technologies-certified group and desktop video application can use two B-channels to make video/data calls when connected to a single MLX extension jack programmed for 2B data. The 2B data devices must be equipped with ISDN-BRI interfaces. NI-1 BRI, PRI, or T1 Switched 56 facilities support 2B data communications at 112 kbps (using two 56-kbps channels) or 128 kbps (using two 64-kbps B-channels). This feature is available for Hybrid/PBX and Key modes only.

Support for T1 Switched 56 Digital Data Transmission

For Hybrid/PBX and Key mode systems, Release 4.0 expands support of T1 functionality by providing access to digital data over the public switched 56-kbps network, as well as to digital data tie-trunk services. Users who have T1 facilities for voice services can now use them for video or data calls at rates of 56 kbps per channel (112 kbps for video calls using 2B data). The Release 4.0 offering also includes point-to-point connectivity over T1 tie trunks, allowing customers to connect two MERLIN LEGEND Communications Systems or a MERLIN LEGEND Communications System with a Lucent Technologies DEFINITY® G1.1 Communications System or DEFINITY Enterprise Communications Server. The two communications systems can be co-located or at different sites.

Forwarding Delay Option

Each user can program a Forwarding Delay setting for the Forward, Remote Call Forwarding, or Follow Me features. The forwarding delay is the number of times that a call rings at the forwarding extension before the call is sent to the receiver. The delay period gives the original call recipient time to answer or to screen calls by checking the displayed calling number (if available). The delay can be set at 0 up to 9 rings. The factory setting for the forwarding delay is 0 rings (no delay).

Voice Announce on Queued Call Console

The system manager can enable the fifth **Call** button on a QCC console (Hybrid/PBX mode only) to announce a call on another user's speakerphone (providing the destination telephone has a voice announce-capable **SA** button available). A QCC cannot receive voice-announced calls; they are received as ringing calls. The factory-set status for the fifth **Call** button is Voice Announce disabled.

Time-Based Option for Overflow on Calling Group

Release 4.0 has added a *time* limit for calls in queue in addition to the previous *number of calls* limit. If the Overflow Threshold Time option is set to a valid number between 1 and 900 seconds, calls that remain in the calling group queue for the set time are sent to the overflow receiver. If the overflow threshold time is set to 0, overflow by time is turned off. The factory-set time limit is 0 seconds (off).

Single-Line Telephone Enhancements

The following changes enhance the performance of single-line telephones:

- **Disable Transfer.** Through centralized telephone programming, the system manager can disable transfer by removing all but one **SA** or **ICOM** button from the extension.
- **No Transfer Return.** When a handset bounces in its cradle, the system interprets this as a switchhook flash and attempts to transfer a call. When the transfer attempt period expires, the user's telephone rings. Release 4.0 eliminates this unintended ringing by disconnecting the call in situations where a switchhook flash is followed by an on-hook state and a dial tone is present.
- **Forward Disconnect.** All ports on 008 OPT, 012, and 016 modules now send forward disconnect to all devices connected to them when forward disconnect is received from the CO. This enhancement prevents the trunk/line from being kept active when one end disconnects from the call. If an answering machine is connected to the port, it does not record silence, busy tones, or other useless messages. This operation is not programmable.

Seven-Digit Password for SPM

Release 4.0 has increased system security by requiring a 7-digit password for system managers or technicians who use SPM to perform programming or the Trunk Test procedure. This password is for use in addition to a remote access barrier code.

Release 4.1 Enhancements

Release 4.1 includes all Release 4.0 functionality, plus the enhancements listed below. There are no hardware changes in Release 4.1.

Coverage Timers Programmed for Individual Extensions

Beginning with Release 4.1, coverage timers, which control the duration of the delay before calls are sent to each level of coverage, are changed as follows:

- The Group Coverage Ring Delay (1–9 rings) is programmed on individual extensions and replaces the Coverage Delay Interval programmed systemwide in previous releases.
- The Primary Cover Ring Delay (1–6 rings) and Secondary Cover Ring Delay (1–6 rings), programmed on individual extensions, replace the Delay Ring Interval programmed systemwide in previous releases.

These enhancements allow the system manager to customize coverage call delivery to match individual extensions' call-handling requirements.

Night Service with Coverage Control

Beginning with Release 4.1, a system manager can enable the Night Service Coverage Control option to automatically control the status of telephones programmed with Coverage VMS (voice messaging system) Off buttons, according to Night Service status.

When Coverage Control is enabled and the MERLIN LEGEND Communications System is put into Night Service, all programmed Coverage VMS Off buttons are automatically turned off (LED is unlit) and all eligible outside calls are sent to the assigned voice messaging system calling group with normal ringing delay. When Night Service is deactivated during the day, all programmed Coverage VMS Off buttons are automatically turned on (LED is lit) and voice mail coverage is disabled for outside calls.

Users can override the Coverage VMS Off button status at any time by pressing the programmed Coverage VMS Off button to turn the LED on or off.

Night Service Group Line Assignment

Beginning with Release 4.1, a system manager can assign lines to Night Service groups to control handling of after-hours calls received on individual lines. This capability replaces the automatic assignment to Night Service groups of only those lines that ring on the Night Service operator console. An outside line must be assigned to a Night Service group to receive Night Service treatment.

With this enhancement, Night Service can be activated and deactivated on lines that do not appear on operator consoles (for example, personal lines), and lines appearing at operator positions can be excluded from Night Service.

Forward on Busy

Beginning with Release 4.1, the Forward, Follow Me, and Remote Call Forward features are enhanced to remove the requirement that a call be ringing at an extension before it can be forwarded. With the Forward on Busy enhancement, a call to an extension with no available **SA** (System Access) or **ICOM** (Intercom) buttons is forwarded immediately to the programmed destination, preventing the caller from hearing a busy signal from the intended call recipient's extension.

Maintenance Testing for BRI Facilities that Are Part of Multiline Hunt Groups (MLHGs)

Beginning with Release 4.1, the NI-1 BRI (National Integrated Services Digital Network-1 Basic Rate Interface) Provisioning Test Tool is enhanced to include testing for BRI facilities that are part of Multiline Hunt Groups (MLHGs).

The NI-1 BRI Provisioning Test Tool is used by Lucent Technologies maintenance personnel on MERLIN LEGEND Communications Systems that include a 800 NI-BRI module. Technicians use the tool during system installation and maintenance to test the functionality of the BRI lines and to report analyzed results.

Release 4.2 Enhancements

Release 4.2 includes all Release 4.1 functionality, plus the enhancements listed below. There are no hardware changes for Release 4.2.

Additional Network Switch and Services Options for ISDN Primary Rate Interface (PRI)

Release 4.2 of the system supports connectivity to MCI® or local exchange carrier (LEC) PRI services and to the following central office switch types (in addition to the 4ESS™ and 5ESS® switch types that carry for AT&T Switched Network services):

- NORTEL® DMS™-100 BCS 36 for local exchange carrier services
- NORTEL DMS-250 generic MCI07 serving the MCI network
- Digital Switch Corporation DEX600E generic 500-39.30 serving the MCI network

Beginning with Release 4.2, the following MCI PRI and PRI local exchange carrier (LEC) services (along with AT&T Switched Network Services) can be provided to users of the MERLIN LEGEND Communications System:

- MCI Toll Services for DMS-250 or DEX600E switch type:
 - MCI Prism® service for domestic outgoing long-distance and international voice calls; for domestic outgoing 56-kbps restricted, 64-kbps unrestricted, and 64-kbps restricted circuit-switched data calls
 - MCI VNet® service for incoming and outgoing domestic and voice calls; for 56-kbps restricted, 64-kbps restricted, and 64-kbps unrestricted circuit-switched data calls
 - MCI 800 for domestic, toll-free, incoming voice calls
 - MCI 900 service numbers
- LEC services for DMS-100 switch types:
 - DMS Virtual Private Network service for calls between the MERLIN LEGEND Communications System and another communications system (such as another MERLIN LEGEND Communications System)
 - DMS INWATS (Inward Wide Area Telephone Service) for domestic toll-free incoming voice calls
 - DMS OUTWATS (Outward Wide Area Telephone Service) for domestic outgoing long-distance voice calls
 - DMS FX (foreign exchange) to provide local call rating for calls from the local exchange to the area serviced by the foreign exchange.

- DMS tie trunk service to provide private exchange call rating for calls placed on a dedicated central office facility between the MERLIN LEGEND Communications System and another communications system (such as another MERLIN LEGEND Communications System)

Improvements to Station Message Detail Recording (SMDR) and Support for MERLIN LEGEND Reporter Application

The SMDR feature is enhanced to provide more details about calling group agent activities and to help system managers assess the effectiveness of call centers in terms of both agent performance and the adequacy of facilities to handle inbound calls. These improvements apply to calling groups that are programmed as Auto Login or Auto Logout type. The SMDR and MERLIN LEGEND Reporter features listed are administrable:

- **TALK Field.** For Auto Login and Auto Logout calling groups, the TALK field records the amount of time a calling group agent spends on a call.
- **DUR. (DURATION) Field.** For Auto Login and Auto Logout calling groups, call timing begins when a call arrives at MERLIN LEGEND Communications System and not after a preset number of seconds. Call timing ends when the call is disconnected; either the caller or the agent hangs up. This allows the system manager to determine how long a caller waited for an agent's attention.
- **Coding of Calls on Reports.** An asterisk (*) appears in the call record when:
 - a. A call is not answered by an Auto Login or Auto Logout calling group agent and is abandoned while waiting for an agent.
 - b. The call is answered by someone not a member of an Auto Login or Auto Logout calling group.

An exclamation point (!) signals that an Auto Login or Auto Logout agent handled a call that was answered by someone who was not a member of that Auto Login or Auto Logout with Overflow group. An ampersand (&) in the call record indicates that the group's overflow receiver answered the call.

MERLIN LEGEND Reporter

MERLIN LEGEND Reporter provides basic call accounting system reports for all incoming calls to Auto Login or Auto Logout type calling groups. MERLIN LEGEND Reporter assists in determining the effectiveness of calling group agents, assessing the level of service provided to callers, and ascertaining whether adequate incoming phone lines and agents are available to handle peak-call load. The SMDR Talk Time option sets up special call records used by

MERLIN LEGEND Reporter. The default is Off, in which case the Release 4.0 SMDR reports are available. If the option is set to On, the following new reports are provided:

- Organization Detail Report
- Organization Summary and Trends Report
- Selection Detail Report
- Account Code Report
- Traffic Report
- Extension Summary Report
- Data Report
- Talk and Queue Time Distribution Report
- Time of Day Report
- ICLID Call Distribution Report
- Facility Grade of Service Report

Maintenance Enhancements

Change to Permanent Error Alarm

Beginning with Release 4.2, the most recent permanent error alarm is not shown on the System Error Log menu screen but is available as an option from that screen. For details, refer to the Maintenance section of the technician guide, *Installation, Programming, and Maintenance*.

Enhanced Extension Information Report

Beginning with Release 4.2, the Extension Information Report includes the Extension Status (ESS) and supervisory mode of each extension.

Release 5.0 Enhancements

Release 5.0 includes all Release 4.2 functionality, plus the enhancements listed below.

Computer Telephony Integration (CTI)

Beginning with Release 5.0, a PassageWay[®] Telephony Services CTI link from the MERLIN LEGEND Communications System to a LAN server running Novell[®] NetWare[®] software allows Lucent Technologies-certified telephony applications to control and monitor MLX and analog multiline telephone (BIS only) operations. The physical connection for the CTI link is an MLX port on a 008 MLX or 408 MLX

module on the MERLIN LEGEND Communications System control unit and ISDN link interface card plugged into the customer's server. The feature is available for Hybrid/PBX mode systems only.



NOTE:

The NetWare server software version must be 3.12, 4.1 or 4.11.

The 008 MLX and 408 MLX modules must have firmware vintage other than 29. If the module has firmware 29, programming a CTI link on the module is prevented. An earlier or later vintage firmware is supported.

Basic Call Control

A CTI link application on a user's computer can assume basic call control of the user's analog multiline or MLX telephone's **SA** buttons. Basic call control includes:

- Answering calls arriving on an **SA** button
- Making calls from an **SA** button
- Hanging up calls
- Hold and retrieving a call on hold at the user's extension



NOTE:

Transfer and 3-way conference, when handled through a CTI link application, provide the original caller's calling number information or other information to the transfer receiver or new conference participant, if the user has screen-pop capability.

Screen Pop

Screen pop occurs when the calling number, called number, or other user-defined identifier (such as account code that a voice-response unit prompts the caller to dial) is used to display a screen associated with the far-end party. For example, Caller ID services can be used to support screen pop on a system that includes a CTI link; using the calling party number as a database key code, information about a caller automatically appears on the user's computer screen when the call arrives at the extension. Depending on the application, screen pop may be available for calls that arrive on line buttons other than **SA** buttons and/or calls that are answered manually at the telephone rather than by the application.

Screen pop can occur on incoming calls from the following sources:

- Calling group distribution
- ISDN PRI Routing by Dial Plan
- An extension on the MERLIN LEGEND Communications System
- Remote access



NOTE:

In the case of remote access calls, the only information that the application can collect about the caller is the remote telephone number.

- A transfer of a call that was answered by a voice response unit
- A transfer, redirection, or conference of a call that was answered at a DLC or at a QCC



NOTES:

1. DLCs (Direct-Line Consoles) may use CTI applications. If they do, they perform the same way as other extensions. A DLC assigned to use a CTI link application is a *monitored* DLC. When a DLC is used as a regular operator console and not using a CTI link extension, it is *non-monitored*.
2. Calls to a QCC or non-monitored DLC do not initiate screen pop at the operator position, but when an operator directs a call to an extension using a CTI application, caller information does initiate screen pop. If the DLC is non-monitored, screen pops can occur after the DLC releases the call.
3. Calls transferred from Cover buttons on non-monitored DLCs do not initiate screen pop at the destination extension.

HotLine Feature

The Release 5.0 HotLine feature is designed for retail sales, catalogue sales, and other types of businesses and organizations and is available in all three modes of system operation. It allows a system manager to program a single-line telephone extension connected to an 008 OPT, 012, or 016 module as a HotLine. When a user lifts the handset at the HotLine extension, the telephone automatically dials the inside extension or outside telephone number programmed as the first Personal Speed Dial number (code #01) for the extension. The system does not permit calls to be transferred, put on hold, or conferenced. (A user can press the telephone's **Hold** button, if it has one, to put a call on local hold, but the call cannot be redirected in any way. Switchhook flashes are ignored.)

Personal Speed Dial codes can be programmed from the extension prior to HotLine assignment (a system programming function). Alternatively, a Personal Speed Dial code can be programmed from the single-line telephone after HotLine operation is assigned. However, because of security considerations, this is a one-time opportunity. Once the Personal Speed Dial number is programmed, any changes to it or any other extension programming must be performed using centralized telephone programming.

Any type of inside or outside line that is normally available to a single-line telephone can be assigned to a HotLine extension. Generally, the HotLine telephone does not receive calls, and its lines should be set to No Ring.



SECURITY ALERT:

If a HotLine extension accesses a loop-start line, that line should provide reliable disconnect and be programmed for reliable disconnect. Otherwise, a user at the extension may be able to stay on the line after a call is completed and then make a toll call.

Group Calling Enhancements

Release 5.0 and later systems include Group Calling features that enhance group calling operations.

Most Idle Hunt Type

In addition to the Circular (factory setting) and Linear hunt types supported in earlier releases, a third hunt type distributes calling group calls in an order based on which agent has waited the longest since transferring or hanging up on an incoming calling group call. For some applications, this hunt type is more efficient than the circular type because it takes into account the varying duration of calls. The system distributes calls based on when an agent last completed a call, not on when he or she last received one. This hunting method ignores non-calling group calls. For example, if an agent transfers a call that arrived on a line not assigned to the calling group, the calling group member's most-idle status is unaffected.

Delay Announcement Devices

The system manager can designate as many as ten primary delay announcement devices per group rather than the single device for each group that is available in Release 4.2 and earlier systems. Furthermore, an additional secondary delay announcement device can be specified, for a total of ten primary device extensions and one secondary device extension per group.

A primary delay announcement device operates in the same fashion as a single delay announcement device, playing once, as soon as it is available, for the caller who has waited the longest for a calling group agent and has not heard a primary delay announcement. If a secondary announcement device is used, it can use the factory setting, which plays the announcement once, or it can be set to repeat the announcement after a certain amount of time. The system manager programs the time (0–900 seconds) between announcements. This setting controls both the interval between primary and secondary announcements and the interval between repetitions of the secondary announcement if it is set to repeat. (See Group Calling Options in Chapter 4 for guidelines on setting the delay.)

The primary and secondary announcement options, when used together, allow an initial message to play for callers, followed by a repeating announcement that, for example, urges callers to stay on the line and wait for a calling group member.

Two or more groups may share an announcement device.

A primary delay announcement device can be administered as a secondary delay announcement device.

Enhanced Calls-in-Queue Alarm Thresholds

Three Calls-in-Queue Alarm thresholds can be set to more clearly indicate the real-time status of the calls waiting in the queue according to the behavior of programmed Calls-in-Queue Alarm buttons. In earlier releases, only one Calls-in-Queue Alarm Threshold setting is available to activate the LEDs at programmed Calls-in-Queue Alarm buttons for a calling group.

Using all three levels, the system manager sets Threshold 3 to the highest value, Threshold 2 to a middle value, and Threshold 1 to the lowest value. A Calls-in-Queue Alarm button indicates the severity of the alarm conditions in the following ways:

- If the number of waiting calls is less than the value programmed for Threshold 1 or drops below that level, the LED is unlit.
- If the number of waiting calls is greater than or equal to the Threshold 1 value but less than the Threshold 2 value, the LED flashes.
- If the number of waiting calls is greater than or equal to the Threshold 2 value but less than the value for Threshold 3, the LED winks.
- If the number of waiting calls is greater than or equal to the highest value, Threshold 3, the LED lights steadily.



NOTE:

A DSS (Direct Station Selector) button that is used as a Calls-in-Queue Alarm button can only indicate two threshold levels, either by flashing or by lighting steadily. If a calling group must use this type of Calls-in-Queue Alarm button, only two threshold levels should be programmed.

If all three thresholds are set to the same value, the result is one threshold only with LED state either off or on (steady). If two values are the same, then the result is two alarm levels (flash, steady). The factory setting is one call for all three thresholds with LED states of off and steady.

An external alert only signals when the number of calls in the queue meets or exceeds the programmed Threshold 3 value.

MLX-5 and MLX-5D Telephones

The MLX-5 nondisplay and MLX-5D display telephones are compatible with all system releases. The display telephone includes a 2-line by 24-character display, and both telephones come with 5 line buttons. In systems prior to Release 5.0, the MLX-5 and MLX-5D telephones are treated as MLX-10 and MLX-10D telephones respectively. As of Release 5.0, the system recognizes the MLX-5 and MLX-5D telephones as 5-button telephones.

If these telephones are connected to communications system releases prior to 5.0 they are recognized by the communications system as 10 button telephones.

About This Book

The MERLIN LEGEND Communications System is an advanced digital switching system that integrates voice and data communications features. Voice features include traditional telephone features, such as Transfer and Hold, and advanced features, such as Group Coverage and Park. Data features allow both voice and data to be transmitted over the same system wiring.

Intended Audience

This book is specifically designed to help you fulfill your role as system manager of the MERLIN LEGEND Communications System Release 5.0. To use this guide, you need have little or no knowledge of the system and no particular experience or expertise.

How to Use This Book

This book provides background information about all aspects of the system, including system components and features, as well as specific information and procedures for managing the system.

The first two chapters are especially important as an introduction to the system and your role as system manager. Therefore, you should read Chapter 1, "Read This First," and Chapter 2, "About the System," if you are not already familiar with these topics.

For more detailed information about features, system programming, and system components, refer to the *Feature Reference* and to *System Programming*.

["Related Documents" on page xlii](#) provides a complete list of system documentation together with ordering information.

In the USA only, Lucent Technologies provides a toll-free customer Helpline 24 hours a day. Call the Helpline at 1 800 628-2888 (consultation charges may apply), or call your Lucent Technologies representative, if you need assistance when installing, programming, or using your system.

Terms and Conventions Used

The terms described here are used in preference to other, equally acceptable terms for describing communications systems.

Lines, Trunks, and Facilities

Facility is a general term that designates a communications path between a telephone system and the telephone company central office. Technically, a *trunk* connects a switch to a switch, for example, the MERLIN LEGEND Communications System to the central office. Technically, a *line* is a loop-start facility or a communications path that does not connect switches, for example, an intercom line or a Centrex line. However, in actual usage, the terms *line* and *trunk* are often applied interchangeably. In this guide, we use *lines/trunks* and *line/trunk* to refer to facilities in general. Specifically, we refer to digital *facilities*. We also use specific terms such as *personal line*, *ground-start trunk*, *DID trunk*, and so on. When you talk to your local telephone company central office, ask about the terms they use for the specific facilities they connect to your system.

Some older terms have been replaced with newer terms. The following list shows the old term on the left and the new term on the right.

Old	New
trunk module	line/trunk module
trunk jack	line/trunk jack
station	extension
station jack	extension jack
analog data station	modem data workstation
7500B data station	ISDN terminal adapter data workstation
analog voice and data station	analog voice and modem data workstation
digital voice and analog data station	MLX voice and modem data workstation
analog data-only station	modem data-only workstation
7500B data-only station	ISDN terminal adapter data-only workstation
MLX voice and 7500B data station	MLX voice and ISDN terminal adapter data workstation

Typographical Conventions

Certain type fonts and styles act as visual cues to help you rapidly understand the information presented:

Example	Purpose
It is <i>very</i> important that you follow these steps. You <i>must</i> attach the wristband before touching the connection.	Italics indicate emphasis.
The part of the headset that fits over one or both ears is called a <i>headpiece</i> .	Italics also set off special terms.
If you press the Feature button on an MLX display telephone, the display lists telephone features you can select. A programmed Auto Dial button gives you instant access to an inside or outside number.	The names of fixed-feature, factory-imprinted buttons appear in bold. The names of programmed buttons are printed as regular text.
Choose Ext. Prog from the display screen.	Plain constant-width type indicates text that appears on the telephone display or PC screen.
To activate Call Waiting, dial <i>*11</i> .	Constant-width type in italics indicates characters you dial at the telephone or type at the PC.

Product Safety Labels

Throughout these documents, hazardous situations are indicated by an exclamation point inside a triangle and the word *CAUTION* or *WARNING*.



WARNING:

Warning indicates the presence of a hazard that could cause death or severe personal injury if the hazard is not avoided.



CAUTION:

Caution indicates the presence of a hazard that could cause minor personal injury or property damage if the hazard is not avoided.

Security

Certain features of the system can be protected by passwords to prevent unauthorized users from abusing the system. You should assign passwords wherever you can and limit knowledge of such passwords to three or fewer people.

Nondisplaying authorization codes and telephone numbers provide another layer of security. For more information, see Appendix A, "Customer Support Information."

Throughout this document, toll fraud security hazards are indicated by an exclamation point inside a triangle and the words *SECURITY ALERT*.



SECURITY ALERT:

Security Alert indicates the presence of toll fraud security hazard. Toll fraud is the unauthorized use of your telecommunications system by an unauthorized party (for example, persons other than your company's employees, agents, subcontractors, or persons working on your company's behalf). Be sure to read "Your Responsibility for Your System's Security" on the inside front cover of this book and "Security of Your System: Preventing Toll Fraud" in Appendix A, "Customer Support Information."

Related Documents

In addition to this book, the documents listed below are part of the documentation set. Within the continental United States, these can be ordered from the Lucent Technologies GBCS Publications Fulfillment Center by calling 1 800 457-1235.

Document No.	Title
	System Documents
555-66-100	<i>Customer Documentation Package</i> Consists of paper versions of <i>System Manager's Guide</i> , <i>Feature Reference</i> , and <i>System Programming</i> .
555-660-110	<i>Feature Reference</i>
555-660-111	<i>System Programming</i>
555-660-112	<i>System Planning</i>
555-660-113	<i>System Planning Forms</i>
555-660-116	<i>Pocket Reference</i>
555-660-118	<i>System Manager's Guide</i>
555-660-150	<i>Network Reference</i>
555-660-800	<i>Customer Reference CD-ROM</i> Contains <i>System Manager's Guide</i> , <i>Feature Reference</i> , <i>System Programming</i> and <i>Network Reference</i> .
	Telephone User Support
555-660-122	<i>MLX Display Telephones User's Guide</i>
555-630-150	<i>MLX-5D, MLX-10D, and MLX-10DP Display Telephone Tray Cards (5 cards)</i>
555-630-153	<i>MLX-28D and MLX-20L Telephone Tray Cards (5 cards)</i>
555-660-124	<i>MLX-5[®] and MLX-10[®] Nondisplay Telephone User's Guide</i>

Document No.	Title
555-630-151	<i>MLX-10 and MLX-5 Nondisplay Telephone Tray Cards (6 cards)</i>
555-630-155	<i>MLX-16DP Display Telephone Tray Cards (5 cards)</i>
555-660-120	<i>Analog Multiline Telephones User's Guide</i>
555-660-126	<i>Single-Line Telephones User's Guide</i>
555-660-138	<i>MDC and MDW Telephones User's Guide</i>
	System Operator Support
555-660-134	<i>MLX Direct-Line Consoles Operator's Guide</i>
555-660-132	<i>Analog Direct-Line Consoles Operator's Guide</i>
555-660-136	<i>MLX Queued Call Console Operator's Guide</i>
	Miscellaneous User Support
555-660-130	<i>Calling Group Supervisor's Guide</i>
555-640-105	<i>Data/Video Reference</i>
	Documentation for Qualified Technicians
555-660-140	<i>Installation, Programming, & Maintenance (IP&M) Binder</i> Includes: <i>Installation, System Programming & Maintenance (SPM), and Maintenance & Troubleshooting</i>
	Toll Fraud Security
555-025-600	<i>BCS Products Security Handbook</i>

How to Comment on This Book

We welcome your comments, both positive and negative. Please use the feedback form on the next page to let us know how we can continue to serve you. If the feedback form is missing, write directly to:

Documentation Manager
Lucent Technologies
211 Mount Airy Road, Room 2W226
Basking Ridge, NJ 07920

Read This First

1

This chapter includes important background information to help you understand the system manager function and how to use this guide.

After a brief overview, this chapter provides the following information:

- A description of system manager responsibilities
- A description of the planning forms that are the record of how your system is set up
- Information about upgrading the system
- A description of environmental requirements for correct and safe system operation

Overview

Although the MERLIN LEGEND Communications System is technologically sophisticated and offers state-of-the-art services, it is designed for ease of use and management.

Once Lucent Technologies personnel install and program the system, it should require only a little of your time. If you need to make changes to the system as business needs change, or if there is a problem with the system, you can use the system reference books and get assistance from Lucent Technologies personnel, as appropriate.

When you do need to perform simple system management tasks, there are several easy-to-use tools available to help you. For example, to program changes in the system, you can use a specially designated system telephone that has a display, or you can use a personal computer (PC).

Whether using a system telephone or a PC to program system changes, you simply make selections from menus; you don't have to remember any special commands or codes.

If you need detailed information or step-by-step instructions, the system guides clearly describe your choices.

Although the number of system reference guides may seem overwhelming at first, this book contains clear instructions on how to use those guides—how to quickly and easily find a solution or needed information when a problem or new business need arises.

There are also several features that can help you manage the system, for example, reports that provide information about how the system is set up, a record of all incoming and outgoing calls, and an error log that describes any system errors that occur. These reports can be viewed on screen or printed out.

If you run into a problem at any time while you are using or managing the system, there are experienced Lucent Technologies personnel who can provide information and instructions, including your local Lucent Technologies representative as well as the Lucent Technologies national technical support organization at the Lucent Technologies Helpline (1 800 628-2888; consultation charges may apply).

Using This Guide

This guide is specifically designed to help you fulfill your function as system manager.

To use this guide, you need little or no knowledge of the system and no particular technical experience or expertise. Also, wherever possible, the guide provides quick reference tables and illustrations, so that you don't have to wade through dense text to get the information you need.

This guide is loosely divided into two parts:

- The first four chapters provide information to help you understand the system, including its hardware components and features.
- The last four chapters specifically deal with managing the system, including how to perform the most common system management tasks and how to “troubleshoot” system problems, that is, what you can do on your own before you call Lucent Technologies for help.

You should scan the first four chapters now so that you have a general idea of how the system works. Then, if and when you need a stronger understanding about a particular aspect of the system or a common system management task, you can read that chapter or section more carefully.

Related Guides

Three categories of guides are available for the system:

- **User Guides and Operator Guides.** Each of these guides describes the use and features of a specific telephone or operator console.
- **System Reference Guides.** These guides provide detailed information about system features and capabilities:
 - *Feature Reference* contains information about features and applications.
 - *System Programming* includes detailed, step-by-step procedures to program the system.
- **Special Reference Guide.** For Release 6.0 and later systems (Hybrid/PBX mode only), the *Network Reference* provides detailed information about private networks made up of linked MERLIN LEGEND Communications Systems and/or DEFINITY Enterprise Communications Server/ProLogix Solutions systems. The features and system management issues associated with private networks are not discussed in the *System Manager's Guide*.



NOTE:

An additional guide, *System Planning*, contains information about completing the planning forms and is used mainly by Lucent Technologies personnel. *Equipment and Operations Reference* contains information about system equipment; it has not been updated since Release 3.0.

The *Feature Reference* and *System Programming* are essential when you perform the common system management tasks described in Chapter 6, "Managing the System," or when you otherwise modify the system as your company needs change and expand.

Both of these guides are described in Chapter 7, "Learning More," which helps you quickly find what you need in each guide.

Your Role as System Manager

As system manager, you coordinate the system to ensure the best possible benefit and performance for your company. Primarily, this involves acting as a contact for people using the system and for Lucent Technologies personnel, as well as making changes to the system as the needs of your company change or expand.

When the system is installed, experienced Lucent Technologies personnel complete all of the programming required to get the system up and running. But if and when you need to make changes to the system, you don't have to be an engineer, a programmer, or a telecommunications specialist. It is more important that you understand the needs of your company and the system's users.

If you like, you can use a personal computer (PC) to do the programming. Otherwise, you can use a system telephone, with a display, for most programming tasks. In both cases, menus guide you through the process. You don't need to remember any special commands or codes.

If you want more detailed instructions, you can use the step-by-step procedures in the system's manuals. The instructions are designed so that you can follow them easily. To quickly find the information or procedure you need, read Chapter 7, "Learning More," for descriptions of the system reference guides and how to use them. As a last resort, call the Lucent Technologies Helpline at 1 800 628-2888 (consultation charges may apply).

System Manager Responsibilities

Depending on the size and complexity of a system, more than one person may perform the system manager function. Lucent Technologies personnel carry out more complex tasks or help you through them.

Specifically, the responsibilities of the system manager may include the following tasks:

- Pre-installation
 - Ensuring appropriate selection of equipment and features by surveying your company's employees and providing the information to your Lucent Technologies representative
 - Helping develop a floor plan that illustrates where to install equipment
 - Participating in any training that your Lucent Technologies representative provides for you and telephone users
- Post-installation
 - Functioning as the in-house contact both for your system's users and for Lucent Technologies personnel

- Planning for and sometimes implementing system modifications that may become necessary as your company changes and grows
- Maintaining records of changes made to the system
- Preparing an updated in-house directory of telephone extension numbers
- Training new users
- Screening repair and/or operational problems or questions and reporting them, if necessary, to the Lucent Technologies Helpline (1 800 628-2888; consultation charges may apply)
- Maintaining the security of the system and overseeing features that help prevent fraud

The System Planning Forms

When a MERLIN LEGEND Communications System is installed and set up, Lucent Technologies personnel program it to function according to the options the customer selects and the features the customer needs. To make the programming process run smoothly, the Lucent Technologies personnel fill out and refer to planning forms that record all of the system's settings and features, those that affect the whole system and those that affect individual extensions. Lucent Technologies representatives use a book called *System Planning* as a guide when filling out forms at the time of an installation or upgrade.

After the system is installed and programmed, copies of these completed planning forms are available for you, as system manager, to use for reference and to update as you make changes to the system. The forms are a complete record of how your system is set up, so keep them in a safe place.

A list of the forms and a description of each form's purpose is in Appendix D. One of the forms, the Employee Communications Survey, is included in Appendix D. Use this form if you need to conduct a survey of your users' needs; for example, to plan system modifications as your company's needs expand.

If you have not received the completed planning forms for your system, contact your Lucent Technologies representative. If you need a blank set of forms, call the Lucent Technologies Customer Information Center at 1 800 457-1235.

Upgrading the System

There are two types of system upgrades:

- **Feature Upgrade.** To upgrade your system to the latest "release" or version as soon as it becomes available. With little or no changes in your existing equipment or wiring, your system can be easily adapted and expanded as your company's business needs change and grow.
- **Maintenance Upgrade.** To fix problems in the system.

In Release 3.0 and later, an upgrade basically involves inserting a memory card (similar to a computer diskette) into a slot on the system's processor or "brain" (part of the system's *control unit*). For a feature upgrade, you need a new memory card; for a maintenance upgrade, Lucent Technologies provides the memory card at no cost to you.

The memory cards are color-coded and have different titles to indicate their contents and function:

- **Feature Upgrade Memory Card.** Orange label with black bars; entitled *Forced Installation*. To upgrade your system to the latest release.
- **Maintenance Upgrade Memory Card.** Orange label; entitled *Upgrade Card*. To fix problems in the system.



NOTE:

A third type of memory card has a white label and is entitled *Translation Card*. This memory card is used to back up and restore your system programming as described in ["Backing Up the System" on page 6-39](#).

For more information about upgrading your system, contact your Lucent Technologies representative.

Environmental Requirements

The control unit requires a regulated environment that is temperature-controlled, clean, and not exposed to direct sunlight. In addition, proper power and grounding are essential for correct and safe system operation, and to protect the system against lightning, power surges, and other problems.

If the control unit and other system components were installed by qualified Lucent Technologies technicians, these requirements were met during installation.

After installation, you can help with the correct operation of the system by making sure the following rules are observed:

- The electrical outlet for the control unit must not be controlled by a switch. Plugging the control unit into an outlet that can be turned on and off by a switch invites accidental disconnection of the system.
- The AC outlet must be properly grounded by using an AC receptacle for a 3-prong plug.
- Do not install the control unit outdoors.
- Do not place the control unit near extreme heat (furnaces, heaters, attics, or direct sunlight).
- Do not expose the control unit to devices that generate electrical interference (such as arc welders, or the motors of air conditioners and ventilators, compressors, and so on).
- Each auxiliary power unit requires one outlet.
- Do not expose the control unit to moisture, corrosive gases, dust, chemicals, spray paint, or similar material.
- Do not place anything that could block ventilation on top of or around the carriers.
- Do not install the control unit under any device that may drip fluid, such as an air conditioner.
- For maintenance purposes, the control unit should be mounted in an accessible location. There should be sufficient room and lighting available to remove the cover(s) and replace modules without moving furniture, boxes, or other objects.

For more information, contact your Lucent Technologies representative.

About the System



This chapter provides a general overview that introduces all of the major aspects of the system and its operation, including:

- Trunks
- Modes of operation
- System components
- Features
- Applications
- Programming the system
- System capacities
- Auxiliary components
- Data communications capabilities



NOTE:

Release 6.0 and later systems (Hybrid/PBX mode only) support private connections between MERLIN LEGEND Communications Systems and DEFINITY Enterprise Communications Server (ECS) or DEFINITY ProLogix Solutions systems using private networks or the public switched telephone network. This aspect of the system is not covered in this guide. For complete information, see the *Network Reference*.

More information about specific system topics is included throughout the guide. The *Feature Reference* and *System Programming* provide detailed information.

Many of the principles of telephone communications have not changed since Alexander Graham Bell made the first phone call in 1876. Because learning about these concepts helps explain how the system works, this chapter begins with some background information about telephone communications. For a more detailed history and description, see Appendix B, "About Telecommunications."

If you are already familiar with the concepts described in this chapter, you can skip the chapter.

Background

Alexander Graham Bell and his assistant, Thomas A. Watson, demonstrated the first working model of a telephone on March 10, 1876. Bell made the call from a transmitter in one room to a receiver a few rooms away.

The first telephone installations were set up like that first call, as direct connections between one telephone and another. When more and more telephones were installed, it quickly became impractical to have every phone connected directly to every other phone. Thus, the concept of *switching* developed, that is, all telephones connected physically to all other telephones, but each telephone could make the electrical cross-connection between itself and another phone so that the caller was connected to the called party.

Again, as more and more telephones and lines were installed, it became impractical to have each telephone perform this switching function, so all lines from all phones were brought into a common place, called a *central office (CO)* or *exchange* (see [Figure 2-1](#)) where human operators switched calls at switchboards. This 2-way connection between the telephone and the CO was (and still is) called the *local loop*. Eventually, more and more COs were created and interconnected, until the current global telephone network evolved (see [Figure 2-2](#)).

As geographic areas expanded and the global telephone network evolved, and as technological advances became available, switches also evolved and are now fully automatic and controlled by computers.

There are now also private switches that, rather than being located at the telephone company's CO, are located on a company's premises. These systems, called *private branch exchanges (PBXs)*, made sense because most of a business' calls are between telephones on site within the company.

The MERLIN LEGEND Communications System includes such a switch, located on a company's premises, that offers access to even more powerful telephone network applications and services. It can operate as a PBX (*Hybrid/PBX mode*) or can be set up to operate in one of two other modes that define how the system works. The system can also use state-of-the-art telephone equipment.

The next sections briefly describe the evolution of telephone equipment and switching. For more information, see Appendix B, "About Telecommunications."

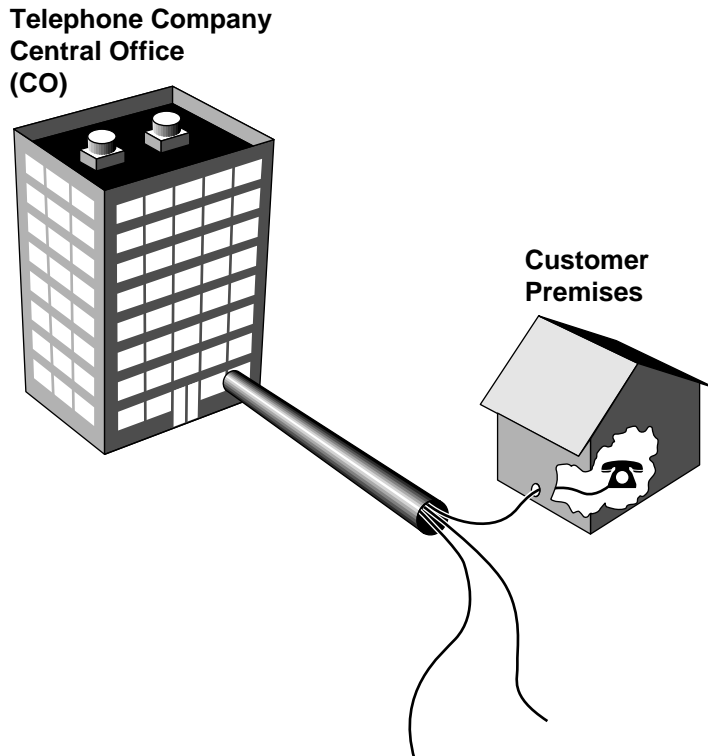

Figure 2-1. The Local Loop

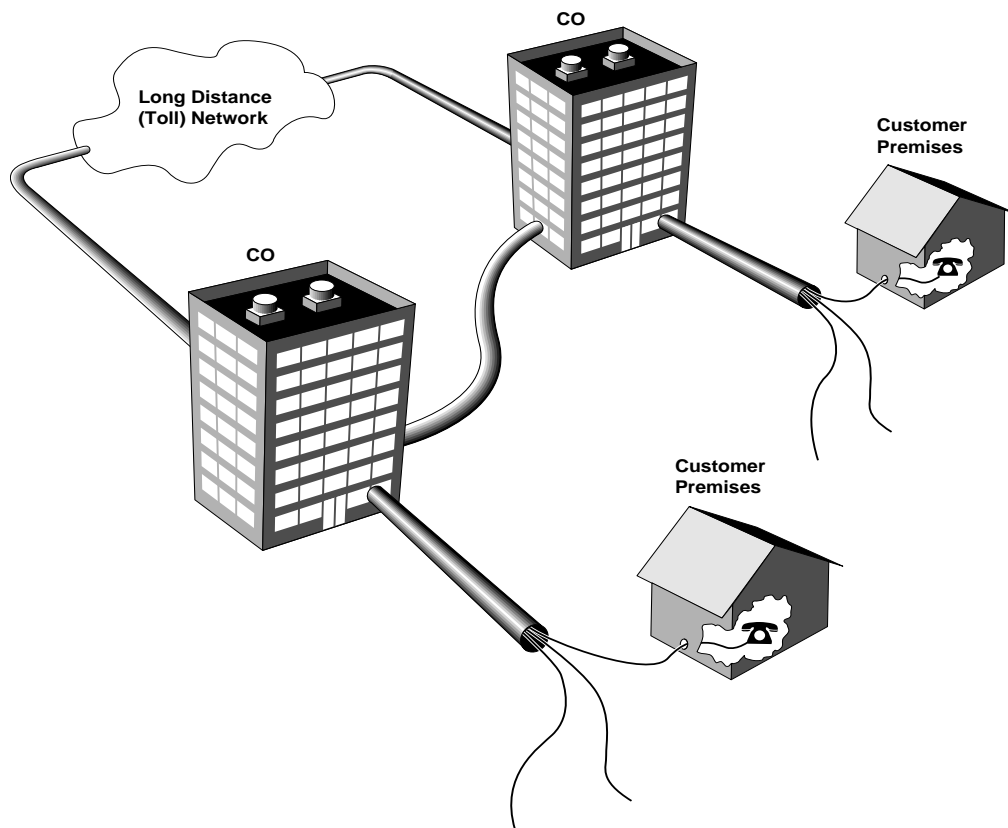

Figure 2-2. The Telephone Network

Telephone Equipment

The first working model of a telephone consisted of a microphone (called a *transmitter*) and a small loudspeaker-like device (called a *receiver*) connected by a pair of wires and a battery.

A telephone is powered by *direct current* (*dc*) which, in early phones, was supplied by a battery inside the phone. Beginning in 1894, COs used a common battery to power all the telephones connected to the exchange.

The receiver for early telephones hung on a hook that activated a switch to control the flow of direct current to the telephone. This hook was called a *switchhook*, a term that is still used today. When a telephone handset is sitting on its cradle (*on-hook*), it draws no current from the CO. When a person removes the handset from the cradle (*off-hook*), current flows and signals the CO that the caller is requesting service.

Similarly, the CO signals the called party by sending current to his or her phone, causing it to ring. When the called party lifts the handset from its cradle, the current flows, indicating to the CO that the party has answered.

Bell realized that a caller needed a way to signal the other person to pick up the phone. After experiments with various bells and buzzers, in 1878 Bell's assistant Watson developed a bell ringer operated by a hand crank.

When human operators handled switching, the caller used the telephone's hand crank to ring the operator, and then told the operator the name of the person he or she wanted to reach. If the called party was available, the operator connected the two parties by using a cord that had plugs at each end. Each plug had parts called a *tip* and a *ring* that functioned as conductors to complete the electrical circuit. The operator connected the two parties by plugging in one end of the cord into the caller's connector (called a *jack*) on the switchboard, and the other end of the cord into the called party's jack.

Once automatic switches were in place, telephone companies assigned numbers to telephone service subscribers, and a dialing mechanism was built into the telephone. The caller identified the called party to the switch by dialing the called party's number.

Telephone users originally dialed numbers by using a mechanical device called a *rotary dialer*. A spring wound up when turned in one direction and, on its return to normal position, caused interruptions in the flow of current, thus creating dial pulses recognized by the switch. The subsequent development of the touch-tone dialer provided a further innovation: the creation of unique tones produced by simply pressing buttons on the dialpad.

Although there are still some rotary-dial telephones in use, most modern telephones have touch-tone dialing, which is faster and, with the advent of services available from touch-tone phones, more versatile.

The terms *tip* and *ring*, however, still describe any telephone equipment that involves only one line, for example, a single-line telephone (such as those in most homes), an answering machine, or a fax machine. These are referred to as *tip/ring (T/R)* devices.

You can use several different types of telephones with the MERLIN LEGEND Communications System, including single-line telephones, analog multiline telephones, and MLX digital telephones. The terms *analog* and *digital* refer to the type of signal the telephone produces:

- **Analog Signal.** A signal that represents a range of frequencies, that is, continuously variable physical qualities such as amplitude; for example, the human voice.
- **Digital Signal.** Information transmitted in a coded form (from a computer) represented by discrete signal elements; for example, off and on or zero and one.

Switching Equipment

As described earlier, the telephone network is composed of a number of centralized switching locations, called *central offices (COs)*, where a telephone circuit is connected, or switched, to another circuit. That is, the caller's line is connected to the called party's line so the two can hold a conversation.

Telephone operators, who supplied the first manual switching, were slow and costly but afforded some special functionality: calls could be forwarded, messages taken, and calls interrupted. Electromechanical switching automated that manual labor and made telephone service universally affordable, but the technology was inflexible and did little more than switch calls. Now, with electronic, computer-controlled switches, both flexibility and functionality are affordable for everyone.

The Evolution of Switches

The method, type, capabilities, and capacities of switches have evolved as geographic areas expanded and technological advances became available. The following list describes each of these progressive innovations. [Figure 2-3](#) illustrates this evolution of switching equipment.

- **Private-Line Service.** In the first telephone installations, communication was directly from one telephone to another, as in Bell's demonstration. Thus, one telephone could communicate with only one other telephone.
- **Party-Line Service.** Several telephones were connected to one line so that a number of people could communicate in the same conversation. But there was no way to reach a telephone on any other line.
- **Station Switching.** All telephones were connected to all other telephones. The telephone itself performed the switching and made the connection. This was workable for a small number of telephones, but quickly became impractical as hundreds of telephones were installed.
- **Centralized Switching.** As the number of telephones grew, all the lines from all the telephones came to a common *central office (CO)* or *exchange*, so that the lines could be electrically cross-connected. Human operators made the connections.

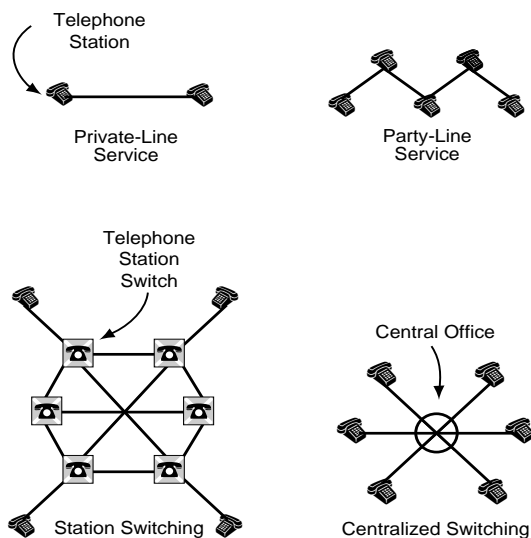

Figure 2-3. The Evolution of Switches

Eventually, as more and more COs were created, a hierarchy of special *switching offices* (SOs) connected the COs locally and then between cities and countries for long-distance (toll) *switching*. The dedicated lines between COs were called *trunks*.

The following list provides an overview of the hierarchy of switching offices. [Figure 2-4](#) illustrates the hierarchy.

- **Level 1: Trunking between COs.** The first level in the hierarchy consists of local COs with direct trunk connections between them. This is referred to as the *local CO network*. The customer premises served by each CO can be a residence with a single phone line or a business with a customer premises switch such as the MERLIN LEGEND Communications System.
- **Level 2: Switching between Tandem (Intermediary) SOs.** When the traffic between two COs exceeds the amount that direct trunking can efficiently and cost-effectively serve, the COs are each connected to a third switching office (SOs) that functions as an Intermediary. This is referred to as the *public tandem network*.

- Level 3 and Above: Switching among All SOs.** To ensure that there is a communications path from each SO to any other SO, ever-increasing levels of SOs combine larger and larger geographical areas. This is referred to as the *toll network* and comprises national and international service.

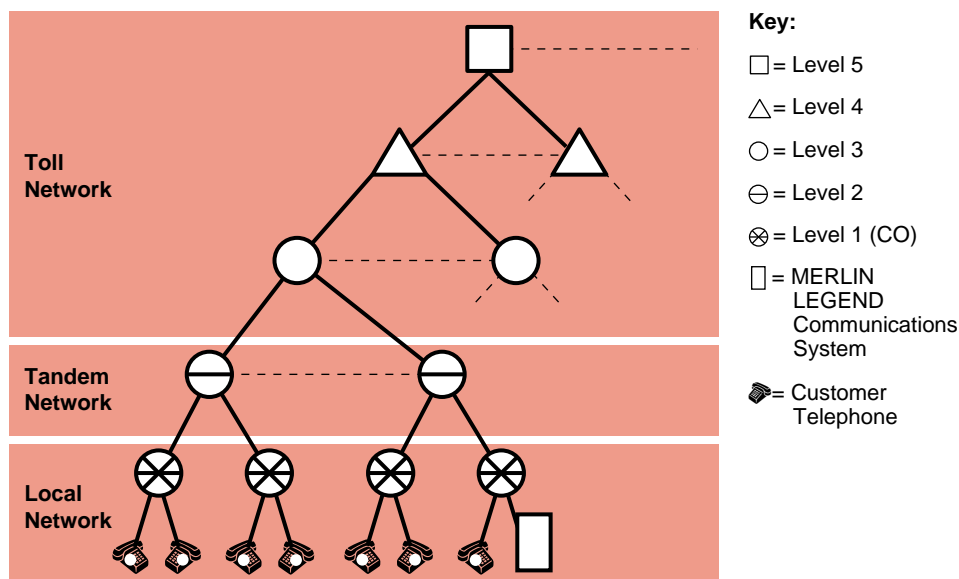

Figure 2-4. The Switching Office Hierarchy

Today, a local area within which there is a single, uniform set of charges for telephone service is called a *local exchange area*. A number of COs may serve a local exchange area, and a call between any two points within an exchange area is a local call. A toll call is a call made to a point outside the local exchange area and includes service through the switching office hierarchy.

Switching Methods

For the first few decades of telephone service, human operators manually switched calls and made the actual connections of circuits. They made the connections at switchboards by using cords that had plugs at each end. Approximately 120 lines terminated at answering jacks on an operator's switchboard. In turn, each operator had 18 cords for making connections.

When a telephone service subscriber made a call, a lamp lit at his or her jack, telling the operator that the person on that line desired service. The operator connected to the subscriber's jack, and the calling party would then give the name (and later, the telephone number) of the party he or she was calling. Then the operator completed the call (that is, completed the circuit) by connecting the cord to one of perhaps 10,000 subscriber jacks within reach. When the call was over

and the parties had hung up, the lamp associated with each connecting cord would go out and the operator knew that the call was complete and the cord could be removed.

The first automatic switch was invented in 1892 by Almon B. Strowger, an undertaker who realized that his competitor was getting all the undertaking business in the town, referred by the town telephone operator—who was also the competing undertaker's wife! The Strowger switch was an electromechanical device controlled by the caller's telephone (*station switching*).

Strowger's switch was adapted for use in the Bell System in 1919. It was noisy and not very flexible at offering new services but, because it was more cost-effective than human operators, it was directly responsible for making telephone service affordable and universal.

In 1938, the Bell System developed and installed the next innovation in electromechanical switching, and it is still in use in some areas today. It had fewer switches, a sophisticated control mechanism, and lower maintenance. However, like its predecessor, it was not flexible because it couldn't be programmed.

It was, therefore, a natural progression that led to the idea of using a computer, with its inherent programmable flexibility, to control the switching operation. This new generation of switching technology was called an *electronic switching system* (ESS). With ever-increasing innovations in technology (beginning with the AT&T No.1 ESS first installed in 1965), the Lucent Technologies 5ESS[®] digital switching system handles 100,000 lines and 650,000 telephone calls per hour. The newer digital switching systems also interface easily with high-speed digital trunks.

As mentioned earlier, the MERLIN LEGEND Communications System is a switch located on a company's premises, providing access to powerful features and advanced telephone network applications and services.

System Overview

The MERLIN LEGEND Communications System can handle voice and data simultaneously over the same lines, and voice features can enhance the use of data communications. The system accommodates businesses with needs ranging from a few telephones to over 100 telephones. Its modular design allows easy expansion.

Many of the terms and concepts introduced in the beginning of this chapter are used in the system. As illustrated in [Figure 2-5](#), the system allows the connection of incoming trunks from the telephone company's central office (CO), connected through the system's *control unit* to telephones and other system equipment, for example, a PC or fax machine.

There are various types of trunks that provide different functionality. Likewise, a variety of telephones and other equipment can be connected to the system. Depending on the trunks and the telephones and other equipment selected, a wide array of features and add-on products (*applications*) can function according to the needs of your company.

The rest of this chapter provides an overview of each primary system aspect:

- Incoming trunks
- Modes of operation
- System components
- Line/trunk and extension modules
- Features
- Applications
- Programming the system
- System capacities
- Auxiliary components
- Data communications capabilities

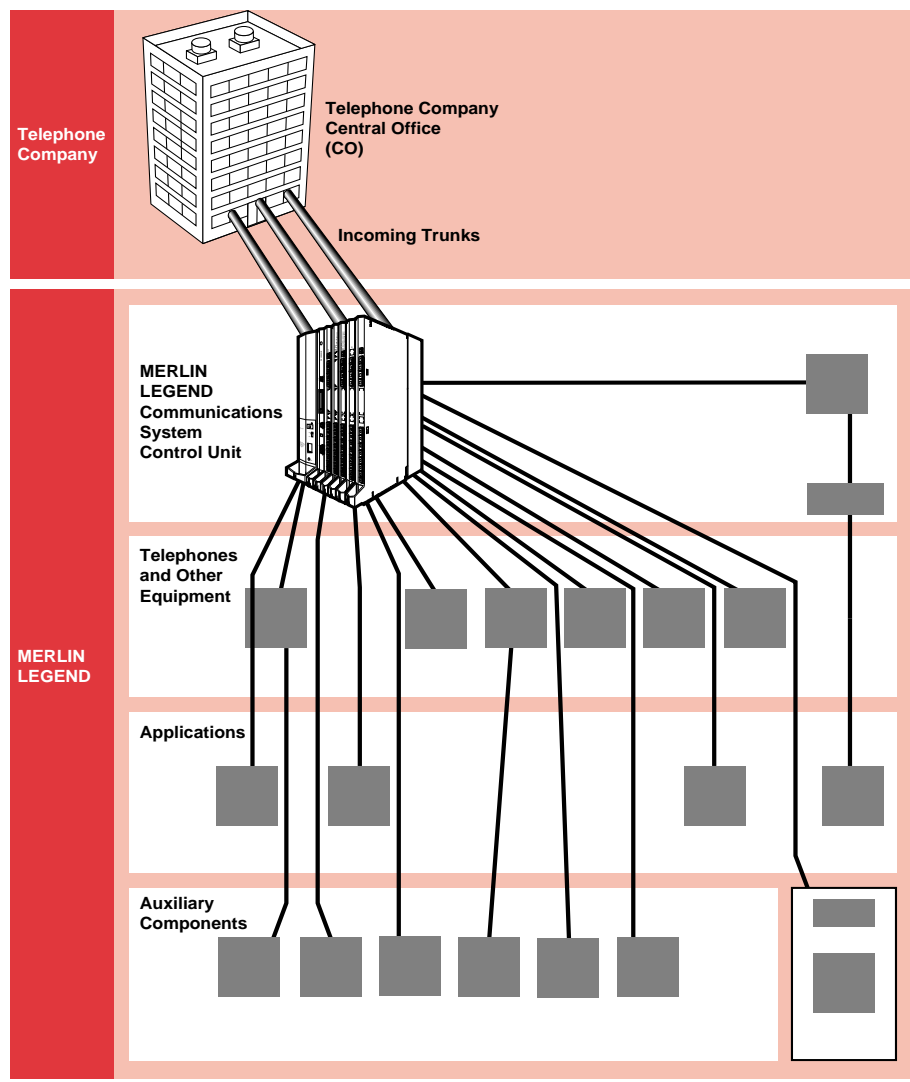

Figure 2-5. System Overview

Incoming Trunks

Trunks are the telephone company's facilities, provided by the central office (CO) to carry voice or data communications (see [Figure 2-6](#)). There are a variety of trunks, each with different capabilities. These types have evolved over the years as technology has advanced and customer needs have expanded.

The decision concerning the type of trunks chosen for your company's system depends primarily on your company's needs. Other factors include cost (due to differing capabilities, the use of some trunks is more expensive than others), and availability (some of the advanced trunks are not available everywhere).

Your company chooses trunks before the system is installed. A Lucent Technologies representative works with you or your company's representative to identify needs and, therefore, the appropriate type and number of trunks. When the Lucent Technologies representative places the order for the system equipment, she or he also contacts the local telephone company and arranges for the trunks.

Depending on the trunk type and what the CO can provide, a variety of services is available, for example, incoming and outgoing WATS (INWATS and OUTWATS).

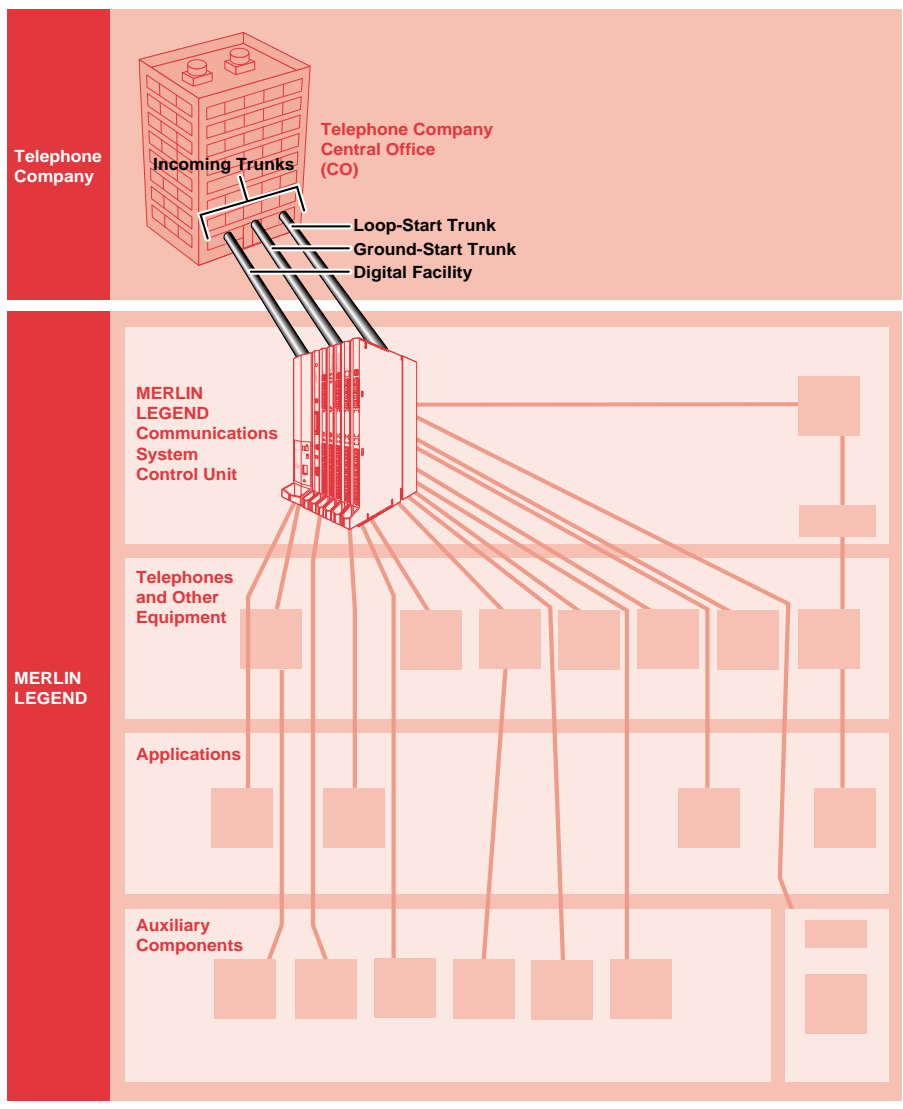

Figure 2-6. Incoming Trunks

The types of trunks are:

- **Loop-Start Lines** (Incoming and Outgoing Calls). Provide incoming and outgoing calls and are intended primarily for single-line telephones and older PBXs. They are the simplest (often the least expensive) and most common facilities in the nationwide telephone network. Although they are not appropriate for some situations, they are necessary for others (for example, some caller identification services).
- **Ground-Start Trunks** (Incoming and Outgoing Calls). Provide a signal at the beginning and end of incoming and outgoing calls to determine the availability of a trunk before the CO routes an incoming call on it. Also, when either the caller or the called party hangs up, the entire circuit is disconnected and dropped. These trunks were introduced to solve the problems that PBXs encounter on loop-start trunks (namely, glare and unreliable disconnect), as described in the Introduction booklet.
- **Tie Trunks**. Private lines that directly connect two communications systems. Using a tie trunk, a user on one system can call an extension on another system by dialing an access code and the extension number or simply the extension number. In Release 6.0 and later systems (Hybrid/PBX mode only), tandem tie trunks, either analog or T1-emulated, can be used for networking. In this case, the user dials only the non-local extension number without an access code. For more information, see the *Network Reference*.

In more complex tie trunk configurations, a person can tie into another system and use a trunk that does not exist on his or her own system. For example, in a company with locations in New York, Chicago, and Los Angeles (with tie trunks between New York and Chicago, and Chicago and Los Angeles), users in New York can access a Los Angeles trunk and make a local call as if they were in Los Angeles themselves.

- **Direct Inward Dial (DID) Trunks** (Incoming Calls Only). Provide fast access to specific individuals; incoming DID calls can be routed directly to an extension or calling group without system operator assistance.
- **Digital Facilities**. MERLIN LEGEND supports two different types of digital facilities: Digital Signal 1 (DS1) and, in Release 4.0 and later systems, National Integrated Services Digital Network 1 Basic Rate Interface (abbreviated *NI-1 BRI*) facilities. T1, PRI, and BRI are the system's interfaces to these Integrated Services Digital Network (ISDN) facilities, which provide end-to-end digital connectivity and switched connections to other networks. All three interfaces allow high-speed data transfer.
 - **National Integrated Services Digital Network 1 Basic Rate Interface (Incoming and Outgoing Calls)**. One NI-1 BRI facility carries the equivalent of three "lines." Two are called *B-channels* and provide voice and data communications services. A third D-channel controls signaling and maintains operations on the B-channels.

— **Digital Signal 1 Facility Programmed for Either T1 or Primary Rate Interface Operation** (Incoming and Outgoing Calls). One Digital Signal 1 (DS1) facility provides the equivalent of 24 lines, called *channels*. In Release 4.0 and later systems, the DS1 facility can be programmed to operate in one of three ways:

- **T1 Voice Operation.** A “line” can be programmed through the system, without the services of a telephone company installer, to emulate a ground-start, loop-start, tie, or DID trunk. This type of T1 operation also gives you access to special services, such as inbound 800 or WATS service for incoming, toll-free service for voice calls. Only this type of T1 operation is available in releases prior to Release 4.0.



NOTES:

1. While you can quickly and easily change the type of line that a channel imitates, you must coordinate the change with the T1 provider so that both ends of the connection are set up for the same type of line/trunk.
2. In Release 6.0 and later systems (Hybrid/PBX mode only), tandem PRI lines can be used for networking. In this case, you order a T1 facility and program it for PRI operation. For more information, see the *Network Reference*.

- **T1 Data Operation.** Available in Release 4.0 and later systems, T1 data operation allows high-speed data communications over the public switched network; this is called *T1 Switched 56 service*. It also provides data tie “lines” to connect one MERLIN LEGEND Communications System to another or to a DEFINITY system. A T1 data-operation “line” is a *channel*.
- **Primary Rate Interface (PRI) Operation.** The 24 “lines” include 23 B-channels. Each B-channel can dynamically provide voice and data services; one D-channel carries signaling information for the B-channels.



NOTE:

Facility is a general term that designates a communications path between a telephone system and the telephone company central office. Specifically, we refer to digital facilities (sometimes called *pipes*). Technically, a *trunk* connects a switch to a switch, for example, the MERLIN LEGEND Communications System to the central office. Technically, a *line* is a loop-start facility or a communications path that does not connect switches, for example, an intercom line or a Centrex line. However, in actual usage, the terms *line* and *trunk* are often applied interchangeably. In this guide, we use *lines/trunks* and *line/trunk* to refer to facilities in general. We also use specific terms such as *personal line*, *ground-start trunk*, *DID trunk*, and so on. When you talk to your local telephone company central office, ask them which terms they use for the specific facilities they connect to your system.

Modes of Operation

The system's mode of operation determines the following:

- The types of outside trunks that can be connected to the system
- How users access outside trunks
- The types of system operator consoles that your business can use
- The features and applications that your business can use and how they work
- How the system is registered with the Federal Communications Commission (FCC)

The choice of system mode depends on your company's needs. Your Lucent Technologies representative and you or your company's representative decide on the system mode when you plan and purchase your system. Lucent Technologies personnel then set the mode when they install the system.



CAUTION:

Because the operating mode significantly affects how the system works, you should know the mode in which your system is configured. You can either check the Planning Forms (Form 1, Page 2, System Mode) or contact your Lucent Technologies representative.

The system operates in one of three modes:

- **Key Mode.** The simplest way to provide people with more than one line from a telephone. Easy to use. Recommended for smaller systems.
- **Hybrid/PBX Mode.** Especially useful where toll fraud/security are a concern. Provides cost-effective call routing, especially useful for special-purpose network services. Recommended for medium to larger systems.
- **Behind Switch Mode.** Used when the system is connected to a system such as DEFINITY. May be appropriate for users who are part of a large organization, for example, a department within a company.

While Key mode is appropriate for smaller systems and has the capacity limitations of any key system, the MERLIN LEGEND Communications System, unlike other key systems, is flexible and allows you to expand to a PBX system when your business outgrows Key mode. [Table 2-1](#) outlines the primary differences among the modes. ["Line Buttons on Multiline Telephones" on page 3-25](#) describes Shared Access (**SA**) buttons and Intercom (**ICOM**) buttons.

Table 2-1. Modes of Operation

	Key Mode	Hybrid/PBX Mode	Behind Switch Mode
Description	Telephones have multiple buttons (or keys) labeled with telephone numbers. Every button corresponds directly to an outside line. Different buttons (ICOM buttons) are used for inside calls.	Outside trunks are grouped in pools for shared use; the system automatically selects an available outside trunk. People use the same button to make both inside and outside calls.	Used when the system (called the local system) is connected to a larger PBX or Centrex system (called the host system). One outside line (a prime line) is assigned to each telephone. The host system provides the interface to outside lines and some features.
Types of Trunks	Ground-start Loop-start Tie DS1 (T1 only) BRI	Ground-start Loop-start Tie DS1 (PRI and T1) DID BRI Private network trunks (Release 6.0 and later)	Ground-start Loop-start Tie
Number of Extensions:			
Fewer than 50	Good	Good	Good
More than 50	Not recommended	Good	Good up to 80
Types of Buttons	A line button for each outside line. Up to 10 ICOM buttons for inside calls.	Up to 10 SA buttons. Pool button to access a specific pool. (Optional) A personal line button for dedicated use of a specific outside trunk.	For multiline phones: Multiple prime line buttons. Up to 10 ICOM buttons.
User Access to Outside Lines/Trunks	Choosing a specific line button	Dialing a code (usually 7) from an SA button	Dialing the host system's dial-out code (usually 7) from a prime line button
Types of Operator Console(s)	DLCs only	DLC, QCC, or a combination of both	DLCs only
Recommended Use	Smaller systems (fewer than 50 extensions)	Medium to larger systems (more than 50 extensions)	For users who are part of a large organization, for example, a department within a company or companies which subscribe to Centrex services for most features

Continued on next page

Table 2-1. Continued

	Key Mode	Hybrid/PBX Mode	Behind Switch Mode
Comments	<p>All users need multiline phones.</p> <p>Line assignments can be customized by phone or groups of phones. For example, you can assign tie trunks only to the telephones where they are needed.</p>	<p>Provides the most efficient use of outside trunks. The Automatic Route Selection (ARS) feature can be programmed for the cost-effective use of pools and the greatest protection against toll fraud. Provides greater functionality for single-line phones than other modes. Fewer line buttons required for users.</p>	<p>Users can have access to most features of both the local system and the host system. Single-line phones can be used.</p>

Components

The system includes the following components:

- **Control Unit.** The circuitry that manages the switching activities of the telephone company's trunks and your system. It consists of *carriers* into which *modules* (circuit packs) are inserted. The module types include a *processor module* (the "brain" of the system), a power supply module, and a variety of line/trunk or extension modules with jacks for connecting the incoming trunks and the extension lines. The following section explains line/trunk and extension modules in more detail.

A plastic cabinet (the cover) protects the control unit.

- **Telephones.** Single-line, cordless, cordless/wireless, and analog multiline telephones, as well as digital MLX telephones that offer a variety of features and advanced capabilities. Most MLX telephones have displays that show call information, list features for using the telephone, and provide menu-driven programming instructions. MLX telephones include the following: MLX-5, MLX-5D, MLX-10, MLX-10D, MLX-10DP, MLX-16DP, MLX-20L, and MLX-28D.
- **System Operator Consoles.** Telephones programmed to handle a variety of operator functions. Types of consoles include:
 - **Analog or MLX Direct-Line Console (DLC).** Outside lines are assigned to individual buttons, and the console can have several calls ringing at the same time. Only certain MLX telephones and analog multiline telephones can be used as DLCs.

— **MLX Queued Call Console (QCC)**. Available only in Hybrid/PBX mode. Incoming calls wait in a queue for the operator and reach the QCC on a first-in, first-out basis, according to the call priority level assigned through system programming. Only one call rings at a time.

The MLX-20L telephone is the only telephone that can be assigned through system programming to function as a QCC. The buttons on the QCC are factory-set with fixed features.

The type of console used depends on the company's needs and the system's mode of operation, as described earlier in this chapter.



NOTE:

One or two Direct Station Selector (DSS) adjuncts can be added to an MLX console to provide 150 or 300 additional extension buttons. The analog System Display Console has 40 built-in DSS buttons and provides access to three pages of extensions, for a total of 120.

- **Auxiliary Components.** Adapters for connecting extra equipment and the adjuncts that add features to the system or extensions. Some adjuncts are: loudspeaker paging systems, headsets, fax machines, and modems. Other add-on components are optional accessories, for example, surge protectors that protect the equipment from lightning and power surges.

[Figure 2-7](#) illustrates some of the components of the system. [“Auxiliary Components” on page 2-26](#) and Chapter 3, “System Components,” include additional information. For more information or to order any of the components, contact your Lucent Technologies representative.

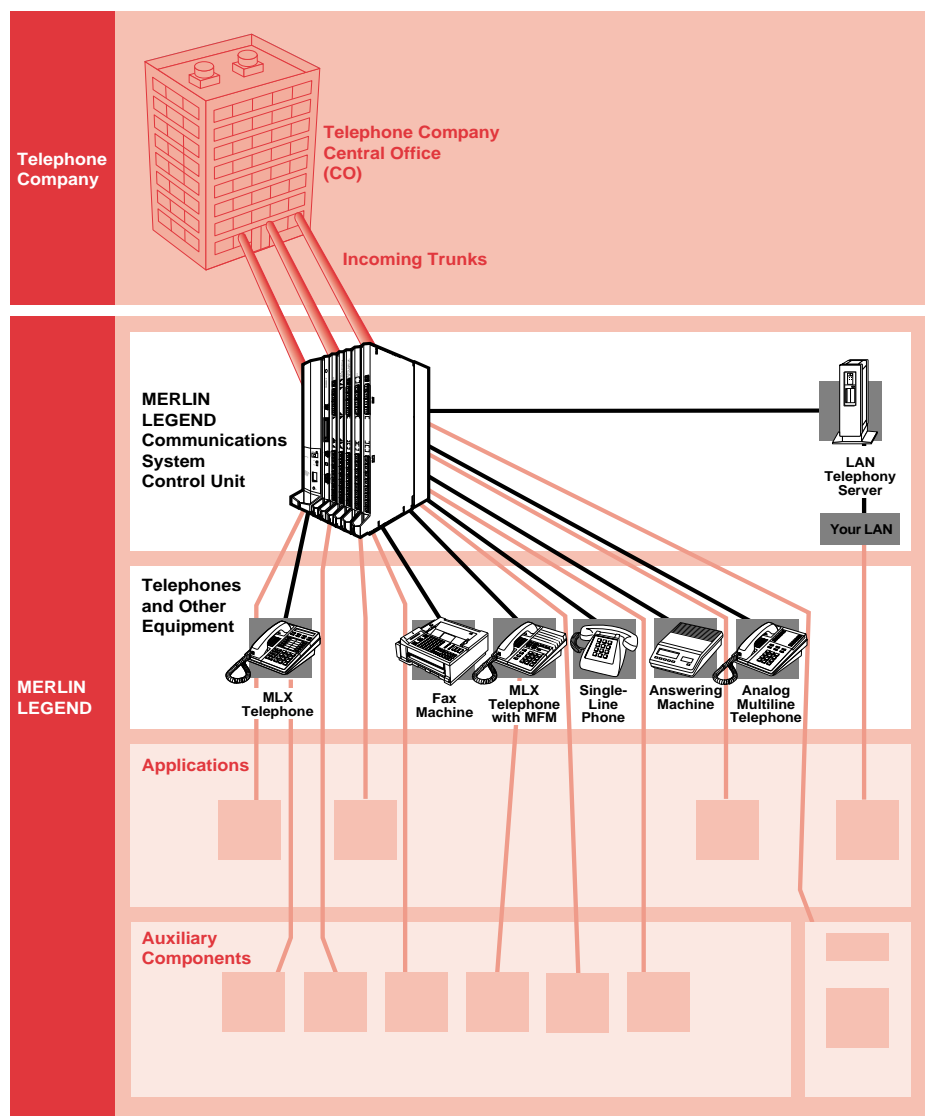

Figure 2-7. System Components

Line/Trunk and Extension Modules

The line/trunk and extension modules inserted into the control unit have jacks for connecting CO trunks and system telephone wires to the control unit.

A system with a basic carrier has five slots for modules. Up to two expansion carriers can be added, each one providing six slots for modules.

The system supports 17 different types of modules that vary in the types of lines/trunks that they support and the types of telephones or other equipment that can be connected to them.

The names of the modules identify their capacities and capabilities. The first digit tells you the number of line/trunk jacks a module supports, while the last two digits describe the number of extension jacks it supports. Following the number may be letters that indicate the type of trunk it supports, that is, *LS* for *loop-start* and *GS* for *ground-start*; if the number indicates line/trunk support and no letters follow, the module supports loop-start trunks. For example, the 408 GS/LS MLX module provides four line/trunk jacks and eight MLX extension jacks, and supports ground-start and loop-start trunks (see [Figure 2-8](#)).

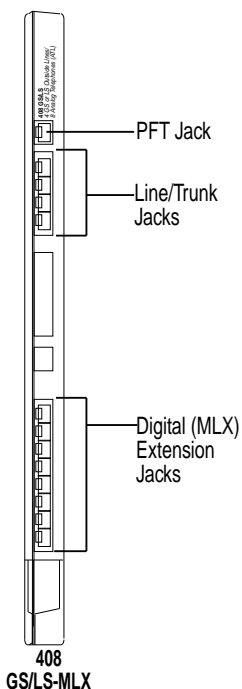

Figure 2-8. 408 GS/LS-MLX Module

Features

The versatility and power of the system are due, in large part, to the variety of feature settings and services it can provide.

Features include traditional items (Transfer and Call Waiting), as well as advanced features (Coverage and Park).

Some functions can be performed in several ways. For example, the system offers a variety of ways to provide call coverage. You therefore choose and set up features according to your specific business needs.

Chapter 4, "Features and Applications," provides additional information about features. The *Feature Reference* provides detailed information, including interactions of features.

Applications

Numerous add-on products (*applications*) are available to enhance the system, including:

- Voice messaging systems answer incoming calls, provide callers with a menu of choices, such as people or departments, and then transfer the call as prompted by the caller using a touch-tone phone. Voice messaging systems may or may not include voice mail services, described below.
- Voice mail services enable system users, for example, to send voice messages to other users, forward voice messages with comments, and return a call.
- Fax messaging services automate the sending, receiving, call-handling, and storage of faxes, in much the same way voice messaging systems handle voice messaging.
- Call accounting applications manage telephone usage by tracking and sorting telephone costs and producing reports on costs.
- A call management application answers and distributes calls to members of a specified group, for example, ticketing agents.
- PassageWay Direct Connection Solution provides an interface between an extension and a PC with Microsoft® Windows®, as well as providing utilities and allowing the integration of Windows applications with telephone activities.
- In Release 5.0 and later systems, the CTI link hardware/software feature is available as part of the Lucent Technologies PassageWay Telephony Services product. It works with Novell NetWare LANs (local area networks) to support LAN applications on Windows 3.1, Windows 95, Windows for Workgroups 3.11, Windows NT, Apple® Macintosh® OS, and UNIX® System clients.



NOTE:

A CTI link is not compatible with all Macintosh OS and UNIX System clients, which must support private data in order to function with the feature. For additional information, consult the *PassageWay Telephony Services Network Manager's Guide*.

- Group and personal videoconferencing and data exchange applications allow multimedia interaction among people who work together but are geographically distant.

In addition, the system provides support for special services, such as Centrex, Basic Rate Interface (BRI), and Primary Rate Interface (PRI).

[Figure 2-9](#) illustrates some of these applications.

Businesses can purchase some applications separately; others are integrated to have a common interface. Most have settings that you can easily customize to suit your company's needs. Some require additional hardware.

In Release 5.0 and later systems, a bridge to PC applications is available: the Computer Telephony Integration (CTI) link or *CTI link* (part of the PassageWay Telephony Services product from Lucent Technologies) for local area networks (LANs). The connection is made through a programmed MLX extension jack. The link allows calls on **SA** buttons to be monitored and controlled from workstations connected on a LAN to a server running Novell NetWare software. The link supports applications such as power dialing for telemarketing salespeople and pop-up database information about a caller (screen-pop applications that use the caller's telephone numbers must be combined with Caller ID services through PRI, NI-1 BRI, or a local service provider via the system's 800 GS/LS ID module). For more information, see ["CTI \(Computer Telephony Integration\) Link" on page 5-23](#) or consult your Lucent Technologies representative.

Chapter 4, "Features and Applications," includes an overview of available applications. Of course, the documentation provided with the product is the most authoritative. Once you have reviewed this material and found an application that seems to fit your needs, contact your Lucent Technologies representative to order the product or discuss it further.

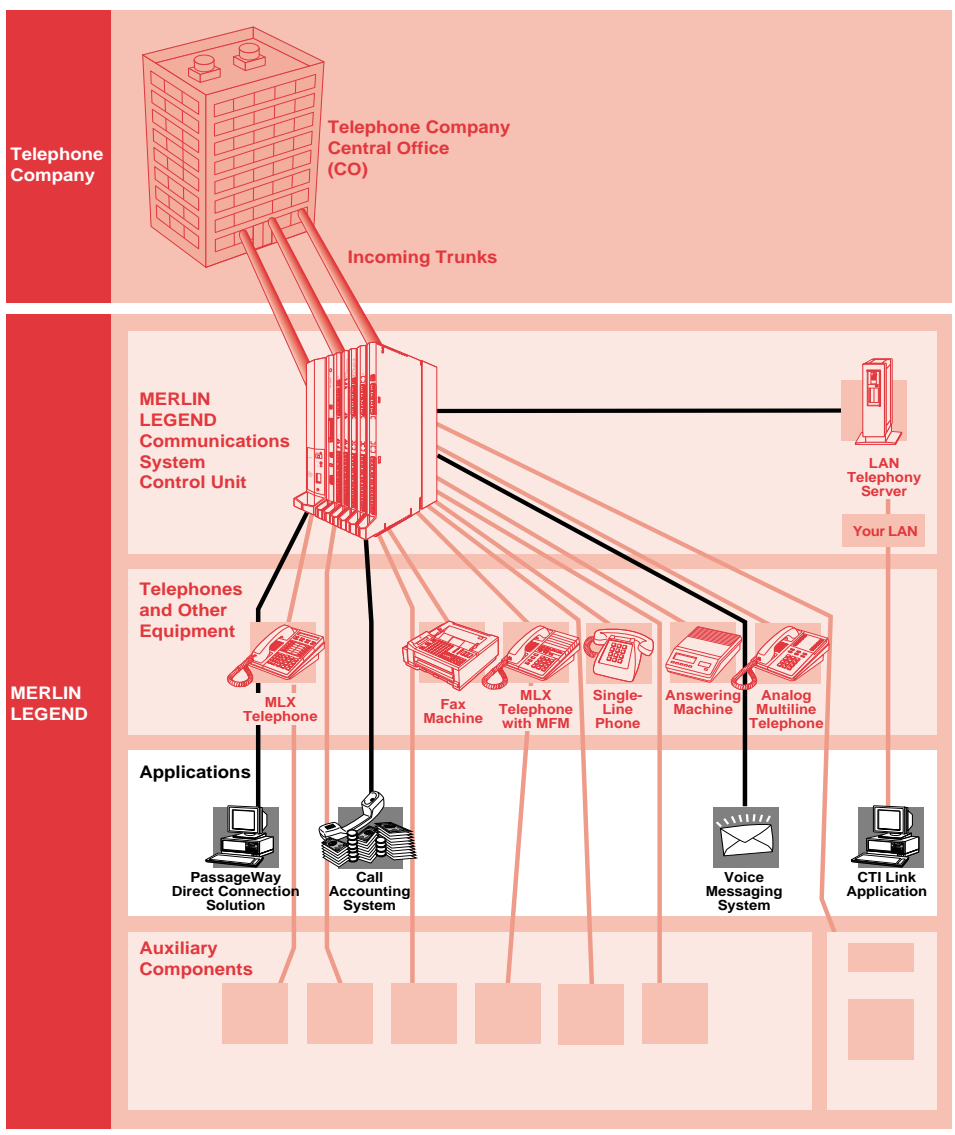

Figure 2-9. Applications

Programming the System

System installation includes programming features, settings, and options selected by you or a representative from your company.

Depending on the feature, either you, as system manager, or a person at his or her extension can make changes to features:

- **System Programming.** Used to program systemwide or group features. A Lucent Technologies technician can also do system programming. You use one of the following:
 - An MLX-20L telephone, referred to as the *programming console*
 - A PC with System Programming and Maintenance (SPM) software, reaching the system in one of three ways: a direct connection between the PC and the system's control unit, an on-site or *local* modem connection to the modem in the control unit, or an off-site *remote* modem connection.
- **Extension Programming.** Can be performed in two ways:
 - **Centralized Telephone Programming.** You program at the programming console.
 - **Telephone Programming.** Either you or the user programs at a specific telephone.

When programming at an MLX telephone or PC, you work with features and options from screen menus. You simply select an item from the menu and enter settings as desired.

System Capacities

The system can support up to 80 line/trunk jacks, 72 of which can actually be B-channels supplied on 100D modules or 800 NI-BRI modules (Release 4.0 and later systems).

The maximum number of extensions depends on the type of equipment included in the system. In theory, you can connect as many as 255 extensions, but this, in fact, is not practical. In Release 4.0 and later systems, a higher-capacity tip/ring (T/R) extension module, the 016, allows the system to support as many as 200 T/R devices such as single-line telephones, modems, and fax machines. The number of extensions you can connect depends on the equipment you are using in your system.

Appendix C describes hardware and software capacities, that is, the minimums and maximums for certain features.

If you have any questions about your system's capacity, contact your Lucent Technologies representative.

Auxiliary Components

There are many other components that people use with the system, including adapters, adjuncts, and accessories. You probably have many of these in your system already. If you're interested in adding any of these components to your system, contact your Lucent Technologies representative.

The following is a list of the types of auxiliary system components, including some examples of each:

- **Adjuncts.** An auxiliary piece of equipment that adds features to the system, for example, a fax machine or a modem. There are three types of adjuncts:
 - **System Adjuncts.** Connect directly to the control unit, for example, a Station Message Detail Recording Printer (SMDR) to print call records, a PC with System Programming and Maintenance (SPM) software to be used for the programming and maintenance of the system, loudspeaker paging systems, and Magic on Hold® to provide background music for callers on hold.
 - **Telephone Adjuncts.** Connect to telephones. For example, Direct Station Selectors (DSSs) can enhance the capabilities of operator and programming consoles, as well as a variety of headsets, speakerphones, and specialty handsets (for users who are hard of hearing or in noisy environments).
 - **Other Adjuncts.** Connect directly to the control unit but are not necessarily used systemwide, for example, a fax machine at its own extension. (Many adjuncts, such as fax machines and modems, can either connect directly to the control unit from their own extensions, or they can connect to a telephone at an extension.)
- **Adapters.** Enable the connection of other equipment or certain telephone company facilities. There are two kinds of adapters, classified according to function:
 - **System Adapters.** Connect adjuncts (for example, a loudspeaker paging system) directly to the control unit and serve the whole system.
 - **Telephone Adapters.** Connect adjuncts to telephones. For example, a Multi-Function Module (MFM) connects an adjunct, such as an answering machine, modem, fax machine, or special strobe, to an MLX telephone.

- **Accessories.** Different kinds of accessories can be added to the system to provide more power or additional protection from power surges. There are three types of accessories:
 - **Power Accessories.** For example, an Uninterruptible Power Supply (UPS) for the system or telephone power units to provide additional power to individual telephones that require them for adjuncts.
 - **Protection Accessories.** For example, for grounding and protecting special telephone connections (like a telephone located in a different building) from lightning strikes and power surges.
 - **Miscellaneous Accessories.** A power-failure transfer (PFT) telephone used to make and receive calls in the event of a commercial power failure or an Off-Premises Range Extender (OPRE) used for a single-line telephone located in a different building from the control unit and more than 1000 feet away.

[Figure 2-10](#) illustrates some of these components. For information about these accessories, see Chapter 3, "System Components," and the *Equipment and Operations Reference* (not updated since Release 3.0).

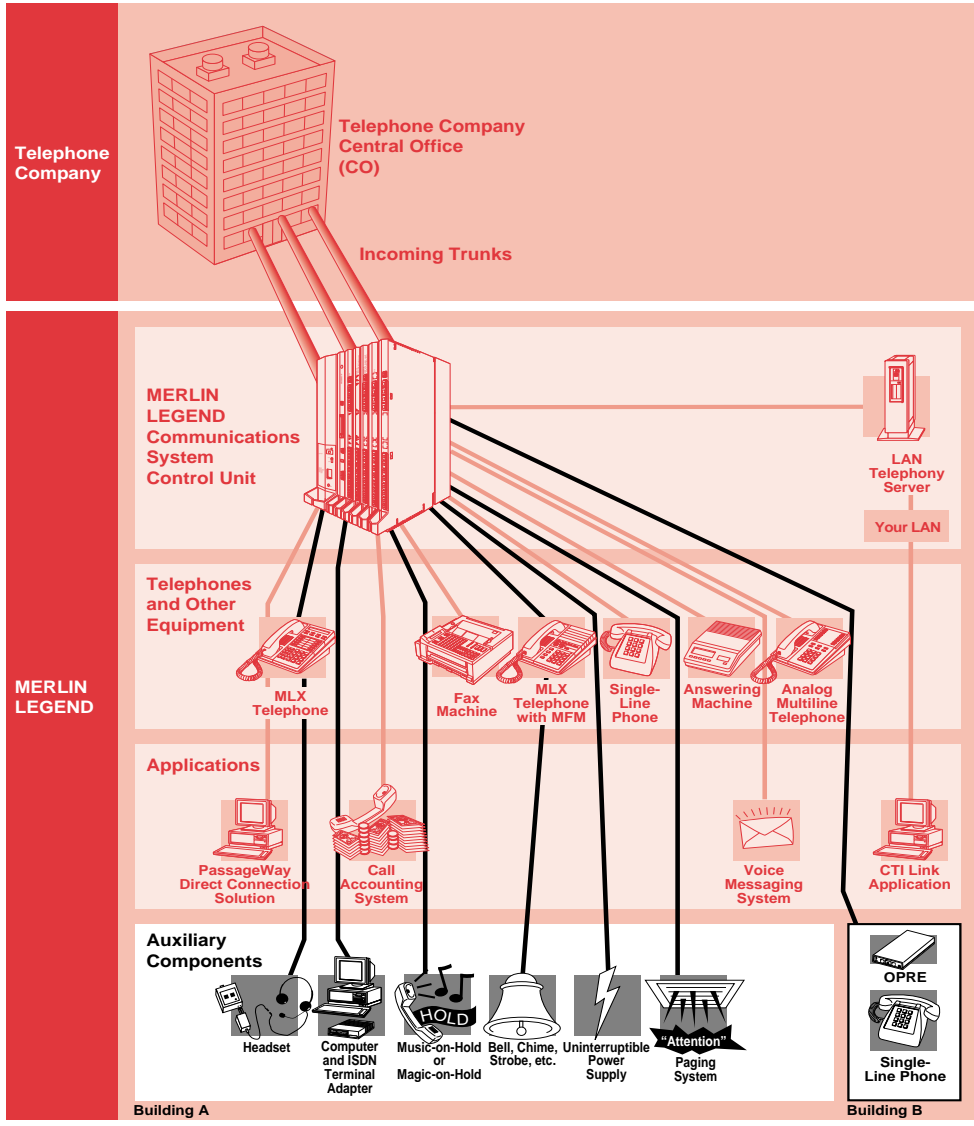

Figure 2-10. Auxiliary System Components

Data Communications Capabilities

One of the important capabilities of the system is that it can carry both voice and data communications simultaneously over the same lines. In addition, system features used for voice communications, such as Automatic Route Selection, calling restrictions, and speed dialing can also enhance the use of data equipment.



NOTE:

For the most up-to-date information about data and video communications, consult the *Data/Video Reference*.

Thus, the system allows you to use telephone lines for communicating not only voices but data and video too. For example, a computer in New York can send data files to a computer in San Diego. At your own company, your PC can communicate with a gateway computer on a local area network (LAN) and gain access to the network; or, you can call your office computer from your home computer and send files back and forth between your home and office.

In addition, the system supports advanced network services that integrate voice and data, such as group and personal videoconferencing.

A special type of extension, called a *data workstation*, is used for data communications. It may include a telephone and always includes two types of equipment:

- **Data Terminal Equipment (DTE)**. For example, a PC, data terminal, printer, optical scanner, or video system.
- **Data Communications Equipment (DCE)**. For example, an internal or external modem or an external Ascend Pipeline™ 50 ISDN terminal adapter.

The DTE connects to the system via the DCE, which has capabilities similar to a telephone. The DCE places the data call, maintains its connection, and terminates the data call.

Sometimes a telephone is also part of a data workstation. The telephone can be either an MLX or an analog multiline telephone that operates independently of the data communications equipment (DCE). You can attach a modem to either an analog or MLX telephone adapter.

A *video workstation* is a type of data workstation that allows group or desktop videoconferencing.

For high-speed data communications over Integrated Services Digital Network Basic Rate Interface (NI-1 BRI, Release 4.0 and later) or Digital Signal 1 (DS1) Primary Rate Interface (PRI) or T1 Switched 56 (Release 4.0 and later) facilities, you can attach an ExpressRoute 1000 ISDN Terminal Adapter or another ISDN (Integrated Digital Services Network) communications device to an MLX extension. Group videoconferencing may require ExpressRoute 1000s, or an ISDN terminal adapter compatible with them, which may be provided with the videoconferencing application. A modem or other communications device can operate (with its data terminal, of course) from its own extension, with no telephone at the extension.

Desktop videoconferencing, data transfer, and screen-sharing applications work with Release 4.0 and later systems. They use any combination of PRI, NI-1 BRI, and T1 Switched 56 data lines/trunks. Such systems can stand alone, and some may also have an MLX telephone attached. Desktop videoconferencing systems can use one MLX B-channel or two (for acceptable video quality). If the system uses both MLX B-channels, you cannot use the phone connected to the same MLX port as the videoconferencing application while the desktop videoconferencing system is making or receiving calls. The use of two B-channels is called *2B data*.

System Components

3

This chapter describes the system's basic hardware. It includes descriptions of the control unit, MLX telephones, analog multiline telephones, single-line telephones, system operator consoles, adjuncts and adapters for the system and telephones, and power-related accessories.

Control Unit

The control unit connects the telephone company's outside trunks to the system's telephones and adjuncts. It is the heart of the system, managing the traffic within the system (inside calls) and making telephone company facilities and outside services available to your company. It includes the following components:

- Carriers (up to three)
- Processor module (one per system)
- Power supply module (one per carrier)
- Line/trunk and extension modules (up to 17 total in three carriers)
- Cover that protects the unit

Carriers

The carriers in the system are the containers that hold the modules on which the circuit boards and connections for lines/trunks and extensions (called *jacks* or *ports*) are located. There can be up to three carriers: one *basic carrier* and two *expansion carriers*.

The carriers hold the modules in slots. For the purposes of system programming and installation, 2-digit numbers indicate the slots, starting with 00 for the processor module.

Inside the back of each carrier is a component called the *backplane*, which holds the circuitry that makes it possible for the modules to “talk” to each other and for the processor module to handle the traffic among the modules.

Every system has a *basic carrier* that holds the following modules in its slots:

- Power supply module (not numbered)
- Processor module (slot 00)
- Up to five line/trunk and extension modules (slots 01–05)

If you need more trunks and/or extensions than can fit in the basic carrier, you can connect up to two *expansion carriers* to the basic carrier. Like the basic carrier, each expansion carrier's leftmost slot holds a power supply module; the remaining six slots hold line/trunk and extension modules. (The processor module in the basic carrier serves the expansion carriers too.) The six slots for line/trunk and extension modules in the expansion carriers are numbered as follows:

- First expansion carrier (slots 06–11)
- Second expansion carrier: slots (12–17)

Processor Module

The processor module is the “brains” of the system, a miniature computer that controls system features and diagnostics, as well as the traffic among the modules (see [Figure 3-1](#)). The processor module provides three jacks, one for Station Message Detail Recording (labeled *SMDR*), one for system programming and maintenance using a PC (labeled *ADMIN*), and one for software maintenance by Lucent Technologies technicians only (this one is plugged shut).

The Personal Computer Memory Card International Association (PCMCIA) interface slot on the processor module is where you insert a PCMCIA memory card. A memory card is very similar to a floppy diskette used in a PC, but it is about the size of a credit card. There are different types of memory cards used with the system, each with a different label (see the next section for more information).

The processor module has a single-character display for numbers and symbols that help Lucent Technologies technicians to understand any problems with the system software and to maintain the system. The module also has a red light that indicates hardware failures.

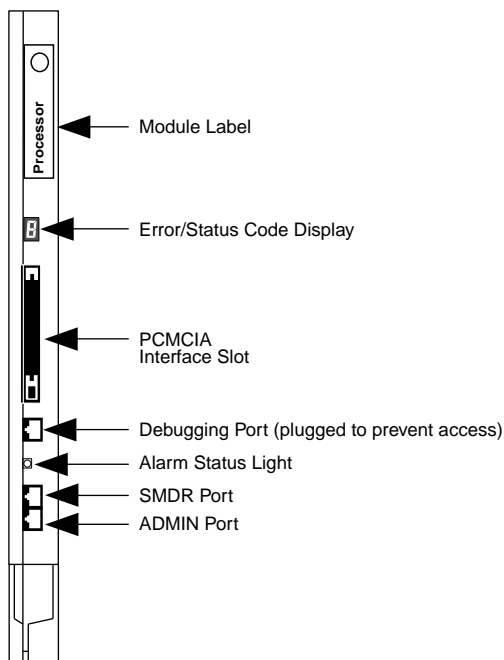

Figure 3-1. Processor Module

A super capacitor in the processor module provides backup power for the system's clock and its memory in case of power failure or system shutdown. The super capacitor retains data for four to five days.

PCMCIA Memory Card

The processor includes 4 MB of on-board memory that can be erased and written over multiple times. A PCMCIA memory card can be used to install or upgrade the system software into this memory. A memory card can also be used to back up and restore system programming.

There are different types of memory cards, each about the size of a credit card. Their labels indicate contents and function. Described below are three types of PCMCIA memory cards that you may encounter. For more information, see *System Programming* or contact your Lucent Technologies representative.

- **Feature Upgrade Memory Card.** Orange label with black bars; entitled *Forced Installation*. To upgrade your system to the latest release.
- **Maintenance Upgrade Memory Card.** Orange label; entitled *Upgrade Card*. To fix problems in the system.

- **Translation Memory Card.** White label; entitled *Translation Card*. To back up and restore your system programming as an alternative to using System Programming and Maintenance (SPM). These procedures are faster when you use the PCMCIA card.

Power Supply Module

The power supply module ([Figure 3-2](#)) provides power to the carrier, to each telephone, and to most adjuncts (some adjuncts, such as fax machines, come with their own power supplies and do not rely on the system). Each carrier requires its own power supply module, installed in the carrier's leftmost slot. The current power supply module is XXX; it works with all releases of the system.

In some systems, you need extra power supplies to support your system components as described in ["Power-Related Hardware" on page 3-46](#).

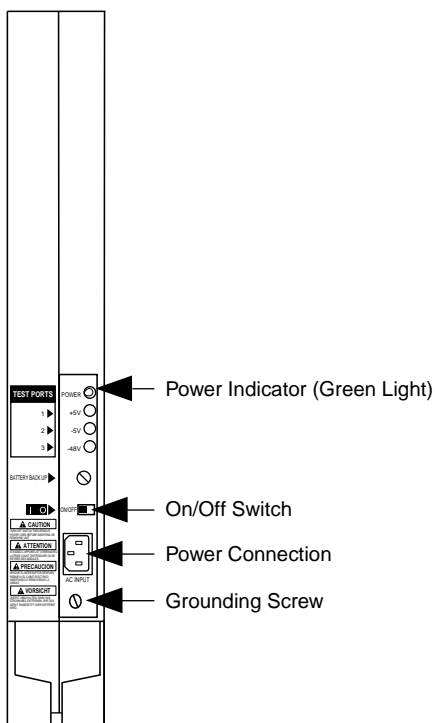

Figure 3-2. Power Supply Module

Line/Trunk and Extension Modules

Line/trunk and extension modules have jacks for connecting telephone company lines/trunks and extension wires to the control unit. The system supports 17 types of line/trunk and extension modules. For maximum flexibility, some modules support only lines/trunks, some only extensions, and some a combination of the two.

Each module has a label that contains its name. As noted in Chapter 2, "About the System," the names of the modules identify their capacities and capabilities. The first digit indicates the number of line/trunk jacks a module supports, while the last two digits describe the number of extension jacks it supports. Following the number may be letters that indicate the type of trunk or trunks it supports; for example, LS for *loop-start* and GS for *ground-start*. A line/trunk module name with no letter following it supports loop-start trunks. The following are examples of module names:

- The 408 GS/LS MLX module provides four trunk jacks supporting ground-start and/or loop-start trunks and eight MLX extension jacks.
- The 016 module (Release 4.0 and later only) provides 16 extension jacks that, in this case, supply tip/ring (T/R) connections for single-line telephones, modems, voice messaging systems that serve the system as a whole, and other components.

The balance of this section presents some specific information about the modules that connect extensions and the modules that connect lines/trunks. [Figure 3-3](#) and [Table 3-1](#) present summary information.

Modules Supporting Extensions

[Table 3-1](#) describes the type of equipment that each module supports. This section highlights some important points about extension modules.



NOTE:

Extension jacks connect to individual telephones and to adjuncts that are attached to extensions. Some adjuncts and applications serve the whole system and connect directly to line/trunk jacks.

Extension Jacks

While the jacks that support MLX extensions and the jacks that support analog extensions may look the same, there is a major difference: an MLX extension jack actually supports two extension numbers at each location served by the jack.

When you use an adapter called a Multi-Function Module in an MLX telephone, you can connect a T/R device (for example, a modem, a fax machine, or an answering machine) to that telephone. Even though a single extension jack on the

module serves both the phone and T/R device, each device has its own extension number and operates independently. In contrast, if you want to use both an analog multiline telephone and a modem or other adjunct at the same location in the system and give each one its own extension number, you must use *two* physical extension jacks on the module.

The Voice Announce to Busy feature, which allows a telephone user to hear a *voice page* (also called a *voice-announced call*) while on another call, has the same requirements as an adjunct that operates independently from the phone: one extension jack (and no adjunct) for an MLX phone; two extension jacks for an analog multiline telephone. Single-line telephones and cordless or wireless telephones (which are analog multiline telephones) cannot receive voice pages.



NOTE:

There is a distinction between an extension jack (sometimes referred to as a *logical ID* or *port*) and an extension number. In system programming, you sometimes need to use port/jack/logical ID numbers rather than extension numbers or system line/trunk numbers. Port/jack/logical IDs are numbered, starting at 1, from the bottom of a module, and are fixed: they cannot be changed. The extension and line/trunk numbers that people in the system dial are flexible and can be programmed.

Touch-Tone Receivers

In addition to jacks for connecting lines/trunks and extensions, various modules also include components called *touch-tone receivers* (TTRs). These TTRs allow the system to process touch tones entered by outside callers for special purposes, such as automated attendants that answer calls from people with touch-tone phones, voice mail systems, and remote access callers who call into the system and use its services. When your Lucent Technologies representative helps plan your system, he or she makes sure that your modules have enough touch-tone receivers to support your needs. When you add an application or adjunct to your system, you sometimes have to make more TTRs available as well, for example, tie trunks connecting networked systems (Release 6.0 and later systems, Hybrid/PBX mode). When you make a change to your system, consult your Lucent Technologies representative for information about additional TTRs that may be required.

016, 012, and 008 OPT Modules

Extension modules that support single-line telephones or off-premises telephones (OPTs) must have ring generators so that the phones get electrical current for their ringers. All 016 extension modules, which are compatible only with Release 4.0 and later systems, include built-in ring generators. Since late in 1993, 012 and 008 modules have come with ring generators built in. Earlier modules required

Lucent Technologies technicians to install ring generators. If your 008 or 012 module has a ring generator, either added or built-in, you should see a label on the front of the module telling you that the ring generator is included.

Also, 016, 012, and 008 modules allow the connection of T/R devices directly to the control unit, without the need for a telephone and adapter at an extension. You can use them to hook up fax machines or PCs with modems, for example. For more information, see [“Adjuncts” on page 3–36](#).



NOTE:

The MERLIN LEGEND Mail[®] Voice Messaging System integrates a T/R module (007 MLM) with a voice messaging system and is both a module and an application.

Modules Supporting Lines/Trunks

[Table 3–1](#) summarizes the modules that support lines/trunks. This section describes a few module features and modules that need additional explanation.



NOTE:

Modes of operation affect features and hardware. For example, Direct Inward Dial is supported only in Hybrid/PBX mode, so if your system uses a different mode of operation, you do not need a DID module. For more information about modes, see Chapter 2, “About the System.”

Power-Failure Transfer Telephones

When your system was planned, the Lucent Technologies representative(s) made sure that you had a module to support one or more power-failure transfer (PFT) telephones. These telephones, which are connected to a special line/trunk jack, allow you to make and receive calls during a commercial power failure. They do not affect the capacity of the modules.

100D Module

The 100D module has only one line/trunk (called a *Digital Signal Level 1* or *DS1* facility) but actually supports 23 or 24 “virtual” lines/trunks. These are called *channels* or *B-channels*, depending upon the type of service you choose. As described in Chapter 2, “About the System,” you can program the DS1 facility to provide either T1 or Primary Rate Interface (PRI) service on the 100D module.



NOTE:

The 100D module is not available in Behind Switch mode.

In addition, PRI and T1 support Group IV (G4) fax machines as well as desktop and group videoconferencing.

PRI and T1 differ in some important ways:

- **Primary Rate Interface (PRI).** PRI supports Integrated Services Access, also called *Shared Access for Switched Services (SASS)* and *Call-by-Call Service Selection*. This feature, available from various telecommunications companies, allows multiple PRI services to use the same facilities, eliminating the need to have dedicated, separate incoming and outgoing B-channel groups. It selects the optimal service for each outgoing call, allowing more than one service over each B-channel, including digital data communications at speeds up to 64 kilobits per second.



NOTES:

1. In releases prior to 4.2, only AT&T services for Lucent Technologies generic 4ESS, Lucent Technologies 5ESS, and other providers' emulations of these services are supported. Release 4.2 and later systems support services on NORTEL DMS-100 generic BCS 36 serving local exchange carriers, NORTEL DMS-250 generic MCI07 serving the MCI network, and Digital Switch Corporation DEX 600E generic 500-39.30 serving the MCI network.
2. For the DMS-100 or DMS-250 switch type, you must give special instructions to the service provider to use variant NTNAPRI (Northern Telecom North America Primary Rate Interface) instead of the AT&T protocol. For the DEX600E switch type, instruct the service provider to use the profile p250. For additional information, refer to *System Planning* or contact your Lucent Technologies representative.

PRI supports *routing by dial plan* for DID-like call-handling. This is especially appropriate for Caller ID services such as AT&T's Station Identification/Automatic Number Identification or the AT&T and MCI Dialed Number Identification Service (DNIS) when your company subscribes. DNIS routes incoming 800 or 900 calls according to customer-selected parameters, such as area code, state, or time of call. For example, a customer can specify that calls received from a particular area code be routed to a specific individual or group responsible for accounts in the area.

The system's PRI platform allows you to choose any combination of the telecommunications company services listed below (your company must subscribe to these).

- **MCI Services** (Release 4.2 and later systems only). Domestic outgoing long-distance and international voice calls; domestic incoming toll-free 800 voice calls; 900 service numbers; and private network voice calls as well as 56- and 64-kbps restricted and unrestricted circuit-switched data calls.
- **Local DMS-100 Services** (Release 4.2 and later systems only). Available from local carriers: private network or tie trunk service for calls between the MERLIN LEGEND Communications System and another communications system (such as another MERLIN LEGEND Communications System); outbound WATS for domestic outgoing long-distance calls; inbound WATS for domestic toll-free incoming voice calls; and, foreign exchange service.
- **AT&T Services.** Domestic outgoing long-distance and voice calls; 56- and 64-kbps circuit-switched data calls with routing by dial plan; 900 service numbers; outbound WATS for domestic outgoing long-distance calls; and domestic toll-free incoming voice calls.
- **T1 Service.** This service is cost-effective and convenient for many businesses. Prior to Release 4.0, it provided voice operation only. In Release 4.0 and later systems, T1 service provides voice operation or high-speed data operation. A T1 channel must be programmed for either voice or data operation and cannot be used for both.



NOTE:

In Release 6.0 and later systems (Hybrid/PBX mode only), tandem PRI lines can be used for networking. In this case, you order a T1 facility and program it for PRI operation. For more information, see the *Network Reference*.

- **Voice Operation.** T1 voice channels can be configured to emulate different types of trunks for voice (analog) use, according to business needs. T1 can emulate loop-start, ground-start, Direct Inward Dial (DID, Hybrid/PBX mode only), and tie trunks. In some areas, T1 service is less expensive than leasing the equivalent number of standard telephone company trunks. T1 also allows access to network subscriber options such as toll-free domestic long-distance services.

You can connect the system's control unit to another system's control unit using an emulated T1 tie trunk programmed for T1-type voice operation. This arrangement provides voice communications or analog data communications using modems.

- **Data Operation.** Available in Release 4.0 and later systems, T1 Switched 56 data operation allows switched data communications at 56 kilobits per second. The same high-speed connectivity can link a MERLIN LEGEND Communications System to another; or it can link a

MERLIN LEGEND Communications System to a DEFINITY system. Whether used for digital tie-trunk emulation or not, a T1 data-operation channel provides data communications only, not voice communications.

800 NI-BRI Module

Available for Release 4.0 and later systems, this module supplies eight line/trunk jacks for connecting central office facilities that use the standard National ISDN 1 (Integrated Services Digital Network 1) protocol and the BRI (Basic Rate Interface) access arrangement (this combination is abbreviated *NI-1 BRI*). These digital facilities are available from COs in many areas.

Each facility actually includes two "virtual" lines, two B-channels for carrying voice and data, as well as a third D-channel for handling signaling and maintenance.



NOTE:

The 800 NI-BRI module is not available in Behind Switch mode.

Summary

[Figure 3-3](#) shows the modules; [Table 3-1](#) lists the number of available jacks for each module and presents a brief description of the equipment you can connect to it.



NOTE:

Modules labeled "GS/LS" can accept ground-start trunks, loop-start trunks, or a combination of both types of trunks.

3 System Components
 Control Unit

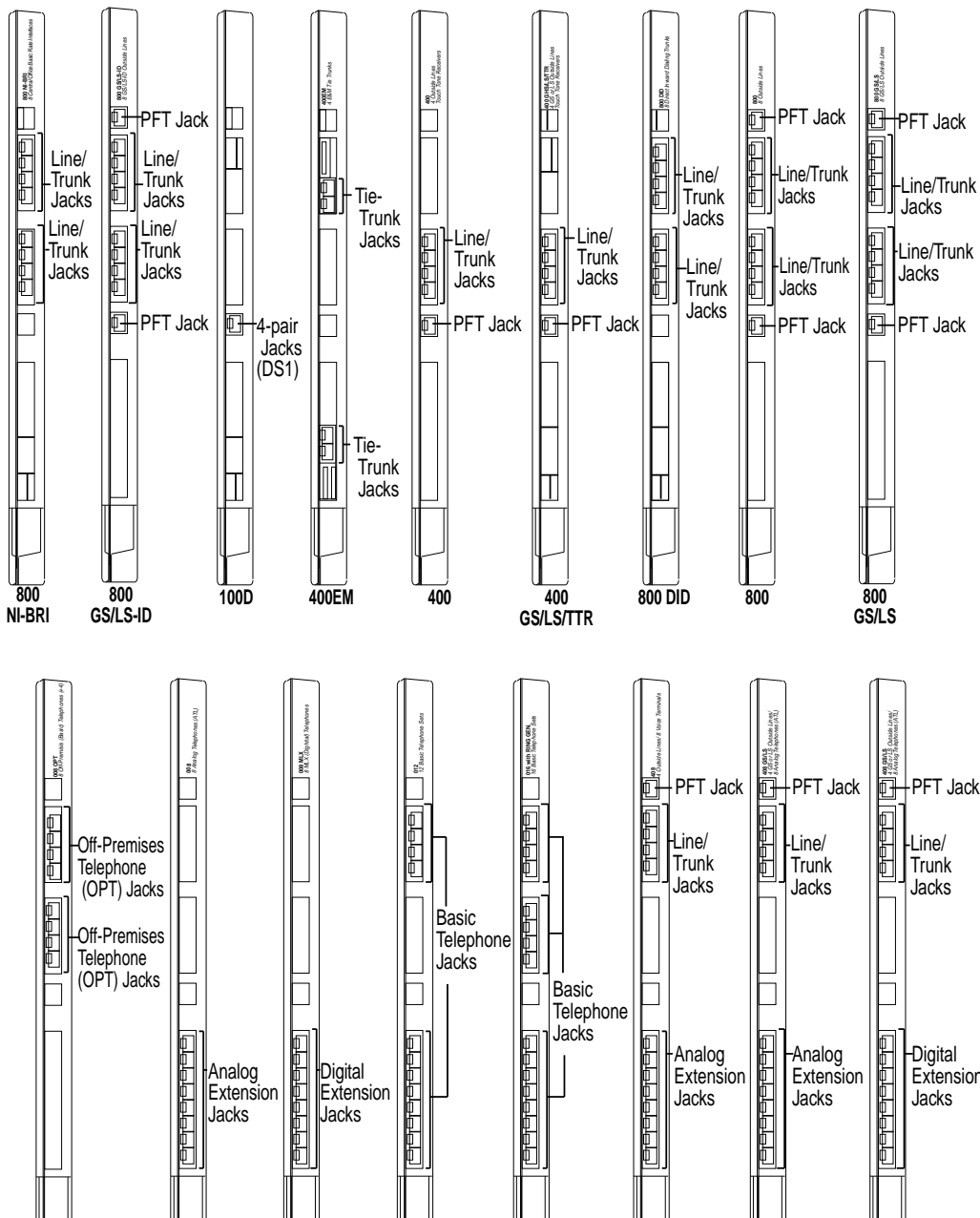

Figure 3-3. Line/Trunk and Extension Modules

Table 3-1. Line/Trunk and Extension Modules

Module	Line/Trunk	Description
008	none	Capacity: 8 analog extension jacks Supports: Analog multiline telephones
008 MLX	none	Capacity: 8 digital extension jacks, each with 1 or 2 extensions (each extension is assigned an individual extension number) Supports: MLX extensions, including: — MLX voice only — MLX voice with Voice Announce to Busy — MLX voice and ISDN terminal adapter — MLX voice and Multi-Function Module (MFM) with T/R adjunct — ISDN terminal adapter only — Access device for data communications between a PC on the system and a high-speed Internet connection, connection to remote node LAN access server, or ISDN router*† — CTI (Computer Telephony Integration) link†‡ — Videoconferencing systems using one jack and 2B data feature, MLX telephone with some video systems*†
008 OPT§	none	Capacity: 8 T/R extensions on 2-way voice transmission path with support for telephones with message-waiting lights, 2 TTRs Supports: On-premises or off-premises single-line telephones
012	none	Capacity: 12 T/R extensions on 2-way voice transmission path with support for telephones with message-waiting lights, 2 TTRs Supports: Single-line telephones; Lucent Technologies Attendant; MERLIN Mail® VMS; Intuity™ CONVERSANT®; T/R adjuncts (such as answering or fax machine); analog data devices (such as modems)
016*	none	Capacity: 16 T/R extensions on 2-way voice transmission path with support for telephones with message-waiting lights, 4 TTRs Supports: Single-line telephones; Lucent Technologies Attendant; MERLIN Mail VMS; CONVERSANT; T/R adjuncts (such as answering or fax machine); analog data devices (such as modems).
100D	T1 or PRI	Capacity: 24 channels ("virtual" lines/trunks) for voice and analog data or for digital data only (T1); or 23 B-channels for voice and data and 1 channel used for signaling (PRI). Supports networking in Release 6.0 and later systems, Hybrid/PBX mode only. Supports: See " 100D Module " on page 3-7 for details. T1 emulates 24 lines/trunks: loop-start, ground-start, tie, and Direct Inward Dial (DID; Hybrid/PBX mode only); can also supply subscriber services. In Release 4.0 and later, T1 can also provide high-speed data communications and digitally emulated tie trunks for data communications. PRI supports subscriber services, allows high-speed digital data communications, and includes special features.

Continued on next page

Table 3-1. Continued

Module	Line/Trunk	Description
800 NI-BRI*	BRI	Capacity: 8 BRI facilities, each with 2 B-channels ("virtual" lines) for voice and data and 1 channel used for signaling. Supports: See "800 NI-BRI Module" on page 3-10 for details. Voice, data, video, and other services at 64 kbps over standard ISDN lines/trunks.
400 [¶]	LS, TTR	Capacity: 4 lines/trunks, 4 TTRs, 1 PFT telephone Supports: 1 PFT telephone
400EM	Tie trunk	Capacity: 4 tie trunks. Supports networking in Release 6.0 and later systems, Hybrid/PBX mode only.
400 GS/LS	LS or GS, TTR	Capacity: 4 lines/trunks, 4 TTRs, 1 PFT telephone Supports: PFT telephone with ground-start (GS) button
408 [¶]	LS	Capacity: 4 lines/trunks, 8 extensions, 1 PFT telephone Supports: Analog multiline telephones; CMS; a PFT telephone
408 GS/LS	LS or GS	Capacity: 4 lines/trunks, 8 extensions, 1 PFT telephone Supports: Analog multiline telephones; CMS; PFT telephone with GS button
408 GS/LS- MLX**	LS or GS	Capacity: 4 lines/trunks, 1 PFT telephone, 8 digital extension jacks for MLX extensions, including: — MLX voice only — MLX voice with Voice Announce to Busy — MLX voice and ISDN terminal adapter — MLX voice and MFM with T/R adjunct — ISDN terminal adapter only — Access device for data communications between a PC on the system and a high-speed Internet connection, connection to remote node LAN access server, or ISDN router [†] — CTI (Computer Telephony Integration) link ^{†‡} — Videoconferencing systems using one jack and 2B data feature, MLX telephone with some video systems* [†]
800 [¶]	LS	Capacity: 8 lines, 2 PFT telephones Supports: 2 PFT telephones
800 DID	DID, TTR	Capacity: 8 lines/trunks, 2 TTRs
800 GS/LS	LS or GS, TTR	Capacity: 8 lines/trunks, 2 PFT telephones Supports: 2 PFT telephones with ground-start (GS) button
800 GS/ LS-ID ^{††}	LS or GS	Capacity: 8 lines/trunks, 2 PFT telephones; 2 TTRs Supports: Caller ID (ground-start trunks only), if you subscribe to caller identification from the local phone company), displays the numbers of incoming callers (from supported areas) on MLX display phones.

Continued on next page

Table 3-1. Continued

Module	Line/Trunk	Description
MERLIN LEGEND Mail 007 MLM**	none	<p>Capacity: 7 internal, system-defined T/R jacks; 2 TTRs; internal remote maintenance device; serial port for PC connection; detachable disk drive for storing messages</p> <p>Supports: MERLIN LEGEND Mail Voice Messaging System; is a component of this application that provides the T/R jacks and other portions of the application.</p>

* For Release 4.0 and later systems only
 † Not compatible with firmware vintage 29; use an earlier or later vintage.
 ‡ For Release 5.0 and later systems only
 § The system software recognizes the OPT module as a 012 module. Even though the OPT module has only 8 jacks, it uses 12 ports of capacity, thereby decreasing overall extension capacity by 4 extensions for every OPT module.
 ¶ Although these MERLIN® II modules are supported, the following are recommended for the system: 400 GS/LS, 408 GS/LS, 408 GS/LS-MLX, 800 GS/LS, and 800 GS/LS-ID.
 ** For Release 2.0 and later systems only
 †† For Release 3.0 and later systems only
 ‡‡ The system software recognizes the MERLIN LEGEND Mail VMS module as a 012 module. Even though the module has a maximum of 7 T/R jacks, including the modem jack, it uses 12 ports of capacity in any of its three configurations.

Telephones

You can use MLX (digital) telephones as well as several different analog and single-line telephones with the system. This section describes these telephones.



NOTE:

Telephones that are located far from the control unit or that have other equipment (*adjuncts*) attached (for example, an answering machine or a fax machine) may need additional power. A special power unit, described in [“Power-Related Hardware” on page 3-46](#), supplies this need.

MLX Telephones

The communications system supports MLX-28D, MLX-20L, MLX-16DP, MLX-10DP, MLX-10D, MLX-10, MLX-5D, and MLX-5 digital telephones:

MLX telephones are available in black or white with factory-set buttons in English, French, Hungarian, or Spanish (the MLX-10DP telephone is available with English-language buttons only). In addition, all models have the following features in common:

- Line buttons (can also be programmed with features) with red and green lights

- Fixed-feature buttons (including **Feature**, **HFAI**, **Mute**, and **Speaker**)
- Red Message light
- Built-in speakerphone
- Multi-function volume control for speakerphone, handset, and ringer
- Telephone card tray for easy reference to frequently used features
- 2-position adjustable desk stand
- 4-pair modular line cord
- Optional Multi-Function Module (MFM) to connect tip/ring (T/R) equipment and alerting devices

MLX display telephones in particular offer enhanced services to telephone users and to you in your role as system manager. MLX display telephones have the following unique features:

- Menu-driven telephone programming
- The ability to select and use features from the display
- Support for Primary Rate Interface (PRI) calling number identification services and the Caller ID feature
- Display in English, French, or Spanish. (You can program the system to provide all displays to MLX telephones in one of these languages; users at MLX telephones can program their own telephones to display in English, French, or Spanish, independently of the system language.)

A list of features specific to each MLX telephone follows.

MLX-28D

The MLX-28D telephone ([Figure 3-4](#)) provides the following features:

- Optional Direct-Line Console (DLC) operation
- Display (2 lines by 24 characters)
- 28 line buttons that can be programmed with features
- 4 fixed display buttons, 4 unlabeled display buttons for screen selection, and 8 fixed-feature buttons
- Support of one or two Direct Station Selectors (DSSs) or PassageWay Direct Connection Solution

MLX-28D telephones cannot be wall-mounted.

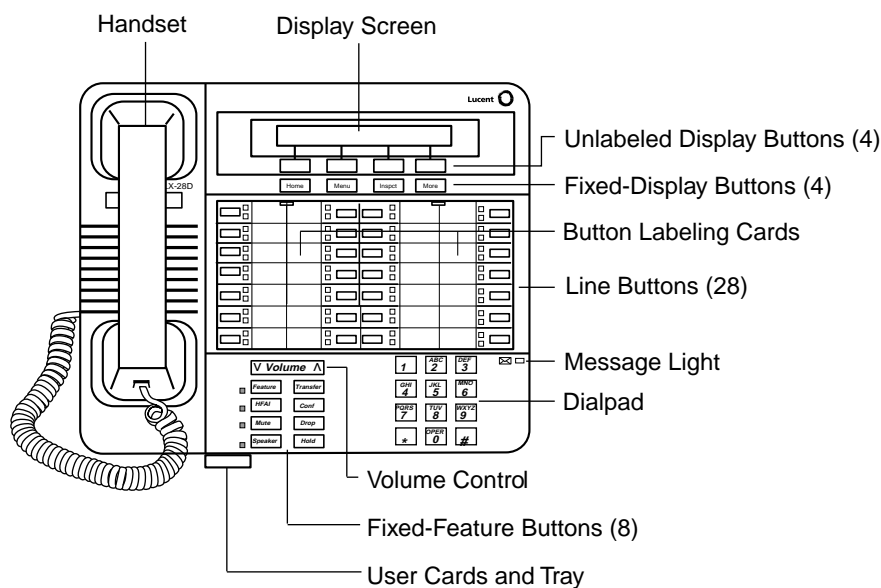

Figure 3-4. MLX-28D Telephone

MLX-20L

The MLX-20L telephone ([Figure 3-5](#)) provides the following features:

- System programming and optional DLC or QCC operation
- Display (7 lines by 24 characters)
- 20 line buttons that can be programmed with features

- 14 fixed and unlabeled display buttons and 8 fixed-feature buttons
- Support of one or two DSSs or PassageWay Direct Connection Solution

MLX-20L telephones cannot be wall-mounted.

When used as a QCC, some restrictions apply. The line buttons are not programmable, and the console cannot have an MFM. Later in this chapter, [“Queued Call Consoles” on page 3-30](#) provides more information about QCCs.

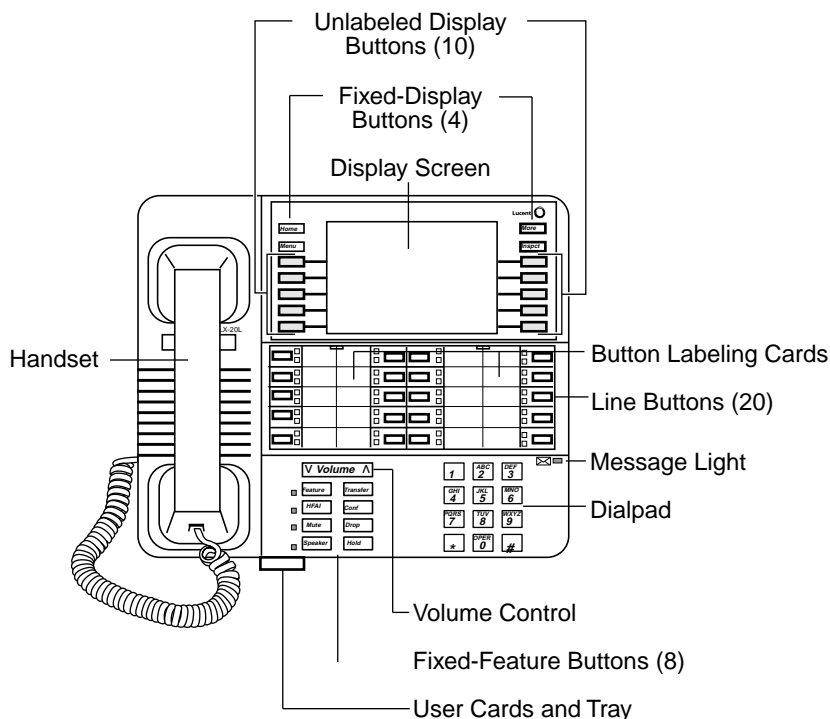

Figure 3-5. MLX-20L Telephone

MLX-16DP

The MLX-16DP telephone ([Figure 3-6](#)) provides the following features:

- Display (2 lines by 24 characters)
- 16 line buttons that can be programmed with features
- 4 fixed display buttons, 4 unlabeled display buttons for screen selection, and 8 fixed-feature buttons
- Support of PassageWay Direct Connection Solution, version 2.1 or later

MLX-16DP telephones cannot be wall-mounted.



NOTES:

1. The MLX-16DP telephone should not be an operator console.
2. The system recognizes the MLX-16DP as an MLX-28D. For this reason, when programming the telephone, be careful not to assign lines or features to buttons that do not actually exist on the telephone. Programming instructions come with the equipment.

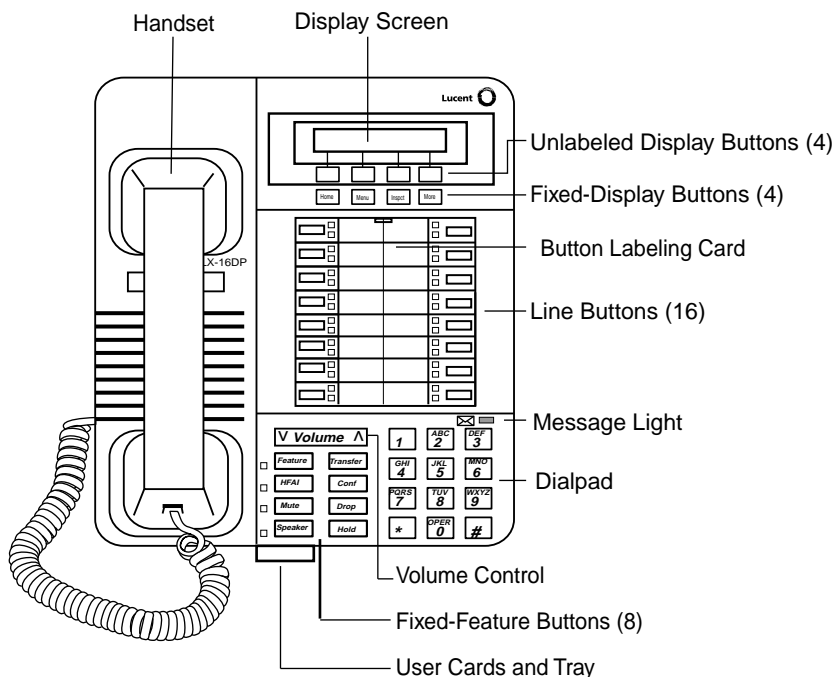

Figure 3-6. MLX-16DP Telephone

MLX-10D

The MLX-10D telephone ([Figure 3-7](#)) provides the following features:

- Display (2 lines by 24 characters)
- 10 line buttons that can be programmed with features
- 4 fixed display buttons, 4 unlabeled display buttons for screen selection, and 8 fixed-feature buttons

MLX-10D telephones can be wall-mounted, but wall-mounting makes the display hard to read.



NOTE:

The MLX-10D should not be an operator console.

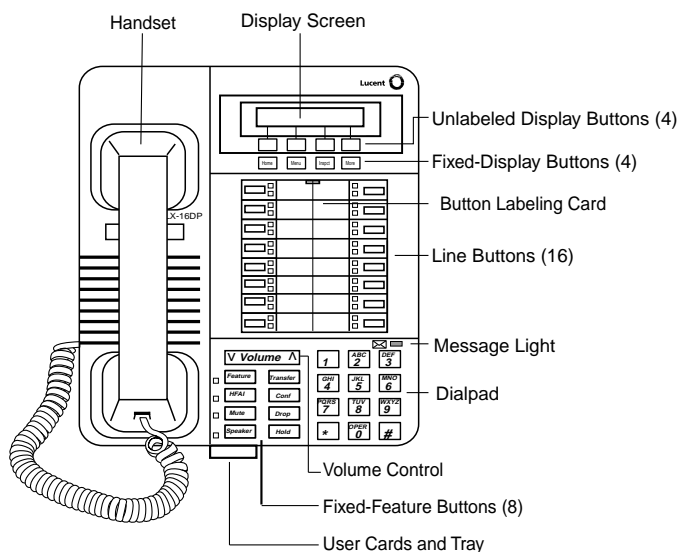

Figure 3-7. MLX-10D Telephone

MLX-10DP

The MLX-10DP telephone is the same as the MLX-10D telephone (see [Figure 3-7](#)), except that the MLX-10DP has an adjunct jack in the back of it for connecting PassageWay Direct Connection Solution applications.



NOTE:

The MLX-10DP should not be an operator console.

MLX-10

The MLX-10 telephone (Figure 3-8) provides the following features:

- 10 line buttons that can be programmed with features
- 8 fixed-feature buttons

MLX-10 telephones can be wall-mounted.

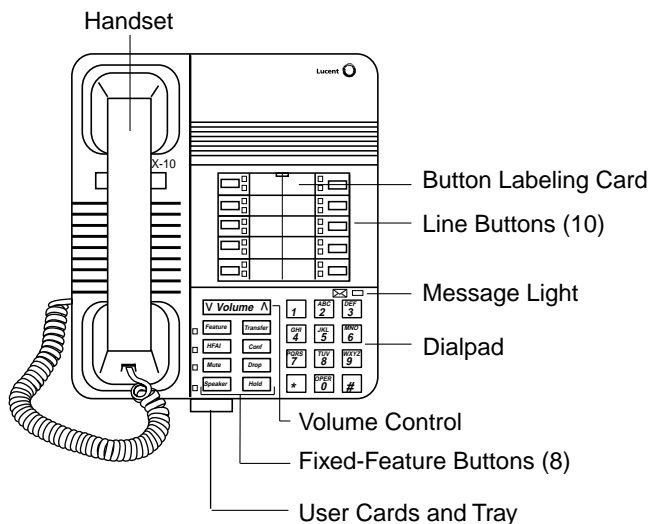

Figure 3-8. MLX-10 Telephone

MLX-5D

The MLX-5D telephone (Figure 3-9) provides the following features:

- Display (2 lines by 24 characters)
- 5 line buttons that can be programmed with features
- 4 fixed display buttons, 4 unlabeled display buttons for screen selection, and 8 fixed-feature buttons



NOTES:

1. The MLX-5D telephone should not be an operator console.
2. In Release 5.0 and later systems, the system recognizes the MLX-5D as a 5-button telephone. In releases prior to 5.0, the system recognizes the MLX-5D as an MLX-10D. For this reason, when programming the telephone, be careful not to assign lines or features to buttons that do not actually exist on the telephone. When an MLX-5D telephone replaces an MLX-10 or MLX-10D telephone, all line and feature buttons must *first* be removed from the extension by centralized telephone programming, so that “phantom buttons” do not exist for the new telephone. Programming instructions come with the equipment.

MLX-5D telephones can be wall-mounted, but wall-mounting makes the display hard to read.

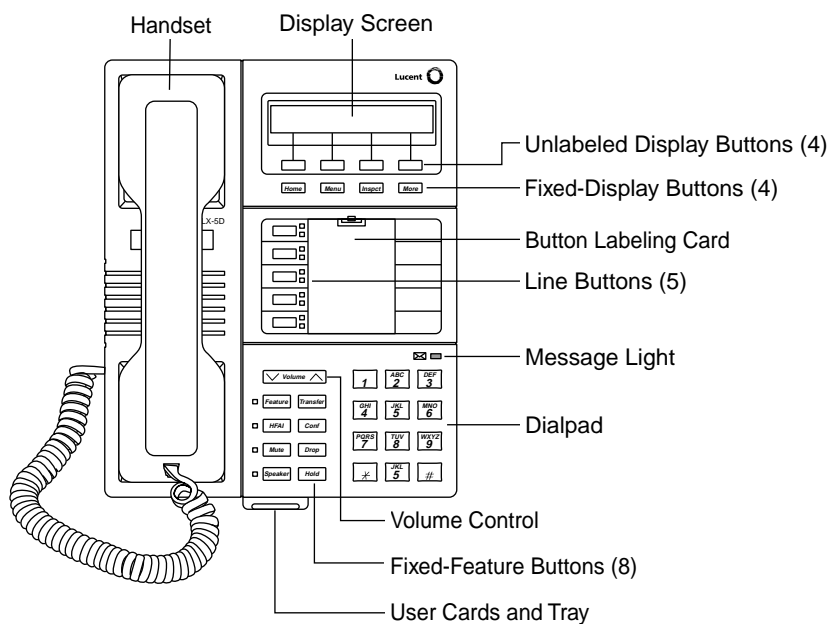

Figure 3-9. MLX-5D Telephone

MLX-5

The MLX-5 telephone provides the following features:

- 5 line buttons that can be programmed with features

- 4 fixed display buttons, 4 unlabeled display buttons for screen selection, and 8 fixed-feature buttons



NOTES:

1. The MLX-5 telephone should not be an operator console.
2. In Release 5.0 and later systems, the system recognizes the MLX-5D as a 5-button telephone. In releases prior to 5.0, the system recognizes the MLX-5 as an MLX-10. For this reason, when programming the telephone, be careful not to assign lines or features to buttons that do not actually exist on the telephone. When an MLX-5 telephone replaces an MLX-10 or MLX-10D telephone, all line and feature buttons must *first* be removed from the extension by centralized telephone programming, so that "phantom buttons" do not exist for the new telephone. Programming instructions come with the equipment.

MLX-5 telephones can be wall-mounted.

Direct Station Selector

The Direct Station Selector (DSS), shown in [Figure 3-10](#), is an adjunct that you can connect to an MLX-20L or an MLX-28D telephone programmed as an operator console (it cannot connect to any other telephone). DSSs enhance the capabilities of both DLCs and QCCs and, when connected to an MLX-20L telephone, help with programming. The DSS has 50 multifunction buttons, all of which have lights.

The system operator can use DSS buttons for one-touch dialing and Transfer. Buttons can be programmed with the following numbers:

- Extension numbers
- Line/trunk numbers
- Pool dial-out codes (Hybrid/PBX only)
- Calling group extension numbers
- Paging group extension numbers
- Park zone access codes
- Automatic Route Selection (ARS) access codes
- Remote Access dial code
- Listed Directory Number (the extension for the QCC queue)

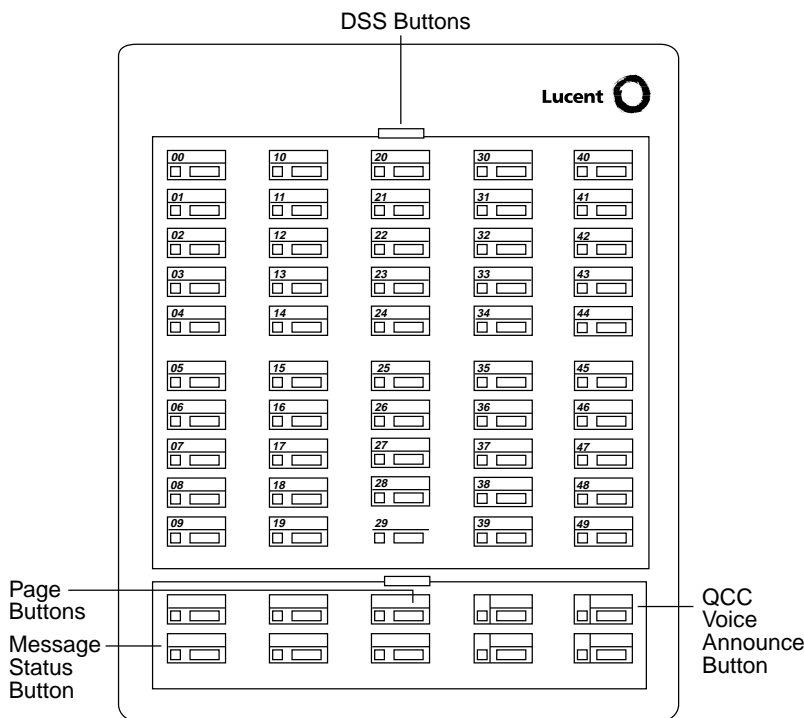

Figure 3-10. Direct Station Selector

Ten fixed-feature buttons with green lights are at the bottom of the DSS. The first three (from left to right) on the top row are **Page** buttons, which you use to select the range of extension numbers represented by the DSS buttons. Each DSS button can represent up to 3 extension numbers, and each set of 50 extension numbers is called a *page*. The DSS can have up to 3 pages of numbers, for a total of 150 extensions handled by one DSS. If the console has two DSSs, only the **Page** buttons on the first DSS are used.

Page buttons act like the Shift key on a PC or typewriter. Each of the 3 **Page** buttons activates a set of 50 numbers. For example, the **Page 1** button may access extensions 0 through 49, the **Page 2** button may access extensions 50 through 99, and the **Page 3** button may access extensions 100 through 149.

If two DSSs are connected together, the total extension capacity of the console increases to 300. Each **Page** button then handles a range of 100 extensions across both DSSs. If your system has more than 150 extensions and you want access to all system extensions through DSSs, you must have two DSSs.



NOTE:

Extensions may have to be renumbered in order to have all extension numbers appear on the DSS.

A fourth button (lower leftmost) is the **Message Status** button, which changes the mode to and from message status operation. The remaining buttons in the bottom two rows are not used.

DSSs ship without auxiliary power supplies; if two DSSs are connected to a console, you must order auxiliary power (329A unit) separately.

Analog Multiline Telephones

In addition to MLX telephones, the system supports the analog multiline telephones listed in [Table 3-2](#).

The displays on analog multiline telephones provide call-handling information; they do not support menu-driven telephone programming, selection of features from the display, or operation in languages other than English.

Table 3-2. Analog Multiline Telephones

Model	Description
BIS-10	10-button telephone with built-in speakerphone
BIS-22	22-button telephone with built-in speakerphone
BIS-22D	22-button telephone with 16-character display and built-in speakerphone
BIS-34D	34-button telephone with 16-character display and built-in speakerphone
MDC 9000 Cordless	Cordless multiline
MDW 9000	Cordless and wireless multiline
MDW 9010	Cordless and wireless multiline
MDW 9030P	Pocket phone
MERLIN II System Display Console	34-button telephone with a built-in DSS (the only telephone model that is uniquely used as an operator console) for Direct-Line Console operation
MERLIN PFC [®] Telephone	Analog multiline phone, fax machine, and copier; requires two analog multiline extension jacks

Single-Line Telephones

Table 3-3 lists the recommended single-line telephones. Other available single-line telephones are also supported but are not recommended for Release 3.0 or later systems. Contact your Lucent Technologies representative for more information.

Table 3-3. Single-Line Telephones

Model	Description
2500 YMGL	Basic desk telephone
2500 MMGL	Basic desk telephone with selectable positive disconnect
8101M	Basic desk telephone with jack to support adjuncts
8102M	Basic desk telephone with jack to support adjuncts and programmable dialing buttons
8110M	Basic desk telephone with jack to support adjuncts, built-in speakerphone, and programmable dialing buttons
3129-WTWA	Touch-tone outdoor telephone with cast aluminum housing, armored handset cord with bell ringers
3129-WRWA	Rotary dial outdoor telephone with same features as 3129-WTWA
3129-WAWA	Auto dial outdoor telephone with cast aluminum housing, armored handset cord with bell ringers
3129-WNWA	Non-dial, automatic ringing on dedicated circuit outdoor telephone with cast aluminum housing, armored handset cord with bell ringers

Line Buttons on Multiline Telephones

Different models of telephones, of course, have different imprinted buttons. The descriptions above summarized these buttons. Line buttons on multiline telephones fall into two categories:

- Buttons that are system-programmed to access an inside or outside line or pool of outside lines
- Blank line buttons that can be programmed—by the system manager only, or by either the system manager or the user—with system features

Buttons are different on Queued Call Consoles (QCCs), and you can read more about them later in this chapter. Direct-Line Consoles are similar to other MLX display telephones, but there are differences that are also described later in this chapter.

The system automatically assigns line buttons to each multiline telephone. You can add, remove, or change this assignment through centralized telephone programming, but every multiline telephone automatically has two **ICOM** (Intercom) or three **SA** (System Access) buttons assigned. Whether your system has **ICOM** buttons or **SA** buttons depends on the system's operating mode (see ["Modes of Operation" on page 2-16](#) for more information about modes).



NOTE:

The system automatically assigns two **ICOM** or **SA** buttons to single-line telephones. Even though the telephone allows only one line, the extra assigned button permits the use of features that require two line buttons (for example, Transfer). In Release 4.0 and later systems only, the system manager can remove one line button assigned to a single-line telephone. This disables Transfer, Park, Account Codes, Pickup, Call Waiting, Conference, Extension Status, and Privacy.

Key Mode Line Buttons

When the system operates in Key mode, you can program two different kinds of line buttons for making and receiving calls:

- **Line Buttons** (or Keys). These buttons are associated with specific *outside lines* for making or receiving calls to telephone numbers other than system extensions ("outside" the system). Line buttons allow you to see activity on other telephones, join conversations, and make and receive calls.
- **ICOM Buttons**. These buttons allow you to make and receive *inside calls* to or from system extension numbers ("inside" the system).

ICOM buttons fall into several categories:

- **ICOM Ring**. Use this button to make inside calls and to receive inside and outside calls transferred from another extension. When you use an **ICOM Ring** button to make an inside call, the telephone at the destination extension rings once per ring cycle to indicate an inside call.
- **ICOM Voice**. Use this button to make inside calls and to receive inside and outside calls transferred from another extension. When you use **ICOM Voice** to make an inside call, the user at the destination extension hears the caller's voice on the speakerphone after a beep that replaces ringing. (If you are using an **ICOM Voice** button to make a voice-announced call and the user at the destination extension has a single-line telephone or a telephone that does not have a speakerphone, or has disabled voice announcements, the telephone rings just as if the call was made on an **ICOM Ring** button.)
- **ICOM Originate Only**. Use this button to make inside calls. You cannot receive inside or outside calls on **ICOM Originate Only** buttons. This type of button ensures that you always have a button available to make or

transfer a call, establish a conference call, answer a call-waiting call, or pick up parked calls. You can program this button for either voice or ring operation.

You can assign any combination of up to 10 **ICOM Voice**, **ICOM Ring**, and **ICOM Originate Only** buttons to each telephone on line buttons 1 through 10. The number of line buttons that you can assign to a telephone is limited only by the number of lines/trunks in the system and the number of buttons available on the telephone.

Line Buttons in Hybrid/PBX Mode

Because outside trunks are pooled in Hybrid/PBX mode, outside numbers are not associated with individual telephones. **SA** buttons on multiline telephones allow you to access a pool of lines and make different kinds of calls from the same button. Other types of buttons may connect the user to pools of special-purpose lines or to personal lines that are not pooled.

You can assign the following types of buttons to multiline telephones:

- **SA Ring.** Use this button to make and receive inside and outside calls. When you use an **SA Ring** button to make an inside call, the telephone at the destination extension rings once per cycle to indicate an inside call.
- **SA Voice.** Use this button to make and receive inside and outside calls. When you use an **SA Voice** button to make an inside call, the user at the destination extension hears your voice on the speakerphone after a single beep, rather than ringing. (If you are using an **SA Voice** button to make a voice-announced call and the user at the destination extension has a telephone that does not have a speakerphone or has disabled voice announcements, the telephone rings just as if the call was made on an **SA Ring** button.)
- **SA Originate Only.** Use this button to make inside and outside calls. You cannot receive calls on **SA Originate Only** buttons. The purpose of this type of button is to ensure that you always have a button available to make or transfer a call, establish a conference call, answer a call-waiting call, or pick up parked calls. For inside calls, you can program the button for either voice or ring operation.
- **Shared SA (SSA).** Use this button to allow two or more users to answer each other's calls, join conversations, or make or receive inside or outside calls on each other's **SA Ring** or **SA Voice** buttons. In a Shared System Access arrangement, one extension is the *principal (or primary)* extension. This extension is the telephone from which **SA Ring**, **SA Voice**, and/or **SA Originate Only** buttons are assigned as Shared **SA** buttons.

SSA buttons are often used by assistants and their supervisors, as well as people who work closely together, such as in a customer service department. For inside calls, you can program the button for either voice or ring operation.

- **Pool.** Use this button to make outside calls on a specific trunk pool. To make an outside call, press the appropriate **Pool** button; no dial-out code is necessary.
- **Personal Line.** Use this button to dedicate the use of a specific outside trunk to one or more telephones in the system. You can use the personal line button to make and receive only outside calls. To make a call, press the appropriate personal line button; no dial-out code is necessary.

You can assign a combination of up to 28 **SA Voice**, **SA Ring**, **SA Originate Only**, and Shared **SA** buttons to any telephone (but *not* to a QCC) with 28 or more line buttons, using buttons 1 through 28. Buttons 1 through 10 can be **SA** buttons, and one must be an **SA** button. Any of the remaining 27 buttons can be assigned as Shared **SA** buttons, but no Shared **SA** buttons are required. The number of personal line buttons that you can assign to a telephone is limited only by the number of trunks in the system and the number of buttons available on the telephone.

Line Buttons and Special Considerations in Behind Switch Mode

When you program the system for Behind Switch mode, the system assigns a single prime line, an **ICOM Ring** button, and an **ICOM Voice** button to each multiline telephone. When you lift the telephone handset, the prime line is selected automatically (even when it is busy) unless you have first selected a different button. The prime line connects only to the host system and from the host to an outside trunk. (For more information about local and host systems in Behind Switch Mode, see [“Modes of Operation” on page 2–16.](#))

To call another person connected to the host system, you dial the *host system extension number* assigned to that person. To access an outside trunk, you dial the host system's *dial-out code* (usually a 7), and the host system selects an available outside trunk.

In Behind Switch mode, **ICOM** buttons allow you to call other people connected to the system but not necessarily to the host. When you press an **ICOM** button, you reach an inside talk path and receive dial tone from the MERLIN LEGEND Communications System (not from the host). You can then reach co-workers without tying up a prime line.

You can use the following types of buttons to make and receive inside calls in Behind Switch mode:

- **ICOM Ring.** Use this button to make inside calls and to receive inside calls and outside calls transferred from another extension. When you use an **ICOM Ring** button to make an inside call, the telephone at the destination extension rings with one burst to indicate an inside call.
- **ICOM Voice.** Use this button to make inside calls and to receive inside calls and outside calls transferred from another extension. When you use an **ICOM Voice** button to make an inside call, the person at the destination extension hears your voice on the speakerphone after a single beep, rather than ringing. (If you are using an **ICOM Voice** button to make a voice-announced call and the user at the destination extension has a telephone with no speakerphone, or has disabled voice announcements, the telephone rings just as if the call was made on an **ICOM Ring** button.)
- **ICOM Originate Only.** Use this button to make inside calls only. Neither inside nor outside calls can be received on an **ICOM Originate Only** button. This button ensures that you always have a button available to make or transfer a call, establish a conference call, answer a call-waiting call, or pick up a parked call. You can program the button for either voice or ring operation.

You can assign a combination of up to 10 **ICOM Voice**, **ICOM Ring**, and **ICOM Originate Only** buttons to each multiline telephone, on buttons 1 through 10. The number of prime line buttons that can be assigned is limited only by the number of trunks provided by the host and the number of buttons available on the telephone.

In Behind Switch mode, you have access to the special features of both the on-site communications system and the host system. When both systems have common features, you must decide which system to use for those features.

When you press a fixed-feature **Conference**, **Drop**, or **Transfer** button, the respective host features are activated, not those of the communications system. However, an unused line button on a telephone can be programmed for the communications system's own Conference, Drop, or Transfer feature. Each system must be programmed to meet your needs, and you must give users the appropriate access instructions.

The way that buttons are programmed in Behind Switch mode has many effects on system feature use and host feature use. For details or advice when planning a modification for this mode of operation, consult your Lucent Technologies representative. Also, see Chapter 4, "Features and Applications," for additional information.

Operator Consoles

Operator consoles are telephones that you program for call handling and other system operator duties. With one exception (the MERLIN II System Display Console with built-in DSS), the telephones themselves are no different from the ones already described. In most cases, the telephone's programming and the extension jack it connects to on the control unit are what makes the telephone an operator console. An operator console can be a *Queued Call Console (QCC)* or *Direct-Line Console (DLC)*. QCCs are available only in Hybrid/PBX mode.

A system operating in Hybrid/PBX mode can include both QCCs and DLCs. [Table 3-4](#) shows the maximum number of both types of system operator positions.

Table 3-4. Maximum Number of System Operator Positions

Position Type	Type of Telephone	Maximum Positions
QCC	MLX-20L	4
DLC	MLX-20L MLX-28D BIS-34D, BIS-22, or BIS-22D analog multiline telephone MERLIN II Display Console	8

The system cannot have more than eight operator positions of any combination (QCCs and/or DLCs); if you use a combination of consoles, no more than four can be QCCs.

Queued Call Consoles

The Queued Call Console (QCC) is available only in Hybrid/PBX mode. In a QCC configuration, the system holds waiting calls in a queue and directs them to a QCC as a position becomes available. Only one call rings at a time.

The MLX-20L telephone is the only telephone that you can assign as a QCC. Unlike other users, the QCC system operator *cannot* use feature codes to activate features; however, the operator can choose features from the display and use the fixed features that have been assigned to the console buttons.

The display also tells the operator about incoming and outgoing calls: extension numbers and names (if programmed), trunk identifiers, reasons for call return and redirection, and the number of unanswered calls waiting for the operator's attention.

QCC Buttons

The system automatically sets the buttons on the QCC with fixed features, and they are not programmable by the system operator or through centralized telephone programming. The QCC has the following fixed-feature buttons:

- **Call.** Five buttons used to answer incoming calls and make inside and outside calls.



NOTE:

In Release 4.0 and later systems, the system manager can enable the Voice Announce to Busy feature on the fifth **Call** button (the factory setting is disabled). Then the QCC operator can use this button to voice announce a call to a user who can receive voice-announced calls. This setting applies to all QCCs in the system.

- **Start.** Initiates the call-directing process by putting a caller on hold at the Source button and providing an inside dial tone to the system operator.
- **Source.** Reconnects the system operator to the original caller before the call is connected to (released to) its destination.
- **Release.** Releases the system operator from a call and/or completes the call-directing process, making the operator available for another call.
- **Destination.** Reconnects the system operator to the destination before a new call is released to its destination.
- **Cancel.** Cancels call directing and reconnects the system operator with the caller (source).
- **Join.** Connects the system operator with the caller (source) and the person being called (destination) in a 3-way conference. All three parties are connected on one **Call** button.
- **Headset Mute** (Headset/Handset Mute). Activates and deactivates the headset or handset microphone.
- **Headset Status.** Activates and deactivates the headset operation of the console.
- **Headset Auto Ans** (Headset Auto Answer). Activates and deactivates the Headset Auto Answer feature when headset operation is enabled by pressing the Headset Status button.
- **Send/Remove Message.** Turns on the telephone Message light to indicate a message waiting and turns off the Message light when all system operator messages are delivered.
- **Position Busy** (Also Called *Backup On*). Temporarily takes the system operator console out of service.
- **Night Service.** Activates and deactivates Night Service.

- **Alarm.** Provides visible indication of a system alarm. When a system alarm occurs, the red light next to the button goes on. The system operator can use the **Inspect** button to determine the number of alarms.
- **Pool Status.** Provides the system operator with the status of all pools (a maximum of 11). The information includes the number of trunks and the number of busy trunks in each pool.
- **Forced Release.** Disconnects the system operator from an active call and makes the system operator available to receive another call.

You can attach one or two DSSs to a QCC. The system operator can use the DSS buttons during call handling, for example, to direct a call, make an inside call, park a call, or see the availability of an extension.

During system programming, you assign certain features and settings to QCC operator extensions. These help determine the types of calls that ring at the extension, which calls get priority, who provides backup when the operator must be away from the phone, and more. See Chapter 4, "Features and Applications," and the *Feature Reference* for details.

Keep these facts in mind if you need to work with QCCs:

- You must connect a QCC to an extension jack on a 008 MLX or 408 GS/LS-MLX module.
- Each 008 or 408 GS/LS-MLX module can carry a maximum of two QCCs.
- You must connect the first QCC to the first MLX extension jack in the system.
- You can connect QCCs only to the first and fifth extension jacks on each module.
- You can connect up to four QCCs for the system.

Direct-Line Consoles

A Direct-Line Console (DLC) operates like other multiline telephones. In all three modes of operation (Key, Hybrid/PBX, and Behind Switch), you assign (or the system automatically assigns) outside lines to individual buttons on the console. You can assign the lines that have been assigned to a DLC to buttons on other consoles or other telephones. Incoming calls can ring on any of the line buttons, and several calls can ring at the same time. The operator directs calls to other users by using the **Transfer** button.

A DLC can use system operator features as well as the telephone features available for non-operator multiline telephones to increase call-handling efficiency. The special system operator features that you can assign to buttons on the console are Alarm, Night Service, Reminder Service for sending reminder beeps

to other telephones, and Send/Remove Message. (For more information about these features, see Chapter 4, "Features and Applications," or see the *Feature Reference*.)

You can use the following telephones as DLCs:

- MLX DLC:
 - MLX-20L telephone
 - MLX-28D telephone
- Analog DLC
 - MERLIN II System Display Console with built-in DSS (the only telephone model that is uniquely used as an operator console)
 - BIS-34D telephone
 - BIS-22D telephone

You can add one or two DSSs to the MLX-20L or MLX-28D telephone to provide 150 (3 pages for each of 50 buttons) or 300 (3 pages for each of 50 buttons for each of 2 DSSs) of additional extension buttons. You cannot attach a DSS to an analog DLC; however, the MERLIN II System Display Console provides a built-in DSS, and Auto Dial buttons can be programmed on BIS phones for rapid access to extensions.

Keep these facts in mind if you need to work with DLCs:

- You can connect an analog DLC to an analog extension jack on either a 008 or a 408 analog multiline telephone module; an MLX DLC connects to a digital extension jack on a 008 MLX or a 408 GS/LS-MLX module.
- When you assign both DLCs and QCCs in Hybrid/PBX mode, the maximum combined number of system operator positions is eight; no more than four can be QCCs. You can assign a maximum of two DLCs per MLX or analog module.
- Only multiline telephones that are connected to the first and fifth extension jacks on MLX or analog modules can be assigned as DLCs. This includes DLCs assigned as calling group supervisors and Call Management System (CMS) supervisors. CMS must be connected to two extension jacks programmed to support analog DLCs.
- You can use an MLX-20L telephone set up as a DLC for system programming if you connect it to the first or fifth extension jack on the first MLX module and then designate that jack for system programming.

Adapters

This section describes the adapters that connect adjuncts to the system and to telephones. System adapters connect directly to the control unit; telephone adapters connect adjuncts to telephones.

System Adapters

Three system adapters connect directly to the control unit: a channel service unit (CSU), the Loop-Start Trunk Adapter, and the PagePal™ paging access adapter.

A *channel service unit (CSU)* is the interface between the 100D module and the Digital Signal 1 (DS1) T1 facility provided by the telephone company.

The Loop-Start Trunk Adapter and PagePal connect loudspeaker paging systems. The PagePac® Plus loudspeaker paging systems require no system adapter.

Installation and operation of these adapters, as well as planning for them, is handled by Lucent Technologies.

Telephone Adapters

The adapters described below connect adjuncts to telephones.

Multi-Function Module

The Multi-Function Module (MFM) enables you to connect tip/ring (T/R) or supplemental alert adjuncts to an MLX telephone. The MFM is a circuit board that mounts inside the telephone. Adjuncts plug into a modular jack on the MFM. The MFM is the only T/R adapter used with MLX telephones. You cannot install an MFM in an MLX-20L telephone that is set up for QCC operation.



WARNING:

Only a qualified technician can install or repair an MFM. To eliminate the risk of electrical shock, do not disassemble the MLX telephone.

T/R adjuncts operate independently of the MLX telephone. If the telephone is in use, the adjunct can send and receive voice or data calls. An MFM accommodates the following T/R adjuncts:

- Answering machines
- Fax machines
- Modems
- Credit card verification terminals

- Cordless telephones
- Single-line touch-tone telephones
- Supplemental alerts (bells, chimes, horns, and strobes)

The MFM is shipped with a power supply that supports one MFM and one DSS. When you connect two DSSs to a telephone, ask your Lucent Technologies representative about getting a different power supply. With either type of power unit, the total cord length cannot exceed 50 feet (15 m) from the telephone.

The MFM supports only touch-tone dialing and does not detect pulse dialing.

You cannot transfer or conference calls from a device connected to an MFM or use the Hold or Pickup features.

The MFM uses one of the two channels when it is active. A channel carries a voice or data call between the system and the extension. This means you cannot use Voice Announce and Speakerphone Paging when an adjunct (such as a fax machine) and an MLX telephone are in use at the same time. When Voice Announce is in use, a person calling an MFM extension gets a busy signal; a person attempting to call out from an adjunct extension with an MFM does not get a dial tone. Also, an adjunct connected by an MFM cannot provide a switchhook flash.

A qualified service technician sets up your MFMs to work with either an adjunct or a supplemental alert.

General Purpose Adapter

A General Purpose Adapter (GPA) enables you to connect a tip/ring (T/R) device—such as a single-line telephone, modem, or answering machine—to an analog multiline telephone. The device must be touch-tone, not rotary, and you must make calls from the analog multiline telephone, because the GPA has no pulse or touch-tone detectors.

The switch on the back of the GPA lets you choose one of the following services:

- **Basic.** Use this setting to dial and answer calls on an analog multiline telephone or to attach a T/R device such as a single-line telephone or a fax machine. Incoming calls ring only on the analog multiline telephone.
- **Join.** Use this setting to add a recording device or a single-line telephone to a call that is in progress on the analog multiline telephone. You cannot originate or answer calls on this setting.
- **Automatic.** When using a GPA set to Automatic, you must lift the handset before using any feature that automatically turns on the speakerphone. These features include Authorization Codes, Auto Dial, Last Number Dial, and Saved Number Dial. You can use this setting in two ways:

- For devices that answer calls, for example, an answering machine or a modem (you need a programmed Auto Answer All button to allow the device to answer calls automatically).
- For voice and data, which enables you to make and receive calls on the telephone when the modem attached to the GPA is busy. You cannot make or receive a data call while on a voice call.

A GPA is *not* recommended for use with a fax machine. See [“Fax Machines” on page 3-38](#).

Adjuncts

This section describes the adjuncts that you can use with the system. System adjuncts connect directly to the control unit and serve the whole system. Telephone adjuncts attach to telephones and serve particular extensions.

System Adjuncts

The system adjuncts described in this section connect directly to the control unit and serve the whole system.



NOTE:

Modems can be connected directly to a 012 or 016 (Release 4.0 or later) module on the control unit or to an extension. (See [“Telephone Adjuncts” on page 3-39](#).)

Station Message Detail Recording Printer

You can connect a Station Message Detail Recording (SMDR) printer to the SMDR jack on the processor module. You need this printer so that you can use system programming to get copies of reports about the system.

SMDR captures detailed usage information about incoming and outgoing voice and data calls and sends the information to a printer. Two SMDR report formats are available: the factory-set Basic format and the Integrated Services Digital Network (ISDN) format. Use the ISDN format if you subscribe to an ISDN network service (such as the AT&T INF02 Automatic Number Identification) or have an 800 GS/LS-ID module and caller identification service from the central office (CO). If you select the ISDN format during system programming, the number identification information prints in the CALLED NUMBER field of the call report. The remainder of the fields are identical to the Basic format.

An SMDR record consists of the following fields:

- CALL TYPE (Basic or ISDN)

- DATE
- TIME
- CALLED NUMBER
- DUR (duration)
- LINE (facility number)
- STN (extension)
- ACCOUNT (account code or authorization code if no account code is entered)
- TALK (Release 5.0 and later systems only; amount of time an Auto Login or Auto Logout calling group agent spends talking to a caller)

The printer should be a 1,200-bpi serial printer set at no parity and one stop bit. For more information, contact your Lucent Technologies representative.

Also, a Call Accounting Terminal application is available for tracking and printing reports on telephone charges. In Release 5.0 and later systems, the MERLIN LEGEND Reporter application provides detailed reports to assist managers in determining calling group agent performance as well as facilities and staffing needs. See ["Applications" on page 4-60](#) for more information.

System Programming and Maintenance PC

You can use a PC with MS-DOS[®] version 3.3 or higher and System Programming and Maintenance (SPM) software to program and maintain the system. Beginning with version 4.25, required for Release 4.1 systems, SPM runs as a DOS application under Windows 95. The PC connects to the ADMIN jack on the processor module. For additional information, see *System Programming* or contact your Lucent Technologies representative.

Loudspeaker Paging Systems

Loudspeaker paging systems use a ground-start/loop-start (GS/LS) line jack. Up to three loudspeaker paging systems can be attached to the control unit. You can program up to three line ports as paging ports. If you connect a paging system other than PagePac Plus, you must also install a Loop-Start Trunk Adapter.

If a loop-start line jack is used for paging, you cannot use it for outside calls unless you install a PagePac Port Saver.

PagePac Plus Loudspeaker Paging System from Lucent Technologies does not require an adapter. The PagePac controller comes equipped with 8 built-in zones, expandable to as many as 48 zones with 16-zone zone expansion modules. PagePac Plus also provides a music source for paging and Music On Hold without a music coupler.

Dial Dictation

You can use a dictation unit as either a system or extension adjunct. Some dictation units connect directly to the control unit via a T/R jack on the 012, 016 (Release 4.0 and later) module or 008 OPT module, or to a telephone using an MFM or a GPA. Other dictation units connect to a PagePal unit that in turn connects to a loop-start port programmed for dial dictation (similar to loudspeaker paging).

Fax Machines

Most industry-standard fax machines work with the system. You can connect a fax machine to the control unit via a T/R jack on the 012 or 016 (Release 4.0 and later) T/R module or to an MFM. Using a fax machine with a GPA is not recommended because the fax machine cannot dial through the GPA. You can use a fax machine as an MLX telephone adjunct if you use it with an MFM.

A fax machine originates and receives fax calls independently of any associated telephone. You can dial calls from the fax machine's dialpad or from an associated single-line telephone.

If the system does not have DID trunks, you should program fax extensions to personal lines. When the system has DID service, it can direct incoming calls automatically to individual fax extensions or to machines in calling groups.

Delay Announcements

Use up to 10 primary delay announcement devices and one secondary device (Release 5.0 and later systems only) to cover incoming calls that wait for an available calling group member (see ["Group Features" on page 4-53](#) for more information about calling groups). To make announcements, use industry-standard announcement devices, which must have disconnect and announcement features. The devices connect directly to an extension jack on a 012, 016 (Release 4.0 and later), or 008 OPT module. Alternatively, an announcement device can connect to an MLX telephone equipped with an MFM or to an analog multiline telephone with a GPA.

Door Phone

The Lucent Technologies Door Phone enables you to speak directly—over the telephone—with people outside your locked business door. When a visitor presses the button on the Door Phone Speaker, it rings a predesignated extension or activates an alert device. You can then speak to the person by using the predesignated phone. Use system programming to designate which phone rings. The Door Phone controller unit connects to a 408 or 800 line/trunk jack.

You can attach an answering machine to greet off-hours visitors or let them leave a message. You can also attach an electromechanical door lock so you can unlock the door by dialing a special code from the telephone.

Telephone Adjuncts

The telephone adjuncts described in this section connect to a telephone either directly or through an adapter.

Modems

A modem can connect at an extension or directly to a 012 or 016 (Release 4.0 and later) module on the control unit.

A modem connected to an MLX telephone requires a Multi-Function Module (MFM); a modem connected to an analog multiline telephone requires a GPA (General Purpose Adapter).

You can connect most industry-standard modems to the system.

Headsets

Headsets allow for hands-free telephone use and consist of several components, depending upon whether manual or one-touch operation is used. Any Lucent Technologies headpiece works in either of these two modes of operation. For more information about installing and using headsets, see the user or operator guide for the telephone where the headset is connected.

Headpieces

Six different headpieces are available as headset components. Each is light, comfortable, and uses a transparent voice tube to eliminate any cumbersome large microphone.

- **Mirage[®]**. Receiver fits over either ear. Not for noisy environments.
- **StarSet[®]**. Eartip fits in ear canal.
- **Supra[®] Monaural**. Adjustable headband and soft ear cushion.
- **Supra Monaural Noise-Canceling (NC)**. Same as above with noise-canceling microphone that reduces background noise by up to 75 percent.
- **Supra Binaural**. Sound in both ears. Features windscreen and reduces background noise transmission by up to 75 percent.
- **Supra Binaural Noise-Canceling (NC)**. Same as above with noise-canceling microphone on flexible boom; features windscreen and reduces background noise transmission by up to 75 percent.

Manual Operation (Analog Multiline Telephones Only)

Manual operation is appropriate when a headset is used occasionally. You must pick up the handset to answer a call and replace it to hang up.

One-Touch Operation (MLX and Analog Multiline Telephones)

One-touch operation allows you to simply touch a button to answer a call and touch another button to hang up.

Specialty Handsets

Model K6S handsets, for users who are hard of hearing, are available for use with MLX telephones.

Four additional specialty handsets are available:

- **Noise-Canceling Handset.** Reduces background noise in an office environment; provides 10 dB (nominal) reduction.
- **High Noise-Canceling Handset.** Reduces background noise in a factory- or warehouse-type environment; provides 20 dB (nominal) reduction.
- **Amplified Speech Handset.** Amplifies the voice of the other party; provides 0 dB to 10 dB (nominal) voice gain.
- **Push-to-Talk Handset.** Activates the mouthpiece only when you push the button on the handset.

Message-Waiting Indicator

You can connect the Z34A message-waiting indicator to single-line telephones that do not have Message lights.

Additional Telephone Adjuncts

You can also connect answering machines and credit card verification terminals to telephones.

Data Communications Adjuncts

You can use a variety of data communications equipment (DCE) with the system. This equipment connects to analog, T/R (tip/ring), or MLX extension jacks and to analog or digital lines/trunks. Data terminal equipment (DTE), such as a PC, connects to the DCE. Generally, dialing is performed at the DTE keyboard, although some configurations use a telephone or data module for dialing. When a telephone is included in your data workstation, you usually use an MFM or GPA as well.



NOTES:

1. For the most up-to-date information about data and video communications, consult the *Data/Video Reference*.
2. If you are using data or video communications devices with the system, contact your Lucent Technologies representative to find out whether there is an applications note that describes the installation and use of your particular equipment.

The types of DCE that the system supports include:

- **Modems.** The system works with a variety of modems for data communications use within the system over analog system lines, or over analog lines/trunks, such as standard loop-start or ground-start lines/trunks (as well as T1 voice facilities emulating ground-start or loop-start lines/trunks). A modem can connect an MLX telephone (with an MFM installed). The modem serves a data terminal (such as a PC or printer) and connects to the system through an MLX extension jack. A GPA allows connection of a modem to an analog extension jack and analog multiline telephone. A modem can also connect to a T/R extension jack on a 008, 012, or 016 (Release 4.0 and later) module for use with data terminals that do not share an extension with a telephone.

- **ISDN Terminal Adapters.** Also called *digital modems*, these devices allow high-speed data or video communications over digital facilities.

An *ISDN terminal adapter* is designed for digital communications within the system or over NI-1 BRI (National Integrated Services Digital Network Basic Rate Interface), PRI (Primary Rate Interface), or T1 Switched 56 facilities. A terminal adapter serves the same purpose as a modem but facilitates high-speed digital communications. Terminal adapters always connect to the system through MLX extension jacks.

You can set up a terminal adapter to handle a variety of data terminal equipment (DTE), including V.35 group videoconferencing systems and Group IV (G4) fax machines.

- **Inverse Multiplexors (IMUXs).** These devices are used to allow data and video communications over two channels or B-channels of a digital facility.
- **Other Access Devices.** The system also supports connection of the Ascend Pipeline 25-Px access device (Release 4.0 and later systems) or Ascend Pipeline 50 for data communications over digital facilities at 56, 64, 112, or 128 kbps. In addition, the built-in DCE included in some videoconferencing systems is supported.



NOTE:

You cannot connect a DCE to a QCC.

In Release 4.0 and later systems, you can program (see *System Programming* for more information) an MLX extension jack for 2B data. This allows some communications equipment, such as desktop videoconferencing systems and the Ascend Pipeline 25-Px or Ascend Pipeline 50, to use both B-channels of an MLX extension jack to make and/or receive 2B calls. To use 2B data, the MLX port must be programmed for this capability. Extensions for MFMs or data communications equipment not supporting 2B data, such as ISDN terminal adapters, should not be programmed for 2B data.

Videoconferencing Systems

The system supports videoconferencing systems with these types of interfaces and built-in DCE or data communications adjuncts:

- **ISDN/BRI.** Beginning with Release 4.0, the system supports desktop and group videoconferencing systems that connect to a single MLX port and support speeds of 56 kbps or 64 kbps over digital facilities. Using the system's 2B Data feature described later in this topic, both B-channels of the MLX port are used to support 2B data calls, at speeds of 112 or 128 kbps (not all video systems support all speeds). These installations do not require separate data communications equipment (DCE).
- **V.35.** Older group video systems with a V.35 use either an inverse multiplexor (IMUX) or two ISDN terminal adapters as their DCE. Some systems include the DCE, and some require separate data communications equipment. With a V.35 interface, a video system must be connected to two MLX extension jacks; it uses the adjunct extensions of each jack to send and receive video calls over two B-channels at speeds of 112 or 128 kbps, depending on the video system and digital facility.

Passive Bus

Some desktop videoconferencing systems allow the extension to include an MLX telephone connected directly to the desktop video system. In this configuration, the desktop video system can use both B-channels for 2B data video calls, as long as the MLX telephone is not making or receiving a call.

If the desktop video system supports 1B data, it can make or receive a call using only one B-channel while the MLX telephone is on a call. One B-channel is not generally adequate for video, but some desktop video applications can switch to two channels once the MLX telephone is not on a call.



NOTE:

See "[Desktop Videoconferencing](#)" on page 5-22 and "[Group Videoconferencing](#)" on page 5-23 for more information about videoconferencing applications.

Ascend Pipeline 25-Px Access Device

This communications device requires Release 4.0 or later. It combines the capabilities of an ISDN terminal adapter and a LAN router, allowing high-speed access to Internet services over digital facilities, or permitting a remote user to dial into a main-site LAN server. It allows outgoing calls only. The Pipeline 25-Px connects to the serial port on a PC, to a PC's network access card, and to an MLX extension jack on the control unit.

The Pipeline 25-Px can use the system's 2B Data feature when it is programmed for the MLX extension jack. This permits data communications of 112 or 128 kbps, depending upon the digital facility, which must be ISDN PRI or NI-1 BRI. In addition, the Pipeline 25-Px allows Internet and LAN connections at 56 or 64 kbps.

One Pipeline 25-Px is required for each PC, and you cannot connect a phone, fax machine, or other device to the Pipeline 25-Px. To use this device for high-speed Internet access, you must have an ISDN account with an Internet service provider (ISP), as well as client software for browsing, email, and other applications.



NOTE:

For more information about installing and using the Pipeline 25-Px from Ascend Communications, Inc., contact your Lucent Technologies representative and request the MERLIN LEGEND Communications System Application Note, *The Internet Connection*.

Summary

[Table 3-5](#) is a summary of the adjuncts.

Table 3-5. Adjunct Summary

Equipment	Description
<p>Alerts (AC): Any audible or visual alert that operates on 20–30 Hz ringing signals; associated with a specific extension (supplemental alert).</p>	<p>Can be connected to:</p> <p>008 OPT, 016 (Release 4.0 and later), or 012 T/R extension jack MFM and MLX extension jack GPA and analog extension jack</p>
<p>Alerts (DC): Audible or visual alert operating on 48-VDC ringing signals; associated with specific extension (supplemental alert) or works on programmed trunk jack (external alert).</p>	<p>Can be connected to:</p> <p>LS trunk jack Requires adapter to provide 48 VDC. MFM and MLX extension jack SAA and analog extension jack</p>
<p>Answer/Record Machine: Industry-standard machine; low ringer equivalence (< 0.15 or < 1.0 total REN for T/R port). It has ability to recognize 600-ms disconnect signal or other means of automatic disconnect (such as voice reset disconnect timer, fixed recording time).</p>	<p>Can be connected to:</p> <p>008 OPT, 016 (Release 4.0 and later), or 012 T/R extension jack MFM and MLX extension jack GPA and analog extension jack <i>Cannot be connected to a QCC.</i></p>
<p>Ascend Pipeline 25-Px: Acts as DCE for high-speed data communications from a PC over digital facilities; also allows remote access to a LAN via the PC's network access card.</p>	<p>Can be connected to:</p> <p>MLX extension jack PC serial port PC network access card <i>Cannot be connected to a telephone, fax machine, or other communications equipment.</i></p>
<p>Credit Card Verification Terminal: Must have touch-tone dialing capability when connected by MFM; rotary or touch-tone dialing can be used on T/R port.</p>	<p>Can be connected to:</p> <p>008 OPT, 016 (Release 4.0 and later), or 012 T/R extension jack MFM and MLX extension jack With MFM, device originates and receives calls independently of phone. GPA and analog extension jack <i>Cannot be connected to a QCC.</i></p>

Continued on next page

Table 3-5. Continued

Equipment	Description
Dial Dictation: A device that requires contact closure can be used on LS/GS line jack only with adapter.	Can be connected to: LS or GS/LS trunk jack 008 OPT, 016 (Release 4.0 and later), or 012 T/R extension jack MFM and MLX extension jack GPA and analog extension jack <i>Cannot be connected to a QCC.</i> <i>Requires adapter to provide 48 VDC.</i>
Direct Station Selector (DSS): A maximum of two DSSs per operator console; 329A power supply required for console with two DSSs.	Connects to DSS jack on MLX operator console only.
Door Phone: Use system programming to designate phone to ring.	Connects to loop-start line/trunk jack.
Fax: Must have touch-tone dialing if connected by MFM; rotary or touch-tone dialing can be used on T/R port. Industry-standard analog interface.	Can be connected to: 008 OPT, 016 (Release 4.0 and later), or 012 T/R extension jack MFM and MLX extension jack With MFM, device originates and receives calls independently of phone. <i>Cannot be connected to a QCC.</i>
Group Calling Delay Announcements: Industry-standard devices that provide disconnect and announcement features. Each calling group can have 10 primary delay announcement devices and 1 secondary device*. Devices can provide delay announcements for more than one group.	Can be connected to: 008 OPT, 016 (Release 4.0 and later), or 012 T/R extension jack MLX telephone with MFM and MLX extension jack (with MFM, device originates and receives calls independently of phone) Analog multiline telephone with GPA and analog extension jack <i>Cannot be connected to a QCC.</i>
Hands-Free Unit	Connects to analog multiline phones.
Headsets and Adapters	Connect to MLX/analog multiline phones.

Continued on next page

Table 3-5. Continued

Equipment	Description
Loudspeaker Paging: External paging system using DTMF signaling. Customer paging systems require an interface unit: for 3-wire input, PagePal can be used.	Connects to LS or GS/LS trunk jack. Bidirectional paging supported; only one line jack is needed for multizone paging.
Message-waiting indicator	Connects to single-line phones.
Modem	Can be connected to: 008 OPT, 016 (Release 4.0 and later), or 012 T/R extension jack MFM and MLX extension jack, GPA and analog extension jack
Music On Hold: [†] Any FCC-registered 8-ohm music source or recorded announcement device.	Connects to LS or GS/LS trunk jack. <i>Music coupler required.</i>
SMDR Printer: Must be located within 50 ft. (15 m) of control unit or use Asynchronous Data Unit (ADU); should be 1,200-bpi serial printer set at no parity and one stop bit.	Connects to SMDR jack on processor module.

* Release 5.0 and later systems only; in earlier releases, a group can have only one primary announcement device.

† If you use equipment that rebroadcasts music or other copyrighted materials, you may be required to obtain a copyright license from and pay license fees to a third party such as American Society of Composers, Artists, and Producers (ASCAP) or Broadcast Music Incorporated (BMI). Or you can purchase a Magic on Hold system, which does not require you to obtain such a license, from Lucent Technologies.

Power-Related Hardware

Your Lucent Technologies representative can plan for added power-related hardware to provide your system with additional power and protection from power surges, although most systems do not need extra surge protection. Other accessories apply to system-specific conditions.

Power Accessories

In a power failure, battery backup units can keep the system running for several hours. When you connect adjuncts and adapters to telephones, the power requirements for the telephones and the system increase. Sometimes it is necessary to add a power accessory, described in this section, to an individual telephone or to the system to accommodate these additional needs.

System Auxiliary Power

When your system is installed, when you change the system operating mode, or when you expand your system, a Lucent Technologies technician calculates the *unit load* on your system and determines your overall power needs. A unit load is a measure of power used to determine the electrical load that the following components have on each carrier's power supply:

- Telephones and adjuncts
- 800 DID modules

Only the telephones and adjuncts that connect to the analog and MLX extension jacks on the control unit require unit load calculation, not equipment that has its own power supply (for example, a fax machine, an MFM, or an answering machine). If, after a system is changed, additional power is required for the control unit, your Lucent Technologies representative sees that an auxiliary power unit is installed.



NOTE:

Some system power supplies limit the number of 100D modules and 800 NI-BRI modules (Release 4.0 and later systems only) installed in a carrier. A newer power supply, the 391A3, eliminates the restriction. Consult your Lucent Technologies representative for details.

Battery Backup Power

An Uninterruptible Power Supply (UPS) unit can provide battery backup for power to the system. Basic UPS provides power for 15 minutes; however, you can add reserve UPS units to basic UPS. Each reserve unit extends backup power for an additional hour.

Telephone Power Units

The KS22911-L1 and 329A power units provide additional power to MLX or analog multiline telephones that have adjuncts, adapters, or two DSSs attached (MLX telephones only), or to telephones located far from the control unit.

These power units are installed between the telephone and the wall jack. Adding local power to a few telephones can reduce system load.

Protection Accessories

This section describes accessories that are needed for grounding and protecting special telephone connections from power surges, electromagnetic interference, and electrostatic discharge.

In-Range Out-of-Building Protection

Your Lucent Technologies representative orders an In-Range Out-of-Building (IROB) protection unit when equipment is connected to the following jacks and is located in a different building but within 1000 feet (305 m) of the control unit:

- Analog multiline telephone extension jacks on 008, 408, and 408 GS/LS modules
- MLX telephone extension jacks on 008 MLX or 408 GS/LS-MLX modules

These units protect the equipment and the control unit from lightning strikes and power surges. Each piece of equipment requires two units, one for the control unit end of the wire run, the other for the equipment end.



CAUTION:

The IROB protectors must be installed by a qualified service technician or installer.

Off-Premises Range Extender

An Off-Premises Range Extender (OPRE) is used for off-premises extensions up to 5.2 miles from the control unit.

146A and 147A Surge Protectors

If you work in an area prone to heavy lightning and/or power surges, the control unit may require surge protectors. The control unit's power supply has built-in protection, so extra protectors are not usually necessary. It is the responsibility of the local telephone company to provide primary protection on the outside lines where they connect to the control unit and to ensure that these protectors are properly grounded. If the telephone company line protector is properly grounded and bonded to the AC power ground, most lightning damage is prevented.

When your system is installed, your Lucent Technologies representative sees that you have the necessary protection. If electrical conditions change, contact your representative and ask for advice.

Electromagnetic Interference Filters

Your Lucent Technologies representative recommends these filters for certain environments where electric motors, radio transmitters, or other radio-frequency generating equipment may interfere with telephone reception.

System Alarms

An alarm condition detected by the system can cause the control unit to activate an alarm device on a loop-start port. When the contacts close, a signal goes to a PagePal unit and then to an external alert (a strobe, horn, bell, or chime).

Trouble Alarm

System operator consoles have programmed Alarm buttons to let you know if there is a problem with the system. An external bell or light can be attached to a console to supplement the button. If this is not enough notice of a system problem, a Lucent Technologies technician can use a loop-start line jack and an adapter to attach a bell or strobe light to the system.

Power-Failure Alarm

A Lucent Technologies technician can use a ground-start or loop-start power-failure transfer (PFT) telephone jack to attach an alerting device that goes off during a power failure. You can connect a PFT telephone to this jack when the jack is connected for a power-failure alarm.

Power-Failure DID Busy-Out

A Lucent Technologies technician may program the PFT jack on a ground-start or module to automatically short the *busy-out* wire pair for a group of DID trunks when a power failure occurs. This signals the CO that the DID trunks are out of service.

Power-Failure Transfer Telephone

A power-failure transfer (PFT) telephone is a single-line telephone connected to a PFT jack on a 400, 400/GS/LS, 408, 408 GS/LS, 408 GS/LS-MLX, 800, 800 GS/LS, or 800 GS/LS-ID module. If there is a power failure, the system shuts off and the PFT telephone automatically connects to an assigned outside line for making and receiving calls.

When your system was planned, your Lucent Technologies representative made sure that it had a module to support one or more PFT telephones in case of an emergency. For more information, contact your Lucent Technologies representative.



NOTES:

1. The PFT jack does not operate unless a power outage occurs or the power supply units are turned off.
2. The PFT telephone can be any basic single-line telephone; a single-line telephone that is connected to an MFM cannot be a PFT telephone.
3. If rotary lines/trunks are in the system, you must use rotary telephones (500MMs recommended) as PFT telephones.

Features and Applications

4

This chapter offers descriptions of system features and applications that are available to help enhance your system. System features make it possible to customize the system to overall business needs, to the requirements of groups within your organization, and to the day-to-day job functions of individuals. Applications provide special functions for specific business needs and work hand-in-hand with system features.



NOTE:

Release 6.0 and later systems (Hybrid/PBX mode only) support private connections between MERLIN LEGEND Communications Systems and DEFINITY Enterprise Communications Server (ECS) or DEFINITY ProLogix Solutions systems using private networks or the public switched telephone network. This aspect of the system is not covered in this guide. For complete information, see the *Network Reference*.

The goal of this chapter is to help you assess system features and applications and decide which are best for your organization's needs as they change. Although features and applications are set up for you at installation, when you add a new user to the system, for example, you may want to consult this chapter for an overview of the feature- and application-related decisions you need to make.

This section provides an overview of the features only. For detailed information, especially about important considerations and feature interactions, refer to the *Feature Reference*.

Features

While there is some overlap, features can be divided roughly into five categories:

- **User Features.** Used at extensions by individuals, including Direct-Line Console (DLC) operators or calling supervisors, to make work easier. User features include Saved Number Dial, Personal Speed Dial, and Personal Directory.
- **Operator Features.** Used by system operators exclusively or primarily for rapid call handling and for monitoring extensions. Operator features are planned by the system manager.
- **General Systemwide Features.** Features and settings that apply to all or most users, for example, One-Touch Hold. These features are set at installation but may need to be changed by you later on.
- **Group Features.** Some user features are planned and/or programmed by the system manager for groups of users. Groups may be set up to answer calls that are not directed to an individual, to have calls covered, to receive speakerphone pages, or to pick up one another's calls. Groups must be set up to associate extensions with operators for Night Service operation.
- **System Management Features.** Features that help you manage the system by, for example, giving you reports on system usage and programming. System managers also plan and implement some features that affect overall system security or efficiency, such as calling restrictions or Automatic Route Selection (ARS).

This section contains:

- **Feature Finders.** Quick reference tables that enable you to look up a feature name according to what it does.
- **Feature Descriptions.** Although a complete list of features (in alphabetical order) with detailed descriptions is contained in the *Feature Reference*, this section expands on the Feature Finders and presents brief descriptions according to the business needs they fulfill.

For example, there are several different coverage methods available. The section [“Covering Calls” on page 4–34](#) describes and compares each method and suggests when you might want to use each. In the next chapter, you see features at work in sample business scenarios.

Feature Finders

The Feature Finders in this section describe features according to activity. Some system management features and all operator-only features are listed in their own Feature Finders. For each feature, the type of feature is noted as well: user, operator, group, general, or system management.

The third column, labeled *PROG*, classifies the feature according to whether it is programmable by regular users (extension programming, abbreviated *EXT*), only by the system manager using centralized telephone programming (abbreviated *CNT*), or only by the system manager using system programming (abbreviated *SYS*). If a feature is labeled *SYS*, you should consult *System Programming* for full programming instructions.



NOTE:

Any feature that can be programmed using extension programming can also be programmed by centralized telephone programming. However, some features can *only* be programmed using centralized telephone programming; these are the features with the *CNT* label.

The following list summarizes the Feature Finders:

- Basic Calling and Answering
 - Answering calls
 - Conferencing and joining calls
 - Dialing and calling
 - Paging
 - Putting a call on hold
 - Transferring calls
 - Using the system from an outside phone
- Covering Calls and Having Calls Covered
 - Covering others' calls
 - Controlling coverage by others
- Timekeeping
- Calling Privileges and Restrictions
 - Preventing people from making calls
 - Allowing calls
- Customizing Phones
- Messaging
 - Leaving messages
 - Receiving messages
 - Setting up messaging
- System Management Functions
 - Group activities

- Lines, line buttons, fixed-feature buttons
- Maintenance
- Numbering lines and extensions
- Operators
- Reports
- Security
- Special Operator and Supervisor Features

Basic Calling and Answering

This Feature Finder ([Table 4-1](#)) covers features that users and Direct-Line Console (DLC) operators may need for basic calling and answering. Operator-only features are listed in the Operator Feature Finder. Note, however, that many of the features here are used by operators, especially DLC operators, as well as regular telephone users.

Table 4-1. Feature Finder: Basic Calling and Answering (Non-Networked Systems)

Basic Calling and Answering	Type	PROG	Considerations	Feature Name
Answering calls				
See the phone number of an outside caller before answering.	General	SYS	MLX display only; requires 800 GS/LS-ID module and caller identification service from phone company. Or requires PRI and Automatic Number Identification (ANI) service.	Caller ID Primary Rate Interface (PRI) and T1
Answer a call ringing at an extension other than your own.	User	EXT		Pickup
Answer a call ringing on a line that is not on your phone.	User	EXT		Pickup
Answer calls for another person or for a group. See Table 4-2 on page 4-13 .	User Operator Group	SYS EXT		Coverage Forward and Follow Me
Take calls for another person after the calls ring at his or her extension, giving the other person a chance to answer first.	User Operator	EXT	Not for QCC	Coverage Forward and Follow Me (Release 4.0 and later only)
Take calls for another person when all his or her SA or ICOM buttons are in use.	User	EXT		Forward and Follow Me (Release 4.1 and later only)

Continued on next page

Table 4-1. Continued

Basic Calling and Answering	Type	PROG	Considerations	Feature Name
Answering calls (continued)				
Answer calls as part of a group that responds to a certain type of call.	Group	SYS		Group Calling Extension Status
Answer a call waiting for you when all your SA or ICOM buttons are in use.	User	EXT		Call Waiting
Answer calls that come to your extension while you are at another extension.	User	EXT		Forward and Follow Me
Answer without using your hands, using a Hands-Free Unit.	User	EXT	For analog multiline without speakers	Auto Answer Intercom
Answer calls using a headset.	User	EXT	MLX or analog multiline	Headset Options: Headset Hang Up (CNT, MLX) Headset Status (CNT, MLX) Headset Auto Answer (EXT, MLX) Headset/Handset Mute (EXT, MLX) Auto Answer All (CNT, analog)
Answer calls using a modem or fax machine (necessary only on analog multiline phones).	User	EXT	Analog multiline, not for QCC	Auto Answer All

Continued on next page

Table 4-1. Continued

Basic Calling and Answering	Type	PROG	Considerations	Feature Name
<i>Conferencing and joining calls</i>				
Conference inside and outside parties where the inside parties do not share a line.	General	SYS	In Release 4.0 and later, system manager can disable on single-line phones.	Conference
Prevent others from joining your calls.	User	EXT	Not for QCC	Privacy
Join a caller and the extension he or she wants.	General	SYS	Not for QCC. In Release 4.0 and later, system manager can disable on single-line phones.	Transfer
<i>Dialing and calling</i>				
Dial an inside or outside number with one touch.	User	EXT	Not for single-line or QCC	Auto Dial
Call anyone in a group at your company.	Group	SYS		Group Calling
Automatically dial a preset outside or inside number by picking up the handset on a single-line telephone.	User	SYS	Single-line telephones only	HotLine (Release 5.0 and later systems)
Make a voice-announced call.	User	CNT	MLX and analog multiline only	System Access/Intercom Buttons
Prevent or allow voice announcements to your telephone when it is busy.	User	SYS EXT	MLX and analog multiline only	Voice Announce to Busy

Continued on next page

Table 4-1. Continued

Basic Calling and Answering	Type	PROG	Considerations	Feature Name
<i>Dialing and calling (continued)</i>				
Set up account codes so that calls can be billed or tracked to a specific client or project.	General	SYS		Account Code Entry/Forced Account Code Entry
For billing to a project or client, use an account code before or during a call.	User	EXT		Account Code Entry/Forced Account Code Entry
Enter a 3-digit code to call a number that people in your company call often.	General	SYS		Speed Dial (System Speed Dial)
Enter a 2-digit code to dial a party you call often.	User	EXT	Phones with 10 or fewer buttons only	Speed Dial (Personal Speed Dial)
Dial by selecting a name from the display for a number that you call often	User	EXT	MLX-20L only	Directories (Personal Directory)
Dial by selecting a name from the display for a number that people in your company call often.	General	SYS	MLX display phones	Directories (System Directory)
Call a co-worker who has left a message on your display, with one touch.	User	CNT EXT	Display phones only	Messaging (Return Call)
Make a call outside normal office hours.	User	SYS		Night Service
Call a number you dialed before.	User	EXT	All but QCC	Last Number Dial Saved Number Dial

Continued on next page

Table 4-1. Continued

Basic Calling and Answering	Type	PROG	Considerations	Feature Name
<i>Dialing and calling (continued)</i>				
Call a busy extension and reach it when it is available.	User	EXT	All but QCC. Do not use Camp-On if your system has voice mail.	Callback Camp-On
When lines are busy, wait for an available line and then have your call put through.	User	EXT	All but QCC	Callback
Change the Extension Directory to reflect new or changed extensions.	General	SYS	Display phones only	Labeling
Change a user's Personal Directory listings.	User	EXT	Display phones only	Labeling
Change the System Directory so that people can call often-used numbers quickly.	General	SYS		Labeling
Transfer a caller to a voice mailbox, if available, without calling the extension.	User	EXT		Direct Voice Mail
Call a co-worker's voice mailbox, if available, without calling extension.	User	EXT		Direct Voice Mail
Make a call from someone else's extension using your own calling privileges.	User	EXT		Authorization Codes
Make a call using a special long-distance service.	User	SYS		Primary Rate Interface (PRI) T1 Switched 56 Service Automatic Route Selection

Continued on next page

Table 4-1. Continued

Basic Calling and Answering	Type	PROG	Considerations	Feature Name
Paging				
Page over your company's loudspeaker system.	User	SYS		Paging (Loudspeaker)
Page a group of co-workers who have speakerphones.	Group	SYS	Only MLX (except QCC) and BIS phones	Paging (Speakerphone) Paging (Group)
Page all the people at your company who have speakerphones.	User	SYS	See item above.	Paging (Speakerphone)
Prevent voice-announced paging calls from coming in over your speakerphone, or allow them.	User	SYS EXT	Only MLX (except QCC in releases prior to 4.0) and BIS phones take speakerphone pages.	Voice Announce
Putting a call on hold				
Put a call on hold.	General	None	Not for single-line	Hold
Put a call on hold at a single-line telephone.	General	SYS	Single-line only	Park
Put a call on hold automatically.	General	SYS	Different on QCC	Transfer (One-Touch Hold)
Put a call on hold so that anybody can pick it up after you page them.	General User	EXT	Different on QCC. In Release 4.0 and later, system manager can disable Park on single-line phones.	Hold Park

Continued on next page

Table 4-1. Continued

Basic Calling and Answering	Type	PROG	Considerations	Feature Name
<i>Transferring calls</i>				
Transfer a call to an inside or outside number.	General	SYS	Different on QCC. In Release 4.0 and later, system manager can disable Transfer on single-line phones.	Transfer
Transfer a call with one touch.	General	SYS	Not for single-line	Transfer (One-Touch Transfer)
<i>Using the system from an outside phone</i>				
Set up barrier codes (passwords) for remote access callers.	User	SYS		Remote Access
Gain access to the system and use it as if you were on an inside extension.	User	SYS		Remote Access
At a phone outside the system, receive calls that come to your system extension.	User	SYS		Forward and Follow Me (Remote Call Forward)

Covering Calls and Having Calls Covered

The Feature Finder in [Table 4-2](#) covers features that users and Direct-Line Console (DLC) operators may need when they are either covering calls for others or having their calls handled by others. When there is no voice mail system, operators cover calls more than anyone else, and many of these features apply to them. Operator-only features are described in a later section.

As explained later in this chapter, you do not have to use the features below for covering calls. Shared lines (personal, prime, or **SA**) offer another method where people working closely together can join or cover one another's calls.

Even though many of these features can be programmed by users at their own telephones, it is important that coverage be planned centrally, so that groups and operators can be assigned to provide coverage as needed. (Users cannot assign operators and groups to cover calls.)



NOTE:

In Release 6.0 and later systems, the Centrex Transfer via Remote Call Forwarding feature allows you to forward Centrex calls on the same Centrex line on which they arrived. For details, see ["Covering Calls" on page 4-34](#).

Table 4-2. Feature Finder: Covering Calls and Having Calls Covered (Non-Networked Systems)

Covering Calls and Having Calls Covered	Type	PROG	Considerations	Feature Name
<i>Covering others' calls</i>				
In a calling group, cover calls for another group.	Group	SYS	Not for QCC	Group Calling Coverage (Group Coverage)
In a calling group, answer calls ringing for others in your group.	Group	EXT	Not for QCC	Group Calling Pickup (Group Pickup)
As an individual, cover calls for a group.	Group	SYS		Coverage (Group Coverage)
Cover all of a co-worker's calls.	User	SYS	Not for QCC	Coverage (Primary Coverage)
Cover a co-worker's calls when they do not answer.	User	SYS EXT		Coverage (Secondary Coverage) Forward and Follow Me (Release 4.0 and later only)
Set calls you cover to ring instantly or after a delay (so someone else can answer first).	User	CNT EXT	CNT used for single-line phones or MFM devices and Forward and Follow Me delay	Coverage Ringing Options Forward and Follow Me (Release 4.0 and later only)
<i>Controlling coverage by others</i>				
Have your calls covered only occasionally.	User	EXT		Forward and Follow Me Coverage (Coverage On/Off)
Have your calls covered by a voice mail system.	General	SYS	Release 4.1 and later: Night Service can control Coverage VMS Off buttons at extensions.	Coverage (Coverage VMS Off) Night Service

Continued on next page

Table 4-2. Continued

Covering Calls and Having Calls Covered	Type	PROG	Considerations	Feature Name
Controlling coverage by others (continued)				
Have all your calls covered by a co-worker.		SYS		Coverage (Primary Coverage)
Have your calls ring immediately at your extension or only after a delay.	User	EXT CNT SYS	CNT used for single-line phones or devices connected to MFMs; Release 4.1 and later: system manager sets delays for each sender.	Coverage Ringing Options
Have a co-worker cover your calls only when you do not answer them right away.	User	SYS CNT	Release 4.1 and later: system manager sets delays for each coverage sender.	Coverage (Secondary Coverage) Coverage (Group Coverage) Forward and Follow Me (Release 4.0 and later only)
When you are the principal user of a SA button and others have Shared SA buttons corresponding to it, have your calls ring at their SSA buttons and not at your SA button.	User	EXT	Not for single-line	System Access/Intercom Buttons (Send Ring)
Have your Centrex calls transferred to another Centrex extension that is outside the system, or to an outside number (for an outside number, requires subscription to Centrex trunk-to-trunk transfer feature).	User	EXT	Release 6.0 and later. For single-line phone, use authorization code to activate from a multiline telephone.	Forward and Follow Me (Centrex Transfer via Remote Call Forwarding)

Calling Privileges and Restrictions

Calling privileges and restrictions are planned and programmed centrally for the extensions in your company, as well as for remote access users. When you add a new extension or make other changes in your system, you may need to add or change calling restrictions. You should also consider security issues when you decide whether to allow the system to forward calls to an outside number or when you plan for voice mail systems. See ["Security" on page 4-51](#) and Appendix A, "Customer Support Information," for more information about security planning and procedures.

Although the features described in [Table 4-3](#) affect individual users, controlling calling privileges is a system management function.



NOTES:

1. Do Not Disturb and Privacy are not calling restrictions, but are included here because they prevent calls to individual extensions.
2. If your system operates in Behind Switch mode with a Centrex service providing features, Centrex (and not system) calling restrictions must be used.

The Authorization Codes feature enables users to apply the calling restrictions of their own extensions when they need to make calls from more restricted phones. For more information, see ["Authorization Codes" on page 4-50](#), or the *Feature Reference*.

In Release 4.0 and later systems, the system manager can remove one of the line buttons (**SA** or **ICOM**) assigned to an extension where there is a single-line telephone. This feature is designed to accommodate hotels and other institutions, where organizations do not want calls transferred from guest extensions. Removing one of the buttons prevents Privacy from being used at the extension.

In Release 3.1 and later systems, default settings for calling restrictions help system managers guard against toll fraud. For more information, see the topics ["Calling Restrictions" on page 4-44](#) and ["Security" on page 4-51](#).

Table 4-3. Feature Finder: Calling Privileges and Restrictions (Non-Networked Systems)

Calling Privileges and Restrictions	Type	PROG	Considerations	Feature Name
<i>Preventing people from making calls</i>				
Prevent calls from coming to your extension.	User	EXT	Not for operators	Do Not Disturb
Prevent an extension from making outside calls.	Sys Mgr	SYS		Calling Restrictions (Toll or Outward Restrictions)
Prevent an extension from making toll calls.	Sys Mgr	SYS		Calling Restrictions (Toll or Outward Restrictions) Automatic Route Selection (ARS)
Prevent other callers who share the same line from joining your calls.	User	EXT		Privacy
Prevent an extension from reaching certain numbers or area codes.	Sys Mgr	SYS		Allowed/Disallowed Lists
Control calls made outside of business hours.	Sys Mgr	SYS		Night Service (with Password)
Set passwords for remote access and control calls made by remote access users.	Sys Mgr	SYS	See <i>System Programming</i> .	
Control calls made on specific outside lines.	Sys Mgr	SYS		Calling Restrictions (Toll or Outward Restrictions) Automatic Route Selection (ARS)

Continued on next page

Table 4-3. Continued

Calling Privileges and Restrictions	Type	PROG	Considerations	Feature Name
<i>Allowing calls</i>				
Allow people to use their own calling privileges at others' extensions.	General	SYS		Authorization Codes
When calling restrictions are applied, allow calls to certain numbers or area codes.	Sys Mgr	SYS	ARS for Hybrid/PBX only	Allowed/Disallowed Lists Speed Dial (System) Automatic Route Selection (ARS Facility Restriction Levels)
Allow certain or all calls outside normal business hours.	Sys Mgr	CNT	Release 4.1 and later: lines can be assigned to Night Service groups for use after hours.	Authorization Codes Night Service
Allow trunk-to-trunk transfer at one or more extensions.	Sys Mgr	SYS	Release 3.1 and later systems	Transfer (Trunk-to-Trunk Transfer)
Use a password to make calls outside normal business hours.	User	CNT		Night Service

Customizing Phones

The Feature Finder in [Table 4-4](#) describes features that people in your company can use to make their telephones work better for them.

A person with an MLX telephone can choose from eight types of rings to distinguish his or her own phone's ringing from those around them. Other ringing options determine whether lines ring immediately when a call comes in, after a delay, or not at all. These ring timing options are applied automatically with some coverage features (see ["Covering Calls" on page 4-34](#)) but can be changed by the user or system manager.

A person at an MLX display telephone can change the language used on the display; the system manager can change the language used on all MLX display telephones in the system.

Table 4-4. Feature Finder: Customizing Phones (Non-Networked Systems)

Customizing Phones	Type	PROG	Considerations	Feature Name
Give your phone its own distinctive ring.	User	EXT		Ringng Options (Personalized Ringng)
Change the way your phone rings when you are already on a call.	User	EXT		Ringng Options (Abbreviated Ring)
Delay or remove the ring from an outside, SA , or ICOM button.	User	EXT CNT	CNT for single-line phones and devices connected to MFMs	Ringng Options
Change the language used (English, French, or Spanish) systemwide; this also changes the clock, which is 12-hour for English and 24-hour for French or Spanish.	Sys Mgr	SYS	MLX display phones only	Language
Change the language used (English, French, or Spanish) at your extension; this also changes the clock, which is 12-hour for English and 24-hour for French or Spanish.	User	EXT	MLX display phones only	Language
Change the language (English, French, or Spanish) used in System Programming and Maintenance (SPM) software.	Sys Mgr	SYS		Labelng
Change the language used (English, French, or Spanish) in Station Message Detail Recording (SMDR) and programming reports.	Sys Mgr	SYS		Labelng

Messaging

The system includes a number of messaging features (see [Table 4-5](#)) that allow people at your company to let others know when they have called and even leave special messages for co-workers at display telephones.

To leave a message for people who have display telephones, use Leave Message or Posted Messages. Leave Message simply displays a message saying that your extension has called; it can be used with or without actually ringing the extension. Posted Messages supply more specific information. Twenty different Posted Messages are available for display when a co-worker calls your extension. The system manager can program the text for all but the first one, according to the needs of people in the company (the first message, DO NOT DISTURB, cannot be changed; Posted Messages posts the message only and does not turn on the Do Not Disturb feature).

To leave a message for a person without a display telephone, contact the operator. Or, if your system includes voice mail, use the Direct Voice Mail feature to leave a message without calling your co-worker.

Table 4-5. Feature Finder: Messaging (Non-Networked Systems)

Messaging	Type	PROG	Considerations	Feature Name
<i>Leaving messages</i>				
Call and let a co-worker with a display phone know that you have called.	User	EXT	Not for QCC	Messaging (Leave Message)
Let a co-worker with a display phone know you wish to speak with him or her, without calling.	User	EXT	Signal/Notify not for single-line or QCC; Leave Message not for QCC	Messaging (Leave Message) Signal/Notify Direct Voice Mail
Let a co-worker with a multiline phone know you wish to speak with him or her, without calling.	User	EXT	Signal/Notify not for single-line phones or QCC	Signal/Notify Direct Voice Mail
Leave a voice mail message for someone or allow a caller to do so.	User	EXT		Direct Voice Mail
Post a specific message (such as, OUT TO LUNCH) for co-workers with display phones.	User	EXT	Not for single-line phones	Messaging (Posted Messages)
Cancel a message left for a co-worker who has a display phone.	User	EXT	Not for QCC	Messaging (Leave Message)
<i>Receiving messages</i>				
Return a call from a co-worker who has left a message.	User	EXT	Display phones only	Messaging (Return Call)
Read messages.	User	EXT	Display phones only	Messaging (Next Message)
Turn off Message light.	User	EXT		Messaging (Message LED Off)
Delete messages.	User	EXT	Display phones only	Messaging (Delete Message)

Continued on next page

Table 4-5. Continued

Messaging	Type	PROG	Considerations	Feature Name
<i>Setting up messaging</i>				
Change the posted messages that users can choose from.	General	SYS		Labeling
Change the extension information that appears on display telephones that have messages.	General	SYS		Labeling
Set up a voice messaging system to take calls.	General	SYS		Group Calling
Set up extensions to receive messages from a machine when it has deliveries for them.	Group	SYS		Group Calling
Set up calling groups to receive messages from co-workers.	Group	SYS		Group Calling
Change the extension information that appears on display telephones with inside calls and messages.	General	SYS		Labeling
Set up an extension to receive messages for a calling group.	Group	SYS		Group Calling

Timekeeping

People at your company can set alarms or reminder calls to let them know when it is time for some event (see [Table 4-6](#)). They also can use a timer to keep track of phone conversations or other activities.

Table 4-6. Feature Finder: Timekeeping

Timekeeping	Type	PROG	Considerations	Feature
Set your own phone to ring at a certain time as a reminder.	User	EXT		Reminder Service
Set the alarm clock on your telephone.	User	EXT	Display phones only	Alarm Clock and Timer
Set the time at your telephone.	User	EXT	Display phones only	Alarm Clock and Timer
Set the timer for calls or other activities.	User	EXT	Display phones only	Alarm Clock and Timer
Set the systemwide time.	General	SYS		See <i>System Programming</i>

System Manager's Functions and Features

Listed in the Feature Finder in [Table 4-7](#) are those features that you program as part of your system management function, along with some system manager activities not included in other Feature Finders. Some features and functions affect the system as a whole, and others affect only certain lines/trunks or extensions.

In addition to the features listed here, system manager features are listed in the other Feature Finders according to the activities they affect. Additionally, features listed as *General*, *SYS*, or *CNT* in the Feature Finders are also the system manager's responsibility. Fortunately, these features are set up for you at installation. Most do not require much attention after installation.

This Feature Finder includes setting up groups, changing line button assignments, and modifying the way some fixed-feature buttons work systemwide. In addition, it outlines some features you can choose to help operators, as well as listing reporting functions.

Table 4-7. Feature Finder: System Manager's Functions and Features (Non-Networked Systems)

System Manager's Functions and Features	Type	PROG	Considerations	Feature Name
Group activities				
Set up a group that shares an extension number for receiving calls.	Group	SYS		Group Calling
Set up a group that shares an extension number to cover calls for others.	Group	SYS		Group Calling Coverage
Set up a group of extensions whose calls are all covered by the same person or persons.	Group	SYS	Release 4.1 and later: system manager sets coverage ring delay for each sender.	Coverage (Group Coverage)
Set up a group to pick up each others' calls.	Group	SYS		Pickup
Set up a group that shares an extension number for receiving speakerphone calls.	Group	SYS		Paging
Set up a group of fax machines to take calls.	Group	SYS		Group Calling
Set up groups associated with operators who turn Night Service on and off for the group.	Group	SYS		Night Service
Set up Night Service to deactivate Coverage VMS Off buttons automatically at members' extensions during Night Service hours, then turn voice mail coverage off when normal operation resumes.	Group	SYS	Release 4.1 and later only: multiline phones only; requires programmed Coverage VMS Off button.	Night Service Coverage (Coverage VMS Off)

Continued on next page

Table 4-7. Continued

System Manager's Functions and Features	Type	PROG	Considerations	Feature Name
Group activities (continued)				
Set up as many as 10 primary delay announcement devices and 1 secondary device (Release 5.0 and later systems only) to play recorded messages to waiting callers when group members are unavailable.	General	SYS		Group Calling
Set up a voice messaging system to take calls.	Group	SYS		Group Calling
Lines, line buttons, fixed-feature buttons				
Change, add, or delete the line buttons (SA or ICOM) available on a user's telephone.	User	SYS	For single-line only in Release 4.0 and later	System Access/Intercom Buttons
Remove one of two assigned line buttons (SA or ICOM) so that Transfer cannot be used. Also disables Conference, Call Waiting, Park, group Pickup, and Privacy.	User	SYS	Single-line phones, Release 4.0 and later. Intended primarily for hotels and motels.	System Access/Intercom Buttons
Assign a line to a Night Service group so that it rings immediately when Night Service is activated.	User	SYS	Release 4.1 and later only; line does not have to appear at any operator position.	Night Service
Specify the line selected when a user lifts the handset or presses the Speaker button.	User	SYS		Automatic Line Selection and Ringing/Idle Line Preference
Take an outside line out of service.	Sys Mgr	SYS		Automatic Maintenance Busy
Copy line assignments, buttons, and features from one extension to another.	User	CNT	See <i>System Programming</i> .	

Continued on next page

Table 4-7. Continued

System Manager's Functions and Features	Type	PROG	Considerations	Feature Name
<i>Lines, line buttons, fixed-feature buttons</i>				
Assign lines that can be answered without operator involvement.	User	SYS	Hybrid/PBX only	Personal Lines
Adjust the ringing at an extension, including one with a single-line phone or MFM.	User	EXT SYS	System manager only for single-line, MFM	Ringing Options Coverage
Allow Drop , Transfer , and Conference buttons to access either host or system features.	General	SYS	Behind Switch mode only	Recall/Timed Flash
<i>Maintenance</i>				
Back up and restore system programming.	Sys Mgr	SYS	See <i>System Programming</i>	
Control what a caller hears while waiting (for example, during transfer or while on hold).	General	SYS		Music on Hold
Set up special phones for calls during a commercial power failure.	General	SYS		Power Failure Transfer (PFT)
Prevent DLC operators from accidentally disconnecting callers.	Operator	SYS	DLC operators only	Hold Direct-Line Console
Fix the hold timer when callers on hold are being disconnected.	General	SYS		Hold
Find out about the Alarm button on operator consoles or set up a special light or bell to signal a system problem.	General	SYS	Operator consoles	Alarm

Continued on next page

Table 4-7. Continued

System Manager's Functions and Features	Type	PROG	Considerations	Feature Name
<i>Maintenance (continued)</i>				
For noisy places: turn off microphone at a phone so that a user hears voice pages but must lift the handset to respond.	User	SYS	MLX only; not for QCC	Microphone Disable
Fix problems with the switchhook, Recall , or Flash button.	General	SYS		Recall/Timed Flash
<i>Numbering lines and extensions (See also SYS items in Table 4-1 on page 4-5)</i>				
Change the overall system numbering plan; for example, change to 2-, 3-, or a variable number of digits for extension numbers.	General	SYS		System Renumbering
Change extension numbers for extensions, adjuncts, trunks, ranges on a Direct Station Selector (DSS), ARS, calling groups, Idle Line Access, Listed Directory Number, paging groups, park zones, pools, or Remote Access.	User General Group Operator	SYS		System Renumbering
<i>Operators</i>				
Allow a QCC operator to join callers and extensions more rapidly.	Operator	SYS	QCC operators only	Queued Call Console
Set up the QCC Call 5 button for use as a voice-announce call button.	Operator	SYS	QCC operators only. Release 4.0 and later	Queued Call Console Voice Announce to Busy
Make sure that the most important calls ring first at a QCC.	Operator	SYS	QCC operators only	Queued Call Console

Continued on next page

Table 4-7. Continued

System Manager's Functions and Features	Type	PROG	Considerations	Feature Name
<i>Operators (continued)</i>				
Prevent DLC operators from accidentally disconnecting callers.	Operator	SYS	DLC operators only	Hold Direct-Line Console
Find out about the Alarm button on operator consoles or set up a special light or bell to signal a system problem.	Operator	SYS		Alarm
<i>Reports</i>				
Get a report on incoming and outgoing calls, including account codes and/or authorization codes if programmed.	Sys Mgr	SYS		Station Message Detail Recording
Get a report about system programming.	Sys Mgr	SYS		Station Message Detail Recording
<i>Security</i>				
Assign barrier codes (passwords) to remote access users.	User	SYS		Remote Access
Change remote access barrier codes often.	Sys Mgr	SYS		Remote Access
Delete unused remote access barrier codes immediately.	Sys Mgr	SYS		Remote Access
Assign passwords as necessary for voice messaging systems (VMSs) and Night Service with Outward Restriction.	User	SYS	See guide for VMS	Night Service

Continued on next page

Table 4-7. Continued

System Manager's Functions and Features	Type	PROG	Considerations	Feature Name
<i>Security (continued)</i>				
Change voice messaging and Night Service passwords frequently.	User	SYS	See guide for VMS	Night Service
Delete unused voice messaging and Night Service passwords immediately.	Sys Mgr	SYS	See guide for VMS	Night Service
Review SMDR reports often.	Sys Mgr	SYS		Station Message Detail Recording
See that the system programming is backed up frequently, automatically or manually, and make sure it is backed up before and after changes.	Sys Mgr	SYS	See <i>System Programming</i>	

Special Operator and Supervisor Features

The Feature Finder in [Table 4-8](#) lists features that are available only to operators. Many of the features listed in other categories are also used by operators, but are not exclusively designed for them. In the PROG column, the notation *AUTO* means that Queued Call Console (QCC) operator telephones are automatically programmed with a button for the feature.

Because of the fixed buttons that are programmed automatically on QCCs, these operators handle calls differently from other users in the system.

Table 4-8. Feature Finder: Special Operator and Supervisor Features (Non-Networked Systems)

Special Operator and Supervisor Features	Type	PROG	Considerations	Feature Name
Set others' phones to ring at a certain time as a reminder.	Operator	EXT	DLC operators only	Reminder Service
Turn an extension's Message light on or off to indicate that you have a message for the party.	Operator	EXT AUTO		Messaging (Send/Remove Message)
Prevent calls from coming to your extension when your phone is too busy to take any more calls or you must be away from your phone.	Operator	AUTO	QCC operators only	Queued Call Console (Position Busy)
Put a call on hold automatically.	Operator	SYS	DLC operators only	Hold
Put a call on hold at one of several reserved extensions, so that anyone can pick it up after you page them.	Operator	SYS		Park
Interrupt a call at a busy extension or one with Do Not Disturb on.	Operator	CNT EXT	QCC and MLX DLC operators can choose the feature from the display.	Barge-In
Supervise a group of people answering calls.	Operator	EXT	DLC operators only	Direct Station Selector Group Calling Extension Status
Find out about the Calls-In-Queue Alarm button that signals either too many calls waiting or calls waiting too long (Release 4.0 and later only) for your or your group's attention.	Operator	SYS AUTO		Group Calling Auto Dial

Continued on next page

Table 4-8. Continued

Special Operator and Supervisor Features	Type	PROG	Considerations	Feature Name
Call an inside or outside number with one touch.	Operator	AUTO	MLX phones or System Display Consoles only	Direct Station Selector
Find out about the Alarm button that signals a system problem.	Operator	SYS AUTO		Alarm
Activate/deactivate Night Service for a Night Service group at the start/end of the work day.	Operator	SYS AUTO		Night Service
Set up the way calls are distributed to calling group members.	Operator Group	SYS		Group Calling
Set up distribution of calling group calls to an overflow receiver according to how long callers have waited, how many calls are waiting, and/or when a caller dials # in response to a delay announcement to leave the calling group queue (Release 6.0 and later).	Operator Group	SYS	Calls overflowing due to time or number of calls in queue take precedence over caller's prompted request.	Group Calling
Control the number of calls that can be in the calling group queue before callers hear a busy signal.	Operator Group	SYS	Release 6.0 and later: Only for calls on some lines; not for remote access, position-busy backup, or coverage calls.	Group Calling
Monitor others' calls.	Operator Group	SYS AUTO		Direct Station Selector Group Calling Extension Status

Continued on next page

Table 4-8. Continued

Special Operator and Supervisor Features	Type	PROG	Considerations	Feature Name
Log a calling group member in or out.	Operator	SYS	DLC operators only	Group Calling Extension Status
Log a delay announcement device for a group in or out.	Operator Group	SYS	DLC operators only	Group Calling

Feature Descriptions

This section provides more detail about certain groups of related features, so that you can gain additional insight when it is necessary to match features with changing business needs. Here, the focus is on the differences among your choices, and not all system features are described. In addition, features that affect security receive special attention. The *Feature Reference* includes complete information about all the features, including their interactions, modes of operation, and the ways that features work on different system equipment.

Covering Calls

The system provides numerous methods for covering calls, allowing one or more users to handle incoming calls for others. In many systems, operators direct calls to groups and individuals. In others, automated attendants perform all or most of this function. When a person is not available, voice mail is often used, and the system allows voice mail, too. There are also several ways that two or more people can work together to personally handle one another's calls, and that is primarily what we describe here.

There are several factors you should keep in mind when you plan for covering calls:

- How heavy is the call volume of the people involved? Can the covering person(s) handle the volume, and is there a backup alternative when they cannot?
- When should calls be covered? Should they be covered all of the time, some of the time, or only when the covered person does not answer immediately? Have you decided how to set ringing delays for each extension (Release 4.1 and later systems only) that is part of a coverage group and/or is covered by Primary or Secondary Cover buttons at co-workers' telephones?
- Are programmed line buttons required for the method you have chosen? Do the phones at the extensions have these buttons available for programming?
- Is a voice mail system providing coverage? Do users need programmed buttons to turn this coverage on and off?
- Should you set Night Service to work with your voice messaging system (Release 4.1 and later systems only), so that telephones' programmed Coverage VMS Off buttons are set centrally to turn voice messaging on during Night Service and turn it off again during normal business hours?

The system includes a group of capabilities called *coverage features*, which are described in ["Coverage" on page 4-37](#). However, there are several other features that also help people cover calls, and a discussion of these follows.

Sharing Lines

The simplest way to cover someone else's calls is to share a line with him or her. This method is most appropriate in Hybrid/PBX and Behind Switch systems.

Listed below are the types of lines that can be shared:

- **Prime Lines** (Behind Switch Only). In this type of arrangement, a person who is covering for someone else has a line button that corresponds to the covered person's prime line. You can adjust the ring timing (Ringing Options feature) so that a call rings immediately at the covering phone, or after a delay. If transferred calls come in on prime lines, they are covered; otherwise, they are not. People who share prime lines can join one another's calls, but you cannot use the system to assure privacy of conversations. Instead, check with your Centrex provider or host system manager.
- **Personal Lines** (Key and Hybrid/PBX). If most or all of a person's calls come in on a line assigned only to his or her extension, someone else can also have a button for that personal line and cover calls. You can adjust the ring timing (Ringing Options feature) so that a call rings immediately at the covering phone or after a delay. Calls that come in on **SA** or **ICOM** buttons, whether transferred outside calls or inside calls, are not covered. People who share personal lines can join one another's calls, and they can use the Privacy feature to assure that others do not listen in.
- **Shared System Access Buttons** (Hybrid/PBX only). Shared **SA** buttons (called **SSA** buttons) offer a simple method for covering calls. The extension being covered (called the *principal extension*) has an **SA** button that also appears as an **SSA** button on up to 16 other extensions. (A covering phone can have up to 27 **SSA** buttons, but only one for a given principal extension.) Ring timing options are automatically set so that a call rings twice at the principal extension before ringing at any **SSA** buttons, but the Send Ring feature allows the principal user to change the ringing on **SSA** buttons so that calls arrive at them immediately.

People who share System Access buttons cannot answer the same call, but they can join one another's calls in progress; they can also use the Privacy feature to assure that others do not listen in. When Privacy is required, a button should be programmed, because turning on the feature prevents all other users of the **SSA** or **SA** button from joining calls. Furthermore, the lighted button provides a reminder when Privacy is on.

Forward and Follow Me

Forward, Follow Me, and Remote Call Forward allow a user to *temporarily* send calls to another inside extension or to an outside number (Remote Call Forward, for example, to someone's "home office"). If the user turns the feature on or off at his or her own phone, it is called *Forward*; if the person turns it on or off from the destination extension, it is called *Follow Me*.

In Release 4.0 and later systems, forwarding features are useful for covering calls regularly, rather than only temporarily. Forward, Follow Me, and Remote Call Forward can be set up to ring first at the forwarding extension before they are sent to the forwarded-to extension. If a call is not answered at the forwarding extension (or if, in Release 4.1 and later systems, the sender's **SA** or **ICOM** lines are busy), it then rings at the extension to which forwarding has been programmed. The system manager programs a forwarding delay so that a calls rings from zero to nine times before being forwarded. Other features, such as Ringing Options, as well as line/trunk availability, affect the number of rings. For additional information about using this feature for covering calls, see ["Direct Voice Mail" on page 4-40](#).

When people use this feature often, they can program a button for it.

The next topic provides information about using the Authorization Codes feature to control forwarding features at your extension.

Centrex Transfer via Remote Call Forwarding

In Release 6.0 and later systems, Centrex Transfer via Remote Call Forwarding can be used in any mode of operation to send outside calls to a remote telephone number. For example, the feature is useful when a person is working either from home or from a Centrex extension that is not connected to the MERLIN LEGEND Communications System. The forwarded outside calls come from outside the communications system, but they may come from extensions that are in the same Centrex system as the person receiving the call. The forwarding call to the outside number is made on the same line/trunk on which the call arrived, conserving Centrex lines.

The outside call may arrive directly or be transferred without consultation from another user or an automated attendant. The following considerations apply:

- Only outside Centrex calls are forwarded using this feature. Inside intercom calls cannot be remote call-forwarded use this method. Use standard Remote Call Forwarding instead.
- To transfer calls outside the Centrex system, your organization must subscribe to a Centrex trunk-to-trunk transfer feature.
- Transfers with consultation and conferences cannot be performed to reach extensions that have Centrex Transfer via Remote Call Forwarding active.
- The Centrex lines, extensions programmed for Centrex Transfer via Remote Call Forwarding, and any automated attendant that transfers calls to the extension must be connected to the same switch. The feature is not supported across private networks (Release 6.0 and later systems, Hybrid/PBX mode only).

When extensions are using the Centrex Transfer via Remote Call Forwarding feature, do not program Music On Hold for callers on hold or awaiting transfer.

Activating Centrex Transfer via Remote Call Forwarding requires that Remote Call Forwarding be enabled for the extension. However, the user dials * instead of a dial-out code, and a Pause character may be required after the *. The Centrex service provider determines whether the Pause is needed.

If the Pause is required, remote call forwarding cannot be activated at a single-line telephone or by a remote access user. The user can employ an authorization code to activate the feature from a multiline extension in the local system. This method is also used to activate remote call forwarding at phantom extensions. A user may activate or deactivate forwarding or Centrex Transfer via Remote Call Forwarding by dialing his or her authorization code from an extension other than the home extension. All digits must be activated within 15 seconds of the start of dialing.

If a Pause is not required, a single-line telephone user may activate the feature at his or her own extension. A remote access user may activate the feature without using an authorization code. Barrier code requirements do apply, however.

Pickup

Pickup allows users to answer calls that come in for others in a group they are part of (called a *pickup group*). It also allows individuals to quickly pick up calls ringing at another extension or at lines that are not on their phones (called Individual Pickup, for a line or an extension).

Generally, Pickup is used with Paging and Park. A call comes in. The person who answers then pages the person who should receive the call, telling that co-worker where the call is parked. The user who ultimately takes the call uses Pickup to answer it.

You should be aware of pickup groups as an option for users who work closely together and can hear one another's phones (when you answer a group pickup call, you cannot determine whose call you are picking up). Operators can be members of pickup groups.

Coverage features (see the next topic) can be used with Pickup. If someone is a member of a pickup group, his or her calls can always be picked up by another group member, whether or not the person at the covered extension has turned on coverage. If coverage is off, Individual Pickup cannot be used to pick up a call.

Coverage

One of the system's unique capabilities is the variety of automatic coverage possibilities. The features we group under the category of *coverage* allow a call ringing at one extension (a *sender's* extension) to also ring at another extension (a *receiver's* extension). Here are the types of senders we refer to:

- An individual at an extension (Individual Coverage)

- A group called a *coverage group* (Group Coverage)

A variety of different receivers can be assigned to take calls for an individual or a coverage group:

- Another individual
- A calling group
- A voice mail system
- An operator

Generally, it is best for callers to receive individual attention. If a sender has Individual Coverage, the receiver can answer with the sender's name. When someone is receiving calls for a coverage group, however, he or she does not know, when the call rings, who the caller is trying to reach. For this reason, Group Coverage is often used as a backup for Individual Coverage.

Group Coverage by a calling group is used to provide voice mail coverage. Coverage by a voice mail system can be combined with other types of coverage, as described in ["Direct Voice Mail" on page 4-40](#). If a calling group of agents covers calls for a coverage group, the person who answers for the sender cannot distinguish the call from any other that he or she receives.

Unless the receiver is a Queued Call Console (QCC, Hybrid/PBX only) operator or a calling group, his or her phone is assigned Cover buttons; each should be labeled with the name of the group or individual he or she is covering for (for example, *Cover Sales* or *Cover Juan*). Covered calls come in on these buttons, so the receiver knows whose call he or she is answering.

Depending upon the needs of the business, a sender can have immediate coverage (called *Primary Coverage*) or delayed coverage (called *Secondary Coverage*), where the call rings at the sender's phone and goes to the receiver's phone only when the sender does not answer.

The ringing for covered calls depends upon whether Primary (immediate) or Secondary (delayed) Coverage is provided, as well as upon any ring timing options that may be assigned to a receiver's programmed Cover button. System programming determines settings for these timers, and calls that are covered by calling groups or operators may be further delayed as they wait for someone to answer. Beginning in Release 4.1, the system manager programs coverage ringing delays for each sender's extension, instead of programming delays for all coverage calls of a given type. This way, the number of rings before a call goes to coverage can be customized for each individual. To learn more about these options, see ["Changing Coverage Delay Options" on page 6-51](#).

Coverage senders can use programmed buttons to toggle the following off and on: voice mail coverage, coverage of inside calls, or all Individual Coverage.

Beginning in Release 4.1 the system manager can coordinate voice mail coverage and Night Service. When an operator turns on Night Service for a Night Service group, Night Service with Coverage Control automatically deactivates the programmed Coverage VMS Off buttons at members' extensions. When the operator turns Night Service Off, the Coverage VMS Off buttons are activated, and the voice messaging system stops taking messages. The user at an extension can manually override this system setting by pressing the button on his or her telephone. When Night Service status changes, the button is again set centrally; the most recent action, whether a change in Night Service status or a user pressing the button, determines the button's setting. For example, a person might leave work early and forget to press his or her lit Coverage VMS Off button. When Night Service goes on, his or her extension is covered by voice mail. If the button at an extension is already set properly when there is a change in Night Service status, the setting remains. (For more information about Night Service, see ["Night Service with Outward Restriction" on page 4-47](#) and ["Night Service Groups" on page 4-55](#).)

[Table 4-9](#) summarizes coverage control options for senders.

Table 4-9. Selective Coverage Features

Selective Coverage Feature	Description	Comments
Coverage Off	Turns off only Individual Coverage; if sender is in a coverage group, Group Coverage remains in effect.	User must have a programmed Coverage Off button.
Coverage Inside	Prevents/allows coverage of inside calls. For example, with Coverage Inside off, only outside calls are covered.	User must dial the feature code or select the feature from the display of a display telephone. Cannot be programmed on a button.
Coverage VMS Off	Prevents or allows voice mail coverage of outside calls. With Coverage VMS Off active (the button is lit), only inside calls are covered by voice mail.	User must have a programmed Coverage VMS Off button; can use this in combination with Coverage Inside to turn all Individual Coverage off. In Release 4.1 and later systems, can be set centrally to coordinate with Night Service.

Depending on the type of call and how the sender's phone is set up, some calls are not eligible for coverage. Furthermore, there are interactions among the various forms of coverage. Nevertheless, coverage features are flexible enough to ensure that a caller does receive attention, and that someone whose calls are being covered can quickly tailor the system to his or her needs. For more information about these topics, refer to the *Feature Reference*.

Direct Voice Mail

When Direct Inward Dial (DID) or Automated Attendant is used, people get calls directly, bypassing the operator. In these cases, the best call-covering solution is to send calls directly to voice mail rather than to the operator. The caller then has the option to leave a message or press \square for the operator. If, after talking to the operator, the caller wants to leave a message, the operator can transfer the call back to the called party's voice mail using the Direct Voice Mail feature. This feature offers several advantages:

- It reduces the burden on the operator.
- It allows the caller to decide whether to leave a message or speak to an operator.
- It allows the caller to leave a message without waiting for the operator to answer.

The Direct Voice Mail feature also allows a caller to leave a message in a voice mailbox without calling the person's extension first.

There are several different configurations that can be set up, depending on the number of users who require this kind of coverage and their needs. For example, if calls must go to an operator and not directly to voice mail, you can use one of the following configurations:

- If eight or fewer extensions require coverage to the system operator, use delayed Primary Coverage or Secondary Coverage to allow calls to be covered by the operator. When a caller dials the user's number, the operator answers and then can send the call to voice mail using the Direct Voice Mail feature.
- In Release 4.0 and later systems, the Forward/Follow Me feature provides this type of coverage, with no system limits on the number of users who can take advantage of the feature. A user's calls are forwarded to the operator, with a delay of zero to nine rings before the call goes to the operator (in Release 4.1 and later systems, the call is forwarded immediately when the **SA** or **ICOM** buttons at the extension are busy). This way, if an **SA** or **ICOM** button is available for the call, the person at the forwarding extension can pick up the call while it is still ringing at his or her phone. If the person does not pick up, the call is forwarded to the operator, who can then send it to voice mail using the Direct Voice Mail feature.

- Alternatively, if fewer than 30 extensions require coverage to the operator, phantom calling groups can be used to provide a second extension number for each user's voice mail. The actual extension covers to the operator (Group Coverage) and the calling group is covered by voice mail. When someone dials the user's number, the call goes to the operator, who can then transfer the call to the voice mail extension
- If more than 30 extensions require coverage to the operator, phantom extensions can be used after the maximum number of phantom calling groups is reached. In this case, the published DID number for the extension is the number for the phantom extension. The actual telephone has a Shared **SA** button where the phantom extension is the principal user, so the call rings at the "real" telephone with the **SSA** button. The operator covers the phantom extension (Group Cover button) and can use the Direct Voice Mail feature to send calls to the "real" extension's voice mail.
- If you need coverage by a personal secretary who is not a system operator at an operator console, then Primary Coverage can be used on the secretary's telephone. The secretary can use Direct Voice Mail to transfer the call back to the user's voice mail. If the secretary is out, calls can either continue to ring or go to voice mail, depending on the status of the user's Coverage VMS Off button.

For more information about how you can use the Direct Voice Mail feature, see the *Feature Reference*.

Summary

[Table 4-10](#) illustrates the various ways that calls can be covered.

Table 4-10. Features for Covering Calls (Non-Networked Systems)

Feature	Covered by	Description	Example
Centrex Transfer via Remote Call Forward	Outside phone or Centrex extension	A person forwards his/her calls to an outside number or to someone on the Centrex system but not connected to the MERLIN LEGEND Communications System using the same line on which the call arrived.	A system user is working from a Centrex extension that is not on the system, or from home (latter requires subscription to Centrex trunk-to-trunk transfer).
Follow Me	Any individual	A person forwards his/her calls, turning the feature on at the destination phone.	A supervisor is helping someone at another desk and remembers that he or she wants to receive calls there.

Continued on next page

Table 4-10. Continued

Feature	Covered by	Description	Example
Forward	Any individual	A person forwards his or her calls to an inside extension, turning the feature on at his or her own phone. (This feature can be activated through remote access as well.) In Release 4.0 or later systems, Forward/Follow Me and Remote Call Forward provide a Delayed Call Forwarding option that allows calls to ring at the forwarding extension. This way of covering calls need not be temporary.	A manager is in a meeting and wants to receive calls in the meeting room. In a Release 4.0 or later system, a manager answers some calls before they are forwarded. When the manager does not answer, calls ring at his or her secretary's extension after a delay.
Remote Call Forward	Outside phone	A person temporarily forwards his or her calls to an outside number, turning the feature on at the destination phone or at the originating phone. He or she uses Remote Access to Remote Call Forward.	A person is working at home and wants to receive calls there.
Group Coverage	A calling group, QCC operator, or individual	Coverage for a group of people. This type of coverage cannot be turned completely off at the extension. Coverage of outside calls always remains in effect.	Calls to a government agency are not directed to individuals, and can be answered, for example, this way: "Hello, this is the IRS Help Line."
Individual Coverage	A calling group, QCC operator, or individual	Coverage for one person. This type of coverage gives the sender maximum control over coverage.	An executive's calls must be answered with her name, so her assistant covers for her, answering, "Hello, this is May's office."

Continued on next page

Table 4-10. Continued

Feature	Covered by	Description	Example
Pickup	A pickup group or any individual	Allows someone to answer calls ringing at another extension or on a line not assigned to his or her phone. With Group Pickup, the person does not need to know the extension number where the call is ringing. With general Pickup for a line or extension, the user must know the line/extension number. A button can be programmed to pick up calls at an extension.	A bookkeeping department works closely together and their calls can usually be handled by anyone in the group. In accounts receivable, clerks sitting next to one another have individual Pickup buttons to answer calls at a neighbor's extension.
Shared Personal Line	One or more individuals	Allows people who share a personal line to cover calls for each other. Privacy is available to prevent joining of calls. (Ring Timing Options can facilitate this.) Does not allow covering of calls on ICOM or SA buttons.	All of the account representatives have their own personal lines for answering customer calls. When they need a technical representative's expertise during a phone conversation, it is easy for the technician to join in.
Shared SA Buttons	One or more individuals	Hybrid/PBX only. Allows people who share an SA button (SSA buttons) to answer calls for the principal user (SA button). Users can join each other's calls, but Privacy can prevent this. The principal user controls ringing at SSA buttons.	A supervisor answers questions with the participation of her group. When she is not able to take a call, they cover for her. This feature is especially useful because the people in this group do not have many line buttons available for programming.
Shared Prime Line	One or more individuals	Behind Switch mode only. Allows people who share a prime line to cover calls for each other. Privacy is not available to prevent joining of calls (Ring Timing Options can be adjusted to avoid confusion.) Does not allow covering of calls on ICOM buttons.	See the example above. In this company, each representative has his or her own prime line and transfers are handled by the Centrex system.

Calling Restrictions

If you and your Lucent Technologies representative planned for calling restrictions as part of the initial setup of the system, the settings required for these calling restrictions are already in place. However, you may wish to change these settings or set restrictions and privileges for new users or new lines/trunks. There are several methods you can use to limit outgoing toll calls:

- **Toll and Outward Restrictions.** Limit toll and outside calls by individual extensions or remote access users, or on pools or trunks.
- **Allowed/Disallowed Lists.** Allow some calls when calling restrictions are in effect or disallow certain calls when restrictions are not applied.
- **Night Service Exclusion List and/or Emergency List.** Allow some calls when Night Service with the Outward Restriction option is used.
- **Pool Dial-Out Code Restriction** (Hybrid/PBX Only). Restrict specific pools. This can be used to reserve certain pools for specific purposes, for example, for data communications.
- **Facility Restriction Levels** (Hybrid/PBX Only). Automatic Route Selection (ARS) allows Facility Restriction Levels (FRLs) to be applied to both routes for pools of outside trunks and extensions for the most reliable control of toll calling.
- **Remote Access.** Remote access callers are required to enter barrier codes in order to reach the system; Disallowed Lists and FRLs can also be assigned with each barrier code.
- **Networking Routes** (Release 6.0 and later systems, Hybrid/PBX mode only). Additional FRLs apply to network routes. See the *Network Reference* for details.

In Release 3.1 and later systems, a system programming feature allows you to help guard against toll fraud when star codes are dialed under certain circumstances. Star codes, typically dialed before an outgoing call, provide special services from the CO. For example, in many areas a telephone user can dial *67 before a telephone number to disable central office-supplied caller identification at the receiving party's telephone. To allow or disallow star codes preceding a call, see ["Revising Allowed Lists" on page 6-71](#) or ["Revising Disallowed Lists" on page 6-74](#). Star code calling is not supported for calls across a network (Release 6.0 and later systems, Hybrid/PBX mode only).

Some central offices supply a second dial tone following the dialed star (*) code, to signal customers that they must dial additional digits. If this second dial tone is not immediate, a hacker can enter digits that are not detected by the CO but are detected by the system's calling restrictions. If your business uses central office star codes and the CO issues a second dial tone after a pause, see *System Programming* for information about including a timed delay that causes the system to prevent the call when digits are entered during the pause.

In Behind Switch mode, calling restrictions must be supplied by the host system, not by the MERLIN LEGEND Communications System.

In Release 3.1 and later systems, the system provides certain default calling restrictions that make it easier for system managers to guard against toll fraud. These are described below with the specific features they affect.

This section describes each type of calling restriction. Some of these features are combined with security measures to prevent system abuse by remote access users or hackers. In addition, users can be assigned authorization codes, which they can enter when they are away from their extensions. When a person enters an authorization code while visiting another system extension, the calling restrictions assigned to his or her own extension are applied to the call. For more information, see ["Authorization Codes" on page 4-50](#).



SECURITY ALERT:

For more information see the section, ["Security" on page 4-51](#). Also consult *"Security of Your System: Preventing Toll Fraud,"* in Appendix A, *"Customer Support Information."*

When you change your system, be aware of the following special considerations that apply to toll calling:

- The Remote Access feature allows employees to dial into the system by dialing the number of a trunk designated for remote access. After a remote access caller reaches the system, you should make sure that he or she must dial a password (called a *barrier code*). After gaining access to the system, the user can, among other things, select a regular or special-purpose outside line (for example, a WATS line) or a pool or an ARS line to make outgoing calls. You can apply calling restrictions to outside lines used to access the system remotely; you can also apply restrictions to barrier codes just as though they were system extensions.
- Some voice messaging systems (described later in this chapter) permit *outcalling*. That is, these systems can be programmed to call an outside number to deliver messages or faxes. This feature can be used for toll abuse, so consider calling restrictions for lines used by such systems.
- Remote Call Forwarding can be allowed or disallowed for your system. If allowed, a user can have calls forwarded to an outside number. (This is not permitted at extensions or on lines where calling restrictions have been applied.)
- When restrictions are applied to extensions, rather than to lines/trunks, a person can ask a co-worker or operator with fewer restrictions to make a toll call on his or her behalf.

- Authorization codes are intended to allow people with less restricted extensions to use extensions where there are more restrictions. If you use authorization codes to enforce restrictions, people may discover that, at some extensions, they can make calls without using authorization codes and gain more privileges than their own extensions allow.

The sections below list the types of restrictions, including the following information:

- Whether the restriction is applied to an extension, line, remote access barrier code (acting as an "extension" for a remote access user), or a combination
- What other restriction features it works in conjunction with, as well as mode restrictions
- A brief description, including recommended use

Since there is some interaction among these features and with other system features, refer to the *Feature Reference* for more detailed information.

Outward and Toll Restrictions

Apply to: Lines/trunks, especially those used for remote access or for outcalling by a voice messaging system (see ["Voice Messaging Systems" on page 4-64](#)), excluding tie and emulated tie trunks programmed as Tie-PBX for Hybrid/PBX mode extensions.

Use with: Allowed Lists to permit restricted users to make some calls. (Tagged System Speed Dial codes or their corresponding tagged Directory listings can also be used to make certain calls.) Can be used with any other calling restrictions.

An extension, line/trunk, or remote access user's barrier code can be programmed to prevent either all outside calls or outside toll calls only. In Release 3.1 and later systems, ports assigned for use by voice messaging systems (generic or integrated VMI ports) are assigned outward restrictions by default. If a voice messaging system is allowed to call out (for example, to send calls to a user's home office), the system manager should remove these restrictions.

In Release 3.1 and later systems in Hybrid/PBX mode, remote access users are automatically restricted from making outside calls using the system. See ["Facility Restriction Levels \(FRLs\)" on page 4-48](#) for more information.

Allowed/Disallowed Lists

Apply to: Extensions and remote access barrier codes

Use Allowed Lists to permit restricted extensions to make some calls. (Tagged System Speed Dial codes or their corresponding marked Directory listings can

also be used to make certain calls.) Use Disallowed Lists to provide some protection from toll abuse when no other restrictions are applied and to restrict remote access callers. Allowed/Disallowed Lists can be used with other calling restrictions. This feature provides flexibility by allowing users whose phones are restricted to call specific numbers related to their business activities, as well as emergency numbers.

Beginning with Release 3.1, star codes can be included in Allowed and Disallowed Lists (in Releases 3.0 and earlier, the system treats star codes no differently from other dialed digits, and you cannot include a star code in an Allowed/Disallowed List; this can affect calling restrictions and ARS routing). Furthermore, they are ignored by the Automatic Route Selection feature when routing calls. Star codes, typically dialed before an outgoing call, provide special services from the CO. For example, in many areas a telephone user can dial *67 before a telephone number to disable central office-supplied caller identification at the receiving party's telephone. To allow or disallow use of this star code preceding a call, you include *67 in an Allowed or Disallowed List. For each star code, a separate list entry is required. For more information about star codes in Allowed/Disallowed Lists, see Chapter 6, "Managing the System."

Beginning with Release 3.1, a default Disallowed List (number 7) is provided with the system. This Disallowed List is automatically assigned to both generic and integrated VMI ports used by voice messaging systems. It includes the following entries, which are often used for toll fraud:

- 0, to prevent international calls
- 10, to prevent access to long-distance service providers
- 1809, to prevent unauthorized international calls routed through the Dominican Republic
- 1700, to prevent unauthorized toll calls with a "700" area code
- 1900, to prevent unauthorized toll calls with a "900" area code
- 976, to prevent local toll calls to numbers with "976" local access codes
- 1www976, where "w" stands for a wildcard entry, to prevent long-distance calls to numbers with "976" local access codes
- 11, to prevent the use of star codes at single-line telephones
- *, to prevent the use of star codes at multiline telephones

Night Service with Outward Restriction

Apply to: Whole system

Use with: Night Service Emergency List and Night Service Exclusion List.
Includes emergency numbers (including, for example, the number dialed by a HotLine) that can be dialed regardless of restrictions. No password is required.

When the Password option of the Night Service feature is programmed, outgoing calls can be restricted by requiring the user to enter a password. The operator who turns Night Service on and off must also enter a password.

A Night Service Exclusion List exempts certain extensions (a HotLine, for example) from the password requirement. Normal calling restrictions, however, are still in effect.



NOTE:

For more information about Night Service, see the *Feature Reference*, [“Covering Calls” on page 4–34](#), and [“Night Service Groups” on page 4–55](#).

Pool Dial-Out Code Restriction

Apply to: Extensions and remote access barrier codes, in Hybrid/PBX mode only

Use with: Any other restrictions

This restriction prevents an extension from dialing specific pool dial-out codes. This restricts outgoing calls from specific pools and can be used to reserve pools for specific purposes, for example, data communications. Beginning with Release 3.1, the default setting for this restriction is on; no extension or remote access user with a barrier code has access to pools until the restriction is removed.

Facility Restriction Levels (FRLs)

Apply to: Extensions in conjunction with lines/trunks, in Hybrid/PBX mode only

Use with: Any other restrictions. Use Disallowed Lists if an FRL is unrestricted, and Allowed Lists if an FRL is highly restricted, especially for emergency numbers. Not necessary for remote access trunks if barrier codes are used. Can be used on all tie trunks.

Automatic Route Selection (ARS) is a Hybrid/PBX mode feature where the system is programmed with dialing plans (called *routes*) that specify certain lines/trunks or network services for outgoing calls, and can choose the most economical facility for a given call at a given time of day. Facility Restriction Levels (FRLs) are assigned to specific routes in an ARS table. There are seven different FRLs that can be assigned to routes, ranging from 0 to 6, where 0 is the least restricted and 6 is the most restricted.

In conjunction with FRLs assigned to routes, FRLs from 0 to 6 are also assigned to extensions and are used to determine whether callers have permission to use the routes. For an extension, 0 is the most restricted and 6 is the least restricted.

To use a route, the extension must have an FRL equal to or greater than the route's FRL. In other words, an extension with an FRL of 0 has the fewest ARS privileges (routes with levels 1 through 6 cannot be used), and an extension with

an FRL of 6 has the most privileges (any route may be used). [Table 4-11](#) shows some examples.

Table 4-11. Facility Restriction Levels

Extension FRL	Route FRL	Allowed
0	0 only	Yes
0	1 and up	No
1	0 and 1	Yes
1	2 and up	No
2	0-2	Yes
2	3 and up	No
3	0-3	Yes
3	4 and up	No
4	0-4	Yes
4	5 and up	No
5	0-5	Yes
5	6	No
6	Any	Yes

In Release 3.1 and later systems, default FRLs help system managers guard against toll fraud. These restrictions are automatically applied to routes, voice messaging ports, and to the barrier codes of remote access users, as follows:

- **Routes.** The default FRL is 2 for default local routes, so system managers can easily change an extension default of 3 to 2 or lower in order to restrict calling. No adjustment to the route FRL is required.
- **Voice Messaging Ports.** The default FRL is 0, restricting all outcalling.
- **Barrier Codes.** The default FRL is 0, restricting all but inside calls.



SECURITY ALERT:

The MERLIN LEGEND Communications System ships with ARS activated with all extensions set to Facility Restriction Level 3, allowing all international calling. To prevent toll fraud, ARS Facility Restriction Levels (FRLs) should be established using:

- *FRL 0 for restriction to inside calls only*

- *FRL 2 for restriction to local calls only*
- *FRL 3 for restriction to domestic long distance (excluding area code 809 for the Dominican Republic as this is part of the North American Numbering Plan, unless 809 is required)*
- *FRL 4 for international calling*
- *Each extension should be assigned the appropriate FRL to match its calling requirement. **All voice mail port extensions and barrier codes not used for outcalling should be assigned to FRL 0 (the default setting in Release 3.1 and later).***

Authorization Codes

Authorization codes are passwords that allow users to apply the calling restrictions of their own extensions when they want to make a call using a more restricted extension.

Using system programming, you can assign one authorization code of 2 to 11 characters for each extension. While each authorization code must be unique, more than one user can use an authorization code simultaneously, for example, to set up a conference call. For optimal security, you should use the longest possible barrier codes (11 characters).

Consider the following points when you assign or modify authorization codes:

- The assignment of authorization codes depends on your company's culture and how system calling restrictions are assigned. For example, you may choose to assign authorization codes only to top-level executives who have a high level of calling privileges or to users who move around the company throughout the day rather than sitting at their own desks.

Or, if there are several phones with little or no outside calling privileges, for example, in common areas used by the public, you may choose to assign authorization codes to all users so they can use those phones if they need to.

- Authorization codes interact with other system features. For example, if the user's own extension is assigned Forced Account Code Entry, the user must enter an account code after entering the authorization code.
- Single-line telephone users who are taking advantage of the Centrex Transfer via Remote Call Forwarding feature (Release 6.0 and later systems) often need an authorization code in order to activate the feature; they do so from a multiline telephone in the system. This is required when a Pause character must be part of the dialing sequence to send calls to the outside number. For details, see ["Centrex Transfer via Remote Call Forwarding" on page 4-36](#).

- An authorization code can also be used to remote call forward calls at phantom extensions.
- Authorization codes can be used for call control and call accounting through the Station Message Detail Recording (SMDR) printout. However, if the user enters both an authorization code and an account code, the account code takes precedence and is stored in the SMDR record.

For more information about authorization codes, see the *Feature Reference*.



SECURITY ALERT:

Authorization codes are not designed to function as a security measure against toll fraud. For information on system security, see the next section, "Security," and "Security of Your System: Preventing Toll Fraud," in Appendix A, "Customer Support Information."

Security

Most security issues are covered in ["Calling Restrictions" on page 4-44](#), which describes the various ways you can help guard against toll fraud. There are four additional features you can use to enhance security and make phone use easier for people in your company:

- **Barrier Codes.** Barrier codes are unique passwords assigned to remote access users. They are designed to prevent unauthorized individuals from using the system. As noted above, you can also apply calling restrictions to barrier codes. Change barrier codes frequently and immediately deactivate any unused barrier codes. In Release 3.1 and later systems (Hybrid/PBX only), remote access barrier codes are restricted, by default, from making outside calls.



NOTE:

Read the Security Alert on [page 4-67](#) before using this feature.

- **Disabling Trunk-to-Trunk Transfer.** In Release 3.1 and later systems, extensions are, by default, not allowed to make trunk-to-trunk transfers, that is, to transfer an outside caller to another outside line/trunk. This enhancement helps secure against toll fraud. To change the trunk-to-trunk transfer privileges of an extension, see Chapter 6, "Managing the System."
- **Star-Code Dialing Pause.** In Release 3.1 and later systems, a system programming feature allows you to help guard against toll fraud when star codes are dialed under certain circumstances. Star codes, typically dialed before an outgoing call, provide special services from the CO. For example, in many areas a telephone user can dial *67 before a telephone number to disable central office-supplied caller identification at the receiving party's telephone (to allow or disallow star codes preceding a call, see Chapter 6, "Managing the System"). Some central offices supply a

second dial tone following the dialed star (*) code, to signal customers that they must dial additional digits. If this second dial tone is not immediate, a hacker can enter digits that are not detected by the CO but are detected by the system's calling restrictions. If your business uses central office star codes and the CO issues a second dial tone after a pause, see *System Programming* for information about including a timed delay that causes the system to prevent the call when digits are entered during the pause.

- **Station Message Detail Recording (SMDR).** This system management feature keeps track of incoming and outgoing calls and prints out reports on a printer attached to your control unit. It also prints programming reports that can alert you to tampering with the system. Inspect these reports frequently. (Call Accounting System applications also provide a utility for detecting toll fraud. See [Table 4-12 on page 4-62.](#))

Toll fraud is a growing criminal industry, and there are individuals who have made a science of defrauding businesses of millions of dollars. You should strongly caution users against the following practices that can compromise the security of the system:

- Writing down barrier codes or passwords and keeping them in a wallet or purse
- Making remote access calls or other password-protected calls from public telephones in such a way that they can be viewed by others, who may even use telescopes or binoculars to see the digits as they are dialed
- Sharing barrier codes or passwords with others or saying them out loud in public locations
- Programming passwords or barrier codes on telephone buttons inside or outside the system

For more information about security, see ["Remote Access" on page 4-58](#) and ["Voice Messaging Systems" on page 4-64.](#)

Dialing Features

Dialing features are straightforward, providing a variety of methods for fast dialing of frequently used numbers. Review the dialing features by looking at "Dialing and Calling" in [Table 4-1 on page 4-5.](#) The analog multiline and cordless/wireless telephone user's and operator's guides include forms for recording dial codes (*not* passwords or barrier codes) that people use often. MLX telephones come with tray cards for this purpose.

When considering dialing features for an extension, keep the following factors in mind:

- Operators often need Direct Station Selectors (DSSs) for easy access to extensions. Auto Dial is also an option when the operator does not cover a large number of extensions.
- Auto Dial buttons require programmed line buttons but are useful for people who have those buttons available and make many calls to a few numbers. They are also useful for entering account codes and other dialed codes and may be appropriate for people who frequently enter the same codes.
- MLX display telephone users can take advantage of Directory features for calling frequently used numbers.
- Speed dial codes are helpful to people who have nondisplay telephones, single-line telephones, and telephones with few line buttons. They are also useful for entering account codes at MLX display telephones, where the user can choose the Account Code feature from the display, or at telephones with a programmed button for the Account Code feature.
- Release 5.0 and later systems include a dialing feature called HotLine. This feature allows a single-line telephone to dial an inside extension or outside number as soon as a user lifts the handset. The feature is designed to help retail customers, for example, dial a number for catalog ordering. It can also be used in a hotel lobby, for example, to reach a concierge. A HotLine telephone dials the first Personal Speed Dial code programmed for the extension. The feature is assigned using system programming. To help guard against toll fraud, a user at a programmed HotLine extension has only one opportunity to program a Personal Speed Dial number. After one Personal Speed Dial number is programmed at the telephone, changes to the number can only be made using centralized telephone programming.
- A Last Number Dial button performs like the redial button available on most home telephones and should be considered for most multiline telephones in the system. Saved Number Dial is similar, but works as a temporary Auto Dial button. Once a number is saved on it, it remains until the feature is used again.

Group Features

Group features allow a programmed group of extensions to receive calls directed to a single extension number. For many purposes, these groups are treated as a single extension. Below, we discuss the uses of these groups.

Calling Groups

A *calling group* is created to receive calls when more than one person answers the same type of calls and it is not important which person answers a call. Examples are call centers of airline agents, customer service representatives, and telemarketers who receive direct response calls from customers placing orders. Calling groups of this type are usually monitored by a special type of operator, a

calling supervisor. When too many calls are waiting for a calling group, calls are sent to an *overflow receiver*. In Release 4.0 and later systems, waiting calls can be sent to the overflow receiver based how long callers have been waiting or how many callers are waiting. In Release 6.0 and later systems, callers can choose overflow treatment if the system has been programmed to allow this.

The system has numerous features and settings to support calling groups:

- Hunt type determines whether calls go in a circular pattern (circular hunt type) to the first available group member, whether calls are distributed based on which agent has waited the longest since transferring or hanging up on an incoming calling group call (most idle agent hunt type, Release 5.0 and later systems only), or whether all calls go to one group member and reach others only when the first person is unavailable (linear hunt type).
- In Release 6.0 and later systems, you can limit the number of calls in the main calling group queue. This applies to or calls arriving on PRI dial-plan routed facilities, dial-in tie trunks, or DID trunks or calls transferred from a voice/mail auto attendant application, and Group Calling calls. When the number of queued calls reaches the limit (0–99), subsequent callers hear a busy signal. Queue control does not apply to coverage calls, remote-access calls, or calls arriving on other types of lines/trunks. If a call is transferred with consultation, it is not queued. These calls can still join the queue when the limit has been reached or exceeded.
- Extensions and supervisor positions can be programmed to log group members in or out (automatically or manually) for the purpose of receiving calls or stopping calls to the extension.
- The light on a Calls-In-Queue Alarm button on a phone goes on when too many calls are waiting for the group. In Release 5.0 and later systems, the system manager or calling group supervisor can specify up to three alarm levels to indicate increasing severity.
- Other extensions or an operator can provide coverage when all the group members are unavailable and too many callers are waiting.
- Calls can be sent to the operator or calling group who provides coverage (the *overflow receiver*) when callers have waited too long (time-based overflow), when too many callers are waiting (number-based overflow), and/or when a caller asks to stop waiting for an agent via touch-tone input (prompt-based overflow available in Release 6.0 and later systems; see the next item for more about delay announcements).
- A delay announcement device can be programmed to play a recording that describes a delay to waiting callers. In Release 5.0 and later systems, a secondary device and message can be set up for each group, allowing callers to hear a primary message first, then a secondary message that may repeat. In addition, as many as 10 primary delay announcement

devices can serve waiting callers in Release 5.0 and later systems. (Music On Hold can also entertain people who are waiting for a group member's attention.)

In Release 6.0 and later systems, your delay announcement device may request that a caller dial # in order to leave the main calling group queue and have their call handled by an overflow QCC operator or calling group. This *Prompt-Based Overflow* feature is particularly useful in combination with a voice messaging application. In this case, the recording might prompt, "Press the pound key to leave a message for the customer service agents."

 **NOTES:**

1. When you change a delay announcement, you may need to adjust the delay announcement interval to ensure that callers do not wait too long for the announcement and that Music On Hold or special ringback does not interrupt the announcement. See the *Feature Reference* for details.
2. In Release 6.0 and later systems, the Prompt-Based Overflow setting requires an additional touch-tone receiver (TTR) for each delay announcement device assigned to the calling group.

- An extension can be assigned to receive messages for a calling group.

Calling groups can be used to designate extensions used by voice messaging systems or fax machines, so that these devices can receive calls directed to a single extension number.

 **NOTE:**

The *Feature Reference* provides detailed information designed to help calling group supervisors and system managers plan calling group options.

Night Service Groups

Night Service groups are assigned for the purpose of Night Service operation, which changes coverage, and potentially calling restrictions, outside of normal business hours. The system manager assigns extensions (including one calling group if desired) and lines (Release 4.1 and later systems only) to a Night Service group, which in turn is assigned to a system operator with a programmed Night Service button on his or her extension. When the operator uses the button to turn Night Service on, calls ring immediately at the extensions in the group. When it is time for normal operation to resume, the operator turns Night Service off.

Beginning with Release 4.1, lines that should ring immediately must also be assigned to a Night Service group. These lines need not be assigned to the operator for the group (particularly useful for personal lines), and their Night

Service status is not affected by Night Service operation at the extension of an operator who handles another Night Service group. If a line is assigned to an operator position but not included in a Night Service group, Night Service does not affect it. The following types of lines can be assigned to a Night Service group:

- Analog ground-start and loop-start lines/trunks as well as digital T1 voice operation lines that emulate these types
- ISDN digital PRI lines that are routed by line appearance
- Digital NI-1 BRI lines
- Automatic incoming tie trunks

The following types of lines cannot be assigned to a Night Service group:

- DID (Direct Inward Dial)
- ISDN digital PRI routed by dial plan
- Tie trunks directed to an extension (dial-in tie trunks)
- Lines whose ports are programmed for Loudspeaker Paging, Alarm, or Music on Hold

For information about how Night Service works with coverage, see [“Covering Calls” on page 4–34](#); to learn more about Night Service and calling restrictions, see [“Night Service with Outward Restriction” on page 4–47](#).

Other Groups

Other groups are assigned to enhance the use of specific system features:

- Pickup groups can be assigned when people need to answer one another's calls (see [“Pickup” on page 4–37](#)).
- Paging groups are used for extensions that have speakerphones and are located in the same work areas or departments. All members of a group can be paged at once. (Note that the Loudspeaker Paging feature is different; a loudspeaker paging system can support *zones* for broadcasting to different areas of a company.)
- Coverage groups are described [“Covering Calls” on page 4–34](#).

Data Communications

You will not find a great deal about data communications in the Feature Finders earlier in this chapter. Although the system allows data communications, it does so with features that also support other functions. Full descriptions of data communications and the equipment for data communications are included in the *Feature Reference* and *Data/Video Reference*. [“Data Communications Adjuncts” on page 3–40](#) also provides information about data communications equipment.

Some data communications setups (called *data workstations*) include a modem connected to an MLX telephone that is equipped with a Multi-Function Module (MFM). MLX extensions make good data workstations because they require only one extension jack for both the phone and the modem (the modem may be inside or external to a data terminal or PC). A modem may also be attached directly to an MLX extension jack. Alternatively, a modem may be attached directly to an analog extension jack or to a General-Purpose Adapter (GPA) and analog multiline telephone; to operate independently, the phone and GPA must each have an analog extension jack. A modem can also be attached directly to a tip/ring (T/R) jack on a 012, 016 (Release 4.0 and later systems), or 008 OPT module.

An Auto Answer All button must be programmed at an analog multiline telephone that is connected by a GPA to a modem. If you use Auto Dial, Last Number Dial, Saved Number Dial, or Authorization Codes at an analog voice and modem data workstation with a GPA set to Auto operation (for automatic answering of data calls), the user must first lift the handset and then activate the feature. If a feature turns on the speakerphone at the telephone, the GPA does not work properly.

Group and personal desktop videoconferencing systems, high-speed data communications, and Group IV (G4) fax machines are supported through digital Basic Rate Interface (BRI), T1 Switched 56, or Primary Rate Interface (PRI) lines (see [“Modules Supporting Lines/Trunks” on page 3–7](#) for more information about these facilities). These arrangements allow high-speed data transmissions through an MLX extension jack that accesses a digital line. An ISDN terminal adapter or other DCE takes the place of a modem for transmitting and receiving data. In some cases, the two B-channels of an MLX extension jack can be combined through system programming of the 2B Data feature; this arrangement allows communications at double the speed of a single digital channel or B-channel, that is, at 112 or 128 kbps.

Depending upon the equipment you are using, there are many interactions between data workstations and system features. Not all features are available at all data workstations. These features should be disabled at most data workstations:

- Voice Announce to Busy
- Call Waiting
- Automatic Callback

Automatic Callback can be used at data workstations that include a desktop videoconferencing and data-sharing system (see Chapter 5, “Optimizing the System,” for more information about this system). Privacy should be turned on at data workstations connected to analog extension jacks, 012 modules, or 016 modules (Release 4.0 and later systems).

Remote Access

The Remote Access feature allows someone outside the system to call in and use the system as if he or she were on the system. You can and should see that a barrier code is programmed for each remote access user, who enters that code as a password for access to the system. Your Lucent Technologies representative can help you plan these barrier codes as needed and help you designate an outside trunk for use by people calling in for remote access to the system.

Remote access requires that you have a certain number of touch-tone receivers (TTRs) to interpret the digits entered by remote access users, who must use touch-tone telephones. These TTRs are supplied on the control unit modules. The number required depends upon the call volume you anticipate, the applications you use, whether or not you are networking using tie trunks (Release 6.0 and later systems, Hybrid/PBX mode), and the features that you use. See [Table 3-1 on page 3-12](#), for information about modules providing TTRs and discuss your needs with your Lucent Technologies representative.

Calling restrictions can and should be associated with each barrier code, so that remote access users cannot make unauthorized calls. In a Hybrid/PBX system, an Automatic Route Selection (ARS) Facility Restriction Level (FRL) can ensure that remote access users are restricted just like other system users.

In Release 3.1 and later systems, the default FRL assignment for a barrier code is 0, restricting all outside calls.

Take these additional measures to enhance system security:

- Change remote access barrier codes frequently. This helps prevent toll fraud when someone has revealed his or her barrier code to others.
- Delete unused barrier codes immediately.
- Always use the longest possible barrier codes.

System Programming includes instructions for adding, deleting, and changing barrier codes.

Account Codes

If your company requires that telephone costs be associated with specific projects, departments, or clients, you should take advantage of the Account Code Entry and Forced Account Code Entry features of the system. Call Accounting Systems, described in ["Applications" on page 4-60](#), are applications that enhance these functions. See *System Programming* for information about programming account codes, and distribute these account codes to people who need them. Dialing features (see ["Dialing Features" on page 4-52](#)) may be used to help automate Account Code Entry.

- **Account Code Entry.** This feature enables users to enter account codes for outside calls, both incoming and outgoing. These codes appear on Station Message Detailed Recording (SMDR) reports and are used for billing or cost accounting to identify outgoing calls with a project, client, or department. You can enter an account code before or during a call, or not at all. You can also change, correct, or cancel an account code while the call is in progress.
- **Forced Account Code Entry.** Forced Account Code Entry is similar, but affects only outgoing calls and *requires* a user to enter an account code before placing an outside call. You can change or correct an account code while a call is in progress, but you cannot cancel it.



NOTE:

Account codes override authorization codes for the purposes of SMDR reporting. If an authorization code is used without an account code, the authorization code is reported. When Forced Account Code Entry is assigned to an extension, the user must enter the authorization code before making the call.

Automatic Route Selection (ARS)

This feature is available for Hybrid/PBX systems only and assures cost-efficient use of the various lines/trunks and facilities in the system. ARS makes decisions, based on programmed routing tables and calling restrictions, that choose the most cost-effective facility for each outgoing call. It also provides enhanced calling restrictions, as described in ["Calling Restrictions" on page 4-44](#).

ARS is complex to program but well worth the effort. If your system was installed with ARS, consult the following system planning form(s) for information about how calls are routed for this feature: Form 3e, Automatic Route Selection worksheet; Form 3f, Automatic Route Selection Tables; and Form 3g, Automatic Route Selection Default and Special Numbers Tables. When you add a line/trunk to your system, this routing may need changes. Consult the *Feature Reference*, *System Programming*, and your Lucent Technologies representative for help.

When you add or change extensions in your system, you may also need to change Facility Restriction Levels (FRLs), the calling restriction feature of ARS. This is not difficult, as long as you refer to the FRLs already programmed for facilities on the system. Consult the system planning forms noted above, as well as the *Feature Reference* and *System Programming*.

System Management Features

The system includes features for which the system manager is responsible and features that help the system manager do his or her job. Features for which the system manager is responsible are detailed in the Feature Finders earlier in this chapter and in the feature descriptions above. Use the *Feature Reference* as your source for further details about all these features.

Features that help you in your work are listed below.

- **Reports.** Review the Station Message Detailing Recording (SMDR) feature for information about the calling and programming reports you can get from the system. When your system is installed, your Lucent Technologies representative should see that an SMDR printer is attached to the control unit for printing these reports. A list of the available reports and how to access and print them is included in [“Using Reports” on page 6–34](#).
- **Programming.** Programming is not really a feature, but you use it to facilitate most aspects of your job when a change to the installed system is necessary. Centralized telephone programming allows you to program extensions with headsets, program Barge-In for operators, and change line button assignments at extensions. You can also use centralized telephone programming to program features and buttons at individual extensions, rather than having users do this themselves. You can copy line button assignments and features from one extension to another.

To program the system, you need an MLX-20L telephone, preferably with a DSS. System programming comprises much of your work of this type, and is outlined, along with centralized telephone programming, in *System Programming*.

Chapter 6, “Managing the System,” provides useful information about the programming and tasks required for common system management duties. The section below describes applications that can help you manage the system.

Applications

The system allows you to take advantage of various call-handling and system management add-on software and/or hardware products (applications), including voice mail and messaging; call accounting and reporting; and call management, call distribution, and reporting.

In addition, Centrex services are supported by the system; Centrex is supplied by a service provider. The system also allows the use of the Primary Rate Interface (PRI) platform for accessing services to which you can subscribe. In Release 4.2 and later systems, you can use this access arrangement, as well as digital facilities supported by the system, to use network services from various

telecommunications companies. For more information, see the *Feature Reference* and [“Modules Supporting Lines/Trunks” on page 3–7](#).

This section provides an *overview* of the applications and services that you can connect to the system. If you are considering adding any of these products to your system, see the following system reference guides for more information:

- *Feature Reference* for information about some considerations you need to take into account
- *System Planning* for planning instructions
- *System Programming* for detailed system programming instructions
- The documentation for specific products and services provides the most detail. No system guide presents full information about the operation and installation of specific applications. Consult your Lucent Technologies representative after you review the system guides.



NOTE:

There are important differences in how applications function in the system's different modes of operation (Key, Hybrid/PBX, or Behind Switch). Also, there may be interactions between an application and certain system features. For more information, see the *Feature Reference* or contact your Lucent Technologies representative.

As you review information about the available applications, ask these questions:

- What adjunct hardware and software are required for the application? Does a UNIX System, DOS, or Windows environment match my expertise or that of others who may use the application?
- How does the application work with the features and settings already programmed for the system?
- Are additional line/trunk and/or extension modules necessary to accommodate the application?

This section summarizes applications in general, then presents some specifics regarding voice messaging applications.

Summary of Applications

[Table 4–12](#) provides a summary of the applications currently available with the system. The *Feature Reference* includes descriptions of applications that were available in the past.

In Release 5.0 and later systems, the Computer Telephony Integration (CTI) link enables the use of worktop software applications for controlling and monitoring calls. The link operates on the system in conjunction with LANs (local area networks) running Novell NetWare server software and is part of the PassageWay

Telephony Services workgroup product. It allows clients, via the telephony server, to use software applications for calling activities. For example, a service representative might automatically view customer information on a computer screen when the customer calls; the incoming telephone number triggers a pop-up information screen from a database available to the network.



NOTE:

In [Table 4-12](#), *H/PBX* stands for "Hybrid/PBX" and *BS* stands for "Behind Switch."

Table 4-12. Application Descriptions and Modes of Operation

Category and Name	Key	H/PBX	BS	Description
Applications Link				
CTI (Computer Telephony Integration) Link		✓		Release 5.0 and later systems only. Provides an interface between the system and a LAN running Novell NetWare, allowing the use of software applications on Windows 3.1, Windows 95, Windows 3.11 for Workgroups, Windows NT, Apple Macintosh OS, and UNIX System clients for call control and monitoring.*
PassageWay Direct Connection Solution	✓	✓	✓	Windows-based. Provides an interface between a PC and the system for application solutions such as programming the MLX telephone at the extension, auto dialing from the PC, and call logging. Can integrate with Windows applications.
Standalone Programming				
System Programming and Maintenance (SPM)	✓	✓	✓	DOS-based PC software that enables system programming from a PC instead of an MLX-20L telephone. See <i>System Programming</i> for a complete description.
Standalone Call Accounting and Management Applications				
Call Accounting System (CAS) Plus V3	✓	✓	✓	DOS-based. Tracks and sorts phone charges, offering a wide range of customizable reports. Also includes messaging features and a special utility for detecting toll fraud.
Call Accounting Terminal (CAT)	✓	✓	✓	Dedicated terminal/printer tracks and sorts charges and prints reports. More detail than SMDR reporting.
MERLIN LEGEND Reporter†		✓		Allows analysis of facilities usage, calling group agent performance, and call traffic patterns.

Continued on next page

Table 4-12. Continued

Category and Name Key H/PBX BS Description

Standalone Call Answering and Voice Mail Packages

MERLIN Mail Voice Messaging System (VMS)	✓	✓		Includes multiple automated attendants for answering calls, as well as voice mail messaging for outside and inside callers.
MERLIN LEGEND Mail Voice Messaging System (VMS)	✓	✓		Same features as MERLIN Mail but is packaged as an integrated unit with its own module to provide voice messaging interface (VMI) ports.
Lucent Technologies Attendant [®]	✓	✓		Answers incoming calls and plays a menu of recorded prompts, then routes calls as prompted by callers. Can route calls to answering or fax machines. Does not work with MERLIN Mail or AUDIX [®] Voice Power [®] .

Integrated Package

Intuity AUDIX Fax Messaging ICAS CONVERSANT	✓	✓		Provides a single interface to the applications and allows easy integration of general system programming with programming for applications. CAS is described above. Fax Messaging manages fax calls to extension users and allows retrieval of faxes from a user's personal fax number. CONVERSANT provides attendant services and also integrates voice mail and interactive menu applications. See "Voice Messaging Systems" on page 4-64 for more information about AUDIX.
---	---	---	--	--

Multi-use Telephone

MERLIN PFC	✓	✓	✓	Phone, fax machine, and copier in one unit. Operates as a BIS-34D telephone.
------------	---	---	---	--

Continued on next page

Table 4-12. Continued

Category and Name	Key	H/PBX	BS	Description
Telephone Company Services				
NI-1 BRI [‡]				Used to connect the system to an ISDN network facility providing voice and digital data services.
Group IV (G4) fax	✓	✓		
Videoconferencing	✓	✓		Videoconferencing and Group IV fax are provided by the subscriber.
Calling Party ID	✓	✓		
PRI				Used to connect the system to an ISDN network facility providing voice and digital data services.
Group IV (G4) fax	✓	✓		
Videoconferencing	✓	✓		Videoconferencing and Group IV fax are provided by the subscriber.
Circuit-switched Data	✓	✓		
Calling Party ID	✓	✓		
T1 Switched 56 [†]				Used to connect the system to an ISDN network facility providing digital data services.
Group IV (G4) fax	✓	✓		
Videoconferencing	✓	✓		Videoconferencing and Group IV fax are provided by the subscriber.
Circuit-switched data	✓	✓		
Centrex	✓	✓	✓	Provides telephone features from the CO.

* Not all Macintosh OS and UNIX system clients are supported. See the *PassageWay Telephony Service Network Manager's Guide* for details.

† Release 5.0 and later systems only

‡ Release 4.0 and later systems only

Voice Messaging Systems

A voice messaging system (VMS) provides call-answering services and may provide voice mail services. [Table 4-13](#) describes the services available by product (note that MERLIN LEGEND Mail services apply to MERLIN Mail). When choosing or planning a VMS, keep the following considerations in mind:

- Each of the VMS applications connects to a special tip/ring (T/R) jack, called a *voice messaging interface (VMI)*. If you plan to add voice messaging to your system, ask your Lucent Technologies representative to help you plan for VMI ports for your system. (You may already have enough on existing modules.)
- Voice messaging systems also require that you have a certain number of touch-tone receivers to interpret the digits entered by callers using touch-tone telephones. These are supplied on the control unit modules. The number required depends upon the call volume you anticipate. Discuss this with your Lucent Technologies representative.
- Use password access to voice mailboxes to protect privacy.

- If you plan to use an outcalling feature (see [Table 4-13](#) for an explanation), consider using calling restrictions to prevent this feature from being abused by people who may make fraudulent toll calls.



NOTE:

In Release 3.1 and later systems, all VMI ports are by default restricted from outcalling in Hybrid/PBX systems, using an extension FRL of 0. VMI ports are automatically assigned a special Disallowed List that restricts many types of calls made by fraudulent callers. In addition, these ports are outward-restricted. For more information, see [“Calling Restrictions” on page 4-44](#).

- The system provides two specific features that work with voice mail systems: Direct Voice Mail and Coverage VMS Off. Direct Voice Mail allows transfer of a caller to a voice mail box, without ringing the mailbox owner at his or her extension. Voice mail can be designated to cover calls in the same fashion that a calling group can; Coverage VMS allows a user to turn this feature on or off and requires a programmed button. Consider how you might take advantage of these features in your company.



NOTE:

Before planning voice messaging, see the Security Alert on [page 4-67](#). Also consult “Security of Your System: Preventing Toll Fraud,” in Appendix A, “Customer Support Information.”

Table 4-13. Voice Messaging Systems

Service or	Application Description	MERLIN LEGEND Mail	Auto Attendant	Intuity AUDIX	AUDIX Voice Power Fax Attendant
Automated Attendant	Answers calls with recorded greeting and menu of choices; transfers calls as callers prompt.	✓†	✓‡	✓	✓
Call Answer	Connects callers to called party's mailbox when extension is busy or unanswered. Enhances an automated attendant.	✓		✓	
Voice Mail	Allows outside callers to leave messages. Allows users to send messages to others, forward messages with comments, and return calls.	✓	✓	✓	
Broadcast messages	Enables you to send a voice mail message to all system users.	✓			
Collected (prompted) digits	Allows a caller to dial digits (a customer number, for example) for better service when the call is transferred to an agent.	✓			
Information Option	Plays a recorded message and then disconnects the caller.			✓	
Message Drop	Plays a message and then allows caller to leave a message (no transfer).			✓	
Dial by name	Lets users call other users by dialing the called party's last name instead of number.	✓		✓	
Outcalling	Automatically calls a user at an outside number (may be a beeper) to signal a new message so user can call to retrieve it.	✓		✓	
Multilevel menus	Allows recording of multiple-level menus and announcements, including different ones for day and night.	✓		✓	
Immediate or delayed answer	Allows call-handling immediately or after a set number of rings, so calls can be answered by an operator.	✓	✓		
Alternate Personal Greetings	Allows a user to record a second greeting in addition to the primary call-answer greeting.			✓	
General mailbox	Provides two special mailboxes with reserve extension; callers with rotary-dial phones or needing help can leave messages.			✓	

Continued on next page

Table 4-13. Continued

Service or Application Description	MERLIN LEGEND Mail	Auto Attendant	Intuity AUDIX	AUDIX Voice Power Fax Attendant
Fax Call Coverage				✓
Fax Messaging				✓
Fax Mail				✓
Route to fax	✓	✓	✓	✓
Fax Broadcast				✓
Route to answering machines		✓		
Fax Response				✓

- * If the caller does not have a touch-tone phone, the system transfers the call to the system operator.
- † Interacts with Night Service feature to provide special after-hours service, for example, directing calls to a specific extension. Also, a night announcement can greet callers after hours. Supports multiple languages.
- ‡ Lucent Technologies Attendant can answer every incoming call or only calls on certain lines/trunks.



SECURITY ALERT:

Your Voice Messaging System permits callers to leave verbal messages for system users or gain access to the backup position in an emergency as well as to create and distribute voice messages among system users.

The Voice Messaging System, through proper programming, can help you reduce the risk of unauthorized persons gaining access to the network. However, phone numbers and passwords can be compromised when they are overheard in a public location, lost through theft of a wallet or purse containing access information or through carelessness (writing codes on a

piece of paper and improperly discarding them). Additionally, hackers may use a computer to dial a password and then publish the information to other hackers. Substantial charges can accumulate quickly. It is your responsibility to take appropriate steps to implement the features properly, evaluate and program the various restriction levels, protect and carefully distribute access codes.

Under applicable tariffs, you will be responsible for payment of toll charges. Lucent Technologies cannot be responsible for such charges and will not make any allowance or give any credit resulting from unauthorized access. To reduce the risk of unauthorized access through your Voice Messaging System, please observe the following procedures:

- *Employees who have voice mailboxes should be required to use the passwords to protect their mailboxes.*
 - *Have them use random sequence passwords.*
 - *Impress upon them the importance of keeping their passwords a secret.*
 - *Encourage them to change their passwords regularly.*
- *The administrator should remove any unneeded voice mailboxes from the system immediately.*
- *Lucent Technologies Voice Messaging Systems have the ability to limit transfers to subscribers only. You are strongly urged to limit transfers in this manner.*
- *Use the system programming capability to do the following:*
 - *Block direct access to outgoing lines and force the use of account codes/barrier codes.*
 - *Disallow trunk-to-trunk transfer unless required (in Release 3.1 and later systems, trunk-to-transfer is disallowed by default and can be permitted only through system programming).*
 - *Assign toll restriction levels to all voice messaging ports. In Release 3.1 and later systems, voice messaging ports are automatically outward-restricted, assigned an FRL of 0 (Hybrid/PBX mode only), and assigned a Disallowed List that restricts calls to many numbers often dialed by toll-fraud abusers.*
 - *If you do not need to use the outcalling feature, completely restrict the outward calling capability of the voice messaging ports (the default in Release 3.1 and later systems). For AUDIX Voice Power and MERLIN Mail, use the "transfer to subscribers only" feature to restrict outside calls.*
- *Monitor SMDR reports or Call Accounting System reports for outgoing calls that might be originated by voice messaging ports.*

A 012 or 016 port (Release 4.0 and later) that is programmed as a generic VMI port or a MERLIN LEGEND Mail Voice Messaging System port (including the Remote Maintenance Device port) can transfer an outside call to an outside number if the default settings are changed in Release 3.1 and later systems. In this case, a single-line telephone, connected to an integrated VMI port can complete trunk-to-trunk transfers. In Release 3.1 and later systems, trunk-to-trunk transfer is automatically disallowed for all extensions, unless it has been enabled (on a per-extension basis) through system programming.

Calling restrictions (for example, Disallowed Lists, Toll Restriction, Facility Restriction Levels) should be programmed, as appropriate, to minimize toll fraud abuse, especially if a single-line telephone is connected to an integrated VMI port. Refer to the "Calling Restrictions" section in the Feature Reference for additional information about programming calling restrictions.

Putting the System to Work

5

This chapter provides two sample business scenarios to help you understand your existing system and other configurations you may want to consider in the future. The following examples are discussed:

- **Scenario 1: A Small Office** (Key Mode). A private medical practice.
- **Scenario 2: A Large Professional Office** (Hybrid/PBX Mode). A law firm with some special needs and concerns, including covering calls and restricting outgoing calls.



NOTE:

Chapter 2 of the *Network Reference* includes additional scenarios that help system managers plan and maintain systems in private networks (Release 6.0 and later systems, Hybrid/PBX mode).

Both scenarios include some general background (a description of the company's staff, particular needs and concerns, and a floor plan) and then descriptions of some of the major aspects of the system as set up to meet the company's needs, for example, equipment, methods of call coverage, and calling restrictions.

To better understand your current system, review the scenario that is most like your own. When you are planning system expansion, review the scenario that involves system aspects for which you are planning.



NOTES:

1. For more information about the system equipment used in the scenarios, see Chapter 3, "System Components." For more information about system features and applications, see Chapter 4, "Features and Applications," or the *Feature Reference*. For more

information about data and video communications, consult the *Data/Video Reference*.

2. Release 6.0 and later systems (Hybrid/PBX mode only) support private connections between MERLIN LEGEND Communications Systems and DEFINITY Enterprise Communications Server (ECS) or DEFINITY ProLogix Solutions systems using private networks or the public switched telephone network. This aspect of the system is not covered in this guide. For complete information and scenarios, see the *Network Reference*.

Scenario 1: A Small Office

This scenario describes a private medical practice. The staff includes one physician, a nurse, an office manager, a billing clerk, the operator/receptionist, and an appointments/payments clerk.

All incoming calls come through the operator/receptionist, who transfers them to the appropriate person. A special concern is restricting outgoing calls for phones in common areas, for example, the waiting room and physical therapy room.

The office manager also functions as the system manager.

Staff Needs

This section describes the needs of the staff members and provides a floor plan of the office.

[Table 5-1](#) describes the staff member needs. [Figure 5-1](#) illustrates the layout of the office.

Table 5-1. Medical Office Needs

Staff Member	Needs
Physician	<p>Personal line in her office; if she is not available, the appointments/payments clerk should take these calls.</p> <p>Minimal interruptions when with patients. At these times, the operator/receptionist or nurse should take messages; the physician must be notified of urgent calls.</p> <p>Ability to beep the nurse's station when she needs assistance</p> <p>Ability to make unrestricted calls from own phone, staff lounge, and meeting room</p>
Nurse	Quick dialing of primary local pharmacy numbers
Office Manager (System Manager)	<p>Ability to generate reports on system use</p> <p>As system manager, needs programming privileges and a programming console</p> <p>PC with modem</p> <p>Fax machine</p>
Billing Clerk	Quick dialing of insurance company numbers
Operator/ Receptionist	<p>Console with four incoming lines; if one line is busy, calls automatically go to the next line.</p> <p>Ability to notify the doctor of a waiting call without actually calling her</p> <p>Ability to switch calls to answering service after hours; however, any staff members working after hours need to be able to receive calls.</p> <p>Ability to switch calls to office manager when no other staff member is available</p> <p>Ability to page staff members when not at their phones; page should exclude certain rooms to avoid disturbing patient care.</p> <p>If staff member is not at his or her desk to receive a transferred call, it returns to the operator/receptionist so she can page the person or take a message.</p> <p>Ability to identify who is calling so the patient's record can quickly be retrieved from the computer database</p>
Waiting Room	Outgoing calls restricted to local calls and 800 numbers (for use by pharmaceutical company representatives)
Lab	Quick access to other labs
Staff Lounge	Outgoing calls restricted for toll calls
All Staff	Ability to dial frequently used numbers quickly

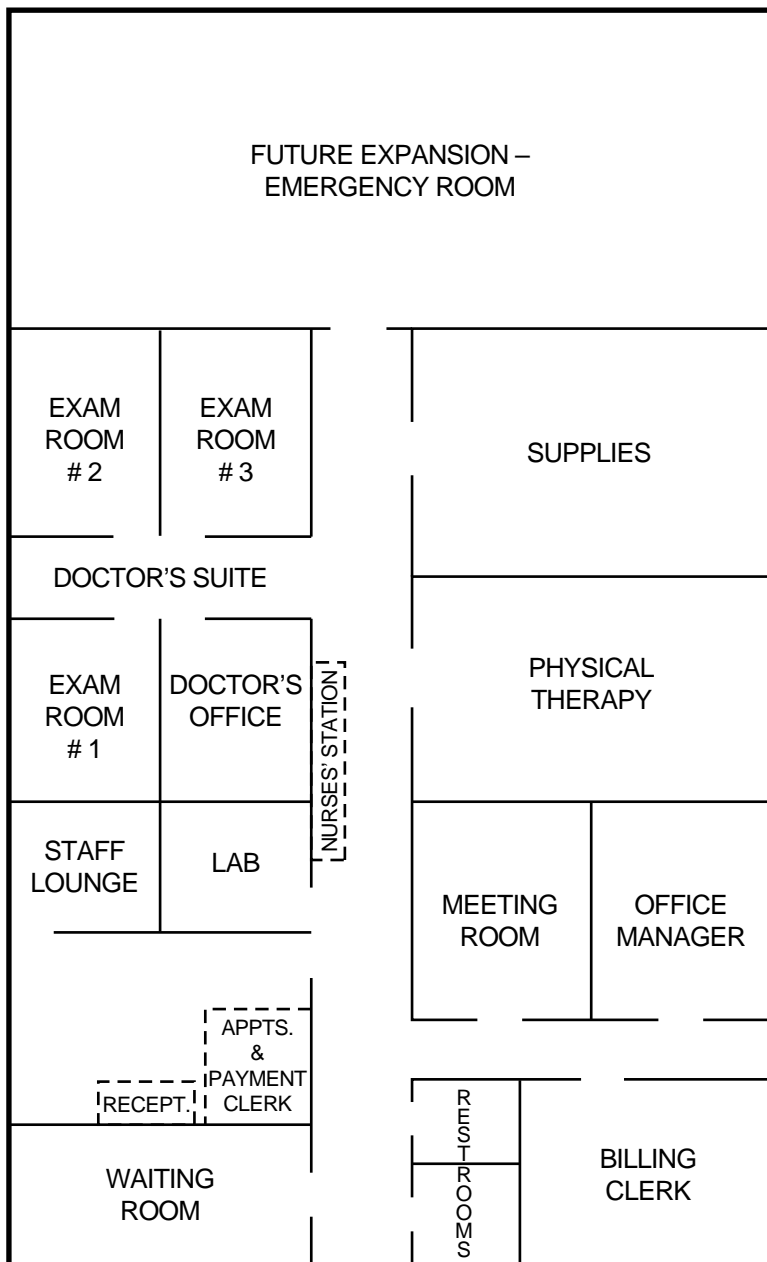

Figure 5-1. Medical Office Floor Plan

System Description

The system is set up for Key mode operation and uses the following equipment and features to answer the needs of the staff:

- **Incoming Lines.** Four lines associated with the office's Listed Directory Number, plus a personal line for the physician and a dedicated line for the office manager's fax machine.
- **Equipment.** The following MLX telephones:
 - MLX-20L telephones for the doctor's office and for the office/system manager



NOTE:

The office manager's telephone is the system programming console.

- MLX-28D telephone for the operator/receptionist console
- MLX-10DP telephones (wall-mounted) and MLX-5D telephones for all other staff members and locations

The system also includes Caller ID and the PassageWay Direct Connection Solution application so the receptionist can quickly identify the caller and access the patient's record on the PC.

To provide battery backup power to the system in the event of a commercial power failure, an Uninterruptible Power Supply (UPS) is installed.

- **Restrictions on Outgoing Calls.** Calling Restrictions and Allowed List features. All phones are unrestricted except the following:
 - Staff lounge: Toll-restricted
 - Waiting room: Toll-restricted with Allowed List for 800 numbers
 - Examination rooms: Toll-restricted with marked System Directory numbers (available from any phone) to call certain pharmacies
- **Transferring Calls.** Operator/receptionist can transfer calls using the Transfer feature with One-Touch Transfer and a Transfer Return Time set to 4 (calls return to the operator/receptionist if the staff member does not answer the phone by the fourth ring).
- **Coverage.** Only certain extensions receive coverage. During office hours, the operator/receptionist handles all calls except those to the fax machine and to the physician's personal line. Occasionally people use Forward or Follow Me features when they are working at another extension or Remote Call Forwarding when they are out of the office.

- For physician: Coverage after 3 rings by appointments/payments clerk; this feature is intended to handle personal line calls. (On all other lines, the operator speaks to the caller and then transfers the call to the doctor only at certain times of the day; otherwise, the operator takes messages.)
- For operator/receptionist when no other staff can be at the operator console: Immediate coverage by the office manager, with Coverage On/Off button at the console.
- For fax machine: No coverage
- **After-Hours Coverage.** Night Service feature with Group Assignment to ring in the doctor's office, nurse's station, and office manager's office. The telephone company sends calls that come into the Listed Directory Number to the outside answering company; people who work late receive Night Service calls on the second line, the number of which is unpublished.
- **Paging.** Loudspeaker Paging feature with multizone paging to two zones:
 - Zone 1: Nurse's station, lab, physical therapy
 - Zone 2: Office manager's office and staff lounge
- **Quick Dialing.** System Directory for the nurse at the nurse's station to call pharmacies, for lab staff to call other labs, and for the billing clerk to call insurance companies. Personal Speed Dial for MLX-10DP and MLX-5D telephone users. Programmed Auto Dial buttons for the physician. Personal Directories for MLX-20L telephone users (office manager and the operator/receptionist). Direct Station Selector (DSS) for operator/receptionist to reach extensions.
- **Phone Use Reports for Office Manager.** Call Accounting Terminal application.
- **Signaling the Doctor or Nurse's Station.** Use of the Signaling feature for doctor to beep the nurse's station for assistance. Use of the Notify feature for operator/receptionist to activate the light next to a programmed button on the phone in the doctor's office.
- **Other Messaging.** The physician uses the Do Not Disturb feature and the Do Not Disturb posted message to prevent interruptions from others in the system. (Only the operator can use Barge-In to contact the doctor in an emergency.) Since all phones are MLX display phones, the people in the office take advantage of the Posted Messages feature when they are out to lunch or otherwise unavailable. (The nurse often posts a message created for his or her use when with a patient.)

Scenario 2: A Professional Office

This scenario describes a law firm. The communications needs of the company fall into these categories:

- **Executive Staff.** Five partners and four associate partners.
- **Secretarial Staff.** Five executive secretaries, a general secretary, two associates' secretaries, and an operator/receptionist.
- **Administrative/Support Staff.** Eight paralegals, an office manager, a word processing pool, and a bookkeeping department. The office manager functions as system manager.
- **All Staff.** All staff members share some common requirements, as do the phones in public areas.

The firm plans with these general considerations in mind:

- A variety of call coverage needs
- A need to track call costs for client billback
- Extensive use of on-line databases and the Internet for research, keeping up to date with professional organizations and publications, and electronic mailing of large legal documents
- Use of Group IV (G4) fax machines for receiving and sending legal documents
- Use by partners, associates, and clients of a PictureTel group videoconferencing system installed in one of the firm's conference rooms
- Security requirements and restrictions on outgoing calls, especially for common areas; for example, the conference room, client meeting rooms, and staff lounge

Because of the extensive data communications needs in this office, many lines are required; furthermore, pools are needed to access certain special line/trunk groups. The operator directs all incoming calls except those to devices such as fax machines and those that arrive on DID and personal lines. For these reasons, a Hybrid/PBX system is required.

[Figure 5-2](#) illustrates the office layout. Following the figure are sections that describe the firm's requirements in more detail and how the system's equipment and features meet these special needs and concerns.

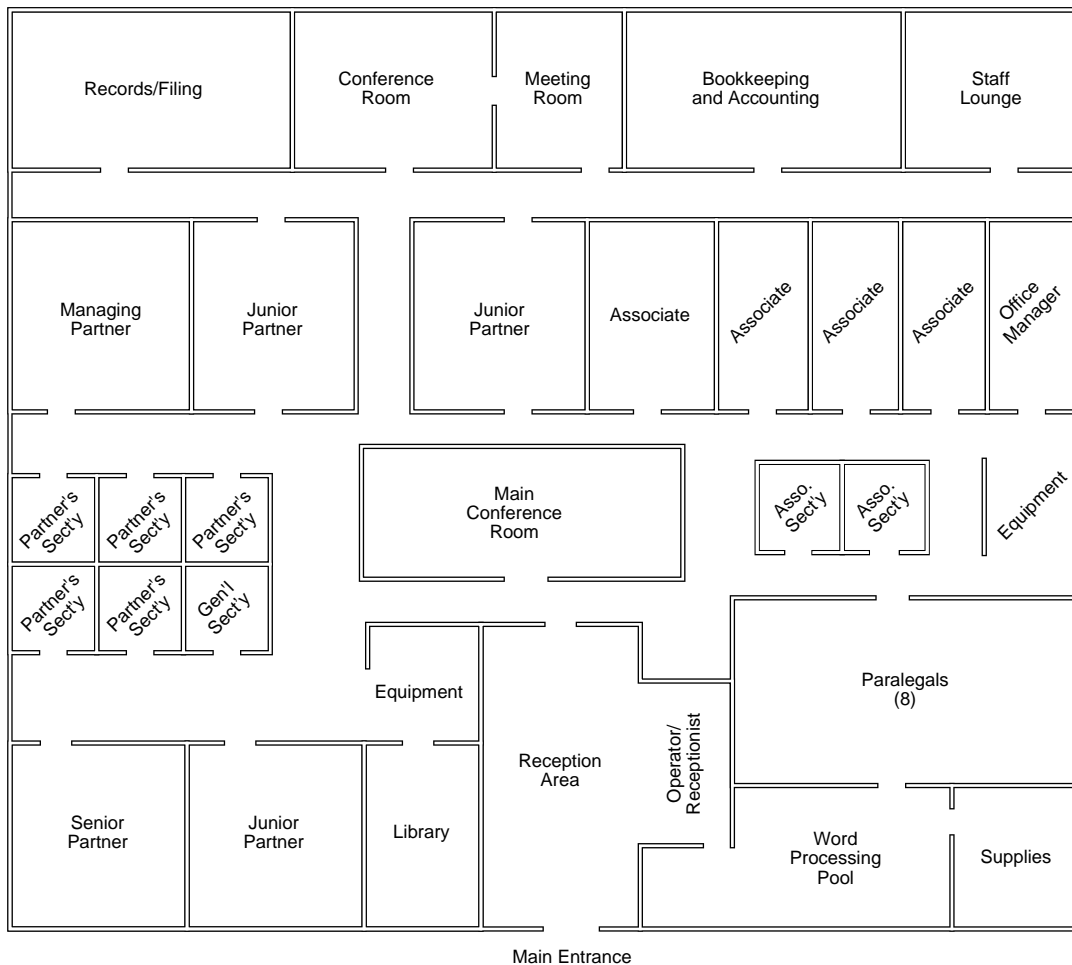

Figure 5-2. Law Firm Floor Plan

Staff Needs

This section describes the needs of the office staff, including the executive staff, secretarial staff, and the administrative/support staff, as well as other miscellaneous needs.

Executive Staff

[Table 5-2](#) describes the needs of the executive staff.

Table 5-2. Executive Staff Needs

Staff Member	Needs
Partners	<p>Partners' calls do not ring at their phones.</p> <p>Partners never answer their own phone calls; executive secretaries answer all their calls. If a secretary is not available, calls must be recorded in the partner's voice mailbox with password access to messages.</p> <p>A personal line</p> <p>No calling restrictions</p> <p>Ability to use own calling privileges at another extension</p> <p>Ability to bill clients for phone time</p> <p>Access to the phone system from an outside phone</p> <p>Ability to forward calls to their cellular phones</p>
Associates	<p>Calls go directly to each associate. If an associate is not available, one of the associates' secretaries answers. If no secretary is available, calls must be recorded in the associate's voice mailbox with password access to messages.</p> <p>Each has a PC with modem.</p> <p>Ability to bill clients for phone time</p> <p>Access to the phone system from an outside phone</p> <p>Ability to forward calls to their cellular phones</p>

Secretarial Staff

[Figure 5-3](#) describes the needs of the secretarial staff.

Table 5-3. Secretarial Staff Needs

Staff Member	Needs
Partners' Executive Secretaries	<p>Answer all of their bosses' calls. Calls come directly and through the operator. If an executive secretary is not available, one of the other executive secretaries answers that partner's call. If no secretary is available to take a partner's call, calls must be recorded in the partner's voice mailbox with password access to messages.</p> <p>Because they need to make calls on behalf of the partners and identify callers, the secretaries need a screen-pop PC application with a database of clients and other contacts for power dialing and caller identification.</p> <p>If the secretary is not available, the secretary's own telephone messages must be recorded with password access to the messages.</p> <p>Some calling restrictions</p> <p>A shared Group IV fax machine</p> <p>Each secretary has a PC on the LAN and uses an ISDN terminal adapter for data communications.</p> <p>They share a recording device for recording depositions.</p> <p>On behalf of partners, need to broadcast faxes and voice mail messages for staff</p>
Associates' Secretary and General Secretary	<p>Answer associates' calls when associates are not available, makes some calls on behalf of the associates. The secretaries need a screen-pop PC application with a database of clients and other contacts for power dialing and caller identification.</p> <p>If associates' secretary is not available, general secretary answers associates' calls.</p> <p>If the secretary is not available, calls must be recorded in the secretary's voice mailbox with password access to messages.</p> <p>Some calling restrictions</p> <p>A shared Group IV fax machine</p> <p>Each secretary has a PC; they use ISDN terminal adapters at their workstations.</p>

Administrative/Support Staff

[Table 5-4](#) describes the needs of the administrative/support staff.

Table 5-4. Administrative/Support Staff Needs

Staff Member	Needs
Paralegals	<p>If a paralegal is not available, another in the group picks up the call. If none are available, calls must be recorded in the paralegal's voice mailbox with password access to messages.</p> <p>Each has a PC on the LAN. Some use ISDN terminal adapters for data communications at 64 kbps. Some have Access Pipeline 25-Px access devices attached to their PCs for high-speed Internet access at 128 kbps.</p> <p>Some calling restrictions</p> <p>Ability to bill clients for phone time</p> <p>Access to the phone system from an outside phone</p> <p>Two shared Group IV fax machines</p>
Office Manager (System Manager)	<p>If the office manager is not available, calls go to the general secretary.</p> <p>PC with fax/modem for purchasing purposes</p> <p>Ability to track and generate reports on calling usage for client billback</p> <p>Equipment to manage the system</p>
Bookkeeping Department Members	<p>If a bookkeeper is not available, another in the group picks up the call. If none are available, calls must be recorded in the bookkeeper's voice mailbox with password access to messages.</p> <p>Calling restrictions</p>
Word Processing Pool Members	<p>If a pool member is not available, another in the group picks up the call. If none are available, calls must be recorded in the staff member's voice mailbox with password access to messages.</p> <p>Calling restrictions</p>
Operator/ Receptionist	<p>Takes calls to Listed Directory Number and remote access calls.</p> <p>Ability to interrupt a call at a busy extension or one with Do Not Disturb on</p> <p>Ability to identify inside callers</p> <p>Loudspeaker paging (except partners' offices, conference room, and client meeting rooms)</p> <p>Fax machine for general use</p>

Other Needs

[Table 5-5](#) describes some of the miscellaneous needs of the office.

Table 5-5. Other Needs

Extension	Needs
All staff members	After hours, staff members must be able to hear phones ring and be able to answer. They need to be able to transfer after-hours calls to voice mail. Messaging among all staff members Least expensive routes for calls Ability to quickly dial most frequently used phone numbers
Phones in common areas	Restrictions on outgoing calls
Fax machines, data communications equipment	Need exclusive use of their own lines

System Description

This section provides an overview of the system features and equipment used to meet the needs of this office. Following this overview, equipment, covering calls, and restrictions on outgoing calls are described in more detail.

- **Lines/Trunks.** One 408 GS/LS module to handle the loudspeaker paging system and provide a power-failure transfer (PFT) telephone. Three 800 NI-BRI (Release 4.0 and later only) modules supply outside line/trunks to the system. Two modules are fully equipped, with eight NI-1 BRI (National Integrated Services Digital Network 1 Basic Rate Interface) facilities on each module, supplying a total of 32 virtual "lines" (B-channels). The third 800 NI-BRI module currently connects three facilities that provide six additional B-channels. The organization receives caller identification services at no additional subscriber cost. (For more information about the NI-1 BRI access arrangement and the 800 NI-BRI module, see ["800 NI-BRI Module" on page 3-10.](#))
- **Extension Modules.** One 016 basic tip/ring telephone module (Release 4.0 and later only) to handle the modems, single-line telephones, analog fax machines, and applications. Six 008 MLX modules serve MLX extensions.



NOTE:

The 016 basic telephone module (Release 4.0 and later only) supports a maximum bit rate of 14.4 kbps. Therefore, the office's analog equipment (fax machines and modems) is restricted to speeds no higher than this.

- **Equipment.** MLX telephones for each staff member, excluding four part-time or temporary workstations in bookkeeping and word processing areas (these use single-line telephones), modems, terminal adapters for videoconferencing and high-speed data communications, Ascend Pipeline 25-Px access devices for high-speed Internet access (outgoing calls only), Group IV (G4) and analog fax machines, a recording machine for depositions, headset for operator/receptionist, Integrated Solutions applications package for office/system manager, PictureTel group videoconferencing system.
- **Covering Calls.** Coverage (Individual and Group) feature with appropriate use of Cover buttons and coverage delays set by the system manager for each sender's extension (Release 4.1 and later systems only), **SA** and **SSA** buttons, and voice messaging system with automated attendant and voice mail, as well as Fax Attendant application and fax mail. Outside regular business hours, Night Service feature with Group Assignment and Outward Restriction. Unanswered calls go immediately to the voice messaging system through the system's Night Service with Coverage Control feature (Release 4.1 and later systems only), which automatically deactivates Coverage VMS Off buttons during Night Service operation, then reactivates them during normal business hours. Individuals use Forward/Follow Me features occasionally.
- **Cost-Effective Calling.** Automatic Route Selection (ARS) for cost-effective line/trunk selection for outgoing calls.
- **Restrictions on Outgoing Calls.** Automatic Route Selection (ARS) with Facility Restriction Levels (FRLs); Allowed/Disallowed Lists; remote access barrier codes; authorization codes are mandatory for anyone using extensions other than their own; pool dial-out code restriction to reserve data-only lines.
- **Tracking Calls and Costs for Client Billback.** Call Accounting System and use of the Account Code Entry feature for tracking calls by customer account for billing purposes.



NOTE:

Partners use the Authorization Codes feature (see the section, ["Calling Restrictions" on page 5-21](#)) so that they can make calls from extensions other than their own and still use their own calling privileges. However, these calls cannot be tracked for client billback using the Account Code Entry feature. When both Account Codes

and Authorization Codes features are used, only the authorization code is printed on reports.

- **Paging.** Loudspeaker paging for certain work areas; secretaries use programmed speakerphone paging buttons to inform their bosses about calls waiting for them.
- **Dialing Features.** System Directory or System Speed Dial codes for all users and devices; Personal Directories for operator, partners, and office manager; Auto Dial buttons for MLX-28D users; Personal Speed Dial codes for MLX-10DP and MLX-5D telephones, modems, and fax machines.
- **CTI Link Applications** (Release 5.0 and later systems only). PassageWay Telephony Services applications running on local area network (LAN) client computers for screen pop of client and contact information as calls come in. These Computer Telephony Integration (CTI) link applications also provide power-dialing features.
- **Other System Features and Applications.** Direct Voice Mail feature, password-protected voice and fax mail services (Intuity AUDIX and Fax Attendant); Remote Access (with barrier codes) for partners to access the system from off-site; the Remote Call Forward feature for associates to forward calls to their cellular phones.

Other system equipment includes an Uninterruptible Power Supply (UPS) to supply backup power in the event of a commercial power failure.

Equipment

This section describes the system equipment used to meet the staff members' needs. Included are the types of telephones and adjuncts.

The system includes the following telephones for staff members, as well as in common areas:

- MLX-20L telephones for all partners for maximum functionality and for the Queued Call Console (QCC) operator console for operator/receptionist
- MLX-28D telephones for executive secretaries to provide display screen, maximum number of buttons (to include **SSA** button for each of the partners' lines), and maximum functionality, installed with PassageWay Telephony Services-supported CTI applications on the staffers' PCs and the LAN
- MLX-16DP telephones for associates' secretaries, installed with PassageWay Telephony Services-supported CTI applications on the staffers' PCs and the LAN

5 Putting the System to Work

Scenario 2: A Professional Office

Page 5-15

- MLX-10DP and MLX-5D telephones for associates, paralegals, as well as some bookkeeping and word processing pool members; used in some cases with PassageWay Telephony Services-supported CTI applications on the staffers' PCs and the LAN
- Single-line telephones for reception, word processing, and bookkeeping areas

The following adjuncts are included in the system:

- Group IV and analog (slower speed) fax machines
- Terminal adapters for high-speed 64-kbps data communications by fax, or PC
- Ascend Communications, Inc. Pipeline 25-Px access devices for 128-kbps Internet access (outgoing calls only)
- PictureTel videoconferencing system for use by partners and associates in meeting with key clients
- Modems and fax/modem for office/system manager
- Direct Station Selector (DSS) for office/system manager and Queued Call console (QCC) operator/receptionist
- Headset for QCC operator/receptionist
- Recording machine for executive secretaries
- Station Message Detail Recording (SMDR) and call accounting printers; paralegals also print out on-line researched information at their printer.

[Table 5-3](#) illustrates the equipment.

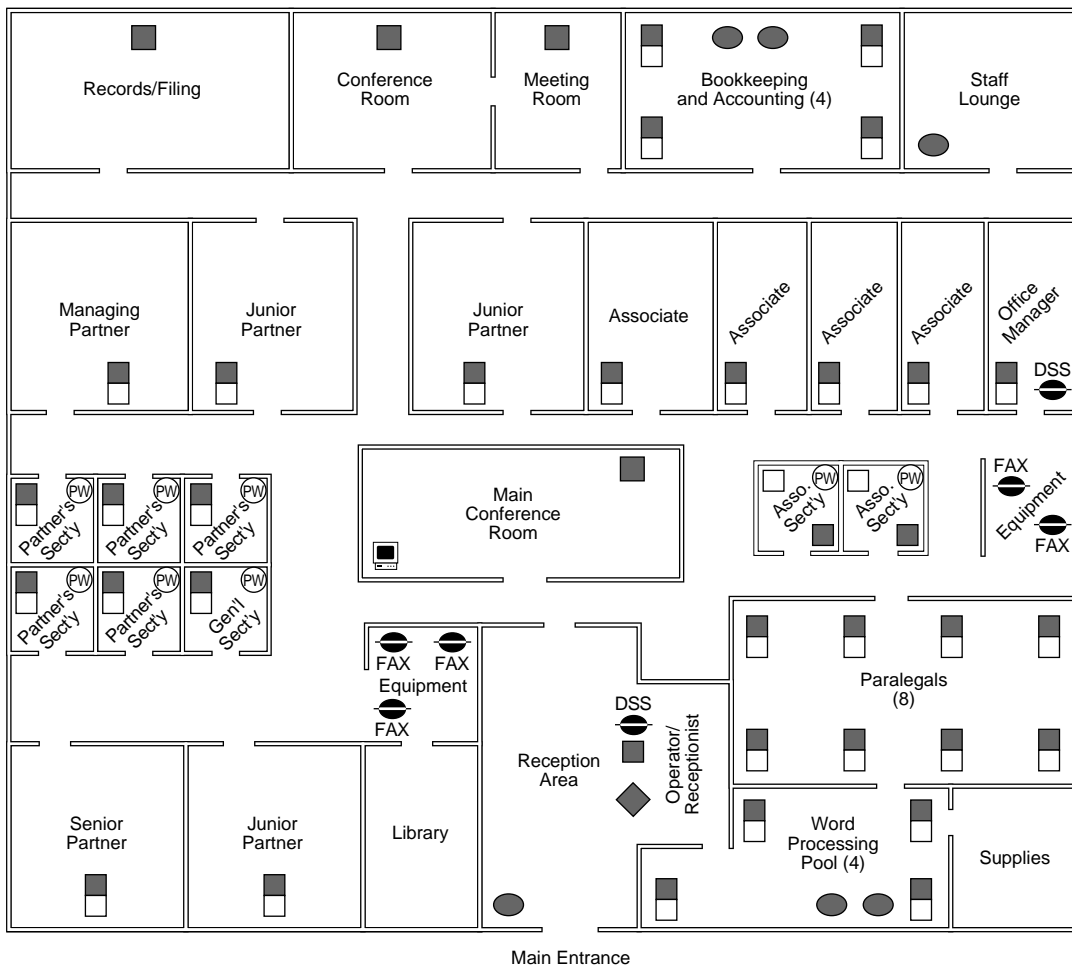

- MLX TELEPHONE
- SINGLE-LINE TELEPHONE
- COMPUTER OR DATA TERMINAL
- Ⓜ PASSAGEWAY APPLICATION
- ◆ OPERATOR POSITION
- ⊖ ADJUNCT
- Ⓜ VIDEOCONFERENCING EQUIPMENT

Figure 5-3. Law Firm Equipment

Call Coverage and Call-Handling

Table 5-6 describes the staff members' call coverage and call-handling needs and the system features used to handle those needs.

Table 5-6. Law Firm Call Coverage and Call-Handling

Staff Member	Needs	Feature/Application
Partners	Never answer phone calls; all calls answered by their executive secretaries.	System Access (SA) button(s) programmed for Send Ring
	If no executive secretary is available, calls can go to voice mail, if desired.	Group Coverage to voice messaging system
Partners' Executive Secretaries	Answer their bosses' calls when their bosses are not available; make calls on behalf of bosses.	Shared System Access (SSA) button for each partner's SA button, ringing immediately. Each secretary has Delay Ring on an SSA button that is usually answered by another secretary.
	If a secretary is not available, one of the other executive secretaries takes the calls.	Use screen-pop CTI application for identifying outside callers and bringing up database information on each caller as the calls come in; use another CTI application for power dialing.
	If no executive secretary is available, coverage by voice mail.	Coverage to voice messaging system application
	Each partner has a separate fax number, but their faxes all go to a single machine.	Intuity AUDIX Fax Attendant application and fax mail
	ISDN terminal adapters	No coverage. If ISDN terminal adapter is not available, calling party gets busy signal.
Associates	If an associate is not available, calls answered by associates' secretaries after two rings.	Each has Individual Coverage, secondary (delayed).
	If no one is available to take calls, voice mail coverage.	Coverage to voice messaging system
	Modems	No coverage; if a modem is not available, calling modem gets busy signal.

Continued on next page

Table 5-6. Continued

Staff Member	Needs	Feature/Application
Paralegals	If a paralegal is not available, another paralegal takes the call.	Delayed Call Forwarding (Release 4.0 and later systems only) and Direct Voice Mail. Calls ring twice at a paralegal's phone. If the person does not answer, the call rings at an assigned co-worker's extension. The call's receiver can transfer it to voice mail if necessary.
	If the forwarded-to receiver is not available, the forwarding extension turns off the Forwarding feature and calls receive voice mail coverage.	Coverage to voice messaging system
	ISDN terminal adapters Ascend Pipeline 25-Px	No coverage. If an ISDN terminal adapter is not available, calling party gets busy signal. Most data calls are outgoing, not incoming, and Pipelines are often used for Internet research.
Associates' Secretaries and General Secretary	Answer their bosses' calls when associates are not available. Make some calls on bosses' behalf.	Cover buttons for associates; associates' secretary's Cover buttons set for 2-ring delay; general secretary's cover buttons are set for 4-ring delay, to handle calls when associates' secretary is not available.
	If a secretary is not available, the other secretary answers.	Use screen-pop CTI application for identifying outside callers and bringing up database information on each caller as the calls come in; use another CTI application for power dialing.
	When no secretary is available, voice mail coverage.	Coverage to voice messaging system
	Each associate has a separate fax number, but their faxes all go to a single machine.	Intuity AUDIX Fax Attendant application and fax mail

Continued on next page

Table 5-6. Continued

Staff Member	Needs	Feature/Application
Office/ System Manager	If manager is not available, voice mail answers. Occasionally forwards calls to general secretary or works at another desk.	Coverage by voice mail system and Forward/Follow Me features
	Fax/modem	Fax Attendant stores faxes for receipt when the fax line is available.
Bookkeeping Department Members	If a bookkeeper is not available, another picks up call.	Pickup (Group). Supervisor has Personalized Ringing pattern.
	If none are available, messages are recorded.	Coverage to voice messaging system
Word Processing Pool	If a pool member is not available, another picks up the call.	Group Pickup
	If no one is available, messages are recorded.	Coverage to voice messaging system
Operator/ Receptionist	Needs backup if call volume through main numbers is too heavy or operator is not at his/her desk.	Coverage for new incoming calls (that is, calls not already covered) to voice messaging system
	Fax machine is for general use.	Intuity AUDIX Fax Attendant application and fax mail

Figure 5-4 illustrates the call coverage patterns. The shaded areas in the figure indicate those extensions that are included in the voice messaging system (VMS) voice mail. If staff members need to remotely access their voice mailboxes to check for messages, they can do so through the voice mail system, bypassing the operator.

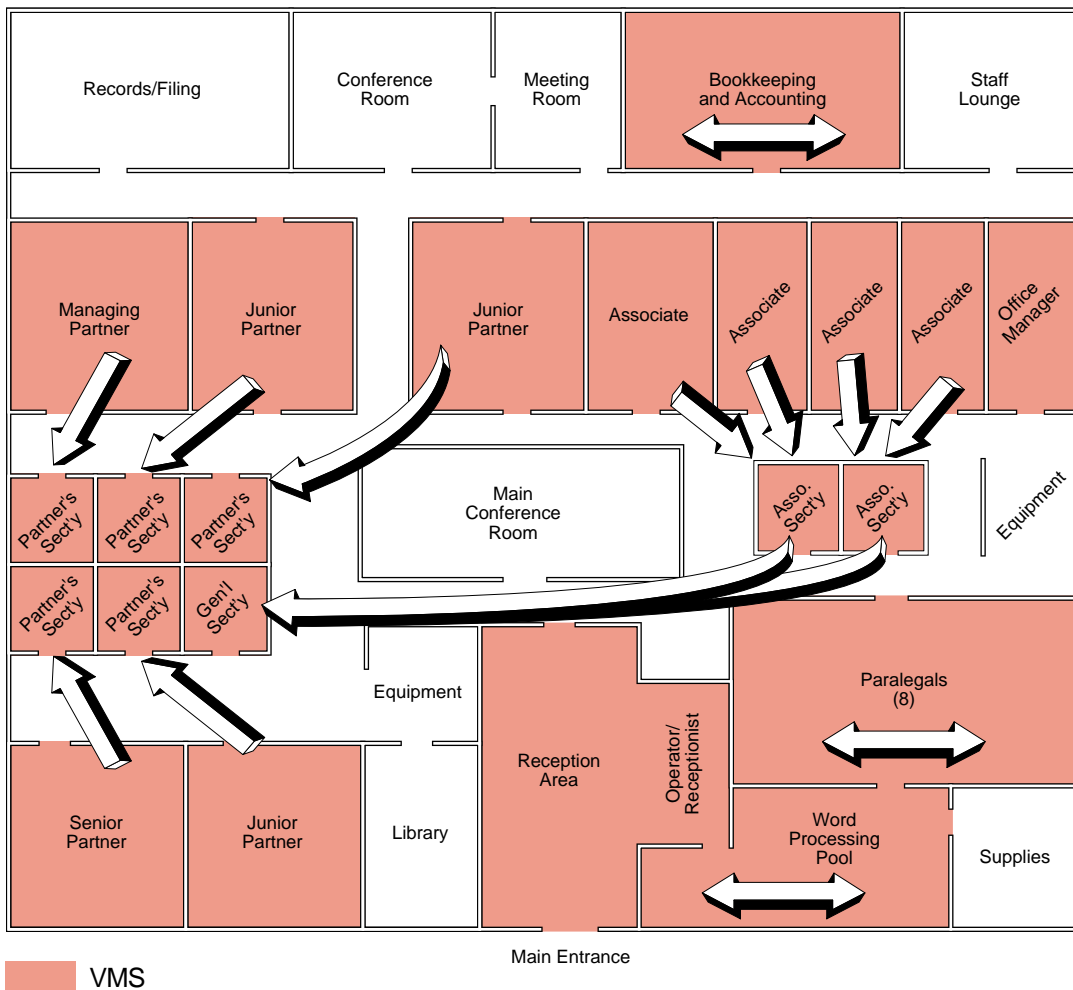

Figure 5-4. Law Firm Call Coverage

Calling Restrictions

The following system features and applications handle calling restrictions requirements (see [Table 5-7](#)):

- Automatic Route Selection (ARS) with appropriate Facility Restriction Levels (FRLs) for each extension, and time-of-day routing (day or night) using ARS subpatterns
- Disallowed List for 900 numbers for all staff and phones
- Authorization codes for partners only
- Pool dial-out code restrictions to reserve certain lines for paralegal modems
- Voice mail and fax mail passwords

Table 5-7. Law Firm Calling Restrictions

Staff Member	Calling Requirements
Partners	Day and night: long-distance and local calling Remote access to system.
Partners' Executive Secretaries	Day: long-distance and local calling Night: local calling only
Associates	Day and night: long-distance and local calling
Paralegals	Day and night: long-distance and local calling
Associates' Secretaries and General Secretary	Day: long-distance and local calling Night: local calling only
Office/System Manager	Day: long-distance and local calling Night: local calling only
Bookkeeping Department Members	Day: non-toll local calling Night: non-toll local calling only
Word Processing Pool	Day: non-toll local calling Night: non-toll local calling only
Operator/ Receptionist	Day: long-distance and local calling Night: local calling only
Reception Area Phone	Day and night: local calling only
All	Day and night: no calls allowed to 976 or 900 numbers



SECURITY ALERT:

The MERLIN LEGEND Communications System ships with ARS activated and all extensions set to Facility Restriction Level 3, allowing all international calling. To prevent toll fraud, ARS Facility Restriction Levels (FRLs) should be established using:

- *FRL 0 for restriction to inside calls only*
- *FRL 2 for restriction to local calls only*
- *FRL 3 for restriction to domestic long distance (excluding area code 809 for the Dominican Republic as this is part of the North American Numbering Plan, unless 809 is required)*
- *FRL 4 for international calling*

Each extension should be assigned the appropriate FRL to match its calling requirement. All voice mail port extensions not used for outcalling should be assigned to FRL 0.

Optimizing Your System

This section describes some features and applications that you read about in the scenarios. They are highlighted here because they can significantly enhance your system.

For more information about any of these products and features, see the *Feature Reference* or contact your Lucent Technologies representative for additional guides or applications notes.



NOTE:

The *Data/Video Reference* includes additional information about videoconferencing, Internet access, and other data communications support.

Desktop Videoconferencing

A desktop videoconferencing application is designed for individual video calls, data transfer, and screen-sharing between two compatible personal computers that are running compatible software.

Some desktop videoconferencing systems can use either one MLX B-channel or two, although one is often not of adequate quality (other desktop video systems support only 2B data). The use of one B-channel is called *1B data*; the use of two data channels is referred to as *2B data*. Depending upon the type of high-speed digital facilities and interface arrangement connected to your system, 1B data transfer takes place at 56 or 64 kbps, and 2B data transfer takes place at 112 or

128 kbps. The 2B Data feature allows the use of a single MLX port for desktop videoconferencing; both the main and adjunct extension numbers are used.

An MLX telephone may be connected to some desktop videoconferencing systems. The telephone shares the MLX extension. If the MLX telephone is on a call, the desktop videoconferencing application has only one B-channel available and is limited to 1B data. On some systems, the second B-channel is added when the MLX telephone becomes idle. See the *Data/Video Reference* for more information about desktop videoconferencing.

Group Videoconferencing

Group videoconferencing enables groups of people in different geographical locations to meet face to face. The applications differ from desktop systems primarily in the size of their screens and the sophistication of the features they provide. Conferees can exchange information, documents, ideas, and data while employing a variety of visual aids, including interactive writing and drawing, prepared text and graphic materials, and prerecorded audio and video material. You can have all the advantages of face-to-face meetings while decreasing your travel budget.

Group video systems that support ISDN/BRI interfaces have built-in data communications devices and can use one MLX B-channel or two (depending on the system), requiring only a single MLX jack and the system's 2B Data feature.

Older group systems that support a V.35 interface may also have built-in data communications devices; if not, they require two Lucent Technologies-certified ISDN terminal adapters, or an inverse multiplexor and two MLX ports. V.35 systems use two adjunct extension numbers.

Most group videoconferencing applications include an easy-to-use control console that allows you to conduct the conference as easily as you operate a telephone. It includes superior camera optics and digital audio signals.

The components of a group video system can be integrated on a mobile console that rolls easily into a conference room prior to a scheduled video conference call. Alternatively, some companies build their systems into a videoconferencing room.

CTI (Computer Telephony Integration) Link

Beginning with Release 5.0, the system supports the CTI (Computer Telephony Integration) link, which allows the use of software applications with the system. Although the CTI link is not, strictly speaking, a feature, it enables considerable feature enhancement to the system. Available in Hybrid/PBX mode, this capability connects the system to a PassageWay Telephony Services product on a local

area network (LAN). The link is made through a programmed MLX extension jack that is connected to an ISDN BRI PC expansion board (such as the EICON board) on a server running Novell NetWare software, version 3.12, 4.11, or 4.1.

The CTI link allows calls on **SA** buttons to be monitored and controlled from client workstation applications connected on a LAN to the server. The link can support LAN workstations with analog BIS (ATL) multiline or MLX telephones, not single-line telephones or analog membrane telephones. The link allows worktop applications to control their associated telephones. QCC operator extensions cannot use CTI link applications, but DLC operators can. Only one link is necessary, and it can support up to 136 LAN clients, depending upon the types of extensions (analog or MLX) and the volume of calls handled by the software applications.

Incoming calls on **SA** buttons may arrive through calling group distribution, PRI routing by dial plan, DID (Direct Inward Dial) lines/trunks, or transfer from a DLC or QCC operator or automated attendant.



NOTE:

A DLC only passes calling party information when it is not one of the extensions using a CTI application. For details, see the *Feature Reference*.

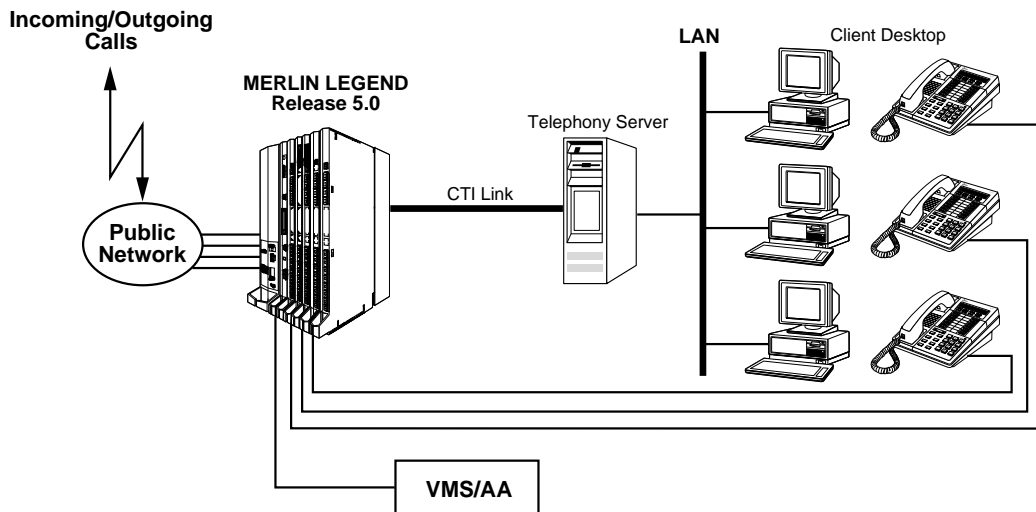

Figure 5-5. CTI Link Overview

Along with the features they provide, applications can perform these system functions through a CTI link:

- Answering calls arriving on an **SA** button
- Making calls from an **SA** button
- Hanging up calls
- Hold and retrieving a call on hold at the user's extension

The link supports applications for customer service and helplines, telemarketing, sophisticated call-handling, and other purposes where automated access to computer system-based information is useful. These applications perform functions such as power dialing of telephone numbers stored in a database, call monitoring, and integration with pop-up database information about a caller via their phone number (in this case, the incoming lines be must provided with Caller ID services through PRI, NI-1 BRI, or a local service provider via the system's 800 GS/LS-ID module). Pop-up database information can also be generated through callers' responses to a voice response unit.

System Requirements

A CTI link requires the following equipment and software:

- MERLIN LEGEND Communications System Release 5.0 or later, in Hybrid/PBX mode
- A standalone LAN telephony server with an Intel® i386, i486, or Pentium® class central processing unit and at least 16 megabytes of RAM (more memory may be needed; see *PassageWay Telephony Services Network Manager's Guide* for details).
- Novell NetWare version 3.12, 4.11, or 4.1



NOTE:

For a NetWare version 3.12 installation, additional files must be obtained from Novell's web site. For details, see *PassageWay Telephony Services Network Manager's Guide*.

- 5 megabytes of available disk space in the system volume
- PassageWay Telephony Services for NetWare software, Release 2.21 or later.
- Eicon/G. Diehl SCOM circuit board with an available 8- or 16-bit ISA slot, to link the communications system and the telephony server.
- An MLX line/trunk or extension module, with a free extension jack (not the first or fifth or any port programmed as an operator or programming console), installed in the communications system control unit. The firmware vintage should be 28 or later, *not including* vintage 29.



NOTE:

If the MLX module for the CTI link is the only MLX module in the system, SPM software, version 5.15 or later, is also required in order to program the CTI link.

For more information about these requirements and about installing a CTI link, see *PassageWay Telephony Services Network Manager's Guide*.

Intuity CONVERSANT

This voice-response system enables you to run Integrated Voice Response (IVR) applications. It consists of hardware and software that supports, for example, automated interactive order-taking. Because it can interface with a computer, it can facilitate quick and easy transaction processing, data retrieval, and data entry using a touch-tone telephone.

Using the example of automated phone orders, you can use CONVERSANT to decrease the need for human order-takers or to handle large call volume without having callers wait. The caller is prompted to enter appropriate responses by using the touch-tone keys on the telephone. It enables your customers to have access to your business and services on a 24-hour, seven-days-per-week basis.

You can customize several aspects of the system, including: the ways inbound calls are directed; the ways to handle calls during normal business hours as opposed to after hours or during holidays; optional seasonal greetings; and interaction with voice mailboxes.

PassageWay Direct Connection Solution

This collection of software applications provides a Microsoft Windows interface between a PC and the system through an MLX-28D, MLX-20L, MLX-16DP, or MLX-10DP telephone.

The applications include:

- **Lucent Technologies Call.** A cardfile that enables you to maintain information such as names, addresses, and telephone numbers. You specify the information you want to store. You can place a call directly from the PC and keep a log of all calls that are made.
- **Lucent Technologies Set.** A telephone programming application that enables you to program telephone features for your MLX telephone from your PC. You can also create and save multiple button programming files for your telephone, and exchange these files with other Lucent Technologies Set users.

- **Log Viewer.** Enables you to view entries that are stored in the PassageWay call log that contains a record of every call you make using Lucent Technologies Call.
- **Lucent Technologies Connect.** Management software that provides the basis for the other PassageWay applications and the diagnostics features to troubleshoot them. Auto dialing capabilities using the common modem command set are also provided.
- **Lucent Technologies Buzz.** An application that enables you to manage incoming calls on loop-start telephone lines connected to 800 LS-ID modules and view the Caller ID calling party number (when available) so you can quickly access customer records on your PC.

Caller ID

Caller ID is generally a subscriber service (calling party identification services sometimes are provided at no extra charge with NI-1 BRI facilities), available from your local exchange carrier or other telecommunications company, supported by the system on analog loop-start or digital facilities. It enables you to screen incoming calls so that you can identify the calling party's number before you answer the call.

Using Caller ID, you can also integrate the calling party information with various applications that your business uses. For example, you can quickly identify the caller, then access and display his or her account information from your computer database while you are on the call.

Managing the System

6

This chapter helps you complete the most common system management tasks. It includes some background on the types of programming and how to access them, and then provides task descriptions and procedures.



CAUTION:

Do not attempt to change either the system numbering plan or the system operating mode. Changing either of these could cause serious disruption of the system and would require significant time and effort to remedy. Also, do not use either the Maintenance or Restart options from the system programming menus except when instructed to do so by a Lucent Technologies representative or when performing the CTI link procedures described in ["Busying-Out and Restoring the MLX Module" on page 6-91](#).

Before you perform the system management tasks, review the general instructions in the next sections, "Using the Task Descriptions" and ["Using the Programming Procedures" on page 6-3](#).

To help troubleshoot system problems, label phones with extension numbers rather than line numbers.



NOTE:

Release 6.0 and later systems (Hybrid/PBX mode only) support private connections between MERLIN LEGEND Communications Systems and DEFINITY Enterprise Communications Server (ECS) or DEFINITY ProLogix Solutions systems using private networks or the public switched telephone network. This aspect of the system is not covered in this guide. For complete information, see the *Network Reference*.

Using the Task Descriptions

Each task description contains the following information:

- A brief description of the task
- Guidelines for planning the change
- A task checklist that includes references to other system reference guides for additional information, if needed
- Programming instructions that contain summary programming procedures for programming from the console and from a PC with SPM

The task descriptions fall loosely into the following categories:

- System tasks (setting system date and time; backing up the system)
- Extensions (adding, moving, or removing an extension; changing calling restrictions)
- Lines (adding and removing)
- Operator consoles (adding a DLC or QCC operator position and adding operator features)
- Auxiliary equipment connections
- Group assignments (calling groups, Allowed Lists, Disallowed Lists, Group Coverage, and Night Service with Group Assignment)
- Labels (changing displays for Extension Directory, trunks, Posted Messages, and calling groups)

To perform a task, follow these general steps:

1. Review the entire task description.
2. Obtain the system planning form(s) noted in the task description.
3. Using the planning guidelines in the task description, plan the changes and record them on the planning form(s). For more information, you may want to refer to the feature description in the *Feature Reference* or the appropriate section in *System Programming*.



NOTE:

You should become familiar with the detailed instructions in *System Programming* before you use the summary programming instructions provided in the task descriptions.

4. Program the changes using either the detailed, step-by-step programming procedure in *System Programming* or the summary programming instructions that follow the task list. You can photocopy the task list and use it to check off tasks as you complete them.

For more information, refer to the following guides:

- For information about the planning forms, see *System Planning*. If you don't have this guide, contact your Lucent Technologies representative.
- For information about the features, including important feature interactions, see the *Feature Reference*.
- For more detailed programming information and instructions, see Chapter 3, "Common Administrative Procedures," in *System Programming*.

Using the Programming Procedures

This section provides an overview of how to read the procedures and summary procedures in this chapter. For more detailed information, see Chapter 1, "Programming Basics," in *System Programming*.

All programming procedures begin from the System Programming menu. For information about how to access this menu from the console or from a PC with System Programming and Maintenance (SPM), or how to use centralized telephone programming, see the appropriate sections that follow in this chapter.

Using Detailed Procedures

The detailed procedures consist of numbered steps in the format shown in the following Steps 4 and 5 extracted from an actual procedure.

Console/Display Instructions

Additional Information

PC

► 4. Select Start.

```
Extension Program      xxxx
Press HOME to Exit

Sys Program           Start
```

xxxx = extension entered in Step 2

F10

Console/Display Instructions

Additional Information

PC

► 5. **Select the line button to which you want to assign the feature.**

```

Select Button:
Extension Program   xxxx
                   Page 1
                   Page 2

Sys Program
    
```

xxxx = extension entered in Step 2

Press the line button or function key that corresponds to your selection.



F7

The format includes numbered steps that appear in a gray bar. It contains three columns, each with a header:

- **Console/Display Instructions.** In most cases, the screen shown in this column contains the results of the previous step. The console key that corresponds to the option you are to select is highlighted in black (see **Start** in sample Step 4). The function key that corresponds to the highlighted console option appears in the right column under the PC header.
- **Additional Information.** This column may contain a note, a value entered in a previous step, branching instructions, general information, or specific instructions. Variable screen information appears as *xs* or *ns* in the screen and is defined in this column (see sample Steps 4 and 5).
- **PC.** Lists the function key that corresponds to the highlighted console option shown in the first column. An arrow symbol (➡), indicates that the instructions under “Additional Information” apply to both the console and the PC and signals you to follow those instructions.

Using Summary Programming Procedures

Some of the task descriptions in this chapter include summary programming procedures. They summarize the detailed procedures in *System Programming*.



NOTE:

You should become familiar with the detailed programming procedures in *System Programming* before you use the summary programming procedures provided in the task descriptions.

The summary programming procedures describe steps for both the console and the PC. You should use the appropriate procedure. The format is as follows:

Console Procedure **More**→Labeling→Grp Calling→Dial calling group ext. no.→Enter→Drop→Enter label→Enter→Exit→Exit

PC Procedure PgUp→F1→F4→Type calling group ext. no.→F10→Alt+P→Type label→F6→F5→F5

The arrows separate each step. [Table 6-1](#) shows the typefaces that indicate what the step involves.

Table 6-1. Typefaces Used in Summary Programming Procedures

Typeface	Meaning
More	Select this option by pressing this imprinted button on the console.
Labeling	Select this menu option using an unlabeled display button.
Dial ext. no.	Enter this information.
PgUp	Press this key on the PC.
F1	Press this function key on the PC.
Alt + P	On the PC, while holding down the first key, press the second key.

Introduction to System Programming

The system offers menu-driven software for performing the tasks described in this chapter.

This section provides an overview of the types of programming, the programming screens, and the appropriate *idle state* that the system must be in to perform certain tasks.

Types of Programming

The following are the three types of programming available for the system:

- **System Programming.** Allows you, as the system manager, to program features that affect all or most system users. Perform system programming using one of the following:
 - **System Programming Console.** An MLX-20L telephone connected to one of the first five jacks on the first MLX module in the control unit.

— **PC with System Programming and Maintenance (SPM) Software.** A PC directly connected through its serial port to the lower RS-232 port on the control unit's processor module, or a PC dialing into the system through a modem either locally or remotely. SPM emulates a system programming console on your PC.

- **Extension Programming.** Allows individual telephone users and system operators (except QCC operators) to change their telephone features to meet individual needs.
- **Centralized Telephone Programming.** Allows you, as the system manager, to program any feature that can be programmed by individual telephone users or system operators. Certain features must be programmed in this manner. You can perform centralized telephone programming on the system programming console or on a PC with SPM.

This chapter describes system programming and centralized telephone programming (both on the system programming console and on a PC with SPM). For information about extension programming, see the appropriate user and operator guides.

Programming Screens

There are three types of system programming screens:

- **Information Screens.** To view what is currently programmed on the system. You cannot make changes on an information screen.
- **Menu Selection Screens.** To select features or options to program.
- **Data Entry Screens.** To enter values or to identify a specific extension or line/trunk you want to program.

This section describes each screen type and the System Programming menu; it also provides information about saving entries and moving among screens.

Information Screens

Information screens display what is currently programmed on your system. You cannot make changes on an information screen. [Figure 6-1](#) shows a sample information screen. When you select **Sys Program** from the main menu screen, the screen shown in [Figure 6-1](#) appears with system setup information.

```
System Set-up
Review and Exit
Size: xxxx
Type: xxxx
Operator: xxxx xxxx xxxx
xxxx xxxx xxxx
Exit
```

Your system information appears in place of xxxx.

Figure 6-1. Information Screen

Menu Selection Screens

A menu selection screen prompts you to select a listed option. The screen title is the first line on all screens. The second line contains a system prompt or instruction. The remaining lines of text vary based on options. [Figure 6-2](#) shows a sample menu selection screen.

An angle bracket (>) appears in the upper right corner of menu selection screens that have additional option screens. Press **More** (or **PgUp**) on the PC) to see the additional screens. Continue to press **More** to move through the screens and eventually return to the original screen.

```
System Programming: >
Make a Selection
System      Extensions
SysRenumbr Options
Operator    Tables
LinesTrunks AuxEquip
Exit       NightSrvc
```

Screen title and **More** indicator (>)
Prompt
Options

Figure 6-2. Menu Selection Screen

Data Entry Screens

A data entry screen prompts you to enter specific data or to make specific choices. If data is currently programmed for the feature, it appears on the screen. Many screens also show data entered on a previous screen, such as an extension or trunk number.

Data entry screens may also contain menu selections. Instead of entering data from the dialpad, you select options on the screen, such as **Yes** or **No**, to enable or disable a feature. To select this type of option, you press the unlabeled display

button next to the option name or the function key that corresponds to the option name. Then your selection is either highlighted or inserted in the screen title. To program or save the highlighted selection, you press the unlabeled display button on the console or next to Enter (F10) on the PC. You can use the Inspect feature to view, verify, or check the entries you save: press the **Inspect** fixed display button on the console or press (PgDn) on the PC. After you have finished inspecting the entries, you can return to the previous screen by pressing the unlabeled display button next to Exit or by pressing (F5) on the PC. See *System Programming* for more information about the Inspect feature.

Figure 6-3 shows a data entry screen with the first (of two) required extension numbers needed to assign analog voice and data.

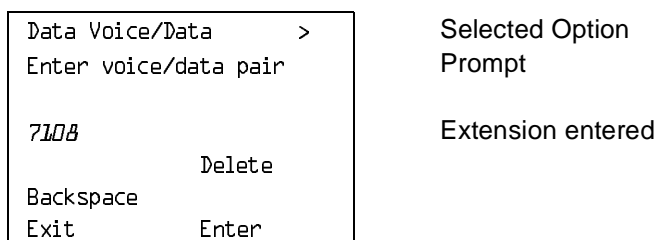

Figure 6-3. Data Entry Screen

System Programming Menu

Figure 6-4 shows the two screens that make up the System Programming menu. This is the main menu of system features and options. You reach the System Programming menu by selecting Sys Program from the system's main menu. Table 6-2 lists the System Programming menu options and describes each one.

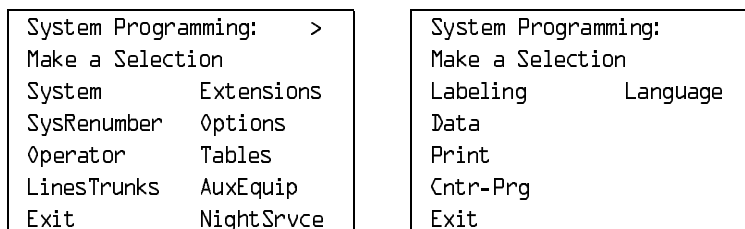

Figure 6-4. System Programming Menu Screens

The system programming hierarchy, included in Appendix B of *System Programming*, details the sequence of screens you work with when you select the system programming options.

Table 6-2. System Programming Menu Options

Option	Description
System	Set system operating conditions.
SysRenumbr	Select the system numbering plan and/or reassign extension numbers with 1- to 4-digit numbers.
Operator	Assign or remove operator positions and program operator features (such as Operator Hold Timer or QCC options).
LinesTrunks	Program line/trunk options.
Extensions	Program extensions (for example, with restrictions and lines).
Options	Program systemwide settings (for example, Transfer Return).
Tables	Program features that require entering information in a table (such as Allowed Lists and Disallowed Lists).
AuxEquip	Program auxiliary equipment connected to the system (for example, loudspeaker paging and fax machines).
NightSrvce	Program Night Service features.
Labeling	Program the labels shown on telephone displays (for example, entries in the System Directory and Posted Messages).
Data	Specify extensions that need voice and data capability.
Print	Print system programming reports (for example, system configuration and extension assignments).
Cntrl Prog	Perform centralized telephone programming (assign features to specific buttons on telephones).
Language	Select the language of the system for MLX display telephones, SMDR reports, and print reports.

Saving Entries and Moving among Screens

At the bottom of each screen, one or more screen keys with functions allow you to change or save your entry or return to a previous screen. Various combinations of these keys appear on each programming screen. [Figure 6-5](#) shows the QCC Priority screen with a typical display of screen keys.

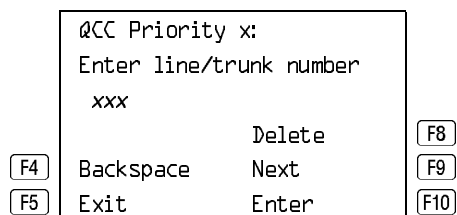

The QCC Queue Priority Level you entered appears in place of x.
 The line/trunk number you entered appears in place of xxx.

Figure 6-5. Screen Keys

For quick reference, [Table 6-3](#) shows the PC keys that correspond to the screen key selections on most screens. These PC keys do not appear on the console display screen.

Table 6-3. Screen Keys

Display/Key	Function
BackSpace / (F4)	Change your entry. Select Backspace ((F4) on the PC) to correct your entry. Each time you press the key, the screen cursor moves backward to erase one character at a time.
Enter / (F10)	Save your entry if the entry is valid. Typically, you select Enter ((F10) on the PC) to complete a procedure and save the information. Occasionally, you must select Exit ((F5) on the PC) and return to a previous screen before you use Enter. If the entry is not valid, the system may beep and/or display an error message and does not save the entry.
Delete / (F8)	Delete a current entry. Select Delete ((F8) on the PC) to delete (or remove) a current entry.
Next / (F9)	Program sequentially numbered items. If you are programming a group of sequentially numbered extensions, lines, or trunks, you may have the option to select Next ((F9) on the PC). This saves your entry and automatically provides the number of the next extension or trunk in the sequence. Typically, you remain at the same screen for as long as you select Next. In a few cases, you may return to an earlier screen in the procedure.
Exit / (F5)	Return to the previous screen. Select Exit ((F5) on the PC) when you complete a procedure, to move up one screen in the menu hierarchy. (Appendix B in <i>System Programming</i> provides a reference to the entire system programming menu hierarchy.) Exit a screen without changes. In most cases, you select Exit ((F5) on the PC) to exit from a screen without making any changes. Exceptions are noted as part of a procedure.

Continued on next page

Table 6-3. Continued

Display/Key	Function
	Complete a procedure. In a few cases, you return to the System Programming menu when you select Exit. In most cases, you return to an intermediate step within the procedure. You can then select one of the options shown on the screen and continue programming, or you can continue to use Exit until you return to the System Programming menu.

Idle States

You can begin some programming procedures only when all or part of the system is not in use; this is called an *idle state*. The idle state must remain in effect until you finish programming.



NOTE:

If a procedure requires an idle state, do it outside normal business hours.

If a procedure requires an idle state and an extension on the system is busy when you begin, you see a screen like the one shown in [Figure 6-6](#). It changes to the appropriate programming screen when the system is no longer busy.

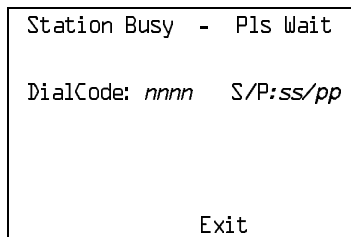

nnnn = a previously entered extension
ss/pp = the slot and port number of the busy extension

Figure 6-6. Station Busy Screen

[Table 6-4](#) explains the various idle states, including a description of each state and the procedures that can be performed only during that idle state.



NOTES:

1. The table includes all the procedures that fall into each idle-state category. Procedures that should be performed only by a Lucent Technologies technician are noted.
2. When an extension is in programming mode, the system considers it busy. Thus, to perform a backup, make sure that no telephone is in programming mode.

Table 6-4. Idle States

Idle State	Description	Procedures
System Forced Idle	<p>The entire system (every line and every extension) is idle. No calls can be made or received.</p> <p>Multiline phone users hear a signal, indicating that the phone cannot be used; display phone users see the message <code>Wait: System Busy</code>; single-line telephone users do not hear a dial tone.</p>	<p>Select system mode (Lucent Technologies only).</p> <p>Identify system operator positions.</p> <p>Renumber the system (Lucent Technologies only).</p> <p>Renumber modules (Lucent Technologies only).</p> <p>Identify extensions with voice signal pairs for Voice Announce to Busy.</p> <p>Restore backup file.</p>
Extension Forced Idle	<p>No calls can be made or received on that phone or data terminal.</p> <p>Multiline telephone users hear a signal, indicating that the phone cannot be used; display phone users see the message <code>Wait: System Busy</code>; single-line telephone users do not hear a dial tone.</p>	<p>Assign call restrictions.</p> <p>Assign pool dial-out restrictions.</p> <p>Copy extension assignments.</p> <p>Assign lines, trunks, or pools.</p> <p>Assign labels to a Personal Directory.</p> <p>Use centralized telephone programming.</p>
Line or Trunk Idle	<p>The line or trunk is idle <i>only</i> at the instant of programming.</p>	<p>Identify loudspeaker paging extension jack.</p> <p>Assign trunks to pools.</p> <p>Assign incoming or outgoing DID or tie trunk type (Lucent Technologies only).</p> <p>Specify tie trunk direction (Lucent Technologies only).</p> <p>Specify tie trunk E&M signal (Lucent Technologies only).</p>
100D Module Idle	<p>Only the 100D module is idle.</p>	<p>Specify (Lucent Technologies only):</p> <ul style="list-style-type: none"> Board type Frame format Board signaling format Board suppression format Board facility compensation

Forced Idle Reminder Tones

The forced idle reminder tone is a high-low “doorphone” tone that sounds under the following circumstances:

- At the extension, to remind the user that the system or the extension is in the forced idle state
- At the programming console or at a PC running SPM, to remind the system manager that the system (or at least one extension) is in the forced idle state because of programming activity

Forced idle reminder tones occur every 20 seconds. You can adjust the volume of these tones with the volume control.

Programming from the Console

This section describes the system programming console and provides the procedure for entering and exiting system programming from the console.

System Programming Console

The system programming console is an MLX-20L telephone connected to the system programming jack (the first jack on the first MLX module).

This jack is also set as an operator position. You can change the system programming jack to any one of the first five jacks on the first MLX module. This allows you to program without interfering with the operator's call handling. However, if you change the programming jack to other than the first or fifth jack on a 008 MLX or 408 GS/LS-MLX module, then you cannot attach a Direct Station Selector (DSS) to the console.

You can also have one or two DSSs connected to the system programming console. Each DSS adds 50 extension buttons to the console, which facilitates assigning features to telephones.

[Figure 6-7](#) shows an MLX-20L telephone with a DSS.

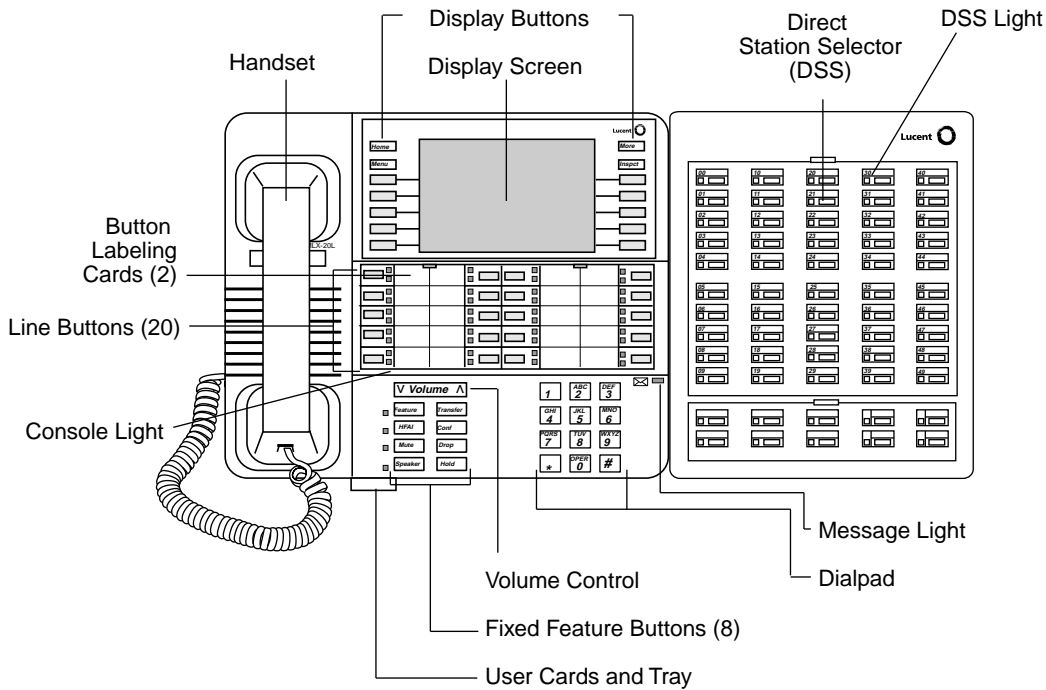

Figure 6-7. MLX-20L Telephone with Direct Station Selector (DSS)

Console Buttons

You can use the 14 buttons located on either side of the console display screen for system programming. These buttons are arranged in two columns of seven buttons, as shown in [Figure 6-8](#).

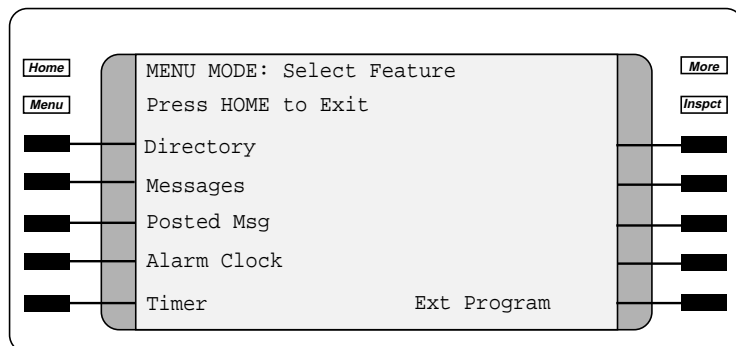

Figure 6-8. Display Buttons and Main Menu

There are two types of console buttons:

- **Fixed Display Buttons.** The top two buttons in each column have the same labels and functions regardless of the screen display:
 - **Home.** Return to normal call-handling mode after you finish programming.
 - **Menu.** Display the main menu shown in [Figure 6-8](#).
 - **More.** Display more items when a menu continues on a subsequent screen, indicated by an angle bracket (>) on the upper right of the screen.
 - **Inspect (Inspect).** View a list of lines or extensions on which a feature is programmed, or view the settings for a feature.
- **Unlabeled Display Buttons.** Use the five unlabeled display buttons on each side of the screen to select commands, options, or items on the screen. The functions of these buttons vary, based on the option you select.



NOTE:

If you are using SPM for system programming, the simulated MLX-20L console screen on your PC screen shows the function keys that correspond to the console screen selections. For example, to save an entry, you select **Enter** on the console or press **(F10)** on your PC. For more information about using function keys, see *System Programming*, Chapter 2.

Console Overlay

The programmable line buttons are on the main part of the console. There are actually 20 line buttons on the console, but you can use the console overlay to program up to 34 lines. Some of the unlabeled line buttons on the lower part of the console may also be used for programming features. You can also use the dialpad for entering feature and programming codes.

Figure 6-9 illustrates the system console overlay. For each of the programmable line buttons, the top numbers represent the lines on a telephone (up to the maximum of 34), and the bottom numbers represent the lines in the system (up to the maximum of 80).

Appendix E in *System Programming* shows the button diagrams for the telephones used in the communications system. Refer to this appendix when programming buttons for other telephones.

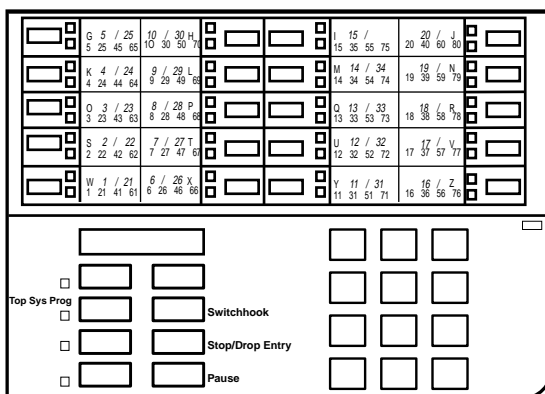

Figure 6-9. Console Overlay

Console and DSS Lights

The red and green lights (sometimes called LEDs) next to each of the 20 line buttons show the status of the line features. The lights on the DSS show the status of features programmed on extensions.

Console Lights

The green and red lights next to each button on the console are on, off, or flashing, depending on whether the line is programmed with a feature. The flashing green light indicates the ring option. The feature determines whether the red or green light indicates feature status. The programming procedures specify which light verifies feature status.

DSS Lights

The lights on the DSS (if one is attached to the console) show the status of features programmed on the extensions. When you select a feature from a menu, the red light next to the DSS button is on, off, or flashing, depending on whether the feature is programmed on the corresponding extension. For example, when you select **Toll Restrict** from the Restrictions menu, you see a red light next to the DSS button for each toll-restricted extension.

Access to System Programming

Follow the steps below to begin system programming from the system programming console. To use this procedure, note the following:

- The summary instructions are numbered and shaded in gray.
- The first column, "Console/Display Instructions," illustrates the display screens and indicates the console buttons to press.
- The middle column, "Additional Information," contains explanatory information if necessary.

The System Programming menu in Step 4 is described in ["System Programming Menu" on page 6-8](#). For information about the procedure format, see ["Using the Programming Procedures" on page 6-3](#).

Console/Display Instructions	Additional Information
-------------------------------------	-------------------------------

► 1. **Display the Menu Mode (main menu) screen.**

Press the **Menu** button.

► 2. **Select System Programming.**

```
MENU MODE: Select Feature
Press HOME to Exit
Directory
Messages
Posted Msg   Sys Program
Alarm Clock  Maintenance
Timer        Ext Program
```

If the programming console is a QCC, **Ext Program** does not appear on this screen.

► 3. **Display the System Programming menu.**

```
System Set-up:
Review and Exit
Size: Large
Type: xxxx
Operator:      xxxx xxxx
```

On the System Set-up screen, system information appears in place of the **xs**.
Size = Large
Type = Key, Hybrid/PBX, or Behind Switch

6 Managing the System

Programming from a PC with SPM

Page 6-18

```

xxxx xxxx   xxxx xxxx
Exit
    
```

Operator = Position extension numbers
 Select Exit

► 4. Make a selection.

```

System Programming:  >
Make a selection
System              Extensions
SysRenumbr         Options
Operator           Tables
LinesTrunks        AuxEquip
Exit               NightSrvc
    
```

Press the button or function key next to your selection.

Exiting System Programming

Use the information in [Table 6-5](#) to return to the System Programming menu, the main menu (Menu Mode screen), or the Home screen.

Table 6-5. Exiting System Programming

To return to:	On the console press:	On the PC press:
Previous menu (or, in some cases go to the next item to program)	Exit	F5
Main menu	Menu	End
Normal call handling	Home	Home

Programming from a PC with SPM

The System Programming and Maintenance (SPM) software package offers an alternative method of programming using a PC. This method frees the system programming console for other uses and also provides additional functions. Using a PC with SPM enables you and qualified service personnel to program the system from off-site locations.

SPM runs on a DOS-based PC as a standalone package, or on a UNIX System platform with Integrated Solution II or Integrated Solution III (IS II/III, no longer available).



NOTE:

Beginning with version 4.25, required for Release 4.1 of the system, SPM runs under Windows 95 as a DOS application.

For more information about setting up and using SPM for programming on a PC with DOS, see Chapter 2 of *System Programming*. For information about accessing SPM from IS II/III, refer to the appropriate book:

- *Integrated Solution System Manager's Guide*
- *Integrated Solution Installation and Maintenance Guide*

Types of PC Connections

There are three ways to connect the PC to the control unit:

- **Direct Local Connection.** For a direct local connection, you must connect the PC to the system programming jack (labeled *ADMIN*). This is the lower modular RS-232 jack on the processor module. (The upper jack is reserved for the SMDR printer.)
- **Local Modem Connection.** For a local modem connection, you must use a modem (either connected to or built into the PC) to access the internal modem in the control unit. Connect the modem to a 012 or 016 (Release 4.0 and later systems only) module in the control unit.
- **Remote Modem Connection (DOS-Based SPM Only).** For a remote modem connection, you must use a modem (either connected to or built into the PC) to access the internal modem in the control unit. You must also use a modem to dial into the system using remote access.



NOTE:

Remote access (modem connection) has priority over local access (direct connection), unless a backup or restore procedure is in progress through a direct local connection. If a modem connection is attempted while any other type of on-site programming is in progress (either at the system console or at a directly connected PC), the system sends a message to the on-site programmer. The message indicates that a modem connection is being established, and the on-site programming session is terminated.

Access to System Programming

Before you can begin system programming from a PC, you need to access the SPM software. The procedure for reaching SPM depends on whether your PC is connected to the control unit with a modem (either local or remote) or without a modem (direct). This section describes both of these procedures.

With a Direct Local Connection

To begin using SPM when your PC is connected directly to the control unit, follow the steps below. For information about the procedure format, see [“Using the Programming Procedures” on page 6-3.](#)

Console/Display Instructions	Additional Information
-------------------------------------	-------------------------------

- ▶ 1. **Set up the proper physical connections between the PC and control unit.**

See Chapter 2 of *System Programming*.

- ▶ 2. **If you installed SPM on the hard disk of the PC, go to Step [5](#).**

Console/Display Instructions Additional Information

▶ 3. If the PC does not have a hard disk, insert the SPM diskette into Drive A.

▶ 4. Type *a:* and press .

A:> appears on the screen.











▶ 5. Type *spm* and press  to display the SPM Welcome screen shown below.

```

Welcome to SPM
The MERLIN LEGEND
System Programming
& Maintenance Utility
Please press any key
to continue
Version X.XX
```

X.XX = current version of SPM

▶ 6. Press any key to display the SPM Main Menu shown below.

SPM Main Menu		
Menu: Select Function		
	Sys Program	Maintenance 
	Backup	Restore 
	Boards	Pass-Thru 
	Print Options	Password 
	Monitor	Language 

- If the SPM Main Menu does not appear or if the information about the screen is garbled, press any key again.
- If the COMM PORT (communications port) screen appears instead of the SPM Main Menu, the SPM software has not been initialized. See Chapter 2 of *System Programming*.



NOTE:

The function keys shown on either side of the display are included here for quick reference. On the PC screen, the system programming keys do not look like actual keys.

▶ 7. To reach the System Programming menu, select Sys Program by pressing .

▶ 8. Perform the procedures in the task descriptions as outlined in this chapter.

With a Local or Remote Modem Connection

The method you use to access SPM by modem depends on whether you are programming on site (locally) or from a remote location.

- If you are on site, the modem must be connected to a 012 or a 016 (Release 4.0 and later only) module on the control unit. To establish a connection to the control unit's internal modem, dial **10*.
- If you are at a remote location, do one of the following:
 - Place a call to the system on a remote access line, enter the barrier code (if required), and dial the code for the internal modem (**10*).
 - Place a voice call to the system on a regular line and ask the operator to transfer you to the modem (by dialing **10*). When you hear the modem answer tone, switch to data mode.

Modem Connections

You must make a data connection to a modem. The following modem dialing commands work for most modems. These may not be the commands your modem uses; refer to the user guide that came with your modem for specific information.

- If the PC is in the same location as the control unit, type **10*.
- If the PC is in a remote location and your system has activated the Remote Access feature, type the following:

ATDT, the remote access telephone number, and *w*10*.

Then press

For example: *ATDT12015551234 w*10* . Also, a barrier code (4 to 11 digits) may be required between the *ATDT* and the *w*10* entries. For example: *ATDT12015551234 w1234567 w*10*.

- When the connection is made, the password prompt appears on the screen. (You may have to press more than once to get the password prompt.)

NOTE:

If you enter a telephone number of fewer than 11 digits, you must end it with a pound sign (#).

- If the PC is in a remote location and your system has not activated the Remote Access feature, do the following:
 1. Use the main telephone number to place a voice call to the system.
 2. Instruct the operator to transfer the call to the modem by transferring the call to **10*.
 3. Put the modem on line by switching it to data mode.

To access SPM through a local or remote modem connection, follow the steps below. For more information about the procedure format, see [“Using the Programming Procedures” on page 6-3.](#)

Console/Display Instructions Additional Information

- ▶ 1. **Set up the appropriate physical connections between the PC and the control unit as described in Chapter 2 of *System Programming*.**
- ▶ 2. **Type *spm* and press  to display the SPM Welcome screen shown below.**

```
Welcome to SPM
The MERLIN LEGEND
System Programming
& Maintenance Utility
Please press any key
to continue
Version X.XX
```

X.XX = current version of SPM

- ▶ 3. **Press any key to display a blank screen on which you can enter modem commands. (You may have to press the key several times.)**
- ▶ 4. **Make a data connection to the modem of the control unit.**

See Chapter 2, “Programming with SPM,” in *System Programming*. When the connection is made, the password prompt appears, as shown in Step 5.

- ▶ 5. **Type the remote access password to display the SPM Main Menu shown in Step 2.**

```
Enter Password:
```

The password does not display when you type it.

Console/Display Instructions

Additional Information

- ▶ **6. To reach the System Programming menu, select System Programming by pressing **F1**.**

SPM Main Menu		
Menu: Select Function		
F1	Sys Prog	Maintenance F6
F2	Backup	Restore F7
F3	Boards	Pass-Thru F8
F4	Print Opts	Password F9
F5	Monitor	Language F10

NOTE:

The function keys shown on either side of the display are included here for quick reference. On the PC screen, these do not look like actual keys.

- ▶ **7. Perform the procedures contained in the task descriptions later in this chapter.**

Centralized Telephone Programming

Centralized telephone programming allows you, as the system manager, to program the following:

- Any feature that can be programmed by individual telephone users or by operators. Certain features can be copied from one extension to another in the system.
- Certain features that can be programmed only by using centralized programming:
 - Barge-In
 - Headset Hang Up
 - Intercom buttons: all types (Key and Behind Switch mode only)
 - System Access buttons: all types (Hybrid/PBX only)

To perform centralized telephone programming, you can use the system programming console or a PC with SPM software as described earlier in this chapter.

If you are programming several telephones of the same type (that is, all analog or all MLX), you can use the Copy Extension feature (described in [“Copying Feature and SA/ICOM Buttons” on page 6–29](#)) to program one extension and then use the programmed extension as a template for programming additional extensions. There are special planning forms for the Copy Extension feature.



NOTE:

Some programming can be performed only when the entire system or some part of it (such as a trunk or an extension) is idle. See the section ["Idle States" on page 6-11](#).

Starting Centralized Telephone Programming

Reach the Centralized Programming menu from the System Programming menu. You can then perform centralized telephone programming by selecting features from the display or by using programming codes.

Follow the procedure below to get to the Centralized Programming menu. For information about the procedure format, see ["Using the Programming Procedures" on page 6-3](#).

Console/Display Instructions

Additional Information

PC

- ▶ 1. **Go to the second screen of the System Programming menu.**

```
System Programming:  >
Make a Selection
System      Extensions
SysRenumbr  Options
Operator    Tables
LinesTrunks AuxEquip
Exit        NightSrvce
```

Press **More**.

PgUp

- ▶ 2. **Select Centralized Programming.**

```
System Programming
Make a selection
Labeling
Data
Print
Ctrn-Prg
Exit
```

F4

Console/Display Instructions

Additional Information

PC

▶ **3. Select a programming option.**

```
Centralized Programming:
Make a selection
█ Program Ext
█ Copy Ext

Exit          Enter
```

Select Program Ext or
Copy Ext.

F1

F2

▶ **4. Go to one of the following topics: [“Guidelines for Programming Extensions” on page 6–26](#); [“Copying Feature and SA/ICOM Buttons” on page 6–29](#); or, [“Copying Line/Trunk Button Assignments” on page 6–33](#).**

The following sections explain the use of menu selections for programming a single extension, and for using the feature and **SA/ICOM** buttons and/or the line/trunk button assignments of one extension as a template for programming several extensions of the same type. For information about copying calling restrictions from one extension to another, see “Copy Call Restrictions” in Chapter 3 of *System Programming*.



NOTE:

You should use programming codes for centralized telephone programming; however, you may also use the List Feature option that is available on the programming screen for extensions as described in the next section. For detailed information about the List Feature option, see Chapter 5 in *System Programming*.

Guidelines for Programming Extensions

Review the items below before you begin to program extensions.

- Refer to Appendix C in *System Programming* to locate the code for the feature that you want to program, or use the List Feature menu (which includes the Find Feature option) by selecting ListFeature from the screen that appears when you are programming a feature (see Step 6 in the procedure that begins on [page 6-28](#)). For more information about using the List Feature menu, see Chapter 5 in *System Programming*.
- If you enter a feature code incorrectly or enter a feature code that is not appropriate for the selected button, you may hear a beep or see the message Programming Error as the green light next to the button flashes. Press the button again and repeat the procedure.

- If you program the wrong feature on a button, follow the steps below:
 1. Press the button.
 2. Select **Delete** (press **F2** on the PC).
 3. Press the button again.
- If you press a line button that is not active, the screen shown below appears. Press **Home** to return to the Home screen.

```
Blank
Press HOME to Exit
                               Page 1
                               Page 2

Sys Program  ListFeature
```

- You can use the Extension Information (Ext Info) report option on the Print menu (accessed from the System Programming menu) to print all of the programmed features for a specific extension.



NOTES:

1. If you are programming buttons at an extension with an MLX-16DP, MLX-5D, or MLX-5 telephone, keep the following in mind:
 - The system recognizes the MLX-16DP as an MLX-28D. If you are replacing an MLX-28D with an MLX-16DP, remove all line and feature button assignments from the extension *first*. This rule also applies when you are replacing other telephones with an MLX-16DP.
 - The System Programming Extension Information Report incorrectly reports MLX-16DP telephones as MLX-28D telephones; keep a separate log of the MLX-16DP telephones on your system.
 - In releases prior to 5.0, the system recognizes the MLX-5D as an MLX-10D and the MLX-5 as an MLX-10. If you are replacing an MLX-5D or an MLX-5 with an MLX-10D or an MLX-10, remove all line and feature button assignments from the extension *first*. This rule also applies when you are replacing other telephones with an MLX-5 or MLX-5D.
 - In releases prior to 5.0, the System Programming Extension Information Report incorrectly reports MLX-5D and MLX-5 telephones as MLX-10D and MLX-10 telephones respectively; keep a separate log of the MLX-5D and MLX-5 telephones on your system.

6 Managing the System

Centralized Telephone Programming

- In Release 5.0 and later systems, the system recognizes MLX-5 and MLX-5D telephones as 5-button telephones. The System Programming Extension Information Report shows the correct identification for these telephones.

At the Centralized Programming menu, use the following procedure to program features onto a single telephone. For information about accessing the Centralized Programming menu, see [“Starting Centralized Telephone Programming” on page 6-25](#).

Console/Display Instructions

Additional Information

PC

► 1. Select Program Extension.

```
Centralized Programming:
Make a selection
Program Ext
Copy Ext

Exit          Enter
```

F1

► 2. Specify the extension you want to program.

```
Centralized Programming:
Enter extension

Backspace
Exit          Enter
```

Dial or type:

Extension number: [nnnn]

Slot and port number: *[sspp]

Logical ID number: #[nnn]

⬅

► 3. Save your entry.

► 4. Select Enter.

F10

► 5. Select Start.

```
Extension Program   xxxx
Press HOME to Exit

Sys Program        Start
```

xxxx = extension entered in Step 2

F10

Console/Display Instructions

Additional Information

PC

► **6. Select the line button where you want to assign the feature.**

```
Select Button:
Extension Program   xxxx
                   Page 1
                   Page 2

Sys Program
```

xxxx = extension entered in Step [2](#)

Press the line button or function key that corresponds to your selection.



If you are programming a telephone with more than 20 line buttons, use Page 2 ([F7](#)) to select the additional buttons. See Appendix E in *System Programming* for button diagrams of all telephones.

► **7. Program the feature(s).**

```
****
Press HOME to Exit
Delete           Page 1
                Page 2

Sys Program   ListFeature
```

**** = current programming of button selected in Step (Line xxx, voice, feature, or blank)

Dial or type the programming code:

*[nnn] or select List Feature ([F10](#)) to display a list of features you can select from.



When the line button is programmed, the system automatically returns to the display in Step [5](#). (Note that this is a sample screen for a line button; other screens may have a different first line.)

► **8. Repeat Steps [5](#) and [6](#) for each line button you want to program for the extension, or press the Home button to return to the Centralized Programming menu.**

Copying Feature and SA/ICOM Buttons

You can use the Copy Extension feature to copy an extension's programmed buttons (with some exceptions) to one or more extensions. Program the features individually on an extension to create a template that can then be copied to other extensions in the system.

Only extensions of the same type can be copied to one another (that is, analog to analog, and MLX to MLX) because the two telephones have different button layouts. For a system that has both analog and MLX telephone types, you need two templates: one for analog and one for MLX.

A Multi-Function Module's programming can be copied to or from another MFM. A Direct Line Console (DLC) can be copied only to another DLC. Single-line telephones' and QCCs' features *cannot* be copied.

[Table 6-6](#) lists the features that can be copied to another extension. Features that can be copied for DLC operator extensions are listed in [Table 6-7](#).

Table 6-6. Features That Can Be Copied: All Telephones

Feature	Analog and MLX Telephones	Analog Telephones Only	MLX Telephones Only
Account Code Entry	✓		
Authorization Code	✓		
Auto Answer All		✓	
Auto Answer Intercom		✓	
Auto Dial Inside	✓		
Auto Dial Outside			
Barge-In	✓		
Callback-Selective	✓		
Camp-On	✓		
Conference†	✓		
Coverage Off	✓		
Coverage VMS Off	✓		
Data Status	✓		
Delete Message		✓	
Direct Voice Mail	✓		
Do Not Disturb	✓		
Drop†	✓		
Extension Status 2 (ES2) (Non-operator)	✓		
Extension Status 1 (ES1) (Non-operator)	✓		
Feature Button		✓	
Forward	✓		
Group Calling	✓		
Group Page	✓		
Headset Auto Answer			✓
Headset Hang Up			✓
Headset Status			✓
Headset/Handset Mute			✓
Last Number Dial*	✓		

Continued on next page

Table 6-6. Continued

Feature	Analog and MLX Telephones	Analog Telephones Only	MLX Telephones Only
Leave Message	✓		
Message Light Off	✓		
Next Message		✓	
Park	✓		
Pickup: Group	✓		
Pickup: General	✓		
Pickup: Extension	✓		
Pickup: Line	✓		
Posted Message	✓		
Privacy	✓		
Recall	✓		
Reminder Service: Set	✓		
Reminder Service: Cancel	✓		
Return Call		✓	
Saved Number Dial*	✓		
Scroll		✓	
Signaling	✓		
SA/ICOM Ring [†]	✓		
SA/ICOM Voice [‡]	✓		
SA/ICOM Originate Only [‡]	✓		
System Speed Dial	✓		
Transfert	✓		

* Number is **not** copied.

† Behind Switch mode only.

‡ Ringing options (No Ring, Delay Ring, and Immediate Ring) are copied with the button.

Table 6-7 shows the operator features that can be copied for operator consoles. QCC features cannot be copied.

Table 6-7. Features That Can Be Copied: Direct-Line Consoles Only

Feature	Analog Direct-Line Console (DLC)	MLX Direct-Line Console (DLC)
Alarm	✓	✓
Extension Status Off	✓	✓
Extension Status 1	✓	✓
Extension Status 2	✓	✓
Missed Reminder	✓	✓
Night Service	✓	✓
Operator Park	✓	✓
Send/Remove Message	✓	✓

At the Centralized Programming menu, follow the procedure below to copy feature buttons from one extension to another. For information about accessing the Centralized Programming menu, see [“Starting Centralized Telephone Programming” on page 6-25](#).

Console/Display Instructions **Additional Information** **PC**

▶ **1. Select Copy Extension.**

```
Centralized Programming:
Make a selection
Program Ext
Copy Ext

Exit          Enter
```

F2

▶ **2. Specify the number of the extension from which you want to copy programming features.**

```
Extension Program Copy:
Enter extension to copy
from

Backspace
Exit          Enter
```

Dial or type [nnn].

↶

▶ **3. Save your entry.**

Select Enter.

F10

Console/Display Instructions	Additional Information	PC
-------------------------------------	-------------------------------	-----------

- ▶ **4. Specify the number of the extension to which you want to copy programmed features or SA or ICOM buttons.**

Copy extension xxxx to:	
Enter extension	
<i>nnnn</i>	
Backspace	Next
Exit	Enter

xxxx = extension entered in Step [2](#)

Dial or type [*nnnn*].



- ▶ **5. Either continue to copy line assignments and programmed features from the copy extension shown to another extension or go to Step [7](#).**

Select Enter ([F10](#)) to continue copying line assignments from the extension currently displayed on Line 1 to additional extensions.

Select Next ([F9](#)) if the extension numbers to be copied to are sequential.

Select Enter ([F10](#)) after completing programming.

Return to Step [4](#) to continue programming. The extension to be copied from is displayed on Line 1.

- ▶ **6. Return to the Centralized Programming menu.**

Select Exit.

[F5](#)

- ▶ **7. Save your entry.**

Select Enter.

[F10](#)

- ▶ **8. Return to the Centralized Programming menu.**

Select Exit.

[F5](#)

Copying Line/Trunk Button Assignments

Use this procedure to copy outside line/trunk button assignments, pool dial-out code restrictions (Hybrid/PBX only), and Night Service information (for operator positions only). You can copy from one extension to another or to a block of extensions with identical requirements. Use system programming for this procedure.

If you are copying assignments from an operator position to a block of extensions that includes both operator and non-operator extensions, the information is copied only to the operator positions; the non-operator positions are not affected. Similarly, if you are copying assignments from a non-operator position to a block of extensions that includes both operator and non-operator extensions, the information is copied only to the non-operator positions; the operator positions are not affected. The system does not provide an error tone to signal that the copy did not work for all of the extensions in the block.

If you are performing this procedure for the first time, see the detailed steps in "Copy Line/Trunk Assignments" of the "Telephones" section, Chapter 3, *System Programming*.

Console Procedures To copy to a single extension:

Extensions→Line Copy→Single→Dial copy from ext. no.→Enter→Dial copy to ext. no.→Enter→Exit→Exit

To copy to a block of extensions:

Extensions→Line Copy→Block→Dial copy from ext. no.→Enter→Dial ext. no. of first telephone in block→Enter→Dial ext. no. of last telephone in block→Enter→Exit→Exit

PC Procedures To copy to a single extension:

[F6]→[F2]→[F1]→Type copy from ext. no.→[F10]→Type copy to ext. no.→[F10]→[F5]→[F5]

To copy to a block of extensions:

[F6]→[F2]→[F2]→Type copy from ext. no.→
[F10]→Type ext. no. of first telephone in block→
[F10]→Type ext. no. of last telephone in block→
[F10]→[F5]→[F5]

Using Reports

The system generates a variety of reports that can help you with your system management tasks:

- The Station Message Detail Recording (SMDR) feature provides information about incoming and outgoing calls. The content of the report depends on which of two formats (Basic or ISDN) you select and can include the type of call (voice or data), the date, the time of the call, the called number, the duration of the call, the number of the trunk used to make or receive the call, and an account code, if applicable. This report prints on the SMDR printer.

- The system programming reports include reports that describe how various aspects of the system are programmed (for example, trunk information, label information, Allowed and Disallowed Lists, and Pickup Groups), and an Error Log that describes any system errors that may occur. You reach these reports from the system programming menus.

The available system programming reports are listed below. With the exception of Trunk Information, the dash lists under the bullets show the sections of each report that automatically print when the report option is selected.

- All
 - Each report
 - All report options
- System Set Up (System Information Report)
- System Dial Plan
 - Pools
 - Telephone Paging Zones
 - Direct Group Calling
 - Lines/Trunks
 - Stations (Extensions)
- Label Information
 - Telephone Personal Directory
 - Message Numbers and Posted Messages
- Trunk Information (trunk option must be specified)
 - Tie
 - DID
 - Loop/Ground
 - General
- T1 Information
- PRI Information
- BRI Information
- Remote Access
 - General Options
 - Non-Tie Restrictions
 - Tie Restrictions

- Barrier Code Restrictions
- Operator Information
 - Position
 - General Options
 - DSS Options
 - QCC Operators
 - Operator Information
- Allowed Lists
- Allowed Lists Assigned to Extensions
- Disallowed Lists
- Disallowed Lists Assigned to Extensions
- Automatic Route Selection
- Tables
- Extension Directory
- System Directory
- Group Page
- Extension Information
- Group Coverage
- Group Calling
- Night Service
- Call Pickup Groups
- Error Logs
- Authorization Codes

Printing SMDR Reports

SMDR reports consist of SMDR call records that print sequentially on a serial printer connected to the SMDR jack on the control unit. If the printer is off, is out of paper, or has a paper jam, up to 100 SMDR records are stored in the SMDR queue. The printing of system programming reports takes precedence; while these reports are printing, SMDR records are stored in the queue.

For more information, see "Station Message Detail Recording (SMDR)" in the *Feature Reference*.

Printing System Programming Reports

System programming reports can be printed out or viewed on the screen of a PC with SPM or printed out on a serial printer connected to the SMDR jack on the processor module in the control unit. You can print individual reports or use the All option to print the entire set of available reports, including all report sections and options. See Appendix F of *System Programming* for samples of the print reports.

For more information, see "Print Reports" in Chapter 4, *System Programming*.



NOTES:

1. If you select the All option, the reports take several minutes to print. You may want to schedule use of the printer during off-peak hours.
2. If you select a report for which there is no information, the report header still prints.
3. Print reports if you cannot back up your system programming information.
4. If your system must handle more than 100 calls per hour, do not print reports during regular hours.
5. If you are printing from the console, your printer must be connected to the SMDR port. If you are programming on a PC with SPM, you have the following choices:
 - Print reports on the SMDR printer (if available).
 - Print reports on the PC printer.
 - Save reports (on hard disk or floppy).
 - View reports (browse).

To print system programming reports, use one of the following procedures:

Console Procedures To print trunk information:

More→Print→Trunk Info→Select trunk type→Exit

To print extension information:

More→Print→**More**→Ext Info→Dial ext. no.→Enter→Exit

To print all other reports:

More→Print→Select report→Exit

PC Procedures

To print trunk information:

PgUp → **F3** → **F6** → Select trunk type → **F5**

To print extension information:

PgUp → **F3** → **PgUp** → **F10** → Type ext. no. → **F10** → **F5**

To print all other reports:

PgUp → **F3** → Select report → **F5**

To save report on disk:

PgUp → **F3** → Select report → **F10** → select **G0T0 FL0PPY**
from below console simulation screen → **F10**

To view report:

Ctrl + **F8**



NOTE:

The Extension Information report incorrectly lists MLX-16DP telephones as MLX-28D telephones. In releases prior to 5.0, MLX-5D and MLX-5 telephones are listed as MLX-10D and MLX-10 telephones, respectively. If you have MLX-16DP, MLX-5D, and MLX-5 telephones in your system, keep a separate log of the extension numbers. In Release 5.0 and later systems, MLX-5 and MLX-5D telephones are correctly identified in the report.

Setting System Date and/or Time

Use this procedure to change the system date and/or time. These must be set correctly. System time affects the functioning of several system features and applications, including Automatic Backup, Night Service, SMDR reports, standalone auto attendant systems, voice mail, and Reminder Service.



NOTE:

Be sure to change the system time appropriately when Daylight Savings Time starts and when it ends.

Planning Guidelines

If you change the system time while the system is in Night Service mode, Night Service is deactivated and must be manually reactivated.

If you have installed applications such as Intuity AUDIX, you may need to set the time in the applications software whenever you reset the system time.

Valid Entries

For date:

Month: 01 to 12

Day: 01 to 31

Year: 00 to 99

For time: 0000 to 2359

Task List: Setting System Date and/or Time

- Open the System Programming menu from the console or a PC with SPM.
- Program the change(s), following the instructions for "Set System Date" or "Set System Time" in the "Basic System Operating Conditions" section in Chapter 3 of *System Programming*, or the summary programming instructions below.

Programming Instructions

Console Procedure **System**→**Date** or **Time**→**Drop**→Dial current date or time→**Enter**→**Exit**

PC Procedure **F1**→**F7** or **F8**→**Alt** + **P**→Type current date or time→**F10**→**F5**

Backing Up the System

Use this procedure to make a copy of your customized system data. You should create a backup after each system upgrade, service technician visit, or major system reconfiguration.

The backup does not copy any application data. For information about application backup, see the documentation for the application.

The backup is performed using the Translation memory card (white label).

For information about the Restore procedure, see Chapter 4, "Advanced Programming Procedures," in *System Programming*.

Planning Guidelines

While the backup is in progress, you cannot access any programming functions.

If any type of programming is taking place at another extension when you begin the backup procedure, the backup is canceled and the number of the first busy

extension appears on the screen. Attempt the backup procedure again when the busy extension becomes idle.



NOTE:

By default, the system is set to perform a backup automatically once a week. You can change this to daily backups or to manual backups. For more information, see "Automatic Backup" in the "Memory Card" section in Chapter 3 of *System Programming*.

Default filenames in manual backups are automatically dated using the MMDD convention with no slashes.

Task List: Backing Up the System

- If necessary, read "Memory Card" in Chapter 3 of *System Programming* for detailed information about this feature, including how to insert the memory card into the PCMCIA interface slot on the processor module and descriptions of the backup files.
- Open the System Programming menu from the console or a PC with SPM.
- Program the change(s), following the instructions for "Backup" in the "Memory Card" section of *System Programming*, Chapter 3, or the summary programming instructions below.
- When you have finished, leave the Translation memory card in the PCMCIA interface slot.

Programming Instructions

- | | |
|-------------------|--|
| Console Procedure | Insert memory card→System→Back/Restore→Backup→Select backup file→Dial new backup filename→Enter→Yes→Exit→Exit→Exit |
| PC Procedure | Insert memory card→[F1]→[F9]→[F2]→Type ext. no.→[F10]→[Alt] + [P]→Type label→[F6]→[F5]→[F5]→[F5] |

Adding an Extension

Use this procedure to add an extension to the system.

Planning Guidelines

The procedure to add an extension involves several decisions on your part. For example, you must decide which features to assign to the extension. These include calling restrictions, Coverage, calling group, Pickup group, paging group, Night Service, Forced Account Code Entry, and Remote Call Forwarding. You can read about these features in the *Feature Reference*.

You also need to make decisions about assigning buttons on multiline telephones. There are two types of buttons: system-programmed buttons (for example, **SA** or **ICOM** buttons) to access an inside or outside line or pool of outside lines, and blank line buttons that can be programmed with system features like Do Not Disturb. For more information about buttons, see [“Line Buttons on Multiline Telephones” on page 3–25](#) of this guide and consult “System Access/Intercom Buttons” in the *Feature Reference*.

For feature buttons, you may choose to simply copy another extension's programmed buttons (with some exceptions) to this new extension. Refer to [“Copying Feature and SA/ICOM Buttons” on page 6–29](#).

Before you actually begin performing the tasks listed below, read through the list and make your decisions now about these and other aspects of the new extension. Otherwise, you may have to stop in the middle of the procedure to collect the necessary information.

For additional planning information, see the “Telephones” section in Chapter 3 of *System Programming*.

Task List: Adding an Extension

- Obtain Form 2a, System Numbering: Extension Jacks. Also obtain any other relevant forms, including group-assigned feature forms (for example, Form 7c, Group Coverage) and forms for the individual extension (for example, Form 4d, MLX Telephone). Appendix D of this guide includes a list of the planning forms.
- On Form 2a, confirm that there is a spare jack that supports the type of extension you want to add. In the Jack Type column, *A* indicates an analog jack, *D* indicates a digital (MLX) jack, and *B* indicates a basic jack (for single-line telephones, adjuncts, and certain applications).



NOTE:

If there are no spare jacks, you must add a module to the control unit before you can add an extension. Contact your Lucent Technologies representative.

- Make decisions about which features and buttons to assign to this extension as described in the planning guidelines above. Record your decisions on the appropriate planning forms.
- Open the System Programming menu from the console or a PC with SPM.
- If your system uses the Set Up Space numbering plan (see Form 2a), single-renumber the extension jack following the instructions in "Single Renumbering" in the "System Renumbering" section of *System Programming*, Chapter 3.



NOTE:

This task requires Extension Forced Idle for this extension jack.

- If you are adding a personal line, Loudspeaker Paging, or **Pool** buttons (Hybrid/PBX only), assign the outside lines/trunks to the buttons on the telephone, following the instructions in "Assign Trunks or Pools to Telephones" in the "Telephones" section of *System Programming*, Chapter 3.

Also, you may choose to copy line/trunk button assignments, pool dial-out code restrictions (Hybrid/PBX only), and Night Service information (for operator positions only) as described in "Copy Line/Trunk Assignments" in the "Telephones" section of *System Programming*, Chapter 3.



NOTE:

This task requires an idle condition: Extension Forced Idle.

- Assign Intercom or System Access buttons by following the instructions in "Assign Intercom or System Access Buttons" in the "Telephones" section of *System Programming*, Chapter 3.



NOTE:

This task requires an idle condition: Extension Forced Idle. Also, you may choose to use the Copy Extension procedure described in ["Copying Feature and SA/ICOM Buttons" on page 6-29](#).

- If the telephone is an analog multiline telephone and does not have a built-in speakerphone (BIS) or Hands-Free Answer on Intercom (HFAI), identify it as such to the system by following the instructions in "Analog Multiline Telephone Without Built-in Speakerphone (BIS) or "Hands-Free Answer Intercom (HFAI) Capability" in the "Telephones" section of *System Programming*, Chapter 3.
- If the telephone is an analog multiline telephone and requires a dedicated pair of extension jacks to provide Voice Announce to Busy or to provide voice and data features, identify it to the system as such by following the

instructions in "Analog Multiline Telephones with Voice Announce to Busy" in the "Telephones" section of *System Programming*, Chapter 3, or the instructions in "Data Features" in Chapter 4 of *System Programming*.

- Program the features following the instructions for each feature in "Optional Telephone Features," "Optional Group Features," and "System Features" in *System Programming*, Chapter 3, or in Chapter 5, "Centralized Telephone Programming" of *System Programming*.
- When you have finished, file the form(s) with the rest of the planning forms.

Programming Instructions

See the appropriate procedures in *System Programming* as noted in the task list above.

Moving an Extension

Use this procedure to move an extension in your system.

Planning Guidelines

There are three ways to move an extension:

- Call Lucent Technologies at 1 800 247-7000. They can arrange for a Lucent Technologies technician to do it for you at your site.
- If you have remote maintenance and administration as part of your maintenance contract, call the Lucent Technologies Helpline at 1 800 628-2888. They can determine whether it can be done remotely. If possible, they can do it remotely for you. If not (for example, if additional ports are required), you can call the 1 800 247-7000 number for service. If you do not have this coverage in your contract and are interested in adding it, contact your Lucent Technologies representative.
- Follow the procedure in this section.

If the extension is not wired or is wired but not connected to the system, or if you are not sure, you must call Lucent Technologies at 1 800 247-7000 to arrange for this to be checked or completed.



NOTE:

Consultation charges may apply when you call Lucent Technologies, and your organization may be charged for service.

Task List: Moving an Extension

- Obtain Form 2a, System Numbering: Extension Jacks.
- Renumber the extension(s) and record the changes on Form 2a. If you are switching two extensions (for example, Extension 303 and Extension 306) because two people are trading offices, you would renumber as follows:
 - 303 → 7103 (the default; to free up 303)
 - 306 → 303
 - 7103 (the original 303) → 306
- Renumbering changes the extension number, but the programming of the extension stays the same. Therefore, for the new Extensions 303 and 306 in the example above, each still has its original programming, even though it has a new extension number. This programming includes Extension Directory labels, Personal Speed Dial, button assignments, and group-assigned features such as Coverage, Pickup, paging, and Night Service. If you need to change the programming for the extension, you must perform the next task.
- If necessary, program the extension that was moved for the appropriate features and buttons as described in "Adding an Extension," earlier in this chapter. Remember to record everything on the appropriate form(s).
- When you have finished, file the form(s) with the rest of the planning forms.

Programming Instructions

See ["Adding an Extension" on page 6-40](#)

Removing an Extension

Use this procedure to remove an extension.

Planning Guidelines

When you remove an extension, you need to remove it from any groups and lists to which it is assigned, for example, Allowed Lists, calling restrictions, Coverage, calling group, Pickup group, paging group, and/or Night Service.

Task List: Removing an Extension

- Obtain Form 2a, System Numbering: Extension Jacks. Also obtain any relevant forms, including group-assigned feature forms (for example, 7c, Group Coverage) and Forms for the individual telephone (for example, 4d, MLX Telephone). Appendix D of this guide includes a list of the planning forms.
- Open the System Programming menu from the console or a PC with SPM.
- If your system uses the Set Up Space numbering plan (see Form 2a), single-renumber the extension jack following the instructions in "Single Renumbering" in the "System Renumbering" section of *System Programming*, Chapter 3.



NOTE:

This task requires an idle condition: Extension Forced Idle for this extension jack.

- If you are removing a personal line, Loudspeaker Paging, or **Pool** button assignments (Hybrid/PBX only), follow the instructions in "Assign Trunks or Pools to Telephones" in the "Telephones" section of *System Programming*, Chapter 3.



NOTE:

This task requires an idle condition: Extension Forced Idle for this extension jack.

- To remove intercom or System Access button assignments, follow the instructions in "Assign Intercom or System Access Buttons" in the "Telephones" section of *System Programming*, Chapter 3.



NOTE:

This task requires an idle condition: Extension Forced Idle for this extension jack.

- If the telephone does not have a built-in speakerphone (BIS) or Hands-Free Answer on Intercom (HFAI), remove it as such from the system by following the instructions in "Analog Multiline Telephone Without Built-in Speakerphone (BIS) or Hands-Free Answer Intercom (HFAI) Capability" in the "Telephones" section of *System Programming*, Chapter 3.
- If the telephone requires a dedicated voice or voice pair of extension jacks to provide the Voice Announce to Busy feature, or to provide voice and data features, remove them from the system as such by following the instructions in "Analog Multiline Telephones with Voice Announce to Busy" in the "Telephones" section of *System Programming*, Chapter 3, or the instructions in "Data Features" in Chapter 4 of *System Programming*.

- Remove the features, following the instructions for each feature in "Optional Telephone Features," "Optional Group Features," and "System Features" in *System Programming*, Chapter 3, or in Chapter 5, "Centralized Telephone Programming," of *System Programming*.
- Remove the extension from any of the group-assigned feature forms or lists on which it appears, and remove its individual telephone form from the planning forms package.
- When you have finished, file the form(s) with the rest of the planning forms.

Programming Instructions

See the procedures in *System Programming* as noted in the task list above.

Assigning a HotLine Extension

Available in Release 5.0 and later systems for Hybrid/PBX, Key, and Behind Switch systems, the HotLine feature allows a system manager to assign single-line telephones as HotLines. When a user lifts the handset of a HotLine telephone, the telephone automatically dials an inside extension or outside number.

The feature is designed to allow immediate access to, for example, an 800-number catalogue sales department, a security office, a hotel concierge, or other inside or outside destinations that people need to reach quickly and effortlessly.

Planning Guidelines

HotLine extensions dial only the first Personal Speed Dial number (assigned to Personal Speed Dial code 01) and are not intended for other purposes. HotLine extensions cannot put a call on hold or perform a transfer or conference.

A HotLine extension can access any type of line available for outgoing calls on single-line telephones. The extension must be connected to a 008, 012, or 016 extension module; it cannot be connected to an MFM.



SECURITY ALERT:

If a HotLine extension accesses a loop-start line, that line should provide reliable disconnect and be programmed for reliable disconnect. Otherwise, a user at the extension may be able to stay on the line after a call is completed and then make a toll call.

Personal Speed Dial code 01 may be programmed at a single-line telephone prior to its assignment as a HotLine extension. When the system manager has used system programming to make an extension a HotLine, there is only one

opportunity to program the necessary Personal Speed Dial code while at the telephone. For security reasons, as long as the extension remains a HotLine, no further programming is allowed at the extension, and changes to the speed dial code must be made using centralized telephone programming.

Because HotLine extensions generally should not receive calls, consider programming the single-line telephone for No Ring.

A single-line telephone without a dialpad can be used for many HotLine applications. If the telephone has a dialpad, it allows dialing of digits after a call is connected, in response to an automated attendant's prompts, for example.

Task List: Assigning a HotLine Extension

- Assemble any required system planning forms, for example, System Form 4f, Tip/Ring Equipment.
- Open the System Programming menu from the console or a PC with SPM.
- If necessary, assign a personal line to the extension, following the instructions in "Assign Trunks or Pools to Telephones" in the "Telephones" section of *System Programming*, Chapter 3.



NOTE:

This task requires an idle condition: Extension Forced Idle.

- If necessary, assign or delete intercom or System Access buttons by following the instructions in "Assign Intercom or System Access Buttons" in the "Telephones" section of *System Programming*, Chapter 3.
- Program Personal Speed Dial code 01 with the inside or outside number required, including any ARS or other access codes as necessary. You can use extension programming to program the code at the single-line telephone, or you can program the number using centralized telephone programming (see ["Centralized Telephone Programming" on page 6-24](#)).
- If necessary, program the line at the extension for No Ring (see ["Centralized Telephone Programming" on page 6-24](#)).
- If Night Service with Outward Restriction is in use on your system, you may need either to add the HotLine extension to the Night Service Exclusion List or add the number dialed by a HotLine to a Night Service Emergency List.
- When you have finished, file the form(s) with the rest of the planning forms.

Programming Instructions

Console Procedure Extensions→**More**→**More**→HotLine→Dial ext.
no.→Enter→Exit→Exit

PC Procedure PgUp→PgUp→F6→F4→Type ext. no.→F3→F6→
F5→F5

Changing Calling Restrictions

Use this procedure to change individual extensions' calling restrictions to one of the following:

- Unrestricted
- Restricted from making all outgoing calls
- Restricted from making toll calls

In Release 3.1 and later systems, checking for calling restrictions is reset after entered star codes pass those restrictions (in some areas, star codes are provided by the central office to allow the use of special features available from the local telephone company). In earlier releases, the star code digits were processed as dialed digits by ARS, Allowed Lists, Disallowed Lists, and calling restrictions. Therefore, the actual called party number was not properly processed when a star code was entered. For more information about star codes, see ["Revising Allowed Lists" on page 6-71](#).

Planning Guidelines

Changing calling restrictions may affect other features, including Allowed Lists, Auto Dial, Automatic Route Selection (ARS), Callback, Conference, Coverage, Disallowed Lists, Display, Extension Status, Forward and Follow Me, Night Service, personal lines, Pools, Speed Dial, and **SA/ICOM** buttons. For more information, see the *Feature Reference*.



NOTES:

1. You can copy restrictions from another extension as described in "Copy Call Restrictions" in the "Optional Telephone Features" section of Chapter 3 in *System Programming*.
2. In Release 3.1 and later systems, ports programmed for voice messaging systems (VMI ports) are factory-set as outward-restricted. To permit outcalling from a voice messaging system, you must change this restriction.

Valid Entries

Unrestricted, Outward-restricted, Toll-restricted

Task List: Changing Calling Restrictions

- Obtain the following forms, as appropriate:
 - 6g, Call Restriction Assignments and Lists
 - 6e, Allowed Lists
 - 6f, Disallowed Lists
 - Forms for individual telephones: Forms 4b, 4d, 4e, 4f, 5a, 5b, or 5c
- If necessary, read "Calling Restrictions" in the *Feature Reference* for detailed information about this feature.
- Plan changes using the planning guidelines above; record the new values on the form(s).
- Open the System Programming menu from the console or a PC with SPM.
- Program the change(s), following the instructions for "Call Restrictions" in the "Optional Telephone Features" section of *System Programming*, Chapter 3, or the summary programming instructions below.
- When you have finished, file the form(s) with the rest of the planning forms.

Programming Instructions

Console Procedure Extensions→Restriction→Dial ext. no.→Enter→
Select restriction→ Enter→Exit

PC Procedure F6→F4→Type ext. no.→F10→Select restriction→
F10→F5

Changing Trunk-to-Trunk Transfer Status

Beginning with Release 3.1, the system includes an option to allow or disallow trunk-to-trunk transfer for each extension. Trunk-to-trunk transfer is the transferring of an outside call to another outside number. When trunk-to-trunk transfer is allowed, there is a risk of toll fraud.

Use this procedure to enable or disable trunk-to-trunk transfer at one or more extensions.

Planning Guidelines



SECURITY ALERT:

The default setting for all extensions, including voice messaging (VMI) ports and remote access barrier codes, disallows trunk-to-trunk transfer. If you elect to enable this feature at an extension, consider the risk of toll-fraud abusers obtaining access to your system and calling out of the system using this feature. For more information about protecting your system from fraudulent toll charges, see Appendix A, "Customer Support Information."

Valid Entries

Enabled, Disabled

A single-line telephone can never perform a trunk-to-trunk transfer unless it is plugged into a port programmed as a VMI port.

Task List: Changing Trunk-to-Trunk Transfer Status

- Obtain the following forms, as appropriate:
 - Form 4b, Analog Multiline Telephone
 - Form 4d, MLX Telephone
 - Form 4e, MFM Adjunct: MLX Telephone
 - Form 4f, Tip/Ring Equipment
 - Form 5a, Direct-Line Console (DLC): Analog
 - Form 5b, Direct-Line Console (DLC): Digital
 - Form 5c, MFM Adjunct: DLC
 - Form 5d, Queued Call Console (QCC)
 - Data Form 1a, Modem Data Station
 - Data Form 1b, 7500B Data Station
- If necessary, read "Transfer" in the *Feature Reference* for detailed information about this feature.
- Plan changes and record the new values on the form(s).
- Open the System Programming menu from the console or a PC with SPM.
- Program the change(s), following the instructions for "Trunk-to-Trunk Transfer" in *System Programming*, Chapter 3, or the summary programming instructions below.

- When you have finished, file the form(s) with the rest of the planning forms.

Programming Instructions

Console Procedure Extensions→**More**→**More**→ TrkTransfer→Toggle LED On/Off or Dial ext. no.→Enter→Exit→Exit

PC Procedure **F6**→**PgUp**→**F7**→Toggle letter R On/Off or Type ext. no.→**F10**→**F5**→**F5**

Changing Coverage Delay Options

Prior to Release 4.1, system managers used system programming to specify systemwide coverage delays. In Release 4.1 and later systems, these settings are replaced by ring delay settings for each extension.



NOTE:

The *Feature Reference* provides a full description of Coverage options, including detailed tables and illustrations that highlight the enhancements provided in Release 4.1 and later systems. Before programming coverage delays, you should review this information.

A call is first directed to the extension that the caller is trying to reach; this is the *sender's* extension. At the phone of an individual covering calls (the *receiver*) is a programmed Cover button that receives calls for the sender. A sender may have immediate (Primary) coverage, if he or she answers few calls, or delayed (Secondary) coverage, if he or she wants only occasional coverage. Often, senders' calls are handled by both types of coverage, to ensure that callers receive attention when a Primary Coverage receiver is not available.

With Primary Coverage, the receiver's programmed Cover button can be set for Delay Ring to allow the sender a chance to answer first. In this case, the Primary Cover Ring Delay option allows the system manager to control the number of rings before the Cover button rings. It also controls the delay before a call is sent from Individual to Group Coverage.

With Secondary Coverage, the Secondary Coverage Delay Interval (fixed systemwide at two rings) is always applied. If a receiver's programmed Cover button is set for Delay Ring, the Secondary Cover Ring Delay is applied to a sender's extension in addition to this interval. It does not affect Secondary or Group Coverage call delivery. The Primary and Secondary Cover Ring Delays replace the systemwide Delay Ring Interval programmed for all Cover buttons in earlier releases. [Table 6-8](#) summarizes the interactions between ring delays and coverage features.

Table 6-8. Ring Delays Affecting Coverage

Timer	Factory Setting	Range	Description
Coverage Delay Interval*	3 rings	1–9 rings	Release 4.0 and prior systems, set systemwide. Delay before sending calls to Group Coverage, when: <ul style="list-style-type: none"> ■ Sender also has Individual Coverage and receiver is available. ■ Sender does not have Individual Coverage or receiver is not available, and Group Coverage receiver is calling group only or QCC queue only (no Group Cover buttons on multiline telephones).
Group Coverage Ring Delay	3 rings	1–9 rings	Release 4.1 and later systems, programmable for each extension. Delay before sending calls to Group Coverage, when: <ul style="list-style-type: none"> ■ Sender has Individual Coverage and receiver is available (in addition to Primary Cover Ring Delay). ■ Sender does not have Individual Coverage or receiver is not available, and Group Coverage receiver is calling group only or QCC queue only (no Group Cover buttons on multiline telephones).
Primary Cover Ring Delay	2 rings	1–6 rings	Release 4.1 and later systems, programmable for each extension. This timer sets: <ul style="list-style-type: none"> ■ The delay before a Primary Cover button programmed for Delay Ring begins to ring audibly. ■ The delay, in addition to the Group Coverage Ring Delay, before calls are sent to Group Coverage when the sender has Individual Coverage and any receiver is available.

Continued on next page

* In Release 4.1 and later systems, this setting is replaced by the Group Coverage Ring Delay.

Table 6-8. Continued

Timer	Factory Setting	Range	Description
Secondary Cover Ring Delay	2 rings	1-6 rings	Release 4.1 and later systems, programmable for each extension. In addition to the fixed Secondary Coverage Delay Interval (2 rings), this timer sets the delay before a Secondary Cover button programmed for Delay Ring begins to ring audibly. This setting does not affect Primary or Group Coverage call delivery.
Secondary Coverage Delay Interval	2 rings	Fixed	Delay before sending Individual Coverage calls to a Secondary Cover button programmed for Immediate Ring, when sender also has Individual Coverage to a Primary Cover button. In Release 4.1 and later systems, the delay (in addition to the Secondary Cover Ring Delay setting for the sender) before a Secondary Cover button programmed for Delay Ring begins to ring audibly.
Retry Timing Interval	5 sec	Fixed	Repetition interval for trying to send calls to group coverage when no receivers are available; continues until call is answered by sender or receiver (or caller hangs up).

A sender can also be part of a Coverage group whose calls are covered by individuals, operators, or a calling group (an option is often used to provide voice messaging system coverage). [Table 6-9](#) summarizes the ways that coverage calls are handled when Group and Individual Coverage are combined.

Table 6-9. Group Coverage Call Delivery Rules (Release 4.1 and Later Systems)

Receiver Type	Sender Status	Primary Coverage Receiver Status	Secondary Coverage Receiver Status	Sent to Group Coverage after...
Group Cover button(s) only or Group Cover button(s) and QCC queue	Available	Available	Available	<i>GCD + PRD</i>
			Unavailable or unassigned	<i>GCD + PRD</i>
	Unavailable	Available	Available	<i>GCD + PRD</i>
			Unavailable or unassigned	Immediate
		Unavailable or unassigned	Available	<i>GCD + PRD</i>
			Unavailable or unassigned	Immediate
QCC Queue only	Available	Available	Available	<i>GCD + PRD</i>
			Unavailable or unassigned	<i>GCD + PRD</i>
	Unavailable	Available	Available	<i>GCD + PRD</i>
			Unavailable or unassigned	<i>GCD</i>
		Unavailable or unassigned	Available	<i>GCD + PRD</i>
			Unavailable or unassigned	Immediate
Calling group only	Available	Available	Available	<i>GCD + PRD</i>
			Unavailable or unassigned	<i>GCD + PRD</i>
	Unavailable	Available	Available	<i>GCD + PRD</i>
			Unavailable or unassigned	<i>GCD</i>
		Unavailable or unassigned	Available	<i>GCD + PRD</i>
			Unavailable or unassigned	Immediate

GCD = Group Coverage Ring Delay
 PRD = Primary Cover Ring Delay

Planning Guidelines

When you plan cover delays, consider whether the sender is part of a coverage group or not. If the sender is covered by only individuals, delays are fairly easy to plan, depending on whether the sender never plans to answer calls or plans to answer them when he or she is at the extension.

When Group Coverage is used in conjunction with Individual Coverage, calls should ring first at receivers for Individual Coverage. Consider the following factors before setting the Group Coverage Ring Delay for an extension:

- If only Primary Coverage is programmed for the sender and any receiver's Primary Cover buttons are set to Delay Ring, make sure the value for each sender's Group Coverage Ring Delay (1–9 rings) is higher than the Primary Cover Ring Delay (1–6 rings).
- If both Primary and Secondary Coverage are programmed for a sender and all the receivers' Cover buttons are set for Immediate Ring, the Group Coverage Ring Delay should be greater than the higher of these two values: the Primary Cover Ring Delay or the 2-ring fixed Secondary Cover Delay Interval.
- If both Primary and Secondary Cover buttons are programmed for a sender and any receiver's Primary and/or Secondary Cover buttons are programmed for Delay Ring, make the value higher than either the Primary Cover Ring Delay or the fixed Secondary Cover Delay Interval (two rings), plus the Secondary Cover Ring Delay (1–6 rings), whichever is greater.



NOTE:

Coverage senders can control the way calls are covered using programmed buttons. For more information, see ["Covering Calls" on page 4–34](#), ["Revising Night Service with Coverage Control" on page 6–81](#), and the *Feature Reference*.

Valid Entries

Group Coverage Ring Delay: 1 to 9 rings
Primary Cover Ring Delay: 1 to 6 rings
Secondary Cover Ring Delay: 1 to 6 rings

Task List: Changing Coverage Ring Delays

- Obtain Form 7c, Group Coverage, if necessary. As appropriate, obtain the form(s) for individual telephones: Forms 4b, 4d, 4e, 4f, 5a, 5b, or 5c.
- Read "Coverage" in the *Feature Reference* for detailed information about these settings.
- Plan changes using the planning guidelines above; record the new values on the form(s).

- Open the System Programming menu from the console or a PC with SPM.
- Program the change(s), following the instructions for "Coverage Delays" in the "Telephones" section of *System Programming*, Chapter 3, or the summary programming instructions below.
- When you have finished, file the forms with the rest of the planning forms.

Programming Instructions

Console Procedures Change the number of rings before a call is sent to Group Coverage receivers:

Extensions→**More**→**More**→Cover Delay→
Group Cover→Dial sender's ext. no.→Enter→
Dial no. of rings (1-9)

Change the delay for Primary Cover buttons programmed for Delay Ring; change the additional delay before a call is sent to Group Coverage receivers when Primary or Secondary Coverage Receivers are available:

Extensions→**More**→**More**→Cover Delay→
Primary→Dial sender's ext. no.→Enter→Dial no. of
rings (1-6)→Enter→Exit

Change the delay for Secondary Cover buttons programmed for Delay Ring:

Extensions→**More**→**More**→Cover Delay→
Secondary→Dial sender's ext. no.→Enter→
Dial no. of rings (1-6)→Enter→Exit

PC Procedures Change the number of rings before a call is sent to Group Coverage receivers:

[F6]→[PgUp]→[PgUp]→[F2]→[F3]→Type sender's ext.
no.→[F10]→Type no. of rings (1-9)→[F10]→[F5]

Change the delay for Primary Cover buttons programmed for Delay Ring; change the additional delay before a call is sent to Group Coverage receivers when Primary or Secondary Coverage Receivers are available:

[F6]→[PgUp]→[PgUp]→[F2]→[F1]→Type sender's ext.
no.→[F10]→Type no. of rings (1-6)→[F10]→[F5]

Change the delay for Secondary Cover buttons programmed for Delay Ring:

[F6]→[PgUp]→[PgUp]→[F2]→[F2]→Type sender's ext.
no.→[F10]→Type no. of rings (1-6)→[F10]→[F5]

Adding/Removing a Line

Use this procedure to add a line to or remove a line from the system.

Planning Guidelines

If you are adding a new line and need to order a module to connect the line, coordinate the installation and connection dates to ensure that the new module is installed before the line is connected to the system.

Task List: Adding/Removing a Line

- Obtain Form 2c, System Numbering: Line/Trunk Jacks. Check the form to confirm that there is a spare jack.



NOTE:

If you are adding a line but there is no spare jack, you need to add a new module. Contact your Lucent Technologies representative.

- Contact your central office (CO) to obtain a new line or to disconnect a line.
- If you are adding a line/trunk, call Lucent Technologies 1 800 247-7000 to arrange for a Lucent Technologies technician to connect the line to the system and set it up (charges may apply). If you are removing a line, it is not necessary to make any such arrangements.



NOTE:

A new module must be installed before a line is connected to it.

- After the line is connected and set up or is disconnected, open the System Programming menu from the console or a PC with SPM to program it as described in the next task.
- Assign the line to or unassign the line from a pool, to/from extensions (if it is a personal line), to/from a calling group, or to/from Remote Access, as appropriate, following the instructions in the "Telephones" section of Chapter 3 in *System Programming*.
- Revise the appropriate planning form(s).
- When you have finished, file the form(s) with the rest of the planning forms.

Programming Instructions

See the appropriate procedures in *System Programming* as noted in the task list above.

Adding a DLC Operator Position

Use this procedure to add a DLC operator position to either an MLX or an analog multiline extension module.

To add a QCC operator position, see the next section, [“Adding a QCC Operator Position” on page 6-61](#).

Planning Guidelines

DLC operator positions can be assigned to the first and fifth extension jacks on any MLX or analog multiline module. The first jack on the first extension module in your system is automatically assigned as the primary operator position.

If your system has Call Management System (CMS), the two CMS connections must be made to analog jacks. Each CMS requires two DLC operator positions on the same analog module to connect the equipment and one position to serve as CMS supervisor.

A maximum of eight DLC operator positions can be assigned. Any combination of operator positions can be assigned as long as there are not more than four QCC operator positions (Hybrid/PBX) and no more than a total of eight operator positions (see [Table 6-10](#)).

Table 6-10. Maximum Number of Operator Positions

Position Type	Type of Telephone	Maximum Positions
QCC	MLX-20L	4
DLC	MLX-20L	8
	MLX-28D	
	BIS-34D, BIS-22, or BIS-22D	
	analog multiline telephone	
	MERLIN II Display Console	

Lines and trunks are assigned on individual buttons.



NOTE:

Because this procedure requires an idle system, you may want to perform it after hours. Also, when you change an extension to or from an operator position, the system returns the port (extension jack) type of that extension to the factory setting. You must reprogram lines and any features for that telephone or console. You may also need to reprogram any attached adjunct equipment and optional features.

The procedure to add an operator position involves several tasks that require decisions, for example, assigning features like calling restrictions, Coverage, calling group, Pickup group, paging group, Night Service, Forced Account Code Entry, and Remote Call Forwarding. If necessary, read about the individual features in the *Feature Reference* for detailed information.

You also need to make decisions about assigning buttons. There are two types of buttons: system-programmed buttons (for example, **SA** or **ICOM** buttons) to access an inside or outside line or pool of outside lines, and blank line buttons that can be programmed with system features like Do Not Disturb. "[Line Buttons on Multiline Telephones](#)" on page 3–25 of this guide includes information about buttons; information about individual features is in the *Feature Reference*.

Before you actually begin performing the items in the task list below, read through the list and make your decisions now about these and other aspects of the new extension rather than having to stop in the middle of the procedure.

For additional planning information, see the "Telephones" section in Chapter 3 of *System Programming*.

Task List: Adding a DLC Operator Position

- Obtain Form 2a, System Numbering: Extension Jacks, Form 6a, Optional Operator Features, and one of the following, as appropriate: 5a, Direct-Line Console (DLC): Analog; or 5b, Direct-Line Console (DLC): Digital.
- If necessary, read "Direct-Line Console" in the *Feature Reference* for detailed information about DLC consoles.
- Check Form 2a for available operator-position jacks; look for the shaded first and fifth lines on the form.



NOTE:

If there are no available operator-position jacks, contact your Lucent Technologies representative.

- Plan changes using the planning guidelines above; record the new values on the form(s).
- Open the System Programming menu from the console or a PC with SPM.
- If your system uses the Set Up Space numbering plan (see Form 2a), single-renumber the extension jack, following the instructions in "Single Renumbering" in the "System Renumbering" section of *System Programming*, Chapter 3.



NOTE:

This task requires an idle condition: Extension Forced Idle for this extension jack.

- Assign the jack, following the instructions for “DLC Operator Positions” in the “System Operator Positions” section of *System Programming*, Chapter 3, or the summary programming instructions below.



NOTE:

This task requires an idle condition: System Idle.

- Assign the lines/trunks, following the instructions for “Assign Trunks or Pools to Telephones” in the “System Operator Positions” section in *System Programming*, Chapter 3.



NOTE:

This task requires an idle condition: Extension Forced Idle for this extension jack. Also, if you need additional **SA** or **SA Originate Only** buttons, you should remove all lines using system programming, then assign the buttons using centralized telephone programming. For more information, see *System Programming*.

- Using centralized telephone programming, assign Ringing Options as described in Chapter 5, “Centralized Telephone Programming,” in *System Programming*.
- If you are adding a personal line, Loudspeaker Paging, or **Pool** buttons (Hybrid/PBX only), assign the outside lines/trunks to the buttons on the telephone following the instructions in “Assign Trunks or Pools to Telephones” in the “Telephones” section of *System Programming*, Chapter 3.



NOTE:

You may choose to copy line/trunk button assignments that other extensions have, for example, a Loudspeaker Paging button. For more information, see “Copy Line/Trunk Assignments” in the “Telephones” section of *System Programming*, Chapter 3.

- Assign intercom or system access buttons by following the instructions in “Assign Intercom or System Access Buttons” in the “Telephones” section of *System Programming*, Chapter 3. Also, you may choose to use the Copy Extension procedure described in [“Copying Feature and SA/ICOM Buttons” on page 6-29](#).



NOTE:

This task requires an idle condition: Extension Forced Idle.

- If the extension requires a dedicated voice or voice pair of extension jacks to provide Voice Announce to Busy or to provide voice and data features, identify it to the system as such by following the instructions in "Analog Multiline Telephones with Voice Announce to Busy" in the "Telephones" section of *System Programming*, Chapter 3, or the instructions in "Data Features" in Chapter 4 of *System Programming*.
- Assign other buttons, for example, Night Service, Send/Remove Message, Camp-On, headset, Auto Dial, Forward, Pickup, or Group Pickup, following instructions in Chapter 5, "Centralized Telephone Programming," of *System Programming*.
- Program the telephone features following the instructions for each feature in "Optional Telephone Features," "Optional Group Features," and "System Features" in *System Programming*, Chapter 3, or in Chapter 5, "Centralized Telephone Programming," of *System Programming*.
- When you have finished, file the form(s) with the rest of the planning forms.

Programming Instructions

See the appropriate procedures in *System Programming* as noted in the task list above.

Adding a QCC Operator Position

Use this procedure to add a QCC operator position (Hybrid/PBX systems only).

To add a DLC operator position, see the previous section, ["Adding a DLC Operator Position" on page 6-58](#).

Planning Guidelines

QCC operator positions can be assigned only to the first and fifth extension jacks of an MLX module. The first jack on the first extension module in your system is automatically assigned as the primary operator position.

A maximum of four QCC operator positions can be assigned.

When other QCC operator positions are added, the primary QCC operator position should be the first one added.

Any combination of operator positions can be assigned as long as there are no more than four QCC operator positions and no more than a total of eight operator positions (see [Table 6-11](#)).

Table 6-11. Maximum Number of Operator Positions

Position Type	Type of Telephone	Maximum Positions
QCC	MLX-20L	4
DLC	MLX-20L	8
	MLX-28D	
	BIS-34D, BIS-22, or BIS-22D analog multiline telephone	
	MERLIN II Display Console	

QCC button assignments are automatic and factory-set. In Release 4.0 and later systems, the **Call 5** button is factory set so that Voice Announce is disabled. The button works the same way as any other **Call** button. If you use system programming to enable the Voice Announce feature, the **Call 5** button is available for originating voice-announced calls; the operator does not receive voice-announced calls on this button.

Lines and trunks are assigned on individual buttons.



NOTE:

Because this procedure requires an idle system, you may want to perform it after hours. Also, when you change an extension to an operator position, the system returns the port (extension jack) type of that extension to the factory setting. You must reprogram lines and any features for that telephone or console. You may also need to change any attached adjunct equipment and optional features.

The procedure to add an extension involves several tasks about which you need to make decisions, for example, assigning features like calling restrictions, Coverage, calling group, Pickup group, paging group, Night Service, Forced Account Code Entry, Remote Call Forwarding. If necessary, read about the individual features in the *Feature Reference* for detailed information.

Before you actually begin performing the items in the task list below, read through the list and make your decisions now about these and other aspects of the new extension rather than having to stop in the middle of the procedure.

For additional planning information, see the "Telephones" section in Chapter 3 of *System Programming*.

Task List: Adding a QCC Operator Position

- Obtain Form 2a, System Numbering: Extension Jacks, Form 6a, Optional Operator Features, and 5d, Queued Call Console (QCC).
- If necessary, read "Queued Call Console" in the *Feature Reference* for detailed information about QCC consoles.
- Check Form 2a for available operator-position jacks; look for the shaded first and fifth lines on the form.



NOTE:

If there are no available operator-position jacks, contact your Lucent Technologies representative.

- Plan changes using the planning guidelines above; record the new values on the form(s).
- Open the System Programming menu from the console or a PC with SPM.
- If your system uses the Set Up Space numbering plan (see Form 2a), single-renumber the extension jack following the instructions in "Single Renumbering" in the "System Renumbering" section of *System Programming*, Chapter 3, or the summary programming instructions below.



NOTE:

This task requires an idle condition: Extension Forced Idle for this extension jack.

- Assign the jack, following the instructions for "QCC Operator Positions" in the "System Operator Positions" section of *System Programming*, Chapter 3, or the summary programming instructions below.



NOTE:

This task requires an idle condition: System Idle.

- Assign the lines/trunks to ring at the QCC, following the instructions for "QCC Operator to Receive Calls" in the "Lines and Trunks" section of *System Programming*, Chapter 4.



NOTE:

This task requires an idle condition: System Idle.

- Assign the QCC queue priority level values, following the instructions in "QCC Queue Priority Level" in the "Lines and Trunks" section of Chapter 4 in *System Programming*.
- Assign optional operator features, as desired, following the instructions in "Optional Operator Features" in Chapter 3 of *System Programming*.
- When you have finished, file the form(s) with the rest of the planning forms.

Programming Instructions

See the appropriate procedures in *System Programming* as noted in the task list above.

Adding Operator Features

Use this procedure to add the following operator features (available in Hybrid/PBX mode only):

- For DLC and QCC: Operator Hold Timer
- For DLC only: DLC Operator Automatic Hold
- For QCC only:
 - Hold Return
 - Automatic Hold or Release
 - Queue over Threshold
 - Elevate Priority
 - Calls-in-Queue Alert
 - QCC Operator to Receive Call Types
 - Call Type Queue Priority Level
 - Voice Announce (Release 4.0 and later systems only)
 - Message Center Operation
 - Automatic or Manual Extended Call Completion
 - Return Ring
 - Position-Busy Backup

Planning Guidelines

Some of the options cannot be programmed for individual operator positions but, rather, apply to all operator positions in the system. These are: Operator Hold Timer, Hold Return, Automatic Hold or Release, Extended Call Completion, Return Ring, Queue over Threshold, Elevate Priority, and QCC Operator to Receive Call Types.

Only one Position-Busy Backup can be programmed per system.

Valid Entries

Operator Hold Timer	10 to 255 seconds
DLC Operator Automatic Hold	Disable, Enable

Hold Return	Remain on hold, Return to QCC queue
Automatic Hold Release	Auto Hold, Auto Release
Queue over Threshold	0 to 99
Elevate Priority	0 (same priority) and 5 to 30 seconds
Calls-in-Queue Alert	Enable, Disable
QCC Operator to Receive Call Types	N/A
QCC Operator Voice Announce to Busy (Release 4.0 and later only)	Disable, Enable
Call Type Queue Priority Level	1 to 7
Message Center Operation	QCC extension numbers
Extended Call Completion	Automatic, Manual
Return Ring	1 to 15 rings
Position-Busy Backup	Calling group number

Task List: Adding Operator Features

- Obtain Form 6a, Optional Operator Features.
- If necessary, read "Direct-Line Console" or "Queued Call Console" in the *Feature Reference* for detailed information about the consoles and the optional operator features.
- Plan changes using the planning guidelines above; record the new values on Form 6a.
- Open the System Programming menu from the console or a PC with SPM.
- Program the change(s), following the appropriate instructions for "Optional Operator Features" in *System Programming*, Chapter 3.
- When you have finished, file Form 6a with the rest of the planning forms.

Programming Instructions

See the appropriate procedure in the "Optional Operator Features" section of Chapter 3, *System Programming*.

Connecting Auxiliary Equipment

Use the information in this section to do the following:

- Identify the line/trunk or extension jacks used for auxiliary equipment and applications, for example, a music source for Music On Hold, loudspeaker paging equipment, maintenance alarm (that is, an external alerting device that sounds or flashes when maintenance problems occur), or a fax machine.
- Specify the extensions to receive a message-waiting indication (MWI) when a fax transmission is received, and specify the length of time before the system registers that a fax has arrived and sends the MWI.
- Specify the number of rings before a call transferred by the voice messaging system goes to the backup position for both integrated and generic voice messaging interface (VMI) ports, rather than going to a voice mailbox.



NOTE:

Although a CTI (Computer Telephony Integration) link, Release 5.0 and later systems only, is treated in the system as auxiliary equipment, the programming of this feature is described later in this chapter in [“Adding a CTI Link” on page 6–89](#) and [“Removing a CTI Link” on page 6–93](#).

Planning Guidelines

For Music On Hold

If you use equipment that rebroadcasts music or other copyrighted materials, you may be required to obtain a copyright license from and pay license fees to a third party [such as the American Society of Composers, Artists, and Producers (ASCAP) or Broadcast Music Incorporated (BMI)]. Music on Hold requires no such license and can be purchased from your Lucent Technologies representative.

Only one Music On Hold line/trunk jack is allowed per system.

You cannot assign the line/trunk identified for Music On Hold to a line/trunk pool. If the line/trunk is currently assigned to a pool, you must remove it before you program this option.

You cannot assign the line/trunk identified for use with Music On Hold to a button on any telephone or as a Remote Access trunk, and you cannot use the line/trunk jack identified for Music On Hold for a loudspeaker paging system or maintenance alarm.

Because this procedure requires an idle system, you may want to perform it after hours.

Valid Entries

Line/trunk numbers

For Loudspeaker Paging

If you use equipment that rebroadcasts music or other copyrighted materials, you may be required to obtain a copyright license from and pay license fees to a third party (such as the ASCAP or BMI). Music on Hold requires no such license and can be purchased from your Lucent Technologies representative.

A maximum of three single-zone or multizone loudspeaker paging systems can be connected to the system.

You cannot assign the line/trunk identified for loudspeaker paging equipment use to a line/trunk pool. If the line/trunk is currently assigned to a pool, you must remove it before you program this option.

You cannot assign the line/trunk identified for loudspeaker paging equipment use as a Remote Access line/trunk, and you cannot use its jack for Music On Hold or maintenance alarm.

Valid Entries

Line/trunk numbers

For Fax Machines

A maximum of 16 fax machines can use the Fax Message Waiting feature. Additional fax machines (more than 16) can be installed, but these machines cannot use this feature.



NOTE:

Fax machines should not be connected to analog multiline telephones with a General-Purpose Adapter (GPA). In a GPA configuration, features cannot be assigned to the fax machine independently of the telephone.

You can specify up to four telephones to receive the message-waiting indication when a fax transmission is received. Note that fax machines can only send and not receive message-waiting indications.

Valid Entries

For the number of seconds: 0 to 30 seconds

For Maintenance Alarms

You cannot assign the line/trunk identified for the maintenance alarm to a button on any telephone or as a Remote Access trunk, and you cannot use its line/trunk jack to connect a loudspeaker paging system or Music On Hold.

Valid Entries

Line/trunk numbers

For Voice Messaging System and Automated Attendant

The number of rings cannot be programmed for individual voice messaging systems; the single setting applies for all. Use the Group Type procedure in "Optional Group Features" (Chapter 3, *System Programming*) to assign VMI ports as either integrated or generic.

Valid Entries

Touch-tone duration: 50 to 200 ms, in increments of 25 ms

Interval between digits: 50 to 200 ms, in increments of 25 ms

Number of rings before transfer: 0 to 9

Task List: Connecting Auxiliary Equipment

- Obtain Form 2c, System Numbering: Line/Trunk Jacks, and the appropriate individual telephone form (4d, 4e, 4f, 5b, or 5c). For a voice messaging system or auto attendant system, see the forms packaged with the application.
- If necessary, read "Auxiliary Equipment" in *System Programming*, Chapter 4, for additional information.
- Plan changes using the planning guidelines above; record the new values on the form(s).
- Open the System Programming menu from the console or a PC with SPM.
- Program the change(s), following the appropriate instructions for "Auxiliary Equipment" in *System Programming*, Chapter 4, or the appropriate summary programming instructions below.



NOTE:

For Music On Hold and maintenance alarms, System Idle is required; for loudspeaker paging, Line/Trunk Idle is required.

- When you have finished, file the form(s) with the rest of the planning forms.

Programming Instructions

For fax machines:

Console Procedure AuxEquip→Fax→Extension→Dial ext.
no.→Enter→Exit→Msg Waiting→Dial fax machine
ext. no.→Enter→Dial message waiting indicator ext.
no.→Enter→Threshold→Drop→Dial no. of
seconds→Enter→Exit→Exit

PC Procedure [F9]→[F3]→[F1]→Type ext. no.→[F10]→[F5]→[F2]→
Type fax machine ext. no.→[F10]→Type message
waiting indicator ext. no.→[F10]→[F3]→[Alt] + [P]→Type
no. of seconds→ [F10]→[F5]→[F5]

For a voice messaging system and auto attendant:

Console Procedure AuxEquip→VMS/AA→TransferRtn→Drop→Dial no. of
rings→Enter→TT Duration→Drop→Dial no. of ms→
Enter→TT Interval→Drop→Dial no. of ms→
Enter→Exit→Exit

PC Procedure [F9]→[F6]→[F1]→[Alt] + [P]→Type no. of rings→[F10]→
[F2]→[Alt] + [P]→Type no. of ms→[F10]→[F3]→
[Alt] + [P]→Type no. of ms→[F10]→[F5]→[F5]

For the other auxiliary equipment noted above:

Console Procedure AuxEquip→MusicOnHold or Ldspkr Pg or
MaintAlarms→Dial line/trunk no.→Enter→Exit

PC Procedure [F9]→[F1]→Type line/trunk no.→[F10]→[F5]

Changing Calling Group Assignments

Use this procedure to assign or remove an extension from a calling group.

Planning Guidelines

An extension can belong to only one calling group. A QCC cannot be a member of a calling group. A delay announcement device should not be programmed as a calling group member.

A calling group can be a Night Service group member.

The total number of extensions can be divided into a maximum of 32 calling groups. A calling group can include a maximum of 20 extensions, but not all 32 calling groups can have this maximum number.

If a linear hunting pattern is indicated on the back of the system planning form (7d), be sure to assign extensions to the group in the exact order that they are shown on the form. The system searches for an available member in the order in which you assign the extensions to the group.

The Extension Status feature must be set to the calling group or CMS mode before you assign members to the group. For more information, see "Extension Status" in the *Feature Reference* and in the "System Features" section of Chapter 3, *System Programming*.

Changing calling group assignments may affect other features; for more information, see the *Feature Reference*.



NOTE:

To assign an extension to a new calling group, you must remove it from its old group before programming the new assignment.

Valid Entries

Extension numbers

Task List: Changing Calling Group Assignments

- Obtain Form 7d, Group Calling.
- If necessary, read "Group Calling" in the *Feature Reference* for detailed information about this feature.
- Plan changes using the planning guidelines above; record the new values on Form 7d.
- Open the System Programming menu from the console or a PC with SPM.
- Program the change(s), following the instructions for "Group Calling Member Assignments" in the "Optional Group Features" section of *System Programming*, Chapter 3, or the summary programming instructions below.
- When you have finished, file Form 7d with the rest of the planning forms.

Programming Instructions

Console Procedure Extensions→**More**→Grp Calling→Members→Dial
calling group ext. no.→Enter→Dial ext. no.→ Enter→
Exit→Exit→Exit

PC Procedure **F6** →**PgUp** →**F4** →**F9** →Type calling group ext. no.→
F10 →Type ext. no.→**F10** →**F5** →**F5** →**F5**

Revising Allowed Lists

An Allowed List provides some flexibility for extensions with calling restrictions by allowing specified extensions to dial certain numbers (for example, 911), regardless of the extension's calling restrictions. Use this procedure to modify an Allowed List of telephone numbers that can be dialed.



NOTE:

A Disallowed List takes precedence over an Allowed List.

Planning Guidelines

Revising Allowed Lists may affect other features, including Auto Dial, Automatic Route Selection (ARS), calling restrictions, Conference, Directories, Forward and Follow Me, Night Service, personal lines, Remote Access, Speed Dial, and Toll Type. For more information, see the *Feature Reference*.



NOTE:

When Allowed Lists are used in conjunction with Remote Access to restrict calls made through the system from remote locations, the Allowed Lists can be assigned to either a specific barrier code (password) or to specific types of remote access trunks (for example, all tie/DID trunks).

In Release 3.1 and later systems, star codes may be included in Allowed and Disallowed Lists. In these releases, dialed star codes are ignored by ARS for routing calls. Star codes are provided by the central office (CO) to allow the use of special features (for example, in many areas *70 turns off a call-waiting feature provided by the central office). In Release 3.0 and earlier systems, the star code digits were processed as dialed digits by ARS, Allowed Lists, Disallowed Lists, and calling restrictions. Therefore, the actual called party number was not properly processed when a star code was entered.

Release 3.1 and later systems permit system managers to include star codes in Allowed and Disallowed Lists. If a star code is allowed, the digits following the star

code are checked normally by Allowed/Disallowed Lists, calling restrictions, and ARS.

The MERLIN LEGEND Communications System Release 3.1 and later observes these Bellcore standards for star codes:

- Only 2- or 3-digit star codes are recognized. Two-digit star codes must begin with 1, 4, 5, 6, 7, 8 or 9. Three-digit star codes must begin with a 2 or a 3.
- The star code or codes must come at the beginning of the string of digits dialed, not at the end or in the middle.
- Multiple leading star codes are allowed. For example, *67*705551212 is recognized correctly, but in 5551212*67*705553131 the stars are ignored.

Valid Entries

6 digits for each number (an area code plus an exchange, or 6 digits with a leading 1, where required)

Asterisk (*, Release 3.1 and later systems only) preceding a maximum of one leading star code per entry

10 numbers for each list (numbered 0 through 9)

8 lists for each system (numbered 0 through 7)

8 lists for each telephone



NOTE:

If you program *1* as the first digit of a list entry, any toll restriction assigned to the extension is removed for calls that can be placed by a toll operator. Also, special characters (such as Pause) are not permitted in Allowed List entries.

Task List: Revising Allowed Lists

- Obtain Form 6e, Allowed Lists and, as appropriate, the form(s) for individual telephones: Forms 4b, 4d, 4e, 4f, 5a, 5b, or 5c.
- If necessary, read "Allowed/Disallowed Lists" in the *Feature Reference* for detailed information about this feature.
- Plan changes using the planning guidelines above; record the new values on the form(s).
- Open the System Programming menu from the console or a PC with SPM.

- Program the change(s), following the instructions for "Allowed Lists" in the "System Features" section of *System Programming*, Chapter 3, or the summary programming instructions below.
- When you have finished, file the forms with the rest of the planning forms.

Programming Instructions

Console Procedure Tables→AllowList→Dial list no. and entry no.→
Enter→Drop→Dial no.→Enter→Exit

PC Procedure [F8]→[F1]→Type list no. and entry no.→[F10]→
[Alt] + [P]→Type no.→[F10]→[F5]

Assigning Allowed Lists to Extensions

Use this procedure to assign individual extensions to established Allowed Lists.

Planning Guidelines

More than one Allowed List can be assigned to an extension.



NOTE:

You can copy calling restrictions. See "Copy Call Restrictions" in Chapter 3 of *System Programming*.

Valid Entries

0 to 7

Task List: Assigning Allowed Lists to Telephones

- Obtain Form 6e, Allowed Lists and, as appropriate, the form(s) for individual telephones: Forms 4b, 4d, 4e, 4f, 5a, 5b, or 5c.
- If necessary, read "Allowed/Disallowed Lists" in the *Feature Reference* for detailed information about this feature.
- Plan changes using the planning guidelines above; record the new values on the form(s).
- Open the System Programming menu from the console or a PC with SPM.
- Program the change(s), following the instructions for "Assign Allowed Lists to Telephones" in the "System Features" section of *System Programming*, Chapter 3, or the summary programming instructions below.
- When you have finished, file the forms with the rest of the planning forms.

Programming Instructions

Console Procedure Tables→AllowTo→Dial list no.→Enter→Dial ext.
no.→Enter→Exit→Exit

PC Procedure [F8]→[F2]→Type list no.→[F10]→Type ext. no.→ [F10]→
[F5]→[F5]

Revising Disallowed Lists

Use this procedure to establish Disallowed Lists that contain telephone numbers than cannot be dialed from specified telephones (including unrestricted telephones). A Disallowed List takes precedence over an Allowed List.

Planning Guidelines

Changing Disallowed Lists may affect other features, including Auto Dial, Automatic Route Selection (ARS), Conference, Forward and Follow Me, personal lines, Remote Access, and Toll Type. For more information, see the *Feature Reference*.

When Disallowed Lists are used in conjunction with Remote Access to restrict calls made through the system from remote locations, the Disallowed Lists can be assigned to either a specific barrier code (password) or to specific types of remote access trunks (for example, all tie/DID trunks).

In Release 3.1 and later systems, star codes may be included in Allowed and Disallowed Lists. In these systems, dialed star codes are ignored by ARS for routing calls. Star codes are provided by the central office (CO) to allow the use of special features (for example, in many areas *70 turns off a call-waiting feature provided by the central office). In Release 3.0 and earlier systems, the star code digits were processed as dialed digits by ARS, Allowed Lists, Disallowed Lists, and calling restrictions. Therefore, the actual called party number was not properly processed when a star code was entered.

Release 3.1 and later systems permit system managers to include star codes in Allowed and Disallowed Lists. If a star code is allowed, the digits following the star code are checked normally by Allowed/Disallowed Lists, calling restrictions, and ARS.

The MERLIN LEGEND Communications System Release 3.1 and later observes these Bellcore standards for star codes:

- Only 2- or 3-digit star codes are recognized. Two-digit star codes must begin with 1, 4, 5, 6, 7, 8 or 9. Three-digit star codes must begin with a 2 or a 3.

- The star code or codes must come at the beginning of the string of digits dialed, not at the end or in the middle. Multiple leading star codes are allowed for dialing, but not in Allowed/Disallowed Lists. For example, *67*705551212 is recognized correctly, but in 5551212*67*705553131 the stars are ignored.
- To prevent rotary phone users from using all star codes, include a separate Disallowed List entry, 11. To disallow specific codes, create separate entries where 11 is substituted for the *, for example, 1167.

Beginning with Release 3.1, a default Disallowed List (number 7) is provided with the system. This Disallowed List is automatically assigned to both generic and integrated VMI ports used by voice messaging systems. It includes the following entries, which are often used for toll fraud:

- 0, to prevent international calls
- 10, to prevent access to long-distance service providers
- 1809, to prevent unauthorized international calls routed through the Dominican Republic
- 1700, to prevent unauthorized toll calls with a "700" area code
- 1900, to prevent unauthorized toll calls with a "900" area code
- 976, to prevent local toll calls to numbers with "976" local access codes
- 1www976, where "w" stands for a wildcard entry, to prevent long-distance calls to numbers with "976" local access codes
- 11, to prevent the use of star codes at rotary telephones
- *, to prevent the use of star codes at multiline telephones

Valid Entries

11 digits for each number (+ wildcard Pause character, entered by pressing the **Hold** button)

Asterisk (*) or star or 11 (Release 3.1 and later systems only) a maximum of one leading star code in each entry

10 numbers for each list (numbered 0 through 9)

8 lists for each system (numbered 0 through 7)

8 lists for each telephone

Task List: Changing Disallowed Lists

- Obtain Form 6f, Disallowed Lists and, as appropriate, the form(s) for individual telephones: Forms 4b, 4d, 4e, 4f, 5a, 5b, or 5c.
- If necessary, read "Allowed/Disallowed Lists" in the *Feature Reference* for detailed information about this feature.
- Plan changes using the planning guidelines above; record the new values on the form(s).
- Open the System Programming menu from the console or a PC with SPM.
- Program the change(s), following the instructions for "Disallowed Lists" in the "System Features" section of *System Programming*, Chapter 3, or the summary programming instructions below.
- When you have finished, file the form(s) with the rest of the planning forms.

Programming Instructions

Console Procedure Tables→Disallow→Dial list no. and entry
no.→Enter→Drop→Dial no.→Enter→Exit

PC Procedure **F8** → **F3** → Type list no. and entry no. → **F10** →
Alt + **P** → Type no. → **F10** → **F5**

Assigning Disallowed Lists to Extensions

Use this procedure to assign established Disallowed Lists to individual extensions.

Planning Guidelines

Each restricted extension can be assigned to more than one list.

Valid Entries

0 to 7

You can copy restrictions. See "Copy Call Restrictions" in the "Optional Telephone Features" section of Chapter 3, *System Programming*.

Task List: Assigning Disallowed Lists to Extensions

- Obtain Form 6f, Disallowed Lists and, as appropriate, the form(s) for individual telephones: Forms 4b, 4d, 4e, 4f, 5a, 5b, or 5c.
- If necessary, read "Allowed/Disallowed Lists" in the *Feature Reference* for detailed information about this feature.
- Plan changes using the planning guidelines above; record the new values on the form(s).
- Open the System Programming menu from the console or a PC with SPM.
- Program the change(s), following the instructions for "Assign Disallowed Lists to Telephones" in the "System Features" section of *System Programming*, Chapter 3, or the summary programming instructions below.
- When you have finished, file the form(s) with the rest of the planning forms.



SECURITY ALERT:

In Release 3.1 and later systems, Disallowed List number 7 is automatically assigned to voice messaging system ports. To help guard against toll fraud, assign this list to other extensions. For more information, see the section above, "Changing Disallowed Lists."

Programming Instructions

Console Procedure Tables→DisallowTo→Dial list no.→Enter→Dial ext. no.→Enter→Exit→Exit

PC Procedure [F8]→[F4]→Type list no.→[F10]→Type ext. no.→[F10]→
[F5]→[F5]

Changing Group Coverage Assignments

Use this procedure to assign or remove an extension from a coverage group.



NOTE:

In Release 4.1 and later systems, you can change, on an extension-by-extension basis, the number of rings at a sender's extension before a call is sent to Group Coverage receivers. For programming information, see Chapter 3, "Common Administrative Procedures," in *System Programming* and ["Changing Coverage Delay Options" on page 6-51.](#)

Planning Guidelines

Changing Group Coverage assignments can affect other features, including Account Code Entry, Auto Answer All, Auto Answer Intercom, Automatic Line Selection, Barge-In, Callback, calling restrictions, Call Waiting, Camp-On, Conference, Direct Station Selector, Do Not Disturb, Forward and Follow Me, Group Calling, Hold, Park, personal lines, Pickup, pools, Recall, Reminder Service, Ringing Options, SMDR, System Access/Intercom Buttons, Transfer, and Voice Announce to Busy. For more information, see the *Feature Reference*.



NOTE:

This procedure assigns *senders*. Before you begin, make certain that the *receivers* for the coverage groups are assigned through extension or centralized telephone programming.

A maximum of 30 coverage groups is allowed, each with an unlimited number of members. Up to eight receivers can be assigned per coverage group.

An extension can be a sender in only one group; it can be a receiver for more than one coverage group. A calling group can be assigned as a receiver for up to 30 coverage groups. In Hybrid/PBX mode only, the QCC queue can be a receiver for up to 30 coverage groups.

If the sender's extension has one or more personal lines assigned, the sender can be assigned as the principal user so that calls received on the personal line follow that user's coverage pattern, if any.

When you reassign an extension to a new coverage group, the extension is automatically removed from its old group.



NOTE:

If you are using a voice messaging system (VMS) as a coverage receiver in a Release 4.1 or later system, you can set up Night Service so that the programmed Coverage VMS Off buttons on coverage senders' telephones are deactivated when Night Service takes effect. When normal operation is resumed, the system automatically activates senders' Coverage VMS Off buttons so that the voice mail system no longer takes messages. For additional information, see ["Revising Night Service with Coverage Control" on page 6-81](#) and the *Feature Reference*.

Valid Entries

Extension numbers

Task List: Changing Group Coverage Assignments

- Obtain Form 7c, Group Coverage.
- If necessary, read "Coverage" in the *Feature Reference* for detailed information about this feature.
- Plan changes using the planning guidelines above; record the new values on Form 7c.
- Open the System Programming menu from the console or a PC with SPM.
- Program the change(s), following the instructions for "Group Coverage Member Assignments" in the "Optional Group Features" section of *System Programming*, Chapter 3, or the summary programming instructions below.
- When you have finished, file Form 7c with the rest of the planning forms.

Programming Instructions

Console Procedure Extensions→**More**→Group Cover→Dial group no.→
Enter→Dial ext. no.→Enter→Exit→Exit

PC Procedure [F6]→[PgUp]→[F3]→Type group no.→[F10]→Type ext.
no.→[F10]→[F5]→[F5]

Revising Night Service with Group Assignment

Use this procedure to add or remove extensions, lines (Release 4.1 and later systems only), and a calling group to a Night Service group for after-hours coverage.

Planning Guidelines

Revising Night Service with Group Assignment may affect other features. For more information, see the *Feature Reference*.

There can be a maximum of eight Night Service groups (no more than one for each operator position assigned). Any number of extensions can be assigned to a Night Service group, and an extension can belong to more than one group.

A calling group can also be assigned to a Night Service group.

In Release 4.1 and later systems, you assign outside lines, as well as extensions, to a Night Service group. When Night Service is turned on by the operator, these lines ring immediately at all extensions assigned to the group. This feature allows

the system manager to control off-hours operation on a line-by-line basis, and is particularly useful when applied to personal lines. Night Service lines do not have to be assigned to the Night Service group operator's extension, nor are all lines assigned to an operator position automatically assigned to that operator's Night Service group. If a line is assigned to a Night Service operator extension but not assigned to the Night Service group, it is excluded from Night Service.

There is no limit to the number of lines and extensions that can be assigned to a Night Service group. A line or extension can be assigned to more than one group. The following types of lines can be assigned to a Night Service group in a Release 4.1 or later system:

- Analog ground-start and loop-start lines/trunks as well as digital T1 voice operation lines that emulate these types
- ISDN digital PRI lines that are routed by line appearance
- Digital NI-1 BRI lines
- Automated incoming tie trunks

The following types of lines cannot be assigned to a Night Service group:

- DID (Direct Inward Dial)
- ISDN digital PRI lines that are routed by dial plan
- Tie trunks directed to an extension (dial-in tie trunks)
- Lines whose ports are programmed for Loudspeaker Paging, Alarm, or Music On Hold

Valid Entries

Extension numbers

Line/trunk numbers

Task List: Revising Night Service with Group Assignment

- Obtain Form 9a, Night Service: Group Assignment.
- If necessary, read "Night Service" in the *Feature Reference* for detailed information about this feature.
- Plan changes using the planning guidelines above; record the new values on Form 9a.
- Open the System Programming menu from the console or a PC with SPM.
- Program the change(s), following the instructions for "Night Service Group Assignment" in the "Labeling" section of *System Programming*, Chapter 3, or the summary programming instructions below.
- When you have finished, file Form 9a with the rest of the planning forms.

Programming Instructions

Console Procedures To assign a calling group to a Night Service group:
NightSrvce→GroupAssign→Calling Group→Dial ext. no. of Night Service operator→Enter→Dial calling group no.→Enter→Exit→Exit

To assign an extension to a Night Service group:
NightSrvce→GroupAssign→Extensions→Dial ext. no. of Night Service operator→Enter→Dial ext. no. of member→Enter→Exit→Exit

To assign a line to a Night Service group (Release 4.1 and later systems only):

NightSrvce→GroupAssign→Lines→Dial ext. no. of Night Service operator→**F10**→Dial outside line no. (801-880)→**F10**→**F5**→**F5**

PC Procedures To assign a calling group to a Night Service group:
F10→**F1**→**F2**→Type ext. no. of Night Service operator→**F10**→Type calling group no.→**F10**→**F5**→**F5**

To assign an extension to a Night Service group:
F10→**F1**→**F1**→Type ext. no. of Night Service operator→**F10**→Type ext. no. of member→**F10**→**F5**→**F5**

To assign a line to a Night Service group (Release 4.1 and later systems only):

F10→**F1**→**F3**→Type ext. no. of Night Service operator→**F10**→Type outside line no. (801-880)→**F10**→**F5**→**F5**

Revising Night Service with Coverage Control

In Release 4.1 and later systems, system managers can coordinate the status of Coverage VMS Off buttons programmed at extensions with Night Service operation.

With this feature enabled (the factory setting is disabled), the following occurs:

- When Night Service is turned on, all Coverage VMS Off buttons are deactivated; that is, the programmed voice-messaging system calling group takes calls.

6 Managing the System

Revising Night Service with Coverage Control

Page 6-82

- When Night Service is turned off and normal operation is resumed, all Coverage VMS Off buttons are activated. Calls follow normal coverage patterns for business-hours operation.

Users can manually override this system-programmed setting by pressing the Coverage VMS Off buttons at their extensions.

Planning Guidelines

Revising Night Service with Coverage Control may affect other features. For more information, see the *Feature Reference*.

If the person at an extension has pressed the programmed Coverage VMS Off button at the telephone (either to turn voice-mail coverage on or off), the Night Service with Coverage Control feature does not toggle the telephone button to the opposite status. For example, if the person at the extension has used the programmed button to turn voice mail coverage off and Night Service is activated, the system-programmed feature has no effect. The voice mail system does not cover calls for the person at the extension. When normal business-hour operation is resumed, voice mail coverage remains off at the extension. In this way, users can activate voice mail coverage, when, for example, they are going to be away from the office for the entire working day, without worrying about whether the system turns voice mail coverage off.

Valid Entries

Enable, Disable

Task List: Revising Night Service with Coverage Control

- Obtain Form 9c, Night Service Options
- If necessary, read "Night Service" in the *Feature Reference* for detailed information about this feature.
- Plan changes using the planning guidelines above; record the new value on Form 9c.
- Open the System Programming menu from the console or a PC with SPM.
- Program the change(s), following the instructions for "Night Service with Coverage Control" in *System Programming*, Chapter 3, or the summary programming instructions below.
- When you have finished, file Form 9c with the rest of the planning forms.

Programming Instructions

- | | |
|-------------------|--|
| Console Procedure | To enable or disable Night Service with Coverage Control:
NightSrvce→Cover Control→Enable or Disable→Enter→Exit |
| PC Procedure | To enable or disable Night Service with Coverage Control:
[F10]→[F9]→[F1] or [F2]→[F10]→[F5] |

Changing Extension Directory Labels

Use this procedure for either of the following purposes:

- To change the alphanumeric system labels so that display telephone users can identify the co-worker who is calling or leaving a message
- To program the Extension Directory feature for MLX telephones



NOTE:

If your system has Integrated Solution III (IS III), use IS III to perform this task.

To program on the system programming console:

Use the buttons next to the display and line/feature buttons to specify alphanumeric characters and punctuation for labels. Use the template provided with the MLX-20L telephone to see which line buttons correspond to which alphanumeric characters.

To program with SPM:

Use the PC keyboard for labels. All letters appear on the screen in uppercase.

Planning Guidelines

Changing Extension Directory Labels may affect other features, including Directories, Group Calling, and Messaging. See the *Feature Reference* for more information.

Valid Entries

A label can have a maximum of seven characters.

Labels can contain capital letters, numbers, and eight types of characters: ampersands (&), dashes (-), spaces, periods (.), commas (,), apostrophes ('), stars (*), and pound signs (#).

Task List: Changing Extension Directory Labels

- Obtain Form 2a, System Numbering: Extension Jacks.
- If necessary, read "Labeling" in the *Feature Reference* for detailed information about this feature.
- Plan changes using the planning guidelines above; record the new values on Form 2a.
- Open the System Programming menu from the console or a PC with SPM.
- Program the change(s), following the instructions for "Extension Directory" in the "Labeling" section of *System Programming*, Chapter 3, or the summary programming instructions below.
- When you have finished, file Form 2a with the rest of the planning forms.

Programming Instructions

Console Procedure **More**→**Labeling**→**Directory**→**Extension**→**Dial ext. no.**→**Enter**→**Drop**→**Enter label**→**Enter**→**Exit**→**Exit**→**Exit**

PC Procedure **PgUp**→**F1**→**F1**→**F2**→**Type ext. no.**→**F10**→**Alt** + **P**→**Type label**→**F6**→**F5**→**F5**→**F5**

Changing Trunk Labels

Use this procedure to establish alphanumeric system labels that help display telephone users identify the line or trunk being used.

To program on the system programming console:

Use the buttons next to the display and line/feature buttons to specify alphanumeric characters and punctuation for labels. Use the template provided with the MLX-20L telephone to see which line buttons correspond to which alphanumeric characters.

To program with SPM:

Use the PC keyboard for labels. All letters appear on the screen in uppercase.

Planning Guidelines

The availability of the caller identification information may be limited by local-serving (caller's) jurisdiction, availability, or central office (CO) equipment.

Valid Entries

Each label can have a maximum of seven characters.

Labels can contain capital letters, numbers, and eight types of characters: ampersands (&), dashes (-), spaces, periods (.), commas (,), apostrophes ('), stars (*), and pound signs (#).

Task List: Changing Trunk Labels

- Obtain Form 2c, System Numbering: Line/Trunk Jacks.
- If necessary, read "Labeling" in the *Feature Reference* for detailed information about this feature.
- Plan changes using the planning guidelines above; record the new values on Form 2c.
- Open the System Programming menu from the console or a PC with SPM.
- Program the change(s), following the instructions for "Lines or Trunks" in the "Labeling" section of *System Programming*, Chapter 3, or the summary programming instructions below.
- When you have finished, file Form 2c with the rest of the planning forms.

Programming Instructions

Console Procedure **More**→Labeling→LinesTrunks→Dial ext. no.→
Enter→Drop→Dial label→Enter→Exit→Exit

PC Procedure PgUp)→F1)→F2)→Type line/trunk no.→F10)→
Alt) + P)→Type label→F6)→F5)→F5)

Changing Posted Message Labels

Use this procedure to add or change existing posted messages that tell callers with display telephones now why the called extension does not answer.

To program on the system programming console:

Use the buttons next to the display and line/feature buttons to specify alphanumeric characters and punctuation for labels. Use the template provided with the MLX-20L telephone to see which line buttons correspond to which alphanumeric characters.

To program with SPM:

Use the PC keyboard for labels. All letters appear on the screen in uppercase.

Planning Guidelines

Messages 2 through 20 can be changed through programming. Message 1, DO NOT DISTURB, cannot be changed.

Valid Entries

1 to 20

Each posted message can have a maximum of 16 characters.

Labels can contain capital letters, numbers, and eight types of characters: ampersands (&), dashes (-), spaces, periods (.), commas (,), apostrophes ('), stars (*), and pound signs (#).

Task List: Changing Posted Message Labels

- Obtain Form 10a, Label Form: Posted Messages.
- If necessary, read "Labeling" in the *Feature Reference* for detailed information about this feature.
- Plan changes using the planning guidelines above; record the new values on Form 10a.
- Open the System Programming menu from the console or a PC with SPM.
- Program the change(s), following the instructions for "Posted Message" in the "Labeling" section of *System Programming*, Chapter 3, or the summary programming instructions below.
- When you have finished, file Form 10a with the rest of the planning forms.

Programming Instructions

Console Procedure **More**→**Labeling**→**PostMessage**→Dial message no.→
Enter→**Drop**→Enter message→Enter→Exit→Exit

PC Procedure **PgUp**→**F1**→**F3**→Type message no.→**F10**→**Alt** + **P**→
Type message→**F6**→**F5**→**F5**

Changing Calling Group Labels

Use this procedure to change alphanumeric system labels for display telephone users to identify calling groups.

To program on the system programming console:

Use the buttons next to the display and line/feature buttons to specify alphanumeric characters and punctuation for labels. Use the template provided with the MLX-20L telephone to see which line buttons correspond to which alphanumeric characters.

To program with SPM:

Use the PC keyboard for labels. All letters appear on the screen in uppercase.

Planning Guidelines

Valid Entries

Each label can have a maximum of seven characters.

Labels can contain capital letters, numbers, and eight types of characters: ampersands (&), dashes (-), spaces, periods (.), commas (,), apostrophes ('), stars (*), and pound signs (#).

Task List: Changing Calling Group Labels

- Obtain Form 7d, Group Calling.
- If necessary, read "Labeling" in the *Feature Reference* for detailed information about this feature.
- Plan changes using the planning guidelines above; record the new values on Form 7d.
- Open the System Programming menu from the console or a PC with SPM.
- Program the change(s), following the instructions for "Group Calling" in the "Labeling" section of *System Programming*, Chapter 3, or the summary programming instructions below.
- When you have finished, file Form 7d with the rest of the planning forms.

Programming Instructions

Console Procedure **More**→**Labeling**→**Grp Calling**→Dial calling group ext. no.→**Enter**→**Drop**→Enter label→**Enter**→**Exit**→**Exit**

PC Procedure **[PgUp]**→**[F1]**→**[F4]**→Type calling group ext. no.→**[F10]**→**[Alt] + [P]**→Type label→**[F6]**→**[F5]**→**[F5]**

Changing System Directory Labels

Use this procedure to change System Speed Dial numbers for all system users. You can also use this procedure to enter the alphanumeric labels shown on the System Directory feature of MLX display telephones.

To program on the system programming console:

Use the buttons next to the display and line/feature buttons to specify alphanumeric characters and punctuation for labels. Use the template provided with the MLX-20L telephone to see which line buttons correspond to which alphanumeric characters.

To program with SPM:

Use the PC keyboard for labels. All letters appear on the screen in uppercase.

Planning Guidelines

Valid Entries

Speed dial code assignments are 600 through 729.

There can be a total of 130 numbers, with a maximum of 11 characters per label.

Labels can contain capital letters, numbers, and eight types of characters: ampersands (&), dashes (-), spaces, periods (.), commas (,), apostrophes ('), stars (*), and pound signs (#).

Task List: Changing System Directory Labels

- Obtain Form 10b, System Speed Dial.
- If necessary, read "Labeling" in the *Feature Reference* for detailed information about this feature.
- Plan changes using the planning guidelines above; record the new values on Form 10b.
- Open the System Programming menu from the console or a PC with SPM.

- Program the change(s), following the instructions for "System Speed Dial Directory" in the "Labeling" section of *System Programming*, Chapter 3, or the summary programming instructions below.
- When you have finished, file Form 10b with the rest of the planning forms.

Programming Instructions

- Console Procedure **More**→**Labeling**→**Directory**→**System**→Dial code no.→**Enter**→**Drop**→Enter label→**Enter**→**Backspace**→Dial telephone no.→**Enter**→**Yes** or **No**→**Enter**→**Exit**→**Exit**→**Exit**
- PC Procedure **PgUp**→**F1**→**F1**→**F1**→Type dial code no.→**F10**→**Alt** + **P**→Type label→**F6**→**F2**→Type telephone no.→**F6**→**F1**/**F2**→**F6**→**F5**→**F5**→**F5**

Adding a CTI Link

Use the procedure in this section to add a CTI (Computer Telephony Integration) link to an MLX port on a 008 or 408 MLX module.



NOTE:

This topic describes only the last steps in adding a CTI link to the system. Additional LAN-related procedures are described in the *PassageWay Telephony Services Network Manager's Guide*.

The CTI link hardware/software feature is available in Release 5.0 and later systems operating in Hybrid/PBX mode and is a component of the PassageWay Telephony Services product. The CTI link operates on the system in conjunction with Novell NetWare LANs (local area networks) that include the PassageWay Telephony Services workgroup product. It allows network clients, via access to a telephony server, to monitor and control calling from their network workstations, using software applications compatible with the CTI link. For example, a service representative might automatically view customer information on a PC screen when the customer calls; the incoming telephone number triggers a pop-up information screen (this feature is called *screen pop*) from a database available to the network. Another possible application would allow "power dialing" from a user's computer, again using a database accessible to LAN clients.

Planning Guidelines

A CTI link is treated by the system as auxiliary equipment. A system can include only one CTI link extension, which is automatically identified as such in the Extension Directory.

Consider the following planning factors before you program a CTI link:

- The CTI link can be programmed before the CTI link hardware is plugged into a port on a 008 MLX or a 408 MLX module. The port you select for the CTI link should be planned with the following conditions in mind:
 - When checking the system Extension Report or planning form (2a, System Numbering: Extension Jacks) to locate an available extension, make sure that both the main extension number (for example, extension 11 in a 2-digit dial plan) and the adjunct extension number (for example, extension 711 in a 2-digit dial plan) are available. Check the report for 2B data programming.
 - If you program a CTI link for a jack that is already programmed for 2B data, the CTI programming renders the 2B data programming nonfunctional, and a 2B data device that you later connect to the jack will not function as such.
 - Do not use the first or fifth extension jack, reserved for operator positions or programming, for the CTI link. System programming and operator extensions cannot be programmed as CTI link extensions.
 - Make sure that the port does not have a telephone, video system, communications equipment, or other device connected to it. Do this before attempting to program the CTI link.
- The firmware for the MLX module must be of vintage earlier or later than 29. If you attempt to program a CTI link on a module of firmware vintage 29, the system halts the process.

If the CTI link extension is programmed as a member of a calling or coverage group, this programming is removed automatically when the port is specified for a CTI link. If there are Cover buttons for this extension at other extensions in the system, the system informs you and asks you to remove this programming. Check the system Extension Report (see ["Using Reports" on page 6-34](#) for information) or relevant system planning forms for extensions and groups (for example, Form 4d, MLX Telephone and Form 7c, Group Coverage) to identify the extensions where the programming should be removed.

Before you program a CTI link, you must busy-out the slot where the module with the CTI link jack is located. After programming is complete, you must restore the slot and return it to service. If you plan to use the console for programming, the programming extension must *not* be on the same module as the planned CTI link. If your system includes only one MLX extension module, you must use SPM (System Programming and Maintenance) software to perform the programming.



CAUTION:

The Maintenance procedures outlined below are normally reserved for Lucent Technologies technicians only. Do not use the Maintenance menu except as outlined below, unless you are instructed to do so by a Lucent Technologies representative.

Busying-Out and Restoring the MLX Module

In order to add or remove a CTI link, you must use maintenance procedures, normally reserved for Lucent Technologies technicians, to terminate service on the MLX 408 line/trunk and extension module or the MLX 008 extension module where the CTI link is being added or removed.

The Busy-Out and Restore procedures do not interrupt calls in progress at the extensions and/or on the lines/trunks connected to the modules. Instead, the procedures wait for any in-progress calls to end. If people are using a module's extensions and/or facilities and you wish to busy-out the module, you may need to ask them to end their calls. While a module is busied-out, no calls can take place on the affected lines/trunks or extensions.

Any active communications via a CTI link are preserved during a Busy-Out procedures, but only for 24 seconds. When 25 seconds have elapsed, the messages are lost. For this reason, you may wish to program a CTI link during off hours.

To busy-out or restore the module, follow these general steps:

1. Determine and note the slot number of the MLX 408 or 008 module. To do this, you must print a System Information Report from the System Programming menu. Use one of the following procedures:

Console Procedure To print system information:

More→Print→SysSet-up→Exit

PC Procedures To print system information:

PgUp→**F3**→**F2**→**F5**

To save report on disk:

PgUp→**F3**→**F2**→**F10**→select **G0T0** **FL0PPY** from below console simulation screen→**F10**

To view the report on the screen:

Ctrl + **F8**

For more information about generating reports, see ["Using Reports" on page 6-34](#).

2. Busy-out or restore the module. Follow one of the methods outlined in the next procedure.
3. If the Busy-Out procedure is taking a long time to complete, someone is using an extension or facility on the module. The actual busying-out (or restoring) takes less than one second.

To busy-out and then restore the MLX module, follow the steps below:

1. Use one of the following procedures. Note that you select the **Maintenance** option from the Main menu, not the System Programming menu.

Console Procedure To busy-out a module:

Menu→**Maintenance**→**Slot**→**Dial slot**
no.→**Enter**→**Busy-Out**→**Yes**

PC Procedure To busy-out a module:

F6→**F2**→Type slot no.→**F10**→**F2**→**F1**

The screen displays progress messages and informs you when the busy-out is complete. Service on any facilities and/or extensions is suspended.

2. Exit the Maintenance menu and return to the System Programming menu. To add a CTI link, follow the procedures at the end of this topic. To remove one, see ["Removing a CTI Link" on page 6-93](#).
3. Restore the module to service. Use one of the following procedures:

Console Procedure To restore a module:

Menu→**Maintenance**→**Slot**→**Dial slot**
no.→**Enter**→**Restore**→**Yes**

PC Procedure To restore a module:

F6→**F2**→Type slot no.→**F10**→**F2**→**F1**

The screen displays progress messages and informs you when the restore is complete. Service resumes on affected facilities and/or extensions.

Task List: Adding a CTI Link

- Obtain Form 2a, System Numbering: Extension Jacks.
- Plan the CTI link addition using the planning guidelines above; record the new values on Form 2a.
- If necessary, read "Auxiliary Equipment" in *System Programming*, Chapter 4, for additional information.
- Follow the procedure in the preceding topic, "Busy-ing-Out and Restoring the MLX Module," to terminate service on the module where the CTI link is planned.
- Open the System Programming menu from the console or a PC with SPM.
- Program the change(s), following the appropriate instructions for "Auxiliary Equipment" in *System Programming*, Chapter 4, or the appropriate summary programming instructions below. To specify the CTI link

extension, use the main extension number (for example, extension 12 in a 2-digit numbering plan), not the adjunct extension number (for example, extension 712 in a 2-digit plan).

- Follow the procedure in the preceding topic, "Busying-Out and Restoring the MLX Module," to restore service on the module where the CTI link is located.
- When you have finished, file Form 2a with the rest of the planning forms.
- To install the server-related hardware associated with the link, contact your Lucent Technologies representative.

Programming Instructions

Console Procedure AuxEquip→CTI Link→Extension→Dial ext. no.→
 Enter→Exit→Exit

PC Procedure [F9]→[F3]→[F1]→Type ext. no.→[F10]→[F5]→[F5]

Removing a CTI Link

Use this procedure to remove the programming for a CTI (Computer Telephony Integration) link from an MLX port on a 008 or 408 MLX module. This hardware/software feature is available in Release 5.0 and later systems operating in Hybrid/PBX mode.



NOTE:

This topic describes only the last steps in adding a CTI link to the system. Additional LAN-related procedures are described in the *PassageWay Telephony Services Network Manager's Guide*.

Task List: Removing a CTI Link

- Obtain Form 2a, System Numbering: Extension Jacks.
- Record the new values on Form 2a.
- If necessary, read "Auxiliary Equipment" in *System Programming*, Chapter 4, for additional information.
- Open the System Programming menu from the console or a PC with SPM.
- Follow the procedure outlined in ["Busying-Out and Restoring the MLX Module" on page 6-91](#) to terminate service on the module where the CTI link is located.

- Program the change(s), following the appropriate instructions for "Auxiliary Equipment" in *System Programming*, Chapter 4, or the appropriate summary programming instructions below.
- Follow the procedure outlined in ["Busying-Out and Restoring the MLX Module" on page 6-91](#) to restore service on the module where the CTI link was located.
- When you have finished, file Form 2a with the rest of the planning forms.
- To remove the server-related hardware associated with the link, contact your Lucent Technologies representative.

Programming Instructions

Console Procedure AuxEquip→CTI Link→Extension→Delete→ Exit→
Exit

PC Procedure F9→F3→F1→F8→F5→F5

Learning More



This chapter provides descriptions of the system manuals and a quick information-finder to help you locate what you need in the system reference guides.



NOTE:

Release 6.0 and later systems (Hybrid/PBX mode only) support private connections between MERLIN LEGEND Communications Systems and DEFINITY Enterprise Communications Server (ECS) or DEFINITY ProLogix Solutions systems using private networks or the public switched telephone network. This aspect of the system is not covered in this guide. For complete information, see the *Network Reference*.

When you do not know where to look for help on a specific feature or activity, check this chapter first. It helps you to determine which guide contains the information you need and how to find it in that guide.

Additional materials may have become available since this book was printed. If you don't find what you need here, contact your Lucent Technologies representative.

Guides

There are three types of guides:

- **System Reference Guides.** Designed to help system managers and Lucent Technologies personnel in planning, programming, and managing the system. These references provide detailed information about system components, features, and capabilities, as well as procedures for programming all aspects of the system.
- **Special Reference Guide.** For Release 6.0 and later systems (Hybrid/PBX mode only), the *Network Reference* provides a general grounding in networks made up of linked MERLIN LEGEND Communications Systems and/or DEFINITY Enterprise Communications Server/ProLogix Solutions systems. In addition, it provides instructions to help you set up, optimize, and maintain networked systems. It also describes feature interactions, required system programming, and supported facilities for such private network features as tandem switching and support for non-local extensions. Networking information is not included in *System Manager's Guide*.
- **User and Operator Guides.** Designed for the users of telephones or system features. Each of these manuals describes the use and features of specific telephones or operator consoles.

This section provides ordering information and then descriptions of the system reference guides and of the user and operator guides.

Ordering and Availability

For information about ordering any of the printed materials, see [“Related Documents” on page xlii](#) in “About This Book,” at the beginning of this book.

System Reference Guides

There are two general system reference guides that you may need to consult as part of your system manager function:

- The *Feature Reference* contains detailed information about features and summary descriptions of applications.
- *System Programming* includes detailed, step-by-step procedures to program the system.

The *Feature Reference* and *System Programming* are essential if you modify the system or add new users and new features.



NOTE:

The *Equipment and Operations Reference* does not include information about hardware that was introduced after Release 3.0 of the system. Consult Chapter 3 of this guide, “System Components,” for general descriptions. For more detailed information about newer hardware

components, contact your Lucent Technologies representative. For general information about applications, disregard the *Equipment and Operations Reference* and consult the *Feature Reference* instead. For ordering information, contact your Lucent Technologies representative.

[Table 7-1](#) contains an overview of the system reference guides, including descriptions of some special tools available in each guide. Following the table, this section describes some common elements contained in both guides, then provides specific information about each guide, including contents and organization, special tools, and how to use the guide.

In addition to the descriptions and information in this section, each of the guides provides information about its contents and how to use the guide to find what you need or to complete a particular task.



NOTE:

An additional guide, *System Planning*, contains information about completing the planning forms. Because it is primarily used by Lucent Technologies personnel, it is not described here.

Table 7-1. System Reference Guides Overview

Guide	Description	Contents Overview
<i>Feature Reference</i>	Provides detailed descriptions, in alphabetical order, of each system feature and some system components. Also includes summary information about applications.	Encyclopedia style; each feature description is a separate entry. <i>Special Tools:</i> Index to features by name (at the front of the guide) Index to features by activity (at the front of the guide)
<i>System Programming</i>	Provides general programming information and step-by-step procedures for programming all aspects of the system.	Chapters 1 through 5 Introduction to programming and using <i>System Programming and Maintenance (SPM)</i> , administrative procedures corresponding to Chapter 6 of this guide, other system programming procedures and centralized telephone programming procedures <i>Special Tools:</i> Chapter 1: a quick reference to programming menus Appendixes Menu hierarchy diagram and quick reference tables for programming and for using a phone and its features

Common Elements

The system reference guides include the following informational and organizational aids:

- **About This Book.** An introduction that includes the purpose and audience of the guide, typographical conventions, how to use the guide, and other relevant information, as well as a Feedback Form to submit your comments on the guide to Lucent Technologies.



NOTE:

We urge you to complete the Feedback Form and send in your comments. The writers at Lucent Technologies need your suggestions.

- **Main Table of Contents.** A list of the chapters and their primary topics, a list of figures, and a list of tables. (Use the tabs to get to chapters quickly.)
- **Glossary.** An alphabetical list of terms and abbreviations used in the guide, along with definitions of each.
- **Index.** An alphabetical list with page references at the back of the guide.
- **Appendix A, Customer Support Information.** Provides Federal Communications Commission (FCC) information, Canadian Department of Communications (DOC) information, and guidelines to help you safeguard the security of your system.

Feature Reference

The *Feature Reference* contains detailed information about each feature. The features are listed alphabetically by name. Some groups of related features appear under one entry, for example, "Messaging." The contents and organization of each entry are described in ["Entries" on page 7-6](#).

This guide includes entries about some system components that are not, strictly speaking, features. These include:

- Ascend Pipeline 25-Px bridge/router and Internet access device (in Appendix I, "Applications")
- Centrex operation
- Computer Telephony Integration (CTI) link (a bridge to software applications for call control and monitoring from a NetWare LAN workstation)
- Direct-Line Console (DLC; features that are exclusive to or different at this operator position)
- Direct Station Selector (DSS)
- Display (a full explanation of the display menus on MLX and analog multiline telephones)
- ExpressRoute 1000 ISDN Terminal Adapter (digital modem for data communications over high-speed digital facilities, in Appendix I, "Applications")
- Integrated Administration (a programming component of Integrated Solutions software applications)

- Multi-Function Module (MFM; a telephone adapter that affects and is affected by system features)
- Personal lines
- Primary Rate Interface (PRI), NI-1 BRI, and T1 Switched 56 service
- Programming
- Queued Call Console (QCC)
- System Renumbering (a programming procedure for changing extension and/or line numbers)
- Touch-Tone or Rotary Signaling (information about supporting the two types of telephone signaling on the system)
- Videoconferencing

Contents and Organization

The *Feature Reference* does not have chapters. Instead, each feature is a section of the guide; the name of the feature explained in the section appears at the bottom of each page.

Entries

Each entry in the guide explains a feature or set of features in great detail.

“At a Glance,” a boxed table at the beginning of each feature description, summarizes the following aspects of the feature or feature group:

- **Users Affected.** Shows what category of users is affected by a feature. For example, “Auto Dial” lists telephone users and Direct-Line Console (DLC) operators as those affected by the feature. (From this you can conclude that Queued Call Console (QCC) operators *cannot* use Auto Dial.)
- **Reports Affected.** Cites the Station Message Detail Recording (SMDR) reports in which you can find information relating to the feature.
- **Modes.** Lists the system operating mode or modes in which the feature is used.
- **Telephones.** Tells you which telephones can use the feature.
- **Programming Code(s).** As appropriate, lists the programming code(s) used to program the feature on a button or to turn it on or off.
- **Feature Code(s).** Lists the feature code(s) you can use to activate the feature or turn it off.
- **MLX Display Label(s).** Lists the name as it appears on the MLX-20L and/or other MLX telephones.

- **System Programming.** If applicable, summarizes the system programming procedure(s) that control the feature.
- **Maximum(s).** If applicable, tells you what maximum numbers apply to the feature.
- **Factory Setting(s).** Shows you the default programming, that is, how the system sets the feature when no one programs it.

Following each “At a Glance” table is a full description of the feature or feature group, telling you how it works for those who have different types of equipment or programmed positions. Following the description, feature entries include (as applicable) each of these sections:

- **Considerations and Constraints.** An explanation of exceptions and unusual conditions pertaining to the feature. This section can help you troubleshoot a problem with the feature.
- **Mode Differences.** An explanation of variations in the use of the feature in the different modes supported by the system.
- **Telephone Differences.** An explanation of variations in the use of the feature with different telephones.
- **Feature Interactions.** A list of issues and considerations to be aware of when using another feature in conjunction with the main feature described. The list is arranged alphabetically by feature.

Appendixes

The *Feature Reference* appendixes include a variety of useful tables and reference tools, in addition to the customer service information in Appendix A:

- An alphabetical list of system features, citing the system planning forms they are associated with (Appendix B)
- An alphabetical list of general systemwide features, including their availability in different operating modes as well as notes on mode differences and availability in different releases of the system (Appendix C)
- Information about general feature use and how operator and user features are activated or programmed on MLX, analog multiline, and single-line telephones (Appendix D)
- A fold-out flowchart showing the system programming hierarchy and menus. Many system programmers remove this chart and hang it on a wall for quick reference (Appendix E)
- A table describing the SMDR reports available for the system, along with samples of those reports (Appendix F)
- Telephone button diagrams for MLX and analog multiline telephones in all three modes of operation (Appendix G)

- A description of the special characters used in dialing sequences for numbers dialed automatically, for example, with the Auto Dial feature. Tells you what these characters are and how to insert them on MLX, analog multiline, and single-line telephones. (Appendix H)
- An overview of the applications you can include with the system (Appendix I)

Special Tools

In addition to the information described in [“Common Elements” on page 7-4](#) and the information in the appendixes, the first pages of the *Feature Reference* include tools to help you find the information you need:

- “Index of Feature Names” shows where you can find information about features and other system components that may have been renamed or reorganized in this release of the communications system and related products. This section is helpful both to people who have used early releases of the system as well as to those who are accustomed to other communications systems.
- The “Index of Features by Activity” lists features according to tasks typically performed with the system. It describes the task and then tells you which *Feature Reference* entry explains it fully.

Using This Guide

Since the entries in the guide are in alphabetical order, you simply look up a feature by name. If you are not sure of the feature name, you can use the “Index to Feature Names” or “Index to Features by Activity” at the front of the guide and/or examine the general index at the back of the guide.

System Programming

This reference guide provides detailed, step-by-step instructions for programming all aspects of the system. You may use some of these programming procedures frequently, for example, the labeling functions to change the names, phone numbers, and extension numbers that display features use. Some you may use only occasionally, depending on how your system is set up. Others may never require your attention.

Since *System Programming* does not provide the full descriptions of features that the *Feature Reference* does, you may need to refer to both guides when you are programming a complex feature for the first time.

Contents and Organization

System Programming is organized into the following chapters:

- **Programming Basics** (Chapter 1). Provides an introduction to programming and idle states, and general information about using the guide.
- **Programming with SPM** (Chapter 2). Provides information about using SPM (PC-based software) that enables you to program the system from a PC rather than from a system programming console.
- **Common Administrative Procedures** (Chapter 3). Contains procedures that system managers use often (as summarized in Chapter 6 of this guide), including a programming summary, whether an idle state is required during programming, the system planning forms required, and the actual step-by-step procedures. This chapter also includes information about backing up system programming using a memory card.



NOTE:

After you are familiar with the step-by-step procedures, you can use the programming summaries to quickly refresh your memory.

- **Programming Procedures** (Chapter 4). Provides each system programming procedure not covered in Chapter 3. The procedures appear in the same order as they do in the menus themselves. Use this in conjunction with the Appendix B flowchart or the annotated menus in the first chapter.



CAUTION:

*As the text indicates, some procedures are for qualified technicians only. Do **not** attempt to perform these yourself.*

- **Centralized Telephone Programming** (Chapter 5). Contains the procedures for centralized telephone programming.

Appendixes

System Programming appendixes include a variety of useful tables and reference tools, in addition to the customer service information in Appendix A:

- A Menu Hierarchy flowchart on a fold-out page showing the system programming hierarchy and menus (Appendix B)
- Summary tables showing the meaning of status lights at the programming console and the DSS used in conjunction with it (Appendix C)
- A description of general feature use on MLX, analog multiline, and single-line telephones (Appendix D)

- A helpful table of features, showing programming codes, the modes in which the feature works on each type of telephone, and the name of the feature as displayed on the MLX-20L telephone (Appendix D)
- A description of the telephone programming that people in the system can perform at their extensions (Appendix D)
- Telephone button diagrams for MLX and analog multiline telephones in all three modes of operation (Appendix E)
- A table describing the SMDR reports available for the system, along with samples of the reports (Appendix F)
- A list of the procedures required to program a new system, in the order in which they are performed (Appendix G)
- Summary tables showing how to insert special characters (for example, a pause in an automatic dialing sequence) for single-line, analog multiline, MLX nondisplay, and MLX display telephones (Appendix H)

Special Tools

In addition to the common organizational elements described earlier in “Common Elements,” this guide provides some other tools for quick reference and to help you find the information you need:

- In Chapter 1, a quick reference to the system programming menus, presented in the order in which they appear in the system, and annotated so that you can find out what they do.
- In Appendix B, a fold-out Menu Hierarchy. Many system programmers remove this chart and hang it on a wall for quick reference.

Using This Guide

To find the detailed procedure for one of the common system management tasks described in Chapter 6 of this *System Manager's Guide*, check the contents list for Chapter 3 of *System Programming*. Otherwise, you can use the quick reference in Chapter 1 and/or the main contents list at the front of the guide or the index at the back of the guide to find a particular programming procedure.

For information about entering or exiting system programming and using the programming procedures, refer to Chapter 1.

To perform the procedures, you may find the Menu Hierarchy and other reference tables in the appendixes helpful.

User and Operator Guides

Most of the user and operator guides share a common format and are intended for standalone use with a certain telephone or operator console. In other words, an operator who has an MLX Direct-Line Console (DLC) requires only the operator guide for that console and does not need to refer to the user's guide as well.

The following is a list of all the user and operator guides for the system:

- *MLX-5D, MLX-10D, MLX-10DP, MLX-16DP, MLX-20L, and MLX-28D Display Telephones User's Guide* (comes with MLX display telephones)
- *MLX-5 and MLX-10 Nondisplay Telephone User's Guide* (comes with MLX-10 and MLX-5 nondisplay telephones)
- *Analog Multiline Telephones User's Guide* (for analog multiline telephones: BIS-10, BIS-10D, BIS-22, BIS-22D, BIS-34D)
- *MDC 9000 and MDW 9000 Telephones User's Guide* (for MDC 9000 and MDW 9000)
- *Single-Line Telephones User's Guide* (for 8101 and 2500 YMGL telephones, as well as older single-line telephones)
- *MLX Direct-Line Consoles Operator's Guide* (for MLX DLC operator consoles)
- *Analog Direct-Line Consoles Operator's Guide* (for analog DLC operator consoles)
- *MLX Queued Call Consoles Operator's Guide* (for QCC operator consoles)
- *Calling Supervisor's Guide* (ordered according to system needs)
- *Data/Video Reference* (different format from other user guides, includes information for system managers as well)

Common Elements

With the exceptions of the *Calling Supervisor's Guide* and the *Data/Video Reference*, described on [page 7-13](#), the user and operator guides include some standard components and organizational aids:

- On the front cover, a descriptive table of contents for rapidly locating needed information
- A diagram of the telephone buttons and display (if applicable), explaining what each does
- A description of the line buttons (**SA**, **ICOM**, **Pool**, and buttons labeled with a telephone number) a person may find on his or her telephone. For operators, descriptions of DSS buttons are also included. For QCC operators, factory-set feature buttons are described.

- Illustrated explanations of tones, rings, and line button lights
- A Feature Finder that acts as an index of features according to the activities people may want to perform; gives feature names and page numbers
- Where applicable in user and operator guides, an illustrated description of headsets, their operation, and their installation
- A section offering step-by-step general call-handling instructions (including, for example, the Transfer, Hold, and Conference features)
- A section containing step-by-step instructions for messaging features
- A general description showing the standard steps for using a feature and a list of features with their feature codes
- In alphabetical order, descriptions of and step-by-step instructions for most or all the features available for the telephone or operator position. Activation of the feature or setting is described; programming instructions are included for features that don't follow the standard programming sequences described later in the guide (for example, Auto Dial).
- Where applicable, a detailed description of the telephone display and how to use it, including illustrations of the various display menus. For MLX telephones, a list of features shows feature names as they appear on both small and large displays.
- A section, where applicable, giving general programming instructions for buttons and settings
- On the inside back cover, where applicable, a list of features/settings and the programming codes for them
- On the outside back cover, where applicable, a list of features and feature codes, as well as special characters with programming instructions

In addition, many of the guides include a pull-out card where people can enter information such as Speed Dial codes, extension numbers for groups, important line numbers or access codes, account codes, and other information. People can place these cards in a location where they can easily refer to them when necessary. (MLX telephones include tray cards for this purpose.)

The user and operator guides are booklets that fit underneath telephones or consoles for easy storage and reference. They are printed in two colors for rapid scanning.

Calling Supervisor's Guide and Data/Video Reference

These two user guides, which you must order separately, differ from the guides described above in the following respects:

- Neither is a standalone guide, and both must be used in conjunction with the guide for the telephone or console at the extension.
- They describe only the features and functions unique to their subjects: calling groups and data communications.
- *Calling Supervisor's Guide* is published in the standard booklet format described above and fits under the phone.
- *Data/Video Reference* is a reference tool, as well as offering step-by-step instructions and guidelines for system managers. It is provided in 8.5-inch by 11-inch format and is 3-hole punched.

Data/Video Reference describes data communications in general, the different types of data and video workstations, and the features used in data communications. It offers step-by-step dialing and programming instructions for data users who have ISDN terminal adapters or modems. In addition, it explains data hunt group operations and the system's support of local-area networks (LANs), videoconferencing systems, and host computer systems for data communications.

Calling Supervisor's Guide describes agent and supervisor calling group features, with step-by-step instructions.

System Guides Information Finder

The following tables are designed as a quick reference tool to help you locate helpful information in *System Programming* and the *Feature Reference*. Sometimes information is available in more than one guide and some summary information is the same in two guides. When summary information is available in both guides, both are listed.

This section includes the following Information Finders:

- **Features** ([Table 7-2](#)). Tells you how to find complete and quick reference feature information, including information about feature programming and planning. This table also provides information about maintenance and troubleshooting, security, and system management, as well as about different feature categories.
- **Programming** ([Table 7-3](#)). Tells you how to find both detailed and quick reference programming information for system and centralized telephone programming activities.

Table 7-2. Information Finder: Features

To learn about. . .	Check this guide. . .
Basics	
How a feature works, including how it works in different modes and on different phones or other equipment, limitations and considerations, interactions with other features	<i>Feature Reference.</i> See entry for feature.
Whether a feature is programmed by the person at the extension or the system manager	<i>Feature Reference.</i> See entry for feature. (<i>System Manager's Guide</i> , Feature Finders in Chapter 4)
General extension feature use and programming on each type of telephone: MLX, analog multiline, and single-line	<i>System Programming</i> , Appendix D <i>Feature Reference</i> , Appendix D
Feature activation codes	<i>Feature Reference.</i> See entry for feature. (User and operator guides provide tables of feature codes on their back covers.)
Reports offering details about a feature as it is used on your system	<i>Feature Reference.</i> See entry for feature and Appendix F. <i>System Programming</i> , Appendix F
Changing Automatic Route Selection (ARS)	Consult your Lucent Technologies representative and see <i>System Programming</i> , Chapter 4. <i>Feature Reference.</i> See "Automatic Route Selection."
Operator features, settings, and options	<i>Feature Reference.</i> See entry for console (DLC or QCC) and for Direct Station Selector (DSS).
Display Features: Labeling	
Changing the information that appears about an extension when you add, delete, or modify extensions in the system	<i>System Programming</i> , Chapter 3
Changing the information that appears about groups when you add, delete, or modify groups in the system	<i>System Programming</i> , Chapter 3
Changing the information that appears about lines and trunks when you add, delete, or modify lines/trunks in the system	<i>System Programming</i> , Chapter 3
Changing Posted Messages	<i>System Programming</i> , Chapter 3
Changing the System Directory for speed dialing numbers that people call often	<i>System Programming</i> , Chapter 3

Continued on next page

Table 7-2. Continued

To learn about. . .	Check this guide. . .
Planning and Programming Features	
Feature factory settings	<i>Feature Reference.</i> See entry for feature.
How features interact with one another	<i>Feature Reference.</i> Under feature entry, see "Feature Interactions."
How features interact with applications	<i>Feature Reference</i> , Appendix I
Feature programming codes	<i>System Programming</i> , Appendix D
Planning features on buttons	<i>Feature Reference</i> , Appendixes B and G <i>System Programming</i> , Appendix E
Copying programmed telephone features from one extension to another	<i>System Programming</i> , Chapter 5
Which system planning forms to consult in order to find out how features are programmed on your system	<i>Feature Reference</i> , Appendix B
Which system planning forms to change when you modify or add features	<i>Feature Reference</i> , Appendix B <i>System Programming.</i> Entry for procedure you are using.
Which modes of operation support a systemwide feature	<i>Feature Reference</i> , Appendix C
Programming special characters (Pause , Stop , and others) in dialing sequences	<i>Feature Reference</i> , Appendix H
Which modes a feature is supported in and which type of phone it works on	<i>System Programming</i> , Appendix D
Maintenance and Troubleshooting	
Which system planning forms to consult in order to see how features are programmed on your system	<i>Feature Reference</i> , Appendix B
Troubleshooting a feature when it doesn't work as expected	<i>Feature Reference.</i> Under feature entry, see "Considerations and Constraints" and "Feature Interactions."
How features interact with applications	<i>Feature Reference</i> , Appendix I, and entries for applications
Reports that offer details about a feature as it is used on your system	<i>Feature Reference.</i> See entry for feature and Appendix F. <i>System Programming</i> , Appendix F
How features interact with one another	<i>Feature Reference.</i> Under feature entry, see "Feature Interactions."
Canceling Reminder Service calls	<i>System Programming</i> , Chapter 4

Continued on next page

Table 7-2. Continued

To learn about. . .	Check this guide. . .
Maintenance and Troubleshooting (continued)	
Changing Recall timer when the switchhook, Recall , or Flash buttons are disconnecting callers	<i>System Programming</i> , Chapter 4 <i>Feature Reference</i> . See "Recall/Timed Flash."
Security	
Setting up authorization codes	<i>Feature Reference</i> . See "Authorization Codes." <i>System Programming</i> , Chapter 3
Setting up Remote Access barrier codes	<i>Feature Reference</i> . See "Remote Access." <i>System Programming</i> , Chapter 4
Changing Automatic Route Selection (ARS) Facility Restriction Levels for extensions or lines/trunks	<i>System Programming</i> , Chapter 4 <i>Feature Reference</i> . See "Automatic Route Selection."
System Management	
Using and understanding memory cards	<i>System Programming</i> , Chapter 3 and 4
Backing up programming, automatically or manually	<i>System Programming</i> , Chapter 3
Backup messages	<i>System Programming</i> , Chapter 3
Changing the language in which reports are printed	<i>System Programming</i> , Chapter 3
Getting reports	<i>System Programming</i> , Chapter 3
Setting up your system to work with the Integrated Administration feature of the Integrated Solutions application	Consult your Lucent Technologies representative and see <i>System Programming</i> , Chapter 4, and <i>Feature Reference</i> , "Integrated Administration."

Table 7-3. Information Finder: Programming

To learn about. . .	Check this guide. . .
Systemwide Basics	
Changing the system's mode of operation	Consult your Lucent Technologies representative and <i>System Programming</i> , Chapter 4
Changing the system programming position	<i>System Programming</i> , Chapter 3
Changing the system date and time	<i>System Programming</i> , Chapter 3
Changing the system language	<i>System Programming</i> , Chapter 3
Changing the system's numbering of lines and extensions	<i>System Programming</i> , Chapter 3
Changing DSS buttons when you renumber the system	<i>System Programming</i> , Chapter 4
Operator positions	<i>System Programming</i> , Chapter 3
Turning One-Touch Transfer or One-Touch Hold on or off	<i>System Programming</i> , Chapter 4
Changing the timing for the return to the originator of transferred, parked, or camped-on calls when the destination extension remains busy	<i>System Programming</i> , Chapter 4
Changing what a caller hears when being transferred	<i>System Programming</i> , Chapter 4
Changing the number of rings for the Delay Ring setting	<i>System Programming</i> , Chapter 4
Programming a CTI (Computer Telephony Integration) link (Release 5.0 and later)	<i>System Programming</i> , Chapter 4
Extension Features and Buttons	
Feature programming codes	<i>System Programming</i> , Appendix D
Allowing or disallowing trunk-to-trunk transfer at an extension.	<i>System Programming</i> , Chapter 3
Planning features on buttons	<i>Feature Reference</i> , Appendixes B and G <i>System Programming</i> , Appendix E
Copying programmed telephone features and line buttons from one extension to another	<i>System Programming</i> , Chapters 3 and 5
Copying calling restrictions from one extension to another	<i>System Programming</i> , Chapter 3
Which system planning forms show how features are programmed	<i>Feature Reference</i> , Appendix B
The modes of operation in which a systemwide feature is available	<i>Feature Reference</i> , Appendix C

Continued on next page

Table 7-3. Continued

To learn about. . .	Check this guide. . .
<i>Extension Features and Buttons (continued)</i>	
Which system planning forms to change when you modify or add features	<i>Feature Reference</i> , Appendix B
Programming special characters (Pause , Stop , and others) in dialing sequences	<i>Feature Reference</i> , Appendix H <i>System Programming</i> , Appendix H
The modes in which a feature works on each type of telephone	<i>System Programming</i> , Appendix D
Assigning line buttons to extensions	<i>System Programming</i> , Chapter 3
Specifying pool dial-out codes	<i>System Programming</i> , Chapter 3
Assigning HotLine extensions	<i>System Programming</i> , Chapter 3
Assigning extensions for fax machines	<i>System Programming</i> , Chapter 3
Programming headset operation for an extension	<i>System Programming</i> , Chapter 5 <i>Feature Reference</i> . See "Headset Options" and "Auto Answer All."
Assigning or change the following features or settings at extensions: Calling restrictions Forced Account Code Entry Microphone on or off Authorization Codes Remote Call Forwarding	<i>System Programming</i> , Chapter 3
Specifying which analog multiline telephones have the Voice Announce to Busy capability	<i>System Programming</i> , Chapter 3
Specifying the analog multiline telephones at data workstations	<i>System Programming</i> , Chapter 3
Specifying the 2B Data feature for a video workstation	<i>System Programming</i> , Chapter 3
Changing the principal user of a personal line	<i>System Programming</i> , Chapter 4
<i>Group Features and Buttons</i>	
Setting up or changing the following group member assignments: Pickup groups Calling groups Coverage groups Paging groups Night Service groups	<i>System Programming</i> , Chapter 3
Changing timing for Night Service	<i>System Programming</i> , Chapter 3
Changing calling restrictions for Night Service	<i>System Programming</i> , Chapter 3

Continued on next page

Table 7-3. Continued

To learn about. . .	Check this guide. . .
Group Features and Buttons (continued)	
Changing the delay before a call coming to a member of a coverage group is covered	<i>System Programming</i> , Chapter 3
Assigning lines or pools to calling groups	<i>System Programming</i> , Chapter 3
Changing the calling group Extension Status feature	<i>System Programming</i> , Chapter 3
Setting up or changing the following calling group features or settings:	<i>System Programming</i> , Chapter 3
Set up call distribution (hunt type)	<i>Feature Reference</i> . See "Group Calling."
Assign delay announcement extension(s).	
Control the number of calls that can be waiting before subsequent calls receive a busy signal (Release 6.0 and later systems).	
Assign operator or group to cover calls for group when too many calls are waiting, when callers have waited too long and/or when the caller requests (Release 6.0 and later systems).	
Allow callers to respond to a delay announcement prompt in order to leave the calling group queue and have their call handled by an operator or group who covers for the calling group (Release 6.0 and later systems).	
Assign operator or group to cover calls for group.	
Specify when a group has too many waiting calls.	
Specify when the group supervisor and/or members are notified that too many calls are waiting or that callers have waited too long.	
Assign an external alert to warn supervisor and/or members when too many calls are waiting.	

Continued on next page

Table 7-3. Continued

To learn about . . .	Check this guide. . .
Operators	
Setting up operator positions	<i>System Programming</i> , Chapter 3
Changing the hold timer when operators are accidentally disconnecting people on hold	<i>System Programming</i> , Chapter 3
Programming Barge-In for an operator	<i>System Programming</i> , Chapter 5
Programming headset operation for an extension	<i>Feature Reference</i> . See "Headset Options" and "Auto Answer All."
Allowing DLC operators to put people on hold automatically	<i>System Programming</i> , Chapter 3
Changing DSS buttons when you renumber the system.	<i>System Programming</i> , Chapter 4
Allowing QCC operators to put a current call on hold automatically when they press a Call button	<i>System Programming</i> , Chapter 3
Allowing QCC operators to release a current call automatically when they press another Call button	<i>System Programming</i> , Chapter 3
Allowing QCC operators to make voice-announced calls	<i>System Programming</i> , Chapter 3 <i>Feature Reference</i> . See "Queued Call Console."
Changing the trunks assigned to ring at a QCC	<i>System Programming</i> , Chapter 3 <i>Feature Reference</i> . See "Queued Call Console."
Changing the types of calls assigned to ring at a QCC	<i>System Programming</i> , Chapter 3 <i>Feature Reference</i> . See "Queued Call Console."
Changing the priority that different types of calls receive in the QCC queue	<i>System Programming</i> , Chapter 3 <i>Feature Reference</i> . See "Queued Call Console."
Allowing a call that has been waiting too long in the QCC queue to get higher priority	<i>System Programming</i> , Chapter 3 <i>Feature Reference</i> . See "Queued Call Console."
Specifying whether QCCs are alerted when there are too many calls waiting for their attention or callers have waited too long	<i>System Programming</i> , Chapter 3

Continued on next page

Table 7-3. Continued

To learn about. . .	Check this guide. . .
Operators (continued)	
Specifying when QCCs are alerted that there are too many calls waiting for their attention	<i>System Programming</i> , Chapter 3 <i>Feature Reference</i> . See "Queued Call Console."
Specifying the backup calling group for QCCs	<i>System Programming</i> , Chapter 3 <i>Feature Reference</i> . See "Queued Call Console."
Specifying whether calls on hold return to QCC queue after operator hold timer has expired twice	<i>System Programming</i> , Chapter 3
Specifying the number of times a call, directed by a QCC, must ring at an unanswered extension before it returns to the QCC queue or message center	<i>System Programming</i> , Chapter 3 <i>Feature Reference</i> . See "Queued Call Console."
Allowing QCCs to finish call direction automatically	<i>System Programming</i> , Chapter 3
Assigning a QCC to act as a message center for directed, unanswered calls, group coverage calls, or DID remote access calls to unassigned extensions	<i>System Programming</i> , Chapter 3
Lines and Trunks	
Adding new lines or trunks to the system	Consult your Lucent Technologies representative and <i>System Programming</i> , Chapter 4.
Changing the settings on lines and trunks	Consult your Lucent Technologies representative and <i>System Programming</i> , Chapter 4.
Changing the channels for T1 DS1 service	Consult your Lucent Technologies representative and <i>System Programming</i> , Chapter 4.
Changing settings for PRI or NI-1 BRI service	Consult your Lucent Technologies representative and network service provider.
Changing the way malfunctioning trunks are taken out of service	Consult your Lucent Technologies representative and <i>System Programming</i> , Chapter 4. <i>Feature Reference</i> . See "Automatic Maintenance Busy."

Continued on next page

Table 7-3. Continued

To learn about. . .	Check this guide. . .
<hr/> <i>Lines and Trunks (continued)</i> <hr/>	
Setting up Remote Access trunks	<i>Feature Reference.</i> See "Remote Access." <i>System Programming</i> , Chapter 4
Changing Automatic Route Selection (ARS) Facility Restriction Levels for lines/trunks	<i>System Programming</i> , Chapter 4 <i>Feature Reference.</i> See "Automatic Route Selection."
Changing settings for DID or tie lines	Consult your Lucent Technologies representative.
Assigning trunks to pools	<i>System Programming</i> , Chapter 4 <i>Feature Reference.</i> See "Pools."

For more information about training, contact your Lucent Technologies representative.

Troubleshooting the System



This chapter provides procedures for solving the most common problems that you may encounter with the system. You may be able to resolve a problem quickly and easily by following the appropriate steps in this chapter.



NOTES:

1. See the *Data/Video Reference* for information about troubleshooting data and video communications.
2. See the *PassageWay Telephony Services Network Manager's Guide* for more information about troubleshooting a CTI (Computer Telephony Integration) link.
3. Release 6.0 and later systems (Hybrid/PBX mode only) support private connections between MERLIN LEGEND Communications Systems and DEFINITY Enterprise Communications Server (ECS) or DEFINITY ProLogix Solutions systems using private networks or the public switched telephone network. This aspect of the system is not covered in this guide. For complete troubleshooting information, see the *Network Reference*.

It is helpful to have the *Feature Reference*, *System Programming*, and the system planning forms at hand to perform some procedures. If the procedure involves using system programming or centralized telephone programming to check a system or feature setting, the troubleshooting procedures indicate where in *System Programming* you can find the programming steps.

You should also have the System Information Sheet at the front of this guide.



CAUTION:

If you must check something on the control unit, proceed with caution. Avoid standing on a box or chair to reach the unit if it is installed out of easy reach. If you do not have a stable ladder or other proper equipment, do not proceed; wait for the Lucent Technologies technician.



NOTES:

1. If power to the system is cut off, the system retains its programming for 4 to 5 days after it stops receiving power. Then all of the system's programmed settings may return to the factory settings.
2. Be sure to change the system time appropriately when Daylight Savings Time starts and when it ends. System time affects the functioning of several system features, including Automatic Backup, Night Service, Station Message Detail Recording (SMDR) reports, standalone auto attendant systems, voice mail, and Reminder Service.
3. For information about removing the control unit housing, see Appendix E.

All Phones Are Dead (No Dial Tone or Lights)

Possible Cause 1: *The control unit is not receiving power.*



WARNING:

To check the power cord on the control unit as instructed in the following procedure, avoid standing on a box or chair to reach the unit if it is out of easy reach. If you do not have a stable ladder or other proper equipment, do not proceed; wait for the Lucent Technologies technician.

What to do: Make sure the control unit's power cord is plugged securely into the wall outlet. Also, if convenient and safe to do so, make sure the other end of the power cord is securely connected to the power supply in the control unit.

- If all phones now have dial tone and lights, you have solved the problem.
- If all phones are still dead, go to Possible Cause 2.

Possible Cause 2: *The power outlet to which the control unit is plugged in is faulty.*

What to do: Test the outlet by plugging in an appliance that you know is working, for example, a lamp or radio.

- If the appliance does not work, the outlet is faulty. If possible, plug the control unit into a different outlet. Check the circuit breaker or call an electrician.
- If the appliance works, the wiring may be faulty elsewhere in the system. Call the Lucent Technologies Helpline at 1 800 628-2888 (consultation charges may apply).

Some Phones Are Dead (No Dial Tone or Lights)

Possible Cause 1: *The telephones are not receiving power.*

What to do: Check that each telephone is plugged into a telephone wall jack known to be working.

- If the phones now have dial tone and lights, there may be a problem with the system wiring or the control unit associated with the faulty phone(s). Call the Lucent Technologies Helpline at 1 800 628-2888 (consultation charges may apply).
- If the phones are still dead, go to Possible Cause 2.

Possible Cause 2: *For single-line telephones, the Idle Line Selection may be set incorrectly. (If not a single-line telephone, skip to Possible Cause 4.)*

What to do: Use centralized telephone programming to ensure that the Ringing/Idle Line Preference is set to On (see Chapter 5 in *System Programming*). Check to see whether the phone now has dial tone.

- If the phone receives dial tone, you have solved the problem.
- If the phone is still dead, go to Possible Cause 3.

Possible Cause 3: *For single-line telephones, the Auto Line Selection may be set incorrectly; see Chapter 5 in System Programming. (If not a single-line telephone, skip to Possible Cause 4.)*

What to do: Use centralized telephone programming to set the Auto Line Selection for the extension. Check to see whether the phone now has dial tone.

- If the phone receives dial tone, you have solved the problem.
- If the phone is still dead, go to Possible Cause 5.



NOTE:

The following procedure may help Lucent Technologies Helpline technicians analyze your problem. However, you should not perform this procedure unless you have experience removing the control unit cover and working with control unit extension jacks. Before proceeding, consult system planning Form 2a, System Numbering: Extension Jacks.



WARNING:

If you must check something on the control unit, proceed with caution. Avoid standing on a box or chair to reach the unit if it is installed out of easy reach. If you do not have a stable ladder or other proper equipment, do not proceed; wait for the Lucent Technologies technician.

Possible Cause 4: *If an MLX telephone is not working, it may be plugged into an MLX extension jack that is programmed for CTI (Computer Telephony Integration) link.*

What to do: Follow the procedure for printing an Extension Information Report to determine whether the jack is programmed for CTI link. See Chapter 6, "Managing the System," or *System Programming* for details.

- If the jack is programmed for a CTI link and you wish to retain the link, plug the MLX telephone into another available MLX jack.
- If the jack is programmed for a CTI link and you wish to remove the link programming, unplug the telephone from the MLX jack. Then see ["Removing a CTI Link" on page 6-93](#) or *System Programming* for the correct procedure.
- If the jack is not programmed for a CTI link, go to Possible Cause 5.

Possible Cause 5: *The telephones may be defective.*

What to do: Test each telephone by replacing the dead telephone with a similar telephone that you know is working properly.

- If the replacement telephone receives dial tone and its lights function, then replace it with the original telephone and check again. If the original telephone still does not receive dial tone and its lights do not function, then the original telephone may be defective. Call the Lucent Technologies Helpline at 1 800 628-2888 (consultation charges may apply).
- If the replacement telephone does not receive dial tone and its lights do not function, there may be a problem with the system wiring or the control unit. To test one possible wiring problem, go to Possible Cause 6.



NOTE:

The following procedure may help Lucent Technologies Helpline technicians analyze your problem. However, you should not perform this procedure unless you have experience removing the control unit cover and working with control unit extension jacks. Before proceeding, consult system planning Form 2a, System Numbering: Extension Jacks.



WARNING:

If you must check something on the control unit, proceed with caution. Avoid standing on a box or chair to reach the unit if it is installed out of easy reach. If you do not have a stable ladder or other proper equipment, do not proceed; wait for the Lucent Technologies technician.

Possible Cause 6: *A module or modules may be defective.*

What to do: Identify the control unit module or modules where the telephones are connected.

- If the telephones are all connected to one module, there may be a problem with the module. Call the Lucent Technologies Helpline at 1 800 628-2888 (consultation charges may apply).
- If the dead telephones are connected to modules that also connect working telephones, test the jacks on the modules. Identify the port where each nonfunctional telephone is connected. Identify a second port in the same module connected to a working telephone and unplug the jack from the module. Plug the jack for the dead telephone into the extension jack that is now open. If the telephone works, call the Lucent Technologies Helpline at 1 800 628-2888 (consultation charges may apply).
- If the telephones do not work when plugged into module jacks that are known to be functioning, call the Lucent Technologies Helpline at 1 800 628-2888 (consultation charges may apply).

Difficulty Making Outside Calls



SECURITY ALERT:

When changing calling restrictions and other security settings, take care not to compromise the security of your system. For more information, consult "Security of Your System: Preventing Toll Fraud," in Appendix A, "Customer Support Information."

Possible Cause 1: *This extension is restricted from making outside calls.*

What to do: Use system programming to check the extension's calling restrictions, if any (see Chapter 3 in *System Programming*). If the extension is toll- or outward-restricted, change it to unrestricted, if appropriate. Try again to make an outside call from the extension.

- If outside calls can now be made from the extension, you have solved the problem.
- If there is still difficulty making outside calls, go to Possible Cause 2.

Possible Cause 2: *If the system (Hybrid/PBX mode) uses pool dial-out codes, the extension may be restricted from dialing the pool dial-out code.*

What to do: Use system programming to find out whether the pool dial-out code has been assigned for the extension (see Chapter 3 in *System Programming*).

- If the pool dial-out code is missing, assign it if appropriate and try again to make an outside call. If you can, you have solved the problem. If you Cannot, go to Possible Cause 3.
- If the pool dial-out code is not missing, go to Possible Cause 3.

Possible Cause 3: *If the system (Hybrid/PBX mode) is set up for Automatic Route Selection (ARS), the extension's Facility Restriction Level (FRL) may be set too low (see Chapter 4 in System Programming). The extension's FRL must be greater than or equal to the route's FRL.*

What to do: Use system programming to check the extension's FRL.

- If the FRL is set to less than 6, increase the FRL to 6 and try again to make an outside call. If the telephone can now make outside calls, adjust the FRL as needed. You have solved the problem.



SECURITY ALERT:

Changing the extension's Facility Restriction Level may compromise the security of your system. If you leave the FRL at 6, ensure that the person at the extension is authorized to make toll calls. For more information, consult the section entitled "Automatic Route Selection" in the Feature Reference and "Security of Your System: Preventing Toll Fraud," in Appendix A, "Customer Support Information."

- If, after setting the FRL to 6, the problem still exists, change the FRL back to the original setting and go to Possible Cause 4.

Possible Cause 4: *A Disallowed List is assigned to the extension.*

What to do: Use system programming to check whether a Disallowed List is assigned to the extension (see Chapter 3 in *System Programming*).

- If a Disallowed List is assigned to the extension, remove it if appropriate. Try again to make an outside call. If you can, you have solved the problem. If you cannot, go to Possible Cause 5.
- If a Disallowed List is not assigned to the extension, go to Possible Cause 5.

Possible Cause 5: *Night Service with Outward Restriction is activated.*

What to do: Check to see whether Night Service with Outward Restriction is activated by checking the light next to the Night Service button on the operator's console.

- If the light is on, then Night Service is activated and there are restrictions on outside calls. Use the Night Service password, if known, or use system programming to put the extension on the Night Service Exclusion List, if appropriate. Finally, try again to make an outside call. If you can, you have solved the problem. If you cannot, go to Possible Cause 6.



SECURITY ALERT:

Extensions on the Night Service Exclusion List have unrestricted calling privileges and are not protected from unauthorized after-hours use.

- If the light is off and Night Service is not activated, go to Possible Cause 6.

Possible Cause 6: *Forced Account Code Entry is assigned to the extension.*

What to do: Use system programming to see whether Forced Account Code Entry is required for that extension (see Chapter 3 in *System Programming*).

- If it is, remove the extension from the list of extensions required to use account codes if appropriate. Try again to make an outside call. If you can, you have solved the problem. If you cannot, go to Possible Cause 7.
- If the extension is not on the list, go to Possible Cause 7.

Possible Cause 7: *In Hotel mode, the extension may be restricted from making calls.*

What to do: Check the Extension Status of the extension by observing its lights on the operator's DLC. To do this, change the console from a normal operator position to a calling supervisor's console by pressing the **Feature** button and dialing **32**, and then touching the **Hold** button. Check either the red light next to the extension's DSS button or the green light next to the Auto Dial button programmed for the extension.

- If the light is flashing or on, then the extension is restricted from making outside calls. To change the Extension Status to 0 and remove restrictions, press the **Feature** button and dial $7\text{L}0$ followed by the DSS button for the extension.

Change the console back to normal operator status by pressing the **Feature** button and dialing 32 , then touching the **Drop** button. Try again to make an outside call. If you can, you have solved the problem. If you cannot, go to Possible Cause 8.

- If the light is off, change the console back to the normal operator position by pressing the **Feature** button and dialing 32 , then touching the **Drop** button. Go to Possible Cause 8.

Possible Cause 8: *The telephone may be defective.*

What to do: Test the telephone by replacing it with a similar telephone that you know is working properly.

- If the replacement telephone can make outside calls, then replace it with the original telephone and check again. If the original telephone still cannot make outside calls, then the original telephone may be defective. Call the Lucent Technologies Helpline at 1 800 628-2888 (consultation charges may apply).
- If the replacement telephone cannot make outside calls, there may be a problem with the system wiring or the control unit. Call the Lucent Technologies Helpline at 1 800 628-2888 (consultation charges may apply).

Phone Does Not Ring

Possible Cause 1: *The phone's ringer volume control is set too low.*

What to do: Adjust the volume control up while the phone is idle and the handset is in the cradle. From another extension, dial the extension where the problem is.

- If you can now hear the phone ring, you have solved the problem.
- If the phone still does not ring, go to Possible Cause 2.

Possible Cause 2: *The Do Not Disturb feature is turned on.*

What to do: Check the green light next to the programmed Do Not Disturb button to see if Do Not Disturb is turned on.

- If the green light is on, then Do Not Disturb is turned on. Press the button to deactivate the feature and to turn the light off. From another extension, dial the extension where the problem is. If the phone now rings, you have solved the problem. If not, go to Possible Cause 3.

- If the green light is not on, then Do Not Disturb is not turned on; go to Possible Cause 3.

Possible Cause 3: *The Forward feature is turned on.*

What to do: Turn off the Forward feature. Use one of the following methods, depending on the type of phone:

- At an MLX or analog multiline telephone with a programmed Forward button, deactivate the feature and turn the light off by pressing the button (if the green light is on, indicating that the feature is active). From another extension, dial the extension where the problem is. If the phone now rings, you have solved the problem. If the phone still does not ring, go to Possible Cause 4.
- At an MLX telephone without a programmed Forward button, deactivate Forward by pressing the **Feature** button and dialing **33** plus the extension number of the phone that is not receiving calls. From another extension, dial the extension where the problem is. If the phone now rings, you have solved the problem. If the phone still does not ring, go to Possible Cause 4.
- At an analog multiline telephone, deactivate Forward by pressing the programmed **Feature** button and dialing **33** plus the extension number of the phone that is not receiving calls. From another extension, dial the extension where the problem is. If the phone now rings, you have solved the problem. If the phone still does not ring, go to Possible Cause 4.
- At a single-line telephone, deactivate Forward by dialing **#33** plus the extension number of the single-line telephone. From another extension, dial the extension where the problem is. If the phone now rings, you have solved the problem. If the phone still does not ring, go to Possible Cause 4.

Possible Cause 4: *The Ringing Options Ring Timing feature for the extension is programmed for No Ring or Delayed Ring.*

What to do: Use centralized telephone programming or extension programming to check the Ringing Options setting for the extension (see Chapter 5 of *System Programming*).



NOTE:

You can check the Ringing Options setting at an MLX display telephone by first pressing the **Inspct** button and then a line button. Ringing can be set for each line or for all lines. To change a setting, use extension programming. At an analog multiline or single-line telephone, check the Ringing Options settings for each line by using centralized telephone programming.

- If the Ringing Options setting is No Ring or Delay Ring, change the setting to Immediate if appropriate. From another extension, dial the extension where the problem is. If the phone now rings, you have solved the problem. If not, go to Possible Cause 5.
- If the Ringing Options setting is Immediate, go to Possible Cause 5.

Possible Cause 5: *The telephone may be defective.*

What to do: Test the telephone by replacing it with a similar telephone that you know is working properly.

- If the replacement telephone rings, then replace it with the original telephone and check again. If the original telephone still does not ring, then the original telephone may be defective. Call the Lucent Technologies Helpline at 1 800 628-2888 (consultation charges may apply).
- If the replacement telephone does not ring, there may be a problem with the system wiring or the control unit. To test one wiring possibility, go to Possible Cause 6.



NOTE:

The following procedure may help Lucent Technologies Helpline technicians analyze your problem. However, you should not perform this procedure unless you have experience removing the control unit cover and working with control unit extension jacks. Before proceeding, consult system planning Form 2a, System Numbering: Extension Jacks.



CAUTION:

If you must check something on the control unit, proceed with caution. Avoid standing on a box or chair to reach the unit if it is installed out of easy reach. If you do not have a stable ladder or other proper equipment, do not proceed; wait for the Lucent Technologies technician.

Possible Cause 6: *The wiring is faulty somewhere in the system.*

What to do: Test the control unit module and jack where the telephone is plugged in.

- Identify the port where the nonfunctional telephone is connected. Identify a second port in the same module connected to a functional telephone and unplug the jack from the module. Plug the jack for the non-working phone into the extension jack that is now open. If the telephone works, call the Lucent Technologies Helpline at 1 800 628-2888 (consultation charges may apply).

- If the telephone still does not work, call the Lucent Technologies Helpline at 1 800 628-2888 (consultation charges may apply).

DLC Console Not Ringing for Incoming Calls

Possible Cause 1: *The Do Not Disturb feature is turned on.*

What to do: Check the green light next to the programmed Do Not Disturb button to see whether Do Not Disturb is turned on.

- If the green light is on, then Do Not Disturb is turned on. Press the button to deactivate the feature and to turn the light off. Finally, check whether incoming calls ring at the console. If they do, you have solved the problem. If not, go to Possible Cause 2.
- If the green light is not on, then Do Not Disturb is not turned on; go to Possible Cause 2.

Possible Cause 2: *The Ringing Options Ring Timing feature for the extension is programmed for No Ring or Delayed Ring.*

What to do: Use centralized telephone programming to check the Ringing Options setting for the extension and each line (see Chapter 5 in *System Programming*).

- If the Ringing Options setting for one or more lines is No Ring or Delay Ring, change the setting to Immediate, if appropriate. Finally, check to see whether incoming calls ring at the console. If they do, you have solved the problem. If not, go to Possible Cause 3.
- If the Ringing Options setting is Immediate, go to Possible Cause 3.

Possible Cause 3: *The telephone may be defective.*

What to do: Test the telephone by replacing it with a similar telephone that you know is working properly.

- If the replacement telephone rings for incoming calls, then replace it with the original telephone and check again. If the original telephone still does not ring for incoming calls, then the original telephone may be defective. Call the Lucent Technologies Helpline at 1 800 628-2888 (consultation charges may apply).
- If the replacement telephone does not ring for incoming calls, there may be a problem with the system wiring or the control unit. Call the Lucent Technologies Helpline at 1 800 628-2888 (consultation charges may apply).

QCC Console Not Ringing for Incoming Calls

Possible Cause 1: *The lines are not assigned to the QCC queue.*

What to do: Use system programming to assign the lines to the QCC queue (see "QCC Operator to Receive Calls" in the "Lines and Trunks" section of Chapter 4, *System Programming*). Finally, check to see whether incoming calls ring at the console.

- If the console rings for incoming calls, you have solved the problem. If not, go to Possible Cause 2.
- If the console is still not ringing, go to Possible Cause 2.

Possible Cause 2: *The Position Busy feature is turned on.*

What to do: Check the green light next to the Position Busy button.

- If the green light is on, then Position Busy is turned on. Press the button to deactivate the feature and to turn the light off. Finally, check to see whether incoming calls ring at the console. If they do, you have solved the problem. If not, go to Possible Cause 3.
- If the green light is off, then Position Busy is not turned on; go to Possible Cause 3.

Possible Cause 3: *The Calls-In-Queue Alert option is disabled (this is the factory setting). The number of calls in the queue has exceeded the programmed threshold or the callers have waited too long, and calls are being directed to a backup.*

What to do: Use system programming to check and see whether the QCC's optional Calls-In-Queue Alert is disabled (see Chapter 3 in *System Programming*).

- If the Calls-In-Queue Alert option is set to Disable, change it to Enable, if appropriate. Finally, check to see whether incoming calls ring at the console. If they do, you have solved the problem. If not, go to Possible Cause 4.
- If the Calls-In-Queue Alert option is set to Enable, go to Possible Cause 4.

Possible Cause 4: *Night Service may be on, and calls may be ringing at extensions assigned to the Night Service group rather than at the QCC.*

What to do: Check the green light next to the Night Service button. In Release 4.0 and prior systems, if there is more than one QCC, all must have Night Service activated in order for calls to ring at Night Service group extensions. In Release 4.1 and later systems, lines assigned to a Night Service group ring when the QCC

assigned for that group has Night Service turned on; other QCCs need not have Night Service turned on.

- If the green light is on at all QCCs in the system, then Night Service is turned on. Press the button to deactivate the feature and to turn the light off. Finally, check to see whether incoming calls ring at the console. If they do, you have solved the problem. If not, go to Possible Cause 5.
- If the green light is off, then Night Service is not turned on; go to Possible Cause 5.

Possible Cause 5: *The telephone may be defective.*

What to do: Test the telephone by replacing it with another MLX-20L telephone that you know is working properly.

- If only one MLX-20L is available, plug that telephone into a jack that you know is working and then retest. If the telephone rings for incoming calls, then the original jack may be faulty; call the Lucent Technologies Helpline at 1 800 628-2888 (consultation charges may apply). If the telephone still does not ring, there may be a problem with the system wiring or the control unit; call the Lucent Technologies Helpline at 1 800 628-2888.
- If the replacement telephone rings for incoming calls, then replace it with the original telephone and check again. If the original telephone still does not ring for incoming calls, then the original telephone may be defective. Call the Lucent Technologies Helpline at 1 800 628-2888 (consultation charges may apply).
- If the replacement telephone does not ring for incoming calls, there may be a problem with the system wiring or the control unit. Call the Lucent Technologies Helpline at 1 800 628-2888 (consultation charges may apply).

Single-Line Phones Ring Back after Completed Call

Possible Cause 1: *The switchhook is pressed and released too quickly after a call is completed.*



NOTE:

Some single-line telephones have a positive disconnect switch. If the switch is set to positive disconnect, Possible Cause 1 does not apply. In this case, skip to Possible Cause 2.

8 Troubleshooting the System

Cannot Transfer Call after Answer on an Outside Line

Page 8-14

What to do: Instruct the user to always replace the handset carefully for at least one to two seconds between calls. If the problem is not resolved, go to Possible Cause 2.

Possible Cause 2: *The telephone may be defective.*

What to do: Test the telephone by replacing it with a similar telephone that you know is working properly.

- If the replacement telephone does not ring back, then replace it with the original telephone and check again. If the original telephone still rings back, then the original telephone may be defective. Call the Lucent Technologies Helpline at 1 800 628-2888 (consultation charges may apply).
- If the replacement telephone rings back, there may be a problem with the system wiring or the control unit. Call the Lucent Technologies Helpline at 1 800 628-2888 (consultation charges may apply).

Cannot Transfer Call after Answer on an Outside Line

Possible Cause 1: *There may be custom calling features (for example, call waiting or 3-way calling) from the local telephone company that are interfering with system timer settings.*

What to do: To check whether you have custom calling features, contact your local telephone company representative.

- If you have custom calling features, Transfer usually works. When it does not, warn the caller that a loud tone will sound; then dial # while on the call and try to transfer the call again. If you can transfer the call, you have solved the problem. If you cannot, go to Possible Cause 2. If you do not use the custom calling features, have the central office (CO) remove them.
- If you have no custom calling features, go to Possible Cause 2.

Possible Cause 2: *The telephone may be defective.*

What to do: Test the telephone by replacing it with a similar telephone that you know is working properly.

- If the replacement telephone can transfer a call, then replace it with the original telephone and check again. If the original telephone still cannot transfer a call, then the original telephone may be defective. Call the Lucent Technologies Helpline at 1 800 628-2888 (consultation charges may apply).

- If the replacement telephone cannot transfer a call, there may be a problem with the system wiring or the control unit. Call the Lucent Technologies Helpline at 1 800 628-2888 (consultation charges may apply).

Night Service Not Working



NOTES:

1. Be sure to change the system time appropriately when Daylight Savings Time starts and when it ends. System time affects the functioning of several system features, including Automatic Backup, Night Service, Station Message Detail Recording (SMDR) reports, standalone auto attendant systems, voice mail, and Reminder Service.
2. In Release 4.1 and later systems, Night Service with Coverage Control affects the status of voice mail coverage for extensions with programmed Coverage VMS Off buttons. If you are having problems with this aspect of Night Service, see "Calls Not Going to Voice Mail," beginning with Possible Cause 3 on [page 8-17](#).

Possible Cause 1: *The system time and/or day may be set incorrectly.*

What to do: Use system programming to check the setting of the system time and date (see Chapter 3 in *System Programming*) or check the time at an MLX display telephone.

- If the settings are incorrect, correct them and activate Night Service again. If it is now working, you have solved the problem. If not, go to Possible Cause 2.
- If the settings are correct, go to Possible Cause 2.

Possible Cause 2: *If the system has Night Service with Time Set, the start and stop time or day of week may be set incorrectly (see Chapter 3 in System Programming).*

What to do: Use system programming to check the settings for the Night Service with Time Set daily start and stop times.

- If the settings are incorrect, correct them and activate Night Service again. If it is now working, you have solved the problem. If not, go to Possible Cause 3.
- If the settings are correct, go to Possible Cause 3.

Possible Cause 3: *The Night Service button may be programmed incorrectly at one or more DLCs.*

What to do: Use centralized telephone programming to check that the button on the DLC operator console is, in fact, programmed for Night Service (see Chapter 5 in *System Programming*); or, at the DLC, press the **Inspect** button and then the programmed Night Service button.

- If the Night Service button is not programmed, program it and activate Night Service again. If it is now working, you have solved the problem. If not, go to Possible Cause 4.
- If the Night Service button is programmed correctly, go to Possible Cause 4.

Possible Cause 4: *If the system has more than one operator console and the night destination is a voice mail system, one of the consoles may not have Night Service on.*

What to do: Check that the green light next to the Night Service button at each console is lit.

- If Night Service now works, you have solved the problem.
- If Night Service is still not working and yours is a Release 4.1 or later system, go to Possible Cause 5.
- If Night Service is still not working and your system release is prior to 4.1, call the Lucent Technologies Helpline at 1 800 628-2888 (consultation charges may apply).

Possible Cause 5: *Lines may not be programmed as part of a Night Service Group. Night Service lines do not have to appear on operator consoles, and lines on operator consoles are not automatically part of that operator's Night Service Group; they must be assigned.*

What to do: Check the Night Service line assignments, following the instructions for "Night Service Group Assignment" in the "Labeling" section of System Programming, Chapter 3 or in ["Revising Night Service with Group Assignment" on page 6–79](#).

- If the lines are correctly assigned, call the Lucent Technologies Helpline at 1 800 628-2888 (consultation charges may apply).
- If the lines are not assigned, program them as members of a Night Service group. If Night Service now works, you have solved the problem. If Night Service still does not work, call the Lucent Technologies Helpline at 1 800 628-2888 (consultation charges may apply).

Calls Not Going to Voice Mail

For calls to go to voice mail, the extension must be part of a coverage group, the coverage group must have a receiver, and the receiver must be the voice mail calling group. A quick way to check this is to check the planning forms for Group Coverage and group calling.

Possible Cause 1: *The extension may not be a member of a coverage group.*

What to do: Use system programming to check that the extension is a member of a coverage group (see "Group Coverage Member Assignments" in the "Optional Group Features" section of Chapter 3, *System Programming*).

- If the extension is not assigned, assign it if appropriate. Check to see whether calls are now going to voice mail. If they are, you have solved the problem. If not, go to Possible Cause 2.
- If the extension is already assigned, go to Possible Cause 2.

Possible Cause 2: *The coverage group may not have the voice mail calling group as its receiver.*

What to do: Use system programming to check that the coverage group has a receiver and that the receiver is the voice mail calling group (see "Group Calling Member Assignments" in the "Optional Group Features" section of Chapter 3, *System Programming*).

- If the voice mail calling group is not assigned as the receiver, assign it if appropriate. Check to see whether calls are now going to voice mail. If they are, you have solved the problem.
- If the voice mail calling group is assigned as the receiver and your system is Release 4.1 or later, go to Possible Cause 3.
- If the voice mail calling group is assigned as the receiver and your system is not Release 4.1 or later, go to Possible Cause 4.

Possible Cause 3: *Night Service with Coverage Control (Release 4.1 and later systems) has automatically activated the extensions' Coverage VMS Off buttons for normal business operation (Night Service off, no voice mail coverage).*



NOTE:

If Night Service is *on* and Night Service with Coverage Control is enabled, someone at the telephone(s) may have manually overridden the systemwide setting, after it took effect, to prevent voice mail coverage at their extension(s). Follow the instructions in this Possible Cause to check current settings for Night Service on/off status and Coverage Control. Then look at the telephone buttons as outlined in Possible Cause 4.

What to do: Check the Night Service button lights at each operator console to see whether Night Service is off (buttons are not lit).

Use system programming to find out whether Night Service with Coverage Control is enabled. Follow the instructions for "Night Service with Coverage Control" in *System Programming*, Chapter 3, or see "Revising Night Service with Coverage Control" on [page 6-81](#).

If Night Service with Coverage Control is enabled and Night Service is off but you expect it to be on, see "[Night Service Not Working](#)" on [page 8-15](#).

- If Night Service with Coverage Control is disabled, and this is appropriate, voice mail coverage is controlled only by the users at extensions. Go to Possible Cause 4.
- If Night Service with Coverage Control is enabled, and this setting is appropriate, users at the extensions should deactivate their Coverage VMS Off buttons or Coverage Off to receive voice mail coverage. If voice mail still does not work, go to Possible Cause 5.

Possible Cause 4: *The user's telephone has Coverage Off or Coverage VMS Off activated. (In Release 4.1, the user at the telephone can override Night Service with Coverage Control by pressing the programmed Coverage VMS Off button since the last Night Service status change.)*

What to do: Check the light next to the programmed Coverage Off button or the programmed Coverage VMS Off button.

- If the light is on, then outside calls do not go to voice mail. Press the button to deactivate the feature and to turn the light off. Check to see whether calls are now going to voice mail. If they are, you have solved the problem.
- If the lights are off, go to Possible Cause 4.

Possible Cause 5: *The voice mail system may not be working.*

What to do: If convenient, check that the power light on the voice mail system unit is on. If yours is a MERLIN LEGEND MAIL Voice Messaging System, it has a green LED at the bottom of its control unit module; the light blinks to indicate a malfunction and is unlit when the module is not properly installed. Try placing a call to other extensions to see whether the calls go to voice mail.

- If the voice mail system power light is off (or if a MERLIN LEGEND MAIL VMS system status LED is blinking or off), and/or it does not work for other extensions, then the voice mail system is not working. Check its documentation; or, if it is a Lucent Technologies voice mail system, call the Lucent Technologies Helpline at 1 800 628-2888 (consultation charges may apply).

- If the power light is on and voice mail works for other extensions, call the Lucent Technologies Helpline at 1 800 628-2888 (consultation charges may apply).

Callers Getting Incorrect Response from Voice Mail

Outside callers who reach the system may get the wrong response when the voice mail system answers calls. They may hear an off-hours message during business hours, for example.



NOTE:

Be sure to change the system time appropriately when Daylight Savings Time starts and when it ends. System time affects the functioning of several system features, including Automatic Backup, Night Service, Station Message Detail Recording (SMDR) reports, standalone auto attendant systems, voice mail, and Reminder Service.

Possible Cause 1: *The system time may be set incorrectly.*

What to do: Check the time at the system programming console or another MLX display telephone. If the time is correct, go to Possible Cause 2.

Possible Cause 2: *If the system uses the Night Service feature and has more than one operator console, one of the consoles may not have the Night Service button activated.*

What to do: Check that the green light next to the Night Service button at each operator's console is on.

- If a green light is off, then Night Service is not activated; press the button to activate Night Service. Make a call to see if you get the correct voice mail greeting. If you do, you have solved the problem.
- If each green light is on, then Night Service is activated for that operator's console. Go to Possible Cause 3.

Possible Cause 3: *The time settings for the voice mail system do not match the system date and time.*

What to do: Follow the instructions in your voice mail system documentation to check that the settings match the system. If the settings are correct or if it is a Lucent Technologies voice mail system, call the Lucent Technologies Helpline at 1 800 628-2888 (consultation charges may apply).

Calls Not Going to Coverage

Possible Cause 1: *An Individual Coverage receiver may not be assigned.*

What to do: At the extension that is to receive calls, program a Cover button for the sender's extension. If a Cover button is programmed, go to Possible Cause 2.

Possible Cause 2: *The user's telephone has Coverage Off or Coverage VMS Off activated.*

What to do: Check the light next to the programmed Coverage Off button or the programmed Coverage VMS Off button.

- If the light is on, then outside calls do not go to coverage. Press the button to deactivate the feature and to turn the light off. Check to see whether calls are now going to coverage. If they are, you have solved the problem.
- If the lights are off, go to Possible Cause 3.

Possible Cause 3: *The extension may not be assigned to a coverage group.*

What to do: Use system programming to check that the extension is a member of a coverage group (see "Group Coverage Member Assignments" in the "Optional Group Features" section of Chapter 3, *System Programming*).

- If the extension is not assigned, assign it if appropriate. Check to see whether calls are now going to coverage. If they are, you have solved the problem. If not, go to Possible Cause 4.
- If the extension is assigned, go to Possible Cause 4.

Possible Cause 4: *The coverage group may not have a receiver assigned.*

What to do: Use system programming to check that a receiver is assigned to the coverage group (see Chapter 4 in *System Programming*).



NOTE:

When you call the Helpline, consultation charges may apply. Before calling the Helpline, you may wish to consult the documentation for your voice messaging system.

- If a receiver is not assigned, assign one if appropriate. Check to see whether calls are now going to coverage. If they are, you have solved the problem. If not, call the Lucent Technologies Helpline at 1 800 628-2888 (consultation charges may apply).
- If the receiver is assigned correctly, call the Lucent Technologies Helpline at 1 800 628-2888 (consultation charges may apply).

Trouble Hearing Called Party

Possible Cause 1: *If a speakerphone is being used, there may be environmental factors that affect the performance of the speaker or microphone (for example, too much background noise).*

What to do: Eliminate the background noise or other interference. If the problem persists or if a speakerphone is not being used, go to Possible Cause 2.

Possible Cause 2: *The telephone handset may be defective.*

What to do: Replace the handset with a handset from the same type of telephone. If you can now hear the called party, contact your Lucent Technologies representative to order a new handset. If you still have trouble hearing, go to Possible Cause 3.

Possible Cause 3: *The telephone may be defective.*

What to do: Test the telephone by replacing it with a similar telephone that you know is working properly.

- If you can hear the called party on the replacement telephone, then replace it with the original telephone and check again. If you still have trouble hearing the called party on the original telephone, then the original telephone may be defective. Call the Lucent Technologies Helpline at 1 800 628-2888 (consultation charges may apply).
- If you cannot hear the called party on the replacement telephone, there may be a problem with the system wiring or the control unit. Call the Lucent Technologies Helpline at 1 800 628-2888 (consultation charges may apply).

Programmed Button Fails



NOTE:

Extension programming is not stored in the telephone itself. Therefore, if you move a telephone to a different extension, the programming for the previous telephone at that extension remains in effect. The extension must be reprogrammed as appropriate.

Possible Cause 1: *The programmed button may be incorrectly programmed or may not be programmed at all.*

You can check the programming of a button at an MLX display telephone by first pressing the **Inspect** button and then the line button.

What to do: Use centralized telephone programming to check the programming for the phone's buttons.

- If the programming is incorrect, reprogram it. Try to use a programmed button. If the button works, you have solved the problem. If not, go to Possible Cause 2.
- If the programming is correct, go to Possible Cause 2.

Possible Cause 2: *The telephone may be defective.*

What to do: Test the telephone by replacing it with a similar telephone that you know is working properly. Program the buttons as appropriate.

- If the programmed button works properly on the replacement telephone, then replace it with the original telephone and check again. If the programmed button on the original telephone still fails, then the original telephone may be defective. Call the Lucent Technologies Helpline at 1 800 628-2888 (consultation charges may apply).
- If the programmed button on the replacement telephone fails, there may be a problem with the system wiring or the control unit. Call the Lucent Technologies Helpline at 1 800 628-2888 (consultation charges may apply).

Reminder Messages Received with the Wrong Time



NOTE:

Be sure to change the system time appropriately when Daylight Savings Time starts and when it ends. System time affects the functioning of several system features, including Automatic Backup, Night Service, Station Message Detail Recording (SMDR) reports, standalone auto attendant systems, voice mail, and Reminder Service.

Possible Cause: *The system time may be set incorrectly.*

What to do: At the programming console or any MLX display telephone, check the system time. If the time is correct, call the Lucent Technologies Helpline at 1 800 628-2888 (consultation charges may apply).

Recall/Switchhook Does Not Work

When this problem occurs, pressing the **Recall** button or switchhook disconnects the call or fails to return dial tone.

NOTE:

If the telephone is an MLX or analog multiline telephone, pressing the switchhook disconnects the call. On these phones, you must use a programmed (on MLX telephones) or fixed (on analog telephones) **Recall** button to activate custom or Centrex calling features.

Possible Cause 1: *The Recall timer may be set incorrectly.*

NOTE:

Some single-line telephones have a positive disconnect switch. If the switch is set to positive disconnect, this Possible Cause 1 does not apply. If this is the case, skip to Possible Cause 2.

What to do: Use system programming to check the setting of the Recall timer system feature (see Chapter 3 in *System Programming*).

- If the setting is less than 650 milliseconds, change the setting to 650 ms or to 1 second. Have someone place a call to the extension, answer it, and press the **Recall** button or the switchhook. If you do not disconnect the caller or you do get dial tone, you have solved the problem. If you do disconnect the caller or you do not get dial tone, go to Possible Cause 2.
- If the setting is for 650 ms or for 1 second, go to Possible Cause 2.

Possible Cause 2: *The line may not have custom calling features.*

What to do: Check with the central office (CO).

- If there are custom calling features, obtain instructions on the use of the features and the Recall timing.
- If there are no custom calling features, go to Possible Cause 3.

Possible Cause 3: *The telephone may be defective.*

What to do: Test the telephone by replacing it with a similar telephone that you know is working properly. Program the buttons as appropriate.

- If the problem is resolved on the replacement telephone, then replace it with the original telephone and check again. If the problem persists on the original telephone, then the original telephone may be defective. Call the Lucent Technologies Helpline at 1 800 628-2888 (consultation charges may apply).
- If the problem persists on the replacement telephone, there may be a problem with the system wiring or the control unit. Call the Lucent Technologies Helpline at 1 800 628-2888 (consultation charges may apply).

Calling Group Members Not Receiving Calls

Possible Cause 1: *The calling group member's telephone is not available.*

What to do: Log the member in by doing one of the following:

- Using the operator's or calling group supervisor's DLC, enter supervisory mode by pressing the **Feature** button, dialing *32*, and pressing the Hold button. Check the light next to the Auto Dial or DSS button for the member's extension. It is off or is flashing when the member is unavailable to take calls. Log the member in by pressing a programmed Available button or by pressing the **Feature** button and dialing *44* before pressing the Auto Dial or DSS button for the extension. Finally, check to see whether calls to the calling group are received. If they are, you have solved the problem. If they are not, go to Possible Cause 2.
- At the member's telephone, do one of the following:
 - If the member's telephone has a programmed Available button and the light next to it is off, the member is logged out. Log the member in by pressing the button. Check to see whether calls to the calling group are now received. If they are, you have solved the problem. If they are not, go to Possible Cause 2.
 - If the member's phone does not have a programmed button (including single-line telephones), log the member in by dialing *#44* while off-hook on an **SA** or **ICOM** line. Check to see whether calls to the calling group are now received. If they are, you have solved the problem. If they are not, go to Possible Cause 2.

Possible Cause 2: *The lines/trunks may not be assigned to the calling group.*

What to do: Assign incoming lines to the calling group extension number (see Chapter 3, *System Programming*). If calls on these lines still do not reach the calling group members, go to Possible Cause 3.

Possible Cause 3: In a Release 6.0 or later system, the queue control setting may be too low, so that callers are receiving a busy signal.

What to do: Consult *System Programming*, Chapter 3, to set the queue control value to a higher number. The factory-set default is 99 calls allowed in the queue, but the value can be set to any number between 0 and 99. If the queue control value is properly set, go to Possible Cause 4.

Possible Cause 4: The telephone may be defective.

What to do: Test the telephone by replacing it with a similar telephone that you know is working properly. Program the buttons as appropriate.

- If calling group calls are received on the replacement telephone, then replace it with the original telephone and check again. If the problem persists on the original telephone, then the original telephone may be defective. Call the Lucent Technologies Helpline at 1 800 628-2888 (consultation charges may apply).
- If calling group calls are not received on the replacement telephone, there may be a problem with the system wiring or the control unit. Call the Lucent Technologies Helpline at 1 800 628-2888 (consultation charges may apply).

Calls Not Receiving Screen Pop

In Release 5.0 and later systems with a CTI link (Hybrid/PBX mode only), screen pop of caller information occurs when a call arrives at an **SA** button. The call may be a calling group call, a transfer or conference from a QCC or unmonitored DLC, or a PRI call where routing is by dial plan. If the problem occurred at the extension of an overflow calling group member, see [“Calling Group Overflow Calls Not Receiving Screen Pop” on page 8-27](#)

Possible Cause 1: The call may not have arrived on an **SA** button.

What to do: The user at the extension may have a personal line for a call that also arrives on an **SA** button. If the user has not answered the call at a personal line button, go to Possible Cause 2.

Possible Cause 2: The receiving extension may not be using a CTI link application.

What to do: Check the system planning form for the extension. Then do one of the following:

- If the extension includes an analog multiline BIS or MLX telephone and is not assigned as a PassageWay Telephony Services client extension, this is most likely the cause of the problem. Consult the *PassageWay Telephony Services Network Manager's Guide* for information about changing the extension's status.
- If the extension is assigned to receive CTI treatment, go to Possible Cause 3.

Possible Cause 3: *The call may have been transferred from a monitored Direct-Line Console (DLC) that is using a CTI link application.*

What to do: Check the system planning form for the DLC that transferred the call or consult the DLC operator. Then do one of the following:

- If the call was from another source, go to Possible Cause 4.
- If the DLC is monitored, this is the cause of the problem. If you wish the DLC to be unmonitored, consult the *PassageWay Telephony Services Network Manager's Guide* for information about changing the extension's status.
- If the DLC is unmonitored, the call arrived on an ISDN line routed by dial plan, or the call was transferred or conferenced by a QCC, go to Possible Cause 5.

Possible Cause 4: *The call may be an outside call transferred from another non-operator system extension.*

What to do: Screen pop only shows the caller information for the inside extension.

Possible Cause 5: *The CTI link is not working.*

What to do: Check the CTI link.

- Consult the *PassageWay Telephony Services Network Manager's Guide* for troubleshooting information.
- If you cannot solve the problem yourself, call the Lucent Technologies Helpline at 1 800 628-2888 (consultation charges may apply).

Calling Group Overflow Calls Not Receiving Screen Pop

In Release 5.0 and later systems with a CTI Link (Hybrid/PBX mode only), screen pop of caller information occurs when a call arrives at an **SA** button of a calling group member or overflow calling group member.

Possible Cause 1: *The call was not delivered to an SA button.*

What to do: In cases where a call is directed to an overflow calling group member who has a personal line for the call and that member's **SA** buttons are unavailable, the call can be delivered to the personal line and not initiate screen pop. To assure proper delivery, set all personal lines on overflow group members' telephones to No Ring. If this is not the problem, go to Possible Cause 2.

Possible Cause 2: *The CTI link is not working.*

What to do: Check the CTI link.

- Consult the *PassageWay Telephony Services Network Manager's Guide* for troubleshooting information.
- If you cannot solve the problem yourself, call the Lucent Technologies Helpline at 1 800 628-2888 (consultation charges may apply).

Secondary Announcements Not Playing as Programmed

In Release 5.0 and later systems, as many as ten primary delay announcement devices and one secondary device can be assigned to play messages for callers waiting for calling group agents. When a delay announcement is first set up or is changed, it may be necessary to adjust the interval between announcements; this interval applies to the delay between the primary and secondary announcements as well as to the interval between repetitions of the secondary announcement (if the secondary announcement is programmed to repeat).

Problems occur when the actual delay interval experienced by callers is not the same as the programmed interval and callers do not hear the secondary announcement when you planned it. The seriousness of the problem can be analyzed through the use of a programmed Calls-in-Queue alarm button that responds to tiered alarm thresholds.



NOTE:

The *Feature Reference* includes detailed information about setting up Group Calling delay announcements and other calling group options.

Consult the *Feature Reference* and *System Programming* as you troubleshoot announcement delays.

To analyze a problem with secondary announcements, follow these preliminary steps:

1. The Calls In Queue Alarm Threshold setting should determine when an alarm is signalled. Set the overflow threshold time to 0.
2. Set up primary and secondary announcements of durations that seem appropriate for your needs.
3. Specify a reasonable announcement interval (for example, 30 seconds).
4. Refer to Table 8-1 and divide the announcement interval (Y) by the length of the secondary announcement (Z).
5. Round off the result and use this value as an alarm threshold when a Calls-in-Queue Alarm button signals a problem.

Table 8-1. Checking the Effectiveness of Delay Announcements

Calls Waiting for Secondary Announcement (N)	Length of Secondary Announcement in Seconds (Z)	Announcement Interval in Seconds (Y)	N * Z	Is N * Z > Y?
3	10	30	30	No
3	20	30	60	Yes
5	15	90	75	No
10	15	90	150	Yes

When the number of calls waiting for a secondary announcement multiplied by the length of that announcement is greater than the announcement interval, an alarm is triggered. [Table 8-1](#) illustrates situations where a programmed Calls-in-Queue Alarm button would or would not indicate a problem.

If problems arise, use the display at the calling group supervisor DLC console to monitor the situation while the problem is most severe. Try to adjust the announcements' durations and the interval setting so that the announcement interval is greater than or equal to the length of the secondary announcement multiplied by the number of calls waiting for the secondary announcement ($Y \geq N * Z$).

Possible Cause 1: *The announcement interval may be too short or the secondary announcement may be too long.*

What to do: Check the number of callers waiting when the alarm goes off, as well as the delay interval and the length of the secondary announcement.

- If only a few callers are waiting when an alarm is signalled, increase the announcement interval or shorten the secondary announcement to solve the problem (see the second example in [Table 8-1](#)).
- If more than a few callers are waiting, go to Possible Cause 2.

Possible Cause 2: *The primary announcement(s) require adjustment.*

What to do: Depending upon your customer needs and current Group Calling options, do one of the following to decrease the queue for the secondary announcement:

- If you are using several primary announcements, decrease the number of primary announcements.
- If the primary announcement is very short, increase its length so that customers are not immediately sent to the secondary announcement queue.
- If neither of the above conditions apply, go to Possible Cause 3.

Possible Cause 3: *The secondary announcement is set to repeat and too many callers are waiting to hear the repeated announcement.*

What to do: Set the repeat option for the secondary announcement to Off. If the secondary announcement is not set to repeat, go to Possible Cause 4.

Possible Cause 4: *Because the secondary announcement is shared by more than one calling group, callers are waiting too long to hear it.*

What to do: Make the secondary announcement exclusive to the group whose callers are experiencing the problem. If the announcement is not shared, go to Possible Cause 5.

Possible Cause 5: *The secondary announcement device is also providing the primary announcement, so that too many callers are waiting for the secondary announcement.*

What to do: Set up a separate secondary announcement. If one announcement is not serving as both primary and secondary, go to Possible Cause 6.

Possible Cause 6: *The calling group is set to use the Prompt-Based Overflow setting that allows callers to dial # in response to a delay announcement so that they can be connected to a voice mail system or other overflow receiver. However, the system lacks sufficient touch-tone receivers (TTRs) to handle the callers' requests. If you are not using this setting, go to Possible Cause 7.*

What to do: Depending upon your customer needs, do one of the following to make more TTRs available:

- Shorten the length of the primary delay announcement that includes the prompt to dial #.
- Decrease the number of primary delay announcement devices.
- Provide more TTRs for the calling group. For information about your options, consult your Lucent Technologies representative.
- Stop using the Prompt-Based Overflow setting. Modify the recording on the delay announcement accordingly.
- If none of these options cures the problem, or if the prompted requests do not seem to be the cause, go to Possible Cause 7.

Possible Cause 7: *There are not enough agents to serve the call volume.*

What to do: Log in additional agents or increase the number of agents in the group.

Other or Unresolved Problems

If you have a problem not listed in this chapter or if, after you complete the appropriate troubleshooting procedure, the problem persists, call the Lucent Technologies Helpline at 1 800 628-2888 (consultation charges may apply) for further assistance. When you call the Helpline, use a copy of the System Information Sheet at the front of this guide to note a few details about your system, along with troubleshooting information.

Customer Support Information



Support Telephone Number

In the USA only, Lucent Technologies provides a toll-tree customer Helpline (1 800 628-2888) 24 hours a day. If you need assistance when installing, programming, or using your system, call the Helpline or your Lucent Technologies representative. Consultation charges may apply.

Outside the USA, if you need assistance when installing, programming, or using your system, contact your Lucent Technologies representative.

Federal Communications Commission (FCC) Electromagnetic Interference Information

This equipment has been tested and found to comply with the limits for a Class A digital device, pursuant to Part 15 of the FCC Rules. These limits are designed to provide reasonable protection against harmful interference when the equipment is operated in a commercial environment. This equipment generates, uses, and can radiate radio frequency energy and, if not installed and used in accordance with the instruction manual, may cause harmful interference to radio communications. Operation of this equipment in a residential area is likely to cause harmful interference, in which case the user will be required to correct the interference at his or her own expense.

Canadian Department of Communications (DOC) Interference Information

This digital apparatus does not exceed the Class A limits for radio noise emissions set out in the radio interference regulations of the Canadian Department of Communications.

Le Présent Appareil Numérique n'émet pas de bruits radioélectriques dépassant les limites applicables aux appareils numériques de la classe A prescrites dans le règlement sur le brouillage radioélectrique edicté par le ministère des Communications du Canada.

FCC Notification and Repair Information

This equipment is registered with the FCC in accordance with Part 68 of its rules. In compliance with those rules, you are advised of the following:

- **Means of Connection.** Connection of this equipment to the telephone network shall be through a standard network interface jack, USOC RJ11C, RJ14C, RJ21X. Connection to E&M tie trunks requires a USOC RJ2GX. Connection to off-premises extensions requires a USOC RJ11C or RJ14C. Connection to 1.544-Mbps digital facilities must be through a USOC RJ48C or RJ48X. Connection to DID requires a USOC RJ11C, RJ14C, or RJ21X. These USOCs must be ordered from your telephone company. Connection to 56-Kbps or 64-Kbps facilities requires a USOC RJ11C, RJ14C, or RJ21.
- **Party Lines and Coin Telephones.** This equipment may not be used with party lines or coin telephone lines.
- **Notification to the Telephone Companies.** Before connecting this equipment, you or your equipment supplier must notify your local telephone company's business office of the following:
 - The telephone number(s) you will be using with this equipment.
 - The appropriate registration number and ringer equivalence number (REN), which can be found on the back or bottom of the control unit, as follows:
 - If this equipment is to be used as a Key system, report the number AS593M-72914-KF-E.
 - If the system provides both manual and automatic selection of incoming/outgoing access to the network, report the number AS593M-72682-MF-E.

- If there are no directly terminated trunks, or if the only directly terminated facilities are personal lines, report the number AS5USA-65646-PF-E.
- The REN (Ringer Equivalence Number) for all three systems is 1.5A.
- The facility interface code (FIC) and service order code (SOC):
 - For tie line connection, the FIC is TL31M and the SOC is 9.0F.
 - For connection to off-premises stations, the FIC is OL13C and the SOC is 9.0F.
 - For equipment to be connected to DID facilities, the FIC is 02RV2-T and the SOC is AS.2.
 - For equipment to be connected to 1.544-Mbps digital service, the SOC is 6.0P and the FIC is:
 - 04DU9-BN for D4 framing format with AMI zero code suppression.
 - 04DU9-DN for D4 framing format with bipolar 8 zero code suppression (B8ZS).04DU9-IKN for extended superframe format (ESF) with AMI zero code suppression.
 - 04DU9-ISN with ESF and B8ZS.
 - For equipment to be connected to 56-Kbps or 64-Kbps digital facilities, the FIC is 02B1Q.
- The quantities and USOC numbers of the jacks required.
- For each jack, the sequence in which lines are to be connected, the line types, the FIC, and the REN by position when applicable.
- **Ringer Equivalence Number (REN).** The REN is used to determine the number of devices that may be connected to the telephone line. Excessive RENs on the line may result in the devices not ringing in response to an incoming call. In most, but not all, areas the sum of the RENs should not exceed five (5.0). To be certain of the number of devices that may be connected to the line, as determined by the total RENs, contact the local telephone company to determine the maximum REN for the calling area.
- **Disconnection.** You must also notify your local telephone company if and when this equipment is permanently disconnected from the line(s).

Installation and Operational Procedures

The manuals for your system contain information about installation and operational procedures.

- **Repair Instructions.** If you experience trouble because your equipment is malfunctioning, the FCC requires that the equipment not be used and that it be disconnected from the network until the problem has been corrected. Repairs to this equipment can be made only by the manufacturers, their authorized agents, or others who may be authorized by the FCC. In the event repairs are needed on this equipment, contact your authorized Lucent Technologies dealer or, **in the USA only**, contact the National Service Assistance Center (NSAC) at 1 800 628-2888.
- **Rights of the Local Telephone Company.** If this equipment causes harm to the telephone network, the local telephone company may discontinue your service temporarily. If possible, they will notify you in advance. But if advance notice is not practical, you will be notified as soon as possible. You will also be informed of your right to file a complaint with the FCC.
- **Changes at Local Telephone Company.** Your local telephone company may make changes in its facilities, equipment, operations, or procedures that affect the proper functioning of this equipment. If they do, you will be notified in advance to give you an opportunity to maintain uninterrupted telephone service.
- **Hearing Aid Compatibility.** The custom telephone sets for this system are compatible with inductively coupled hearing aids as prescribed by the FCC.
- **Automatic Dialers.** WHEN PROGRAMMING EMERGENCY NUMBERS AND/OR MAKING TEST CALLS TO EMERGENCY NUMBERS:
 - Remain on the line and briefly explain to the dispatcher the reason for the call.
 - Perform such activities in off-peak hours, such as early morning or late evening.
- **Direct Inward Dialing (DID).** This equipment returns answer supervision signals to the Public Switched Telephone Network when:
 - Answered by the called station
 - Answered by the attendant
 - Routed to a recorded announcement that can be administered by the customer premises equipment user
 - Routed to a dial prompt

This equipment returns answer supervision on all DID calls forwarded back to the Public Switched Telephone Network. Permissible exceptions are when:

 - A call is unanswered
 - A busy tone is received
 - A reorder tone is received

Allowing this equipment to be operated in such a manner as not to provide proper answer supervision signaling is in violation of Part 68 rules.

New Network Area and Exchange Codes. The MERLIN LEGEND Communications System software does not restrict access to any new area codes or exchange codes established by a local telephone company. If the user has established toll restrictions on the system that could restrict access, then the user should check the lists of allowed and disallowed dial codes and modify them as needed.

Equal Access Codes. This equipment is capable of providing users access to interstate providers of operator services through the use of access codes. Modifications of this equipment by call aggregators to block access dialing codes is a violation of the Telephone Operator Consumers Act of 1990.

DOC Notification and Repair Information

NOTICE: The Canadian Department of Communications (DOC) label identifies certified equipment. This certification means that the equipment meets certain telecommunications network protective, operational, and safety requirements. The DOC does not guarantee the equipment will operate to the user's satisfaction.

Before installing this equipment, users should ensure that it is permissible to connect it to the facilities of the local telecommunications company. The equipment must also be installed using an acceptable method of connection. In some cases, the company's inside wiring for single-line individual service may be extended by means of a certified connector assembly (telephone extension cord). The customer should be aware that compliance with the above conditions may not prevent degradation of service in some situations.

Repairs to certified equipment should be made by an authorized Canadian maintenance facility designated by the supplier. Any repairs or alterations made by the user to this equipment, or any equipment malfunctions, may give the telecommunications company cause to request the user to disconnect the equipment.

Users should ensure for their own protection that the electrical ground connections of the power utility, telephone lines, and internal metallic water pipe system, if present, are connected. This precaution may be particularly important in rural areas.



CAUTION:

Users should not attempt to make such connections themselves, but should contact the appropriate electrical inspection authority or electrician, as appropriate.

To prevent overloading, the Load Number (LN) assigned to each terminal device denotes the percentage of the total load to be connected to a telephone loop used by the device. The termination on a loop may consist of any combination of devices subject only to the requirement that the total of the Load Numbers of all the devices does not exceed 100.

DOC Certification No.: 230 4095A

CSA Certification No.: LR 56260

Load No.: 6

Renseignements sur la notification du ministère des Communications du Canada et la réparation

AVIS: L'étiquette du ministère des Communications du Canada identifie le matériel homologué. Cette étiquette certifie que le matériel est conforme à certaines normes de protection, d'exploitation et de sécurité des réseaux de télécommunications. Le Ministère n'assure toutefois pas que le matériel fonctionnera à la satisfaction de l'utilisateur.

Avant d'installer ce matériel, l'utilisateur doit s'assurer qu'il est permis de le raccorder aux installations de l'entreprise locale de télécommunication. Le matériel doit également être installé en suivant une méthode acceptée de raccordement. Dans certains cas, les fils intérieurs de l'entreprise utilisés pour un service individuel à ligne unique peuvent être prolongés au moyen d'un dispositif homologué de raccordement (cordon prolongateur téléphonique interne). L'abonné ne doit pas oublier qu'il est possible que la conformité aux conditions énoncées ci-dessus n'empêchent pas la dégradation du service dans certaines situations. Actuellement, les entreprises de télécommunication ne permettent pas que l'on raccorde leur matériel à des jacks d'abonné, sauf dans les cas précis prévus par les tarifs particuliers de ces entreprises.

Les réparations de matériel homologué doivent être effectuées par un centre d'entretien canadien autorisé désigné par le fournisseur. La compagnie de télécommunications peut demander à l'utilisateur de débrancher un appareil à la suite de réparations ou de modifications effectuées par l'utilisateur ou à cause de mauvais fonctionnement.

Pour sa propre protection, l'utilisateur doit s'assurer que tous les fils de mise à la terre de la source d'énergie électrique, des lignes téléphoniques et des

canalisations d'eau métalliques, s'il y en a, sont raccordés ensemble. Cette précaution est particulièrement importante dans les régions rurales.

AVERTISSEMENT: L'utilisateur ne doit pas tenter de faire ces raccordements lui-même; il doit avoir recours à un service d'inspection des installations électriques, ou à un électricien, selon le cas.

A Customer Support Information

Renseignements sur la notification du ministère des Communications du Canada

L'indice de charge (IC) assigné à chaque dispositif terminal indique, pour éviter toute surcharge, le pourcentage de la charge totale qui peut être raccordée à un circuit téléphonique bouclé utilisé par ce dispositif. La terminaison du circuit bouclé peut être constituée de n'importe quelle combinaison de dispositifs, pourvu que la somme des indices de charge de l'ensemble des dispositifs ne dépasse pas 100.

No d'homologation: 230 4095A

No de certification: CSA LR 56260

L'indice de charge: 6

MERLIN LEGEND D.O.C.
Location Label Placement

Ministère des Communications
du Canada emplacement de
l'étiquette

Lucent **MERLIN LEGEND**

This device complies with Part 15 of the FCC Rules. Operation is subject to the following two conditions: (1) this device may not cause harmful interference, and (2) this device must accept any interference received, including interference that may cause undesired operation.

Complies with Part 68, FCC Rules. See the SystemReference Manual for proper FCC Classification.
FCC Reg. Nos. MF: AS593M-72682-MFE
KF: AS593M-72914-KF-E
PF: AS5EUSA-65646-PF-E
REN: 1.5A

Model 511A Control Unit

UL LISTED 538E **CSA** **LR 56260**

TELEPHONE EQUIPMENT

MADE IN U.S.A.

Use only Lucent Technologies manufactured MERLIN LEGEND circuit modules, carrier assemblies, and power units, as specified in the Installation Manual, in this product. There are no user serviceable parts inside. Contact your authorized agent for service and repair.

This digital apparatus does not exceed the Class A limits for radio noise emissions set out in the radio interference regulations of the Canadian Department of Communications.

Le présent appareil numérique n'émet pas de bruits radioélectriques dépassant les limites applicables aux appareils numériques de la classe A prescrites dans le Règlement sur le brouillage radioélectrique édicté par le ministère des Communications du Canada.

WARNING: If equipment is used for out-of-building applications, approved secondary protectors are required. See Installation Manual.

AVERTISSEMENT: Si l'équipement est utilisé pour des applications extérieures, l'installation d'un protecteur secondaire est requise. Voir le manuel d'installation.

CANADA

DR ID

Security of Your System: Preventing Toll Fraud

As a customer of a new telephone system, you should be aware that there is an increasing problem of telephone toll fraud. Telephone toll fraud can occur in many forms, despite the numerous efforts of telephone companies and telephone equipment manufacturers to control it. Some individuals use electronic devices to prevent or falsify records of these calls. Others charge calls to someone else's number by illegally using lost or stolen calling cards, billing innocent parties, clipping on to someone else's line, and breaking into someone else's telephone equipment physically or electronically. In certain instances, unauthorized individuals make connections to the telephone network through the use of the Remote Access features of your system.

The Remote Access features of your system, if you choose to use them, permit off-premises callers to access the system from a remote telephone by using a telephone number with or without a barrier code. The system returns an acknowledgment signaling the user to key in his or her barrier code, which is selected and administered by the system manager. After the barrier code is accepted, the system returns dial tone to the user. In Release 3.1 and later systems, barrier codes are by default restricted from making outside calls. In prior releases, if you do not program specific outward calling restrictions, the user is able to place any call normally dialed from a telephone associated with the system. Such an off-premises network call is originated at, and will be billed from, the system location.

The Remote Access feature, as designed, helps the customer, through proper administration, to minimize the ability of unauthorized persons to gain access to the network. Most commonly, phone numbers and codes are compromised when overheard in a public location, through theft of a wallet or purse containing access information, or through carelessness (for example, writing codes on a piece of paper and improperly discarding it). Additionally, hackers may use a computer to dial an access code and then publish the information to other hackers. Enormous charges can be run up quickly. It is the customer's responsibility to take the appropriate steps to properly implement the features, evaluate and administer the various restriction levels, protect access codes, and distribute access codes only to individuals who have been fully advised of the sensitive nature of the access information.

Common carriers are required by law to collect their tariffed charges. While these charges are fraudulent charges made by persons with criminal intent, applicable tariffs state that the customer of record is responsible for payment of all long-distance or other network charges. Lucent Technologies cannot be responsible for such charges and will not make any allowance or give any credit for charges that result from unauthorized access.

To minimize the risk of unauthorized access to your communications system:

- Use an unpublished Remote Access number.
- Assign access codes randomly to users on a need-to-have basis, keeping a log of *all* authorized users and assigning one code to one person.
- Use random-sequence access codes, which are less likely to be easily broken.
- Use the longest-length access codes the system will allow.
- Deactivate all unassigned codes promptly.
- Ensure that Remote Access users are aware of their responsibility to keep the telephone number and any access codes secure.
- When possible, restrict the off-network capability of off-premises callers, using calling restrictions, Facility Restriction Levels (Hybrid/PBX mode only), and Disallowed List capabilities. In Release 3.1 and later systems, a prepared Disallowed List (number 7) is provided and is designed to prevent the types of calls that toll-fraud abusers often make.
- When possible, block out-of-hours calling.
- Frequently monitor system call detail reports for quicker detection of any unauthorized or abnormal calling patterns.
- Limit Remote Call Forwarding to persons on a need-to-have basis.
- Change access codes every 90 days.
- Use the longest-length barrier codes possible, following the guidelines for passwords. (See "Choosing Passwords.")

Toll Fraud Prevention

Toll fraud is the unauthorized use of your telecommunications system by third parties to make long-distance telephone calls. Under the law, you, the customer, are responsible for paying part or all of those unauthorized calls. Thus, the following information is of critical importance.

Unauthorized persons concentrate their activities in two areas with the MERLIN LEGEND Communications System:

- They try to transfer out of the MERLIN LEGEND Communications System to gain access to an outgoing trunk and make long-distance calls.
- They try to locate unused or unprotected mailboxes and use them as drop-off points for their own messages.

The following is a discussion of how toll fraud is often perpetrated and ways to prevent unauthorized access that can lead to toll fraud.

Physical Security, Social Engineering, and General Security Measures

Criminals called *hackers* may attempt to gain unauthorized access to your communications system and voice messaging system in order to use the system features. Hackers often attempt to trick employees into providing them with access to a network facility (line/trunk) or a network operator. This is referred to as social engineering. Hackers may pose as telephone company employees and employees of Lucent Technologies or your authorized dealer. Hackers will go through a company's trash to find directories, dialing instructions, and other information that will enable them to break into the system. The more knowledgeable they appear to be about the employee names, departments, telephone numbers, and the internal procedures of your company, the more likely it is that they will be able to trick an employee into helping them.

Preventive Measures

Take the following preventive measures to limit the risk of unauthorized access by hackers:

- Provide good physical security for the room containing your telecommunications equipment and the room with administrative tools, records, and system manager information. These areas should be locked when not attended.
- Provide a secure trash disposal for all sensitive information, including telephone directories, call accounting records, or anything that may supply information about your communications system. This trash should be shredded.
- Educate employees that hackers may try to trick them into providing them with dial tone or dialing a number for them. All reports of trouble, requests for moving extensions, or any other administrative details associated with the MERLIN LEGEND Communications System should be handled by one person (the system manager) or within a specified department. Anyone claiming to be a telephone company representative should be referred to this person or department.
- No one outside of Lucent Technologies needs to use the MERLIN LEGEND Communications System to test facilities (lines/trunks). If a caller identifies him- or herself as a Lucent Technologies employee, the system manager should ask for a telephone number where the caller can be reached. The system manager should be able to recognize the number as a Lucent Technologies telephone number. *Before connecting the caller to the administrative port of the MERLIN LEGEND Communications System, the system manager should feel comfortable that a good reason to do so exists.* In any event, it is not advisable to give anyone access to network facilities or operators, or to dial a number at the request of the caller.

- Any time a call appears to be suspicious, call the Lucent Technologies BCS Fraud Intervention Center at 1 800 628-2888 (fraud intervention for System 25, PARTNER[®] and MERLIN systems).
- Customers should also take advantage of Lucent Technologies monitoring services and devices, such as the NetPROTECTSM family of fraud-detection services, CAS with HackerTracker[®], and CAT Terminal with Watchdog. Call 1 800 638-7233 to get more information on these Lucent Technologies fraud detection services and products.

Security Risks Associated with Transferring through Voice Messaging Systems

Toll fraud hackers try to dial into a voice mailbox and then execute a transfer by dialing *7. The hacker then dials an access code (either 7 for Automatic Route Selection or a pooled facility code) followed by the appropriate digit string to either direct dial or access a network operator to complete the call.



NOTE:

In Release 3.1 and later systems, all extensions are initially and by default restricted from dial access to pools. In order for an extension to use a pool to access an outside line/trunk, this restriction must be removed.

Preventive Measures

Take the following preventive measures to limit the risk of unauthorized transfers by hackers:

- Outward restrict all MERLIN LEGEND Communications System voice mail port extension numbers. This denies access to facilities (lines/trunks). In Release 3.1 and later systems, voice mail ports are by default outward restricted.
- As an additional security step, network dialing for all extensions, including voice mail port extensions, should be processed through ARS using dial access code 7.



SECURITY ALERT:

*The MERLIN LEGEND Communications System ships with ARS activated with all extensions set to Facility Restriction Level 3, allowing all international calling. **To prevent toll fraud**, ARS Facility Restriction Levels (FRLs) should be established using:*

- FRL 0 for restriction to internal dialing only
- FRL 2 for restriction to local network calling only

- FRL 3 for restriction to domestic long-distance (excluding area code 809 for the Dominican Republic as this is part of the North American Numbering Plan, unless 809 is required)
- RL 4 for international calling

In Release 3.1 and later systems, default local and default toll tables are factory-assigned an FRL of 2. This simplifies the task of restricting extensions: the FRL for an extension merely needs to be changed from the default of 3.

Each extension should be assigned the appropriate FRL to match its calling requirements. All voice mail port extensions not used for Outcalling should be assigned to FRL 0 (the default setting in Release 3.1 and later).

- Deny access to pooled facility codes by removing pool dial-out codes 70, 890-899, or any others on your system.
- Create a Disallowed List or use the pre-prepared Disallowed List number 7 (Release 3.1 and later systems only) to disallow dialing 0, 11, 10, 1700, 1809, 1900, and 976 or 1(wildcard)976. In Release 3.1 and later systems, Disallowed List number 7 does not include 800 and 1800 and 411 and 1411, but Lucent Technologies recommends that you add them. **Assign all voice mail port extensions to this Disallowed List. Lucent Technologies recommends assigning Disallowed List number 7. This is an added layer of security, in case outward restriction is inadvertently removed.** (In Release 3.1 and later systems, voice messaging ports are assigned by default to Disallowed List number 7.)

If Outcalling is required by voice messaging system extensions:

- Program an ARS Facility Restriction Level (FRL) of 2 on voice mail port extension(s) used for Outcalling.
- If 800 and 411 numbers are used, remove 1800, 800, 411, and 1411 from Disallowed List number 7.
- If Outcalling is allowed to long-distance numbers, build an Allowed List for the voice mail port extension(s) used for Outcalling. This list should contain the area code and the first three digits of the local exchange telephone numbers to be allowed.

Additional general security for voice messaging systems:

- Use a secure password for the General Mailboxes.
- The default administration mailbox, 9997, must be reassigned to the system manager's mailbox/extension number and securely password protected.

- All voice messaging system users must use secure passwords known only to the user.

Security Risks Associated with the Automated Attendant Feature of Voice Messaging Systems

Two areas of toll fraud risk associated with the Automated Attendant feature of voice messaging systems are the following:

- Pooled facility (line/trunk) access codes are translated to a menu prompt to allow Remote Access. If a hacker finds this prompt, the hacker has immediate access. (In Release 3.1 and later systems, dial access to pools is initially factory-set to restrict all extensions: to allow pool access, this restriction must be removed by the system manager.)
- If the Automated Attendant prompts callers to use Remote Call Forwarding (RCF) to reach an outside telephone number, the system may be susceptible to toll fraud. An example of this application is a menu or Submenu that says, "To reach our answering service, select prompt number 5," and transfers a caller to an external telephone number.

Remote Call Forwarding can be used securely only when the central office provides "reliable disconnect" (sometimes referred to as forward disconnect or disconnect supervision), which guarantees that the central office does not return a dial tone after the called party hangs up. In most cases, the central office facility is a loop-start line/trunk which does not provide reliable disconnect. When loop-start lines/trunks are used, if the calling party stays on the line, the central office does return a dial tone at the conclusion of the call, enabling the caller to place another call as if it were being placed from your company. Ground-start trunks provide reliable disconnect and should be used whenever possible.

Preventive Measures

Take the following preventive measures to limit the risk of unauthorized use of the Automated Attendant feature by hackers:

- *Do not* use Automated Attendant prompts for Automatic Route Selection (ARS) Codes or Pooled Facility Codes.
- Assign all unused Automated Attendant Selector Codes to zero, so that attempts to dial these are routed to the system attendant.
- If Remote Call Forwarding (RCF) is required, MERLIN LEGEND Communications System owners should coordinate with their Lucent Technologies Account Team or authorized dealer to verify the type of central office facility used for RCF. If it is a ground-start line/trunk, or if it is a loop-start line/trunk and central office reliable disconnect can be ensured, then nothing else needs to be done.



NOTE:

In most cases these are loop-start lines/trunks without reliable disconnect. The local telephone company must be involved in order to change the facilities used for RCF to ground start lines/trunks. Usually a charge applies for this change. Also, hardware and software changes may be necessary in the MERLIN LEGEND Communications System. The *MERLIN MAIL* MERLIN and *MERLIN LEGEND MAIL* Automated Attendant feature merely accesses the RCF feature in the MERLIN LEGEND Communications System. Without these changes being made, this feature is highly susceptible to toll fraud. These same preventive measures must be taken if the RCF feature is active for MERLIN LEGEND Communications System extensions whether or not it is accessed by an Automated Attendant menu.

Security Risks Associated with the Remote Access Feature

Remote Access allows the MERLIN LEGEND Communications System owner to access the system from a remote telephone and make an outgoing call or perform system administration, using the network facilities (lines/trunks) connected to the MERLIN LEGEND Communications System. Hackers, scanning the public switched network by randomly dialing numbers with war dialers (a device that randomly dials telephone numbers, including 800 numbers, until a modem or dial tone is obtained), can find this feature, which will return a dial tone to them. They can even employ war dialers to attempt to discover barrier codes.

Preventive Measures

Take the following preventive measures to limit the risk of unauthorized use of the MERLIN LEGEND Communications System Remote Access feature by hackers:

- The Remote Access feature can be abused by criminal toll fraud hackers, if it is not properly administered. Therefore, this feature should not be used unless there is a strong business need.
- It is strongly recommended that customers invest in security adjuncts, which typically use one-time passcode algorithms. These security adjuncts discourage hackers. Since a secure use of the Remote Access feature generally offers savings over credit-card calling, the break-even period can make the investment in security adjuncts worthwhile.
- If a customer chooses to use the Remote Access feature without a security adjunct, then multiple barrier codes should be employed, with one per user if the system permits. The MERLIN LEGEND Communications System permits a maximum of 16 barrier codes.
- The maximum length should be used for each barrier code, and should be changed periodically. Barrier codes, like passwords, should consist of a random, hard-to-guess sequence of digits. While MERLIN LEGEND

Communications System Release 3.0 permits a barrier code of up to 11 digits, systems prior to Release 3.0 permit barrier codes of up to only four digits.

If Remote Access is used, an upgrade to MERLIN LEGEND Communications System Release 3.0 is encouraged to take advantage of the longer barrier code.

Other Security Hints

Make sure that the Automated Attendant Selector Codes do not permit outside line selection.

Following are a number of measures and guidelines that can help you ensure the security of your communications system and voice messaging system.

Multiple layers of security are always recommended to keep your system secure.

Educating Users

Everyone in your company who uses the telephone system is responsible for system security. Users and attendants/operators need to be aware of how to recognize and react to potential hacker activity. Informed people are more likely to cooperate with security measures that often make the system less flexible and more difficult to use.

- Never program passwords or authorization codes onto Auto Dial buttons. Display telephones reveal the programmed numbers and internal abusers can use the Auto Dial buttons to originate unauthorized calls.
- Discourage the practice of writing down barrier codes or passwords. If a barrier code or password needs to be written down, keep it in a secure place and never discard it while it is active.
- Operators or attendants should tell their system manager if they answer a series of calls where there is silence on the other end or the caller hangs up.
- Users who are assigned voice mailboxes should frequently change personal passwords and should not choose obvious passwords.
- The system manager should advise users with special telephone privileges (such as Remote Access, Outcalling, and Remote Call Forwarding) of the potential risks and responsibilities.
- Be suspicious of any caller who claims to be with the telephone company and wants to check an outside line. Ask for a callback number, hang up and confirm the caller's identity.

- Never distribute the office telephone directory to anyone outside the company; be careful when discarding it (shred the directory).
- Never accept collect telephone calls.
- Never discuss your telephone system's numbering plan with anyone outside the company.

Educating Operators

Operators or attendants need to be especially aware of how to recognize and react to potential hacker activity. To defend against toll fraud, operators should follow the guidelines below:

- Establish procedures to counter *social engineering*. Social engineering is a con game that hackers frequently use to obtain information that may help them gain access to your communications system or voice messaging system.
- When callers ask for assistance in placing outside or long-distance calls, ask for a callback extension.
- Verify the source. Ask callers claiming to be maintenance or service personnel for a callback number. Never transfer to *10 without this verification. Never transfer to extension 900.
- Remove the headset and/or handset when the console is not in use.

Detecting Toll Fraud

To detect toll fraud, users and operators should look for the following:

- Lost voice mail messages, mailbox lockout, or altered greetings
- Inability to log into voice mail
- Inability to get an outside line
- Foreign language callers
- Frequent hang-ups
- Touch-tone sounds
- Caller or employee complaints that the lines are busy
- Increases in internal requests for assistance in making outbound calls (particularly international calls or requests for dial tone)
- Outsiders trying to obtain sensitive information
- Callers claiming to be the "phone" company
- Sudden increase in wrong numbers

Establishing a Policy

As a safeguard against toll fraud, follow these guidelines for your MERLIN LEGEND Communications System and voice messaging system:

- Change passwords frequently (at least quarterly). Changing passwords routinely on a specific date (such as the first of the month) helps users to remember to do so.
- Always use the longest-length password allowed.
- Establish well-controlled procedures for resetting passwords.
- Limit the number of invalid attempts to access a voice mailbox to five or less.
- Monitor access to the MERLIN LEGEND Communications System dial-up maintenance port. Change the access password regularly and issue it only to authorized personnel. Disconnect the maintenance port when not in use. (However, this eliminates Lucent Technologies' 24-hour maintenance surveillance capability and may result in additional maintenance costs.)
- Create a communications system management policy concerning employee turnover and include these suggestions:
 - Delete all unused voice mailboxes in the voice mail system.
 - If a terminated employee had Remote Access calling privileges and a personal authorization code, remove the authorization code immediately.
 - If barrier codes and/or authorization codes were shared by the terminated employee, these should be changed immediately.
- Regularly back up your MERLIN LEGEND Communications System files to ensure a timely recovery should it be required. Schedule regular, off-site backups.
- Keep the Remote Maintenance Device turned off when not in use by Lucent Technologies or your authorized dealer.
- Limit transfers to registered subscribers only.
- Use the Security Violations Notification options (Mailbox Lock or Warning Message) to alert you of any mailbox break-in attempts. Investigate all incidents.
- Review security policies and procedures and keep them up to date.

Choosing Passwords

Passwords should be the maximum length allowed by the system.

Passwords should be hard to guess and should **not** contain:

- All the same numbers (for example, 1111, 666666)
- Sequential characters (for example 123456)
- Numbers that can be associated with you or your business, such as your name, birthday, business name, business address, telephone number, or social security number
- Words and commonly used names

Passwords should be changed regularly, at least on a quarterly basis. Recycling old passwords is not recommended. Never program passwords (or authorization codes or barrier codes) onto a speed dial button.

Physical Security

You should always limit access to the system console (or attendant console) and supporting documentation. The following are some recommendations:

- Keep the system console and supporting documentation in an office that is secured with a changeable combination lock. Provide the combination only to those individuals having a real need to enter the office.
- Keep telephone wiring closets and equipment rooms locked.
- Keep telephone logs and printed reports in locations that only authorized personnel can enter.
- Design distributed reports so they do not reveal password or trunk access code information.
- Keep the voice messaging system Remote Maintenance Device turned off.

Limiting Outcalling

When Outcalling is used to contact subscribers who are off-site, use the MERLIN LEGEND Communications System Allowed Lists and Disallowed Lists or Automatic Route Selection features to minimize toll fraud.

If the Outcalling feature will not be used, outward restrict all voice messaging system ports. If Outcalling will be used, ports not used for Outcalling should be Outward Restricted (for MERLIN MAIL Voice Messaging Systems, port 2 on a 2-port system, port 4 on a 4-port system, ports 5 and 6 on a 6-port system; for MERLIN LEGEND MAIL Voice Messaging Systems, port 7 of the system's module). Use Outward Restriction, Toll Restrictions, Allowed Lists, Disallowed

Lists and Facility Restrictions Levels, as appropriate, to minimize the possibility of toll fraud.

Limited Warranty and Limitation of Liability

Lucent Technologies warrants to you, the customer, that your MERLIN LEGEND Communications System will be in good working order on the date Lucent Technologies or its authorized reseller delivers or installs the system, whichever is later ("Warranty Date"). If you notify Lucent Technologies or its authorized reseller within one year of the Warranty Date that your system is not in good working order, Lucent Technologies will without charge to you repair or replace, at its option, the system components that are not in good working order. Repair or replacement parts may be new or refurbished and will be provided on an exchange basis. If Lucent Technologies determines that your system cannot be repaired or replaced, Lucent Technologies will remove the system and, at your option, refund the purchase price of your system, or apply the purchase price towards the purchase of another Lucent Technologies system.

If you purchased your system directly from Lucent Technologies, Lucent Technologies will perform warranty repair in accordance with the terms and conditions of the specific type of Lucent Technologies maintenance coverage you selected. If you purchased your system from an a Lucent Technologies-authorized reseller, contact your reseller for the details of the maintenance plan applicable to your system.

This Lucent Technologies limited warranty covers damage to the system caused by power surges, including power surges due to lightning.

The following will not be deemed to impair the good working order of the system, and Lucent Technologies will not be responsible under the limited warranty for damages resulting from:

- Failure to follow Lucent Technologies' installation, operation, or maintenance instructions
- Unauthorized system modification, movement, or alteration
- Unauthorized use of common carrier communications services accessed through the system
- Abuse, misuse, or negligent acts or omissions of the customer and persons under the customer's control
- Acts of third parties and acts of God

LUCENT TECHNOLOGIES' OBLIGATION TO REPAIR, REPLACE, OR REFUND AS SET FORTH ABOVE IS YOUR EXCLUSIVE REMEDY.

EXCEPT AS SPECIFICALLY SET FORTH ABOVE, LUCENT TECHNOLOGIES, ITS AFFILIATES, SUPPLIERS, AND AUTHORIZED RESELLERS MAKE NO WARRANTIES, EXPRESS OR IMPLIED, AND SPECIFICALLY DISCLAIM ANY WARRANTIES OF MERCHANTABILITY OR FITNESS FOR A PARTICULAR PURPOSE.

Limitation of Liability

Except as provided below, the liability of Lucent Technologies and its affiliates and suppliers for any claims, losses, damages, or expenses from any cause whatsoever (including acts or omissions of third parties), regardless of the form of action, whether in contract, tort, or otherwise, shall not exceed the lesser of: (1) the direct damages proven; or (2) the repair cost, replacement cost, license fee, annual rental charge, or purchase price, as the case may be, of the equipment that gives rise to the claim. Except as provided below, Lucent Technologies and its affiliates and suppliers shall not be liable for any incidental, special, reliance, consequential, or indirect loss or damage incurred in connection with the equipment. As used in this paragraph, consequential damages include, but are not limited to, the following: lost profits, lost revenues, and losses arising out of unauthorized use (or charges for such use) of common carrier telecommunications services or facilities accessed through or connected to the equipment. For personal injury caused by Lucent Technologies's negligence, Lucent Technologies's liability shall be limited to proven damages to person. **No action or proceeding against Lucent Technologies or its affiliates or suppliers may be commenced more than twenty-four (24) months after the cause of action accrues.** THIS PARAGRAPH SHALL SURVIVE FAILURE OF AN EXCLUSIVE REMEDY.

Remote Administration and Maintenance

The Remote Administration and Maintenance feature of your telecommunications system, if you choose to use it, permits users to change the system features and capabilities from a remote location.

The Remote Administration and Maintenance feature, through proper administration, can help you reduce the risk of unauthorized persons gaining access to the network. However, telephone numbers and access codes can be compromised when overheard in a public location, or lost through theft of a wallet or purse containing access information or through carelessness (for example, writing codes on a piece of paper and improperly discarding them). Additionally, hackers may use a computer to dial an access code and then publish the information to other hackers. Substantial charges can accumulate quickly. It is your responsibility to take appropriate steps to implement the features properly, evaluate and administer the various restriction levels, and protect and carefully distribute access codes.

Under applicable tariffs, you will be responsible for payment of toll charges. Lucent Technologies cannot be responsible for such charges and will not make any allowance or give any credit resulting from unauthorized access.

To reduce the risk of unauthorized access through Remote Administration and Maintenance, please observe the following procedures:

- The System Administration and Maintenance capability of a Hybrid/PBX or Key system is protected by a password.
 - Change the default password immediately.
 - Continue to change the password regularly.
 - Give the password only to people who need it and impress upon them the need to keep it secret.
 - If anyone who knows the password leaves the company, change the password immediately.
- If you have a special telephone line connected to your Hybrid/PBX or Key system for Remote Administration and Maintenance, you should do one of the following:
 - Unplug the line when it is not being used.
 - Install a switch in the line to turn it off when it is not being used.
 - Keep the Remote Administration and Maintenance telephone number secret. Give it only to people who need to know it, and impress upon them the need to keep it a secret. Do not write the telephone number on the Hybrid/PBX or Key system, the connecting equipment, or anywhere else in the system room.

If your Remote Administration and Maintenance feature requires that someone in your office transfer the caller to the Remote Administration and Maintenance extension, you should impress upon your employees the importance of transferring only authorized individuals to that extension.

About Telecommunications

B

Many of the terms and concepts involved in telephone communications have been in use since Alexander Graham Bell made the first phone call in 1876. Because understanding them will help you to understand how the system works, this section contains a brief history and description of telephone communications.

Basically, telephone communications involves four elements:

- **Telephone Extension Equipment** (also referred to by an older term, *telephone station equipment*). The telephone instrument and/or other equipment (for example, a fax machine) used to transmit and receive the telephone signal.
- **Transmission Facilities.** The equipment and media (for example, wire, cable, and optical fiber) that provide the communications path that carries the telephone signal.
- **Switching Equipment.** The equipment that makes the electrical cross connections so that the caller is connected to the called party.
- **Signaling.** The transmission of information that controls the network, for example, alerting the switch that a user wants to make a call, transmitting the telephone number of the called party, and alerting the called party of the call. Signals also tell the switch about how to make the connections.

This appendix provides information about each of the elements.

Telephone Extension Equipment

Telephone extension equipment is the user's gateway to the global communications network and an array of services. While today's telephones range from single-line telephones to multiline telephones with various features and options, telephone extension equipment can now also involve such things as digital data terminals (for example, personal computers) or advanced videoconferencing equipment. As sophisticated as the equipment has become, many of the basic components and concepts are based on the original telephones.

The first working model of a telephone was demonstrated on March 10, 1876 by Alexander Graham Bell and his assistant, Thomas A. Watson. It consisted of a microphone, called a *transmitter*, and a small loudspeaker-like device, called a *receiver*, connected by a pair of wires and a battery.

Early telephones continued to be powered by *direct current* (dc) supplied by a battery inside the telephone itself until, in 1894, the telephone company used a common battery to power all the telephones connected to an exchange. The telephone company office was called the *central office* (CO), as it is today, and this was where the battery was located.

The flow of direct current to early telephones was controlled by the receiver (or *handset*) which hung on a hook that activated electrical contacts. This hook was called a *switchhook*, a term and concept that is still used today. The status of the switchhook signals the central office about the status of the telephone extension equipment:

- **Idle Status.** When the handset is sitting on its cradle (*on-hook*), the switchhook contacts are open (not connected) and no current is drawn from the CO. This signals the CO that the telephone is available to receive calls.
- **Busy Status.** When the handset is removed from the cradle (*off-hook*), the switchhook contacts are closed (connected) and current flows. This signals the CO either that the caller is requesting service or that the user is already on a call and is not available for another call.

Likewise, the CO signals the called party by sending current to his or her phone, causing it to ring. When the called party lifts the handset from its cradle, the current flows, indicating to the CO that the party has answered and that it can stop the ringing. Originally, various bells and buzzers were used to signal the called party to pick up the phone. But in 1878, Watson developed a bell-ringer with a hammer attached to an armature which was, in turn, powered by magnetic energy and operated by a hand crank. A form of this ringer is still used in some of today's telephones.

Identifying which telephone to ring (that is, supplying the identity of the called party) was communicated verbally from the caller to the operator when human operators handled call connections. After automatic switches were in place, telephone numbers were assigned to telephone service subscribers. The caller identified the called party to the switch by dialing the called party's number. The numbers were originally dialed by using a mechanical device called a *rotary dialer* with a spring that was wound up by turning it in one direction; on its return to normal position, it created interruptions in the flow of current, generating dial pulses recognized by the switch.

Although there are still some rotary-dial telephones in use today, most modern telephones have touch-tone dialing that involves the creation of unique tones produced by pressing buttons on the dialpad. Touch-tone dialing is faster and, with the advent of services available from touch-tone phones, more versatile.

Today's telephones still consist of the components described above. But, with continued innovations, these basic elements have been enhanced to include many other features and components, for example, built-in speakerphones, programmable features and buttons, and even the capability to transmit and receive digital signals.

Transmission Facilities

The telephone network can transmit various types of information which originates in either of two forms: *analog* (continuously variable physical signals, for example, speech or video signals) or *digital* (representation of signals in discrete elements such as zero and one, for example, signals from computers). This information is conveyed from one place to another in the network over communications paths provided by transmission facilities. These facilities involve different types of media as well as electronic equipment.

There are various types of media, including:

- **Open Wire.** Strung on poles, uninsulated copper wire was used in the early days of telecommunications until physical congestion became a problem. It is still found, though rarely, in rural areas.
- **Paired Wire.** Commonly called *twisted pair*. Consists of two copper wires, individually insulated with wood pulp or plastic, twisted together.
- **Paired Cable.** Combines many twisted pairs (from 6 to 3600) into a single cable, originally sheathed in lead but now insulated with plastic. Cable can be strung on poles, buried underground, or installed in a conduit of either long blocks of concrete or plastic pipe. The first transoceanic underseas cable was laid by AT&T in 1958.

A problem encountered, however, with many wire pairs running parallel to each other is *crosstalk*, that is, the leaking of the electric signal from one pair to another so that you can hear noise or intelligible speech.

- **Coaxial Cable.** Consists of a number of one-way voice circuits. Two such cables make a 2-way pair, with each cable carrying the transmission in one direction. Its high frequencies and copper grounding decrease crosstalk. Used since 1946 for long-distance transmission, coaxial cable is now being replaced by optical fiber.
- **Microwave Radio.** Used to carry conversations across and between continents, microwave radio was the backbone of the telephone system until the advent of optical fiber. Because the microwave radio beam follows a straight path, towers need to be located about every 26 miles to allow for the curvature of the earth. Thus, it is very costly to reach remote telephone users, and cannot be used across great distances or oceans. This problem was solved by the launching in 1962 of a "tower" very high in the sky: *Telstar I*, the first communications satellite.
- **Optical Fiber.** A long, hair-thin strand of high-quality glass surrounded by a sheath of glass with different characteristics, clad in a plastic outer sheath, and using a laser as the light source. First described in 1887 by a British physicist, the idea of using light as a transmission medium was implemented in 1880 by Bell. The first transoceanic undersea optical cable was completed by AT&T in 1988.

Optical fiber is flexible, inexpensive, and not prone to electrical and electromagnetic interference; there is no crosstalk, and it is well-suited to carrying digital signals.

Sometimes these media carry only one signal, while other times they carry many signals combined together (multiplexed). They also vary greatly in the number of signals they can carry.

Some of the equipment used in transmission facilities is located at different points along the transmission media to amplify, and sometimes regenerate, the transmitted signals. Other transmission equipment is used where transmission facilities connect to switching systems.

The communications paths provided by transmission facilities can be classified into three broad categories:

- **Lines.** A facility that connects a customer's telephone extension equipment and a switching system.
- **Trunks.** A facility that connects two switching systems.
- **Channels.** A facility dedicated to a specific customer to provide special services.

As noted earlier in this guide, the differentiation between the terms *line* and *trunk* has blurred and the two terms are now often used interchangeably.

The services provided by channels can greatly enhance a company's effectiveness and efficiency. If the MERLIN LEGEND Communications System has a DS1 facility as one of its incoming trunks, the one facility provides 24 "lines" that are called *channels* or *B-channels*, depending on the type of service the facility is programmed for (T1 or PRI). If programmed for T1 service, the channels can be configured to emulate different types of trunks (loop-start, ground-start, DID, and tie) according to business needs, and can provide a variety of special services. If programmed for PRI service, additional special services are available and each B-channel can be programmed to dynamically provide different services over the same B-channel.

Switching Equipment

The primary function of switching equipment is to interconnect the transmission facilities at various key locations and route the telephone signals through the telephone network. The telephone network is composed of a number of these key centralized locations called central offices (COs). At the COs, the electrical signal carried on one telephone circuit is connected, or switched, to another circuit, forming a communications path; that is, the caller's line is connected to the called party's line so they can hold a conversation.

In the early telephone network, switching was performed manually by human operators. Today, electronic computer-controlled switching systems are fast, flexible, and economical, providing reliable, efficient, and cost-effective service.

There are now also private switches that, rather than being located at the telephone company's CO, are located on a company's premises. These systems, called *private branch exchanges* (PBXs), were developed because most of a business' calls are between telephones on-site within the company. The MERLIN LEGEND Communications System is a such a switch, located on the customer's premises, that provides advanced services and features and yet also provides many of the special functions originally performed by human operators.

The Evolution of Switches

The method, type, capabilities, and capacities of switches have evolved as geographic areas expanded and technological advances became available.

Three basic types of technology have been used in switching:

- **Manually-Operated Switching.** Human operators made the connections of circuits by placing plug-ended wires into jacks on a switchboard. Manual switching was slow, labor-intensive and, therefore, costly, but it afforded some special functionality: calls could be forwarded, messages taken, and calls interrupted.
- **Electromechanical Switching.** Electrically operated devices with mechanical parts and motion. Electromechanical switching automated the manual labor and allowed telephone service to be universally affordable, but the technology was inflexible since changes in service required changes in the device itself. It also required high maintenance due to wear and tear on parts, and did little more than switch calls.
- **Electronic Switching.** Electronic, computer-controlled equipment. Electronic switching reduced the size, power consumption, and cost. At the same time, it increased operating speeds, ruggedness, and reliability. Computer control provides flexibility because changes and enhancements are made to the switching system's software rather than to the hardware.

Manual switching was used for the first few decades of telephone service. Switching was performed by human operators who made the actual connections of circuits at a switchboard by using cords that had plugs at each end. Each of the plugs had a *tip* and a *ring* which completed the electrical circuit over which the signals traveled. The operator plugged one end of the cord into the caller's jack, and then completed a call (that is, completed a circuit) by plugging in the other end of the cord to the called party's jack, one of perhaps 10,000 subscriber jacks within reach.

Approximately 120 lines terminated at answering jacks on the operator's switchboard. In turn, each operator had 18 cords that could be used to make connections.

The first automatic switch was invented in 1892 by Almon B. Strowger, an undertaker, whose competitor was getting all the undertaking business in the town—referred by the other undertaker's wife, who was the town's telephone operator. The Strowger switch was an electromechanical device controlled by the caller's telephone.

Strowger's switch was adapted for use in the Bell System starting in 1919. It was slow, noisy, and not very flexible with respect to offering new services but, because it was more cost-effective than human operators, it was directly responsible for making telephone service affordable and universal.

The next innovation in electromechanical switching was the Bell System's crossbar switch, first installed in 1938, and still in use in some areas today. It had fewer switches, a sophisticated control mechanism, and lower maintenance but, like its predecessor, was not flexible because it could not be programmed.

It was, therefore, a natural progression to the idea of using a computer, with its inherent programmable flexibility, to control the operation of the switching network that resulted in the new generation of switching technology called an *electronic switching system* (ESS).

The No1. ESS, developed by AT&T and installed in 1965, served from 10,000 to 65,000 lines at a maximum of 25,000 calls in the busy hour. With ever-increasing innovations in technology, the Lucent Technologies 5ESS digital switching system in 1983 could handle 100,000 lines and 650,000 telephone calls per hour.

Because most trunks are digital, the newer digital switching systems interface easily with digital trunks.

The Evolution of Switching Offices

In the early days of the telephone network, there was little or no switching involved in telephone service (see Figure 2–3 in Chapter 2, “About the System”):

- **Private-Line Service.** In the initial telephone installations, telephone communication was from one telephone directly to another, as in Bell's demonstration that went from an instrument in one room to another instrument a few rooms away. Thus, one telephone could communicate with only one other telephone.
- **Party-Line Service.** Several telephones were connected to one line so a number of people could communicate in the same conversation. But there was no way to reach a telephone on any other line.
- **Station Switching.** All telephones were connected to all other telephones. The telephone itself performed the switching and made the connection. This was workable for a small number of telephones but quickly became impractical as hundreds of telephones were installed.

As the number of telephones grew, centralized switching evolved, that is, all the lines from all the telephones came to a common place, called a *central office* (CO) or *exchange*, where the electrical cross connections could be made between the telephones. The actual connections were made manually by human operators.

As geographical areas enlarged, it was impractical to bring all the lines into one CO, so more COs were created to serve the nearby surrounding areas. Eventually a hierarchy of special switching offices (SOs) was created to connect the COs locally and then connect cities and countries for long-distance (toll) switching:

- **Trunking between COs.** A CO was interconnected to another CO by a dedicated line called a *trunk*, so a call from a party served by one CO could be made to a party served by another CO. This is referred to as the *local CO network* and is the first level in the switching hierarchy.

- **Tandem Switching between COs.** As growth continued, special SOs, called *tandem offices*, were developed to function as intermediaries and handle the switching of calls over trunks between COs. This is referred to as the *public tandem network* and is the second level in the hierarchy.
- **Toll Switching between Cities.** As even more growth occurred, extended switching systems, called *toll offices*, were then developed to handle long-distance switching between cities. This is referred to as the *toll network* and comprises the third and higher levels in the hierarchy. The toll network involves national and international service.

The SO hierarchy is illustrated in [Figure 2-4 on page 2-8](#) in Chapter 2 of this guide.

Today, the hierarchy of the local exchange of the CO through tandem offices and toll offices is still in use. An area within which there is a single uniform set of charges for telephone service is called an *exchange area*. An exchange area may be served by a number of COs, and a call between any two points within an exchange area is a *local call*. A *toll call* is a call made to a point outside the local exchange area, and includes service through the switching office hierarchy.

In addition to the telephone company switches and switching hierarchy, private switching systems (PBXs) were developed. In a PBX, the switch is located on the company's premises. The telephone company's Centrex service enables a business to have the services of a PBX, but supplied from the CO.

As noted in the previous section, the MERLIN LEGEND Communications System is a private switch, located on a company's premises, that offers access to even more powerful telephone network applications and services. It can operate in PBX mode, along with two other modes that define how the system works.

Signaling

Telephone service involves a vast network of transmission and switching equipment whose status and operation must somehow be controlled. This is done by means of various types of signals.

Originally, a caller alerted the operator that he or she wanted service by turning the crank on the telephone, which caused a lamp to flash for that line on the switchboard at the exchange office. The operator plugged in on that line, the caller verbally gave the number of the called party, and the operator visually checked the lamp of the called party to see whether the person was available. If not, the operator told the caller that the line was busy. If the line was available, the operator rang the called party's telephone and connected the parties. When the call was over, the operator could observe that both lamps went out.

If the call was between switching offices, the two operators completed the steps of the process.

Thus, the functions of signaling are:

- Alerting for a request for service
- Transmitting the address information (the telephone number) of the called party.
- Supervising the status of circuits and lines
- Transmitting information such as dial tone to indicate service is available, busy signal indicating that the called party is not available, and various announcements

As switching systems were developed that automated much of the network's operation, an additional realm of signaling was required: machine-to-machine.

Because a primary objective of the telephone industry is for operation of the telephone to be simple, universal, and practical, a relatively small number of standard signals are required. On the other hand, since interoffice signaling is between machines, the emphasis is on efficiency and flexibility rather than usability. This has resulted in a large variety of signaling arrangements.

Signal Transmission

There are basically five types of signaling systems:

- Direct current (dc)
- Inband tone
- Out-of-band tone
- Digital
- Common-channel interoffice

The signals for alerting and supervisory functions are generated by the flow (or absence of flow) of the direct current between the telephones and the switching office.

Address information is communicated either by interruptions in the direct current produced by rotary-dial telephones, or by the unique tones produced by touch-tone telephones. Information signals (dial tone, busy signal, and so on) are provided by the transmission of certain combinations of tones. For touch-tone telephone service, dual-tone multifrequency (DTMF) signaling is used.

The supervision of trunks between COs also occurs by the flow (or absence of flow) of direct current. However, because long-distance trunks carry only

alternating current (AC), a different kind of frequency is used. In 1976, AT&T introduced a new interoffice signaling scheme called common channel interoffice signaling (CCIS) in which a separate circuit between the offices is dedicated to digital signaling transmissions between the computers that control the switches.

The enhanced CCIS system in use today is called *common channeling signaling* (CCS) system and supports advanced features, such as calling-number identification (Caller ID). The calling party's number is transmitted from switching office to office. This and other advanced services are available on the "intelligent" network that has evolved because of the use of computers to control signaling.

Telephone Numbering Plans

Unlike the verbal communication of the called party's name in manually switched systems, automated switching systems require that each telephone extension be identified by a unique address that is convenient, readily understandable, and similar in format to other extensions connected to the network.

In the early days of telecommunications, when a maximum of 10,000 lines could be serviced by a telephone exchange, a 4-digit alphanumeric "address" was used to specify the called party, for example, WA51 (Waverly 51).

Subsequently, 3-digit area codes were introduced to specify the area of the country to be reached, and country codes were introduced for international dialing. Finally, the individual telephone numbers expanded to the 7-digit numbers in use today: a 3-digit central office code and a 4-digit extension number.



NOTE:

In the past, the North American Numbering Plan has used area codes that have only a 0 or 1 for the middle digit, for example, 908 or 215. Currently, the numbering plan is being changed so that any number (0 through 9) can be used for the middle digit. This system has already been designed to take that change into account.

Various standardized numbers have also been created for special services, for example, area code 800 for toll-free service, and 911 for emergency service.

A special numbering plan is also used within the MERLIN LEGEND Communications System to identify individual telephones, adjuncts (for example, fax machines), trunks, and other features and aspects of the system. Depending on the number of extensions and the needs of your company, you can choose from three different numbering plans that allow 2-digit numbers, 3-digit numbers, or customizable variable-length numbers, respectively.

System Capacities



This appendix provides some information about the hardware and software capacities for the system. Environmental requirements for the control unit and power and grounding requirements are contained in the *Equipment and Operations Reference*.

You can configure the system as a standalone unit or as part of a private network. Maximum system capacities are as follows:

- Up to 108 simultaneous two-party conversations
- Up to 80 line/trunk jacks, including loop-start, ground-start, DID, and tie
- Up to 255 extension endpoints that support a combination of the following:
 - Up to 255 physical extension jacks for telephones and adjuncts
 - Up to 127 logical digital data ports (through 7500B data modules connected to jacks on the MLX module) providing RS-232 connections to data terminals and personal computers
- System call-handling capability of 3828 hundred call seconds per hour (ccs/hr)
- Up to three 100D DS1 modules
- Up to five 800 NI-BRI modules (Release 4.0 and later only)

The system has a total capacity of 335 jacks (80 outside lines/trunks plus 255 extensions); however, each MLX module extension jack supports two logical endpoints (extension devices that can operate simultaneously and independently of each other). For example, an MLX telephone with a Multi-Function Module (MFM) plugs into one extension jack, but the jack supports both the telephone and

the equipment (for example, a fax or an answering machine) connected to the MFM.

Similarly, although the 100D module has only one jack, it can serve up to 24 endpoints (emulated, T1 digital, or PRI facilities). Thus, you can configure the system to connect up to 80 lines/trunks and 255 extension endpoints, a total of 335 endpoints.



NOTE:

The system has a time-slot capacity of 216. If more than 216 endpoints are in use at the same time, blocking can occur.

[Table C-1](#) lists the hardware and software capacities of the system. Some constraining factors appear with a checkmark (✓) and are explained at the end of the table.

If you are planning to expand your system, contact your Lucent Technologies representative for additional considerations.

Table C-1. Hardware and Software Capacities

	Limit	Constraining Factor
<i>Allowed/Disallowed Lists</i>		
Number of lists	8	
Entries per list	10	
Digits per entry	7	
<i>Automatic Route Selection</i>		
Number of ARS tables	16	
Subpatterns per table	2	
Routes per subpattern	6	
Entries per table	100	
Entries across all tables	1,600	
Default tables	4	
<i>Callback</i>		
Number of calls in queue	64	

Continued on next page

Table C-1. Continued

	Limit	Constraining Factor
<i>Calling Groups</i>		
Number of groups	32	
Members per group	200	✓
Groups per member	32	
Primary delay announcements per system	200	✓
Secondary delay announcements per system	32	✓
Primary delay announcements per group	10	✓
Secondary delay announcements per group	1	✓
Groups per delay announcement	32	
External alerts per group	1	
Coverage groups per group	1	
<hr/>		
<i>Carriers</i>		
Line/trunk and extension module slots per basic carrier	3	
Line/trunk and extension module slots per expansion carrier	5	
Maximum slots available for line/trunk and extension modules	6	
	17	
<hr/>		
<i>Coverage Groups</i>		
		✓
Number of groups	30	
Senders per group	144	
Groups per sender	1	
Receiver buttons per group	8	
Groups per QCC receiver	30	
<hr/>		
<i>CTI (Computer Telephony Integration) Link (Release 5.0 and later)</i>		
Number per system	1	
Extensions per link	136	✓
Extension jacks required	1 MLX	✓
<hr/>		
<i>Data Hunt Groups</i>		
Number of groups	32	
Members per group	20	
Groups per member	1	

Continued on next page

Table C-1. Continued

	Limit	Constraining Factor
<i>Direct Inward Dial</i>		
Number of blocks	2	
Number of trunks	80	
<i>Directories</i>		
System Directory	1	
Listings per Directory	130	
Extension Directory	1	
Listings per Directory	144	
Personal Directory (MLX-20L only)	48	
Listings per Directory	50	
<i>Extensions</i>		
Total physical jacks	255	
Total endpoints	255	
<i>100D Module (maximum 2 per carrier)</i>	3	
<i>800 NI-BRI Module (maximum 3 per carrier, Release 4.0 and later only)</i>	5	
<i>Endpoints (devices)</i>	255	
<i>Fax Machines with Message Waiting</i>	16	✓
<i>Lines/Trunks</i>	80	
<i>Night Service</i>		
Groups	8	
Members per group (including one group calling number)	144	
Groups per member	8	
Emergency Allowed List entries	10	
Lines per group (Release 4.1 and later)	80	

Continued on next page

Table C-1. Continued

	Limit	Constraining Factor
<i>System Operator Consoles</i>		
DLCs:		
MLX-20L or MLX-28D	8	✓
BIS-22D, BIS-34, BIS-34D, or MERLIN II System Display Console	8	
QCCs	4	
DSSs	16	
Combination of DLCs and QCCs	8	
Number of consoles per module	2	
<hr/>		
<i>Park Codes (number of codes)</i>	8	
<hr/>		
<i>Personal Lines</i>	64	
<hr/>		
<i>Pool Buttons</i>	64	
<hr/>		
<i>Pickup</i>		
Number of groups	30	
Members per group	15	
Groups per member	1	
<hr/>		
<i>Pools (trunk groups)</i>		
Maximum number of pools	11	
Maximum number of trunks in pool	80	
<hr/>		
<i>Ports (not simultaneously)</i>		
Total	224	
Voice and data (physical pools)	144	
Voice Announce to Busy extensions	127	
Voice-mail interface	20	✓
Digital data devices	127	
Paging	3	✓
Delay announcements	200	✓
<hr/>		
<i>Remote Access</i>		
Number of barrier codes	16	
Digits per code, systemwide	4-11	
<hr/>		
<i>Shared System Access Buttons</i>		
Number of buttons per principal extension	27	
<hr/>		

Continued on next page

Table C-1. Continued

	Limit	Constraining Factor
<i>Speed Dial</i>		
Personal Speed Dial		✓
Entries per telephone	24	
Entries per system	1,200	
Digits per entry	28	
System Speed Dial		
Entries per system	130	
Digits per entry	40	
<i>System Programming Equipment</i>		
MLX-20L	1	
RS-232 jack (to connect PC w/SPM)	1	
Modem (built-in processor module)	1	
<i>Telephones (not simultaneously)</i>		
Single-line	200	
Analog multiline		
Without Voice Announce to Busy	136	✓
With Voice Announce to Busy	68	
MLX-20L	48	✓
All other MLX telephones (with/without 7500B data module/MFM)	127	
Power failure transfer	20	✓
Traffic (100 call seconds/hr/system)	3,828	✓
<i>Two-Party Conversations</i>	108	✓
<i>2B data calls</i>	54	✓
<i>Voice-Messaging Systems</i>	1	

Constraining Factors

This section describes the constraining factors that limit the capacities supplied in [Table C-1](#).

Calling Groups

Members of groups. Queued Call Consoles (QCCs) cannot be members of calling groups.

Delay announcements per system. In Release 5.0 and later systems, each of a maximum of 32 groups can have 10 primary delay announcements and a single secondary announcement, for a maximum of 200 (maximum number of system extensions). In earlier releases, a group can have only one delay announcement.

Delay announcements per group. In Release 5.0 and later systems, a group can have 10 primary delay announcements and one secondary delay announcement.

Coverage Groups

Senders per group. QCCs cannot be senders.

CTI (Computer Telephony Integration) Link (Release 5.0 and later systems)

Extensions per link. Determined by types of telephones used. Maximum of 136 applies when all telephones are analog multiline; when all are MLX telephones, the maximum is 127.

Extension jacks required. The link requires an extension jack on an MLX 008 or 408 GS/LS MLX module; the module must not be of firmware vintage 29.

Fax Machines with Message Waiting

The system can support more than 16 fax machines, but those in excess of 16 cannot use the fax message-waiting indication.

System Operator Consoles

DLCs (Direct-Line Consoles). Two consoles are allowed for each MLX or analog module, with a maximum of eight per system. Up to two Direct Station Selectors (DSSs) can be attached to an MLX operator console, and one is built into the MERLIN II System Display Console.

Ports (not achievable simultaneously)

Voice-mail interface	Although the system software supports up to 24 voice-mail interface (VMI) ports, all the VMI ports must be in the same calling group, and the maximum number of extensions in a calling group is 20.
Paging	Software real-time limits, loop-start only
Delay announcements	Maximum number of single-line extension jacks (if these are used to connect delay announcement devices)

Speed Dial

Personal Speed Dial. Single-line and 5- or 10-button telephones only.

System Programming Equipment

Remote access overrides on-site programming except during backup or restore.

Telephones (not achievable simultaneously)

Analog multiline without Voice Announce to Busy 17 slots for each of 8 ports per board

MLX-20L RAM limit and the total includes the MLX-20L telephone used for system programming

Power-failure transfer One for each four LS/GS trunk jacks.

Traffic (hundred call seconds/hr/system)

Assumes 20 percent internal traffic.

Two-Party Conversations

216 time slots

System Planning Forms

D

This appendix contains a table that lists each system planning form. The forms are in numerical order and organized according to planning purpose as shown in [Table D-1](#). Information about filling in the forms is contained in *System Planning*.

Also included in this list is the Employee Communications Survey form. If you need to plan system modifications as your company's needs expand, use this form to conduct a survey of system users' needs. Make copies of the form and save the original for future use.

Table D-1. System Planning Forms

Used for Planning	Form No.	Form Title
Features and Calling Privileges	N/A	Employee Communications Survey
Control Unit Assembly and Operating Conditions	1	System Planning
System Component Numbering	2a	System Numbering: Extension Jacks
	2b	System Numbering: Digital Adjuncts
	2c	System Numbering: Line/Trunk Jacks
	2d	System Numbering: Special Renumbers

Continued on next page

Table 4-1. Continued

Used for Planning	Form No.	Form Title
Incoming Line/Trunk Connections	3a	Incoming Trunks: Remote Access
	3b	Incoming Trunks: DS1 Connectivity (100D Module)
	3c	Incoming Trunks: Tie
	3d	Incoming Trunks: DID
	3e	Automatic Route Selection Worksheet
	3f	Automatic Route Selection Tables
	3g	Automatic Route Selection Default and Special Numbers Tables
	3h	LS-ID Delay
	4a	Extension Copy: Analog Multiline Telephone Template
	4b	Analog Multiline Telephone
	4c	Extension Copy: MLX Telephone Template
	4d	MLX Telephone
	4e	MFM Adjunct: MLX Telephone
	4f	Tip/Ring Equipment
	5a	Direct-Line Console (DLC): Analog
	5b	Direct-Line Console (DLC): Digital
	5c	MFM Adjunct: DLC
	5d	Queued Call Console (QCC)
	Data Form 1a	Modem Data Station
	Data Form 1b	ISDN Terminal Adapter Data Station
Data Form 3	Digital Data/Video Station	
Features for Operators	6a	Optional Operator Features
Features for User Groups	6b	Optional Extension Features
	6c	Principal User of Personal Line
	Data Form 2	Data Hunt Groups

Continued on next page

Table 4-1. Continued

Used for Planning	Form No.	Form Title
Features for Systemwide Use	6d	Message-Waiting Receivers
	6e	Allowed Lists
	6f	Disallowed Lists
	6g	Call Restriction Assignments and Lists
	6h	Authorization Codes
	6i	Pool Dial-Out Code Restrictions
	7a	Call Pickup Groups
	7b	Group Paging
	7c	Group Coverage
	7d	Group Calling
	8a	System Features
	9a	Night Service: Group Assignment
	9b	Night Service: Outward Restriction
	9c	Night Service: Time Set
	10a	Label Form: Posted Message
	10b	System Speed Dial

Removing/Reinstalling the Control Unit Cover



This appendix provides instructions for removing the control unit housing, and for reinstalling it.



NOTE:

Use these instructions only as directed by a Lucent Technologies representative.

Removing the Control Unit Housing

To remove the control unit housing, see [Figure E-1](#).

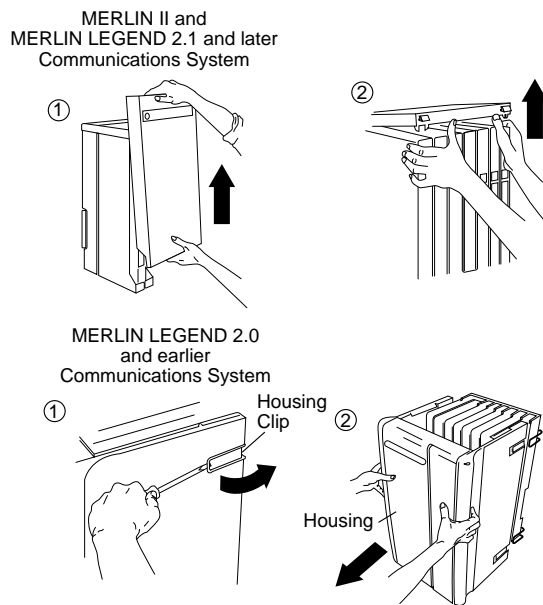

Figure E-1. Removing the Control Unit Housing

Installing the Control Unit Housing

Installing the control unit housing involves two tasks: installing the top cover and then installing the front cover.

This section contains instructions for both tasks.

Installing the Top Cover

To install the control unit top cover, see [Figure E-2](#) and follow these steps:

1. Be sure the cords have been pressed through the wire managers at the base of the modules.
2. Hold the top cover with the hooks facing you.
3. Engage the tabs at the rear of the top cover with the carrier.
4. Lower the top cover so that the legs lock into the vents on the module.

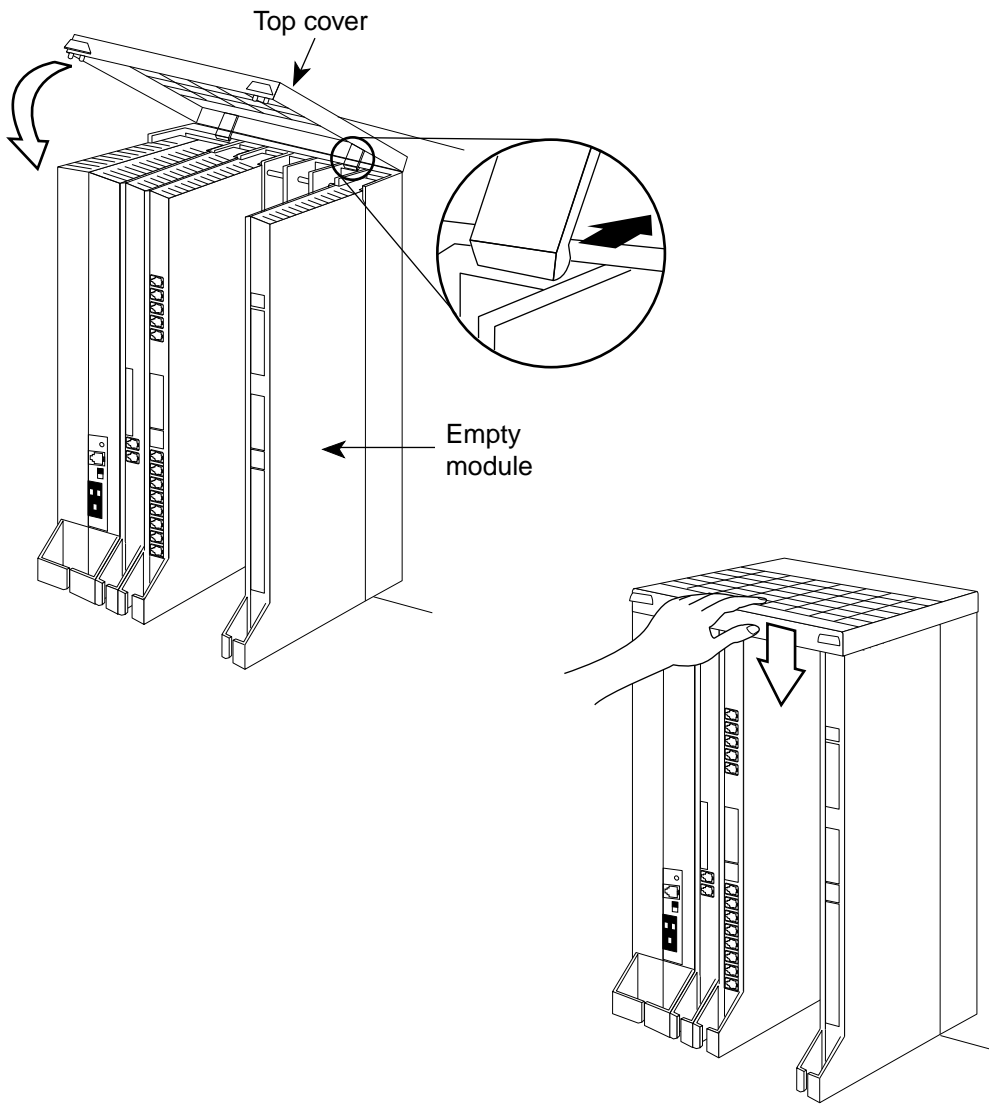

Figure E-2. Installing the Top Cover

Installing the Front Cover

To install the front cover, see [Figure E-3](#) and follow these steps:

1. Hook the top of the front cover into the top cover.
2. Push down on the bottom of the front cover until it locks securely on the base of the wire manager on the modules.

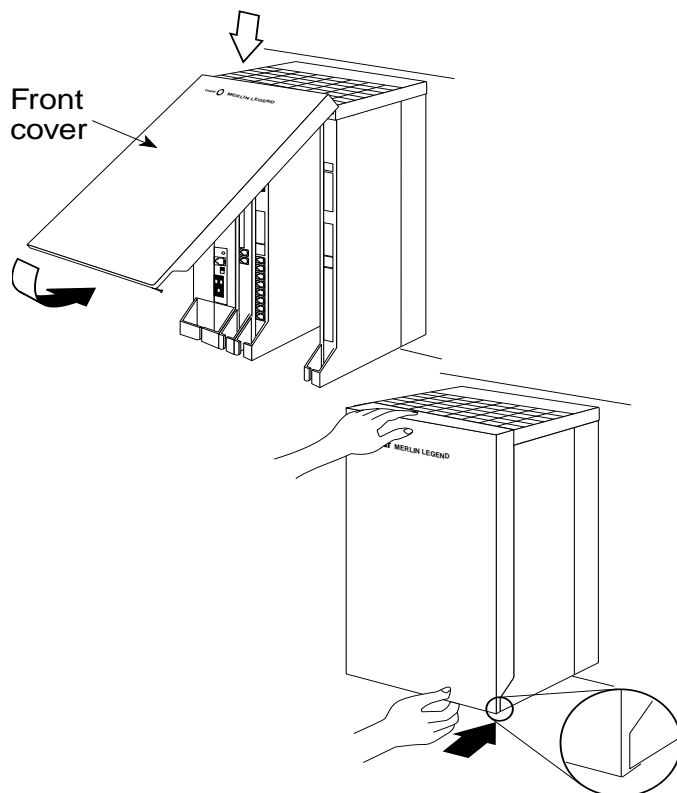

Figure E-3. Installing the Front Cover

Glossary

Italics

The use of italics in the glossary denotes multiple usage of the italicized text throughout the glossary.

Numerics

- | | |
|--------------------------|---|
| 2B data | Digital information carried by two <i>B-channels</i> for better performance and quality; the <i>bit rate</i> is twice that of one B-channel used alone. |
| 7500B data module | See <i>ISDN 7500B Data Module</i> |
-

A

- | | |
|----------------------------|--|
| account code | Code used to associate incoming and outgoing calls with corresponding accounts, employees, projects, and clients. |
| ACCUNET | AT&T's switched digital service for 56-kbps, 64-kbps restricted, and 64-kbps clear circuit-switched data calls. |
| address | A coded representation of the destination of data or of the data's originating terminal, such as the dialed extension number assigned to the data terminal. Multiple terminals on one communications line must each have a unique address. |
| ADDS | (Automated Document Delivery System) Computer-based application that stores documents in a database and automatically faxes them on request. |
| adjunct | Optional equipment used with the communications system, such as an alerting device or <i>modem</i> that connects to a multiline telephone or to an extension jack. |
| ALS | (Automatic Line Selection) Programmed order in which the system makes outside lines available to a user. |
| ambiguous numbering | Numbering of extension ranges, remote access codes, or other system components that causes conflicts in network operations. These numbers can be unique and still be ambiguous. For example, Extension 441 is different from Extension 4410. However, for <i>UDP routing</i> purposes, the two numbers are ambiguous and a call intended for Extension 4410 is misrouted on the first three digits sent, to Extension 441. See also <i>unambiguous numbering</i> . |
| AMI | (alternate mark inversion) Line coding format in which a binary one is represented by a positive or negative pulse, a binary zero is represented by no line signal, and subsequent binary ones must alternate in polarity: |

AMI	(alternate mark inversion) Line coding format in which a binary one is represented by a positive or negative pulse, a binary zero is represented by no line signal, and subsequent binary ones must alternate in polarity; otherwise, a <i>bipolar violation</i> occurs. AMI is used in the <i>DS1</i> interface.
Analog data station	See <i>modem data station</i> .
analog transmission	Mode of transmission in which information is represented in continuously variable physical quantities, such as amplitude, frequency, phase, or resistance. See also <i>digital transmission</i> .
ANI	(Automatic Number Identification) Process of automatically identifying a caller's billing number and transmitting that number from the caller's local central office to another point on or off the public network.
application	Software and/or hardware that adds functional capabilities to the system. For example, MERLIN Identifier is an application that provides caller identification information (if available in the local area or jurisdiction).
ARS	(Automatic Route Selection) System feature that routes calls on outside facilities according to the number dialed and line/trunk availability. To initiate ARS, the user dials a <i>dial-out code</i> , also called an "ARS access code."
ASCAP	(American Society of Composers, Artists, and Producers)
ASN	(AT&T Switched Network) AT&T telecommunications services provided through an Integrated Digital Services Network Primary Rate Interface (ISDN-PRI) trunk, <i>Accunet</i> switched digital service, <i>Megacom</i> , <i>Megacom 800</i> , Software Defined Network (SDN), Multiquest, and Shared Access for Switch Services (SASS).
asynchronous data transmission	A method of transmitting a short bitstream of digital data, such as printable characters represented by a 7- or 8-bit ASCII code. Each string of data bits is preceded by a start bit and followed by a stop bit, thus permitting data to be transmitted at irregular intervals. See also <i>synchronous data transmission</i> .
AT&T Attendant	Application with equipment that connects to one or more <i>tip/ring</i> extension jacks and automatically answers incoming calls with a recorded announcement; directs calls in response to touch tones.
AT&T Switched Network	See <i>ASN</i> .
AUDIX Voice Power	A voice-processing application, part of <i>IS II/III</i> , that provides Automated Attendant, Call Answer, Information Service, Message Drop, Voice Mail, and, optionally, <i>Fax Attendant System</i> for use with the system.

Automated Attendant	<i>IS III/III, MERLIN LEGEND MAIL, and Lucent Technologies Attendant</i> application that automatically answers incoming calls with a recorded announcement and directs callers to a department, an extension, or the system operator.
Automated Document Delivery System	See <i>ADDS</i> .
automatic immediate cycling	Process that occurs in private network when all available routes for a call specify systems with matching <i>switch identifiers</i> . The call is routed from the originating system to the destination system and back to the originating system in a continuous loop. <i>Switch identifiers</i> labelling systems must be unique across a network.
Automatic Line Selection	See <i>ALS</i> .
Automatic Number Identification	See <i>ANI</i> .
automatic ringdown tie-trunk	See <i>automatic-start tie trunk</i> .
Automatic Route Selection	See <i>ARS</i> .
automatic-start tie trunk	<i>Tie trunk</i> on which incoming calls are routed to an operator or other designated destination without a start signal, as soon as the trunk is seized; the destination is specified during programming. Also called "automatic ringdown" or "auto-in" tie trunk.
auxiliary power unit	Device that provides additional power to the system.

B

B8ZS	(bipolar 8 zero substitution) Line-coding format that encodes a string of eight zeros in a unique binary sequence to detect bipolar violations.
backup	Procedure for saving a copy of system programming onto a floppy disk or <i>memory card</i> . See also <i>restore</i> .
bandwidth	Difference, expressed in hertz, between the highest and lowest frequencies in a range that determines channel capacity.
barrier code	Password used to limit access to the <i>Remote Access</i> feature of the system. In a <i>private network</i> , it is especially important that barrier codes be required for all types of remote access.
basic carrier	Hardware that holds and connects the <i>processor module, power supply module</i> , and up to five other modules in the system. See also <i>expansion carrier</i> .

baud rate	Strictly speaking, a measurement of transmission speed equal to the number of signal level changes per second. In practice, often used synonymously with <i>bit rate</i> and <i>bps</i> .
B-channel	(Bearer-channel) 64- or 56-kbps channel that carries a variety of digital information streams, such as voice at 64 kbps, data at up to 64 kbps, wideband voice encoded at 64 kbps, and voice at less than 64 kbps, alone or combined.
Basic Rate Interface	See <i>BRI</i> .
Bearer-channel	See <i>B-channel</i> .
Behind Switch mode	One of three modes of system operation, in which the control unit is connected to (behind) another telephone switching system, such as <i>Centrex</i> or <i>DEFINITY</i> , which provides features and services to telephone users. See also <i>Hybrid/PBX mode</i> and <i>Key mode</i> .
binary code	Electrical representation of quantities or symbols expressed in the base-2 number system, which includes zeros and ones.
bipolar 8 zero substitution	See <i>B8ZS</i> .
bipolar signal	Digital signal in which pulses (ones) alternate between positive and negative. See also <i>AMI</i> , <i>B8ZS</i> , and <i>bipolar violation</i> .
bipolar violation	Condition occurring when two positive or two negative pulses are received in succession. See also <i>AMI</i> and <i>B8ZS</i> .
BIS	(Built-In Speakerphone) Part of the model name of some analog multiline telephones.
bit	(binary digit) One unit of information in binary notation; it can have one of two values, zero or one.
bit rate	Speed at which bits are transmitted, usually expressed in <i>bps</i> . Also called "data rate."
blocking	Condition in which end-to-end connections cannot be made on calls because of a full load on all possible services and facilities. See also <i>glare</i> .
BMI	(Broadcast Music Incorporated)
board	A module, for example, 100D or 408 MLX GS/LS, that allows you to connect lines/trunks and extensions to the communications system.
board assignment	System Programming and Maintenance (SPM) procedure for assigning line/trunk and extension modules to slots on the control unit.
board renumbering	System programming procedure for renumbering boards that have already been assigned to specific slots on the control unit.

BRI	(Basic Rate Interface) A standard protocol for accessing Integrated Service Digital Network (ISDN) services.
broadband	Transmission path having a bandwidth greater than a voice-grade channel.
BTMI	(basic telephone modem interface)
bus	Multiconductor electrical path used to transfer information over a common connection from any of several sources to any of several destinations.
button	Key on the face of a telephone that is used to access a line, activate a feature, or enter a code on a communications system.
byte	Sequence of <i>bits</i> (usually eight) processed together. Also called "octet."

C

Call Accounting System	See <i>CAS</i> .
Call Accounting Terminal	See <i>CAT</i> .
Caller ID	A service provided by some local telephone companies (if local regulations allow) that supplies the calling party telephone number. In Release 3.0 and later, an 800 GS/LS-ID module on the system can capture this information and display it on the screens of MLX telephones. See also <i>ANI</i> .
Calling group	Team of individuals who answer the same types of calls.
Call Management System	See <i>CMS</i> .
CAS	(Call Accounting System) DOS- or UNIX System-based application that monitors and manages telecommunications costs.
CAT	(Call Accounting Terminal) Standalone unit with a built-in microprocessor and data buffer that provides simple call accounting at a low cost.
CCITT	(International Telegraph and Telephone Consultative Committee)
CCS	(common-channel signaling) Signaling in which one channel of a group of channels carries signaling information for each of the remaining channels, permitting each of the remaining channels to be used to nearly full capacity. In the system's 100D module, channel 24 can be designated as the signaling channel for channels 1–23.

centralized telephone programming	Programming of features on individual telephones; performed at a central location by the system manager. See also <i>system programming</i> and <i>extension programming</i> .
central office	See <i>CO</i> .
Centrex	Set of system features to which a user can subscribe on telephone trunks from the local telephone company.
channel	Telecommunications transmission path for voice and/or data.
channel service unit	See <i>CSU</i> .
checksum	Sum of ones in a sequence of ones and zeros used to detect or correct errors in data transmission.
circuit-switched data call	Data call made through an exclusively established and maintained connection between <i>data stations</i> .
class of restriction	See <i>COR</i> .
clear data channel	Clear data channels (also called unrestricted data channels) allow the transmission of occurrences of more than seven contiguous zero bits. If a clear data channel is requested and only restricted channels are available, the call will be rejected. See also restricted data channel.
clock synchronization	When digital signals are transmitted over a communications link, the receiving end must be synchronized with the transmitting end to receive the digital signals without errors using clock synchronization. A system synchronizes itself by extracting a timing signal from an incoming digital stream. All the digital facilities in a network operate from a single common clock, preferably a port connected to a digital <i>PSTN</i> facility on a <i>hub system</i> or a system that connects two network systems. In this case, all digital facilities specify a loop clock source. One system in a network may be specified as a local clock source when no functioning digital facility in the network is connected to the <i>PSTN</i> . All other digital facilities then use this clock and specify their clock sources as loop. Primary, secondary, and tertiary clock sources are specified to allow backup synchronization in the event that the primary source is out of service.
CMS	(Call Management System) DOS-based application that simulates the actions of a system operator by answering and distributing calls. Also produces reports for call analysis.
CO	(central office) Location of telephone switching equipment that provides local telephone service and access to toll facilities for long-distance calling.
coaxial cable	Cable consisting of one conductor, usually a small copper tube or wire within and insulated from another conductor of larger diameter, usually copper tubing or copper braid.

codec	(coder-decoder) Device used to convert analog signals such as speech, music, or television to digital form for transmission over a digital medium and back to the original analog form.
collected digits	Digits that a caller dials in response to an integrated voice response application's menus (also called <i>prompted digits</i>); collected digits may be used to initiate <i>screen pop</i> at a system extension. See also <i>CTI link</i> .
combination configuration	A <i>private network</i> arrangement that combines characteristics of <i>Virtual Private Network (VPN)</i> , a <i>series configuration</i> , and a <i>star configuration</i> .
common channel signaling	See <i>CCS</i> .
communications system	Software-controlled processor complex that interprets dialing pulses, tones, and/or keyboard characters and makes the proper interconnections both inside and outside. Consists of a computer, software, a storage device, and carriers with special hardware to perform the actual connections. Provides voice and/or data communications services, including access to public and private networks, for telephones and other equipment. Also referred to in this guide as "system," short for MERLIN LEGEND Communications System.
control unit	<i>Processor module, power supply module, other modules, carriers, and housing of the system.</i>
console	Telephone and <i>adjuncts</i> (if any) at operator or system programmer extension.
CONVERSANT	Entry-level voice response application that automatically answers and routes calls and executes telephone transactions.
conversion resource	See <i>modem pool</i> .
coordinating system manager	In a <i>private network</i> that includes more than two systems, the system manager who acts as a clearinghouse for any changes made on local systems, that effect the network, assuring that all system managers work together and that local system changes do not have undesirable effects on the network as a whole.
COR	(class of restriction) Various types of restrictions that can be assigned to <i>remote access trunks</i> or barrier codes. These restrictions consist of calling restrictions, <i>ARS Facility Restriction Levels (FRLs)</i> , Allowed Lists, Disallowed Lists, and Automatic Callback queuing.
Coverage	Set of system features that can determine how extensions' calls are covered when the person at the extension is busy or not available.
CRC	(cyclic redundancy check) An error-detection code used on <i>DS1</i> facilities with the extended superframe format (<i>ESF</i>).

CSU	(channel service unit) Equipment used on customer premises to provide <i>DS1</i> facility terminations and signaling compatibility.
CTI link	(Computer Telephony Integration) link. A hardware/software feature that is part of the PassageWay Telephony Services application. It allows the use of Lucent Technologies-certified software applications on a <i>LAN</i> running Novell NetWare software in a <i>Hybrid/PBX mode</i> system. These applications may provide special features for client control of such calling activities as power dialing. See also <i>screen pop</i> .
cyclic redundancy check	See <i>CRC</i> .

D

D4 framing format	<i>Framing format</i> consisting of a sequence of individual frames of 24 eight-bit slots and one signal bit (193 bits) in a 12-frame superframe. See also <i>ESF</i> .
Data-channel	See <i>D-channel</i> .
data communications equipment	See <i>DCE</i> .
data module	A type of <i>ISDN terminal adapter</i> that acts as the <i>DCE</i> at a <i>data workstation</i> that communicates over high-speed <i>digital</i> facilities.
data rate	See <i>bps</i> .
data station	Special type of extension where data communications take place; includes <i>DTE</i> and <i>DCE</i> ; sometimes a telephone is also part of a data station.
data terminal	An input/output device (often a personal computer) that can be connected to the control unit via an interface.
data terminal equipment	See <i>DTE</i> and <i>data terminal</i> .
data workstation	Special type of extension where data communications take place; includes <i>DTE</i> and <i>DCE</i> ; sometimes a telephone is also part of a data workstation.
DCE	(data communications equipment) Equipment such as <i>modems</i> or <i>ISDN terminal adapters</i> used to establish, maintain, and terminate a connection between the system and data terminal equipment (<i>DTE</i>), such as printers, personal computers, host computers, or network workstations.
DCP	(Digital Communications Protocol) AT&T proprietary protocol to transmit digitized voice and data over the same communications link.

D-channel	(Data-channel) 16- or 64-kbps channel that carries signaling information or data on a <i>PRI</i> or <i>BRI</i> .
dedicated feature buttons	The imprinted feature buttons on a telephone: Conf or Conference , Drop , Feature , HFAI (Hands Free Answer on Intercom), Hold , Message , Mute or Microphone , Recall , Speakerphone or Spkrphone , and Transfer .
delay-start tie trunk	<i>Tie trunk</i> or <i>tandem tie trunk</i> on which the originating end of the tie trunk transmits an off-hook signal to the receiving end and waits for the receiving end to send an off-hook signal followed by an on-hook signal. Also called "dial-repeating tie trunk."
desktop videoconferencing system	A system application that allows face-to-face, simultaneous video and voice communications between individuals and requires high-speed data transmission facilities. See also <i>group videoconferencing system</i> .
DFT	(direct facility termination) See <i>personal line</i> .
DHG	(data hunt group) Group of analog or digital <i>data stations</i> that share a common access code. Calls are connected in a round-robin fashion to the first available data station in the group.
dial access	See <i>feature code</i> .
Dialed Number Identification Service	See <i>DNIS</i> .
dial-out code	Digit (usually a 9) or digits dialed by telephone users to get an outside line.
dial plan	Numbering scheme for system extensions, lines, and trunks.
dial-repeating tie trunk	<i>Tie trunk</i> on which the originating end of the tie trunk transmits an off-hook signal to the receiving end and waits for the receiving end to send an off-hook signal followed by an on-hook signal. Also called "dial-repeating tie trunk."
DID	(Direct Inward Dial) Service that transmits from the telephone company central office and routes incoming calls directly to the called extension, <i>calling group</i> , or outgoing line/trunk <i>pool</i> , bypassing the system operator.
DID trunk	Incoming trunk that receives dialed digits from the local exchange, allowing the system to connect directly to an extension without assistance from the system operator.
digital	Representation of information in discrete elements such as off and on or zero and one. See also <i>analog transmission</i> .
Digital Communications Protocol	See <i>DCP</i> .
digital data station	See <i>ISDN terminal adapter data station</i> .
Digital Signal 0	See <i>DS0</i> .

Digital Signal 1	See <i>DS1</i> .
digital subscriber line	See <i>DSL</i> .
digital switch element	See <i>DSE</i> .
digital transmission	Mode of transmission in which the information to be transmitted is first converted to digital form and then transmitted as a serial stream of pulses. See also <i>analog transmission</i> .
DIP switch	(dual in-line package) Switch on a 400EM module used to select the signaling format for tie-line transmission. Also used on other equipment for setting hardware options.
direct facility termination	(DFT) See <i>personal line</i> .
Direct Inward Dial	See <i>DID</i> .
Direct-Line Console	See <i>DLC</i> .
Direct Station Selector	See <i>DSS</i> .
display buttons	Buttons on an MLX display telephone used to access the telephone's display.
DLC	(Direct-Line Console) Telephone used by a system operator to answer outside calls (not directed to an individual or a group) and inside calls, transfer calls, make outside calls for users with outward calling restrictions, set up conference calls, and monitor system operation.
DNIS	(Dialed Number Identification Service) Service provided by AT&T and MCI; it routes incoming 800 or 900 calls according to customer-selected parameters, such as area code, state, or time of call.
door answering unit	Device connected to a basic telephone jack and used at an unattended extension or front desk.
DOS	(disk operating system)
drop-and-insert equipment	A device that can be installed between systems connected by <i>tandem PRI trunks</i> or T1-emulated <i>tandem tie trunks</i> to allow fractional use of the facility, that is, use of fewer than 23 of the PRI <i>B-channels</i> or fewer than 24 of the T1 <i>channels</i> . In a PRI facility, the equipment must never drop Channel 24, the <i>D-channel</i> . All channels must still be programmed and all count towards the system maximum of 80 lines.
DS0	(Digital Signal 0) Single 64-kbps voice or data channel.
DS1	(Digital Signal 1) <i>Bit</i> -oriented signaling interface that multiplexes twenty-four 64-kbps channels into a single 1.544-Mbps stream.

DSL	(Digital Subscriber Line) A Digital Subscriber Line provides full-duplex service on a single twisted metallic pair (2-wire) at a rate sufficient to support ISDN Basic Rate Access.
DSS	(Direct Station Selector) 60-button <i>adjunct</i> that enhances the call-handling capabilities of an MLX-20L or MLX-28D telephone used as an operator console.
DTE	(data terminal equipment) Equipment that makes the endpoints in a connection over a data connection; for example, a data terminal, personal computer, host computer, or printer.
DTMF signaling	(dual-tone multifrequency signaling) Touch-tone signaling from telephones using the voice transmission path. DTMF signaling provides 12 distinct signals, each representing a dialed digit or character, and each composed of two voiceband frequencies.

E

E&M signaling	Trunk supervisory signaling, used between two communications systems, in which signaling information is transferred through two-state voltage conditions (on the Ear and Mouth leads) for analog applications and through two <i>bits</i> for digital applications. See also <i>tie trunk</i> .
EIA	(Electronic Industries Association)
EIA-232-D	Physical interface, specified by the <i>EIA</i> , that transmits and receives asynchronous data at speeds of up to 19.2-kbps over cable distances of 50 feet (15 m).
Electronic Switching System	See <i>ESS</i> .
endpoint	Final destination in the path of an electrical or telecommunications signal.
ESF	(extended superframe format) <i>PRI</i> framing format consisting of individual frames of 24 eight-bit slots and one signaling bit (193 bits) in a 24-frame extended superframe.
ESS	(Electronic Switching System) Class of central office (<i>CO</i>) switching systems developed by Lucent Technologies in which the control functions are performed principally by electronic data processors operating under the direction of a stored program.
expansion carrier	Carrier added to the control unit when the basic carrier cannot house all of the required modules. Houses a power supply module and up to six additional modules.
ExpressRoute 1000	Data communications device that allows connection between an RS-232 <i>DTE</i> device and the control unit using MLX extension jacks on the 008 MLX or 408 GS/LS-MLX module.

extended superframe format	See <i>ESF</i> .
extension	An endpoint on the internal side of the communications system. An extension can be a telephone with or without an adjunct. Also called "station." See also <i>data workstation</i> .
extension jack	An analog, digital, or <i>tip/ring</i> physical interface on a module in the control unit for connecting a telephone or other device to the system. Also called "station jack."
extension programming	Programming performed at an extension to customize telephones for personal needs; users can program features on buttons, set the telephone ringing pattern, and so on. See also <i>centralized telephone programming</i> and <i>system programming</i> .

F

facility	Equipment (often a <i>line/trunk</i>) constituting a telecommunications path between the system and the telephone company central office (<i>CO</i>).
Facility Restriction Level	See <i>FRL</i> .
factory setting	Default state of a device or feature when an optional setting is not programmed by the user or system manager.
fax	(facsimile) Scanning and transmission of a graphic image over a telecommunications facility, or the resulting reproduced image, or the machine that does the scanning and transmitting.
Fax Attendant System	Fax handling and processing application available with <i>AUDIX Voice Power</i> .
FCC	(Federal Communications Commission)
feature	Function or service provided by the system.
feature code	Code entered on a dialpad to activate a feature.
feature module	Prior to Release 3.0, a circuit pack inserted into the <i>processor module</i> , used to provide system features and replaced when the system is upgraded.
Feature screen	Display screen on MLX display telephones; provides quick access to commonly used features.
ferrite core	Attachment to the AC power cord and ground wire of the carrier power supply for compliance with FCC, part 15 requirements.
Flash ROM	Beginning with Release 3.0, a type of read-only memory provided on the <i>processor module</i> , used to supply system features.
foil shield	Copper foil sheet (for power units) used to prevent excessive noise on the module.

forced idle	Condition of the system during certain programming or maintenance procedures; system prevents initiation of new calls.
foreign exchange	See <i>FX</i> .
Fractional-T1	A digital transmission facility consisting of at least one, and fewer than 24 <i>DS0</i> channels using robbed-bit signaling and connecting a <i>PBX</i> and a <i>central office</i> or toll office.
frame	One of several segments of an analog or digital signal that has a repetitive characteristic. For example, a <i>DS1</i> frame consists of a framing <i>bit</i> and 24 bytes, which equals 193 bits.
framing format	Pattern of <i>frames</i> used in transmissions.
frequency generator	See <i>ring generator</i> .
FRL	(Facility Restriction Level) Calling restriction type that restricts calls to certain specified <i>ARS</i> and <i>UDP</i> routes.
FX	(Foreign exchange) Central office (<i>CO</i>) other than the one that is providing local access to the public telephone network.

G

General Purpose Adapter	See <i>GPA</i> .
glare	Condition that occurs when a user tries to call out on a <i>loop-start line</i> at the same time that another call arrives on the same line.
GPA	(General Purpose Adapter) Device that connects an analog multiline telephone to optional equipment such as an answering machine or a fax machine.
ground-start trunk	Trunk on which the communications system, after verifying that the trunk is idle (no ground on tip lead), transmits a request for service (puts ground on ring lead) to the telephone company central office (<i>CO</i>).
Group IV (G4) fax machine	A fax unit, offering 400 by 100 dots per inch (DPI) in fine mode, that can operate at any speed for communication with a Group III (G3) fax machine or another Group IV (G4) fax machine.
group videoconferencing system	A system application that allows face-to-face, simultaneous video and voice communications between groups and requires high-speed data transmission facilities. See also <i>desktop videoconferencing system</i> .

H

Hands Free Answer on Intercom	See <i>HFAI</i> .
hands-free unit	See <i>HFU</i> .
headset	Lightweight earpiece and microphone used for hands-free telephone operation.
HFAI	(Hands Free Answer on Intercom) Feature that allows a user to answer a voice-announced call.
HFU	(Hands-Free Unit) Unit for analog multiline telephones that allows users to make and receive calls on the speakerphone without using the handset.
Home screen	Display normally shown on an MLX display telephone; shows time, date, and call information, and shows when some features are in use.
host	Telephone company or other switch providing features and services to the system users, usually when the system is operating in <i>Behind Switch mode</i> .
hub system	In <i>private network</i> that is arranged in a <i>star configuration</i> , the communications system through which all calls across the network pass.
Hybrid/PBX mode	One of three modes of system operation, in which the system uses line/trunk <i>pools</i> and <i>ARS</i> in addition to <i>personal lines</i> . Provides a single interface (SA buttons) to users for both internal and external calling. See also <i>Behind Switch mode</i> and <i>Key mode</i> .

I

ICLID	(Incoming Call Line Identification) See <i>Caller ID</i> .
ICOM buttons	(intercom buttons) Telephone buttons that provide access to inside system lines for calling other extensions or receiving calls from them.
immediate-start tie trunk	<i>Tie trunk</i> on which no start signal is necessary; dialing can begin immediately after the trunk is seized.
in-band signaling	See <i>robbed-bit signaling</i> .
inside dial tone	A tone users hear when they are off-hook on an SA or ICOM button.
Inspect screen	Display screen on an MLX display telephone that allows the user to preview incoming calls and see a list of the features programmed on line buttons.

Integrated Administration	Capability of <i>IS III</i> that simplifies the programming of common information for the system, <i>AUDIX Voice Power</i> , and, if it is also installed, <i>Fax Attendant System</i> .
Integrated Services Digital Network	See <i>ISDN</i> .
Integrated Solution II/III	See <i>IS II/III</i> .
Integrated Voice Power Automated Attendant	<i>IS II</i> application that automatically answers incoming calls with a recorded announcement and directs callers to a department, an extension, or the system operator.
intercom buttons	See ICOM buttons .
interface	Hardware and/or software that links systems, programs, or devices.
intersystem calls	In a <i>private network</i> , calls between a local extension and a <i>local or non-local dial plan</i> extension.
Intuity CONVERSANT	Voice response application that automatically answers and routes calls and executes telephone transactions.
I/O device	(input/output device) Equipment that can be attached to a computer internally or externally for managing a computer system's input and output of information.
IROB protector	(In-Range Out-of-Building protector) Surge-protection device for off-premises telephones at a location within 1000 feet (305 m) of cable distance from the control unit.
IS II/III	(Integrated Solution II or Integrated Solution III) Set of UNIX System-based applications that augments and provides additional services using the system.
ISDN	(Integrated Services Digital Network) Public or private network that provides end-to-end digital connectivity for all services to which users have access by a limited set of standard multipurpose user and <i>network interfaces</i> ; provides digital circuit-switched or packet-switched connections within the network and to other networks for national and international digital connectivity.
ISDN 7500B Data Module	Data communications device that allows connection between an RS-232 <i>DTE</i> device and the control unit by MLX extension jacks on the 008 MLX or 408 GS/LS-MLX module.
ISDN terminal adapter	(Integrated Services Digital Network terminal adapter) A device that connects the communications system with <i>data terminal equipment (DTE)</i> ; for example, an <i>ISDN terminal adapter</i> or <i>modem</i> acting as <i>data communications equipment (DCE)</i> for a PC.

ISDN terminal adapter data station A type of data station that includes an ISDN terminal adapter as its DCE. It may also include an MLX telephone for simultaneous voice and data (ISDN terminal adapter data-only station). These data stations connect to MLX extension jack modules for digital transmission of data over a DS1 facility.

J

jack Physical connection point to the system for a telephone, line/trunk, or other device. Also called "port."

K

kbps (kilobits per second)

Key mode One of three modes of system operation, in which the system uses personal lines on line buttons for outside calls, with a separate interface (**ICOM buttons**) for inside calling. See also *Behind Switch mode* and *Hybrid/PBX mode*.

L

LAN (local area network) Arrangement of interconnected personal computers or terminals, sometimes accessing a host computer, sometimes sharing resources such as files and printers.

LDN (Listed Directory Number)

LED (light-emitting diode) Semiconductor device that produces light when voltage is applied; light on a telephone.

line Connection between extensions within the communications system; often, however, used synonymously with *trunk*.

line and trunk assignment Assignment of lines and trunks connected to the system control unit to specific buttons on each telephone.

line coding Pattern that data assumes as it is transmitted over a communications channel.

line compensation Adjustment for the amount of cable loss in decibels (dB), based on the length of cable between a 100D module and a channel service unit (*CSU*) or other far-end connection point.

line/trunk Refers to inside system lines and outside lines/trunks in general terms. See also *line* and *trunk*.

line/trunk jack	Physical interface on a module in the control unit for connecting an outside line/trunk to the communications system. Also called "trunk jack."
line/trunk and extension module	Module on which the jacks for connecting central office lines/trunks and/or the jacks for connecting the extensions are located.
local dial plan	In a system that is part of a <i>private network</i> , a list of extension ranges that the local system references in order to route local <i>intersystem calls via UDP</i> .
local host computer access	A method for connecting an extension jack to an on-site computer for data-only calls through a <i>modem</i> or <i>ISDN terminal adapter</i> .
local loop	The two-way connection between a customer's premises and the central office (CO).
local user	In a <i>private network</i> , a person whose extension is connected to the local control unit.
logical ID	Unique numeric identifier for each <i>extension</i> and <i>line/trunk jack</i> in the system control unit.
loop-start line	Line on which a closure between the tip and ring leads is used to originate or answer a call. High-voltage 20-Hz AC ringing current from the central office signals an incoming call.
Lucent Technologies Attendant	Application with equipment that connects to one or more <i>tip/ring (T/R)</i> extension jacks and automatically answers incoming calls with a recorded announcement; directs calls in response to touch tones.

M

Magic on Hold	A Lucent Technologies Music On Hold enhancement that promotes a company's products or services.
Mbps	(megabits per second)
Megacom	The AT&T tariffed digital <i>WATS</i> offering for outward calling.
Megacom 800	The AT&T tariffed digital 800 offering for inward calling.
memory card	Storage medium, similar in function to a floppy disk, that allows information to be added to or obtained from the communications system through the PCMCIA interface slot on the processor module.
MERLIN Identifier	Adjunct that allows users to receive, store, and use information provided by Caller ID.
MERLIN and MERLIN LEGEND MAIL Voice Messaging Systems	Applications that provide automated attendant, call answering, and voice-mail services on the system.

MFM	(Multi-Function Module) Adapter that has a <i>tip/ring</i> mode for answering machines, modems, fax machines, and <i>tip/ring</i> alerts, and an <i>SAA</i> mode for -48 VDC alerts. It is installed inside an MLX telephone and is used to connect optional equipment to the telephone. The optional equipment and the telephone operate simultaneously and independently.
MLX-5 or MLX-5D telephone	5-line button digital telephone offered with (MLX-5D) or without (MLX-5) a 2-line by 24-character display.
MLX-10, MLX-10D or MLX-10DP telephone	10-line button digital telephone offered with (MLX-10D) or without (MLX-10) a 2-line by 24-character display. The MLX-10DP allows connection of <i>Passageway Direct Connection Solution</i> .
MLX-16DP telephone	16-line button digital telephone offered with a 2-line by 24-character display, allowing connection of <i>Passageway Direct Connection Solution</i> .
MLX-20L telephone	20-line button digital telephone with a 7-line by 24-character display.
MLX-28D telephone	28-line button digital telephone with a 2-line by 24-character display.
mode codes	Streams of touch-tone codes used by voice messaging applications to communicate with the system's control unit.
modem	Device that converts digital data signals to analog signals for transmission over a telephone line, and analog signals received on a telephone line to digital signals.
modem data station	A type of data station that includes a modem as its DCE. It may also include an MLX telephone for simultaneous voice and data (MLX voice and modem data station), an analog multiline telephone (analog voice and modem data station), or a single-line telephone for dialing only (modem data-only station). These data stations connect respectively to MLX, analog, or <i>tip/ring</i> extension jack modules. They provide analog transmission of data.
modem pool	Pair, or group of pairs, of <i>modems</i> and data modules with interconnected RS-232 interfaces that converts digital signals to analog, or analog signals to digital, thereby allowing users with <i>ISDN terminal adapter data stations</i> to communicate with users who have analog <i>modem data stations</i> .

module	Circuit pack in the control unit that provides the physical jacks for connection of telephones and/or outside lines/trunks to the communications system. In the name of a module, the first digit indicates the number of <i>line/trunk jacks</i> it contains; the last digit indicates the number of <i>extension jacks</i> it contains. If no letters appear after the number, a line/trunk module provides <i>loop-start lines</i> or an extension jack module provides analog or <i>tip/ring jacks</i> . For example, a 408 GS/LS MLX module contains four line/trunk jacks and eight digital (MLX) extension jacks, and provides either <i>loop-start (LS)</i> or <i>ground-start (GS)trunks</i> .
monitored extension	Extension for which one or more CTI applications is receiving call information. The CTI application does not have to be directly attached to the equipment at the extension in order to monitor calls. The call information may appear on the PC screen of another extension that has been programmed to receive it. See also <i>CTI link</i> and <i>unmonitored extension</i> .
Multi-Function Module	See <i>MFM</i> .
multiline telephone	An analog or digital (MLX) telephone that provides multiple line buttons for making or receiving calls or programming features.
multiplexing	The division of a transmission channel into two or more independent channels, either by splitting the frequency band into a number of narrower bands or by dividing the channel into successive time slots.
Music On Hold	Customer-provided music source or Magic on Hold connected to the system through a <i>loop-start</i> jack.

N

network	Configuration of communications devices and software connected for information interchange.
network interface	Hardware, software, or both that links two systems in an interconnected group of systems, for example, between the local telephone company and a PBX.
NI-1 BRI	(National Integrated Services Digital Network 1 Basic Rate Interface) A type of digital facility that carries the equivalent of three lines. Two are called <i>B-channels</i> and provide voice and data communications services. A third <i>D-channel</i> controls signaling and maintains operations on the B-channels.
non-local user	In a <i>private network</i> , a user who is connected to another system in the network and not to the local system.
non-local dial plan	In a system that is part of a <i>private network</i> , a list of extension ranges that the local system references in order to route non-local <i>intersystem calls via UDP</i> .

non-satellite system In a *private network*, a *communications system* that is directly connected to and located more than 200 miles from the local system.

O

off-hook Telephone is said to be off-hook when the user has lifted the handset, pressed the **Speakerphone** button to turn on the speakerphone, or used a headset to connect to the communications system or the telephone network.

off-premises telephone See *OPT*.

ones density Requirement for channelized *DS1* service to the public network that eight consecutive zeros cannot occur in a digital data stream.

on-hook Telephone is said to be on-hook when the handset is hung up, the speakerphone is turned off, and the user is not using a headset to connect to the communications system or the telephone network.

OPT (off-premises telephone) *Single-line telephone* or other *tip/ring* device connected to the system via a 008 OPT module in the control unit. Appears as an inside extension to the system, but may be physically located away from the system.

OPX (off-premises extension)

out-of-band signaling Signaling that uses the same path as voice-frequency transmission and in which the signaling is outside the band used for voice frequencies.

P

parity The addition of a *bit* to a bit string so that the total number of ones is odd or even, used to detect and correct transmission errors.

PassageWay Direct Connection Solution Set of software applications that provides an interface between a personal computer and an MLX telephone.

PBX (private branch exchange) Local electronic telephone switch that serves local stations (for example, extensions within a business) and provides them with access to the public network.

PC personal computer

PCMCIA memory card (Personal Computer Memory Card International Association memory card) See *memory card*.

peripheral system	In a <i>private network</i> , a system that does not connect to more than one other system, sometimes called an "end node."
personal line	Central office line/trunk that terminates directly at one or more extensions. In <i>Hybrid/PBX mode</i> , a personal line cannot be part of a line/trunk <i>pool</i> . Also called "DFT" (direct facility termination).
PFT	(Power Failure Transfer) Feature that provides continuity of telephone service during a commercial power failure by switching some of the system's line/trunk connections to telephones connected to specially designated extension jacks.
phantom extension	An extension that is not actually plugged into the system but is used, for example, as a calling group member covered by a <i>voice messaging system</i> .
pool	In <i>Hybrid/PBX mode</i> , a group of outside lines/trunks that users can access with a Pool button or by dialing an access code on an SA button. Also used by the <i>ARS</i> feature when choosing the least expensive route for a call.
point-to-point facility	In a <i>private network</i> , a line/trunk that passes through the <i>PSTN</i> without using the switching capabilities of the <i>PSTN</i> .
port	See <i>jack</i> . Also, refers to <i>extension</i> or <i>line/trunk jacks</i> before these are numbered according to the <i>dial plan</i> during programming. The lowest jack on a module is always Port 1.
Power Failure Transfer	See <i>PFT</i> .
power supply module	Device that directs electricity to modules and telephones on the system. One power supply module is needed for each carrier, and an <i>auxiliary power unit</i> is added if needed.
PRI	(Primary Rate Interface) Standard interface that specifies the protocol used between two or more communications systems. As used in North America, it provides twenty-three 64-kbps <i>B-channels</i> for voice and/or data and one 16-kbps <i>D-channel</i> , which carries multiplexed signaling information for the other 23 channels.
primary system operator position	First jack on the first MLX or analog multiline extension module in the control unit, that is, the extension jack with the lowest logical ID in the system.
prime line	Individual extension number assigned to a telephone in a system operating in <i>Behind Switch mode</i> . Each telephone user has his or her own prime line and is automatically connected to that line when he or she lifts the handset.
private communications network or private network	An interconnected group of <i>communications systems</i> , which may consist of MERLIN LEGEND Communications Systems, DEFINITY Enterprise Communications Servers (ECS), and/or DEFINITY ProLogix Solutions.

private network trunks	The facilities that connect <i>communications systems</i> in a <i>private network</i> . See also <i>tandem tie trunks</i> and <i>tandem PRI trunks</i> .
processor module	Module in the second slot of the control unit (Slot 0, to the right of the <i>power supply module</i>). Includes the software and memory that runs the system.
programming port reassignment	Reassignment of the system programming jack position to any of the first five extension jacks on the first MLX module in the control unit.
protocol	Set of conventions governing the format and timing of message exchanges between devices, such as an MLX telephone and the control unit.
PSTN	Network that is commonly accessible for local or long-distance calling. Also called "public network" or "public switched network."
PSTN trunk	In a <i>private network</i> , a facility that connects a networked system to the public switched telephone network.
public switched telephone network	See <i>PSTN</i> .

Q

QCC	(Queued Call Console) MLX-20L telephone used by a system operator in <i>Hybrid/PBX mode</i> only. Used to answer outside calls (directed to a system operator position) and inside calls, direct inside and outside calls to an extension or an outside telephone number, serve as a message center, make outside calls for users with outward calling restrictions, set up conference calls, and monitor system operation.
------------	---

R

RAM	(random-access memory) Computer memory in which an individual <i>byte</i> or range of bytes can be addressed and read or changed without affecting other parts of memory.
read-only memory	See <i>ROM</i> .
Remote Access	System feature that allows an outside caller to gain access to the system, almost as if at a system extension. In a <i>private network</i> , remote access settings are used to control calls routed via <i>ARS</i> or <i>UDP</i> routing across the network.
restore	Procedure whereby saved and archived system programming is reinstated on the system, from a floppy disk or <i>memory card</i> . See also <i>backup</i> .

restricted data channel	Restricted data channels do not allow the transmission of occurrences of more than seven contiguous zero bits. See also unrestricted data channel.
ring generator	Circuit pack added to the power supply that generates a high-voltage, 20–30 Hz signal to ring a telephone.
riser cable	Cable that runs between floors in a multistory building and connects wiring closets.
RS-232	Physical interface, specified by the Electronics Industries Association (EIA), that transmits and receives asynchronous data at distances of up to 50 feet (15 m).
robbed-bit signaling	Signaling in which the least significant <i>bit</i> of every sixth frame per channel is used for signaling in that channel.
ROM	(read-only memory) Computer memory that can be read but cannot be changed.

S

SAA	(Supplemental Alert Adapter) Device that permits alerting equipment to be connected to an analog multiline telephone jack so that people working in noisy or remote areas of a building can be alerted to incoming calls.
SA buttons	Telephone buttons that provide access to both inside and outside calls.
satellite system	In a <i>private network</i> , a <i>communications system</i> that is directly connected to and located within 200 miles of the local system.
screen pop	Refers to a computer-telephony software application that takes caller information (for example, provided by Caller ID service), queries a database, and displays a screen with information about the caller onto a user's PC screen. Screen pop requires that an identifying number or code be available to identify the calling party. See also <i>CTI link</i> .
SDN	(Software Defined Network) AT&T private networking service created by specialized software within the public network.
series configuration	A <i>private network</i> arrangement where either two or four or more communications systems are connected in a line, with no particular system acting as the <i>hub system</i> . See also <i>star configuration</i> .
SID	[station (extension) identification]
signaling	Sending of information between devices to set up, maintain, or cease a connection such as a telephone call.
simplex signaling	Transmission of signals in one direction only across a telecommunications channel.

single-line telephone	Industry-standard touch-tone or rotary-dial telephone that handles one call at a time and is connected to the system via an <i>extension jack</i> on a 012, 016, or 008 OPT module.
slot	Position in a <i>carrier</i> for a module; numbered from 0.
SMDR	(Station Message Detail Recording) Feature that captures usage information on incoming and outgoing calls.
SMDR printer	Printer used to produce SMDR reports. Connected to the system via an RS-232 jack on the <i>processor module</i> .
Software Defined Network	See <i>SDN</i> .
special character	Pause, Stop, or End-of-Dialing signal in a programmed dialing sequence such as a speed dial number.
SPM	(System Programming and Maintenance) <i>DOS</i> - or <i>UNIX</i> System-based application for programming the system.
square key	Configuration in <i>Key mode</i> operation in which all outside lines appear on all telephones.
star configuration	A <i>private network</i> arrangement where either three or more communications systems are connected with one system acting as the <i>hub system</i> . See also <i>series configuration</i> .
station	See <i>extension</i> .
station jack	See <i>extension jack</i> .
Station Message Detail Recording	See <i>SMDR</i> .
Supplemental Alert Adapter	See <i>SAA</i> .
switch	See <i>communications system</i> .
Switched 56 service	DS1 Switched 56 Service is an end-to-end digital, 56-kbps, full duplex, synchronous, circuit-switched service offering. The service is offered by network service providers and by some Local Exchange Carriers (LECs) as circuit-switched, 56-kbps service. T1-emulated tandem tie trunks in a private network can be programmed for data.
switchhook flash	Momentary (320 ms to 1 second) on-hook signal used as a control; may be directed to the control unit or to a <i>host</i> switch outside the system. Also called "Recall" or "timed flash."
switch identifier	A number assigned to a <i>tandem trunk</i> in a <i>private network</i> . It identifies the system connected to the far end of the trunk. Switch identifiers are based on the type of system and its distance from the system where the identifier is assigned. See also <i>satellite system</i> and <i>non-satellite system</i> .
synchronous data transmission	Method of transmitting a continuous digital data stream in which the transmission of each binary <i>bit</i> is synchronized with a master clock. See also <i>asynchronous data transmission</i> .

system acceptance test	Test of all trunks, telephones, data terminals, and features after installation to ensure that they are working correctly.
System Access buttons	See SA buttons .
system date and time	Date and time that appear on MLX display telephones and <i>SMDR</i> reports.
system programming	Programming of system functions and features that affect most users, performed from an MLX-20L telephone or a computer using <i>SPM</i> . See also <i>extension programming</i> and <i>centralized telephone programming</i> .
System Programming and Maintenance	See <i>SPM</i> .
system renumbering	Procedure used to change the numbers assigned to telephones, adjuncts, <i>calling groups</i> , paging groups, park zones, <i>Remote Access</i> , and lines/trunks.

T

T1	Type of digital transmission facility that in North America transmits at the <i>DS1</i> rate of 1.544 Mbps.
T1-emulated data	A T1 tie trunk programmed for S56DATA for use by data calls at speeds up to 56 kbps. These trunks may be used for tandem and non-tandem operation.
T1-emulated voice	A T1 tie trunk programmed for Tie-PBX or Tie-Toll for use by voice calls.
T1 Switched 56 service	<i>T1</i> digital data transmission over the <i>public network</i> or over a <i>private network</i> at 56 kbps. See <i>Switched 56 service</i> .
tandem switching	The capability of <i>private network</i> communications systems that allows them to direct outside calls from one facility to another facility, rather than just to an extension. Calls may be sent, for example, from a <i>PSTN</i> facility to a <i>tandem trunk</i> or vice versa.
tandem trunk	An private outside facility (as opposed to an inside system line) that connects two communications systems in a <i>private network</i> and can carry calls to another outside facility through <i>tandem switching</i> . The trunk is not connected to the <i>PSTN</i> .
tandem tie trunk	A <i>tandem trunk</i> that is an analog <i>delay-start tie trunk</i> , providing a single line/trunk per facility and allowing <i>analog transmission</i> of voice and low-speed data. Or a T1 facility offering 24 channels on emulated tie trunks and programmed for voice or data
tandem PRI trunk	(tandem Primary Rate Interface trunk) A private network trunk.

TAPI	Telephony Application Programming Interface. An application programming interface that allows computer telephony applications to be used. TAPI is not yet supported by the MERLIN LEGEND Communications System. <i>See also TAPI, CTI</i>
telephone power supply unit	Equipment that provides power to an individual telephone.
terminal adapter	<i>See ISDN terminal adapter.</i>
tie trunk	Private trunk directly connecting two telephone switches.
timed flash	<i>See switchhook flash.</i>
tip/ring	Contacts and associated conductors of a <i>single-line telephone</i> plug or jack.
touch-tone receiver	<i>See TTR.</i>
T/R	<i>See tip/ring.</i>
trunk	Telecommunications path between the communications system and the telephone company central office (<i>CO</i>) or another switch. Often used synonymously with <i>line</i> .
trunk jack	<i>See line/trunk jack.</i>
trunk pool	<i>See pool.</i>
TSAPI	Telephony Services Application Programming Interface. An application programming interface that allows computer telephony applications to be used. TSAPI is supported by the MERLIN LEGEND Communications System Release 5.0. <i>See also TAPI, CTI.</i>
TTR	(touch-tone receiver) Device used to decode <i>DTMF</i> touch-tones dialed from <i>single-line</i> or <i>Remote Access</i> telephones.

U

UDP	(Uniform Dial Plan) Composed of the <i>local dial plan</i> and <i>non-local dial plan</i> . A dial plan that allows a caller at any extension in a <i>private network</i> to dial the same number of digits to reach any other extension in the private network, even if the originating extension is physically connected to one communications system and the terminating extension is physically connected to a different communications system.
------------	---

unambiguous numbering	The practice of numbering of extension ranges, remote access codes, or other system components to avoid routing conflicts in network or local calling. For example, Extension 441 is unique when compared to Extension 4410. However it is ambiguous, because a system routes as soon as it matches the digits sent for a call with the digits in a local plan or in a non-local dial plan extension range. When a caller dials <i>4410</i> , a system routes the call to Extension 441 immediately, without considering the last dialed digit.
Uniform Dial Plan	See <i>UDP</i> .
uninterruptible power supply	See <i>UPS</i> .
unit load	Measure of the power load drain of a module, telephone, or <i>adjunct</i> .
unmonitored extension	An extension for which no CTI application is receiving call information. See also <i>CTI link</i> and <i>monitored extension</i> .
unrestricted data channel	Unrestricted data channels (also called clear data channels) allow the transmission of occurrences of more than seven contiguous zero bits. If an unrestricted data channel is requested and only restricted channels are available, the call will be rejected. See also <i>restricted data channel</i> .
UPS	(uninterruptible power supply) Device that connects to the system to provide 117 VAC to the equipment when the commercial power source fails.

V

VAC	(alternating-current voltage)
VDC	(direct-current voltage)
VMI	(voice messaging interface) An enhanced <i>tip/ring</i> port.
videoconferencing system	System application that allows face-to-face meetings, with voice and video, to occur between individuals or groups. This application requires high-speed data transmission facilities. See also <i>desktop videoconferencing</i> and <i>group videoconferencing</i> .
virtual private network	See <i>VPN</i> .
VPN	(virtual private network) A type of <i>private network</i> that uses the switching capabilities of the <i>PSTN</i> , rather than <i>tandem switching</i> , to direct calls between connected communications systems. A VPN may constitute a part of a private network.
voice-band channel	A transmission channel, generally in the 300–3400-Hz frequency band.

voice mail Application that allows users to send messages to other system extensions, forward messages received with comments, and reply to messages.

voice messaging interface See *VMI*.

W

WATS (Wide Area Telecommunications Service) Service that allows calls to certain areas for a flat-rate charge based on expected usage.

wink-start tie trunk *Tie trunk* on which the originating end transmits an off-hook signal and waits for the remote end to send back a signal (a wink) that it is ready for transmission.

Index

Numerics

- 007 MLM module, [3-14](#)
 - 008 OPT module, [3-6](#) to [3-7](#)
 - 012 T/R module, [3-6](#) to [3-7](#)
 - 016 T/R module, [2-25](#), [3-5](#), [3-6](#) to [3-7](#)
 - 100D module
 - description, [3-7](#) to [3-10](#)
 - interface, [3-34](#)
 - 146A and 147A surge protectors, [3-48](#)
 - 1B data, [5-22](#)
 - 2B Data feature
 - definition, [2-30](#), [3-42](#)
 - extension jacks, [5-23](#)
 - Internet access, [3-43](#)
 - videoconferencing interface, [3-42](#)
 - 408 GS/LS MLX module, [2-21](#), [3-5](#)
 - 5ESS digital switching system, [2-9](#)
 - 800 GS/LS-ID module, [3-36](#)
 - 800 NI-BRI module, [3-10](#)
-

A

- Accessories
 - definition, [2-27](#)
 - power-related, [3-47](#)
 - protection, [3-48](#) to [3-49](#)
- Account Code Entry/Forced Account Code Entry, [4-58](#) to [4-59](#)
- Adapters
 - definition, [2-26](#)
 - descriptions, [3-34](#) to [3-36](#)
 - system, [3-34](#)
 - telephone, [3-34](#) to [3-36](#)
- Adjuncts
 - connecting to system, [3-43](#) to [3-46](#)
 - data communications, [3-40](#) to [3-42](#)
 - definition, [2-26](#)
 - descriptions, [3-36](#) to [3-46](#)
 - summary, [3-43](#) to [3-46](#)
 - system, [3-36](#) to [3-39](#)
 - telephone, [3-39](#) to [3-40](#)
 - tip/ring (T/R), [3-34](#) to [3-35](#)
- Alarm Clock and Timer features, [4-23](#)
- Alarms, [6-67](#) to [6-69](#)
- Alerts, [3-44](#)
- Allowed/Disallowed Lists
 - assigning to extensions, [6-73](#) to [6-74](#), [6-76](#) to [6-77](#)
 - changing, [6-71](#) to [6-73](#), [6-74](#) to [6-76](#)
 - description, [4-46](#) to [4-47](#)
 - overview, [4-44](#)
 - star codes, [6-71](#) to [6-72](#), [6-74](#) to [6-75](#)

- Analog facilities
 - emulated, [3-9](#)
 - types supported, [2-14](#)
- Analog multiline telephones
 - descriptions, [3-24](#)
 - headset operation, [3-40](#)
 - tip/ring (T/R) adapter, [3-35](#) to [3-36](#)
- Analog signal, [2-5](#)
- Answering machines, [3-40](#), [3-44](#)
- Applications
 - choosing, [4-61](#)
 - descriptions, [4-60](#) to [4-69](#)
 - link to local area network (LAN), [2-23](#), [4-61](#) to [4-62](#)
 - overview, [2-22](#) to [2-24](#)
 - platform, [4-61](#) to [4-62](#)
 - summary, [4-61](#) to [4-64](#)
 - using, [4-60](#) to [4-69](#)
 - voice-messaging systems, [4-64](#) to [4-69](#)
- ARS, see Automatic Route Selection (ARS)
- Ascend Pipeline 25-Px access device
 - description, [3-43](#)
 - overview, [3-41](#)
- Ascend Pipeline 50 access device, [3-41](#)
- Asynchronous Data Unit (ADU), [3-46](#)
- AT&T network services, [3-8](#)
- AUDIX Voice Power, [4-63](#), [4-66](#) to [4-67](#), [6-38](#)
- Authorization Codes feature, [4-37](#)
 - considerations, [4-50](#) to [4-51](#)
 - description, [4-50](#) to [4-51](#)
 - example of use, [5-13](#)
- Auto Answer All
 - button, [4-57](#)
 - feature, [4-6](#)
- Auto Dial
 - buttons, [4-53](#)
 - feature, [4-53](#)
- Automated attendants
 - Direct Voice Mail feature, [4-40](#)
 - programming, [6-68](#) to [6-69](#)
- Automatic Callback feature, [4-57](#)
- Automatic Maintenance Busy feature, [4-25](#)
- Automatic Route Selection (ARS) feature
 - calling restriction feature, [4-48](#) to [4-50](#)
 - overview, [4-59](#)
 - routes, [4-48](#)
- Auxiliary components
 - adapters, [3-34](#) to [3-36](#)
 - adjuncts, [3-36](#) to [3-46](#)
 - overview, [2-19](#), [2-26](#) to [2-28](#)
 - programming, [6-66](#) to [6-69](#)

B

- Backing up the system
 - automatically, [6-40](#)
 - procedure, [6-39](#) to [6-40](#)
 - Translation memory card, [1-6](#), [3-4](#)

- Backplane, [3-2](#)
 - Barge-In feature, [4-31](#), [5-6](#)
 - Barrier codes
 - calling restrictions, [4-49](#)
 - definition, [4-51](#)
 - remote access, [4-58](#)
 - B-channels
 - 2B Data feature, [3-42](#)
 - data transfer, [5-22](#)
 - definition, [2-14](#)
 - Behind Switch mode
 - calling restrictions, [4-45](#)
 - definition, [2-16](#)
 - description, [2-17](#) to [2-18](#)
 - line buttons, [3-28](#) to [3-29](#)
 - Bell, Alexander Graham, [2-2](#), [2-5](#)
 - BRI (Basic Rate Interface), see National Integrated Services Digital Network 1 Basic Rate Interface (NI-1 BRI)
 - Busying-out a module, [6-91](#) to [6-92](#)
-

C

- Call Accounting System (CAS) Plus V3, [4-62](#)
- Call Accounting Terminal (CAT) application, [3-37](#), [4-62](#)
- Call Management System (CMS), [6-38](#)
- Call Waiting feature, [4-57](#)
- Callback feature, [4-9](#)
- Call-by-Call Service Selection, [3-8](#)
- Caller ID
 - description, [5-27](#)
 - example, [5-5](#)
 - module, [3-36](#)
 - services, [3-8](#)
- Calling features, see Dialing and calling features
- Calling group
 - adding or removing extensions, [6-69](#) to [6-71](#)
 - caller-prompted overflow treatment, [4-32](#)
 - delay announcement device, [3-45](#)
 - description, [4-53](#) to [4-55](#)
 - features, [4-31](#) to [4-33](#)
 - number of calls allowed in queue, [4-32](#), [4-54](#), [8-25](#)
 - programming labels, [6-87](#) to [6-88](#)
 - troubleshooting, [8-24](#) to [8-25](#), [8-27](#) to [8-30](#)
- Calling restrictions
 - allowing calls, [4-17](#)
 - changing, [6-48](#) to [6-49](#), [6-71](#) to [6-73](#), [6-74](#) to [6-76](#)
 - considerations, [4-45](#) to [4-46](#)
 - copying, [6-33](#) to [6-34](#)
 - default Disallowed List, [4-47](#)
 - description, [4-44](#) to [4-50](#)
 - example, [5-21](#) to [5-22](#)
 - Hybrid/PBX mode, [4-44](#)
 - outward and toll, [4-46](#)
 - preventing calls, [4-16](#)
 - programming, [6-48](#) to [6-49](#)
 - star codes, [6-71](#) to [6-72](#), [6-74](#) to [6-75](#)
- Calling supervisor, [4-54](#)

- [Calling Supervisor's Guide, 7-13](#)
- Canadian Department of Communications (DOC) information, see Appendix A
- Carriers, [3-1](#) to [3-2](#)
- CAS, see Call Accounting System (CAS) Plus V3
- Central office (CO), [3-9](#), [4-60](#) to [4-61](#), [8-14](#), [8-23](#)
- Centralized telephone programming
 - description, [6-24](#) to [6-34](#)
 - features that must be programmed using, [6-24](#)
 - overview, [6-6](#)
 - programming extensions, [6-26](#) to [6-29](#)
 - starting, [6-25](#) to [6-26](#)
- Centrex operation
 - definition, [2-17](#)
 - forwarding, [4-36](#) to [4-37](#)
 - line buttons, [3-28](#)
 - services, [4-60](#) to [4-61](#)
- Centrex Transfer via Remote Call Forwarding feature, [4-12](#), [4-14](#), [4-36](#) to ??, [4-50](#)
- Centrex Transfer via Remote Call Forwarding feature, ?? to [4-37](#)
- changing forwarding with, [4-37](#)
- Channel service unit (CSU), [3-34](#)
- Channels, [2-15](#)
- CMS, see Call Management System (CMS)
- CO, see Central office (CO)
- Computer Telephony Integration (CTI) link
 - adding, [6-89](#) to [6-93](#)
 - description, [4-61](#) to [4-62](#), [5-23](#) to [5-25](#)
 - example, [5-10](#) to [5-18](#)
 - overview, [2-23](#)
 - programming, [6-89](#) to [6-94](#)
 - removing, [6-93](#) to [6-94](#)
 - troubleshooting, [8-1](#), [8-25](#) to [8-27](#)
- Conference feature, [3-29](#)
- Control unit
 - alarms, [3-49](#)
 - carriers, [3-1](#) to [3-2](#)
 - connecting PC, [6-20](#) to [6-24](#)
 - definition, [2-18](#)
 - environment, [1-6](#) to [1-7](#)
 - line/trunk and extension modules, [3-5](#) to [3-14](#)
 - overview, [3-1](#) to [3-14](#)
 - power supply module, [3-4](#)
 - processor module, [3-2](#) to [3-3](#)
 - removing cover, see Appendix E
 - troubleshooting, [8-2](#), [8-5](#), [8-10](#) to [8-11](#)
- Control unit housing, see Appendix E
- CONVERSANT application, [5-26](#)
- Copy Extension feature, [6-24](#), [6-29](#) to [6-33](#)
- Coverage delay options, [6-51](#) to [6-56](#)
- Coverage features
 - changing extensions assigned to groups, [6-77](#) to [6-79](#)
 - Night Service feature, [4-39](#)
 - programming, [6-51](#) to [6-56](#), [6-77](#) to [6-79](#)
 - ring delays, [4-38](#)
 - summary, [4-39](#)
 - troubleshooting, [8-17](#) to [8-18](#), [8-20](#)
 - using, [4-37](#) to [4-40](#)
- Coverage VMS Off buttons, [6-81](#) to [6-83](#)

Covering calls

- considerations, [4-34](#)
- controlling, [4-13](#) to [4-14](#)
- coverage features, [4-37](#) to [4-40](#)
- coverage group assignments, [6-77](#) to [6-79](#)
- description, [4-34](#) to [4-43](#)
- example, [5-5](#) to [5-6](#), [5-16](#) to [5-20](#)
- forwarding features, [4-35](#) to [4-37](#)
- picking up others' calls, [4-37](#)
- programming Night Service, [6-81](#) to [6-83](#)
- ring delays, [6-51](#) to [6-56](#)
- sharing lines, [4-35](#)
- summary of features, [4-41](#) to [4-43](#)
- voice messaging systems, [4-40](#) to [4-41](#)

Credit card verification terminals, [3-40](#), [3-44](#)

CSU (channel service unit), see Channel service unit (CSU)

CTI (Computer Telephony Integration) link, see Computer Telephony Integration (CTI) link

Customer Information Center, [1-5](#)

D

Data communications

- adjuncts, [3-40](#) to [3-42](#)
- features, [4-56](#) to [4-57](#)
- overview, [2-29](#) to [2-30](#)
- troubleshooting, [8-1](#)

Data communications equipment (DCE)

- definition, [2-29](#)
- types supported, [3-41](#) to [3-42](#)

Data terminal equipment (DTE), [2-29](#)

Data workstations

- definition, [2-29](#)
- description, [4-57](#)

Data/Video Reference guide, [7-13](#)

Daylight Savings Time, [6-38](#), [8-2](#)

D-channel, [2-14](#)

DEFINITY Enterprise Communications Server, [7-2](#)

DEFINITY Enterprise Communications Server (ECS), [2-1](#)

DEFINITY ProLogix Solutions, [2-1](#), [7-2](#)

DEFINITY system, [2-15](#), [3-10](#)

Delay announcement devices, [3-38](#), [8-27](#) to [8-30](#)

Desktop videoconferencing systems

- description, [5-22](#) to [5-23](#)
- interface, [3-42](#)
- MLX telephones, [3-42](#)

Dial dictation equipment, [3-38](#), [3-45](#)

Dialed Number Identification Service (DNIS), [3-8](#)

Dialing and calling features

- Auto Dial buttons, [4-53](#)
- example, [5-6](#)
- overview, [4-52](#) to [4-53](#)
- speed dialing, [4-53](#)

Dialing plans, [4-48](#)

DID, see Direct Inward Dial (DID) trunks

- Digital facilities
 - data communications, [4-57](#)
 - modules supporting, [3-7](#) to [3-10](#)
 - services supported, [3-9](#) to [3-10](#)
 - types supported, [2-14](#) to [2-15](#)
 - Digital modems, see [ISDN terminal adapters](#)
 - Digital signal, [2-5](#)
 - Digital Signal 1 (DS1)
 - module, [3-7](#) to [3-10](#)
 - overview, [2-15](#)
 - Direct Inward Dial (DID) trunks, [2-14](#), [3-9](#)
 - Direct Station Selector (DSS)
 - alternative to Auto Dial buttons, [4-53](#)
 - description, [3-22](#) to [3-24](#)
 - lights, [6-17](#)
 - system programming, [6-14](#), [6-16](#) to [6-17](#)
 - Direct Voice Mail feature, [4-40](#) to [4-41](#)
 - Direct-Line Console (DLC)
 - adding, [6-58](#) to [6-61](#)
 - connecting to system, [3-33](#)
 - considerations, [3-33](#)
 - features, [3-32](#) to [3-33](#)
 - features that can be copied from, [6-32](#)
 - overview, [2-18](#)
 - telephones, [3-16](#), [3-16](#) to [3-17](#)
 - troubleshooting, [8-11](#)
 - Directory features, [6-83](#) to [6-84](#), [6-88](#) to [6-89](#)
 - DLC, see [Direct-Line Console \(DLC\)](#)
 - DMS-100 services, [3-9](#)
 - Do Not Disturb feature, [5-6](#), [8-8](#), [8-11](#)
 - DS1, see [Digital Signal 1 \(DS1\)](#)
-

E

- Electromagnetic interference filters, [3-49](#)
- Employee Communications Survey, [1-5](#)
- Environmental requirements, [1-6](#) to [1-7](#)
- Equipment
 - adapters, [3-34](#) to [3-36](#)
 - adjuncts, [3-36](#) to [3-46](#)
 - auxiliary components, [2-19](#), [2-26](#) to [2-28](#)
 - background, [2-4](#) to [2-9](#)
 - control unit, [2-18](#), [3-1](#) to [3-14](#)
 - data communications, [2-29](#), [3-41](#) to [3-42](#)
 - line/trunk and extension modules, [2-21](#), [3-5](#) to [3-14](#)
 - overview, [2-18](#) to [2-20](#)
 - power supply module, [3-4](#)
 - power-related, [3-46](#) to [3-50](#)
 - switching, [2-6](#) to [2-9](#)
 - telephones, [3-14](#) to [3-33](#)
- Equipment and Operations Reference guide*, [1-3](#)
- Exchange, see [Central office \(CO\)](#)
- Extension Directory feature, [6-83](#) to [6-84](#)
- Extension Information report, [6-27](#)
- Extension jacks, [3-5](#), [3-5](#) to [3-6](#), [5-23](#)
- Extension programming, [2-25](#), [6-6](#), [8-21](#) to [8-22](#)

Extensions

- adding, [6-40](#) to [6-43](#)
- assigning calling restrictions, [6-73](#) to [6-74](#), [6-76](#) to [6-77](#)
- assigning to coverage groups, [6-77](#) to [6-79](#)
- assigning to Night Service groups, [6-79](#) to [6-81](#)
- auxiliary components, [6-66](#) to [6-69](#)
- calling group, [6-69](#) to [6-71](#)
- copying features, [6-29](#) to [6-33](#)
- guidelines for programming, [6-26](#) to [6-29](#)
- labels, [6-83](#) to [6-84](#)
- moving, [6-43](#) to [6-44](#)
- programming, [6-6](#)
- programming trunk-to-trunk transfer, [6-49](#) to [6-51](#)
- removing, [6-44](#) to [6-46](#)
- seeing what is programmed, [6-27](#)

F

Facilities, [2-15](#)

Facilities, see also Digital facilities, Analog facilities

Facility Restriction Levels (FRLs)

- description, [4-48](#) to [4-50](#)
- overview, [4-44](#)

Fax Attendant System, [4-63](#)

Fax machines

- description, [3-38](#)
- feature, [4-6](#)
- Group IV (G4), [4-64](#), [5-7](#)
- programming extensions, [3-38](#), [6-67](#) to [6-69](#)

Feature finders

- basic calling and answering, [4-4](#) to [4-11](#)
- calling privileges and restrictions, [4-15](#) to [4-17](#)
- covering calls and having calls covered, [4-12](#) to [4-14](#)
- customizing phones, [4-18](#) to [4-19](#)
- messaging, [4-20](#) to [4-22](#)
- operator and supervisor features, [4-30](#) to [4-33](#)
- overview, [4-2](#) to [4-4](#)
- system manager's features and functions, [4-23](#) to [4-29](#)
- timekeeping, [4-23](#)

Feature Reference guide

- applications, [4-61](#)
- description, [7-5](#) to [7-8](#)
- finding information, [7-14](#) to [7-16](#)
- overview, [1-3](#), [7-2](#) to [7-4](#)
- using, [7-5](#) to [7-8](#)

Feature Upgrade memory card, [1-6](#), [3-3](#)

Features

- answering calls, [4-5](#) to [4-6](#)
- calling restrictions, [4-16](#) to [4-17](#), [4-44](#) to [4-50](#)
- conferencing and joining calls, [4-7](#)
- copying from one extension to another, [6-29](#) to [6-33](#)
- covering calls, [4-13](#), [4-13](#) to [4-14](#), [4-34](#) to [4-43](#), [6-51](#) to [6-56](#)
- data communications, [4-56](#) to [4-57](#)
- descriptions, [4-34](#) to [4-60](#)
- dialing and calling, [4-7](#) to [4-9](#), [4-52](#) to [4-53](#)
- finding, [4-4](#) to [4-33](#)
- fixed, [4-25](#) to [4-26](#)

Features, (cont)

- forwarding, [4-35](#) to [4-37](#)
 - group, [4-24](#) to [4-25](#), [4-53](#) to [4-56](#)
 - holding calls, [4-10](#)
 - information finder, [7-14](#) to [7-16](#)
 - maintenance, [4-26](#) to [4-27](#)
 - messaging, [4-21](#) to [4-22](#)
 - numbering, [4-27](#)
 - operator, [4-27](#) to [4-28](#), [4-30](#) to [4-33](#)
 - overview, [2-22](#)
 - paging, [4-10](#)
 - remote access, [4-58](#)
 - remote use, [4-11](#)
 - reports, [4-28](#)
 - security, [4-28](#) to [4-29](#)
 - summary, [4-3](#) to [4-4](#)
 - system management, [4-23](#) to [4-29](#), [4-60](#)
 - timekeeping, [4-23](#)
 - transferring calls, [4-11](#)
 - using, [4-1](#) to [4-60](#)
- Federal Communications Commission (FCC) information, see Appendix A
- Forced Account Code Entry feature, [4-59](#)
- Forced idle reminder tones, [6-13](#)
- Forward/Follow Me features
- troubleshooting, [8-9](#)
 - using, [4-35](#) to [4-37](#), [8-9](#)
 - when lines are busy, [4-36](#)
- FRLs (Facility Restriction Levels), see Facility Restriction Levels (FRLs)
- Function keys, [6-15](#)
-

G

General-Purpose Adapter (GPA)

- description, [3-35](#) to [3-36](#)
 - fax machines, [3-38](#)
 - settings, [3-35](#) to [3-36](#)
- Ground-start trunks, [2-14](#)
- Group Calling delay announcement device, [3-45](#)
- Group features
- assigning members, [6-69](#) to [6-71](#)
 - calling groups, [4-53](#) to [4-55](#)
 - description, [4-53](#) to [4-56](#)
 - Night Service, [4-55](#) to [4-56](#)
 - paging, [4-56](#)
 - programming, [6-77](#) to [6-79](#), [6-87](#) to [6-88](#)
- Group features, see also Calling group
- Group videoconferencing systems
- description, [5-23](#)
 - interfaces, [3-42](#)
-

H

- Handsets, [3-40](#)
- Hands-Free Unit (HFU), [3-45](#)
- Headpieces, [3-39](#)

Headsets

- description, [3-39](#) to [3-40](#)
 - features, [4-6](#)
 - manual operation, [3-40](#)
- Helpline, Lucent Technologies, [8-30](#)
- History of telephony, [2-2](#) to [2-9](#)
- History of telephony, see also Appendix B
- Hold feature, [4-10](#)
- Home button, [6-15](#)
- Host system, [2-17](#), [3-28](#)
- HotLine feature, [4-5](#), [4-7](#), [4-53](#), [6-46](#) to [6-48](#)
- Hybrid/PBX mode
- calling restrictions, [4-44](#), [4-48](#) to [4-50](#)
 - definition, [2-16](#)
 - description, [2-17](#) to [2-18](#)
 - example, [5-12](#) to [5-22](#)
 - line buttons, [3-27](#) to [3-28](#)
 - operator consoles, [3-30](#), [3-30](#) to [3-32](#)
 - routing calls, [4-59](#)
 - unique console, [2-19](#)
-

I

ICOM buttons

- automatic assignment, [3-26](#)
 - copying features programmed, [6-29](#) to [6-33](#)
 - definition, [2-17](#)
 - types, [3-26](#) to [3-27](#), [3-28](#) to [3-29](#)
- Idle states
- definition, [6-11](#)
 - description, [6-11](#) to [6-12](#)
- In-Range Out-of-Building (IROB) protection, [3-48](#)
- Inspct button, [6-15](#)
- Integrated Solution II (IS II), [6-18](#)
- Integrated Solution III (IS III), [6-18](#)
- Integrated voice response (IVR), see CONVERSANT application
- Internet access
- devices, [3-41](#) to [3-42](#)
 - local area network (LAN) devices, [3-43](#)
- Intuity, [GL-15](#)
- Inverse multiplexors (IMUXs), [3-41](#)
- ISDN terminal adapters, [3-41](#)
- ISDN/BRI interface, [3-42](#), [5-23](#)
-

K

Key mode

- definition, [2-16](#)
- description, [2-17](#) to [2-18](#)
- example, [5-5](#) to [5-6](#)
- line buttons, [3-26](#) to [3-27](#)

L

Labeling feature

- calling group labels, [6-87](#) to [6-88](#)
- directories, [4-9](#)
- extension names, [6-83](#) to [6-84](#)
- language, [4-19](#)
- line/trunk labels, [6-84](#) to [6-85](#)
- Posted Messages, [6-85](#) to [6-86](#)
- System Directory labels, [6-88](#) to [6-89](#)

LANs (Local Area Networks, see Local area networks (LANs))

Last Number Dial feature, [4-53](#)

Leave Message feature, [4-20](#)

Line buttons, [3-25](#) to [3-29](#)

Line/trunk and extension jacks, [3-12](#) to [3-14](#)

Line/trunk and extension modules

- connecting Direct-Line Consoles (DLCs), [3-33](#)
- connecting Queued Call Consoles (QCCs), [3-32](#)
- digital facilities, [3-7](#) to [3-10](#)
- overview, [2-21](#), [3-5](#) to [3-14](#)
- Power-Failure Transfer (PFT) telephone support, [3-7](#)
- touch-tone receivers (TTRs), [3-6](#)
- understanding names, [2-21](#), [3-5](#)

Lines, [2-15](#)

Lines/trunks

- adding or removing, [6-57](#)
- assigning names, [6-84](#) to [6-85](#)
- assigning to Night Service, [4-55](#) to [4-56](#), [6-79](#) to [6-81](#)
- auxiliary components, [6-66](#) to [6-69](#)
- copying buttons, [6-33](#) to [6-34](#)
- emulated, [3-9](#)
- modules, [3-7](#) to [3-10](#)
- overview, [2-12](#) to [2-15](#)

Local area networks (LANs)

- applications, [2-23](#), [4-61](#) to [4-62](#)
- link to applications, [5-23](#) to [5-25](#)
- router, [3-43](#)

Local carrier services, [3-9](#)

Local exchange, [2-8](#)

Local loop, [2-2](#), [2-3](#)

Logical ID, see Extension jacks

Loop-Start Trunk Adapter, [3-34](#), [3-37](#)

Loop-start trunks, [2-14](#)

Loudspeaker paging systems, [3-37](#), [3-46](#), [6-67](#) to [6-69](#)

Lucent Technologies

- Attendant, [4-63](#), [4-66](#) to [4-67](#)
- Door Phone, [3-38](#) to [3-39](#)
- Helpline, [8-30](#)

M

Magic on Hold, [6-66](#)

Maintenance alarms, [6-67](#) to [6-69](#)

Maintenance Upgrade memory card, [1-6](#), [3-3](#)

Managing the system, see System management

- MCI network services, [3-8](#), [3-9](#)
- Memory cards
 - backing up the system, [3-4](#)
 - fixing system problems, [3-3](#)
 - interface slot, [3-2](#)
 - overview, [1-6](#), [3-3](#) to [3-4](#)
- Menu button, [6-15](#)
- MERLIN II System Display Console, [3-30](#), [3-33](#)
- MERLIN LEGEND MAIL Voice Messaging System, [3-7](#), [8-18](#) to [8-19](#)
- MERLIN LEGEND Mail Voice Messaging System, [4-63](#), [4-66](#) to [4-67](#)
- MERLIN LEGEND Reporter, [3-37](#)
- MERLIN Mail Voice Messaging System, [4-63](#), [4-66](#) to [4-67](#)
- MERLIN Phone-Fax-Copier (PFC), [4-63](#)
- Message-waiting indicator, [3-40](#)
- Messaging
 - leaving messages, [4-21](#)
 - message-waiting indicator, [3-40](#)
 - programming, [6-85](#) to [6-86](#)
 - receiving messages, [4-21](#)
 - setting up, [4-22](#)
- MFM, see Multi-Function Module (MFM)
- Mirage headpiece, [3-39](#)
- MLX telephones
 - changing language of display, [4-18](#) to [4-19](#)
 - connecting to videoconferencing systems, [3-42](#), [5-23](#)
 - descriptions, [3-14](#) to [3-22](#)
 - dialing feature, [4-53](#)
 - headset operation, [3-40](#)
 - tip/ring (T/R) adapter, [3-34](#) to [3-35](#)
 - troubleshooting, [8-4](#)
- MLX-10 telephone, [3-20](#)
- MLX-10D telephone, [3-19](#)
- MLX-10DP telephone, [3-19](#)
- MLX-16DP telephone, [3-18](#)
- MLX-20L telephone
 - description, [3-16](#) to [3-17](#)
 - operator console, as, [2-19](#)
 - programming console, [6-13](#) to [6-17](#)
 - troubleshooting, [8-13](#)
- MLX-28D telephone, [3-16](#)
- MLX-5 telephone, [3-21](#) to [3-22](#)
- MLX-5D telephone, [3-20](#) to [3-21](#)
- Modems
 - description, [3-39](#)
 - feature, [4-6](#)
 - support, [3-41](#)
 - system programming using, [6-22](#) to [6-24](#)
- Modes of operation
 - applications for different ones, [4-61](#) to [4-64](#)
 - differences, [2-17](#) to [2-18](#)
 - overview, [2-16](#) to [2-18](#)
- Modules
 - busy-ing-out, [6-91](#) to [6-92](#)
 - definition, [2-18](#)
 - extension, [3-5](#) to [3-7](#)
 - line/trunk, [3-7](#) to [3-10](#)
 - line/trunk and extension, [2-21](#), [3-5](#) to [3-14](#)

Modules, (cont)

- power supply, [3-4](#)
- processor, [3-2](#) to [3-4](#)
- restoring, [6-91](#) to [6-92](#)
- tip/ring (T/R), [3-6](#) to [3-7](#)

More button, [6-15](#)

Multi-Function Module (MFM)

- description, [3-34](#) to [3-35](#)
- fax machines, [3-38](#)
- overview, [3-5](#)

Music On Hold

- device, [3-46](#)
- feature, [6-66](#) to [6-69](#)

N

National Integrated Services Digital Network 1 Basic Rate Interface (NI-1 BRI) facilities

- module, [3-10](#)
- overview, [2-14](#)

Network Reference guide, [1-3](#), [7-2](#)

NI-1 BRI, see National Integrated Services Digital Network 1 Basic Rate Interface (NI-1 BRI)

Night Service feature

- assigning extensions, [6-79](#) to [6-81](#)
- assigning lines/trunks, [6-79](#) to [6-81](#)
- calling restrictions, [4-44](#), [4-47](#) to [4-48](#)
- copying operator programming, [6-33](#) to [6-34](#)
- coverage, [6-81](#) to [6-83](#)
- groups, [4-55](#) to [4-56](#)
- programming, [6-79](#) to [6-83](#)
- troubleshooting, [8-12](#) to [8-13](#), [8-15](#) to [8-16](#), [8-17](#) to [8-18](#)
- voice messaging systems, [4-39](#), [4-55](#) to [4-56](#)

Notify feature, [5-6](#)

Novell NetWare, [4-61](#)

O

Off-Premises Range Extender (OPRE), [3-48](#)

Operating modes, see Modes of operation

Operator consoles

- adding, [6-58](#) to [6-64](#)
- adjunct, [3-22](#) to [3-24](#)
- features, [4-27](#) to [4-28](#)
- functioning, [3-30](#) to [3-33](#)
- list of features programmable, [6-64](#)
- maximum number, [3-30](#)
- MLX, [3-16](#) to [3-17](#)
- overview, [2-18](#) to [2-19](#)
- programming features, [6-64](#) to [6-65](#)
- telephones, [3-16](#), [3-16](#) to [3-17](#), [3-24](#)

Operator guides, see User and operator guides

Outward and toll restrictions, [4-46](#)

Overview, [1-1](#) to [1-5](#), [2-9](#) to [2-30](#)

P

- PagePal paging access adapter, [3-34](#)
- Paging features, [4-10](#)
- Paging groups, [4-56](#)
- PassageWay Direct Connection Solution
 - description, [5-26](#) to [5-27](#)
 - equipment, [3-19](#)
 - example, [5-5](#)
 - overview, [4-62](#)
- PassageWay Telephony Services, [2-23](#), [4-61](#), [5-23](#)
- Passwords, see Authorization Codes feature, Barrier codes, Night Service feature
- PCMCIA (Personal Computer Memory Card International Association) card, see Memory cards
- Personal computers (PCs), [6-18](#) to [6-24](#)
- Personal lines, [3-28](#), [4-35](#)
- Personalized Ringing feature, [5-19](#)
- PFT, see Power-Failure Transfer (PFT)
- Pickup feature, [4-37](#), [4-56](#)
- Pickup groups, [4-56](#)
- PictureTel group videoconferencing system, [5-7](#)
- Pipeline 25-Px, see Ascend Pipeline 25-Px access device
- Pool Dial-Out Code restriction, [4-44](#), [4-48](#), [5-21](#), [6-33](#) to [6-34](#)
- Pools, [3-28](#)
- Ports, see Extension jacks
- Position-Busy Backup feature, [6-64](#), [8-12](#)
- Posted Messages feature, [4-20](#), [5-6](#), [6-85](#) to [6-86](#)
- Power accessories
 - backup and auxiliary, [3-47](#)
 - definition, [2-27](#)
 - protection, [3-48](#) to [3-49](#)
 - system, [3-47](#)
 - telephone, [3-47](#)
- Power outage, [8-2](#)
- Power supply module, [3-4](#), [3-47](#)
- Power-Failure Transfer (PFT) telephones, [3-7](#), [3-49](#) to [3-50](#)
- Power-related equipment
 - backup and auxiliary accessories, [3-47](#)
 - description, [3-46](#) to [3-50](#)
 - Power-Failure Transfer (PFT) telephone, [3-49](#) to [3-50](#)
 - protection accessories, [3-48](#) to [3-49](#)
 - system alarms, [3-49](#)
- Primary Rate Interface (PRI)
 - module for supporting, [3-7](#) to [3-10](#)
 - overview, [2-15](#)
 - services and applications, [3-7](#) to [3-10](#)
- Prime lines, [2-17](#), [3-28](#) to [3-29](#), [4-35](#)
- Privacy feature, [4-57](#)
- Private branch exchanges (PBXs), [2-2](#)
- Problems, see Troubleshooting
- Processor module, [2-18](#), [3-2](#) to [3-3](#)

Programming

- added components, [6-66](#) to [6-69](#)
 - backing up, [6-39](#) to [6-40](#)
 - busy-ing-out a module, [6-91](#) to [6-92](#)
 - calling restrictions, [6-48](#) to [6-49](#)
 - centralized, [6-24](#) to [6-34](#)
 - Computer Telephony Integration (CTI) link, [6-89](#) to [6-94](#)
 - coverage delays, [6-51](#) to [6-56](#)
 - entering data, [6-7](#) to [6-8](#)
 - information finder, [7-17](#) to [7-22](#)
 - information screens, [6-6](#) to [6-7](#)
 - menu selection, [6-7](#)
 - MLX-16DP telephone, [3-18](#)
 - MLX-5 telephone, [3-22](#)
 - MLX-5D telephone, [3-21](#)
 - Night Service with coverage control, [6-81](#) to [6-83](#)
 - operator features, [6-64](#) to [6-65](#)
 - overview, [2-25](#)
 - restoring a module, [6-91](#) to [6-92](#)
 - screens, [6-6](#) to [6-8](#)
 - summary procedures, using, [6-3](#) to [6-5](#)
 - tones emitted during, [6-13](#)
 - types, [6-5](#) to [6-6](#)
- Programming, see also System programming, Centralized telephone programming
- Protection accessories, [2-27](#), [3-48](#) to [3-49](#)
-

Q

Queued Call Console (QCC)

- adding, [6-61](#) to [6-64](#)
 - allowing voice-announced calls, [6-62](#)
 - buttons, [3-31](#) to [3-32](#)
 - connecting to system, [3-32](#)
 - considerations, [3-32](#)
 - features, [3-30](#) to [3-32](#), [8-12](#) to [8-13](#)
 - overview, [2-19](#)
 - telephone, [3-16](#) to [3-17](#)
 - troubleshooting, [8-12](#) to [8-13](#)
-

R

Recall/Timed Flash features, [4-26](#), [8-23](#) to [8-24](#)

Recall/Timed Flash features, see also Switchhook

Release 4.1 and later systems only, [4-34](#), [4-36](#), [4-38](#), [4-40](#), [4-55](#) to [4-56](#), [4-60](#), [5-13](#), [6-51](#) to [6-56](#), [6-79](#) to [6-80](#), [6-81](#) to [6-83](#)

Release 4.2 and later systems only, [3-9](#)

Release 5.0 and later systems only, [2-23](#), [4-53](#), [4-61](#), [5-23](#), [6-89](#) to [6-94](#)

Release 6.0 and later systems only, [1-3](#), [2-1](#), [3-6](#), [3-9](#), [4-12](#), [4-32](#), [4-36](#) to [4-37](#), [4-50](#), [4-54](#), [4-55](#), [5-1](#), [7-2](#), [8-25](#)

Reminder service feature, [4-23](#), [8-22](#)

Remote Access feature

- barrier codes, [4-58](#)
- description, [4-58](#)
- overview, [4-11](#)

Reports

- extension information, [6-27](#)
 - using, [6-34](#) to [6-38](#)
- Restoring a module, [6-91](#) to [6-92](#)
- Ring generators, [3-7](#)
- Ringling Options feature, [6-60](#), [8-9](#) to [8-10](#), [8-11](#)
- Routing by Dial Plan, [3-8](#)

S

- S56, see T1 operation
- SA buttons
- automatic assignment, [3-26](#)
 - copying programming, [6-29](#) to [6-33](#)
 - sharing, [4-35](#)
 - types, [3-27](#) to [3-28](#)
- Security
- overview, [4-51](#) to [4-52](#)
 - summary of features, [4-28](#) to [4-29](#)
- Security, see also Appendix A
- Send Ring feature, [5-17](#)
- Shared Access for Switched Services (SASS), [3-8](#)
- Signaling feature, [5-6](#)
- Single-line telephones
- line buttons assigned, [3-26](#)
 - overview, [3-25](#)
 - programming as HotLine extensions, [6-46](#) to [6-48](#)
 - troubleshooting, [8-3](#), [8-13](#) to [8-14](#)
- SMDR jack, [6-37](#)
- SMDR, see Station Message Detail Recording (SMDR)
- Specialty handsets, [3-40](#)
- Speed dial codes, [4-53](#)
- SPM, see System Programming and Maintenance (SPM) software
- SSA buttons, [4-35](#), [5-17](#)
- Star codes
- calling restrictions, [4-44](#), [6-71](#) to [6-72](#), [6-74](#) to [6-75](#)
 - dialing pause, [4-51](#) to [4-52](#)
- StarSet headpiece, [3-39](#)
- Station Busy screen, [6-11](#)
- Station Message Detail Recording (SMDR)
- description of report format, [3-36](#) to [3-37](#)
 - jack, [3-2](#)
 - printer, [3-36](#) to [3-37](#)
 - printing, [6-36](#)
 - security, [4-52](#)
- Station Message Detail Recording (SMDR), see also Reports
- Supra Binaural headpiece, [3-39](#)
- Supra Binaural Noise-Canceling (NC) headpiece, [3-39](#)
- Supra Monaural headpiece, [3-39](#)
- Supra Monaural Noise-Canceling (NC) headpiece, [3-39](#)
- Surge protection, [3-48](#)
- Switched 56 service, see T1 operation
- Switchhook, [2-4](#), [8-13](#) to [8-14](#), [8-23](#) to [8-24](#)

Switching

- equipment, [2-6](#) to [2-8](#)
- evolution, [2-6](#) to [2-9](#)
- hierarchy, [2-7](#) to [2-8](#)
- methods, [2-8](#) to [2-9](#)

Switching offices (SOs), [2-7](#)

System

- applications, [2-22](#) to [2-24](#), [4-60](#) to [4-69](#)
- auxiliary components, [2-26](#) to [2-28](#)
- background, [2-2](#) to [2-9](#)
- backing up, [1-6](#), [6-39](#) to [6-40](#)
- backup power, [3-47](#)
- capacities, [2-25](#)
- components, [2-18](#) to [2-20](#)
- data communications capabilities, [2-29](#) to [2-30](#)
- date and time, [6-38](#) to [6-39](#), [8-22](#)
- environment, [1-6](#) to [1-7](#)
- features, [2-22](#), [4-1](#) to [4-60](#)
- idle states, [6-11](#) to [6-12](#)
- modes of operation, [2-16](#) to [2-18](#)
- optimizing, [5-22](#) to [5-27](#)
- overview, [2-1](#) to [2-30](#)
- planning, [1-5](#)
- power outage, [8-2](#), [8-2](#) to [8-3](#)
- programming, [2-25](#), [6-3](#) to [6-34](#)
- reports about, [6-34](#) to [6-38](#)
- troubleshooting, [8-1](#) to [8-30](#)
- upgrading, [1-6](#)

System adapters

- definition, [2-26](#)
- descriptions, [3-34](#)

System adjuncts

- definition, [2-26](#)
- descriptions, [3-36](#) to [3-39](#)

System alarms, [3-49](#)

System capacities, [2-25](#)

System capacities, see also Appendix C

System examples

- professional office, [5-7](#) to [5-22](#)
- small office, [5-2](#) to [5-6](#)

System guides

- description, [7-1](#) to [7-22](#)
- reference, [1-3](#), [7-2](#) to [7-10](#), [7-13](#) to [7-22](#)
- related to this one, [1-3](#)
- user and operator, [1-3](#), [7-11](#) to [7-13](#)
- using this book, [1-2](#)

System management

- adding Direct-Line Console (DLC), [6-58](#) to [6-61](#)
- adding extensions, [6-40](#) to [6-43](#)
- adding operator positions, [6-58](#) to [6-64](#)
- adding or removing lines/trunks, [6-57](#)
- adding Queued Call Console (QCC), [6-61](#) to [6-64](#)
- after-hours operation, [6-79](#) to [6-83](#)
- assigning calling restrictions, [6-73](#) to [6-74](#), [6-76](#) to [6-77](#)
- assigning labels to extensions, [6-83](#) to [6-84](#)
- assigning labels to lines/trunks, [6-84](#) to [6-85](#)
- assigning lines and features, [4-25](#) to [4-26](#)
- backing up, [6-39](#) to [6-40](#)
- calling group assignments, [6-69](#) to [6-71](#)
- centralized telephone programming, [6-24](#) to [6-34](#)

System management, (cont)

- changing calling group labels, [6-87](#) to [6-88](#)
- changing calling restrictions, [6-48](#) to [6-49](#), [6-71](#) to [6-73](#), [6-74](#) to [6-76](#)
- changing Posted Messages, [6-85](#) to [6-86](#)
- changing System Directory labels, [6-88](#) to [6-89](#)
- connecting auxiliary equipment, [6-66](#) to [6-69](#)
- covering calls, [6-77](#) to [6-79](#)
- features, [4-23](#) to [4-29](#), [4-60](#)
- linking to local area network (LAN), [6-89](#) to [6-93](#)
- maintenance, [4-26](#) to [4-27](#)
- moving extensions, [6-43](#) to [6-44](#)
- numbering, [4-27](#)
- operator features, [4-27](#) to [4-28](#)
- overview, [1-4](#) to [1-5](#)
- programming, [4-60](#), [6-1](#) to [6-94](#)
- programming from a PC, [6-18](#) to [6-24](#)
- programming from the console, [6-13](#) to [6-18](#)
- programming operator features, [6-64](#) to [6-65](#)
- programming procedures, [6-3](#) to [6-5](#)
- removing extensions, [6-44](#) to [6-46](#)
- reports, using, [4-28](#), [4-60](#), [6-34](#) to [6-38](#)
- restricting trunk-to-trunk transfer, [6-49](#) to [6-51](#)
- security, [4-28](#) to [4-29](#)
- setting date and time, [6-38](#) to [6-39](#), [8-22](#)
- system planning forms, [1-5](#)
- system programming, [6-5](#) to [6-13](#)
- tasks described, [6-2](#) to [6-3](#)
- troubleshooting, [8-1](#) to [8-30](#)

System manager

- responsibilities, [1-4](#) to [1-5](#)
- role, [1-4](#) to [1-5](#)

System numbering, [4-27](#)

System operator consoles, see Operator consoles

System overview

- applications, [2-22](#) to [2-24](#)
- auxiliary components, [2-26](#) to [2-28](#)
- capacities, [2-25](#)
- components, [2-18](#) to [2-21](#)
- data communications capabilities, [2-29](#) to [2-30](#)
- features, [2-22](#)
- incoming trunks, [2-12](#) to [2-15](#)
- introduction, [2-9](#) to [2-11](#)
- modes of operation, [2-16](#) to [2-18](#)
- programming, [2-25](#)

System planning

- adding extensions, [6-40](#) to [6-43](#)
- adding operator positions, [6-58](#) to [6-64](#)
- adding or removing lines/trunks, [6-57](#)
- calling restrictions, [6-48](#) to [6-49](#)
- forms, [1-5](#)
- moving extensions, [6-43](#) to [6-44](#)
- removing extensions, [6-44](#) to [6-46](#)

System Planning guide

- applications, [4-61](#)
- overview, [1-3](#)

System programming

- backing up, [6-39](#) to [6-40](#)
- connecting PC, [6-20](#) to [6-24](#)
- console, [6-13](#) to [6-17](#)
- detailed procedures, [6-3](#) to [6-4](#)
- exiting, [6-18](#)
- idle states, [6-11](#) to [6-12](#)
- introduction, [6-5](#) to [6-13](#)
- jack, [3-2](#)
- main menu, [6-8](#) to [6-9](#)
- Maintenance option, [6-1](#)
- navigation, [6-9](#) to [6-11](#)
- on-site PC, [6-20](#) to [6-22](#)
- overview, [2-25](#), [6-5](#) to [6-6](#)
- printing reports about, [6-37](#) to [6-38](#)
- remote, [6-20](#), [6-22](#)
- reports about, [6-34](#) to [6-38](#)
- Restart option, [6-1](#)
- saving changes, [6-9](#) to [6-11](#)
- starting, [6-17](#) to [6-18](#)
- summary procedures, [6-4](#) to [6-5](#)
- using a PC, [6-18](#) to [6-24](#)
- using the console, [6-13](#) to [6-18](#)

System Programming and Maintenance (SPM) software

- connecting PC, [6-20](#) to [6-24](#)
- overview, [2-25](#)
- PC to use, [3-37](#)
- using, [6-18](#) to [6-24](#)

System programming console

- buttons, [6-14](#) to [6-15](#)
- description, [6-13](#) to [6-17](#)
- lights, [6-16](#)
- overlay, [6-16](#)

System Programming guide

- applications, [4-61](#)
- description, [7-8](#) to [7-10](#)
- finding information, [7-17](#) to [7-22](#)
- overview, [1-3](#), [7-2](#) to [7-4](#)
- procedures in, [6-2](#)
- using, [7-8](#) to [7-10](#)

System programming, see also Programming, Centralized telephone programming

System reference guides

- common elements, [7-4](#) to [7-5](#)
- finding information in, [7-13](#) to [7-22](#)
- overview, [7-2](#) to [7-4](#)

T

T1 operation

- data, [2-15](#), [3-9](#) to [3-10](#)
- module for supporting, [3-7](#) to [3-10](#)
- overview, [2-15](#), [3-9](#) to [3-10](#)
- services and applications, [3-7](#) to [3-10](#)
- voice, [2-15](#), [3-9](#)

T1 Switched 56 service

- definition, [2-15](#)
- module, [3-7](#) to [3-10](#)

- Tandem network, [2-7](#)
- TAPI, [GL-26](#)
- Technical support, [8-30](#)
- Telephone adapters
 - definition, [2-26](#)
 - descriptions, [3-34](#) to [3-36](#)
- Telephone adjuncts
 - definition, [2-26](#)
 - descriptions, [3-39](#) to [3-40](#)
- Telephones
 - adapters, [3-34](#) to [3-36](#)
 - adjuncts, [3-39](#) to [3-40](#)
 - analog multiline, [3-24](#)
 - line buttons, [3-25](#) to [3-26](#)
 - MLX, [3-14](#) to [3-22](#)
 - operator consoles, [3-16](#), [3-16](#) to [3-17](#)
 - overview, [2-4](#) to [2-5](#), [3-14](#) to [3-33](#)
 - power accessories, [3-47](#)
 - Power-Failure Transfer (PFT), [3-7](#), [3-49](#) to [3-50](#)
 - programming, [6-24](#) to [6-34](#), [8-21](#) to [8-22](#)
 - single-line, [3-25](#)
 - troubleshooting, [8-2](#) to [8-5](#), [8-8](#) to [8-11](#), [8-21](#)
 - volume control, [8-8](#)
- Tie trunks
 - analog, [2-14](#)
 - digital, [2-15](#)
 - linking communications systems, [3-9](#), [3-9](#) to [3-10](#)
- Timekeeping
 - features, [4-23](#)
 - setting system date and/or time, [6-38](#) to [6-39](#)
- Tip/ring (T/R)
 - adapter, [3-34](#) to [3-35](#)
 - definition, [2-5](#)
 - modules, [3-6](#) to [3-7](#)
 - types of adjuncts, [3-34](#) to [3-35](#)
- Toll and outward restrictions, [4-44](#)
- Toll fraud, see Security
- Touch-tone receivers (TTRs)
 - definition, [3-6](#)
 - prompt-based overflow, [4-55](#), [8-29](#) to [8-30](#)
 - remote access, [4-58](#)
- Transfer feature
 - Behind Switch mode, [3-29](#)
 - example of settings, [5-5](#)
 - overview, [4-11](#)
 - troubleshooting, [8-14](#) to [8-15](#)
 - trunk-to-trunk, [4-51](#), [6-49](#) to [6-51](#)
- Translation memory card, [1-6](#), [3-4](#), [6-39](#) to [6-40](#)
- Troubleshooting
 - all phones dead, [8-2](#) to [8-3](#)
 - callers getting incorrect response from voice messaging system, [8-19](#)
 - calling group members not receiving calls, [8-24](#) to [8-25](#)
 - calls not going to coverage, [8-20](#)
 - control unit, [8-2](#), [8-5](#), [8-10](#) to [8-11](#)
 - CTI link calls, [8-25](#) to [8-27](#)
 - delay announcements, [8-27](#) to [8-30](#)
 - difficulty making outside calls, [8-5](#) to [8-8](#)
 - Direct-Line Console (DLC) not ringing, [8-11](#)
 - Night Service feature, [8-15](#) to [8-16](#), [8-17](#) to [8-18](#)
 - phone not ringing, [8-8](#) to [8-11](#)

Troubleshooting, (cont)

- programmed buttons, [8-21](#) to [8-22](#)
- Queued Call Console (QCC) not ringing, [8-12](#) to [8-13](#)
- Recall or switchhook does not work, [8-23](#) to [8-24](#)
- reference materials, [8-1](#)
- Reminder messages received with wrong time, [8-22](#)
- single-line telephones ring back after call completed, [8-13](#) to [8-14](#)
- some phones dead, [8-3](#) to [8-5](#)
- transfer does not work after answer on outside line, [8-14](#) to [8-15](#)
- trouble hearing called party, [8-21](#)
- voice messaging system not working, [8-17](#) to [8-19](#)

Trunks

- definition, [2-12](#)
- types, [2-14](#)

Trunks, see also Facilities, Lines/trunks

Trunk-to-trunk transfer feature

- overview, [4-51](#)
- programming, [6-49](#) to [6-51](#)

TSAPI, [GL-27](#)

TTRs, see Touch-tone receivers (TTRs)

U

Uninterruptible Power Supply (UPS), [3-47](#)

Unit load calculation, [3-47](#)

Upgrading the system

- memory card, [3-3](#)
- overview, [1-6](#)

User and operator guides

- description, [7-11](#) to [7-13](#)
 - overview, [7-11](#)
-

V

V.35 interface, [3-42](#), [5-23](#)

Video workstations

- definition, [2-29](#)
- description, [5-22](#) to [5-23](#)

Videoconferencing systems

- facilities, [3-7](#) to [3-10](#)
- interfaces, [3-42](#)
- passive-bus configuration, [3-42](#)
- types supported, [3-42](#)

Voice Announce feature, [6-62](#)

Voice Announce to Busy feature, [3-6](#), [4-57](#)

Voice mail, see Voice messaging systems

Voice messaging interface (VMI), [4-64](#)

Voice messaging systems

- after-hours coverage, [6-81](#) to [6-83](#)
- default Facility Restriction Level (FRL), [4-50](#)
- description, [4-64](#) to [4-67](#)
- feature, [4-40](#) to [4-41](#)
- Night Service feature, [4-39](#), [4-55](#) to [4-56](#)
- programming, [6-68](#) to [6-69](#)
- security issues, [4-45](#), [4-67](#) to [4-69](#)
- services available with each one, [4-66](#) to [4-67](#)
- troubleshooting, [8-17](#) to [8-19](#)