

AT&T

MERLIN[®] Plus
COMMUNICATIONS SYSTEM
Release 2

Installation Manual

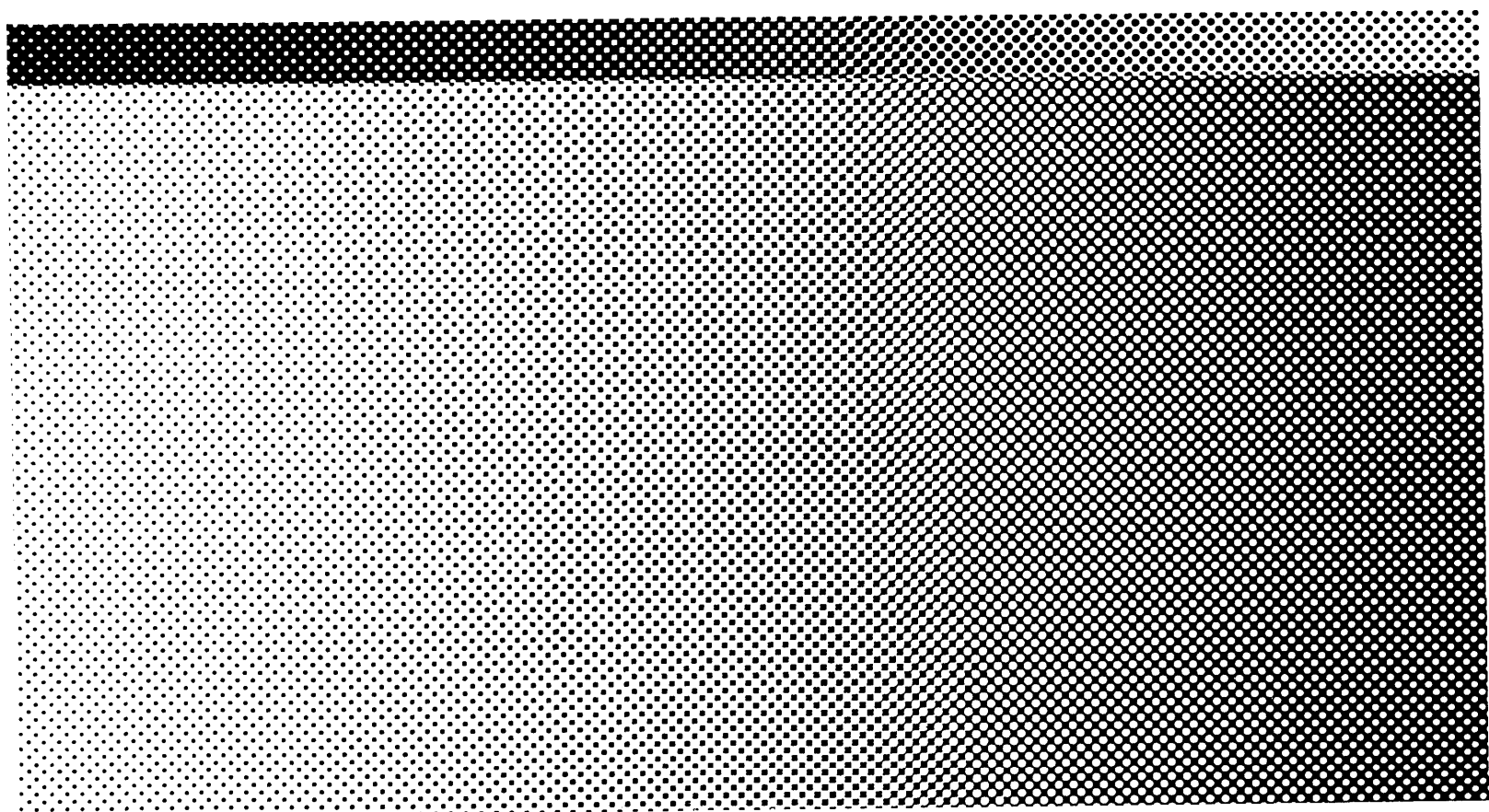

**©1988 AT&T
All Rights Reserved
Printed in USA**

**Issue 1
August, 1988**

NOTICE

The information in this document is subject to change without notice. AT&T assumes no responsibility for any errors that may appear in this document.

MERLIN is a registered trademark of AT&T.
IDEAL EZ Check is a registered trademark of Ideal Industries, Inc.

To order copies of this document, call the AT&T Customer Information Center, 1-800-432-6600 and include the document number 518-600-008 with your order.

Contents

Introduction	1
---------------------	---

Step 1: Installing the Control Unit	3
FCC Regulations	3
Prepare the Network Interface	3
Test the Outside Lines	5
Mounting the Control Unit	6
Insert the Modules	12
Connect the Control Unit to the AC Outlet	15
Connect the Outside Lines to the Control Unit	16

Step 2: Wiring the Voice Terminals	19
Preparation Considerations	19
Voice Terminal Wiring Procedure	21

Step 3: Connecting the Voice Terminals	22
Prepare the Voice Terminals	22
Connect Each Voice Terminal to the System	24
Testing Each Voice Terminal	24
Auxiliary Line Telephone	29

Step 4: Testing the System	30
Test the Voice Terminal Jacks for a Dial Tone	30
Place an Outside Call	32
Place an Intercom Call	33
Test Each Line Number	34
Speakerphone Performance Tips	34

Step 5: Adding Accessories	35
Accessory Equipment	35

Step 6: Changing the System	42
Adding an Outside Line	42
Adding a Voice Terminal	42
Moving a Voice Terminal	43

Jack Field Wiring Supplement	44
Constructing and Connecting the Jack Field	45
Extending the Network Interface to the Jack Field	50

FCC Registration and Repair Information	53
Appendix A: System Connectivity Overview	55
Appendix B: Quick Reference Installation Requirements	57
Connecting the control unit	60
Appendix C: Grounding Requirements	61
Before You Turn the Power On	61
External Grounding	63
Appendix D: Wiring Reference Tables	65
Typical System Wiring Installation	67
Appendix E: Direct Connection Wiring	69
Direct Connection	69
Index	I-1

This manual shows you how to install and test a MERLIN®Plus Communications System, Release 2. You should perform the tasks in the order presented since many of the early tasks prepare the system for those to be performed later.

The following is a brief overview of the installation steps in this manual:

- Set up and connect the system's control unit, beginning with the network interface, as described in "Step 1: Installing the Control Unit."
- Install the wiring for your voice terminals as described in "Step 2: Wiring the Voice Terminals."
- Connect your voice terminals to the system according to the instructions in "Step 3: Connecting the Voice Terminals."
- To make sure you've installed the system correctly, test the system using the procedures in "Step 4: Testing the System."
- Learn about some accessories you may want to add to your system in "Step 5: Adding Accessories."
- You can easily rearrange your system once it's in place by following the instructions in "Step 6: Changing the System."

If you are installing a jack field and building wiring, read the instructions in the "Jack Field Wiring Supplement" at the end of this manual before installing the MERLIN Plus system.

When you complete the steps in this manual, you will be ready to customize the system to meet the needs of your business by following the instructions in Section 3, "Administering the System," in the *MERLIN Plus System Manual*.

NOTE: Your system may not be fully operable until you program and administer it.

For reference purposes, place this manual in the System Manual binder when you are finished with the installation.

Figure 1 shows a typical MERLIN Plus system.

Figure 1 A typical MERLIN Plus system overview.

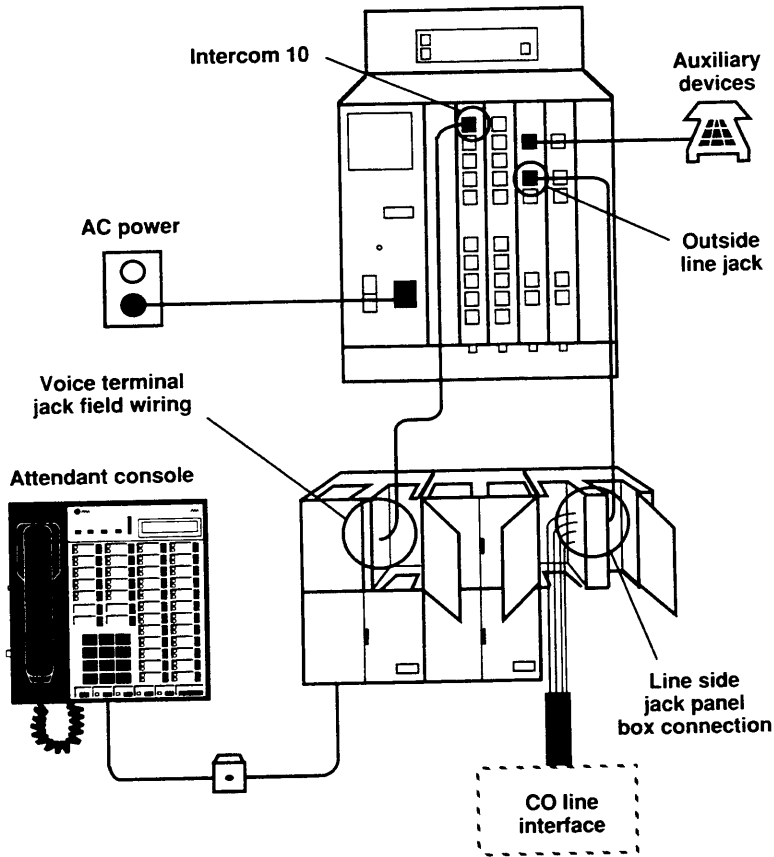

Step 1: Installing the Control Unit

FCC REGULATIONS

To comply with FCC regulations, notify your local telephone company of the following before permanently connecting your system to their lines:

- System registration number: AS593M-13529-KF-E
- Ringer equivalence number: 0.8A
- Telephone numbers of the lines to which you are connecting your system

For more information on FCC requirements and regulations, see "FCC Registration and Repair Information" at the end of this manual.

PREPARE THE NETWORK INTERFACE

The local telephone company provides you with the telephone numbers for your outside telephone lines as well as an installed network interface with 1-line (RJ11-type) adapters, 2-line (RJ14-type) adapters, or a 50-pin (RJ21-type) connector. See Figure 2.

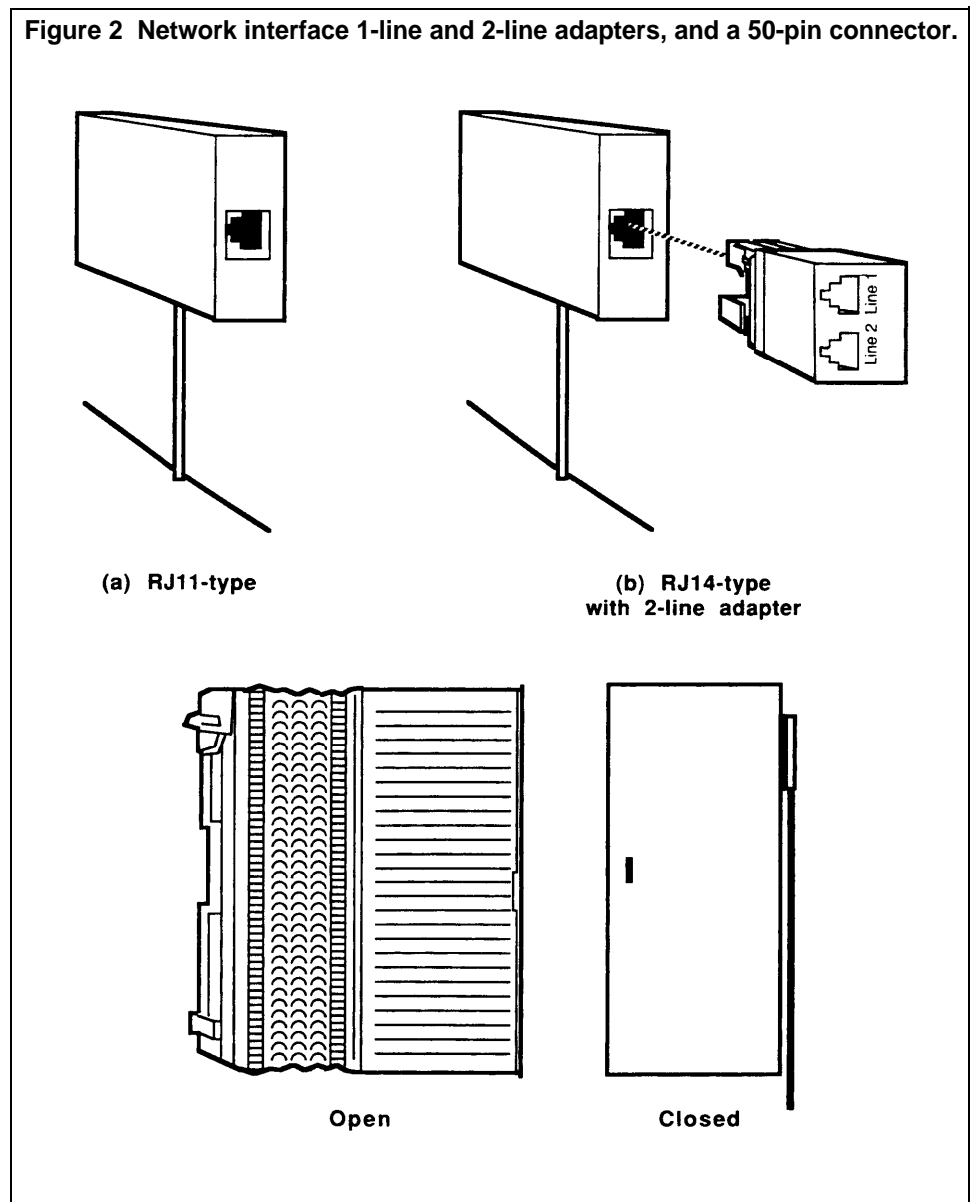

The 2-line adapter has two jacks, each of which carries a single-pair line from the 2-line network interface jack. The 50-pin connector (attached to a 66-type block) carries up to 25 lines. You can connect your outside telephone lines from these (or other) network interface connectors to the control unit in many ways. The method you use to connect your outside telephone lines to the control unit depends on the type of network interface the local telephone company installs at the control unit location. The table on the next page tells you what to do next depending on the type of network interface you have.

If the Network Interface Has	And	Do This
A 1-line (RJ11-type) adapter for each outside line	Each jack is labeled with its telephone number	Go on to the next procedure, "Test the Outside Lines."
	Each jack is not labeled with its telephone number	<ol style="list-style-type: none"> 1 Mark or label each jack with its telephone number from the list provided by the local telephone company. 2 Go on to the next procedure, "Test the Outside Lines."
A 2-line (RJ14-type) adapter for every two outside lines	Each jack is labeled with the telephone numbers for its outside lines	<ol style="list-style-type: none"> 1 Plug a 2-line adapter into each jack. 2 Go on to the next procedure, "Test the Outside Lines."
	Each jack is not labeled with the telephone numbers for its two outside lines	<ol style="list-style-type: none"> 1 Mark or label each jack with the telephone numbers for its outside lines from the list provided by the local telephone company. 2 Plug a 2-line adapter into each jack. 3 Go on to the next procedure, "Test the Outside Lines."
A 50-pin (RJ21-type) connector for the outside lines	The interface is labeled with the telephone numbers for the outside lines	See the instructions for extending the network interface to the jack field in the "Jack Field Wiring Supplement" at the end of this manual.
	The interface is not labeled with telephone numbers for the outside lines	<ol style="list-style-type: none"> 1 Mark or label the interface with the numbers for your outside lines. 2 See the instructions for extending the network interface to the jack field in the "Jack Field Wiring Supplement" at the end of this manual.

TEST THE OUTSIDE LINES

You may want to test whether a dial tone is audible at the network interface connection. If so, you need either a basic rotary dial telephone, a Touch-Tone telephone with a modular cord, or a tool that tests for dial tones. Because a MERLIN Plus system voice terminal works only with a control unit, you cannot use a MERLIN Plus system voice terminal for this test.

- 1 Bring the telephone or testing tool to the jacks for your outside lines (either at the network interface or at the jack field).
- 2 Plug the telephone's modular cord or the tool's testing cord into each outside line jack and listen for a dial tone. See Figure 3.

Figure 3 Testing outside lines for a dial tone.

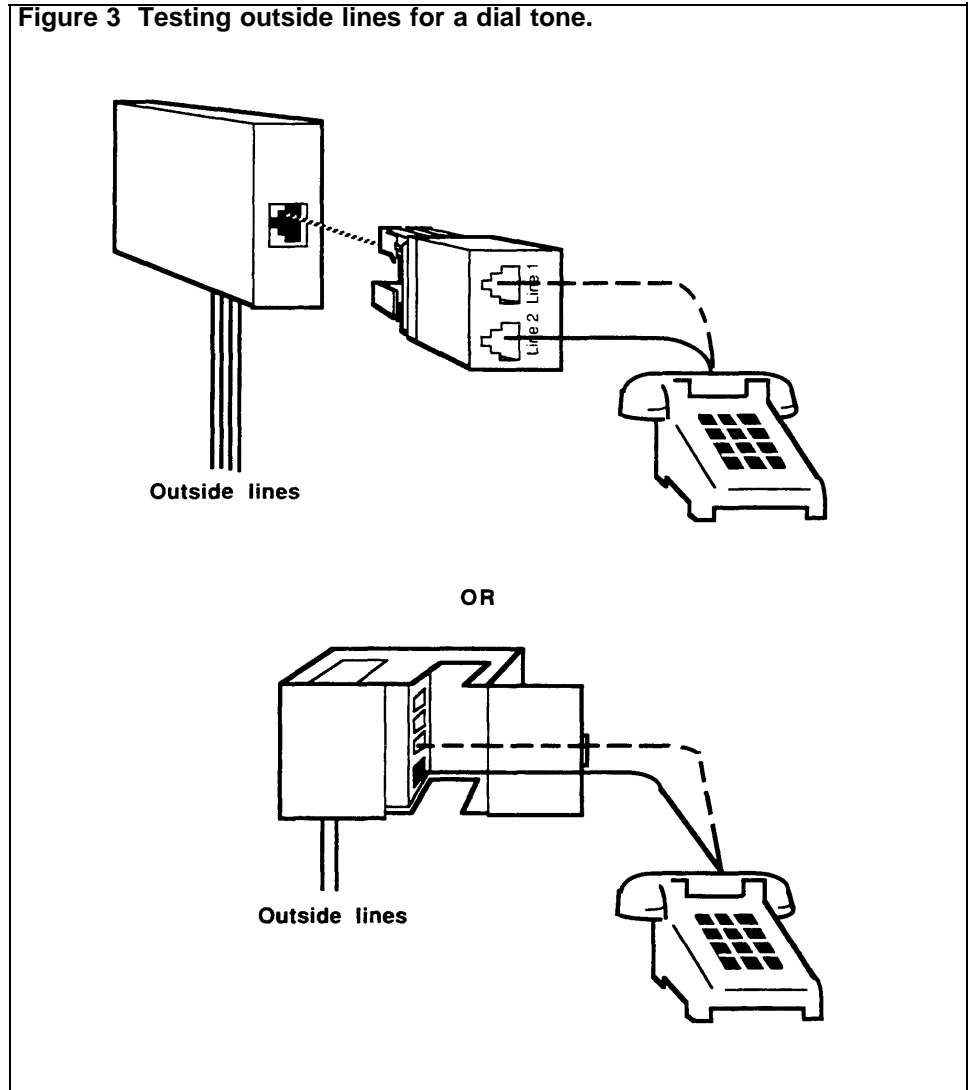

If	And	Do This
Each outside line has a dial tone		Go on to the next procedure, "Mounting the Control Unit."
A line does not have a dial tone	The jack for that line at the network interface is a 1-line (RJ11-type) jack	Have the local telephone company check the line and the network interface. Meanwhile, go on to the next procedure, "Mounting the Control Unit," and continue with the installation.
	The jack for that line at the network interface is a 2-line (RJ14-type) jack with a 2-line adapter	Replace the adapter with a new one, and test again for a dial tone. If the problem remains, have the local telephone company check the line and the network interface. Meanwhile, go on to the next procedure, "Mounting the Control Unit," and continue with the installation.
	The jack for that line is in the jack field	Check the wiring run from the jack in the jack field to the connector at the network interface and fix any loose connections. If the problem remains, have the local telephone company check the line and the network interface. Meanwhile, go on to the next procedure, "Mounting the Control Unit," and continue with the installation.

MOUNTING THE CONTROL UNIT

Control Unit Location The control unit is designed to be mounted on a wall in an environment that meets certain requirements for proper operation. (See Figure 4.) Check that the following environmental and measurement requirements are met before proceeding:

Warning Do not install the control unit in areas that may be exposed to water leakage or accidental spills of liquids. In the event that liquids come in contact with the control unit, turn off and unplug the unit and contact your AT&T technician immediately.

- The control unit is within 5 feet of a grounded ac power source.

NOTE: If the outlet is not properly grounded, install an 18-gauge (or thicker) wire from the ground lug on the control unit to the building ground. For more information on grounding and grounding tests, see Appendix C: Grounding Requirements."

In areas of the country with frequent lightning or severe transient voltage, you may also want to provide external protection to the control unit with an ac surge suppressor at the wall power source. You can combine both ac and CO line surge protection with the 147A Protector, installed as described in CIB 3109.

- The control unit is within cord length of the network interface provided by the local telephone company. Cord lengths are 7, 14, and 25 feet. Also, up to 400 feet of DIW cable can be used to connect the network interface to the control unit.

- The control unit is within 6 inches of a jack field.
- The network interface is available for installation or has already been installed.
- The wiring runs from the control unit to the voice terminal locations do not exceed 1000 feet.
- The temperature range of the location is between 40 and 104 °F (4 to 40 °C).
- The control unit location is safe from sources of extreme heat (furnaces, heaters, attics, or direct sunlight).
- The control unit has at least 1 inch of ventilation space around its sides.
- The control unit location is safe from exposure to corrosive gases, dust, chemicals, or similar substances.
- The humidity of the control unit location does not exceed 80 percent.

FIGURE 4 Diagram of the control unit location.

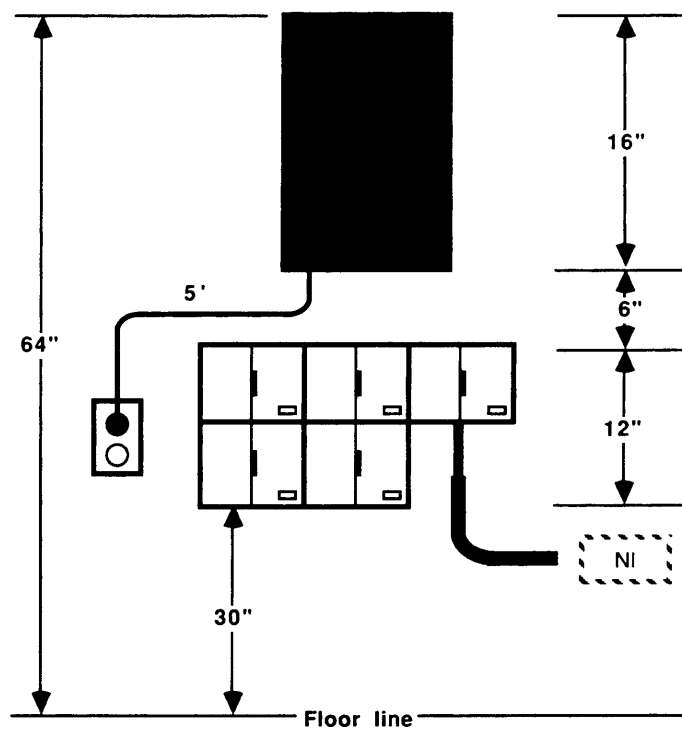

Equipment

Four 1 1/4-inch No. 8 self-tapping screws come with the system for mounting the unit on a wall. Regardless of the mounting surface, you will need a long-shafted screwdriver for your installation. However, the construction of the wall you have selected for mounting the control unit determines if you will need additional or substituted items for mounting.

If the mounting surface is:	You will need:
Concrete Brick Concrete block	Four 1 1/4-inch No. 8 masonry anchors
Plaster Plasterboard	Four 3/16-inch toggle bolts
Plywood Sheet metal	Screws supplied and one 9/64-inch drill bit

In addition to the screwdriver and hardware mentioned, you also need:

- Pencil or other sharp-pointed marker
- Notepaper
- Tape measure
- Power drill (or hand drill)
- Appropriate drill bits

Removing Control Unit Covers

Locate and identify the front and top covers of the control unit (Figure 5).

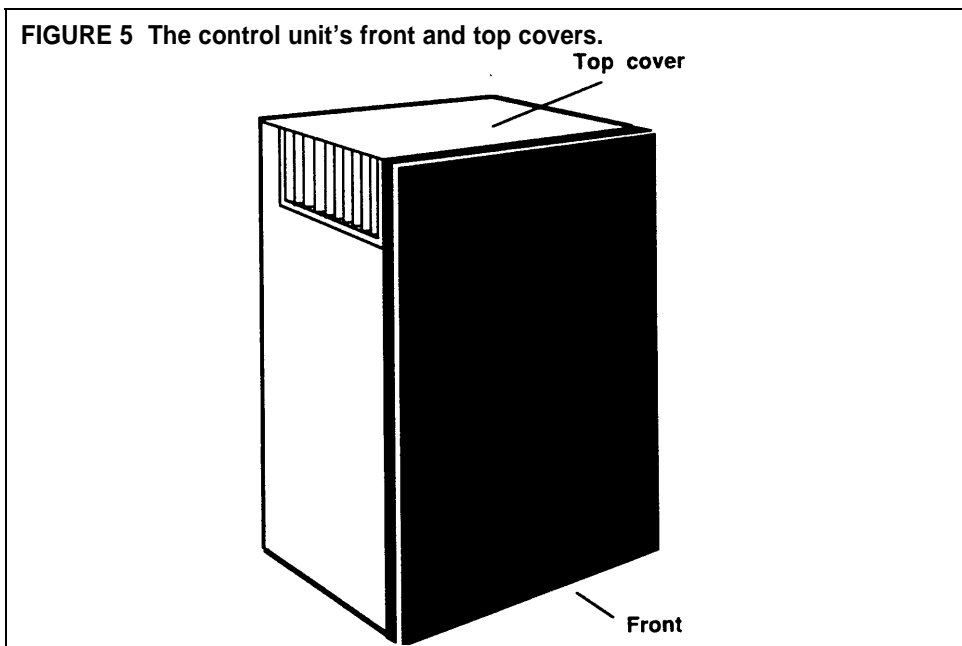

Locate the back of the control unit and note the four screw holes used for securing the control unit to the wall (Figure 6).

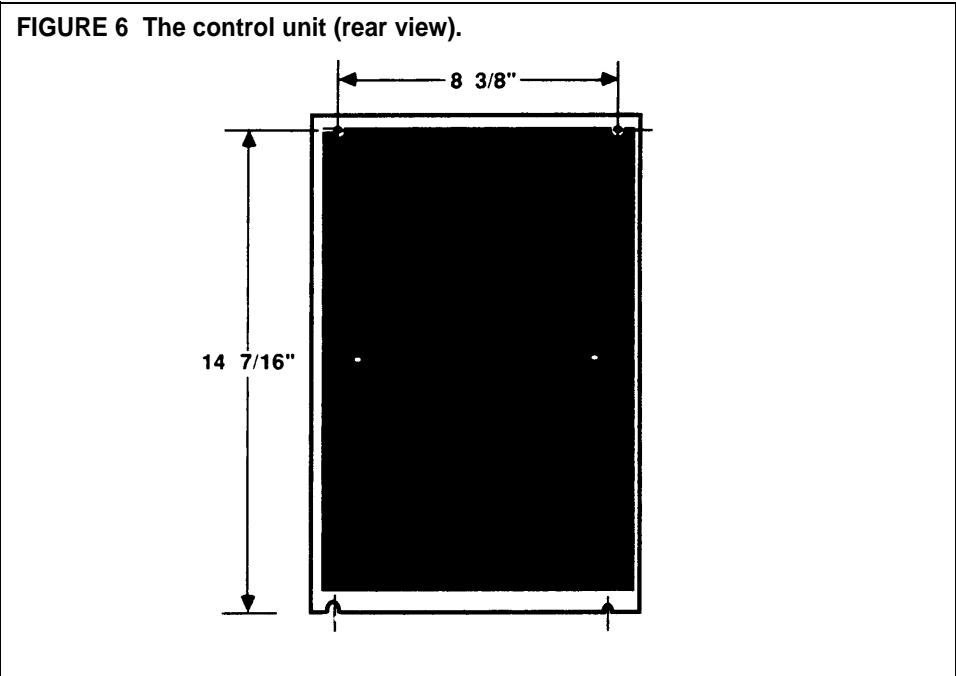

As noted in Figure 6, the horizontal distance between the center of these holes measures $8 \frac{3}{8}$ inches, and the vertical distance measures $14 \frac{7}{16}$ inches. Make note of these measurements since you may need them to locate and drill mounting holes in the wall.

In order to reach the mounting holes from the front of the control unit, you have to remove the front and top covers. Remove the front cover by pressing down on the two top corner tabs and pulling the top away from the control unit, as shown in Figure 7.

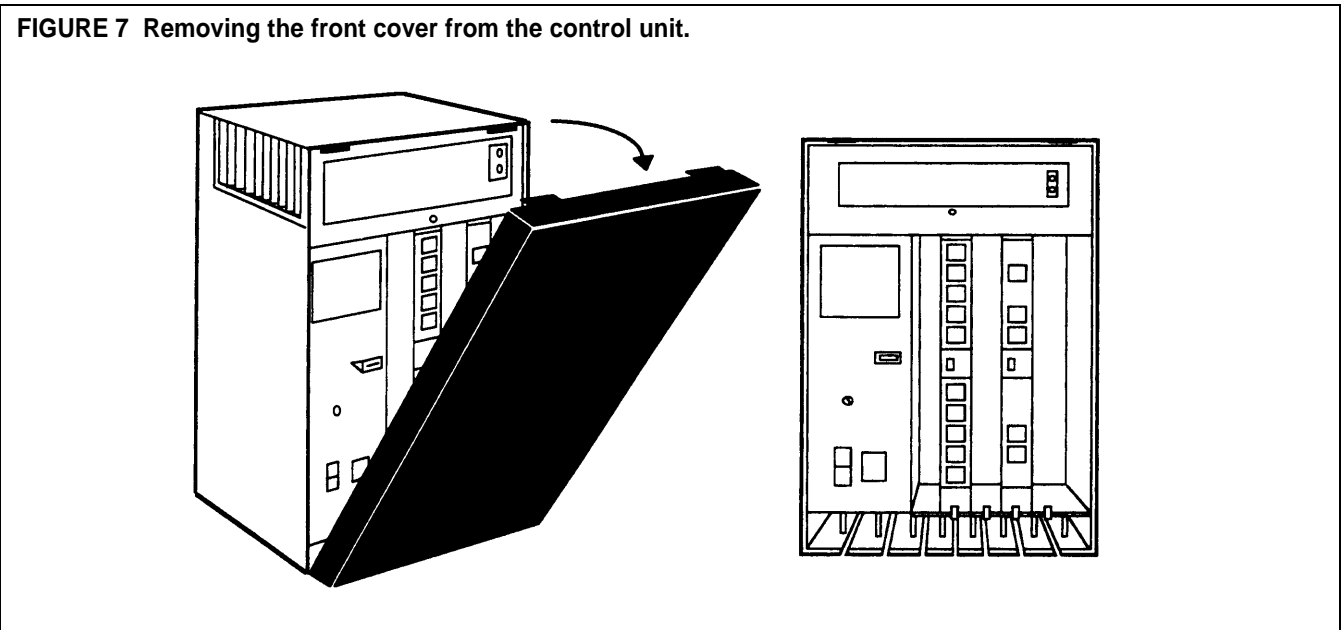

Remove the top cover by first unscrewing the screw located at the center bottom of the cover. This screw is designed to stay in the hole of the cover after it has been removed from the control unit. Press down on the tab located at the center of the top and back edge and pull the top cover away, as shown in Figure 8.

Once these covers are removed, you can reach the screw holes from the front of the unit.

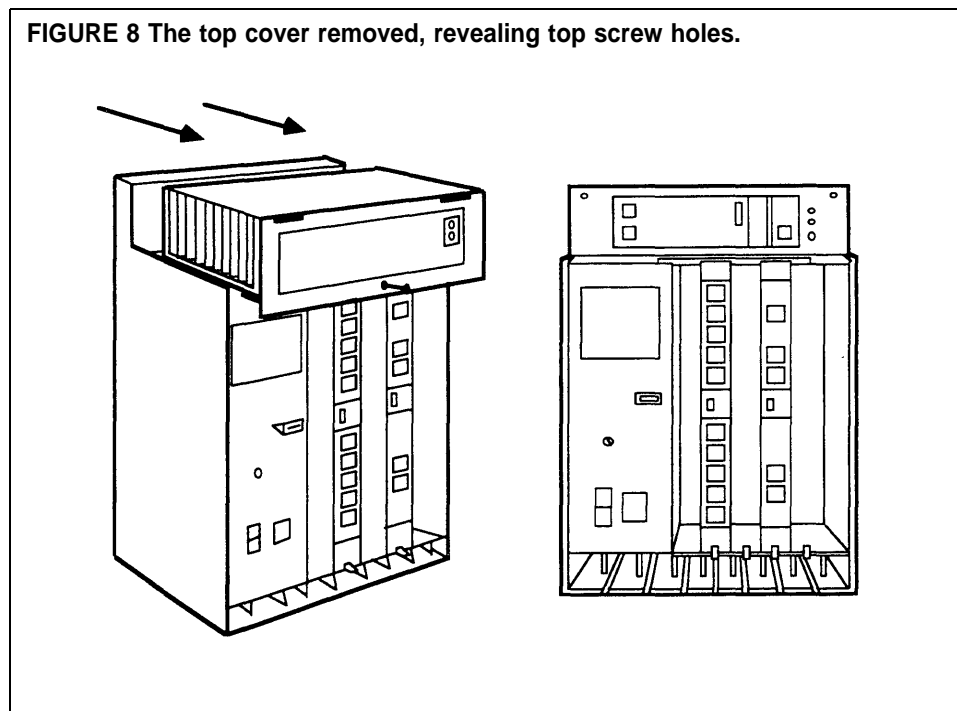

Wall-Mounting Procedure

The wall surface and individual circumstances determine the exact procedure for mounting the control unit on the wall. Use the following instructions and Figure 9 as a guide for installing your system.

- 1 Using the dimensions shown in Figure 6, mark the centerline positions of the holes to be drilled on the wall.

or

Place the control unit on the wall where you plan to mount it, and, once you've checked that it is level, use the holes in the control unit as guides to mark the positions of the holes to be drilled on the wall.

Place the control unit aside.

- 2 Drill the four holes and insert the bottom two screws until they are screwed in about half their length.
- 3 Fit the control unit's bottom screw slots on the two screws.
- 4 Press the unit against the wall and insert the top two screws.
- 5 Tighten all screws.

FIGURE 9 Mounting the control unit on the wall.

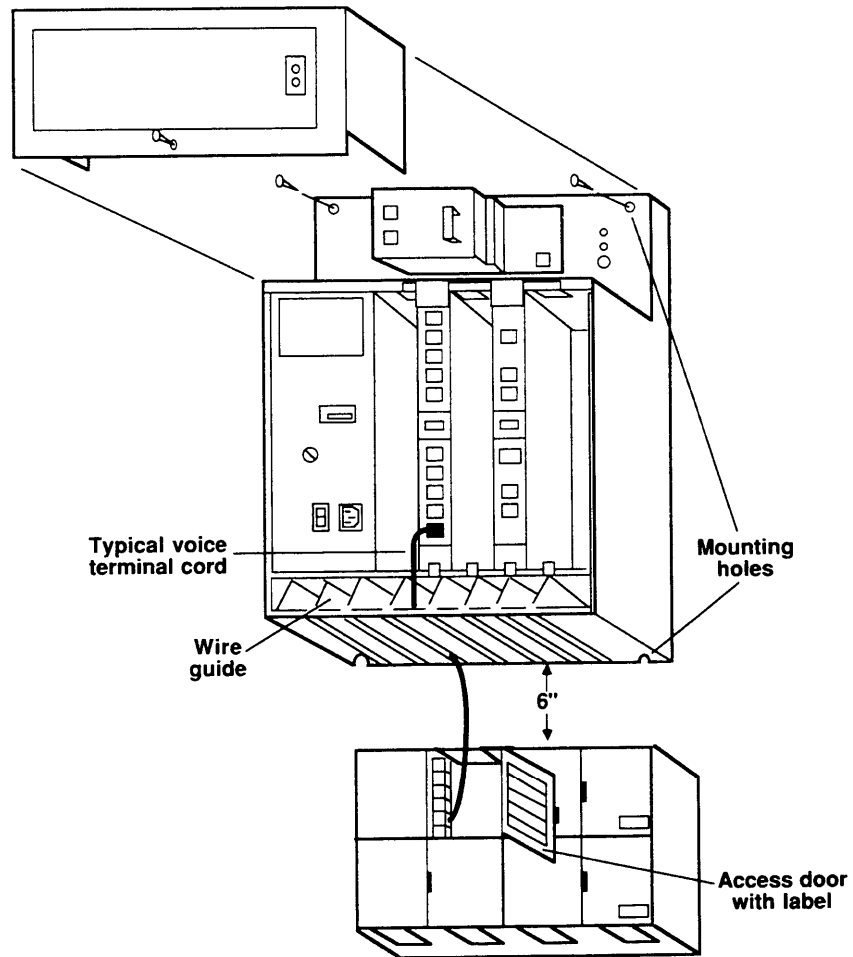

INSERT THE MODULES

The control unit comes with covers in place and with the following modules already installed:

- Power supply module
- Memory module
- Line module (line board)
- Voice terminal module (station board)

You have already removed the front and top covers to mount the unit on the wall. The power supply module is on the left inside the control unit. See Figure 10. The memory module houses a battery that will preserve all programming for at least four days in case of a power failure. The voice terminal module (station board) has 10 jacks for 10 voice terminal connections, and the line module (line board) has 4 jacks for outside line connections and one jack for auxiliary use. Notice the protective safety latches at the bottom of the line and voice terminal module slots.

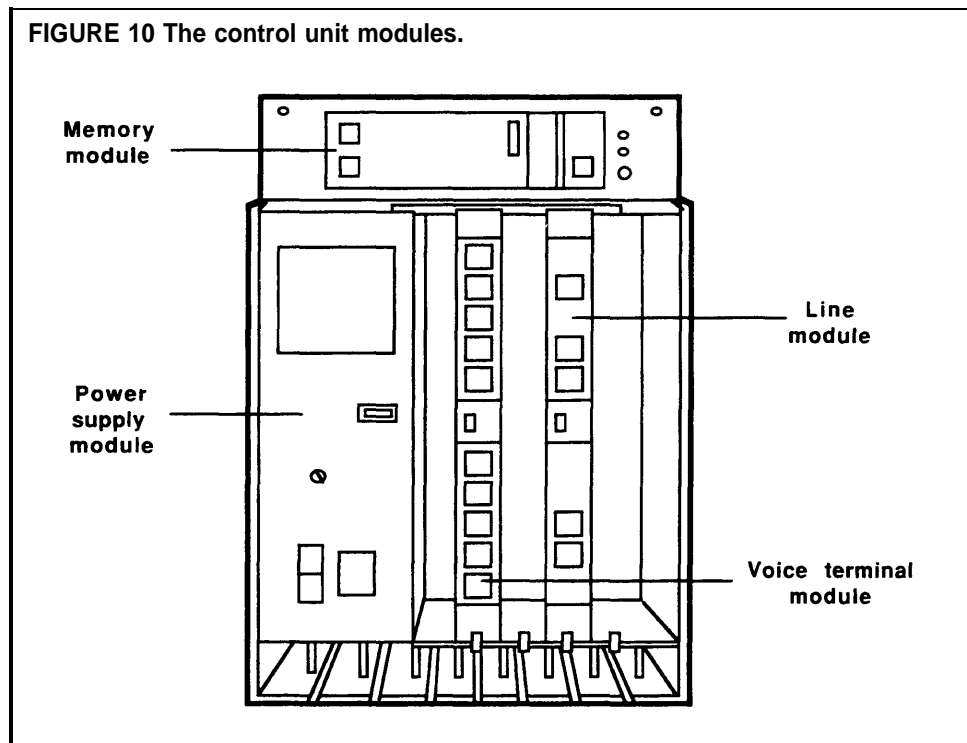

If you did not order a second line or voice terminal module, go on to the next procedure, "Connect the Control Unit to the AC Outlet." However, if you have ordered the additional two modules, insert them now following the instructions below.

CAUTION: Make sure the power cord is unplugged and the power switch on the control unit is set to *Off* before you insert or remove any modules. You risk damage to the system and the modules if the power is on during this procedure.

Inserting a Line Module

Make sure that the power switch is off and that the system is unplugged from the power source. Then do as follows:

- 1 Be sure the top and front covers are off.
- 2 Locate the slot immediately to the right of the line module already installed. Notice the plastic channels at the top and bottom of the slots.
- 3 Align the top and bottom edges of the line module to the channel openings so that the gold connectors face in and the components face out and to the right of the slot.

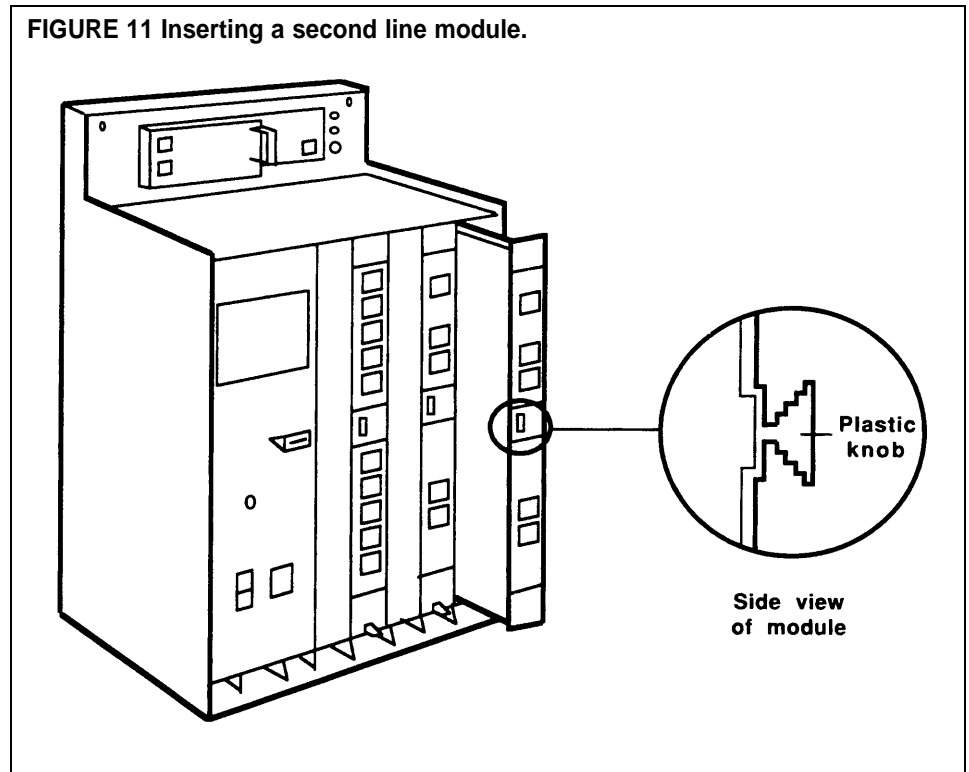

- 4 Hold the module by the plastic knob and slide it into the slot. See Figure 11.
- 5 Slide the module in until the gold connectors insert fully into the port at the back of the unit and the module snaps into place.
- 6 Check that the module is held in place by the safety catch at the bottom of the slot. It should fit snugly against the bottom front of the module.

CAUTION: You may need to exert mild force to insert the module; however, do not use excessive force. If you have difficulty, remove the module from the slot, align the module properly, and try again.

If you still have difficulty, check the module and the channel for damage. If you find any damage, such as broken pieces or plastic chips, contact your equipment supplier for assistance. If there is no damage, try one more time; the module should snap into place.

Inserting a Voice Terminal Module

Make sure the power is off, the control unit is not plugged into the power source, and the covers are off. Then locate the slot between the voice terminal module and the line module already in place. Align the edges and install the voice terminal module using the same procedure you used for inserting the line module. Check to see that the module is securely in place. See Figure 12 at (a).

When two line modules and two voice terminal modules are installed in this system, the control unit is at full capacity as shown in Figure 12 at (b). As designed, empty space remains to the left of the first voice terminal and to the right of the second line module.

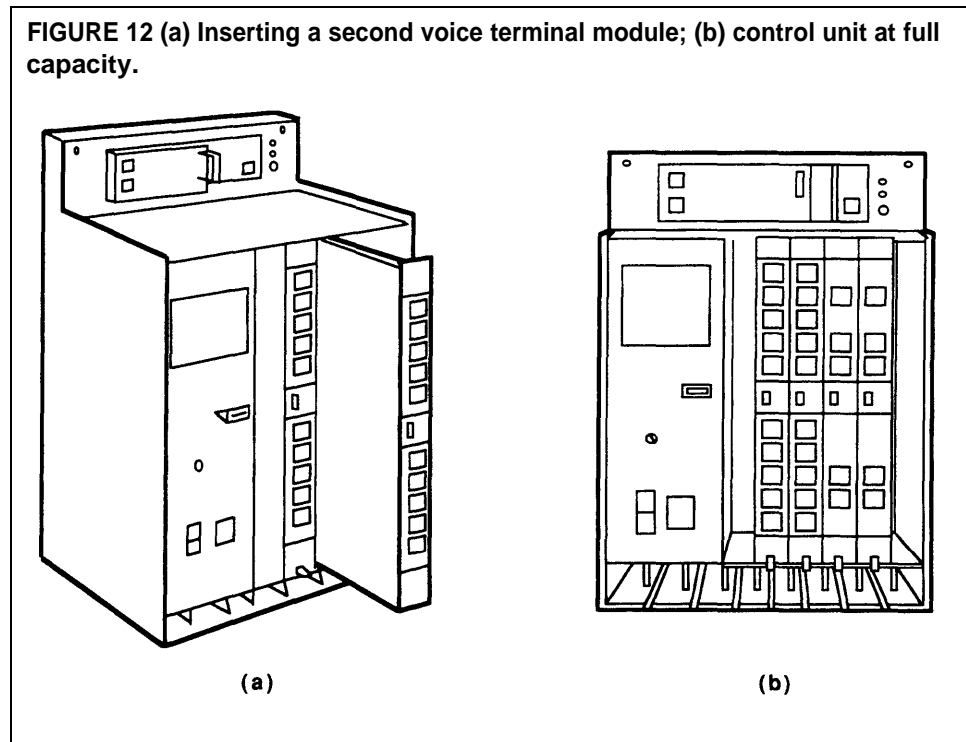

Once you have installed all modules, go on to the next procedure, "Connect the Control Unit to the AC Outlet."

CONNECT THE CONTROL UNIT TO THE AC OUTLET

The ac outlet should be a 117-volt, 60-Hz, 3-prong, third-wire grounded outlet. You should have an electrician check the outlet's third wire to make sure the outlet is properly grounded. Proper grounding helps protect the system against damage from power surges caused by static discharges and lightning. See "Appendix C: Grounding Requirements" before connecting the control unit to the power source.

Once you are satisfied that the outlet is properly grounded, connect the control unit to the ac outlet as follows:

- 1 Make sure the power switch on the control unit is set to *Off*.
- 2 Plug one end of the power cord into the socket just below the power switch on the front of the control unit.
- 3 Thread the cord through the cable channel at the bottom of the control unit.
- 4 Plug the other end of the cord into the ac outlet, allowing for a foot or so of slack.
- 5 Set the power switch on the control unit to *On*.

The green power light on the control unit goes on.

The red warning light on the control unit blinks once, then goes off unless a malfunction occurs.

The orange light on the power module goes on indicating that the outlet is properly wired and grounded. If the orange light is off when the green light is on, the outlet is not functioning, or may be miswired or improperly grounded. Contact a qualified electrician immediately.

See Figure 13.

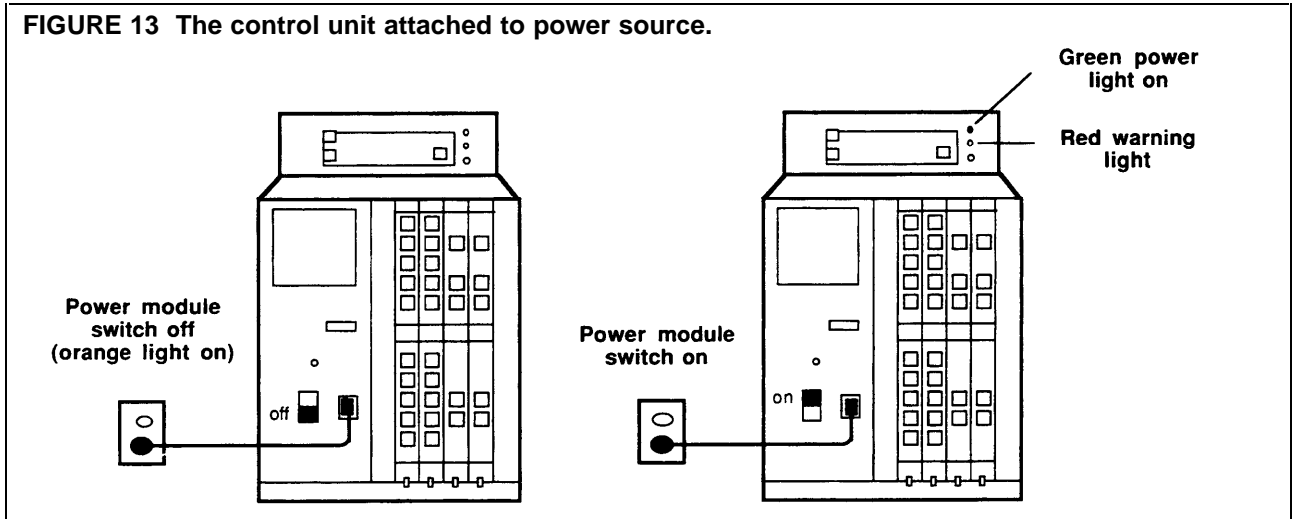

As soon as the unit is turned on, the red warning light should flash once, then remain off. Observe the lights on the control unit to determine its condition before proceeding. If any of the conditions described in the following table exist, take the recommended steps to correct the situation.

If	Then
The green power light doesn't go on and the orange light on the power switch also doesn't go on	Test the outlet by plugging in a radio or a lamp.
The green power light is on, but the orange power switch light is off .	The outlet is not functioning, is miswired or improperly grounded. Have it repaired or use another outlet.
The green power light is off but the orange power switch light is on and the outlet is working properly	<i>Stop</i> the installation. Turn off the control unit, unplug it from the ac outlet, and contact your equipment supplier for assistance.
The red warning light continually flashes or remains lit	Unplug the power cord and plug it in again.
The red warning light continues to flash or remains lit	Set the power switch to <i>Off</i> , and make sure that each module is seated firmly in its slot. Then set the power switch to <i>On</i> .
If the red warning light still continually flashes or remains lit	<i>Stop</i> the installation. Contact your equipment supplier for assistance.

When the unit is on and only the green power light and orange power switch light remain on, the control unit is working correctly. Before you connect any lines to the control unit, turn the power off.

CONNECT THE OUTSIDE LINES TO THE CONTROL UNIT

As shown on the label attached to the power module, control unit line jacks are designated by the letters A through H. The A line jack is the second from the top, B is third from the top, C is fourth, and so on. The topmost line jack, the Auxiliary jack, is described under "Auxiliary Line Telephone" in this manual.

Connect the outside lines to the line jacks in an unbroken sequence. If you start with A, for example, the next connection should be B, the next C, and so on. Although any outside line can be connected to any line jack, do not skip jacks once you have begun. If you start with B, the next connection should be C, followed by D, and so on. This simplifies future line administration.

Also, group special line types such as WATS lines together in the sequence, and place personal lines, if any, at the end of the sequence.

You need the following items to connect the control unit to the jacks for your outside lines, whether they appear at the jack field, or at the network interface.

- A completed System Configuration Form (Figure 14)
- A single-pair modular line cord for each outside line

Use a 7-foot cord if the control unit is within 6 feet of the network interface; use longer cords as required for greater distances. Only use one cord length; don't use extensions.

FIGURE 14 A System Configuration Form.

System Configuration Form

Dial Signals

 Touch-Tone
 Rotary (Pulse)

Long Distance Dialing

 Toll Prefix
 Area Code Only

Transfer Return Interval

 No Return
 3 Rings

Voice Terminals

Intercom Number	Name	Location	Paging Groups	
			Group 1	Group 2
10	(Attendant) Joanne Conlin	Front office		
11	Hal Peterson	Main office		
12	Gail Zaccari	Back office		
13				
14				

Outside Telephone Lines

Control Unit Jack/Line	Hold Disconnect Interval		Telephone Number	Line Type (PBX/Centrex, Local, WATS, etc.)
	Short	Long		
A		✓	555-1234	
B		✓	555-7071	PBX
C		✓	555-3374	WATS
D				

See Figure 15 and follow this procedure to connect your outside lines:

- 1 Refer to your System Configuration Form when connecting the outside lines you've assigned to each line jack on the control unit. The outside line numbers are the telephone numbers listed at the network interface.
- 2 Mark or label a D2R cord on both ends with "A."
- 3 Plug one end of the line cord into the control unit jack labeled "A."
- 4 Plug the other end of the cord into the network interface or jack field that corresponds with the telephone number shown on your System Configuration form.
- 5 Repeat steps 2 through 4 for lines B through H or until you have connected all your outside lines to the control unit.

CAUTION: Do not run cords inside or on top of air plenums or ducts, along hot pipes, or across walkways. If you use staples to attach the cords to a wall, be careful not to pierce the cords.

FIGURE 15 The control unit connected to labeled outside lines.

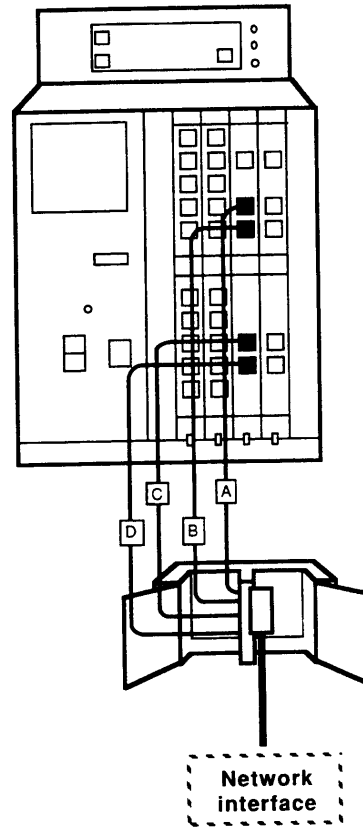

NOTE: If you're in an area with frequent lightning activity or severe transient voltage and are using the 147A Protector (see CIB 3109), the outside lines from the control unit plug into corresponding jacks on the protector itself.

Step 2: Wiring the Voice Terminals

PREPARATION CONSIDERATIONS

Before connecting the voice terminals to the control unit, keep your System Configuration Form handy and review the following:

Locations

- The wiring run from the control unit to a voice terminal location *cannot* exceed 1000 feet.
- A voice terminal located in another building requires two Model 341 In-Range, Out-of-Building (IROB) protectors. (See Section 5, "Reference," in the System Manual for more information on IROB protectors.)

Intercom Numbers

- The intercom numbers for a MERLIN Plus system with 10 or fewer voice terminals run from 10 to 19.
- For a system with more than 10 voice terminals, the numbers run from 10 to 29.
- These numbers correspond to the numbers on the voice terminal jacks on the control unit. For example, the voice terminal to which you've assigned intercom number 12 will be connected to the control unit through voice terminal jack number 12.

Intercom 10

- By design, the intercom 10 position is the primary call-handling position in the system. It is also the position used for system administration.
- You should assign intercom number 10 to the attendant's location.
- The voice terminal you've assigned to the attendant's location should be a 22-button (BIS-22) or 34-button (BIS-34D or BIS-34) model. (See Section 4, "Using the Attendant Console," in the System Manual for more information.)

Intercom 19 and Printed Reports

- Printed reports require a MERLIN Plus System Data Collector and a printer (AT&T 475 or equivalent).
- The MERLIN Plus system is capable of printing for your use two kinds of reports. The Call Report (also known as the Station Message Detail Recording [SMDR]) prints records of outgoing and/or incoming calls. System Feature Report (SFR) allows you to verify with a printout your administered systemwide features as well as the individual features programmed onto voice terminals. If your system will *not* have the Call Report option or if you do not plan to verify your system or voice terminal features, skip this section, go onto "Intercoms 11 through 29," and treat intercom number 19 just like any other intercom number available for assignment to a voice terminal.
- If you will be printing Call Reports or System Feature Reports, you should know that the system automatically assigns intercom number 19 to the data collector and printer. But if you want to assign intercom number 19 to a voice terminal and assign another intercom number to the data collector and printer, you can do so.
- A good alternate choice for the data collector and printer is the intercom number directly following the last intercom number you plan to assign to a voice terminal. For example, if you have 15 voice terminals, they will be assigned intercom numbers 10 through 24 (corresponding to voice terminal jacks 10 through 24 on the control unit). You would then connect the data collector and printer to voice terminal jack 25 on the control unit during system installation and assign intercom number 25 to the Call Report feature during system administration.

Intercoms 11 through 29

- After you have assigned intercom number 10 to the system attendant's location and another intercom number to the data collector and printer (if you are using them), assign intercom numbers to the voice terminals in the remaining locations in any order that makes sense to you. To simplify system administration, however, you should assign consecutive intercom numbers beginning with 11.
- Each jack number of the control unit's voice terminal module corresponds to the intercom number of the voice terminal to be plugged into it.

VOICE TERMINAL WIRING PROCEDURE

When you planned your system, you recorded the intercom numbers for specific locations within your business on the System Configuration Form. Check and make a note of these assignments now, before you begin connecting the voice terminals to the control unit. When you are ready, install the voice terminal wiring as follows:

- 1 Use your System Configuration Form as a reference for each intercom number.
- 2 Mark or label a D8W cord on one end with "10."
- 3 Plug the unlabeled end into the control unit jack that is labeled "10."
- 4 Plug the other end into the corresponding jack in the jack field.
- 5 Repeat steps 2 through 4 for the remaining intercom numbers, 11, 12, and so forth, until all voice terminal wiring is connected.

NOTE: For short and temporary connections, you can connect the voice terminals directly to the control unit. However, the jack field connection is the recommended method. See Figure 16.

FIGURE 16 Connecting voice terminal wiring through a jack field.

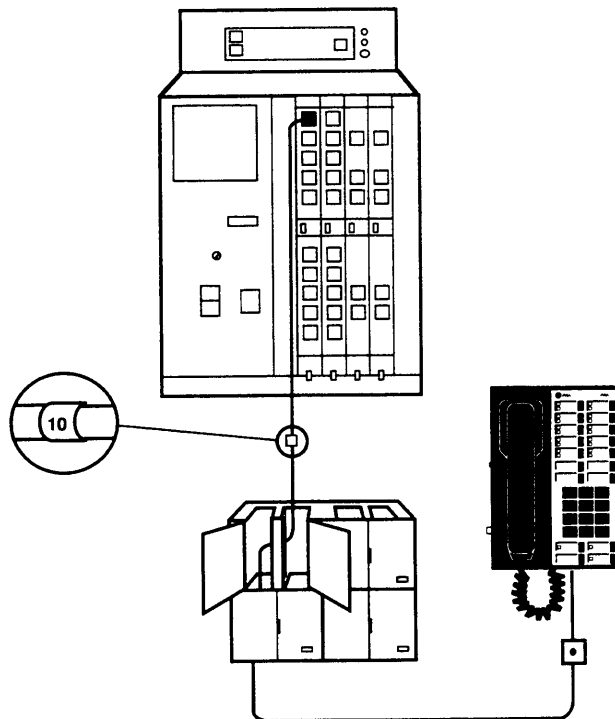

Step 3: Connecting the Voice Terminals

Any of the following voice terminal models will work at any voice terminal location connected to your MERLIN Plus system:

- 5-Button voice terminal
- BIS-10 voice terminal
- 10-Button voice terminal
- 10-Button voice terminal with Hands Free Answer on Intercom (HFAI-10)
- BIS-22 voice terminal
- BIS-34D with Display voice terminal
- BIS-34 voice terminal
- 34-Button (SP-34) voice terminal with speakerphone
- 34-Button (SP-34) voice terminal with speakerphone and display
- 34-Button deluxe voice terminal
- 34-Button voice terminal

Assign voice terminals to their locations based on the requirements of your system and the needs of individual users. For example, an attendant/receptionist at the intercom 10 location will require a BIS-34D, 34-Button or 22-Button voice terminal. Refer to your completed System Configuration Form when necessary.

PREPARE THE VOICE TERMINALS

The following items come boxed together:

- Voice terminal body
- Handset
- Coiled handset cord
- Modular voice terminal cord
- Desk stand and/or wall mount
- Instructions for assembling the voice terminal

See Figure 17 as you prepare each voice terminal for connection to the system as follows:

- 1 Attach the desk stand or wall mount to the voice terminal body according to the instructions that came with the components.
- 2 Plug one end of the coiled handset cord into the handset.
- 3 Plug the other end of the coiled handset cord into the jack near the handset rest at the lower edge of the voice terminal body. The jack also may be located at the base of the voice terminal body and have a handset symbol next to it.
- 4 Plug the modular voice terminal cord into the jack labeled "Line" at the base of the voice terminal.

NOTE: The control unit power should be off at this point. However, if the power is on and the other end of this modular voice terminal cord is already plugged into the control unit, a red light may go on next to a button when you plug the cord into the line jack on the voice terminal, and the voice terminal may ring. Don't be alarmed. The red light *should* go on if the control unit power is on; go to the next step.

- 5 Find the Test/Program (T/P) switch on the left side of the voice terminal and set it to the center position. If the switch is set to *T* or *P*, the voice terminal rings as soon as you connect it to a system that is turned on. Turn the power off at the control unit until you are ready to test the voice terminals.
- 6 Find the volume control for the ringing tone, also on the left side of the voice terminal, and slide it to the center position. See Figure 18.

FIGURE 17 Preparing the voice terminal desk stand or wall mount.

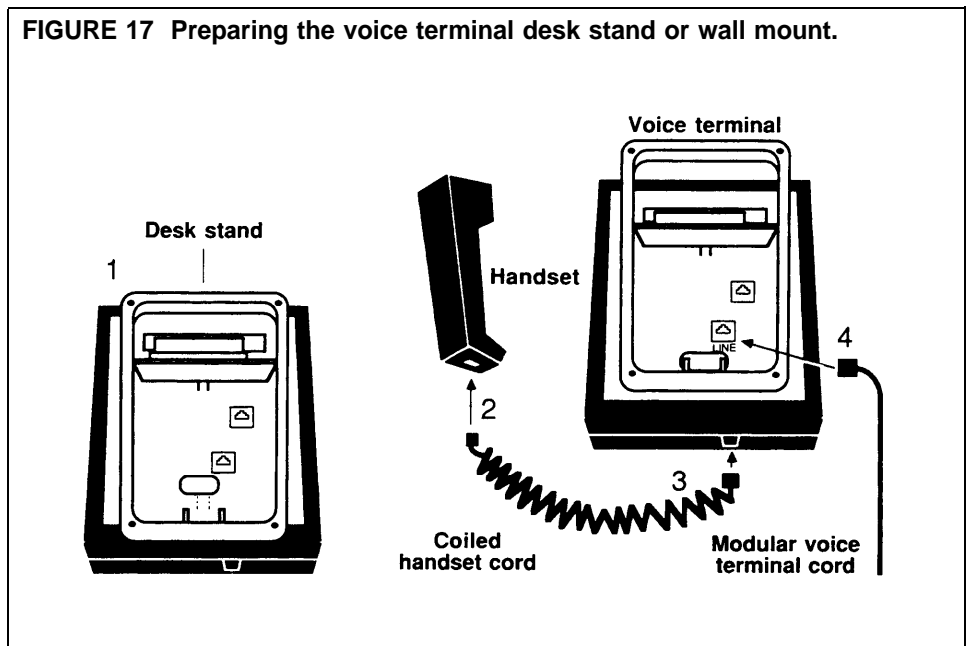
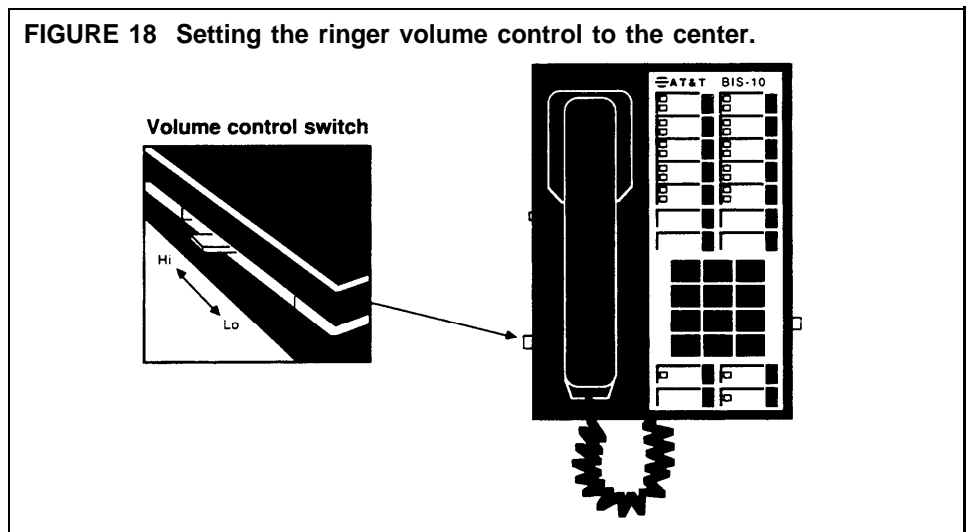

FIGURE 18 Setting the ringer volume control to the center.



CONNECT EACH VOICE TERMINAL TO THE SYSTEM

Since the voice terminal module can be damaged if a modular cord is unplugged while there is power to the control unit, make sure that the control unit power is off before connecting each voice terminal to the system. This prevents you from damaging the voice terminal module if you accidentally pull on a cord that is attached to it. When the power is off, follow these steps to connect each voice terminal to the system:

- 1 Place the voice terminal in its designated location.
- 2 Plug the voice terminal into the wall jack or control unit jack as indicated on the System Configuration Form.
- 3 Go on to "Testing Each Voice Terminal."

TESTING EACH VOICE TERMINAL

When you have completed the voice terminal connections, you are ready to test that they are connected properly.

Preparing For Testing

Make sure that the Test/Program (T/P) switch on the left side of each voice terminal is set to the center position. This step prevents the phones from ringing when the power at the control unit is turned on. Also, make sure the volume control for ringing and button clicks located on the left side of each voice terminal is in the center position.

If you're using a BIS, SP, or HFAI model voice terminal, adjust the speakerphone volume according to the model you have:

For 10-Button models, the speakerphone volume switch is located on the right side of the voice terminal (Figure 19).

- 1 Slide the switch away from you to increase the volume.
- 2 Slide the switch towards you to decrease the volume.

On 22- and 34-Button models, the speakerphone volume is adjusted by a thumbwheel located on the face of the voice terminal (Figure 19).

- 1 Turn the thumbwheel to the right to increase the volume.
- 2 Turn the thumbwheel to the left to decrease the volume.

Testing the Voice Terminals

When you have prepared each voice terminal for testing, test them as follows:

- 1 Turn on the power at the control unit.
A red light goes on next to a line button when you plug a voice terminal into it.
- 2 Test to see that each voice terminal operates properly by sliding the T/P switch to *T* and, if necessary, holding it there. See Figure 20.
All the red and green lights on the voice terminal begin to flash, and a tone sounds.

FIGURE 19 Adjusting the Speakerphone volume.

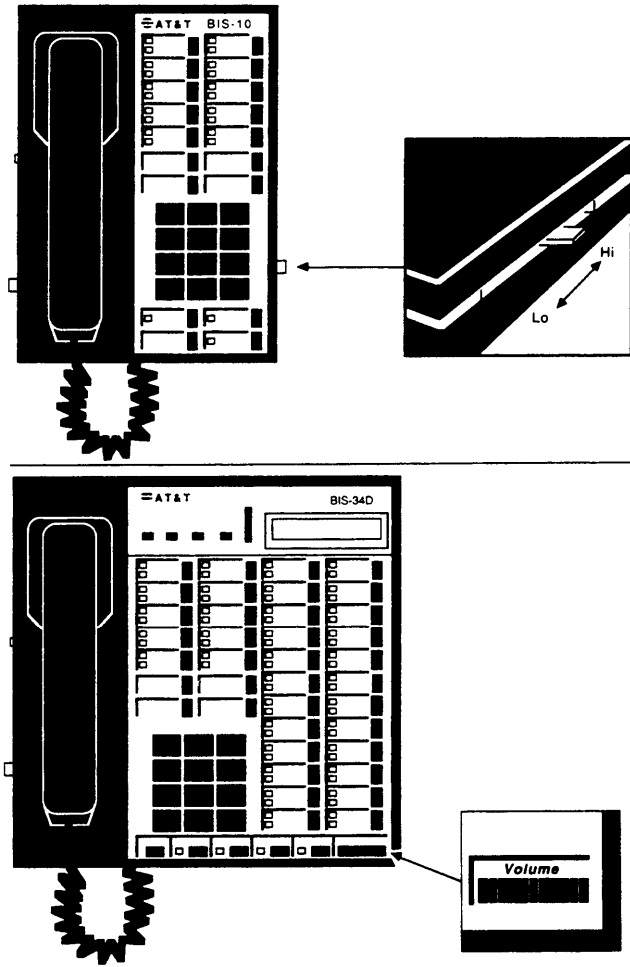
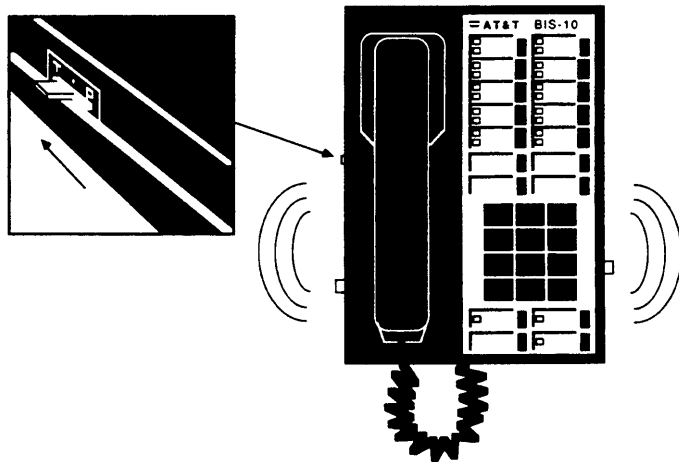

FIGURE 20 Verifying correct tone and light operation.



If the lights do not flash:

Do This	If	Then
1 Check the green power light on the control unit.	The green power light is on	Go on to Step 2.
	The green power light is off	Make sure the power cord is plugged into the ac outlet. Then set the power switch on the control unit to <i>Off</i> and back again to <i>On</i> . If the green power light still does not go on, contact your equipment supplier for assistance before continuing with the installation.
2 Check the wiring run from the control unit to the voice terminal.	The wiring connections are secure	Make a note of the problem, and refer to Section 7, "Troubleshooting the System," in the System Manual after you've completed the installation.
	You find one or more loose connections	Fix the connections. If the voice terminal lights still do not flash, make a note of it, and refer to Section 7, "Troubleshooting the System," in the System Manual after you've completed the installation.

If the tone does not sound:

Do This	If	Then
Use the voice terminal's volume control to turn up the volume.	The tone sounds	You've solved the problem.
	The tone still doesn't sound	Make a note of it, and refer to Section 7, "Troubleshooting the System," in the System Manual.

3 Slide the T/P switch to the center position.

The lights stop flashing and the tone stops.

4 Touch **Speakerphone** or lift the handset.

The green light goes on next to the shining red light, and you hear a dial tone.

5 Press one or more dial pad buttons.

The dial tone stops.

6 Touch **Speakerphone** again or hang up the handset.

The green light next to the shining red light goes off.

If your system does not respond as described, make a note of it, and refer to Section 7, "Troubleshooting the System," in the System Manual after you've completed the installation.

Verify Intercom Number

Verify the voice terminal's intercom number as follows:

- 1 Touch the fifth button down (**Intercom**) in the leftmost row of buttons. See Figure 21.
- 2 Touch **Speakerphone** or lift the handset.
- 3 Dial the voice terminal's intercom number.
A busy signal verifies the intercom number.

Identify Each Voice Terminal

As you test the voice terminals, label each one with its intercom number as follows:

- 1 Fill in an intercom number label for each voice terminal.
- 2 Pry the plastic number card retainer away from its slot beneath the handset using a straightened paper clip or similar tool.
- 3 Lay the intercom number label in the slot, and replace the plastic retainer (Figure 21).

FIGURE 21 Verifying and labeling the intercom number.

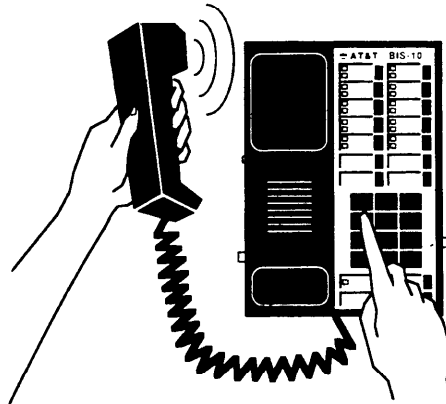
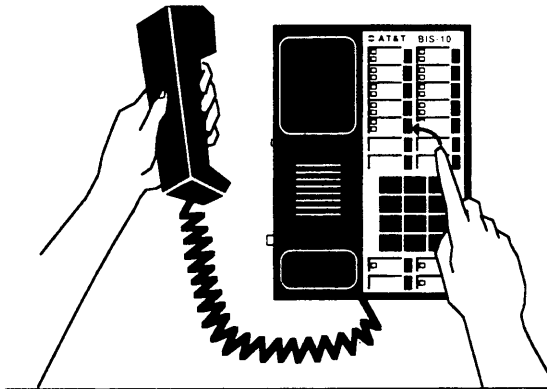
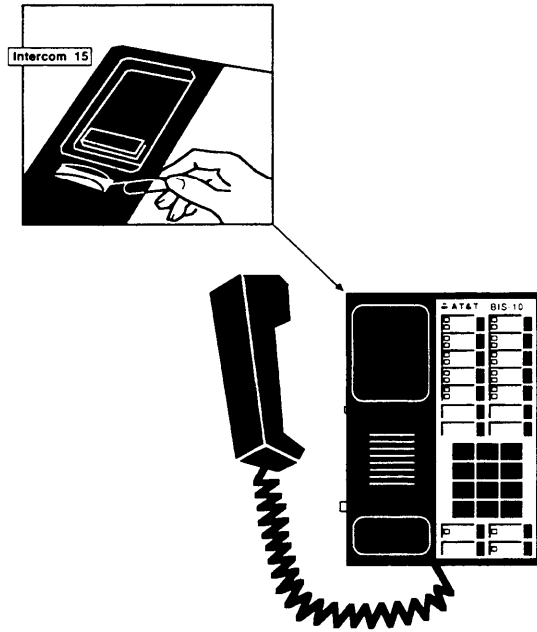

AUXILIARY LINE TELEPHONE

The auxiliary jack (the top jack) on each line module bridges and monitors the outside line connected to the first line jack (the second jack from the top, line A) on the module. If you have a second line module, its auxiliary jack connects to line E, and you can gain access to it with a basic Touch-Tone or rotary dial telephone. Note the location of the Aux jack in Figure 22.

This jack provides many services.

- You can connect accessories, such as a modem, answering machine, or a Fax machine to it and reap the benefits of a dedicated line.
- When the line is not used by any accessory attached to the Aux jack, MERLIN Plus system voice terminal users have access to it.
- The jack can be used as a single-line extension phone that not only works as part of the MERLIN Plus communications system, but also continues to work after a power failure.

NOTE: A MERLIN Plus system voice terminal is not designed for and will not work in the Aux port.

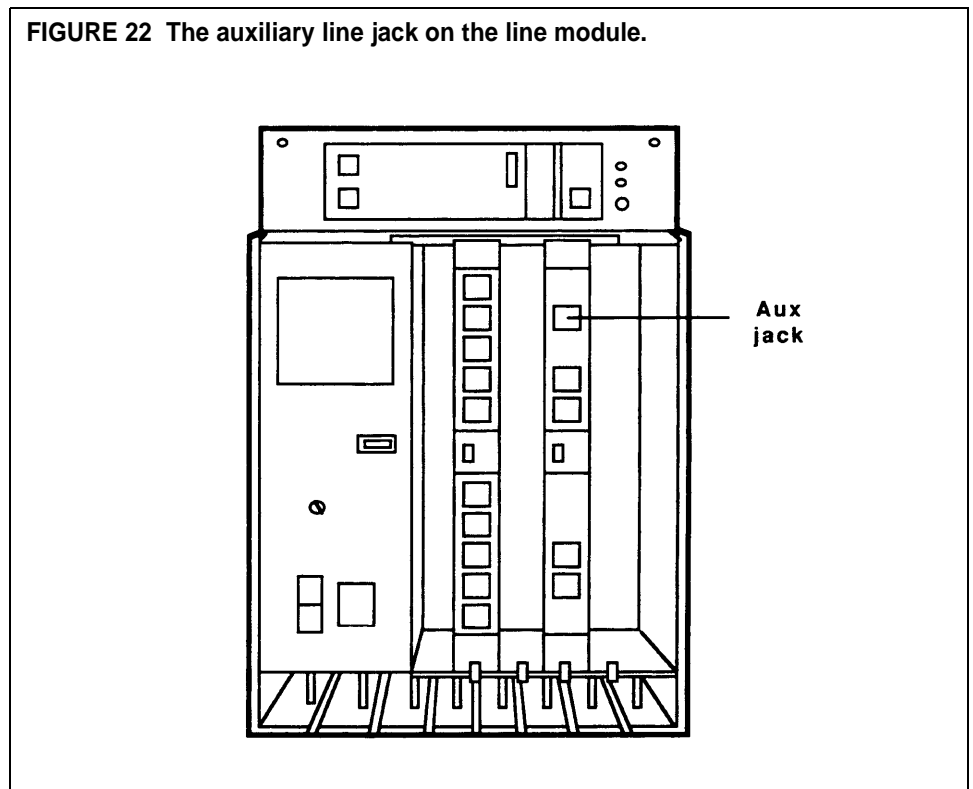

See Section 5, "Reference," in the System Manual for more information about auxiliary line devices and their proper use.

Step 4: Testing the System

Now that your system is in place, you should test it to make sure that it's operating properly. The following tests will help you determine if your system's components are working as they should. If these tests reveal any problems, find their solution in Section 7, "Troubleshooting the System," in the System Manual and take the recommended corrective action.

CAUTION: Turn the control unit power off when plugging and unplugging modular cords.

TEST THE VOICE TERMINAL JACKS FOR A DIAL TONE

To make sure that each voice terminal jack has a dial tone, follow these steps:

- 1 Take a MERLIN Plus system voice terminal to the control unit.
- 2 Make sure the control unit power is off.
- 3 Unplug the cord from the jack for intercom 10 on the control unit and plug in the modular voice terminal cord for the voice terminal you are testing. See Figure 23.
- 4 Turn on the control unit power.
The voice terminal's red light goes on next to the fourth button down in the leftmost row of buttons.
- 5 Touch the fifth button down in the leftmost row of buttons (**Intercom**). See Figure 24.
The red light goes on next to the button.
- 6 Touch **Speakerphone** or pick up the handset and listen for a dial tone.
The green light goes on next to the red light, and you hear a dial tone.
- 7 Touch **Speakerphone** or replace the handset and touch a line button on the voice terminal, then again touch **Speakerphone** or pick up the handset.
*The red light goes to the button touched.
The green light goes on next to the red light, and you hear a dial tone.*
- 8 Repeat step 7 for each line button on the voice terminal.
- 9 Turn off the control unit.
- 10 Unplug the voice terminal cord from the control unit and plug it into the next voice terminal jack. As you go along, make sure all the cords are plugged into the correct jacks on the control unit (match the number on the cord's label with the number next to the jack on the control unit).
- 11 Repeat steps 3 through 10 until every voice terminal jack on the control unit is tested.
- 12 When you're finished, make sure the control unit is turned off, all the cords are plugged into the correct jacks on the control unit, and return the voice terminal to its original location.
- 13 Turn on the control unit again for subsequent tests.

FIGURE 23 Plugging in a voice terminal to test jacks for dial tone.

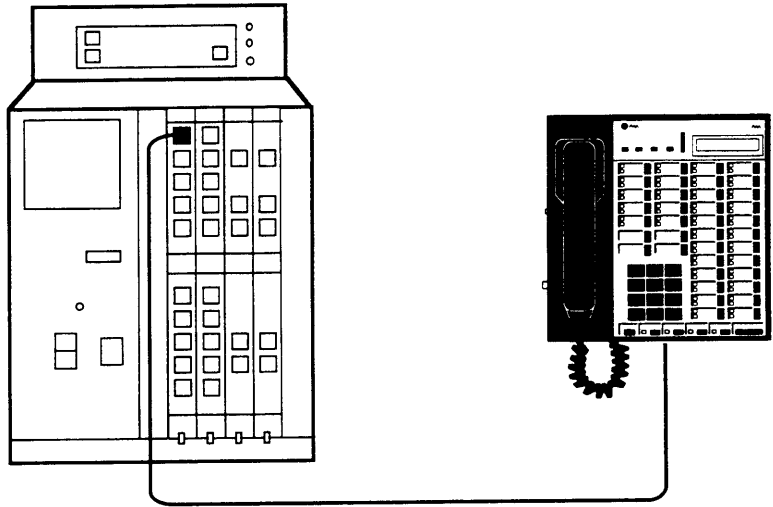
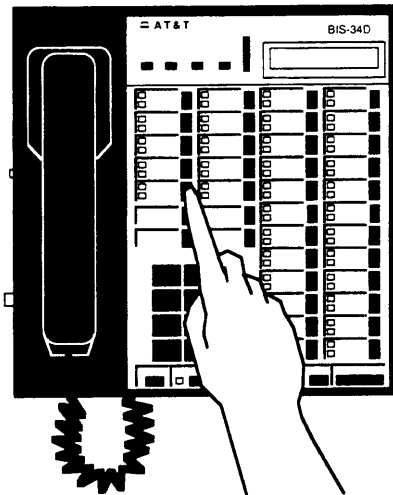
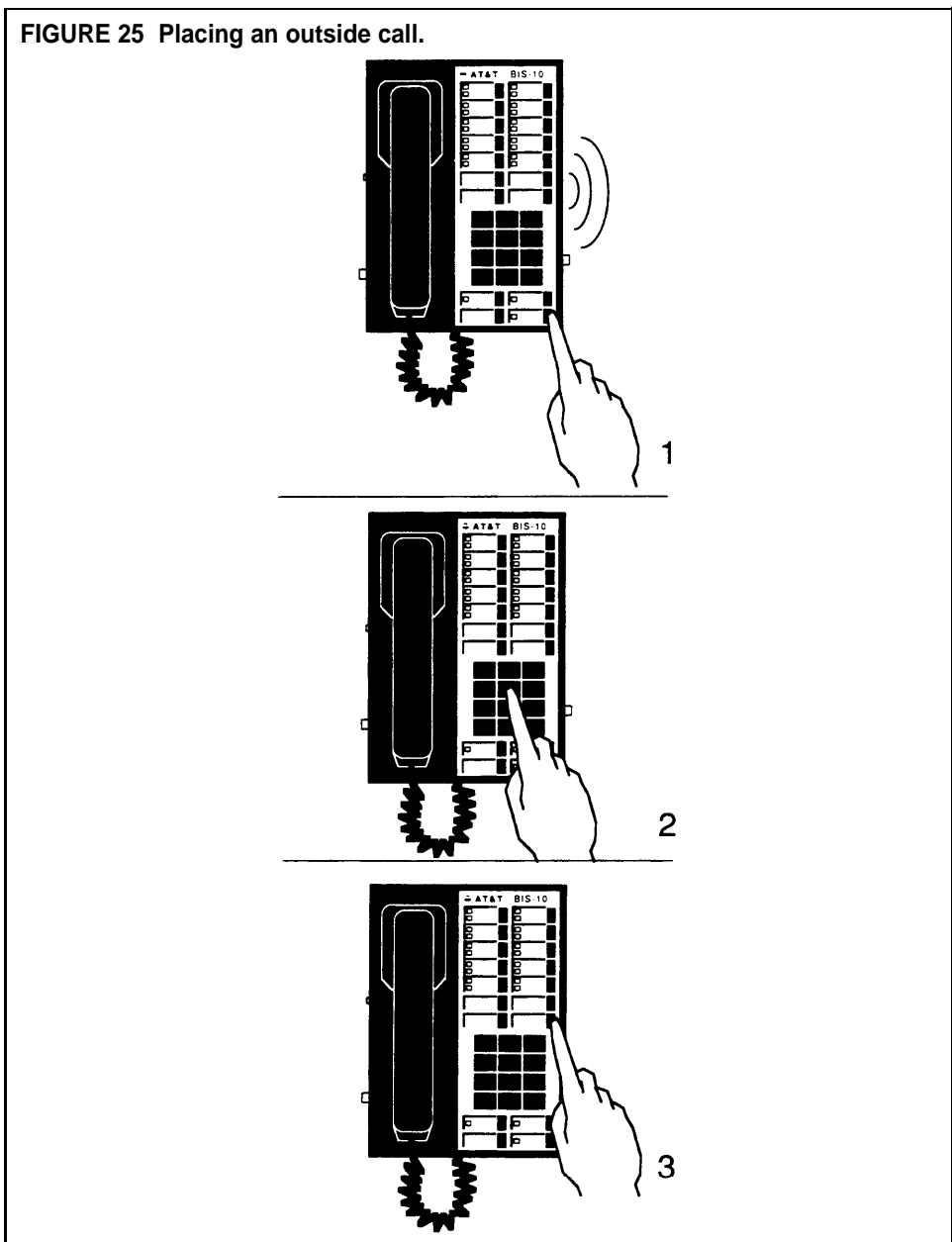

FIGURE 24 Testing voice terminal jacks for dial tone.



PLACE AN OUTSIDE CALL To make sure you can use your system to place an outside call, use any voice terminal in your system and do as follows:

- 1 Touch **Speakerphone** or lift the handset.
The green light goes on next to the red light.
- 2 Dial an outside number where you know someone will answer the call.
- 3 After the call is answered, ask the person who answers to hold, and place the call on hold by touching **Hold**. See Figure 25.
The green light next to the line button flashes rapidly.
- 4 Return to the held call by touching the line button next to the flashing green light.
- 5 Verify two-way communication, and then touch **Speakerphone** or hang up the handset.



PLACE AN INTERCOM CALL

To make sure you can use your system to place an intercom call, perform this test from one voice terminal to another in your system. Make sure someone is available to answer the intercom call. See Figure 26.

- 1 At any voice terminal in your system, touch the fifth button down (**Intercom**) in the leftmost row of buttons.
The red light next to the button goes on.
- 2 Touch **Speakerphone** or lift the handset.
The green light next to the red light goes on, and you hear a dial tone.

FIGURE 26 Placing an intercom call.

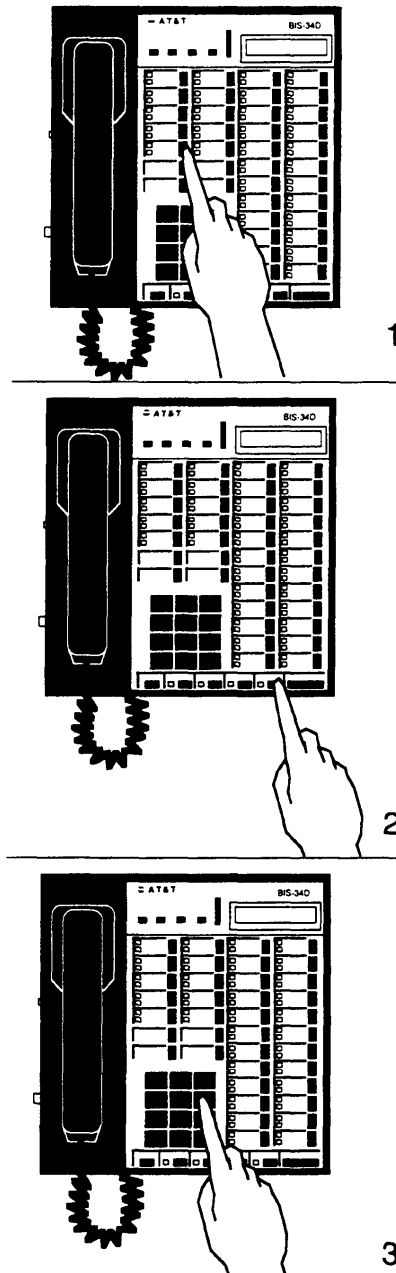

-
- 3 Dial the intercom number for the voice terminal where the other person is waiting for the call.

*Through the speaker or your handset you'll hear the other voice terminal ring.
At the other voice terminal, one long beep sounds, the red light glows steadily next to the fifth button down (Intercom) in the leftmost row of buttons, and the green light next to the red light flashes.*

- 4 When the other person answers, speak into your speaker or handset to verify two-way communication.

At the other voice terminal, the green light stops flashing and glows steadily.

- 5 After verifying two-way communication, touch **Speakerphone** or hang up the handset at both voice terminals.

On both voice terminals, the lights go out, and the red light goes on next to the fourth button down in the leftmost row of buttons.

TEST EACH LINE NUMBER Go to the voice terminal for intercom 10. From any other voice terminal in your system, have another person dial your outside telephone line numbers in order as follows:

- 1 Using a line other than the one to be dialed, have the other person dial the number for line A.

When your voice terminal starts to ring, the green light flashes and the red light goes on next to the button for line A (the fourth button down in the leftmost row.)

If the green light flashes next to the wrong line button, make sure the connections are correct between the jacks in the line module(s) in the control unit and the jacks at the network interface or in the jack field. (For example, you may have plugged the line cord for line A into the wrong jack on the control unit.)

- 2 When you have verified two-way communication, touch **Speakerphone** or hang up the handsets at both voice terminals.
- 3 Repeat the above steps for line B, line C, and so forth until you have tested all of your telephone numbers.

Once all tests are completed successfully, replace both control unit covers.

SPEAKERPHONE PERFORMANCE TIPS

For optimal use of the speakerphone on the BIS, HFAI, or SP voice terminals, follow these guidelines:

- Place the voice terminal in an area with low background noise.
- Room acoustics and background noise may affect the proper operation of your voice terminal's speakerphone. High background noise is caused by loud voices and loud office equipment such as typewriters, copiers, etc.
- Keep books and papers away from the area under and next to the microphone.
- Let one person talk at a time. When both parties speak simultaneously, transmission can be broken.
- Always face your terminal when talking.
- Place your voice terminal at least six inches away from the edge of the desk or table upon which it rests.

Step 5: Adding Accessories

Once you have installed your MERLIN Plus system, you may want to add accessories to enhance its capabilities.

ACCESSORY EQUIPMENT

You can connect the headset adapter or the general purpose adapter to the port labeled OTHER on the voice terminal. A headset can be plugged into the headset adapter while the general purpose adapter allows you to connect Touch-Tone (*not* rotary) equipment, such as modems, autodialers, answering machines and telephone extensions (including cordless telephones) to your voice terminals. See Figure 27.

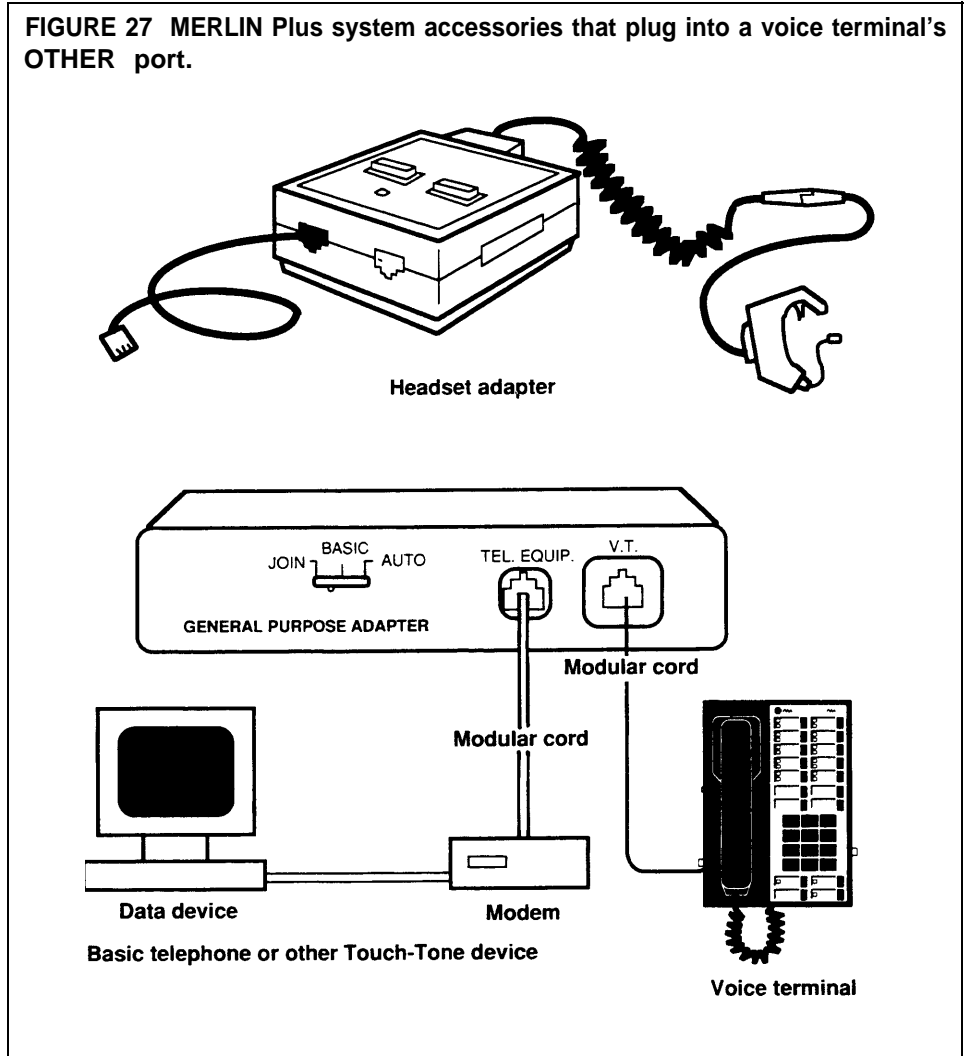

You can also add accessory equipment to the system that plugs into the control unit. You can add a data collector and printer to your system to collect data on calls and print Call Reports. The 450F adapter allows the data collector to share port 19 with the Busy Buster feature. Refer to the *MERLIN Plus System Manual* for more information on Busy Buster. See Figure 28.

You may also add a Basic Telephone and Modem Interface (BTMI) in order to connect a basic telephone, dialing modem, or facsimile machine to the system. See Figure 29.

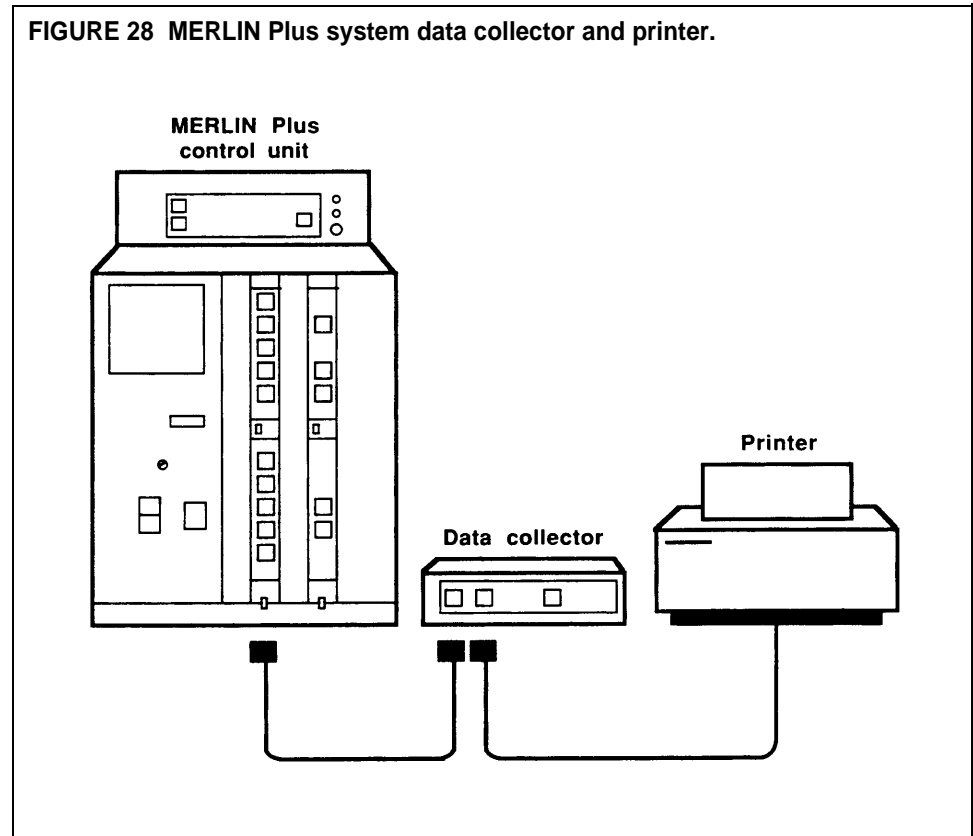
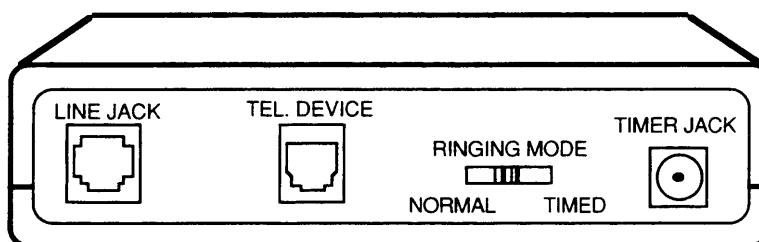

FIGURE 29 MERLIN Plus system Basic Telephone Modem Interface.



BTMI
Basic Telephone Modem Interface

If you have a compatible audio system, you can connect it to the Music-on-Hold jack to provide background music or prerecorded messages for incoming calls. See Figure 30.

Caution Users of equipment that rebroadcasts copyrighted music or other material may be required to obtain a copyright license from a third party, such as ASCAP or BMI.

You can connect a Loudspeaker Paging System to the control unit to page people, make announcements, and provide background music. If your paging system is electronically compatible, you have the option of connecting it to a CO port, so that you can place and receive calls whenever paging is not in progress. However, when connecting the paging system to a CO port, be sure to refer to the *MERLIN Plus System MANUAL* for proper administration procedures. See Figure 31.

FIGURE 30 MERLIN Plus system Music-on-Hold jack.

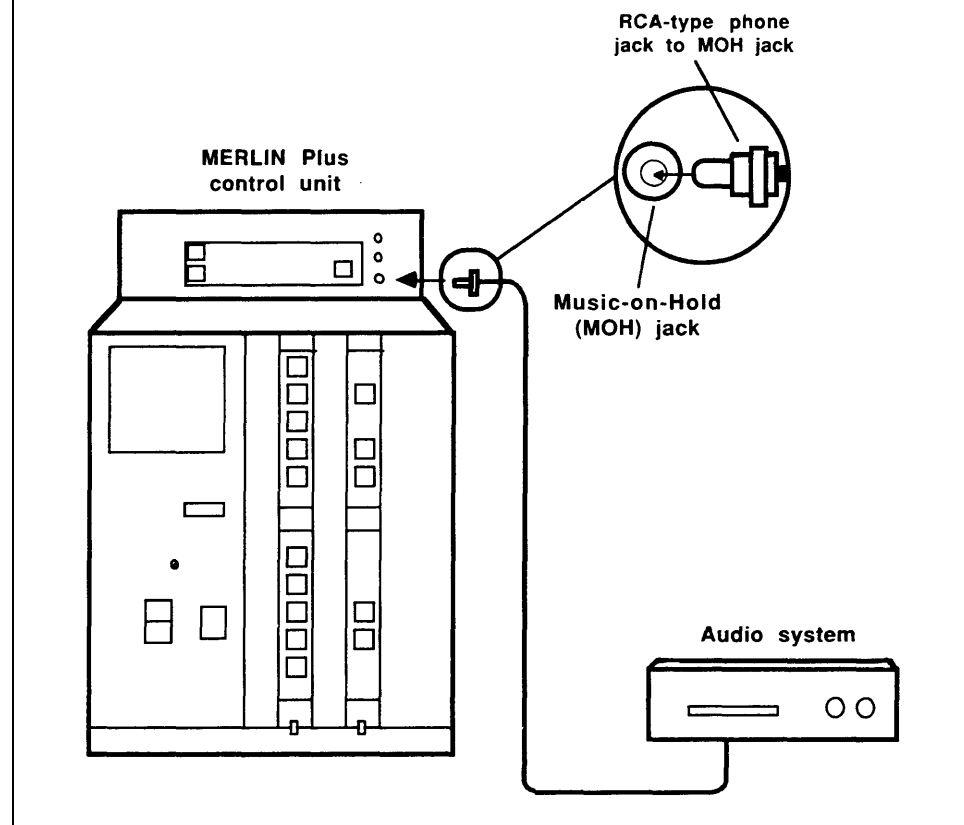

FIGURE 31 MERLIN Plus system Loudspeaker Page connected to CO line.

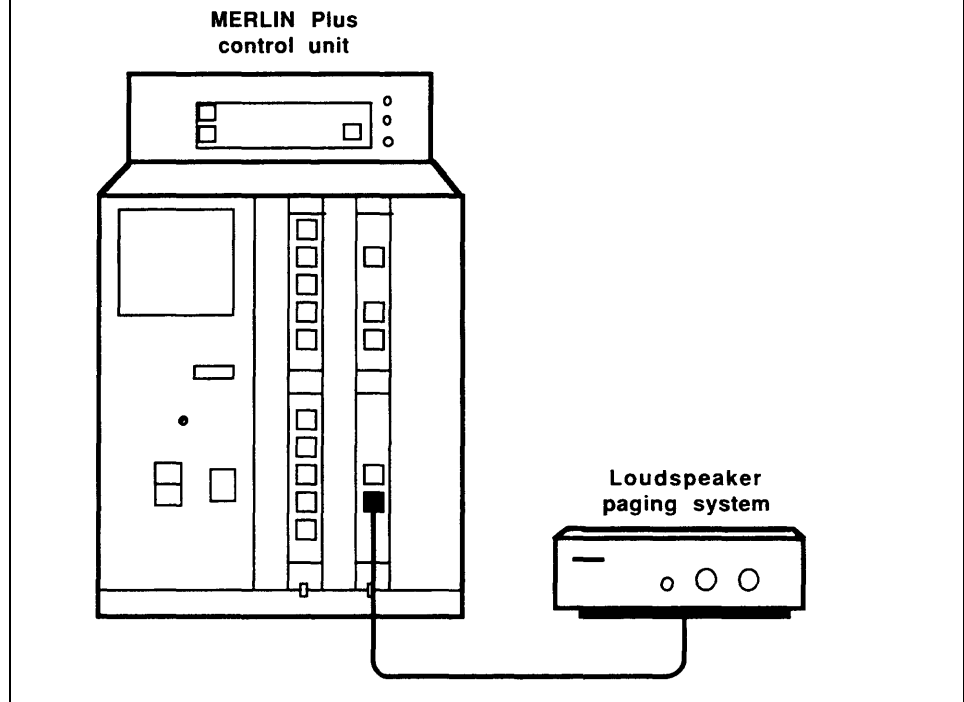

FIGURE 32 MERLIN Plus system alerters.

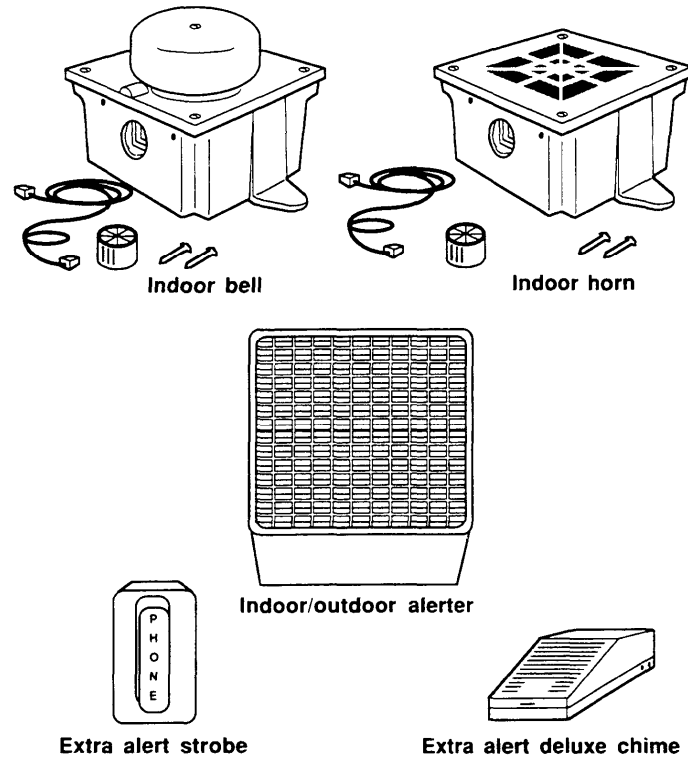
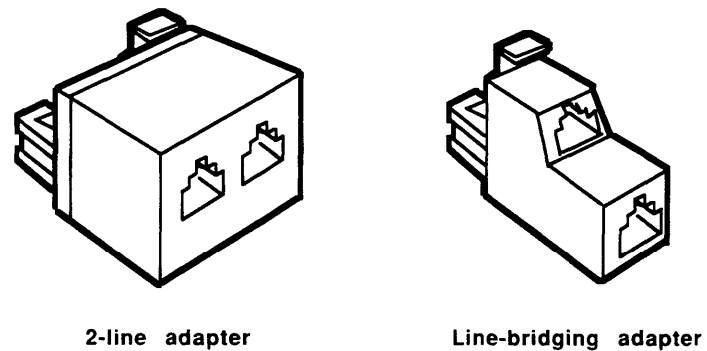

FIGURE 33 MERLIN Plus system CO line wiring accessories.



Supplemental alert adapters allow you to connect alerting devices such as horns, bells, and strobe lights to your system. See Figure 32.

See Figure 33 for other Central Office (CO) line accessories and voice terminal wiring accessories.

To add accessory equipment to your system, follow the instructions that come with the components.

Accessories that Extend Telephone Range

You may have to provide a voice terminal power supply for a voice terminal located more than 1000 feet from the control unit. In such cases, you'll need a power supply kit that allows you to double the range of the wiring run from the control unit to the voice terminal. See Figure 34.

If you place a voice terminal in another building outside of the main building, but within 1000 feet of the MERLIN Plus system control unit, the voice terminal becomes an In-Range, Out-of-Building (IROB) voice terminal. You must use two Model 341 IROB protectors to protect the control unit and the IROB voice terminal from lightning, contact with power lines, or power currents induced by power lines. You must place one IROB protector where the cable from the control unit leaves the building, and place the other where the cable enters the building in which the IROB voice terminal is located. See Figure 35.

See Section 5, "Reference," in the System Manual for more information on installing and operating power accessories.

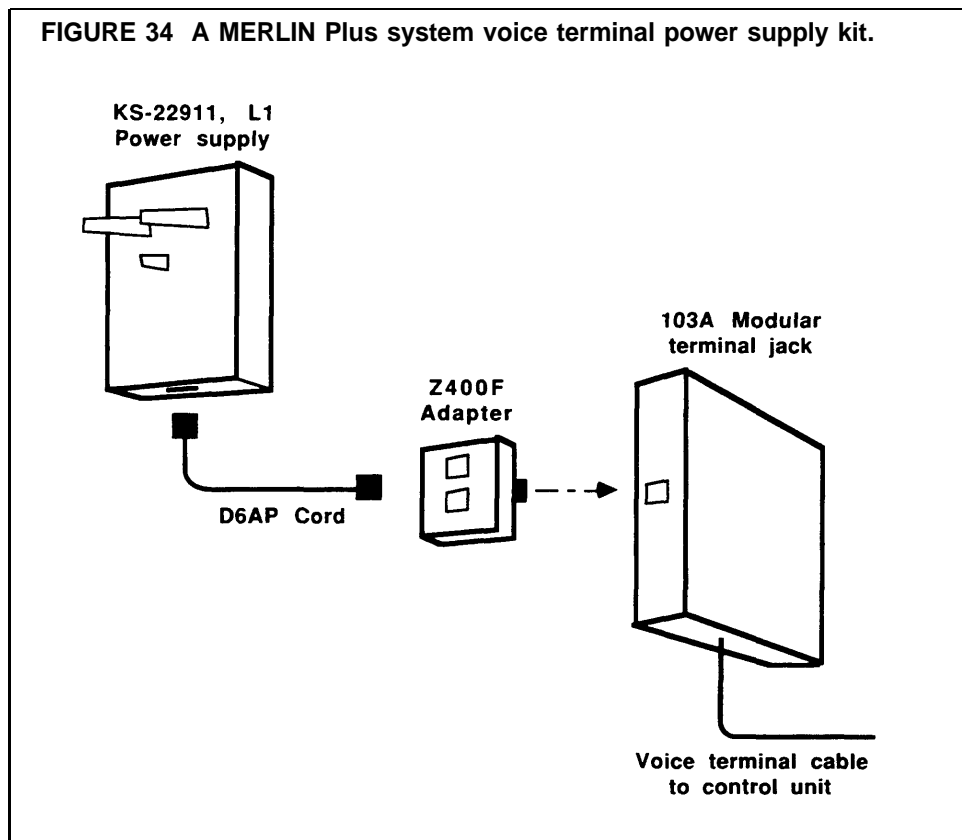
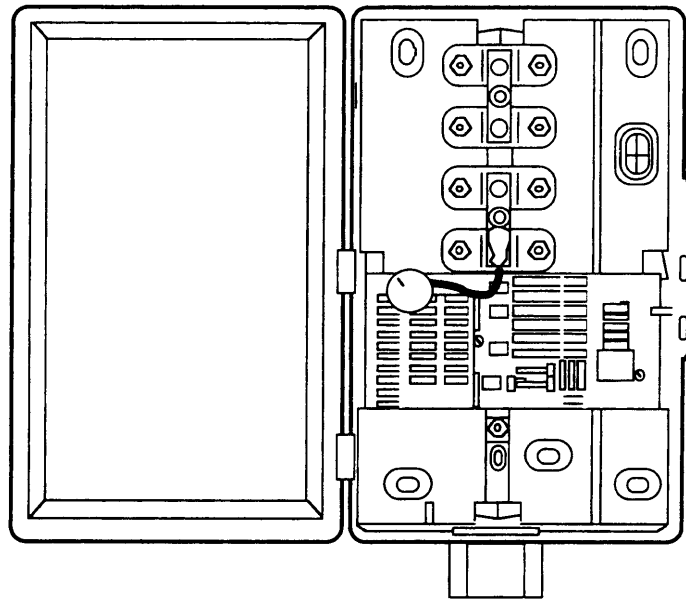
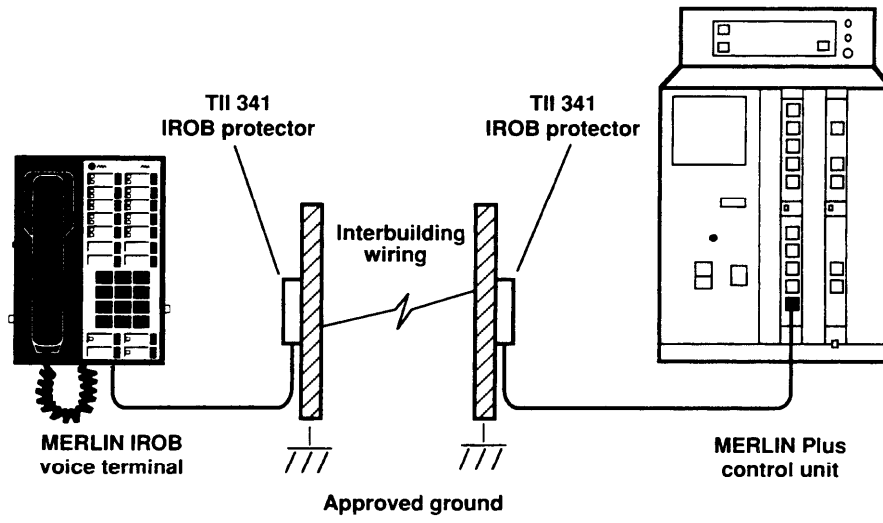

FIGURE 35 An In-Range, Out-of-Building protector.



IROB protector

Step 6: Changing the System

Your MERLIN Plus communications system is designed so that you can make changes quickly and easily. You can increase your system's capacity by adding outside lines or voice terminals. Modular plugs on much of the system wiring and labels on key components make it easy for you to reorganize the system in the event of office rearrangement.

The most common system changes are adding an outside line, adding a voice terminal, and moving a voice terminal.

ADDING AN OUTSIDE LINE Your MERLIN Plus system may have up to eight outside lines. If you have fewer than eight outside lines, and your system becomes so busy that people in your office frequently must wait to make calls, you may want to add one or more outside lines.

To add lines to your system, do as follows:

- 1 Have your local telephone company add the outside line(s) and network interface jack(s) to those you already have in place.
- 2 Install a D2R line cord between the network interface and the next available CO line jack using the procedures in "Prepare the Network Interface" and "Connect the Outside Lines to the Control Unit," in "Step 1: Installing the Control Unit."

Contact your equipment supplier to order an additional line module if needed. Insert an additional line module according to the instructions in "Step 1: Installing the Control Unit," under "Insert the Modules."

- 3 Administer the line to the voice terminals assigned to it using the instructions in Section 3, "Administering the System," in the System Manual.
- 4 Label a new line button on each voice terminal where the new line appears.

ADDING A VOICE TERMINAL

You can easily add more voice terminals to your MERLIN Plus system as your business and communications demands increase. Your system can accommodate up to 20 voice terminals.

We recommend that you install wiring for future growth and flexibility during the initial installation. To add a voice terminal to your MERLIN Plus system when the wiring is present:

- 1 Connect the control unit to building wiring using a D8W cord. Instructions for this procedure are in the section "Step 2: Wiring the Voice Terminals" under "Voice Terminal Wiring Procedure."
- 2 Connect the voice terminal to the wall jack at the telephone location.
- 3 Administer the voice terminal using the procedures in Section 3, "Administering the System," in the System Manual.
- 4 Program the voice terminal and label the buttons.

If you need an additional voice terminal module (station board), contact your equipment supplier. Install the module as described in the section "Step 1: Installing the Control Unit" under "Inserting a Voice Terminal Module."

MOVING A VOICE TERMINAL

You can easily move a voice terminal from one location to another within your system without having to reprogram the voice terminal.

To move a voice terminal, see Figure 36 and do as follows:

- 1 Make sure the necessary wiring is in place or is available. (See "Step 2: Wiring the Voice Terminals".)
- 2 Unplug the voice terminal at its old location, and plug it in at its new location.
- 3 At the jack field, locate the cord labeled with the voice terminal's intercom number. Unplug it from the jack in the jack field corresponding to the voice terminal's old location and plug it into the jack in the jack field for the voice terminal's new location.

You do not have to change any labels in the system. Note also that you do not have to reprogram the voice terminal, or even turn the control unit off. Simply make note of the location change on the System Configuration Form.

FIGURE 36 Moving a voice terminal (jack field connection).

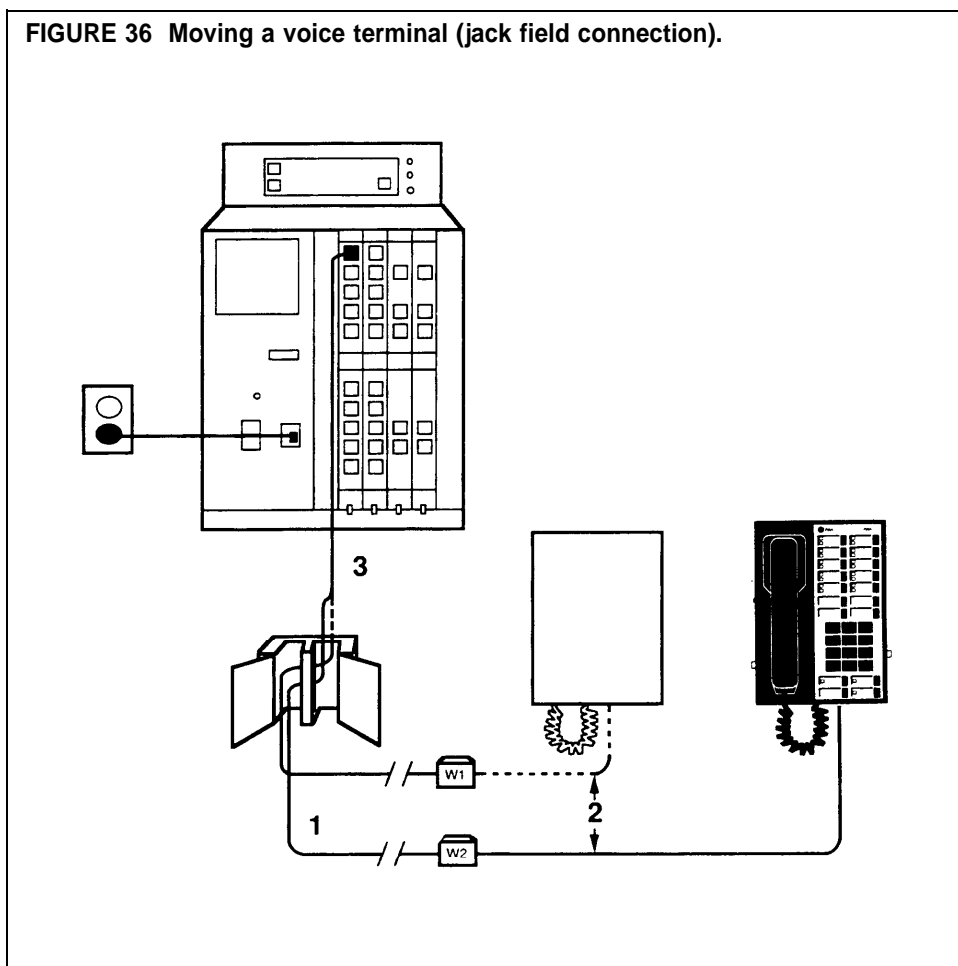

Jack Field Wiring Supplement

A jack field is a group of jacks at the control unit location that serves as a point of administration for telephone wiring. This section tells you how to construct a jack field and how to extend the network interface provided by the local telephone company to the jack field. Also, this section describes the hardware designed specifically to ensure the following:

- A neat, reliable, and durable wire installation
- Easy rearrangement, changes, and upgrades to your MERLIN Plus System
- Simple line swapping and maintenance strategy

A permanent wiring run between the voice terminal and the control unit should be installed for each voice terminal. Also, we recommend that you plan and install wiring for future voice terminal locations. To install voice terminal wiring, follow the instructions in the procedure "Constructing and Connecting the Jack Field."

If the local telephone company provided a network interface that is far removed from the control unit location or an RJ21-type multiline network interface, you should extend the network interface to the jack field. Follow the instructions in the procedure "Extending the Network Interface to the Jack Field." See Figure 37 for a typical complete wiring installation.

If all necessary wiring is in place, go back to the beginning of this manual and read "Step 1: Installing the Control Unit," and follow the instructions.

FIGURE 37 A complete wiring installation.

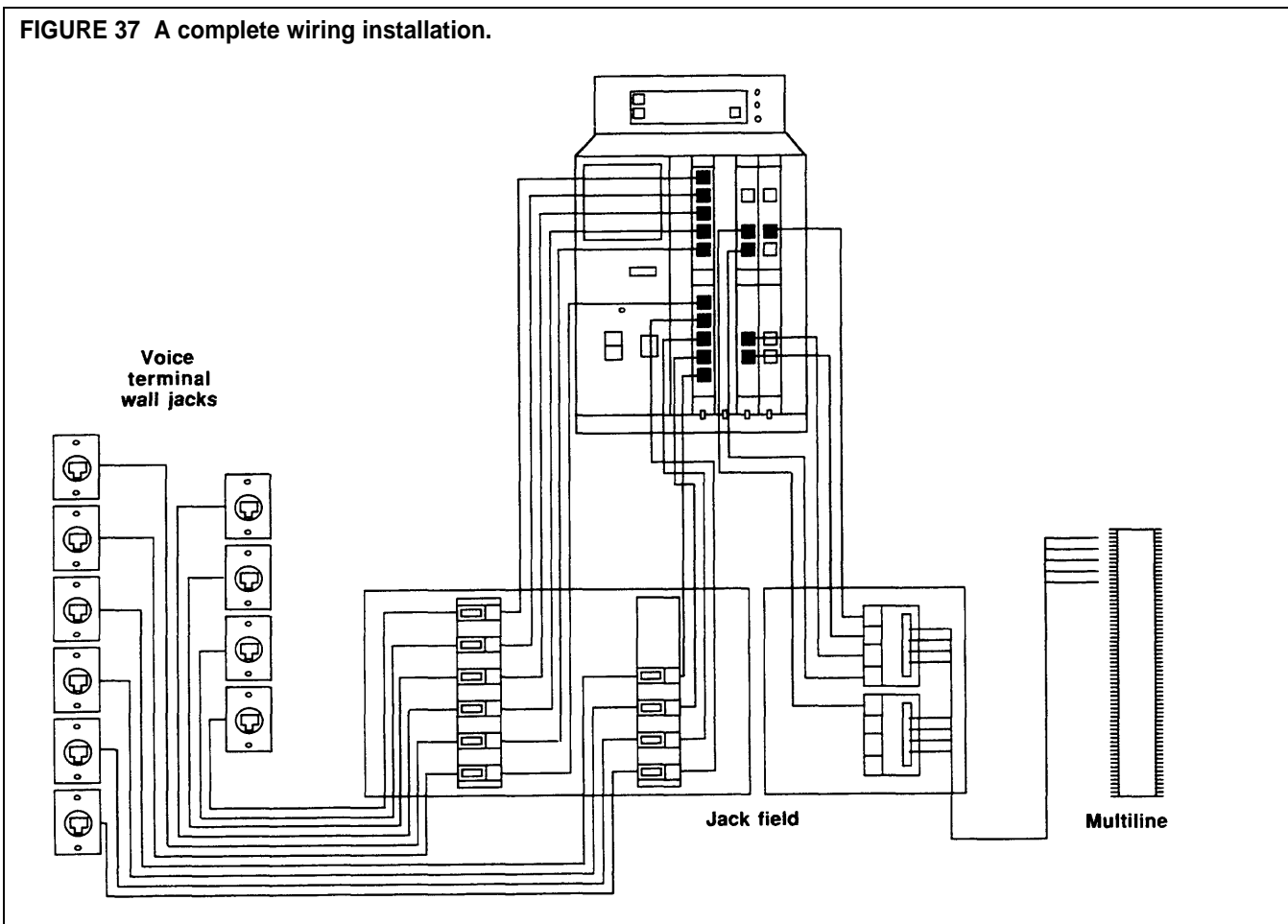

CONSTRUCTING AND CONNECTING THE JACK FIELD

While you can connect your voice terminal locations to your control unit in any of several different ways, the method described here greatly simplifies certain aspects of system administration. This method calls for wiring runs that terminate in modular wall jacks at the voice terminal locations and in modular jacks in a jack field at the control unit location. Modular jumper cords then connect the jacks in the jack field to the appropriate jacks in the control unit.

Labels on the jack panel boxes, the jacks, and the modular jumper cords make the jack field a key factor when programming the system and maintaining those programs even as office assignments change.

The following example shows how a jack field makes the system easy to maintain.

Moving Voice Terminals Attached to a Jack Field (Example)

Smith has intercom number 14 and is located in Room 104. Jones, with intercom 18, is in Room 108. Smith and Jones have their voice terminals programmed very differently from each other. A redefinition of assignments within the business calls for Smith and Jones to trade offices.

At the jack field, following the labels on the components, you:

- 1 Unplug the jumper cord labeled 14 from the jack for Room 104.
- 2 Unplug the jumper cord 18 from the jack for Room 108.
- 3 Plug cord 14 into the jack for Room 108.
- 4 Plug cord 18 into the jack for Room 104.

Smith and Jones can now simply unplug their voice terminals from the wall jacks at their old locations and plug them in at their new locations. They keep their original intercom numbers, and they do not have to reprogram their voice terminals.

You do not have to change any labels in the system. Simply make note on the System Configuration Form of the new locations for Smith and Jones.

Jack Field Construction Recommendations

In order to construct a jack field and install building wiring, we recommend the following:

- Plan ahead.
Draw a floor plan that shows the routes of the wiring runs from your control unit location to your voice terminal locations. Identify each run by marking both the wall jack end for each voice terminal location and the jack field end at the control unit location.
- Use modular wall jacks at the voice terminal locations.
These are cutdown-to-modjack adapters with screw-on covers that terminate the wiring runs to the voice terminal locations.
- Use voice terminal wiring Z601A adapters at the jack field.
These are cutdown-to-modjack adapters that allow for connecting cable without stripping wires.
- Use jack panel boxes (apparatus boxes).
Each box holds six Z601A adapters.

-
- Use spooled DIW cable.
 - Use labels.

You probably need most, if not all, of the following tools and equipment to complete your wiring installation. Which items you need depends mostly on the layout, dimensions, and structural particulars of your place of business.

- Cable stripping tool

You need a tool for stripping the outside jacket from the cable without damaging the wires.

- Cable termination tool (punch down tool)

The connecting blocks on your adapters have caps that punch wires down when the cap is pushed onto the block. For large installations we recommend you use a punch down tool for punching down wires.

- Diagonal cutters, wire snips, scissors

You may need scissors to trim wires after you punch them down onto the blocks.

- Plywood or similar board

If you are mounting the jack field on a brick, concrete, concrete block, or hollow wall, you must first attach a board to the wall to provide a proper mounting surface for the jack field. The size depends on the number of wiring boxes and whether you are mounting the control unit on it as well.

- Drill and bits

You may have to drill holes in some walls for some wiring runs. You may also have to drill pilot holes for the screws used to attach the jack panel boxes to the plywood board.

- Cable ties and clips

You can use cable ties to bundle the cables and cords at the control unit location to reduce cord clutter. You can use cable clips to attach the cable to walls and baseboards along your wiring runs.

- Stapler and staples

You may want to use wiring staples in place of cable clips at various points on your wiring runs.

Constructing a Jack Field

The control unit must be placed within 5 feet of an ac outlet, within one cord length (7, 14, 25 feet or up to a 400 feet of spooled DIW cable) of the network interface, and 6 inches above a jack field. See Figure 38.

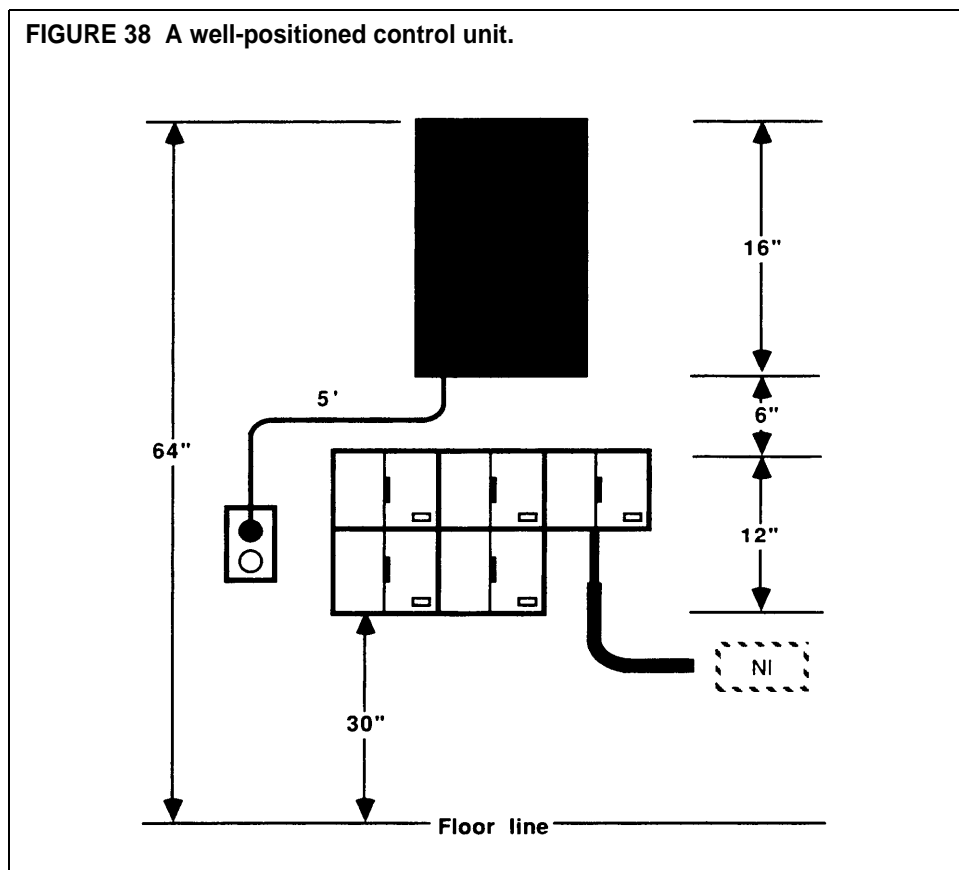

At the location where you plan to install your control unit, do as follows:

- 1 Use the measurements in Figure 38 to mark positions on a wall (or other mounting surface) for the control unit and the jack field. Also, check that the distances from the control unit position to the ac outlet and the network interface are within limits and that the control unit's distance from the floor allows for easy access.
- 2 Attach a label to the outside of the right door of each jack panel box. Each label should identify the jacks in each box by wiring run number.
- 3 Attach the boxes to each other by meshing their tongues and grooves. See Figure 39. Use only as many boxes as you need.
- 4 Use appropriate screws to attach the jack panel boxes to the mounting surface.

5 Snap as many Z601A adapters as you need into the boxes, filling the boxes from top to bottom.

- If one of the jacks on the adapter has a black dot on it, make sure that the jack with the black dot faces to the right.
- If you are using cutdown-to-modjack adapters, make sure the jacks on the adapters face to the right.

FIGURE 39 Attaching jack boxes to create a jack field.

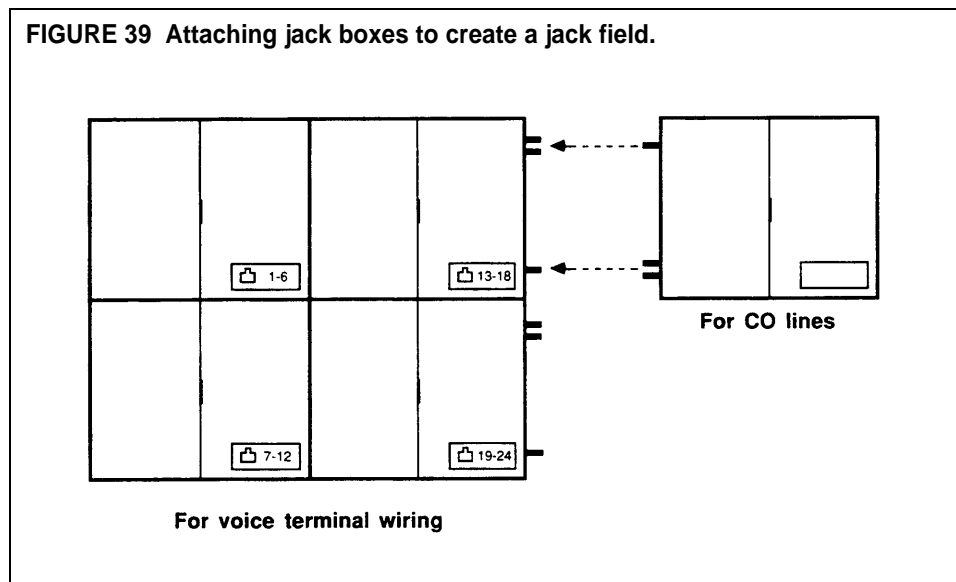

Running the Cables

Follow these steps to run cables from the jack field to your voice terminal locations (Figure 40).

CAUTION: Do not run cables inside or on top of air plenums or ducts, along hot pipes, or across walkways. If you use staples, be careful not to pierce the cable.

- 1 On your floor plan, assign a wiring run number (1, 2, 3, etc.) to each voice terminal location. Rough in the cables between the jack field and voice terminal locations, allowing enough room for slack. We recommend marking each end with the wiring run number.
- 2 Write the voice terminal location on each wiring run label (for example, □ 1 Reception, □ 2 Sales, □ 3 Shop). Attach the label for the wiring runs in consecutive order to the inside of the right door of the box labeled □ 16, beginning at the top. Label the remaining wiring runs and wiring boxes in the same way until there is a label assigning a wiring run to each jack in the jack field.
- 3 Insert the Z601A adapters into the apparatus boxes.
- 4 Plug the cables into the Z601A adapter next to the appropriate label for the wiring run in the jack field.

Your jack field is now complete. Now install the wall jacks at the voice terminal locations and make sure the wiring is neat and secure.

FIGURE 40 Running the cables.

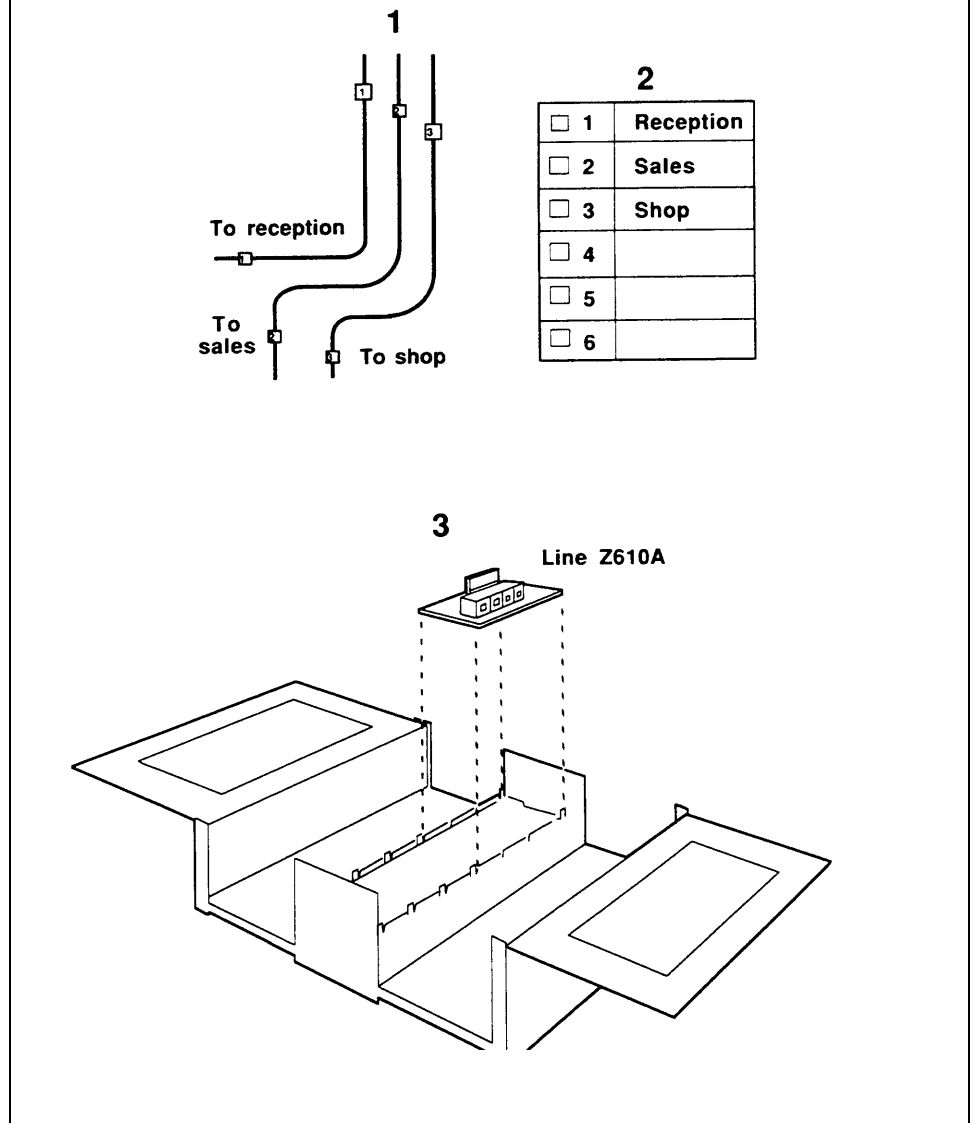

Terminating the Wiring Runs in Modular Wall Jacks

There are many types of wall jacks used to terminate wiring runs. The type of wiring (concealed, surface mount, wall-mounted telephone, group office, and so forth) determines the type of wall jack to be used. Once you have determined the location of the wall jack and have trimmed the cable (leaving about 4 inches excess extending beyond the wall jack location), use the instructions that came with the wall jack to complete the installation. Once you've completed the wiring, attach a wiring run label for the voice terminal location to the cover.

You should now have in place a properly installed and labeled jack field with building wiring connecting your voice terminal locations to your control unit location.

EXTENDING THE NETWORK INTERFACE TO THE JACK FIELD

If the local telephone company has provided an RJ21-type network interface, you cannot connect your control unit to the network interface directly with modular line cords. You must first extend the network interface to a group of single-pair modular jacks mounted in a jack panel box in the jack field. Then connect the control unit to your outside lines by plugging the modular line cords into the jacks.

You need the following equipment (Figure 41) to extend an RJ21 network interface to the jack field:

- 4-line adapter

This should be a cutdown-to-modjacks adapter that provides four single-pair jacks for the MERLIN Plus system control unit. One adapter accommodates four outside lines.

- Jack panel box (apparatus box)

The box should hold two 4-line adapters, and be identical to the jack panel boxes with the voice terminal wiring labels in the jack field.

- Single-ended 25-pair connector cable

This cable has to be long enough to reach from the network interface to the jack field with some slack. Before you order this cable, check to see whether the 50-pin connector at the network interface is male or female and order a length of cable with a 50-pin connector of the opposite gender.

- Labels

FIGURE 41 Equipment for extending the network interface to the jack field.

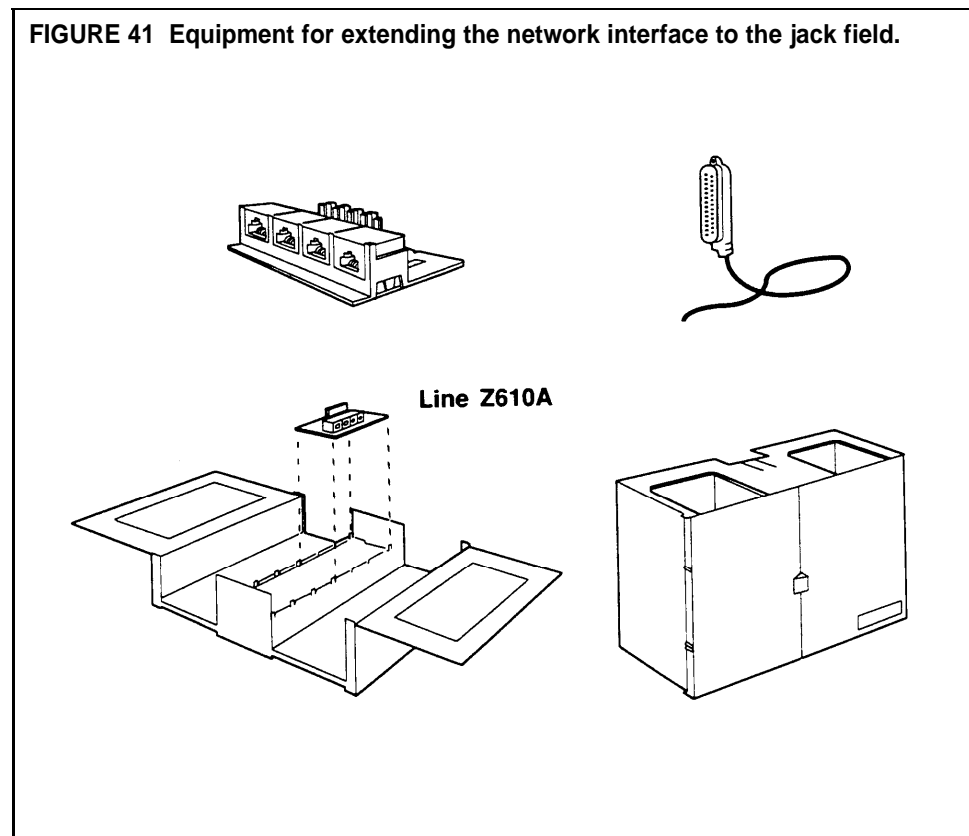

Add Jacks to the Jack Field

To add jack boxes to the jack field, do the following:

- 1 Position the jack panel box so that the door with the handle is on the right (as you face it), and attach it to the top box in the rightmost column of boxes already in the jack field by meshing the tongues and grooves.
- 2 Use appropriate screws to attach the jack panel box to the mounting surface that supports the jack field.
- 3 Pull the two plastic caps off the connecting block on the 4-line adapter, and set the caps aside. You'll need the caps again in a later step.
- 4 Snap the 4-line adapter into the jack panel box so that the jacks on the adapter face to the right. If you have more than four outside lines, remove the plastic caps from the other adapters and snap them into the box in the same way.

Connect the Outside Lines to the Jack Field

To connect outside lines to the jack field, do the following:

- 1 Attach the connector on the 25-pair cable to the 50-pin connector at the network interface.
- 2 Slit the jacket at the free end of the 25-pair cable, and cut away as much of the jacket as necessary to allow the individual twisted pairs of colored wires to reach the adapter(s) in the jack field.
- 3 Following the order and color code, place the colored wires in the grooves on the block of the adapter. If you have more than four outside lines, continue placing wires in grooves on the remaining adapters until you have attached a pair of wires for each outside line.
- 4 Align the two plastic caps over the grooved block that holds the colored wires on the adapter, and push the caps down until they snap into place. If you have more than one adapter, do the same with each of them.
- 5 If the caps did not trim the wires when you snapped them down onto the block, use a pair of scissors to trim the ends of the wire protruding from the grooves. When you're finished, none of the wires should extend far enough beyond the plastic caps to touch each other.

Label the Jacks and the Jack Panel Box

You should have a label sheet that includes a telephone number directory, jack-identifier label strips, and labels for the jack panel box and the line jacks. To label the jacks in the box, do the following:

- 1 On the telephone number directory, fill in the telephone numbers for your outside lines in the order in which they appear at the network interface or on the list provided by the local telephone company.
- 2 Using the telephone number directory as a guide, label the jacks in the jack panel box with the appropriate line jack labels.
- 3 Attach the label to the outside of the right door of the jack panel box.
- 4 Attach the long, narrow label showing jacks 1 through 8 to the inside of the right door of the jack panel box.

5 Attach the telephone number directory to the inside of the jack panel box's left door, then close it.

You should now have a single-pair modular jack in the jack field for each outside line.

FCC Registration and Repair Information

This equipment is registered with the FCC in accordance with part 68 of its Rules. In compliance with the Rules, you are advised of the following:

Means of Connection You must connect this equipment to the telephone network through several standard network interface jacks, USOC RJ11C or RJ14C, or a multiline network interface cable and a USOC RJ21 connector. You can order these from your local phone company. Do not use this equipment with party lines or coin telephone lines.

Notification of the Local Telephone Company Before connecting this equipment, you or your equipment supplier must notify your local telephone company's business office of the following:

- Telephone numbers you will be using with this equipment
- Equipment's registration number and the ringer equivalence number (REN)

You must notify your local telephone company if and when this equipment is permanently disconnected from the line(s).

Installation and Operational Procedures This manual contains information about installation and operational procedures.

Repair Instructions If you experience trouble because your equipment is malfunctioning, the FCC requires that the equipment not be used and that it be disconnected from the network until the problem has been corrected. Repairs to this equipment can only be made by the manufacturers, their authorized agents, or by others who may be authorized by the FCC.

Rights of the Local Telephone Company If this equipment causes harm to the telephone network, the local telephone company may discontinue your service temporarily. If possible, they will notify you in advance. But if advance notice is not practical, you will be notified as soon as possible. You will also be informed of your right to file a complaint with the FCC.

Your local telephone company may make changes in its facilities, equipment, operations, or procedures that affect the proper functioning of this equipment. If they do, you will be notified in advance to give you an opportunity to maintain uninterrupted telephone service,

Hearing Aid Compatibility The custom telephone sets for this system are compatible with inductively coupled hearing aids as prescribed by the FCC.

Appendix A: System Connectivity Overview

Figure 42 illustrates system connectivity.

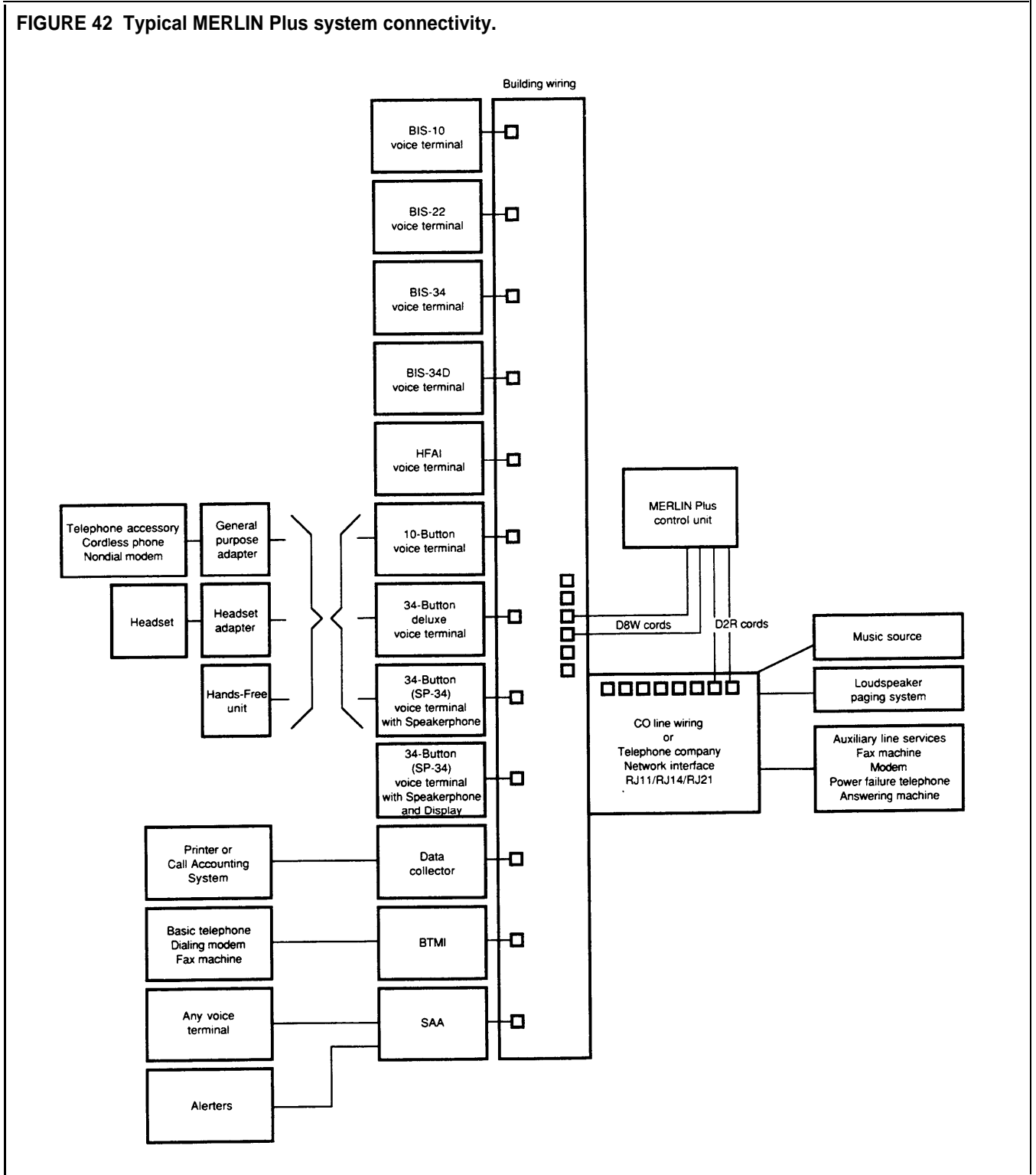

Appendix B: Quick Reference Installation Requirements

Before you install the control unit, make sure that the installation area meets the following requirements.

Environment

The environment for the control unit should be as follows:

- *Temperature:* 40 to 104 °F (4 to 40 °C).
- *Humidity:* not to exceed 80%.
- *Airborne Contamination:* no exposure to corrosive gases, dust, chemicals, or similar substances.
- *Ventilation:* 1-inch space above and to the sides.

Wiring

A branch circuit is part of your building wiring and it includes all the wires, receptacles, and switches controlled by one circuit breaker. For best results, your MERLIN Plus system control unit should be plugged into a dedicated ac branch circuit, that is, one that is not used by other appliances, such as heaters, refrigerators, coffee makers, or microwave ovens than can generate large transient voltage when they switch on and off.

The control unit should be located within:

- A single cord length of the network interface, allowing for slack. You can use up to 400 feet of DIW cable.
- 6 inches of the jack field that is centered beneath it.
- 5 feet of a **grounded** ac power source (not switch-controlled).

Also, a wiring run from the control unit to a voice terminal location *cannot* exceed 1000 feet.

Caution Because lightning can induce high voltage on parallel runs of wire that are near each other, do *not* route wiring from the control unit to voice terminals along side CO line or ac building wires. If voice terminal wiring must cross CO or ac wiring, cross them as near to 90 degrees as possible.

AC Outlet Check

Check, or have checked by a qualified electrician, the outlet into which your MERLIN Plus system control unit will be plugged. Check that the hot, neutral, and ground wires are properly connected to the outlet by using an IDEAL EZ Check® circuit tester (IDEAL Industries, Inc., model 61035) or equivalent circuit tester.

The outlet can also be tested using a voltmeter by taking the measurements shown in Figure 43.

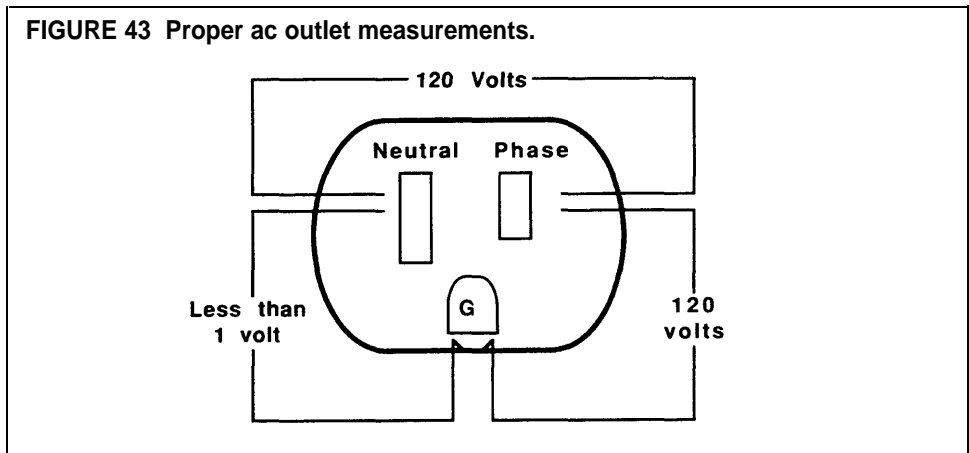

Mounting the Control Unit

The control unit is designed to be wall mounted 6 inches above the jack field that is centered beneath it in two columns. See Figure 44. The slots at the bottom of the control unit provide for simple, neat cord management.

FIGURE 44 Mounting the control unit on the wall.

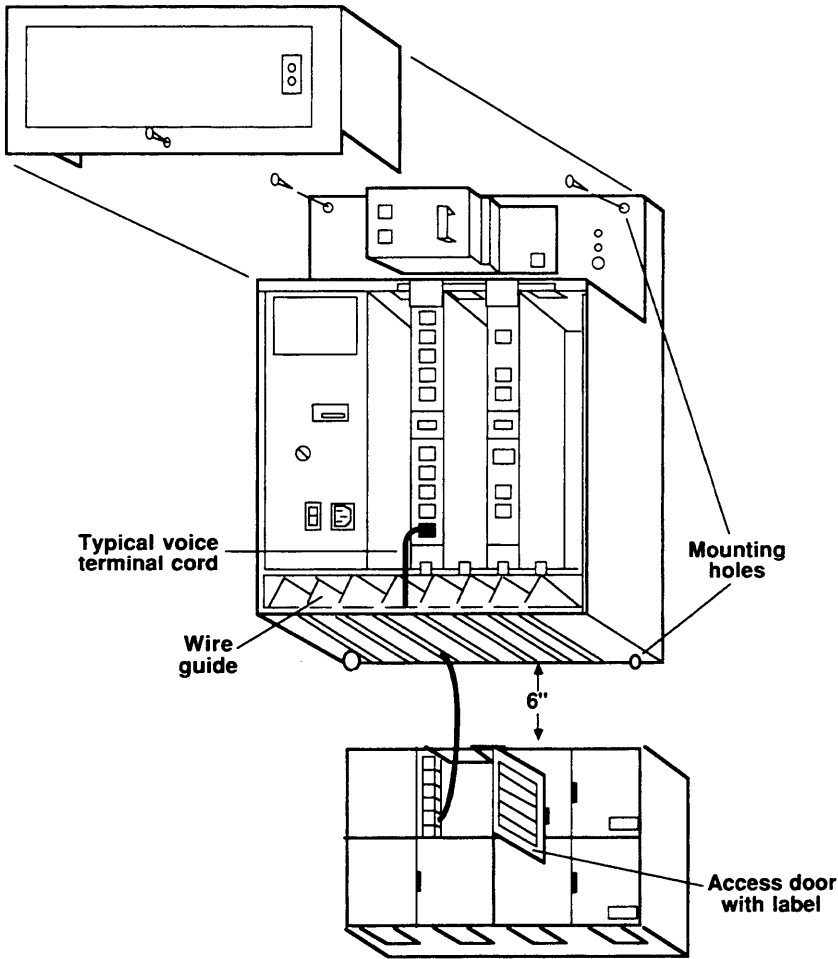

CONNECTING THE CONTROL UNIT

Before connecting the control unit to the system, see Figure 45 and be sure of the following:

- The building wiring is completely installed.
- The jack field labels correspond with the distant end locations.
- The distant end labels correspond with the jack field labels (optional).
- The network interface labels have the correct telephone numbers.

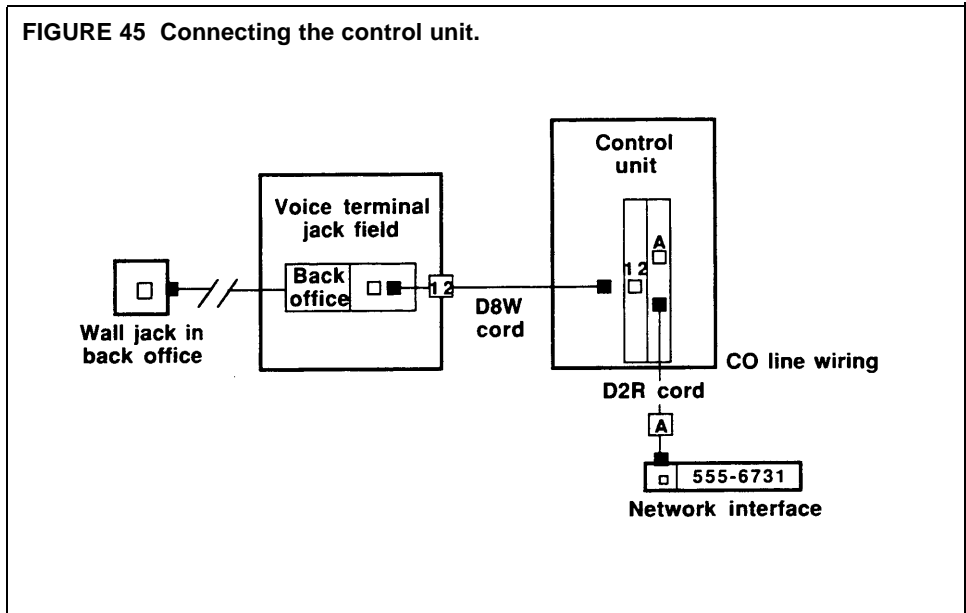

Make sure the control unit power is off before connecting system wires. Then, refer to the System Configuration Form for each step in the following procedures.

Voice Terminal Wiring

- 1 Label one end of each D8W cord for each intercom number.
- 2 Plug the unlabeled end of each voice terminal cord into its corresponding voice terminal jack of the control unit.
- 3 Plug the labeled end of each voice terminal cord into the appropriately labeled jack in the apparatus box of the jack field.

CO Line Wiring

- 1 Label each line cord running from the network interface to the control unit (A through H).
- 2 Plug the unlabeled end of each line cord into the corresponding control unit line jack.
- 3 Plug the labeled end of each line cord into the appropriately labeled jack at the network interface.

For future reference, you may want to copy on a sheet of paper all of the assignments that are labeled at the jack field.

Appendix C: Grounding Requirements

Proper grounding is fundamental for the MERLIN Plus Communications System for protection against:

- Lightning
- Power surges
- Power crosses on Central Office (CO) lines
- Static discharge

BEFORE YOU TURN THE POWER ON

Check the following considerations before you turn the power on for the MERLIN Plus system.

Grounding Requirements

The control unit, the CO line protector, and the ac power service panel should be as close to each other as possible. The adequacy of lightning protection is a direct function of the distance between these pieces of equipment.

Recognizing that equipment may be spread throughout a building, the National Electric Code requires that the ground point for the CO line protector must be bonded to the ac power ground. Proper grounding helps prevent equipment damage due to lightning energy and/or power transients conducted into the equipment via CO and ac power lines.

CO Line Protector Tests

The following tests verify proper grounding and bonding of the CO line protector. These tests should be performed on every new installation. You will need a volt-ohm-millimeter (VOM) capable of measuring 115 VAC.

CAUTION: This test procedure is for *experienced technicians only*— do not perform this or any other electrical measurement unless you have the proper training and experience. You may prefer that a properly certified electrician perform this procedure.

WARNING: Hazardous voltages that may cause death or injury are present during the following tests. Use great care when working with ac power line voltages.

At the common equipment location:

- 1 Set the VOM to the scale on which you can read 115 VAC.
- 2 Measure ac outlet voltages as follows:
 - Hot to third wire (green wire) ground—should be about 115 VAC.
 - Neutral to third wire ground—should be less than 2.5 VAC.

NOTE: Any circuit tester, such as the IDEAL EZ CHECK circuit tester (IDEAL Industries, INC., model 61035), may be used instead of the VOM to determine whether or not an outlet is wired properly.

If the voltages measured are not as required in this step, inform the customer that he must have his electrician install a dedicated, properly grounded ac outlet.

-
- 3 Visually verify that individual CO line protectors (carbon blocks, gas tubes, etc) are in place.
 - 4 Set the VOM to the scale on which you can read 1 VAC.
 - 5 Measure voltage between CO protector ground lug and the third wire ground of the nearest ac outlet on the circuit to be used. This voltage should be less than 1 VAC.

WARNING: If the ac voltage reading is greater than 1 volt, do not measure resistance in the following step as this measurement could damage the VOM.

- 6 If the voltage reading of step 5 is proper, set the VOM to the scale on which you can read resistance (ohms). Read the resistance between the same two points as in step 5. If the bonding of protector grounds is proper, the resistance should be less than 1 ohm.
- 7 If the resistance measurement is greater than 1 ohm, the ac outlet should be checked for proper ground. This check can be made with an ohmmeter as measured previously at the common equipment outlet.
 - Set the VOM to read ac voltage.
 - Measure the ac outlet voltages at the outlet nearest the CO line protector as follows:
 - Hot to third wire ground– should be about 115 VOM.
 - Neutral to third wire ground– should be less than 2.5 VOM.
- 8 If the voltage readings do not measure the values suggested, then the ac outlet is improperly wired. Notify the customer that an electrician should repair the outlet.
- 9 If the outlet is properly grounded, and either the resistance or voltage measurement of the protector is not of proper value, call the local telephone company Customer Operations Group (COG). Give the COG the business name and address and request that the local telephone company properly ground and bond the CO line protector to the ac power.

If access to an ac outlet is not feasible, the following test can be used to check protector grounding. This test does not check for bonding of power and telephone company protector grounds.

- 1 Connect the craft test set between the protector ground lug and the ring side of the CO line.
- 2 If the dial tone is present, the protector is grounded.
- 3 If there is no dial tone, the protector is not grounded; notify the COG as stated in step 9, above.

EXTERNAL GROUNDING

If the CO line protector is properly grounded and bonded to ac power, most lightning damage will be prevented.

NOTE: In areas of the country with frequent lightning activity or severe ac transient voltage, additional protection is strongly recommended.

Either of the following methods are acceptable:

- Install an AT&T model 147A Protector for ac and CO lines. The 147A Protector has a capacity of four CO lines. If you have five to eight telephone lines, also use a model 146A Protector, an add-on unit for CO lines.
- Install a Coupled Bonding Conductor (CBC) according to Figure 46.
- As shown in Figure 46, the CBC runs from the primary protector ground wire along the route of the inside wire, around the network interface, and to the ground of the MERLIN Plus system. The CBC can be implemented using the shield of a shielded cable or a No. 14 or heavier gauge solid conductor tie-wrapped to the communications wire.

In some states the Local Exchange Carrier (LCE), the serving telephone company will provide upon request, a CBC connection at the network interface. The equipment ground is then connected to the LEC-supplied ground at the network interface.

FIGURE 46 Typical MERLIN Plus system grounding plan.

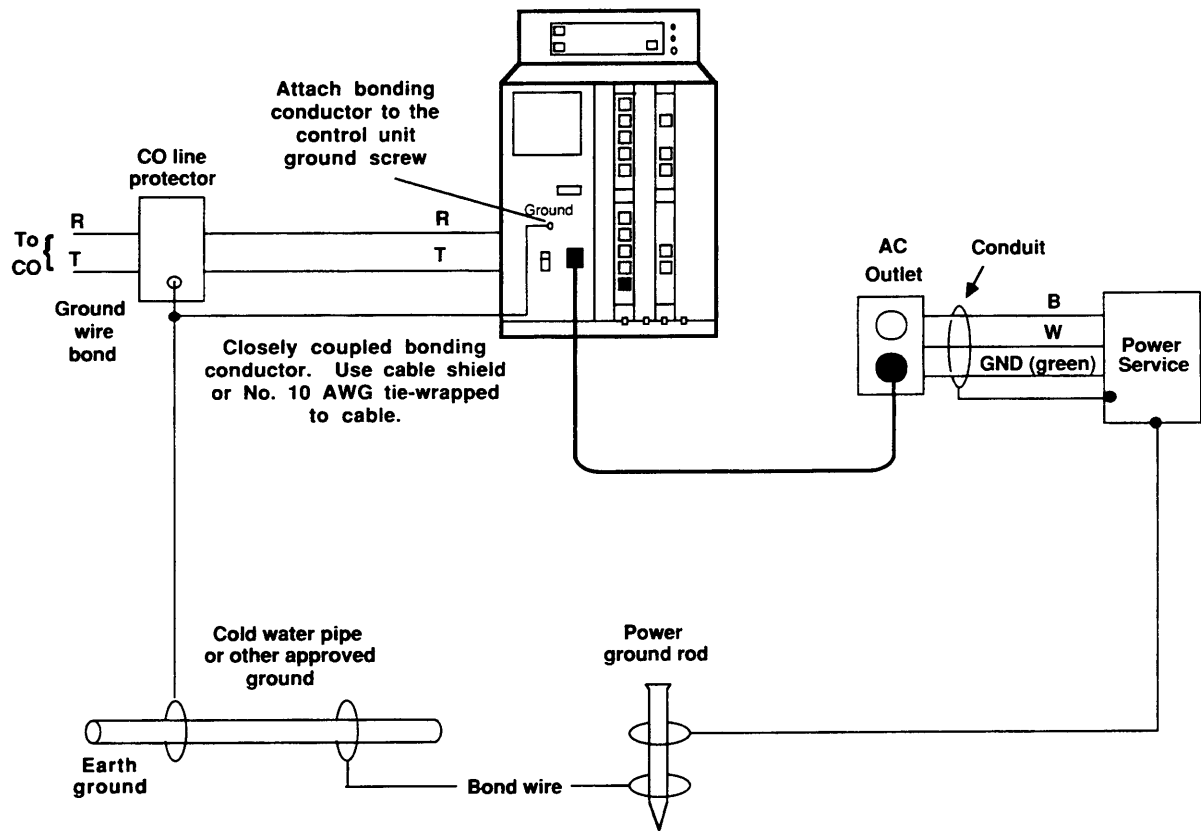

Appendix D: Wiring Reference Tables

TABLE D-1 Wiring Parts Cross Reference.

PPEC	Description	Apparatus Code	COMCODE	SKU
61400 2750-D14 2750-D08 2750-D07	Net Intf Adptr Net Brdg Adptr	Z122C Apparatus Box	103980843	58080
		2A Adapter Mounting	103970562	58078
		Z601A Adapter	103946653	58082
		Z610A Adapter	103950556	58085
		267C Adapter	103715652	53300
		267A2 Adapter	103715082	51970
		103A Corm Block	103104220	56390
		102A Corm Block	103083200	56120
		65B Faceplate	103658498	51930
		61407	NI/CU Mod Cord	D2R-29 Cord 7 ft
61208 32910	CU Jumper Cord	D8W-87 Cord 2.5 ft	104860148	57368
	Cbl Strp Tool	953A Tool	103951588	51990
	1000 ft 4-Pr Cable	(Spooled DIW Cable)	403101140	

TABLE D-2 4-Pair Wiring for the MERLIN Plus System

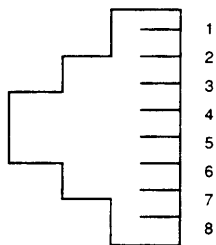

Signal	Pair	Modjck Pins	Modular Cord Wire Colors	102A 103A Z601A Term. Strep	DIW Cable Colors	25-Pair Cable Colors	25-Pair Corm. Pin No.	Paging Jack	AUX Jack
V1T V1R	1	5 4	GREEN RED	1 2	W-BI BLUE	W-BI BI-W	1 26	V1T V1R	V1R* V1T*
CT CR	2	1 2	BLUE ORANGE	3 4	W-O ORANGE	W-O O-W	2 27		
-48V GND	3	3 6	BLACK YELLOW	5 6	W-G GREEN	W-G G-W	3 28	1 2	
V2T V2R	4	7 8	BROWN SLATE	7 8	W-BR BROWN	W-BR BR-W	4 29		

* Note that the cord (e.g., D2R) used with AUX Service reverses these signals.

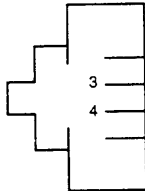

TABLE D-3 CO Line Wiring, 6-Position Jack, Single-Pair.

RJ11 NI Specification			D2R Cord		CU Line Jack	
<u>Signal</u>	<u>Pin</u>	<u>Color</u>	<u>Plug</u>	<u>Plug</u>	<u>Pin</u>	<u>Signal</u>
T	4	GREEN	4	3	3	T
R	3	RED	3	4	4	R

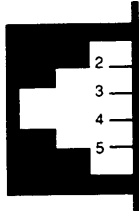

TABLE D-4 CO Line Wiring, 6-Position Jack, Two-Pair.

RJ14 NI Specification			267A2 Adapter			267C Adapter		
<u>Signal</u>	<u>Pin</u>	<u>Color</u>	<u>Plug</u>	<u>Jack 1</u>	<u>Jack 2</u>	<u>Plug</u>	<u>Jack</u>	<u>Pin</u>
T1	4	GREEN	4	4	4	4		4
R1	3	RED	3	3	3	3	1	3
T2	2	BLACK	2	2	2	2		4
R2	5	YELLOW	5	5	5	5	2	3

TABLE D-5 CO Line Wiring, 6-Position Jack, Multipair.

RJ21 NI Specification				CO Line Wiring		Z610A Adapter		
<u>Signal</u>	<u>Color</u>	25-Pair <u>Terminal Corm Pin</u>		<u>Number</u>	<u>Jack No.</u>	<u>Terminal</u>	<u>Jack</u>	<u>Pin No.</u>
T1	B1-W	1	26		4	1		4
R1	W-B1	2	1	1	3	2	1	3
T2	O-W	3	27		4	3		4
R2	W-O	4	2	2	3	4	2	3
T3	G-W	5	28		4	5		4
R3	W-G	6	3	3	3	6	3	3
T4	BR-W	7	29		4	7		4
R4	W-BR	8	4	4	3	8	4	3
T5	S-W	9	30		4			
R5	W-S	10	5	5	3			
T6	B1-R	11	31		4			
R6	R-B1	12	6	6	3			
T7	O-R	13	32		4			
R7	R-O	14	7	7	3			
T8	G-R	15	33		4			
R8	R-G	16	8	8	3			

**TYPICAL SYSTEM WIRING
INSTALLATION**

Figure 47 shows a typical wiring installation for a MERLIN Plus system. Local telephone lines connect with system wiring at a network interface. Voice terminal wiring connects to the control unit through building wiring and a jack field.

FIGURE 47 Typical MERLIN Plus system wiring installation.

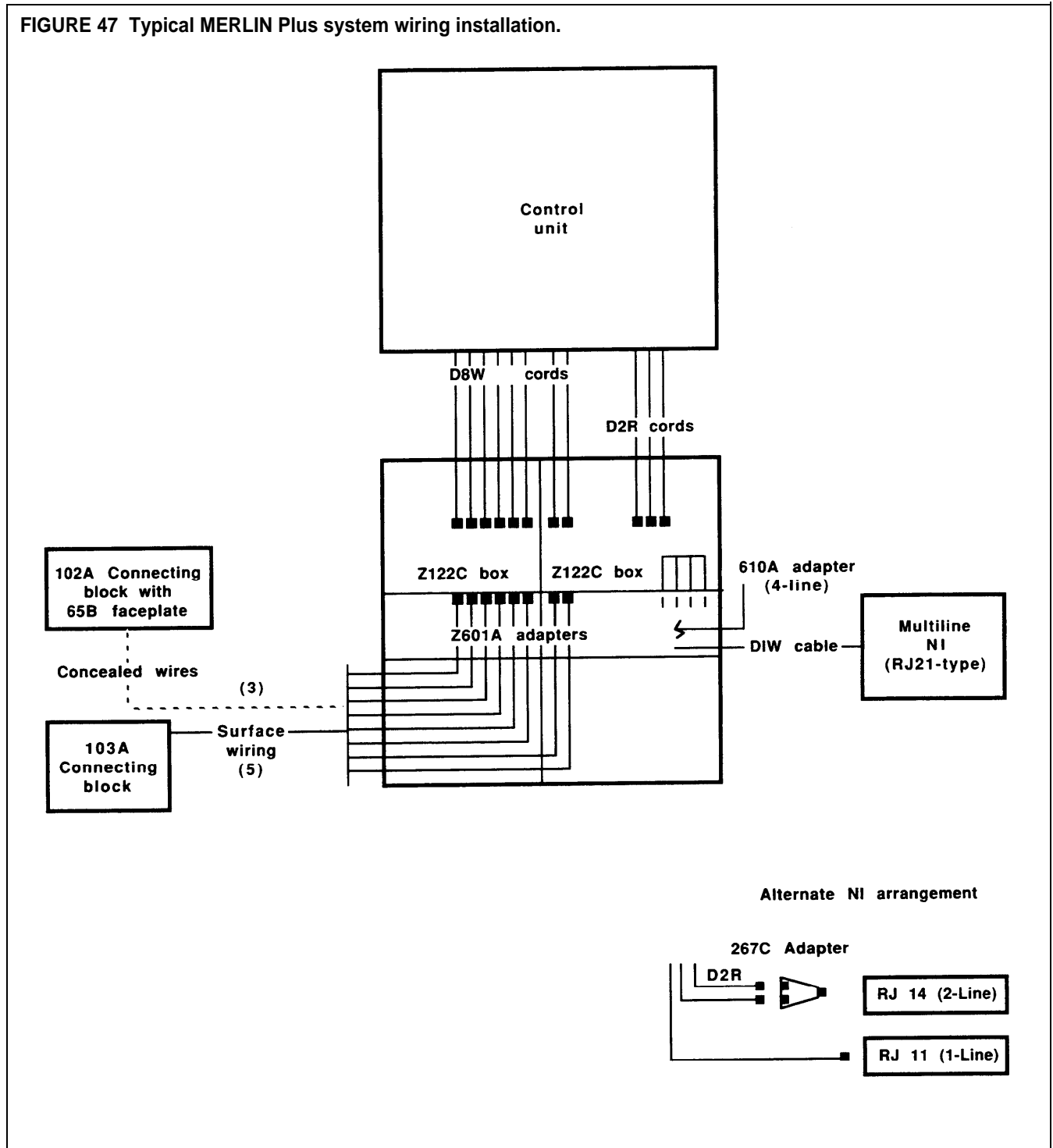

TABLE D-6 Material List for 8 Telephones and 3 Lines (Figure 47).

Voice Terminal Wiring

Qty	Item
3	102A Connecting Block (1 shown)
3	65B Faceplate (1 shown)
5	103A Connecting Block (1 shown)
1	1000 ft Cable Spool, DIW
2	Z122C Apparatus Box
8	Z601A Adapters
8	D8W Cords, 2.5 ft

Line Side Wiring

Option 1: Using Multiline Network Interface (RJ21):

Qty	Item
3	D2R Cords
1	Z610A Adapter
span capacity	Z122C Apparatus Box

Option 2: Using One-Pair/Two-Pair Network Interfaces (RJ11/RJ14):

Qty	Item
3	D2R Cords
1	267C Adapter

Appendix E: Direct Connection Wiring

You can connect your voice terminal locations in either of two ways:

- Through the building wiring to a jack field at the control unit location.
or
- Directly, with modular voice terminal cords and, if necessary, modular voice terminal extension cords.

Jack field wiring is the recommended method for almost all cases. This method is illustrated and explained throughout this manual. However, if you need to use direct connection wiring, use the following instructions.

DIRECT CONNECTION

Follow these steps to connect your voice terminal locations directly to the control unit:

- 1 Make a note of each voice terminal location you have selected for each intercom number. Keep in mind that you may have to change intercom number assignments later.
- 2 Mark or label each cord at both ends with matching labels, beginning with 10. See Figure 48.

If the distance between a voice terminal location and the control unit requires the use of extension cords, mark or label each end of the wiring run.

- 3 Attach one label near the plug that goes to the voice terminal and the matching label near the plug that goes to the control unit.
- 4 Run the cords from the voice terminal locations to the control unit.

CAUTION: Do not run cords inside air plenums or ducts, along hot pipes, or across walkways. If you use staples to attach cords to walls or baseboards, be careful not to pierce the cords.

- 5 Thread each cord through the bottom channel of the control unit and up to the voice terminal jack with the same number as the cord label and plug it in. Refer to the label on the power module to check the number assignments for the voice terminal jacks.

FIGURE 48 Voice terminal wiring, direct connection.

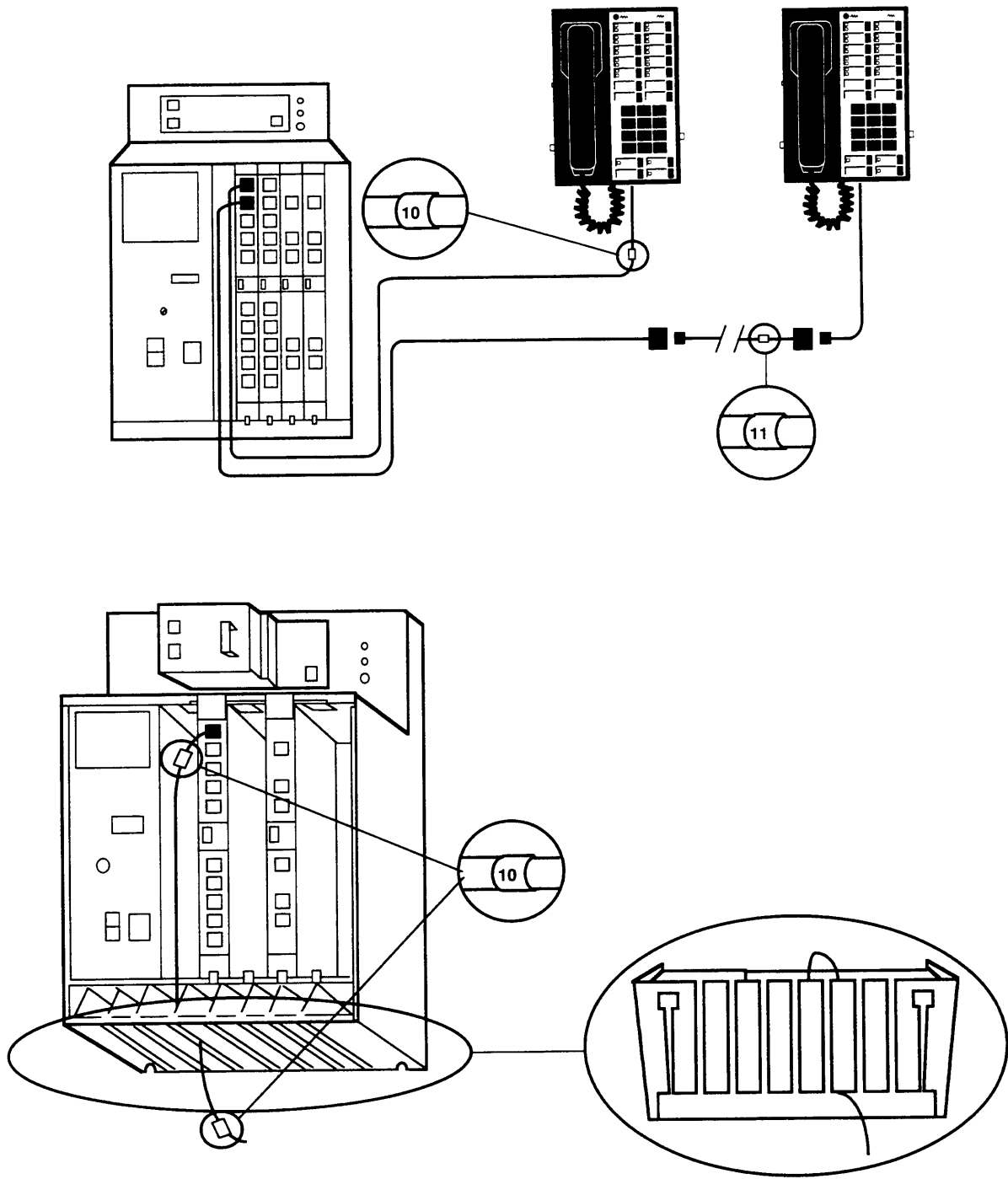

Any of the following voice terminal models will work at any voice terminal location directly connected to your MERLIN Plus system:

- 5-Button voice terminal
- BIS-10 voice terminal
- 10-Button voice terminal
- 10-Button voice terminal with Hands Free Answer on Intercom (HFAI)
- BIS-22 voice terminal
- BIS-34 voice terminal
- BIS-34D voice terminal
- 34-Button (SP-34) voice terminal with speakerphone
- 34-Button (SP-34) voice terminal with speakerphone and display
- 34-Button deluxe voice terminal
- 34-Button voice terminal

Assign voice terminals to the locations based on the requirements of your system and the needs of individual users. For example, an attendant/receptionist at the intercom 10 location will require one of the 34-button voice terminals or a BIS-22 voice terminal. For more information on voice terminals and preparing them for the system connection, see "Step 3: Connecting the Voice Terminals" under "Prepare the Voice Terminals."

Make sure the control unit power is off before plugging and unplugging modular cords into the control unit. This prevents you from damaging the voice terminal module if you accidentally pull on a cord that is attached to it. When the power is off, follow these steps to connect each voice terminal to the system:

1 Place the voice terminal in its designated location.

2 Plug the voice terminal into the system.

If each connection only requires one modular cord, test the connection as described in "Testing Each Voice Terminal," in "Step 3: Connecting the Voice Terminals."

If each connection requires one or more extension cords, plug the loose end of the voice terminal's modular cord into the jack on the extension cord that terminates the wiring run to the control unit. Then go back to "Testing Each Voice Terminal" in "Step 3: Connecting the Voice Terminals."

Moving voice terminals directly connected to the control unit

To move a telephone with a direct connection to the control unit, do the following:

- 1 Find the modular cord that terminates the wiring run from the *new* location to the control unit.
- 2 Go to the control unit and locate the jack with the voice terminal's intercom number.
- 3 Turn the control unit off.
- 4 If another cord is in the jack with the voice terminal's new location number, unplug it. (Place it aside until you have use for it.)

-
- 5** Plug the cord for the new location into the corresponding control unit jack with the voice terminal's intercom number.
 - 6** Relabel the cord at the new location and again at the control unit end.
 - 7** Turn the control unit back on.
 - 8** Record the change.

You do not have to reprogram the voice terminal.

Index

A

- Accessories, 29
 - adding, 35 – 41
- Accessory equipment, 35
- Adapter, 4-line, 50, 51
 - RJ11-type, 3, 4
 - RJ14-type, 3, 4
 - Z601A, 45, 48
- Adding a voice terminal. *See* Voice terminal, adding
- Apparatus box, 50, 60
- Auxiliary jack, 16, 29
- Auxiliary line, 16
- Auxiliary line telephone, line module jack, 29

B

- Battery, 12
- BIS voice terminals. *See* Voice terminal

C

- Cable, 25-pair, 51
- Cable stripping tool, 46
- Cable termination tool (punch down tool), 46
- Cables running, procedures for, 48
- Call Report, 20
- Changing the system, adding and moving lines, voice terminals, 42 – 43
- CO line wiring, 60
 - 6-position jack, multipair, 66
 - 6-position jack, single-pair, 66
 - 6-position jack, two-pair, 66
- Connect each voice terminal to the system, procedure, 24
- Connect the control unit to the ac outlet, 12
- Connect the outside lines to the jack field, procedure, 51
- Connecting the voice terminals, 22 – 29
- Connectivity overview. *See* System connectivity overview
- Connector, 50-pin, 51
 - RJ21-type, 3, 4
- Connector cable, single-ended 25-pair, 50
- Constructing a jack field, control unit location, 47
- Constructing a jack field, procedure, 47
- Constructing and connecting the jack field, 45 – 49
- Control unit at full capacity, description of, 14
- Control unit
 - connecting, 60
 - connecting outside lines to, 16 – 18
 - connecting outside lines to, items required, 16
 - connecting outside lines to, method, 16
 - connecting outside lines to, procedure, 17
 - connecting to ac outlet, 15 – 16
 - connecting to ac outlet, outlet type, 15
 - connecting to ac outlet, procedure, 15
 - environment of, 7
 - front and top covers, 8
 - grounding, 6
 - installing, 3 – 18
 - location requirements, 6
 - maximum wiring run, 7
 - mounting, 6 – 11, 58
 - mounting hardware, 8
 - mounting hole access, 8
 - mounting wall types, 8

D

- Data collector, 36
- Dial tone test tool, 5
- DIW cable, 46, 47

E

- Extending the network interface to the jack field, 50 – 52
 - required items, 50

F

- FCC registration and repair information, 53
- FCC regulations, notifying local phone company, 3
 - ringer equivalence number, 3
 - system registration number, 3
- 4-Pair wiring, 65
- 5-Button voice terminal, 22, 71

G

- General purpose adapters, 35
- Ground, CO line protector tests, 61 – 62
 - third-wire, 15
- Grounding requirements, 15, 61 – 64

I

- In-Range, Out-of-Building protectors, 19, 40
- In-Range, Out-of-Building voice terminal, 40
- Installation requirements, control unit environment, 57
 - quick reference, 57 – 60
- Intercom 10, as attendant location, 19
 - for system administration, 19
- Intercom number, labeling, 27
 - verification procedure, 27

J

- Jack, RJ11-type, 6
 - RJ14-type, 6
- Jack field, 43
 - adding jacks to, procedure, 51
 - connect the outside lines to, 51
 - constructing and connecting, advantages of, 45
 - constructing, control unit location, 47
 - construction recommendations, 45
 - defined, 44
 - installation, 1
 - labels, 60
 - moving voice terminals within, example, 45
 - wiring supplement, 1, 4, 44 – 52
- Jack panel box, 50
 - labeling, 51
- Jack panel boxes. *See* Apparatus boxes
- Jacks, labeling, 51

L

- Line board. *See* Line module
- Line cord, single-pair modular, 16
- Line jacks, 16
- Line module, 12
 - inserting, 13
- Lines, testing for a dial tone, 30 – 31

M

Memory module, 12
Modules, inserting, 12 – 14
Moving a voice terminal. *See* Voice terminal, moving

N

Network interface, multiline, RJ21-type, 44
 preparation of, 3 – 4
 RJ21-type, 50
Network interface adapters and connectors, 3

O

Outside line, adding, 42
Outside lines, connect to the jack field, 51
 testing, 5

P

Power accessories, IROB, 39
Power supply module, 12
Printer, 36

R

RJ11-type adapters, 3
RJ11-type jack, 6
RJ14-type adapters, 3
RJ14-type jack, 6
RJ21-type connector, 3
Rotary dial telephone, 5, 29
Running cables, procedure for, 48

S

66-type block, 3
Speakerphone performance tips, 34
Station board. *See* Voice terminal module
Station Message Detail Recording. *See* Call Report
Supplemental alert adapters, 39
System, changing. *See* Changing the system
System Configuration Form, 16, 17, 21, 60
System connectivity overview, 55
System Feature Report, 20
System wiring, typical installation, 67

T

Telephone, rotary dial, 5, 29
 Touch-Tone, 5, 29
10-Button voice terminal, 71
10-Button voice terminal with Hands Free Answer on
 Intercom, 71
Test the Outside Lines, 4
Testing each line number, 34
Testing lines for a dial tone, 30 – 31
Testing outside lines, 5
Testing the system, 30 – 34
 placing an intercom call, 33
 placing an outside call, 32
 procedures, 30 – 34
Testing the voice terminals, lights do not flash, 25
 tone does not sound, 26
Testing voice terminals, 24 – 27
34-Button deluxe voice terminal, 22, 71
34-Button voice terminal, 22, 71
Touch-Tone equipment, 35
Touch-Tone telephone, 5, 29
T/P switch, 23, 24, 26

V

Voice terminal
 adding, 42
 BIS-10, 22, 71
 BIS-22, 22, 71
 BIS-34, 22, 71
 BIS-34D, 22, 71
 BIS-34D with Display, 22, 71
 components, 22
 connecting to the system, procedure for, 24
 5-button, 22, 71
 Hands Free Answer on Intercom (HFAI-10), 22
 intercom 19 and Call Report, 20
 intercom numbers, 19
 jacks, 12
 locations, 19
 maximum wiring run, 19, 57
 moving, 43
 10-button, 22, 71
 10-button, with Hands Free Answer on
 Intercom, 22, 71
 testing, 24 – 27
 testing, lights do not flash, 25
 testing, tone does not sound, 26
 34-button deluxe, 22, 71
 34-button (SP-34), with speakerphone, 22, 71
 34-button (SP-34), with speakerphone and
 display, 22, 71
 types, 22
Voice terminal module, 12
 inserting, 14
Voice terminal power supply, 40
Voice terminal wiring, 19 – 21, 60
 direct connection, 69
 intercom connections, 19
 preparation for, 19–20
 procedure, 21
Voice terminals, connecting, 22 – 29
 intercom 10, 19. *See also* Intercom 10
 intercoms 11 through 29, 20
 moving direct-connected, 71
 prepare for connection, 22 – 23
Volt-ohm-millimeter, 61, 62

W

Wiring, direct connection, 69 – 72
Wiring parts cross reference table, 65
Wiring reference tables, 65 – 68
Wiring runs, procedures for terminating in modular
 wall jacks, 49
Wiring the voice terminals, 19 – 21
 intercom connections, 19

518-600-008

