

Lucent Technologies
Bell Labs Innovations



PARTNER MAIL VS[®]

Voice Messaging System
Release 4

Installation and Programming

585-322-521
Comcode 107970212
Issue 1
March 1997

Notice

Every effort was made to ensure that the information in this book was complete and accurate at the time of printing. However, information is subject to change.

Your Responsibility for Your System's Security

Toll fraud is the unauthorized use of your telecommunications system by an unauthorized party, for example, persons other than your company's employees, agents, subcontractors, or persons working on your company's behalf. Note that there may be a risk of toll fraud associated with your telecommunications system, and if toll fraud occurs, it can result in substantial additional charges for your telecommunications services.

You and your System Manager are responsible for the security of your system, such as programming and configuring your equipment, to prevent unauthorized use. The System Manager is also responsible for reading all installation, instruction, and system administration documents provided with this product in order to fully understand the features that can introduce risk of toll fraud and the steps that can be taken to reduce that risk.

Lucent Technologies does not warrant that this product is immune from or will prevent unauthorized use of common-carrier telecommunication services or facilities accessed through or connected to it. Lucent Technologies will not be responsible for any charges that result from such unauthorized use.

Federal Communications Commission Statement

This equipment has been tested and found to comply with the limits for a Class A digital device, pursuant to Part 15 of the FCC Rules. These limits are designed to provide reasonable protection against harmful interference when the equipment is operated in a commercial environment. This equipment generates, uses, and can radiate radio frequency energy and, if not installed and used in accordance with the instruction manual, may cause harmful interference to radio communications. Operation of this equipment in a residential area is likely to cause harmful interference, in which case the user will be required to correct the interference at his own expense.

Canadian Department of Communications (DOC) Interference Information

This digital apparatus does not exceed the Class A limits for radio noise emissions set out in the radio interference regulations of the Canadian Department of Communications.

Le Présent Appareil Numérique n'émet pas de bruits radioélectriques dépassant les limites applicable aux appareils numériques de la class A prescrites dans le reglement sur le brouillage radioélectrique édicté par le ministère des Communications du Canada.

Trademarks

PARTNER, PARTNER MAIL VS, PARTNER MAIL, MLS-34D, MLS-18D, MLS-12D, MLS-12, MLS-6, MLC-6, MDC 9000, MDW 9000, MDW 9010, and MDW 9030P are registered trademarks of Lucent Technologies in the U.S. and other countries.

Ordering Information

Call: Lucent Technologies Publications Center
Voice 1 800 457-1235 International Voice 317 361-5353
Fax 1 800 457-1764 International Fax 317 361-5355

Write: Lucent Technologies Publications Center
P.O. Box 4100
Crawfordsville, IN 47933

Order: Document No. 585-322-521, Issue 1, March 1997, Comcode 107970212

Support Telephone Number

In the continental U.S., Lucent Technologies provides a toll-free customer helpline 24 hours a day. Call the Lucent Technologies Helpline at **1 800 628-2888** or your Lucent Technologies authorized dealer if you need assistance when installing, programming, or using your system. Consultation charges may apply. Outside the continental U.S., contact your local Lucent Technologies authorized representative.

Lucent Technologies Fraud Intervention

If you *suspect you are being victimized* by toll fraud and you need technical support or assistance, call Technical Service Center Toll Fraud Intervention Hotline at **1 800 643-2353**.

WWW Home Page

The WWW home page for Lucent Technologies is www.lucent.com.

Important Safety Instructions



WARNING:

The following list provides basic safety precautions that should always be followed when using the system:

1. Read and understand all instructions.
2. Follow all warnings and instructions marked on the product.
3. Unplug all telephone connections before cleaning. **DO NOT** use liquid cleaners or aerosol cleaners. Use a damp cloth for cleaning.
4. This product should be serviced by (or taken to) a qualified repair center when service or repair work is required.
5. **DO NOT** use this product near water, for example, in a wet basement location.
6. **DO NOT** place this product on an unstable cart, stand, or table.
7. Never push objects of any kind into slots or openings as they may touch dangerous voltage points or short out parts that could result in a risk of fire or electric shock. Never spill liquid of any kind on the product.
8. Avoid using this product during an electrical storm. There may be a remote risk of electric shock from lightning.
9. **DO NOT** use the telephone to report a gas leak in the vicinity of the leak.
10. The product is provided with a three-wire grounding type plug. This is a safety feature. **DO NOT** defeat the safety purpose of the grounding type plug. **DO NOT** staple or otherwise attach the AC power supply cord to building surfaces.



CAUTION:

***DO NOT** block or cover the ventilation slots and openings. They prevent the product from overheating. **DO NOT** place the product in a separate enclosure unless proper ventilation is provided.*

SAVE THESE INSTRUCTIONS

Contents

	About This Guide	xi
	▪ Purpose	xi
	▪ Terminology	xi
	▪ Key Sequences	xii
	▪ How to Use This Guide	xiii
	▪ Reference Materials	xiv
1	Overview	1-1
	▪ Tutor Feature	1-3
	▪ Languages	1-4
	▪ Voice Messaging Services	1-4
	▪ Security	1-15
2	Installation	2-1
	▪ Before You Start	2-1
	▪ Installing the PARTNER MAIL VS Module	2-2
3	Understanding Programming	3-1
	▪ Communications System Programming	3-1
	▪ Voice Messaging System Programming	3-4
4	Initial Programming	4-1
	▪ Overview	4-1
	▪ Voice Mail System Configurations	4-2
	▪ Initial Communications System Setup	4-3
	▪ Voice Messaging System Programming	4-6
	▪ Communications System Programming	4-19
	▪ Verifying System Operation	4-29

Contents

5	System Management	5-1
	■ General Information	5-2
	■ Language	5-8
	■ Automated Attendant Service	5-18
	■ Modifying Mailboxes	5-36
	■ Line Coverage	5-52
	■ Telephone Button Programming	5-60

6	Troubleshooting	6-1
	■ When You Need Help	6-1
	■ Automated Attendant Service	6-2
	■ Call Answer Service	6-6
	■ Voice Mail Service	6-7
	■ Language	6-11

A	Specifications	A-1
----------	-----------------------	-----

B	FCC Information	B-1
	■ Federal Communications Commission (FCC) Interference Information	B-1
	■ IC Notification and Repair Information	B-3

C	Warranty Information	C-1
	■ Repair Information	C-1
	■ Lucent Technologies Warranty and Limitation of Liability	C-3

Contents

D	Voice Messaging System Planning Forms	D-1
----------	--	-----

E	Communications System Planning Forms	E-1
----------	---	-----

F	Case Studies	F-1
	▪ Purpose	F-1
	▪ Case Study #1	F-2
	▪ Case Study #2	F-21

GL	Glossary	GL-1
-----------	-----------------	------

IN	Index	IN-1
-----------	--------------	------

Menu Map
Programming Flowchart
System Programming Reference

Figures

1	Overview	1-1
	1-1. Voice Messaging Services	1-5
	1-2. Immediate and Delayed Call Handling	1-9

2	Installation	2-1
	2-1. Voice Messaging System Extensions for PARTNER Plus, PARTNER II, and PARTNER 48	2-3
	2-2. Sample Voice Messaging System Extensions for PARTNER Advanced Communications Systems	2-4
	2-3. Installing the Mailbox Expansion Card	2-5

3	Understanding Programming	3-1
	3-1. Programming Menus	3-6

5	System Management	5-1
	5-1. Language Menu	5-8
	5-2. Automated Attendant Service Menu	5-19
	5-3. Modifying Mailboxes	5-37
	5-4. Dial Plan for PARTNER Plus, PARTNER II, and PARTNER 48	5-39
	5-5. Dial Plan for PARTNER Advanced Communications Systems	5-40
	5-6. Line Ownership	5-53

About This Guide

Purpose

This guide provides instructions for installing, upgrading, programming, and managing the PARTNER MAIL VS[®] Voice Messaging System on the PARTNER[®] Plus, PARTNER II, PARTNER 48, or PARTNER Advanced Communications System (ACS). It is intended for the *technician* who installs the hardware and programs the initial system settings and for the *System Manager*, the person who is responsible for managing the system on an on-going basis.

Terminology

This guide uses the following terms:

- *Voice messaging system (VMS)*: the PARTNER MAIL VS Voice Messaging System.
- *Subscribers*: a user who has a mailbox on the voice messaging system.
- *Communications system (CS)*: in most countries, Release 3.1 or later of the PARTNER Plus, PARTNER II, and PARTNER 48 systems, or Release 1.0 of the PARTNER Advanced Communications System. In the U.K., Release 2.0 or later of the PARTNER Plus and PARTNER 48 systems.
- *System phones*: the telephones specifically designed to work with the communications system, including (where available) the PARTNER-34D, PARTNER-18D, PARTNER-18, PARTNER 6, MLS-34D, MLS-18D, MLS-12D, MLS-12, MLS-6, MLC-6, MDC 9000, MDW 9000, MDW 9010, and MDW 9030P.

Key Sequences

This guide instructs you to press key sequences on the telephone's dialpad to perform tasks. Each sequence includes a number. If the keys on your dialpad also have letters, the number in the sequence is equivalent to a letter associated with the task in English. For example, to delete a message from your mailbox, you press [*] [2], which is equivalent to [*] [D] on the dialpad. The numerical key sequences and their associated letter sequences are listed below for your reference:

Delete	[*] [2]	[*] [D]
Help	[*] [4]	[*] [H]
Restart	[*] [7]	[*] [R]
Transfer	[*] [9]	[*] [T]
Exit	[*] [*] [9]	[*] [*] [X]

How to Use This Guide

If you are the *technician*, refer to the appropriate chapters to help you:

- **Install the voice messaging system hardware.** Chapter 2 provides instructions for installing and upgrading the voice messaging system module in the communication system's control unit. It also provides instructions for installing the Mailbox Expansion Card.
- **Refresh your memory about programming.** Chapter 3 offers general programming information for both the communications system and the voice messaging system.
- **Perform initial programming.** Chapter 4 provides step-by-step programming instructions for integrating the voice messaging system with the communications system. It also provides test procedures that you should use after installation to ensure that the system is working properly.
- **Solve problems.** Chapter 6 provides information to help you identify and correct problems you may have with the voice messaging system.

If you are the *System Manager*, refer to the appropriate chapters to help you:

- **Learn about the voice messaging system.** Chapter 1 describes the voice messaging system's features and services.
- **Learn about programming.** Chapter 3 offers general programming information for both the communications system and the voice messaging system.
- **Manage the voice messaging system.** Chapter 5 provides instructions for changing system settings to accommodate the changing needs of the business. It also offers guidelines for setting up and using the receptionist's extension.
- **Solve problems.** Chapter 6 provides information to help you identify and correct problems you may have with the voice messaging system.

After you are experienced with the system, use the Table of Contents or Index to locate the information you need.

This guide contains some information about communications system features as well as voice messaging system features. For detailed information about a specific communications system feature, refer to the *Programming and Use* guide for the communications system.

Product Safety Statements

Product safety statements are identified in this guide by a .



CAUTION:

Indicates the presence of a hazard that will or can cause minor personal injury or property damage if the hazard is not avoided.



WARNING:

Indicates the presence of a hazard that can cause severe or fatal personal injury if the hazard is not avoided.

How to Comment on This Guide

A feedback form is located at the end of this guide, after the appendixes. If the form is missing, send your comments and recommendations for changes to Publications Manager, Lucent Technologies, 211 Mount Airy Road (Room 2W-226), Basking Ridge, NJ 07920 (FAX 1 908 953-6912).

Reference Materials

In addition to this guide, the following materials are available (the order numbers are in parentheses) for the voice messaging system:

- Using the PARTNER MAIL VS Voice Messaging System (585-322-523)
- Tutor Labels (585-322-510)

To order these materials, call the Lucent Technologies' BCS Publications Center at 1 800 457-1235 in the continental U.S. or at 1 317 361-5353.

Some of these materials also are available in other languages. For more information about these materials or about communications system materials, contact the BCS Publications Center, your Lucent Technologies' Representative or local Authorized Dealer.

Overview

1

Contents

Tutor Feature	1-3
Languages	1-4
Voice Messaging Services	1-4
■ Automated Attendant Service	1-6
Communications System Features Affecting Automated Attendant Service	1-8
Group Call Distribution	1-8
VMS Hunt Schedule	1-8
VMS Hunt Delay	1-9
Transfer Return Extension	1-10
Automated Attendant Service Scenarios	1-10
Music On Hold	1-11
■ Call Answer Service	1-11
Communications System Features Affecting Call Answer Service	1-12
VMS Extension Coverage	1-12
Immediate VMS Extension Coverage (Do Not Disturb)	1-12
Line Coverage	1-12
Voice Mailbox Transfer	1-13
■ Voice Mail Service	1-13
Mailboxes	1-14
Guest Mailboxes	1-14
Security	1-15
■ System Security Guidelines	1-15
■ Security Policy and User Education	1-16

Overview

1

The PARTNER MAIL VS Voice Messaging System is designed to work with the communications system to automate the call handling needs of the business.

The voice messaging system:

- Expands easily and supports four configurations to accommodate growth and ensure optimal performance. The basic system configuration consists of 2 voice channels (ports) and 10 mailboxes. Any one of three optional Mailbox Expansion Cards may be installed to increase the number of ports and/or subscribers. These configurations include: 2 ports and 20 mailboxes, 4 ports and 20 mailboxes, and 4 ports and 40 mailboxes.
- Handles up to two calls (in the 2-port configuration) or four calls (in the 4-port configuration) simultaneously and provides service for a predetermined number of subscribers.
- Answers outside calls, plays a customized message prompting the caller to press digits for the party with whom the caller wants to speak, and efficiently routes the call to the appropriate party—all without the aid of a receptionist.
- Allows outside callers to hear all voice prompts and customized messages in the language selected for the system. And in bilingual mode, callers can choose between two languages selected for the system.
- Allows you to create up to two Automated Attendant Announcements (in each language selected for the system). For example, you can offer callers a choice of a standard business hours/location announcement or a frequently updated announcement featuring special offers.
- Allows callers to leave a private message if the called party does not answer or is busy on another call, or to transfer to another system extension or the receptionist's extension for assistance.

- Allows subscribers to retrieve messages from any touch-tone phone on the premises or from a remote location. And the system informs subscribers how many of these messages are new and how many are old (previously saved) messages.
- Allows subscribers to forward messages with comment to one or more mailboxes on the system.
- Allows System Managers to implement the language that subscribers choose for their own mailbox use.
- Allows subscribers to have the system “outcall” a specific telephone or pager number according to a predefined schedule whenever a new message is received. (Note that this feature is available to subscribers only when it is administered for them by their System Manager.)
- Provides after-hours service in addition to daytime service.



NOTE:

Outcalling, Automated Attendant Announcements, and Message Forward features are introduced with this new release of PARTNER MAIL VS. The ability to expand the standard 2-port, 10-mailbox configuration to any one of three other configurations with the installation of the appropriate Mailbox Expansion Card is also a new feature of Release 4.

In addition, the voice messaging system offers a built-in Tutor feature, which is discussed in the next section.

Tutor Feature

Tutor is an “on-line help” feature that allows users to easily access and listen to information about commonly-used communications system features. Any user can access the Tutor—users do not have to be voice messaging system subscribers.

Tutor provides information about the following subjects:

- System phone features such as ringing patterns, volume control, speakerphone, display, buttons, and lights.
- Various types of internal calls including group paging calls, voice interrupt on busy calls, and hands-free answer on intercom calls.
- System features such as Conference, Transfer, Auto Dialing, Personal Speed Dialing, Last Number Redial, and Save Number Redial.

To access the Tutor menu, users simply make a call to the voice messaging system. The system plays:

```
Welcome to PARTNER MAIL VS. Please enter extension  
and #. Otherwise, to access PARTNER Tutor, press * 4.
```

When users dial [*] [4], they hear instructions for using Tutor, followed by a list of topics and subtopics. The user can then enter the topic and subtopic numbers of their choice. Refer to “Using the Tutor Feature” in Chapter 5 for a list of topic and subtopic numbers.

Instruction labels, which are designed for placement in the handset cradle on the base of the system phone, are shipped with the voice messaging system hardware.

Languages

The voice messaging system supports multiple languages. You can choose to have outside callers hear all voice prompts and customized messages in one of the supported languages (*Monolingual Mode*) or you can let outside callers choose between two languages preselected for the system by the System Manager (*Bilingual Mode*).

When the system operates in Monolingual Mode, the language you choose for voice prompts is referred to as the *System Language*. When the system operates in Bilingual Mode, the language you choose for voice prompts when calls are first answered is referred to as the *Primary Language*. Outside callers then have the option of switching to the *Secondary Language* for the remainder of the call.

Voice Messaging Services

The voice messaging system provides three types of service:

- **Automated Attendant Service.** Answers outside calls and transfers them to the destination selected by the caller or plays an Announcement selected by the caller.
- **Call Answer Service.** Allows the caller to leave a message or to transfer to another extension if the called party is busy or does not answer.
- **Voice Mail Service.** Allows subscribers to listen to messages and manage their own mailbox.

Figure 1-1 provides an overview of the features associated with each service.

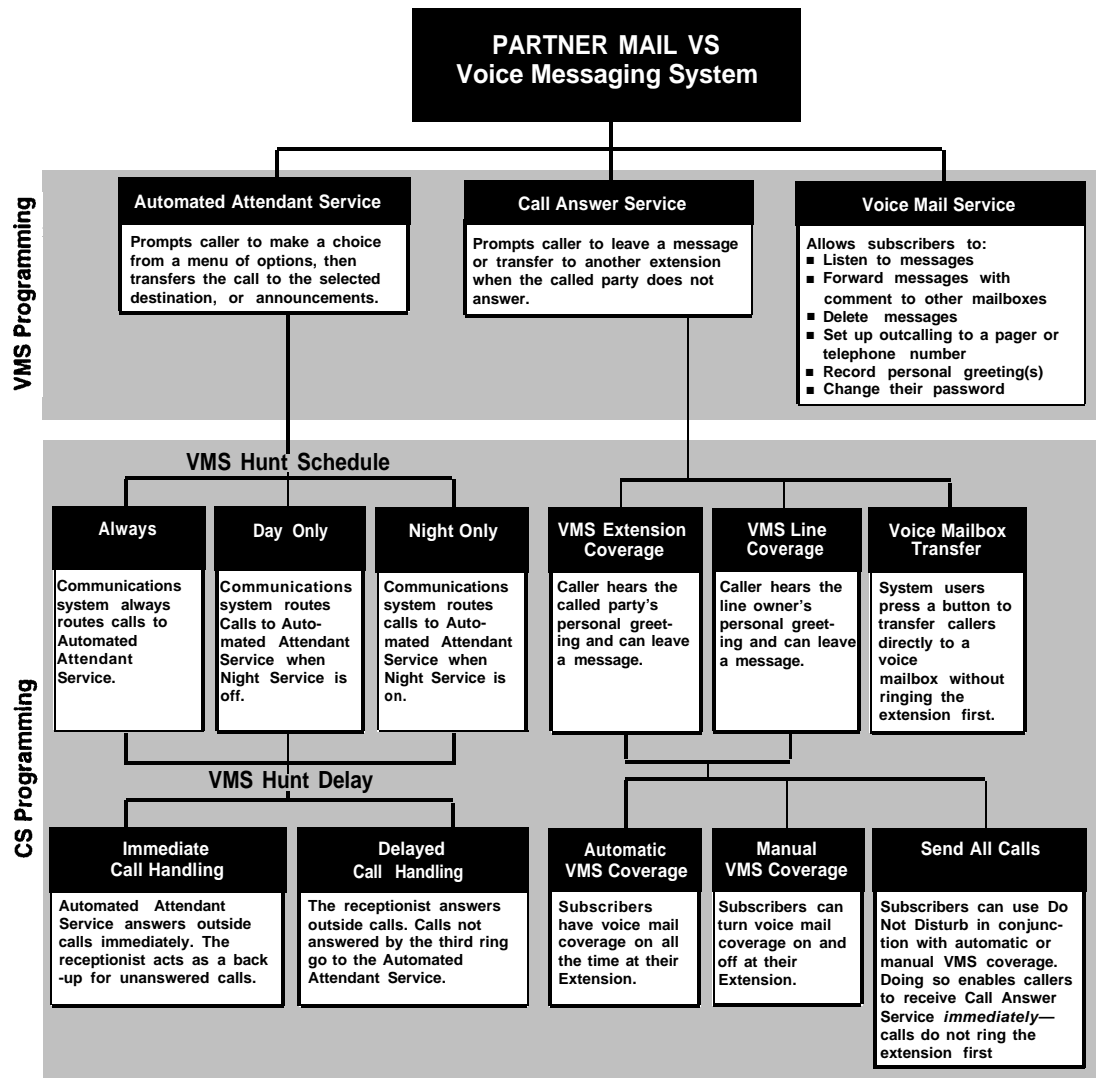

Automated Attendant Service

The Automated Attendant Service can answer and route outside calls *without* assistance from a receptionist. After an outside call is answered, the Automated Attendant Service plays a customized message (called the *menu prompt*). Typically the message welcomes callers—to let them know they have reached the correct number—then offers callers a menu of options for transferring to the desired party or listening to an Announcement. (It is recommended that the menu offer not more than five options to avoid confusing callers.)

You can record up to two Announcements in Monolingual Mode (or up to two Announcements for each language in Bilingual Mode). Announcements are often used to answer frequently asked questions, such as business hours and location, emergency service, special offers, etc. Each Announcement can be up to four minutes in length. Callers can choose to listen to these Announcements, so your staff has more time to answer other calls and perform other tasks.

You can customize the menu prompt for use during normal business hours (called the *Day Menu Prompt*) and for use after normal business hours (called the *Night Menu Prompt*). For example, you can set up Automated Attendant Service so that callers hear the following prompt during the day if the system is set for Monolingual Mode and the System Language is U.S. English:

Thank you for calling the ANY Travel Agency. If you know the extension you want, dial it now or press 0 to speak with the receptionist. For information on this month's special travel package, press 3. For directions to ANY Travel Agency, press 4. To speak to an agent about Corporate Travel, press 5. Press * 4 to replay this message.

Note that callers who want general information regarding the current discount travel package or agency location can choose to listen to an Announcement. For example, when callers press [3] they hear the following Announcement:

Are you tired of battling the ice, snow, and after-Christmas sale crowds? Take advantage of our January sunny escape package-3 days and 2 nights in San Juan, Puerto Rico for \$439 per person, including hotel and airfare. To speak to an agent about this package or other winter getaways, press * 8 and extension 13.

For after-hours callers, you can set up Automated Attendant Service to play this prompt:

You have reached the ANY Travel Agency. Our hours are 8 to 5, Monday through Friday. Please press 9 to leave a message and we will return your call when the office opens.

For a system set for Bilingual Mode, the Day Menu Prompt should let callers know that they can switch from the Primary Language to the Secondary Language. Note that callers can also press [*][1] while listening to an Automated Attendant Announcement to switch between the Primary and Secondary Languages. In the following example, the Primary Language is Latin American Spanish and the Secondary Language is U.S. English:

Gracias por llamar a Software México. For English, press * 1. Si usted tiene teléfono de tonos y conoce el número de extensión, marquelo ahora. De lo contrario, espere a ser atendido por nuestra operadora.

For after-hours callers, you can set up Automated Attendant Service to play this prompt:

Gracias por llamar a Software México. For English, press * 1. Nuestro horario de oficina es de 9 a 14:30 horas y de 16 a 18 horas. Si usted tiene teléfono de tonos y conoce el número de la extensión a la que desea llamar, marquelo ahora. De lo contrario, espere y deje un mensaje con la operadora.



NOTE:

When the system is installed initially, Automated Attendant Service has this factory-set Day Menu Prompt:

Hello, welcome to PARTNER MAIL VS. Please enter the extension number of the person you wish to reach or press 0 to reach the receptionist.

In addition, Automated Attendant Service has this factory-set Night Menu Prompt:

Good Evening. Welcome to PARTNER MAIL VS. Please enter the extension number of the person you wish to reach, or press 9 to leave a message with the receptionist.

Automated Attendant Service is useful for many businesses, such as car dealerships, insurance agencies, and stores. For example, a car dealership can use Automated Attendant Service to allow its customers to reach the customer service department directly. This frees sales people to handle customer transactions while the Automated Attendant Service transfers service calls to the appropriate department. In this case, the Automated Attendant Service can be programmed to prompt the caller to enter a single digit to reach any available customer service representative.

Communications System Features Affecting Automated Attendant Service

When planning Automated Attendant Service, you must choose settings for the following communications system features:

- **Group Call Distribution.** Specifies the outside lines that are to be answered by Automated Attendant Service.
- **VMS Hunt Schedule.** Specifies when the communications system is to route calls to the Automated Attendant Service.
- **VMS Hunt Delay.** Specifies whether the Automated Attendant Service is to provide immediate or delayed call handling.
- **Transfer Return Extension.** Specifies how unanswered calls are transferred by the voice mail system.

Each of these features is explained briefly below. For more information about these communications system features, see the *Programming and Use* guide for your communications system.

Group Call Distribution

This feature lets you specify the outside lines for which you want Automated Attendant Service coverage. You can specify some or all of your lines.

VMS Hunt Schedule

This feature determines when the communications system is to route calls to the Automated Attendant Service. VMS Hunt Schedule works in conjunction with the communication system's Night Service feature so that the voice messaging system can play the appropriate menu prompt. In other words, the menu prompt the caller hears depends on the VMS Hunt Schedule setting you select and the status of the Night Service button at the receptionist's extension.

You can choose one of the following VMS Hunt Schedule settings:

- **Always** (factory setting). Routes outside calls to Automated Attendant Service all the time. When Night Service is off, the Day Menu Prompt plays; when Night Service is on, the Night Menu Prompt plays.
- **Day Only.** Routes outside calls to Automated Attendant Service only when Night Service is off. The Day Menu Prompt plays.
- **Night Only.** Routes outside calls to Automated Attendant Service only when Night Service is on. The Night Menu Prompt plays.

VMS Hunt Delay

This option specifies either immediate or delayed call handling(see Figure 1-2):

- **Immediate** (factory setting). The Automated Attendant Service answers outside calls on the second ring and plays the Day or Night Menu Prompt. The receptionist can act as backup. Callers using rotary phones or callers requesting assistance can be transferred to the receptionist's extension.
- **Delayed.** The Automated Attendant Service answers outside calls after the fourth ring. This delay gives the receptionist time to answer the call.

The VMS Hunt Delay setting you select is used for both day and night operation.

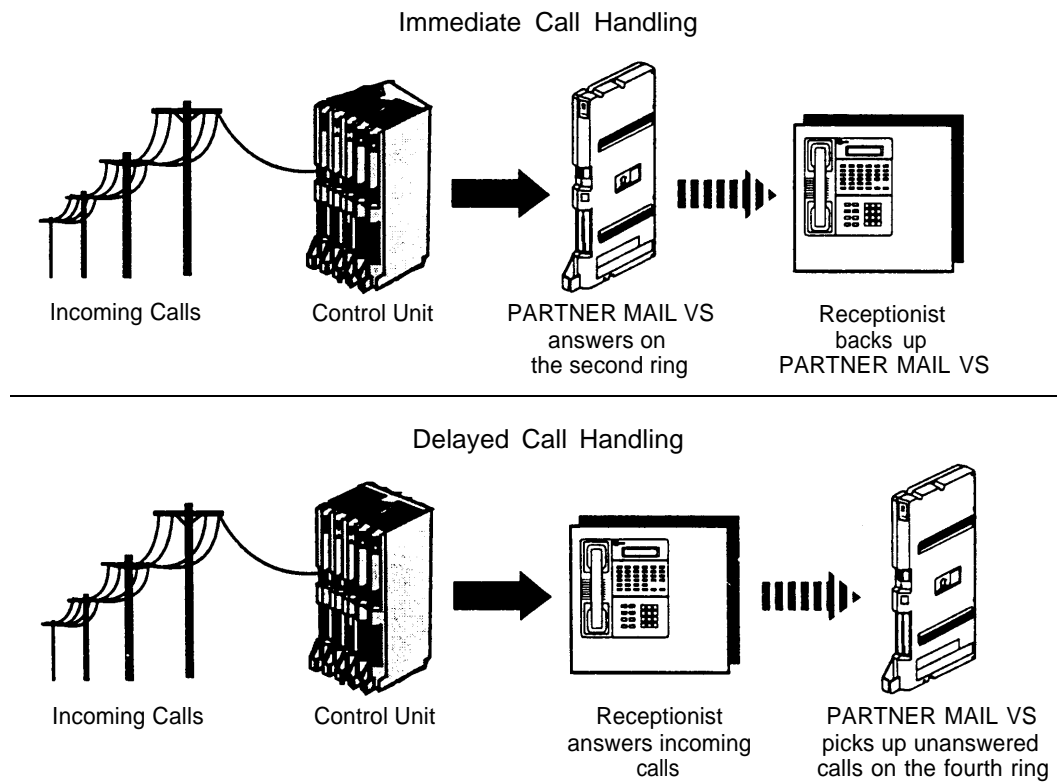

Figure 1-2. Immediate and Delayed Call Handling

Transfer Return Extension

For extensions associated with the mail system unit, this option specifies how unanswered calls are transferred by the voice mail system.

If the mail system transfers a call to an extension that has no Voice Mail coverage, or if Voice Mail coverage is Off, and that extension does not answer, the communications system transfers the call to the Transfer Return Extension.

For extensions that do not have Voice Mail coverage, this option can be programmed to ensure that unanswered calls transferred by the mail system return to the designated extension, where they ring until answered.

Automated Attendant Service Scenarios

The following sample scenarios illustrate typical ways in which Automated Attendant Service is set up with the communications system features:

- Case 1: The receptionist is the primary call handler. Automated Attendant Service handles overflow.
 - a. Use Group Call Distribution (#206) Setting 1 to identify the lines to be answered by Automated Attendant Service.
 - b. Set VMS Hunt Schedule (#507) to Always.
 - c. Set VMS Hunt Delay (#506) to Delayed.
- Case 2: Automated Attendant Service is the primary call handler.
 - a. Use Group Call Distribution (#206) Setting 1 to identify the lines to be answered by Automated Attendant Service.
 - b. Set VMS Hunt Schedule (#507) to Always.
 - c. Set VMS Hunt Delay (#506) to Immediate.
 - d. Set Automatic Extension Privacy (#304) to Assigned for all PARTNER MAIL VS extensions. (When VMS Hunt Delay is set to Immediate, you can use this feature to prevent users from accidentally picking up calls sent to the voice mail system.)
- Case 3: The receptionist answers calls during the day; Automated Attendant Service answers calls at night.
 - a. Use Group Call Distribution (#206) Setting 1 to identify the lines to be answered by Automated Attendant Service.
 - b. Set VMS Hunt Schedule (#507) to Night Only.
 - c. Set VMS Hunt Delay (#506) to Immediate.

Music On Hold

If you use Automated Attendant Service, you also may want to use the communications system's Music On Hold feature. When Music On Hold is Active and an audio source is connected to the system, callers waiting to be transferred hear music or recorded material. If Music On Hold is Not Active, callers hear tones, ringing, or silence (depending on how the communications system is set up) while they are being transferred.

For more information, see Music On Hold and Ring on Transfer in the *Programming and Use* guide for the communications system.

Call Answer Service

This service offers callers the following options when they reach an extension that is unable to answer their call:

- If the system is in Bilingual Mode, press [*] [1] while listening to the personal greeting to switch between the Primary and Secondary Languages.
- Leave a detailed, confidential message in the called party's mailbox.
- Press [0] to transfer to the receptionist's extension for assistance.
- Press [*] [2] to transfer to another system extension.

Callers can press [0] or [*] [2] before, during, or after leaving a message.



NOTE:

Until subscribers record a personal greeting for their mailbox, outside callers hear this factory-set message in either the System Language (Monolingual Mode) or the Primary Language (Bilingual Mode):

```
Extension XX is not available. To leave a message,
wait for the tone. After recording hang up or press 1
for more options.
```

Communications System Features Affecting Call Answer Service

Call Answer Service works with the following communications system features:

- VMS Extension Coverage
- Do Not Disturb
- Line Coverage
- Voice Mailbox Transfer

Each of these features is explained briefly below. For more information on these communications system features, see the *Programming and Use* guide for your communications system.

VMS Extension Coverage

VMS Extension Coverage may be either automatic or manual.

- **Automatic VMS Coverage:** When the communications system's Automatic VMS Cover feature is Assigned for an extension, intercom and transferred callers can leave messages or transfer to another extension when the called person does not answer by the fourth ring (or by the number of rings specified with the communications system's VMS Cover Rings (#117)* feature). The system greets the caller with the subscriber's personal greeting (or with the system greeting if a personal greeting is not recorded). If the system is in Bilingual Mode and the subscriber recorded a personal greeting in two languages, the caller can switch between the two languages by pressing [*] [1].
- **Manual VMS Coverage:** Regardless of the Automatic VMS Cover setting, the communications system allows subscribers to press a programmed button to turn voice mail coverage on and off at their extension. To make this possible, the VMS Cover feature must be programmed on a button with lights on the subscriber's system phone.

Do Not Disturb

The Do Not Disturb button can be used to prevent calls for the extensions from audibly alerting (lights still flash). Subscribers (with communications system 4.0 or later) who have VMS Extension Coverage—either automatic or manual—can use this communications system feature when they want calls sent to their mailboxes immediately.

Line Coverage

Line Coverage lets callers who call in on a covered line leave messages in the mailbox of a specific subscriber (known as the *owner* of the covered line). When a call comes in on a covered line, the system routes the caller directly to the line owner's mailbox if the call is not answered. The caller has the option of leaving a message or transferring to another extension.

* VMS Cover Rings (#117) is not available on all systems. Check the *Programming and Use* guide for the communications system.

Line ownership typically is assigned to personal lines or to lines to be used for outside access to the voice messaging system when Automated Attendant Service is not used. (Lines in the system can be assigned either Line Coverage or Automated Attendant Service coverage—a single line *cannot* be assigned both types of coverage.)

Voice Mailbox Transfer

A Voice Mailbox Transfer button can be programmed on a user's phone to transfer callers directly to a subscriber's mailbox *without* ringing the extension first. This feature is useful when a user is handling calls for a subscriber who is not at his or her desk.

Voice Mail Service

This service allows subscribers to manage their own *mailboxes*. With it, a subscriber can:

- Listen to messages, then save or delete them.
- Record a personal greeting (in Bilingual Mode, the user may record his or her personal greeting in both the Primary and Secondary Languages)
- Change the default password for his or her mailbox to ensure that messages are kept confidential.
- Forward messages with comment to another subscriber's mailbox
- Have the system outcall a specified telephone or pager number according to a predefined schedule whenever a new message is received.
- Transfer to another extension or to the receptionist's extension.

A subscriber's extension number and mailbox number are the same. When a caller leaves a message, the voice messaging system places the message in the subscriber's mailbox and turns on the message light (if available) at the subscriber's phone. If the subscriber has Outcalling privileges, the system will call the programmed telephone or pager number if the message is received during the hours specified in the subscriber's Outcalling schedule and Outcalling is turned on.

Subscribers can retrieve messages at their convenience from any touch-tone phone either while on-site or from an off-site location. The system informs subscribers of the number of new and old (saved) messages in their mailboxes, and plays new messages first. Subscribers can refer to *Using PARTNER MAIL VS®* for instructions on recording a personal greeting, changing a password, forwarding a message, specifying a telephone or pager number and schedule for Outcalling, and performing other Voice Mail Service procedures.

Voice Mail Service also allows the System Manager to program the voice messaging system. See "Voice Messaging System Programming" in Chapter 3 for more information.

When subscribers call into the Voice Mail Service, they hear this factory-set prompt in either the System Language (Monolingual Mode) or the Primary *and* Secondary Language (Bilingual Mode):

```
Welcome to PARTNER MAIL VS. Please enter extension
and #. Otherwise, to access PARTNER Tutor, press * 4.
```

The System Manager can change, on a per mailbox basis, the language subscribers hear after they access their mailboxes. The Mailbox Language is used for voice prompts for recording a personal greeting, retrieving messages, and other Voice Mail services. The Mailbox Language can be different from the System Language selected in Monolingual Mode or the Primary and Secondary Languages selected in Bilingual Mode.

Mailboxes

The voice messaging system provides a predetermined number of mailboxes which are assigned to extensions in order beginning with extension 10. For example, the system may have 10 default mailboxes for extensions 10 through 19. If a Mailbox Expansion Card is installed, the number of default mailboxes is increased; for example, installation of a Mailbox Expansion Card could increase the number of default mailboxes to 20, for extensions 10 through 29. Mailbox Expansion Cards can also allow for configurations consisting of four ports and 20 mailboxes, and four ports and 40 mailboxes.

The System Manager can change default mailbox assignments. First, delete mailboxes for any extensions that do not require voice mail coverage. Then, create mailboxes for extensions that need them. Note that the mailbox assigned to extension 10, the receptionist's extension, cannot be deleted.



NOTE:

Mailboxes should be deleted from extensions that connect auxiliary equipment (such as fax machines or doorphones) to keep the maximum number of mailboxes available for users and to safeguard system security.

Guest Mailboxes

The System Manager can create *guest mailboxes* for users who do not have their own phone, but still require mailboxes. If this is the case, either the Automated Attendant Service or system users can transfer a caller directly to the guest mailbox where the caller can leave a message. Guests can call the voice messaging system from any touch-tone phone to retrieve their messages. For more information on guest mailboxes, see "Guest Mailboxes" in Chapter 5.

Security

The System Manager is responsible for the security of the system. It is important that you fully understand and appropriately administer this product to reduce your risk of incurring charges that result from unauthorized use of the system. Under the law, you, the customer are responsible for paying part or all of those unauthorized calls.

Be aware that criminals called *hackers* may attempt to gain unauthorized access to your communications system and your voice mail system. Hackers often try to trick a company's employees into providing them with access to an outside line or an outside operator. They may also concentrate their activities in two areas related to the mail system:

- They try to dial into a mailbox, then execute a transfer by dialing [*] [#]. Then they dial an access code, followed by a digit string to either direct dial or access a network operator to complete the call.
- They try to locate unused or unprotected mailboxes and use them as drop-off points for their own messages.

System Security Guidelines

To reduce the risk of unauthorized use of your communications and voice mail systems, you should

- require that the System Manager's Password be changed from the factory setting. Use a hard-to-guess value.
- delete any unused mailboxes immediately.
- require all employees who have voice mailboxes to use passwords to protect their mailboxes.
- permit no Outcalling or permit this privilege only for those with legitimate business need.
- advise subscribers to change their passwords (a 4-digit password is recommended) when they log into the Voice Mail Service for the first time and frequently thereafter. Subscribers can refer to the instructions for changing their passwords in *Using the PARTNER MAIL VS®*.
- familiarize yourself with the impact of the Outcalling feature on system performance and security. If Outcalling is not permitted on the system, Outgoing Call Restriction should be set to Inside Only for the voice mail system extensions. It is strongly recommended that you use the communications system Call Restriction features (that is, Outgoing Call Restriction used with Allowed and Disallowed Lists) to restrict Outcalling numbers. See "Outgoing Call Restriction" in Chapter 4 for details.
- monitor your call reporting system records of outgoing calls to identify possible system abuse.

You should also

- provide effective physical security for the room containing your telecommunications equipment and the room with administrative tools, records, and System Administration information. These areas should be locked when unattended.
- provide a secure trash disposal for all sensitive information, including your company's telephone directories, call accounting records, or anything that may supply information about your communications system. This trash should be shredded.

Security Policy and User Education

As part of your responsibility for protecting system security, you should establish and communicate security policies for all system users. You should let users know what measures they should take to protect system security and explain how hackers may try to gain access to the system. In particular, you should provide users with the following information:

- All reports of trouble, requests to move extensions, or any other administrative details associated with the communications system or the voice mail system should be handled by one person (the System Manager) or within one department. Anyone claiming to be a telephone company representative should be referred to this person or department.
- If a caller claims to be an authorized telephone company representative, verify his or her identity before permitting that person *any access* to the system.
- Establish well-controlled policies for passwords:
 - Establish a specific date for changing passwords (for example, the first of each month) and help users remember to do it.
 - Advise subscribers to use a 4-digit password.
 - Tell users that passwords should not be recycled. They should be hard to guess and should not contain:
 - all the same numbers (for example, 4444)
 - sequential characters (for example, 1234)
 - personal information that can be associated with them (such as their name, birthdate, telephone number, or social security number)
 - Discourage the practice of writing down passwords. If a password needs to be written down, keep it in a secure place and never discard it while it is still active.
 - Tell users never to program passwords onto Auto Dial buttons. Display phones reveal the programmed numbers.
- Educate employees that hackers may try to trick them into providing them with dial tone or dialing a number for them.

- Ask users to tell you if any of the following suspicious activity occurs:
 - inability to log into Voice Mail
 - lost mail messages or altered greetings
 - inability to get an outside line
 - series of calls where there is silence on the other end or the caller hangs up
 - sudden increase in wrong numbers
 - caller complaints that your lines are busy
 - callers claiming to represent the “phone” company. Ask for a callback number.
 - callers trying to obtain sensitive information or asking for assistance in placing outside or long-distance calls. Ask for a callback number.
 - increases in internal requests for assistance in making outside calls (particularly international calls or requests for dial tone).
- Make users with Outcalling privileges aware of the potential risks and their responsibilities.
- Never distribute the office telephone directory to anyone outside the company.
- Collect old office telephone directories and shred them.
- Never discuss your telephone system’s numbering plan with anyone outside your company.
- Any time a call appears to be suspicious, call the Technical Service Center at 1 800 628-2888 (in the U.S.).

Installation

2

Contents

Before You Start	2-1
Installing the PARTNER MAIL VS Module	2-2

Installation

2

This chapter provides instructions for installing the voice messaging system's hardware in the communications system's control unit.

Before You Start

Refer to Appendix A to verify that you have the appropriate voice messaging system and communications system hardware. Then

- Make sure the communications system control unit, processor module(s), and line/extension modules have been installed.
- Make sure this installation meets the environmental and electrical requirements listed in Appendix A of this guide.

Installing the PARTNER MAIL VS Module

To install the voice messaging system module in the communications system's control unit:

1. Turn off power to the communications system's control unit: either pull out the main circuit breaker on the upper right rear corner of the control unit or move the on/off switch to the "off" position, or remove the power cord from the AC outlet.



CAUTION:

Failure to turn off power may damage the control unit and/or the voice messaging system.

2. Install the voice messaging system module in the first available slot to the right of the last installed 206 or 400 module. *Do not* install the voice messaging system module in the *first* slot of the PARTNER Plus system control unit or the PARTNER II or PARTNER 48 system primary carrier (see Figure 2-1).



NOTE:

The voice messaging system module should always be installed after the 206 and 400 modules to ensure consecutive extension numbering. If the control unit is upgraded with more 206 or 400 modules, the voice messaging system module should be removed, the new modules should be installed, and the voice messaging system module should be replaced in the first available slot after the 206 and 400 modules. The VMS Hunt Group Extensions and Transfer Return Extensions must then be reprogrammed (see Chapter 4).

On the PARTNER Advanced Communications System, you must install the voice messaging system module in the slot to the right of the PARTNER ACS module in the 2-slot carrier. If your system has a 5-slot carrier, you may install the voice messaging system module in any slot *except* the center slot (see Figure 2-2).

Push slowly but firmly in the center of the module until the module locks into place, and is attached to the rear of the backplane. Do not force the module. If it does not insert easily, remove the module, clear any obstruction, and reinsert it.

- Refer to Figure 2-1 or Figure 2-2 for your system, then record the extensions associated with the PARTNER MAIL VS module on Form B1 of the *System Planner* for the communications system.

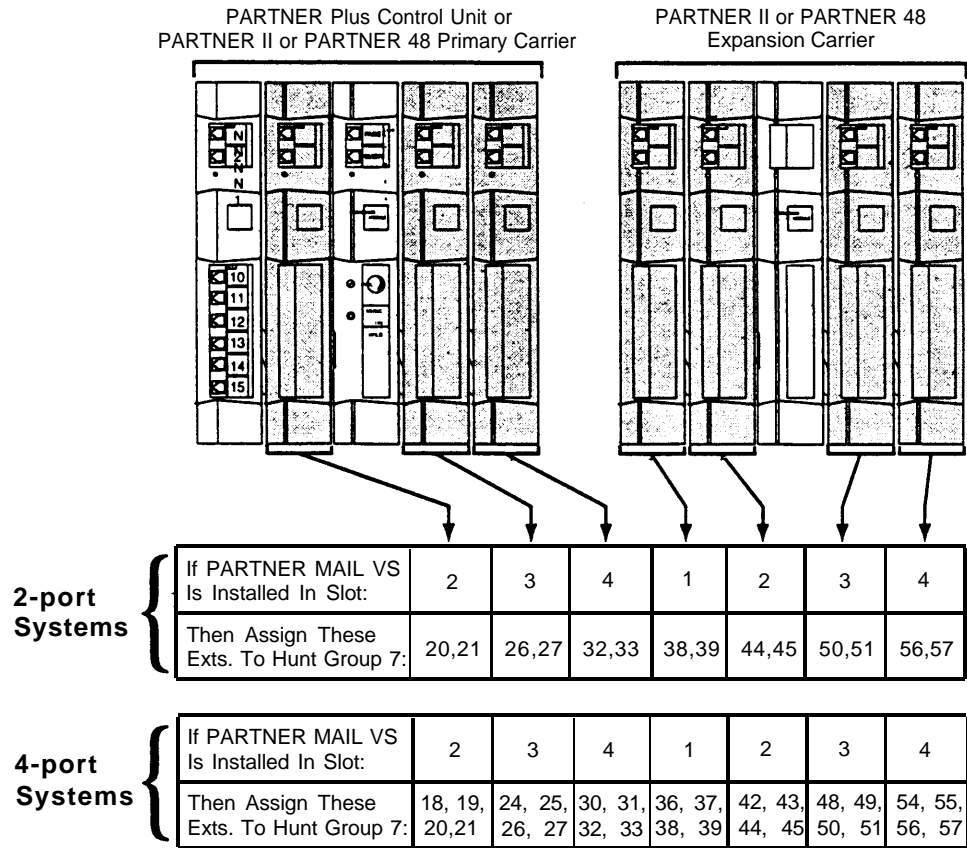

Figure 2-1. Voice Messaging System Extensions for PARTNER Plus, PARTNER II, and PARTNER 48

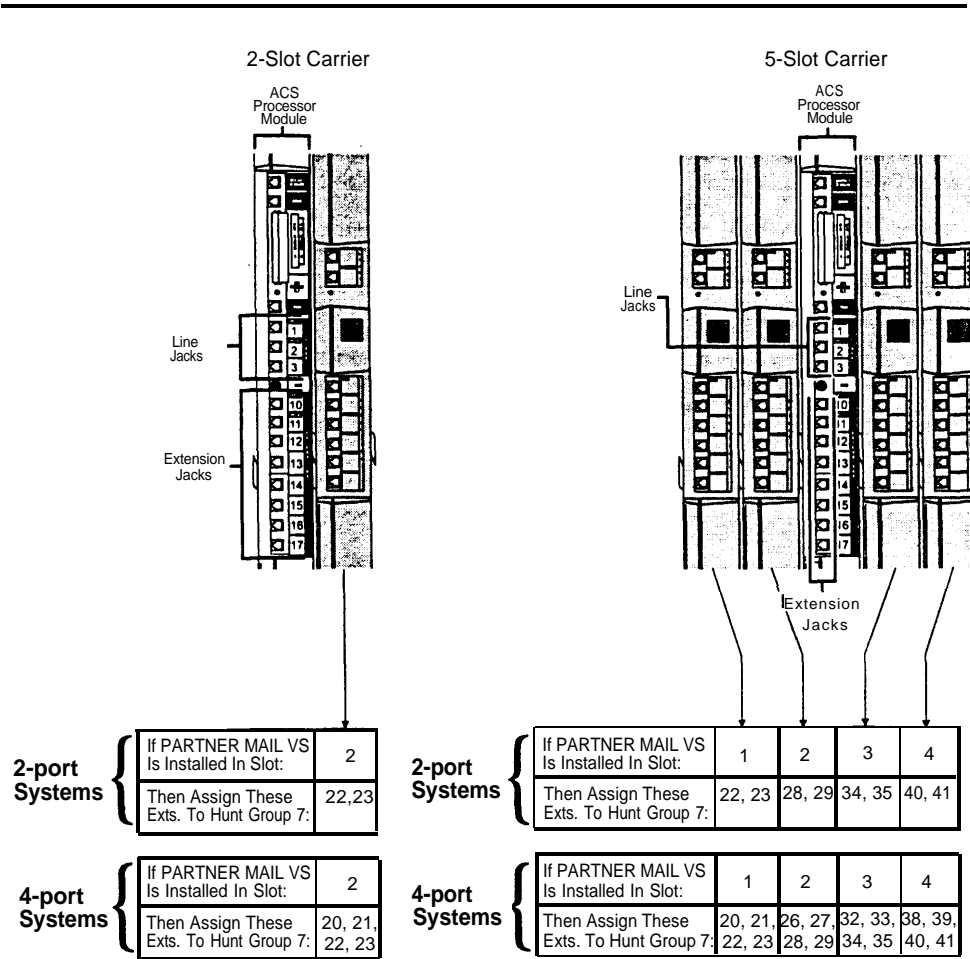

Figure 2-2. Sample Voice Messaging System Extensions for PARTNER Advanced Communications Systems

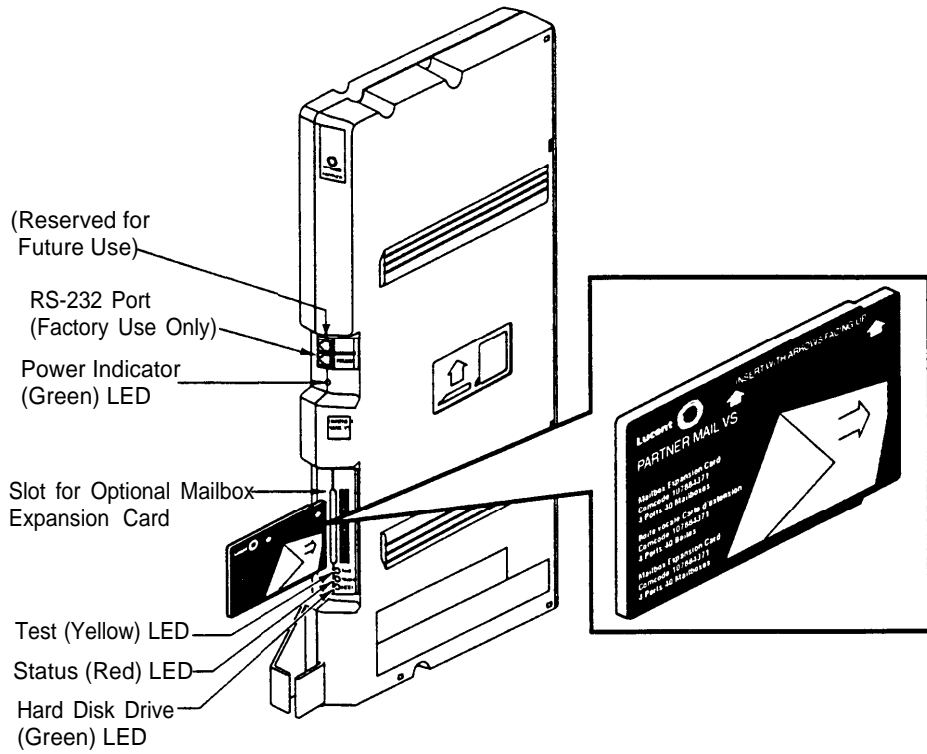

Figure 2-3. Installing the Mailbox Expansion Card

4. To install the Mailbox Expansion Card, insert the card in the vertical slot on the lower front of the voice messaging system module (see Figure 2-3). Make sure the arrows on the Mailbox Expansion Card label face up and in. Also make sure the card is pushed in all the way.
5. Turn on power to the control unit. The green Power LED should light—if it does, skip to Step 6. If the green Power LED does not light, power down the control unit, reseal the voice messaging system module, then power up the control unit again. If the green Power LED still does not light, call for support as indicated on the inside front cover of this guide.
6. Next, the voice messaging system module performs self-diagnostic tests. The LEDs work as follows:

LED	State
Green Power	ON
Yellow Test	ON
Red Status	ON for approximately 2 seconds

7. After approximately 10 seconds when the tests are completed, the yellow Test LED goes off. When this occurs, check the red Status LED:
 - If the red Status LED is not lit, the module passed the tests. Continue with Step 8.
 - If the red Status LED is lit, power down the control unit, re-install the Mailbox Expansion Card if it was installed in Step 4, then power up the control unit again. If the red Status LED comes on again, call for support as indicated on the inside front cover.
8. After the module passes the self-diagnostic tests, the extensions associated with the voice messaging system module go off-hook. Two outside lines show red steady on system phones with those lines for about one minute. When the lines become idle, the voice messaging system is ready to receive calls.

Understanding Programming

3

Contents

Communications System Programming	3-1
■ Planning Forms	3-2
■ Using System Programming	3-2
The Programming Overlays	3-3
Programming Mode	3-3
Voice Messaging System Programming	3-4
■ Planning Forms	3-4
■ Using System Programming	3-5
The Programming Main Menu	3-6
Accessing the Programming Main Menu	3-6
Programming Guidelines	3-7

Understanding Programming

3

This chapter provides general programming information for the communications system and the voice messaging system. Both systems must be programmed so they can work together as an integrated unit. Before you begin any programming, you must ensure that all required communications system and voice messaging system planning forms described in this chapter are completed. You will refer to these forms during programming.

Communications System Programming

When the communications system is installed, it uses factory settings that reflect the most common usage of the equipment. You can change these settings as required to customize them for the business.

You can program the communications system from extension 10. Some systems also allow programming from extension 11. Check the *Programming and Use* guide for the communications system for more information. If your system supports programming from both extensions, you may find it more convenient to program from extension 11. This capability allows the receptionist to continue handling calls at extension 10 while you program.

System Programming changes settings for the system as a whole, or for individual lines or extensions. (Refer to the *Programming and Use* guide for the communications system for more information about System Programming options.)

On some communications systems, a password may be required to enter System Programming mode. Check the *Programming and Use* guide for the communications system for more information.

Planning Forms

Refer to the communications system's *System Planner* when you are changing system settings, and be sure to record any changes you make. The following forms from the *System Planner* contain information about the voice messaging system:

- **Form A: System Configuration.** Contains basic information about the system including the line number and type of voice messaging service required for each line.
- **Form B1: System Extensions.** Contains basic information about each extension. This includes the type of phone or auxiliary equipment at the extension, and the name of the user or a description of how the extension is used.
- **Form B2: Customized Extension Settings.** Contains feature settings, such as Automatic VMS Cover and Automatic Extension Privacy, and group assignments for each extension.
- **Form C: Button Assignments.** Specifies which features are programmed on buttons for each extension. This includes VMS Cover, Do Not Disturb, Voice Mailbox Transfer, and Voice Mail Messages buttons.

Samples of these forms and instructions for completing them are included in Appendix E.

Using System Programming

System Programming requires a system display phone at extension 10 (or 11 if available), with a programming overlay placed over the phone's dialpad. System Programming procedures are identified by # and a 3-digit code (for example, the procedure code for System Date is #101).

You can program the system in one of two ways:

- **Direct Method.** You access a programming procedure directly by dialing the code for that procedure. This method works best when you are using only a few procedures during the programming session, and you know the codes. For example, press [#] [1] [0] [1] to change the system date.
- **Cycle Method.** You cycle through a sequence of procedures in numerical order by pressing [*Next Procedure*] or [*Prev Procedure*]. You should use this method when programming the communications system for the first time, or when you are changing a series of related settings. However, procedures #399, #609, and #728 are skipped when you cycle through procedures.



NOTE:

You can talk on the telephone while you program. This is useful if you need to call for support while programming. However, you must place the call before you enter programming mode, and you must use the handset (not the speakerphone) to talk.

The Programming Overlays

During System Programming, the normal functions of several buttons on the phone at extension 10 (or 11 if available) change. For example, left [*Intercom*] becomes [*System Program*], which is the button used to enter programming mode. To identify these buttons while programming, place the appropriate programming overlay provided with the system over the dialpad of the phone at extension 10 or 11.

Use the following special buttons while programming:

- [*Next Procedure*] and [*Prev Procedure*] cycle forward and backward through the programming procedures.
- [*Next Item*] and [*Prev Item*] cycle forward and backward through a procedure's parameters. A parameter is typically an outside line, an extension, or a telephone list entry.
- [*Next Data*] and [*Prev Data*] cycle forward and backward through the valid list entries. These buttons work only for fixed data, such as a line or extension number. They do not work for variable data such as date, time, password, telephone numbers, or doorphone assignments.
- [*Remove*] returns the current setting to the factory setting.
- [*Enter*] ends an entry of variable length, such as a telephone number in an Allowed Phone Number List.
- [*System Program*] starts the System Programming process.
- [*Central Tel Program*] starts the Centralized Telephone Programming process (that is, customizing individual telephones from extension 10, or 11 if available).
- [*Feature*], when followed by [*0*] [*0*], enters or exits programming mode.

Programming Mode

To enter programming mode:

1. At extension 10 (or 11 if available), make sure the programming overlay is in place over the system phone's dialpad.
2. Press [*Feature*] [*0*] [*0*].
3. Press [*System Program*] [*System Program*].
4. Enter the System Password, if required.
5. Enter specific programming procedure codes.

Voice Messaging System Programming

Before you program the voice messaging system, obtain completed copies of planning forms for the communications system *and* the voice messaging system. These forms provide the names, extensions, mailboxes and other information required to program the voice messaging system.

Planning Forms

You need the following forms for the voice messaging system:

- **Form 1: Language.** Shows the Language Mode, Monolingual or Bilingual. Also specifies the System Language for Monolingual Mode or the Primary and Secondary Language for Bilingual Mode.
- **Form 2: Mailbox Assignments.** Shows factory-set mailbox assignments with and without the Mailbox Expansion Card. Allows you to change mailbox assignments, to indicate whether Outcalling capability is assigned, and to identify the language used for each mailbox.
- **Form 3: Menu Definition.** Shows transfer options for Automated Attendant Service. Allows you to specify the extension or group number for a selector code transfer or announcement number and to provide a description of that extension or group.
- **Form 3A: Automated Attendant Announcement—System Language or Primary Language.** Shows the announcement number(s) and the script used to record the associated announcement(s) in the System Language for Monolingual Mode or the Primary Language for Bilingual Mode. You can record up to two announcements in Monolingual Mode and in the Primary Language for Bilingual Mode.
- **Form 3B: Automated Attendant Announcement—Secondary Language.** Used only if the system is set for Bilingual Mode. Shows the announcement number(s) and the script used to record the associated announcement(s) in the Secondary Language for Bilingual Mode. You can record up to two announcements in Bilingual Mode.
- **Form 4: Day Menu Prompt—System Language or Primary Language.** Shows the script used to record the Day Menu Prompt in the System Language for Monolingual Mode or the Primary Language for Bilingual Mode.
- **Form 4A: Day Menu Prompt—Secondary Language.** Used only if the system is set for Bilingual Mode. Shows the script used to record the Day Menu Prompt in the Secondary Language.
- **Form 5: Night Menu Prompt: System Language or Primary Language.** Shows the script used to record the Night Menu Prompt in the System Language for Monolingual Mode or the Primary Language for Bilingual Mode.

- **Form 5A: Night Menu Prompt: Secondary Language.** Used only if the system is set for Bilingual Mode. Shows the script used to record the Night Menu Prompt in the Secondary Language.
- **Form 6: Line Ownership.** Identifies the lines assigned VMS Line Coverage. Also shows for each owned line, the associated telephone number, the name of the subscriber who owns the line, and the owner's mailbox number.

Samples of these forms and instructions for completing them are included in Appendix D.

Using System Programming

A special login number is required to program the voice messaging system. The following information applies to this login:

- The login number is 99.
- 99 is not an extension number.
- This login does not have an associated mailbox.
- The language associated with this login is either the System Language chosen for Monolingual Mode or the Primary Language chosen for Bilingual Mode; it cannot be changed.
- This login's factory-set Password is 1234. If you are the System Manager, refer to "Changing Your Password" in Chapter 5 to change the password before you begin to program the system.



NOTE:

Although this login has a Password, it does not have an associated mailbox.

To begin programming the voice messaging system, you make a call to the Voice Mail Service, enter the login and password, and select option 9 (you are not prompted for this option). This takes you to the Programming Main Menu (shown in Figure 3-1).

The Programming Main Menu

The Programming Main Menu allows you to access the Language Mode and the language(s) associated with that mode, the Automated Attendant Service Menu, mailbox assignments, and line ownership assignments.

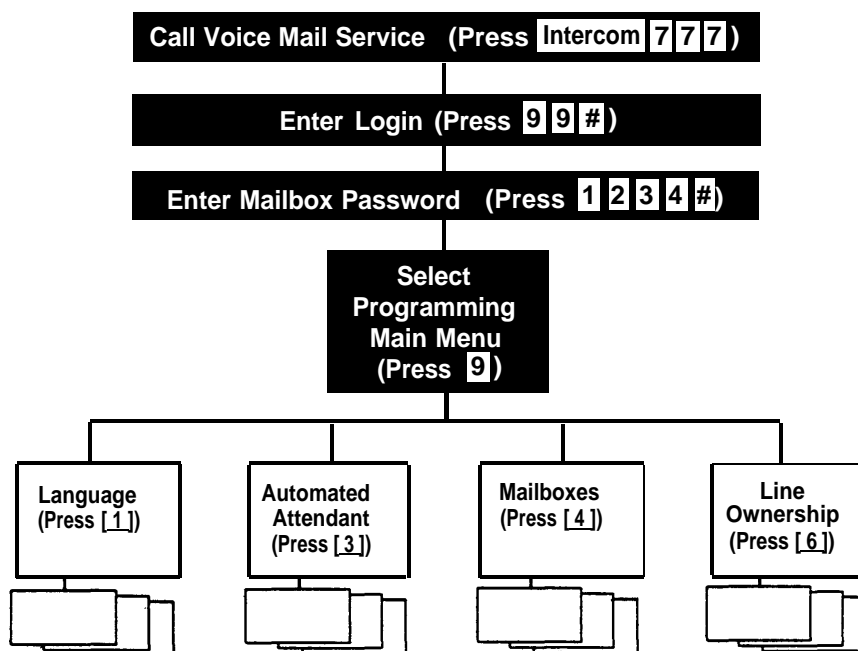

Figure 3-1. Programming Menus

Accessing the Programming Main Menu

To access the Programming Main Menu:

1. Press [*Intercom*] [z] [z] [z] or a programmed VMMsgs button.

The system plays:

Welcome to PARTNER MAIL VS. Please enter extension and #. Otherwise, to access PARTNER Tutor, press * 4.

2. Press [9] [9] [#].

The system plays:

Enter password and #.

3. Enter the Password and press #. (The factory-set Password is 1234.)

The system plays:

System Manager. PARTNER MAIL VS Release 4.

The system plays the available programming options. It does not play option 9 (the Programming Main Menu), which only the System Manager can access.

4. Press [9] to access the Programming Main Menu.

The system plays:

To program the System Language press 1, for Automated Attendant press 3, for mailboxes press 4, for line ownership press 6. If finished press * #.

Programming Guidelines

Once you are familiar with the voice messaging system, use these shortcuts to save time while programming:

- You do not have to wait for a prompt to play before entering digits for the next step.
- Press [*] [#] to return to the previous menu.
- Press [*] [4] to repeat the current menu options.
- Press [*] [7] at any point during programming to restart at the Programming Main Menu.
- Use the handset rather than the speakerphone to record prompts and greetings to avoid background noise in your recordings.
- To ensure that you hear voice prompts, turn off your microphone when programming the system using the speakerphone.
- Hang Up to exit programming.

Initial Programming

4

Contents

Overview	4-1
Voice Mail System Configurations	4-2
■ Upgrading Your Voice Mail System	4-2
Initial Communications System Setup	4-3
■ VMS Hunt Group Extensions	4-3
■ Transfer Return Extensions	4-4
■ Outgoing Call Restriction	4-4
Voice Messaging System Programming	4-6
■ Language	4-6
Monolingual Mode	4-6
Bilingual Mode	4-7
■ Automated Attendant Service	4-8
Monolingual Mode	4-8
Menu Definition, Day Menu Prompt, and Announcements	4-8
Night Menu Prompt	4-10
Bilingual Mode	4-11
Menu Definition, Day Menu Prompts, and Announcements	4-11
Night Menu Prompt	4-13
■ Voice Mail Service	4-15
Deleting a Mailbox	4-15
Creating a Mailbox	4-16
Modifying a Mailbox's Language	4-16
Assigning Outcalling Privileges	4-17
■ Line Ownership	4-18
Assigning Line Ownership	4-18

Contents

Communications System Programming	4-19
■ Automated Attendant Service	4-19
Group Call Distribution	4-19
VMS Hunt Delay	4-20
Automatic Extension Privacy	4-20
VMS Hunt Schedule	4-20
Night Service	4-21
Music On Hold	4-21
Disallowed Phone Numbers	4-22
Creating a Disallowed Phone Number List	4-22
Assigning the Disallowed Phone Number List	4-22
Allowed Phone Numbers	4-23
Creating an Allowed Phone Number List	4-23
Assigning the Allowed Phone Number List	4-23
■ Call Answer Service	4-24
Line Coverage	4-24
VMS Line Coverage	4-24
Line Coverage Extension	4-25
Automatic VMS Cover	4-25
VMS Cover Rings	4-26
■ Telephone Button Programming	4-26
VMS Cover	4-26
Do Not Disturb	4-27
Voice Mailbox Transfer	4-27
Voice Mail Messages	4-28
Verifying System Operation	4-29
■ Voice Mail Service	4-29
■ Automated Attendant Service	4-29
Day Menu	4-29
Night Menu	4-30
■ Call Answer Service	4-31
VMS Extension Coverage	4-31
VMS Line Coverage	4-31
Line Coverage Extension	4-31

Overview

This chapter identifies the four possible voice messaging system configurations. It tells you how to perform initial programming of the voice messaging and communications systems. The first two procedures allow you to access and program the voice messaging system—you must perform these procedures first for every installation. The next set of procedures covers voice messaging system programming. The last section covers how to program the communications system.

The order of the procedures in this chapter enables you to program the Menu Definition and to record the Day and/or Night Prompts and Automated Attendant Announcements *before* the voice messaging system begins to handle calls—this order is recommended for voice messaging systems that are being added to existing communications systems. If this is a new installation, however, you can program the communications system first, then the voice messaging system if you prefer.

In addition, you can either follow the step-by-step instructions or use the flowchart at the end of this manual as a quick guide. If you use the step-by-step instructions, note that Step 1 of each procedure for the voice messaging system is logging in. However, if you are already logged in, you can skip Step 1.

Finally, some features and procedures in this chapter may not be available on your communications system. If you are not sure, check the *Programming and Use* guide for that system.

Voice Mail System Configurations

The PARTNER Mail VS supports the following configurations:

- 2 voice channels (ports), 10 mailboxes (standard)
- 2 ports, 20 mailboxes (requires a Mailbox Expansion Card)
- 4 ports, 20 mailboxes (requires a Mailbox Expansion Card)
- 4 ports, 40 mailboxes (requires a Mailbox Expansion Card)

Figures 2-1 and 2-2 (in Chapter 2) show the possible extension numbers for all configurations.

Upgrading Your Voice Mail System

If you are upgrading your voice mail system with the addition of a Mailbox Expansion Card, when you return power to the system the appropriate number of mailboxes is activated. For example, if you are upgrading to a 4-port, 20-mailbox configuration, the first 20 mailboxes are activated. And previously existing programming (including existing mailbox assignment information, personal greetings, and passwords) is saved. You do not need to reprogram the system; however, you should:

- Delete any unused mailboxes and create new ones following the procedures in “Voice Mail Service,” later in this chapter.



NOTE:

Numbering of existing mailboxes should be detailed on Form 2 for the voice messaging system. You can also play existing mailbox numbers and receive information on the number of existing mailboxes, as well as the maximum mailbox capacity for the current system configuration. At the Programming Main Menu, press [4] to receive the message indicating how many mailboxes currently exist and how many are allowed. For more information, see “Checking a Mailbox’s Status,” in Chapter 5.

- **For 4-port configurations:** Add two extensions to the VMS Hunt Group (Extension Hunt Group 7). These additional extensions correspond to the middle two extensions. For example, if you are upgrading from two to four ports, extensions 18 and 19 would be added to extensions 20 and 21. You must perform this task to ensure that the system functions properly. See “Initial System Setup,” earlier in this chapter, for specific instructions on how to assign the additional VMS Hunt Group Extensions.

Initial Communications System Setup

You must perform the first two procedures for every installation. The procedure for Outgoing Call Restriction is strongly recommended to ensure system security. For the following procedures, you need to know the extension numbers associated with the PARTNER MAIL VS system module. Figures 2-1 and 2-2 (in Chapter 2) show the possible extension numbers. For the extension numbers appropriate to this installation, locate Form B1 of the *System Planner* for the communications system.

VMS Hunt Group Extensions

You must use this procedure to assign the extensions associated with the voice messaging system module to Hunt Group 7. This Hunt Group, which is called the VMS Hunt Group, is used exclusively for the voice messaging system.

To assign the PARTNER MAIL VS extensions specified on Form B1 to Hunt Group 7:

1. At extension 10*, press [*Feature*] [0] [0] [*System Program*] [*System Program*].
2. Enter the System Password, if required.
3. Press [#] [5] [0] [5].
4. At the **Group:** prompt, press [z].
5. At the **Extension:** prompt, enter the first PARTNER MAIL VS extension number specified on Form B1.
6. Press [*Next Data*] until the display reads 1 Assigned.
7. Press [*Next Item*] or [*Prev Item*] until the next PARTNER MAIL VS extension number specified on Form B1 displays.
8. Press [*Next Data*] until the display reads 1 Assigned.
9. If additional PARTNER MAIL VS extensions are shown on Form B1, repeat Steps 7 and 8 for each one.
10. Continue with "Transfer Return Extensions" on the next page.

* Some systems also allow programming from extension 11. Check the *Programming and Use* guide for the communications system.

Transfer Return Extensions

For extensions associated with the voice mail system unit, use the following procedure. If the voice mail system transfers a call to an extension that has no Voice Mail coverage, or if Voice Mail coverage is Off, and that extension does not answer, the communications system transfers the call to the Transfer Return Extension.

For extensions that do not have Voice Mail coverage, this procedure ensures that unanswered calls transferred by the voice mail system return to the designated extension, where they will ring until they are answered.

To assign extension 10 as the transfer return extension for the PARTNER MAIL VS extensions specified on Form B1:

1. Press [#][3][0][6]*.
2. At the **Extension:** prompt, enter the first PARTNER MAIL VS extension number specified on Form B1.
3. At the **Data:** prompt, press [1][0].
4. Press [*Next Item*] or [*Prev Item*] until the next PARTNER MAIL VS extension number specified on Form B1 displays.
5. At the **Data:** prompt, press [1][0].
6. If additional PARTNER MAIL VS extensions are specified on Form B1, repeat Steps 4 and 5 for each one.
7. Press [*Feature*][0][0] to exit programming.
8. Continue with the next section for information about programming the voice messaging system.

Outgoing Call Restriction

Use this procedure to restrict all extensions associated with the voice mail system unit from making outside calls. Outgoing call restriction is strongly recommended, in particular, to protect system security when Outcalling privileges are assigned to subscribers on Form 2.

1. Press [#][4][0][1].
2. At the **Extension:** prompt, enter the first PARTNER MAIL VS extension number specified on Form B1.
3. Press [*Next Data*] until the display reads 2 *Inside Only*.
4. Press [*Next Item*] or [*Prev Item*] until the next PARTNER MAIL VS extension number specified on Form B1 displays.
5. Press [*Next Data*] until the appropriate value displays.
6. Repeat Steps 4 and 5 for each PARTNER MAIL VS extension.

* In some countries, the procedure code for Transfer Return Extension is #309. Check the *Programming and Use* guide for the communications system.

7. Press [*Feature*] [0] [0] to exit programming.
8. Refer to the next section for information about programming the voice messaging system.



NOTE:

If Outcalling is permitted, be sure to create Allowed and Disallowed Phone Lists as needed for Outcalling numbers. See “Disallowed Phone Numbers” and “Allowed Phone Numbers,” later in this chapter, for instructions.

Voice Messaging System Programming

Language

Before you begin, locate Form 1 for the voice messaging system. Check to see if any of the Language settings are changed from the factory defaults:

- If none of the Language settings is changed, skip to “Automated Attendant Service” and follow the instructions for Monolingual Mode.
- If any of the Language settings are changed, follow the appropriate procedure for *either* Monolingual Mode or Bilingual Mode.

Monolingual Mode

To change the System Language as specified on Form 1:

1. If necessary, access the Programming Main Menu. If you are already at the Programming Main Menu, skip to Step 2.
 - a. Press [*Intercom*] [Z] [Z] [Z] or the programmed VMMsgs button.
 - b. Press [9] [9] [#].
 - c. Enter the Mailbox Password and press [#].
 - d. Press [9].
2. Press [1] for Language.
3. Press [2] for System Language.
4. Press [6] to modify System Language.
5. Enter the number corresponding to the System Language specified on Form 1.
6. Press [9] to confirm your selection.
7. Press [*] [Z] to return to the Programming Main Menu.
8. Continue with the section, “Automated Attendant Service.”

Bilingual Mode

To change the Language Mode and the Primary and Secondary Languages as specified on Form 1:

1. If necessary, access the Programming Main Menu. If you are already at the Programming Main Menu, skip to Step 2.
 - a. Press [*Intercom*] [Z] [Z] [Z] or the programmed VMMsgs button.
 - b. Press [2] [2] [#].
 - c. Enter the Mailbox Password and press [#].
 - d. Press [2].
2. Press [1] for Language.
3. Press [1] for Language Mode.
4. Press [2] for Bilingual Mode.
5. Press [2] for System Language.
6. Press [1] for Primary Language or [2] for Secondary Language.
7. Press [6] to modify the language.
8. Enter the number corresponding to the language specified on Form 1.
9. Press [2] to confirm your selection.
10. To modify the other language, press [3] [#] and repeat Steps 6 through 9. Otherwise, skip this step.
11. Press [3] [Z] to return to the Programming Main Menu.
12. Continue with the next section, "Automated Attendant Service."

Automated Attendant Service

Before you begin, locate Forms 1, 3, 3A, 4, and 5 for the voice messaging system. If the system is set for Bilingual Mode, also locate Forms 3B, 4A, and 5A. If Automated Attendant Service is not to be used; skip to “Voice Mail Service.” Otherwise, to program Automated Attendant Service:

- If the system is set for Monolingual Mode, use the procedures below.
- If the system is set for Bilingual Mode, use the procedures later in this chapter.

Monolingual Mode

Menu Definition, Day Menu Prompt, and Announcements

To define the Automated Attendant Service menu as specified on Form 3 and to record the Day Menu Prompt specified on Form 4 and Automated Attendant Announcement(s) specified on Form 3A, follow this procedure.

It is important to understand that you must *approve* each element (that is, the Menu Definition, the Day Menu Prompt, and any Announcements, as well as *save* all of these entries (in Step 15). **If you exit at any point before saving your approved entries, your entries will be lost.** This procedure is designed to ensure that callers do not hear the incomplete menu while you are in the process of building/modifying it.

1. If necessary, access the Programming Main Menu. If you are already at the Programming Main Menu, skip to Step 2.
 - a. Press [*Intercom*] [*Z*] [*Z*] [*Z*] or the programmed VMMsgs button.
 - b. Press [*g*] [*g*] [*#*].
 - c. Enter the Mailbox Password and press [*#*].
 - d. Press [*g*].
2. Press [*g*] for Automated Attendant.
3. Press [*1*] for Day Menu.
4. Press [*g*] to modify the Menu Definition and/or Day Menu Prompt.
5. Enter a Selector Code for which information is specified in Column C of Form 3. If Column C is empty, skip to Step 10.
6. Press [*g*] to confirm that you are modifying this Selector Code action.
7. Do one of the following:
 - Press [*1*] for Selector Code Transfer.
 - Press [*g*] for Announcement.
 - Press [*g*] for Direct Extension Transfer (factory-default setting).

8. Do one of the following:
 - If you chose Selector Code Transfer in Step 7, enter the extension, Hunt Group, or Calling Group number specified in Column C of Form 3. This value corresponds to the Selector Code entered in Step 5. Then, press [#]. Go to Step 10.
 - If you chose Announcement in Step 7, enter the Announcement number (1 or 2) specified in Column C of Form 3A. This value corresponds to the Selector Code entered in Step 5. Go to Step 9.
9. To record an Announcement, lift the handset, press [1], and record the Announcement from Form 3A. Press [1] after recording.
10. Repeat Steps 5 through 8 for each Selector Code for which there is information in Column C.
11. Press [*] [#] to approve your entries and finish modifying the Menu Definition.
12. If you do not want to record a Day Menu Prompt or Announcement, press [#] to approve the Menu Definition and go to Step 16.
13. To record a Day Menu Prompt, lift the handset, press [1], and record the Menu Prompt from Form 4. Press [1] after recording.
14. Choose an option or skip this step:
 - Press [2] [1] to immediately re-record this Menu Prompt or Announcement. Begin recording immediately after the beep; press [1] after recording. Repeat, if desired.
 - Press [2] [3] to play back this Menu Prompt or Announcement.
 - Press [*] [3] to delete this Menu Prompt or Announcement and return to Step 12 to be prompted for re-recording.
15. Press [*] [#] to *approve and save* the Menu Definition, the Day Menu Prompt, and any Announcements.
16. Press [*] [Z] to return to the Programming Main Menu.
17. Continue with “Night Menu Prompt” or go to the section, “Voice Mail Service.”

Night Menu Prompt

To record the Night Menu Prompt specified on Form 5:

1. If necessary, access the Programming Main Menu. If you are already at the Programming Main Menu, skip to Step 2.
 - a. Press [*Intercom*] [7] [7] [7] or the programmed VMMSgs button.
 - b. Press [9] [9] [#].
 - c. Enter the Mailbox Password and press [#].
 - d. Press [9].
2. Press [3] for Automated Attendant.
3. Press [2] for Night Menu.
4. Press [6] to modify the Night Menu Prompt.
5. Lift the handset, press [1], and record the Menu Prompt from Form 5.
6. Press [1] after recording.
7. Choose an option or skip this step:
 - Press [2] [1] to immediately re-record this Menu Prompt. Begin recording immediately after the beep; press [1] after recording. Repeat, if desired.
 - Press [2] [3] to play back this Menu Prompt.
 - Press [*] [3] to delete this Menu Prompt and return to Step 5 to be prompted for re-recording.
8. Press [*] [#] to approve the Night Menu Prompt.
9. Press [*] [7] to return to the Programming Main Menu.
10. Continue with the section, "Voice Mail Service."

Bilingual Mode

Menu Definition, Day Menu Prompts, and Announcements

To define the Automated Attendant Service menu as specified on Form 3 and to record the Day Menu Prompts for the Primary and Secondary Languages specified on Form 4 and 4A, and the Automated Attendant Announcement(s) specified on Form 3B, follow this procedure.

It is important to understand that you must *approve* each element (that is, the Menu Definition, the Day Menu Prompt, and any Announcements, as well as *save* all of these entries (in Step 22). **If you exit at any point before saving your approved entries, your entries will be lost.** This procedure is designed to ensure that callers do not hear the incomplete menu while you are in the process of building/modifying it. Be sure to allow yourself enough time to complete this procedure in its entirety.

1. If necessary, access the Programming Main Menu. If you are already at the Programming Main Menu, skip to Step 2.
 - a. Press [*Intercom*] [*Z*] [*Z*] or the programmed VMMsgs button.
 - b. Press [*g*] [*g*] [*#*].
 - c. Enter the Mailbox Password and press [*#*].
 - d. Press [*g*].
2. Press [*g*] for Automated Attendant.
3. Press [*1*] for Day Menu.
4. Press [*g*] to modify the Menu Definition and/or Day Menu Prompts.
5. Enter a Selector Code for which information is specified in Column C of Form 3. If Column C is empty, skip to Step 10.
6. Press [*g*] to confirm that you are modifying this Selector Code action.
7. Do one of the following:
 - Press [*1*] for Selector Code Transfer.
 - Press [*g*] for Announcement.
 - Press [*g*] for Direct Extension Transfer (factory-default setting).
8. Do one of the following:
 - If you chose Selector Code Transfer in Step 7, enter the extension, Hunt Group, or Calling Group number specified in Column C of Form 3. This value corresponds to the Selector Code entered in Step 5. Then, press [*#*]. Go to Step 10.
 - If you chose Announcement in Step 7, enter the Announcement number (1 or 2) specified in Column C of Form 3A. This value corresponds to the Selector Code entered in Step 5. Go to Step 9.
9. To record an Announcement, lift the handset, press [*1*], and record the Announcement from Form 3A. Press [*1*] after recording.

10. Repeat Steps 5 through 8 for each Selector Code for which there is information in Column C.
11. Press [*] [#] to approve your entries and finish modifying the Menu Definition.
12. At this point, do one of the following:
 - If you do not want to record a Day Menu Prompt or Announcement, press [#] to approve the Menu Definition and go to Step 22.
 - If you want to record the Day Menu Prompt in the Primary Language, continue with Step 13.
 - If you want to record the Announcement in the Secondary Language, return to Step 17.
 - If you want to record the Day Menu Prompt or Announcement in the Secondary Language, skip to Step 17.
13. Lift the handset, press [1] and record the Menu Prompt from Form 4. Press [1] after recording.
14. Press [1] after recording.
15. Choose an option or skip this step:
 - Press [2] [1] to immediately re-record this Menu Prompt. Begin recording immediately after the beep; press [1] after recording. Repeat, if desired.
 - Press [2] [3] to play back this Menu Prompt.
 - Press [*] [3] to delete this Menu Prompt and return to Step 13 to be prompted for re-recording.
16. Press [*] [#] to approve this Day Menu Prompt.
17. If you want to record the Day Menu Prompt or Announcement in the Secondary Language, continue with Step 18; otherwise, skip to Step 21.
18. Press [2] and record the Menu Prompt from Form 4A (or Announcement from Form 3B).
19. Press [1] after recording.
20. Choose an option or skip this step:
 - Press [2] [1] to immediately re-record this Menu Prompt or Announcement. Begin recording immediately after the beep; press [1] after recording. Repeat, if desired.
 - Press [2] [3] to play back this Menu Prompt or Announcement.
 - Press [*] [3] to delete this Menu Prompt or Announcement and return to Step 18 to be prompted for re-recording.
21. Press [*] [#] to approve this Day Menu Prompt or Announcement.
22. Press [#] to *approve and save* all entries. The Menu Definition, Day Menu Prompts, and Announcements (if any) now take effect.

23. Press [*] [Z] to return to the Programming Main Menu.
24. Continue with “Night Menu Prompt” or go to the section, “Voice Mail Service.”

Night Menu Prompt

To record the Night Menu Prompt in the Primary and Secondary Languages specified on Form 5 and Form 5A:

1. If necessary, access the Programming Main Menu. If you are already at the Programming Main Menu, skip to Step 2.
 - a. Press [*Intercom*] [Z] [Z] [Z] or the programmed VMMsgs button.
 - b. Press [*] [*] [#].
 - c. Enter the Mailbox Password and press [#].
 - d. Press [*].
2. Press [*] for Automated Attendant.
3. Press [2] for Night Menu.
4. Press [*] to modify the Night Menu Prompt.
5. At this point, do one of the following:
 - If you want to record the Night Menu Prompt in the Primary Language, continue with Step 6.
 - To record the Night Menu Prompt in the Secondary Language, skip to Step 11.
6. Lift the handset, press [1], and record the Menu Prompt from Form 5.
7. Press [1] after recording.
8. Choose an option or skip this step:
 - Press [2] [1] to immediately re-record this Menu Prompt. Begin recording immediately after the beep; press [1] after recording. Repeat, if desired.
 - Press [2] [*] to play back this Menu Prompt.
 - Press [*] [*] to delete this Menu Prompt and return to Step 6 to be prompted for re-recording.
9. Press [*] [#] to approve this Night Menu Prompt.
10. If you want to record the Night Menu Prompt in the Secondary Language, continue with Step 11; otherwise, skip to Step 15.
11. Press [2] and record the Menu Prompt from Form 5A.
12. Press [1] after recording.

13. Choose an option or skip this step:
 - Press [2] [1] to immediately re-record this Menu Prompt. Begin recording immediately after the beep; press [1] after recording. Repeat, if desired.
 - Press [2] [3] to play back this Menu Prompt.
 - Press [*] [3] to delete this Menu Prompt and return to Step 11 to be prompted for re-recording.
14. Press [*] [#] to approve this Night Menu Prompt.
15. Press [#] to approve all changes. The Night Menu Prompts now take effect.
16. Press [*] [Z] to return to the Programming Main Menu.
17. Continue with the next section, "Voice Mail Service."

Voice Mail Service

Before you begin, locate Form 2 for the voice messaging system. Check to see if mailboxes are numbered differently from the factory defaults, if any mailbox is to be deleted, or if a Mailbox Language is changed for any mailbox.

- If mailboxes are not numbered differently, no mailbox is deleted, no mailbox's language is changed, and no Outcalling is assigned, skip to "Line Ownership."
- If any mailbox is to be deleted, use the procedure below.
- If mailboxes are numbered differently, first use the procedure below to delete all mailboxes from extensions that do not require coverage; then use the procedure on the next page to create mailboxes for all extensions that require coverage.
- If Mailbox Language is changed for any mailbox, see "Modifying a Mailbox's Language" later in this section.
- If Outcalling is chosen, see "Assigning Outcalling Privileges" later in this section.

Deleting a Mailbox



NOTE:

The receptionist's mailbox (at extension 10) cannot be deleted.

To delete mailboxes as specified on Form 2:

1. If necessary, access the Programming Main Menu. If you are already at the Programming Main Menu, skip to Step 2.
 - a. Press [*Intercom*] [Z] [Z] [Z] or the programmed VMMsgs button.
 - b. Press [9] [9] [#].
 - c. Enter the Mailbox Password and press [#].
 - d. Press [9].
2. Press [4] for Mailboxes.
3. Enter the number of a mailbox to be deleted as indicated on Form 2, followed by [#].
4. Press [5] [3] to delete the mailbox.
5. Press [9] to confirm mailbox deletion.
6. Repeat Steps 3 through 5 for each mailbox to be deleted.
7. Press [5] [Z] to return to the Programming Main Menu.
8. Continue with "Creating a Mailbox" or "Modifying a Mailbox's Language," or go to "Assigning Outcalling Privileges" or "Line Ownership," later in this chapter.

Creating a Mailbox

To create mailboxes as specified on Form 2:

1. If necessary, access the Programming Main Menu. If you are already at the Programming Main Menu, skip to Step 2.
 - a. Press [*Intercom*] [Z] [Z] [Z] or the programmed VMMSgs button.
 - b. Press [9] [9] [#].
 - c. Enter the Mailbox Password and press [#].
 - d. Press [9].
2. Press [4] for Mailboxes.
3. Enter the number of a mailbox to be created as indicated on Form 2, followed by [#].
4. Press [4] to create this mailbox.
5. Repeat Steps 3 and 4 for each mailbox to be created.
6. Press [*] [Z] to return to the Programming Main Menu.
7. Continue with “Modifying a Mailbox’s Language,” or go to “Assigning Outcalling Privileges” or “Line Ownership,” later in this chapter.

Modifying a Mailbox’s Language

To modify a mailbox’s language as specified on Form 2:

1. If necessary, access the Programming Main Menu. If you are already at the Programming Main Menu, skip to Step 2.
 - a. Press [*Intercom*] [Z] [Z] [Z] or the programmed VMMSgs button.
 - b. Press [9] [9] [#].
 - c. Enter the Mailbox Password and press [#].
 - d. Press [9].
2. Press [4] for Mailboxes.
3. Enter the number of a mailbox whose language is to change as indicated on Form 2, followed by [#].
4. Press [6] for Mailbox Language.
5. Press [6] to modify Mailbox Language.
6. Enter the number corresponding to the Mailbox Language specified on Form 2.
7. Press [9] to confirm.
8. Repeat Steps 3 through 7 for each mailbox whose language is to be changed.
9. Press [*] [Z] to return to the Programming Main Menu.
10. Continue with “Assigning Outcalling Privileges” or “Line Ownership,” later in this chapter.

Assigning Outcalling Privileges

When the system is first installed, the Outcalling feature is not assigned to any mailbox.



CAUTION:

Before you assign mailboxes Outcalling privileges, you should consider the several system performance and security issues: If the privilege is assigned to a majority of users and their message traffic is heavy, system performance could be adversely affected. Outcalling attempts could be delayed. In rare instances, an Outcall may not be performed if it is delayed beyond the scheduled Outcalling period.

Additionally, there are no restrictions on the Outcalling numbers entered by subscribers. Therefore, it is strongly recommended that you limit the number of subscribers who have the Outcalling privilege. And call restrictions should be used for the communications system. See “Outgoing Call Restriction” earlier in this chapter for details.

To enable the Outcalling feature for a mailbox as specified on Form 2:

1. If necessary, access the Programming Main Menu. If you are already at the Programming Main Menu, skip to Step 2.
 - a. Press [*Intercom*] [Z] [Z] [Z] or the programmed VMMsgs button.
 - b. Press [2] [2] [#].
 - c. Enter the Mailbox Password and press [#].
 - d. Press [2].
2. Press [4] for Mailboxes.
3. Enter the number of a mailbox whose Outcalling permission is to change as indicated on Form 2, followed by [#].
4. Press [5] for Outcalling Administration.
5. Press [2] to turn on the Outcalling feature.
6. Repeat Steps 3 through 5 for each mailbox whose Outcalling permission is to be changed.
7. Press [*] [Z] to return to the Programming Main Menu.
8. Continue with the next section, “Line Ownership.”



NOTE:

Although you have assigned Outcalling for a specific mailbox, the subscriber must specify a telephone or pager number, and turn outcalling on before this feature will function. Subscribers may also establish an Outcalling schedule (optional).

Line Ownership

Before you begin, locate Form 6 for the voice messaging system.

- If Form 6 is filled out, use the procedure below to assign ownership.
- If Form 6 is not filled out, skip to “Communications System Programming.”

Assigning Line Ownership

To assign an owner to an outside line as specified on Form 6:

1. If necessary, access the Programming Main Menu. If you are already at the Programming Main Menu, skip to Step 2.
 - a. Press [*Intercom*] [Z] [Z] [Z] or the programmed VMMsgs button.
 - b. Press [2] [2] [#].
 - c. Enter the Mailbox Password and press [#].
 - d. Press [2].
2. Press [6] for Line Ownership.
3. Press [4] to assign Line Ownership.
4. Enter a line number specified in Column A of Form 6, followed by [#].
5. Enter the line owner's mailbox number specified in Column D of Form 6, followed by [#].
6. Repeat Steps 4 and 5 for each owned line.
7. Hang up to exit voice messaging system programming.
8. Refer to the next section to program the communications system.

Communications System Programming

Automated Attendant Service

Before you begin, locate Forms A, B1, and C of the *System Planner* for the communications system.

Refer to Form A, Page 1, Line Coverage, to see if any lines are checked for VMS-AA. If so, use this section to program Automated Attendant Service; otherwise, skip to "Call Answer Service."

Group Call Distribution

Use this procedure to specify the outside lines on which Automated Attendant Service is required.

To assign VMS-AA lines specified on Form A, Page 1, Line Coverage, to Hunt Group 7:

1. At extension 10*, press [*Feature*] [0] [0] [*System Program*] [*System Program*].
2. Enter the System Password if required.
3. Press [#] [2] [0] [6][†].
4. At the **Group:** prompt, press [7].
5. At the **Line:** prompt, enter the first VMS-AA line specified in the Line Coverage column of Form A, Page 1.
6. Press [*Next Data*] until the display reads 1 Assigned.
7. To program another line, press [*Next Item*] or [*Prev Item*] until the appropriate line number displays.
8. Press [*Next Data*] until the display reads 1 Assigned.
9. Repeat Steps 7 and 8 for each VMS-AA line on Form A.
10. Continue with "VMS Hunt Delay" below.

* Some systems also allow programming from extension 11. Check the *Programming and Use* guide for the communications system.

† In some countries, the procedure code for Group Call Distribution is #205. Check the *Programming and Use* guide for the communications system.

VMS Hunt Delay

Check Form A, Page 2, VMS Hunt Delay. If Delayed is specified, follow the procedure below. Otherwise, skip to the next section, "Automatic Extension Privacy."

To change the VMS Hunt Delay setting from Immediate to Delayed as specified on Form A, Page 2:

1. Press [#][5][0][6].
2. Press [*Next Data*] until the appropriate value displays.
3. Continue with "VMS Hunt Schedule" on the next page.

Automatic Extension Privacy

If VMS Hunt Delay is set to Immediate, use this procedure to prevent users from accidentally picking up calls sent to the voice messaging system.

To set Automatic Extension Privacy (#304) to Assigned for the PARTNER MAIL VS extensions specified on Form B1:

1. Press [#][3][0][4].
2. Enter the first PARTNER MAIL VS extension number specified on Form B1.
3. Press [*Next Data*] until the display reads 1 Assigned.
4. Press [*Next Item*] or [*Prev Item*] until the next PARTNER MAIL VS extension number specified on Form B1 displays.
5. Press [*Next Data*] until the display reads 1 Assigned.
6. If additional PARTNER MAIL VS extensions are specified on Form B1, repeat Steps 4 and 5 for each one.
7. Continue with "VMS Hunt Schedule" below.

VMS Hunt Schedule

Check Form A, Page 2, VMS Hunt Schedule. If Day Only or Night Only is selected, follow the procedure below. Otherwise, skip to the next section "Night Service."

To change the VMS Hunt Schedule setting from Always to Day Only or Night Only as specified on Form A, Page 2:

1. Press [#][5][0][7].
2. Press [*Next Data*] until the appropriate value displays.
3. Continue with "Night Service Button" below.

Night Service

Check Form C for extension 10. If a Night Service button is specified, follow the procedure below.

To program Night Service on a button with lights at extension 10 as specified on Form C:

1. Press [#][5][0][3].
2. At this point, do one of the following:
 - If you want to assign Night Service to the first available button on the system phone, press [*Next Data*] until the display reads:
Night Service
1 Assigned-Ext10
Go to Step 3.
 - If you want to assign Night Service to a specific button*, press [3].
The display reads:
Night Service
3 Select Button
Press the desired programmable button with lights to assign Night Service to that button.
3. Label the Night Service button at extension 10.
4. Continue with “Music On Hold” below.

Music On Hold

If desired, program Music On Hold. See the *Programming and Use* guide for the communications system for instructions.

Continue with the next section, “Disallowed Phone Numbers.”

* Select button (option 3) is not available on all systems. Check the *Programming and Use* guide for the communications system.

Disallowed Phone Numbers

If Outcalling is permitted, a Disallowed Phone Number List (#404) can be created to restrict calls.

Creating a Disallowed Phone Number List

Check communications system Planning Form D to see if a Disallowed Phone Number List is needed for Outcalling. If so, continue with the procedures in this section; otherwise, skip to "Allowed Phone Numbers."

To create a list of Disallowed Phone Numbers:

1. Press [#] [4] [0] [4].
2. At the **List Number:** prompt, enter the list number (1-4).
3. At the **Entry:** prompt, select a list entry (01-10).
4. At the **Data-----** prompt, enter the first number.
5. To save the number in memory, you must press [*Enter*].
6. At this point:
 - To change the number you just entered, press [*Remove*] and repeat Steps 4 and 5.
 - To delete the number you just entered, press [*Remove*].
 - To enter other numbers in this list, press [*Next Item*] and repeat Steps 4 and 5.

Assigning the Disallowed Phone Number List

The Disallowed Phone Number List that was created for Outcalling should be assigned to the extension(s) that are connected to the Outcalling port.

To assign a Disallowed Phone Number List to the extensions:

1. Press [#] [4] [0] [5].
2. Enter the number of the extension to be programmed.
3. Enter the list number (1-4).
4. To assign the list, press [*Next Data*] until the display reads 1 **Assigned**.
5. To save the number in memory, you must press [*Enter*].
6. To program another extension, press [*Next Procedure*] [*Prev Procedure*] and repeat from Step 2.

Allowed Phone Numbers

If Outcalling is permitted, an Allowed Phone Number List (#407) can be created to identify numbers to which Outcalling is allowed.

Creating an Allowed Phone Number List

Check communications system Planning Form D to see if an Allowed Phone Number List is needed for Outcalling. If so, continue with the procedures in this section; otherwise, skip to the next section.

**NOTE:**

If the PARTNER MAIL VS extensions were restricted to Inside Only using Outgoing Call Restriction (#401), Outcalling *will not work* unless an Allowed Phone Number List is created and assigned. Outcalls can be made only to the numbers included in the list.

To create a list of Allowed Phone Numbers:

1. Press [#] [4] [0] [7].
2. At the List Number: prompt, enter the list number (1-4).
3. At the Entry: prompt, select a list entry (01-10).
4. At the Data----- prompt, enter the first number.
5. To save the number in memory, you must press [Enter].
6. At this point:
 - To change the number you just entered, press [Remove] and repeat Steps 4 and 5.
 - To delete the number you just entered, press [Remove].
 - To enter other numbers in this list, press [Next Item] and repeat Steps 4 and 5.

Assigning the Allowed Phone Number List

The Allowed Phone Number List that was created for Outcalling should be assigned to the extension(s) that are connected to the Outcalling port.

To assign the Allowed Phone Number List to the extensions:

1. Press [#] [4] [0] [8].
2. Enter the number of the extension to be programmed.
3. Enter the list number (1-4).
4. To assign the list, press [Next Data] until the display reads 1 Assigned.
5. To save the number in memory, you must press [Enter].
6. To program another extension, press [Next Procedure] [Prev Procedure] and repeat from Step 2.
7. Continue with the next section, "Call Answer Service."

Call Answer Service

Before you begin, locate Forms A and B2 of the *System Planner* for the communications system.

- Refer to Form A, Page 1, Line Coverage. If either check marks or extension numbers appear in the VMS-Mail column, use “Line Coverage” on the next page to program personal lines for Call Answer Service.
- If nothing is specified in the VMS-Mail column of Form A, refer to Form B2 to see if Automatic VMS Cover is assigned to any extensions. If it is, refer to “Automatic VMS Cover” and “VMS Cover Rings” later in this chapter.
- If neither VMS-Mail for personal lines or Automatic VMS Cover is specified, skip to “Telephone Button Programming.”

Line Coverage

Refer to Form A, Page 1, Line Coverage, VMS-Mail:

- If check marks appear for any lines in this column, use the procedure in “VMS Line Coverage” below.
- If extension numbers are specified for any lines in this column, use the procedure in “Line Coverage Extension” below.

VMS Line Coverage

To assign VMS-Mail lines checked on Form A, Page 1, Line Coverage, to Hunt Group 7:

1. Press [#][2][0][6]*.
2. At the **Group:** prompt, press [z].
3. At the **Line:** prompt, enter the first line checked in the VMS-Mail column.
4. Press [*Next Data*] until the display reads 3 VMS Line Cover .
5. To program another line, press [*Next Item*] or [*Prev Item*] until the appropriate line number displays.
6. Press [*Next Data*] until the display reads 3 VMS Line Cover .
7. Repeat Steps 5 and 6 for each VMS-Mail line checked on Form A.
8. If extension numbers are specified for any lines in this column, use the following procedure in “Line Coverage Extension.” Otherwise, continue with the section, “Automatic VMS Cover.”

* In some countries, the procedure code for Group Call Distribution is #205. Check the *Programming and Use* guide for the communications system.

Line Coverage Extension

To assign line coverage for the extension numbers specified in the VMS-Mail column on Form A, Page 1, Line Coverage:

1. Press [#] [2] [0] [8]*.
2. At the **Line :** prompt, enter the first line for which an extension is specified in the VMS-Mail column of Form A, Page 1, Line Coverage.
3. At the **Data :** prompt, enter the number of the extension specified in the VMS-Mail column.
4. To program another line, press [*Next Item*] or [*Prev Item*] until the appropriate line number displays.
5. At the **Data :** prompt, enter the number of the extension specified in the VMS-Mail column.
6. Repeat Steps 4 and 5 for each VMS-Mail line for which an extension number is written on Form A.
7. Continue with the next section, "Automatic VMS Cover."

Automatic VMS Cover

Check Form B2 to see if Automatic VMS Cover is assigned to any extensions. If it is, follow the procedure below. If not, skip to "VMS Cover Rings."

To change the Automatic VMS Cover setting for an extension to Assigned as indicated on Form B2:

1. Press [#] [3] [1] [0].
2. Enter the number of the first extension to which Automatic VMS Cover is to be assigned.
3. Press [*Next Data*] until the display reads 1 Assigned.
4. To program another extension, press [*Next Item*] or [*Prev Item*] until the extension number shows on the display.
5. Press [*Next Data*] until the display reads 1 Assigned.
6. Repeat Steps 4 and 5 for each extension to which Automatic VMS Cover is to be assigned.
7. Continue with "VMS Cover Rings" below.

* Extension Line Coverage (#208) is not available on all systems. Check the *Programming and Use* guide for the communications system.

VMS Cover Rings

Check Form A, Page 2, to see if VMS Cover Rings (#117)* is different from the factory setting of 3. If it is, follow the procedure below beginning with Step 1. If not, skip to Step 3 of the procedure below.

To change the number of times calls ring before they are sent to the voice messaging system as indicated on Form A, Page 2, VMS Cover Rings:

1. Press [#][1][1][Z].
2. Enter the VMS Cover Rings setting specified on Form A.
3. Press [*Feature*][0][0] to exit programming mode.
4. Continue with the next section, "Telephone Button Programming."

Telephone Button Programming

Before you begin, locate Form C of the *System Planner* for the communications system. Be sure you have a version of the form for each subscriber's phone.

Use this section to program buttons on subscribers' phones, including the receptionist's phone. This section uses Centralized Telephone Programming.

When you are finished programming, be sure to label all buttons on subscribers' phones.

VMS Cover

This button allows the subscriber to turn voice mail coverage on and off.

To program a VMS Cover button as specified on Form C:

1. Press [*Feature*][0][0][*System Program*][*System Program*][*Central Tel Program*].
2. Enter the number of the extension to be programmed.
3. Press a programmable button with lights.
4. Press [*Feature*][1][5][†].
5. At this point, do one of the following:
 - Go to Step 3 of the next procedure to program another button for this extension.
 - Press [*Central Tel Program*] and go to Step 2 of any button programming procedure in this section to program a button for a different extension.
 - Press [*Feature*][0][0] to exit.

* VMS Cover Rings (#117) is not available on all systems. Check the *Programming and Use* guide for the communications system.

† In some countries, the feature code for Voice Mailbox Transfer is [1][5]. Check the *Programming and Use* guide for the communications system.

Do Not Disturb

Used in conjunction with either automatic VMS cover or manual VMS cover, this button lets subscribers send callers immediately to his or her mailbox (instead of ringing the extension first).

To program a Do Not Disturb (DND) button as specified on Form C:

1. Press [*Feature*] [0] [0] [*System Program*] [*System Program*] [*Central Tel Program*].
2. Enter the number of the extension to be programmed.
3. Press a programmable button with lights.
4. Press [*Feature*] [0] [1].
5. At this point, do one of the following:
 - Go to Step 3 of the next procedure to program another button for this extension.
 - Press [*Central Tel Program*] and go to Step 2 of any button programming procedure in this section to program a button for a different extension.
 - Press [*Feature*] [0] [0] to exit.

Voice Mailbox Transfer

This button lets *any system user* transfer calls directly to a subscriber's mailbox, without ringing the extension first.

To program a Voice Mailbox Transfer (VMBox) button as specified on Form C:

1. Press [*Feature*] [0] [0] [*System Program*] [*System Program*] [*Central Tel Program*].
2. Enter the number of the extension to be programmed.
3. Press a programmable button.
4. Press [*Feature*] [1] [4]*.
5. At this point, do one of the following:
 - Go to Step 3 of the next procedure to program another button for this extension.
 - Press [*Central Tel Program*] and go to Step 2 of any button programming procedure in this section to program a button for a different extension.
 - Press [*Feature*] [0] [0] to exit.

* In some countries, the feature code for Voice Mailbox Transfer is [1] [5]. Check the *Programming and Use* guide for the communications system.

Voice Mail Messages

This intercom Auto Dial button allows the subscriber to access the voice messaging system with the touch of one button.

To program a Voice Mail Messages (VMMsgs) button as specified on Form C:

1. Press [*Feature*] [0] [0] [*System Program*] [*System Program*] [*Central Tel Program*].
2. Dial the number of the extension to be programmed.
3. Press a programmable button.
4. Press left [*Intercom*] [z] [z] [z].
5. At this point, do one of the following:
 - Press [*Central Tel Program*] and go to Step 2 of any button programming procedure in this section to program a button for a different extension.
 - Press [*Feature*] [0] [0] to exit.

Verifying System Operation

After you finish programming the voice messaging system and the communications system, you should perform the tests described in this section to verify system operation.

If your system allows programming from extension 11*, you should perform these tests from extension 11 to keep extension 10 free for the receptionist to handle calls.

Voice Mail Service

Make a call to the VMS Hunt Group by pressing [*Intercom*][z][z][z] or the programmed VMMsgs button. You should hear the Voice Mail Service greeting:

Welcome to PARTNER MAIL VS. Please enter extension and #. Otherwise, to access PARTNER Tutor, press * 4.

Automated Attendant Service

- If the VMS Hunt Schedule is set for Day Only or Always, follow the procedure for Day Menu.
- If the VMS Hunt Schedule is set for Night Only, follow the procedure for Night Menu.

Day Menu

1. Make sure the Night Service button at extension 10 is off.
2. Call in on a line answered by the Automated Attendant Service.
3. If the system is set for:
 - *Immediate*, Automated Attendant Service should answer the call on the second ring.
 - *Delayed*, Automated Attendant Service should answer the call after the fourth ring.
4. Listen for the Day Menu Prompt.
5. After the prompt, choose an option from the day menu.
6. Make sure your call is transferred to the appropriate extension or group, or the correct Announcement is played.
7. Repeat Steps 2 through 6 for each option on the day menu.
8. If the system is set for Bilingual Mode, press [*][1] to check the Day Menu Prompt in the Secondary Language. You should also hear any recorded Announcement.

* Some systems allow programming from extension 11. Check the *Programming and Use* guide for the communications system.

9. Repeat Steps 2 through 4 for each line that has Automated Attendant Service coverage.
10. If the VMS Hunt Schedule is set for Always, continue with “Night Menu” below.

Night Menu

1. Make sure the Night Service button at extension 10 is on.
2. Call in on a line answered by the Automated Attendant Service.
3. If the system is set for:
 - *Immediate*, Automated Attendant Service should answer the call on the second ring.
 - *Delayed*, Automated Attendant Service should answer the call after the fourth ring.
4. Listen for the Night Menu Prompt.
5. If you already tested the Day Menu, go to Step 8. Otherwise, after the prompt, choose an option from the night menu.
6. Make sure your call is transferred to the appropriate extension or group, or the correct announcement is played.
7. Repeat Steps 2 through 6 for each option on the night menu.
8. If the system is set for Bilingual Mode, press [*] [1] to check the Night Menu Prompt in the Secondary Language. You should also hear any recorded Announcement.

Call Answer Service

VMS Extension Coverage

1. Press the Do Not Disturb button at the appropriate destination extensions to quickly route your test calls to Call Answer Service.
2. For extensions that do not have Automatic VMS Cover, turn on coverage by pressing the VMS Cover button at those extensions.
3. Call the first extension that has VMS coverage (either automatic or manual). *If Do Not Disturb is on at the extension, Call Answer Service should answer the call after one ring and you should hear the default greeting for that mailbox. (If Do Not Disturb is not on, the call rings at the extension before Call Answer Service answers it.)*
4. Repeat this procedure for every extension that has voice mail coverage.

VMS Line Coverage

1. Call in on the first line that is programmed for VMS Line Cover. *Call Answer Service should answer the call on the fifth ring and the factory-set greeting should prompt you to leave a message in that line owner's mailbox.*
2. Repeat this procedure for every line that has VMS Line Cover.

Line Coverage Extension

1. Make sure VMS Cover is on at the owner's extension.
2. Call in and make sure the call goes to VMS Cover by the number of rings specified by VMS Cover Rings (#117)*.
3. Verify that you hear the factory-set mailbox greeting for the line owner.
4. Repeat this procedure for every Line Coverage extension.

* VMS Cover Rings (#117) is not available on all systems. Check the *Programming and Use* guide for the communications system.

Contents

General Information	5-2
▪ Changing Your Password	5-2
▪ Training Co-Workers	5-3
Language	5-3
Outcalling	5-3
Using the Tutor Feature	5-5
Receptionist's Responsibilities	5-6
Group Calling Tips	5-7
Language	5-8
▪ Modifying the Language Mode	5-9
▪ Monolingual Mode	5-10
Playing the System Language	5-10
Modifying the System Language	5-11
▪ Bilingual Mode	5-13
Playing the Primary Language	5-13
Modifying the Primary Language	5-14
Playing the Secondary Language	5-15
Modifying the Secondary Language	5-16
Automated Attendant Service	5-18
▪ Menu Definition, Prompt, and Announcements	5-20
Other Options	5-22
▪ Monolingual Mode	5-22
Playing the Menu Definition and Announcements	5-22
Playing the Day or Night Menu Prompt	5-23
Modifying the Menu Definition, Day Menu Prompt, and Announcements	5-24
Modifying the Night Menu Prompt	5-26

Contents

■ Bilingual Mode	5-27
Playing the Menu Definition and Announcements	5-27
Playing the Day and Night Menu Prompts in the Primary and Secondary Languages	5-28
Modifying the Menu Definition, Day Menu Prompts, and Announcements	5-30
Modifying the Night Menu Prompts	5-32
■ Group Call Distribution	5-34
■ VMS Hunt Delay	5-34
■ Automatic Extension Privacy	5-35
■ VMS Hunt Schedule	5-35
Modifying Mailboxes	5-36
■ Hardware Considerations	5-39
■ Guest Mailboxes	5-40
■ Checking a Mailbox's Status	5-42
■ Deleting a Mailbox	5-42
■ Creating a Mailbox	5-44
■ Reinitializing a Password	5-45
■ Reinitializing a Mailbox	5-46
■ Playing a Mailbox's Language	5-47
■ Modifying a Mailbox's Language	5-48
■ Administering Outcalling for a Mailbox	5-49
■ Automatic VMS Cover	5-51
■ VMS Cover Rings	5-51
Line Coverage	5-52
■ VMS Line Coverage	5-53
Scanning Line Ownership	5-54
Assigning Line Ownership	5-55
Modifying Line Ownership	5-56
Deleting Line Ownership	5-57
Group Call Distribution	5-58
■ Extension Line Coverage	5-59
Telephone Button Programming	5-60
■ VMS Cover	5-60
■ Do Not Disturb	5-61
■ Voice Mailbox Transfer	5-61
■ Voice Mail Messages	5-62

This chapter provides the programming procedures you can use to make changes to the voice messaging system to reflect changes in your company. Most changes you make will occur because of personnel changes. The following list identifies areas of system programming that you are likely to change as you manage the system on an on-going basis:

- **Language.** Allows you to change the Language Mode (Monolingual or Bilingual) and the language(s) supported by that mode.
- **Automated Attendant Service.** Allows you to change the prompt that outside callers hear when the Automated Attendant answers calls and to redefine menu options for transferring outside callers to specific destinations and for changing announcements that callers can choose to hear. Also allows you to specify new lines for Automated Attendant Service coverage, if you add new lines to your system.
- **Mailbox Assignments.** Allows you to delete and create mailboxes, reset mailboxes and subscriber's passwords to factory settings, assign/ cancel Outcalling privileges for a subscriber's mailbox, and change the language a subscriber hears when using Voice Mail Service.
- **Line Coverage.** Allows you to modify line coverage using either VMS Line Coverage or Extension Line Coverage.
- **Telephone Button Programming.** Allows you to program buttons on subscriber's system phones for convenient use of voice messaging system features.

If you are a new System Manager, you should review the following section for general information that you need to know in your new role. You should use the rest of this chapter on an as-needed basis. Also, if you have not done so already, you should read Chapter 1 for a description of the voice messaging system's features and services and Chapter 3 for an overview of voice messaging system and communications system programming.

General Information

This section tells you how to change the System Manager's password, which is required for changing voice messaging system settings. It also provides information that you should share with all system users and other information that is specifically for the receptionist at extension 10.

Changing Your Password

The factory setting for login 99's (the System Manager's) Password is 1234. To prevent unauthorized programming of the system, you should change the default password immediately after installation or any time the password has been reset. You can assign up to four digits for a Password. It is recommended that you create a Password from random, non-sequential digits.

If you change the Password and forget it, you must contact the BCS Technical Service Center at 1 800 628-2888 or call your Lucent Technologies' Representative or local Authorized Dealer for instructions on how to reset the Password.

To change the Password for login 99:

1. Press [*Intercom*] [Z] [Z] [Z] or the programmed VMMsgs button.
2. Press [2] [2] [#].
3. Enter the existing password (for example, 1234) and press [#].
4. Press [2] to change the password.
The prompt asks you to enter your new password.
5. Enter up to four digits for the new password and press [#].
The prompt asks you to re-enter your new password.
6. Enter your new password again followed by [#].
The new password is now active.
7. Hang up to quit.

Training Co-Workers

Language

You should let system users know about the following language options:

- You can change the language of voice prompts that a subscriber hears when recording a personal greeting, retrieving messages, and other Voice Mail services. This language can be different from the System Language set for Monolingual Mode or the Primary and Secondary Languages set for Bilingual Mode.
- If the system is set for Bilingual Mode, subscribers can record two personal greetings: one in the Primary Language and a second in the Secondary Language. They should include a sentence early in the greetings that lets callers know that they can switch to the other language by pressing [*] [1] while the greeting is playing.

Outcalling

You should let system users know that they can turn this feature on or off, retrieve their messages from a touch-tone phone, as well as enter and change their Outcalling number and schedule. Instructions for performing these tasks are provided in *Using the PARTNER MAIL VS® Voice Messaging System*.

In addition, you should provide users with the following information about the Outcalling feature:

- Although you are responsible for assigning Outcalling privileges to a subscriber's mailbox, the subscriber must turn on Outcalling and specify an Outcalling number. Otherwise, the system does not notify subscribers when new messages have arrived in their mailboxes.
- If the subscriber is logged into the system, the system does not place an outcall.
- If the subscriber disconnects from the system without listening to a new message, the outcall is placed according to schedule.
- The Outcalling number may contain up to 60 digits, including the * and # symbols. (The * represents a 1.5-second pause.)
- The "9" dialed to get an outside line must be included in the Outcalling number. And a pause (*) should be included after the "9."
- Subscribers may also specify a schedule (that is, a start time and end time) for Outcalling. For example, they may direct the system to outcall only during the hours of 7:30 p.m. to 8:00 a.m. Otherwise, the default schedule is 24 hours.
- The start and end times entered by a user are based on a 24-hour clock; however, the voice playback of these times is based on the system language selection of 12 or 24-hour format. In the example above, the subscriber would enter the start time of 7:30 p.m. as 1930# and 8:00 a.m. as 0800#.

- If a message arrives at a subscriber's mailbox after the specified Outcalling time interval, Outcalling notification for that message is not initiated at the next Outcalling time interval.
- The system attempts to outcall three times within a *minimum* time interval of 15 minutes between attempts. However, during heavy message traffic periods the time interval may be longer.
- For a pager/beeper number:
 - Subscribers can program a callback number as part of the Outcalling number.
 - Subscribers are advised to enter several pauses (where each pause is represented by a * sign) after the Outcalling number (before entering their PIN and/or callback number) to allow the paging system sufficient time to answer. Subscribers should experiment to determine the correct number of pauses needed after the pager service number. It is important to ensure that enough time is allowed for the call to be dialed and answered before additional information (such as the PIN or callback number) is dialed.
 - It is strongly recommended that subscribers verify that the system can function properly with the Outcalling number as it is entered. Subscribers should leave a message in their own mailbox during a scheduled Outcalling period to ensure that the system places the call to their beeper.
- For a telephone number:
 - After the system has sent all the digits of the Outcalling number, the system plays a message that announces the subscriber's mailbox number and notification that a new message has arrived. It also instructs the subscriber how to access the new message and how to cancel the Outcalling notification. This message is repeated five times unless it is interrupted by the subscriber.
 - The subscriber may make up to three attempts to log in during the outcall before the system disconnects.
 - A subscriber can cancel Outcalling for a new message without logging in or listening to the new message by pressing [*] [#] when listening to the Outcalling notification message.

Using the Tutor Feature

Tutor is an “on-line help” feature that allows all system users (not just voice messaging system subscribers) to easily access and listen to information on commonly-used communications system features. You should let system users know about this feature and recommend that users stick the Tutor Service label (provided with the voice messaging system hardware) into the depression for the handset mouthpiece on the base of their system phone.

To access the Tutor menu, users simply call the voice messaging system by dialing [*Intercom*] [z] [z] [z] and enter [*] [4] after they hear the `Please enter extension` prompt. Voice prompts request the user to enter topic and subtopic numbers. The available topics are:

1 Autodial Features

- 1 Last Number Redial
- 2 Save Number Redial
- 3 Personal Speed Dial
- 4 Intercom Auto Dial
- 5 Outside Auto Dial

2 Internal Calls

- 1 Hands Free Answer on Intercom
- 2 Voice Interrupt On Busy
- 3 Group Paging

3 Fixed Features

- 1 Transfer
- 2 Conference

4 About Your Phone

- 1 Buttons and Lights
- 2 Display
- 3 Speakerphone
- 4 Volume
- 5 Ring Patterns

Information about each subtopic is presented in short, easy to understand segments. After a segment plays, the user hears one beep or two beeps:

- One beep means that there is more information about the subtopic. The user can press [*] [4] to replay the previous segment or [#] to play the next segment.
- Two beeps indicate the end of the information about the subtopic. The user can press [*] [4] to replay the previous segment or [#] to return to the Tutor Main Menu.



NOTE:

Tutor's prompts play in either the System Language selected for Monolingual Mode or the Primary Language selected for Bilingual Mode. This cannot be changed.

Receptionist's Responsibilities

After the voice messaging system is installed, the receptionist at extension 10 should be aware of certain interactions between the voice messaging system and the receptionist's extension. Use the following list as a guide when you explain these interactions to the receptionist:

- The receptionist's extension is factory set as extension 10 and cannot be changed. The mailbox for this extension can handle up to 60 minutes of stored messages (or 120 messages).
- When the Automated Attendant Service answers outside calls, the receptionist will receive calls from any caller who presses [0] or stays on the line after hearing the menu prompt. "VMS" shows on the display of the receptionist's phone to identify calls transferred by the voice messaging system.
- The personal greeting recorded at the receptionist's mailbox should be more general than personal, since this mailbox is the destination for business calls when the receptionist is not available.
- If the receptionist requests a personal mailbox, you can create a guest mailbox for that purpose. See "Guest Mailboxes" later in this chapter for instructions. Once the guest mailbox is created, the receptionist should tell people who might call to dial the extension number of the guest mailbox to leave personal messages when they call and hear the Automated Attendant Service prompt.

Additionally, the receptionist can record a note on the personal greeting at extension 10 to notify callers of the guest mailbox. For example, the personal greeting for extension 10 can also say "If you would like to leave a personal message for Ms. Smith, dial [*] [8] [3] [3]." In this example, 33 represents the 2-digit extension number of the guest mailbox. Remind the receptionist to log in to the guest mailbox regularly to check for messages, since the guest mailbox does not have an associated phone with a message waiting light.

- If Automatic VMS Cover is not assigned to extension 10, you should program a VMS Cover button and a Do Not Disturb button on the system phone at extension 10. Then instruct the receptionist to press both the VMS Cover and Do Not Disturb buttons (to turn the features on) whenever the receptionist leaves the desk or leaves for the day. This ensures that any calls routed to extension 10 when the receptionist is away are immediately covered by the voice messaging system. If the receptionist has Automatic VMS Cover, program only the Do Not Disturb button at the extension.
- If selector code 9 on the Automated Attendant Service menu is left at the factory setting (which is highly recommended), callers can be routed directly to the receptionist's mailbox to leave a message. If this is the case, let the receptionist know that he or she should review the messages each morning and distribute them to the appropriate people.

Group Calling Tips

It is important to note that voice mail coverage is not provided for group calls. If your system is set up for group transfer, be sure that the receptionist is aware of the following items:

- If the Automated Attendant Service transfers a call to a Hunt Group or Calling Group*, and all members in the group are busy (members are either on the phone or have Do Not Disturb on), the call is transferred to the receptionist's extension. When callers transfer to a busy group, they hear Music On Hold, tones, ringing, or silence (depending on how the communications system is set up) until the receptionist answers.
- If the Automated Attendant Service transfers a call to a Calling Group and the call is not answered, the call is transferred to the receptionist's extension after the programmed number of transfer return rings. The call will not be sent to the voice mailbox.
- If the Automated Attendant Service transfers a call to a Hunt Group that has only one available member and that member does not answer the call, the call is transferred to the receptionist's extension after the programmed number of transfer return rings. The call will not be sent to the voice mailbox.

* Calling Groups are not available on all systems. Check the *Programming and Use* guide for the communications system.

Language

You can choose the Language Mode, either Monolingual or Bilingual, and the Language(s) used by that mode (see Figure 5-1). Monolingual Mode supports a single System Language that callers hear when they call in to the voice messaging system. Bilingual Mode supports two languages, a Primary Language and a Secondary Language. Callers who call in to a voice messaging system set for Bilingual Mode, hear the Automated Attendant Service menu prompt, announcements, and mailbox greetings in the Primary Language, but have the option of switching to the Secondary Language by pressing [*] [1].

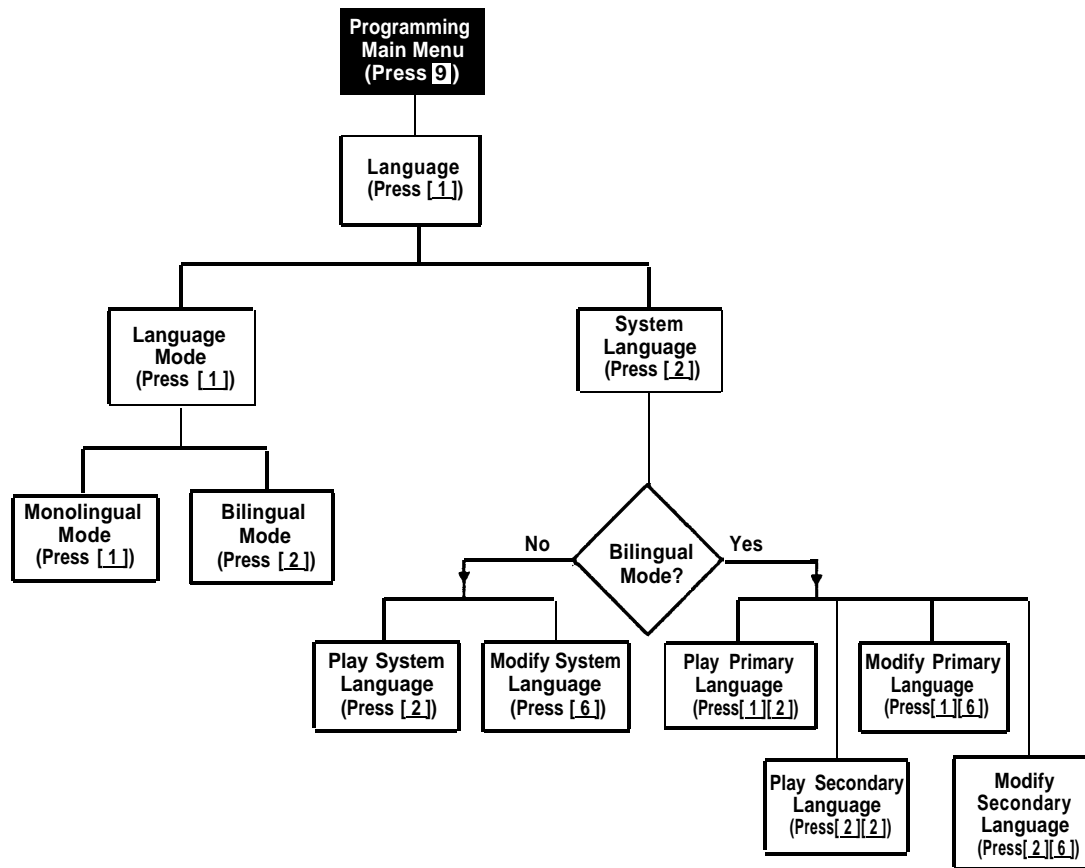

Figure 5-1. Language Menu

If you need to change current programming for Language, you can use the instructions presented in this section. For example:

- If you want to change the Language Mode from Monolingual to Bilingual or Bilingual to Monolingual, use “Modifying the Language Mode.”
- If you want to change the current System Language used in Monolingual Mode, use “Modifying the System Language.”
- If you want to change the current Primary and/or Secondary Language used in Bilingual Mode, use “Modifying the Primary Language” and/or “Modifying the Secondary Language.”

Modifying the Language Mode

Update Form 1 for the voice messaging system to show the change in Language Mode.

When you change the Language Mode, the system continues to use any recorded messages associated with the selected language. For example, if you change from Monolingual to Bilingual Mode and the System Language in Monolingual Mode was Latin American Spanish callers will hear Latin American Spanish as the Primary Language. Also, when you change the mode, listen to the Automated Attendant Service Day and Night Menu Prompts to make sure they are still relevant, and re-record them if necessary.

To change the Language Mode:

1. Access the Programming Main Menu:
 - a. Press [*Intercom*] [Z] [Z] [Z] or the programmed VMMsgs button.
 - b. Press [2] [2] [#].
 - c. Enter the Password and press [#].
 - d. Press [2].

The system plays the system programming options.

2. Press [1] for Language.

The system plays:

To program Language Mode, press 1. To program System Language, press 2. If finished, press * #.

3. Press [1] for Language Mode.

The system plays the current Language Mode then:

For Monolingual Mode, press 1. For Bilingual Mode, press 2. If finished, press * #.

4. Either:
 - Press [1] for Monolingual Mode.
The system plays:
System is in Monolingual Mode. To program Language Mode, press 1. To program System Language, press 2. If finished, press * #.
 - Press [2] for Bilingual Mode.
The system plays:
System is in Bilingual Mode. To program Language Mode, press 1. To program System Language, press 2. If finished, press * #.
5. At this point, do one of the following:
 - To change the System Language if the system is set for Monolingual Mode, go to Step 3 of “Modifying the System Language.”
 - To change the Primary Language if the system is set for Bilingual Mode, go to Step 3 of “Modifying the Primary Language.”
 - Press [*] [Z] to return to the Programming Main Menu or hang up to quit.

Monolingual Mode

Playing the System Language

To listen to the current System Language:

1. Access the Programming Main Menu:
 - a. Press [*intercom*] [Z] [Z] [Z] or the programmed VMMsgs button.
 - b. Press [2] [2] [#].
 - c. Enter the Password and press [#].
 - d. Press [2].

The system plays the system programming options.
2. Press [1] for Language.
The system plays:
To program Language Mode, press 1. To program System Language, press 2. If finished, press * #.
3. Press [2] for System Language.
The system plays:
To play System Language, press 2. To modify System Language, press 6. If finished press * #.

4. Press [2].

The system plays:

System language is LANGUAGE (where LANGUAGE is the current language). To play System Language, press 2. To modify System Language, press 6. If finished, press * #.

5. At this point, do one of the following:

— To change the System Language, go to Step 4 of “Modifying the System Language.”

— Press [*] [2] to return to the Programming Main Menu or hang up to quit.

Modifying the System Language

Update Form 1 for the voice messaging system to show the change in the System Language selected for Monolingual Mode.

When you change the System Language, the system uses any recorded messages already associated with the new System Language. After changing the System Language, listen to the Automated Attendant Service Day and Night Menu Prompts to make sure they are still relevant, and re-record them if necessary.



NOTE:

When you change the System Language, the Mailbox Language for any mailboxes that were left at the factory setting also change to reflect the new System Language. Any mailboxes that were assigned a different language do not change.

To change the System Language:

1. Access the Programming Main Menu:

- a. Press [*Intercom*] [2] [2] [2] or the programmed VMMsgs button.

- b. Press [*] [*] [#].

- c. Enter the Password and press [#].

- d. Press [*].

The system plays the system programming options.

2. Press [1] for Language.

The system plays:

To program Language Mode, press 1. To program System Language, press 2. If finished, press * #.

3. Press [2] for System Language.

The system plays:

To play System Language, press 2. To modify System Language, press 6. If finished press * #.

4. Press [6].

The system plays the current System Language, then prompts you to enter the number corresponding to the desired language.

5. Press the number for the language you want to use.

The system plays:

For LANGUAGE (where LANGUAGE is the current language),
press 9 to confirm or 6 to cancel.

6. Either:

— Press [6] to cancel your selection.

The system plays:

System Language has not been changed.

— Press [9] to confirm your selection.

The system plays:

System Language has been changed.

7. Press [✶] [Z] to return to the Programming Main Menu or hang up to quit.

Bilingual Mode

Playing the Primary Language

To listen to the current Primary Language:

1. Access the Programming Main Menu:
 - a. Press [*Intercom*] [*Z*] [*Z*] [*Z*] or the programmed VMMsgs button.
 - b. Press [*g*] [*g*] [#].
 - c. Enter the Password and press [#].
 - d. Press [*g*].

The system plays the system programming options.

2. Press [*1*] for Language.

The system plays:

To program Language Mode, press 1. To program System Language, press 2. If finished, press * #.

3. Press [*2*] for System Language.

The system plays:

To program Primary Language, press 1. To program Secondary Language, press 2. If finished press * #.

4. Press [*1*] for Primary Language.

The system plays:

To play Primary Language, press 2. To modify Primary Language, press 6. If finished press * #.

5. Press [*2*] to play the Primary Language.

The system plays:

Primary Language is LANGUAGE (where LANGUAGE is the current language). To play Primary Language, press 2. To modify Primary Language, press 6. If finished, press * #.

6. At this point, do one of the following:
 - To change the Primary Language, go to Step 5 of “Modifying the Primary Language.”
 - Press [*x*] [*Z*] to return to the Programming Main Menu or hang up to quit.

Modifying the Primary Language

Update Form 1 for the voice messaging system to show the change in the Primary Language selected for Bilingual Mode.

When you change the Primary Language, the system uses any recorded messages already associated with the new Primary Language. After changing the Primary Language, listen to the Automated Attendant Service Day and Night Menu Prompts to make sure they are still relevant; re-record them if necessary.

NOTE:

When you change the Primary Language, the Mailbox Language for any mailboxes that were left at the factory setting also change to reflect the new Primary Language. Any mailboxes that were assigned a different language do not change.

To change the Primary Language:

1. Access the Programming Main Menu:
 - a. Press [*Intercom*] [z] [z] [z] or the programmed VMMsgs button.
 - b. Press [*g*] [*g*] [#].
 - c. Enter the Password and press [#].
 - d. Press [*g*].

The system plays the system programming options.
2. Press [1] for Language.

The system plays:

To program Language Mode, press 1. To program System Language, press 2. If finished, press * #.
3. Press [2] for System Language.

The system plays:

To program Primary Language, press 1. To program Secondary Language, press 2. If finished, press * #.
4. Press [1] for Primary Language.

The system plays:

To play Primary Language, press 2. To modify Primary Language, press 6. If finished, press * #.
5. Press [*g*].

The system plays the current Primary Language, then prompts you to enter the number corresponding to the desired language.

6. Press the number for the language you want to use.

The system plays:

For LANGUAGE (where LANGUAGE is the current language),
press 9 to confirm or 6 to cancel.

7. Either:

— Press [6] to cancel your selection.

The system plays:

Primary Language has not been changed.

— Press [9] to confirm your selection.

The system plays:

Primary Language has been changed.

8. Press [*] [Z] to return to the Programming Main Menu or hang up to quit.

Playing the Secondary Language

To listen to the current Secondary Language:

1. Access the Programming Main Menu:

- a. Press [*intercom*] [Z] [Z] [Z] or the programmed VMMsgs button.

- b. Press [2] [2] [#].

- c. Enter the Password and press [#].

- d. Press [2].

The system plays the system programming options.

2. Press [1] for Language.

The system plays:

To program Language Mode, press 1. To program System
Language, press 2. If finished, press * #.

3. Press [2] for System Language.

The system plays:

To program Primary Language, press 1. To program
Secondary Language, press 2. If finished, press * #.

4. Press [2] for Secondary Language.

The system plays:

To play Secondary Language, press 2. To modify
Secondary Language, press 6. If finished, press * #.

5. Press [2].

The system plays:

Secondary language is LANGUAGE (where LANGUAGE is the current language). To play Secondary Language, press 2. To modify Secondary Language, press 6. If finished, press * #.

6. At this point, do one of the following:

- To change the Secondary Language, go to Step 5 of “Modifying the Secondary Language.”
- Press [*][2] to return to the Programming Main Menu or hang up to quit.

Modifying the Secondary Language

Update Form 1 for the voice messaging system to show the change in the Secondary Language selected for Bilingual Mode.

When you change the Secondary Language, the system uses any recorded messages already associated with the new Secondary Language. After changing the Secondary Language, listen to the Automated Attendant Service Day and Night Menu Prompts to make sure they are still relevant; re-record them if necessary.

To change the Secondary Language:

1. Access the Programming Main Menu:

- a. Press [*Intercom*][2][2][2] or the programmed VMMSgs button.
- b. Press [2][2][#].
- c. Enter the Password and press [#].
- d. Press [2].

The system plays the system programming options.

2. Press [1] for Language.

The system plays:

To program Language Mode, press 1. To program System Language, press 2. If finished, press * #.

3. Press [2] for System Language.

The system plays:

To program Primary Language, press 1. To program Secondary Language, press 2. If finished, press * #.

4. Press [2] for Secondary Language.

The system plays:

To play Secondary Language, press 2. To modify Secondary Language, press 6. If finished, press * #.

5. Press [*g*].

The system plays the current Secondary Language, then prompts you to enter the number corresponding to the desired language.

6. Press the number for the language you want to use.

The system plays:

For LANGUAGE (where LANGUAGE is the current language),
press 9 to confirm or 6 to cancel.

7. Either:

— Press [*g*] to cancel your selection.

The system plays:

Secondary Language has not been changed.

— Press [*g*] to confirm your selection.

The system plays:

Secondary Language has been changed.

8. Press [*x*] [*z*] to return to the Programming Main Menu or hang up to quit.

Automated Attendant Service

Automated Attendant Service (see Figure 5-2) can provide both day and night operation so callers can hear an appropriate prompt in either the System or Primary Language when they call your company. The voice messaging system switches to day or night operation depending on the setting of the Night Service button at extension 10—the receptionist’s extension. You can customize the day and/or night menu to welcome the caller and offer the caller a list of options for transferring to a system extension or group, or for hearing an Announcement that you record. These Announcements can tell callers about your business hours and location, emergency cover information, and seasonal or special offers.

You can record up to two Announcements (of up to four minutes each). If the system is set for Bilingual Mode, you can record up to two Announcements in each language. Be sure to record the Day and Night Menu Prompts in both the Primary and Secondary Languages as well. Then callers can press [*] [1] to switch between the languages.

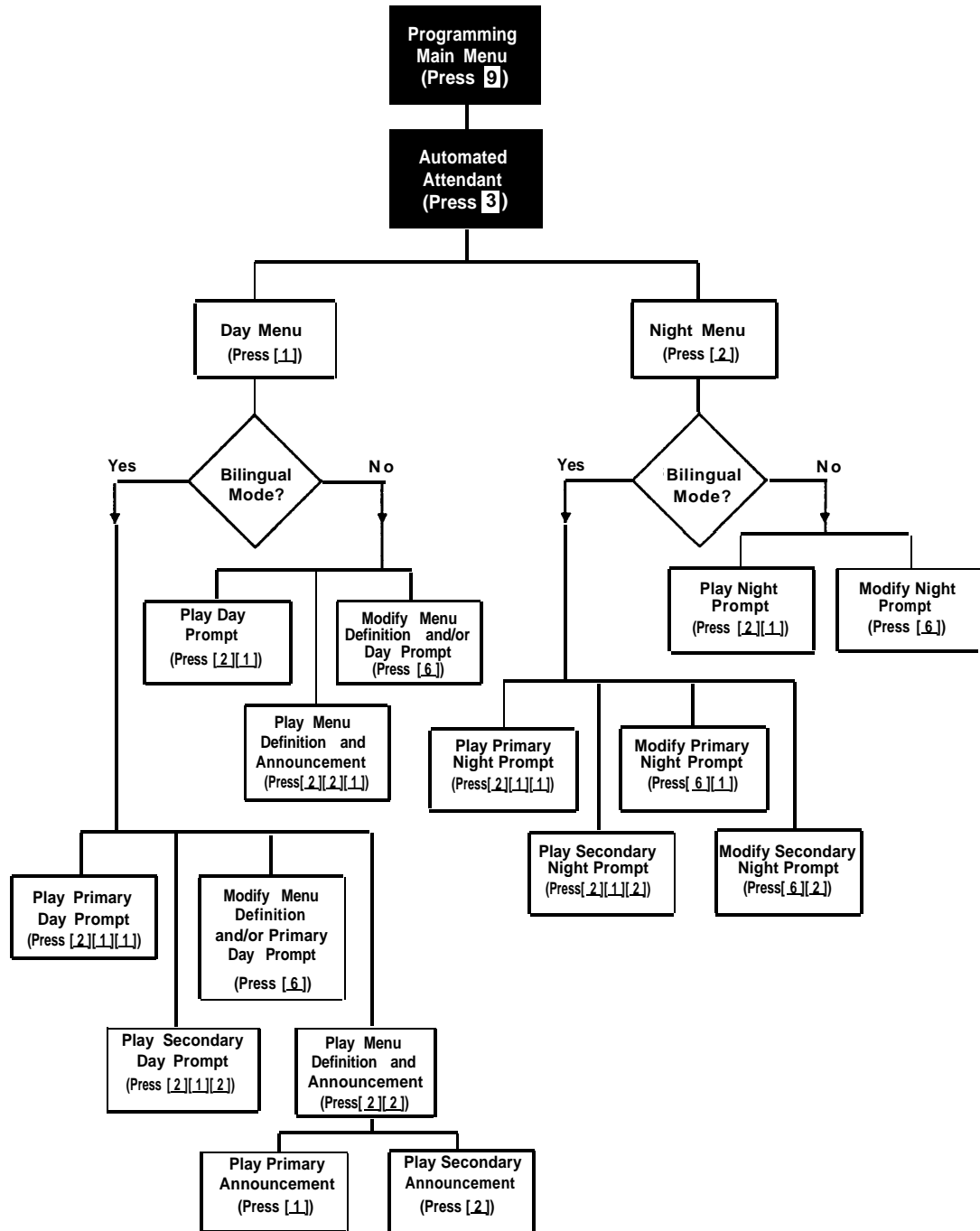

Figure 5-2 Automated Attendant Service Menu

If you need to change current programming for the Automated Attendant Service, you can use the instructions presented in this section. For example:

- If you want to change the transfer options available for outside callers, use “Modifying the Menu Definition, Day Menu Prompt, and Announcements” and “Modifying the Night Menu Prompt” for either Monolingual Mode or Bilingual Mode to update the options, prompts, and/or Announcements callers hear.
- If you add a line to the system that requires Automated Attendant Service, use “Group Call Distribution” to include the new line.
- If you want to change the way Automated Attendant Service handles calls, use “VMS Hunt Delay” and/or “VMS Hunt Schedule.”

Menu Definition, Prompt, and Announcements

When the Automated Attendant Service answers a call, the caller hears a menu prompt that requests the caller to press one or more buttons on the dialpad to transfer to a specific extension or group of extensions, or to hear an Announcement. After the caller presses the button(s), the system transfers the call to the appropriate extension or group, and the caller hears Music On Hold, tones, ringing, or silence, or an Announcement (depending on how the communications system is set up). *Menu Definition* lets you specify the extensions or groups to which outside callers are transferred or the Announcements that callers hear.

The voice messaging system uses the Menu Definition for **both** day and night operation. To set up the menu, you define digits 1 through 9, called *Selector Codes*, for the following types of call transfer:

- **Direct Extension Transfer.** This is the factory setting for selector codes 1 through 8. If you use the factory setting, callers can enter an extension number directly from the menu. For direct extension transfer, the selector code represents a range of extensions. For example, selector code 1 allows outside callers to transfer directly to any extension that begins with a 1—extensions 10–19. For selector code 2, outside callers can transfer directly to any extension that begins with a 2—extensions 20–29, and so on.

Selector code 9 is different from selector codes 1 through 8. If you leave selector code 9 at the factory setting, outside callers are transferred directly to the receptionist’s mailbox where they can leave a message. This is especially useful for night operation. If you use it, callers are routed directly to the receptionist’s mailbox—the system does not ring the extension first.

- **Selector Code Transfer.** You can assign any of the selector codes to one specific extension or group. Then when a caller presses the single-digit selector code, the system transfers the call to the specific extension or Calling Group or Hunt Group that you assigned to that digit.

- **Announcement.** You can assign any of the selector codes to an Announcement number. When a caller presses the single-digit selector code, the system plays an Announcement (primary or secondary) that you assigned to that digit. Each Announcement can be up to four minutes in length. You can set the system to play the Announcement and hang up or prompt the caller to press [*] [#] and an extension number.



NOTE:

Voice mail coverage is not provided for group calls. See “Group Calling Tips,” earlier in this chapter, for more information.

Depending on your business, you can define the menu so that some options accommodate callers during normal business hours and other options accommodate after-hours callers. For example: the ANY Travel Agency wants to give outside callers the ability to transfer directly to any employee in their system by dialing the employee’s 2-digit extension number. The company has employees assigned at extensions 10 through 25. Therefore, the company leaves Selector Codes 1 and 2 at the factory setting (Direct Extension Transfer). This leaves Selector Codes 3 through 9 available for Selector Code Transfer. In this case, ANY Travel Agency assigns Selector Code 3 to extension 21 and Selector Codes 4 and 5 to Hunt Groups 1 and 2, respectively.

A sample Day Menu Prompt for the ANY Travel Agency follows:

```
Thank you for calling the ANY Travel Agency.  If you
know the extension of the person you are calling, enter
the extension number now.  To speak with a cruise
specialist, press 3.  For corporate travel, press 4.
For personal travel, press 5.  For assistance, press 0
or, if you have a rotary phone, stay on the line.
```

A sample night menu prompt for the ANY Travel Agency follows:

```
You have reached the ANY Travel Agency.  Our business
hours are 9 to 5, Monday through Friday.  To leave a
message, press 9 and we will return your call as soon as
possible.  If this is an emergency, press 6 for our
special traveler’s assistance information.
```

In this case, the caller who needs after-hours assistance can press [#] to hear the following Announcement:

```
If you have misplaced your airline tickets or passport,
missed your flight or limousine pickup, or have any
other travel emergency after ANY Travel’s standard
business hours, call 1 800 555 6060 to speak with our
special traveler’s assistance program representative.
```

Other Options

Automated Attendant Service provides the following built-in options—no programming required—for use in your menu prompt:

- A third type of transfer option, which is always available to outside and inside callers, may be useful in certain situations. With this type of transfer, when callers press [*] [9], the system prompts them to enter an extension number. Using the example above, if you assigned Selector Code Transfer to Selector Codes 1 and 2 (rather than starting the assignment from 3), you could request callers to press [*] [9], to allow them to transfer to extensions 10 to 25.
- As shown in the sample Day Menu Prompt, you can also instruct a caller to stay on the line for assistance. If so, the voice messaging system *automatically* transfers the call to the receptionist's extension. This option is especially important for callers who have rotary phones.
- As shown in the sample Day Menu Prompt, callers can press [9] at any time to transfer automatically to the receptionist's extension for assistance.
- If the system is set for Bilingual Mode, callers can press [*] [1] to switch between the Primary and Secondary Languages. In this case, you must record two messages for the Day and Night Menu Prompts and Automated Attendant Announcements: one each in the Primary and Secondary Languages.

Monolingual Mode

Playing the Menu Definition and Announcements

This procedure lets you listen to the current Menu Definition and any Announcement associated with a Selector Code. The Menu Definition is accessed through the Day Menu.

To play the current menu definition:

1. Access the Programming Main Menu:
 - a. Press [*Intercom*] [z] [z] [z] or the programmed VMMsgs button.
 - b. Press [9] [9] [#].
 - c. Enter the Password and press [#].
 - d. Press [9].

The system plays the system programming options.

2. Press [9] for Automated Attendant.

The system plays:

To program the Day Menu, press 1. For the Night Menu, press 2.

3. Press [1] for the Day Menu.

The system plays:

To play the menu, press 2; to modify the menu, press 6.
If finished, press * #.

4. Press [2].

The system plays:

To play the menu prompt, press 1. To play the Menu Definition, press 2. If finished, press * #.

5. Press [2] to play the Menu Definition.

The system plays the current Menu Definition. If an Announcement is recorded, the system plays the Selector Code number and associated Announcement number.

6. Press [1] to play or [#] to skip the recorded Announcement assigned to the Selector Code.

The system plays the recorded Announcement and goes to the next Selector Code.

7. Press [*] [z] to return to the Programming Main Menu or hang up to quit.

Playing the Day or Night Menu Prompt

To listen to the current Day or Night Menu Prompt:

1. Access the Programming Main Menu:

- a. Press [*Intercom*] [z] [z] [z] or the programmed VMMsgs button.

- b. Press [9] [9] [#].

- c. Enter the Password and press [#].

- d. Press [9].

The system plays the system programming options.

2. Press [2] for Automated Attendant.

The system plays:

To program the Day Menu, press 1. For the Night Menu, press 2. If finished, press * #.

3. Either:

- Press [1] for the Day Menu.

- Press [2] for the Night Menu.

The system plays:

To play the menu, press 2; to modify the menu, press 6.
If finished, press * #.

4. Press [2].
The system plays:
To play the menu prompt, press 1. To play the Menu Definition, press 2. If finished, press * #.
5. To play the Menu Prompt, press [1].
The system plays the Day or Night Menu Prompt depending on your choice in Step 3.
6. Press [*] [2] to return to the Programming Main Menu or hang up to quit.

Modifying the Menu Definition, Day Menu Prompt, and Announcements

Update Forms 3 and 4 for the voice messaging system to show modifications to the Menu Definition and/or Day Menu Prompt; update Forms 3 and 3A for the voice messaging system to show modifications to the Announcements, if any. Then use the updated forms while performing the following procedure.



CAUTION:

*It is important to understand that you must approve each element (that is, the Menu Definition, the Day Menu Prompt, and any Announcements, as well as save all of these entries (in Step 15). **If you exit at any point before saving your approved entries, your entries will be lost.** This procedure is designed to ensure that callers do not hear the incomplete menu while you are in the process of modifying it.*

To change the Menu Definition, Day Menu Prompt, and/or Announcements:

1. Access the Programming Main Menu:
 - a. Press [*Intercom*] [2] [2] [2] or the programmed VMMSgs button.
 - b. Press [2] [2] [#].
 - c. Enter the Password and press [#].
 - d. Press [2].

The system plays the system programming options.
2. Press [2] for Automated Attendant.
The system plays:
To program the Day Menu, press 1. For the Night Menu, press 2. If finished, press * #.
3. Press [1].
The system plays:
To play the menu, press 2; to modify the menu, press 6. If finished, press * #.

4. Press [6].

The system plays:

Please enter a selector code from 1 to 9. When finished modifying the Menu Definition, press * #.

5. If you want to modify only the Day Menu Prompt, go to Step 10. Otherwise, continue with Step 6.
6. Enter a Selector Code from 1 through 9.

The system plays the current Selector Code Action (or Announcement Number and Announcement), then asks:

Do you want to make a modification? Press 9 to confirm or 6 to cancel.

7. Press [2] to confirm that you want to modify this Selector Code.

The system plays:

For selector code transfer, press 1; for announcement, press 3; for direct extension transfer, press 5.

8. At this point, do one of the following:
 - If you want to return the Selector Code to the factory setting (direct extension transfer for Selector Code 1 through 8 and transfer to receptionist's mailbox for Selector Code 9), press [5]. Repeat Steps 6 through 8 for each Selector Code you want to modify. Go to Step 10.
 - If you want to assign a different extension or group to the Selector Code, press [1] then enter the desired extension or group number, followed by [#]. Repeat Steps 6 through 8 for each Selector Code you want to modify. Go to Step 10.
 - If you want to change an Announcement, press [3]. Go to Step 9.

9. Enter an Announcement number (1 or 2). Go to Step 11.

The system plays:

To record a new announcement, press 1; to use existing announcement, press #.

10. Press [*] [#] to approve your entries and finish modifying the Menu Definition.

The system plays:

To record a new prompt for this menu, press 1. To use the existing prompt and save any Menu Definition changes, press #.

11. If you do not want to record a new Day Menu Prompt or Announcement, press [#] and go to Step 16; otherwise, continue with Step 12.
12. To record a new Day Menu Prompt or Announcement, lift the handset, press [1], and record after the beep. The prompt or Announcement can be up to four minutes long.
13. Press [1] when you are finished recording.

14. Choose an option or skip this step:
 - Press [2] [1] to immediately re-record the Day Menu Prompt or Announcement. Begin recording immediately after the beep; press [1] after recording. Repeat, if desired. Otherwise, go to Step 15.
 - Press [2] [3] to play back the Day Menu Prompt or Announcement. Repeat, if necessary.
 - Press [3] [3] to delete the Day Menu Prompt or Announcement.
Return to Step 11.
15. Press [3] [#] to *approve and save* the Day Menu Prompt or Announcement.
The system plays:
Approved. Menu Definition saved.
16. Press [3] [Z] to return to the Programming Main Menu or hang up to quit.

Modifying the Night Menu Prompt

Update Form 5 for the voice messaging system to show modifications to the Night Menu Prompt; then use the updated form while performing the following procedure.

To change the Night Menu Prompt:

1. Access the Programming Main Menu:
 - a. Press [*Intercom*] [Z] [Z] [Z] or the programmed VMMsgs button.
 - b. Press [9] [9] [#].
 - c. Enter the Password and press [#].
 - d. Press [9].
The system plays the system programming options.
2. Press [3] for Automated Attendant.
The system plays:
To program the Day Menu, press 1. For the Night Menu, press 2. If finished, press * #.
3. Press [2].
The system plays:
To play the menu, press 2; to modify the menu, press 6. If finished, press * #.
4. Press [6].
The system plays:
To record a new prompt for this menu, press 1. To use the existing prompt, press #.
5. Lift the handset, press [1], and record the Night Menu Prompt.

6. Press [1] when you are finished recording.
 7. Choose an option or skip this step:
 - Press [2] [1] to immediately re-record the Night Menu Prompt. Begin recording immediately after the beep; press [1] after recording. Repeat, if desired.
 - Press [2] [2] to play back the Night Menu Prompt.
 - Press [*] [2] to delete the Night Menu Prompt.

The system plays:

Deleted. To record a new prompt for this menu, press 1. To use the existing prompt, press #.

Return to Step 5.
 8. Press [*] [#] to approve the Night Menu Prompt.
- The system plays:
- Approved.
9. Press [*] [Z] to return to the Programming Main Menu or hang up to quit.

Bilingual Mode

Playing the Menu Definition and Announcements

This procedure lets you listen to the current Menu Definition and any Announcement associated with a Selector Code. The Menu Definition is accessed through the Day Menu.

To play the current Menu Definition:

1. Access the Programming Main Menu:
 - a. Press [*Intercom*] [Z] [Z] [Z] or the programmed VMMsgs button.
 - b. Press [2] [2] [#].
 - c. Enter the Password and press [#].
 - d. Press [2].

The system plays the system programming options.
 2. Press [2] for Automated Attendant.
- The system plays:
- To program the Day Menu, press 1. For the Night Menu, press 2. If finished, press * #.
3. Press [1] for the Day Menu.
- The system plays:
- To play the menu, press 2; to modify the menu, press 6. If finished, press * #.

4. Press [2].

The system plays:

To play the menu prompt, press 1. To play the Menu Definition, press 2. If finished, press * #.

5. Press [2] to play the Menu Definition.

The system plays the current Menu Definition. If an Announcement is recorded, the system plays the Selector Code and associated Announcement number.

6. Either:

— Press [#] if you do not want to listen to the Announcement and go to the next Selector Code.

— Press [1] to play the Primary Language Announcement assigned to the Selector Code.

— Press [2] to play the Secondary Language Announcement assigned to the Selector Code.

The system plays the recorded Announcement.

7. Press [*] [Z] to return to the Programming Main Menu or hang up to quit.

Playing the Day and Night Menu Prompts in the Primary and Secondary Languages

To listen to the current Day or Night Menu Prompts in the Primary and Secondary Languages selected for Bilingual Mode:

1. Access the Programming Main Menu:

a. Press [*Intercom*] [Z] [Z] [Z] or the programmed VMMsgs button.

b. Press [2] [2] [#].

c. Enter the Password and press [#].

d. Press [2].

The system plays the system programming options.

2. Press [3] for Automated Attendant.

The system plays:

To program the Day Menu, press 1. For the Night Menu, press 2. If finished, press * #.

3. Either:

— Press [1] for the Day Menu.

— Press [2] for the Night Menu.

The system plays:

To play the menu, press 2; to modify the menu, press 6. If finished, press * #.

4. Press [2].

The system plays:

To play the menu prompt, press 1. To play the Menu Definition, press 2. If finished, press * #.

5. Press [1] to play the menu prompt.

The system plays:

To play Primary Language prompt, press 1. To play Secondary Language prompt, press 2. If finished, press * #.

6. Either:

— Press [1] for the Primary Language prompt.

— Press [2] for the Secondary Language prompt.

The system plays the Day or Night Menu Prompt (depending on your choice in Step 3) in either the Primary or Secondary Language (depending on your choice in Step 6).

7. Repeat Step 6 to play the Day or Night Menu Prompt in the other language.
8. Press [*] [Z] to return to the Programming Main Menu or hang up to quit.

Modifying the Menu Definition, Day Menu Prompts, and Announcements

Update Forms 3 and 4A for the voice messaging system to show modifications to the Menu Definition and/or Day Menu Prompts; update forms 3, 3A, and 3B for the voice messaging system to show modifications to the Automated Attendant Announcements. Then use the updated forms while performing the following procedure.



CAUTION:

*It is important to understand that you must approve each element (that is, the Menu Definition, the Day Menu Prompt, and any Announcements, as well as save all of these entries (in Step 21). **If you exit at any point before saving your approved entries, your entries will be lost.** This procedure is designed to ensure that callers do not hear the incomplete menu while you are in the process of modifying it.*

To change the Menu Definition, Day Menu Prompts, and Announcements:

1. Access the Programming Main Menu:
 - a. Press [*Intercom*] [Z] [Z] [Z] or the programmed VMMsgs button.
 - b. Press [9] [9] [#].
 - c. Enter the Password and press [#].
 - d. Press [9].

The system plays the system programming options.
2. Press [3] for Automated Attendant.

The system plays:

To program the Day Menu, press 1. For the Night Menu, press 2. If finished, press * #.
3. Press [1].

The system plays:

To play the menu, press 2; to modify the menu, press 6. If finished, press * #.
4. Press [6].

The system plays:

Please enter a selector code from 1 to 9. When finished modifying the Menu Definition, press * #.
5. If you want to modify only the Day Menu Prompt or Announcement, go to Step 10. Otherwise, continue with Step 6.

6. Enter a Selector Code from 1 through 9.

The system plays the current Selector Code Action (or Announcement number and Announcement), then asks:

Do you want to make a modification? Press 9 to confirm or 6 to cancel.

7. Press [9] to confirm that you want to modify this Selector Code.

8. At this point, do one of the following:

— If you want to return the Selector Code to the factory setting (Direct Extension Transfer for Selector Code 1 through 8 and transfer to receptionist's mailbox for Selector Code 9), press [5]. Repeat Steps 6 through 8 for each Selector Code you want to modify. Go to Step 10.

— If you want to assign a different extension or group to the Selector Code, press [1] then enter the desired extension or group number, followed by [#]. Repeat Steps 6 through 8 for each Selector Code you want to modify. Go to Step 10.

— If you want to change an Announcement, press [3]. Go to Step 9.

9. Enter an Announcement number (1 or 2). Go to Step 11.

The system plays:

To record a new announcement, press 1; to use existing announcement, press #.

10. Press [*] [#] to finish modifying the Menu Definition.

The system plays:

To record Primary Language prompt, press 1. To record Secondary Language prompt, press 2. To save Menu Definition changes, press #.

11. If you do not want to record a Day Menu Prompt or Announcement, press [#] to approve the Menu Definition and go to Step 21; otherwise, continue with Step 12.

12. Lift the handset and:

— Press [1] to record the Day Menu Prompt or Announcement in the Primary Language.

— Press [2] to record the Day Menu Prompt or Announcement in the Secondary Language.

13. Record the prompt or Announcement (up to four minutes in length) after the beep.

14. Press [1] when you are finished recording.

15. Choose an option or skip this step:
 - Press [2] [1] to immediately re-record this Day Menu Prompt or Announcement. Begin recording immediately after the beep; press [1] after recording. Repeat, if desired. Otherwise, go to Step 16.
 - Press [2] [3] to play back this Day Menu Prompt or Announcement.
 - Press [*] [3] to delete this Day Menu Prompt or Announcement.
Return to Step 12.
16. Press [*] [#] to approve this Day Menu Prompt or Announcement.
The system plays:
Approved.
17. To record the Day Menu Prompt or Announcement in the other language, repeat Steps 12 through 16.
18. Do one of the following:
 - If you approved the Day Menu Prompt, go to Step 21.
 - If you approved an Announcement, go to Step 19.
19. Press [*] [#] to move up a menu level.
20. Press [*] [#] to move up another menu level.
21. Press [#] to *approve and save* all changes.
The new Day Menu Prompts, Announcements, and Selector Code changes now take effect.
22. Press [*] [Z] to return to the Programming Main Menu or hang up to quit.

Modifying the Night Menu Prompts

Update Form 5 and 5A for the voice messaging system to show modifications to the Night Menu Prompts; then use the updated form while performing the following procedure.

To change the Night Menu Prompts:

1. Access the Programming Main Menu:
 - a. Press [*Intercom*] [Z] [Z] [Z] or the programmed VMMsgs button.
 - b. Press [2] [2] [#].
 - c. Enter the Password and press [#].
 - d. Press [2].

The system plays the system programming options.

2. Press [3] for Automated Attendant.

The system plays:

To program the Day Menu, press 1. For the Night Menu, press 2. If finished, press * #.

3. Press [2].

The system plays:

To play the menu, press 2; to modify the menu, press 6.
If finished, press * #.

4. Press [6].

The system plays:

To record Primary Language prompt, press 1. To record
Secondary Language prompt, press 2. To save any
recordings, press #.

5. Lift the handset:

- Press [1] to record the Night Menu Prompt in the Primary Language.
- Press [2] to record the Night Menu Prompt in the Secondary Language.

6. Record the prompt after the beep.

7. Press [1] when you are finished recording.

8. Choose an option or skip this step:

- Press [2][1] to immediately re-record this Night Menu Prompt. Begin recording immediately after the beep; press [1] after recording. Repeat, if desired.
- Press [2][3] to play back this Night Menu Prompt.
- Press [3][3] to delete this Night Menu Prompt.

The system plays:

Deleted. To record Primary Language prompt,
press 1. To record Secondary Language prompt,
press 2. To save any recordings, press #.

Return to Step 5.

9. Press [3][#] to approve this Night Menu Prompt.

The system plays:

Approved.

10. To record the Night Menu Prompt in the other language, repeat Steps 5 through 9.

11. Press [#] to approve all changes.

The new Night Menu Prompts now take effect.

12. Press [3][Z] to return to the Programming Main Menu or hang up to quit.

Group Call Distribution

Use this communications system procedure to specify a new outside line on which you want Automated Attendant Service.

Update Line Coverage on Form A, Page 1 of the *System Planner* for the communications system to show modifications to VMS-AA lines before you begin.

To assign VMS-AA lines to Hunt Group 7:

1. Press [*Feature*] [0] [0] [*System Program*] [*System Program*].
2. Enter the System Password, if required.
3. Press [#] [2] [0] [6]*.
4. At the Group: prompt, press [7].
5. At the Line: prompt, enter the first VMS-AA line to be programmed as specified in the Line Coverage column of Form A, Page 1.
6. Press [*Next Data*] until the display reads 1 Assigned. (Be careful not to choose 3 VMS Line Cover because you will assign VMS Line Coverage rather than Automated Attendant Service to the line.)
7. To program another line, press [*Next Item*] or [*Prev Item*] until the appropriate line number displays.
8. Press [*Next Data*] until the display reads 1 Assigned.
9. Repeat Steps 7 and 8 for each VMS-AA line.
10. Press [*Feature*] [0] [0] to exit programming.

VMS Hunt Delay

Use this communications system procedure to specify either immediate or delayed call handling.

Update Form A, Page 2 of the *System Planner* for the communications system to show modifications to the VMS Hunt Delay setting before you begin.

To change the VMS Hunt Delay setting:

1. Press [*Feature*] [0] [0] [*System Program*] [*System Program*].
2. Enter the System Password, if required.
3. Press [#] [5] [0] [6].
4. Press [*Next Data*] until the appropriate value displays.
5. Press [*Feature*] [0] [0] to exit programming.

* In some countries, the procedure code for Group Call Distribution is #205. Check the *Programming and Use* guide for the communications system.

Automatic Extension Privacy

If VMS Hunt Delay is set to Immediate, use this procedure to prevent users from accidentally picking up calls sent to the voice messaging system.

Update Form B1 of the *System Planner* for the communications system to show Automatic Extension Privacy (#304) as Assigned for the PARTNER MAIL VS extensions.

To change the Automatic Extension Privacy setting:

1. Press [*Feature*] [0] [0] [*System Program*] [*System Program*].
2. Enter the System Password, if required.
3. Press [#] [3] [0] [4].
4. Enter the first PARTNER MAIL VS extension number specified on Form B1.
5. Press [*Next Data*] until the display reads 1 Assigned.
6. Press [*Next Item*] or [*Prev Item*] until the next PARTNER MAIL VS extension number specified on Form B1 displays.
7. Press [*Next Data*] until the display reads 1 Assigned.
8. If additional PARTNER MAIL VS extensions are specified on Form B1, repeat Steps 6 and 7 for each one.
9. Press [*Feature*] [0] [0] to exit programming.

VMS Hunt Schedule

Use this communications system procedure to specify when the communications system is to route calls to the voice messaging system.

Update Form A, Page 2 of the *System Planner* for the communications system to show modifications to the VMS Hunt Schedule setting before you begin.

To change the VMS Hunt Schedule setting:

1. Press [*Feature*] [0] [0] [*System Program*] [*System Program*].
2. Enter the System Password, if required.
3. Press [#] [3] [0] [7].
4. Press [*Next Data*] until the appropriate value displays.
5. Press [*Feature*] [0] [0] to exit programming.

Modifying Mailboxes

The voice messaging system is shipped with mailboxes already created for a predetermined number of extensions. If a Mailbox Expansion Card is installed, mailbox capacity is increased. The characteristics of mailboxes are as follows:

- **Receptionist's Extension.** Extension 10 has a maximum storage capacity of 60 minutes (or 120 messages). Each message has a maximum length of four minutes.
- **All Other Extensions.** Other extensions each have a maximum storage capacity of 20 minutes (or 40 messages).

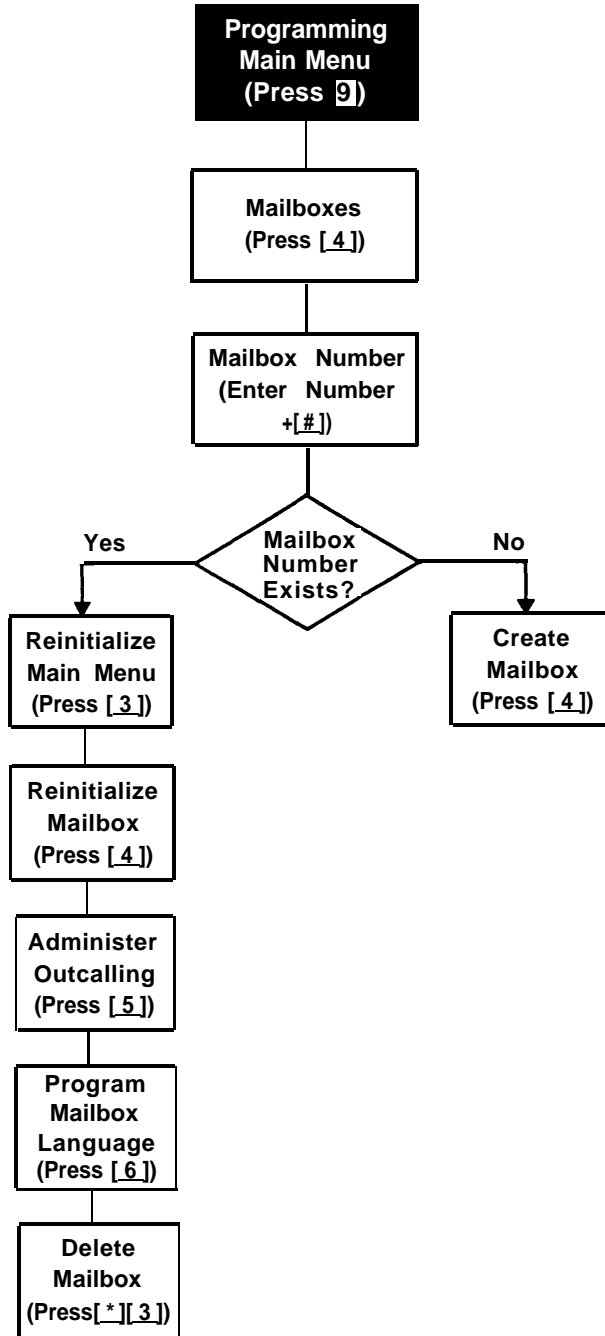

Figure 5-3. Modifying Mailboxes

If you need to change current mailbox programming, you can use the instructions presented in this section. For example:

- If an employee leaves the company, you can set up the previously assigned mailbox number for a new employee. To do so, use “Reinitializing a Mailbox,” which returns the mailbox to its factory settings and deletes any messages that were in the mailbox.
- If you want to reassign a mailbox (move a mailbox from the current extension to a different one), first use “Deleting a Mailbox” then use “Creating a Mailbox.” You may also need to perform these procedures when you increase the number of mailboxes as the result of upgrading the PARTNER MAIL VS configuration. Keep in mind that you should always delete mailboxes from extensions to which you connect auxiliary equipment (such as doorphones and fax machines) to keep the maximum number of mailboxes available for subscribers.
- If a subscriber forgets his or her password, use “Reinitializing a Password” to return the password to the factory setting (1234).
- If a subscriber would like to interact with Voice Mail Service using a language different from the one assigned to his or her mailbox, use “Modifying a Mailbox’s Language.”
- If you want to activate or deactivate Outcalling for a subscriber’s mailbox, refer to “Administering Outcalling for a Mailbox.” As the default setting, Outcalling privileges are denied. Even after you activate Outcalling for a subscriber’s mailbox, the subscriber must also turn on this feature and specify an Outcalling number by following the procedure in *Using the PARTNER MAIL VS® Voice Messaging System*.

Before you change mailbox assignments, you should review the next two sections “Hardware Considerations” and “Guest Mailboxes.”

Hardware Considerations

After you delete a mailbox, you can reassign that mailbox to another subscriber's extension using the "Creating a Mailbox" procedure. Remember that mailbox numbers and extension numbers are the same. You can also assign available mailboxes to extensions that do not have phones connected to them so that guests—employees who work off-premises most of the time, such as salespeople—can access messages while on the road. See "Guest Mailboxes" on the next page for details.

After initial installation, you have default mailboxes for a predetermined number of extensions. When you reassign mailboxes, you can use any mailbox in your system's dial plan. The dial plan is the maximum number of extensions supported by your system. This means on a PARTNER Plus system, you can create mailboxes for extensions 11 through 33; on a PARTNER Advanced Communications System, you can create mailboxes for extensions 11 through 41 (on the 5-slot carrier); on a PARTNER II or PARTNER 48 system, you can create mailboxes for extensions 11 through 57. (Note that the mailbox at extension 10 cannot be deleted.) Figures 5-4 and 5-5 shows the dial plan for each system.

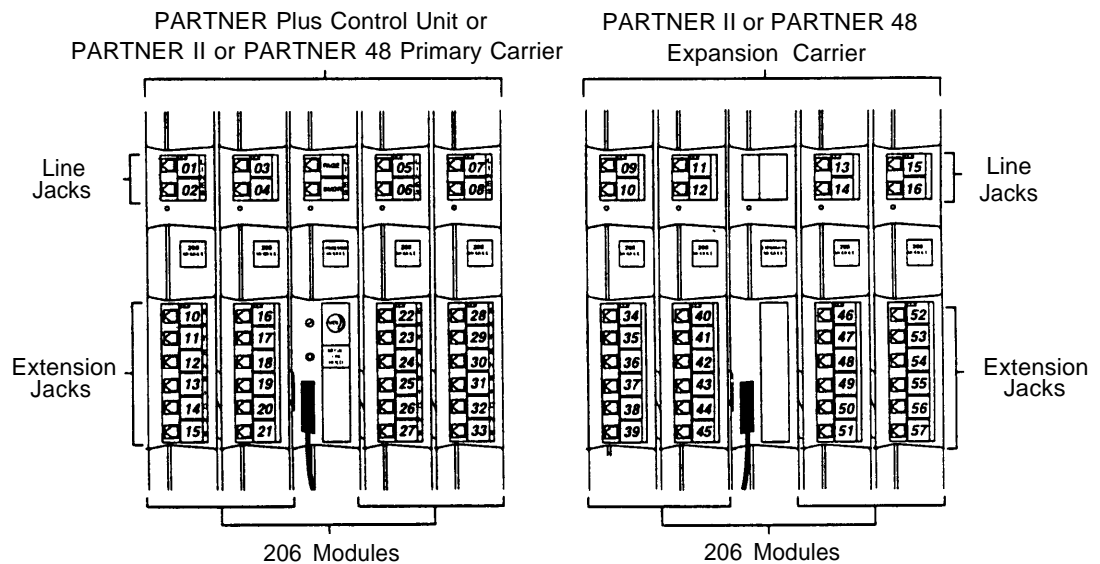

Figure 5-4. Dial Plan for PARTNER Plus, PARTNER II, and PARTNER 48

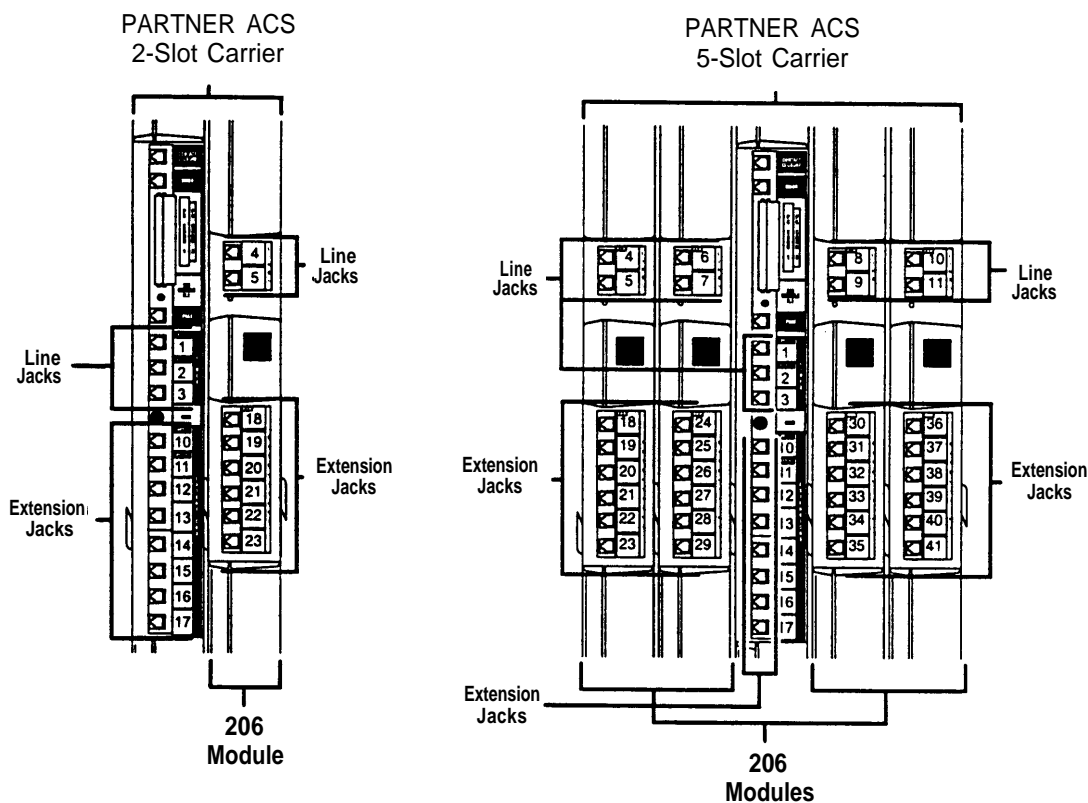

Figure 5-5. Dial Plan for PARTNER Advanced Communications Systems

Keep in mind that the modules you have installed in your carrier may differ from these figures, and will determine the number of extension jacks to which you can connect phones.

Guest Mailboxes

You can assign available mailboxes to extensions in the dial plan that *do not have phones connected to them*. Guest mailboxes are useful for employees who work off-premises most of the time. Guest mailboxes provide all the benefits of a regular mailbox (including Outcalling privileges) except the subscriber does not receive visual indication of a message deposited in the mailbox since there is no phone (and therefore no message waiting light) associated with the mailbox. Guests can call the voice messaging system from any touch-tone phone to retrieve their messages.

Review the following notes before you program guest mailboxes:

- If you *have* empty slots in the carrier, you can assign guest mailboxes to those extensions in the dial plan that correspond to the empty slot(s). When you assign guest mailboxes, it is recommended that you start assignments from the high end of the dial plan. (On a PARTNER Plus system, work backwards from extension 33; on a PARTNER II or PARTNER 48 system, work backwards from extension 57; on a PARTNER Advanced Communications System, work backwards from extension 41.)

After you create a guest mailbox, use “Automatic VMS Cover,” later in this section, to assign automatic coverage to the guest mailbox. Calls to these extensions are routed immediately to the mailbox—the call does not try ringing the extension first.

- If you *do not have* empty slots in the carrier, you can assign guest mailboxes to the unused extension numbers associated with the voice messaging system module. You also need to assign automatic coverage to these guest mailboxes. You can use any of the six extensions on the voice messaging system module for guest mailbox assignments.

Calls routed to these extensions are routed to the subscriber’s mailbox depending on the extension used. Refer to the table below to determine whether calls are routed on an immediate or delayed basis.

For a 2-port system:

- If the bottom two extensions are used, calls are routed to the subscriber’s mailbox on an immediate basis.
- If the remaining four extensions are used, calls are routed to the subscriber’s mailbox after four rings (or after the number of rings programmed in the VMS Cover Ring Interval).

For a 4-port system:

- If the bottom four extensions are used, calls are routed to the subscriber’s mailbox on an immediate basis.
- If the remaining two extensions are used, calls are routed to the subscriber’s mailbox after four rings (or after the number of rings programmed in the VMS Cover Ring Interval).

A 2-port voice messaging system uses the bottom two extension numbers associated with the slot in which the module is installed (see Figures 2-1 and 2-2 in Chapter 2). For example, if the module is installed in the last slot on a PARTNER Plus (see Figure 5-4), it uses extensions 32 and 33. In this case, you can use extensions 28 through 33 for guest mailboxes.

A 4-port system uses the bottom four extensions (for example, 30, 31, 32, and 33). In this case, you can use extensions 28 through 33 for guest mailboxes.

Checking a Mailbox's Status

Use this procedure to determine if a mailbox exists:

1. Access the Programming Main Menu:
 - a. Press [*Intercom*] [z] [z] [z] or the programmed VMMsgs button.
 - b. Press [9] [9] [#].
 - c. Enter the Password and press [#].
 - d. Press [9].

The system plays the system programming options.
2. Press [4] to program mailboxes.

The system tells you how many mailboxes currently exist and how many are allowed, then:

Please enter the mailbox number followed by # or press # for the next mailbox.
3. Enter the number of the mailbox whose status you want to check followed by [#], or simply press [#].

The system responds as follows:

 - If you entered a mailbox number followed by [#], the system tells you whether or not the mailbox exists.
 - If you entered [#], the system tells you the number of the first existing mailbox.
4. Press [#] repeatedly to hear the next existing mailbox number.
5. Press [*] [z] to return to the Programming Main Menu or hang up to quit.

Deleting a Mailbox

Update Form 2 for the voice messaging system to show mailboxes to be deleted; then use the updated form while performing the following procedure.

Review the following notes before you delete a mailbox:

- The receptionist's mailbox (at extension 10) cannot be deleted.
- Any messages in the mailbox are lost when a mailbox is deleted. The message light is turned off. The personal greeting is lost.
- If you delete a mailbox from an extension that has VMS Cover assigned, unassign Automatic VMS Cover or remove the VMS Cover button. This action prevents unanswered intercom and transferred calls to this extension from being transferred to the receptionist's extension.
- If you delete a mailbox that was assigned a line owner using VMS Line Cover, either delete line ownership from that line or assign a different mailbox as the owner of that line. Similarly, if you delete a mailbox that was assigned a line owner using Extension Line Coverage, either unassign coverage or assign a different extension as the owner.



SECURITY ALERT:

As a safeguard against toll fraud, delete unused mailboxes.

To delete a mailbox:

1. Access the Programming Main Menu:
 - a. Press [*Intercom*] [z] [z] [z] or the programmed VMMsgs button.
 - b. Press [9] [9] [#].
 - c. Enter the Password and press [#].
 - d. Press [9].

The system plays the system programming options.

2. Press [4] to program mailboxes.

The system tells you how many mailboxes exist and how many are allowed, then:

Please enter the mailbox number followed by # or press # for the next mailbox.

3. Enter the number of the mailbox you want to delete followed by [#].

The system says whether or not the mailbox exists, then:

To reinitialize the password, press 3. To reinitialize the mailbox, press 4. To administer Outcalling, press 5. To program the Mailbox Language, press 6. To delete the mailbox, press * D.

4. Press [3] [3].

The system plays:

Mailbox XX has YY new messages and ZZ old messages. Do you want to delete? Press 9 to confirm or 6 to cancel.

5. Press [9] to confirm mailbox deletion.

The system plays:

Deleted.

6. Press [3] [z] to return to the Programming Main Menu or hang up to quit.

Creating a Mailbox

Update Form 2 for the voice messaging system to show mailboxes to be created; then use the updated form while performing the following procedure.

The system is shipped with mailboxes for a predetermined number of extensions. If you already have the maximum amount of mailboxes, you must delete an unused mailbox before you can create a new one.

Review the following notes before you create a mailbox:

- Mailboxes can be created for extensions 11 through 33 for the PARTNER Plus, 11 through 41 for PARTNER Advanced systems, and 11 through 57 for the PARTNER II and PARTNER 48 system. See “Hardware Considerations” earlier in this chapter for details.
- When a mailbox is created, it uses the factory set password (1234) and the factory set Mailbox Language in either the System Language (in Monolingual Mode) or Primary Language (in Bilingual Mode). The Mailbox Language can be changed on a per mailbox basis. See “Modifying a Mailbox Language,” later in this chapter for details.
- You can create a guest mailbox for an extension that does not have a phone connected to it. See “Guest Mailboxes” earlier in this chapter for details.

To create a mailbox:

1. Access the Programming Main Menu:
 - a. Press [*Intercom*] [Z] [Z] [Z] or the programmed VMMsgs button.
 - b. Press [*g*] [*g*] [#].
 - c. Enter the Password and press [#].
 - d. Press [*g*].

The system plays the system programming options.
2. Press [4] to program mailboxes.

The system tells you how many mailboxes exist and how many are allowed, then:

Please enter the mailbox number followed by # or press # for the next mailbox.
3. Enter the number of the mailbox you want to create followed by [#].

The system plays:

Mailbox XX does not exist. To create this mailbox, press 4. If finished with this mailbox, press * #, or press # for the next mailbox.

4. Press [4].
The system plays:
Created.
5. Press [*] [z] to return to the Programming Main Menu or hang up to quit.

Reinitializing a Password

If a subscriber forgets the password for his or her mailbox, you can reinitialize the password to the factory setting of 1234 so the user can retrieve messages. Remind the subscriber to change the password immediately after logging in for the first time.

To reinitialize a password to 1234:

1. Access the Programming Main Menu:
 - a. Press [*Intercom*] [z] [z] [z] or the programmed VMMsgs button.
 - b. Press [9] [9] [#].
 - c. Enter the Password and press [#].
 - d. Press [9].

The system plays the system programming options.
2. Press [4] to program mailboxes.
The system tells you how many mailboxes exist and how many are allowed, then:
Please enter the mailbox number followed by # or press # for the next mailbox.
3. Enter the number of the mailbox whose password you want to reinitialize followed by [#].
The system plays:
Mailbox XX exists. To reinitialize the password, press 3. To reinitialize the mailbox, press 4. To administer Outcalling, press 5. To program the Mailbox Language, press 6. To delete the mailbox, press * D. If finished with this mailbox, press * #, Or press # for the next mailbox.
4. Press [9].
The system plays:
The password has been reinitialized.
5. Press [*] [z] to return to the Programming Main Menu or hang up to quit.

Reinitializing a Mailbox

To prepare a previously used mailbox for a new subscriber, you can reinitialize the mailbox. This procedure deletes any messages left in the mailbox and turns off the phone's message light (if lit), erases the personal greeting (if recorded), changes the password back to the factory setting (1234), and changes the Mailbox Language back to either the System Language (Monolingual Mode) or the Primary Language (Bilingual Mode).

To reinitialize a mailbox:

1. Access the Programming Main Menu:

- a. Press [*Intercom*] [Z] [Z] [Z] or the programmed VMMSgs button.
- b. Press [9] [9] [#].
- c. Enter the Password and press [#].
- d. Press [9].

The system plays the system programming options.

2. Press [4] to program mailboxes.

The system tells you how many mailboxes exist and how many are allowed, then:

Please enter the mailbox number followed by # or press # for the next mailbox.

3. Enter the number of the mailbox you want to reinitialize followed by [#].

The system plays:

Mailbox XX exists. To reinitialize the password, press 3. To reinitialize the mailbox, press 4. To administer Outcalling, press 5. To program the Mailbox Language, press 6. To delete, press * D. If finished with this mailbox, press * #, or press # for the next mailbox.

4. Press [4].

The system plays:

Mailbox XX has YY new and ZZ old messages. Do you want to reinitialize this mailbox? Press 9 to confirm or 6 to cancel.

5. Press [9].

The system plays:

Reinitialized.

6. Press [*] [Z] to return to the Programming Main Menu or hang up to quit.

Playing a Mailbox's Language

To play the language currently used for a mailbox:

1. Access the Programming Main Menu:
 - a. Press [*Intercom*] [Z] [Z] [Z] or the programmed VMMSgs button.
 - b. Press [9] [9] [#].
 - c. Enter the Password and press [#].
 - d. Press [9].

The system plays the system programming options.

2. Press [4] to program mailboxes.

The system tells you how many mailboxes exist and how many are allowed, then:

Please enter the mailbox number followed by # or press # for the next mailbox.

3. Enter the number of the mailbox whose language you want to play followed by [#].

The system plays:

Mailbox XX exists. To reinitialize the password, press 3. To reinitialize the mailbox, press 4. To administer Outcalling, press 5. To program the Mailbox Language, press 6. To delete the mailbox, press * D. If finished with this mailbox, press * #, or press # for the next mailbox.

4. Press [9].

The system plays:

To play Mailbox Language, press 2. To modify Mailbox Language, press 6. If finished, press * #.

5. Press [2].

The system plays:

Mailbox language is LANGUAGE (where LANGUAGE is the current language).

6. Press [*] [Z] to return to the Programming Main Menu or hang up to quit.

Modifying a Mailbox's Language

Update Form 2 for the voice messaging system to show the languages assigned to mailboxes; then use the updated form while performing the following procedure.

To modify a mailbox's language:

1. Access the Programming Main Menu:

- a. Press [*Intercom*] [Z] [Z] [Z] or the programmed VMMsgs button.
- b. Press [9] [9] [#].
- c. Enter the Password and press [#].
- d. Press [9].

The system plays the system programming options.

2. Press [4] to program mailboxes.

The system tells you how many mailboxes currently exist and how many are allowed, then:

Please enter the mailbox number followed by # or press # for the next mailbox.

3. Enter the number of the mailbox whose language you want to modify followed by [#].

The system plays:

Mailbox XX exists. To reinitialize the password, press 3. To reinitialize the mailbox, press 4. To administer Outcalling, press 5. To program the Mailbox Language, press 6. To delete the mailbox, press * D. If finished with this mailbox, press * #, or press # for the next mailbox.

4. Press [6].

The system plays:

To play Mailbox Language, press 2 To modify Mailbox Language, press 6. If finished, press * #.

5. Press [6].

The system plays the current Mailbox Language, then prompts you to enter the number corresponding to the desired language.

6. Enter the number corresponding to the language you want to use for this mailbox.

The system plays:

For LANGUAGE (where LANGUAGE is the current language), press 9 to confirm or 6 to cancel.

7. Either:

— Press [2] to confirm.

The system plays:

Mailbox Language has been changed.

— Press [6] to cancel.

The system plays:

Mailbox Language has not been changed.

8. Press [*] [Z] to return to the Programming Main Menu or hang up to quit.

Administering Outcalling for a Mailbox

The Outcalling feature dials a telephone or pager number to notify a subscriber that a new message has arrived in the subscriber's voice mailbox. With this feature subscribers can be alerted to the arrival of new messages whether they're at their desks, on the road, or at an alternate work location. And subscribers can determine the schedule for when Outcalling begins and ends.

Before subscribers can turn on Outcalling, specify the Outcalling number, and establish an Outcalling schedule (optional), you must assign Outcalling privileges for their mailboxes. You may also remove Outcalling privileges by following the instructions below. Be sure to update Form 2 to indicate the current status of Outcalling privileges for each mailbox.



CAUTION:

Before you assign mailboxes Outcalling privileges, you should review the system performance and security issues discussed in detail in Chapter 1. There are no restrictions on the Outcalling Numbers entered by subscribers. Therefore, it is strongly recommended that you limit the number of subscribers who have the Outcalling privilege. And call restrictions should be used for the communications system. See "Outgoing Call Restriction" in Chapter 4 for details.

To assign or remove Outcalling privileges for a mailbox:

1. Access the Programming Main Menu:

- a. Press [*Intercom*] [Z] [Z] [Z] or the programmed VMMsgs button.
- b. Press [2] [2] [#].
- c. Enter the Password and press [#].
- d. Press [2].

The system plays the system programming options.

2. Press [4] to program mailboxes.

The system tells you how many mailboxes exist and how many are allowed, then:

Please enter the mailbox number followed by # or press # for the next mailbox.

3. Enter the number of the mailbox for which you want to activate/deactivate Outcalling privileges followed by [#].

The system plays:

Mailbox XX exists. To reinitialize the password, press 3. To reinitialize the mailbox, press 4. To administer Outcalling, press 5. To program the Mailbox Language, press 6. To delete the mailbox, press * D. If finished with this mailbox, press * #, or press # for the next mailbox.

4. Press [5] to administer Outcalling.

The system plays:

To turn on Outcalling, press 9. To turn off Outcalling, press 6.

5. Either:

— Press [9] to activate Outcalling.

The system plays:

Outcalling is turned on.

— Press [6] to deactivate Outcalling.

The system plays:

Outcalling is turned off.

6. To activate/deactivate Outcalling for another mailbox, repeat steps 3 through 5.
7. Press [*] [z] to return to the Programming Main Menu or hang up to quit.

Automatic VMS Cover

Use this communications system procedure to assign automatic voice mail coverage to the appropriate extensions.

Update Form B2 of the *System Planner* for the communications system before you begin.

To assign Automatic VMS Cover to extensions:

1. Press [*Feature*] [0] [0] [*System Program*] [*System Program*].
2. Enter the System Password, if required.
3. Press [#] [3] [1] [0].
4. Enter the number of the extension to be covered by the voice messaging system.
5. Press [*Next Data*] until the display reads 1 Assigned.
6. To program another extension, press [*Next Item*] or [*Prev Item*] until the extension number shows on the display. Then repeat Step 5.
7. Press [*Feature*] [0] [0] to exit programming mode.

VMS Cover Rings

Use this communications system procedure* to change the number of times calls should ring at the extension before they are sent to the subscriber's mailbox.

Update Form A, Page 2 of the *System Planner* for the communications system before you begin.

To change the number of times calls ring before they are sent to the voice messaging system:

1. Press [*Feature*] [0] [0] [*System Program*] [*System Program*].
2. Enter the System Password, if required.
3. Press [#] [1] [1] [Z].
4. Enter the VMS Cover Rings setting.
5. Select another procedure or exit programming mode.

* VMS Cover Rings (#117) is not available on all systems. Check the *Programming and Use* guide for the communications system.

Line Coverage

This feature lets callers who call in on a covered line leave messages in the mailbox of a specific subscriber. Line coverage typically is used for personal lines or outside access to the voice messaging system if Automated Attendant Service is not used.

There are two ways to set up line coverage:

- For VMS Line Coverage, you must program the voice messaging system's Line Ownership feature and the communication system's Group Call Distribution (#206)* feature.

With this method, when a call on a covered line is not answered within five rings, the voice messaging system routes the caller to the line owner's mailbox. The caller then hears the personal greeting for the line owner's mailbox.

- For Extension Line Coverage, you only need to program the communication system's Line Coverage Extension (#208)† feature.

This method provides flexibility for calls ringing on covered lines. You can specify the number of times calls ring at the user's extension before going to the user's mailbox (using the communication system's VMS Cover Rings (#117)† feature). In addition, if the user's extension has Do Not Disturb on, calls on the line can go immediately to coverage.

For both types of line coverage, voice mail coverage must be on at the user's extension.



IMPORTANT:

A line can be assigned coverage as described in this section *or* it can be assigned Automated Attendant Service coverage—a single line *cannot* be assigned both types of coverage.

* In some countries, the procedure code for Group Call Distribution is #205. Check the *Programming and Use* guide for the communications system.

† Line Coverage Extension (#208) and VMS Cover Rings (#117) are not available on all systems. Check the *Programming and Use* guide for the communications system.

VMS Line Coverage

If you specify VMS Line Coverage for any system lines, you must assign an owner to the covered lines to prevent the system from transferring callers who call in on those lines to the receptionist's extension.

This section provides instructions on how to:

- Use Line Ownership (see Figure 5-6) to scan, assign, modify, and delete current assignments for VMS Line Coverage
- Use Group Call Distribution to specify new lines for VMS Line Coverage

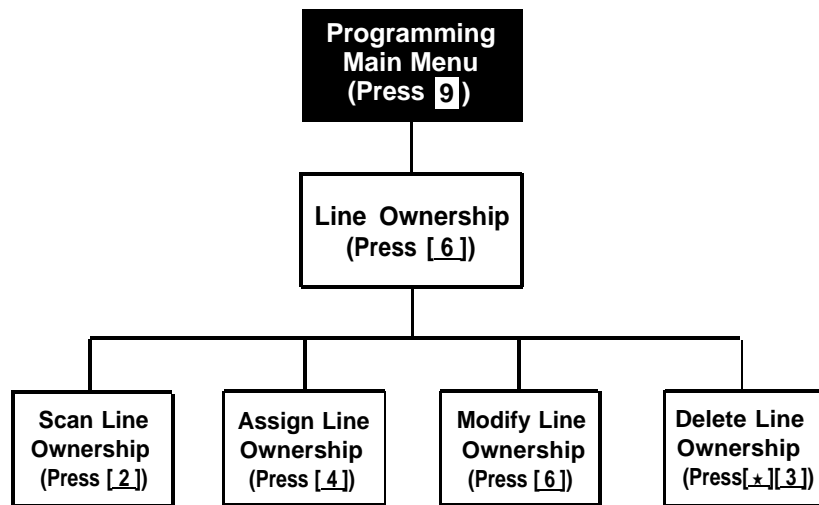

Figure 5-6. Line Ownership

Scanning Line Ownership

To review the current owners of outside lines:

1. Access the Programming Main Menu:
 - a. Press [*Intercom*] [Z] [Z] [Z] or the programmed VMMsgs button.
 - b. Press [9] [9] [#].
 - c. Enter the Password and press [#].
 - d. Press [9].

The system plays the system programming options.

2. Press [6] for line ownership.

The system plays:

To scan line ownership, press 2; to assign line ownership, press 4; to modify line ownership, press 6. To delete line ownership, press * D.

3. Press [2].

The system plays:

Please enter the CO line number followed by #, or press # for the next line owner.

4. Enter a specific outside line number followed by [#], or press [#] for the first outside line number that has been assigned an owner.

The system responds as follows:

- If you entered a line number followed by [#], the system tells you whether or not an owner is assigned.
- If you entered [#], the system tells you the mailbox number of the owner of the first outside line that has an owner.

5. Press [#] to hear the mailbox number for the next outside line that has an owner.
6. Press [*] [Z] to return to the Programming Main Menu or hang up to quit.

Assigning Line Ownership

Update Form 6 for the voice messaging system to show the line number that requires coverage and the line owner's extension number; then use the updated form while performing the following procedure. Make sure you also use "Group Call Distribution (#206)" later in this section to assign coverage to lines.

To associate an outside line with a specific subscriber's mailbox:

1. Access the Programming Main Menu:

- a. Press [*Intercom*] [z] [z] [z] or the programmed VMMsgs button.
- b. Press [9] [9] [#].
- c. Enter the Password and press [#].
- d. Press [9].

The system plays the system programming options.

2. Press [6] for line ownership.

The system plays:

To scan line ownership, press 2; to assign line ownership, press 4; to modify line ownership, press 6. To delete line ownership, press * D.

3. Press [4].

The system plays:

Please enter the CO line number followed by #. If finished, press * #.

4. Enter the number of the outside line that you want to associate with a specific subscriber's mailbox followed by [#].

If the line already has an owner, the system announces the mailbox number of that owner. Otherwise, the system plays:

CO line X has no owner. Entre the mailbox number of the new line owner followed by #. If finished, press * #.

5. Enter the mailbox number followed by [#].

The system plays:

CO Line X owner is mailbox YY.

If the mailbox does not exist, you are told so. See "Creating a Mailbox" earlier in this chapter for instructions on creating mailboxes.

6. Repeat Steps 4 and 5 until you assign line ownership for all of the appropriate lines.

7. Press [*] [z] to return to the Programming Main Menu or hang up to quit.

Modifying Line Ownership

Update Form 6 for the voice messaging system to show modifications to line ownership; then use the updated form while performing the following procedure.

To change line ownership:

1. Access the Programming Main Menu:
 - a. Press [*Intercom*] [Z] [Z] [Z] or the programmed VMMsgs button.
 - b. Press [9] [9] [#].
 - c. Enter the Password and press [#].
 - d. Press [9].

The system plays the system programming options.
2. Press [6] for line ownership.

The system plays:

To scan line ownership, press 2; to assign line ownership, press 4; to modify line ownership, press 6. To delete line ownership, press * D.
3. Press [6].

The system plays:

Please enter the CO line number followed by #.
If finished, press * #.
4. Enter the number of the outside line whose ownership you want to modify followed by [#].

If the line does not have an owner, the system tells you so. Otherwise, the system plays:

CO line X owner is mailbox YY. Enter the mailbox number of the new line owner followed by #. If finished, press * #.
5. Enter the new mailbox number followed by [#].

The system plays:

CO Line X owner is mailbox YY.

If the mailbox does not exist, you are told so. See "Creating a Mailbox" earlier in this chapter for instructions on creating mailboxes.
6. Repeat Steps 4 and 5 to modify the line ownership for any other lines.
7. Press [*] [Z] to return to the Programming Main Menu or hang up to quit.

Deleting Line Ownership

Update Form 6 for the voice messaging system to show the ownership assignments you want to delete; then use the updated form while performing the following procedure.

**NOTE:**

If you remove line ownership, either use Group Call Distribution (#206) to remove VMS Line Coverage from the line or assign a new mailbox number as the owner of the line to prevent the system from transferring callers who call in on the covered line to the receptionist's extension.

To delete an existing line owner assignment:

1. Access the Programming Main Menu:
 - a. Press [*Intercom*] [Z] [Z] [Z] or the programmed VMMsgs button.
 - b. Press [9] [9] [#].
 - c. Enter the Password and press [#].
 - d. Press [9].

The system plays the system programming options.
2. Press [6] for line ownership.

The system plays:

To scan line ownership, press 2; to assign line ownership, press 4; to modify line ownership, press 6. To delete line ownership, press * D.
3. Press [*] [9].

The system plays:

Please enter the CO line number followed by #.
If finished, press * #.
4. Enter the number of the outside line whose ownership you want to delete followed by [#].

The system responds as follows:

 - If the line has an owner, the system tells you the mailbox number of the owner and asks you to confirm the deletion. Go to Step 5.
 - If the line has no owner, the system tells you so and asks you to enter another CO line number. Enter another line number followed by [#] or go to Step 7.
5. Press [9] to confirm that you want to delete the ownership assignment.

The system plays:

Deleted.
6. Repeat Steps 4 and 5 to delete other line ownership assignments.
7. Press [*] [Z] to return to the Programming Main Menu or hang up to quit.

Group Call Distribution

Use this procedure to modify the assignment of outside lines for VMS Line Coverage.

Update Form A, Page 1, Line Coverage of the *System Planner* for the communications system to show modifications to VMS-MAIL lines before you begin.

To modify VMS-MAIL lines assignments:

1. Press [*Feature*] [0] [0] [*System Program*] [*System Program*].
2. Enter System Password, if required.
3. Press [#] [2] [0] [0]*.
4. At the **Group:** prompt, press [z].
5. At the **Line:** prompt, enter the first VMS-MAIL line to be programmed as specified in the Line Coverage column of Form A, Page 1.
6. Press [*Next Data*] until the display reads 3 VMS Line Cover or 2 Not Assigned. (Be careful not to choose 1 Assigned because you will assign Automated Attendant Service coverage rather than ownership to the line.)
7. To program another line, press [*Next Item*] or [*Prev Item*] until the appropriate line number displays. Then press [*Next Data*] until 3 VMS Line Cover or 2 Not Assigned is displayed.
8. Press [*Feature*] [0] [0] to exit programming.

* In some countries, the procedure code for Group Call Distribution is #205. Check the *Programming and Use* guide for the communications system.

Extension Line Coverage

After assigning Extension Line Coverage, make sure VMS coverage is on for the extension. See “Automatic VMS Cover” earlier in this chapter or “VMS Cover” later in this chapter.

Use this procedure to modify the assignment of outside lines for Extension Line Coverage*.

To assign VMS-MAIL lines specified on Form A, Page 1, Line Coverage, to specific extensions:

1. Press [*Feature*] [0] [0] [*System Program*] [*System Program*].
2. Enter System Password, if required.
3. Press [#] [2] [0] [8].
4. At the **Line:** prompt, enter the first VMS-MAIL line to be programmed as indicated by the extension number in the Line Coverage column of Form A, Page 1.
5. At the **Data:** prompt, enter the number of the extension in the VMS-MAIL column.
6. To program another line, press [*Next Item*] or [*Prev Item*] until the appropriate line number displays. Then repeat Step 5.
7. Press [*Feature*] [0] [0] to exit programming.

* This feature is not available on all systems. Check the *Programming and Use* guide for the communications system.

Telephone Button Programming

Update Form C of the *System Planner* for the communications system if you change button programming for a subscriber's extension.

It is recommended that the following features be programmed on buttons on each subscriber's system phone:

- VMS Cover allows the subscriber to manually turn on and off voice mail coverage.
- Do Not Disturb allows the subscriber to send callers to his or her mailbox immediately without first ringing the subscriber's extension.
- Voice Mailbox Transfer allows the subscriber to transfer callers directly to other subscribers' voice mailboxes.
- VM Messages allows the subscriber to access the voice messaging system for message retrieval with the touch of a button.

The procedures in this section use Centralized Telephone Programming.

VMS Cover

To give a subscriber the ability to turn voice mail coverage on and off, you can program a VMS Cover button on the subscriber's system phone.

To program a VMS Cover button:

1. Press [*Feature*] [0] [0] [*System Program*] [*System Program*] [*Central Tel Program*].
2. Enter the number of the extension to be programmed.
3. Press a programmable button with lights.
4. Press [*Feature*] [1] [5]*.
5. Program another button for this extension or press [*Feature*] [0] [0] to exit programming mode.
6. Label the button at the user's extension.

* In some countries, the feature code for VMS Cover is [1] [6]. Check the *Programming and Use* guide for the communications system.

Do Not Disturb

Used in conjunction with either automatic or manual extension coverage, this button lets subscribers send callers immediately to their voice mailbox.

To program a Do Not Disturb button:

1. Press [*Feature*] [0] [0] [*System Program*] [*System Program*] [*Central Tel Program*].
2. Enter the number of the extension to be programmed.
3. Press a programmable button with lights.
4. Press [*Feature*] [0] [1].
5. Program another button for this extension or press [*Feature*] [0] [0] to exit programming mode.
6. Label the button at the user's extension.

Voice Mailbox Transfer

A Voice Mailbox Transfer button lets *any system user* transfer calls directly to another subscriber's mailbox, without ringing the extension. If, for example, a caller wants to talk to a subscriber who is on vacation, the receptionist can transfer the call directly to the subscriber's mailbox by pressing this button and entering the subscriber's extension number (or pressing an Auto Dial button). The voice messaging system answers the call, the caller hears the subscriber's personal greeting (if recorded), and the caller can then leave a message for the subscriber.

To program a Voice Mailbox Transfer button:

1. Press [*Feature*] [0] [0] [*System Program*] [*System Program*] [*Central Tel Program*].
2. Enter the number of the extension to be programmed.
3. Press a programmable button.
4. Press [*Feature*] [1] [4]*.
5. Program another button for this extension or press [*Feature*] [0] [0] to exit programming mode.
6. Label the button at the user's extension.

* In some countries, the feature code for Voice Mailbox Transfer is [1] [5]. Check the *Programming and Use* guide for the communications system.

Voice Mail Messages

This intercom Auto Dial button allows the subscriber to access the voice messaging system with one touch of a button.

To program a Voice Mail Messages button:

1. Press [*Feature*] [0] [0] [*System Program*] [*System Program*] [*Central Tel Program*].
2. Enter the number of the extension to be programmed.
3. Press a programmable button.
4. Press [*Intercom*] [z] [z] [z].
5. Program another button for this extension or press [*Feature*] [0] [0] to exit programming mode.
6. Label the button at the user's extension.

Contents

When You Need Help	6-1
Automated Attendant Service	6-2
■ Outside Callers Hear Ringing, but System Does Not Answer	6-2
■ Outside Callers Hear Silence, Tones, or Ringing During Transfer	6-3
■ System Does Not Answer Immediately	6-3
■ System Cuts Off Part of Greeting	6-3
■ System Transfers Call to Receptionist Before Playing the Menu Prompt	6-3
■ System Does Not Transfer Calls Properly	6-4
■ System Does Not Respond to Entered Digits	6-4
■ Unanswered Transferred Calls Ring Continually	6-5
Call Answer Service	6-6
■ Call Answer Service Takes Too Long to Answer Calls	6-6
■ Call Answer Service Terminates Message While Caller Is Recording	6-6
■ Messages Cannot Be Deposited in Mailbox	6-6
Voice Mail Service	6-7
■ Subscriber Unable to Log In to Voice Mail	6-7
■ Date or Time in Message Headers is Incorrect	6-7
■ Subscriber Cannot Forward Messages to Another Subscriber	6-8
■ Subscribers Hear Busy Signal When Calling In to Voice Mail	6-8
■ Message Light Does Not Turn Off	6-9
■ Outcalling Is Delayed	6-9
■ Outcalling to a Digital Pager Is Not Working	6-9
■ Outcalling to a Telephone Is Not Working	6-10
Language	6-11
■ Cannot Switch Between Primary and Secondary Languages	6-11
■ Cannot Understand Language Prompts	6-11

When You Need Help

If you have a problem with your system, you may be able to solve it yourself by following the appropriate troubleshooting procedures described in this chapter. If not, you can call for help: **in the continental U.S., call the Technical Service Center at 1 800 628-2888; outside the continental U.S., call your Lucent Technologies Representative or local Authorized Dealer.**

The following sections describe various difficulties that might occur, possible causes for the difficulty, and procedures you can follow to try to solve the problem.

Automated Attendant Service

Outside Callers Hear Ringing, but System Does Not Answer

Possible Cause 1: This is normal when the PARTNER MAIL VS extensions are busy.

What to do: There are a number of ways to reduce the amount of time a PARTNER MAIL VS extension is busy. For example, you can recommend that users access the Tutor Service feature during non-peak calling hours, you can reduce the number of options in the Automated Attendant Service menu, or you can reduce the length of the Automated Attendant Service menu prompt.

Possible Cause 2: The PARTNER MAIL VS module may not be installed correctly.

What to do: Check the PARTNER MAIL VS module to make sure it is securely mounted in the control unit. Also check the module's LEDs: the Power LED should be steady green and the Status LED should not be lit.

If the Power and Status LEDs are lit, perform the System Save Reset All procedure by entering 989-RESET (989-73738) after you log in as the System Manager.

If the Power LED is not lit, power down the control unit, reseal the PARTNER MAIL VS module, and power up the control unit.

- If the module is working properly after one minute, the problem is solved.
- If the module still does not work properly, go to Possible Cause 3.

Possible Cause 3: The PARTNER MAIL VS may not be programmed correctly.

What to do: Refer to Figure 2-1 in Chapter 2 to determine the extension numbers that are associated with the PARTNER MAIL VS module. Then use Hunt Group Extensions (#505) to verify that the VMS extensions are assigned to Hunt Group 7.

- If Hunt Group 7 does not have the correct VMS extensions, assign the correct extension numbers.
- If Hunt Group 7 has the correct VMS extensions, call for help*.

* In the continental U.S., help is available at 1 800 628-2888. Outside the continental U.S., call your Lucent Technologies Representative or local Authorized Dealer.

Outside Callers Hear Silence, Tones, or Ringing During Transfer

Possible Cause: Music On Hold is not set up for the system.

What to do: See Music On Hold (#602) in the *Programming and Use* guide for the communications system.

System Does Not Answer Immediately

Possible Cause 1: Automated Attendant Service is programmed for Delayed call handling.

What to do: If you do not want Delayed call handling, program the communications system's VMS Hunt Delay feature for Immediate call handling.

Possible Cause 2: The PARTNER MAIL VS extensions may be busy.

What to do: There are a number of ways to reduce the amount of time a PARTNER MAIL VS extension is busy. For example, you can recommend that users access the Tutor Service feature during non-peak calling hours, you can reduce the number of options in the Automated Attendant Service menu, or you can reduce the length of the Automated Attendant Service menu prompt.

System Cuts Off Part of Greeting

Possible Cause 1: You may have begun recording the greeting too soon.

What to do: Re-record the greeting. After the prompt to record the greeting, pause a moment before speaking.

Possible Cause 2: A touch-tone signal may have been recorded accidentally with the greeting.

What to do: Re-record the greeting.

System Transfers Call to Receptionist Before Playing the Menu Prompt

Possible Cause: The extensions associated with the PARTNER MAIL VS module were not assigned to Hunt Group 7.

What to do: Refer to Figure 2-1 in Chapter 2 to determine the extension numbers that are associated with the PARTNER MAIL VS module. Then use Hunt Group Extensions (#505) to verify that the VMS extensions are assigned to Hunt Group 7.

System Does Not Transfer Calls Properly

Possible Cause 1: If this occurs when the Automated Attendant Service answers calls, the Menu Definition may be programmed incorrectly.

What to do: Follow the steps for “Verifying System Operation” in Chapter 4 to test Automated Attendant Service.

- If outside calls are not transferred to the correct extension or group, follow the instructions for “Menu Definition and Day Menu Prompt” as appropriate for Monolingual or Bilingual Mode in Chapter 4 to reprogram the Menu Definition.
- If outside calls are transferred to the correct extension or group, go to Possible Cause 2.

Possible Cause 2: A valid destination was not entered by the caller.

What to do: Make sure a valid destination was entered. Check the *Programming and Use* guide for your communications system to determine valid extension and group numbers.

System Does Not Respond to Entered Digits

Possible Cause 1: System is not receiving touchtones.

What to do: The voice messaging system may not be able to interpret touchtones while a greeting plays. Wait until the greeting finishes before entering the touchtones. If you are using a speakerphone, turn off the microphone.

Possible Cause 2: If this occurs when the Automated Attendant Service answers calls, the Menu Definition may be programmed incorrectly.

What to do: Follow the steps for “Verifying System Operation” in Chapter 4 to test Automated Attendant Service.

- If outside calls are not transferred to the correct extension or group, follow the instructions for “Menu Definition and Day Menu Prompt” as appropriate for Monolingual or Bilingual Mode in Chapter 4 to reprogram the Menu Definition.
- If outside calls are transferred to the correct extension or group, go to Possible Cause 3.

Possible Cause 3: The line is too noisy.

What to do: Call your local telephone company.

Unanswered Transferred Calls Ring Continually

Possible Cause: In some countries, the telephone company does not always provide a far-end disconnect signal. This causes the line to remain open even after the caller hangs up.

What to do: Assign voice mail coverage to all extensions in the system; this is especially important for extension 10. Also, make sure voice mail coverage is on at extension 10 at night when no one is around to manually disconnect calls. The voice messaging system will disconnect any call to an extension that has voice mail coverage after 15 seconds of silence.

Call Answer Service

Call Answer Service Takes Too Long to Answer Calls

Possible Cause: Calls ring four times at a subscriber's extension to give the subscriber a chance to answer the call.

What to do: Recommend that subscribers program a Do Not Disturb button on their system phones. They should turn on the feature when they leave their desks or whenever they are too busy to answer calls. Calls to extensions with Do Not Disturb on are answered immediately.

Call Answer Service Terminates Message While Caller Is Recording

Possible Cause: The caller's recording time exceeded the mailbox's message time limit. (The time limit for recording a message is four minutes.)

What to do: Let the caller know the recording time limit. Also let the caller know that he or she can press [*] [#] and the appropriate extension number to transfer to the extension again—this avoids making another outside call—to finish the message if necessary.

Messages Cannot Be Deposited in Mailbox

Possible Cause: The mailbox is full.

What to do: Old messages must be deleted regularly from mailboxes. When a subscriber's mailbox is full, the caller cannot leave a message in that mailbox but is given the option of transferring to another extension. For all subscribers, mailboxes can store up to 20 minutes of recorded messages (or 40 messages, whichever is reached first). The receptionist's mailbox at extension 10 can store up to 60 minutes of recorded messages (or 120 messages).

Voice Mail Service

Subscriber Unable to Log In to Voice Mail

Possible Cause 1: A subscriber entered the number of a mailbox that does not exist.

What to do: Make sure the subscriber enters an existing mailbox number. Use “Playing a Mailbox’s Status” in Chapter 5 to check the status of existing mailboxes.

- If the subscriber tries again and succeeds, the problem is solved.
- If the subscriber still cannot log in, go to Possible Cause 2.

Possible Cause 2: The subscriber forgot his or her password or entered it incorrectly.

What to do: The subscriber should try entering the password again.

- If the subscriber can log in, the problem is solved.
- If the subscriber still cannot log in, re-initialize the password as described in Chapter 5. (If you forget the password for login 99, you must call for help*.)

Date or Time in Message Headers Is Incorrect

Possible Cause: The day, date, or time programmed for the communications system is incorrect or the PARTNER MAIL VS system was not updated with the correct time.

What to do: Refer to System Date (#101), System Day (#102), or System Time (#103) in the *Programming and Use* guide for the communications system to check the day, date, or time settings. If the day, date, and time are correct, choose one of these procedures and re-enter the correct value. After one minute, this updates the day, date, and time on the voice messaging system. If message headers for new messages are still incorrect, call for help*.

* In the continental U.S., help is available at 1 800 628-2888. Outside the continental U.S., call your Lucent Technologies Representative or local Authorized Dealer.

Subscriber Cannot Forward Messages to Another Subscriber

Possible Cause 1: The recipient's mailbox is full or does not have enough space remaining to accommodate the message.

What to do: Old messages must be deleted regularly from mailboxes. When a subscriber's mailbox is full, the caller cannot leave a message in that mailbox but is given the option of transferring to another extension. The sender cannot resend the forwarded message until the mailbox has more message space. For all subscribers, mailboxes can store up to 20 minutes of recorded messages (or 40 messages). The receptionist's mailbox at extension 10 can store up to 60 minutes of recorded messages (or 120 messages).

Possible Cause 2: The message has been forwarded the maximum of 13 times.

What to do: Verify the number of times the message has been forwarded.

Subscribers Hear Busy Signal When Calling In to Voice Mail

Possible Cause 1: This is normal when the PARTNER MAIL VS extensions are busy.

What to do: There are a number of ways to reduce the amount of time a PARTNER MAIL VS extension is busy. For example, you can recommend that users access the Tutor Service feature during non-peak calling hours, you can reduce the number options in the Automated Attendant Service menu, or you can reduce the length of the Automated Attendant Service menu prompt. If you have a 2-port system, you may want to consider upgrading to a 4-port system.

Possible Cause 2: The PARTNER MAIL VS module may not be installed correctly.

What to do: Check the PARTNER MAIL VS module to make sure it is securely mounted in the control unit. Also check the module's LEDs: the Power LED should be steady green and the Status LED should not be lit.

If the Power and Status LEDs are lit, perform the System Save Reset All procedure by entering 989-RESET (989-73738) after you log in as the System Manager.

If the Power LED is not lit, power down the control unit, reseal the PARTNER MAIL VS module, and power up the control unit.

- If the module is working properly after one minute, the problem is solved.
- If the module still does not work properly, go to Possible Cause 3.

Possible Cause 3: The PARTNER MAIL VS may not be programmed correctly.

What to do: Refer to Figure 2-1 in Chapter 2 to determine the extension numbers that are associated with the PARTNER MAIL VS module. Then use Hunt Group Extensions (#505) to verify that the VMS extensions are assigned to Hunt Group 7.

- If Hunt Group 7 does not have the correct VMS extensions, assign the correct extension numbers.
- If Hunt Group 7 has the correct VMS extensions, call for help*.

Message Light Does Not Turn Off

Possible Cause: There are messages in the mailbox. The message light stays on if there are any new (unretrieved) messages in the mailbox.

What to do: Retrieve or delete all new messages from the mailbox.

Outcalling Is Delayed

Possible Cause 1: There is heavy call traffic and Outcalling volume on the mail system. The Outcalling port is also used in call handling. If your system performs heavy Outcalling or has heavy call volume, the port may frequently be unavailable for Outcalling.

What to do: You may need more ports (if you have a 2-port system), or you may need to reduce the number of subscribers who have Outcalling privileges.

Outcalling to a Digital Pager Is Not Working

Possible Cause 1: The Outcalling number is not properly programmed.

What to do: Check that the Outcalling number is correct. If not, reprogram the number.

Possible Cause 2: Insufficient number of pauses in Outcalling number.

What to do: It is important to include a sufficient number of pauses between the pager number and the Personal Identification Number (PIN), or between the pager number and the callback number. Leave several pauses after the pager number. You must allow enough time for the paging system to answer before the PIN and/or callback number is dialed.

In addition, a pause should follow the "9" dialed to get an outside line. And if the communications system is set to rotary (rather than touchtone) service, pauses may need to be included after every digit in the Outcalling number.

* In the continental U.S., help is available at 1 800 628-2888. Outside the continental U.S., call your Lucent Technologies Representative or Authorized Dealer.

Possible Cause 3: A line may not be available to place a call.

What to do: If all lines are in use when the system attempts to outcall, the outcall does not go through. The mail system attempts to outcall three times within a *minimum* time interval of 15 minutes between attempts. When subsequent attempts are made during a peak line-activity period, these attempts may be delayed much longer. And if the subscriber's Outcalling Schedule end time occurs before the additional attempts, these attempts will not be made by the system. You may need to obtain more lines if the problem occurs frequently.

Possible Cause 4: The message was received outside the hours programmed in the subscriber's Outcalling Schedule, or the Outcalling period was ended.

What to do: This is standard operation. Outcalling is performed only during the hours specified by the subscriber's Outcalling Schedule. Outcalling will be done only for message received during the Outcalling period.

Possible Cause 5: Outcalling may not be turned on.

What to do: Have the mailbox owner verify that Outcalling is turned on. The System Manager should also verify that the Outcalling privilege is assigned.

Outcalling to a Telephone Is Not Working

Possible Cause 1: The Outcalling number is not properly programmed.

What to do: Check that the Outcalling number is correct. If not, reprogram the number.

Possible Cause 2: A line may not be available to place a call.

What to do: If all lines are in use when the system attempts to outcall, the outcall does not go through. The mail system attempts to outcall three times within a *minimum* time interval of 15 minutes between attempts. When subsequent attempts are made during a peak line-activity period, these attempts may be delayed much longer. And if the subscriber's Outcalling Schedule end time occurs before the additional attempts, these attempts will not be made by the system. You may need to obtain more lines if the problem occurs frequently.

Possible Cause 3: The message was received outside the hours programmed in the subscriber's Outcalling Schedule, or the Outcalling period was ended.

What to do: This is standard operation. Outcalling is performed only during the hours specified by the subscriber's Outcalling Schedule. Outcalling will be done only for message received during the Outcalling period.

Possible Cause 4: Outcalling may not be turned on.

What to do: Have the mailbox owner verify that Outcalling is turned on. The System Manager should also verify that the Outcalling privilege is assigned.

Language

Cannot Switch Between Primary and Secondary Languages

Possible Cause: The system is set for Monolingual Mode.

What to do: Refer to “Modifying the Language Mode” in Chapter 5 to determine the system’s Language Mode.

Cannot Understand Language Prompts

Possible Cause: Either a language you do not understand was inadvertently chosen while programming, or you do not understand the factory-set language.

What to do: To change the language to one you understand, do one of the following:

- If the system is set for Monolingual Mode:
 - a. Press [*Intercom*] [Z] [Z] [Z].
 - b. Press [2] [2] [#].
 - c. Enter the System Manager’s Mailbox Password.
 - d. Press [2] [1] [2] [2].
 - e. Press the number corresponding to the desired language.
 - f. Press [2].
- If the system is set for Bilingual Mode:
 - a. Press [*Intercom*] [Z] [Z] [Z].
 - b. Press [2] [2] [#].
 - c. Enter the System Manager’s Mailbox Password.
 - d. Press [2] [1] [2] [1] [2].
 - e. Press the number corresponding to the desired language.
 - f. Press [2].

Specifications



Capacities																													
Mailboxes	<ul style="list-style-type: none"> ■ Mail Capacity: Ext. 10, 60 minutes (120 messages); subscriber, 20 minutes (40 messages) ■ Message Length: 1 second to 4 minutes 																												
Automated Attendant	<ul style="list-style-type: none"> ■ Personal Greeting Length: 1 second to 4 minutes ■ Answers on this number of rings: 2 (immediate) or 4 (delayed) ■ Receptionist's Extension (Dial 0): Extension 10 ■ Dial 0 Timeout: 5 seconds ■ Dial 0 Timeout Action (day and night): Transfer to receptionist ■ Menu Levels: 1 ■ Menu Options: 9 allowed (5 recommended) 																												
System Capacities	<p>Without Mailbox Expansion Card: 2 voice channels (ports), 10 mailboxes, 240 minutes of voice storage maximum</p> <p>With Mailbox Expansion Card (Maximum):</p> <table border="1" data-bbox="773 1400 1321 1527"> <thead> <tr> <th># of Ports</th> <th># of Mailboxes</th> <th>Voice Storage</th> </tr> </thead> <tbody> <tr> <td>2</td> <td>20</td> <td>440 minutes</td> </tr> <tr> <td>4</td> <td>20</td> <td>440 minutes</td> </tr> <tr> <td>4</td> <td>40</td> <td>840 minutes</td> </tr> </tbody> </table> <p>Total Number of Calls Supported During Peak Usage Hour:</p> <table border="1" data-bbox="839 1591 1321 1749"> <thead> <tr> <th rowspan="2">Call Connect Time †</th> <th colspan="2">Calls</th> </tr> <tr> <th>2-port</th> <th>4-port</th> </tr> </thead> <tbody> <tr> <td>0.5 minutes</td> <td>25</td> <td>122</td> </tr> <tr> <td>1 minute</td> <td>12</td> <td>61</td> </tr> <tr> <td>1.5 minutes</td> <td>8</td> <td>40</td> </tr> </tbody> </table>			# of Ports	# of Mailboxes	Voice Storage	2	20	440 minutes	4	20	440 minutes	4	40	840 minutes	Call Connect Time †	Calls		2-port	4-port	0.5 minutes	25	122	1 minute	12	61	1.5 minutes	8	40
# of Ports	# of Mailboxes	Voice Storage																											
2	20	440 minutes																											
4	20	440 minutes																											
4	40	840 minutes																											
Call Connect Time †	Calls																												
	2-port	4-port																											
0.5 minutes	25	122																											
1 minute	12	61																											
1.5 minutes	8	40																											

† Call connect time is an average for all calls to the PARTNER MAIL VS system including Tutor, Automated Attendant Service, Call Answer Service, and Voice Mail Service. This information assumes a 2% probability of system blockage.

<p>Communications System</p>	<p>The PARTNER MAIL VS system is supported on the following PARTNER Plus, PARTNER II, PARTNER Advanced, and PARTNER 48 communications systems:</p> <ul style="list-style-type: none"> ■ In most countries: Release 3.1 or later of PARTNER Plus, PARTNER II, and PARTNER 48, and Release 1.0 of PARTNER Advanced Communications System ■ In United Kingdom: Release 2.0 or later of PARTNER Plus and PARTNER 48
<p>Languages Supported</p>	<ul style="list-style-type: none"> ■ U.S. English ■ United Kingdom English ■ Latin American Spanish ■ Canadian French <p>Default Mode: Monolingual Default Languages: Monolingual Mode: U.S. English Bilingual Mode: U.S. English (primary)/Latin American Spanish (secondary)</p>
<p>Dimensions and Weights (approx.)</p>	<ul style="list-style-type: none"> ■ PARTNER MAIL VS: 11"(D) x 17"(H) x 1.5"(W) or 27.9 x 43.2 x 3.8 cm 4.3 lbs or 2.0 kgs ■ Mailbox Exp. Card: 3.4"(D) x 2.1"(H) x 0.2"(W) or 8.6 x 5.3 x 0.5 cm .07 lbs or 32 grams
<p>Electrical Specifications</p>	<p>15 Watts (52 BTU/hour) during normal and maximum power consumption</p> <ul style="list-style-type: none"> ■ Maximum current 0.13 Amps ■ Battery backup compatible
<p>Processors Specifications</p>	<ul style="list-style-type: none"> ■ 68000 microprocessor, 256Kbytes RAM, 512Kbytes ROM ■ Voice encoding method: Regular Pulse Excitation–Long Term Prediction (RPE–LTP) Linear Predictive Coder ■ Digital Signal Processor (DSP), 16 bit

<p>Environmental Requirements— Control Unit</p>	<ul style="list-style-type: none"> ■ Mount on a wall at least 2 feet (0.6 meters) from the floor (wall mounting required) ■ Locate within 5 feet (1.5 meters) of the network interface jacks and a properly grounded electrical outlet not controlled by switch, using supplied 7-foot (2.1 meter) cords ■ Mount the Expansion Carrier at least 6" (15.2 cm) and not more than 24" (61 cm) away from the Primary Carrier ■ Operating temperature 32° to +104°F (0° to +40°C), not in direct sunlight ■ Humidity 15%-90%, noncondensing ■ For proper ventilation and easy replacement of modules, provide at least 6" (15.2cm) clearance at the top and sides and 2 feet (0.6 meters) at the front and bottom of the control unit ■ Locate in an area free of excess moisture, corrosive gases, dust and chemicals
<p>Electrical Requirements</p>	<ul style="list-style-type: none"> ■ U.S. and Canada: 90–130 VAC, 50–60 Hz, 3-prong outlet separate ground, separately fused at 15 Amps; Other countries: 180–264 VAC, 50–60 Hz, fused at 10 Amps ■ Outlet must not be controlled by an on/off switch ■ Grounding to comply with Underwriters Laboratories (UL) 1459: <ol style="list-style-type: none"> 1. An insulated grounding conductor that is not smaller in size and equivalent in insulation material and thickness to the grounded and ungrounded branch circuit supply conductors, except that it is green with or without one or more yellow stripes, is to be installed as part of the circuit that supplies the product or system. 2. The grounding conductor mentioned in item A is to be connected to ground at service equipment. 3. The attachment-plug receptacles in the vicinity of the product or system are all to be of a grounding type, and the grounding conductors serving these receptacles are to be connected to earth ground at the service equipment.
<p>Safety Requirements</p>	<ul style="list-style-type: none"> ■ U.S.: Meets UL 1459 Issue 2 ■ Canada: Meets CSA C22.2, 225

**Government
Approvals and
Local Phone
Company
Information**

- U.S.: FCC Part 68
FCC registration number (U.S.): AS5 USA-61630-KF-E
FCC Part 15 Class A
REN (outside line jack): 0.9A per line jack
Jack type: RJ11C
Loop start lines
- Canada: IC CP01, Issue 7
IC registration number (Canada): 230 3756A
IC CS03, Issues 6&7
Load Number = 7
Loop start lines

FCC Information

B

Federal Communications Commission (FCC) Interference Information

This equipment has been tested and found to comply with the limits for a Class A digital device, pursuant to Part 15 of FCC rules. These limits are designed to provide reasonable protection against harmful interference when the equipment is operated in a commercial environment. This equipment generates, uses, and can radiate radio frequency energy and, if not installed and used in accordance with the instruction manuals, may cause harmful interference to radio communications. Operation of this equipment in a residential area is likely to cause harmful interference, in which case the user will have to correct the interference at his or her own expense.



NOTE:

References to FCC regulations are not applicable outside of the U.S.

FCC Notification and Repair Information

This equipment is registered with the FCC in accordance with Part 68 of its rules. In compliance with those rules, you are advised of the following:

- **Means of Connection:** Connection to the telephone network shall be through a standard network interface jack USOC RJ11C. These USOCs must be ordered from your local telephone company.

This equipment may not be used with party lines or coin telephone lines.

- **Notification to the Telephone Companies:** Before connecting this equipment, you or your equipment supplier must notify your local telephone company's business office of the following:
 - The telephone number(s) you will be using with this equipment.
 - The appropriate registration number and ringer equivalence number (REN), which can be found on the right hand side of the primary carrier.

You must also notify your local telephone company if and when this equipment is permanently disconnected from the line(s).

- **Repair Instructions:** If you experience trouble because your equipment is malfunctioning, the FCC requires that you disconnect the equipment from the network and not use it until the problem has been corrected. Repairs to this equipment can only be made by the manufacturer, its authorized agents, or by others who may be authorized by the FCC. In the event repairs are needed on this equipment, please contact the Lucent Technologies Technical Service Center at 1 800 643-2353. For warranty information, see Appendix C.
- **Rights of the Local Telephone Company:** If this equipment causes harm to the telephone network, the local telephone company may discontinue your service temporarily. If possible, they will notify you in advance. But if advance notice is not practical, you will be notified as soon as possible. You will also be advised of your right to file a complaint with the FCC.

Your local telephone company may make changes in its facilities, equipment, operations, or procedures that affect the proper functioning of this equipment. If they do, you will be notified in advance to give you an opportunity to maintain uninterrupted telephone service.

IC Notification and Repair Information

The Industry Canada (IC) label identifies certified equipment. This certification means that the equipment meets certain telecommunications network protective, operational, and safety requirements. The IC does not guarantee the equipment will operate to the user's satisfaction.

Before installing the equipment, users should ensure that it is permissible to connect it to the facilities of the local telecommunications company. The equipment must also be installed using an acceptable method of connection. In some cases, the company's inside wiring for single-line individual service may be extended by means of a certified connector assembly (telephone extension cord). The customer should be aware that compliance with the above conditions may not prevent degradation of service in some situations.

Repairs to certified equipment should be made by an authorized Canadian maintenance facility designated by the supplier. Any repairs or alterations made by the user to this equipment, or any equipment malfunctions, may give the telecommunications company cause to request the user to disconnect the equipment.

Users should ensure for their own protection that the electrical ground connections of the power utility, telephone lines, and internal metallic water pipe system, if present, are connected. This precaution may be particularly important in rural areas.



CAUTION:

Users should not attempt to make such connections themselves, but should contact the appropriate electrical inspection authority or electrician, as appropriate.

To prevent overloading, the Load Number (LN) assigned to each terminal device denotes the percentage of the total load to be connected to a telephone loop used by the device. The termination on a loop may consist of any combination of devices subject only to the requirement that the total of the Load Numbers of all the devices does not exceed 100.

IC Certification No.: 230 3756A
CSA Certification No.: LR 60486
Load No.: 7

Renseignements sur la notification du ministère des Communications du Canada et la réparation

L'étiquette du Ministère des Communications du Canada identifie le matériel homologué. Cette étiquette certifie que le matériel est conforme à certaines normes de protection, d'exploitation et de sécurité des réseaux de télécommunications. Le Ministère n'assure toutefois pas que le matériel fonctionnera à la satisfaction de l'utilisateur.

Avant d'installer ce matériel, l'utilisateur doit s'assurer qu'il est permis de le raccorder aux installations de l'entreprise locale de télécommunication. Le matériel doit également être installé en suivant une méthode acceptée de raccordement. Dans certains cas, les fils intérieurs de l'entreprise utilisés pour un service individuel à ligne unique peuvent être prolongés au moyen d'un dispositif homologué de raccordement (cordon prolongateur téléphonique interne). L'abonné ne doit pas oublier qu'il est possible que la conformité aux conditions énoncées ci-dessus n'empêchent pas la dégradation du service dans certaines situations. Actuellement, les entreprises de télécommunication ne permettent pas que l'on raccorde leur matériel à des jacks d'abonné, sauf dans les cas précis prévus par les tarifs particuliers de ces entreprises.

Les réparations de matériel homologué doivent être effectuées par un centre d'entretien canadien autorisé désigné par le fournisseur. La compagnie de télécommunications peut demander à l'utilisateur de débrancher un appareil à la suite de réparations ou de modifications effectuées par l'utilisateur ou à cause de mauvais fonctionnement.

Pour sa propre protection, l'utilisateur doit s'assurer que tous les fils de mise à la terre de la source d'énergie électrique, des lignes téléphoniques et des canalisations d'eau métalliques, s'il y en a, sont raccordés ensemble. Cette précaution est particulièrement importante dans les régions rurales.



AVERTISSEMENT:

L'utilisateur ne doit pas tenter de faire ces raccordements lui-même; il doit avoir recours à un service d'inspection des installations électriques, ou à un électricien, selon le cas.

L'indice de charge (IC) assigné à chaque dispositif terminal indique, pour éviter toute surcharge, le pourcentage de la charge totale qui peut être raccordée à un circuit téléphonique bouclé utilisé par ce dispositif. La terminaison du circuit bouclé peut être constituée de n'importe quelle combinaison de dispositifs, pourvu que la somme des indices de charge de l'ensemble des dispositifs ne dépasse pas 100.

No d'homologation: 230 3756A
No de certification CSA: LR 60486
L'indice de charge: 7

Warranty Information



Repair Information

Outside the continental U.S., contact your Lucent Technologies Representative or local Authorized Dealer for warranty and repair information applicable to your system.

In-Warranty Repairs

If you purchased or leased your system directly from Lucent Technologies, Lucent Technologies will repair it free of charge during the one-year warranty period. Simply call the Lucent Technologies Technical Service Center and ask for service.

Business-Day service is standard during the warranty period for both the control unit and system phones. Business-Day service is performed during normal business hours. However, if you need 24-hour service protection during the warranty period on the control unit in case there is a major system failure, you can purchase an Around-the-Clock service contract from your local Lucent Technologies sales office. (Around-the-Clock service is not available for phones.)

If you purchased or leased your system through a Lucent Technologies Authorized Dealer, contact your dealer for repairs.

Post-Warranty Repairs

If you purchased your system from Lucent Technologies and you have a post-warranty service contract, Lucent Technologies service is provided under the terms of that contract.

To significantly reduce unexpected repair costs after the warranty period, you can purchase a post-warranty service contract from Lucent Technologies. If you do not have a contract, Lucent Technologies service is provided on a time-and-materials basis by calling the Lucent Technologies Technical Service Center. A contract provides you, within the applicable coverage period and response times, service calls with no charge for parts and labor on covered repairs. Both Business-Day and Around-the-Clock coverages of varying lengths are available. To order a post-warranty service contract, call 1 800 247-7000 (in the continental U.S. only).

If you leased your system from Lucent Technologies, Business-Day service is included in your lease. To upgrade to Around-the-Clock service, call 1 800 247-7000 (in the continental U.S. only).

If you purchased or leased your system through a Lucent Technologies Authorized Dealer, contact your dealer for repairs.

Lucent Technologies Warranty and Limitation of Liability

Lucent Technologies warrant you, the customer, that your system will be in good working order on the date Lucent Technologies or its authorized reseller delivers or installs the system, whichever is later ("Warranty Date"). If you notify Lucent Technologies or its Authorized Dealer within one year of the Warranty Date that your system is not in good working order, Lucent Technologies will without charge to you repair or replace, at its option, the system components that are not in good working order. Repair or replacement parts may be new or refurbished and will be provided on an exchange basis. If Lucent Technologies determines that your system cannot be repaired or replaced, Lucent Technologies will remove the system and, at your option, refund the purchase price of your system or apply the purchase price towards the purchase of another Lucent Technologies system.

If you purchased your system directly from Lucent Technologies, Lucent Technologies will perform warranty repair in accordance with the terms and conditions of the specific type of Lucent Technologies maintenance coverage you selected. A written explanation of Lucent Technologies' types of maintenance coverage may be obtained from Lucent Technologies by calling 1 800 247-7000 (in the continental U.S. only). If you purchased your system from a Lucent Technologies Authorized Dealer, contact your reseller for the details of the maintenance plan applicable to your system.

This Lucent Technologies limited warranty covers damage to the system caused by power surges.

Unless otherwise expressly agreed to in a written agreement signed by Lucent Technologies, Lucent Technologies will not be responsible under this limited warranty for damages resulting from:

- Failure to follow Lucent Technologies' installation, operation, or maintenance instructions;
- Unauthorized system modification, movement, or alteration;
- Unauthorized use of common carrier communication services accessed through the system;
- Abuse, misuse, or negligent acts or omissions of the customer and persons under the customer's control; or
- Act of third parties and acts of God.

LUCENT TECHNOLOGIES' OBLIGATION TO REPAIR, REPLACE, OR REFUND, AS SET FORTH ABOVE, IS YOUR EXCLUSIVE REMEDY.

EXCEPT AS SPECIFICALLY SET FORTH ABOVE, LUCENT TECHNOLOGIES, ITS AFFILIATES, SUPPLIERS, AND DEALERS MAKE NO WARRANTIES, EXPRESS OR IMPLIED, AND SPECIFICALLY DISCLAIM ANY WARRANTIES OF MERCHANTABILITY OR FITNESS FOR A PARTICULAR PURPOSE.

Limitation of Liability

Except as provided below, the liability of Lucent Technologies and its affiliates and suppliers for any claims, losses, damages, or expenses from any cause whatsoever (including acts or omissions of third parties), regardless of the form of action, whether in contract, tort, or otherwise, shall not exceed the lesser of: (1) the direct damages proven; or (2) the repair cost, replacement cost, license fee, annual rental charge, or purchase price, as the case may be, of the equipment that directly gives rise to claim. Except as provided below, Lucent Technologies and its affiliates and suppliers shall not be liable for any incidental, special, reliance, consequential, or indirect loss or damage incurred in connection with the equipment. As used in this paragraph, consequential damages include, but are not limited to, the following: lost profits, lost revenues, and losses arising out of unauthorized use (or charges for such use) of common carrier telecommunications services or facilities accessed through or connected to the equipment. For personal injury caused by Lucent Technologies' negligence, Lucent Technologies' liability shall be limited to proven damages to person. No action or proceeding against Lucent Technologies or its affiliates or suppliers may be commenced more than twelve (12) months after the cause of action accrues. THIS PARAGRAPH SHALL SURVIVE FAILURE OF AN EXCLUSIVE REMEDY.

Voice Messaging System Planning Forms

D

This appendix contains the voice messaging system forms. We suggest you fill in a *photocopy* of the form you need, leaving the blank original in the book, in case you need to make revisions in the future. These forms must be completed *before the voice mail system is installed* because they serve as a reference for the person who installs and programs the system.

It is important to keep an accurate, up-to-date record of the programming for the voice mail system. If you change the system after installation, you should update the forms that were used when the system was installed.



NOTE:

Before you begin to fill out the voice mail system Planning Forms, you need a complete, current copy of the communications system Planning Forms. Samples of these forms are contained in Appendix E.

For a general description of all the Planning Forms, see Chapter 3. Instructions for completing each form are contained on the form itself.

How To Use the Forms

The following table shows what voice mail system forms should be completed according to your voice mail system feature selection:

To	Use VMS Form	From Programming Main Menu, press
Select Language Mode, System Language, Primary and Secondary Language	1	[1]
Assign Mailboxes to subscribers, identify Mailbox Language and Outcalling privileges	2	[4]
Identify Menu Definition (i.e., Direct Extension Transfer, Selector Code Transfer), Ext. # or Group # for Selector Code Transfer, or Annc. #. Required For Automated Attendant Service.	3	[2]
Script Automated Attendant Announcements (in System or Primary Language). Required if Annc. # is assigned to a Selector Code.	3A	[2]
Script Automated Attendant Announcements (in Secondary Language). Required for Bilingual Mode if Annc. # is assigned to a Selector Code.	3B	[2]
Script the Day Menu Prompt (in System or Primary Language). Required if VMS Hunt Schedule is set to Day Only or Always.	4	[2]
Script the Day Menu Prompt (in Secondary Language). Required for Bilingual Mode if VMS Hunt Schedule is set to Day Only or Always.	4A	[2]
Script the Night Menu Prompt (in System or Primary Language). Required if VMS Hunt Schedule is set to Night Only or Always.	5	[2]
Script the Night Menu Prompt (in Secondary Language). Required for Bilingual Mode if VMS Hunt Schedule is set to Night Only or Always.	5A	[2]
Assign Line Ownership (cannot be assigned to lines assigned Automated Attendant coverage). Required if VMS Line Coverage exists for one or more lines.	6	[6]

Form 1: Language

A

Language Mode:

- Monolingual ✓
- Bilingual

B

Monolingual Mode–System Language:

- U.S. English ✓
- U.K. English
- Latin American Spanish
- Canadian French
- Other-specify _____

C

Bilingual Mode–Primary Language:

- U.S. English ✓
- U.K. English
- Latin American Spanish
- Canadian French
- Other-specify _____

Bilingual Mode–Secondary Language:

- U.S. English
- U.K. English
- Latin American Spanish ✓
- Canadian French
- Other-specify _____

General Information

- Factory defaults are identified by the ✓ symbol.
- If the system is set for Bilingual Mode, make sure you record the Automated Attendant Day Menu Prompts and Night Menu Prompts and Announcements (if any) in both the Primary and Secondary Languages. Also, subscribers can record two personal greetings—one in the Primary Language and another in the Secondary Language.
- Subscribers can have a Mailbox Language different from the languages selected here. Mailbox Language is specified on Form 2.

Completing this Form

- A Language Mode** Check “Bilingual” if the Language Mode should be set to Bilingual. If you check Bilingual, also see **C** below; if not, see **B**.
- B Monolingual Mode—System Language** Check the Primary language desired if different from the default.
- C Bilingual Mode—Primary Language** Check the Primary Language desired if different from the default.
Bilingual Mode—Secondary Language Check the Secondary Language desired if different from the default.

Programming Language

- To program the Language Mode, as well as the System Language in Monolingual Mode or the Primary and Secondary Languages in Bilingual Mode, dial [1] from the Programming Main Menu.

Form 2: Mailbox Assignments

A Mailbox	B Subscriber Name	C Mailbox Language	D Outcalling Assigned
10 ✓			
(11 ✓)			
(12 ✓)			
(13 ✓)			
(14 ✓)			
(15 ✓)			
(16 ✓)			
(17 ✓)			
(18 ✓)			
(19 ✓)			
(20 ✓)			
(21 ✓)			
(22 ✓)			
(23 ✓)			
(24 ✓)			
(25 ✓)			

General Information

- Factory defaults are identified by the ✓ symbol.
- The system comes with a predetermined number of mailboxes. The optional Mailbox Expansion Card doubles the capacity.
- Mailbox 10 is reserved for the receptionist at extension 10 and cannot be changed.
- Mailbox 10 provides 60 minutes of message recording time. All other mailboxes provide 20 minutes of message recording time.
- For system security, mailboxes should be deleted where they are not needed; for example, mailboxes should be deleted for extensions in use by auxiliary equipment (such as a fax or doorphone) and the extensions assigned to the VMS Hunt Group.
- Guest mailboxes can be created for users who don't have their own phone by assigning an unused extension number as the mailbox number. Unused extension numbers include: 1) vacant extension jacks in installed 206 modules and 2) extensions in your DIAL plan higher than the last extension jack in the last installed 206 module. See "Guest Mailboxes" in Chapter 5 for more information.

A Mailbox	B Subscriber Name	C Mailbox Language	D Outcalling Assigned
(26 ✓)			
(27 ✓)			
(28 ✓)			
(29 ✓)			
(30 ✓)			
(31 ✓)			
(32 ✓)			
(33 ✓)			
(34 ✓)			
(35 ✓)			
(36 ✓)			
(37 ✓)			
(38 ✓)			
(39 ✓)			
(40 ✓)			

Completing this Form

- A Mailbox** To assign a mailbox to an extension other than the factory default, cross out the factory default and write in the extension to be used.
- For PARTNER PLUS, use an extension number from 11-33.
 - For PARTNER Advanced Communications System, use an extension number from 11-41.
 - For PARTNER II or PARTNER 48, use an extension number from 11-57.
- To mark an unused mailbox for deletion without assigning an extension, cross out the factory default.
- B Subscriber Name** For every mailbox in use, write the name of the mailbox subscriber.
- C Mailbox Language** For each mailbox that requires a language different from the System Language or Primary Language indicated on Form 1, write the name of the language in this space. Supported languages are listed on Form 1.
- D Outcalling Assigned** For each mailbox in use, indicate whether Outcalling is assigned.

Programming Mailboxes

You can change a mailbox assignment by deleting an existing mailbox and creating a new one.

- To program mailboxes, dial [4] from the Programming Main menu.

Form 3: Menu Definition

Required for Automated Attendant Service

A Description	B Selector Code	C Range of Extensions for Direct Extension Transfer	D Ext. # or Group # for Selector Code Transfer, or Announcement #
	1	(10–19 ✓)	
	2	(20–29 ✓)	
	3	(30–39 ✓)	
	4	(40–49 ✓)	
	5	(50–57 ✓)	
	6		
	7	(71–74, 771–776 ✓)	
	8		
	9	Transfer to Mailbox 10 ✓	

General Information

Factory defaults are identified by the ✓ symbol.

- This Menu Definition applies to both the Day and Night Menu prompts.
- The **Selector Code** is the first digit dialed by the caller in response to the menu prompts.
- In **Direct Extension Transfer**, Selector Codes 1–5 and 7 represent the first digit for a range of extensions. These Selector Codes let callers dial extension numbers directly.
- In **Selector Code Transfer**, Selector Codes 1–9 represent a specific extension, Group Calling number, (if available) or Hunt Group number to which the caller will be transferred. Use the following values:

PARTNER Plus: 10–33 or 771–776
 PARTNER Advanced: 11–41, 71–74, or 771–776
 PARTNER II: 10–57, 71–74, or 771–776
 PARTNER 48: 10–57, 71, or 771–776

Selector Code Transfer lets callers dial a single digit to reach a single extension or group, such as the VP of Sales at extension 37 or the order processing operators assigned to Hunt Group 774.
- Selector Code 9 lets callers transfer directly to mailbox 10 (receptionist mailbox) where they can leave a message.
- The Description and Selector Code number from this form will be used to complete the Day and Night Menu Prompts (Forms 4, 4A, 5, and 5A).
- For Announcement entries in **Description**, **Selector Code**, and **Announcement #** of this form will be used to complete Forms 3A and 3B.

Completing this Form

For Direct Extension Transfer...

- A Description** Write “Direct Extension Transfer.”
- C Range of Extensions for Direct Extension Transfer**
Leave the factory default.
- D Ext. # or Group # for Selector Code Transfer...**Leave blank.

For Selector Extension Transfer...

- A Description** Write the name of the person or group to receive the transfer.
- C Range of Extensions for Direct Extension Transfer**
Cross out the factory default if you want the caller to dial the corresponding Selector Code to transfer to the extension, announcement, or group identified in **D** below.
- D Ext. #, or Group # for Selector Code Transfer...**Write the extension, announcement, or group number to receive the transfer.

For Announcement...

- A Description** Write “Announcement.”
- C Range of Extensions for Direct Extension Transfer**
Cross out the factory default if you want the caller to dial the corresponding Selector Code to hear the Announcement identified in **D** below.
- D Announcement #** Write the Announcement number (1 or 2).

Form 3: Menu Definition

Programming the Menu

- To program the menu definition, dial [3] from the Programming Main Menu and select the Day Menu.

After defining the menu, the system will prompt you to record the menu prompt. See Form 4 for the Day Menu Prompt and Form 5 for the Night Menu Prompt; for Bilingual Mode, also see Forms 4A and 5A. See Form 3A for Automated Attendant Announcement(s); for Bilingual Mode, also see Form 3B.

Form 3A: Automated Attendant Announcement— System Language or Primary Language

Required if Selector Code Transfer is set to Announcement

Announcement # _____ :
Announcement # _____ :

General Information

- After the Announcement plays, you can program the system to hang up or to offer callers the option of pressing *4 (to repeat this Announcement), *7 (to return to the Main Menu), *8 (to transfer to an extension), or 0.
- If the system is set for Bilingual Mode, let callers know they can switch the language they hear while listening to the Announcement. For example, "Para español, marque * 1."
- Announcements can supply frequently requested information so that your staff is free to assist customers or to perform other tasks more efficiently.
- An Announcement can be up to four minutes long.

Completing this Form

Write the Announcement and its number in the space provided.

Recording the Announcement(s)

- To record the Announcement, dial [3] from the Programming Main Menu.

Form 3B: Automated Attendant Announcement—Secondary Language

Required for Bilingual Mode only if Selector Code transfer is set to Announcement

Announcement # _____ :
Announcement # _____ :

General Information

- After the Announcement plays, you can program the system to hang up or to offer callers the option of pressing *4 (to repeat this Announcement), *7 (to return to the Main Menu), *8 (to transfer to an extension), or 0.
- Let callers know they can switch to the Primary Language while listening to the Announcement. For example, "For English, press * 1."
- Announcements can supply frequently requested information so that your staff is free to assist customers or to perform other tasks more efficiently.
- An Announcement can be up to four minutes long.

Completing this Form

Write the Announcement and its number in the space provided.

Recording the Announcement(s)

- To record the Announcement, dial [3] from the Programming Main Menu.

Form 4: Day Menu Prompt— System Language or Primary Language

Required if VMS Hunt Schedule is set to Day Only or Always

General Information

The Day Menu Prompt plays to callers when the VMS Hunt Schedule is set to Day Only or Always and Night Service is off. The Day Menu Prompt and the Night Menu Prompt use the **same** Menu Definition.

- The Day Menu Prompt should contain a welcome and a list of menu options.
- The welcome should introduce the company. For example, "Thank you for calling the Any Travel Agency."
- If the system is set for Bilingual Mode, let callers know they can switch the language they hear while on the call. For example, "Para español, marque * 1."
- The menu options should contain instructions that correspond to the Menu Definition set up on Form 3.
 - If callers can dial extension numbers (Direct Extension Transfer), the prompt should instruct callers to dial the extension number. For example, "If you know the extension of the person you want to reach, dial it now."
 - If callers can dial a single digit to transfer to an extension or group (Selector Code Transfer), the prompt should provide instructions such as "To speak to someone in sales, press 6."
 - If callers can choose an Announcement, include that information. For example, "For directions to our office, press 4."

It is recommended that you keep the number of menu options to 5 or less to avoid confusing the caller.

Completing this Form

Write the message that you want callers to hear when they call during normal business hours, including the instructions to the caller for selecting menu options.

Suggested options include:

- "Remain on the line for assistance."
- "Dial 0 for assistance."
- "To hear this menu again, dial * 4."

Recording the Day Menu Prompt

- To record the Day Menu Prompt, dial [3] from the Programming Main Menu.

Form 4A: Day Menu Prompt—Secondary Language

Required for Bilingual Mode only if VMS Hunt Schedule is set to Day Only or Always

General Information

The Day Menu Prompt plays to callers when the VMS Hunt Schedule is set to Day Only or Always and Night Service is off. The Day Menu Prompt and the Night Menu Prompt use the **same** Menu Definition.

- The Day Menu Prompt should contain a welcome and a list of menu options.
- The welcome should introduce the company. For example, "Thank you for calling the Any Travel Agency."
- Let callers know they can switch back to the Primary Language. For example, "For English, press * 1."
- The menu options should contain instructions that correspond to the Menu Definition set up on Form 3.
 - If callers can dial extension numbers (Direct Extension Transfer), the prompt should instruct callers to dial the extension number. For example, "If you know the extension of the person you want to reach, dial it now."
 - If callers can dial a single digit to transfer to an extension or group (Selector Code Transfer), the prompt should provide instructions such as "To speak to someone in sales, press 6."
 - If callers can choose an Announcement, include that information. For example, "For directions to our office, press 4."

It is recommended that you keep the number of menu options to 5 or less to avoid confusing the caller.

Completing this Form

Write the message that you want callers to hear when they call during normal business hours, including the instructions to the caller for selecting menu options.

Suggested options include:

- "Remain on the line for assistance."
- "Dial 0 for assistance."
- "To hear this menu again, dial * 4."

Recording the Day Menu Prompt

- To record the Day Menu Prompt, dial [3] from the Programming Main Menu.

Form 5: Night Menu Prompt— System Language or Primary Language

Required if VMS Hunt Schedule is set to Night Only or Always

General Information

The Night Menu Prompt plays to callers when the VMS Hunt Schedule is set to Night Only or Always and Night Service is on. The Night Menu Prompt and the Day Menu Prompt use the **same** Menu Definition.

- The Night Menu Prompt should contain a welcome and a list of menu options.
- The welcome should introduce the company. For example, “You have reached the Any Travel Agency. Our hours are 9 AM to 5 PM, Monday through Friday.”
- If the system is set for Bilingual Mode, let callers know they can switch the language they hear while on the call. For example, “Para español, marque * 1.”
- The menu options should contain instructions that correspond to the Menu Definition set up on Form 3.
 - If callers can dial extension numbers (Direct Extension Transfer), the prompt should instruct callers to dial the extension number. For example, “If you know the extension of the person you want to reach, dial it now and leave a message.”
 - If callers can dial a single digit to transfer to an extension or group (Selector Code Transfer), the prompt should provide instructions such as “To leave a message for Pat, press 6.” Keep in mind that there are no group mailboxes.

- If Selector Code 9 is left as the default, the prompt should instruct callers to press 9 to leave a message with the receptionist.

It is recommended that you keep the number of menu options to 5 or less to avoid confusing the caller.

Completing this Form

Write the message that you want callers to hear when they call after normal business hours, including instructions to the caller for selecting menu options.

Suggested options include:

- “Dial 9 or remain on the line to leave a message.”
- “To hear this menu again, dial * 4.”

Recording the Night Menu Prompt

- To record the Night Menu Prompt, dial [3] from the Programming Main Menu.

Form 5A: Night Menu Prompt—Secondary Language

Required for Bilingual Mode only if VMS Hunt Schedule is set to Night Only or Always

General Information

The Night Menu Prompt plays to callers when the VMS Hunt Schedule is set to Night Only or Always and Night Service is on. The Night Menu Prompt and the Day Menu Prompt use the **same** Menu Definition.

- The Night Menu Prompt should contain a welcome and a list of menu options.
- The welcome should introduce the company. For example, “You have reached the Any Travel Agency. Our hours are 9 AM to 5 PM, Monday through Friday.”
- Let callers know they can switch back to the Primary Language. For example, “For English, press *1.”
- The menu options should contain instructions that correspond to the Menu Definition set up on Form 3.
 - If callers can dial extension numbers (Direct Extension Transfer), the prompt should instruct callers to dial the extension number. For example, “If you know the extension of the person you want to reach, dial it now and leave a message.”
 - If callers can dial a single digit to transfer to an extension or group (Selector Code Transfer), the prompt should provide instructions such as “To leave a message for Pat, press 6.” Keep in mind that there are no group mailboxes.

- If Selector Code 9 is left as the default, the prompt should instruct callers to press 9 to leave a message with the receptionist.

It is recommended that you keep the number of menu options to 5 or less to avoid confusing the caller.

Completing this Form

Write the message that you want callers to hear when they call after normal business hours, including instructions to the caller for selecting menu options.

Suggested options include:

- “Dial 9 or remain on the line to leave a message.”
- “To hear this menu again, dial * 4.”

Recording the Night Menu Prompt

- To record the Night Menu Prompt, dial [3] from the Programming Main Menu.

Form 6: Line Ownership

Required if VMS Line Coverage exists for one or more lines

A Line #	B Telephone Number	C Line Owner (Subscriber Name)	D Mailbox

General Information

- Lines in the system are assigned either ownership or Automated Attendant Service coverage—a single line *cannot* be assigned both types of coverage.
- Note that more than one line may be assigned to the same mailbox, but a single line cannot be assigned to more than one mailbox.
- Lines that are assigned ownership typically are used for personal lines or outside access to the voice messaging system if Automated Attendant Service is not used. If the company has users who need to access mailboxes when no one is around to transfer them to their mailboxes, you can set up the system as follows:
 - Assign extension 10 as owner of the covered lines.
 - Instruct users to press [*] [Z] when they hear the personal greeting from extension 10.
- See the communications system planning forms to determine line numbers, telephone numbers, and line owners' extensions.
- As an alternative to VMS Line Coverage you can use Extension Line Coverage. See Chapter 5 for more information.

Completing this Form

- A Line #** Write the number of the outside line to be covered by the voice mailbox of the line owner.
 - For PARTNER PLUS, specify an outside line number from 01–12.
 - For PARTNER Advanced, specify an outside line number from 01–15.
 - For PARTNER II or PARTNER 48 specify an outside line number from 01–24.
- B Telephone Number** Write the telephone number of the outside line to be covered.
- C Line Owner** Write the name of the person responsible for picking up messages on this line. This is a subscriber from Form 2, “Mailbox Assignments.”
- D Mailbox** Write the mailbox number assigned to the subscriber.

Programming Line Ownership

- To program line ownership, dial [6] from the Programming Main Menu.

Communications System Planning Forms

E

This appendix contains samples of the communications systems Planning Forms. These forms identify certain features of the communications system that must be programmed *before the voice mail system is installed* to ensure that both systems are integrated and function appropriately.

It is important to keep an accurate, up-to-date record of the programming for the both systems. If you change the communications system after installation, you should update the forms that were used when the communications system was installed and ensure that any corresponding voice mail system forms are updated accordingly. Samples of the voice mail system Planning Forms are included in Appendix D.

For a general description of all the Planning Forms, see Chapter 3. Instructions for completing each form are contained on the form itself.

How To Use the Forms

The following table shows what procedures should be used and to which communications systems forms they correspond in planning for voice mail system installation and programming:

To	Use Feature/Procedure	Complete CS Form
Assign the extensions associated with the VMS hardware to Hunt Group 7.	Hunt Group Extensions (#505)	B2
Assign lines to Hunt Group 7 so calls can ring directly to the VMS and receive Automated Attendant Service.	Group Call Distribution (#206)	B1
Identify an extension as an owner of an outside line so calls on that line can ring directly to the owner's voice mailbox when Automatic VMS Cover or VMS Cover is on at owner's ext.	Line Coverage Extension (#208)	A, B2
Determine when outside calls should be answered by the Automated Attendant Service of the VMS (i.e., immediate or delayed call handling).	VMS Hunt Delay (#506)	A
Determine when outside calls should ring the VMS Hunt Group (always, day only, or night only) depending on the status of the Night Service Button at ext. 10.	VMS Hunt Schedule (#507)	A
Determine whether an extension's unanswered intercom and transferred calls and outside calls on lines assigned ownership are automatically covered by the VMS.	Automatic VMS Cover (#310)	B2
Specify the number of times intercom and transferred calls or outside calls on lines assigned ownership ring at extensions before they are sent to the VMS.	VMS Cover Rings (#117)	A
Identify the extension to which a call transferred by the VMS should be routed if the destination extension does not answer and does not have voice mail coverage active. (The transfer return extension for the VMS is typically ext. 10).	Transfer Return Extension (#306)	B1



Form A: System Configuration

Required for PARTNER Advanced Communications System.
For additional instructions, see page 2.

1. Customer Billing Name			
2. Installation Address			
3. Contact Name			Phone () -
4. Person to be Trained		Phone () -	Alternate Trainee's Name Phone () -
5. Sold by <input type="checkbox"/> Lucent Technologies Sales Force		Salesperson's Name	
<input type="checkbox"/> Dealer: _____		Phone () -	

6. Features Customer is most interested in (most important first):

7. System Lines									
Line Jack No.	Write the Telephone Numbers in order customer desires (list personal and dedicated lines last)	Write R if Rotary (Dial Pulse) Line {#201}	Line Coverage—You can select one per line				Write User's Name for Personal or Owned Line or Identify Equipment for Dedicated Line	Check if Caller ID Service	Identify other Local Telephone Company Subscription Services (e.g., Repeat Call)
			AA {#607}	VMS- ² AA {#206}	Hunt ³ Group (write no.) {#206}	VMS- ⁴ Mail {#206} or {#208}			
01									
02									
03									
04									
05									
06									
07									
08									
09									
10									
11									
12									
13									
14									
15									

1. Check if desired. Also see Form B1, AA Extension {#607} column.
 2. Check if desired. Also see Form A, Item 9, and Form B1, PARTNER MAIL or PARTNER MAIL VS column.
 3. Write group number (1–6) covering this line. Also see Form B2, Hunt Group Extensions {#505} 1–6.
 4. Check desired line for #206 or enter line owner's extension number for #208. Also see Form B1, PARTNER MAIL or PARTNER MAIL VS column.



Required for PARTNER Advanced Communications System.
For additional instructions, see pages 3 and 4.

8. System Settings. Write response on line for each item.

- Receptionist answers calls during business hours? Write "Yes" or "No"_____.
- Number of Lines {#104}—By default, 3 lines per PARTNER ACS processor module, 2 lines per 206 module and 4 lines per 400 module are assigned to each extension. Write number if different from default_____.
- Transfer Return Rings {#105}—By default, a transferred call rings 4 times before going to the transfer return extension. Write number (0-9, 0 = no return) if different from default_____.
- Outside Conference Denial {#109}—By default, a conference call can include 2 outside parties. Write "No" if 2 outside parties are not allowed_____.
- VMS Cover Rings {#117}—By default, a call rings 3 times before going to the user's mailbox. Write number (1-9) if different from default_____.
- Ring on Transfer {#119}—By default, the caller hears ringing when the call is transferred. Write "NA" if Music on Hold or silence is desired_____.
- Toll Call Prefix {#402}—By default, 0 or 1 must be dialed before the area code for a long distance call. Write "No" if 0 or 1 is not required_____.
- System Password {#403}—By default, no password is programmed to override dialing restrictions and to turn Night Service on and off. Write 4 digits if password is desired _____.
- Star Code Dial Delay {#410}—By default, the system inserts a 0 second delay after a valid Central Office star code when it autodials. Write number (1-5) of seconds if a longer delay is desired or "NO" if this feature should not be active_____.
- Music on Hold {#602}—By default, the Music on Hold jack on the processor module is active. Write "No" if the jack is deactivated_____.

9. Line Coverage.

If VMS-AA is checked on Form A, Item 7, specify the following:

- VMS Hunt Delay {#506}—By default, VMS answers calls after 2 rings. Write "Del" if calls ring 4 times before VMS answers_____.
- VMS Hunt Schedule {#507}— By default, VMS is on all the time. Check if Day only or Night only is desired:
 - Day only
 - Night only

10. Auxiliary Equipment (System). Check if applicable:

- Battery Backup
- Caller ID Devices
- Loudspeaker Paging: Number of zones_____
- Magic on Hold (Music on Hold {#602} must be active.)
- Uninterruptible Power Supply
- SMDR. If checked, specify the following if appropriate:
 - SMDR Record Type {#608}—By default, all calls are included on call reports. Write "Out" if only outgoing calls are reported_____.
 - SMDR Output Format {#610}—By default, up to 15 digits are printed for dialed numbers in the Number field of the call report. Write "24" if a maximum of 24 digits is desired_____.
- PARTNER Contact Closure Adjunct. If checked, write in the number (1-4) below to specify Operation Type for each Contact Closure as appropriate:

OperationType {#613}	Contact Closure 1	Contact Closure 1
1 = 1 second on		
2 = 3 seconds on (✓)	_____	_____
3 = 5 seconds on		
4 = Toggle		

- Backup/Restore PC Card. If checked, write "Active" if Automatic System Programming Backup {#123} is desired_____.

11. Notes: Write any additional information that you want to communicate to the installer.

12. Installation Date

13. Order Nos.

14. Sales Support Representative's Name

Telephone No.



Form B1: System Extensions

Required for PARTNER Advanced Communications System.
For additional instructions, see page 5.

Ext. Jack No.	Write Name/Description	Check if Ext. Name Display (CTP) ¹	Identify Telephone Attached to this Extension											Identify Auxiliary Equipment Attached to this Extension							Write in Other Equipment	Write Transfer Return Ext. No. (#306)										
			34-Button Display ²	Intercom Autodialer	18-Button Display ²	18-Button ²	12-Button Display ²	12-Button ²	6-Button ²	Cordless/wireless	Standard ³	Call Waiting (#316)	External Hotline (#311) ⁴	Hotline (#603) ⁵	Alert Extension for Hotline	PARTNER MAIL ⁶	PARTNER MAIL VS ⁶	Answering Machine	Extra Alert	IROB			Modem ⁷	PassageWay	FAX Machine Extension (#601) ⁷	Doorphone 1 (#604) ⁸	Alert Extensions (#606) for Doorphone 1	Doorphone 2 (#605) ⁸	Alert Extensions (#606) for Doorphone 2	AA Extension (#607) ⁹	Contact Closure Group (#612) ¹⁰	
10																																
11																																
12																																
13																																
14																																
15																																
16																																
17																																
18																																
19																																
20																																
21																																
22																																
23																																
24																																
25																																
26																																
27																																

IMPORTANT: A system display phone is required for programming at extension 10 or 11. Extension 10 typically is the receptionist's extension. Extension 11 is recommended as a second programming extension (typically the System Manager's extension).

1. If checked, see Form B1, Page 3 of 3.
2. If there is a mix of PARTNER-model and MLS-model phones, write "P" for PARTNER and "M" for MLS.
3. Write "T" for touch-tone or "R" for rotary. If Call Waiting is desired, check next column.
4. Must be standard phone. If immediate dialing is required, use a dedicated line. Do not assign restrictions that prevent dialing the outside number, Forced Account Code Entry (#307), or groups. Also see Form D, External Hotline (#311).
5. Standard phone is recommended. Write extension number of corresponding alert extension or "70" for loud-speaker paging system in next column.
6. Also write Transfer Return Ext. No. (#306) on this form (usually extension 10). Also see Form B2, Identify Group Assignments, VMS Only.
7. To prevent other extensions from interrupting calls, assign Automatic Extension Privacy (#304) on Form B2.
8. Check corresponding alert extensions in next column. To prevent outside calls, remove all outside lines—see Lines Not Assigned on Form B2.
9. Also write Transfer Return Ext. No. (#306) on this form.
10. Write "1," "2," or "B" (for Both) to identify which Contact Closure the extension can activate.



Form B1: System Extensions

May be used if Ext. Name Display is checked on Form B1,
page 1 of 3 or page 2 of 3.

Character Codes

Letters:

A = 21	N = 62
B = 22	O = 63
C = 23	P = 71
D = 31	Q = 72
E = 32	R = 73
F = 33	S = 74
G = 41	T = 81
H = 42	U = 82
I = 43	V = 83
J = 51	W = 91
K = 52	X = 92
L = 53	Y = 93
M = 61	Z = 94

Numbers:

blank = 11	
0 = 00	5 = 50
1 = 10	6 = 60
2 = 20	7 = 70
3 = 30	8 = 80
4 = 40	9 = 90

Ext. Jack No.	Write 2-Digit Code for Each Character To Be Displayed — See Table at Right													
10														
11														
12														
13														
14														
15														
16														
17														
18														
19														
20														
21														
22														
23														
24														
25														
26														
27														
28														
29														
30														
31														
32														
33														
34														
35														
36														
37														
38														
39														
40														
41														

Note: Only 12 characters display on MLS-model phones.



Form B2: Customized Extension Settings

Required if you want to change extension settings from defaults.
For additional instructions, see pages 6 and 7.

Ext. Jack No.	Identify Extension Settings if Different than Default							Identify Line Ringing {CTP} Option If Different than Default				Identify Restrictions/Permissions If Different than Defaults					Identify Group Assignments							
	Display Language {#303}¹	Automatic Extension Privacy {#304}	Abbreviated Ringing {#305}	Forced Account Code Entry {#307}	Distinctive Ring {#308}	Automatic VMS Cover {#310}	Voice Interrupt On Busy {#312}	Write line numbers in each column to show desired Line Ringing options				Write line numbers for Line Access Restriction {#302}					Outgoing Call Restriction {#401}³	Disallowed List Assignment {#405}	Allowed List Assignment {#408}	Pickup Group Extensions {#501}	Calling Group Extensions {#502}	Hunt Group Extensions {#505}	VMS Only ⁷	Night Service Group Extensions {#504}
	F ✓	NA ✓	A ✓	NA ✓	A ✓	NA ✓	NA ✓	Immediate ✓	Delayed	No Ring	Lines² Not Assigned	Outgoing only	Incoming only	No Access	NR ✓	1-8	1-8	1-4	1-4	1-6	7	NA ✓	NA ✓	
10																								
11																								
12																								
13																								
14																								
15																								
16																								
17																								
18																								
19																								
20																								
21																								
22																								
23																								
24																								
25																								
26																								
27																								

- Write S for Spanish or F for French.
- Use Line Assignment {#301} to remove lines from or assign lines to extensions.
- Write IN for inside Only or LOC for Local Only to indicate restrictions for all outgoing calls on *all lines*.
- Write list number (1-8). Also see Form D, Disallowed Phone Number Lists {#404}.
- Write list number (1-8). Also see Form D, Allowed Phone Number Lists {#407}.

- Write group number (1-4).
- Write group number (1-4). If a loudspeaker is connected and Simultaneous Paging is desired, put appropriate extensions in Calling Group 1. Also see Form C, Simultaneous Paging.
- Write group number (1-6).
- Check off the same PARTNER MAIL or PARTNER MAIL VS extensions indicated on Form B1.

- Assignments**
- ✓ = Default
 - A = Assigned or Active
 - E = English
 - NA = Not Assigned or Not Active
 - NR = No Restriction
 - {CTP} = Centralized Telephone Programming



Form B2: Customized Extension Settings

Required if you want to change extension settings from defaults.
For additional instructions, see pages 6 and 7.

Ext. Jack No.	Identify Extension Settings If Different than Default							Identify Line Ringing {CTP} Option If Different than Default				Identify Restrictions/Permissions If Different than Defaults					Identify Group Assignments									
	Display Language {#303} ¹	Automatic Extension Privacy {#304}	Abbreviated Ringing {#305}	Forced Account Code Entry {#307}	Distinctive Ring {#308}	Automatic VMS Cover {#310}	Voice Interrupt On Busy {#312}	Write line numbers in each column to show desired Line Ringing options				Write line numbers for Line Access Restriction {#302}					Outgoing Call Restriction {#401} ³	Disallowed List ⁴ Assignment {#405}	Allowed List ⁵ Assignment {#408}	Pickup Group ⁶ Extensions {#501}	Calling Group ⁷ Extensions {#502}	Hunt Group ⁸ Extensions {#505}	VMS Only ⁹	Night Service Group Extensions {#504}		
E ✓	NA ✓	A ✓	NA ✓	A ✓	NA ✓	NA ✓	Immediate ✓	Delayed	No Ring	Lines ² Not Assigned	Outgoing only	Incoming only	No Access	NR ✓	1-8	1-8	1-4	1-4	1-6	7	NA ✓	NA ✓	NA ✓	NA ✓		
28																										
29																										
30																										
31																										
32																										
33																										
34																										
35																										
36																										
37																										
38																										
39																										
40																										
41																										

- Write S for Spanish or F for French.
- Use Line Assignment {#301} to remove lines from or assign lines to extensions.
- Write IN for Inside Only or LOC for Local Only to indicate restrictions for all outgoing calls on *all lines*.
- Write list number (1-8). Also see Form D, Disallowed Phone Number Lists {#404}.
- Write list number (1-8). Also see Form D, Allowed Phone Number Lists {#407}.

- Write group number (1-4).
- Write group number (1-4). If a loudspeaker is connected and Simultaneous Paging is desired, put appropriate extensions in Calling Group 1. Also see Form C, Simultaneous Paging.
- Write group number (1-6).
- Check off the same PARTNER MAIL or PARTNER MAIL VS extensions indicated on Form B1.

Assignments

- ✓ = Default
- A = Assigned or Active
- E = English
- NA = Not Assigned or Not Active
- NR = No Restriction
- {CTP} = Centralized Telephone Programming

Make as many copies as you need. Use template and/or checklist.
For additional instructions, see pages 8 through 13.

Check Desired Features

Also write in extension or group number

Night Service Button (#503)	NightSvc	LED Required
Outgoing Call Restriction Button (#114) ¹	OCR	
Wake Up Service Button (#115)	Wake	
Caller ID Inspect (F 17)	ID-Inspect	
Caller ID Name Display (F 16)	ID-Name	
Do Not Disturb (F 01)	DND	
Privacy (F 07)	Priv	
VMS Cover (F 15)	VMSCover	
Voice Interrupt on Busy Talk-Back (F 18)	VIOB	
Account Code Entry (F 12) ²	ACE	
Background Music (F 19) ²	Music	
Call Forwarding/Call Follow-Me (F 11 XX XX) ^{2,3}	CF-XX XX	
Call Park (I XX) ³	Park	
Call Pickup (I 6 XX)	Pickup-XX	
Conference Drop (F 06)	Drop	
Contact Closure 1 (F 41) ²	CC1	
Contact Closure 2 (F 42) ²	CC2	
Direct Line Pickup-Active Line(I 68)	DLPA	
Direct Line Pickup-Idle Line(I 8)	DLPI	
Exclusive Hold (F 02)	ExHold	
Fax Management (I XX) ²	FAX-XX	
Group Calling-Ring/Page (I 7 G or I *7 G)	GCall-g	
Group Hunt-Ring/Signal(I 77 G or I *77 G)	Hunt-g	
Group Pickup(I 66 G)	P/U Grp-g	
Intercom Autodial (I XX or I *XX) ²	Ext-XX	
Last Number Redial (F 05)	LNR	
Loudspeaker Paging (I 70)	Loudspk	
Manual Signaling (F 13 XX or F 13 *XX) ²	MS-XX	
Message Light Off (F 10 XX) ⁵	MsgOff-XX	
Message Light On (F 09 XX) ⁵	MsgOn-XX	
Recall (F 03)	Recall	
Save Number Redial (F 04)	SNR	
Simultaneous Paging(I * 70)	SPage	
Station Lock (F 21) ²	Lock	
Touch-Tone Enable (F 08)	TT-EN	
Voice Mail Messages Button (I 777)	VMMsgs-777	
Voice Mailbox Transfer (F 14)	VMBx	

1. Requires Auto Dial button for each extension.
2. Button with lights is recommended, but not required.
3. Extension number can be programmed as Auto Dial button.
4. You can program the origination extension only or both the origination and destination extension.
5. You can program the extension number.

SAMPLE

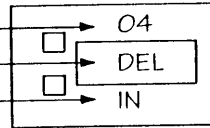

Template Instructions

- If desired, write in line number, dial code feature, or auto dial number
- If desired, write in Line Ringing (Imm, Del, or No) from Form B2
- If desired, write in Line Access Restriction (Out, In, or No) from Form B2

<input type="checkbox"/>	<input type="checkbox"/>	<input type="checkbox"/>	<input type="checkbox"/>	<input type="checkbox"/>	<input type="checkbox"/>
<input type="checkbox"/>	<input type="checkbox"/>	<input type="checkbox"/>	<input type="checkbox"/>	<input type="checkbox"/>	<input type="checkbox"/>
<input type="checkbox"/>	<input type="checkbox"/>	<input type="checkbox"/>	<input type="checkbox"/>	<input type="checkbox"/>	<input type="checkbox"/>
<input type="checkbox"/>	<input type="checkbox"/>	<input type="checkbox"/>	<input type="checkbox"/>	<input type="checkbox"/>	<input type="checkbox"/>
<input type="checkbox"/>	<input type="checkbox"/>	<input type="checkbox"/>	<input type="checkbox"/>	<input type="checkbox"/>	<input type="checkbox"/>
<input type="checkbox"/>	<input type="checkbox"/>	<input type="checkbox"/>	<input type="checkbox"/>	<input type="checkbox"/>	<input type="checkbox"/>
<input type="checkbox"/>	<input type="checkbox"/>	<input type="checkbox"/>	<input type="checkbox"/>	<input type="checkbox"/>	<input type="checkbox"/>
<input type="checkbox"/>	<input type="checkbox"/>	<input type="checkbox"/>	<input type="checkbox"/>	<input type="checkbox"/>	<input type="checkbox"/>
<input type="checkbox"/>	<input type="checkbox"/>	<input type="checkbox"/>	<input type="checkbox"/>	<input type="checkbox"/>	<input type="checkbox"/>
<input type="checkbox"/>	<input type="checkbox"/>	<input type="checkbox"/>	<input type="checkbox"/>	<input type="checkbox"/>	<input type="checkbox"/>
Intercom	Intercom	Ext.			

Specify Automatic Line Selection: _____

Identify extensions programmed as shown: _____

F = Feature button G = Group I = Left Intercom button XX = Extension



Form C2: Intercom Autodialer

Make as many copies as you need. Extension 10, Extension 11, or both can have an Intercom Autodialer. For additional instructions, see page 9.

Template Instructions

- The numbers in the lower right corner for each button represent the default extension assignments. If you change them, write in the new assignments.
- If desired, write in Intercom Ring (Ext-XX) or Voice Signal (ExtVS-XX), or Manual Signal Ring (MS-XX) or Voice Signal (MSVS-XX)
- If desired, write in user name for this extension

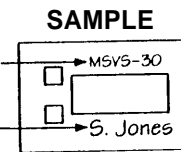

Extensions programmed as shown (circle choices): 10 11

<input type="checkbox"/> <input type="checkbox"/>	<input type="checkbox"/> <input type="checkbox"/>	<input type="checkbox"/> <input type="checkbox"/>	<input type="checkbox"/> <input type="checkbox"/>
10	22	34	
<input type="checkbox"/> <input type="checkbox"/>	<input type="checkbox"/> <input type="checkbox"/>	<input type="checkbox"/> <input type="checkbox"/>	<input type="checkbox"/> <input type="checkbox"/>
11	23	35	
<input type="checkbox"/> <input type="checkbox"/>	<input type="checkbox"/> <input type="checkbox"/>	<input type="checkbox"/> <input type="checkbox"/>	<input type="checkbox"/> <input type="checkbox"/>
12	24	36	
<input type="checkbox"/> <input type="checkbox"/>	<input type="checkbox"/> <input type="checkbox"/>	<input type="checkbox"/> <input type="checkbox"/>	<input type="checkbox"/> <input type="checkbox"/>
13	25	37	
<input type="checkbox"/> <input type="checkbox"/>	<input type="checkbox"/> <input type="checkbox"/>	<input type="checkbox"/> <input type="checkbox"/>	<input type="checkbox"/> <input type="checkbox"/>
14	26	38	
<input type="checkbox"/> <input type="checkbox"/>	<input type="checkbox"/> <input type="checkbox"/>	<input type="checkbox"/> <input type="checkbox"/>	<input type="checkbox"/> <input type="checkbox"/>
15	27	39	
<input type="checkbox"/> <input type="checkbox"/>	<input type="checkbox"/> <input type="checkbox"/>	<input type="checkbox"/> <input type="checkbox"/>	<input type="checkbox"/> <input type="checkbox"/>
16	28	40	
<input type="checkbox"/> <input type="checkbox"/>	<input type="checkbox"/> <input type="checkbox"/>	<input type="checkbox"/> <input type="checkbox"/>	<input type="checkbox"/> <input type="checkbox"/>
17	29	41	
<input type="checkbox"/> <input type="checkbox"/>	<input type="checkbox"/> <input type="checkbox"/>	<input type="checkbox"/> <input type="checkbox"/>	<input type="checkbox"/> <input type="checkbox"/>
18	30		
<input type="checkbox"/> <input type="checkbox"/>	<input type="checkbox"/> <input type="checkbox"/>	<input type="checkbox"/> <input type="checkbox"/>	<input type="checkbox"/> <input type="checkbox"/>
19	31		
<input type="checkbox"/> <input type="checkbox"/>	<input type="checkbox"/> <input type="checkbox"/>	<input type="checkbox"/> <input type="checkbox"/>	<input type="checkbox"/> <input type="checkbox"/>
20	32		
<input type="checkbox"/> <input type="checkbox"/>	<input type="checkbox"/> <input type="checkbox"/>	<input type="checkbox"/> <input type="checkbox"/>	<input type="checkbox"/> <input type="checkbox"/>
21	33		



Make as many copies as you need. Use template and/or checklist.
For additional instructions, see pages 8 through 13.

Check Desired Features

Also write in extension or group number

Template Instructions

- If desired, write in line number, dial code feature, or auto dial number
- If desired, write in Line Ringing (Imm, Del, or No) from Form B2
- If desired, write in Line Access Restriction (Out, In, or No) from Form B2

SAMPLE

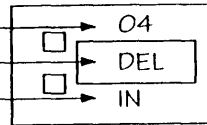

				} PARTNER-18D only
<input type="checkbox"/> <input type="checkbox"/>	<input type="checkbox"/> <input type="checkbox"/>	<input type="checkbox"/> <input type="checkbox"/>	<input type="checkbox"/> <input type="checkbox"/>	
<input type="checkbox"/> <input type="checkbox"/>	<input type="checkbox"/> <input type="checkbox"/>	<input type="checkbox"/> <input type="checkbox"/>	<input type="checkbox"/> <input type="checkbox"/>	
<input type="checkbox"/> <input type="checkbox"/>	<input type="checkbox"/> <input type="checkbox"/>	<input type="checkbox"/> <input type="checkbox"/>	<input type="checkbox"/> <input type="checkbox"/>	
<input type="checkbox"/> <input type="checkbox"/>	<input type="checkbox"/> <input type="checkbox"/>	<input type="checkbox"/> <input type="checkbox"/>	<input type="checkbox"/> <input type="checkbox"/>	
<input type="checkbox"/> <input type="checkbox"/>	<input type="checkbox"/> <input type="checkbox"/>	<input type="checkbox"/> <input type="checkbox"/>	<input type="checkbox"/> <input type="checkbox"/>	
<input type="checkbox"/> <input type="checkbox"/> Intercom	<input type="checkbox"/> <input type="checkbox"/> Intercom	Ext.		

Specify Automatic Line Selection: _____
Identify extensions programmed as shown: _____

Night Service Button (#503)	NightSvc	Ext. 10 Only	LED Required
Outgoing Call Restriction Button (#114) ¹	OCR		
Wake Up Service Button (#115)	Wake		
Caller ID Inspect (F 17)	ID-Inspect		
Caller ID Name Display (F 16)	ID-Name		
Do Not Disturb (F 01)	DND		
Privacy (F 07)	Priv		
VMS Cover (F 15)	VMSCover		
Voice Interrupt on Busy Talk-Back (F 18)	VIOB		
Account Code Entry (F 12) ²	ACE		
Background Music (F 19) ²	Music		
Call Forwarding/Call Follow-Me (F 11 XX XX) ² CF-XX XX			
Call Park (I XX) ³	Park		
Call Pickup(I 6 XX)	Pickup-XX		
Conference Drop (F 06)	Drop		
Contact Closure 1 (F 41) ²	CC1		
Contact Closure 2 (F 42) ²	CC2		
Direct Line Pickup-Active Line(I 68)	DLPA		
Direct Line Pickup-Idle Line(I 8)	DLPI		
Exclusive Hold (F 02)	ExHold		
Fax Management (I XX) ²	FAX-XX		
Group Calling-Ring/Page(I 7 G or I *7 G)	GCall-g		
Group Hunt-Ring/Signal (I 77 G or I *77 G)	Hunt-g		
Group Pickup(I 66 G)	P/U Grp-g		
Intercom Autodial (I XX or I *XX) ²	Ext-XX		
Last Number Redial (F 05)	LNR		
Loudspeaker Paging(I 70)	Loudspk		
Manual Signaling (F 13 XX or F 13 *XX) ²	MS-XX		
Message Light Off (F 10 XX) ⁵	MsgOff-XX		
Message Light On (F 09 XX) ⁵	MsgOn-XX		
Recall (F 03)	Recall		
Save Number Redial (F 04)	SNR		
Simultaneous Paging(I * 70)	SPage		
Station Lock (F 21) ²	Lock		
Touch-Tone Enable (F 08)	TT-EN		
Voice Mail Messages Button(I 777)	VMMsgs-777		
Voice Mailbox Transfer (F 14)	VMBox		

1. Requires Auto Dial button for each extension.
2. Button with lights is recommended, but not required.
3. Extension number can be programmed as Auto Dial button.
4. You can program the origination extension only or both the origination and destination extension.
5. You can program the extension number.

F = Feature button G = Group I = Left Intercom button XX = Extension

Make as many copies as you need. Use template and/or checklist.
For additional instructions, see pages 8 through 13.

Template Instructions

- If desired, write in line number, dial code feature, or auto dial number
- If desired, write in Line Ringing (Imm, Del, or No) from Form B2
- If desired, write in Line Access Restriction (Out, In, or No) from Form B2

SAMPLE

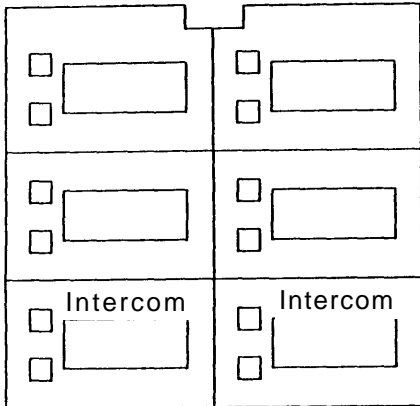
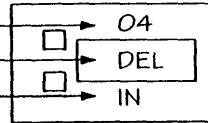

Ext.

Check Desired Features

Also write in extension or group number

		LED Required
<input type="checkbox"/>	Do Not Disturb (F 01)	DND
<input type="checkbox"/>	Privacy (F 07)	Priv
<input type="checkbox"/>	VMS Cover (F 15)	VMSCover
<input type="checkbox"/>	Voice Interrupt on Busy Talk-Back (F 18)	VI0B
<input type="checkbox"/>	Account Code Entry (F 12) ¹	ACE
<input type="checkbox"/>	Background Music (F 19) ¹	Music
<input type="checkbox"/>	Call Forwarding/Call Follow-Me (F 11 XX XX) ² CF-XX XX	
<input type="checkbox"/>	Call Park (I XX) ³	Park
<input type="checkbox"/>	Call Pickup (I 6 XX)	Pickup-XX
<input type="checkbox"/>	Conference Drop (F 06)	Drop
<input type="checkbox"/>	Contact Closure 1 (F 41) ¹	CC1
<input type="checkbox"/>	Contact Closure 2 (F 42) ¹	CC2
<input type="checkbox"/>	Direct Line Pickup-Active Line(I 68)	DLPA
<input type="checkbox"/>	Direct Line Pickup-Idle Line(I 8)	DLPI
<input type="checkbox"/>	Exclusive Hold (F 02)	ExHold
<input type="checkbox"/>	Fax Management (I XX) ¹	FAX-XX
<input type="checkbox"/>	Group Calling-Ring/Page(I 7 G or I *7 G)	GCall-g
<input type="checkbox"/>	Group Hunt-Ring/Signal (I 77 G or I *77 G)	Hunt-g
<input type="checkbox"/>	Group Pickup (I 66 G)	P/U Grp-g
<input type="checkbox"/>	Intercom Autodial(I XX or I *XX) ¹	Ext-XX
<input type="checkbox"/>	Last Number Redial (F 05)	LNR
<input type="checkbox"/>	Loudspeaker Paging(I 70)	Loudspk
<input type="checkbox"/>	Manual Signaling (F 13 XX or F 13 *XX) ¹	MS-XX
<input type="checkbox"/>	Message Light Off (F 10 XX) ⁴	MsgOff-XX
<input type="checkbox"/>	Message Light On (F 09 XX) ⁴	MsgOn-XX
<input type="checkbox"/>	Recall (F 03)	Recall
<input type="checkbox"/>	Save Number Redial (F 04)	SNR
<input type="checkbox"/>	Simultaneous Paging(I * 70)	SPage
<input type="checkbox"/>	Station Lock (F 21) ¹	Lock
<input type="checkbox"/>	Touch-Tone Enable (F 08)	TT-EN
<input type="checkbox"/>	Voice Mail Messages(I 777)	VMMsgs-777
<input type="checkbox"/>	Voice Mailbox Transfer (F 14)	VMB0x

F = Feature button G = Group I = Left Intercom button L = Line XX = Extension

1. Button with lights is recommended, but not required.
2. You can program the origination extension only or both the origination and destination extension.
3. Extension number can be programmed as Auto Dial button.
4. You can program the extension number.

Specify Automatic Line Selection: _____

Identify extensions programmed as shown: _____



Make as many copies as you need. Use template and/or checklist.
For additional instructions, see pages 8 through 13.

Template Instructions

- If desired, write in line number, dial code feature, or auto dial number
- If desired, write in Line Ringing (Imm, Del, or No) from Form B2
- If desired, write in Line Access Restriction (Out, In, or No) from Form B2

SAMPLE

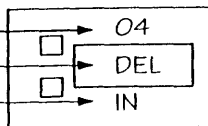

<input type="checkbox"/>	<input type="checkbox"/>	<input type="checkbox"/>	<input type="checkbox"/>	<input type="checkbox"/>	<input type="checkbox"/>
<input type="checkbox"/>	<input type="checkbox"/>	<input type="checkbox"/>	<input type="checkbox"/>	<input type="checkbox"/>	<input type="checkbox"/>
<input type="checkbox"/>	<input type="checkbox"/>	<input type="checkbox"/>	<input type="checkbox"/>	<input type="checkbox"/>	<input type="checkbox"/>
<input type="checkbox"/>	<input type="checkbox"/>	<input type="checkbox"/>	<input type="checkbox"/>	<input type="checkbox"/>	<input type="checkbox"/>
<input type="checkbox"/>	<input type="checkbox"/>	<input type="checkbox"/>	<input type="checkbox"/>	<input type="checkbox"/>	<input type="checkbox"/>
<input type="checkbox"/>	<input type="checkbox"/>	<input type="checkbox"/>	<input type="checkbox"/>	Ext.	
<input type="checkbox"/>	<input type="checkbox"/>	<input type="checkbox"/>	<input type="checkbox"/>	<input type="checkbox"/>	<input type="checkbox"/>
<input type="checkbox"/>	<input type="checkbox"/>	<input type="checkbox"/>	<input type="checkbox"/>	<input type="checkbox"/>	<input type="checkbox"/>

Specify Automatic Line Selection: _____
Identify extensions programmed as shown: _____

Check Desired Features

Also write in extension or group number

Feature Name	Feature Code	Ext. 10 Only	LED Required
Night Service Button {#503}	NightSvc		
Outgoing Call Restriction Button {#114} ¹	OCR		
Wake Up Service Button {#115}	Wake		
Caller ID Inspect (F 17)	ID-Inspect		
Caller ID Name Display (F 16)	ID-Name		
Do Not Disturb (F 01)	DND		
Privacy (F 07)	Priv		
VMS Cover (F 15)	VMSCover		
Voice Interrupt on Busy Talk-Back (F 18)	VIOB		
Account Code Entry (F 12) ²	ACE		
Background Music (F 19) ²	Music		
Call Forwarding/Call Follow-Me (F 11 XX XX) ^{2*} CF-XX XX			
Call Park (I XX) ³	Park		
Call Pickup (I 6 XX)	Pickup-XX		
Conference Drop (F 06)	Drop		
Contact Closure 1 (F 41) ²	CC1		
Contact Closure 2 (F 42) ²	CC2		
Direct Line Pickup-Active Line(I 68)	DLPA		
Direct Line Pickup-Idle Line(I 8)	DLPI		
Exclusive Hold (F 02)	ExHold		
Fax Management (I XX) ²	FAX-XX		
Group Calling-Ring/Page(I 7 G or I *7 G)	GCall-g		
Group Hunt-Ring/Signal(I 77 G or I *77 G)	Hunt-g		
Group Pickup (I 66 G)	P/U Grp-g		
Intercom Autodial (I XX or I *XX) ²	Ext-XX		
Last Number Redial (F 05)	LNR		
Loudspeaker Paging(I 70)	Loudspk		
Manual Signaling (F 13 XX or F 13 *XX) ²	MS-XX		
Message Light Off (F 10 XX) ⁵	MsgOff-XX		
Message Light On (F 09 XX) ⁵	MsgOn-XX		
Recall (F 03)	Recall		
Save Number Redial (F 04)	SNR		
Simultaneous Paging(I * 70)	SPage		
Station Lock (F 21) ²	Lock		
Touch-Tone Enable (F 08)	TT-EN		
Voice Mail Message Button (I 777)	VMMsgs-777		
Voice Mailbox Transfer (F 14)	VMBox		

1. Requires Auto Dial button for each extension.
2. Button with lights is recommended, but not required.
3. Extension number can be programmed as Auto Dial button.
4. You can program the origination extension only or both the origination and destination extension.
5. You can program the extension number.

F = Feature button G = Group I = Left Intercom button XX = Extension



Make as many copies as you need. Use template and/or checklist.
For additional instructions, see pages 8 through 13.

Check Desired Features

Also write in extension or group number

Template Instructions

- If desired, write in line number, dial code feature, or auto dial number
- If desired, write in Line Ringing (Imm, Del, or No) from Form B2
- If desired, write in Line Access Restriction (Out, In, or No) from Form B2

SAMPLE

<input type="checkbox"/>	O4
<input type="checkbox"/>	DEL
<input type="checkbox"/>	IN

<input type="checkbox"/> <input type="checkbox"/>	<input type="checkbox"/> <input type="checkbox"/>	<input type="checkbox"/> <input type="checkbox"/>	<input type="checkbox"/> <input type="checkbox"/>
<input type="checkbox"/> <input type="checkbox"/>	<input type="checkbox"/> <input type="checkbox"/>	<input type="checkbox"/> <input type="checkbox"/>	<input type="checkbox"/> <input type="checkbox"/>
<input type="checkbox"/> <input type="checkbox"/>	<input type="checkbox"/> <input type="checkbox"/>	<input type="checkbox"/> <input type="checkbox"/>	<input type="checkbox"/> <input type="checkbox"/>
<input type="checkbox"/> <input type="checkbox"/>	<input type="checkbox"/> <input type="checkbox"/>	<input type="checkbox"/> <input type="checkbox"/>	<input type="checkbox"/> <input type="checkbox"/>
<input type="checkbox"/> <input type="checkbox"/>	<input type="checkbox"/> <input type="checkbox"/>	<input type="checkbox"/> <input type="checkbox"/>	<input type="checkbox"/> <input type="checkbox"/>
<input type="checkbox"/> Intercom	<input type="checkbox"/> Intercom	Ext.	

Specify Automatic Line Selection: _____

Identify extensions programmed as shown: _____

Night Service Button (#503)	NightSvc	Ext. 10 Only	LED Required
Outgoing Call Restriction Button (#114) ¹	OCR		
Wake Up Service Button (#115)	Wake		
Caller ID Inspect (F 17)	ID-Inspect		
Caller ID Name Display (F 16)	ID-Name		
Do Not Disturb (F 01)	DND		
Privacy (F 07)	Priv		
VMS Cover (F 15)	VMSCover		
Voice Interrupt on Busy Talk-Back (F 18)	VI0B		
Account Code Entry (F 12) ²	ACE		
Background Music (F 19) ²	Music		
Call Forwarding/Call Follow-Me (F 11 XX XX) ² CF-XX XX	Park		
Call Park (I XX) ³	Park		
Call Pickup (I 6 XX)	Pickup-XX		
Conference Drop (F 06)	Drop		
Contact Closure 1 (F 41) ²	CC1		
Contact Closure 2 (F 42) ²	CC2		
Direct Line Pickup-Active Line (I 68)	DLPA		
Direct Line Pickup-Idle Line (I 8)	DLPI		
Exclusive Hold (F 02)	ExHold		
Fax Management (I XX) ²	FAX-XX		
Group Calling-Ring/Page (I 7 G or I *7 G)	GCall-g		
Group Hunt-Ring/Signal (I 77 G or I *77 G)	Hunt-g		
Group Pickup (I 66 G)	P/U Grp-g		
Intercom Autodial (I XX or I *XX) ²	Ext-XX		
Last Number Redial (F 05)	LNR		
Loudspeaker Paging (I 70)	Loudspk		
Manual Signaling (F 13 XX or F 13 *XX) ²	MS-XX		
Message Light Off (F 10 XX) ⁵	MsgOff-XX		
Message Light On (F 09 XX) ⁵	MsgOn-XX		
Recall (F 03)	Recall		
Save Number Redial (F 04)	SNR		
Simultaneous Paging (I * 70)	SPage		
Station Lock (F 21) ²	Lock		
Touch-Tone Enable (F 08)	TT-EN		
Voice Mail Messages Button (I 777)	VMMsgs-777		
Voice Mailbox Transfer (F 14)	VMB0x		

F = Feature button G = Group I = Left Intercom button XX = Extension



Make as many copies as you need. Use template and/or checklist.
For additional instructions, see pages 8 through 13.

Check Desired Features

Also write in extension or group number

Template Instructions

- If desired, write in line number, dial code feature, or auto dial number
- If desired, write in Line Ringing (Imm, Del, or No) from Form B2
- If desired, write in Line Access Restriction (Out, In, or No) from Form B2

SAMPLE

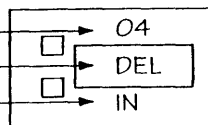

<input type="checkbox"/>	<input type="checkbox"/>	<input type="checkbox"/>	<input type="checkbox"/>
<input type="checkbox"/> <input type="checkbox"/>	<input type="checkbox"/> <input type="checkbox"/>	<input type="checkbox"/>	<input type="checkbox"/>
<input type="checkbox"/> <input type="checkbox"/>	<input type="checkbox"/> <input type="checkbox"/>	<input type="checkbox"/> <input type="checkbox"/>	<input type="checkbox"/> <input type="checkbox"/>
<input type="checkbox"/> <input type="checkbox"/>	<input type="checkbox"/> <input type="checkbox"/>	<input type="checkbox"/> <input type="checkbox"/>	<input type="checkbox"/> <input type="checkbox"/>
<input type="checkbox"/> <input type="checkbox"/>	<input type="checkbox"/> <input type="checkbox"/>	<input type="checkbox"/> <input type="checkbox"/>	<input type="checkbox"/> <input type="checkbox"/>
<input type="checkbox"/> Intercom	<input type="checkbox"/> Intercom	Ext.	

Specify Automatic Line Selection: _____

Identify extensions programmed as shown: _____

Night Service Button (#503)	NightSvc	Ext. 10 Only	LED Required
Outgoing Call Restriction Button (#114) ¹	OCR		
Wake Up Service Button (#115)	Wake		
Caller ID Inspect (F 17)	ID-Inspect		
Caller ID Name Display (F 16)	ID-Name		
Do Not Disturb (F 01)	DND		
Privacy (F 07)	Priv		
VMS Cover (F 15)	VMSCover		
Voice Interrupt on Busy Talk-Back (F 18)	VIOB		
Account Code Entry (F 12) ²	ACE		
Background Music (F 19) ²	Music		
Call Forwarding/Call Follow-Me (F 11 XX XX) ⁴ CF-XX XX			
Call Park (I XX) ³	Park		
Call Pickup (I 6 XX)	Pickup-XX		
Conference Drop (F 06)	Drop		
Contact Closure 1 (F 41) ²	CC1		
Contact Closure 2 (F 42) ²	CC2		
Direct Line Pickup-Active Line (I 68)	DLPA		
Direct Line Pickup-Idle Line (I 8)	DLPI		
Exclusive Hold (F 02)	ExHold		
Fax Management (I XX) ²	FAX-XX		
Group Calling-Ring/Page (I 7 G or I *7 G)	GCall-g		
Group Hunt-Ring/Signal (I 77 G or I *77 G)	Hunt-g		
Group Pickup (I 66 G)	P/U Grp-g		
Intercom Autodial (I XX or I *XX) ²	Ext-XX		
Last Number Redial (F 05)	LNR		
Loudspeaker Paging (I 70)	Loudspk		
Manual Signaling (F 13 XX or F 13 *XX) ⁵	MS-XX		
Message Light Off (F 10 XX) ⁵	MsgOff-XX		
Message Light On (F 09 XX) ⁵	MsgOn-XX		
Recall (F 03)	Recall		
Save Number Redial (F 04)	SNR		
Simultaneous Paging (I * 70)	SPage		
Station Lock (F 21) ²	Lock		
Touch-Tone Enable (F 08)	TT-EN		
Voice Mail Messages Button (I 777)	VMMsgs-777		
Voice Mailbox Transfer (F 14)	VMBBox		

F = Feature button G = Group I = Left Intercom button XX = Extension



Form C8: MLS-6 Phone

Make as many copies as you need. Use template and/or checklist.
For additional instructions, see pages 8 through 13.

Template Instructions

- If desired, write in line number, dial code feature, or auto dial number
- If desired, write in Line Ringing (Imm, Del, or No) from Form B2
- If desired, write in Line Access Restriction (Out, In, or No) from Form B2

SAMPLE

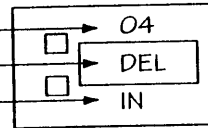

<input type="checkbox"/>	<input type="checkbox"/>	<input type="checkbox"/>	<input type="checkbox"/>
<input type="checkbox"/>	<input type="checkbox"/>	<input type="checkbox"/>	<input type="checkbox"/>
<input type="checkbox"/>	<input type="checkbox"/>	Ext.	
<input type="checkbox"/>	<input type="checkbox"/>	<input type="checkbox"/>	
<input type="checkbox"/>	<input type="checkbox"/>	<input type="checkbox"/>	

Specify Automatic Line Selection: _____
Identify extensions programmed as shown: _____

Check Desired Features

Also write in extension or group number

		LED Required
<input type="checkbox"/>	Do Not Disturb (F 01)	DND
<input type="checkbox"/>	Privacy (F 07)	Priv
<input type="checkbox"/>	VMS Cover (F 15)	VMSCover
<input type="checkbox"/>	Voice Interrupt on Busy Talk-Back (F 18)	VIQB
<input type="checkbox"/>	Account Code Entry (F 12) ¹	ACE
<input type="checkbox"/>	Background Music (F 19) ¹	Music
<input type="checkbox"/>	Call Forwarding/Call Follow-Me (F 11 XX XX) ^{1,2} CF-XX XX	
<input type="checkbox"/>	Call Park (I XX) ³	Park
<input type="checkbox"/>	Call Pickup (I 6 XX)	Pickup-XX
<input type="checkbox"/>	Conference Drop (F 06)	Drop
<input type="checkbox"/>	Contact Closure 1 (F 41) ¹	CC1
<input type="checkbox"/>	Contact Closure 2 (F 42) ¹	CC2
<input type="checkbox"/>	Direct Line Pickup-Active Line(I 68)	DLPA
<input type="checkbox"/>	Direct Line Pickup-Idle Line (I 8)	DLPI
<input type="checkbox"/>	Exclusive Hold (F 02)	ExHold
<input type="checkbox"/>	Fax Management (I XX) ¹	FAX-XX
<input type="checkbox"/>	Group Calling-Ring/Page (I 7 G or I *7 G)	GCall-g
<input type="checkbox"/>	Group Hunt-Ring/Signal(I 77 G or I *77 G)	Hunt-g
<input type="checkbox"/>	Group Pickup (I 66 G)	P/U Grp-g
<input type="checkbox"/>	Intercom Autodial (I XX or I *XX) ¹	Ext-XX
<input type="checkbox"/>	Last Number Redial (F 05)	LNR
<input type="checkbox"/>	Loudspeaker Paging(I 70)	Loudspk
<input type="checkbox"/>	Manual Signaling (F 13 XX or F 13 *XX) ¹	MS-XX
<input type="checkbox"/>	Message Light Off (F 10 XX) ⁴	MsgOff-XX
<input type="checkbox"/>	Message Light On (F 09 XX) ⁴	MsgOn-XX
<input type="checkbox"/>	Recall (F 03)	Recall
<input type="checkbox"/>	Save Number Redial (F 04)	SNR
<input type="checkbox"/>	Simultaneous Paging(I * 70)	SPage
<input type="checkbox"/>	Station Lock (F 21) ¹	Lock
<input type="checkbox"/>	Touch-Tone Enable (F 08)	TT-EN
<input type="checkbox"/>	Voice Mail Messages(I 777)	VMMsgs-777
<input type="checkbox"/>	Voice Mailbox Transfer (F 14)	VMBox

F = Feature button G = Group I = Left Intercom button L = Line XX = Extension

1. Button with lights is recommended, but not required.
2. You can program the origination extension only or both the origination and destination extension.
3. Extension number can be programmed as Auto Dial button.
4. You can program the extension number.



Form D: Number Lists

Required if Form B2 identifies Disallowed or Allowed List Assignments.
For additional instructions, see page 14.

Disallowed Phone Number Lists {#404}
Required only if Disallowed List Assignment {#405} is specified on Form B2.
Write the telephone numbers that users are prevented from dialing.

List 1		List 2		List 3		List 4		List 5		List 6		List 7		List 8	
Entry	Telephone Number	Entry	Telephone Number	Entry	Telephone Number	Entry	Telephone Number	Entry	Telephone Number	Entry	Telephone Number	Entry	Telephone Number	Entry	Telephone Number
01		01		01		01		01		01		01		01	
02		02		02		02		02		02		02		02	
03		03		03		03		03		03		03		03	
04		04		04		04		04		04		04		04	
05		05		05		05		05		05		05		05	
06		06		06		06		06		06		06		06	
07		07		07		07		07		07		07		07	
08		08		08		08		08		08		08		08	
09		09		09		09		09		09		09		09	
10		10		10		10		10		10		10		10	

Allowed Phone Number Lists {#407}
Required only if Allowed List Assignment {#408} is specified on Form B2.
Write the telephone numbers that users can dial regardless of assigned restrictions.

List 1		List 2		List 3		List 4		List 5		List 6		List 7		List 8	
Entry	Telephone Number	Entry	Telephone Number	Entry	Telephone Number	Entry	Telephone Number	Entry	Telephone Number	Entry	Telephone Number	Entry	Telephone Number	Entry	Telephone Number
01		01		01		01		01		01		01		01	
02		02		02		02		02		02		02		02	
03		03		03		03		03		03		03		03	
04		04		04		04		04		04		04		04	
05		05		05		05		05		05		05		05	
06		06		06		06		06		06		06		06	
07		07		07		07		07		07		07		07	
08		08		08		08		08		08		08		08	
09		09		09		09		09		09		09		09	
10		10		10		10		10		10		10		10	

1. Telephone Number can be up to 12 characters, including 0-9, *, and #. Write ! for wildcard (press Hold to program).



Required if Form B1 identifies External Hotlines. For additional instructions, see page 15.

Emergency Phone Number List {#406}		
Write Emergency Phone Numbers that can be dialed from any phone that has access to an outside line regardless of assigned restrictions.		
Entry	Telephone Number ¹	Person/Place
01		
02		
03		
04		
05		
06		
07		
08		
09		
10		

- 1. Telephone Number can be up to 12 digits (0-9).
- 2. Telephone Number can be up to 28 characters, including 0-9, *, #, and special dialing functions. You can have more than 10 External Hotlines.

External Hotline {#311}	
Required if External Hotline {#311} is checked on Form B1.	
Write Extension Jack number specified on Form B1, and the corresponding telephone number to be assigned to Personal Speed Dial Code 80 for that extension.	
Ext.Jack	Telephone Number ²

NOTE: An External Hotline phone is a standard phone that dials the specified telephone number when the handset is lifted.



Form D: Number Lists

Required only if Forced Account Code Verification is desired.
For additional instructions, see page 15.

Forced Account Code List {#409}

Entry	Account Code (up to 6 digits)	Write Description	Entry	Account Code (up to 6 digits)	Write Description	Entry	Account Code (up to 6 digits)	Write Description
01			34			67		
02			35			68		
03			36			69		
04			37			70		
05			38			71		
06			39			72		
07			40			73		
08			41			74		
09			42			75		
10			43			76		
11			44			77		
12			45			78		
13			46			79		
14			47			80		
15			48			81		
16			49			82		
17			50			83		
18			51			84		
19			52			85		
20			53			86		
21			54			87		
22			55			88		
23			56			89		
24			57			90		
25			58			91		
26			59			92		
27			60			93		
28			61			94		
29			62			95		
30			63			96		
31			64			97		
32			65			98		
33			66			99		

1. Valid entries are 0-9; write ! for wildcard (press Hold to program).



Form E: System Speed Dial Numbers

Optional for PARTNER Advanced Communications System.
For additional instructions, see page 16.

To Dial: On system phones, press [*Feature*] + 3-digit code. On standard phones, press [#] + 3-digit code while receiving intercom dial tone.

Code	Name/Company	★ ¹	Telephone Number ²
600			
601			
602			
603			
604			
605			
606			
607			
608			
609			
610			
611			
612			
613			
614			
615			
616			
617			
618			
619			
620			
621			
622			
623			
624			
625			
626			
627			
628			
629			
630			
631			
632			
633			

Code	Name/Company	★ ¹	Telephone Number ²
634			
635			
636			
637			
638			
639			
640			
641			
642			
643			
644			
645			
646			
647			
648			
649			
650			
651			
652			
653			
654			
655			
656			
657			
658			
659			
660			
661			
662			
663			
664			
665			
666			

Code	Name/Company	★ ¹	Telephone Number ²
667			
668			
669			
670			
671			
672			
673			
674			
675			
676			
677			
678			
679			
680			
681			
682			
683			
684			
685			
686			
687			
688			
689			
690			
691			
692			
693			
694			
695			
696			
697			
698			
699			

¹You can dial System Speed Dial numbers that are marked with ★ at any time, regardless of dialing restrictions placed on your extension. System Speed Dial numbers are programmed by the System Manager (report problems and suggested revisions to your System Manager).

²Telephone number can be up to 28 digits, including 0-9, ★, # and special dialing functions (see page 16 of instructions for detailed information).



Required for PARTNER II System and PARTNER Plus System.

For additional instructions, see page 2.

1. Customer Billing Name			
2. Installation Address			
3. Contact Name			Phone () -
4. Person to be Trained		Phone () -	Alternate Trainee's Name Phone () -
5. Sold by <input type="checkbox"/> Lucent Technologies Sales Force		Salesperson's Name Phone () -	
<input type="checkbox"/> Dealer: _____		_____ () -	

6. Configure Hardware for Hybrid Mode (PARTNER II system only):
 No Yes If yes, call local telephone company—
 MF Mode and FCC # AS5 USA-21312-MF-E

7. Features Customer is most interested in (most important first):

8. System Lines

Line Jack No.	Write the Telephone Numbers in order customer desires (list personal and dedicated lines last)	Write R if Rotary (Dial Pulse) Line (#201)	Hybrid Mode Only: Write auxiliary pool 881, 882, 883 or No Pool (#207)	Line Coverage—You can select one per line						Write Ext. No for Call Cover (#208)	Write User's Name for Personal or Owned Line or Identify Equipment for Dedicated Line	Check if Caller ID Service	Identify other Local Telephone Company Subscription Services (e.g., Repeat Call)
				AA ¹ {#607}	DXD ² {#205}	VMS- ³ AA {#206}	ASA ⁴ {#204}	Hunt Group (Write no.) {#206}	VMS- ⁶ Mail {#206} or {#208}				
01													
02													
03													
04													
05													
06													
07													
08													
09													
10													
11													
12													
13													
14													
15													
16													
17													
18													
19													
20													
21													
22													
23													
24													

PARTNER II System Only

1. Check if desired. Also see Form B1, AA Extension {#607} column.
 2. Check if desired. Also see Form A, Item 10—DXD, and Form C, Direct Extension Dial Button {#113}.
 3. Check if desired. Also see Form A, Item 10—VMS-AA, and Form B1, PARTNER MAIL or PARTNER MAIL VS column.
 4. Check if desired. Also see Form A, Item 10—ASA, and Form C, Automatic System Answer Button {#111}.

5. Write group number (1–6) covering this line. Also see Form B2, Hunt Group Extensions {#505} 1–6.
 6. Check desired line for #206 or enter line owner's extension number for #208. Also see Form B1, PARTNER MAIL or PARTNER MAIL VS column.
 7. Write extension number of line owner eligible for Call Coverage. Also write line owner's name in next column.



Required for PARTNER II System and PARTNER Plus System.
For additional instructions, see page 3.

9. System Settings. Write response on line for each item.

- Receptionist answers calls during business hours? Write "Yes" or "No"_____.
- Number of Lines {#104}—By default, 2 lines per 206 module and 4 lines per 400 module are assigned to each extension (or to pool 880 in PARTNER II Hybrid Mode). Write number if different from default_____.
- Transfer Return Rings {#105}—By default, a transferred call rings 4 times before going to the transfer return extension. Write number (0-9, 0 = no return) if different from default_____.
- Outside Conference Denial {#109}—By default, a conference call can include 2 outside parties. Write "No" if 2 outside parties are not allowed_____.
- Call Coverage Rings {#116} (PARTNER II only)—By default, a covered call rings 2 times before going to the covering extension. Write number (1-9) if different from default_____.
- VMS Cover Rings {#117}—By default, a call rings 3 times before going to the user's mailbox. Write number (1-9) if different from default_____.
- Ring on Transfer {#119}—By default, the caller hears ringing when the call is transferred. Write "NA" if music on hold or silence is desired_____.
- Toll Call Prefix {#402}—By default, 0 or 1 must be dialed before the area code for a long distance call. Write "No" if 0 or 1 is not required_____.
- System Password {#403}—By default, no password is programmed to override dialing restrictions and to turn Night Service on and off. Write 4 digits if password is desired____ _.
- Music on Hold {#602}—By default, the Music on Hold jack on the processor module is active. Write "No" if the jack is deactivated_____.

10. Line Coverage. Complete items based on Line Coverage selection on Form A, Item 8.

DXD: (PARTNER II system only) If DXD is checked, specify the following:

Direct Extension Dial Delay {#112}—By default, a call rings 2 times before it is answered by the system. Write number (0-9) if different from default_____.

Direct Extension Dial Record/Playback (I 892)—message of up to 20 seconds that caller hears when call is answered with the Direct Extension Dial feature. Write message below and record from extension 10 or 11:

VMS-AA: If VMS-AA is checked, specify the following:

VMS Hunt Delay {#506}—By default, VMS answers calls after 2 rings. Write "Del" if calls ring 4 times before VMS answers_____.

VMS Hunt Schedule {#507}—By default, VMS is on all the time. Check if Day only or Night only is desired:

- Day only
- Night only

ASA: (PARTNER II system only) If ASA is checked, specify the following:

Automatic System Answer Delay {#110}—By default, a call rings 2 times before it is answered by the system. Write number (0-9) if different from default_____.

Automatic System Answer Mode {#121}—By default, ASA calls are put on hold after the greeting plays. Check if calls should continue to ring or be disconnected:

- Ring
- Disconnect

ASA Record/Playback (I 891)—message of up to 10 seconds that caller hears when the call is answered by the Automatic System Answer feature. Write message below and record from extension 10 or 11:



Required for PARTNER II System and PARTNER Plus System.
For additional instructions, see page 4.

11. Auxiliary Equipment (System). Check if applicable:

- Battery Backup
- Caller ID Devices
- Loudspeaker Paging: Number of zones_____
- Magic on Hold (Music on Hold {#602} must be active.)
- Uninterruptible Power Supply
- SMDR If checked, specify the following if appropriate:
 - SMDR Record Type (#608)—By default, all calls are included on call reports. Write “Out” if only outgoing calls are reported_____.
 - SMDR Output Format (#610)—By default, up to 15 digits are printed for dialed numbers in the Number field of the call report. Write “24” if a maximum of 24 digits is desired_____.
 - SMDR Talk Time (#611) (PARTNER II only)—By default, a Talk field is not included on the call report. Write “Active” if the Talk field is desired_____.

12. Notes: Write any additional information that you want to communicate to the installer.

13. Installation Date

14. Order Nos.

15. Sales Support Representative's Name

Telephone No.



Form B1: System Extensions

Required for PARTNER II System and PARTNER Plus System.
For-additional instructions, see page 5.

Ext. Jack No.	Write Name/Description	Check if Ext. Name Display (CTP) ¹	Identify Telephone Attached to this Extension												Identify Auxiliary Equipment Attached to this Extension									Write in Other Equipment	Write Transfer Return Ext. No. (#306)								
			34-Button Display ²	Intercom Autodialer	18-Button Display ²	18-Button ²	12-Button Display ²	12-Button ²	6-Button ²	Cordless/Wireless	Standard ³	Call Waiting (#316)	External Hotline (#311) ⁴	Hotline (#603) ⁵	Alert Extension for Hotline	PARTNER MAIL ⁶	PARTNER MAIL VS ⁶	Answering Machine	Extra Alert	IROB	Modem ⁷	PassageWay	FAX Machine Extension (#601) ⁷			Doorphone 1 (#604) ⁸	Alert Extensions (#606) for Doorphone 1	Doorphone 2 (#605) ⁸	Alert Extensions (#606) for Doorphone 2	AA Extension (#607) ⁹			
10																																	
11																																	
12																																	
13																																	
14																																	
15																																	
16																																	
17																																	
18																																	
19																																	
20																																	
21																																	
22																																	
23																																	
24																																	
25																																	
26																																	
27																																	
28																																	
29																																	
30																																	
31																																	
32																																	
33																																	

IMPORTANT: A system display phone is required for programming at extension 10 or 11. Extension 10 typically is the receptionist's extension. Extension 11 is recommended as a second programming extension (typically the System Manager's extension).

1. If checked, see Form B1, Page 3 of 4
2. If there is a mix of PARTNER-model and MLS-model phones, write "P" for PARTNER and "M" for MLS.
3. Write "T" for touch-tone or "R" for rotary. If Call Waiting is desired, check next column.
4. Must be standard phone. If immediate dialing is required, use a dedicated line. Do not assign restrictions that prevent dialing the outside number, Forced Account Code Entry (#307), or groups. Also see Form D, External Hotline (#311).
5. Standard phone is recommended. Write extension number of corresponding alert extension or "70" for loud-speaker paging system in next column.
6. Also write Transfer Return Ext. No. (#306) on this form (usually extension 10). Also see Form B2, Identify Group Assignments, VMS Only.
7. To prevent other extensions from interrupting calls, assign Automatic Extension Privacy (#304) on Form B2.
8. Check corresponding alert extensions in next column. To prevent outside calls, remove all outside lines-see Lines/Pools Not Assigned on Form B2.
9. Also write Transfer Return Ext. No. (#306) on this form.



Required for PARTNER II System extensions 34 through 57.
For additional instructions, see page 5.

Ext. Jack No.	Write Name/Description	Check if Ext. Name Display (CTP) ¹	Identify Telephone Attached to this Extension											Identify Auxiliary Equipment Attached to this Extension									Write in Other Equipment	Write Transfer Return Ext. No. (#306)										
			34-Button Display ²	Intercom Autodialer	18-Button Display ²	18-Button ²	12-Button Display ²	12-Button ²	6-Button ²	Cordless/Wireless	Standard ³	Call Waiting (#316)	External Hotline (#311) ⁴	Hotline (#603) ⁵	Alert Extension for Hotline	PARTNER MAIL ⁶	PARTNER MAIL VS ⁶	Answering Machine	Extra Alert	IROB	Modem ⁷	PassageWay			FAX Machine Extension (#601) ⁸	Doorphone 1 (#604) ⁸	Alert Extensions (#606) for Doorphone 1	Doorphone 2 (#605) ⁸	Alert Extensions (#606) for Doorphone 2	AA Extension (#607) ⁹				
34																																		
35																																		
36																																		
37																																		
38																																		
39																																		
40																																		
41																																		
42																																		
43																																		
44																																		
45																																		
46																																		
47																																		
48																																		
49																																		
50																																		
51																																		
52																																		
53																																		
54																																		
55																																		
56																																		
57																																		

- If checked, see Form B1, Page 4 of 4
- If there is a mix of PARTNER-model and MLS-model phones, write "P" for PARTNER and "M" for MLS.
- Write "T" for touch-tone or "R" for rotary. If Call Waiting is desired, check next column.
- Must be standard phone. If immediate dialing is required, use a dedicated line. Do not assign restrictions that prevent dialing the outside number, Forced Account Code Entry (#307), or groups. Also see Form D, External Hotline (#311).
- Standard phone is recommended. Write extension number of corresponding alert extension or "70" for loud-speaker paging system in next column.
- Also write Transfer Return Ext. No. (#306) on this form (usually extension 10). Also see Form B2, Identify Group Assignments, VMS Only.
- To prevent other extensions from interrupting calls, assign Automatic Extension Privacy (#304) on Form B2.
- Check corresponding alert extensions in next column. To prevent outside calls, remove all outside lines-see Lines/Pool Not Assigned on Form B2.
- Also write Transfer Return Ext. No. (#306) on this form.



May be used if Ext. Name Display is checked on Form B1,
Page 1 of 4.

Character Codes

Ext. Jack No.	Write 2-Digit Code for Each Character To Be Displayed – See Table at Right														
10															
11															
12															
13															
14															
15															
16															
17															
18															
19															
20															
21															
22															
23															
24															
25															
26															
27															
28															
29															
30															
31															
32															
33															

Letters:	
A = 21	N = 62
B = 22	O = 63
C = 23	P = 71
D = 31	Q = 72
E = 32	R = 73
F = 33	S = 74
G = 41	T = 81
H = 42	U = 82
I = 43	V = 83
J = 51	W = 91
K = 52	X = 92
L = 53	Y = 93
M = 61	Z = 94
Numbers:	
blank = 11	
0 = 00	5 = 50
1 = 10	6 = 60
2 = 20	7 = 70
3 = 30	8 = 80
4 = 40	9 = 90

Note: Only 12 characters display on MLS-model phones.



May be used if Ext. Name Display is checked on Form B1,
Page 2 of 4.

Character Codes

Ext. Jack No.	Write 2-Digit Code for Each Character To Be Displayed — See Table at Right											
34												
35												
36												
37												
38												
39												
40												
41												
42												
43												
44												
45												
46												
47												
48												
49												
50												
51												
52												
53												
54												
55												
56												
57												

Letters:	
A = 21	N = 62
B = 22	O = 63
C = 23	P = 71
D = 31	Q = 72
E = 32	R = 73
F = 33	S = 74
G = 41	T = 81
H = 42	U = 82
I = 43	V = 83
J = 51	W = 91
K = 52	X = 92
L = 53	Y = 93
M = 61	Z = 94
Numbers:	
blank = 11	
0 = 00	5 = 50
1 = 10	6 = 60
2 = 20	7 = 70
3 = 30	8 = 80
4 = 40	9 = 90

Note: Only 12 characters display on MLS-model phones.



Form B2: Customized Extension Settings

Required if you want to change extension settings from defaults for PARTNER II System and PARTNER Plus System. For additional instructions, see pages 6 and 7.

Ext. Jack No.	Identify Extension Settings if Different than Default								Identify Line Ringing (CTP) Option If Different than Default				Identify Restrictions/Permissions If Different than Defaults						Identify Group Assignments							
	Display Language (#303) ¹	Automatic Extension Privacy (#304)	Abbreviated Ringing (#305)	Forced Account Code Entry (#307)	Distinctive Ring (#308)	Automatic VMS Cover (#310)	Voice Interrupt On Busy (#312)	Line Access Mode (#313) ²	Hybrid Mode Only: List individual lines (#301) for Pooled Extensions	Write line numbers or pool access codes in each column to show desired Line Ringing options				Write line numbers or pool access codes for Line Access Restriction (#302) or Pool Access Restriction (#315)						Identify Group Assignments						
	E ✓	NA ✓	A ✓	NA ✓	A ✓	NA ✓	NA ✓	P ✓	NA ✓	Immediate ✓ lines	Delayed	No Ring ✓ pools	Lines/Pools ³ Not Assigned	Outgoing only	Incoming only	No Access	NR ✓	Outgoing Call Restriction (#401) ⁴	Disallowed List ⁵ Assignment (#405)	Allowed List ⁶ Assignment (#408)	Pickup Group ⁷ Extensions (#501)	Calling Group ⁸ Extensions (#502)	Hunt Group ⁹ Extensions (#505)	VMS Only ¹⁰	Night Service (Group Extensions (#504))	
10								K	ALL																	
11																										
12																										
13																										
14																										
15																										
16																										
17																										
18																										
19																										
20																										
21																										
22																										
23																										
24																										
25																										
26																										
27																										
28																										
29																										
30																										
31																										
32																										
33																										

1. Write S for Spanish or F for French.
 2. In Hybrid Mode only, write K for Key extension. Extension 10 always operates as a Key extension.
 3. In Key Mode, use Line Assignment (#301) to remove lines from or assign lines to extensions. In Hybrid Mode, use Pool Extension Assignment (#314) to remove pools from or assign pools to extensions.
 4. Write IN for Inside Only or LOC for Local Only to indicate restrictions for all outgoing calls on *all lines*.

5. Write list number (1-4). Also see Form D, Disallowed Phone Number Lists (#404).
 6. Write list number (1-4). Also see Form D, Allowed Phone Number Lists (#407).
 7. Write group number (1-4).
 8. Write group number (1-4). If a loudspeaker is connected and Simultaneous Paging is desired, put appropriate extensions in Calling Group 1. Also see Form C, Simultaneous Paging.
 9. Write group number (1-6).
 10. Check off the same PARTNER MAIL or PARTNER MAIL VS extensions indicated on Form B1.

Assignments
 ✓ = Default
 A = Assigned or Active
 E = English
 NA = Not Assigned or Not Active
 NR = No Restriction
 P = Pooled
 {CTP} = Centralized Telephone Programming



Form B2: Customized Extension Setting

Required if you want to change extension settings from defaults for PARTNER II System extensions 34 through 57. For additional instructions, see pages 6 and 7.

Ext. Jack No.	Identify Extension Settings if Different than Default									Identify Line Ringing {CTP} Option If Different than Default				Identify Restrictions/Permissions If Different than Defaults					Identify Group Assignments					
	Display Language {#303} ¹	Automatic Extension Privacy {#304}	Abbreviated Ringing {#305}	Forced Account Code Entry {#307}	Distinctive Ring {#308}	Automatic VMS Cover {#310}	Voice Interrupt On Busy {#312}	Line Access Mode {#313} ²	Hybrid Mode Only: List individual lines {#301} for Pooled Extensions	Write line numbers or pool access codes in each column to show desired Line Ringing options	Write line numbers or pool access codes for Line Access Restriction {#302} or Pool Access Restriction {#315}			Outgoing Call Restriction {#401} ⁴	Disallowed List ⁵ Assignment {#405}	Allowed List ⁶ Assignment {#408}	Pickup Group ⁷ Extensions {#501}	Calling Group ⁸ Extensions {#502}	Hunt Group ⁹ Extensions {#505}	VMS Only ¹⁰	Night Service Group Extensions {#504}			
E ✓	NA ✓	A ✓	NA ✓	A ✓	NA ✓	NA ✓	P ✓	NA ✓	Immediate ✓ lines	Delayed	No Ring ✓ pools	Lines/Pools ³ Not Assigned	Outgoing only	Incoming only	No Access	NR ✓	1-4	1-4	1-4	1-4	1-6	7	NA ✓	
34																								
35																								
36																								
37																								
38																								
39																								
40																								
41																								
42																								
43																								
44																								
45																								
46																								
47																								
48																								
49																								
50																								
51																								
52																								
53																								
54																								
55																								
56																								
57																								

- Write S for Spanish or F for French.
- In Hybrid Mode only, write K for Key extension.
- In Key Mode, use Line Assignment {#301} to remove lines from or assign lines to extensions. In Hybrid Mode, use Pool Extension Assignment {#314} to remove pools from or assign pools to extensions.
- Write IN for Inside Only or LOC for Local Only to indicate restrictions for all outgoing calls on all lines.

- Write (1-4) number (1-4). Also see Form D, Disallowed Phone Number Lists {#404}.
- Write list number (1-4). Also see Form D, Allowed Phone Number Lists {#407}.
- Write group number (1-4).
- Write group number (1-4). If a loudspeaker is connected and Simultaneous Paging is desired, put appropriate extensions in Calling Group 1. Also see Form C, Simultaneous Paging.
- Write group number (1-6).
- Check off the same PARTNER MAIL or PARTNER MAIL VS extensions indicated on Form B1.

Assignments

- ✓ = Default
- A = Assigned or Active
- E = English
- NA = Not Assigned or Not Active
- NR = No Restriction
- P = Pooled
- {CTP} = Centralized Telephone Programming



For additional instructions,
see page 9.

PARTNER II only

<input type="checkbox"/> <input type="checkbox"/>	<input type="checkbox"/> <input type="checkbox"/>	<input type="checkbox"/> <input type="checkbox"/>	<input type="checkbox"/> <input type="checkbox"/>
<input type="checkbox"/> <input type="checkbox"/>	<input type="checkbox"/> <input type="checkbox"/>	<input type="checkbox"/> <input type="checkbox"/>	<input type="checkbox"/> <input type="checkbox"/>
<input type="checkbox"/> <input type="checkbox"/>	<input type="checkbox"/> <input type="checkbox"/>	<input type="checkbox"/> <input type="checkbox"/>	<input type="checkbox"/> <input type="checkbox"/>
<input type="checkbox"/> <input type="checkbox"/>	<input type="checkbox"/> <input type="checkbox"/>	<input type="checkbox"/> <input type="checkbox"/>	<input type="checkbox"/> <input type="checkbox"/>
<input type="checkbox"/> <input type="checkbox"/>	<input type="checkbox"/> <input type="checkbox"/>	<input type="checkbox"/> <input type="checkbox"/>	<input type="checkbox"/> <input type="checkbox"/>
<input type="checkbox"/> <input type="checkbox"/>	<input type="checkbox"/> <input type="checkbox"/>	<input type="checkbox"/> <input type="checkbox"/>	<input type="checkbox"/> <input type="checkbox"/>
<input type="checkbox"/> <input type="checkbox"/>	<input type="checkbox"/> <input type="checkbox"/>	<input type="checkbox"/> <input type="checkbox"/>	<input type="checkbox"/> <input type="checkbox"/>
<input type="checkbox"/> <input type="checkbox"/>	<input type="checkbox"/> <input type="checkbox"/>	<input type="checkbox"/> <input type="checkbox"/>	<input type="checkbox"/> <input type="checkbox"/>
<input type="checkbox"/> <input type="checkbox"/>	<input type="checkbox"/> <input type="checkbox"/>	<input type="checkbox"/> <input type="checkbox"/>	<input type="checkbox"/> <input type="checkbox"/>
<input type="checkbox"/> <input type="checkbox"/>	<input type="checkbox"/> <input type="checkbox"/>	<input type="checkbox"/> <input type="checkbox"/>	<input type="checkbox"/> <input type="checkbox"/>
<input type="checkbox"/> <input type="checkbox"/>	<input type="checkbox"/> <input type="checkbox"/>	<input type="checkbox"/> <input type="checkbox"/>	<input type="checkbox"/> <input type="checkbox"/>
<input type="checkbox"/> <input type="checkbox"/>	<input type="checkbox"/> <input type="checkbox"/>	<input type="checkbox"/> <input type="checkbox"/>	<input type="checkbox"/> <input type="checkbox"/>
<input type="checkbox"/> <input type="checkbox"/>	<input type="checkbox"/> <input type="checkbox"/>	<input type="checkbox"/> <input type="checkbox"/>	<input type="checkbox"/> <input type="checkbox"/>

SAMPLE

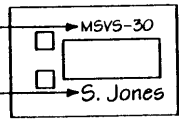

Template Instructions

- If desired, write in Intercom Ring (Ext-XX) or Voice Signal (ExtVS-XX), or Manual Signal Ring (MS-XX) or Voice Signal (MSVS-XX)
- If desired, write in user name for this extension

Extensions programmed as shown (circle choices): 10 11



Make as many copies as you need. Use template and/or checklist.
For additional instructions, see page 8.

Check Desired Features

Also write in extension or group number

Template Instructions

- If desired, write in line number, pool access code, dial code feature, or auto dial number
- If desired, write in Line Ringing (Imm, Del, or No) from Form B2
- If desired, write in Line Access Restriction or Pool Access Restriction (Out, In, or No) from Form B2

SAMPLE

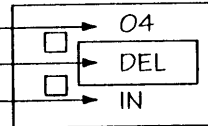

				PARTNER-18D only
<input type="checkbox"/>	<input type="checkbox"/>	<input type="checkbox"/>	<input type="checkbox"/>	
<input type="checkbox"/>	<input type="checkbox"/>	<input type="checkbox"/>	<input type="checkbox"/>	
<input type="checkbox"/>	<input type="checkbox"/>	<input type="checkbox"/>	<input type="checkbox"/>	
<input type="checkbox"/>	<input type="checkbox"/>	<input type="checkbox"/>	<input type="checkbox"/>	
<input type="checkbox"/>	<input type="checkbox"/>	<input type="checkbox"/>	<input type="checkbox"/>	
<input type="checkbox"/>	<input type="checkbox"/>	<input type="checkbox"/>	<input type="checkbox"/>	
<input type="checkbox"/>	<input type="checkbox"/>			Ext.
<input type="checkbox"/>	<input type="checkbox"/>			

		Ext. 10 Only	LED Required
Night Service Button (#503)	NightSvc		
Outgoing Call Restriction Button (#114) ¹	OCR		
Wake Up Service Button (#115)	Wake		
Caller ID Inspect (F 17)	ID-Inspect		
Caller ID Name Display (F 16)	ID-Name		
Do Not Disturb (F 01)	DND		
Privacy (F 07)	Priv		
VMS Cover (F 15)	VMSCover		
Voice Interrupt on Busy Talk-Back (F 18)	VIOB		
Account Code Entry (F 12) ²	ACE		
Background Music (F 19) ²	Music		
Backup Failure Alarm (F 58) ²	Backup		
Call Forwarding/Call Follow-Me (F 11 XX XX) ^{2,3} :CF-XX XX			
Call Park (I XX) ⁴	Park		
Call Pickup (I 6 XX)	Pickup-XX		
Conference Drop (F 06)	Drop		
Contact Closure 1 (F 41) ²	CC1		
Direct Line Pickup-Active Line(I 68)	DLPA		
Direct Line Pickup-Idle Line(I 8)	DLPI		
Exclusive Hold (F 02)	ExHold		
Fax Management(I XX) ²	FAX-XX		
Group Calling-Ring/Page(I 7 G or I * 7 G)	GCall-g		
Group Hunt-Ring/Signal(I 77 G or I *77 G)	Hunt-g		
Group Pickup (I 66 G)	P/U Grp-g		
Intercom Autodial (I XX or I *XX) ²	Ext-XX		
Last Number Redial (F 05)	LNR		
Loudspeaker Paging(I 70)	Loudspk		
Manual Signaling (F 13 XX or F 13 *XX) ²	MS-XX		
Message Light Off (F 10 XX) ⁵	MsgOff-XX		
Message Light On (F 09 XX) ⁵	MsgOn-XX		
Recall (F 03)	Recall		
Save Number Redial (F 04)	SNR		
Simultaneous Paging(I * 70)	SPage		
Station Lock (F 21) ²	Lock		
Touch-Tone Enable (F 08)	TT-EN		
Voice Mail Messages Button(I 777)	VMMsgs-777		
Voice Mailbox Transfer (F 14)	VMBox		

1. PARTNER II system only.
2. Requires Auto Dial button for each extension.
3. Button with lights is recommended, but not required.
4. Extension number can be programmed as Auto Dial button.
5. You can program the origination extension only or both the origination and destination extension.
6. You can program the extension number.

* For PARTNER II systems in Hybrid mode only, if pool 880 is assigned, these two buttons are associated with this pool.

Specify Automatic Line Selection: _____
Identify extensions programmed as shown: _____

F = Feature button G = Group I = Left Intercom button XX = Extension

Make as many copies as you need. Use template and/or checklist.
For additional instructions, see page 8.

Template Instructions

- If desired, write in line number, pool access code, dial code feature, or auto dial number
- If desired, write in Line Ringing (Imm, Del, or No) from Form B2
- If desired, write in Line Access Restriction or Pool Access Restriction (Out, In, or No) from Form B2

SAMPLE

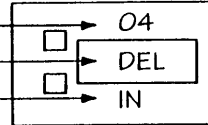

<input type="checkbox"/> <input type="checkbox"/> <input type="checkbox"/> <input type="checkbox"/>	<input type="checkbox"/> <input type="checkbox"/> <input type="checkbox"/> <input type="checkbox"/>
<input type="checkbox"/> <input type="checkbox"/> * <input type="checkbox"/> <input type="checkbox"/> *	<input type="checkbox"/> <input type="checkbox"/> * <input type="checkbox"/> <input type="checkbox"/> *
<input type="checkbox"/> Intercom <input type="checkbox"/> <input type="checkbox"/>	<input type="checkbox"/> Intercom <input type="checkbox"/> <input type="checkbox"/>

Ext.

* For PARTNER II systems in Hybrid mode only, if pool 880 is assigned, these two buttons are associated with this pool.

Specify Automatic Line Selection: _____
Identify extensions programmed as shown: _____

Check Desired Features

Also write in extension or group number

		LED Required
Do Not Disturb (F 01)	DND	
Privacy (F 07)	Priv	
VMS Cover (F 15)	VMSCover	
Voice Interrupt on Busy Talk-Back (F 18)	VIOB	
Account Code Entry (F 12) ¹	ACE	
Background Music (F 19) ¹ ✓	Music	
Call Coverage (F 20 XX XX) ^{1,2,3} ✓	Cover-XX XX	
Call Forwarding/Call Follow-Me (F 11 XX XX) ^{1,3} CF-XX XX		
Call Park (I XX) ⁴	Park	
Call Pickup (I 6 XX)	Pickup-XX	
Conference Drop (F 06)	Drop	
Direct Line Pickup-Active Line(I 68)	DLPA	
Direct Line Pickup-Idle Line(I 8)	DLPI	
Exclusive Hold (F 02)	ExHold	
Fax Management (I XX) ¹	FAX-XX	
Group Calling-Ring/Page (I 7 G or I *7 G)	GCall-g	
Group Hunt-Ring/Signal(I 77 G or I *77 G)	Hunt-g	
Group Pickup (I 66 G)	P/U Grp-g	
Intercom Autodial (I XX or I *XX) ¹	Ext-XX	
Last Number Redial (F 05)	LNR	
Loudspeaker Paging(I 70)	Loudspk	
Manual Signaling (F 13 XX or F 13 *XX) ¹	MS-XX	
Message Light Off (F 10 XX) ⁵	MsgOff-XX	
Message Light On (F 09 XX) ⁵	MsgOn-XX	
Recall (F 03)	Recall	
Save Number Redial (F 04)	SNR	
Simultaneous Paging(I * 70)	SPage	
Station Lock (F 21) ¹	Lock	
Touch-Tone Enable (F 08)	TT-EN	
Voice Mail Messages(I 777)	VMMsgs-777	
Voice Mailbox Transfer (F 14)	VMBox	

F = Feature button G = Group I = Left Intercom button L = Line XX = Extension

1. Button with lights is recommended, but not required.
2. PARTNER II system only.
3. You can program the origination extension only or both the origination and destination extension.
4. Extension number can be programmed as Auto Dial button.
5. You can program the extension number.



Make as many copies as you need. Use template and/or checklist. For additional instructions, see page 8.

Template Instructions

- If desired, write in line number, pool access code, dial code feature, or auto dial number
- If desired, write in Line Ringing (Imm, Del, or No) from Form B2
- If desired, write in Line Access Restriction or Pool Access Restriction (Out, In, or No) from Form B2

SAMPLE

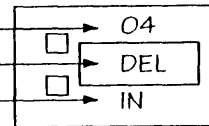

<input type="checkbox"/> <input type="checkbox"/>	<input type="checkbox"/> <input type="checkbox"/>	<input type="checkbox"/> <input type="checkbox"/>	<input type="checkbox"/> <input type="checkbox"/>	<input type="checkbox"/> <input type="checkbox"/>	<input type="checkbox"/> <input type="checkbox"/>
<input type="checkbox"/> <input type="checkbox"/>	<input type="checkbox"/> <input type="checkbox"/>	<input type="checkbox"/> <input type="checkbox"/>	<input type="checkbox"/> <input type="checkbox"/>	<input type="checkbox"/> <input type="checkbox"/>	<input type="checkbox"/> <input type="checkbox"/>
<input type="checkbox"/> <input type="checkbox"/>	<input type="checkbox"/> <input type="checkbox"/>	<input type="checkbox"/> <input type="checkbox"/>	<input type="checkbox"/> <input type="checkbox"/>	<input type="checkbox"/> <input type="checkbox"/>	<input type="checkbox"/> <input type="checkbox"/>
<input type="checkbox"/> <input type="checkbox"/>	<input type="checkbox"/> <input type="checkbox"/>	<input type="checkbox"/> <input type="checkbox"/>	<input type="checkbox"/> <input type="checkbox"/>	<input type="checkbox"/> <input type="checkbox"/>	<input type="checkbox"/> <input type="checkbox"/>
<input type="checkbox"/> <input type="checkbox"/>	<input type="checkbox"/> <input type="checkbox"/>	<input type="checkbox"/> <input type="checkbox"/>	<input type="checkbox"/> <input type="checkbox"/>	Ext.	
<input type="checkbox"/> <input type="checkbox"/> *	<input type="checkbox"/> <input type="checkbox"/> *	<input type="checkbox"/> <input type="checkbox"/>	<input type="checkbox"/> <input type="checkbox"/>	<input type="checkbox"/> <input type="checkbox"/> Intercom	<input type="checkbox"/> <input type="checkbox"/> Intercom

* For PARTNER II systems in Hybrid mode only, if pool 880 is assigned, these two buttons are associated with this pool.

Specify Automatic Line Selection: _____

Identify extensions programmed as shown: _____

Check Desired Features

Also write in extension or group number

		Ext. 10 Only	LED Required
<input type="checkbox"/>	Night Service Button (#503)	NightSvc	
<input type="checkbox"/>	Outgoing Call Restriction Button (#114) ¹	OCR	
<input type="checkbox"/>	Wake Up Service Button (#115)	Wake	
<input type="checkbox"/>	Caller ID Inspect (F 17)	ID-Inspect	
<input type="checkbox"/>	Caller ID Name Display (F 16)	ID-Name	
<input type="checkbox"/>	Do Not Disturb (F 01)	DND	
<input type="checkbox"/>	Privacy (F 07)	Priv	
<input type="checkbox"/>	VMS Cover (F 15)	VMSCover	
<input type="checkbox"/>	Voice Interrupt on Busy Talk-Back (F 18)	VIOB	
<input type="checkbox"/>	Account Code Entry (F 12) ²	ACE	
<input type="checkbox"/>	Background Music (F 19) ²	Music	
<input type="checkbox"/>	Backup Failure Alarm (F 58) ²	Backup	
<input type="checkbox"/>	Call Forwarding/Call Follow-Me (F 11 XX XX) ² CF-XX XX		
<input type="checkbox"/>	Call Park (I XX) ⁴	Park	
<input type="checkbox"/>	Call Pickup (I 6 XX)	Pickup-XX	
<input type="checkbox"/>	Conference Drop (F 06)	Drop	
<input type="checkbox"/>	Contact Closure 1 (F 41) ²	CC1	
<input type="checkbox"/>	Direct Line Pickup-Active Line(I 68)	DLPA	
<input type="checkbox"/>	Direct Line Pickup-Idle Line(I 8)	DLPi	
<input type="checkbox"/>	Exclusive Hold (F 02)	ExHold	
<input type="checkbox"/>	Fax Management (I XX) ²	FAX-XX	
<input type="checkbox"/>	Group Calling-Ring/Page (I 7 G or I *7 G)	GCall-g	
<input type="checkbox"/>	Group Hunt-Ring/Signal(I 77 G or I *77 G)	Hunt-g	
<input type="checkbox"/>	Group Pickup (I 66 G)	P/U Grp-g	
<input type="checkbox"/>	Intercom Autodial (I XX or I *XX) ²	Ext-XX	
<input type="checkbox"/>	Last Number Redial (F 05)	LNR	
<input type="checkbox"/>	Loudspeaker Paging (I 70)	Loudspk	
<input type="checkbox"/>	Manual Signaling (F 13 XX or F 13 *XX) ²	MS-XX	
<input type="checkbox"/>	Message Light Off (F 10 XX) ⁵	MsgOff-XX	
<input type="checkbox"/>	Message Light On (F 09 XX) ⁵	MsgOn-XX	
<input type="checkbox"/>	Recall (F 03)	Recall	
<input type="checkbox"/>	Save Number Redial (F 04)	SNR	
<input type="checkbox"/>	SimultaneousPaging(I * 70)	SPage	
<input type="checkbox"/>	Station Lock (F 21) ²	Lock	
<input type="checkbox"/>	Touch-Tone Enable (F 08)	TT-EN	
<input type="checkbox"/>	Voice Mail Messages Button(I 777)	VMMsgs-777	
<input type="checkbox"/>	Voice Mailbox Transfer (F 14)	VMBox	

1. PARTNER II system only.
2. Requires Auto Dial button for each extension.
3. Button with lights is recommended, but not required.
4. Extension number can be programmed as Auto Dial button.
5. You can program the origination extension only or both the origination and destination extension.
6. You can program the extension number.

F = Feature button G = Group I = Left Intercom button XX = Extension



Make as many copies as you need. Use template and/or checklist.
For additional instructions, see page 8.

Check Desired Features

Also write in extension or group number

Template Instructions

- If desired, write in line number, pool access code, dial code feature, or auto dial number
- If desired, write in Line Ringing (Imm, Del, or No) from Form B2
- If desired, write in Line Access Restriction or Pool Access Restriction (Out, In, or No) from Form B2

SAMPLE

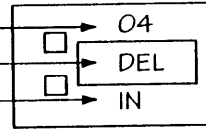

<input type="checkbox"/> <input type="checkbox"/>	<input type="checkbox"/> <input type="checkbox"/>	<input type="checkbox"/> <input type="checkbox"/>	<input type="checkbox"/> <input type="checkbox"/>
<input type="checkbox"/> <input type="checkbox"/>	<input type="checkbox"/> <input type="checkbox"/>	<input type="checkbox"/> <input type="checkbox"/>	<input type="checkbox"/> <input type="checkbox"/>
<input type="checkbox"/> <input type="checkbox"/>	<input type="checkbox"/> <input type="checkbox"/>	<input type="checkbox"/> <input type="checkbox"/>	<input type="checkbox"/> <input type="checkbox"/>
<input type="checkbox"/> <input type="checkbox"/> *	<input type="checkbox"/> <input type="checkbox"/> *	<input type="checkbox"/> <input type="checkbox"/>	<input type="checkbox"/> <input type="checkbox"/>
<input type="checkbox"/> <input type="checkbox"/> Intercom	<input type="checkbox"/> <input type="checkbox"/> Intercom	Ext.	

* For PARTNER II systems in Hybrid mode only, it pool 880 is assigned, these two buttons are associated with this pool.

Specify Automatic Line Selection: _____

Identify extensions programmed as shown: _____

		LED Required
Night Service Button (#503)	NightSvc	
Outgoing Call Restriction Button (#114) ¹	OCR	
Wake Up Service Button (#115)	Wake	
Caller ID Inspect (F 17)	ID-Inspect	
Caller ID Name Display (F 16)	ID-Name	
Do Not Disturb (F 01)	DND	
Privacy (F 07)	Priv	
VMS Cover (F 15)	VMSCover	
Voice Interrupt on Busy Talk-Back (F 18)	VIOB	
Account Code Entry (F 12) ^f	ACE	
Background Music (F 19) ²	Music	
Backup Failure Alarm (F 58) ²	Backup	
Call Forwarding/Call Follow-Me (F 11 XX XX) ⓈF-XX XX	Park	1. PARTNER II system only.
Call Park (I XX) ⁴	Park	2. Requires Auto Dial button for each extension.
Call Pickup (I 6 XX)	Pickup-XX	3. Button with lights is recommended, but not required.
Conference Drop (F 06)	Drop	
Contact Closure 1 (F 41) ²	CC1	
Direct Line Pickup-Active Line(I 68)	DLPA	
Direct Line Pickup-Idle Line(I 8)	DLPI	
Exclusive Hold (F 02)	ExHold	4. Extension number can be programmed as Auto Dial button.
Fax Management (I XX) ²	FAX-XX	
Group Calling-Ring/Page(I 7 G or I *7 G)	GCall-g	
Group Hunt-Ring/Signal(I 77 G or I *77 G)	Hunt-g	
Group Pickup(I 66 G)	P/U Grp-g	5. You can program the origination extension only or both the origination and destination extension.
Intercom Autodial (I XX or I *XX) ²	Ext-XX	6. You can program the extension number.
Last Number Redial (F 05)	LNR	
Loudspeaker Paging(I 70)	Loudspk	
Manual Signaling (F 13 XX or F 13 *XX) ²	MS-XX	
Message Light Off (F 10 XX) ⁵	MsgOff-XX	
Message Light On (F 09 XX) ⁵	MsgOn-XX	
Recall (F 03)	Recall	
Save Number Redial (F 04)	SNR	
Simultaneous Paging(I * 70)	SPage	
Station Lock (F 21) ²	Lock	
Touch-Tone Enable (F 08)	TT-EN	
Voice Mail Messages Button(I 777)	VMMsgs-777	
Voice Mailbox Transfer (F 14)	VMBBox	

F = Feature button G = Group I = Left Intercom button XX = Extension



Make as many copies as you need. Use template and/or checklist.
For additional instructions, see page 8.

Template Instructions

- If desired, write in line number, pool access code, dial code feature, or auto dial number
- If desired, write in Line Ringing (Imm, Del, or No) from Form B2
- If desired, write in Line Access Restriction or Pool Access Restriction (Out, In, or No) from Form B2

SAMPLE

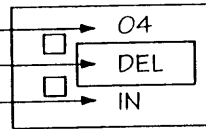

<input type="checkbox"/>	<input type="checkbox"/>	<input type="checkbox"/>	<input type="checkbox"/>
<input type="checkbox"/> <input type="checkbox"/>	<input type="checkbox"/> <input type="checkbox"/>	<input type="checkbox"/>	<input type="checkbox"/>
<input type="checkbox"/> <input type="checkbox"/>	<input type="checkbox"/> <input type="checkbox"/>	<input type="checkbox"/> <input type="checkbox"/>	<input type="checkbox"/> <input type="checkbox"/>
<input type="checkbox"/> <input type="checkbox"/> *	<input type="checkbox"/> <input type="checkbox"/> *	<input type="checkbox"/>	<input type="checkbox"/>
<input type="checkbox"/> Intercom	<input type="checkbox"/> Intercom	Ext.	

* For PARTNER II systems in Hybrid mode only, if pool 880 is assigned, these two buttons are associated with this pool.

Specify Automatic Line Selection: _____

Identify extensions programmed as shown: _____

Check Desired Features

Also write in extension or group number

		Ext	LED Required
<input type="checkbox"/>	Night Service Button (#503)	NightSvc	LED Required
<input type="checkbox"/>	Outgoing Call Restriction Button (#114)	OCR	
<input type="checkbox"/>	Wake Up Service Button (#115)	Wake	
<input type="checkbox"/>	Caller ID Inspect (F 17)	ID-Inspect	
<input type="checkbox"/>	Caller ID Name Display (F 16)	ID-Name	
<input type="checkbox"/>	Do Not Disturb (F 01)	DND	
<input type="checkbox"/>	Privacy (F 07)	Priv	
<input type="checkbox"/>	VMS Cover (F 15)	VMSCover	
<input type="checkbox"/>	Voice Interrupt on Busy Talk-Back (F 18)	VIOB	
<input type="checkbox"/>	Account Code Entry (F 12) ²	ACE	
<input type="checkbox"/>	Background Music (F 19) ²	Music	
<input type="checkbox"/>	Backup Failure Alarm (F 58) ²	Backup	
<input type="checkbox"/>	Call Forwarding/Call Follow-Me (F 11 XX XX) ² CF-XX XX	Park	
<input type="checkbox"/>	Call Park (I XX) ⁴	Pickup-XX	
<input type="checkbox"/>	Call Pickup (I 6 XX)	Drop	
<input type="checkbox"/>	Conference Drop (F 06)	CC1	
<input type="checkbox"/>	Contact Closure 1 (F 41) ²	DLPA	
<input type="checkbox"/>	Direct Line Pickup-Active Line(I 68)	DLPI	
<input type="checkbox"/>	Direct Line Pickup-Idle Line(I 8)	ExHold	
<input type="checkbox"/>	Exclusive Hold (F 02)	FAX-XX	
<input type="checkbox"/>	Fax Management (I XX) ²	GCall-g	
<input type="checkbox"/>	Group Calling-Ring/Page (I 7 G or I*7 G)	Hunt-g	
<input type="checkbox"/>	Group Hunt-Ring/Signal(I 77 G or I*77 G)	P/U Grp-g	
<input type="checkbox"/>	Group Pickup (I 66 G)	Ext-XX	
<input type="checkbox"/>	Intercom Autodial(I XX or I*XX) ²	LNR	
<input type="checkbox"/>	Last Number Redial (F 05)	Loudspk	
<input type="checkbox"/>	Loudspeaker Paging (I 70)	MS-XX	
<input type="checkbox"/>	Manual Signaling (F 13 XX or F 13*XX) ²	MsgOff-XX	
<input type="checkbox"/>	Message Light Off (F 10 XX) ⁵	MsgOn-XX	
<input type="checkbox"/>	Message Light On (F 09 XX) ⁵	Recall	
<input type="checkbox"/>	Recall (F 03)	SNR	
<input type="checkbox"/>	Save Number Redial (F 04)	SPage	
<input type="checkbox"/>	Simultaneous Paging(I* 70)	Lock	
<input type="checkbox"/>	Station Lock (F 21) ²	TT-EN	
<input type="checkbox"/>	Touch-Tone Enable (F 08)	VMMsgs-777	
<input type="checkbox"/>	Voice Mail Messages Button(I 777)	VMBox	
<input type="checkbox"/>	Voice Mailbox Transfer (F 14)		

F = Feature button G = Group I = Left Intercom button XX = Extension



Make as many copies as you need. Use template and/or checklist.
For additional instructions, see page 8.

Template Instructions

- If desired, write in line number, pool access code, dial code feature, or auto dial number
- If desired, write in Line Ringing (Imm, Del, or No) from Form B2
- If desired, write in Line Access Restriction or Pool Access Restriction (Out, In, or No) from Form B2

SAMPLE

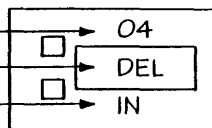

*	*		
<input type="checkbox"/> <input type="checkbox"/>	<input type="checkbox"/> <input type="checkbox"/>	<input type="checkbox"/> <input type="checkbox"/>	<input type="checkbox"/> <input type="checkbox"/>
Intercom	Intercom	Ext.	

* For PARTNER II systems in Hybrid mode only, if pool 880 is assigned, these two buttons are associated with this pool.

Check Desired Features

Also write in extension or group number

		LED Required
Do Not Disturb (F 01)	DND	
Privacy (F 07)	Priv	
VMS Cover (F 15)	VMSCover	
Voice Interrupt on Busy Talk-Back (F 18)	VIQB	
Account Code Entry (F 12) ¹	ACE	
Background Music (F 19) ¹ ✓	Music	
Call Coverage (F 20 XX XX) ^{2,3} ✓	Cover-XX XX	
Call Forwarding/Call Follow-Me (F 11 XX XX) ^{1,3} CF-XX XX		
Call Park (I XX) ⁴	Park	
Call Pickup (I 6 XX)	Pickup-XX	
Conference Drop (F 06)	Drop	
Direct Line Pickup-Active Line (I 68)	DLPA	
Direct Line Pickup-Idle Line (I 8)	DLPI	
Exclusive Hold (F 02)	ExHold	
Fax Management (I XX) ¹	FAX-XX	
Group Calling-Ring/Page (I 7 G or I *7 G)	GCall-g	
Group Hunt-Ring/Signal (I 77 G or I *77 G)	Hunt-g	
Group Pickup (I 66 G)	P/U Grp-g	
Intercom Autodial (I XX or I *XX) ¹	Ext-XX	
Last Number Redial (F 05)	LNR	
Loudspeaker Paging (I 70)	Loudspk	
Manual Signaling (F 13 XX or F 13 *XX) ¹	MS-XX	
Message Light Off (F 10 XX) ⁵	MsgOff-XX	
Message Light On (F 09 XX) ⁵	MsgOn-XX	
Recall (F 03)	Recall	
Save Number Redial (F 04)	SNR	
Simultaneous Paging (I * 70)	SPage	
Station Lock (F 21) ¹	Lock	
Touch-Tone Enable (F 08)	TT-EN	
Voice Mail Messages (I 777)	VMMsgs-777	
Voice Mailbox Transfer (F 14)	VMBox	

F = Feature button G = Group I = Left Intercom button L = Line XX = Extension

1. Button with lights is recommended, but not required.
2. PARTNER II system only.
3. You can program the origination extension only or both the origination and destination extension.
4. Extension number can be programmed as Auto Dial button.
5. You can program the extension number.

Specify Automatic Line Selection: _____

Identify extensions programmed as shown: _____



Required if Form B1 identifies External Hotlines, or if Form B2 identifies Disallowed or Allowed List Assignments. For additional instructions, see pages 14 and 15.

Disallowed Phone Number Lists {#404}							
Required only if Disallowed List Assignment {#405} is specified on Form B2.							
Write the telephone numbers that users are prevented from dialing.							
List 1		List 2		List 3		List 4	
Entry	Telephone Number ¹	Entry	Telephone NUmber ¹	Entry	Telephone Number ¹	Entry	Telephone Number ¹
01		01		01		01	
02		02		02		02	
03		03		03		03	
04		04		04		04	
05		05		05		05	
06		06		06		06	
07		07		07		07	
08		08		08		08	
09		09		09		09	
10		10		10		10	

Emergency Phone Number List {#406}		
Write Emergency Phone Numbers that can be dialed from any phone that has access to an outside line regardless of assigned restrictions.		
Entry	Telephone Number	Person/Place
01		
02		
03		
04		
05		
06		
07		
08		
09		
10		

Allowed Phone Number Lists {#407}							
Required only if Allowed List Assignment {#408} is specified on Form B2.							
Write the telephone numbers that users can dial regardless of assigned restrictions.							
List 1		List 2		List 3		List 4	
Entry	Telephone Number	Entry	Telephone Number ¹	Entry	Telephone Number ¹	Entry	Telephone Number ¹
01		01		01		01	
02		02		02		02	
03		03		03		03	
04		04		04		04	
05		05		05		05	
06		06		06		06	
07		07		07		07	
08		08		08		08	
09		09		09		09	
10		10		10		10	

External Hotline {#311}	
Required if External Hotline {#311} is checked on Form B1.	
Write Extension Jack number specified on Form B1, and the corresponding telephone number to be assigned to Personal Speed Dial Code 80 for that extension.	
Ext.Jack	Telephone Number ²

1. Telephone Number can be up to 12 characters, including 0-9, *, and #. Write ! for wildcard (press Hold to program).
 2. Telephone Number can be up to 12 digits (0-9).
 3. Telephone Number can be up to 28 characters, including 0-9, *, #, and special dialing functions. You can have more than 10 External Hotlines.

NOTE: An External Hotline phone is a phone that dials the specified telephone number when the handset is lifted.



Form D: Number Lists

Required only if Forced Account Code Verification is desired.
For additional instructions, see page 15.

Forced Account Code List {#409}																				
Entry	Account Code (up to 6 digits)					Write Description	Entry	Account Code (up to 6 digits)					Write Description	Entry	Account Code (up to 6 digits)					Write Description
01							34							67						
02							35							68						
03							36							69						
04							37							70						
05							38							71						
06							39							72						
07							40							73						
08							41							74						
09							42							75						
10							43							76						
11							44							77						
12							45							78						
13							46							79						
14							47							80						
15							48							81						
16							49							82						
17							50							83						
18							51							84						
19							52							85						
20							53							86						
21							54							87						
22							55							88						
23							56							89						
24							57							90						
25							58							91						
26							59							92						
27							60							93						
28							61							94						
29							62							95						
30							63							96						
31							64							97						
32							65							98						
33							66							99						

1. Valid entries are 0-9; write ! for wildcard (press Hold to program).



Form E: System Speed Dial Number

Optional for PARTNER II System and PARTNER Plus System.
For additional instructions, see page 16.

To Dial: On system phones, press [*Feat*] + 3-digit code. On standard phones, press [#] + 3-digit code while receiving intercom dial tone.

Code	Name/Company	★ ¹	Telephone Number ²
600			
601			
602			
603			
604			
605			
606			
607			
608			
609			
610			
611			
612			
613			
614			
615			
616			
617			
618			
619			
620			
621			
622			
623			
624			
625			
626			
627			
628			
629			
630			
631			
632			
633			

Code	Name/Company	★ ¹	Telephone Number ²
634			
635			
636			
637			
638			
639			
640			
641			
642			
643			
644			
645			
646			
647			
648			
649			
650			
651			
652			
653			
654			
655			
656			
657			
658			
659			
660			
661			
662			
663			
664			
665			
666			

Code	Name/Company	★ ¹	Telephone Number ²
667			
668			
669			
670			
671			
672			
673			
674			
675			
676			
677			
678			
679			
680			
681			
682			
683			
684			
685			
686			
687			
688			
689			
690			
691			
692			
693			
694			
695			
696			
697			
698			
699			

¹ You can dial System Speed Dial numbers that are marked with ★ at any time, regardless of dialing restrictions placed on your extension. System Speed Dial numbers are programmed by the System Manager (report problems and suggested revisions to your System Manager).

² Telephone number can be up to 28 digits, including 0-9, ★, # and special dialing functions (see page 16 of instructions for detailed information).

Case Studies

F

Purpose

This appendix contains two case studies based on actual customer requirements. Each case study defines the call handling requirements of the business and explains how the planning forms for the communications system and voice messaging system were filled out. You can use these case studies to determine how customer requirements were matched to PARTNER MAIL VS system features.

Case Study #1

About the Customer

Tennis Land is a sports center that offers tennis enthusiasts six tennis courts and a large, well-stocked shop for purchasing a variety of tennis paraphernalia including racquets and tennis wear. In addition, Tennis Land offers lessons and clinics from staff coaches. When the coaches are not giving lessons or clinics, hosting tournaments, or traveling with the Tennis Land team in exhibition matches, they help the sales people in the shop. Stan Williams—the owner, Sally Parker—the manager, and the coaches all have private offices.

Stan purchased a PARTNER Advanced Communications System Release 1.0 and a PARTNER MAIL VS Release 4 Voice Messaging System. He believes that the systems' features will help his employees provide better service to customers.

Sally is responsible for managing the systems; she established these facts:

- The system will have three outside lines and 8 extensions.
- The clerk will have a PARTNER-18D phone at extension 10. Sally's PARTNER-18D phone will be extension 11. Stans' PARTNER-18D phone will be extension 12. The three coaches will have PARTNER-18 phones. Two MLS-12 phones will be in the shop.
- Stan's callers should be able to reach him without having to be transferred by an employee or the PARTNER MAIL VS system, so Stan will have a personal line. When Stan is not available, his callers will be sent directly to his mailbox where they can leave messages.
- Stan prefers that customers speak with an employee while the center is open, so all lines will ring at all phones. Although there is no receptionist, the clerk and the salespeople will serve the receptionist function by answering calls when they can.
- During business hours, calls will go to the Automated Attendant Service of the PARTNER MAIL VS system only when the clerk and salespeople are busy.
- All of Tennis Land's customers and employees speak English, so the PARTNER MAIL VS system will be set for Monolingual Mode with U.S. English as the System Language.
- Potential customers call frequently to inquire about Tennis Land's hours and location, as well as tournament and exhibition match schedules. Therefore, when the Automated Attendant Service answers, callers can choose to hear either an announcement that includes Tennis Land's hours of operation and directions to the center or another detailing current and upcoming competitions.
- Callers who receive Automated Attendant Service and want to speak to a salesperson will be able to reach the first available person in the shop.

- The mailbox at extension 10 will be used for general messages. Customers who receive Automated Attendant Service and stay on the line or press 0 for assistance will be routed to this extension, which is at the clerk's desk. Customers who call after business hours will have the option of leaving a message in this mailbox.
- Stan, Sally, and each coach will have a mailbox and Automatic VMS Cover. Callers will be routed automatically to the appropriate mailbox where they can leave a message when the person they called is not available.
- Stan, Sally, and each coach will also have Outcalling privileges so that when they are moving around the club during tournaments or traveling with the team, they can be alerted via their pagers to the arrival of messages being left in their voice mailboxes.

Stan especially wants customers to be able to leave messages for the coaches when they are away from their offices. This capability will help prevent missed appointments and lost income when customers call about lessons and clinics.

Filling Out the Planning Forms

This section explains how the System Planner for the PARTNER Advanced Communications System Release 1.0 and the forms for the PARTNER MAIL VS Release 4 Voice Messaging System are filled out based on the facts in the Tennis Land case. For brevity, “CS” refers to the System Planner forms for the communications system and “VMS” refers to the forms for the voice messaging system.

CS Form A, Page 1 of 2

- **Write the Telephone Numbers in order customer desires:** Telephone numbers in this column represent Tennis Land’s three lines. The last line, Line 03, is Stan’s personal line.
- **VMS-AA:** In this column, checks for Lines 01, 02, and 03 indicate that unanswered calls on those lines go to the Automated Attendant Service of the PARTNER MAIL VS system.
- **VMS-Mail:** Stan’s extension number, 12, in this column indicates that the Line Coverage Extension (#208) feature sends unanswered calls on Line 04 directly to Stan’s mailbox.

CS Form A, Page 2 of 2

System Settings:

- **Receptionist answers calls during business hours?** The clerk and salespeople will serve the receptionist function; so “Yes” appears on this line.
- **Ring on Transfer (#119):** “NA” written in the space provided indicates that music or recorded messages will be played while calls are being transferred.
- **Music on Hold (#602):** The blank line indicates that a Music on Hold device is installed.

Line Coverage:

- **VMS Hunt Delay (#506):** “Del” (Delayed) indicates that the Automated Attendant Service acts as a backup, picking up calls after the fourth ring. A person has a chance to answer before a call goes to the PARTNER MAIL VS system.
- **VMS Hunt Schedule (#507):** The absence of any check mark indicates that the Automated Attendant Service picks up unanswered calls during business hours and after hours. (This setting is the default.)

CS Form B1, Page 1 of 3

- **Write Name/Description:** The names listed for extensions 10 through 19 in this column identify the extension assignments.
- **Identify Telephone Attached to this Extension:** Check in these columns specify the type of telephone each person or location has.
- VMS in the **Write Name/Description** column and checks in the **PARTNER MAIL VS** column indicate that the PARTNER MAIL VS module is installed in Slot 3 of the Control Unit. The module uses extensions 22 and 23, the last two extensions for that slot.
- **Write Transfer Return Ext. No.:** "10" in this column indicates that when a call transferred by the PARTNER MAIL VS system is unanswered, it goes to extension 10 where the clerk can answer it.

CS Form B2, Page 1 of 2

- **Automatic VMS Cover (#310):** Check in this column indicate that unanswered calls to extensions 10 through 15 automatically are covered by the Automated Attendant Service.
- **Hunt Group Extensions 1-6 (#505):** "1" in this column indicates that extensions 16 and 17 make up Hunt Group 1. A call transferred to this group rings three times at the first non-busy extension. If it is not answered, it moves to the next non-busy extensions in the group, continuing until someone answers or the caller hangs up.
- **Hunt Group Extensions VMS Only:** column for extensions 22 and 23 satisfy the requirement that the extensions used by the PARTNER MAIL VS module be assigned to Hunt Group 7.

CS Form C3, PARTNER-18 Phone

- The first Form C3 identifies the buttons programmed on the PARTNER-18D phone at extension 10: Night Service, Do Not Disturb, Voice Mail Messages, and Voice Mailbox Transfer.

The Night Service button allows the user to turn Night Service on and off. When Night Service is off, the Day Menu prompt plays. When Night Service is on, the Night Menu Prompt plays.

A subscriber can use the Do Not Disturb button to send callers to the general mailbox without ringing the extension first.

The Voice Mail Messages button allows the user to call Voice Mail Service with one touch.

The Voice Mailbox Transfer button allows the user to transfer callers directly to another subscriber's mailbox without ringing the extension first.

- The second Form C3 indicates the buttons programmed on the PARTNER-18 phones at extensions 11, 12, 13, 14, and 15: Do Not Disturb, Voice Mail Messages, and Voice Mailbox Transfer.

CS Form C7, MLS-12 Phone

- Form C7 indicates that a Voice Mailbox Transfer button is programmed on the MLS-12 phones at extensions 16 and 17.

VMS Form 1

- The default settings for Language Mode (Monolingual) and System Language (U.S. English) are used.

VMS Form 2

- **Subscriber Name:** In this column, the names assigned to mailboxes 10 through 15 indicate that the clerk, Sally, Stan, and the coaches have mailboxes.
- Mailboxes 16 through 19 are marked for deletion. For system security, it is advisable to delete unused mailboxes.
- **Outcalling Assigned:** “Yes” in this column indicates that Outcalling privileges are assigned to Sally, Stan, and the coaches.

VMS Form 3

- **Description:** In this column, “Direct Extension Transfer” for Selector Code 1 indicates that when callers get the Automated Attendant Service, they can transfer to any extension (10 to 19) by entering the extension number.
- “Shop” in the **Description** column and “771” in the **Specific Ext. # or Group # for Selector Code Transfer, or Announcement #** column for Selector Code 4 indicate that when callers get the Automated Attendant Service, they can press 4 to transfer to Hunt Group 1 (which is defined on CS Form B2 as extensions 16 and 17 in the shop).
- “Announcement” in the **Description** column and the numbers (1 and 2) in the **Specific Ext. # or Group # for Selector Code Transfer, or Announcement #** column indicate that when callers get the Automated Attendant Service they can choose to hear one of two Announcements.

VMS Form 3A

- When an unanswered call goes to the Automated Attendant Service and the caller chooses to hear an Announcement, the caller hears one of the Announcements on Form 3A.

VMS Form 4

- When Night Service is off and an unanswered call goes to the Automated Attendant Service, the caller hears the Day Menu Prompt on Form 4.

VMS Form 5

- When Night Service is on and an unanswered call goes to the Automated Attendant Service, the caller hears the Night Menu Prompt on Form 5.

Post-Installation Recommendations

- Stan, Sally, and the coaches should record a personal greeting and change the factory set password for their mailboxes.
- Stan, Sally, and the coaches should turn on Outcalling and enter an Outcalling number and schedule.
- The clerk should record a general business greeting for the mailbox at extension 10 and change the factory-set password for that mailbox.



Form A: System Configuration

Required for PARTNER Advanced Communications System.
For additional instructions, see page 2.

1. Customer Billing Name <i>Tennis Land</i>	
2. Installation Address <i>4 Clay Court, Anytown, NJ</i>	
3. Contact Name <i>Sally Parker</i>	Phone <i>(908) 555-4567</i>
4. Person to be Trained <i>Sally Parker</i>	Phone <i>(908) 555-4567</i>
5. Sold by <input type="checkbox"/> Lucent Technologies Sales Force <input type="checkbox"/> Dealer: _____	
Alternate Trainee's Name <i>Marisol Colon</i>	Phone <i>(908) 555-1718</i>

6. Features Customer is most interested in (most important first):

PARTNER MAIL VS

Line Jack No.	Write the Telephone Numbers in order customer desires (list personal and dedicated lines last)	Write R if Rotary (Dial Pulse) Line (#201)	Line Coverage—You can select one per line				Write User's Name for Personal or Owned Line or Identify Equipment for Dedicated Line	Check if Caller ID Service	Identify other Local Telephone Company Subscription Services (e.g., Repeat Call)
			AA ¹ {#607}	VMS- ² AA {#206}	Hunt ³ Group (write no.) {#206}	VMS- ⁴ Mail {#206} or {#208}			
01	<i>555-4567</i>			✓					
02	<i>555-4568</i>			✓					
03	<i>555-4569</i>					<i>12</i>	<i>Stan Williams</i>		
04									
05									
06									
07									
08									
09									
10									
11									
12									
13									
14									
15									

1. Check if desired. Also see Form B1, AA Extension {#607} column.
 2. Check if desired. Also see Form A, Item 9, and Form B1, PARTNER MAIL or PARTNER MAIL VS column.
 3. Write group number (1-6) covering this line. Also see Form B2, Hunt Group Extensions {#505} 1-6.
 4. Check desired line for #206 or enter line owner's extension number for #208. Also see Form B1, PARTNER MAIL or PARTNER MAIL VS column.



Required for PARTNER Advanced Communications System.
For additional instructions, see pages 3 and 4.

8. System Settings. Write response on line for each item.

- Receptionist answers calls during business hours? Write "Yes" or "No" Yes.
- Number of Lines {#104}—By default, 3 lines per PARTNER ACS processor module, 2 lines per 206 module and 4 lines per 400 module are assigned to each extension. Write number if different from default _____.
- Transfer Return Rings {#105}—By default, a transferred call rings 4 times before going to the transfer return extension. Write number (0-9, 0 = no return) if different from default _____.
- Outside Conference Denial {#109}—By default, a conference call can include 2 outside parties. Write "No" if 2 outside parties are not allowed _____.
- VMS Cover Rings {#117}—By default, a call rings 3 times before going to the user's mailbox. Write number (1-9) if different from default _____.
- Ring on Transfer {#119}—By default, the caller hears ringing when the call is transferred. Write "NA" if Music on Hold or silence is desired N/A.
- Toll Call Prefix {#402}—By default, 0 or 1 must be dialed before the area code for a long distance call. Write "No" if 0 or 1 is not required _____.
- System Password {#403}—By default, no password is programmed to override dialing restrictions and to turn Night Service on and off. Write 4 digits if password is desired _____.
- Star Code Dial Delay {#410}—By default, the system inserts a 0 second delay after a valid Central Office star code when it autodial. Write number (1-5) of seconds if a longer delay is desired or "NO" if this feature should not be active _____.
- Music on Hold {#602}—By default, the Music on Hold jack on the processor module is active. Write "No" if the jack is deactivated _____.

9. Line Coverage.

If VMS-AA is checked on Form A, Item 7, specify the following:

- VMS Hunt Delay {#506}—By default, VMS answers calls after 2 rings. Write "Del" if calls ring 4 times before VMS answers Del.
- VMS Hunt Schedule {#507}—By default, VMS is on all the time. Check if Day only or Night only is desired:
 - Day only
 - Night only

10. Auxiliary Equipment (System). Check if applicable:

- Battery Backup
- Caller ID Devices
- Loudspeaker Paging: Number of zones _____
- Magic on Hold (Music on Hold {#602} must be active.)
- Uninterruptible Power Supply
- SMDR. If checked, specify the following if appropriate:
 - SMDR Record Type {#608}—By default, all calls are included on call reports. Write "Out" if only outgoing calls are reported _____.
 - SMDR Output Format {#610}—By default, up to 15 digits are printed for dialed numbers in the Number field of the call report. Write "24" if a maximum of 24 digits is desired _____.
- PARTNER Contact Closure Adjunct. If checked, write in the number (1-4) below to specify Operation Type for each Contact Closure as appropriate:

OperationType {#613}	Contact Closure 1	Contact Closure 1
1 = 1 second on		
2 = 3 seconds on (✓)	_____	_____
3 = 5 seconds on		
4 = Toggle		

- Backup/Restore PC Card. If checked, write "Active" if Automatic System Programming Backup {#123} is desired _____.

11. Notes: Write any additional information that you want to communicate to the installer.

12. Installation Date

13. Order Nos.

14. Sales Support Representative's Name

Telephone No.



Form B1: System Extensions

Required for PARTNER Advanced Communications System.
For additional instructions, see page 5.

Ext. Jack No.	Write Name/Description	Check if Ext. Name Display (CTP) ¹	Identify Telephone Attached to this Extension										Identify Auxiliary Equipment Attached to this Extension										Write in Other Equipment	Write Transfer Return Ext. No. {#306}												
			34-Button Display ²	Intercom Autodialer	18-Button Display ²	18-Button ²	12-Button Display ²	12-Button ²	6-Button ²	Cordless/Wireless	Standard ³	Call Waiting {#316}	External Hotline {#311} ⁴	Hotline {#603} ⁵	Alert Extension for Hotline	PARTNER MAIL ⁶	PARTNER MAIL VS ⁶	Answering Machine	Extra Alert	IROB	Modem ⁷	PassageWay			FAX Machine Extension {#601} ⁸	Doorphone 1 {#604} ⁸	Alert Extensions {#606} for Doorphone 1	Doorphone 2 {#605} ⁸	AA Extension {#607} ⁹	Contact Closure Group {#612} ¹⁰						
10	Clerk		✓	✓																																
11	Sally Parker		✓	✓																																
12	Stan Williams		✓																																	
13	Jean (Coach)																																			
14	Vito (Coach)																																			
15	Bill (Coach)																																			
16	Shop																																			
17	Shop																																			
18																																				
19																																				
20																																				
21																																				
22	VMS																																			10
23	VMS																																			10
24																																				
25																																				
26																																				
27																																				

IMPORTANT: A system display phone is required for programming at extension 10 or 11. Extension 10 typically is the receptionist's extension. Extension 11 is recommended as a second programming extension (typically the System Manager's extension).

1. If checked, see Form B1, Page 3 of 3.
2. If there is a mix of PARTNER-model and MLS-model phones, write "P" for PARTNER and "M" for MLS.
3. Write "T" for touch-tone or "R" for rotary. If Call waiting is desired, check next column.
4. Must be standard phone. If immediate dialing is required, use a dedicated line. Do not assign restrictions that prevent dialing the outside number, Forced Account Code Entry {#307}, or groups. Also see Form D, External Hotline {#311}.
5. Standard phone is recommended. Write extension number of corresponding alert extension or "70" for loud-speaker paging system in next column.
6. Also write Transfer Return Ext. No. {#306} on this form (usually extension 10). Also see Form B2, Identify Group Assignments, VMS Only.
7. To prevent other extensions from interrupting calls, assign Automatic Extension Privacy {#304} on Form B2.
8. Check corresponding alert extensions in next column. To prevent outside calls, remove all outside lines—see Lines Not Assigned on Form B2.
9. Also write Transfer Return Ext. No. {#306} on this form.
10. Write "1," "2," or "B" (for Both) to identify which Contact Closure the extension can activate.



Form B2: Customized Extension Settings

Required if you want to change extension settings from defaults.
For additional instructions, see pages 6 and 7.

Ext. Jack No.	Identify Extension Settings if Different than Default							Identify Line Ringing {CTP} Option If Different than Default				Identify Restrictions/Permissions If Different than Defaults					Identify Group Assignments								
	Display Language (#303) ¹	Automatic Extension Privacy (#304)	Abbreviated Ringing (#305)	Forced Account Code Entry (#307)	Distinctive Ring (#308)	Automatic VMS Cover (#310)	Voice Interrupt On Busy (#312)	Write line numbers in each column to show desired Line Ringing options				Write line numbers for Line Access Restriction (#302)					Outgoing Call Restriction (#401) ³	Disallowed List ⁴ Assignment (#405)	Allowed List ⁵ Assignment (#408)	Pickup Group ⁶ Extensions (#501)	Calling Group ⁷ Extensions (#502)	Hunt Group ⁸ Extensions (#505)	VMS Only ⁹	Night Service Group Extensions (#504)	
	E ✓	NA	A ✓	NA	A ✓	NA	NA	Immediate ✓	Delayed	No Ring	Lines ² Not Assigned	Outgoing only	Incoming only	No Access	NR ✓	1-8	1-8	1-4	1-4	1-6	7	NA ✓	NA ✓	NA ✓	
10						✓																			
11						✓																			
12						✓																			
13						✓																			
14						✓																			
15						✓																			
16																									1
17																									1
18																									
19																									
20																									
21																									
22																									
23																									✓
24																									
25																									
26																									
27																									

- Write S for Spanish or F for French.
- Use Line Assignment (#301) to remove lines from or assign lines to extensions.
- Write IN for Inside Only or LOC for Local Only to indicate restrictions for all outgoing calls on *all lines*.
- Write list number (1-8). Also see Form D, Disallowed Phone Number Lists (#404).
- Write list number (1-8). Also see Form D, Allowed Phone Number Lists (#407).

- Write group number (1-4).
- Write group number (1-4). If a loudspeaker is connected and Simultaneous Paging is desired, put appropriate extensions in Calling Group 1. Also see Form C, Simultaneous Paging.
- Write group number (1-6).
- Check off the same PARTNER MAIL or PARTNER MAIL VS extensions indicated on Form B1.

- Assignments**
- ✓ = Default
 - A = Assigned or Active
 - E = English
 - NA = Not Assigned or Not Active
 - NR = No Restriction
 - {CTP} = Centralized Telephone Programming



Make as many copies as you need. Use template and/or checklist.
For additional instructions, see pages 8 through 13.

Check Desired Features

Also write in extension or group number

Template Instructions

- If desired, write in line number, dial code feature, or auto dial number
- If desired, write in Line Ringing (Imm, Del, or No) from Form B2
- If desired, write in Line Access Restriction (Out, In, or No) from Form B2

SAMPLE

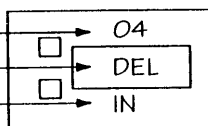

				} PARTNER-18D only
<input type="checkbox"/>	<input type="checkbox"/>	<input type="checkbox"/>	<input type="checkbox"/>	
<input type="checkbox"/>	<input type="checkbox"/>	<input type="checkbox"/>	<input type="checkbox"/>	
<input type="checkbox"/>	<input type="checkbox"/>	<input type="checkbox"/>	<input type="checkbox"/>	
<input type="checkbox"/> Night <input type="checkbox"/> SVC	<input type="checkbox"/> DND <input type="checkbox"/>	<input type="checkbox"/> VMMsgs <input type="checkbox"/>	<input type="checkbox"/> VMBox <input type="checkbox"/>	
<input type="checkbox"/> 01 <input type="checkbox"/> IMM	<input type="checkbox"/> 02 <input type="checkbox"/> IMM	<input type="checkbox"/> 03 <input type="checkbox"/> IMM	<input type="checkbox"/>	
<input type="checkbox"/> Intercom <input type="checkbox"/>	<input type="checkbox"/> Intercom <input type="checkbox"/>	Ext.		

Specify Automatic Line Selection: _____
Identify extensions programmed as shown: 10

<input checked="" type="checkbox"/>	Night Service Button (#503)	NightSvc	Ext. 10 LED Required
<input type="checkbox"/>	Outgoing Call Restriction Button (#114) ¹	OCR	
<input type="checkbox"/>	Wake Up Service Button (#115)	Wake	
<input type="checkbox"/>	Caller ID Inspect (F 17)	ID-Inspect	
<input type="checkbox"/>	Caller ID Name Display (F 16)	ID-Name	
<input checked="" type="checkbox"/>	Do Not Disturb (F 01)	DND	
<input type="checkbox"/>	Privacy (F 07)	Priv	
<input type="checkbox"/>	VMS Cover (F 15)	VMSCover	
<input type="checkbox"/>	Voice Interrupt on Busy Talk-Back (F 18)	VIOB	
<input type="checkbox"/>	Account Code Entry (F 12) ²	ACE	
<input type="checkbox"/>	Background Music (F 19) ²	Music	
<input type="checkbox"/>	Call Forwarding/Call Follow-Me (F 11 XX XX) ^{2,4}	CF-XX XX	
<input type="checkbox"/>	Call Park (I XX) ³	Park	
<input type="checkbox"/>	Call Pickup (I 6 XX)	Pickup-XX	
<input type="checkbox"/>	Conference Drop (F 06)	Drop	
<input type="checkbox"/>	Contact Closure 1 (F 41) ²	CC1	
<input type="checkbox"/>	Contact Closure 2 (F 42) ²	CC2	
<input type="checkbox"/>	Direct Line Pickup-Active Line (I 68)	DLPA	
<input type="checkbox"/>	Direct Line Pickup-Idle Line (I 8)	DLPI	
<input type="checkbox"/>	Exclusive Hold (F 02)	ExHold	
<input type="checkbox"/>	Fax Management (I XX) ²	FAX-XX	
<input type="checkbox"/>	Group Calling-Ring/Page (I 7 G or I *7 G)	GCall-g	
<input type="checkbox"/>	Group Hunt-Ring/Signal (I 77 G or I *77 G)	Hunt-g	
<input type="checkbox"/>	Group Pickup (I 66 G)	P/U Grp-g	
<input type="checkbox"/>	Intercom Autodial (I XX or I *XX) ²	Ext-XX	
<input type="checkbox"/>	Last Number Redial (F 05)	LNR	
<input type="checkbox"/>	Loudspeaker Paging (I 70)	Loudspk	
<input type="checkbox"/>	Manual Signaling (F 13 XX or F 13 *XX) ²	MS-XX	
<input type="checkbox"/>	Message Light Off (F 10 XX) ⁵	MsgOff-XX	
<input type="checkbox"/>	Message Light On (F 09 XX) ⁵	MsgOn-XX	
<input type="checkbox"/>	Recall (F 03)	Recall	
<input type="checkbox"/>	Save Number Redial (F 04)	SNR	
<input type="checkbox"/>	Simultaneous Paging (I * 70)	SPage	
<input type="checkbox"/>	Station Lock (F 21) ²	Lock	
<input type="checkbox"/>	Touch-Tone Enable (F 08)	TT-EN	
<input checked="" type="checkbox"/>	Voice Mail Messages Button (I 777)	VMMsgs-777	
<input checked="" type="checkbox"/>	Voice Mailbox Transfer (F 14)	VMBox	

- Requires Auto Dial button for each extension.
- Button with lights is recommended, but not required.
- Extension number can be programmed as Auto Dial button.
- You can program the origination extension only or both the origination and destination extension.
- You can program the extension number.

F = Feature button G = Group I = Left Intercom button XX = Extension



Make as many copies as you need. Use template and/or checklist.
For additional instructions, see pages 8 through 13.

Check Desired Features

Also write in extension or group number

Template Instructions

- If desired, write in line number, dial code feature, or auto dial number
- If desired, write in Line Ringing (Imm, Del, or No) from Form B2
- If desired, write in Line Access Restriction (Out, In, or No) from Form B2

SAMPLE

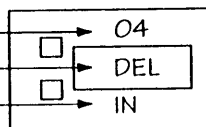

				} PARTNER-18D only
<input type="checkbox"/>	<input type="checkbox"/>	<input type="checkbox"/>	<input type="checkbox"/>	
<input type="checkbox"/>	<input type="checkbox"/>	<input type="checkbox"/>	<input type="checkbox"/>	
<input type="checkbox"/>	<input type="checkbox"/>	<input type="checkbox"/>	<input type="checkbox"/>	
<input type="checkbox"/> DND	<input type="checkbox"/> VMMsgs	<input type="checkbox"/> VMBox	<input type="checkbox"/>	
<input type="checkbox"/> SVC	<input type="checkbox"/>	<input type="checkbox"/>	<input type="checkbox"/>	
<input type="checkbox"/> 01	<input type="checkbox"/> 02	<input type="checkbox"/> 03	<input type="checkbox"/>	
<input type="checkbox"/> IMM	<input type="checkbox"/> IMM	<input type="checkbox"/> IMM	<input type="checkbox"/>	
<input type="checkbox"/> Intercom	<input type="checkbox"/> Intercom	Ext.	<input type="checkbox"/>	
<input type="checkbox"/>	<input type="checkbox"/>		<input type="checkbox"/>	

Specify Automatic Line Selection: _____

Identify extensions programmed as shown: 11, 12, 13, 14, 15

Night Service Button (#503)	NightSvc	Ext. 10 Only	LED Required
Outgoing Call Restriction Button (#114) ¹	OCR		
Wake Up Service Button (#115)	Wake		
Caller ID Inspect (F 17)	ID-Inspect		
Caller ID Name Display (F 16)	ID-Name		
<input checked="" type="checkbox"/> Do Not Disturb (F 01)	DND		
Privacy (F 07)	Priv		
VMS Cover (F 15)	VMSCover		
Voice Interrupt on Busy Talk-Back (F 18)	VI0B		
Account Code Entry (F 12) ²	ACE		
Background Music (F 19) ²	Music		
Call Forwarding/Call Follow-Me (F 11 XX XX) ^{2,4} CF-XX XX			
Call Park (I XX) ³	Park		
Call Pickup (I 6 XX)	Pickup-XX		
Conference Drop (F 06)	Drop		
Contact Closure 1 (F 41) ²	CC1		
Contact Closure 2 (F 42) ²	CC2		
Direct Line Pickup-Active Line (I 68)	DLPA		
Direct Line Pickup-Idle Line (I 8)	DLPI		
Exclusive Hold (F 02)	ExHold		
Fax Management(I XX) ²	FAX-XX		
Group Calling-Ring/Page (I 7 G or I *7 G)	GCall-g		
Group Hunt-Ring/Signal(I 77 G or I *77 G)	Hunt-g		
Group Pickup (I 66 G)	P/U Grp-g		
Intercom Autodial(I XX or I *XX) ²	Ext-XX		
Last Number Redial (F 05)	LNR		
Loudspeaker Paging (I 70)	Loudspk		
Manual Signaling (F 13 XX or F 13 *XX) ²	MS-XX		
Message Light Off (F 10 XX) ⁵	MsgOff-XX		
Message Light On (F 09 XX) ⁵	MsgOn-XX		
Recall (F 03)	Recall		
Save Number Redial (F 04)	SNR		
Simultaneous Paging(I * 70)	SPage		
Station Lock (F 21) ²	Lock		
Touch-Tone Enable (F 08)	TT-EN		
<input checked="" type="checkbox"/> Voice Mail Messages Button(I 777)	VMMsgs-777		
<input checked="" type="checkbox"/> Voice Mailbox Transfer (F 14)	VMBox		

1. Requires Auto Dial button for each extension.
2. Button with lights is recommended, but not required.
3. Extension number can be programmed as Auto Dial button.
4. You can program the origination extension only or both the origination and destination extension.
5. You can program the extension number.

Make as many copies as you need. Use template and/or checklist.
For additional instructions, see pages 8 through 13.

Check Desired Features

Also write in extension or group number

Template Instructions

- If desired, write in line number, dial code feature, or auto dial number
- If desired, write in Line Ringing (Imm, Del, or No) from Form B2
- If desired, write in Line Access Restriction (Out, In, or No) from Form B2

SAMPLE

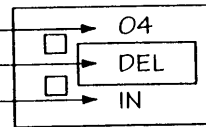

<input type="checkbox"/>	<input type="checkbox"/>	<input type="checkbox"/>	<input type="checkbox"/>
<input type="checkbox"/> <input type="checkbox"/>	<input type="checkbox"/> <input type="checkbox"/>	<input type="checkbox"/>	<input type="checkbox"/>
VMB _{ox} <input type="checkbox"/> <input type="checkbox"/>	<input type="checkbox"/> <input type="checkbox"/>	<input type="checkbox"/> <input type="checkbox"/>	<input type="checkbox"/> <input type="checkbox"/>
01 <input type="checkbox"/> IMM <input type="checkbox"/>	02 <input type="checkbox"/> IMM <input type="checkbox"/>	03 <input type="checkbox"/> IMM <input type="checkbox"/>	<input type="checkbox"/> <input type="checkbox"/>
<input type="checkbox"/> Intercom <input type="checkbox"/>	<input type="checkbox"/> Intercom <input type="checkbox"/>	Ext.	

Specify Automatic Line Selection: _____
Identify extensions programmed as shown: 16, 17

Night Service Button (#503) NightSvc	Ext. 10 Only	LED Required
Outgoing Call Restriction Button (#114) ¹ OCR		
Wake Up Service Button (#115) Wake		
Caller ID Inspect (F 17) ID-Inspect		
Caller ID Name Display (F 16) ID-Name		
Do Not Disturb (F 01) DND		
Privacy (F 07) Priv		
VMS Cover (F 15) VMSCover		
Voice Interrupt on Busy Talk-Back (F 18) VIOB		
Account Code Entry (F 12) ² ACE		
Background Music (F 19) ² Music		
Call Forwarding/Call Follow-Me (F 11 XX XX) ^{2,c} CF-XX XX		
Call Park (I XX) ³ Park		
Call Pickup (I 6 XX) Pickup-XX		
Conference Drop (F 06) Drop		
Contact Closure 1 (F 41) ² CC1		
Contact Closure 2 (F 42) ² CC2		
Direct Line Pickup-Active Line(I 68) DLPA		
Direct Line Pickup-Idle Line(I 8) DLPI		
Exclusive Hold (F 02) ExHold		
Fax Management(I XX) ² FAX-XX		
Group Calling-Ring/Page (I 7 G or I* 7 G) GCall-g		
Group Hunt-Ring/Signal (I 77 G or I*77 G) Hunt-g		
Group Pickup (I 66 G) P/U Grp-g		
Intercom Autodial (I XX or I*XX) ² Ext-XX		
Last Number Redial (F 05) LNR		
Loudspeaker Paging (I 70) Loudspk		
Manual Signaling (F 13 XX or F 13 *XX) ² MS-XX		
Message Light Off (F 10 XX) ⁵ MsgOff-XX		
Message Light On (F 09 XX) ⁵ MsgOn-XX		
Recall (F 03) Recall		
Save Number Redial (F 04) SNR		
Simultaneous Paging(I * 70) SPage		
Station Lock (F 21) ² Lock		
Touch-Tone Enable (F 08) TT-EN		
Voice Mail Messages Button(I 777) VMMsgs-777		
<input checked="" type="checkbox"/> Voice Mailbox Transfer (F 14) VMBox		

1. Requires Auto Dial button for each extension.
2. Button with lights is recommended, but not required.
3. Extension number can be programmed as Auto Dial button.
4. You can program the origination extension only or both the origination and destination extension.
5. You can program the extension number.

F = Feature button G = Group I = Left Intercom button XX = Extension

Form 2: Mailbox Assignments

A Mailbox	B Subscriber Name	C Mailbox Language	D Outcalling Assigned
10 ✓	<i>Clerk</i>		
(11 ✓)	<i>Sally Parker</i>		<i>Yes</i>
(12 ✓)	<i>Stan Williams</i>		<i>Yes</i>
(13 ✓)	<i>Jean</i>		<i>Yes</i>
(14 ✓)	<i>Vito</i>		<i>Yes</i>
(15 ✓)	<i>Bill</i>		<i>Yes</i>
(16 ✓)			
(17 ✓)			
(18 ✓)			
(19 ✓)			
(20 ✓)			
(21 ✓)			
(22 ✓)			
(23 ✓)			
(24 ✓)			
(25 ✓)			

General Information

- Factory defaults are identified by the ✓ symbol.
- The system comes with a predetermined number of mailboxes. The optional Mailbox Expansion Card doubles the capacity.
- Mailbox 10 is reserved for the receptionist at extension 10 and cannot be changed.
- Mailbox 10 provides 60 minutes of message recording time. All other mailboxes provide 20 minutes of message recording time.
- For system security mailboxes should be deleted where they are not needed; for example, mailboxes should be deleted for extensions in use by auxiliary equipment (such as a fax or doorphone) and the extensions assigned to the VMS Hunt Group.
- Guest mailboxes can be created for users who don't have their own phone by assigning an unused extension number as the mailbox number. Unused extension numbers include: 1) vacant extension jacks in installed 206 modules and 2) extensions in your DIAL plan higher than the last extension jack in the last installed 206 module. See "Guest Mailboxes" in Chapter 5 for more information.

A Mailbox	B Subscriber Name	C Mailbox Language	D Outcalling Assigned
(26 ✓)			
(27 ✓)			
(28 ✓)			
(29 ✓)			
(30 ✓)			
(31 ✓)			
(32 ✓)			
(33 ✓)			
(34 ✓)			
(35 ✓)			
(36 ✓)			
(37 ✓)			
(38 ✓)			
(39 ✓)			
(40 ✓)			

Completing this Form

- A Mailbox** To assign a mailbox to an extension other than the factory default, cross out the factory default and write in the extension to be used.
- For PARTNER PLUS, use an extension number from 11-33.
 - For PARTNER Advanced Communications System, use an extension number from 11-41.
 - For PARTNER II or PARTNER 48, use an extension number from 11-57.
- To mark an unused mailbox for deletion without assigning an extension, cross out the factory default.
- B Subscriber Name** For every mailbox in use, write the name of the mailbox subscriber.
- C Mailbox Language** For each mailbox that requires a language different from the System Language or Primary Language indicated on Form 1, write the name of the language in this space. Supported languages are listed on Form 1.
- D Outcalling Assigned** For each mailbox in use, indicate whether Outcalling is assigned.

Programming Mailboxes

You can change a mailbox assignment by deleting an existing mailbox and creating a new one.

- To program mailboxes, dial [4] from the Programming Main menu.

Form 3: Menu Definition

Required for Automated Attendant Service

A Description	B Selector Code	C Range of Extensions for Direct Extension Transfer	D Ext. # or Group # for Selector Code Transfer, or Announcement #
<i>Direct Extension Transfer</i>	1	(10-19 ✓)	
	2	(20-29 ✓)	
	3	(30-39 ✓)	
<i>Shop</i>	4	(40-49 ✓)	771
<i>Announcement</i>	5	(50-57 ✓)	Ann. #1
<i>Announcement</i>	6		Ann. #2
	7	(71-74, 771-776 ✓)	
	8		
	9	Transfer to Mailbox 10 ✓	

General Information

- Factory defaults are identified by the ✓ symbol.
- This Menu Definition applies to both the Day and Night Menu prompts.
- The **Selector Code** is the first digit dialed by the caller in response to the menu prompts.
- In **Direct Extension Transfer**, Selector Codes 1-5 and 7 represent the first digit for a range of extensions. These Selector Codes let callers dial extension numbers directly.
- In **Selector Code Transfer**, Selector Codes 1-9 represent a specific extension, Group Calling number, (if available) or Hunt Group number to which the caller will be transferred. Use the following values:
 - PARTNER Plus: 10-33 or 771-776
 - PARTNER Advanced: 11-41, 71-74, or 771-776
 - PARTNER II: 10-57, 71-74, or 771-776
 - PARTNER 48: 10-57, 71, or 771-776
- Selector Code Transfer lets callers dial a single digit to reach a single extension or group, such as the VP of Sales at extension 37 or the order processing operators assigned to Hunt Group 774.
- Selector Code 9 lets callers transfer directly to mailbox 10 (receptionist mailbox) where they can leave a message.

The Description and Selector Code number from this form will be used to complete the Day and Night Menu Prompts (Forms 4, 4A, 5, and 5A).
- For Announcement entries in **Description**, **Selector Code**, and **Announcement #** of this form will be used to complete Forms 3A and 3B.

Completing this Form

For Direct Extension Transfer...

- A Description** Write "Direct Extension Transfer."
- C Range of Extensions for Direct Extension Transfer** Leave the factory default.
- D Ext. # or Group # for Selector Code Transfer ...** Leave blank.

For Selector Extension Transfer...

- A Description** Write the name of the person or group to receive the transfer.
- C Range of Extensions for Direct Extension Transfer** Cross out the factory default if you want the caller to dial the corresponding Selector Code to transfer to the extension, announcement, or group identified in **D** below.
- D Ext. #, or Group # for Selector Code Transfer...** Write the extension, announcement, or group number to receive the transfer.

For Announcement...

- A Description** Write "Announcement."
- C Range of Extensions for Direct Extension Transfer** Cross out the factory default if you want the caller to dial the corresponding Selector Code to hear the Announcement identified in **D** below.
- D Announcement #** Write the Announcement number (1 or 2).

Form 3A: Automated Attendant Announcement— System Language or Primary Language

Required if Selector Code Transfer is set to Announcement

Announcement # 1 :

*Tennis Land is located at 4 Clay Court, just 5 blocks east of Anytown Shopping plaza on Route 66. Our courts are available daily from 6 a.m. to 8 p.m., and our shop is open Monday through Saturday, 10 a.m. to 6 p.m. To return to the Main Menu, press *7.*

Announcement # 2 :

Welcome to Tennis Land's Calendar of Events. This month we will be hosting the 6th Annual Anytown Father/Daughter Tennis Tournament on the 12th. Stan will once again be offering his "Killer Serve Clinic" on the 19th. And our own tennis Land team will be traveling to mayberry for an exhibition match. Be sure to sign up at the Main Desk for these exciting events. For more information, press 0 now.

General Information

- After the Announcement plays, you can program the system to hang up or to offer callers the option of pressing *4 (to repeat this Announcement), *7 (to return to the Main Menu), *8 (to transfer to an extension), or 0.
- If the system is set for Bilingual Mode, let callers know they can switch the language they hear while listening to the Announcement. For example, "Para español, marque * 1."
- Announcements can supply frequently requested information so that your staff is free to assist customers or to perform other tasks more efficiently.
- An Announcement can be up to four minutes long.

Completing this Form

Write the Announcement and its number in the space provided.

Recording the Announcement(s)

- To record the Announcement, dial [3] from the Programming Main Menu.

Form 4: Day Menu Prompt— System Language or Primary Language

Required if VMS Hunt Schedule is set to Day Only or Always

<i>Thank you for calling Tennis Land.</i>
<i>If you know the extension of the person you want to reach, dial it now.</i>
<i>To speak to someone in the shop, press 4.</i>
<i>To get information about our location and hours, press 5.</i>
<i>To get information about tournaments and special events, press 6.</i>
<i>If you would like to hear this message again, press * 4.</i>
<i>If you require assistance, please stay on the line.</i>

General Information

The Day Menu Prompt plays to callers when the VMS Hunt Schedule is set to Day Only or Always and Night Service is off. The Day Menu Prompt and the Night Menu Prompt use the **same** Menu Definition.

- The Day Menu Prompt should contain a welcome and a list of menu options.
- The welcome should introduce the company. For example, "Thank you for calling the Any Travel Agency."
- If the system is set for Bilingual Mode, let callers know they can switch the language they hear while on the call. For example, "Para español, marque * 1."
- The menu options should contain instructions that correspond to the Menu Definition set up on Form 3.
 - If callers can dial extension numbers (Direct Extension Transfer), the prompt should instruct callers to dial the extension number. For example, "If you know the extension of the person you want to reach, dial it now."
 - If callers can dial a single digit to transfer to an extension or group (Selector Code Transfer), the prompt should provide instructions such as "To speak to someone in sales, press 6."
 - If callers can choose an Announcement, include that information. For example, "For directions to our office, press 4."

It is recommended that you keep the number of menu options to 5 or less to avoid confusing the caller.

Completing this Form

Write the message that you want callers to hear when they call during normal business hours, including the instructions to the caller for selecting menu options.

Suggested options include:

- "Remain on the line for assistance."
- "Dial 0 for assistance."
- "To hear this menu again, dial * 4."

Recording the Day Menu Prompt

- To record the Day Menu Prompt, dial [3] from the Programming Main Menu.

Form 5: Night Menu Prompt— System Language or Primary Language

Required if VMS Hunt Schedule is set to Night Only or Always

<i>Thank you for calling Tennis Land. We are currently closed.</i>
<i>To get information about our location and hours, press 5.</i>
<i>To get information about tournaments and special events, press 6.</i>
<i>To leave a message for one of our staff, please dial that extension now.</i>
<i>Otherwise, press 9, or stay on the line to leave a message at the Main Desk, and we will return your call when we re-open.</i>

General Information

- The Night Menu Prompt plays to callers when the VMS Hunt Schedule is set to Night Only or Always and Night Service is on. The Night Menu Prompt and the Day Menu Prompt use the **same** Menu Definition.
- The Night Menu Prompt should contain a welcome and a list of menu options.
- The welcome should introduce the company. For example, "You have reached the Any Travel Agency. Our hours are 9 AM to 5 PM, Monday through Friday."
- If the system is set for Bilingual Mode, let callers know they can switch the language they hear while on the call. For example, "Para español, marque * 1."
- The menu options should contain instructions that correspond to the Menu Definition set up on Form 3.
 - If callers can dial extension numbers (Direct Extension Transfer), the prompt should instruct callers to dial the extension number. For example, "If you know the extension of the person you want to reach, dial it now and leave a message."
 - If callers can dial a single digit to transfer to an extension or group (Selector Code Transfer), the prompt should provide instructions such as "To leave a message for Pat, press 6." Keep in mind that there are no group mailboxes.

- If Selector Code 9 is left as the default, the prompt should instruct callers to press 9 to leave a message with the receptionist.

It is recommended that you keep the number of menu options to 5 or less to avoid confusing the caller.

Completing this Form

Write the message that you want callers to hear when they call after normal business hours, including instructions to the caller for selecting menu options.

Suggested options include:

- "Dial 9 or remain on the line to leave a message."
- "To hear this menu again, dial * 4."

Recording the Night Menu Prompt

- To record the Night Menu Prompt, dial [3] from the Programming Main Menu.

Case Study #2

About the Customer

Software Mexico is a small company that develops PC-based software in Tijuana, Mexico. The company prides itself on personalized service and customer satisfaction. The owner, Jose Ramirez, employs a staff of nine including a receptionist, a system administrator, five programmers, a customer service representative, and a bookkeeper. Jose and his employees speak both English and Spanish. Sixty percent of Software Mexico's customers speak Spanish; the other 40 percent speak English.

Jose purchased a PARTNER Plus Release 4.1 Communications System and a PARTNER MAIL VS Release 4 Voice Messaging System because the integrated system can answer outside calls and offer callers the option of listening to prompts and transferring to extensions in either English or Spanish.

Receptionist Vera Gonzalez is responsible for managing the systems; she established these facts:

- The system will have four outside lines and 12 extensions.
- Jose and Vera will have PARTNER-34D phones; the other eight employees will have PARTNER-18D phones. In addition, two standard phones will be installed in the waiting room so customers can make local calls.
- Jose prefers that Vera help with various office tasks, so all lines will ring delayed at extension 10, and the PARTNER MAIL VS system will answer them. Vera will act as backup; she will answer calls from customers who press 0 or stay on the line for assistance, as well as transfer returned calls. Also, Vera will be responsible for checking the messages in the mailbox at extension 10 and forwarding them to the appropriate people.
- Calls will go to the Automated Attendant Service of the PARTNER MAIL VS system during the day and at night.
- The majority of Software Mexico's callers have questions about their software or inquiries about bills. Therefore, callers who receive Automated Attendant Service and want to speak to the customer service representative or the bookkeeper can do so easily by pressing a single digit as explained in the Automated Attendant Service prompt.
- Since the majority of Software Mexico's customers speak Spanish, the system should answer outside calls and play messages and prompts in Spanish. Callers will have the option of listening to the prompts and messages in English.
- Each employee will have a mailbox and Automatic VMS Cover assigned to his or her extension. This arrangement allows callers to leave personal messages when the employee is unable to answer a call.

Filling Out the Planning Forms

This section explains how the System Planner for the PARTNER Plus Release 4.1 Communications System and the forms for the PARTNER MAIL VS Release 4 Voice Messaging System are filled out based on the facts in the Software Mexico case. For brevity, “CS” refers to the System Planner forms for the communications system and “VMS” refers to the forms for the voice messaging system.

CS Form A, Page 1 of 3

- **Write the Telephone Numbers in order customer desires:** Telephone numbers in this column represent Software Mexico’s four lines.
- **VMS-AA:** In this column, checks for Lines 01, 02, 03, and 04 indicate that unanswered calls on those lines go to the Automated Attendant Service of the PARTNER MAIL VS system.

CS Form A, Page 2 of 3

System Settings:

- **Receptionist answers calls during business hours?** “No” on this line indicates that Vera will backup the voice messaging system.
- **Music on Hold (#602):** The blank line indicates that a Music on Hold device is installed.
- **Ring on Transfer (#119):** “NA” written in the space provided indicates that music or recorded messages will be played while calls are being transferred.

Line Coverage:

- **VMS Hunt Delay (#506):** The blank line indicates that the Automated Attendant Service answers outside calls immediately.
- **VMS Hunt Schedule (#507):** The absence of any check mark indicates that the Automated Attendant Service picks up unanswered calls during business hours and after hours. (This setting is the default.)

CS Form B1, Page 1 of 3

- **Write Name/Description:** In this column, the names listed for extensions 10 through 19 and 22 and 23 identify the extension assignments.
- **Identify Telephone Attached to this Extension:** Checks in these columns specify the type of telephone each person or location has.
- “VMS” in the **Write Name/Description** column and checks in the **PARTNER MAIL VS** column indicate that the PARTNER MAIL VS module is installed in Slot 4 of the Control Unit. The module uses extensions 32 and 33, the last two extensions for that slot.
- “10” in the **Write Transfer Return Ext. No.** column indicates that when a call transferred by the PARTNER MAIL VS system is unanswered, it goes to extension 10 where Vera can answer it.

CS Form B2, Page 1 of 2

- **Automatic VMS Cover:** Checks in this column indicate that unanswered calls to extensions 10 through 19 automatically are covered by the Automated Attendant Service.
- **Hunt Group Extensions VMS Only:** In this column, check marks for extensions 32 and 33 satisfy the requirement that the extensions used by the PARTNER MAIL VS module be assigned to Hunt Group 7.
- **Automatic Extension Privacy:** In this column, check marks for the extensions used by the PARTNER MAIL VS module indicate that Automatic Extension Privacy is assigned to these extensions. This feature prevents subscribers from accidentally picking up calls that are being answered by the voice mail system.

CS Form C1, PARTNER-34D Phone

- The first Form C1 identifies the buttons programmed on the PARTNER-34D phone at extension 10: Night Service, Do Not Disturb, Voice Mail Messages, and Voice Mailbox Transfer.

The Night Service button allows Vera to turn Night Service on and off. When Night Service is off, the Day Menu Prompt plays. When Night Service is on, the Night Menu Prompt plays.

Vera can use the Do Not Disturb button to send callers to the general mailbox without ringing the extension first.

The Voice Mail Messages button allows Vera to call Voice Mail Service with one touch.

The Voice Mailbox Transfer button allows Vera to transfer callers directly to another subscriber’s mailbox without ringing the extension first.
- The second Form C1 indicates the buttons programmed on the phone at extension 11: Do Not Disturb, Voice Mail Messages, and Voice Mailbox Transfer.

CS Form C3, PARTNER-18 Phone

- Form C3 identifies the buttons programmed on the PARTNER-18 phones at extensions 12, 13, 14, 15, 16, 17, 18, and 19: Voice Mail Messages and Voice Mailbox Transfer.

VMS Form 1

- **Language Mode:** The check mark in the Bilingual box indicates that the system allows outside callers to choose between two languages.
- **Primary Language:** The check mark in the Latin American Spanish box indicates that the system answers outside calls in Spanish. The check mark in the U.S. English box for **Secondary Language** indicates that the system can play messages and prompts in English when callers press [*][1].

VMS Form 2

- **Subscriber Name:** In this column, the names listed for mailboxes 10 through 19 indicate that all employees have mailboxes.
- English in the **Mailbox Language** column for extensions 13, 16, and 19 indicates the subscribers at those extensions prefer to listen to prompts and messages in English when retrieving messages, recording personal greetings, and accessing other Voice Mail Services. The rest of the subscribers prefer prompts and messages in Spanish, the system's Primary Language.
- **Outcalling Assigned:** "Yes" in this column for Jose, the system administrator, and the customer service representative indicates that they have Outcalling privileges, so that they can be notified of new voice mail while they are away from their offices.

VMS Form 3

- **Description:** In this column, "Direct Extension Transfer" for Selector Code 1 and 2 indicates that when callers get the Automated Attendant Service they can transfer to any extension (10 to 29) by entering the extension number.
- "Customer Service" in the **Description** column and "18" in the **Specific Ext. # or Group # for Selector Code Transfer, or Announcement #** column for Selector Code 4 indicate that when callers get the Automated Attendant Service, they can press 4 to transfer to extension 18 (the Customer Service representative).
- "Customer Service" in the **Description** column and "19" in the **Specific Ext. # or Group # for Selector Code Transfer, or Announcement #** column for Selector Code 5 indicate that when callers get the Automated Attendant Service, they can press 5 to transfer to extension 19 (the Bookkeeper).

VMS Form 4

- When Night Service is off and a call goes to the Automated Attendant Service, the caller hears the prompt on Form 4 in Spanish (the Primary Language).

VMS Form 4A

- When Night Service is off and a call goes to the Automated Attendant Service, the caller hears the prompt on Form 4 in English (the Secondary Language) when he or she presses [*] [1].

VMS Form 5

- When Night Service is on and a call goes to the Automated Attendant Service, the caller hears the prompt on Form 5 in Spanish (the Primary Language).

VMS Form 5A

- When Night Service is on and a call goes to the Automated Attendant Service, the caller hears the prompt on Form 5 in English (the Secondary Language) when he or she presses [*] [1].

Post-Installation Recommendations

- Since callers can leave a message in the mailbox at extension 10, Vera should record a general business greeting for this extension in both Spanish and English. The greetings should instruct callers to press [*] [1] to switch to the other language.
- All employees should record a personal greeting in both Spanish and English. The greetings should instruct callers to press [*] [1] to switch to the other language. In addition, employees change the factory-set password for their mailboxes.



Required for PARTNER II System and PARTNER Plus System.
For additional instructions, see page 2.

1. Customer Billing Name <i>Software México</i>	
2. Installation Address <i>1111 Tijuana Plaza. Juarez</i>	
3. Contact Name <i>Vera Gonzalez</i>	Phone <i>(52) 555- 1234</i>
4. Person to be Trained <i>Vera Gonzalez</i>	Phone () -
Alternate Trainee's Name Phone () -	
5. Sold by <input type="checkbox"/> Lucent Technologies Sales Force <input type="checkbox"/> Dealer: _____	Salesperson's Name <i>Colleen Rivera</i> Phone <i>(52) 555- 6812</i>

6. Configure Hardware for Hybrid Mode (PARTNER II system only):
No Yes If yes, call local telephone company—
MF Mode and FCC # AS5 USA-21312-MF-E

7. Features Customer is most interested in (most important first):

PARTNER MAIL VS

8. System Lines

Line Jack No.	Write the Telephone Numbers in order customer desires (list personal and dedicated lines last)	Write R if Rotary (Dial Pulse) Line {#201}	Hybrid Mode Only: Write auxiliary pool 881, 882, 883 or No Pool {#207}	Line Coverage—You can select one per line					Write ⁷ Ext. No. for Call Cover {#208}	Write User's Name for Personal or Owned Line or Identify Equipment for Dedicated Line	Check if Caller ID Service	Identify other Local Telephone Company Subscription Services (e.g., Repeat Call)
				AA ¹ {#607}	DXD ² {#205}	VMS-AA ³ {#206}	ASA ⁴ {#204}	Hunt Group (write no.) {#206}				
01	555-1234					✓						
02	555-1235					✓						
03	555-1236					✓						
04	555-1237					✓						
05												
06												
07												
08												
09												
10												
11												
12												
13												
14												
15												
16												
17												
18												
19												
20												
21												
22												
23												
24												

PARTNER II System Only

1. Check if desired. Also see Form B1, AA Extension {#607} column.
 2. Check if desired. Also see Form A, Item 10—DXD, and Form C, Direct Extension Dial Button {#113}.
 3. Check if desired. Also see Form A, Item 10—VMS-AA, and Form B1, PARTNER MAIL or PARTNER MAIL VS column.
 4. Check if desired. Also see Form A, Item 10—ASA, and Form C, Automatic System Answer Button {#111}.
 5. Write group number (1–6) covering this line. Also see Form B2, Hunt Group Extensions {#505} 1–6.
 6. Check desired line for #206 or enter line owner's extension number for #208. Also see Form B1, PARTNER MAIL or PARTNER MAIL VS column.
 7. Write extension number of line owner eligible for Call Coverage. Also write line owner's name in next column.



Required for PARTNER II System and PARTNER Plus System.
For additional instructions, see page 3.

9. System Settings. Write response on line for each item.

- Receptionist answers calls during business hours? Write "Yes" or "No" No.
- Number of Lines {#104}—By default, 2 lines per 206 module and 4 lines per 400 module are assigned to each extension (or to pool 880 in PARTNER II Hybrid Mode). Write number if different from default _____.
- Transfer Return Rings {#105}—By default, a transferred call rings 4 times before going to the transfer return extension. Write number (0-9, 0 = no return) if different from default _____.
- Outside Conference Denial {#109}—By default, a conference call can include 2 outside parties. Write "No" if 2 outside parties are not allowed _____.
- Call Coverage Rings {#116} (PARTNER II only)—By default, a covered call rings 2 times before going to the covering extension. Write number (1-9) if different from default _____.
- VMS Cover Rings {#117}—By default, a call rings 3 times before going to the user's mailbox. Write number (1-9) if different from default _____.
- Ring on Transfer {#119}—By default, the caller hears ringing when the call is transferred. Write "NA" if music on hold or silence is desired N/A.
- Toll Call Prefix {#402}—By default, 0 or 1 must be dialed before the area code for a long distance call. Write "No" if 0 or 1 is not required _____.
- System Password {#403}—By default, no password is programmed to override dialing restrictions and to turn Night Service on and off. Write 4 digits if password is desired _____.
- Music on Hold {#602}—By default, the Music on Hold jack on the processor module is active. Write "No" if the jack is deactivated _____.

10. Line Coverage. Complete items based on Line Coverage selection on Form A, Item 8.

DXD: (PARTNER II system only) If DXD is checked, specify the following:

Direct Extension Dial Delay {#112}—By default, a call rings 2 times before it is answered by the system. Write number (0-9) if different from default _____.

Direct Extension Dial Record/Playback (I 892)—message of up to 20 seconds that caller hears when call is answered with the Direct Extension Dial feature. Write message below and record from extension 10 or 11:

VMS-AA: If VMS-AA is checked, specify the following:

VMS Hunt Delay {#506}—By default, VMS answers calls after 2 rings. Write "Del" if calls ring 4 times before VMS answers _____.

VMS Hunt Schedule {#507}—By default, VMS is on all the time. Check if Day only or Night only is desired:

- Day only
- Night only

ASA: (PARTNER II system only) If ASA is checked, specify the following:

Automatic System Answer Delay {#110}—By default, a call rings 2 times before it is answered by the system. Write number (0-9) if different from default _____.

Automatic System Answer Mode {#121}—By default, ASA calls are put on hold after the greeting plays. Check if calls should continue to ring or be disconnected:

- Ring
- Disconnect

ASA Record/Playback (I 891)—message of up to 10 seconds that caller hears when the call is answered by the Automatic System Answer feature. Write message below and record from extension 10 or 11:



Form B1: System Extensions

Required for PARTNER II System and PARTNER Plus System.
For additional instructions, see page 5.

Ext. Jack No.	Write Name/Description	Check if Ext. Name Display (CTP) ¹	Identify Telephone Attached to this Extension													Identify Auxiliary Equipment Attached to this Extension										Write in Other Equipment	Write Transfer Return Ext. No. (#306)							
			34-Button Display ²	Intercom Autodialer	18-Button Display ²	18-Button ²	12-Button Display ²	12-Button ²	6-Button ²	Cordless/Wireless	Standard ³	Call Waiting (#316)	External Hotline (#311) ⁴	Hotline (#603) ⁵	Alert Extension for Hotline	PARTNER MAIL ⁶	PARTNER MAIL VS ⁶	Answering Machine	Extra Alert	IROB	Modem ⁷	PassageWay	FAX Machine Extension (#601) ⁷	Doorphone 1 (#604) ⁸	Alert Extensions (#606) for Doorphone 1			Doorphone 2 (#605) ⁸	Alert Extensions (#606) for Doorphone 2	AA Extension (#607) ⁹	Contact Closure Group (#612) ¹⁰			
10	Vera Gonzalez	<input checked="" type="checkbox"/>	<input checked="" type="checkbox"/>		<input checked="" type="checkbox"/>																													
11	Jose Ramirez	<input checked="" type="checkbox"/>																																
12	Juan (SA)			<input checked="" type="checkbox"/>																														
13	Programmer 1			<input checked="" type="checkbox"/>																														
14	Programmer 2			<input checked="" type="checkbox"/>																														
15	Programmer 3			<input checked="" type="checkbox"/>																														
16	Programmer 4			<input checked="" type="checkbox"/>																														
17	Programmer 5			<input checked="" type="checkbox"/>																														
18	Felipe (CS Rep)			<input checked="" type="checkbox"/>																														
19	Rosa (Bookkeeper)			<input checked="" type="checkbox"/>																														
20																																		
21																																		
22	Waiting Room								<input checked="" type="checkbox"/>																									
23	Waiting Room								<input checked="" type="checkbox"/>																									
24																																		
25																																		
32																																		
33																<input checked="" type="checkbox"/>																		
																<input checked="" type="checkbox"/>																		

IMPORTANT: A system display phone is required for programming at extension 10 or 11. Extension 10 typically is the receptionist's extension. Extension 11 is recommended as a second programming extension (typically the System Manager's extension).

- If checked, see Form B1, Page 3 of 3.
- If there is a mix of PARTNER-model and MLS-model phones, write "P" for PARTNER and "M" for MLS.
- Write "T" for touch-tone or "R" for rotary. If Call Waiting is desired, check next column.
- Must be standard phone. If immediate dialing is required, use a dedicated line. Do not assign restrictions that prevent dialing the outside number, Forced Account Code Entry (#307), or groups. Also see Form D, External Hotline (#311).
- Standard phone is recommended. Write extension number of corresponding alert extension or "70" for loudspeaker paging system in next column.
- Also write Transfer Return Ext. No. (#306) on this form (usually extension 10). Also see Form B2, Identify Group Assignments, VMS Only.
- To prevent other extensions from interrupting calls, assign Automatic Extension Privacy (#304) on Form B2.
- Check corresponding alert extensions in next column. To prevent outside calls, remove all outside lines—see Lines Not Assigned on Form B2.
- Also write Transfer Return Ext. No. (#306) on this form.
- Write "1," "2," or "B" (for Both) to identify which Contact Closure the extension can activate.



Form B2: Customized Extension Settings

Required if you want to change extension settings from defaults for PARTNER II System and PARTNER Plus System. For additional instructions, see pages 6 and 7.

Ext. Jack No.	Identify Extension Settings if Different than Default							Identify Line Ringing (CTP) Option If Different than Default				Identify Restrictions/Permissions If Different than Defaults						Identify Group Assignments							
	Display Language (#303) ¹	Automatic Extension Privacy (#304)	Abbreviated Ringing (#305)	Forced Account Code Entry (#307)	Distinctive Ring (#308)	Automatic VMS Cover (#310)	Voice Interrupt On Busy (#312)	Write line numbers in each column to show desired Line Ringing options				Write line numbers for Line Access Restriction (#302) No Restriction ✓						Outgoing Call Restriction (#401) ³	Disallowed List ⁴ Assignment (#405)	Allowed List ⁵ Assignment (#408)	Pickup Group ⁶ Extensions (#501)	Calling Group ⁷ Extensions (#502)	Hunt Group ⁸ Extensions (#505)	VMS Only ⁹	Night Service Group Extensions (#504)
	E ✓	NA ✓	A ✓	NA ✓	A ✓	NA ✓	NA ✓											Immediate ✓	Delayed	No Ring	Lines ² Not Assigned	Outgoing only	Incoming only	No Access	NA ✓
10						✓																			
11						✓																			
12						✓																			
13						✓																			
14						✓																			
15						✓																			
16						✓																			
17						✓																			
18						✓																			
19						✓																			
20																									
21																									
22																									
23																									
24																									
25																									
32																									
33																								✓	✓

1. Write S for Spanish or F for French.
2. Use Line Assignment (#301) to remove lines from or assign lines to extensions.
3. Write IN for Inside Only or LOC for Local Only to indicate restrictions for all outgoing calls on all lines.
4. Write list number (1-8). Also see Form D, Disallowed Phone Number Lists (#404).
5. Write list number (1-8). Also see Form D, Allowed Phone Number Lists (#407).

6. Write group number (1-4).
7. Write group number (1-4). If a loudspeaker is connected and Simultaneous Paging is desired, put appropriate extensions in Calling Group 1. Also see Form C, Simultaneous Paging.
8. Write group number (1-6).
9. Check off the same PARTNER MAIL or PARTNER MAIL VS extensions indicated on Form B1.

- Assignments**
- ✓ = Default
 - A = Assigned or Active
 - E = English
 - NA = Not Assigned or Not Active
 - NR = No Restriction
 - {CTP} = Centralized Telephone Programming



Make as many copies as you need. Use template and/or checklist.
For additional instructions, see pages 8 through 13.

Check Desired Features

Also write in extension or group number

Template Instructions

- If desired, write in line number, dial code feature, or auto dial number
- If desired, write in Line Ringing (Imm, Del, or No) from Form B2
- If desired, write in Line Access Restriction (Out, In, or No) from Form B2

SAMPLE

<input type="checkbox"/>	04
<input type="checkbox"/>	DEL
<input type="checkbox"/>	IN

<input type="checkbox"/>	<input type="checkbox"/>	<input type="checkbox"/>	<input type="checkbox"/>	<input type="checkbox"/>	<input type="checkbox"/>
<input type="checkbox"/>	<input type="checkbox"/>	<input type="checkbox"/>	<input type="checkbox"/>	<input type="checkbox"/>	<input type="checkbox"/>
<input type="checkbox"/>	<input type="checkbox"/>	<input type="checkbox"/>	<input type="checkbox"/>	<input type="checkbox"/>	<input type="checkbox"/>
<input type="checkbox"/>	<input type="checkbox"/>	<input type="checkbox"/>	<input type="checkbox"/>	<input type="checkbox"/>	<input type="checkbox"/>
<input type="checkbox"/>	<input type="checkbox"/>	<input type="checkbox"/>	<input type="checkbox"/>	<input type="checkbox"/>	<input type="checkbox"/>
<input type="checkbox"/> Night <input type="checkbox"/> SVC	<input type="checkbox"/> DND <input type="checkbox"/>	<input type="checkbox"/> VMMsgs <input type="checkbox"/>	<input type="checkbox"/> VMBox <input type="checkbox"/>	<input type="checkbox"/>	<input type="checkbox"/>
<input type="checkbox"/> 01 <input type="checkbox"/> IMM	<input type="checkbox"/> 02 <input type="checkbox"/> IMM	<input type="checkbox"/> 03 <input type="checkbox"/> IMM	<input type="checkbox"/> 04 <input type="checkbox"/> IMM	<input type="checkbox"/>	<input type="checkbox"/>
<input type="checkbox"/> Intercom <input type="checkbox"/>	<input type="checkbox"/> Intercom <input type="checkbox"/>	Ext.			

Specify Automatic Line Selection: _____
Identify extensions programmed as shown: 10

<input checked="" type="checkbox"/>	Night Service Button (#503)	NightSvc	Ext. 10 Only	LED Required
<input type="checkbox"/>	Outgoing Call Restriction Button (#114) ¹	OCR		
<input type="checkbox"/>	Wake Up Service Button (#115)	Wake		
<input type="checkbox"/>	Caller ID Inspect (F 17)	ID-Inspect		
<input type="checkbox"/>	Caller ID Name Display (F 16)	ID-Name		
<input checked="" type="checkbox"/>	Do Not Disturb (F 01)	DND		
<input type="checkbox"/>	Privacy (F 07)	Priv		
<input type="checkbox"/>	VMS Cover (F 15)	VMSCover		
<input type="checkbox"/>	Voice Interrupt on Busy Talk-Back (F 18)	VIQB		
<input type="checkbox"/>	Account Code Entry (F 12) ²	ACE		
<input type="checkbox"/>	Background Music (F 19) ²	Music		
<input type="checkbox"/>	Call Forwarding/Call Follow-Me (F 11 XX XX) ^{2,4} CF-XX XX			
<input type="checkbox"/>	Call Park (I XX) ³	Park		
<input type="checkbox"/>	Call Pickup (I 6 XX)	Pickup-XX		
<input type="checkbox"/>	Conference Drop (F 06)	Drop		
<input type="checkbox"/>	Contact Closure 1 (F 41) ²	CC1		
<input type="checkbox"/>	Contact Closure 2 (F 42) ²	CC2		
<input type="checkbox"/>	Direct Line Pickup-Active Line (I 68)	DLPA		
<input type="checkbox"/>	Direct Line Pickup-Idle Line(I 8)	DLPI		
<input type="checkbox"/>	Exclusive Hold (F 02)	ExHold		
<input type="checkbox"/>	Fax Management (I XX) ²	FAX-XX		
<input type="checkbox"/>	Group Calling-Ring/Page (I 7 G or I *7 G)	GCall-g		
<input type="checkbox"/>	Group Hunt-Ring/Signal(I 77 G or I *77 G)	Hunt-g		
<input type="checkbox"/>	Group Pickup (I 66 G)	P/U Grp-g		
<input type="checkbox"/>	Intercom Autodial(I XX or I *XX) ²	Ext-XX		
<input type="checkbox"/>	Last Number Redial (F 05)	LNR		
<input type="checkbox"/>	Loudspeaker Paging (I 70)	Loudspk		
<input type="checkbox"/>	Manual Signaling (F 13 XX or F 13 *XX) ²	MS-XX		
<input type="checkbox"/>	Message Light Off (F 10 XX) ⁵	MsgOff-XX		
<input type="checkbox"/>	Message Light On (F 09 XX) ⁵	MsgOn-XX		
<input type="checkbox"/>	Recall (F 03)	Recall		
<input type="checkbox"/>	Save Number Redial (F 04)	SNR		
<input type="checkbox"/>	Simultaneous Paging(I * 70)	SPage		
<input type="checkbox"/>	Station Lock (F 21) ²	Lock		
<input type="checkbox"/>	Touch-Tone Enable (F 08)	TT-EN		
<input checked="" type="checkbox"/>	Voice Mail Messages Button(I 777)	VMMsgs-777		
<input checked="" type="checkbox"/>	Voice Mailbox Transfer (F 14)	VMBox		

1. Requires Auto Dial button for each extension.
2. Button with lights is recommended, but not required.
3. Extension number can be programmed as Auto Dial button.
4. You can program the origination extension only or both the origination and destination extension.
5. You can program the extension number.

F= Feature button G = Group I = Left Intercom button XX = Extension



Form C3: PARTNER-18/18D Phone

Make as many copies as you need. Use template and/or checklist.
For additional instructions, see pages 8 through 13.

Check Desired Features

Also write in extension or group number

Template Instructions

- If desired, write in line number, dial code feature, or auto dial number
- If desired, write in Line Ringing (Imm, Del, or No) from Form B2
- If desired, write in Line Access Restriction (Out, In, or No) from Form B2

SAMPLE

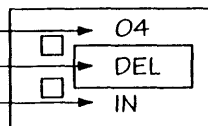

<input type="checkbox"/>	<input type="checkbox"/>	<input type="checkbox"/>	<input type="checkbox"/>	} PARTNER-18D only
<input type="checkbox"/>	<input type="checkbox"/>	<input type="checkbox"/>	<input type="checkbox"/>	
<input type="checkbox"/>	<input type="checkbox"/>	<input type="checkbox"/>	<input type="checkbox"/>	
<input type="checkbox"/> DND	<input type="checkbox"/> VMMSgs	<input type="checkbox"/> VMBox	<input type="checkbox"/>	
<input type="checkbox"/> 01	<input type="checkbox"/> 02	<input type="checkbox"/> 03	<input type="checkbox"/> 04	
<input type="checkbox"/> IMM	<input type="checkbox"/> IMM	<input type="checkbox"/> IMM	<input type="checkbox"/> IMM	
<input type="checkbox"/> Intercom	<input type="checkbox"/> Intercom	Ext.		

Specify Automatic Line Selection: _____

Identify extensions programmed as shown: 11

Night Service Button (#503)	NightSvc	Ext. 10 Only	LED Required
Outgoing Call Restriction Button (#114) ¹	OCR		
Wake Up Service Button (#115)	Wake		
Caller ID Inspect (F 17)	ID-Inspect		
Caller ID Name Display (F 16)	ID-Name		
<input checked="" type="checkbox"/> Do Not Disturb (F 01)	DND		
Privacy (F 07)	Priv		
VMS Cover (F 15)	VMSCover		
Voice Interrupt on Busy Talk-Back (F 18)	VIOB		
Account Code Entry (F 12) ²	ACE		
Background Music (F 19) ²	Music		
Call Forwarding/Call Follow-Me (F 11 XX XX) ^{2,4} CF-XX XX			
Call Park (I XX) ³	Park		
Call Pickup (I 6 XX)	Pickup-XX		
Conference Drop (F 06)	Drop		
Contact Closure 1 (F 41) ²	CC1		
Contact Closure 2 (F 42) ²	CC2		
Direct Line Pickup-Active Line(I 68)	DLPA		
Direct Line Pickup-Idle Line(I 8)	DLPI		
Exclusive Hold (F 02)	ExHold		
Fax Management (I XX) ²	FAX-XX		
Group Calling-Ring/Page (I 7 G or I *7 G)	GCall-g		
Group Hunt-Ring/Signal(I 77 G or I *77 G)	Hunt-g		
Group Pickup (I 66 G)	P/U Grp-g		
Intercom Autodial (I XX or I *XX) ²	Ext-XX		
Last Number Redial (F 05)	LNR		
Loudspeaker Paging(I 70)	Loudspk		
Manual Signaling (F 13 XX or F 13 *XX) ²	MS-XX		
Message Light Off (F 10 XX) ⁵	MsgOff-XX		
Message Light On (F 09 XX) ⁵	MsgOn-XX		
Recall (F 03)	Recall		
Save Number Redial (F 04)	SNR		
Simultaneous Paging(I * 70)	SPage		
Station Lock (F 21) ²	Lock		
Touch-Tone Enable (F 08)	TT-EN		
<input checked="" type="checkbox"/> Voice Mail Messages Button (I 777)	VMMSgs-777		
<input checked="" type="checkbox"/> Voice Mailbox Transfer (F 14)	VMBox		

F = Feature button G = Group I = Left Intercom button XX = Extension



Form C3: PARTNER-18/18D Phone

Make as many copies as you need. Use template and/or checklist.
For additional instructions, see pages 8 through 13.

Check Desired Features

Also write in extension or group number

Template Instructions

- If desired, write in line number, dial code feature, or auto dial number
- If desired, write in Line Ringing (Imm, Del, or No) from Form B2
- If desired, write in Line Access Restriction (Out, In, or No) from Form B2

SAMPLE

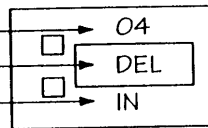

				} PARTNER-18D only
<input type="checkbox"/>	<input type="checkbox"/>	<input type="checkbox"/>	<input type="checkbox"/>	
<input type="checkbox"/>	<input type="checkbox"/>	<input type="checkbox"/>	<input type="checkbox"/>	
<input type="checkbox"/>	<input type="checkbox"/>	<input type="checkbox"/>	<input type="checkbox"/>	
<input type="checkbox"/> DND	<input type="checkbox"/> VMMsgs	<input type="checkbox"/> VMBox	<input type="checkbox"/>	
<input type="checkbox"/> 01 IMM	<input type="checkbox"/> 02 IMM	<input type="checkbox"/> 03 IMM	<input type="checkbox"/> 04 IMM	
<input type="checkbox"/> Intercom	<input type="checkbox"/> Intercom	Ext.		

Specify Automatic Line Selection: _____

Identify extensions programmed as shown: 12 13 14 15 16 17 18 19

	Night Service Button (#503)	NightSvc	Ext. 10 Only	LED Required
	Outgoing Call Restriction Button (#114) ¹	OCR		
	Wake Up Service Button (#115)	Wake		
	Caller ID Inspect (F 17)	ID-Inspect		
	Caller ID Name Display (F 16)	ID-Name		
<input checked="" type="checkbox"/>	Do Not Disturb (F 01)	DND		
	Privacy (F 07)	Priv		
	VMS Cover (F 15)	VMSCover		
	Voice Interrupt on Busy Talk-Back (F 18)	VIOB		
	Account Code Entry (F 12) ²	ACE		
	Background Music (F 19) ²	Music		
	Call Forwarding/Call Follow-Me (F 11 XX XX) ^{2,4} CF-XX XX			
	Call Park (I XX) ³	Park	1. Requires Auto Dial button for each extension. 2. Button with lights is recommended, but not required. 3. Extension number can be programmed as Auto Dial button. 4. You can program the origination extension only or both the origination and destination extension. 5. You can program the extension number.	
	Call Pickup (I 6 XX)	Pickup-XX		
	Conference Drop (F 06)	Drop		
	Contact Closure 1 (F 41) ²	CC1		
	Contact Closure 2 (F 42) ²	CC2		
	Direct Line Pickup-Active Line (I 68)	DLPA		
	Direct Line Pickup-Idle Line (I 8)	DLPI		
	Exclusive Hold (F 02)	ExHold		
	Fax Management (I XX) ²	FAX-XX		
	Group Calling-Ring/Page (I 7 G or I *7 G)	GCall-g		
	Group Hunt-Ring/Signal (I 77 G or I *77 G)	Hunt-g		
	Group Pickup (I 66 G)	P/U Grp-g		
	Intercom Autodial (I XX or I *XX) ²	Ext-XX		
	Last Number Redial (F 05)	LNR		
	Loudspeaker Paging (I 70)	Loudspk		
	Manual Signaling (F 13 XX or F 13 *XX) ²	MS-XX		
	Message Light Off (F 10 XX) ⁵	MsgOff-XX		
	Message Light On (F 09 XX) ⁵	MsgOn-XX		
	Recall (F 03)	Recall		
	Save Number Redial (F 04)	SNR		
	Simultaneous Paging (I * 70)	SPage		
	Station Lock (F 21) ²	Lock		
	Touch-Tone Enable (F 08)	TT-EN		
<input checked="" type="checkbox"/>	Voice Mail Messages Button (I 777)	VMMsgs-777		
<input checked="" type="checkbox"/>	Voice Mailbox Transfer (F 14)	VMBox		

F = Feature button G = Group I = Left Intercom button XX = Extension

Form 1: Language

A

Language Mode:

- Monolingual ✓
 Bilingual

B

Monolingual Mode—System Language:

- U.S. English ✓
 U.K. English
 Latin American Spanish
 Canadian French
 Other—specify _____

C

Bilingual Mode—Primary Language:

- U.S. English ✓
 U.K. English
 Latin American Spanish
 Canadian French
 Other—specify _____

Bilingual Mode—Secondary Language:

- U.S. English
 U.K. English
 Latin American Spanish ✓
 Canadian French
 Other—specify _____

General Information

- Factory defaults are identified by the ✓ symbol.
- If the system is set for Bilingual Mode, make sure you record the Automated Attendant Day Menu Prompts and Night Menu Prompts and Announcements (if any) in both the Primary and Secondary Languages. Also, subscribers can record two personal greetings—one in the Primary Language and another in the Secondary Language.
- Subscribers can have a Mailbox Language different from the languages selected here. Mailbox Language is specified on Form 2.

Completing this Form

- A Language Mode** Check “Bilingual” if the Language Mode should be set to Bilingual. If you check Bilingual, also see **C** below; if not, see **B**.
- B Monolingual Mode—System Language** Check the Primary language desired if different from the default.
- C Bilingual Mode—Primary Language** Check the Primary Language desired if different from the default.
- Bilingual Mode—Secondary Language** Check the Secondary Language desired if different from the default.

Programming Language

- To program the Language Mode, as well as the System Language in Monolingual Mode or the Primary and Secondary Languages in Bilingual Mode, dial [1] from the Programming Main Menu.

Form 2: Mailbox Assignments

A Mailbox	B Subscriber Name	C Mailbox Language	D Outcalling Assigned
10 ✓	Vera		
(11 ✓)	Jose		Yes
(12 ✓)	Juan		Yes
(13 ✓)	Prog. 1	English	
(14 ✓)	Prog. 2		
(15 ✓)	Prog. 3		
(16 ✓)	Prog. 4	English	
(17 ✓)	Prog. 5		
(18 ✓)	Felipe		Yes
(19 ✓)	Rosa	English	
(20 ✓)			
(21 ✓)			
(22 ✓)			
(23 ✓)			
(24 ✓)			
(25 ✓)			

A Mailbox	B Subscriber Name	C Mailbox Language	D Outcalling Assigned
(26 ✓)			
(27 ✓)			
(28 ✓)			
(29 ✓)			
(30 ✓)			
(31 ✓)			
(32 ✓)			
(33 ✓)			
(34 ✓)			
(35 ✓)			
(36 ✓)			
(37 ✓)			
(38 ✓)			
(39 ✓)			
(40 ✓)			

General Information

- Factory defaults are identified by the ✓ symbol.
- The system comes with a predetermined number of mailboxes. The optional Mailbox Expansion Card doubles the capacity.
- Mailbox 10 is reserved for the receptionist at extension 10 and cannot be changed.
- Mailbox 10 provides 60 minutes of message recording time. All other mailboxes provide 20 minutes of message recording time.
- For system security, mailboxes should be deleted where they are not needed; for example, mailboxes should be deleted for extensions in use by auxiliary equipment (such as a fax or doorphone) and the extensions assigned to the VMS Hunt Group.
- Guest mailboxes can be created for users who don't have their own phone by assigning an unused extension number as the mailbox number. Unused extension numbers include: 1) vacant extension jacks in installed 206 modules and 2) extensions in your DIAL plan higher than the last extension jack in the last installed 206 module. See "Guest Mailboxes" in Chapter 5 for more information.

Completing this Form

- A Mailbox** To assign a mailbox to an extension other than the factory default, cross out the factory default and write in the extension to be used.
- For PARTNER PLUS, use an extension number from 11-33.
 - For PARTNER Advanced Communications System, use an extension number from 11-41.
 - For PARTNER II or PARTNER 48, use an extension number from 11-57.
- To mark an unused mailbox for deletion without assigning an extension, cross out the factory default.
- B Subscriber Name** For every mailbox in use, write the name of the mailbox subscriber.
- C Mailbox Language** For each mailbox that requires a language different from the System Language or Primary Language indicated on Form 1, write the name of the language in this space. Supported languages are listed on Form 1.
- D Outcalling Assigned** For each mailbox in use, indicate whether Outcalling is assigned.

Programming Mailboxes

You can change a mailbox assignment by deleting an existing mailbox and creating a new one.

- To program mailboxes, dial [4] from the Programming Main menu.

Form 3: Menu Definition

Required for Automated Attendant Service

A Description	B Selector Code	C Range of Extensions for Direct Extension Transfer	D Ext. # or Group # for Selector Code Transfer, or Announcement #
<i>Direct Extension Transfer</i>	1	(10-19 ✓)	
<i>Direct Extension Transfer</i>	2	(20-29 ✓)	
	3	(30-39 ✓)	
<i>Customer Service (Felipe)</i>	4	(40-49 ✓)	
<i>Billing Dept. (Rosa)</i>	5	(50-57 ✓)	
	6		
	7	(71-74, 771-776 ✓)	
	8		
	9	Transfer to Mailbox 10 ✓	

General Information

- Factory defaults are identified by the ✓ symbol.
 - This Menu Definition applies to both the Day and Night Menu prompts.
 - The **Selector Code** is the first digit dialed by the caller in response to the menu prompts.
 - In **Direct Extension Transfer**, Selector Codes 1-5 and 7 represent the first digit for a range of extensions. These Selector Codes let callers dial extension numbers directly.
 - In **Selector Code Transfer**, Selector Codes 1-9 represent a specific extension, Group Calling number, (if available) or Hunt Group number to which the caller will be transferred. Use the following values:
 - PARTNER Plus: 10-33 or 771-776
 - PARTNER Advanced: 11-41, 71-74, or 771-776
 - PARTNER II: 10-57, 71-74, or 771-776
 - PARTNER 48: 10-57, 71, or 771-776
- Selector Code Transfer lets callers dial a single digit to reach a single extension or group, such as the VP of Sales at extension 37 or the order processing operators assigned to Hunt Group 774.
- Selector Code 9 lets callers transfer directly to mailbox 10 (receptionist mailbox) where they can leave a message.
 - The Description and Selector Code number from this form will be used to complete the Day and Night Menu Prompts (Forms 4, 4A, 5, and 5A).
 - For Announcement entries in **Description**, **Selector Code**, and **Announcement #** of this form will be used to complete Forms 3A and 3B.

Completing this Form

For Direct Extension Transfer...

- A Description** Write "Direct Extension Transfer."
- C Range of Extensions for Direct Extension Transfer** Leave the factory default.
- D Ext. # or Group # for Selector Code Transfer** ...Leave blank.

For Selector Extension Transfer...

- A Description** Write the name of the person or group to receive the transfer.
- C Range of Extensions for Direct Extension Transfer** Cross out the factory default if you want the caller to dial the corresponding Selector Code to transfer to the extension, announcement, or group identified in **D** below.
- D Ext. #, or Group # for Selector Code Transfer...** Write the extension, announcement, or group number to receive the transfer.

For Announcement...

- A Description** Write "Announcement."
- C Range of Extensions for Direct Extension Transfer** Cross out the factory default if you want the caller to dial the corresponding Selector Code to hear the Announcement identified in **D** below.
- D Announcement #** Write the Announcement number (1 or 2).

Form 4: Day Menu Prompt— System Language or Primary Language

Required if VMS Hunt Schedule is set to Day Only or Always

<i>Gracias por llamar a Software Mexico. For English press star one. Si usted tiene teléfono de tonos y conoce el número de extensión a la que desea llamar, marquelo ahora. De lo contrario espere a ser atendido por nuestra operadora. Para servicios al cliente, marque cuatro; para informacion de facturacion, marque cinco.</i>

General Information

The Day Menu Prompt plays to callers when the VMS Hunt Schedule is set to Day Only or Always and Night Service is off. The Day Menu Prompt and the Night Menu Prompt use the **same** Menu Definition.

- The Day Menu Prompt should contain a welcome and a list of menu options.
- The welcome should introduce the company. For example, "Thank you for calling the Any Travel Agency"
- If the system is set for Bilingual Mode, let callers know they can switch the language they hear while on the call. For example, "Para español, marque * 1."
- The menu options should contain instructions that correspond to the Menu Definition set up on Form 3.
 - If callers can dial extension numbers (Direct Extension Transfer), the prompt should instruct callers to dial the extension number. For example, "If you know the extension of the person you want to reach, dial it now."
 - If callers can dial a single digit to transfer to an extension or group (Selector Code Transfer), the prompt should provide instructions such as "To speak to someone in sales, press 6."
 - If callers can choose an Announcement, include that information. For example, "For directions to our office, press 4."

It is recommended that you keep the number of menu options to 5 or less to avoid confusing the caller.

Completing this Form

Write the message that you want callers to hear when they call during normal business hours, including the instructions to the caller for selecting menu options.

Suggested options include:

- "Remain on the line for assistance."
- "Dial 0 for assistance."
- "To hear this menu again, dial * 4."

Recording the Day Menu Prompt

- To record the Day Menu Prompt, dial [3] from the Programming Main Menu.

Form 4A: Day Menu Prompt—Secondary Language

Required for Bilingual Mode only if VMS Hunt Schedule is set to Day Only or Always

<i>Thank you for calling Software Mexico. If you know the extension number, dial it now. If not</i>
<i>please wait and the attendant will answer your call. For Customer Service, press 4. For</i>
<i>Billing, press 5.</i>

General Information

- The Day Menu Prompt plays to callers when the VMS Hunt Schedule is set to Day Only or Always and Night Service is off. The Day Menu Prompt and the Night Menu Prompt use the **same** Menu Definition.
- The Day Menu Prompt should contain a welcome and a list of menu options.
- The welcome should introduce the company. For example, "Thank you for calling the Any Travel Agency"
- Let callers know they can switch back to the Primary Language. For example, "For English, press * 1."
- The menu options should contain instructions that correspond to the Menu Definition set up on Form 3.
 - If callers can dial extension numbers (Direct Extension Transfer), the prompt should instruct callers to dial the extension number. For example, "If you know the extension of the person you want to reach, dial it now."
 - If callers can dial a single digit to transfer to an extension or group (Selector Code Transfer), the prompt should provide instructions such as "To speak to someone in sales, press 6."
 - If callers can choose an Announcement, include that information. For example, "For directions to our office, press 4."

It is recommended that you keep the number of menu options to 5 or less to avoid confusing the caller.

Completing this Form

Write the message that you want callers to hear when they call during normal business hours, including the instructions to the caller for selecting menu options.

Suggested options include:

- "Remain on the line for assistance."
- "Dial 0 for assistance."
- "To hear this menu again, dial * 4."

Recording the Day Menu Prompt

- To record the Day Menu Prompt, dial [3] from the Programming Main Menu.

Form 5: Night Menu Prompt— System Language or Primary Language

Required if VMS Hunt Schedule is set to Night Only or Always

<i>Gracias por llamar a Software México. For English, press star one. Nuestro horario de oficina es de 9:00 a 14:30 horas y de 16:00 a 18:00 horas. Si usted tiene teléfono de tonos y conoce el número de la extensión a la que desea llamar, marquel ahora. De lo contrario, espere y deje un mensaje con la operadora.</i>

General Information

The Night Menu Prompt plays to callers when the VMS Hunt Schedule is set to Night Only or Always and Night Service is on. The Night Menu Prompt and the Day Menu Prompt use the **same** Menu Definition.

- The Night Menu Prompt should contain a welcome and a list of menu options.
- The welcome should introduce the company. For example, “You have reached the Any Travel Agency. Our hours are 9 AM to 5 PM, Monday through Friday.”
- If the system is set for Bilingual Mode, let callers know they can switch the language they hear while on the call. For example, “Para español, marque * 1.”
- The menu options should contain instructions that correspond to the Menu Definition set up on Form 3.
 - If callers can dial extension numbers (Direct Extension Transfer), the prompt should instruct callers to dial the extension number. For example, “If you know the extension of the person you want to reach, dial it now and leave a message.”
 - If callers can dial a single digit to transfer to an extension or group (Selector Code Transfer), the prompt should provide instructions such as “To leave a message for Pat, press 6.” Keep in mind that there are no group mailboxes.

- If Selector Code 9 is left as the default, the prompt should instruct callers to press 9 to leave a message with the receptionist.

It is recommended that you keep the number of menu options to 5 or less to avoid confusing the caller.

Completing this Form

Write the message that you want callers to hear when they call after normal business hours, including instructions to the caller for selecting menu options.

Suggested options include:

- “Dial 9 or remain on the line to leave a message.”
- “To hear this menu again, dial * 4.”

Recording the Night Menu Prompt

- To record the Night Menu Prompt, dial [3] from the Programming Main Menu.

Form 5A: Night Menu Prompt—Secondary Language

Required for Bilingual Mode only if VMS Hunt Schedule is set to Night Only or Always

<i>Good Evening. Thank you for calling Software Mexico. Our business hours are from 9:00 to 2:30 and 4:00 to 6:00. If you know the extension number and you want to leave a message, dial it now. If not, please wait and leave a message for the attendant.</i>

General Information

- The Night Menu Prompt plays to callers when the VMS Hunt Schedule is set to Night Only or Always and Night Service is on. The Night Menu Prompt and the Day Menu Prompt use the **same** Menu Definition.
- The Night Menu Prompt should contain a welcome and a list of menu options.
- The welcome should introduce the company. For example, "You have reached the Any Travel Agency. Our hours are 9 AM to 5 PM, Monday through Friday."
- Let callers know they can switch back to the Primary Language. For example, "For English, press * 1."
- The menu options should contain instructions that correspond to the Menu Definition set up on Form 3.
 - If callers can dial extension numbers (Direct Extension Transfer), the prompt should instruct callers to dial the extension number. For example, "If you know the extension of the person you want to reach, dial it now and leave a message."
 - If callers can dial a single digit to transfer to an extension or group (Selector Code Transfer), the prompt should provide instructions such as "To leave a message for Pat, press 6." Keep in mind that there are no group mailboxes.

- If Selector Code 9 is left as the default, the prompt should instruct callers to press 9 to leave a message with the receptionist.

It is recommended that you keep the number of menu options to 5 or less to avoid confusing the caller.

Completing this Form

Write the message that you want callers to hear when they call after normal business hours, including instructions to the caller for selecting menu options.

Suggested options include:

- "Dial 9 or remain on the line to leave a message."
- "To hear this menu again, dial * 4."

Recording the Night Menu Prompt

- To record the Night Menu Prompt, dial [3] from the Programming Main Menu.

Glossary

A

Announcement

An informative message that provides frequently requested information. It is recorded by the System Manager and plays to callers who select it from an Automated Attendant's Menu.

Auto Dial button

A programmable button on a system phone that lets the user dial a series of digits simply by pressing that button. An Auto Dial button can be used to dial the voice messaging system with one touch. *See also* Programmable button.

Automated Attendant Service

A component of the voice messaging system that consists of a menu definition and prompt. It provides outside callers with options enabling them to reach an extension, a Hunt Group, or (for PARTNER II systems) a Calling Group, by pressing a single digit or by dialing an extension or group number.

Auxiliary equipment

Telecommunications equipment (other than system phones) that can be connected to the control unit. Auxiliary equipment includes industry standard devices that can connect directly to the public telephone network (such as doorphones or fax machines) as well as devices that require the interface provided by the control unit (such as a loudspeaker paging system).

Automatic VMS Cover

A communications system feature that provides voice mail coverage for a subscriber's unanswered transferred and intercom calls.

B

Bilingual Mode

A Language Mode setting that allows messages and prompts to be played in either of two languages. *See also* Monolingual Mode.

C

Call Answer Service

A component of the voice messaging system that lets callers leave a message at an unanswered extension or transfer to another extension.

Calling Group

A group of extensions that can be called simultaneously by dialing a group calling code. This feature may not be available on your system; check your *Programming and Use* guide. *See also* Hunt Group.

Centralized Telephone Programming

A method of telephone programming that lets you program individual extensions in the system from a system display phone at extension 10 (or 11 if available). Centralized Telephone Programming is an alternative to Extension Programming.

Control Unit

Hardware that connects lines coming into the building to the extensions in the system and also provides system features.

Communications system

The control unit and system phones, plus all other telecommunications devices that are connected to the control unit. Certain releases of PARTNER Plus, PARTNER II, PARTNER 48, and PARTNER Advanced communications systems can be used with the PARTNER MAIL VS system.

D

Delayed Call Handling

A communications system feature that allows the communications system to send incoming outside calls to the Automated Attendant Service if the receptionist does not answer by the third ring. *See also* Immediate Call Handling.

Dial plan

The range of extensions provided for a specific system. The PARTNER Plus system includes extensions 10-33; the PARTNER ACS includes extensions 10-41; the PARTNER II and PARTNER 48 systems include extensions 10-57.

Do Not Disturb

A communications system feature that can be used in conjunction with automatic or manual voice coverage to send callers immediately to a subscriber's mailbox rather than ringing the extension first.

E

Extension

An endpoint in the system (numbered 10-33 for PARTNER Plus system; 10-41 for PARTNER ACS; 10-57 for PARTNER II and PARTNER 48 systems) that connects telephones or standard devices, which can be dialed using the Intercom button. *See also* Extension number and Programming extension.

Extension coverage

A feature that allows callers to leave messages or transfer to another extension when the extension called is busy or not answered, and Automatic VMS Cover is on.

Extension jack

The six jacks on the lower half of a 206 module that allow you to connect phones (or other telecommunications devices) to the control unit.

Extension Line Coverage

A voice messaging system feature that lets a subscriber's extension (mailbox) be assigned as the owner of a covered line. When a call comes in on the covered line, the system routes the caller to the mailbox specified as the line owner if the call is not answered. *See also* Line Coverage Extension.

Extension number

The number assigned to each extension jack on a 206 module. Extension jack numbers run consecutively from 10 through 33 for the PARTNER Plus system, 10 through 41 for the PARTNER ACS, and 10 through 57 for the PARTNER II and PARTNER 48 systems. They are used for intercom calling.

Extension Programming

A method of telephone programming that lets users program their own extensions from their system phones. *See also* Centralized Telephone Programming.

G

Group Call Distribution

A communications system feature that directs incoming calls on specified lines to a Hunt Group for either Automated Attendant Service or Line Coverage. *See also* Automated Attendant Service, Hunt Group, VMS Hunt Group, and VMS Line Coverage.

H

Hunt Group

A group of extensions that takes incoming or transferred calls in round-robin fashion. Calls to the Hunt Group are directed to the first available extension in the group, with the extension that answered most recently being the last one in the hunt order. *See also* Calling Group and VMS Hunt Group.

I

Immediate Call Handling

A communications system feature that allows the Automated Attendant Service to answer every incoming outside call on specified lines and play the Automated Attendant Service day or night menu. *See also* Delayed Call Handling.

Industry-standard device

A telephone or other telecommunications device that can be connected directly to the public telephone network. *See also* Standard phone.

Intercom call

A call that is made to another system extension.

L

Language Mode

See Bilingual Mode and Monolingual Mode.

Line Coverage Extension

A communications system feature that directs incoming calls on a specific line to a specific extension.

Line jack

The location on 206 and 400 modules that allow you to connect outside lines to the control unit.

Line number

The number assigned to each line jack on a 206 or 400 module. Line jack numbers run consecutively from 01 through 12 (for a PARTNER Plus system), 01 through 15 (for a PARTNER ACS), or from 01 through 24 (for PARTNER II and PARTNER 48 systems).

Line Ownership

A voice messaging system feature that lets you program VMS Line Coverage. *See also* Group Call Distribution and VMS Line Coverage.

M

Mailbox

A storage area for messages associated with a system subscriber.

Mailbox Language

The language assigned to a subscriber's mailbox.

Mailbox Password

A code of up to four digits that subscribers enter to log in to the voice messaging system. A password is used to keep messages confidential.

Menu Definition

A voice messaging system feature that lets you customize the Automated Attendant Service transfer options available to outside callers.

Menu Prompt

The customized day or night message that an outside caller hears after the Automated Attendant Service answers the call.

Monolingual Mode

A Language Mode setting that allows messages and prompts to be played in one of several available languages. *See also* Bilingual Mode.

Music On Hold system

Equipment that lets you play recorded music or messages to callers who are placed on hold. A music-on-hold audio source must be connected to the processor module in the control unit.

N

Night Service

A communications system feature that is used in conjunction with Automated Attendant Service to activate the Night Menu Prompt.

O

On-touch Intercom Calling button

See Auto Dial button.

Outcalling

A voice messaging system feature that, when assigned to a subscriber, allows the subscriber to have the system call a pager or telephone number according to a predefined schedule whenever a new message is received in the subscriber's voice mailbox.

P

Primary Language

In Bilingual Mode, the language callers initially hear when they call in to the voice messaging system. *See also* Secondary Language.

Programmable button

A system phone button that does not have a line assigned; it can be set up to dial a number or access a feature.

Programming extension

An extension from which you can program the communications system. It can be either extension 10 (or 11 if available).

R

Receptionist

The person who primarily is responsible for answering outside calls. This is the person at extension 10.

S

Secondary Language

In Bilingual Mode, the language callers have the option of hearing when they call in to the voice messaging system. *See also* Primary Language.

Selector Code

A single digit (1-9) used to define transfer options for outside callers on the Automated Attendant Service menu. *See also* Menu Definition and Menu Prompt.

Send All Calls

A communications system feature that lets subscribers use Do Not Disturb to send callers immediately to their mailbox (calls *do not* ring the extension first) provided voice mail coverage is on at the extension.

Standard phone

An industry-standard touch-tone or rotary phone such as you might have in your home. Some standard phones include special feature buttons for frequently used calling functions. *See also* Industry-standard device.

Subscriber

A user who is assigned a mailbox.

System Language

In Monolingual Mode, the language callers hears when they call in to the voice messaging system.

System Manager

The person responsible for managing both the communications and voice messaging systems.

System phone

A telephone that is specifically designed for use with PARTNER systems. Models include the PARTNER-34D, PARTNER-18D, PARTNER-18, PARTNER-6, MLS-34D, MLS-18D, MLS-12, MLS-12D, MLS-6, MDC 9000, and MDW 9000 phones.

System programming

Procedures that allow you to customize the communications system settings. System programming requires a system display phone and is done from extension 10 (or 11 if available).

T

Telephone programming

Customizes extensions to meet the needs of individual users, including the assignment of features to programmable buttons. Telephone Programming can be done either centrally or from the user's own extension. See also Centralized Telephone Programming and Extension Programming.

Tutor

A voice messaging system feature that lets any communications system user access and listen to information about their phone and commonly-used communications system features.

206 module

A system module that contains jacks for connecting up to two outside lines and up to six extensions.

V

VMS Cover button

A button on a system phone that allows a subscriber to turn voice mail coverage on and off manually at that extension. See also Automatic VMS Cover.

VMS Hunt Delay

A communications system feature that lets you set the Automated Attendant to handle calls using either Immediate Call Handling or Delayed Call Handling. See also Delayed Call Handling and Immediate Call Handling

VMS Hunt Group

Hunt Group 7, reserved by the communications system to identify extensions associated with the voice messaging system hardware. See also VMS Hunt Delay and VMS Hunt Schedule.

VMS Hunt Schedule

A communications system feature that allows you to set the communications system to route outside calls to the Automated Attendant Service always, only when the Night Service button at the receptionist's extension is on, or only when the Night Service button is off.

VMS Line Coverage

A voice messaging system feature that lets the System Manager associate a personal line with a specific subscriber's mailbox for voice mail coverage. See also Group Call Distribution and Line Ownership

Voice Mail Service

A component of the voice messaging system that allows subscribers to listen to and delete messages, record personal greetings, and change their passwords. It also allows the System Manager to program the voice messaging system.

Voice Mailbox

See Mailbox.

Voice Mailbox Transfer button

A button on a system phone that enables the user to transfer a call directly to a subscriber's mailbox.

Voice messaging system (VMS)

An optional device that automates call handling: answers calls and routes them to caller designated extension; permits callers to leave messages at unanswered extensions; and allows subscribers to retrieve their messages. See also Automated Attendant Service, Call Answer Service, and Voice Mail Service.

Index

A

Allowed Number List, 4-23
Announcements, 1-6, 5-18, 5-21
Automated Attendant Announcement
 initial programming, 4-11
Automated Attendant Service
 Announcements, 1-6, 5-18
 communications system options, 1-8, 1-10
 factory-set messages, 1-7
 Music-On-Hold, 1-11
 overview, 1-6
 programming, 4-8, 4-19, 5-18
 testing the operation of, 4-29
 using Group Call Distribution for, 5-34
Automatic Extension Privacy, 4-20
Automatic VMS Cover, 1-12, 4-25, 5-51

B

Button programming
 Do Not Disturb, 4-27, 5-61
 VMS Cover, 4-26, 5-60
 Voice Mail Messages, 4-28, 5-62
 Voice Mailbox Transfer, 4-27, 5-61

C

Call Answer Service
 communications system options, 1-12
 factory-set message, 1-11
 initial programming, 4-24
 overview, 1-11
 testing the operation of, 4-31
Call handling
 delayed, 1-9
 immediate, 1-9
Calling Group, 5-7
Capacities, 5-36
Changing language
 mailbox, 5-47
CO Line Coverage
 assigning Line Ownership, 4-18
 initial programming, 4-24
 overview, 1-12, 5-52
Communications system, 1-1

Communications system programming
 dial plan for mailboxes, 5-39
 dialpad overlays for, 3-3
 entering programming mode, 3-3
 initial setup, 4-1, 4-19
 methods of, 3-2
 overview, 3-1
 planning forms, 3-2

D

Day Menu Prompt
 changing the, 5-24, 5-30
 description, 1-6
 factory-set prompt, 1-7
 initial programming, 4-11
 listening to, 5-23, 5-28
 sample message, 5-21
Delayed call handling, 1-9
Dial Plan, 5-39
Dialpad key sequences, xii
Direct Extension Transfer, 5-20
Disallowed Number List, 4-22
Do Not Disturb, 1-12
 programming a button, 4-27
Do Not Disturb button, 5-61

E

Extension coverage
 automatic, 1-12, 4-25
 immediate, 1-12
 manual, 1-12
 overview, 1-12
Extensions
 transfer return, 4-4
 VMS (Hunt Group 7), 4-3
Extensions coverage
 manual, 4-26

F

FCC information, B-1

G

- Group Call Distribution
 - for Automated Attendant Service, 5-34
 - for CO Line Coverage, 5-58
 - initial programming, 4-19
 - overview, 1-8
 - Guest mailboxes
 - creating, 5-44
 - deleting, 5-42
 - for receptionist, 5-6
 - overview, 1-14, 5-40
-

H

- Helpline, 6-1
 - Hunt Group, 5-7
-

I

- Immediate call handling, 1-9
 - Installation
 - guidelines, 2-1
 - Mailbox Expansion Card, 2-5
 - voice messaging system module, 2-2
-

K

- Key sequences, xii
-

L

- Line Ownership
 - and Group Call Distribution, 5-58
 - and mailbox deletion, 5-42
 - assigning, 5-55
 - changing, 5-56
 - checking, 5-54
 - deleting, 5-57
 - initial programming, 4-18
 - Login
 - for voice messaging system, 3-5
-

M

- Mailbox Expansion Card
 - description, 1-1
 - Mailboxes
 - assigning Outcalling privileges, 4-17
 - capacity, 5-36
 - checking the status of, 5-42
 - creating, 5-44
 - deleting, 5-42
 - dial plan for, 5-39
 - for guests, 1-14
 - initial programming, 4-15, 4-16
 - overview, 5-36
 - re-initializing, 4-16, 4-17, 5-46, 5-47, 5-48
 - Main menu, 3-6
 - Manual VMS Cover, 1-12
 - Menu definition
 - changing the, 5-24, 5-30
 - description, 5-20
 - initial programming, 4-8, 4-11
 - listening to, 5-22, 5-27, 5-28
 - overview, 5-20
 - Menu prompt, 5-20
 - Message light, 5-42
 - Music On Hold, 1-11
-

N

- Night Menu Prompt
 - changing the, 5-32
 - description, 1-6
 - factory-set prompt, 1-7
 - initial programming, 4-10, 4-13
 - listening to, 5-23, 5-28
 - sample message, 5-21
 - Night Service
 - initial programming, 4-21
 - overview, 1-8
-

O

- Outcalling
 - guidelines, 5-3
 - verfying operation, 5-4
- Outcalling privileges
 - assigning, 4-17, 5-49
 - removing, 5-49
- Outcalling Call Restriction, 1-15, 4-4

P

- PARTNER MAIL VS
 - Release 4 features, 1-2
 - supported configurations, 4-2
 - upgrading, 4-2
- Password
 - for subscribers, 1-13
 - for the System Manager, 5-2
 - reinitializing, 5-45
- Personal greeting, 1-13
- Planning forms
 - communications system, 3-2
 - voice messaging system, 3-4
- Problems
 - solving, 6-1
- Programming
 - communications system, 3-1
 - telephone buttons, 4-26
 - voice messaging system, 3-4
- Programming Main Menu
 - accessing the, 3-6
 - description, 3-6
- Programming overlays, 3-3

R

- Receptionist
 - duties, 5-6
 - extension 10, 5-36
 - mailbox, 5-42
- Reference materials, xv
- Reinitializing
 - mailbox, 5-46
 - password, 5-45
- Rotary phones, 5-22

S

- Security, 1-15
 - Outcalling feature, 1-15
- Security policy, 1-16
- Selector Code Transfer, 5-20
- Selector codes, 5-20
- Support, 6-1
 - customer, 6-1
- System Manager
 - duties, 5-1
 - password for, 5-2
- System test, 4-29

T

- Telephone button programming, 4-26
- Telephone company notification, B-2
- Terminology, xi
- Transfer
 - for Automated Attendant Service callers, 5-20
 - using * 8, 5-22
- Transfer Return Extension
 - overview, 1-10
- Transfer return extensions, 4-4
- Tutor Service, 1-3, 5-5
 - labels, xv
 - menu, 5-5

V

- VMS Cover, 5-42
- VMS Cover button, 4-26, 5-60
- VMS extensions
 - determining, 2-3, 5-41
 - specifying, 4-3
- VMS Hunt Delay
 - changing the setting, 5-34
 - initial programming, 4-20
 - overview, 1-9
- VMS Hunt Schedule
 - changing the setting, 5-35
 - initial programming, 4-20
 - overview, 1-8
- Voice mail coverage
 - and groups, 5-7
 - for CO lines, 1-12
 - for extensions, 1-12, 4-25, 4-26
- Voice Mail Messages button, 4-28, 5-62
- Voice Mail Service
 - factory-set message, 1-14
 - initial programming, 4-15
 - overview, 1-13
 - testing the operation of, 4-29
- Voice Mailbox Transfer
 - description, 1-13
 - programming a button, 4-27
- Voice Mailbox Transfer button, 5-61
- Voice messaging system
 - features, 1-1
 - overview, 1-4
- Voice messaging system programming
 - guidelines, 3-7
 - initial setup, 4-1
 - login, 3-5
 - main menu, 3-6
 - method of, 3-5
 - overview, 3-4
 - planning forms, 3-4

Call Voice Mail Service (Press Intercom 7 7 7)

Enter Login (Press 9 9 #)

Enter Mailbox Password
(Press 1 2 3 4 for factory default and #)

Select Programming Main Menu
(Press 9)

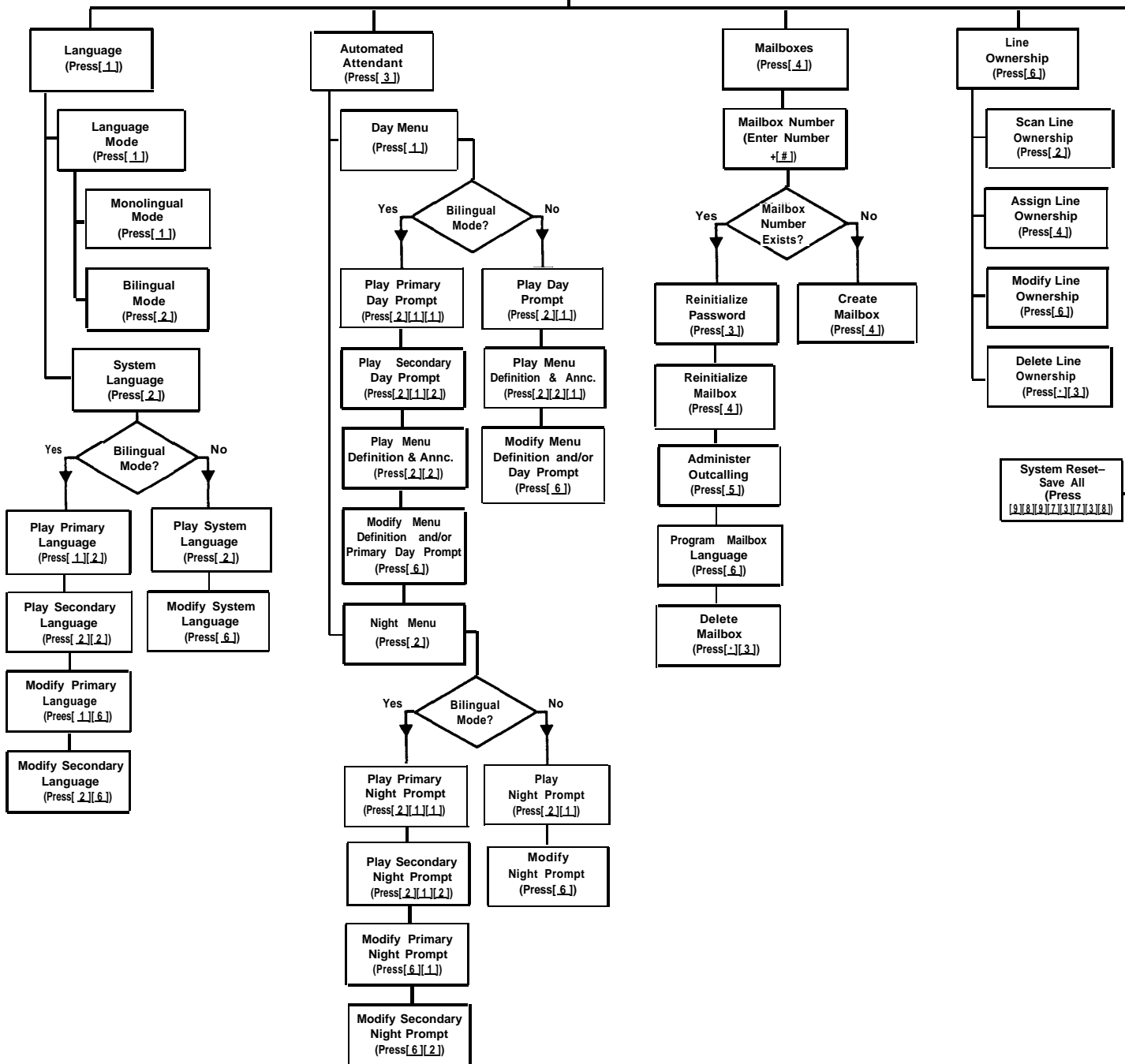

Programming Flowchart

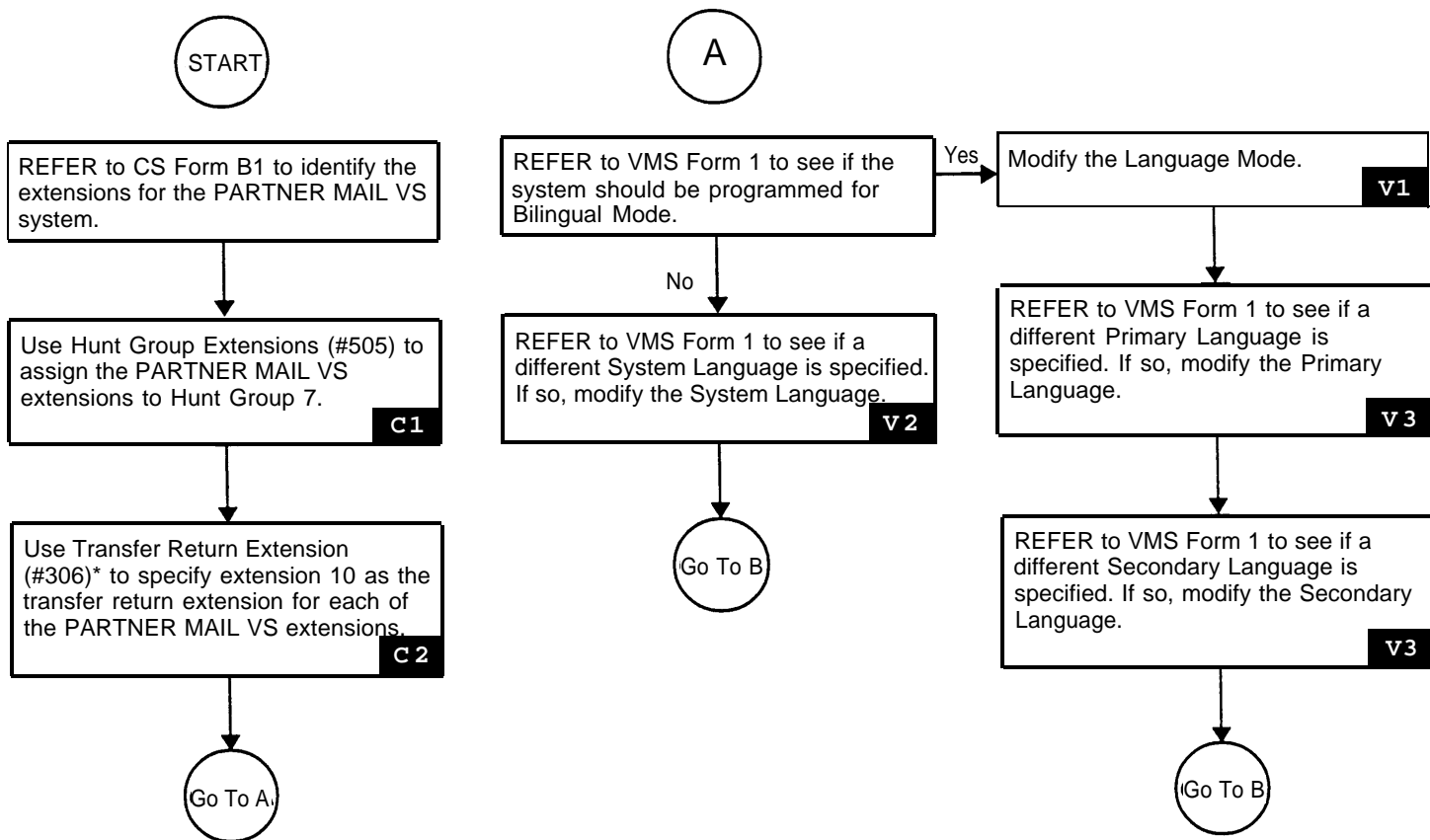

Key:

- CS – Refers to the System Planner forms for the **Communications System**.
- VMS – Refers to the forms for the **Voice Messaging System**.
- C# – Refers to the quick reference programming procedure for the Communications System.
- V# – Refers to a quick reference programming procedure for the Voice Messaging System.

Note: C#/V# procedures follow this flowchart.

* In some countries, the procedure code for Transfer Return Extension is #309. Check the *Programming and Use* guide for the communications system.

Programming Flowchart

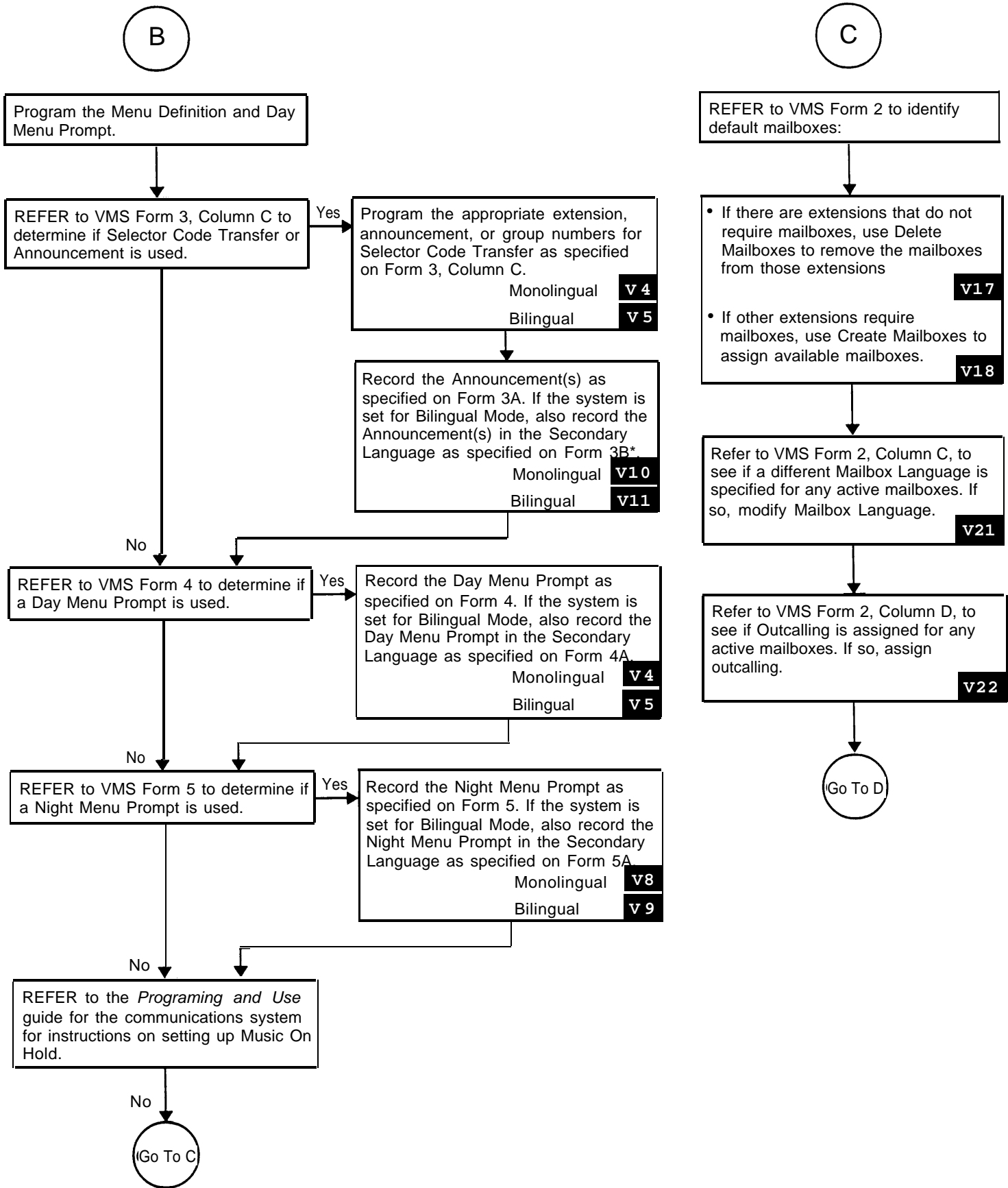

* A maximum of two Announcements can be recorded in Monolingual Mode. In Bilingual Mode, two Announcements can be recorded in the Primary Language and two Announcements can be recorded in the Secondary Language.

Programming Flowchart

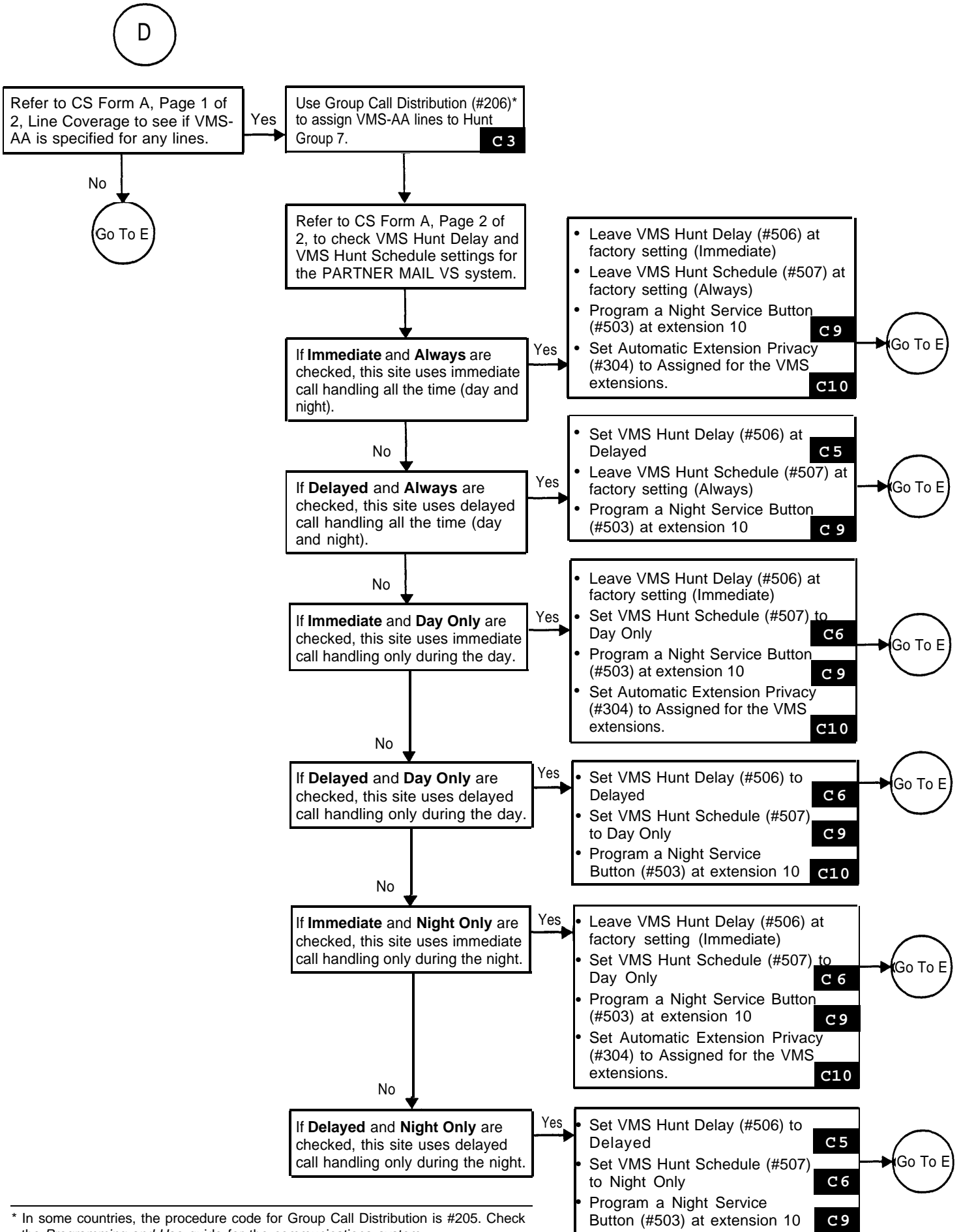

* In some countries, the procedure code for Group Call Distribution is #205. Check the *Programming and Use* guide for the communications system.

E

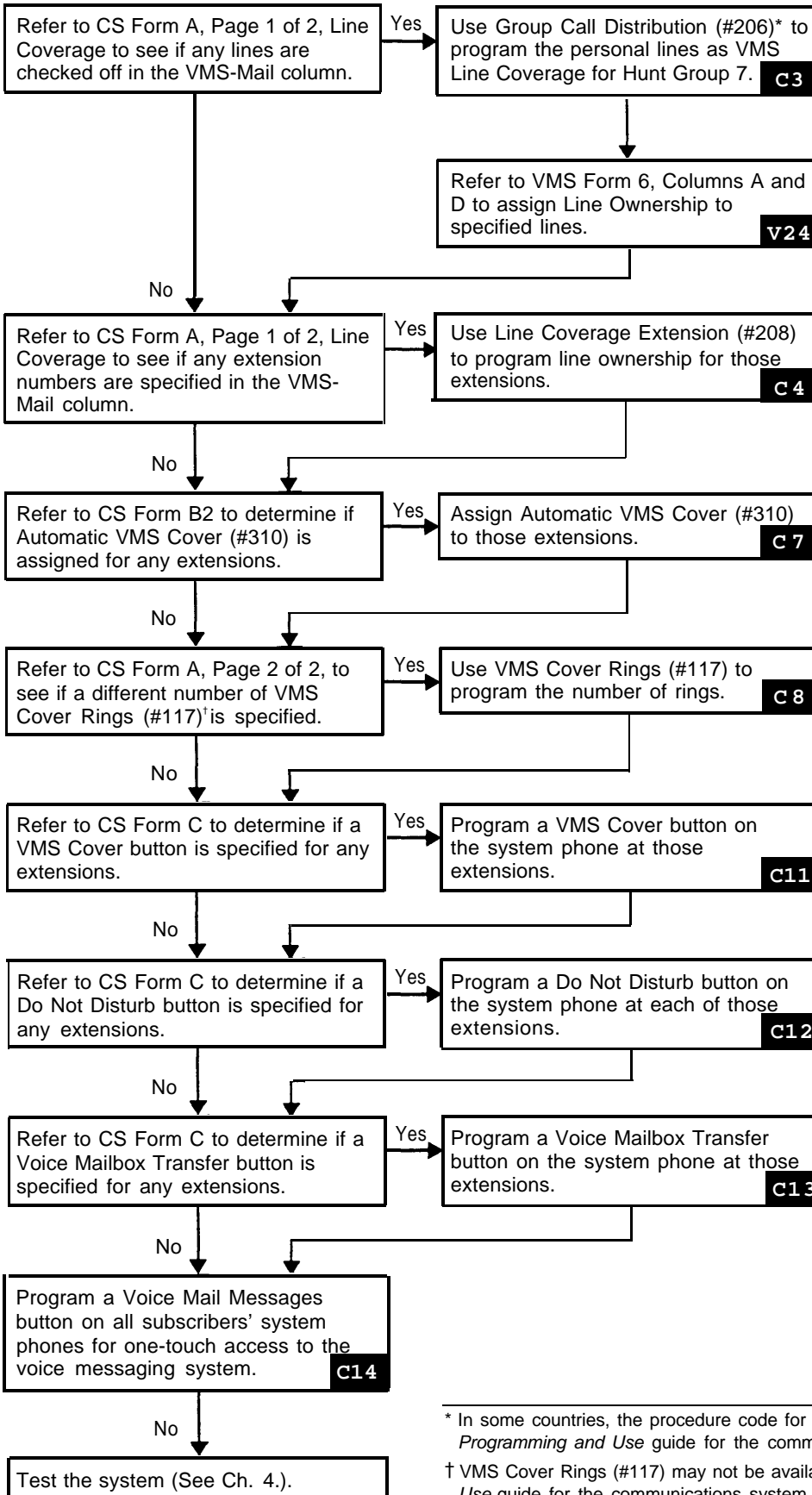

* In some countries, the procedure code for Group Call Distribution is #205. Check the *Programming and Use* guide for the communications system.

† VMS Cover Rings (#117) may not be available on your system. Check the *Programming and Use* guide for the communications system.

PARTNER MAIL VS® System Programming Reference

To Program the PARTNER MAIL VS System

TO START PROGRAMMING

PRESS [*Intercom*] [7] [7] [7]
PRESS [9] [9] and [#]
ENTER your Password
(factory setting is 1234) and [#]
PRESS [9] to access the Programming
Main Menu

TO REPLAY A MENU

PRESS [★] [4]

TO RETURN TO THE PROGRAMMING MAIN MENU

PRESS [★] [7]

TO RETURN TO A PREVIOUS MENU

PRESS [★] [#]

TO EXIT PROGRAMMING

PRESS [★] [★] [9]

Language

REFER to Form 1
PRESS [1] to program Language

Automated Attendant

REFER to Forms 3, 3A, 4, and 5
PRESS [3] to program Automated
Attendant Service

Automated Attendant

REFER to Forms 3, 3A, 4, 4A, 5, and 5A
PRESS [3] to program Automated
Attendant Service

TO MODIFY THE LANGUAGE MODE

PRESS [1] for Language Mode
PRESS [1] for Monolingual Mode or
[2] for Bilingual Mode

V1

TO MODIFY THE SYSTEM LANGUAGE—MONOLINGUAL MODE

PRESS [2] for System Language
PRESS [6] to modify
ENTER the number of the desired
System Language
PRESS [9] to confirm

V2

TO MODIFY THE PRIMARY AND SECONDARY LANGUAGES— BILINGUAL MODE

PRESS [2] for System Language
PRESS [1] for Primary Language
PRESS [6] to modify
ENTER the number of the desired
System Language
PRESS [9] to confirm
PRESS [★] [#]
PRESS [2] for Secondary Language
PRESS [6] to modify
ENTER the number of the desired
System Language
PRESS [9] to confirm

V3

TO MODIFY THE MENU DEFINITION AND DAY MENU PROMPT— MONOLINGUAL MODE

PRESS [1] for Day Menu
PRESS [6] to modify
ENTER a Selector Code 1 through 9
PRESS [9] to modify
PRESS [1] for Selector Code Transfer
ENTER an extension, Hunt Group, or
Calling Group number and [#]
To program another Selector Code for
Selector Code Transfer, repeat
PRESS [★] [#] to approve
PRESS [1] to record the Day Menu
Prompt
PRESS [1] after recording
PRESS [★] [#] to approve all changes

V4

TO CHANGE SELECTOR CODE TRANSFER TO DIRECT EXTENSION TRANSFER—MONOLINGUAL MODE

PRESS [1] for Day Menu
PRESS [6] to modify
ENTER a Selector Code 1 through 9
PRESS [9] to modify
PRESS [5] for Direct Extension Transfer
To program another Selector Code for
Direct Extension Transfer,
repeat
PRESS [★] [#] to approve
PRESS [1] to record the Day Menu
Prompt
PRESS [1] after recording
PRESS [★] [#] to approve all changes

V12

TO MODIFY ANNOUNCEMENT— MONOLINGUAL MODE

PRESS [1] for Day Menu
PRESS [6] to modify
ENTER a Selector Code 1 through 9
PRESS [9] to confirm
PRESS [3] to play the Announcement
recorded for the Selector Code
ENTER an Announcement number
PRESS [1] to rerecord the
Announcement
PRESS [1] after recording
PRESS [★] [#] to move up a menu level
PRESS [★] [#] to continue without
programming Selector Codes
PRESS [#] to approve all changes

V10

TO CHANGE SELECTOR CODE TRANSFER TO ANNOUNCEMENT— MONOLINGUAL MODE

PRESS [1] for Day Menu
PRESS [6] to modify
ENTER a Selector Code 1 through 9
PRESS [9] to modify
PRESS [3] for Announcement
ENTER an Announcement number
PRESS [1] to record the Announcement
PRESS [1] after recording
PRESS [★] [#] to approve
PRESS [★] [#] to continue without
programming another Selector
Code, or
To program another Selector Code,
repeat
PRESS [1] to record the Day Menu
Prompt
PRESS [1] after recording
PRESS [★] [#] to approve all changes

V14

To Program the PARTNER MAIL VS System

TO START PROGRAMMING

PRESS [*Intercom*] [7] [7] [7]
 PRESS [9] [9] and [#]
 ENTER your Password
 (factory setting is 1234) and [#]
 PRESS [9] to access the Programming
 Main Menu

TO REPLAY A MENU

PRESS [★] [4]

TO RETURN TO THE PROGRAMMING MAIN MENU

PRESS [★] [7]

TO RETURN TO A PREVIOUS MENU

PRESS [★] [#]

TO EXIT PROGRAMMING

PRESS [★] [★] [9]

Automated Attendant

REFER to Forms 3, 3A, 3B, 4, 4A, 5, and 5A
 PRESS [3] to program Automated
 Attendant Service

Automated Attendant

REFER to Forms 3, 3A, 3B, 4, 4A, 5, and 5A
 PRESS [3] to program Automated
 Attendant Service

Automated Attendant

REFER to Forms 3, 3A, 3B, 4, 4A, 5, and 5A
 PRESS [3] to program Automated
 Attendant Service

TO MODIFY THE MENU DEFINITION AND DAY MENU PROMPT— BILINGUAL MODE

PRESS [1] for Day Menu
 PRESS [6] to modify
 ENTER a Selector Code [1] through [9]
 PRESS [9] to modify
 PRESS [1] for Selector Code Transfer
 ENTER an extension, Hunt Group, or
 Calling Group number and [#]
 To program another Selector Code for
 Selector Code Transfer, repeat
 PRESS [★] [#] to approve
 PRESS [1] to record the Day Menu
 Prompt in the Primary
 Language
 PRESS [1] after recording
 PRESS [★] [#] to approve
 PRESS [2] to record the Day Menu
 Prompt in the Secondary
 Language
 PRESS [1] after recording
 PRESS [★] [#] to approve
 PRESS [#] to approve all changes

V5

TO MODIFY ANNOUNCEMENT— BILINGUAL MODE

PRESS [1] for Day Menu
 PRESS [6] to modify
 ENTER a Selector Code 1 through 9
 PRESS [9] to confirm
 PRESS [3] to play the Announcement
 recorded for the Selector Code
 ENTER an Announcement number
 PRESS [1] to record the Announcement
 in the Primary Language
 PRESS [1] after recording
 PRESS [★] [#] to approve
 PRESS [2] to record the Announcement
 in the Secondary Language
 PRESS [1] after recording
 PRESS [★] [#] to approve
 PRESS [★] [#] to move up a menu level
 PRESS [★] [#] to move up another menu
 level
 PRESS [#] to approve all changes

V11

TO CHANGE SELECTOR CODE TRANSFER TO DIRECT EXTENSION TRANSFER—BILINGUAL MODE

PRESS [1] for Day Menu
 PRESS [6] to modify
 ENTER a Selector Code 1 through 9
 PRESS [9] to modify
 PRESS [5] for Direct Extension Transfer
 To program another Selector Code for
 Direct Extension Transfer,
 repeat
 PRESS [★] [#] to approve
 PRESS [1] to record the Day Menu
 Prompt in the Primary Language
 PRESS [1] after recording
 PRESS [★] [#] to approve
 PRESS [2] to record the Day Menu
 Prompt in the Secondary
 Language
 PRESS [1] after recording
 PRESS [★] [#] to approve
 PRESS [#] to approve all changes

V13

TO CHANGE SELECTOR CODE TRANSFER TO ANNOUNCEMENT— BILINGUAL MODE

PRESS [1] for Day Menu
 PRESS [6] to modify
 ENTER a Selector Code 1 through 9
 PRESS [9] to modify
 PRESS [3] for Announcement
 ENTER an Announcement number
 PRESS [1] to record the Announcement
 in the Primary Language
 PRESS [1] after recording
 PRESS [★] [#] to approve
 PRESS [2] to record the Announcement
 in the Secondary Language
 PRESS [1] after recording
 PRESS [★] [#] to approve the
 Announcements
 PRESS [★] [#] to continue without
 programming another Selector
 Code, or
 PRESS [★] [#] to program another
 Selector Code, repeat
 PRESS [1] to record the Day Menu
 Prompt in the Primary Language
 PRESS [1] after recording
 PRESS [★] [#] to approve
 PRESS [2] to record the Day Menu
 Prompt in the Secondary
 Language
 PRESS [1] after recording
 PRESS [★] [#] to approve
 PRESS [#] to approve all changes

V15

TO PLAY THE MENU DEFINITION— MONOLINGUAL MODE

PRESS [1] for Day Menu
 PRESS [2] for playback of the
 Day Menu definition
 PRESS [2] for playback of the Selector
 Codes
 PRESS [1] to play the recorded
 Announcement assigned to the
 Selector Code, or
 PRESS [#] to skip

V6

PARTNER MAIL VS® System Programming Reference

To Program The PARTNER MAIL VS System

TO START PROGRAMMING

PRESS [*Intercom*] [7] [7] [7]
PRESS [9] [9] and [#]
ENTER your Password
(factory setting is 1234) and [#]
PRESS [9] to access the Programming
Main Menu

TO REPLAY A MENU

PRESS [★] [4]

TO RETURN TO THE PROGRAMMING MAIN MENU

PRESS [★] [7]

TO RETURN TO A PREVIOUS MENU

PRESS [★] [#]

TO EXIT PROGRAMMING

PRESS [★] [★] [9]

Automated Attendant

REFER to Forms 3, 3A, 3B, 4, 4A, 5 and 5A
PRESS [3] to program Automated
Attendant Service

Mailboxes

REFER to Form 2
PRESS [4] to program Mailboxes

Line Ownership

REFER to Form 6
PRESS [6] to program Line Ownership

TO PLAY THE MENU DEFINITION— BILINGUAL MODE

PRESS [1] for Day Menu
PRESS [2] for playback of the
Day Menu definition
PRESS [2] for playback of the Selector
Codes
PRESS [1] to play the Primary Language
Announcement assigned to the
Selector Code, or
PRESS [2] to play the Secondary
Language Announcement
assigned to the Selector Code,
or
PRESS [#] to skip

V 7

TO PLAY A MAILBOX'S STATUS

ENTER a mailbox number and [#], or
PRESS [#] for the first mailbox
PRESS [#] to play the next existing
mailbox's status

V16

TO DELETE A MAILBOX

ENTER a mailbox number and [#]
PRESS [★] [3] to delete the mailbox
PRESS [9] to confirm

V17

TO CREATE A MAILBOX

ENTER the new mailbox number and [#]
PRESS [4] to create the new mailbox

V18

TO SCAN LINE OWNERSHIP

PRESS [2] to scan
ENTER the line number and [#], or
PRESS [#] to scan the first line
number that has an owner
LISTEN to the line owner's name and
mailbox number
PRESS [#] to scan the next line

V23

TO ASSIGN LINE OWNERSHIP

PRESS [4] to assign
ENTER the line number and [#]
ENTER the mailbox number and [#]

V24

TO MODIFY THE NIGHT MENU PROMPT—MONOLINGUAL MODE

PRESS [2] for Night Menu
PRESS [6] to modify
PRESS [1] to record the Night Menu
Prompt
PRESS [1] after recording
PRESS [★] [#] to approve

V 8

TO REINITIALIZE A PASSWORD

ENTER a mailbox number and [#]
PRESS [3] to reset the password to 1234

V19

TO MODIFY LINE OWNERSHIP

PRESS [6] to modify
ENTER the line number and [#]
ENTER the new owner's mailbox
number and [#]

V25

TO MODIFY THE NIGHT MENU PROMPT—BILINGUAL MODE

PRESS [2] for Night Menu
PRESS [6] to modify
PRESS [1] to record the Night Menu
Prompt in the Primary Language
PRESS [1] after recording
PRESS [★] [#] to approve
PRESS [2] to record the Night Menu Prompt
in the Secondary Language
PRESS [1] after recording
PRESS [★] [#] to approve
PRESS [#] to approve all changes

V9

TO REINITIALIZE A MAILBOX

ENTER the mailbox number and [#]
PRESS [4] to reinitialize the mailbox
PRESS [9] to confirm

V20

TO DELETE LINE OWNERSHIP

PRESS [★] [3] to delete
ENTER the line number and [#]
PRESS [9] to confirm

V26

TO MODIFY A MAILBOX'S LANGUAGE

ENTER the mailbox number and [#]
PRESS [6] to program Language
PRESS [6] to modify
ENTER the number of the desired
language
PRESS [9] to confirm

V21

TO ASSIGN/REMOVE OUTCALLING FOR A MAILBOX

ENTER the mailbox number and [#]
PRESS [5] to administer Outcalling
PRESS [9] to assign Outcalling, or
PRESS [6] to remove Outcalling
To assign/remove Outcalling for another
mailbox, repeat

V22

PARTNER MAIL VS® System Programming Reference

To Program the Communications System for PARTNER MAIL VS

Place the Programming Overlay on the dial pad of the system display phone at extension 10*

TO START SYSTEM PROGRAMMING

PRESS [Feature] [0] [0]

PRESS [System Program]

PRESS [System Program]

ENTER System Password if required

TO END SYSTEM PROGRAMMING

PRESS [Feature] [0] [0]

TO USE A SPECIFIC PROCEDURE

DIAL [#] and three-digit procedure code

Example: [#] [5] [0] [5] for Hunt Group Extensions

TO CYCLE THROUGH SYSTEM PROGRAMMING PROCEDURES

PRESS [Next Procedure] or [Prev Procedure]

TO CYCLE THROUGH AVAILABLE SETTINGS

PRESS [Next Data] or [Prev Data]

TO RETURN TO FACTORY SETTINGS

PRESS [Remove]

HUNT GROUP EXTENSIONS

DIAL **#505**

PRESS [Z] for the VMS Hunt Group

DIAL the extension number

DIAL 1 = Assigned to group

2 = Not assigned to group ✓

PRESS [Next Item] to program the next extension

C1

GROUP CALL DISTRIBUTION

DIAL **#206****

PRESS [Z] for the VMS Hunt Group

DIAL a line number

DIAL 1 = Assigned

2 = Not Assigned

3 = VMS Line Cover ✓

PRESS [Next Item] to program another line

C3

AUTOMATIC VMS COVER

DIAL **#310**

DIAL an extension number

DIAL 1 = Assigned

2 = Not Assigned ✓

PRESS [Next Item] to program another extension

C7

TRANSFER RETURN EXTENSION

DIAL **#306**†

DIAL the extension number

DIAL 10 (the receptionist's extension)

PRESS [Next Item] to program the next extension

C2

LINE COVERAGE EXTENSION

DIAL **#208****

DIAL a line number

DIAL an extension number

PRESS [Next Item] to program another line

PRESS [Remove] to unassign ownership

C4

VMS COVER RINGS

DIAL **#117****

DIAL one digit (1-9) for the number of rings before the call is sent to the voice messaging system

✓ = 3 rings

C8

VMS HUNT DELAY

DIAL **#506**

DIAL 1 = Immediate ✓

2 = Delayed

C5

NIGHT SERVICE BUTTON

DIAL **#503**

DIAL 1 = Assigned

2 = Not Assigned ✓

3 = Select button** then PRESS a programmable button (to assign Night Service to that button)

If you use option 3 after a Night Service button has been assigned, the Night Service button moves from the old button to the new button you select.

C9

VMS HUNT SCHEDULE

DIAL **#507**

DIAL 1 = Always ✓

2 = Day Only

3 = Night Only

C6

AUTOMATIC EXTENSION PRIVACY

DIAL **#304**

DIAL the extension number

DIAL 1 = Assigned

2 = Not Assigned ✓

PRESS [Next Item] to program another extension

C10

✓ = Factory Setting

 = Button with Lights Required

* Some systems allow programming from extension 11. Check the *Programming and Use* guide for the communications system.

† In some countries, the procedure code for Transfer Return Extension is #309. Check the *Programming and Use* guide for the communications system.

†† In some countries, the procedure code for Group Call Distribution is #205. Check the *Programming and Use* guide for the communications system.

** Line Coverage Extension (#208), VMS Cover Rings (#117), and option 3 of the Night Service Button (#503) procedure may not be available on your system. Check the *Programming and Use* guide for the communications system.

PARTNER MAIL VS® System Programming Reference

To Program the Communications System for PARTNER MAIL VS

Place the Programming Overlay on the dial pad of the system display phone at extension 10*

TO START CENTRALIZED TELEPHONE PROGRAMMING

PRESS [Feature] [0] [0]

PRESS [System Program] [System Program]

PRESS [Central Tel Program]

DIAL the extension number to be programmed

Buttons on which lines are assigned for the extension light up to show the current Line Ringing setting; remaining buttons can be programmed with Auto Dial numbers or features.

TO PROGRAM ANOTHER FEATURE AT THE SAME EXTENSION

After you program one feature, continue with the instructions in the box for the next feature.

TO CHANGE SETTINGS FOR ANOTHER EXTENSION

PRESS [Central Tel Program]

DIAL the new extension's number

TO ERASE A FEATURE OR AUTO DIAL BUTTON

PRESS the programmed button

PRESS [Mic]

TO END CENTRALIZED TELEPHONE PROGRAMMING

PRESS [Feature] [0] [0]

VMS COVER

PRESS a programmable button with lights

PRESS [Feature] [1] [5][†]

C11

VOICE MAILBOX TRANSFER

PRESS a programmable button

PRESS [Feature] [1] [4]^{††}

C13

VOICE MAIL MESSAGES AUTO DIAL BUTTON

PRESS a programmable button

PRESS left [Intercom]

DIAL [Z][Z][Z]

C14

DO NOT DISTURB

PRESS a programmable button with lights

PRESS [Feature] [0] [1]

C12

 = Button with Lights Required

* Some systems allow programming from extension 11. Check the *Programming and Use* guide for the communications system.

† In some countries, the procedure code for Transfer Return Extension is #309. Check the *Programming and Use* guide for the communications system.

†† In some countries, the procedure code for Group Call Distribution is #205. Check the *Programming and Use* guide for the communications system.