

## System Speed dial Numbers

Use the boxes below to record the system's Speed Dial numbers, which are programmed only at extension 10.

To dial: Press **[Feature]** followed by Dial Code.

DIAL CODE	NAME	TELEPHONE NUMBER
20		
21		
22		
23		
24		
25		
26		
27		
28		
29		

Note: An MLS-12 phone can also have up to 8 outside phone numbers for one-touch dialing –see p.3.

## System Extension Numbers

Use the boxes below to record the extension number assignments in your system.

To dial: Press **[Intercom]** followed by the extension number.

Example: to call extension 11, press **[Intercom]** **[1]** **[1]**

EXT.	NAME	EXT.	NAME
10		16	
11		17	
12		18	
13		19	
14		20	
15		21	

999-506-144 Comcode 106 431 323 Copyright © AT&T 1990

 **PARTNER™ Communications System**  
Quick Reference for Use with MLS-6™ and MLS-12™ Telephones

# Telephone Buttons and Indicators

## Help!

If you have problems with your phone, see "Troubleshooting" in the Installation and Use Manual, or call our toll-free Helpline: **1 800 628-2888**

## Hint for MLS-12 users:

For continuous hands-free operation, leave the [Mic] on all the time. then press [Spkr] to make and receive calls.

## Calling Feature Buttons

[MLS-12 only]

These four buttons, from left to right, are pressed to use the following features: **Privacy**, **Last Number Redial**, **Recall**, and **Conference Drop**. See p. 5.

## Line Buttons

Press to make or answer outside calls. Green and red lights next to each button show what is happening on the line. See "Lights," p. 4.

## Intercom Buttons

Press either button to make or answer an inside (intercom) call to another extension.

## Feature Button

Press to dial Speed Dial numbers (p. 1), store Auto Dial numbers (p. 4), and, on all MLS-phones use calling features (p. 5).

## Conf (Conference) Button

Press to add other parties to your call (p. 6).

## Transfer Button

Press to transfer a call to another extension (p. 6).

## Hold Button

Press to put a call on hold (p. 6).

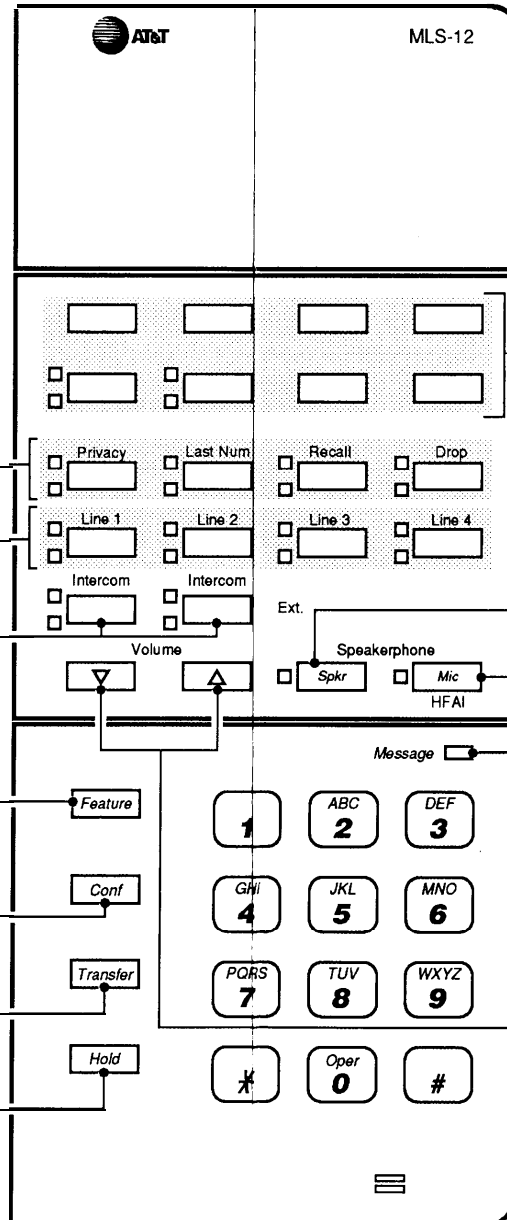

## Auto Dial Buttons (2 with lights)

[MLS-12 only]

Stores Auto Dial numbers for dialing with one touch. See p. 4.

## Spkr (Speaker) Button

Press to dial without lifting handset. With [Spkr] on, the green light appears and you can hear what is being transmitted from the other end. When the party answers, lift the handset to talk (or press [Mic] if you have an MLS-12).

## Mic (Microphone) Button

[MLS-12 only]

Press to talk without lifting the handset. With [Mic] on, the green light appears and the person on the other end can hear you.

## Message Indicator

Flashes to show settings while programming.

## Volume Control Buttons

Press to decrease (▼) or increase (▲) the volume of the ringer, speaker, and handset.

- To adjust ringer volume, while phone is idle and handset is on the phone, press ▼ or ▲.
- To adjust speaker volume, press ▼ or ▲ while listening through the speaker.
- To adjust handset earpiece volume, while listening on a call, lift the handset and press ▼ or ▲.

## Ringing Patterns

You can tell the type of call coming in by the way the phone rings:

**Ring...Ring...Ring...Ring...Ring...Ring...** Outside Call

**Ring-BEEP...Ring-BEEP...Ring-BEEP...** Inside Call

**Ring-BEEP-BEEP...Ring-BEEP-BEEP...** Transferred Call

## Lights

Red (top) light shows what is happening on the line at ANOTHER extension.

Green (bottom) light shows what is happening on the line at YOUR extension.

 Steady on: Line is busy.

 Off (off continuously): Line is idle, available for use.

 Flash (long on, long off): Call is ringing on the line.

 Alternating Red/Green Flash: Appears at both extensions in a conference or joined call.

 Wink (long on, short off): Call is on hold (anyone with line can pick up).

 Flutter (short on, short off): Conference call is on hold.

## Storing an Auto Dial Number

MLS-12 ONLY

To store an outside number for one-touch dialing:

1. Press [Feature] [0] [0] .
2. Press the Auto Dial button to which you want the number assigned (see diagram of telephone).
3. Dial the telephone number (maximum 20 digits, which can include special functions – see box below).

To store more numbers, repeat steps 2 and 3.

4. Press [Feature] [0] [0] when you are finished.

To dial: Press the Auto Dial button on which the number is stored.

### Adding Special Functions to a Dial Sequence

To insert a...	Press...
Pause (1.5 seconds)	Hold
Recall	Spkr
Stop	Mic
Touch-Tone Enable	Transfer

## Answering a Call

[Line] or  
[Intercom]

1. Press the flashing [Line] or [Intercom] button.
2. Lift the handset.

If you lift the handset without pressing a line button, you will be connected to the line ringing longest.

## Joining a Call

**To connect yourself to an outside call being conducted at another extension:**

1. Press the [Line] button (steady red light).
2. Lift the handset.

You cannot:

- Join an intercom (inside) call
- Join a conference call
- Join a call when the other extension has Privacy on.

## Using Calling Features

To use these features on an MLS-12 phone, press the Calling Feature button. To use on MLS-6, press [Feature] plus 2-digit code.

Feature	How to Use with MLS-6	How to Use with MLS-12	Description
Privacy	Not Available	Press [Privacy] Press again to turn off	Prevents other people with the same line from joining your calls. A steady green light shows Privacy is on.
Last Number Redial	Press [Feature] [0] [5]	Press [Last Num]	Redials the last outside number you dialed. Useful for redialing a busy number.
Recall	Press [Feature] [0] [3]	Press [Recall]	"Recalls" a dial tone. If you are not on a PBX or Centrex, use Recall to end a call without hanging up—you will get a dial tone and can then make another call. Otherwise, use Recall to get the PBX/Centrex dial tone.
Conference Drop	Press [Feature] [0] [6]	Press [Drop]	Drops the last party added to a conference call.

## Making a Call

### To call an outside party:

Outside:  
[Line] +  
Telephone Number

1. Press an idle (not lit) outside [Line] button.
2. Lift handset.
3. Dial telephone number.

### To call an inside party [another extension]:

Inside – Ringing:  
[Intercom] +  
Ext. Number

1. Press an idle (not lit) [Intercom] button.
2. Lift handset.
3. To ring the extension, dial 2-digit extension number, *or*

Inside – Voice-Signalled:  
[Intercom] + [\*] +  
Ext. Number

To voice signal another MLS phone, so your voice is heard through the speaker, dial [\*] plus the extension.

If you lift the handset without pressing a button, you will be connected to the first idle line or intercom programmed for your extension.

## Making a Conference Call

### To add parties to a call (max. 2 parties plus you):

Telephone or Ext. Number +  
[Conf] +  
Telephone or Ext. Number +  
[Conf]

1. Call the first party (can use Speed Dial or Auto Dial buttons).
2. After the first party answers, press [Conf] .
3. Press an idle [Line] or [Intercom] button, then call the second party.
4. After the second party answers, press [Conf] again. You are connected with both parties. If no one answers or the call is refused, to reconnect the first party, press the line button next to the winking green light.

To Drop:  
[Drop] (MLS-12)  
[Feature] [0] [6] (MLS-6)

### To drop the last party added to the call:

MLS-12 phone → Press [Drop]

MLS-6 phone → Press [Feature] [0] [6]

**You cannot transfer or join a conference call.**

## Putting a Call on Hold

### To put an outside or intercom call on hold:

To Hold:  
[Hold]

1. Press [Hold] .

### To pickup a held call:

To Pick Up:  
[Line]

1. Press the held line button.
2. Lift handset.

## Transferring a Call

### To pass a call to another extension:

[Transfer] +  
Ext. Number

1. Press [Transfer] .
2. Dial the extension to which you want the call transferred.
3. When someone answers, announce the call, then hang up.

If no one answers or the call is refused, to reconnect the caller, press the line button next to the winking green light.