

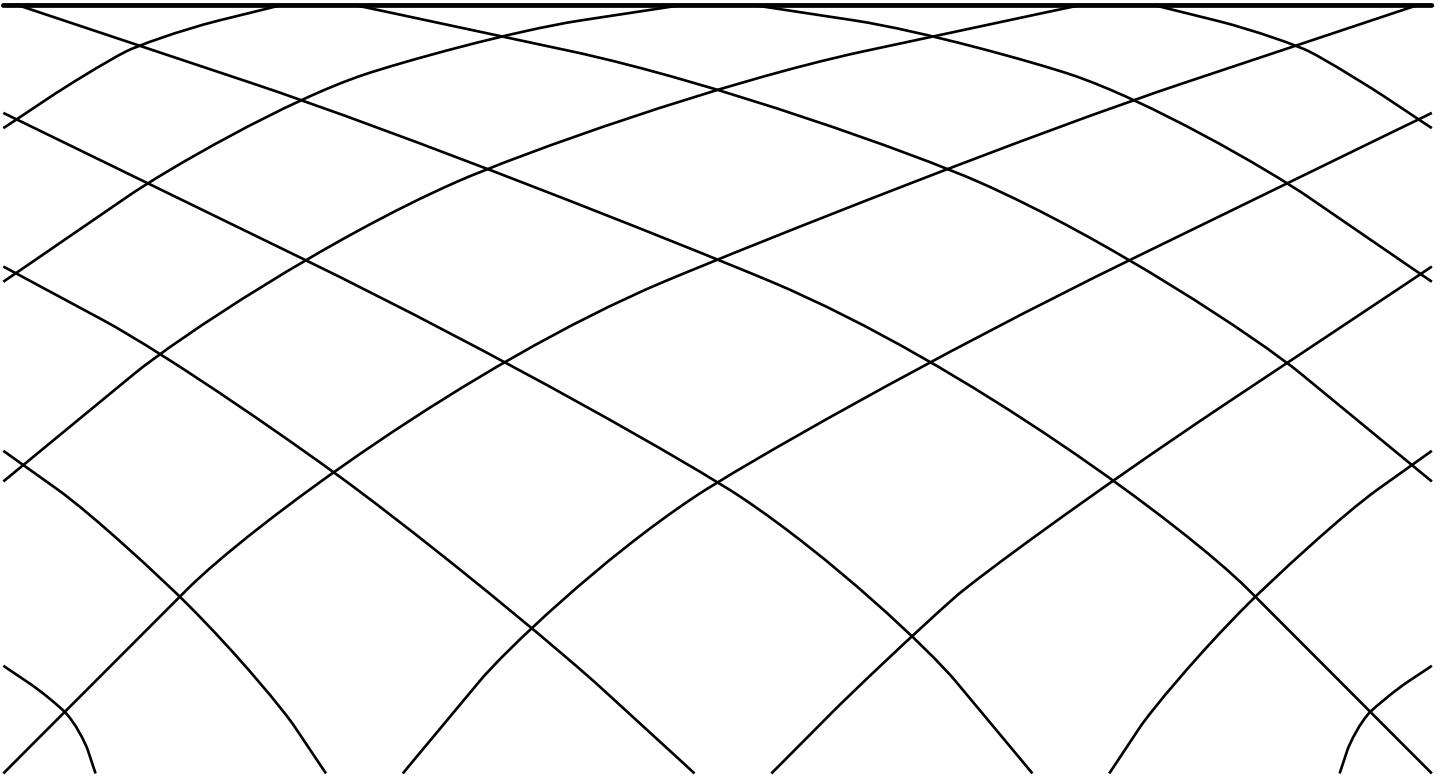

DEFINITY® Communications System and System 75 and System 85

Terminals and Adjuncts
Reference Manual



©1994 AT&T
All Rights Reserved
Printed in USA

Notice

While reasonable effort was made to ensure that the information in this document was complete and accurate at the time of printing, AT&T cannot assume responsibility for any errors. Changes and/or corrections to the information contained in this document may be incorporated into future issues.

ORDERING INFORMATION

Call: AT&T GBCS Publications Fulfillment Center
1 800 457-1235
Outside U.S.: 1 317 361-5353

Write: AT&T GBCS Publications Fulfillment Center
P.O. Box 4100
Crawfordsville, IN 47933

Order: Document No. AT&T 555-015-201
Issue 7, November 1994

Published by
AT&T GBCS Documentation Development Group
AT&T Bell Laboratories
Middletown, NJ 07748-0076

Contents

INTRODUCTION	1-1
Purpose	1-1
Organization	1-3
GENERAL INFORMATION	2-1
Voice Terminals	2-1
Facilities Common to All Voice Terminals.....	2-4
Adjuncts	2-11
EXPOSED PORT PROTECTION	2-21
Requirements	2-21
AVAILABILITY	2-25
ADJUNCT POWER	2-31
Information on the Older Power Supplies	2-33
The MSP-1 Power Supply	2-35
ADMINISTRATION	2-39
Aliasing	2-39
Button and Feature Caveats	2-49
VOICE TERMINAL FEATURES	3-1
7101A Voice Terminal	3-17
Applications	3-17
Physical Description	3-17
Distance Limitations	3-19
Power Requirements	3-19
Power Failure Operation	3-19
FCC Registration	3-19
Hearing Aid Compatible	3-20

7101A Equipment Price Element Code (PECs)	3-21
Adjuncts	3-21
Additional Documents	3-21
7102A and 7102 Plus Voice Terminals	3-25
Applications	3-25
Physical Description	3-25
Distance Limitations	3-28
Power Requirements	3-28
Power Failure Operation	3-28
FCC Registration	3-29
Hearing Aid Compatible	3-29
7102 Equipment Price Element Code (PECs)	3-29
Adjuncts	3-29
Additional Documents	3-29
7103A Fixed Feature Voice Terminal	3-33
Applications	3-33
Physical Description	3-33
Distance Limitations	3-35
Power Requirements	3-35
Power Failure Operation	3-35
FCC Registration	3-36
Hearing Aid Compatible	3-36
7103A (Fixed Feature) Equipment Price Element Code (PECs)	3-37
Adjuncts	3-37
Additional Documents	3-37
7103A Programmable Voice Terminal	3-41
Applications	3-41
Physical Description	3-41
Distance Limitations	3-43
Power Requirements	3-43

Power Failure Operation	3-44
FCC Registration	3-44
Hearing Aid Compatible	3-45
7103A (Programmable) Equipment Price Element Code (PECs)	3-45
Adjuncts	3-45
Additional Documents	3-45
7104A Voice Terminal	3-49
Applications	3-49
Physical Description	3-49
Distance Limitations	3-52
Power Requirements	3-52
Power Failure Operation	3-52
FCC Registration	3-52
Hearing Aid Compatible	3-52
7104 Equipment Price Element Code (PECs)	3-53
Adjuncts	3-53
Additional Documents	3-53
7203H Voice Terminal	3-57
Applications	3-57
Physical Description	3-57
Distance Limitations	3-59
Power Requirements	3-59
Power Failure Operation	3-59
FCC Registration	3-60
Hearing Aid Compatible	3-60
7203H Equipment Price Element Code (PECs)	3-61
Adjuncts	3-61
Additional Documents	3-61
7205H Voice Terminal	3-65
Applications	3-65

Physical Description	3-65
Distance Limitations	3-67
Power Requirements	3-67
Power Failure Operation	3-68
FCC Registration	3-68
Hearing Aid Compatible	3-68
7205H Equipment Price Element Code (PECs)	3-68
Adjuncts	3-68
Additional Documents	3-69
7303S Voice Terminal	3-73
Applications	3-73
Physical Description	3-73
Distance Limitations	3-75
Power Requirements	3-76
Power Failure Operation	3-76
FCC Registration	3-76
Hearing Aid Compatible	3-76
7303S Equipment Price Element Code (PECs)	3-76
Adjuncts	3-77
Additional Documents	3-77
7305S Voice Terminal	3-81
Applications	3-81
Physical Description	3-81
Distance Limitations	3-83
Power Requirements	3-84
Power Failure Operation	3-84
FCC Registration	3-84
Hearing Aid Compatible	3-85
7305S Equipment Price Element Code (PECs)	3-85
Adjuncts	3-85

Additional Documents	3-86
7401D and 7401 Plus Voice Terminals	3-91
Applications	3-91
Special Operational Characteristics	3-91
Physical Features	3-92
Distance Limitations	3-94
Power Requirements	3-95
Switch Administration	3-96
Power Failure Operation	3-100
FCC Registration	3-100
UL and CSA Approval	3-100
Hearing Aid Compatible	3-100
7401D Equipment PECs & COMCODES	3-100
7401 Plus Equipment with PECs and COMCODES	3-101
Adjuncts	3-103
Additional Documents	3-104
7402 Plus Voice Terminal	3-107
Applications	3-107
Physical Features	3-107
Distance Limitations	3-111
Power Requirements	3-111
Switch Administration	3-112
Power Failure Operation	3-115
FCC Registration	3-115
UL and CSA Approval	3-115
Hearing Aid Compatible	3-115
7402 Plus Equipment PECs and COMCODES	3-115
Adjuncts	3-116
Additional Documents	3-117

7403D Voice Terminal	3-121
Applications	3-121
Physical Description	3-121
Distance Limitations	3-123
Power Requirements	3-123
Power Failure Operation	3-124
FCC Registration	3-124
Hearing Aid Compatible	3-125
7403D Equipment Price Element Code (PECs)	3-125
Adjuncts	3-125
Additional Documents	3-125
 7404D Voice Terminal	 3-129
Applications	3-129
Physical Description	3-129
Distance Limitations	3-131
Power Requirements	3-132
Power Failure Operation	3-132
FCC Registration	3-132
Hearing Aid Compatible	3-132
7404D Equipment Price Element Code (PECs)	3-132
Adjuncts	3-133
Additional Documents	3-133
 7405D Voice Terminal	 3-137
Applications	3-137
Physical Description	3-137
Distance Limitations	3-139
Power Requirements	3-140
Power Failure Operation	3-140
FCC Registration	3-140
Hearing Aid Compatible	3-140

7405D Equipment Price Element Code (PECs)	3-141
Adjuncts	3-141
Additional Documents	3-142
7406D, 7406BIS, and 7406 Plus Voice Terminals	3-147
Applications	3-148
Physical Features	3-148
Distance Limitations	3-155
Power Requirements	3-155
Switch Administration	3-156
Power Failure Operation	3-162
FCC Registration	3-162
UL and CSA Approval	3-162
Hearing Aid Compatibility	3-162
7406D/7406BIS Equipment PECs & COMCODES	3-162
7406 Plus Equipment PECs and COMCODES	3-165
Adjuncts	3-166
Additional Documents	3-166
7407D, Enhanced 7407D, and 7407 Plus Voice Terminals	3-173
Applications	3-174
Special Operational Characteristics	3-174
Physical Features	3-177
Distance Limitations	3-184
Power Requirements	3-184
Switch Administration	3-185
Power Failure Operation	3-192
FCC Registration	3-192
UL and CSA Approval	3-192
Hearing Aid Compatible	3-192
7407D/Enhanced 7407D Equipment PECs & COMCODES	3-192
7407 Plus Equipment PECs and COMCODES	3-193

Adjuncts	3-194
Additional Documents	3-195
7410D and 7410 Plus Voice Terminals	3-199
Applications	3-199
Physical Features	3-199
Distance Limitations	3-202
Power Requirements	3-203
Switch Administration	3-204
Power Failure Operation	3-209
FCC Registration	3-209
UL and CSA Approval	3-209
Hearing Aid Compatible	3-209
7410D Equipment with PECs and COMCODES	3-209
7410 Plus Equipment PECs and COMCODES	3-210
Adjuncts	3-211
Additional Documents	3-212
7434D Voice Terminal	3-215
Applications	3-215
Physical Description	3-215
Distance Limitations	3-218
Power Requirements	3-219
Power Failure Operation	3-219
FCC Registration	3-219
Hearing Aid Compatible	3-219
7434 Equipment Price Element Codes (PECs)	3-219
Adjuncts	3-220
Additional Documents	3-220
7444 Voice Terminal	3-223
Applications	3-223
Physical Description	3-223

Distance Limitations	3-227
Power Requirements	3-228
Switch Administration	3-229
Power Failure Operation	3-233
FCC Registration	3-233
UL and CSA Approval	3-233
Hearing Aid Compatible	3-233
7444 Equipment PECs and COMCODES	3-233
Adjuncts	3-234
Additional Documents	3-235
8403 Voice Terminal	3-239
Applications	3-239
Physical Features	3-239
Wiring Information.....	3-243
Distance Limitations	3-245
Power Requirements	3-246
Switch Administration	3-246
Power Failure Operation	3-250
FCC Registration	3-250
UL and CSA Approval	3-250
Hearing Aid Compatible	3-250
8403 Equipment PECs & COMCODES	3-250
Adjuncts	3-251
Additional Documents	3-252
8410 Voice Terminal	3-255
Applications	3-255
Physical Features	3-255
Wiring Information.....	3-263
Distance Limitations	3-265
Power Requirements	3-265

Switch Administration	3-266
Power Failure Operation	3-270
FCC Registration	3-270
UL and CSA Approval	3-270
Hearing Aid Compatible	3-270
8410 Equipment PECs & COMCODES	3-270
Adjuncts	3-272
Additional Documents	3-272
8434 and 8434DX Voice Terminal	3-277
Applications	3-278
Physical Description	3-279
Wiring Information.....	3-286
Distance Limitations	3-287
Power Requirements	3-288
Switch Administration	3-289
Power Failure Operation	3-293
FCC Registration	3-293
UL and CSA Approval	3-293
Hearing Aid Compatible	3-293
8434 and 8434DX Equipment PECs and COMCODES	3-293
Adjuncts	3-295
Additional Documents	3-295
CALLMASTER® and CALLMASTER® II and III Voice Terminals	3-301
Applications	3-302
Special Operational Characteristics	3-302
Physical Description	3-303
Distance Limitations	3-307
Power Requirements	3-307
Switch Administration	3-307
Power Failure Operation	3-312

FCC Registration	3-312
CALLMASTER Equipment Price Element Code (PECs)	3-312
Adjuncts	3-313
Additional Documents	3-313
500 Series Telephone	3-317
Applications	3-317
Physical Description	3-317
Distance Limitations	3-319
Power Requirements	3-319
Power Failure Operation	3-320
FCC Registration	3-320
500 Series Equipment Price Element Code (PECs)	3-320
Adjuncts	3-320
Additional Documents	3-320
2500 Series Telephones	3-323
Applications	3-323
Physical Description	3-323
Distance Limitations	3-325
Power Requirements	3-325
Power Failure Operation	3-325
FCC Registration	3-325
Price Element Code (PECs)	3-326
Adjuncts	3-326
2500 DMGC Telephone.....	3-329
Applications	3-329
Physical Description	3-329
Distance Limitations	3-331
Power Requirements	3-331
Power Failure Operation	3-331
FCC Registration	3-331

2500 DMGC Equipment Price Element Code (PECs)	3-332
Adjuncts	3-332
Additional Documents	3-332
2500 YMGK Telephone	3-335
Applications	3-335
Physical Description	3-335
Distance Limitations	3-337
Power Requirements	3-337
Power Failure Operation	3-337
FCC Registration	3-337
2500 YMGK Equipment Price Element Code (PECs)	3-338
Adjuncts	3-338
Additional Documents	3-338
2500 MMGL and 2500 YMGL Telephones	3-341
Applications	3-341
Physical Description	3-341
Distance Limitations	3-344
Power Requirements	3-344
Switch Administration	3-344
Power Failure Operation	3-344
FCC Registration	3-345
UL and CSA Approval	3-345
Hearing Aid Compatible	3-345
2500 MMGL and 2500 YMGL Equipment Price Element Codes (PECs)	3-345
8101 Telephone	3-349
Applications	3-349
Physical Description	3-349
Other Physical Features	3-350
Distance Limitations	3-352
Power Requirements	3-352

Switch Administration	3-352
Power Failure Operation	3-353
Ringer Equivalency Numbers	3-353
FCC Registration	3-353
Hearing Aid Compatible	3-353
8101 Telephone PECs and COMCODES.....	3-353
Adjuncts	3-354
Additional Documents	3-354
8102 and 8102M Telephones	3-357
Applications	3-357
Physical Description	3-357
Other Physical Features	3-359
Distance Limitations	3-360
Power Requirements	3-360
Switch Administration	3-361
Administration of Hidden Features.....	3-362
Power Failure Operation	3-362
Ringer Equivalency Numbers	3-362
FCC Registration	3-362
Hearing Aid Compatible	3-363
8102 and 8102M Telephones PECs and COMCODES	3-363
Adjuncts	3-364
Additional Documents	3-365
8110 and 8110M Telephones	3-369
Applications	3-369
Physical Description	3-369
Distance Limitations	3-373
Power Requirements	3-374
Switch Administration	3-375
Administration of Hidden Features.....	3-375

Power Failure Operation	3-375
Ringer Equivalency Numbers	3-375
FCC Registration	3-376
Hearing Aid Compatible	3-376
8110 and 8110M Telephones Equipment PECs and COMCODES	3-376
Adjuncts	3-378
Additional Documents	3-378
ISDN 7505 Modular Terminal	3-381
Applications	3-381
Physical Description	3-381
Distance Limitations	3-384
Power Requirements	3-384
Terminating Resistor	3-384
Power Failure Operation	3-384
FCC Registration	3-384
Hearing Aid Compatible	3-385
7505 Equipment Price Element Code (PECs)	3-385
Adjuncts	3-386
Additional Documents	3-386
ISDN 7506 Display Terminal	3-389
Applications	3-389
Physical Description	3-389
Distance Limitations	3-393
Power Requirements	3-393
Terminating Resistor	3-393
Power Failure Operation	3-393
FCC Registration	3-393
Hearing Aid Compatible	3-393
7506 Equipment Price Element Code (PECs)	3-394
Adjuncts	3-394

Additional Documents	3-394
ISDN 7507 Display Terminal	3-397
Applications	3-397
Physical Description	3-397
Distance Limitations	3-400
Power Requirements	3-400
Terminating Resistor	3-401
Power Failure Operation	3-401
FCC Registration	3-401
Hearing Aid Compatible	3-401
7507 Equipment Price Element Code (PECs)	3-402
Adjuncts	3-402
Additional Documents	3-402
ISDN 8503T Voice Terminal	3-405
Applications	3-405
Physical Description	3-405
Other Physical Features	3-408
Distance Limitations	3-410
Power Requirements	3-410
Switch Administration	3-411
Power Failure Operation	3-411
FCC Registration	3-411
Hearing Aid Compatible	3-411
8503T Equipment PECs and COMCODES	3-412
Adjuncts	3-412
Additional Documents	3-413
ISDN 8510T Voice/Data Terminal	3-417
Applications	3-417
Physical Description	3-417
Data Features	3-424

Distance Limitations	3-424
Power Requirements	3-425
Switch Administration	3-427
Button Numbering	3-427
The Service Profiler ID (SPID)	3-427
Hidden/Craft Features	3-428
Power Failure Operation	3-428
FCC Registration	3-428
Hearing Aid Compatible	3-428
8510T Equipment PECs and COMCODES	3-429
Adjuncts	3-430
Additional Documents	3-430
ISDN 8520T Voice/Data Terminal	3-433
Applications	3-433
Physical Description	3-433
Data Features	3-438
Distance Limitations	3-439
Power Requirements	3-439
Switch Administration	3-440
Button Numbering	3-440
The Service Profiler ID (SPID)	3-440
Hidden/Craft Features	3-441
Power Failure Operation	3-441
FCC Registration	3-441
Hearing Aid Compatible	3-441
8520T Equipment PECs and COMCODES	3-441
Adjuncts	3-442
Additional Documents	3-443
ISDN 8528T Voice Terminal	3-447
Applications	3-447

Physical Description	3-447
Distance Limitations	3-453
Power Requirements	3-453
Switch Administration	3-453
Button Numbering	3-453
The Service Profiler ID (SPID)	3-454
Power Failure Operation	3-454
FCC Registration	3-454
Hearing Aid Compatible	3-454
8528T Equipment PECs and COMCODES	3-454
Adjuncts	3-455
Additional Documents	3-456
MDC 9000 Cordless Telephone	3-461
Applications	3-461
Physical Features	3-461
Out-of-Range Indication	3-465
Distance and Installation Limitations (for the Charging Base)	3-465
Switch Administration	3-467
FCC Registration	3-468
Hearing Aid Compatibility	3-468
MDC 9000 Equipment PECs & COMCODES	3-469
Additional Documents	3-470
MDW 9000 Wireless Telephone	3-475
Applications	3-475
Physical Features	3-475
Out-of-Range Indication	3-480
Distance and Installation Limitations	3-481
Switch Administration	3-481
FCC Registration	3-483
Hearing Aid Compatibility	3-483

UL and CSA Approval	3-483
MDW 9000 Equipment PECs & COMCODES	3-484
Additional Documents	3-485
Other Voice Terminals	3-487
Voice Terminals Reusable from Other Systems	3-487
Models 7302H, 7303H, 7305H01B, and 7305H02B	3-487
Multi-Button Electronic Telephone (MET) Sets	3-488
ADJUNCTS	4-1
Call Coverage Modules	4-5
Applications	4-5
Physical Description	4-5
Power	4-6
Call Coverage Module PEC Codes	4-6
Considerations	4-6
Digital Display Module	4-9
Applications	4-9
Physical Description	4-9
Power	4-11
Digital Display Module PEC Codes	4-11
Considerations	4-11
Function Key Modules	4-15
Applications	4-15
Physical Description	4-15
Power	4-15
Considerations	4-16
Digital Terminal Data Module PEC Codes	4-16
801A Expansion Module	4-19
Applications	4-19

Physical Description	4-19
Power	4-20
Administering the Expansion Module	4-20
801A Expansion Module PEC Codes	4-21
Additional Documents	4-21
Headset Adapters	4-25
Applications	4-25
Physical Description	4-25
Power	4-26
Considerations	4-26
Headset PEC Codes	4-27
Message Waiting Indicator	4-31
Applications	4-31
Physical Description	4-31
Power	4-31
Message Waiting Indicator PEC Codes	4-32
4A, S101A, and S102A Speakerphones	4-35
Applications	4-35
Physical Description	4-35
Power	4-36
Considerations	4-36
Speakerphone PEC Codes	4-37
S201A and S202A Speakerphones	4-41
Applications	4-41
Physical Description	4-41
Power	4-42
Considerations	4-42
S201A and S202A Speakerphone PEC Codes	4-42

S203A Speakerphone	4-45
Applications	4-45
Physical Description	4-45
Power	4-46
Bridging	4-47
FCC Registration	4-47
S203A Price Element Codes (PECs)	4-47
 Loudspeaker	 4-51
Applications	4-51
Physical Description	4-51
Power	4-51
 Messaging Cartridge	 4-55
Applications	4-55
Considerations	4-55
Messaging Cartridge Price Element Codes (PECs)	4-55
 Automatic Dialer	 4-59
Applications	4-59
Physical Description	4-59
Power	4-60
Automatic Dialer PEC codes	4-60
 DATA MODULES	 5-1
 7400A Data Module	 5-5
Applications	5-5
Physical Description	5-5
Features	5-7
Power	5-7
Considerations	5-8
FCC Registration	5-8

7400A Data Module Price Element Codes (PEC)	5-8
Additional Documents	5-8
7400B and 7400B Plus Data Module	5-11
Applications	5-11
Physical Description	5-12
Features	5-13
Power	5-14
Setting Options	5-14
Notes for Use with PC Packages	5-15
FCC Registration	5-16
7400B Data Module PEC Codes	5-16
Additional Documents	5-16
8400B Plus Data Module	5-19
Applications	5-19
Physical Description	5-21
Features	5-23
Power	5-24
Setting Options	5-24
Notes for Use with PC Packages	5-25
FCC Registration	5-25
8400B Plus Data Module PEC Codes	5-26
Additional Documents	5-26
7500B Data Module	5-29
Applications	5-29
Physical Description	5-29
Features	5-30
Distance Limitations	5-32
Power Requirements	5-32
Terminating Resistor	5-32
FCC Registration	5-32

Additional Documents	5-32
ISDN Asynchronous Data Module (ADM)	5-33
Physical Description	5-33
Features	5-33
Power Requirements	5-33
Price Element Codes (PECs)	5-34
Additional Documents	5-34
Digital Terminal Data Module (DTDM)	5-37
Physical Description	5-37
Features	5-39
Power	5-39
FCC Registration	5-39
DTDM Equipment PEC Codes	5-39
Additional Documents	5-40
Z702AL1 Data Service Unit (DSU)	5-43
Applications	5-43
Features	5-43
Physical Description	5-44
Power	5-44
Z702AL1 DSU PEC Codes	5-45
Additional Documents	5-45
703A Data Service Unit (DSU)	5-49
Applications	5-49
Features	5-49
Physical Appearance	5-50
Power	5-51
703 DSU Price Element Codes (PECs)	5-51
Additional Documents	5-51

DEFINITY High Speed Link	5-55
Physical Description	5-55
Features	5-57
Applications	5-57
Power	5-60
Considerations	5-60
FCC Registration	5-61
High Speed Link Price Element Codes (PEC)	5-61
Additional Documents	5-61
Processor Data Module (PDM)	5-65
Features	5-65
Physical Description	5-65
Power	5-66
PDM Equipment Price Element Code (PEC)	5-66
Additional Documents	5-66
Trunk Data Module (TDM)	5-69
Features	5-69
Physical Description	5-69
Power	5-70
TDM Equipment Price Element Codes (PEC)	5-70
Additional Documents	5-70
Modular Trunk Data Module (MTDM)	5-73
Features	5-73
Physical Description	5-73
Power	5-74
MTDM Equipment Price Element Codes (PECs)	5-75
Additional Documents	5-75
3270 Data Module	5-79
The 3270A and 3270T	5-81

The 3270C	5-82
3270 Equipment Price Element Codes (PECs)	5-83
Additional Documents	5-83
Asynchronous Data Unit (ADU)	5-87
Features	5-87
Physical Description	5-87
Power	5-88
Z3A Data Module Price Element Codes (PECs)	5-88
Additional Documents	5-89
DCIU Interface Units	5-91
105A Isolating Data Interface (IDI)	5-91
48250 Local Distribution Service Unit	5-91
2500-Series DSU	5-91
2500-Series Data Service Unit (DSU)	5-93
Physical Description	5-93
Features	5-93
Power	5-94
Distance limitations	5-94
2500-Series DSU Price Element Codes (PECs)	5-94
Additional Documents	5-94
PC PLATFORMS (PC/PBX AND PC/ISDN) AND APPLICATION SOFTWARE ...	6-1
PC Platforms (PC/PBX and PC/ISDN)	6-3
Overview	6-3
Platforms	6-3
PC/PBX and PC/PBX MicroChannel Platforms	6-3
PC/ISDN Platform	6-5
Additional Documents	6-6

PC/PBX Connection	6-7
Applications	6-7
Capabilities	6-7
PC/PBX Price Element Codes (PECs)	6-8
Additional Documents	6-8
E78 Plus/ISDN Software	6-9
Applications	6-9
Physical Description	6-9
Capabilities	6-9
E78 Price Element Codes (PECs)	6-10
Additional Documents	6-10
Blank Templates for Model Design	7-1
Index	I-1

Figures

Figure 1-1.	Interface Between System Switch and Typical Terminals/Adjuncts	1-2
Figure 2-1.	Call Appearance/Feature Buttons.....	2-6
Figure 2-2.	Button Lights	2-7
Figure 2-3.	Data Link Components	2-14
Figure 2-4.	Local and Satellite Power Sources for Voice Terminals Adjuncts	2-33
Figure 2-5.	Local Powering Arrangement for: ISDN-T VTs; the DCP 7444 and 8434 VTs (for their VF Displays); and Adjuncts Connected to All Telephones Except the 8102 ...	2-37
Figure 2-6.	Local Powering Arrangement for Adjuncts Connected to the 8102 Analog Telephone.....	2-38
Figure 3-1.	The 7101A Voice Terminal.....	3-15
Figure 3-2.	The 7102A and 7102 Plus Voice Terminal	3-23
Figure 3-3.	The 7103A Fixed Feature Voice Terminal	3-31
Figure 3-4.	The 7103A Programmable Voice Terminal	3-39
Figure 3-5.	The 7203H Voice Terminal	3-55
Figure 3-6.	7205H Voice Terminal	3-63
Figure 3-7.	The 7303S Voice Terminal.....	3-71
Figure 3-8.	The 7305S Voice Terminal.....	3-79
Figure 3-9.	The 7401 Plus (7401D02A) Voice Terminal	3-88
Figure 3-10.	Button Numbering for Administering the 7401D and 7401 Plus Voice Terminals Connected to a System 75 or a DEFINITY G1 or G3 Switch	3-98
Figure 3-11.	Button Numbering for Administering the 7401D and 7401 Plus Voice Terminals Connected to a System 85 or a DEFINITY G2 Switch	3-99
Figure 3-12.	The 7402 Plus Voice Terminal	3-105
Figure 3-13.	Button Numbering for Administering the 7402 Plus Voice Terminal Connected to a System 75 or a DEFINITY G1 or G3 Switch	3-113
Figure 3-14.	Button Numbering for Administering the 7402 Plus Voice Terminal Connected to a System 85 or a DEFINITY G2 Switch	3-114
Figure 3-15.	The 7403D Voice Terminal	3-119
Figure 3-16.	The 7404D Voice Terminal	3-127
Figure 3-17.	The 7405D Voice Terminal	3-135
Figure 3-18.	The 7406D (7406D01A or 7406D03A) Voice Terminal with Display	3-144
Figure 3-19.	The 7406BIS (7406D05A) Voice Terminal with Display	3-145

Figure 3-20.	The 7406 Plus (7406D07A) Voice Terminal with Display	3-146
Figure 3-21.	Button Numbering for Administering the 7406D and 7406BIS Voice Terminals Connected to a System 75 or a DEFINITY G1 or G3 Switch	3-158
Figure 3-22.	Button Numbering for Administering the 7406D and 7406BIS Voice Terminals Connected to a System 85 or a DEFINITY G2 Switch	3-159
Figure 3-23.	Button Numbering for Administering the 7406 Plus Voice Terminal Connected to a System 75 or a DEFINITY G1 or G3 Switch	3-160
Figure 3-24.	Button Numbering for Administering the 7406 Plus Voice Terminal Connected to a System 85 or a DEFINITY G2 Switch	3-160
Figure 3-25.	The 7407D (7407D01B) Voice Terminal	3-169
Figure 3-26.	The Enhanced 7407D (7407D02C) Voice Terminal	3-170
Figure 3-27.	The 7407 Plus (7407D02D) Voice Terminal	3-171
Figure 3-28.	Button Numbering for Administering the 7407D (7407D01B) Voice Terminal Connected to a System 75 or a DEFINITY G1 or G3 Switch	3-186
Figure 3-29.	Button Numbering for Administering the 7407D (7407D01B) Voice Terminal Connected to a System 85 or a DEFINITY G2 Switch	3-187
Figure 3-30.	Button Numbering for Administering the Enhanced 7407D (7407D02C) Voice Terminal Connected to a System 75 or a DEFINITY G1 or G3 Switch	3-188
Figure 3-31.	Button Numbering for Administering the Enhanced 7407D (7407D02C) Voice Terminal Connected to a System 85 or a DEFINITY G2 Switch	3-189
Figure 3-32.	Button Numbering for Administering the 7407 Plus Voice Terminal Connected to a System 75 or a DEFINITY G1 or G3 Switch	3-190
Figure 3-33.	Button Numbering for Administering the 7407 Plus Voice Terminal Connected to a System 85 or a DEFINITY G2 Switch	3-191
Figure 3-34.	The 7410D (7410D01A) Voice Terminal	3-197
Figure 3-35.	The 7410 Plus (7410D02A) Voice Terminal	3-198
Figure 3-36.	Button Numbering for Administering the 7410D Voice Terminal Connected to a System 75 or a DEFINITY G1 or G3 Switch	3-205
Figure 3-37.	Button Numbering for Administering the 7410D Voice Terminal Connected to a System 85 or a DEFINITY G2 Switch	3-206
Figure 3-38.	Button Numbering for Administering the 7410 Plus Voice Terminal Connected to a System 75 or a DEFINITY G1 or G3 Switch	3-207
Figure 3-39.	Button Numbering for Administering the 7410 Plus Voice Terminal Connected to a System 85 or a DEFINITY G2 Switch	3-208
Figure 3-40.	The 7434D Voice Terminal	3-213
Figure 3-41.	The 7444 Voice Terminal	3-221
Figure 3-42.	Button Numbering for Administering the 7444 Voice Terminal Connected to a System 75 or a DEFINITY G1 or G3 Switch	3-231

Figure 3-43.	Button Numbering for Administering the 7444 Voice Terminal Connected to a System 85 or a DEFINITY G2 Switch	3-232
Figure 3-44.	The 8403 Voice Terminal	3-237
Figure 3-45.	Button Numbering for Administering the 8403 Voice Terminal Connected to a System 75 or a DEFINITY G1 or G3 Switch	3-248
Figure 3-46.	Button Numbering for Administering the 8403 Voice Terminal Connected to a System 85 or a DEFINITY G2 Switch	3-249
Figure 3-47.	8410D Voice Terminal (With Display)	3-253
Figure 3-48.	Button Numbering for Administering the 8410 Voice Terminal Connected to a System 75 or a DEFINITY G1 or G3 Switch	3-268
Figure 3-49.	Button Numbering for Administering the 8410 Voice Terminal Connected to a System 85 or a DEFINITY G2 Switch	3-269
Figure 3-50.	8434 Voice Terminal	3-274
Figure 3-51.	8434DX Voice Terminal	3-275
Figure 3-52.	Button Numbering for Administering the 8434 and 8434DX Voice Terminal Connected to a System 75 or a DEFINITY G1 or G3 Switch	3-291
Figure 3-53.	Button Numbering for Administering the 8434 and 8434DX Voice Terminal Connected to a System 85 or a DEFINITY G2 Switch	3-292
Figure 3-54.	The 602 CALLMASTER Voice Terminal with Optional Handset	3-298
Figure 3-2.	The CALLMASTER II and CALLMASTER III Voice Terminal	3-299
Figure 3-3.	Button Numbering for Administering the 602 CALLMASTER Voice Terminal Connected to a System 75 or a DEFINITY G1 or G3 Switch	3-308
Figure 3-4.	Button Numbering for Administering the 602 CALLMASTER Voice Terminal Connected to a System 85 or a DEFINITY G2 Switch	3-309
Figure 3-5.	Button Numbering for Administering the CALLMASTER II or CALLMASTER III Voice Terminal Connected to a System 75 or a DEFINITY G1 or G3 Switch	3-310
Figure 3-6.	Button Numbering for Administering the CALLMASTER II or CALLMASTER III Voice Terminal Connected to a System 85 or a DEFINITY G2 Switch	3-311
Figure 3-7.	The 500 Series Telephone.....	3-315
Figure 3-8.	The 2500 DMGC Telephone	3-327
Figure 3-9.	The 2500 YMGC Telephone	3-333
Figure 3-10.	The 2500 MMGL Telephone	3-339
Figure 3-11.	The 2500 YMGL Telephone	3-340
Figure 3-12.	The 8101 Telephone	3-347
Figure 3-13.	The 8102 and 8102M Telephone (The 8102M is shown here).....	3-355
Figure 3-14.	The 8110 and 8110M Telephones (The 8110M is shown here)	3-367

Figure 3-15.	The 7505 Asynchronous Data Modular Terminal	3-379
Figure 3-16.	The 7506 Asynchronous Data Modular Display Terminal.....	3-387
Figure 3-17.	The 7507 Asynchronous Data Modular Display Terminal.....	3-395
Figure 3-18.	The Desk-mounted ISDN 8503T Voice Terminal	3-403
Figure 3-19.	The ISDN 8510T Voice/Data Terminal.....	3-415
Figure 3-20.	The ISDN 8520T Voice/Data Terminal.....	3-431
Figure 3-21.	The ISDN 8528T Voice Terminal	3-445
Figure 3-22.	MDC 9000 Telephone, Top View of Handset, including Enlarged Display Area ...	3-458
Figure 3-23.	MDC 9000 Telephone, Top View of Charging Base	3-459
Figure 3-24.	Button Numbering for a MDC 9000 Connected to System 75 or DEFINITY Generic 1 or 3	3-467
Figure 3-25.	Button Numbering for a MDC 9000 Connected to System 85 or DEFINITY Generic 2	3-468
Figure 3-26.	MDW 9000 Telephone including Enlarged Display Area	3-472
Figure 3-27.	MDW 9000 Telephone, Top View of Charging Cradle	3-472
Figure 3-28.	MDW 9000 Telephone, Radio Module.....	3-474
Figure 3-29.	Button Numbering for an MDW 9000 Connected to a System 75 or DEFINITY Generic 1 or 3	3-482
Figure 3-30.	Button Numbering for an MDW 9000 Connected to a System 85 or DEFINITY Generic 2	3-482
Figure 4-1.	The C201A Call Coverage Module mounted on a 7434D Voice Terminal	4-3
Figure 4-2.	The D401A Digital Display Module mounted on a 7434D Voice Terminal	4-8
Figure 4-3.	The F201 or F401A Function Key Module mounted on a 7405D Voice Terminal...	4-13
Figure 4-4.	The 801A Expansion Module.....	4-18
Figure 4-2.	Button Numbering for Administering the 801A Expansion Module	4-20
Figure 4-3.	The 500A Headset Adapter	4-23
Figure 4-4.	The Z34A Message Waiting Indicator	4-29
Figure 4-5.	The S101A and S102A Speakerphones	4-34
Figure 4-6.	The S201A and S202A Speakerphones	4-39
Figure 4-7.	The S203 Speakerphone	4-44
Figure 4-8.	The 107-Type Loudspeaker	4-49
Figure 4-9.	The Messaging Cartridge	4-53
Figure 4-10.	The 2870A1 Automatic Dialer	4-57
Figure 5-1.	The 7400A Data Module	5-3

Figure 5-2.	The 7400B Plus Data Module	5-10
Figure 5-2.	Block Diagram of the 7400B Interface	5-12
Figure 5-3.	The 8400B Plus Data Module	5-18
Figure 5-2.	Typical Installation of the U.S. Configuration, including Telephone and Separate Power Supply	5-19
Figure 5-3.	Typical Installation of the International Configuration, including Telephone and Separate Power Supply	5-20
Figure 5-4.	Typical Installation of the U.S. and International Configuration, including Telephone and Closet Power Supply	5-21
Figure 5-5.	The 7500B Data Module	5-28
Figure 5-6.	Digital Terminal Data Module mounted on a 7405D Voice Terminal	5-36
Figure 5-2.	Block Diagram of DTDM Interfaces	5-37
Figure 5-3.	The Optional Z702AL1 Data Service Unit shown with 7407D01B Voice Terminal	5-42
Figure 5-2.	Block Diagram of Z702AL1 Data Service Unit Interfaces	5-43
Figure 5-3.	The 703A Data Service Unit	5-47
Figure 5-2.	Block Diagram of 703A Data Service Unit	5-49
Figure 5-3.	The DEFINITY High Speed Link	5-53
Figure 5-2.	Switched Network Application	5-58
Figure 5-3.	Permanent (Private Line) Applications.....	5-60
Figure 5-4.	The Processor Data Module (stand-alone model)	5-63
Figure 5-5.	The Trunk Data Module (stand-alone model)	5-68
Figure 5-6.	The MTDM, the Stand-alone model	5-72
Figure 5-7.	The 3270A or 3270T Data Module	5-77
Figure 5-2.	3270C Data Module	5-80
Figure 5-3.	The Z3A Asynchronous Data Unit	5-85

Tables

Table 2-A.	Voice Terminals Usable with DEFINITY, System 75, and System 85	2-3
Table 2-B.	Adjunct/Voice Terminal Compatibility	2-12
Table 2-C.	Recommended Protectors	2-22
Table 2-D.	IROB Protection	2-23
Table 2-E.	Availability.....	2-26
Table 2-F.	DEFINITY G1 and System 75 Voice Terminal Administration	2-40
Table 2-G.	DEFINITY G1 and System 75 Terminal and Module Administration	2-44
Table 2-H.	DEFINITY G2 and System 85 Voice Terminal Administration	2-45
Table 2-I.	DEFINITY G2 and System 85 Terminal and Module Administration	2-48
Table 3-A.	Single-Line (and 7401) Voice Terminal Features	3-2
Table 3-B.	Multi-Appearance Hybrid Voice Terminal Features	3-5
Table 3-C.	Multi-Appearance Digital Voice Terminal Features	3-7
Table 3-D.	Multi-Appearance ISDN Voice Terminal Features	3-13
Table 3-E.	Default Softkey Features on the 8410	3-259
Table 3-F.	Alternate Softkey Features on the 8410	3-260
Table 3-G.	Default Softkey Features on the 8434 and 8434DX	3-283
Table 3-H.	Alternate Softkey Features on the 8434 and 8434DX	3-284

INTRODUCTION

Purpose

Voice terminals and adjuncts are voice and data devices that are connected to the system switch in a business communications system. This manual provides concise physical and functional descriptions of the voice terminals/telephones, adjuncts, and data modules that can be used with DEFINITY® Generic 1, Generic 2, Generic 3, System 75, and System 85. The book is intended as an aid for both AT&T and customer personnel in selecting appropriate components for these systems and for the training of personnel and management of the system.

This issue replaces all previous issues of this document. The reason for reissue is to add more information on the items included in previous issues of this document and to include the following new items:

- 8101 Telephone
- 8403 (8403D01A) Voice Terminal
- 8410B (8410D02A) Voice Terminal (without a display)
- 8410D (8410D01A) Voice Terminal with display
- 8434 (8434D01A) Voice Terminal
- CALLMASTER III Voice Terminal
- MDC Cordless Telephone
- MDW Wireless Telephone

In Issue 3, four new sections were added. The **EXPOSED PORT PROTECTION** section discusses the different protection required for lightning protection. The **AVAILABILITY** section lists the availability of the products covered in this manual. The **ADJUNCT POWER** section discusses the different types of adjunct power supplies available. The **ADMINISTRATION** section discusses how to administer some of the newer terminals when the software of the version switch being used does not contain the proper administration procedures for the new terminal.

The equipment covered in this manual includes the following specific groups:

- Telephones/Voice Terminals
- Adjuncts used with the voice terminals to enhance voice operations
- Data Modules (adjuncts that support data operations)
- PC Platforms (PC/PBX) and Application Software

Attendant consoles, applications processors (APs), printers, and data terminals used with APs are not described in this manual.

Figure 1 shows a typical arrangement of terminals and adjuncts connected to the system switch.

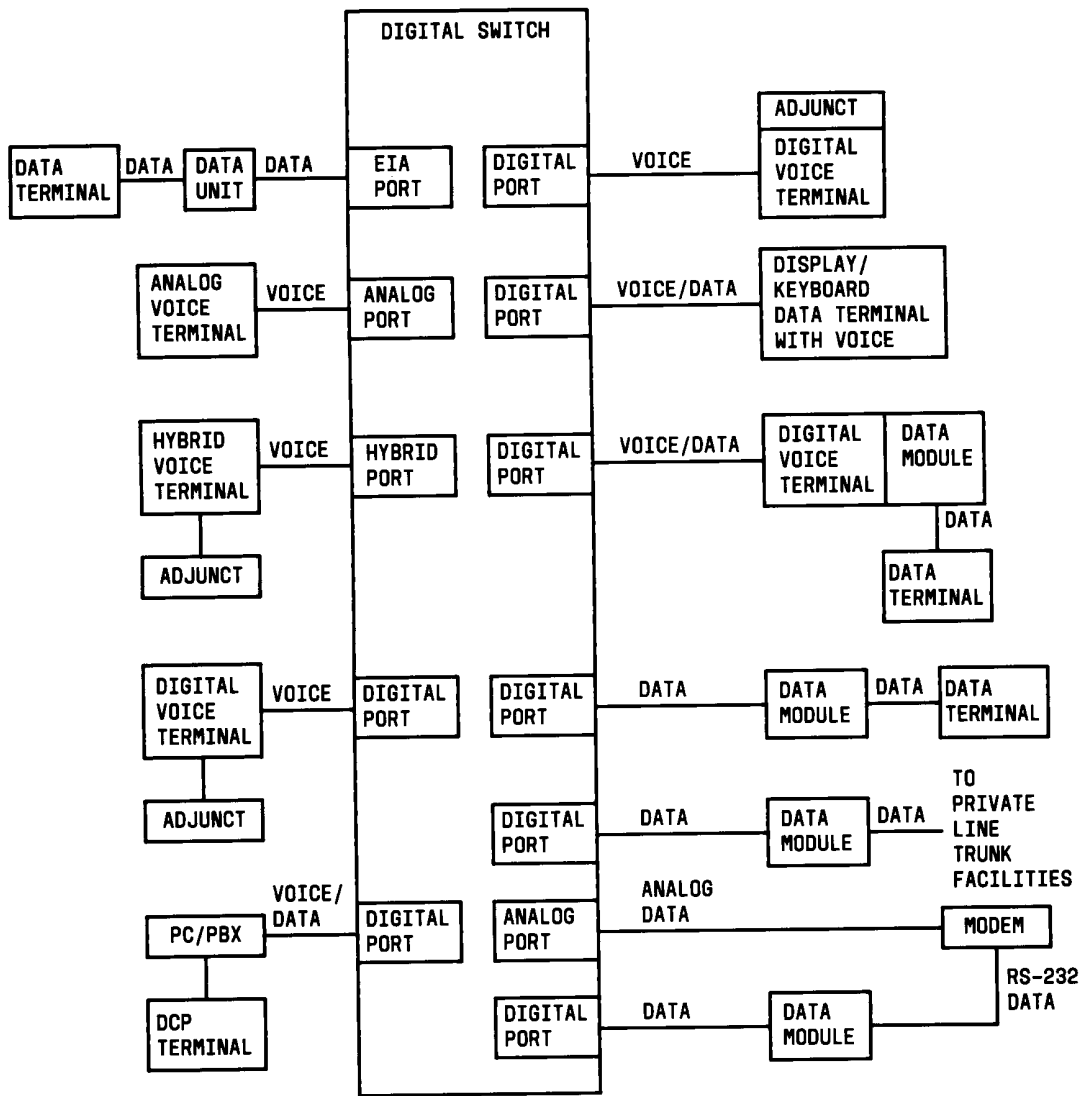

FIGURE 1-1. Interface Between System Switch and Typical Terminals/Adjuncts

Organization

The remainder of this manual is divided into nine main sections; tabs are provided for convenient access to each section. All equipment descriptions are supported by illustrations.

- **GENERAL INFORMATION**—Gives background data that applies to the entire range of equipment covered in this manual.
- **EXPOSED PORT PROTECTION**—Contains information on the protection required by exposed ports. This section also lists some of the AT&T protection devices and gives parameters that non-AT&T devices must meet.
- **AVAILABILITY**—Lists the ordering status of the equipment covered in this manual.
- **ADJUNCT POWER**—Lists the different terminals and adjuncts that require adjunct power supplies and the recommended adjunct power supply. Information has also been added about the MSP-1 power supply.
- **ADMINISTRATION**—When some of the newer terminals are used with some older versions of the switches, the administration of the switch does not allow for the use of the new terminals. These new terminals must be administered using the administration procedures of a similar older terminal. This is called aliasing. This section contains the aliasing information and the appropriate caveats.
- **VOICE TERMINALS**—Provides detailed coverage of the main groups of voice terminals, divided into eleven tabbed subsections. This section contains detailed information on each voice terminal that can be ordered as a component of DEFINITY Generic 1, Generic 2, or Generic 3, or possibly all three. It also contains brief descriptions of voice terminals that were previously installed in earlier business communications systems. Check each description to see if these voice terminals are compatible with DEFINITY G1, G2, or G3, System 75, and System 85.

The nine tabbed subsections and the voice terminals described in each subsection are listed as follows:

7100 SERIES

Model 7101A
Model 7102A
Model 7102 Plus
Model 7103A Fixed Feature
Model 7103A Programmable
Model 7104A

7200 SERIES

Model 7203H
Model 7205H

7300 SERIES

Model 7303S
Model 7305S

7400 SERIES

Model 7401D
Model 7401 Plus
Model 7402 Plus
Model 7403D
Model 7404D
Model 7405D
Model 7406D
Model 7406BIS
Model 7406 Plus
Model 7407D
Model Enhanced 7407D
Model 7407 Plus
Model 7410D
Model 7410 Plus
Model 7434D
Model 7444

8400 SERIES

Model 8403
Model 8410
Model 8434

CALLMASTER®

602 CALLMASTER
CALLMASTER II
CALLMASTER III

500/2500 SERIES

Model 500 Series
Model 2500 Series
Model 2500 DMGC
Model 2500 YMGK
Model 2500 MMGL
Model 2500 YMGL

8100 SERIES

Model 8101
Model 8102
Model 8110

ISDN VOICE TERMINALS

Model 7505 ISDN
Model 7506 ISDN
Model 7507 ISDN
Model 8503T ISDN
Model 8510T ISDN
Model 8520T ISDN

CORDLESS AND WIRELESS TELEPHONES

MDC 9000 Cordless Telephone
MDW 9000 Wireless Telephone

OTHER

Voice terminals reusable
from other systems:
Models 7203H, 7303H,
7305H01B, and 7305H02B
Multi-Button Electronic
Telephone (MET) Sets

- **ADJUNCTS**—Contains information on the devices that can be used with voice terminals to supplement services and features. This section contains information on the controls, buttons, lights, and functions of DEFINITY G1, G2, G3, System 75, and System 85 voice terminals and telephone adjuncts. Adjuncts that are identical in appearance and function, but have different codes, are covered under the same heading. Adjuncts that are basically data modules are covered in the **Data Modules** section in this manual.

The adjuncts covered in this section are:

- | | |
|----------------------------|----------------------|
| –Call Coverage Modules | –Speakerphones |
| –Digital Display Module | –Loudspeaker |
| –Function Key Module | –Messaging Cartridge |
| –Headset Adapters | –Automatic Dialer |
| –Message Waiting Indicator | |

- **DATA MODULES**—Contains information on the devices that provide data communications interface. This section contains information on the data modules and other related data equipment used with DEFINITY G1, G2, G3, System 75, and System 85. These devices provide data interface functions which include modems, protocol converters, and data units.

The data modules covered in this section are:

- | | |
|--|--|
| –7400A Data Module | –Modular Trunk Data
Module (MTDM) |
| –7400B and 7400B Plus
Data Module | –3270 Data Module |
| –7500B Data Module | –Asynchronous Data Unit (ADU) |
| –ISDN Asynchronous Data
Module (ADM) | –Multiple Asynchronous Data
Unit (MADU) |
| –Digital Terminal Data
Module (DTDM) | –DCIU Interface Units |
| –Z702AL1 Data Service Unit | –2500-SERIES Data Service Unit |
| –703A Data Service Unit | –Modems (Data Sets) |
| –DEFINITY High Speed Link (HSL) | –Local Distribution Service
Unit (LDSU) |
| –Processor Data Module (PDM) | –Isolating Data Interface (DI) |
| –Trunk Data Module (TDM) | –Protocol Converters |
| –Modular Processor Data
Module (MPDM) | |

- **PC Platforms (PC/PBX and PC/ISDN) and Application Software**—Contains information on the different PC/PBX Platforms, the PC/PBX Connection, and E78 Plus ®/ISDN.
- **Blank Templates for Model Design**—Includes blank templates of voice terminal faceplates on which the Software Associate can designate the numbers, feature codes, or features to be administered on each voice terminal button.

GENERAL INFORMATION

This section provides general information on all of the equipment described in this manual. Information is provided on voice terminals, adjuncts, data modules, and data terminals. Detailed information on these types of equipment can be found behind the tab for each particular type of equipment.

Voice Terminals

The advanced, multi-appearance voice terminals combine the capabilities of both a telephone and a terminal and have a variety of controlling and monitoring functions. While providing basic telephone service (placing and answering calls), voice terminals can also be used to activate the advanced features of the system.

This part explains higher level topics that apply to voice terminals as a group and contains descriptions of facilities and characteristics that are common to all or most terminals. **Table A** presents a summary of all voice terminals used with DEFINITY G1, G2, G3, System 75, and System 85.

The complete line of voice terminals are two basic types, *single-line voice terminals* and *multi-appearance voice terminals*. The operational differences between these types are in the way they access features and the way they receive calls.

Single-Line Voice Terminals

The term “single-line” means that only one incoming call can be ringing at an idle terminal. Once an incoming call has been answered, however, a single-line voice terminal can handle both the active call and another call on hold or waiting. When a single-line terminal user is busy on a call, an incoming call does not ring but alerts the user via a “call waiting tone” (in the handset or speakerphone) that a call is waiting to be answered. While a single-line terminal is occupied with two calls, any other calls placed to the terminal get a busy tone.

All single-line voice terminals are analog in operation; that is, transmission of all signals between the terminal and its port, at the system digital switch, is in analog form over a tip and ring pair of wires. The port circuit provides analog/digital signal conversion. Power for these terminals is supplied from the switch on the single voice pair. Single-line terminals have many applications but are more limited in their access to system features than multi-appearance terminals.

Multi-Appearance Voice Terminals

A multi-appearance voice terminal gives its user much more flexibility in handling calls than a single-line voice terminal. A multi-appearance voice terminal, represented by a unique primary extension number, has multiple call appearances (buttons with lights) where incoming calls to the number can be answered and outgoing calls can be originated. Incoming calls can ring simultaneously at all appearances except for those translated as originate-only. As long as at least one appearance is idle, callers will not receive busy tone. When all call appearances, except call appearances translated as originate-only, are busy, callers will hear busy tone unless the incoming call is a priority call or the Restrict Last Appearance feature is deactivated. The terminal user must decide the order to answer multiple incoming calls.

The two sub-types of multi-appearance voice terminals are digital and hybrid. Digital terminals generate and receive voice and control signals in digital form. Connection between terminals and the system switch is over 2-pair digital links; no conversion is necessary at the digital line port. Hybrid terminals, as the name implies, combine analog and digital. They are connected to the system switch by three pairs of links; on MET-like hybrid sets, one pair is for analog voice, and the other two pairs are for digital control signals, and on ATL-like hybrid sets, one pair is for digital control signals, and the other two pairs are for analog voice. DC power for all multi-appearance terminals (except for the 7404D and 7407D01B, which are AC powered) is conducted from the switch over the digital pairs.

Digital multi-appearance voice terminals have several important advantages over hybrids:

- Digital voice terminals can support and control data terminals.
- The Digital Communications Protocol (DCP) or ISDN-BRI interface between a digital voice terminal and the system switch supports simultaneous voice and data calls over the terminal's standard mounting cord.
- Digital terminals have a wider selection of adjuncts.
- Call information displays are available with some digital voice terminals.

TABLE 2-A. Voice Terminals Usable with DEFINITY, System 75, and System 85

TYPE	MODEL
Single-Line Analog	2500 Series 2500 DMGC 2500 YMGK 2500 MMGL 2500 YMGL 7101A 7102A, 7102 Plus 7103A Fixed Feature and 7103A Programmable 7104A (usable only with DEFINITY G1 and System 75) 8101, 8102 and 8110
Multi-Appearance Hybrid	7203H (usable only with DEFINITY G2 and System 85) 7205H (usable only with DEFINITY G2 and System 85) 7303S 7305S
Single-Appearance Digital	7401D and 7401 Plus (have two virtual* appearances, but no call appearance buttons)
Multi-Appearance Digital	7402 Plus 7403D, 7404D, 7405D 7406D, 7406BIS, 7406 Plus 7407D, Enhanced 7407D, 7407 Plus 7410D, 7410 Plus 7434D 7444 8403, 8410 (with or without display), 8434 602A, 602D CALLMASTER CALLMASTER II with Recorder Interface CALLMASTER III without Recorder Interface
ISDN Terminals	7505, 7506, 7507 (usable only with DEFINITY) 8503T, 8510T, 8520T (usable only with DEFINITY G2 and G3)
Cordless and Wireless	MDC 9000 Cordless Telephone MDW 9000 Wireless Telephone
REUSABLE FROM EARLIER SYSTEMS	
Single-Line Analog	500 (can also be ordered new) 2500 Series (can also be ordered new)
Multi-Appearance Hybrid (MERLIN®)	7305H 7305H01B 7305H02B
Multi-Button Electronic Telephone (MET) Sets	10 Button with or without Built-In Speakerphone 20 Button 30 Button 7203M (12 button)

* The word "virtual" refers to the fact that there are no call appearance buttons associated with either appearance. Refer to the description of the 7401D and 7401 Plus Voice Terminal for more information.

Facilities Common to All Voice Terminals

Every DEFINITY G1, G2, G3, System 75, and System 85 voice terminal has the following equipment:

- A pushbutton pad for touch-tone dialing (except for the Model 500, which has a rotary dial)
- A handset with a coiled modular cord
- A 7-foot modular mounting cord (except for the Model 2554 wall set).

Buttons

All multi-appearance voice terminals and most single-line terminals have buttons for handling calls and activating various functions that enhance basic calling.

Fixed Feature Buttons

Buttons that are factory labeled and require no administration are referred to as fixed feature buttons. The following buttons, in several combinations, are found on most voice terminals. They are dedicated to standard calling functions and are located adjacent to or above the pushbutton dial pad for calling convenience.

Note: Fixed feature buttons that are limited to a small number of terminals are explained in the detailed descriptions of those terminals.

- **Recall Button** (on older sets)—provides a timed flash that is more accurate than a manual switchhook flash and prevents accidental dropping of calls. The following list of uses for this button is only valid for single-line terminals:
 - ▶ Put an active call on hold and obtain recall dial tone for making another call.
 - ▶ Disconnect from a second call and return to a call on hold, when pressed twice.
 - ▶ Place an active call on hold and answer a waiting call using Dial Access Code, then toggle between the two calls (using the Recall button and Dial Access Code).
 - ▶ Place an active call on hold; receive recall dial tone, and dial the Feature Access Code to answer a waiting call. Toggle between the two calls by performing the same action.
 - ▶ Add a party, previously put on hold, to a conference with a third party.
 - ▶ Drop the party previously added.
- **Disconnect Button** (on older sets)—allows the terminal user, after completing one call, to permanently disconnect from the call and get dial tone for placing a new call without going on- and off-hook. On System 85 and DEFINITY G2, depending on the administration, this button can be used to reconnect to the call on hold on multiple appearance voice terminals.

- **Hold Button**—is used to temporarily disconnect from one call, without dropping it, so that another call can be answered or originated. The user can return to the call on hold.
- **Drop Button**—is used to permanently disconnect the last party added to a conference call. On System 85 and DEFINITY G2, this button also gives dial tone on the same call appearance if dialing or on a 2-party call.

Note: On some voice terminals, this button is also used to perform a test of the voice terminal's lights, ringer, and display (if the terminal has one).

- **Conference Button**—enables the terminal user to set up a conference call by adding new calls to an existing 2-party connection. The user can add as many as five calls to a conference. (On System 85 and DEFINITY G2 the user can only build a 3-party conference call using this button; 6-party conference calls can be built by the attendant.)

Note: On some voice terminals, this button is also used to select a personalized ring from 8 available ringing patterns.

- **Transfer Button**—enables the terminal user to shift an active call to another voice terminal.
- **Select Ring Button** (on older sets)—enables the terminal user to select a personalized ringing pattern.
- **Speaker Button**—turns on either a listen-only speaker or a 2-way speakerphone which allows the user to speak and listen to the far-end party.

Note: On some voice terminals, this button also allows the user to initiate an acoustic test of the surrounding environment (the Reset Speakerphone feature) through a series of tones. When the tones stop, the speakerphone has finished adjusting itself for optimal performance.

- **Mute Button**—turns off the microphone of the built-in speakerphone or the handset so the other person on the call cannot hear you.

Administrable Buttons

Buttons that are not fixed feature buttons are administered (or assigned) by the System Manager or the terminal user for many functions. Buttons that may be administered include call appearance/feature buttons and feature-only buttons.

Every multi-appearance voice terminal has a minimum of three buttons while others have as many as 34 buttons that can be administered as call appearances, that is, positions for answering incoming calls and originating outgoing calls (see **Figure 1**). In DEFINITY G1 and System 75, software defaults the first three of these buttons for appearances of the terminal's primary (or home) extension number; the System Manager has the option of administering Button #3 differently. In DEFINITY G2 and System 85, no buttons are defaulted for the primary extension number; the System Manager *must* administer all the required positions. Buttons not used for the primary extension number can be assigned as appearances of other extensions or for activating optional features.

Example shows buttons present of 7410 Plus feature buttons

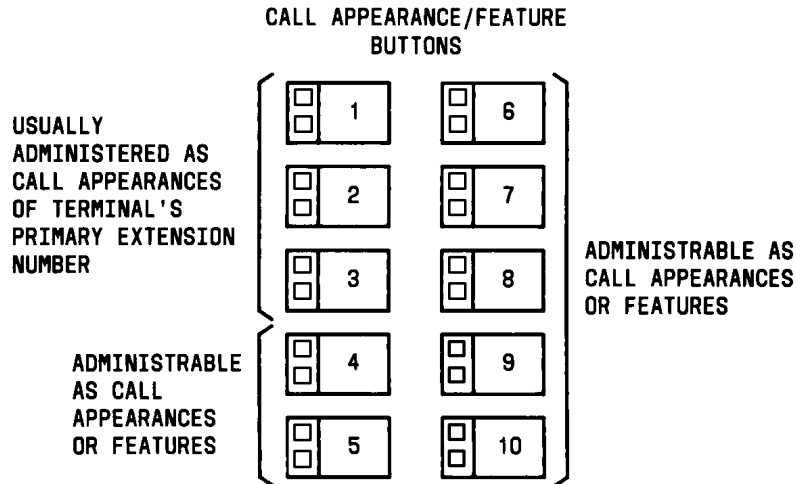

FIGURE 2-1. Call Appearance/Feature Buttons

Associated with each call appearance/feature button is a pair of lights that provide information on the availability and status of the appearance. These lights are described in the next part of this manual (titled "Lights").

Any button that can be administered and is not used for a call appearance can be assigned to an optional feature. Included in this category are buttons with two lights (call appearance/feature buttons) and buttons with one or no lights, intended specifically for features. Some features require light feedback to inform the terminal user when the feature is active; others are simple, one-time operations for which light feedback would be meaningless. Good feature administration matches features to appropriate buttons whenever possible.

Lights

Indicator lights provide silent visual reminders to the voice terminal user regarding lines, features, and messages taken at other locations. The lights on DEFINITY G1, G2, G3, and System 75 and 85 voice terminals are light-emitting diodes (LEDs) or neon lights.

On all multi-appearance voice terminals, each call appearance/feature button has two indicator lights: a red light and a green status light. When a call appearance/feature button is used for a feature, only the status light is operational; the red light remains off at all times. Feature-only buttons have either a single green status light or no light at all. The various arrangements of red and green lights are shown in **Figure 2**.

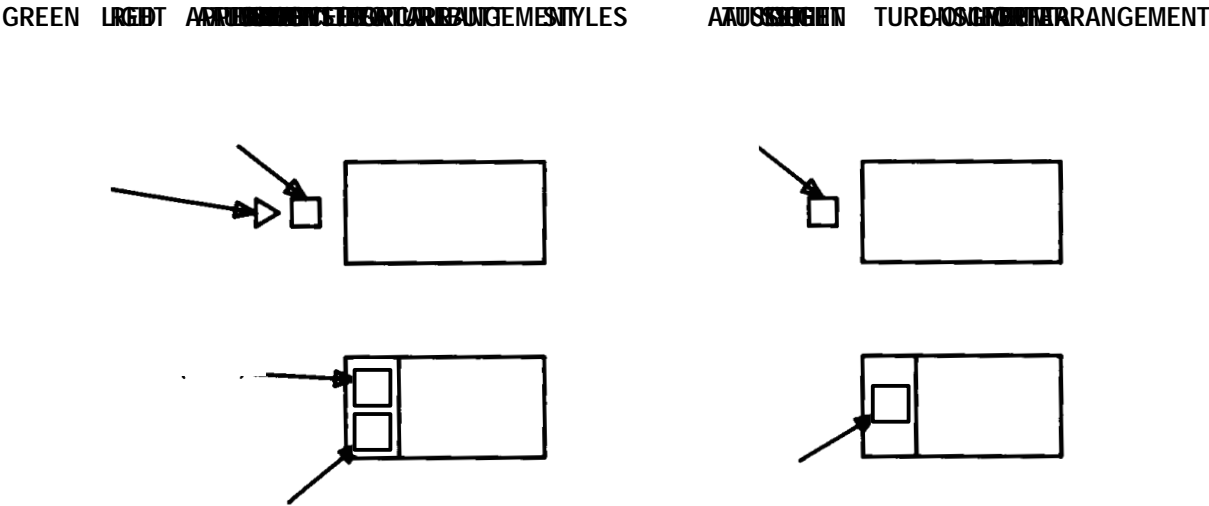

FIGURE 2-2. Button Lights

Red Light

The red light normally has two states: lighted steadily or dark (off).* One red light is always on at a multi-appearance voice terminal when the handset is on hook. It identifies the call appearance the user will be automatically connected to if the handset is lifted. When the handset is lifted, the red light identifies the call appearance that is active.

The red light is off when the handset is lifted but not connected to a call appearance; for example, when one call has been put on hold but another call appearance button has not been pressed. When certain features such as Preselection, Idle Line Originating preference, or No Line Originating Preference are administered, the red light is also off while on hook.

Green Status Light

The green status light can indicate any one of the following six conditions:

- Off—the call appearance is idle or the assigned feature is not activated.
- Lighted steadily—the call appearance is busy or the assigned feature is active.
- Flashing (slow on-off for equal periods, one cycle per second)—an unanswered incoming call on that call appearance.
- Fluttering (fast on-off for equal periods, 10 cycles per second)—a call placed on hold on that call appearance by the voice terminal user.
- Broken Fluttering (fast on-off modulated at the slow rate)—feature denial to the calling voice terminal or an unknown or invalid action.
- Winking (long on-short off at about three cycles per second)—a call placed on hold from another voice terminal or an action pending.

Message Light

The Message light, when on, indicates that a message is waiting for the voice terminal's user (for example, Leave Word Calling or voice mail messages). When the user retrieves the message, the light is automatically turned off.

* On the ISDN-BRI 7505, 7506, and 7507 sets, the red light flashes when the set is using phantom power.

Tones

The tones that a voice terminal user hears can be divided into two categories:

- Ringing Tones—those that are generated in the base of the voice terminal and can be heard in the surrounding area; they indicate incoming calls.
- Handset Tones—those that are transmitted through the handset and heard only by the user or through the speakerphone when it is turned on.

External Ringing Tones

Ring tones are the only tones heard *outside the voice terminal* when it is receiving a call. This signal cycles in 1-, 2-, or 3-ring patterns. On System 75 and DEFINITY G1 and G3, only one cycle of ringing is heard if the multi-appearance voice terminal is busy with another call. On System 85 and DEFINITY G2, the cycling repeats (except on the ISDN 7500-series sets).

- One ring—a call from another voice terminal in the system
- Two rings—a call from the attendant or outside caller
- Three rings—priority calls, for example, Automatic Callback, Priority Calling, or Ringback from a queued call
- One short unmodulated tone—an intercom call
- Ring-Ping (half ring)—a call redirected away from the voice terminal because Send All Calls or Call Forwarding is active; also called coverage tone.
- On System 85 and DEFINITY G2, any of these external tones, plus a repeated unmodulated tone, may be administered to indicate an intercom call.

Handset Tones

The following tones are heard through the handset:

- **Answer Tone**—a high-pitched continuous tone indicating that a data endpoint has answered.
- **Busy Tone**—a low-pitched tone repeated 60 times a minute; indicates that the number dialed is in use.
- **Call Waiting Tone (Single-Line Voice Terminals)**—one, two, or three beeps (short bursts of high-pitched tone), not repeated; indicates to the user at a busy single-line terminal that an incoming call is waiting to be answered. The number of beeps indicates the source of the waiting call:

One beep—a call from another voice terminal in the system

Two fast beeps—a call from the attendant or an outside caller

Three fast beeps—a priority call

- **Confirmation Tone**—(three short bursts of tone) indicates that a feature activation or cancellation has been accepted, or that an outgoing call from a single-line voice terminal has been placed in a ringback queue.
- **Coverage Tone**—(one long burst of tone) indicates to the calling party that a call to an extension number will be answered at another extension number by a covering user.
- **Dial Tone**—(a continuous steady tone) indicates that dialing or feature activation can begin.
- **Intercept Tone**—(an alternating high and low tone) indicates either a dialing error or a denial of the service requested.
- **Recall Dial Tone**—(three short bursts of dial tone followed by steady dial tone) indicates that the feature requested has been accepted and dialing can start.
- **Recorded Telephone Dictation Ready Tone**—(a high-pitched continuous tone) indicates that a dictation machine has been connected to the voice terminal.
- **Reorder Tone**—(a fast-busy tone repeated 120 times a minute) indicates that all outgoing trunks are busy or feature resource is not available. Try again.
- **Ringback Tone**—(a low-pitched tone repeated 15 times a minute) indicates to the calling party that the number dialed has been reached successfully and is ringing.
- **Ringback Tone, Call Waiting**—(a ringback tone with a short lower-pitched signal at the end) indicates to the calling party that the extension called is busy, but that the called party has been given the call waiting signal.
- **Time-Out Tone**—[an alternating high and low tone (same as intercept tone)] indicates a failure to dial within a preset interval (usually 10 seconds) after lifting the handset or after dialing the previous digit.
- **Warning Tone (Bridging)**—(a low-pitched tone heard by all parties in a Busy Verification attempt that bridges on to an active call) initially applied in a 2-second (System 75 and G1) or 4-second (System 85 and G2) burst, then in half-second bursts every 15 seconds.

Desk/Wall Mounting Arrangements

All the voice terminals covered in this manual, except the Model 2554, are intended for free-standing desktop use. However, wall-mounting is feasible for many terminals and appropriate kits are available. The detailed description of each voice terminal contains wall-mounting information and limitations.

Adjuncts

Adjuncts are optional devices that extend the existing capabilities of voice terminals or provide new services. Some adjuncts are physically attached to their voice terminals, and others are free-standing, connected by way of mounting cords. The adjuncts have styling and colors that are compatible with the associated voice terminals.

Table B provides a cross-reference between adjuncts and the voice terminals with which they are used. The following limitations apply to the use of multiple adjuncts:

- A speakerphone and a headset adapter cannot be connected to the same voice terminal simultaneously because they plug into the same jack on the terminal.
- A C401A Call Coverage Module and a D401A Digital Display Module cannot be mounted on the same 7405D or 7434D Voice Terminal simultaneously because they attach to the same part of the terminal.

None of the adjuncts have facilities for wall mounting, and wall-mounting kits are not available. However, the modules (call coverage, function key, and digital display) are attached to their voice terminals, which can then be mounted on a wall. Free-standing adjuncts (speakerphones and headset adapters) associated with wall-mounted terminals can be placed on a nearby shelf or table.

TABLE 2-B. Adjunct/Voice Terminal Compatibility

ADJUNCT	TERMINALS	FUNCTION
Call Coverage Module, C201A	7205H	Adds 20 call appearance/ feature buttons.
Call Coverage Module, C401A	7405D 7434D	
Call Coverage Module, C401B	7405D 7434D	
Digital Display Module, D401A	7405D 7434D	Displays call-related and personal service information.
Digital Display Module, D401B	7405D 7434D	
Function Key Module, F201A	7205H	Adds 24 feature buttons.
Function Key Module, F401A	7405D	
Headset Adapter, 500A	7102 Plus 7103A 7203H 7205H 7401 Plus 7402 Plus 7403D 7405D 7406D 7406BIS 7406 Plus Enhanced 7407D 7407 Plus 7410D 7410 Plus 7434D 7444 8403, 8410, 8434 CALLMASTER 8102 7505,06,07 ISDN 8503T ISDN 8510T ISDN 8520T ISDN 515 BCT	Provides for connection and control of standard headset.

TABLE 2-B (continued).
Adjunct/Voice Terminal Compatibility

ADJUNCT	TERMINALS	FUNCTION
Headset Adapter, 502A	7303S 7305S	Provides for connection and control of standard headset.
Message Waiting Indicator, Z34A	2500	Indicates that a message has been left for the terminal.
Messaging Cartridge	7404D	Provides display of call-related and personal service information on data terminal screen.
PC/PBX Plug-in Cartridge	7404D	Provides interface with PCs.
Speakerphone, S101A Speakerphone, S201A	Same as 500A Headset Adapter	Provides hands-free calling.
Speakerphone, S102A Speakerphone, S202A	Same as 502A Headset Adapter	Provides hands-free calling. Provides improved voice quality by adapting to room acoustics.
Speakerphone, 4A Speakerphone, 203A Loudspeaker, 107	2500 Analog or standalone 2500	Provides hands-free calling. Provides hands-free answering. Provides hands-free calling when not used as standalone. Provides amplification for the received voice signal.
Automatic Dialer, 2870A1	MET	Provides the capability to record and automatically dial 31 numbers.

Several power supplies and connection schemes are available for providing auxiliary adjunct power when it is required. Refer to the **ADJUNCT POWER** section of this manual for more information on these power sources.

Data Modules

Data modules provide an interface between the system's digital switch and Data Terminal Equipment (DTE) or Data Communications Equipment (DCE). DTE is defined as a data source or a data link or a combination of both; typical examples are data terminals and host computers. DCE is equipment that provides the functions for establishing, maintaining, and terminating a data call; a modem is an example of DCE.

An interface device between the switch and DTE or DCE is necessary because the set of data transmission rules and formats—the data protocol—at the switch is different from the protocol at the DTE or DCE. The digital ports of the switch present a Digital Communications Protocol (DCP) or ISDN-BRI interface to all devices connected to them. DCP supports simultaneous voice and data communications by multiplexing the two sets of signals into one digital stream. Digital voice terminals and some data terminals can be connected directly to the switch. But, if a data endpoint has a different protocol (EIA RS-232C or RS-232D is the most common) than the switch, a data module must be inserted to provide compatibility. The data module provides the two-way data signal conversion and processing required between different protocols. **Figure 3** shows a simplified diagram of the components of a typical data link.

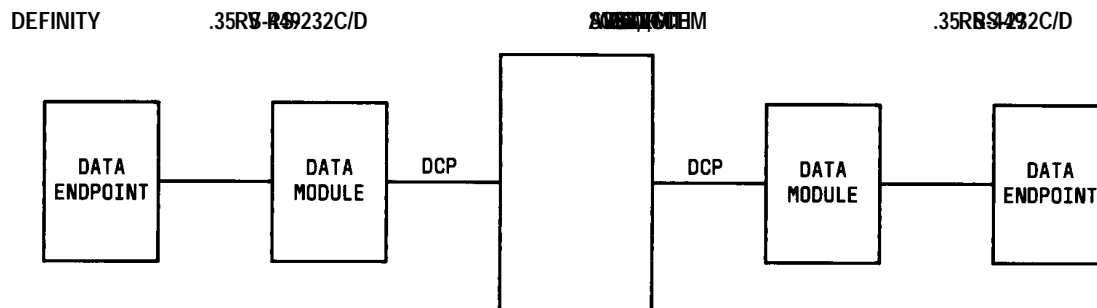

FIGURE 2-3. Data Link Components

The connection between a data module and a data endpoint must always have a DCE or DTE interface. If the endpoint is a DCE, the data module must present a DTE interface to it. If the endpoint is a DTE, then the data module must present a DCE interface. In general, modules are classified as DCE- or DTE-type according to the kind of data endpoint to which they are connected.

Data modules are available to match a wide variety of data needs:

- Asynchronous operation at data rates from 0.3-19.2 kbps and even, odd, mark/space, zero/one or no parity options
- Synchronous operation at data rates of 0.3, 1.2, 2.4, 4.8, 9.6, 19.2, 56, and 64 kbps
- Half- or full-duplex operation and internal or external timing options at the appropriate data rates

The following data equipment is available with DEFINITY G1, G2, G3, System 75, and System 85:

- **7400A Data Module**—In DTE mode, works with asynchronous DCE in the modem pool at data rates of 0.3-19.2 kbps, full-duplex. Supports both Hayes-compatible and D-lead modems. In DCE mode, the 7400A has Hayes®, Keyboard Dial or Answer-Only interface. Also works with asynchronous DTE where rack mounting is needed. Takes the place of MTDM or MPDM in asynchronous applications.
- **7400B and 7400B Plus Data Modules**—Works with asynchronous DTE at data rates of 0.3-19.2 kbps, full-duplex. Can be used with most 7400-series DCP voice terminals for simultaneous voice/data or standalone. Emulates a Hayes-compatible modem, therefore, can be used with standard PC communications packages. Takes the place of previous DCP asynchronous data stands.
- **Modular Processor Data Module (MPDM)**—Works with synchronous DTE at data rates of 0.3-64 kbps. Also works at full- or half-duplex with internal or external timing at the appropriate data rates. Supports V.35, RS-232, and RS-449 interfaces and RS-366 Automatic Calling Unit interface at the previously mentioned rates. Video codes are an example of 56 or 64 kbps endpoints where calls are set up via the RS-366 interface. The MPDM also supports asynchronous applications, but the 7400B Plus supersedes it for applications requiring Hayes emulation and the 7400A supersedes it for remaining asynchronous applications.
- **Modular Trunk Data Module (MTDM)**—Works with a synchronous DCE in modem pool applications at data rates of 0.3-19.2 kbps. Also works at full- or half-duplex with internal or external timing at the appropriate synchronous data rates. The 7400A supersedes it for asynchronous applications.
- **7500B Data Module**—Works with asynchronous or synchronous DCE or DTE on BRI switch interface (DEFINITY G2 or 5ESS® switch only). Supports RS-232 and V.35 interfaces and RS-366 Automatic Calling Unit interface (for the RS-232 interface only).
- **ISDN Asynchronous Data Module (ADM)**—Works with asynchronous DTE as a data stand for 7500-series BRI phones (DEFINITY G2 and 5ESS switch only). Supports Hayes command set for compatibility with PC communications packages.
- **Definity High Speed Link**—Works with synchronous V.35 DTE at data rates of 56 kbps half or full duplex or 64 Kbps full duplex. Supports Permanent (private line type) calls and switched calls. Switched calls can be set up using either the RS-366 or RS-232 (Hayes ATD command) interface; via DTR or Hotline dialing; or manually using the front panel call control feature. Replaces the ACCUNET® MPDM for video, LAN, CC/FEP and other high speed applications.
- **Asynchronous Data Unit (ADU)**—Works with asynchronous DTE at data rates of 0.3-19.2 kbps. Used where the user has an analog voice phone and needs basic capabilities for asynchronous terminals as opposed to PCs. Connects to SN 238 (System 85 and DEFINITY G2 traditional modules) or TN726 (System 75 and DEFINITY G1 and G2 universal modules).
- **Multiple Asynchronous Data Unit (MADU)**—Works with asynchronous DTE at data rates of 0.3-19.2 kbps in host applications. The MADU is rack-mounted and supports busy-out. It connects to the same switch ports as the ADU.

- **2500-Series Data Service Unit (DSU), Isolating Data Interface (IDI), and Local Distribution Service Unit (LDSU)**—DCIU interface units for DEFINITY G2 and System 85.

- PC Platform Products:

PC/PBX Platform—PC expansion cards and software for XT/AT bus and MicroChannel™ bus PCs in the DCP environment. Supports common, open data interface with PC/ISDN platform. Supported software includes PC/PBX Connection (for advanced phone management, access to synchronous and asynchronous hosts, and high-speed PC-to-PC communication) and E78 Plus. Works with any 7400-series phone.

PC/ISDN Platform—PC expansion card and software for XT/AT bus PCs in the BRI environment (DEFINITY G2 and 5ESS). Supports common, open data application interface with PC/PBX Platform. Supported software includes E78 Plus and high-speed PC-to-PC file transfer applications.

E78 Plus/ISDN—Software written to the open data applications interface which provides full 3270 terminal emulation and fast file transfer in IBM environments.

3270 Data Module—The 3270C Data module connects to an IBM® 3274 or 3174 Cluster Controller and converts DCP data from the PC platform products to the IBM Coax A format to access IBM mainframes for 3270 terminal emulation and fast file transfer.

The above PC platform products allow PC users to:

- ▶ Dial calls from the PC and use customized phone features from the keyboard, including a personalized phone directory, log of calls received and made, note-taking on calls, and phone message retrieval.
- ▶ Connect to a variety of asynchronous hosts and to IBM mainframes, allowing file transfer to and from the mainframe using standard IBM file transfer protocols and the standard DCA IRMA board user interface.
- ▶ Transfer files from PC to PC at rates up to 1.2 kbps over a 64 kbps facility using a PC package from Hilgraeve, Inc.
- ▶ Switch back and forth from the above capabilities to DOS programs at the touch of a key, when the PC/PBX application is run in the background.

Data Terminals

A data terminal is a workstation at which data is entered and retrieved; it communicates through lines, trunks, switches, and data modules with data endpoints such as computers and other data terminals. Some data terminals contain built-in voice capabilities similar to digital voice terminals. For detailed information on buttons, lights, and tones, refer to the general information about voice terminals at beginning of this section.

The following data terminals are available with System 75, System 85, and DEFINITY G1 and G2:

- AT&T Personal Terminal 510A (no longer manufactured)(DA)
- AT&T Personal Terminal 510D (no longer manufactured)(DA)
- Model 513 Business Communications Terminal (BCT) (no longer manufactured)(DA)
- Model 515 BCT (no longer manufactured)(DA)
- Model 610 BCT
- Model 615 MT

The 513 BCT, 610 BCT, and 615 MT, in addition to being optional units of peripheral equipment, are used in DEFINITY G1 and System 75 as System Access Terminals (SATs). The SAT is dedicated to system administration and maintenance and is located in or nearby the equipment room with the DEFINITY G1 or System 75. This manual does not cover the 513, 610, or 615 as an SAT but only as peripheral data terminals used for sending and receiving data calls.

Technical Specifications

Technical specifications are provided for the call progress tones, external ringing tones, and indicator light signals that are used with DEFINITY G1, G2, G3, System 75, and System 85.

Call Progress Tones

The following call progress tones are generated by the system:

STONE	FREQUENCY	PATTERN (In ms)
Ringback Tone	440 Hz + 480 Hz	1000 on, 3000 off; repeated
Bridging Warning Tone*	440 Hz	500 on, 15000 off; repeated
Busy Tone	480 Hz + 620 Hz	500 on, 500 off; repeated
Call Waiting Tones		
Internal	750 Hz + 20 Hz	100 on; not repeated
External or Handled by Attendant	750 Hz + 20 Hz	100 on, 100 off, 100 on; not repeated
Priority Call	750 Hz + 20 Hz	100 on, 100 off, 100 on, 100 off, 100 on; not repeated
Coverage Tone	440 Hz	600 on, followed by silence; not repeated
Confirmation Tone	350 Hz + 440 Hz	100 on, 100 off, 100 on, 100 off, 100 on followed by silence; not repeated
Dial Tone	350 Hz + 440 Hz	Continuous
Intercept Tone	480 Hz & 620 Hz	250 on (480 Hz), 250 on (620 Hz); repeated
Reorder Tone	480 Hz + 620 Hz	250 on, 250 off; repeated
Call Waiting Ringback Tone	440 Hz + 480 Hz; 440 Hz	1000 on (440 Hz + 480 Hz), 200 on (440 Hz), 2800 off; repeated

* This tone is used with the Busy Verification and Executive Override features and Service Observing when the warning tone is enabled.

External Ringing Tones

The following external ringing tone patterns are generated by the system:

RINGING TONE	PATTERN (In ms)
1	1200 on, 4000 off; repeated
2	400 on, 200 off, 600 on, 4000 off; repeated
3	200 on, 100 off, 200 on, 100 off, 600 on, 4000 off; repeated.

For most currently available voice terminals, the user can select a Personalized Ringing pattern (out of eight possible ringing patterns). The tone patterns are the same as those previously described. The three tones are 530 Hz [low (L)], 750 Hz [medium (M)], and 1060 Hz [high (H)]. The tone sequences are as follows: (Each of these sequences is prefaced by a medium level tone.)

RING PATTERN	TONE SEQUENCE
1	MMM
2	HHH
3	LLL
4	LHH
5	HHL
6	HLL
7	HLH
8	LHL

Indicator Lights Signals

The following light signals are generated by the system for the attendant console and multi-appearance voice terminals.

LAMP SIGNAL	PATTERN (In ms)
Dark (Off)	Off
Lighted (On)	On
Flashing	500 on, 500 off; repeated
Fluttering	50 on, 50 off; repeated
Broken Flutter	5 cycles of 50 on, 50 off, followed by 500 off; repeated
Wink	350 on, 50 off; repeated

EXPOSED PORT PROTECTION

Requirements

All port packs and terminals require unique protection and grounding arrangements as defined in the checklists (*AT&T System 75 Electrical Protection, Grounding, and Exposure Checklist*, 555-200-120 and *AT&T System 85 Electrical Protection, Grounding, and Exposure Checklist*, 555-103-120). These arrangements provide an adequate barrier to the potentially damaging voltages and currents inherent in lightning and power surges present in exposed applications. Moreover, the National Electrical Code requires that an approved protector be provided on all exposed circuits.

Exposed Ports And Terminals Defined

Ports and terminals that utilize facilities that are subject to disturbances from lightning, ground potential rises (GPR), or possible contact or induction from electrical power sources or circuits in excess of 300 volts (RMS) to ground are classified as exposed. Any ports or terminals served by such exposed facilities are classified as exposed and require protection at both the port and terminal ends. The checklists contain flowcharts that are beneficial in determining exposure status and tables to determine the type of protector required.

Out-of-Building Campus Stations

An out-of-building campus station is a telephone or voice terminal that is not physically located in the same building as the equipment room, but is located on the same property. Both analog telephones and digital voice terminals can be used as out-of-building stations.

Carbon block, or equivalent, protection is required at both building entrances for analog out-of-building stations. Sneak current protection is also required. Protection can be provided by a 4-type protector or a 3-type protector plus a separate sneak current protector. The 4-type protector is equipped with a heat coil for sneak current protection. The 4-type primary protector is the preferred device.

Protection is required at both entrances for digital out-of-building voice terminals. There are two different types of protectors that can be used to protect digital voice terminals and digital line circuit packs in an out-of-building environment: the 4C3S-75 Enhanced Protector and the ITW Linx Enhanced Protector.

Note: The 4C3S-75 Enhanced Protector may only be used on Vintage 14 or newer TN754 Circuit Packs. The 4C3S-75 can be used on all vintages of the TN754B Circuit Pack. The ITW Linx Enhanced Protector may be used on all Vintages of the TN754 and TN754B Circuit Packs.

The 4C3S-75 Enhanced Protector is equipped with a heat coil for sneak current protection and the ITW Linx Enhanced Protector is equipped with replaceable fuses for sneak current protection.

The maximum range for out-of-building voice terminals is 3,400 feet when using 24 AWG wire

and 2,200 feet when using 26 AWG wire. The range can be extended to 5,000 feet (24 AWG) or 4,000 feet (24 AWG) with the use of a Data Link Protector (DLP). The DLP is an isolating transformer used to remove phantom power on the switch side and reintroduce it on the terminal side. When a DLP is used, the voice terminal must be locally powered by an external power supply or through the AC power cord provided with some of the 7400 series voice terminals. The DLP is installed on the equipment side of the protection in both buildings. In high lightning areas, the DLP may also be installed to provide the maximum degree of protection and reliability.

Table A shows the recommended protectors for the DEFINITY G1, G2, G3, System 75, and System 85. **Table B** shows the in-range, out-of-building (IROB) protection for DEFINITY line circuits and terminals.

Caution: The following circuit pack and terminal arrangements are not allowed to be installed in an exposed environment:

1. 7300 Series connected to the TN762B or ANN17 Circuit Pack
2. MET terminals connected to the TN735 Circuit Pack
3. Analog terminals connected to the TN746 Circuit Pack

TABLE 2-C. Recommended Protectors

PRIMARY	PRIMARY (w/Heat Coil)	ENHANCED PRIMARY	SECONDARY
3B1A (carbon)	4B1C (carbon)	4C3S-75 (solid state)	79A Fuse
3B1E-W (wide-gap gas tube)	4B1E-W (wide-gap gas tube)	ITW Linx (gas tube avalanche suppress)	SCP-1
3C1S (solid state)	4C1S (solid state)		

TABLE 2-D. IROB Protection

CIRCUIT PACKS	TERMINAL	REQUIRED PROTECTOR*	SEE NOTE
SN224	7203, 7205, MET	EP	—
SN228B, SN229	2500 Series, 2500DMGC, 7100 Series	P	1
TN742, TN746B, TN769	500 Series, 2500 Series, 7100 Series	P	1
SN270	7400 Series	EP	—
TN754	7400 Series	(ITW)	2
TN754, V14	7400 Series	EP	3
TN556	T. Term	EP & P	4

*P = Primary, EP = Enhanced Primary

Notes:

1. Primary protection with heat coils for sneak protection are coded with the number **4** as the first numeric. DEFINITY ports require sneak current protection for IROB terminal installations.
2. The TN754, V1 through V13 may be installed with either the DLP and primary protector or the ITW Linx Enhanced Primary protector. These vintages may not be installed with the 4C3S-75 Enhanced Primary protector.
3. The 4C3S-75 Enhanced Protector may only be used on Vintage 14 or newer TN754 Circuit Packs. The ITW Linx Enhanced Protector may be used on all Vintages of the TN754 Circuit Pack.
4. The TN556 Circuit Pack requires Enhanced Primary protection at the port and Primary (3- or 4-type) protection at the terminal.

For more information on exposed port protection, refer to:

- *DEFINITY Communications System Generic 1 and Generic 3 Wiring, 555-204-111*
- *DEFINITY Communications System Generic 2 and System 85 Wiring, 555-104-630*

AVAILABILITY

This section provides the availability of the products described in this manual. The availability of these products is constantly changing as new products and different versions of existing products are introduced. The status of some of the products in this list may have changed since this manual was issued. Check the Sales Manual for the final determination of the equipment status.

The following convention is used in **Table A**:

- **DA**—Discontinued Availability
- **GA**—General Availability
- **LA**—Limited Availability

TABLE 2-E. Availability

EQUIPMENT	ORDERING STATUS
7101A Voice Terminal	DA
7102A01A Voice Terminal	LA
7102A01B (7102 Plus) Voice Terminal	LA
7103A Fixed Feature Voice Terminal	DA
7103A Programmable Voice Terminal	DA
7104A Voice Terminal	DA
7203H Voice Terminal	DA
7205H Voice Terminal	DA
7302H Voice Terminal	DA
7303H Voice Terminal	DA
7303S Voice Terminal	DA
7305H01B Voice Terminal	DA
7305H02B Voice Terminal	DA
7305S Voice Terminal	DA
7401D01A Voice Terminal	DA
7401D02A (7401 Plus) Voice Terminal	GA (DA 1/2/95)
7402 Plus Voice Terminal	GA (DA 1/2/95)
7403D Voice Terminal	DA
7404D Voice Terminal	DA
7405D Voice Terminal	DA
7406D01A & 7406D02A Voice Terminal	DA
7406D03A & 7406D04A Voice Terminal	DA
7406D06A (7406BIS) Voice Terminal	DA
7406D05A (7406BIS) Voice Terminal w/display	DA
7406D08A (7406 Plus) Voice Terminal	GA (DA 1/2/95)
7406D07A (7406 Plus) Voice Terminal w/display	GA
7407D01B Voice Terminal	DA
7407D02C (Enhanced 7407D) Voice Terminal	DA
7407D02D (7407 Plus) Voice Terminal	GA

TABLE 2-E (continued).
Availability

EQUIPMENT	ORDERING STATUS
7410D01A Voice Terminal	DA
7410D02A (7410 Plus) Voice Terminal	GA
7434D Voice Terminal (packaged with display)	DA
7434D Voice Terminal (packaged with call cov. module)	GA
7444 Voice Terminal	GA
8403 Voice Terminal	GA
8410 Voice Terminal	GA
8434 Voice Terminal	GA
CALLMASTER (602A1 and 603D1)	LA
CALLMASTER II	GA
CALLMASTER III	GA
MDC Cordless 9000	GA
MDW Wireless 9000	GA
MET Sets	LA
500 Telephone	GA
2500 Series Telephone	DA
2500 DMGC Telephone	DA
2500 YMGK Telephone	GA
2500 MMGL Telephone	GA
2500 YMGL Telephone	GA
8101 Telephone	GA
8102 Telephone	GA
8110 Telephone	GA
7505 ISDN Voice Terminal	DA
7506 ISDN Voice Terminal	DA
7507 ISDN Voice Terminal	DA
8503T ISDN Voice Terminal	GA
8510T ISDN Voice/Data Terminal	GA
8520T ISDN Voice/Data Terminal	GA
Message Waiting Indicator	GA
F401A Function Key Module	DA
F201A Function Key Module	DA
500A Headset Adapter	GA
502A Headset Adapter	GA

TABLE 2-E (continued).
Availability

EQUIPMENT	ORDERING STATUS
D401A Digital Display Module	GA
D401B Digital Display Module	GA
C401A Call Coverage Module	DA
C401B Call Coverage Module	GA
C201A Call Coverage Module	DA
4A Speakerphone	DA
S101A Speakerphone	DA
S102A Speakerphone	DA
S201A Speakerphone	GA
S202A Speakerphone	GA
S203A Speakerphone	GA
Message Cartridge	DA
2870A1 Automatic Dialer	GA
107 Loudspeaker	DA
7500B Data Module	LA
2500 Data Service Unit	GA
105A Isolating Data Interface	GA
48250 Local Distribution Service Unit	GA
Multiple Asynchronous Data Unit	GA
Asynchronous Data Module	GA
3270A Data Module	DA
3270C Data Module	GA
3270T Data Module	DA
Trunk Data Module	DA
Processor Data Module	DA
Modular Trunk Data Module	GA
Modular Processor Data Module	GA
703A Data Service Unit	DA
Z702AL1 Data Service Unit	DA

TABLE 2-E (continued).
Availability

EQUIPMENT	ORDERING STATUS
DEFINITY High Speed Link	GA
Digital Terminal Data Module	DA
7400A Data Module	GA
7400B Data Module	DA
7400B Plus Data Module	GA
PC/PBX Platform	GA
PC/ISDN Platform	GA
PC/PBX Connection	DA
E78 Plus/ISDN	DA
PC/ISDN Interface Software Developer's Guide	GA

ADJUNCT POWER

Power for several of the adjuncts must be provided locally at the voice terminal or from a satellite closet through the terminal wiring. The following power supplies are currently recommended:

- The MSP-1 (WP92464L1) Power Supply—replaces the KS-22911 L1/2, 329A, and 353A DC power supplies and the 2012D AC transformer. The MSP-1 can be used to supply local power to ISDN-T 65xx, 75xx, and 85xx series voice terminals connected to an AT&T DEFINITY Communications System and to the DCP 7444 and 8434 voice terminals which need auxiliary power for their vacuum fluorescent displays. The MSP-1 can also supply auxiliary power to adjunct equipment such as the S201A and CS201A speakerphones or a 500A Headset Adapter attached to any currently manufactured analog, DCP, or ISDN-T voice terminal equipped with an Adjunct jack. For more information on the MSP-1 power supply, see the short section with connection diagrams later in this section.
- The ISDN 1145B1 Bulk Power Unit, 1146B Power Distribution Unit, and the 2.5/5.0 A.H. back-up batteries provide an uninterruptible power source for ISDN telephones and terminals, NT1s, terminal adjuncts, and other customer premises equipment. During AC power interruptions, batteries are automatically switched on to provide continuous power to the load.

The distribution of power to the terminal equipment is provided by the 1146B distribution unit. The 1146B provides 32 standard 110 connections to the load with overcurrent protection and alarm lights. The 1145B1/1146B power arrangement is compact (measuring only 6.5 inches deep), lightweight, plastic enclosed, and designed for easy wall- or rack-mounting.

During normal operation, the power supply/charger provides DC power to the load via the distribution unit while maintaining the battery in a fully charged condition. The power system continuously monitors systems conditions with the status displayed on the front panel of the power supply and distribution unit.

The following power supplies and transformers are NO LONGER recommended. They have been replaced by the MSP-1 power supply and the 1145B1 bulk power unit described above.

- 2012D AC transformer— can be used locally or in a satellite closet to power a single 18 volt headset adapter or speakerphone.
- KS-22911, L2 DC power supply—can be used locally or in a satellite closet to power a headset adapter or speakerphone plus one additional adjunct. This unit has a 48 volt power output of 10 watts.
- KS-21239, L4, L5 AC transformer—can be used locally or in a satellite closet to power a single 24 volt speakerphone-dialer.
- PS3081096 AC transformer—can be used locally or in a satellite closet to power the 24 V S201A or S203A speakerphones.
- 329A DC power supply—can be used locally or in a satellite closet and is capable of supplying power to any number of adjuncts that may be added to a digital voice terminal. This unit has a power output of 25 watts.

- 346A modular bulk DC power supply—can be used in a satellite closet only and is capable of supplying power to any number of adjuncts that may be added to a digital voice terminal. This unit provides switch-selectable options for four outputs at 10 watts or two outputs at 20 watts.
- 85B1-49 power unit—can be used locally or in a satellite closet to power the 4A speaker-phone.
- 95B1 power unit—can be used locally or in a satellite closet to power a 2870A1 automatic dialer.
- 353 DC Power Supply—can be used locally only. It is designed to supply power to ISDN-BRI stations and their adjuncts. It has a power output of 12 watts.
- 945 Bulk DC Power Supply—can be used in a satellite closet only. It is designed to power ISDN-BRI stations and their adjuncts. It can optionally be equipped with a battery to provide terminal operation for a limited time in case of an AC power failure. Up to 26 ISDN-BRI terminals can be supported by the 945 power supply.

Information on the Older Power Supplies

The following diagram shows the connections with the older power supplies.

Note: The MSP-1 replaces the KS-22911 L1/2, 329A, and 353A DC power supplies and the 2012D AC transformer.

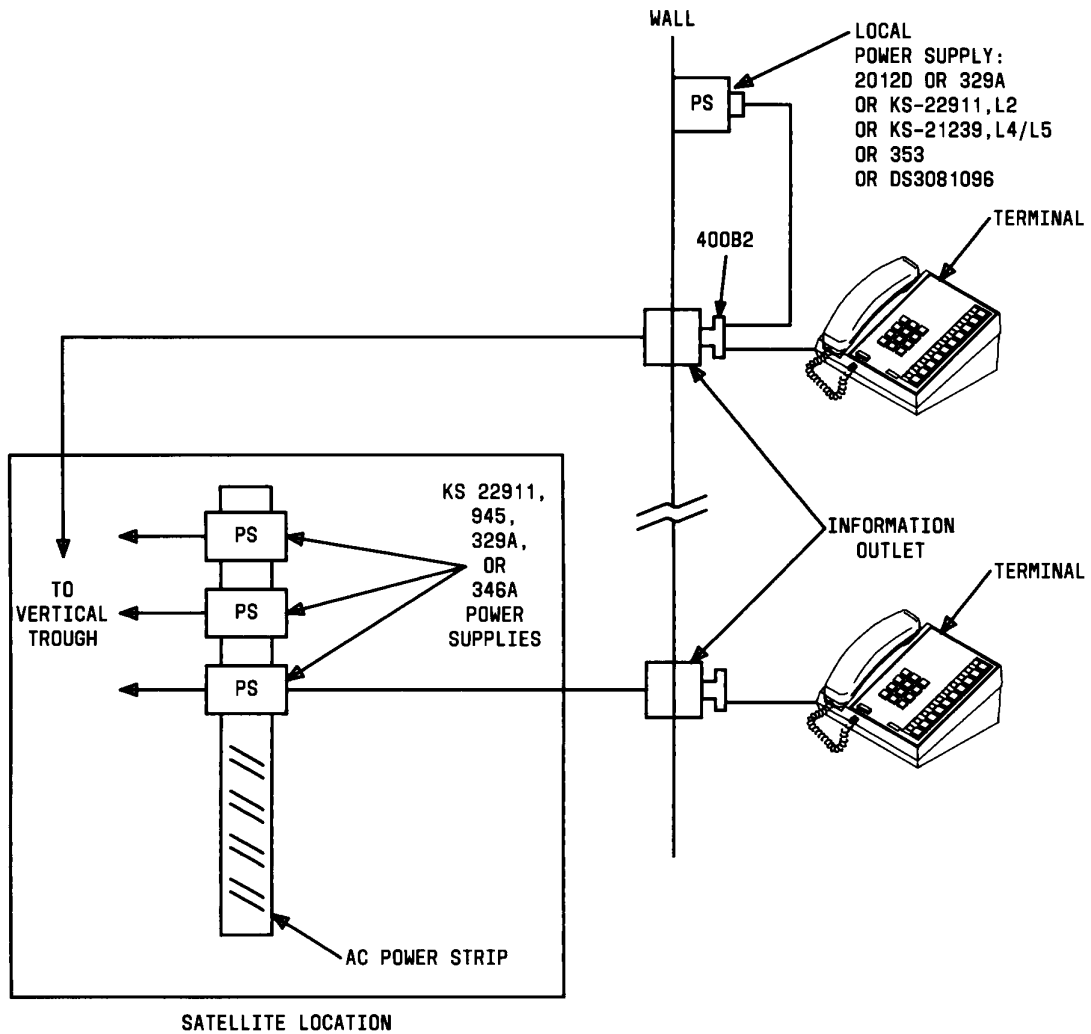

FIGURE 2-4. Local and Satellite Power Sources for Voice Terminals Adjuncts

One of these power supplies must be used for each voice terminal equipped with one or more adjuncts. Each of these power supplies (except the 95B1) has a maximum cable distance of 250 feet (76 m) between the power supply and the adjunct(s). The maximum cable distance for the 95B1 is 150 feet (45m). Voice terminal adjuncts and modules are not operational during interruptions of commercial AC power unless their power supplies are also powered through standby power of other essential AC power service.

The 329A and 346A power supplies clustered in a satellite closet are normally mounted on AC power strips. Power to these strips is provided from a dedicated 120 volt AC, 60-Hz, 20-ampere circuit breaker and feeder either directly or through a 543A telephone power unit. The 543A unit provides an inductive filter to limit inrush current on the feeder. It comes equipped with an AC power cord which plugs into the dedicated feeder and provides four receptacles for AC power strips.

The 945 bulk power system is usually rack mounted and is intended to be located in an equipment room or satellite closet. It is optionally made up of the following components:

- 945-1 bulk power supply unit
- 945-2 battery reserve unit
- 945-3 system enclosure, equipped with one or two 945-1 and/or a 945-2
- 945-4 single enclosure for 945-1 unit

Several power supplies and connection schemes are available for providing auxiliary adjunct power when it is required. Regardless of its source, auxiliary power is introduced into a pair of spare leads in the individual voice terminal's line, at some wiring interface. The auxiliary power is fed into the terminal on the mounting line cord. From the terminal, power is distributed to the adjunct(s). An auxiliary power source is usually mounted in a satellite closet or adjacent to the voice terminal's wall jack.

The MSP-1 Power Supply

The MSP-1 (WP92464L1) Power Supply can be used to supply local power to ISDN-T 65xx, 75xx, and 85xx series voice terminals connected to an AT&T DEFINITY Communications System and to the DCP 7444 and 8434 voice terminals which need auxiliary power for their vacuum fluorescent displays. The MSP-1 can also supply auxiliary power to adjunct equipment such as the S201A and CS201A speakerphones or a 500A Headset Adapter attached to any currently manufactured analog, DCP, or ISDN-T voice terminal equipped with an Adjunct jack.

CAUTION: The MSP-1 Power Supply can be used *only* with telecommunications equipment, indoors, in a controlled environment.

NOTES:

One power supply will support one telephone with or without an adjunct.

The maximum loop range between the telephone and the power supply is 250 feet.

This power supply replaces the KS-22911-L1/2, 329A, and 353A DC Power Supplies and the 2012D AC Transformer.

The MSP-1 power supply has a single output of -48 volt DC, 0.4 amperes, and can operate from either a 120 VAC 60 Hz power source (105 to 129 VAC) or a 220/230/240 50 Hz power source (198 to 264 VAC). Input voltage selection is automatic; that is, the power supply adjusts itself for the type of input voltage. The output capacity is 19.2 watts.

Contents of the MSP-1 Package (and Comcodes)

The MSP-1 package includes the following items: (Comcodes are provided for additional orders)

- One MSP-1 power supply (Comcode: 406743419)
- One 6-foot, 7-inch input power cord (Comcode: 403271117)
- One 7-foot D8W cord (Comcode: 103786786)
- Double-sided adhesive fastener strips for mounting the power supply on a flat vertical surface (Comcode: 406824789)
- These printed instructions.

Connecting the Power Supply

The power output is provided through 3 modular jacks on the power supply. These jacks are labeled, from left to right,

PHONE	OTHER	LINE
-7 +8	-2 +5	

The - and + numbers under “PHONE” and “OTHER” refer to the pins on which power is present and the polarity of that power.

The PHONE and LINE jacks are 8-pin female non-keyed 657-type jacks that can accept D4, D6, and D8 modular plug cables. The OTHER jack is a 6-pin female non-keyed 657-type jack.

The following local powering arrangements, shown in **Figures 1 and 2**, can be used with the MSP-1 power supply.

- **Figure 1** shows the local powering arrangement for: ISDN voice terminals; the DCP 7444 and 8434 voice terminals' VF displays; and adjuncts connected to all telephones except the 8102.
- **Figure 2** shows the local powering arrangement for adjuncts connected to the 8102 telephone.

Note: The type of cord(s) needed to make these connections are designated in each drawing.

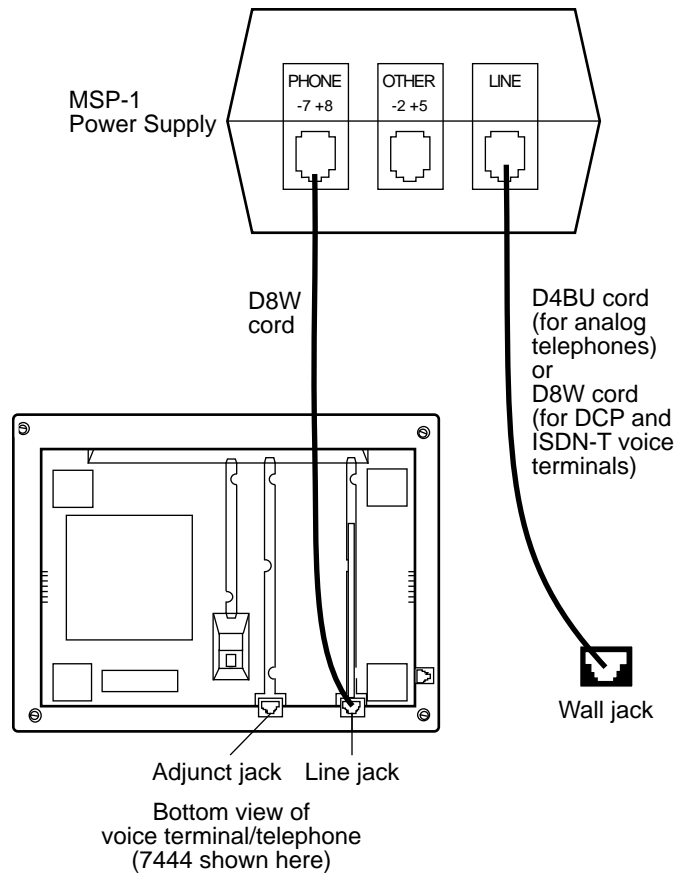

FIGURE 2-5. Local Powering Arrangement for: ISDN-T VTs; the DCP 7444 and 8434 VTs (for their VF Displays); and Adjuncts Connected to All Telephones Except the 8102

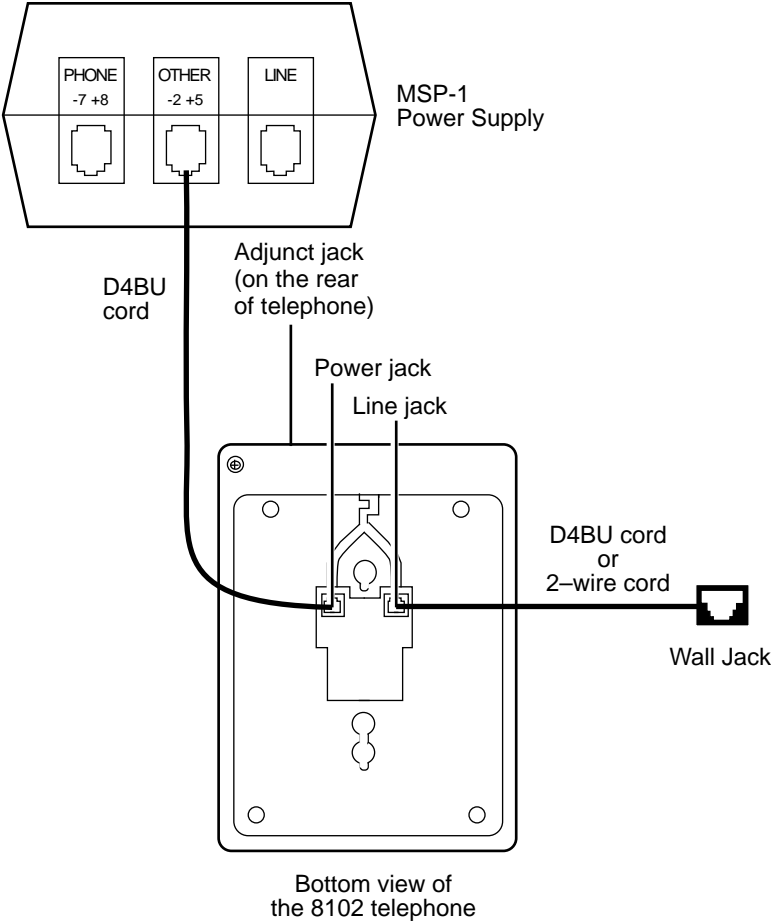

FIGURE 2-6. Local Powering Arrangement for Adjuncts Connected to the 8102 Analog Telephone

ADMINISTRATION

This section contains some of the information necessary to administer the different voice terminals on DEFINITY G1, G2, G3, System 75, or System 85. It also provides the caveats required when administering some of the newer voice terminals to the older systems. Other administration information for DEFINITY G1 and G3 or System 75 is provided in the DEFINITY G1 and G3 and System 75 Implementation and Administration manuals. The administration information for DEFINITY G2 and System 85 is provided in the System 85 and DEFINITY G2 Translation Service Manual.

Important: The sections of this manual which describe the newer voice terminals provide detailed information on administering that voice terminal. In most cases, diagrams of the button numbering schemes are also provided. For example, if you want to administer a 7407 Plus voice terminal, see the section on the 7407 Voice Terminals under the tab labeled **7400 Series**.

Aliasing

When some of the newer voice terminals are used with some older versions of the switches, the administration procedures of the switch does not allow for the use of the new terminals. These new terminals must be administered using the administration procedures of a similar older terminal. This is called “aliasing” a set.

When aliasing is used to administer a voice terminal, often the “old” screen used in administering buttons and features displays more buttons than can actually be assigned to the new terminal. These differences are provided in this section also.

The following tables list the aliases used in administering the terminals. If the terminal you are administering is not listed in the tables, then it is administered as itself in all versions of the switch.

TABLE 2-F. DEFINITY G1 and System 75 Voice Terminal Administration

VOICE TERMINAL	SYSTEM			
	S75 R1V1	S75 R1V2	S75 R1V3	G1 and G3
8101/8102/8110	2500			
7102A	7101A			
7104A	7101A or 2500*	S		
7203H	X			
7205H	X			
"MERLIN"*** SMALL	7303S			
"MERLIN" MEDIUM	7305S			
"MERLIN" LARGE	7305S			
7401D	7403D			S
7401 Plus	7403D			7401D
7402 Plus	7403D		7410D	
7406	7405D DD	S		
7406BIS	7405D	S		
7406 Plus	7405D	7406D or 7406BIS		
7407D	7405D DD	S		
Enhanced 7407D	7405D DD	7407D		
7407 Plus	7405D DD	7407D		
7410	7403D			
7410 Plus	7403D			7410D
7434	7405D			

S = Administered as Self

TABLE 2-F (continued).
DEFINITY G1 and System 75 Voice Terminal Administration

X = Not Allowed

DD = Digital Display Module

* If equipped with a message waiting adjunct, administer as a 7101A; otherwise, administer as 2500.

** MERLIN Communications System

TABLE 2-F (continued).
DEFINITY G1 and System 75 Voice Terminal Administration

VOICE TERMINAL	SYSTEM			
	S75 R1V1	S75 R1V2	S75 R1V3	G1 and G3
7444	7405D DD	7405D or 7407D*		7434D or 7407D*
8403	7405**			
8410B	7403			7410***
8410D	7405+D***			

DD = Digital Display Module

*CAVEATS for administration of the 7444 voice terminal:

If the 7444 voice terminal is administered as a 7405D or a 7407D, the following caveats apply:

- Only 10 call appearance buttons can be administered with two lights, a red and a green light.
- If the voice terminal is administered as a 7407D, the S1 switch on the back of the 7444 voice terminal must be in the OFF position.

When the 7444 voice terminal is administered as a 7405D or a 7434 voice terminal, the following caveats apply:

- The S1 switch on the back of the 7444 voice terminal must be in the ON position.
- Only one line of the display will show switch-related information.

When a 7444 is administered as a 7434, DEFINITY G1 allows a maximum of 10 appearances of the primary line while DEFINITY G2 allows a maximum of 12 appearances. Each switch handles appearances of other lines (that is, lines used in Bridging, Call Pickup, etc.) in a different manner. Information about administering these appearances can be found in switch documentation and help screens.

** If the 8403 is connected to a DEFINITY G3V3 (and later), the 8403 can be administered as itself.

*** If the 8410B is connected to a DEFINITY G3i or G3r, it can be administered as a 7410 Plus. If the 8410B or 8410D is connected to a DEFINITY G3V3 (or later), the set can be administered as itself.

TABLE 2-F (continued).
DEFINITY G1 and System 75 Voice Terminal Administration

VOICE TERMINAL	SYSTEM			
	S75 R1V1	S75 R1V2	S75 R1V3	G1 and G3
8434 (for extra features)*	7405+D+F			
8434 (for additional coverage)*	X			7434+D
602 CALLMASTER	X	X	S	
CALLMASTER II & III	X	X	602 CALLMASTER	
7505 ISDN	X			S
7506 ISDN	X			S
7507 ISDN	X			S
8503T	X			S
8510T	X			S**
8520T	X			S
MDC 9000	7303S Hybrid***			
MDW 9000	7303S Hybrid***			

S = Administered as Self

X = Not Allowed

+D = with Display Module

+F = with Feature Key Module

* CAVEATS for administration of the 8434 voice terminal:

The 8434 may be aliased as a 7405+D+F to support all system features. However, in this case, while all the call appearance/feature buttons AND the softkey features will be functional, there can be a maximum of only 10 call appearances. On the 7405, the Display Module is a 1-line display, and thus the 1-line display option should be selected.

On some systems, the 8434 can be aliased as a 7434+D or a 7444 to support coverage. In this case, there can be up to 34 call appearances (including bridged call appearances), but the 15 softkey features will NOT be functional because the Feature Key Module is not allowed with the 7434 or 7444. On the 7434, the Display Module is a 1-line display, and thus the 1-line display option should be selected. If the set is administered as a 7444, it can be optioned for a 2-line display.

An 8434 connected to a DEFINITY G3V2 can be administered as a 7444; an 8434 connected to a DEFINITY G3V3 (or later) can be administered as itself.

**An 8510T voice terminal connected to a DEFINITY G1 or G3 can be administered as itself, but an 8510 data terminal must be administered as a 7507.

***A MDC 9000 Cordless Telephone or a MDW 9000 Wireless Telephone connected to a DEFINITY G3V3 (or later) can be administered as itself.

TABLE 2-G. DEFINITY G1 and System 75 Terminal and Module Administration

PCs AND DIGITAL MODULES	SYSTEM			
	S75 R1V1	S75 R1V2	S75 R1V3	G1 and G3
PC/PBX PLATFORM	7405D DD & DM	PC		
MPDM	S			
MTDM	S			
7400A DM	PDM or TDM (modem pool only)			S
7400B & 7400B Plus DM	PDM (data only) or DM (voice and data)			S
High Speed Link	PDM			
3270A DCP	PDM			
3270C DCP	PDM			
3270T DCP	PDM			
PC/ISDN PLATFORM	X	X	X	X

S = Administered as Self
 X = Not Allowed
 PC = Personal Computer
 DD = Digital Display Module
 DM = Data Module
 TDM = Trunk Data Module
 PDM = Processor Data Module

TABLE 2-H. DEFINITY G2 and System 85 Voice Terminal Administration

VOICE TERMINAL	SYSTEM				
	S85 R2V1	S85 R2V2	S85 R2V3	S85 R2V4	G2
500			A		
2500			A		
2500 YMGK			A		
7101A			A		
7102A			A		
7102 Plus			A		
7103A			A		
7104A			A		
10 MET			7203H		
20 MET			7205H		
30 MET			7205H		
"MERLIN" SMALL			X		
"MERLIN" MEDIUM			7303S		
"MERLIN" LARGE			7305S		
7401D		7403D		S	
7401 Plus		7403D		7401D	
7402 Plus		7403D		7410D	
7404	7403D DM		S		
7406D		7405D DD		S	
7406BIS		7405D DD		S	
7406 Plus		7405D DD		7406D or 7406BIS	
7407D	7405 DD		S		
Enhanced 7407D	7405D DD		7407D		
7407 Plus	7405D DD		7407D		

X = Not Allowed

A = Administered as Analog On-premises or Off-premises

S = Administered as Self

DD = Digital Display Module

DM = Data Module (DTDM or ADS)

TABLE 2-H (continued).
DEFINITY G2 and System 85 Voice Terminal Administration

VOICE TERMINAL	SYSTEM				
	S85 R2V1	S85 R2V2	S85 R2V3	S85 R2V4	G2
7410D	7403D				S
7410 Plus	7403D				7410D
7434D	7405D				S
7444	7405D DD	7405D DD or 7407D*			7434D or 7407D*
8403	7405				
8410B	7403				7410D
8410D	7405+D				

S = Administered as Self

DD = Digital Display Module

*CAVEATS for administration of the 7444 voice terminal:

If the 7444 voice terminal is administered as a 7405D or a 7407D, the following caveats apply:

- Only 10 call appearance buttons can be administered with two lights, a red and a green light.
- If the voice terminal is administered as a 7407D, the S1 switch on the back of the 7444 voice terminal must be in the OFF position.

When the 7444 voice terminal is administered as a 7405D or a 7434 voice terminal, the following caveats apply:

- The S1 switch on the back of the 7444 voice terminal must be in the ON position.
- Only one line of the display will show switch-related information.

When a 7444 is administered as a 7434, DEFINITY G1 allows a maximum of 10 appearances of the primary line while DEFINITY G2 allows a maximum of 12 appearances. Each switch handles appearances of other lines (that is, lines used in Bridging, Call Pickup, etc.) in a different manner. Information about administering these appearances can be found in switch documentation and help screens.

TABLE 2-H (continued).
DEFINITY G2 and System 85 Voice Terminal Administration

VOICE TERMINAL	SYSTEM				
	S85 R2V1	S85 R2V2	S85 R2V3	S85 R2V4	G2
8434 (for extra features)*	7405+D+F				
8434 (for additional coverage)*	X				7434+D
602 CALLMASTER	X	S			
CALLMASTER II & III	X	602 CALLMASTER			
7505 ISDN	X				S
7506 ISDN	X				S
7507 ISDN	X				S
8503T	X				7505
8510T	X				7507
8520T	X				7507
MDC 9000	7303S Hybrid				
MDW 9000	7303S Hybrid				

X = Not Allowed

A = Administered as Analog On-premises or Off-premises

S = Administered as Self

* CAVEATS for administration of the 8434 voice terminal:

The 8434 may be aliased as a 7405+D+F to support all system features. However, in this case, while all the call appearance/feature buttons AND the softkey features will be functional, there can be a maximum of only 10 call appearances. On the 7405, the Display Module is a 1-line display, and thus the 1-line display option should be selected.

On some systems, the 8434 can be aliased as a 7434+D or a 7444 to support coverage. In this case, there can be up to 34 call appearances (including bridged call appearances), but the 15 softkey features will NOT be functional because the Feature Key Module is not allowed with the 7434 or 7444. On the 7434, the Display Module is a 1-line display, and thus the 1-line display option should be selected. If the set is administered as a 7444, it can be optioned for a 2-line display.

TABLE 2-I. DEFINITY G2 and System 85 Terminal and Module Administration

DISPLAY TERMINALS AND DIGITAL MODULES	SYSTEM				
	S85 R2V1	S85 R2V2	S85 R2V3	S85 R2V4	G2
PC/PBX PLATFORM	7405D DD & DM	PT 510D		PC	
BCT 513	X		EIA PORT		
MPDM	PDM				
MTDM	TDM				
7400A DM	PDM or TDM (modem pool only)				S
7400B & 7400B Plus DM	PDM (data only) or DM (voice and data)				S
7500B DM	X				S
High Speed Link	PDM				
3270A DCP	PDM				
3270C DCP	PDM				
3270T DCP	PDM				
PC/ISDN PLATFORM	X				GTA

S = Administered as Self
 X = Not Allowed
 PC = Personal Computer
 DD = Digital Data Module
 DM = Data Module
 PDM = Processor Data Module
 TDM = Trunk Data Module
 GTA = Generalized Terminal Administration (see System 85 and DEFINITY G2
 Button and Feature Caveats section)

Button and Feature Caveats

System 75 and DEFINITY G1

TERMINAL	ALIASED AS	SWITCH RELEASE	BUTTONS THAT DO NOT EXIST*	DO NOT ASSIGN FEATURES TO BUTTON(S)
7401D	7403D	R1V1—R1V3	10	—
7406D01A— 7406D04A	7405D (Note 1)	R1V1	6—10, 19—24	—
7406D05A, 7406D06A	7405D (Note 1)	R1V1	6—10, 19—24	2, 3 (Note 2)
	Self	R1V2—R1V3, G1	—	2, 3 (Note 2)
CALLMASTER II & III	602 CALLMASTER	R1V3 (Note 3)	7—10	22 and 28 (Note 4)

* Do not assign features to these buttons.

Notes:

- 7406D02A, 7406D04A, and 7406D06A aliased as 7405D;
7406D02A, 7406D04A, and 7406D06A w/ 7400B Plus aliased as 7405D w/ DM;
7406D01A, 7406D03A, and 7406D05A aliased as 7405D w/ DD;
7406D01A, 7406D03A, and 7406D05A w/ 7400B Plus aliased as 7405D w/ DM and DD;
7406D01A and 7406D02A w/ Z703A DSU aliased as 7405D w/ DM and DD.
- Reserved for Speaker and Mute.
- Not supported in earlier releases.
- These buttons are used for the Log in and Release features.

System 85 and DEFINITY G2

TERMINAL	ALIASED AS	SWITCH RELEASE	BUTTONS THAT DO NOT EXIST*	DO NOT ASSIGN FEATURES TO BUTTON(S)
7401D	7403D	R2V1—R2V3	12	—
7406D01A— 7406D04A	7405D (Note 1)	R2V1—R2V3	8—12, 31—36	—
7406D05A, 7406D06A	7405D (Note 1)	R2V1—R2V3	8—12, 31—36	14, 15 (Note 2)
	Self	R2V4—G2	—	14, 15 (Note 2)
CALLMASTER II & III	602 CALLMASTER	R2V2—R2V4 (Note 3)	9—12	24 and 30 (Note 4)

* Do not assign features to these buttons.

Notes:

1. 7406D02A, 7406D04A, and 7406D06A aliased as 7405D;
7406D02A, 7406D04A, and 7406D06A w/ 7400B Plus aliased as 7405D w/ DM;
7406D01A, 7406D03A, and 7406D05A aliased as 7405D w/ DD;
7406D01A, 7406D03A, and 7406D05A w/ 7400B Plus aliased as 7405D w/ DM and DD;
7406D01A and 7406D02A w/ Z703A DSU aliased as 7405D w/ DM and DD.
2. Reserved for Speaker and Mute.
3. Not supported in R2V1.
4. These buttons are used for the Log In and Release features.

PC/ISDN Platform (DEFINITY G2). To administer the PC/ISDN Platform, the Generalized Terminal Administration (GTA) capability of DEFINITY G2 must be used. Below is an overview of how to administer it. See the *PC/ISDN Installation and Reference Manual* for detailed instructions.

PC/ISDN Administration on DEFINITY G2. Ordinary BRI terminals used with DEFINITY G2 require initialization. They also support Maintenance Information Messages (MIMs). Because PC/ISDN supports neither MIMs nor terminal initialization, the system administrator must have created a *terminal type* for each type of terminal being used with PC/ISDN. If the terminal is to have an associated display, the display type must be changed to 6 for *personal computer*. Each terminal thus created is simply a copy of the terminal type for the terminal at hand with the ISDN-MIM feature set to *None* and the display type set to 6. For example, if the terminal to be administered is an AT&T model 7507, the system administrator might copy the 7507 terminal (type 57) to a new terminal type (e.g., type 157) and modify it to exclude support of the ISDN-MIM feature.

VOICE TERMINAL FEATURES

The DEFINITY G1, G2, G3, System 75 and 85 voice terminals provide a wide range of features. The following tables provide information on the major features of a particular type of telephone or voice terminal.

- **Table A** shows the features that are available with single-line voice terminals and the 7401D and 7401 Plus voice terminals.
- **Table B** shows the features that are available with multi-appearance hybrid voice terminals.
- **Table C** shows the features that are available with multiple-appearance digital voice terminals.
- **Table D** shows the features available with the ISDN voice terminals.

TABLE 3-A. Single-Line (and 7401) Voice Terminal Features

PHYSICAL FEATURES	VOICE TERMINALS						
	500	2500/ 2554	2500 DMGC	2500 YMGK	2500 MMGL	2500 YMGL	7101A
Analog	√	√	√	√	√	√	√
Digital							
Touch-Tone Dial		√	√	√	√	√	√
Rotary Dial	√						
Message Light			√	√		√	√
Dial Access to Features	√	√	√	√	√	√	√
Built-in Digital Display							
Feature-only Buttons							
Recall Button			√	√			√
Mute Button						√	
Flash Button						√	
Redial Button						√	
Hold Button						√	
Disconnect Button							√
Built-in "Listen-Only" Speaker							
Personalized Ringing							
User Programming Button							
Tone Ringing			√	√	√	√	√
Feature/Call Activity Light							
Optional Enhancements							
Message Waiting Adjunct		√					
Headset Adapter							
External Speakerphone							

TABLE 3-A (continued).
Single-Line (and 7401) Voice Terminal Features

PHYSICAL FEATURES	VOICE TERMINALS				
	7102A	7102 Plus	7103A FIXED	7103A PROG.	7104A
Analog	√	√	√	√	√
Digital					
Touch-Tone Dial	√	√	√	√	√
Message Light	√	√	√	√	
Dial Access to Features	√	√	√	√	√
Built-in Digital Display				√	
Feature-only Buttons			8	10	16
Hold Button					
Recall Button	√	√	√	√	√
Flash Button					
Built-in "Listen-Only" Speaker				√	
Disconnect Button			√	√	
Personalized Ringing			√	√	√
Last Number Dialed (or Redial) Button				√	
User Programming Button				√	√
Pause Button					
Auto Answer Button					
Built-in Speakerphone					
Tone Ringing	√	√	√	√	√
Feature/Call Activity Light					
Optional Enhancements					
Headset Adapter		√	√	√	
External Speakerphone		√	√	√	

TABLE 3-A (continued).
Single-Line (and 7401) Voice Terminal Features

PHYSICAL FEATURES	VOICE TERMINALS				
	7401D*	7401 Plus	8101	8102	8110
Analog			√	√	√
Digital	√	√			
Touch-Tone Dial	√	√	√	√	√
Message Light	√	√	√	√	√
Dial Access to Features	√	√	√	√	√
Built-in Digital Display					
Feature-only Buttons					
Hold Button			√	√	√
Recall Button					
Flash Button			√	√	√
Redial Button			√	√	√
Built-in "Listen-Only" Speaker					
Disconnect Button					
Personalized Ringing	√	√	√	√	√
User Programming Button				√	√
Pause Button				√	√
Auto Answer Button					√
Built-in Speakerphone					√
Tone Ringing	√	√	√	√	√
Adjunct Equipment Jack		√		√	
Optional Equipment					
Headset Adapter		√		√	
External Speakerphone		√		√	

* This model has two "virtual" appearances, but no call appearance buttons.

TABLE 3-B. Multi-Appearance Hybrid Voice Terminal Features

PHYSICAL FEATURES	VOICE TERMINALS			
	7203H	7205H	7303S	7305S
Call Appearance/ Feature Buttons with In-Use and Status Lights	10	10	10	10
Feature-only Buttons		24		24
Dial and Buttons Access to Features	√	√	√	√
Conference, Transfer, Hold, and Drop Buttons	√	√	√	√
Disconnect Button	√	√		
Recall Button	√	√	√	√
Self-Test Switch			√	√
Message Light	√	√	√	√
Built-in "Listen Only" Speaker			√	√
Built-in Digital Display				
Built-in Speakerphone				
Built-in Calculator				
Personalized Ringing				
Built-in Data Module and Data Call in Progress Light				

TABLE 3-B (continued).
Multi-Appearance Hybrid Voice Terminal Features

PHYSICAL FEATURES	VOICE TERMINALS			
	7203H	7205H	7303S	7305S
AC Powered				
DC Powered	√	√	√	√
Optional Enhancements				
Headset Adapter	√	√	√	√
External Speakerphone	√	√	√	√
Digital Terminal Data Module				
Data Module Base				
Call Coverage Module		√		
Function Key Module		√		
Digital Display Module				
Messaging Cartridge				

TABLE 3-C. Multi-Appearance Digital Voice Terminal Features

PHYSICAL FEATURES	VOICE TERMINALS						
	7402 Plus	7403D	7404D	7405D	7406D	7406BIS	7406 Plus
Call Appearance/ Feature Buttons	6	10	6	10	5	5	5
Feature-Only Buttons				24	3	1	
Shiftable Feature Buttons					8	8	9
Dial and Buttons Access to Features	√	√	√	√	√	√	√
Conference, Transfer, Hold, and Drop Buttons	√	√	√	√	√	√	√
Disconnect Button		√		√			
Self-Test Capability	√	√	√	√		√	√
Message Light	√	√	√	√	√	√	√
Built-in Speakerphone	√ (Note 1)				√ (Note 1)	√	√
Reset Speakerphone Capability							√
Mute Button						√	√
Built-in Digital Display					√ (Note 2)	√ (Note 2)	√ (Note 2)
Personalized Ringing	√				√	√	√
Built-in Data Module and Data Call in Progress Light			√				

Note 1. The 7402 Plus and 7406D01A—7406D04A voice terminals have a “listen-only” speaker.

Note 2. The following 7406 sets have built-in displays: 7406D01A, 7406D03A, 7406D05A, and 7406D07A.

TABLE 3-C (continued).
Multi-Appearance Digital Voice Terminal Features

PHYSICAL FEATURES	VOICE TERMINALS						
	7402 Plus	7403D	7404D	7405D	7406D	7406BIS	7406 Plus
AC Powered			√				
DC Powered (supplied by PBX)	√	√		√	√	√	√
Optional Enhancements							
Headset Adapter	√	√		√	√	√	√
External Speakerphone	√	√		√	√	√	√
Digital Terminal Data Module		√		√			
Data Module Base					√		
Call Coverage Module				√			
Function Key Module				√			
Digital Display Module				√			
Messaging Cartridge			√				
7400B+ Data Module	√	√	√	√	√	√	√

TABLE 3-C (continued).
Multi-Appearance Digital Voice Terminal Features

PHYSICAL FEATURES	VOICE TERMINALS						
	7407	Enhd 7407	7407 Plus	7410	7410 Plus	7434D	7444
Call Appearance/ Feature Buttons	10	10	10	10	10	34	34
Feature-only Buttons	11	24	24				
Dual-Function Feature Buttons	11						
Display Control Buttons	7	7	7				
Dial and Buttons Access to Features	√	√	√	√	√	√	√
Conference, Transfer, Hold, and Drop Buttons	√	√	√	√	√	√	√
Self-Test Capability	√	√	√	√	√	√	√
Message Light	√	√	√	√	√	√	√
Built-in Speakerphone	√	√	√		√ (Note 3)		√
Reset Speakerphone Capability			√				√
Mute Button		√	√				√
Built-in Digital Display	√	√	√				√
Personalized Ringing	√	√	√	√	√	√	√

Note 3. The 7410D02A voice terminal has a “listen-only” speaker.

TABLE 3-C (continued).
Multi-Appearance Digital Voice Terminal Features

PHYSICAL FEATURES	VOICE TERMINALS						
	7407D	Enhd 7407	7407 Plus	7410	7410 Plus	7434D	7444
AC Powered	√						
DC Powered (supplied by PBX)		√	√	√	√	√	√
Optional Enhancements							
Headset Adapter		√	√	√	√	√	√
External Speakerphone		√	√	√	√	√	√
Digital Terminal Data Module							
Data Module Base	√						
Call Coverage Module						√	
Function Key Module							
Digital Display Module						√	
7400B+ Data Module	√	√	√	√	√	√	√

TABLE 3-C (continued).
Multi-Appearance Digital Voice Terminal Features

PHYSICAL FEATURES	VOICE TERMINALS				
	8403	8410	8434	602CM	CM II & III
Call Appearance/ Feature Buttons	3	10	34	10	6
Feature-only Buttons				17	15
Dial and Buttons Access to Features	√	√	√	√	√
Conference, Transfer, Hold, and Drop Buttons	√	√	√	√	√
Softkeys		4	5		
Available Softkey Features		12	15		
Self-Test Capability	√	√	√	√	√
Message Light	√	√	√	√	√
Built-in Speakerphone	√ (Note 4)	√	√		
Reset Speakerphone Capability		√	√		
Mute Button	√	√	√	√	√
Built-in Digital Display		√ (Note 5)	√	√	√
Personalized Ringing	√	√	√	√	√

Note 4. The 8403 voice terminal has a “listen-only” speaker.

Note 5. Only the 8410D has a built-in display.

TABLE 3-C (continued).
Multi-Appearance Digital Voice Terminal Features

PHYSICAL FEATURES	VOICE TERMINALS				
	8403	8410	8434	602 CM	CM II & III
AC Powered					
DC Powered (supplied by PBX)	√	√	√ (Note 6)	√	√
Optional Enhancements					
Headset Adapter	√	√	√	√	√
External Speakerphone	√	√	√	√	√
Digital Terminal Data Module					
Data Module Base					
Call Coverage Module					
Function Key Module					
Digital Display Module					
7400B+ Data Module	√	√	√	√	√

Note 6. In order to use the display on the 8434 voice terminal, you must connect an auxiliary power supply to the voice terminal. An MSP-1 Power Supply is recommended.

TABLE 3-D. Multi-Appearance ISDN Voice Terminal Features

PHYSICAL FEATURES	VOICE TERMINALS					
	7505	7506	7507	8503T	8510T	8520T
Call Appearance/ Feature Buttons with Lights	9 or 10* (Note 7)	9 or 10* (Note 7)	30 or 31* (Note 7)	3	10	20
Shiftable Feature Buttons	4	4				
Feature-Only Buttons			9			
Dial and Buttons Access to Features	√	√	√	√	√	√
Conference, Transfer, Hold, and Drop Buttons	√	√	√	√	√	√
Memory Dialing				√		
Message Light	√	√	√	√	√	√
Redial Button	√	√	√	√	√	√
Self-Test Capability	√	√	√	√	√	√
Built-in Speakerphone	√	√	√		√	√
Mute Button	√	√	√	√	√	√
Built-in Digital Display		√	√		√	√
Softkeys and Display Control Buttons					√	√
Personalized Ringing	√	√	√	√	√	√
Optional Enhancements						
Headset Adapter	√	√	√	√	√	√
Asynchronous Data Module	√	√	√		√	√

Note 7. If the 7505 or 7506 sets have data, there are only 9 (or 30) call appearance/feature buttons; if the 7507 terminal has data, there are 30 (rather than 31) call appearance/feature buttons.

7101A VOICE TERMINAL

MESSAGE

LIGHT

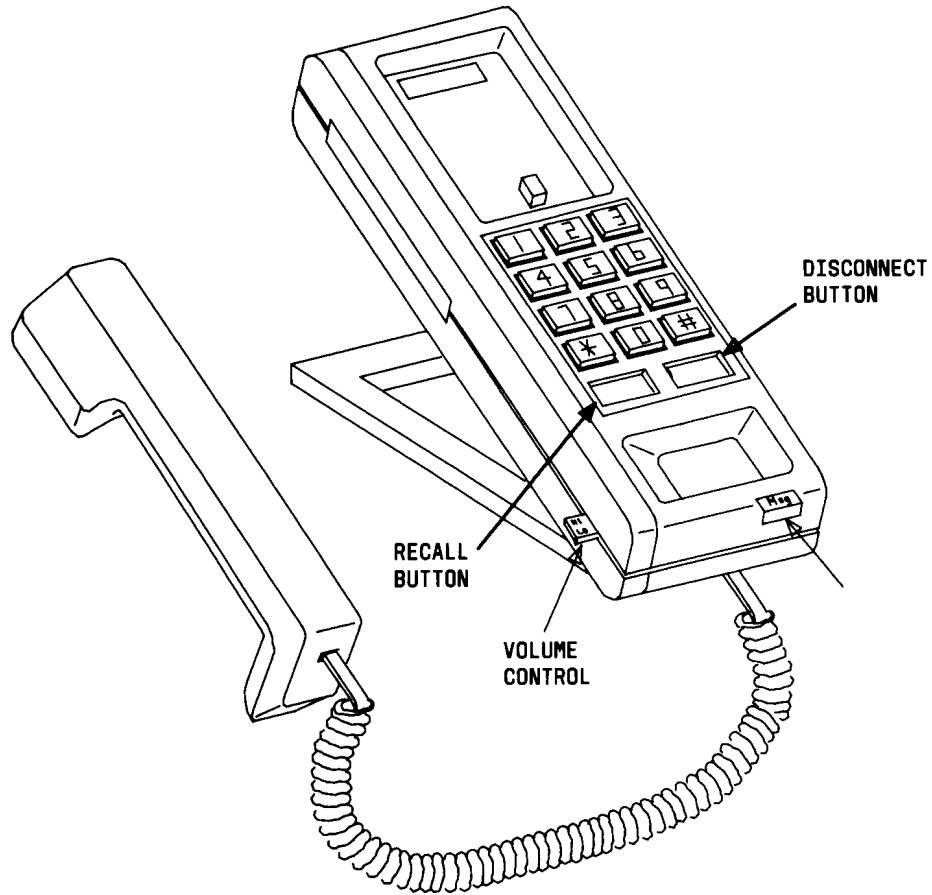

FIGURE 3-1. The 7101A Voice Terminal

7101A Voice Terminal

The 7101A voice terminal is a single-line analog model that requires one tip and ring pair for operation. It is equipped with a Message Waiting light and a handy Recall button for activating the system's special features. It cannot be physically bridged to the same analog line port due to the message waiting and loop current circuitry.

The 7101A is discontinued.

Applications

The 7101A terminal can be used with the DEFINITY G1, G2, G3, System 75, and System 85. This voice terminal is especially suitable for manufacturing, warehousing, guard and/or reception areas, or office desks where multiple line appearances or one touch access to special features is not required.

Physical Description

Dimensions

Note: The following dimensions are approximate.

Width = 3-3/4 inches

Depth (front to back) = 8-3/4 inches

Height (maximum with handset in place) = 5-1/2 inches

Thickness of housing = 1-1/2 inches

Features

Two Fixed Feature Buttons

- RECALL button
- DISCONNECT button

Message Light

The green Message light goes on when a message is left for the user. It goes off when the user retrieves the message.

Other Physical Features

Handset

The 7101A is equipped with an R-type handset.

Dial pad

The 7101A is equipped with a 12-button touch-tone dial pad.

Jacks

The 7101A housing contains two jacks. The handset cord jack is just under the left front edge of the housing. The LINE jack is on the bottom center of the housing. The handset contains a jack for the handset cord.

Cords

Two cords are supplied with the 7101A terminal: a coiled 7-foot modular handset cord and a 7-foot modular line cord. Optional longer cords are available: a 12-foot handset cord; 14-foot and 25-foot line cords.

Ringling

The 7101A has electronic tone ringling. The volume control is on the left side of the housing.

Mounting Options

The 7101A comes equipped with a non-adjustable desk stand. An optional wall mounting kit may be ordered.

Color Options

The 7101A is available in black only.

Distance Limitations

The maximum allowable distances of a 7101A from the DEFINITY G1, G2, G3, System 75, or System 85 cabinet are shown in the table below.

SYSTEM	PORT BOARD	NOMINAL MAXIMUM RANGE IN FEET (METERS)		SEE NOTE
		24 AWG	26 AWG	
SYSTEM 85	SN229	3,500 (1,067)	3,500 (1,067)	—
	SN228B	15,000 (4,572)	9,000 (2,743)	—
DEFINITY G2	SN229	3,500 (1,067)	3,500 (1,067)	—
	SN228B	15,000 (4,572)	9,000 (2,743)	—
	TN742	15,200 (4,633)	10,000 (3,050)	—
	TN746	—	—	1
DEFINITY G1 and G3 SYSTEM 75	TN742	15,200 (4,633)	10,000 (3,050)	—
	TN769	15,200 (4,633)	10,000 (3,050)	—
	TN746	—	—	1

1. The 7101A cannot be used with the TN746 Port Circuit Pack.

Power Requirements

The 7101A is powered by the tip and ring leads. It does not require any external power supply.

Power Failure Operation

The 7101A cannot be used as an emergency station during power failure transfer conditions.

FCC Registration

The 7101A is not FCC registered.

Hearing Aid Compatible

This voice terminal is compatible with the inductively coupled hearing aids prescribed by the FCC.

7101A Equipment Price Element Code (PECs)

The 7101A Voice Terminal and optional components can be ordered with the following PECs:

- Basic voice terminal (black)—3170-00M
- Handset cord (12 feet, black)—2725-01L COL09
- Line cord (14 feet, silver)—2725-07N COL18
- Line cord (25 feet, silver)—2725-07S COL18

Adjuncts

None.

Additional Documents

The following documents contain additional information relating to the 7101A Voice Terminal:

- *DEFINITY Generic 1 and System 75 7101A Voice Terminal User's Guide*, 555-200-709
- *DEFINITY Generic 2 and System 85 7101A Voice Terminal User's Guide*, 999-700-047
- *DEFINITY Generic 1 and Generic 2, System 75, and System 85 Terminals and Adjuncts Installation and Test*, 555-015-104

7102A and 7102 Plus VOICE TERMINALS

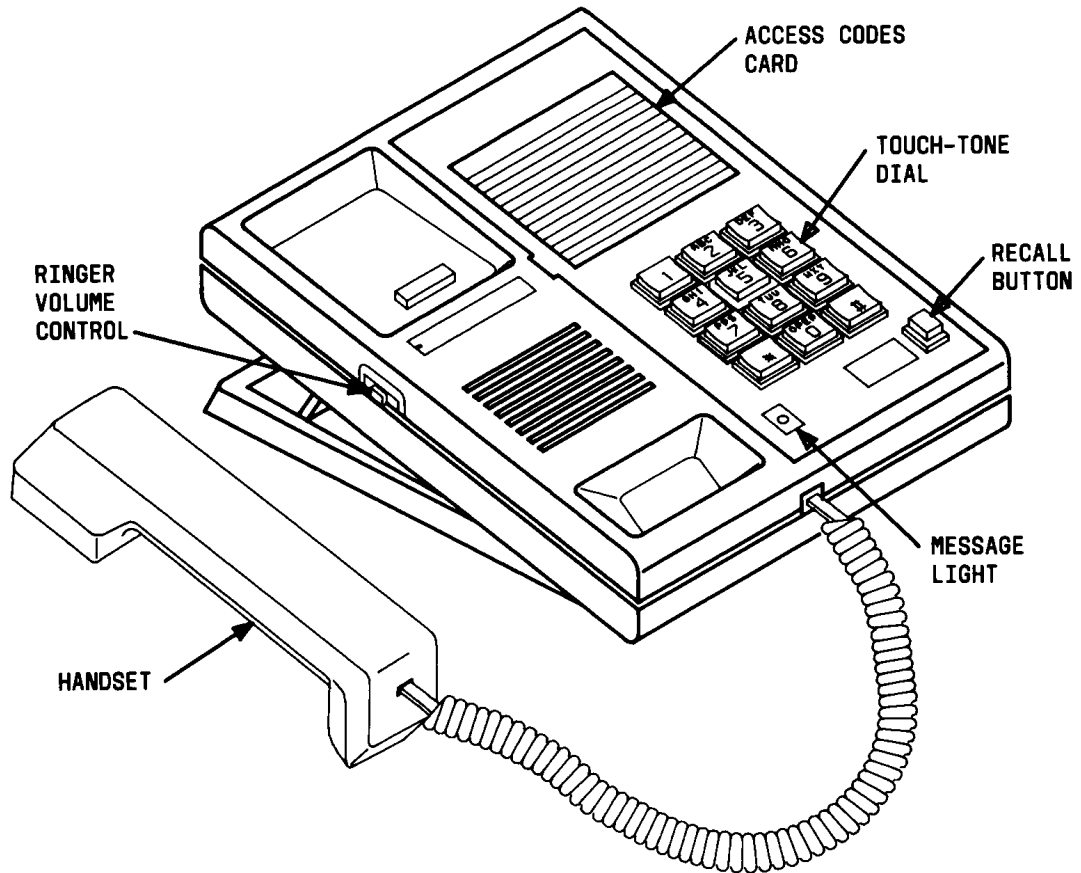

FIGURE 3-2. The 7102A and 7102 Plus Voice Terminal

7102A and 7102 Plus Voice Terminals

The 7102A voice terminal is available in two versions, the 7102A01A and the 710201B, called the 7102 Plus. The front of the two sets is exactly the same in appearance. The only difference is that the 7102A01B is equipped with an adjunct jack. This jack allows speakerphone/headset capability.

The 7102A and the 7102 Plus voice terminals are single-line analog models that require one tip and ring pair for operation. It allows access to system features via the Recall Button and dial codes. The 7102A and 7102 Plus voice terminal faceplate contains a Feature Access Code Card that can be customized to reflect the most frequently accessed features.

Both of the 7102 voice terminals have been discontinued, but continue to be supported.

Applications

The 7102A and 7102 Plus voice terminals can be used with the DEFINITY G1, G2, G3, System 75, and System 85. The 7102 voice terminals are especially suitable for manufacturing, warehousing, guard and/or reception areas, or office desks where multiple line appearances or one-touch access to special features is not required.

Physical Description

Dimensions

Note: The following dimensions for the 7102A and the 7102 Plus are approximate.

Width = 7 inches

Depth (front to back) = 8-3/4 inches

Height (maximum with handset in place) = 5-1/2 inches

Thickness of housing = 1-1/2 inches

Features

One Fixed Feature Button

- The RECALL Button

Message Light

The red Message light flashes when a message is left for the user. It goes off when the user retrieves the message.

Other Physical Features

Handset

The 7102 voice terminals are equipped with an R-type handset.

Dial Pad

The 7102 voice terminals are equipped with a 12-button touch-tone dial pad.

Jacks

The 7102A01A housing contains two jacks. The handset cord jack is just under the center front edge of the housing. The LINE jack is on the bottom center of the housing. The handset contains a jack for the handset cord.

The 7102 Plus housing contains three jacks. The handset cord jack is just under the center front edge of the housing. The handset contains a jack for the handset cord. The LINE jack is on the bottom center of the housing. The modular speakerphone/headset jack is located on bottom of the set.

Cords

Two cords are supplied with the 7102 voice terminals: a coiled 7-foot modular handset cord and a 7-foot modular line cord. Optional longer cords are available: a 12-foot handset cord; 14-foot and 25-foot line cords.

Ringling

The 7102 voice terminals have electronic tone ringling. The volume control is on the left side of the housing.

Mounting Options

The 7102 voice terminals come equipped with both a non-adjustable desk stand and a wall mounting bracket.

Color Options

The 7102 voice terminals are available in two colors: black and misty cream.

Distance Limitations

The maximum allowable distances of a 7102A or 7102 Plus voice terminal from the DEFINITY G1, G2, G3, System 75, or System 85 cabinet are shown in the table below.

SYSTEM	PORT BOARD	NOMINAL MAXIMUM RANGE IN FEET (METERS)	
		24 AWG	26 AWG
SYSTEM 85	SN229	3,500 (1,067)	3,500 (1,067)
	SN228B	28,400 (8,662)	17,900 (5,460)
DEFINITY G2	SN229	3,500 (1,067)	3,500 (1,067)
	SN228B	28,400 (8,662)	17,900 (5,460)
	TN742	15,200 (4,633)	10,000 (3,050)
	TN746	3,000 (915)	2,000 (610)
DEFINITY G1 & G3 SYSTEM 75	TN742	15,200 (4,633)	10,000 (3,050)
	TN769	15,200 (4,633)	10,000 (3,050)
	TN746	3,000 (915)	2,000 (610)

Power Requirements

The 7102 voice terminals are powered by the tip and ring leads. These voice terminals do not require any external power supply.

Power Failure Operation

The 7102A and the 7102 Plus voice terminals can be used as an emergency station during power failure transfer conditions but will not support any adjuncts.

If the 7102A or 7102 Plus voice terminal is being used as an emergency station for a DEFINITY G1 or G3 or System 75 that is equipped with a Z1A Emergency Transfer Unit, a ground start switch (551A and 77A bracket) is required. Installation instructions can be found in the *DEFINITY Communications System Generic 1 and Generic 3 Wiring Guide*, 555-204-111.

FCC Registration

The 7102 voice terminals are FCC registered (AS-593M-17706-TE-T).

Hearing Aid Compatible

This voice terminal is compatible with the inductively coupled hearing aids prescribed by the FCC.

7102 Equipment Price Element Code (PECs)

The 7102A and the 7102 Plus voice terminals and optional components can be ordered with the following PECs:

- 7102A voice terminal (black and misty cream)—3185-MWR (not orderable)
- 7102 Plus voice terminal (black and misty cream)—3188-MWS (not orderable)
- Handset cord (12 feet, black)—2725-01L COL09
- Line cord (14 feet, silver)—2725-07N COL18
- Line cord (25 feet, silver)—2725-07S COL18

Adjuncts

The 7102A01A cannot be equipped with any adjuncts. The 7102A01B can be equipped with one of the following adjuncts:

- S101A Speakerphone
- S201A Speakerphone
- 500A Headset Adapter with a standard headset

Additional Documents

The following documents contain additional information relating to the 7102A voice terminal:

- *DEFINITY Generic 1 7102 Voice Terminal User's Guide*, 555-204-728
- *System 75 7102 Voice Terminal User's Guide*, 555-200-728

- *DEFINITY Generic 2 and System 85 7102 Voice Terminal User's Guide* , 555-104-715
- *DEFINITY Generic 1 and Generic 2, System 75, and System 85 Terminals and Adjuncts Installation and Test*, 555-015-104

7103A FIXED FEATURE VOICE TERMINAL

MESSAGE

LIGHT

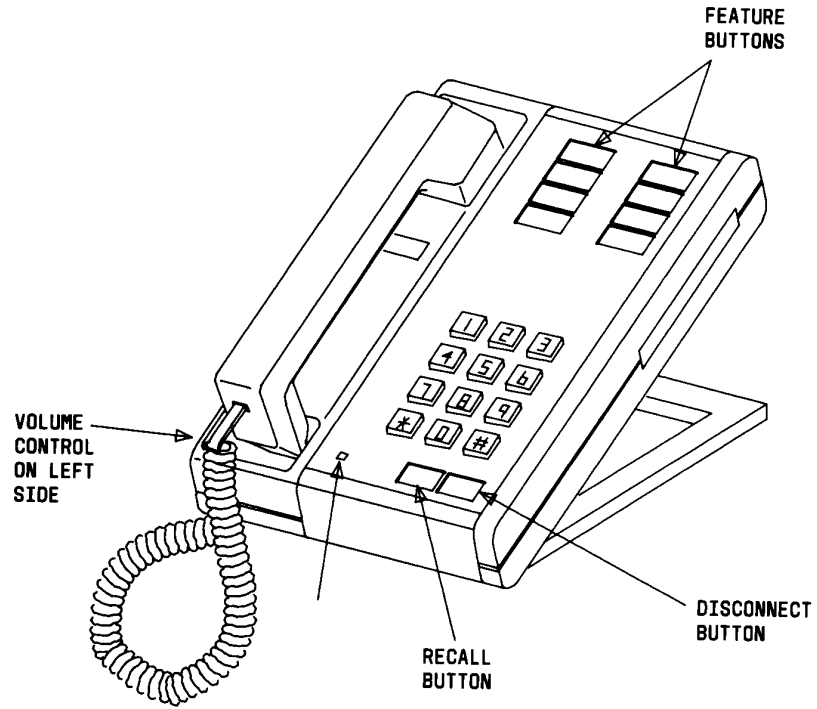

FIGURE 3-3. The 7103A Fixed Feature Voice Terminal

7103A Fixed Feature Voice Terminal

The 7103A Fixed Feature voice terminal is a single-line analog model which has been discontinued. The feature buttons on this terminal must be programmed by the system manager. It requires one tip and ring pair for operation. It cannot be physically bridged to the same analog line port due to the message waiting and loop current circuitry.

Applications

The 7103A voice terminal can be used with the DEFINITY G1, G2, G3, System 75, and System 85. This voice terminal is especially suitable for groups of office workers who make frequent calls to the same destinations or use the same features.

Physical Description

Dimensions

Note: The following dimensions are approximate.

Width = 7 inches

Depth (front to back) = 8-3/4 inches

Height (maximum with handset in place) = 5-1/2 inches

Thickness of housing = 1-1/2 inches

Features

Two Fixed Feature Buttons

- RECALL button
- DISCONNECT button

Eight Feature Buttons

The System Manager designates and programs all buttons, except fixed feature buttons, for the common needs of all voice terminal users. Within any one system, all 7103A Fixed Feature voice terminals have identical features at the same button positions.

Message Light

The green Message light goes on when a message is left for the user. It goes off when the user retrieves the message.

Other Physical Features

Handset

The 7103A voice terminal is equipped with an R-type handset.

Dial pad

The 7103A voice terminal is equipped with a 12-button touch-tone dial pad.

Jacks

The 7103A voice terminal housing contains three jacks. The handset cord jack is just under the left side of the housing. The LINE and OTHER jacks are on the bottom center of the housing. The handset contains a jack for the handset cord.

Cords

Two cords are supplied with the 7103A voice terminal: a coiled 7-foot modular handset cord and a 7-foot modular line cord. Optional longer cords are available: a 12-foot handset cord; 14-foot and 25-foot line cords.

Ringling

The 7103A voice terminal has electronic tone ringling. The volume control is on the left side of the housing.

Mounting Options

The 7103A voice terminal comes equipped with a nonadjustable desk stand. An adjustable desk stand or a wall mounting bracket can be optionally ordered.

Color Options

The 7103A voice terminal is available in black only.

Distance Limitations

The maximum allowable distances of a 7103A voice terminal from the DEFINITY G1, G2, G3, System 75, or System 85 cabinet are shown in the table below.

SYSTEM	PORT BOARD	NOMINAL MAXIMUM RANGE IN FEET (METERS)		SEE NOTE
		24 AWG	26 AWG	
SYSTEM 85	SN229	3,500 (1,067)	3,500 (1,067)	—
	SN228B	15,000 (4,572)	9,000 (2,743)	—
DEFINITY G2	SN229	3,500 (1,067)	3,500 (1,067)	—
	SN228B	15,000 (4,572)	9,000 (2,743)	—
	TN742	15,200 (4,633)	10,000 (3,050)	—
	TN746	—	—	1
DEFINITY G1 & G3 SYSTEM 75	TN742	15,200 (4,633)	10,000 (3,050)	—
	TN769	15,200 (4,633)	10,000 (3,050)	—
	TN746	—	—	1

1. The 7103A cannot be used with the TN746 Port Circuit Pack.

Power Requirements

The 7103A voice terminal is powered by the tip and ring leads. If the 7103A voice terminal is equipped with any adjunct, auxiliary power will be required for the adjunct. Refer to the ADJUNCT POWER section of this manual.

Power Failure Operation

The 7103A voice terminal cannot be used as an emergency station during power failure transfer conditions.

FCC Registration

The 7103A voice terminal is not FCC registered.

Hearing Aid Compatible

This voice terminal is compatible with the inductively coupled hearing aids prescribed by the FCC.

7103A (Fixed Feature) Equipment Price Element Code (PECs)

The 7103A voice terminal and optional components was ordered with the following PECs:

- Basic voice terminal—(not orderable)
- Handset cord (12 feet, black)—2725-01L COL09
- Line cord (14 feet, silver)—2725-07N COL18
- Line cord (25 feet, silver)—2725-07S COL18

Adjuncts

One of the following adjuncts can be used with this voice terminal:

- S101A Speakerphone
- S201A Speakerphone
- 500A Headset Adapter with a standard headset

Additional Documents

The following documents contain additional information relating to the 7103A voice terminal:

- *DEFINITY Generic 1 and System 75 7103A Voice Terminal User's Guide*, 555-200-710
- *DEFINITY Generic 2 and System 85 7103A Voice Terminal User's Guide*, 999-700-048
- *DEFINITY Generic 1 and Generic 2, System 75, and System 85 Terminals and Adjuncts Installation and Test*, 555-015-104

7103A PROGRAMMABLE VOICE TERMINAL

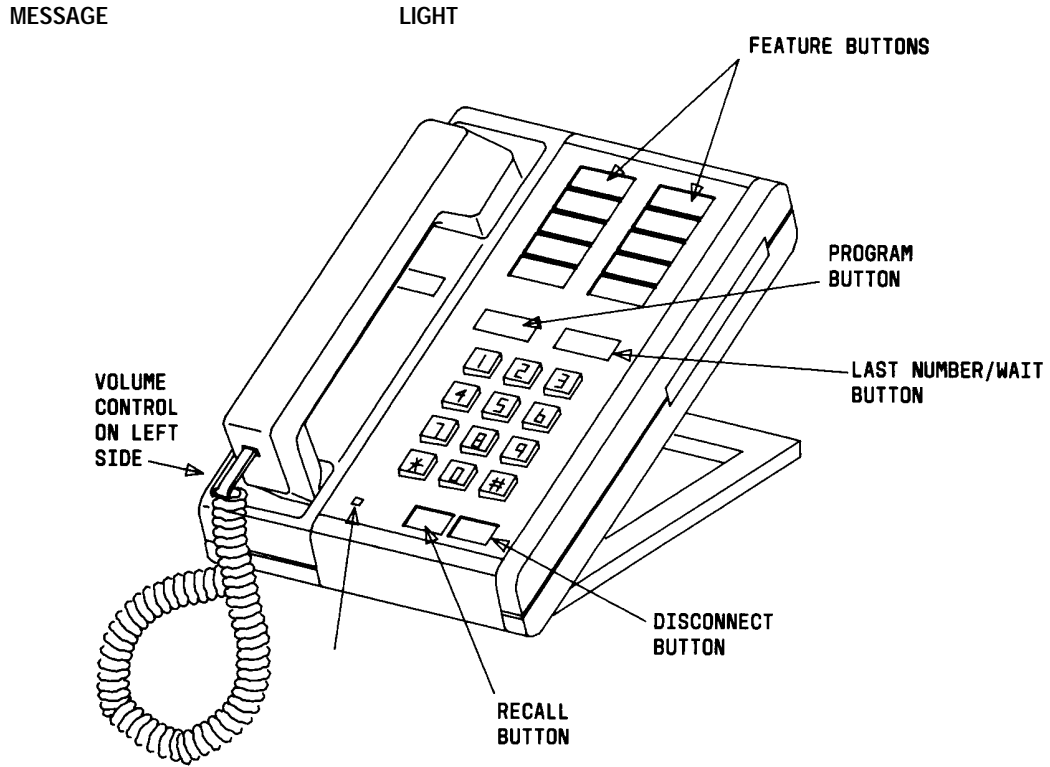

FIGURE 3-4. The 7103A Programmable Voice Terminal

7103A Programmable Voice Terminal

The 7103 Programmable voice terminal is a single-line analog model no longer manufactured. However, some remanufactured terminals may still be ordered. The 10 feature buttons can be programmed by the user for one-touch feature access or for one-touch Speed Dialing. It requires one tip and ring pair for operation. It cannot be physically bridged to the same analog line port due to the message waiting and loop current circuitry.

Applications

The 7103A voice terminal can be used with the DEFINITY G1, G2, G3, System 75, and System 85. This voice terminal is especially suitable for groups of office workers who make frequent calls to the same destinations or use the same features.

Physical Description

Dimensions

Note: The following dimensions are approximate.

Width = 7 inches

Depth (front to back) = 8-3/4 inches

Height (maximum with handset in place) = 5-1/2 inches

Thickness of housing = 1-1/2 inches

Features

Four Fixed Feature Buttons

- RECALL button
- DISCONNECT button
- LAST NUMBER/WAIT button —dual function button: In its normal (Last Number) mode, this button is used to automatically redial the last number dialed; in the Wait mode, it is used to enter a delay in a number being stored on a feature button.

- **PROGRAM button** —This button is used to enter mode for programming feature buttons for feature access or for Repertory Dialing. With the Repertory Dialing feature, the terminal user can store in-house or external numbers. Operation of this button also puts the Last Number/Wait button into the Wait mode.

Ten User-Programmable Feature Buttons

The 10 programmable buttons allow each user to enter often-used telephone numbers or choose the most desirable features provided by the system.

Message Light

The green Message light goes on when a message is left for the user. It goes off when the user retrieves the message.

Other Physical Features

Handset

The 7103A voice terminal is equipped with an R-type handset.

Dial pad

The 7103A voice terminal is equipped with a 12-button touch-tone dial pad.

Jacks

The 7103A voice terminal housing contains three jacks. The handset cord jack is just under the left side of the housing. The LINE and OTHER jacks are on the bottom center of the housing. The handset contains a jack for the handset cord.

Cords

Two cords are supplied with the 7103A voice terminal: a coiled 7-foot modular handset cord and a 7-foot modular line cord. Optional longer cords are available: a 12-foot handset cord; 14-foot and 25-foot line cords.

Ringling

The 7103A voice terminal has electronic tone personalized ringling. The personalized ringling is controlled by two ring switches on the bottom of the voice terminal. The volume control is on the left side of the housing.

Mounting Options

The 7103A voice terminal comes equipped with a nonadjustable desk stand. An adjustable desk stand or a wall mounting bracket can be optionally ordered.

Color Options

The 7103A voice terminal is available in black only.

Distance Limitations

The maximum allowable distances of a 7103A voice terminal from the DEFINITY G1, G2, G3, System 75, or System 85 cabinet are shown in the table below.

SYSTEM	PORT BOARD	NOMINAL MAXIMUM RANGE IN FEET (METERS)		SEE NOTE
		24 AWG	26 AWG	
SYSTEM 85	SN229	3,500 (1,067)	3,500 (1,067)	—
	SN228B	15,000 (4,572)	9,000 (2,743)	—
DEFINITY G2	SN229	3,500 (1,067)	3,500 (1,067)	—
	SN228B	15,000 (4,572)	9,000 (2,743)	—
	TN742	15,200 (4,633)	10,000 (3,050)	—
	TN746	—	—	1
DEFINITY G1 & G3 SYSTEM 75	TN742	15,200 (4,633)	10,000 (3,050)	—
	TN769	15,200 (4,633)	10,000 (3,050)	—
	TN746	—	—	1

1. The 7103A cannot be used with the TN746 Port Circuit Pack.

Power Requirements

The 7103A voice terminal is powered by the tip and ring leads. If the 7103A voice terminal is equipped with any adjunct, auxiliary power will be required for the adjunct. Refer to the **ADJUNCT POWER** section of this manual.

Power Failure Operation

The 7103A voice terminal cannot be used as an emergency station during power failure transfer conditions.

FCC Registration

The 7103A voice terminal is not FCC registered.

Hearing Aid Compatible

This voice terminal is compatible with the inductively coupled hearing aids prescribed by the FCC.

7103A (Programmable) Equipment Price Element Code (PECs)

The 7103A voice terminal and optional components can be ordered with the following PECs:

- Basic voice terminal—3171-14F
- Handset cord (12 feet, black)—2725-01L COL09
- Line cord (14 feet, silver)—2725-07N COL18
- Line cord (25 feet, silver)—2725-07S COL18

Adjuncts

One of the following adjuncts can be used with this voice terminal:

- S101A Speakerphone
- S102A Speakerphone
- 500A Headset Adapter with a standard headset

Additional Documents

The following documents contain additional information relating to the 7103A voice terminal:

- *DEFINITY Generic 1 and System 75 7103A Voice Terminal User's Guide*, 555-200-717
- *DEFINITY Generic 2 and System 85 7103A Voice Terminal User's Guide*, 999-700-464
- *DEFINITY Generic 1 and Generic 2, System 75, and System 85 Terminals and Adjuncts Installation and Test*, 555-015-104

7104A VOICE TERMINAL

Figure 1. The 7104A Voice Terminal

Figure 2. The 7104A Voice Terminal with attached Message Waiting Adjunct

7104A Voice Terminal

The 7104A voice terminal is a single-line analog model no longer manufactured. However, some remanufactured terminals may still be ordered. The 7104A voice terminal is equipped with a display that is used to display stored numbers. It requires one tip and ring pair for operation. It cannot be physically bridged to the same analog line port due to the message waiting and loop current circuitry.

Applications

The 7104A voice terminal can be used with the DEFINITY G1 and G3, and System 75. This voice terminal is especially suitable for managers, office support personnel, and others.

Physical Description

Dimensions

Note: The following dimensions are approximate.

Width = 8 inches

Depth (front to back) = 8-3/4 inches

Height (maximum with handset in place) = 5-1/2 inches

Thickness of housing = 1-1/2 inches

Features

Two Fixed Feature Buttons

- RECALL button
- DISCONNECT button

Eight Special Fixed Feature Buttons

- SHIFT button —used for toggling between the two modes of the following four dual function feature buttons and the eight dual function one-touch dialing buttons.
- SET CLOCK/TIMER button —used for setting time and for timing a call.
- AM/DLYD RING button —used in time-setting procedure and to delay ringing on incoming calls.
- PM/ABRV RING button —used in time-setting procedure and to provide abbreviated ringing on incoming calls.
- SAVE/SEND button —used to save a dialed number, then call it again.
- PROGRAM button —used in recording numbers for one-touch dialing.
- DISPLAY button —used to display stored numbers.
- SPACE, PAUSE, and STOP buttons —used in recording numbers for one-touch dialing.

Eight dual function buttons

These buttons are divided into gray and blue halves and can be programmed for one-touch dialing of sixteen frequently called numbers and/or system features.

Loudspeaker

The 7104A voice terminal has a built in loudspeaker for group listening and on-hook dialing. The loudspeaker can be turned on and off with the SPEAKER button.

Display

A 14-Character Liquid Crystal Display (LCD) provides the following displays. Each display is local to the individual terminal.

Abbreviated Ring mode in effect	Number programmed
Date	Program mode in effect
Delayed Ring mode in effect	Shift mode in effect
Display mode in effect	Speaker on
Low Battery	Time
Number called	

Pull out tray

The 7104A voice terminal is equipped with a pull out tray with an Instruction card for Voice Terminal operation.

Other Physical Features***Handset***

The 7104A voice terminal is equipped with an R-type handset.

Dial pad

The 7104A voice terminal is equipped with a 12-button touch-tone dial pad.

Jacks

The 7104A voice terminal housing contains two jacks. The handset cord jack is just under the left side of the housing. The LINE jack is on the bottom center of the housing. The handset contains a jack for the handset cord.

Cords

Two cords are supplied with the 7104A voice terminal: a coiled 7-foot modular handset cord and a 7-foot modular line cord. Optional longer cords are available: a 12-foot handset cord; 14-foot and 25-foot line cords.

Ringling

The 7104A voice terminal has electronic tone personalized ringling. The personalized ringling is controlled by a ring switch under the rear end cap of the voice terminal. The volume control is on the left side of the housing.

Mounting Options

The 7104A voice terminal comes equipped with a nonadjustable desk stand.

Color Options

The 7104A voice terminal is available in three colors: black, misty cream, and chocolate brown.

Distance Limitations

The maximum allowable distances of a 7104A voice terminal from the DEFINITY G1, G3 and System 75 cabinet are shown in the table below.

SYSTEM	PORT BOARD	NOMINAL MAXIMUM RANGE IN FEET (METERS)	
		24 AWG	26 AWG
DEFINITY G1 & G3 SYSTEM 75	TN742	15,200 (4,633)	10,000 (3,050)
	TN769	15,200 (4,633)	10,000 (3,050)
	TN746	3,000 (915)	2,000 (610)

Power Requirements

The 7104A voice terminal is powered by the tip and ring leads. Battery power is used for some circuits during the on-hook state when loop current is not available. The battery power is provided by four 1.5 volt AA batteries. The batteries are contained in a battery pack that is accessed through the rear end cap.

Power Failure Operation

The 7104A voice terminal cannot be used as an emergency station during power failure transfer conditions.

FCC Registration

The 7104A voice terminal is not FCC registered.

Hearing Aid Compatible

This voice terminal is compatible with the inductively coupled hearing aids prescribed by the FCC.

7104 Equipment Price Element Code (PECs)

The 7104A voice terminal and optional components can be ordered with the following PECs:

- Basic voice terminal (black, misty cream, and chocolate brown)—3150-010
- Handset cord (12 feet, black)—2725-01L COL09
- Line cord (14 feet, silver)—2725-07N COL18
- Line cord (25 feet, silver)—2725-07S COL18

Adjuncts

The optional Z34A Message waiting Adjunct can be used with this voice terminal to provide a visual message waiting indication.

Additional Documents

The following documents contain additional information relating to the 7104A voice terminal:

- *DEFINITY Generic 1 and System 75 7104A Voice Terminal User's Guide*, 555-015-720
- *DEFINITY Generic 1 and Generic 2, System 75, and System 85 Terminals and Adjuncts Installation and Test*, 555-015-104

7203H VOICE TERMINAL

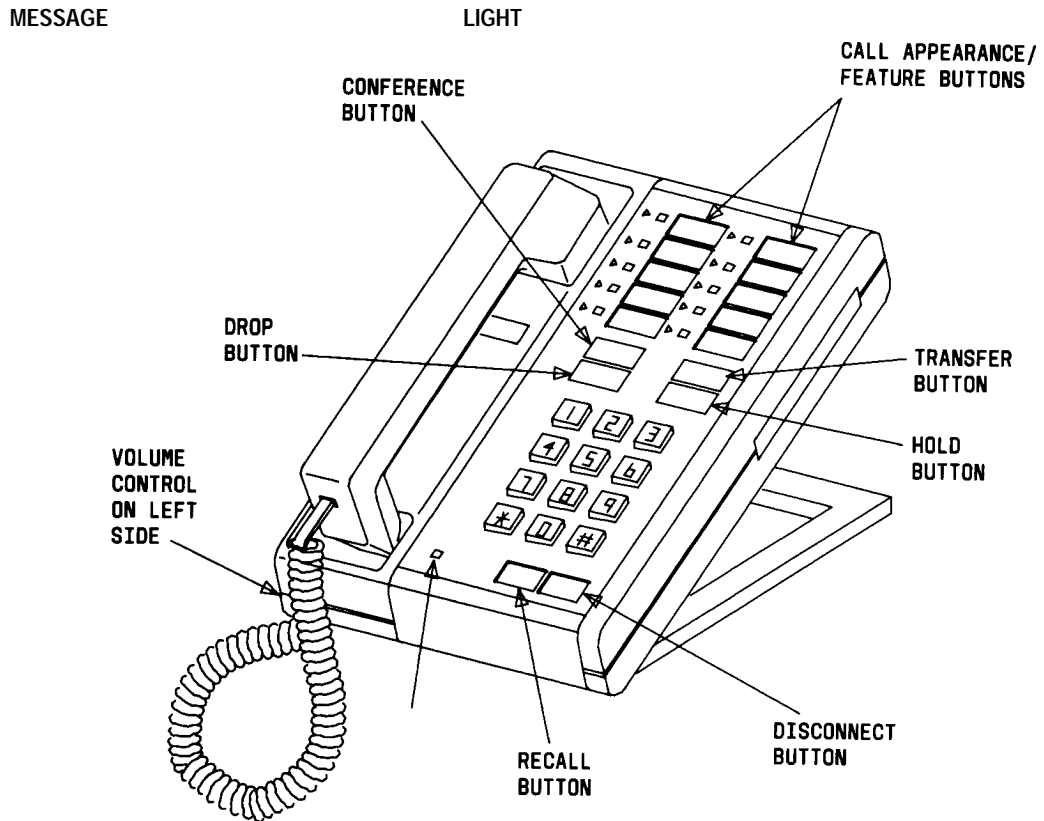

FIGURE 3-5. The 7203H Voice Terminal

7203H Voice Terminal

The 7203H voice terminal is a multi-appearance hybrid voice terminal which provides for up to 10 incoming lines. Buttons not used for line appearances may be used for one-touch feature access or for Speed Dialing. It requires three pair wiring for operation. One wire pair is used for analog voice, while the other two pairs are used for digital control and signaling.

The 7203H voice terminal was discontinued in March 1988, but will be supported until March 1993.

Applications

The 7203H voice terminal can be used with all System 85 and DEFINITY G2 switches (on DEFINITY G2, they can only be used on a traditional module and the SN224 circuit pack). This voice terminal is suitable for managers, executive secretaries, office support personnel, and others who do not need data capabilities.

Physical Description

Dimensions

Note: The following dimensions are approximate.

Width = 7 inches

Depth (front to back) = 8-3/4 inches

Height (maximum with handset in place) = 5-1/2 inches

Thickness of housing = 1-1/2 inches

Features

Six Fixed Feature Buttons

- RECALL button
- DISCONNECT button

- CONFERENCE button
- DROP button
- TRANSFER button
- HOLD button

Message Light

The green Message light goes on when a message is left for the user. It goes off when the user retrieves the message.

Call Appearance/Feature Buttons

The 7203H voice terminal has 10 call appearance/feature buttons. Adjacent to each button is a pair of red and green status indicator lights.

Other Physical Features

Handset

The 7203H voice terminal is equipped with an R-type handset.

Dial pad

The 7203H voice terminal is equipped with a 12-button touch-tone dial pad.

Jacks

The 7203H voice terminal housing contains three jacks. The handset cord jack is just under the left side of the housing. The handset contains a jack for the handset cord. The LINE jack is on the bottom center of the housing. The modular speakerphone/handset jack is located on the bottom of the set.

Cords

Two cords are supplied with the 7203H voice terminal: a coiled 7-foot modular handset cord and a 7-foot modular line cord. Optional longer cords are available: a 12-foot handset cord; 14-foot and 25-foot line cords.

Ringling

The 7203H voice terminal has electronic tone ringing. The volume control is on the left side of the housing.

Mounting Options

The 7203H voice terminal comes equipped with a nonadjustable desk stand. An optional wall mounting kit can be ordered.

Color Options

The 7203H voice terminal was available in various colors; however, maintenance replacements are available in black only.

Distance Limitations

The maximum allowable distances of a 7203H voice terminal from the DEFINITY G2 and System 85 cabinet are shown in the following table.

SYSTEM	PORT BOARD	NOMINAL MAXIMUM RANGE IN FEET (METERS)	
		24 AWG	26 AWG
SYSTEM 85 DEFINITY G2	SN224	3,000 (914)	2,300 (700)

Power Requirements

The 7203H voice terminal is powered by the tip and ring leads. If the 7203H is equipped with any adjunct, auxiliary power will be required for the adjunct. Refer to the **ADJUNCT POWER** section of this manual.

Power Failure Operation

The 7203H voice terminal cannot be used as an emergency station during power failure transfer conditions.

FCC Registration

The 7203H voice terminal is not FCC registered.

Hearing Aid Compatible

This voice terminal is compatible with the inductively coupled hearing aids prescribed by the FCC.

7203H Equipment Price Element Code (PECs)

The 7203H voice terminal and optional components were ordered with the following PECs:

- Basic voice terminal—3182-16H/CLR
- Handset cord (12 feet)—2725-01L COL09
- Line cord (14 feet, silver)—2725-07N COL18
- Line cord (25 feet, silver)—2725-07S COL18

Adjuncts

One of the following adjuncts can be used with this voice terminal:

- S101A Speakerphone
- S201A Speakerphone
- 500A Headset Adapter and a standard headset

Additional Documents

The following documents contain additional information relating to the 7203H voice terminal:

- *System 85 7203H Voice Terminal User's Guide*, 555-102-709
- *DEFINITY Generic 1 and Generic 2, System 75, and System 85 Terminals and Adjuncts Installation and Test*, 555-015-104

7205H VOICE TERMINAL

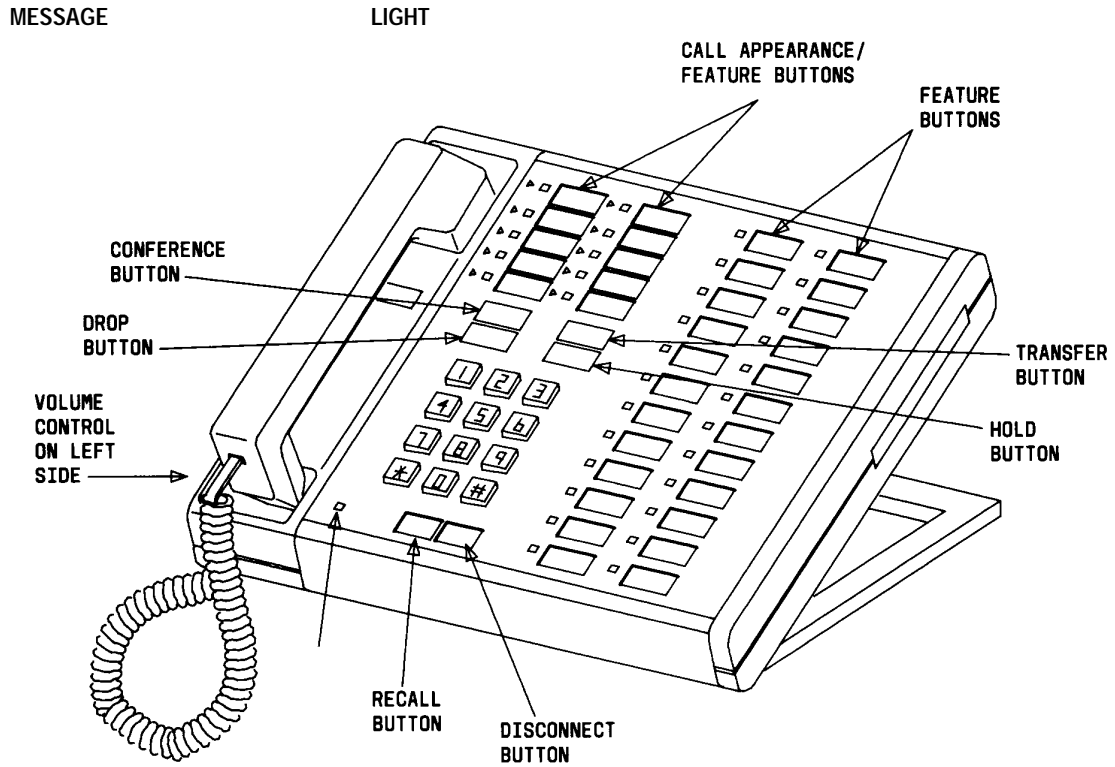

FIGURE 3-6. 7205H Voice Terminal

7205H Voice Terminal

The 7205H is a multi-appearance hybrid voice terminal which provides six buttons for fixed features, 10 buttons for line appearances or one-touch feature activation, and 24 feature-only buttons. It requires 3-pair wiring for operation. One wire pair is used for analog voice, while the other two pairs are used for digital control and signaling.

The 7205H voice terminal was discontinued in March 1988, but will be supported until March 1993.

Applications

The 7205H voice terminal can be used with System 85 and DEFINITY G2 (on DEFINITY G2, they can only be used on a traditional module and the SN224 circuit pack). This voice terminal is suitable for managers, executive secretaries, office support personnel, and others who do not need data capabilities.

Physical Description

Dimensions

Note: The following dimensions are approximate.

Width = 10-1/4 inches

Depth (front to back) = 8-3/4 inches

Height (maximum with handset in place) = 5-1/2 inches

Thickness of housing = 1-1/2 inches

Features

Six Fixed Feature Buttons

- RECALL button
- DISCONNECT button

- CONFERENCE button
- DROP button
- TRANSFER button
- HOLD button

Message Light

The green Message light goes on when a message is left for the user. It goes off when the user retrieves the message.

Call Appearance/Feature Buttons

The 7205H voice terminal has 10 call appearance/feature buttons. Adjacent to each button is a pair of red and green indicator lights.

Feature-Only Buttons

The 7205H voice terminal has 24 feature-only buttons.

Other Physical Features

Handset

The 7205H voice terminal is equipped with an R-type handset.

Dial pad

The 7205H voice terminal is equipped with a 12-button touch-tone dial pad.

Jacks

The 7205H voice terminal housing contains three jacks. The handset cord jack is just under the left side of the housing. The LINE jack is on the bottom center of the housing. The handset contains a jack for the handset cord. The modular speakerphone/handset jack is located on the bottom of the set.

Cords

Two cords are supplied with the 7205H voice terminal: a coiled 7-foot modular handset cord and a 7-foot modular line cord. Optional longer cords are available: a 12-foot handset cord; 14-foot and 25-foot line cords.

Ringling

The 7205H voice terminal has electronic tone ringing. The volume control is on the left side of the housing.

Mounting Options

The 7205H voice terminal comes equipped with a nonadjustable desk stand. An optional wall mounting kit can be ordered.

Color Options

The 7205H voice terminal was available in various colors; however, maintenance replacements will be black only.

Distance Limitations

The maximum allowable distances of a 7205H voice terminal from the System 85 and DEFINITY G2 cabinet are shown in the following table.

SYSTEM	PORT BOARD	ADJUNCTS	NOMINAL MAXIMUM RANGE IN FEET (METERS)	
			24 AWG	26 AWG
SYSTEM 85	SN224	0	3,000 (915)	2,300 (700)
DEFINITY G2		1	1,750 (533)	1,100 (335)
		2	1,000 (305)	750 (288)

Power Requirements

The 7205H voice terminal is powered by the tip and ring leads. If the 7205H is equipped with the S101A speakerphone or the 500A headset adapter, auxiliary power will be required for the adjunct. Refer to the **ADJUNCT POWER** section of this manual.

The C201A call coverage module attaches to the top of the voice terminal, and the F201A function key module attaches to the right side. These optional modules use the same phantom power from the switch (through the digital pairs) that also powers the 7205H voice terminal. This impacts the distance allowed from the switch.

Power Failure Operation

The 7205H voice terminal cannot be used as an emergency station during power failure transfer conditions.

FCC Registration

The 7205H voice terminal is not FCC registered.

Hearing Aid Compatible

This voice terminal is compatible with the inductively coupled hearing aids prescribed by the FCC.

7205H Equipment Price Element Code (PECs)

The 7205H voice terminal and optional components was ordered with the following PECs:

- Basic voice terminal—3183-40H/CLR
- Handset cord (12 feet)—2725-01L COL09
- Line cord (14 feet, silver)—2725-07N COL18
- Line cord (25 feet, silver)—2725-07S COL18

Adjuncts

The following adjuncts can be used with this voice terminal:

- S101A Speakerphone or 500A Headset Adapter and a standard headset
- C201A Call Coverage Module
- F201A Function Key Module
- S201A Speakerphone

Additional Documents

The following documents contain additional information relating to the 7205H voice terminal:

- *System 85 7205H Voice Terminal User's Guide*, 555-102-709
- *DEFINITY Generic 1 and Generic 2, System 75, and System 85 Terminals and Adjuncts Installation and Test*, 555-015-104

7303S VOICE TERMINAL

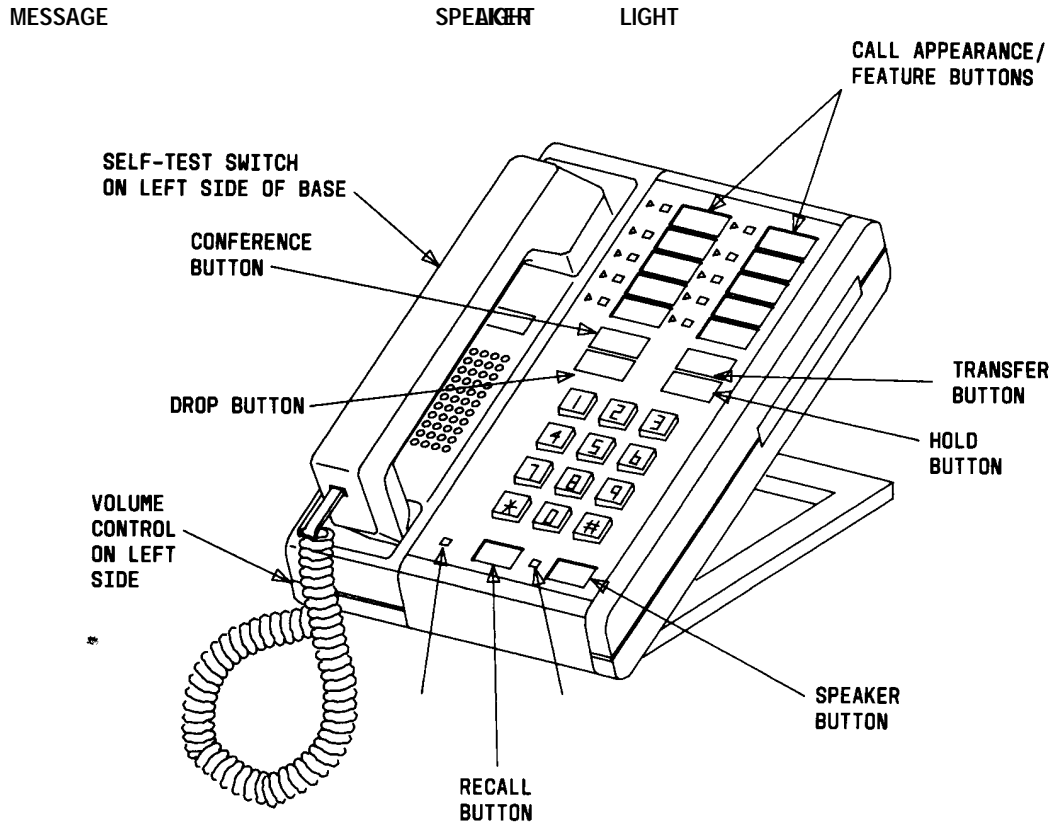

FIGURE 3-7. The 7303S Voice Terminal

7303S Voice Terminal

The 7303S is a multi-appearance hybrid voice terminal which provides access to 10 line appearances or selected programmable features. The 7303S voice terminal is also equipped with six fixed feature buttons. It requires 3-pair wiring for operation. One wire pair is used for analog voice, while the other two pairs are used for digital control and signaling.

The 7303S voice terminal was discontinued in July 1990, but will be supported until July 1995.

Applications

The 7303S voice terminal can be used with the DEFINITY G1, G2, G3, System 75 and System 85 (R2 only). This voice terminal is suitable for managers, executive secretaries, office support personnel, and others who do not need data capabilities.

Physical Description

Dimensions

Note: The following dimensions are approximate.

Width = 7 inches

Depth (front to back) = 8-3/4 inches

Height (maximum with handset in place) = 5-1/2 inches

Thickness of housing = 1-1/2 inches

Features

Six Fixed Feature Buttons

- RECALL button
- SPEAKER button
- CONFERENCE button

- DROP button
- TRANSFER button
- HOLD button

Message Light

The green Message light goes on when a message is left for the user. It goes off when the user retrieves the message.

Call Appearance/Feature Buttons

The 7303S voice terminal has 10 call appearance/feature buttons. Adjacent to each button is a pair of red and green indicator lights.

Self Test

The 7303S voice terminal is equipped with a self-test for its buttons and tone ringer. The self-test switch is located on the left side of the base.

Loudspeaker

The 7303S voice terminal has a built-in listen only loudspeaker. The volume control for the speaker is the same control used for the tone ringer volume. It is located on the left side of the housing.

Other Physical Features

Handset

The 7303S voice terminal is equipped with an R-type handset.

Dial pad

The 7303S voice terminal is equipped with a 12-button touch-tone dial pad.

Jacks

The 7303S voice terminal housing contains three jacks. The handset cord jack is just under the left side of the housing. The handset contains a jack for the handset cord. The LINE jack is on the bottom center of the housing. The modular speakerphone/handset jack is located on the bottom of the set.

Cords

Two cords are supplied with the 7303S voice terminal: a coiled 7-foot modular handset cord and a 7-foot modular line cord. Optional longer cords are available: a 12-foot handset cord; 14-foot and 25-foot line cords.

Ringling

The 7303S voice terminal has electronic tone ringing. The volume control is on the left side of the housing.

Mounting Options

The 7303S voice terminal comes equipped with a nonadjustable desk stand. An optional wall mounting kit can be ordered.

Color Options

The 7303S Voice Terminal was available in various colors; however, maintenance replacements are black or misty cream only.

Distance Limitations

The maximum allowable distances of a 7303S voice terminal from the DEFINITY G1, G2, G3, System 75, or System 85 cabinet are shown in the table below.

SYSTEM	PORT BOARD	ADJUNCTS	NOMINAL MAXIMUM RANGE IN FEET (METERS) (See NOTE)	
			24 AWG	26 AWG
SYSTEM 85	ANN17B	0	1,700 (519)	1,000 (305)
		1	1,000 (305)	650 (198)
DEFINITY G2	ANN17B	0	1,700 (519)	1,000 (305)
		1	1,000 (305)	650 (198)
	TN762B	-	1000 (305)	750 (229)
DEFINITY G1 & G3 SYSTEM 75	TN762	-	1000 (305)	750 (229)

Note: Range may be extended to 2,000 feet (610m) for 24- or 26-AWG wire by adding local -48 volt DC power in the satellite closet. Power supplies such as the 346A or 329A may be connected to the fourth pair from the terminals to obtain the increased range. These power supplies must be within 250 feet of the terminals.

Power Requirements

The 7303S voice terminal is powered by the tip and ring leads. If the 7303S is equipped with an adjunct, it is powered by the same power source. This impacts the maximum nominal cabling distance. The range may be extended by adding a -48 volt DC power source in the satellite closet.

Power Failure Operation

The 7303S voice terminal cannot be used as an emergency station during power failure transfer conditions.

FCC Registration

The 7303S voice terminal is not FCC registered.

Hearing Aid Compatible

This voice terminal is compatible with the inductively coupled hearing aids prescribed by the FCC.

7303S Equipment Price Element Code (PECs)

The 7303S voice terminal and optional components were ordered with the following PECs:

- Basic voice terminal—3176-16S/CLR
- Handset cord (12 feet)—2725-01L COL09
- Line cord (14 feet, silver)—2725-07N COL18
- Line cord (25 feet, silver)—2725-07S COL18

Adjuncts

One of the following adjuncts can be used with this voice terminal:

- S102A Speakerphone
- S202A Speakerphone
- 502A Headset Adapter and a standard headset

Additional Documents

The following documents contain additional information relating to the 7303S voice terminal:

- *DEFINITY Generic 2, System 85 7303S Voice Terminal User's Guide*, 555-103-707
- *DEFINITY Generic 1, System 75 7303S Voice Terminal User's Guide*, 555-200-706
- *DEFINITY Generic 1 and Generic 2, System 75, and System 85 Terminals and Adjuncts Installation and Test*, 555-015-104

7305S VOICE TERMINAL

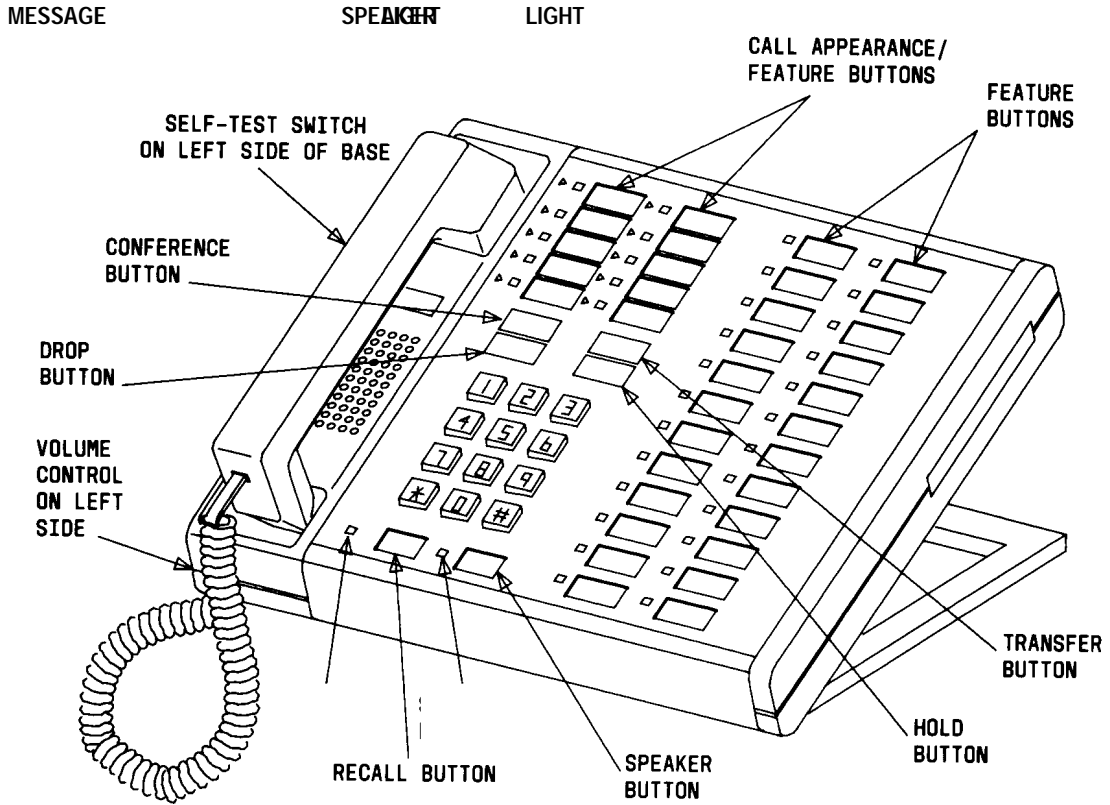

FIGURE 3-8. The 7305S Voice Terminal

7305S Voice Terminal

The 7305S voice terminal is a multi-appearance hybrid voice terminal which provides access to 10 line appearances. The 10 line appearance buttons can also be used as programmable feature buttons. The 7305S voice terminal is also equipped with 24 programmable feature buttons and six fixed feature buttons. It requires 3-pair wiring for operation. One wire pair is used for analog voice, while the other two pairs are used for digital control and signaling.

The 7305S voice terminal was discontinued in July 1990, but will be supported until July 1995.

Applications

The 7305S voice terminal can be used with the DEFINITY G1, G2, G3, System 75, and System 85 (R2V2 or higher). This voice terminal is suitable for managers, executive secretaries, office support personnel, sales support people, and others who do not need data capabilities.

Physical Description

Dimensions

Note: The following dimensions are approximate.

Width = 10-1/4 inches

Depth (front to back) = 8-3/4 inches

Height (maximum with handset in place) = 6-1/4 inches

Thickness of housing = 1-1/2 inches

Six Fixed Feature Buttons

- RECALL button
- SPEAKER button
- CONFERENCE button
- DROP button
- TRANSFER button

- HOLD button

Message Light

The green Message light goes on when a message is left for the user. It goes off when the user retrieves the message.

Call Appearance/Feature Buttons

The 7305S voice terminal has 10 call appearance/feature buttons. Adjacent to each button is pair of red and green indicator lights.

Feature-Only Buttons

The 7305S voice terminal has 24 feature-only buttons. Adjacent to each button is a green (status) indicator light.

Self-Test

The 7305S voice terminal is equipped with a self-test for its buttons and tone ringer. The self-test switch is located on the left side of the base.

Loudspeaker

The 7305S voice terminal has a built-in listen only loudspeaker. The volume control for the speaker is the same control used for the tone ringer volume. It is located on the left side of the housing.

Other Physical Features

Handset

The 7305S voice terminal is equipped with an R-type handset.

Dial pad

The 7305S voice terminal is equipped with a 12-button touch-tone dial pad.

Jacks

The 7305S voice terminal housing contains three jacks. The handset cord jack is just under the left side of the housing. The handset contains a jack for the handset cord. The LINE jack is on

the bottom center of the housing. The modular speakerphone/handset jack is located on the bottom of the set.

Cords

Two cords are supplied with the 7305S voice terminal: a coiled 7-foot modular handset cord and a 7-foot modular line cord. Optional longer cords are available: a 12-foot handset cord; 14-foot and 25-foot line cords.

Ringling

The 7305S voice terminal has electronic tone ringing. The volume control is on the left side of the housing.

Mounting Options

The 7305S voice terminal comes equipped with a adjustable desk stand. An optional wall-mounting kit can be ordered.

Color Options

The 7305S voice terminal was available in black and misty cream.

Distance Limitations

The maximum allowable distances of a 7303S from the DEFINITY G1, G2, G3, System 75, or System 85 cabinet are shown in the table below.

SYSTEM	PORT BOARD	ADJUNCTS	NOMINAL MAXIMUM RANGE IN FEET (METERS) (See NOTE)	
			24 AWG	26 AWG
SYSTEM 85	ANN17B	0	1,000 (305)	650 (198)
		1	700 (213)	450 (137)
DEFINITY G2	ANN17B	0	1,000 (305)	650 (198)
		1	700 (213)	450 (137)
	TN762B	-	1,000 (305)	750 (229)
DEFINITY G1 & G3 SYSTEM 75	TN762	-	1,000 (305)	750 (229)

Note: Range may be extended to 2,000 feet (610m) for 24- or 26-AWG wire by adding local -48 volt DC power in the satellite closet. Power supplies such as the 346A or 329A may be connected to the fourth pair from the terminals to obtain the increased range. These power supplies must be within 250 feet of the terminals.

Power Requirements

The 7305S voice terminal is powered by the tip and ring leads. If the 7305S voice terminal is equipped with the S202A or S102A speakerphone or the 500A headset adapter, auxiliary power will be required for the adjunct. Refer to the **ADJUNCT POWER** section of this manual.

Power Failure Operation

The 7305S voice terminal cannot be used as an emergency station during power failure transfer conditions.

FCC Registration

The 7305S voice terminal is not FCC registered.

Hearing Aid Compatible

This voice terminal is compatible with the inductively coupled hearing aids prescribed by the FCC.

7305S Equipment Price Element Code (PECs)

The 7305S voice terminal and optional components were ordered with the following PECs:

- Basic voice terminal (black)—3177-40SA/CLR
- Handset cord (12 feet)—2725-01L COL09
- Line cord (14 feet, silver)—2725-07N COL18
- Line cord (25 feet, silver)—2725-07S COL18

Adjuncts

One of the following adjuncts can be used with this voice terminal:

- S102A Speakerphone
- 502A Headset Adapter and a standard headset
- S202A Speakerphone

Additional Documents

The following documents contain additional information relating to the 7305S voice terminal:

- *System 85 7305S Voice Terminal User's Guide*, 555-103-707
- *System 75 7305S Voice Terminal User's Guide*, 555-200-706
- *DEFINITY Generic 1 and Generic 2, System 75, and System 85 Terminals and Adjuncts Installation and Test*, 555-015-104

7401D and 7401 Plus VOICE TERMINAL

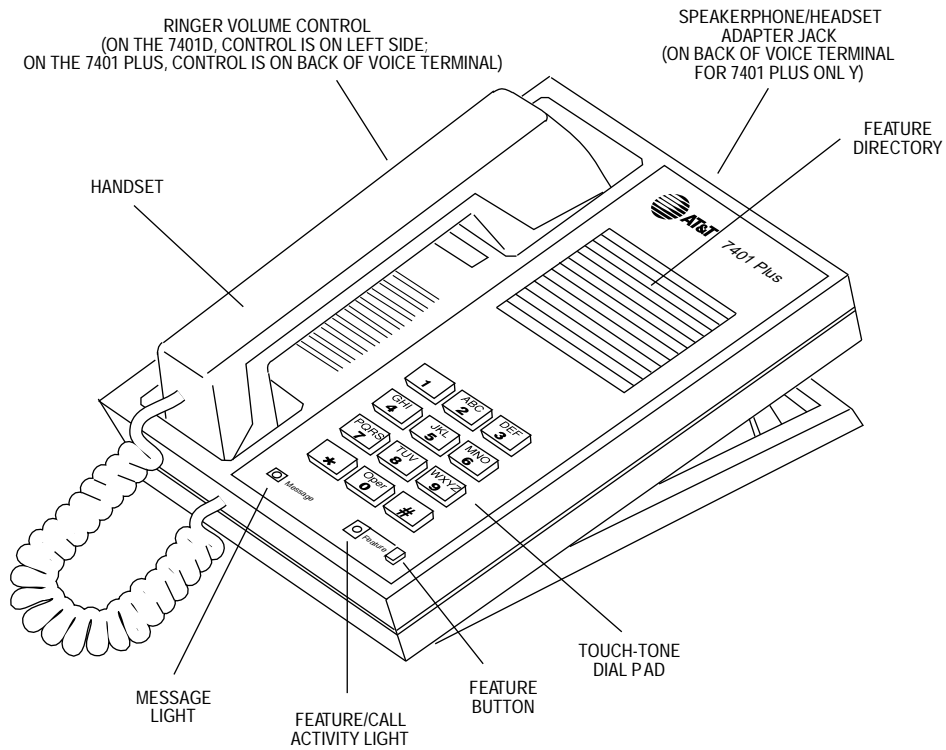

FIGURE 3-9. The 7401 Plus (7401D02A) Voice Terminal

7401D and 7401 Plus Voice Terminals

The **7401D (7401D01A)** and the **7401 Plus (7401D02A)**, the newest 7401 set) are both single appearance digital voice terminals which have no call appearance buttons or lights, but have two *virtual* call appearances (refer to the section below titled **Special Operational Characteristics**). The user answers a call by going off-hook. The second appearance is primarily used with the Conference and Transfer features. However, it can be used to originate an outgoing call or receive a second incoming call. Depending on how the 7401D or the 7401 Plus voice terminal is administered, the second call appearance may be restricted to incoming priority calls and outgoing calls only.

Note: The 7401D01A is no longer being manufactured. The 7401D02A (7401 Plus) will be discontinued as of January 2, 1995.

Applications

The 7401D (7401D01A) and the 7401 Plus (7401D02A) voice terminals can be used with the DEFINITY Communications System G1, G2, G3, System 75, and System 85. These voice terminals are especially suitable for general office workers with low call volumes, manufacturing, warehousing, guard and/or reception areas, or office desks.

The 7401D and 7401 Plus voice terminals can also provide simultaneous voice and data communications with the 7400B Data Module. PC platform products can also be useful in providing voice capabilities since these screen-based products can greatly enhance the telephone capabilities of these basic voice terminals.

Special Operational Characteristics

The 7401D (7401D01A) and 7401 Plus (7401D02A) do not have traditional call appearance buttons with indicators. To the user, these voice terminals appear to be single call appearance sets. However, there are two *virtual* call appearances with *virtual* in-use and *virtual* status indicators. That is, to the PBX, the 7401D and 7401 Plus voice terminals appear to be a two call appearance set. These call appearances are necessary to provide the Conference, Transfer, and Hold features.

The Automatic Line Management (ALM) feature of the 7401D or 7401 Plus voice terminal automatically selects one of the two *virtual* call appearances when the user goes off-hook either by the user's lifting the handset (on the 7401D or the 7401 Plus voice terminal) or turning on the optional speakerphone adjunct (on the 7401 Plus voice terminal). ALM follows a hierarchical algorithm. From the user's point of view, the hierarchical order of actions which could take place is:

1. If either of the status lights of the virtual call appearances is flashing when the user takes the telephone off-hook, the voice terminal will always pick-up the “ringing” call. If both virtual call appearances are in the flashing state, the voice terminal will select the call that was ringing for the longer period of time.
2. If neither of the status lights is flashing, but one is winking or fluttering when the telephone goes off-hook, the voice terminal will automatically “un-hold” the held call. If both virtual call appearances are in the held state, the voice terminal will select the call that was on hold for the longer period of time.
3. If neither of the status lights is flashing, winking, or fluttering, but one is steady when the voice terminal goes off-hook, the voice terminal will automatically bridge on to the busy appearance. If both virtual call appearances are in the steady state, the voice terminal will choose the first virtual call appearance. (A call appearance can be in the busy state due to another party answering the call. This can occur in conjunction with such features as coverage, bridging or pickup.)
4. Otherwise, no special action is taken; the voice terminal will pick up an idle virtual call appearance as determined by the PBX.

Physical Features

Dimensions

Note: The dimensions described here for the 7401D and 7401 Plus voice terminals are approximate:

Width = 6 3/8 inches

Depth (front to back) = 8 3/4 inches

Height (maximum with handset in place) = 5 1/2 inches

Thickness of housing = 1 1/2 inches

Features

The Feature Button

The FEATURE button allows the dial pad to serve as 12 feature buttons without indicators:

- Four standard fixed feature buttons: Conference, Transfer, Drop, Hold
- The Select Ring feature

- Seven administrable feature buttons used with the FEATURE button

Feature/Call Activity Light

The green Feature/Call Activity light goes on steadily when the user presses the FEATURE button. This light flutters when there is an incoming call, when a call is put on hold, or when a call has been answered by another bridged extension. It flutters intermittently when Select Ring is used.

Feature Directory

The **7401D** (7401D01A) voice terminal has a reversible feature directory card. One side lists fixed features and leaves spaces for features assigned by the System Manager; the other side lists fixed and recommended features.

The **7401 Plus** (7401D02A) voice terminal has a one-sided feature directory card. The directory lists fixed features and has spaces for features assigned by the System Manager.

Message Light

The Message light goes on when a message is left for the user. It goes off when the user retrieves the message. On the **7401D** voice terminal, the Message light is green; on the **7401 Plus** voice terminal, the Message light is red.

Other Physical Features

Handset

The **7401D** and **7401 Plus** voice terminals are equipped with an R-type handset.

Dial pad

The **7401D** and the **7401 Plus** voice terminals are equipped with a 12-button touch-tone dial pad. On the **7401 Plus** voice terminal, the letters “Q” and “Z” have been added to the appropriate dial pad keys for directory access, and the “5” button on the dial pad has raised bars for visually-impaired users.

Jacks

The **7401D** and **7401 Plus** voice terminals' housing has a Handset cord jack. (On the **7401D** voice terminal, this jack is located just under the center front edge of the housing; on the **7401 Plus** the Handset cord jack is located on the back of the housing near the front/center.) Both voice terminals have a Line jack located on the back of the housing.

The **7401 Plus** (7401D02A) voice terminal also has a Speakerphone/headset adapter jack to which the user can connect adjunct equipment.

Cords

Two cords are supplied with the **7401D** (7401D01A) and the **7401 Plus** (7401D02A) voice terminal: a coiled 9-foot handset cord and a 7-foot line cord.

Optional longer cords are available: a 12-foot handset cord, and 14-foot and 25-foot line cords.

Ringling

The **7401D** and **7401 Plus** voice terminals have electronic tone ringling. With the Select Ring feature, the user can choose any one of 8 different ringling patterns.

The **7401D** (7401D01A) voice terminal has a volume control on the left side of the housing.

The **7401 Plus** (7401D02A) voice terminal has a volume control for the tone ringer on the back of the voice terminal, along the left edge.

Mounting Options

The **7401D** and **7401 Plus** voice terminals come equipped with both a nonadjustable desk stand and a wall mounting bracket.

Color Options

The **7401D** and **7401 Plus** voice terminals are available in black and misty cream.

Distance Limitations

The maximum allowable distances of a 7401D or a 7401 Plus voice terminal from the DEFINITY G1, G2, G3, System 75, or System 85 cabinet are shown in the following table.

SYSTEM	PORT BOARD	NOMINAL MAXIMUM RANGE IN FEET (METERS) (SEE NOTE)	
		24 AWG	26 AWG
System 85	SN270B	3,400 (1,034)	2,200 (671)
	TN754	3,400 (1,034)	2,200 (671)
DEFINITY G2	SN270B	3,400 (1,034)	2,200 (671)
	TN754	3,400 (1,034)	2,200 (671)
DEFINITY G1 & G3 System 75	TN754	3,400 (1,034)	2,200 (671)

Note: These ranges can be extended to 5,000 feet (1524 m) for 24 AWG wire and 4,000 feet (1219 m) for 26 AWG wire with the use of a Data Link Protector (DLP). Refer to the **EXPOSED PORT PROTECTION** section in this manual.

Power Requirements

The 7401D and 7401 Plus voice terminals receive power from the system and do not require any external power supply. Additional external power is required when the 7401 Plus voice terminal is equipped with any adjuncts, such as an external speakerphone. Refer to the **Adjunct Power** section of this manual.

Switch Administration

Aliasing

The 7401 voice terminals must be aliased in the following way:

If this type of voice terminal:	Is connected to this system:	It must be administered as:
7401D 7401 Plus	System 75, R1V1, V2, V3 System 85, R2V1, V2, V3	a 7403D voice terminal
7401D	DEFINITY Generic 1 & G3 System 85, R2V4 or above DEFINITY Generic 2	itself
7401 Plus	DEFINITY Generic 1 & G3 System 85, R2V4 or above DEFINITY Generic 2	a 7401D voice terminal

Button Numbering

The 7401 Plus (7401D02A) voice terminal can be administered in the same manner as the 7401D (7401D01A) voice terminal. Both types of voice terminals have 12 possible voice features; however, only seven of these features can be administered on the voice terminal (F1 through F7 on the Feature Directory). The remaining five features are fixed (F8, F9, F0, F#, and F* on the Feature Directory):

- F8 Conference
- F9 Transfer
- F0 Drop
- F# Hold
- F* Select Ring

The following button diagrams of the 7401D and 7401 Plus voice terminals will help you administer both of these voice terminals connected to a System 75 or DEFINITY G1 and G3 and to a System 85 or DEFINITY G2.

Figures 2 and 3 show button numbering for both the 7401D and the 7401 Plus voice terminals.

Note: Although these figures show the 7401 Plus set, the administration of the two types of voice terminals is the same.

If you need more information, refer to *DEFINITY Communications System Generic 3 Implementation*, and *DEFINITY Communications System Generic 2 Administration of Features and Hardware*.

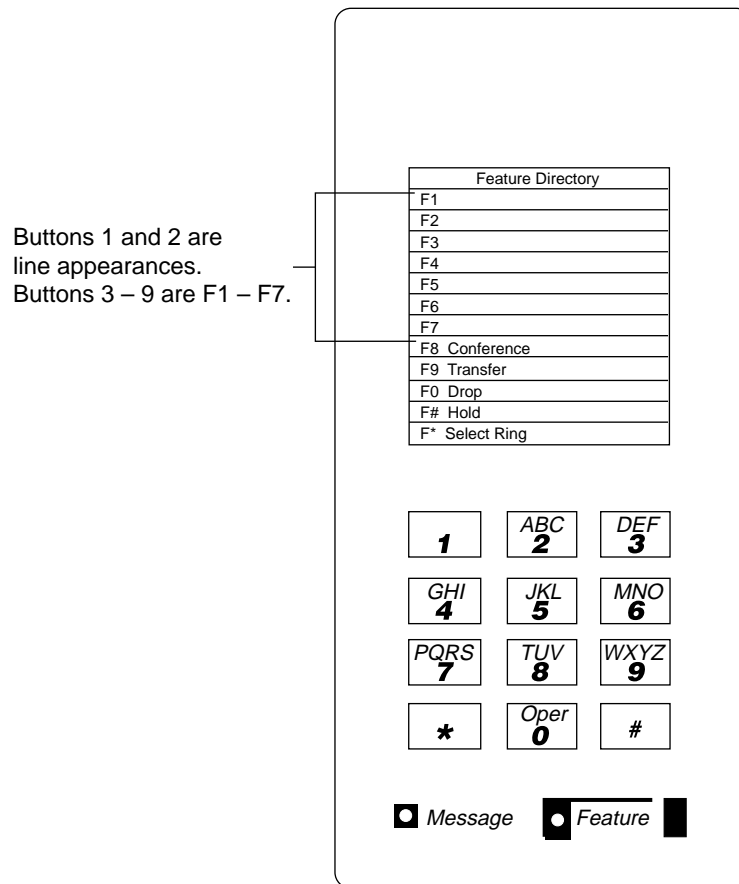

FIGURE 3-10. Button Numbering for Administering the 7401D and 7401 Plus Voice Terminals Connected to a System 75 or a DEFINITY G1 or G3 Switch

Buttons 1 and 2 are the Hold button and the Message light.
 Buttons 3 and 4 are line appearances.
 Buttons 5 – 11 are F1 through F7.

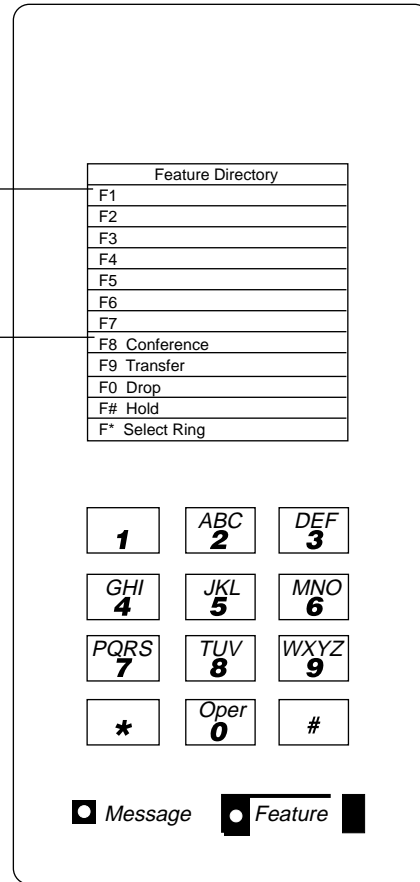

FIGURE 3-11. Button Numbering for Administering the 7401D and 7401 Plus Voice Terminals Connected to a System 85 or a DEFINITY G2 Switch

Power Failure Operation

The 7401D and 7401 Plus voice terminals cannot be used as an emergency station during power failure transfer conditions.

FCC Registration

These voice terminals are FCC-registered along with the switch (as a system), but do not have a separate FCC registration label.

UL and CSA Approval

These voice terminals have been tested and have met the Underwriters Laboratories (UL) Standards UL 1459 and have also met the Canadian Standards Association (CSA) Standards CSA-C22.2 No.225-M90.

Hearing Aid Compatible

These voice terminals are compatible with the inductively coupled hearing aids prescribed by the FCC.

7401D Equipment PECs & COMCODES

The 7401D (7401D01A) voice terminals and components can be ordered with these Price Element Codes (PECs) and COMCODES:

- **Basic 7401D** voice terminal
PEC: 3184-CDT (Black=COL09; Misty Cream=COL22)
COMCODE: Black=105353056; Misty Cream=105269153
- **Handset**
COMCODE: Black=105157291; Misty Cream=105158885
- **Handset cord (9 feet)**
COMCODE: Black=105635429; Misty Cream=105635437
- **Handset cord (12 feet)**
PEC: 2725-01L (Black=COL09; Misty Cream=COL22)
COMCODE: Black=102401445; Misty Cream=104211339
- **Line cord (7 feet, silver)**
COMCODE: 105304646

- **Line cord (14 feet, silver)**
PEC: 2725-07N (COL18)
COMCODE: 103786802
- **Line cord (25 feet, silver)**
PEC: 2725-07S (COL18)
COMCODE: 103786828
- **Faceplate and tab**
COMCODE: Black=846209161; Misty Cream=846209179
- **Button designation cards**
(Package of 50)
PEC: 31841 (Black=COL09; Misty Cream=COL22)
COMCODE: Black=846051225; Misty Cream=846051183
- **Desk stand/Wall mount assembly**
COMCODE: 846028546.

7401 Plus Equipment with PECs and COMCODES

The following 7401 Plus (7401D02A) voice terminal and components can be ordered with the following PECs and COMCODES:

- **Basic 7401 Plus Voice Terminal**
PEC: 3184-PLS (Black=COL18; Misty Cream=COL22)
COMCODE: Black=106224454; Misty Cream=106224462
- **Handset**
COMCODE: Black=105519086; Misty Cream=105520787
- **Handset cord (9 feet)**
COMCODE: Black=105635429; Misty Cream=105635437
- **Handset cord (12 feet)**
PEC: 2725-01L (Black=COL09; Misty Cream=COL22)
COMCODE: Black=102401445; Misty Cream=104211339
- **Line cord (7 feet)**
COMCODE: 103786778
- **Line cord (14 feet, silver)**
PEC: 2725-07N (COL18)
COMCODE: 103786828
- **Line cord (25 feet, silver)**
PEC: 2725-07S (COL18)
COMCODE: 103786802

- **Faceplate**
(Package of 50)
PEC: 31846
COMCODE: Black=846551141 Misty Cream=846551406
- **Button designation card**
PEC: 31844 (Package of 50 cards)
Single Sheets, COMCODE: 846521656
Pack of 50, COMCODE: 846521664
Tractor Feed, 200 Sheets, COMCODE: 846551672
Tractor Feed, 500 Sheets, COMCODE: 846551680.
- **Desk stand/Wall mount assembly**
COMCODE: 846028546

Adjuncts

One of the following adjuncts can be used with the 7401D (7401D01A) voice terminal:

- R6 Amplifier Handset (PEC: 3152-002)
- R8 Noisy Location Handset (PEC: 3152-003)
- 7400B Data Module

The following adjuncts can be used with the 7401 Plus (7401D02A) voice terminal:

- S101A Speakerphone (no longer orderable)
- S201A Speakerphone
- CS201A Speakerphone
- 7400B Data Module
- 500A Headset Adapter (and a standard headset; see “Headsets” below)
- R6 Amplifier Handset (PEC: 3152-002)
- R8 Noisy Location Handset (PEC: 3152-003)
- R2H Standard Handset (PEC: 3152-006)
- Shoulder Rest

Headsets

A list of compatible headsets, consisting of both modular and plug prong base units and selection of headpieces, appears in “Headset Adapters” in the **Adjuncts** section (behind the **Adjuncts** tab) later in this manual.

Additional Documents

The following documents contain additional information relating to the 7401D and 7401 Plus voice terminals: (Use the 9 digit number listed after each document to order the book from the GBCS Publications Fulfillment Center.)

- *7401D Voice Terminal Installation Instructions*, 555-015-106
- *System 75 7401D Voice Terminal User's Guide*, 555-200-727
- *DEFINITY Communications System Generic 1 7401D Voice Terminal User's Guide*, 555-204-727
- *DEFINITY Communications System Generic 2 and System 85 7401D Voice Terminal User's Guide*, 555-104-712
- *DEFINITY Communications System Generic 1 and System 75 7401 Plus Voice Terminal User's Guide*, 555-204-740
- *DEFINITY Communications System Generic 2 and System 85 7401 Plus Voice Terminal User's Guide*, 555-104-740

The following document is shipped with every 7401 Plus voice terminal:

- *7401 Plus and 7410 Plus Voice Terminals Installation Instructions*.

7402 Plus VOICE TERMINAL

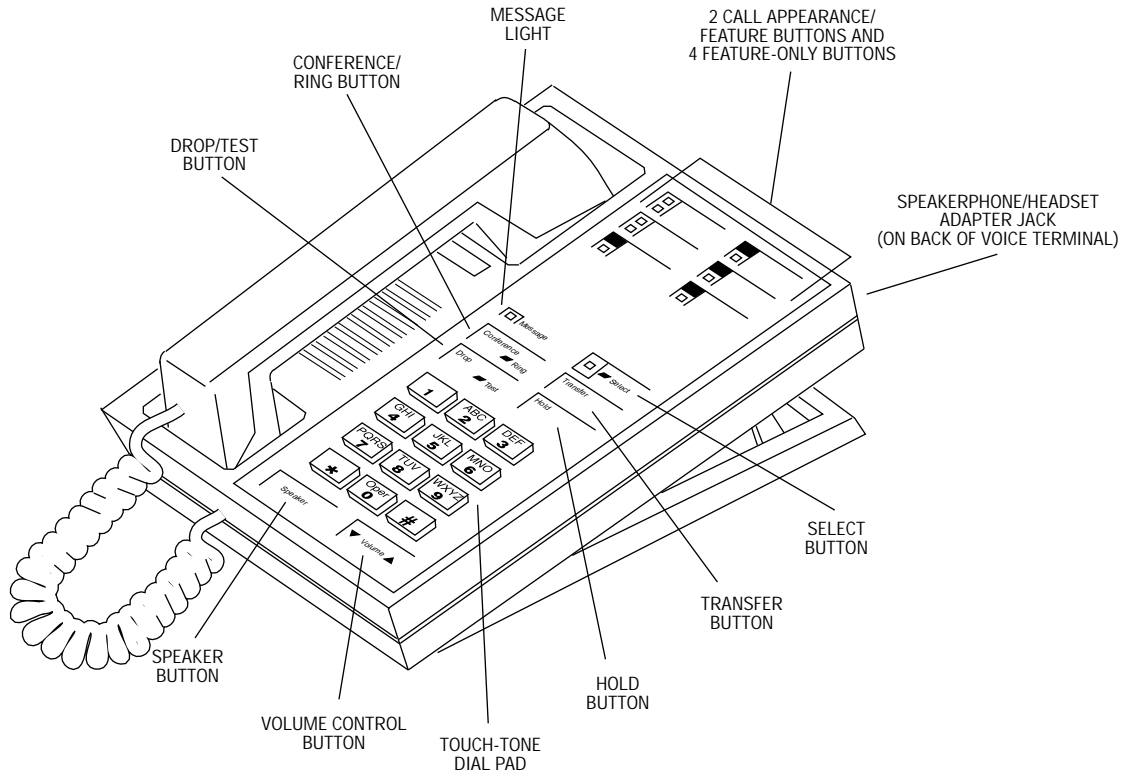

FIGURE 3-12. The 7402 Plus Voice Terminal

7402 Plus Voice Terminal

The 7402 Plus is a multi-appearance digital voice terminal with two line appearances, four variable feature buttons, four standard fixed feature buttons (CONFERENCE, DROP, TRANSFER, and HOLD), a SELECT button, a Message light, a SPEAKER button for accessing a listen-only speaker, a Ringer Volume control, and a Speakerphone/headset adapter jack on the back of the voice terminal for connecting adjunct equipment. By pressing the SELECT button and then the CONFERENCE/RING button, the user can choose among eight possible programmable ringing patterns. A Self-Test feature can also be activated to test the lights and tone ringer on the voice terminal.

Note: The 7402 Plus will be discontinued as of January 1, 1995.

Applications

The 7402 Plus voice terminal can be used with the DEFINITY Communications System G1, G2, G3, System 75, and System 85. This voice terminal is especially suitable for managers, executive secretaries, and other office support personnel who require access to multiple lines for call handling, call coverage, bridging, conferencing, and sophisticated voice communications.

The 7402 Plus voice terminal can also provide simultaneous voice and data communications with the 7400B Data Module. PC platform products can also be useful in providing voice capabilities since these screen-based products can greatly enhance the telephone capabilities of these basic voice terminals.

Physical Features

Dimensions

Note: The following dimensions for the 7402 Plus voice terminal are approximate.

Width = 6 3/8 inches

Depth (front to back) = 8 3/4 inches

Height (maximum with handset in place) = 5 1/2 inches

Thickness of housing = 1 1/2 inches

Features

Four Standard Fixed Feature Buttons

- CONFERENCE/RING button
- DROP/TEST button
- TRANSFER button
- HOLD button

Message Light

The red Message light goes on when a message is left for the user. It goes off when the user retrieves the message.

Call Appearance and Feature Buttons

The 7402 Plus voice terminal has two call appearance buttons, each with a red and green status light. The 7402 Plus also has four variable feature buttons. Each of these feature buttons has a green status light next to it.

SELECT button

The 7402 Plus voice terminal has a SELECT button which can be used in two ways:

- When used with the CONFERENCE/RING button, the user can select a personalized ring from eight ringing patterns.
- When used with the DROP/TEST button, the user can initiate a self-test of the lights and ringer on the voice terminal.

SPEAKER button

The 7402 Plus voice terminal has a SPEAKER button which allows the user to place calls while on-hook, to monitor calls on which the user has been put on hold, or retrieve messages without lifting the handset. However, the Speaker feature is for listening only. In order to speak to the other party, the user must use the handset (the speaker must be off).

VOLUME control button

When the speaker is active on the 7402 Plus voice terminal speaker, the VOLUME control button affects the loudness of the Speaker (listen-only) feature.

At all other times (when the speaker is not being used), the VOLUME control button affects the volume of the tone ringer.

Other Physical Features***Handset***

The 7402 Plus voice terminal is equipped with an R-type handset.

Dial pad

The 7402 Plus voice terminal is equipped with a 12-button touch-tone dial pad. The letters “Q” and “Z” have been added to the appropriate dial pad keys for directory access, and the “5” button on the dial pad has raised bars for visually-impaired users.

Jacks

The 7402 Plus voice terminal’s housing contains three jacks. The Handset cord jack is on the back of the housing near the front. The Line jack and the Speakerphone/headset adapter jack on both voice terminals are on the back of the voice terminal.

Cords

Two cords are supplied with the 7402 Plus voice terminal: a coiled 9-foot modular handset cord and a 7-foot D8W 8-conductor modular line cord.

Optional longer cords are available: a 12-foot handset cord; 14-foot and 25-foot line cords.

Ringling

The 7402 Plus voice terminal has electronic tone ringling. With the Personalized Ringling feature, the user can choose any one of eight different ringling patterns.

The volume on the 7402 Plus voice terminal can be controlled with the VOLUME “arrow” button on the front of the voice terminal.

Mounting Options

The 7402 Plus voice terminal comes equipped with a desk stand or can be wall-mounted.

Color Options

The 7402 Plus voice terminal is available in black and misty cream.

Distance Limitations

The maximum allowable distances of a 7402 Plus voice terminal from the DEFINITY G1, G2, G3, System 75, or System 85 cabinet are shown in the following table.

SYSTEM	PORT BOARD	NOMINAL MAXIMUM RANGE IN FEET (METERS) (SEE NOTE)	
		24 AWG	26 AWG
System 85	SN270B	3,400 (1,034)	2,200 (671)
	TN754	3,400 (1,034)	2,200 (671)
DEFINITY G2	SN270B	3,400 (1,034)	2,200 (671)
	TN754	3,400 (1,034)	2,200 (671)
DEFINITY G1 & G3 System 75	TN754	3,400 (1,034)	2,200 (671)

Note: These ranges can be extended to 5,000 feet (1524 m) for 24 AWG wire and 4,000 feet (1219 m) for 26 AWG wire with the use of a Data Link Protector (DLP).

Power Requirements

The 7402 Plus voice terminal receives power from the system and does not require any external power supply. Additional external power is required when the 7402 Plus voice terminal is equipped with any adjuncts, such as an external speakerphone.

Switch Administration

Aliasing

The 7402 voice terminals must be aliased in the following way:

If you are administering the 7402 Plus with this system:	The voice terminal must be administered as a:
System 75, R1V1, V2	7403D voice terminal
System 75, R1V3	7410D
DEFINITY Generic 1, 2, or 3	7410D

Button Numbering

The following button diagrams of the 7402 Plus voice terminal will help you administer this voice terminal when it is connected to a System 75 or DEFINITY G1 and G3 and to a System 85 or DEFINITY G2.

In these figures, the button numbers on the six administrable call appearance and feature buttons correspond to button assignments on Page 2 of the voice terminal administration screen form.

If you need more information, refer to *DEFINITY Communications System Generic 3 Implementation*, and *DEFINITY Communications System Generic 2 Administration of Features and Hardware*.

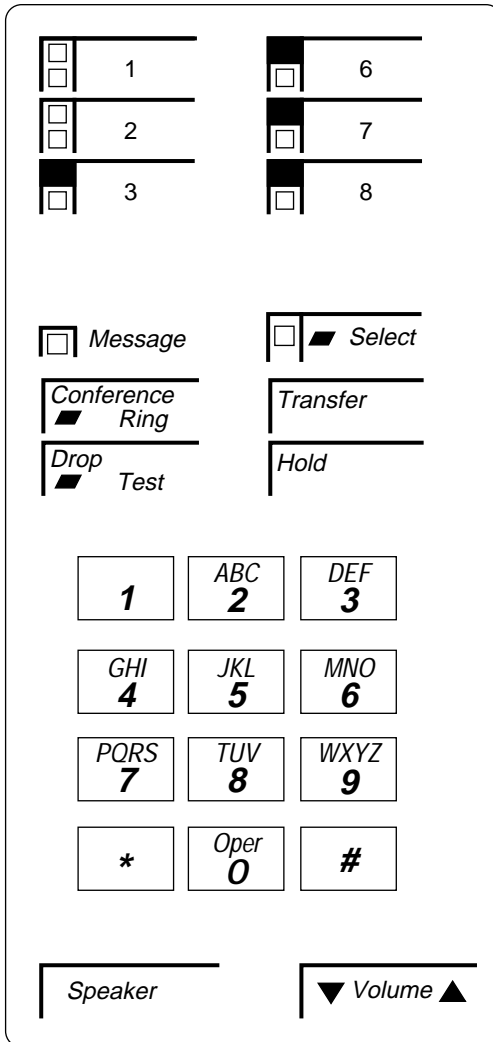
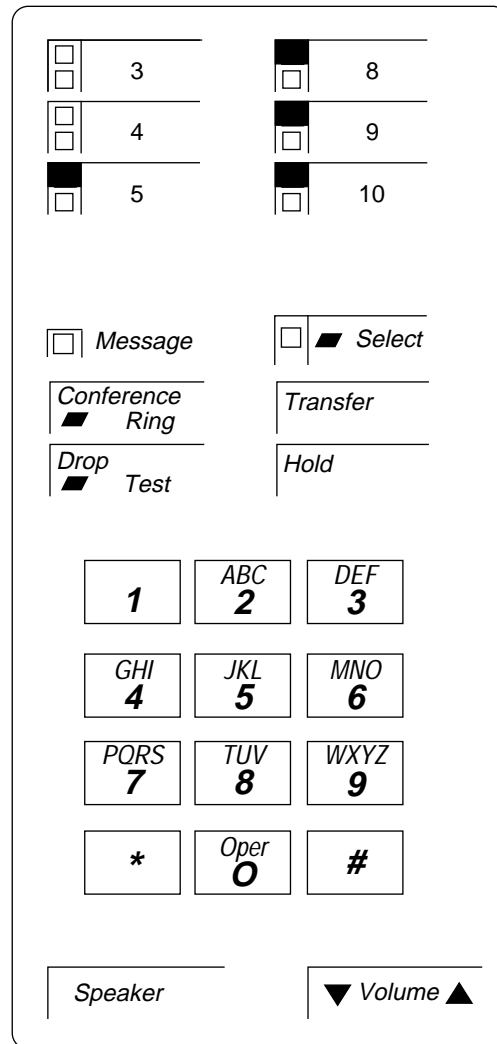

FIGURE 3-13. Button Numbering for Administering the 7402 Plus Voice Terminal Connected to a System 75 or a DEFINITY G1 or G3 Switch



NOTE: THE HOLD BUTTON IS BUTTON #1. THE MESSAGE LIGHT IS BUTTON #2.

FIGURE 3-14. Button Numbering for Administering the 7402 Plus Voice Terminal Connected to a System 85 or a DEFINITY G2 Switch

Power Failure Operation

The 7402 Plus voice terminal cannot be used as an emergency station during power failure transfer conditions.

FCC Registration

The 7402 Plus voice terminal is FCC-registered along with the switch (as a system), but does not have a separate FCC registration label.

UL and CSA Approval

This voice terminal has been tested and has met the Underwriters Laboratories (UL) Standards UL 1459 and has also met the Canadian Standards Association (CSA) Standards CSA-C22.2 No.225-M90.

Hearing Aid Compatible

This voice terminal is compatible with the inductively coupled hearing aids prescribed by the FCC.

7402 Plus Equipment PECs and COMCODES

The 7402 Plus voice terminal and components can be ordered with the following PECs and COMCODES:

- **Basic 7402 Plus** voice terminal
PEC: 3189-PLS (Black=COL09; Misty Cream=COL22)
COMCODE: Black=105425185; Misty Cream=105425144
- **Handset**
COMCODE: Black=105519086; Misty Cream=105520787
- **Handset cord (9 feet)**
COMCODE: Black=105635429; Misty Cream=105635437
- **Handset cord (12 feet)**
PEC: 2725-01L (Black=COL09; Misty Cream=COL22)
COMCODE: Black=102401445; Misty Cream=104211339
- **Line Cord (7 feet, silver)**
COMCODE: 103786778

- **Line cord (14 feet, silver)**
PEC: 2725-07N (COL18)
COMCODE: 103786802
- **Line cord (25 feet, silver)**
PEC: 2725-07S (COL18)
COMCODE: 103786828
- **Button designation card**
PEC: 31866A (Package of 25 tractor feed cards)
PEC: 31890A (Package of 100 tractor feed cards)

Single sheets COMCODE: 846523892
Pack of 50 COMCODE: 846523900
Tractor feed, 200 Sheets COMCODE: 846551448
Tractor feed, 500 Sheets COMCODE: 846551455
- **Faceplate**
COMCODE: Black=846523876; Misty Cream=846523884

(Package of 50)
PEC: 31867 (Black=COL09; Misty Cream=COL22)
COMCODE: Black=847043304, Misty Cream=847043312
- **Desk stand/Wall mount assembly**
COMCODE: 846028546.

Adjuncts

The following adjuncts can be used with this voice terminal:

- S101A Speakerphone (no longer orderable)
- S201A Speakerphone
- CS201A Speakerphone
- 7400B Data Module
- 500A Headset Adapter (and a standard headset; see “Headsets” below)
- R6 Amplifier Handset (PEC: 3152-002)
- R8 Noisy Location Handset (PEC: 3152-003)
- R2H Standard Handset (PEC: 3152-019)
- Shoulder Rest

Headsets

A list of compatible headsets, consisting of both modular and plug prong base units and selection of headpieces, appears in “Headset Adapters” in the **Adjuncts** section (behind the **Adjuncts** tab) later in this manual.

Additional Documents

The following documents contain additional information relating to the 7402 Plus voice terminal: (use the 9-digit number listed after each document to order the book from the GBCS Publications Fulfillment Center.)

- *DEFINITY Communications System Generic 1 and System 75 7402 Plus Voice Terminal User's Guide, 555-230-760*
- *DEFINITY Communications System Generic 2 and System 85 7402 Plus Voice Terminal User's Guide, 555-104-724*

The following document is shipped with every 7402 Plus voice terminal:

- *7402 Plus Voice Terminal Installation Instructions, 555-015-140.*

7403D VOICE TERMINAL

MESSAGE

LIGHT

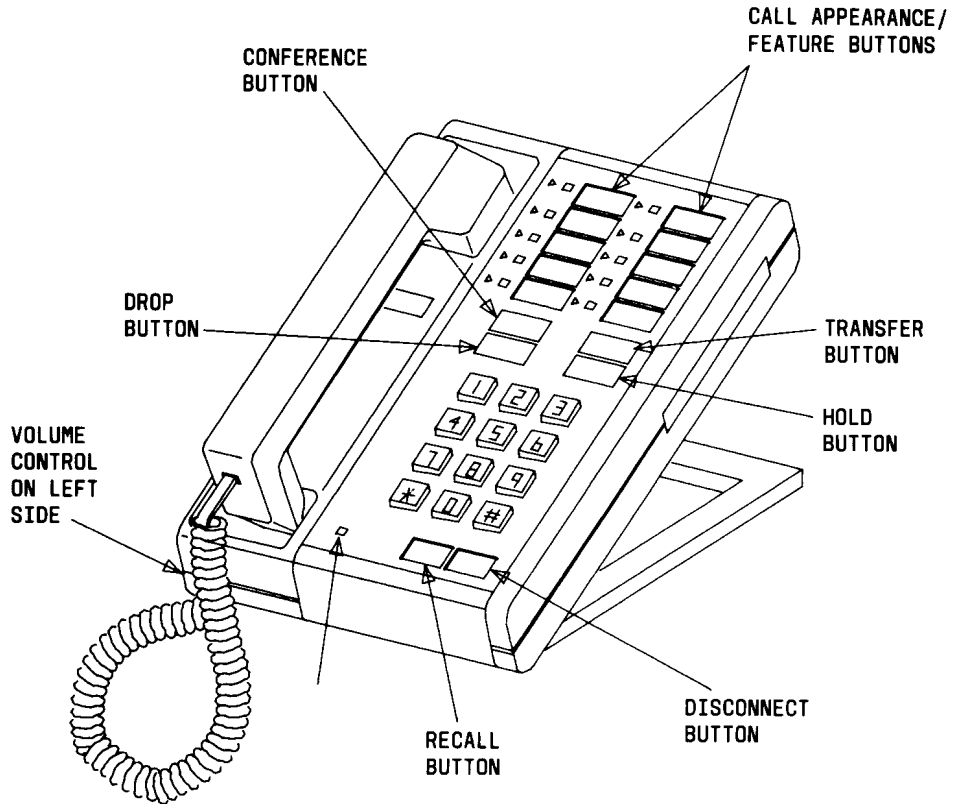

FIGURE 3-15. The 7403D Voice Terminal

7403D Voice Terminal

The 7403D is a multi-appearance digital voice terminal which has 10 buttons available for line appearances, one-touch feature access, or Speed Dialing. In addition, the 7403D voice terminal may be equipped with a Digital Terminal Data Module (DTDM) which attaches to the right side and allows the connection of a EIA RS-232C data terminal. The 7403D voice terminal has been discontinued.

Applications

The 7403D voice terminal can be used with the DEFINITY G1, G2, G3, System 75, and System 85. This voice terminal is especially suitable for managers, executive secretaries, and office support personnel. When equipped with a DTDM or 7400B, it is also suitable for users who have data terminals.

Physical Description

Dimensions

Note: The following dimensions for the 7403D voice terminal are approximate.

Width = 7 inches

Depth (front to back) = 8-3/4 inches

Height (maximum with handset in place) = 5-1/2 inches

Thickness of housing = 1-1/2 inches

Features

Six Fixed Feature Buttons

- RECALL button
- DISCONNECT button
- CONFERENCE button

- DROP button
- TRANSFER button
- HOLD button

Message light

The green Message light goes on when a message is left for the user. It goes off when the user retrieves the message.

Call Appearance/Feature Buttons

The 7403D voice terminal has 10 call appearance/feature buttons. Adjacent to each button is a red light and a green status indicator light.

Self-Test

The 7403D voice terminal is equipped with a self-test for its buttons and tone ringer. The self-test switch is located on the left side of the base.

Other Physical Features

Handset

The 7403D voice terminal is equipped with an R-type handset.

Dial pad

The 7403D voice terminal is equipped with a 12-button touch-tone dial pad.

Jacks

The 7403D voice terminal housing contains three jacks. The handset cord jack is just under the left side of the housing. The handset contains a jack for the handset cord. The LINE and OTHER jacks are on the bottom center of the housing.

Cords

Two cords are supplied with the 7403D voice terminal: a coiled 7-foot modular handset cord and a 7-foot modular line cord. Optional longer cords are available: a 12-foot handset cord; 14-foot and 25-foot line cords.

Ringling

The 7403D voice terminal has electronic tone ringing. The volume control is on the left side of the housing.

Mounting Options

The 7403D voice terminal comes equipped with a nonadjustable desk stand. An optional wall mounting kit can be ordered.

Color Options

The 7403D voice terminal was available in black and misty cream.

Distance Limitations

The maximum distance the 7403D voice terminal can be located from the system cabinet is shown in the following table.

SYSTEM	PORT BOARD	NOMINAL MAXIMUM RANGE IN FEET (METERS) (SEE NOTE)	
		24 AWG	26 AWG
SYSTEM 85	SN270B	3,400 (1,034)	2,200 (671)
	TN754	3,400 (1,034)	2,200 (671)
DEFINITY G2	SN270B	3,400 (1,034)	2,200 (671)
	TN754	3,400 (1,034)	2,200 (671)
DEFINITY G1 & G3 SYSTEM 75	TN754	3,400 (1,034)	2,200 (671)

Note: These ranges can be extended to 5,000 feet (1524 m) for 24 AWG wire and 4,000 feet (1219 m) for 26 AWG wire with the use of a Data Link Protector (DLP). Refer to **EXPOSED PORT PROTECTION**.

Power Requirements

The 7403D voice terminal receives power from the system and does not require any external power supply. Additional power is required when the 7403D voice terminal is equipped with a DTDM. Refer to the **ADJUNCT POWER** section of this manual.

Power Failure Operation

The 7403D voice terminal cannot be used as an emergency station during power failure transfer conditions.

FCC Registration

The 7403D voice terminal is not FCC registered.

Hearing Aid Compatible

This voice terminal is compatible with the inductively coupled hearing aids prescribed by the FCC.

7403D Equipment Price Element Code (PECs)

The 7403D voice terminal has been discontinued, and thus it cannot be ordered.

Adjuncts

One of the following adjuncts can be used with this voice terminal:

- S101A Speakerphone
- S201A Speakerphone (PEC 3152-007A)
- 500A Headset Adapter and a standard headset (PEC 3152-001A)
- Z701A Digital Terminal Data Module
- 7400B Data Module
- R6 Amplifier Handset (PEC 3152-002A)
- R8 Noisy Location Handset (PEC 3152-003A)

Additional Documents

The following documents contain additional information relating to the 7403D voice terminal:

- *System 85 7403D Voice Terminal User's Guide*, 555-103-709
- *System 75 7403D Voice Terminal User's Guide*, 555-200-704
- *DEFINITY Generic 1 and Generic 2, System 75, and System 85 Terminals and Adjuncts Installation and Test*, 555-015-104.

7404D VOICE TERMINAL

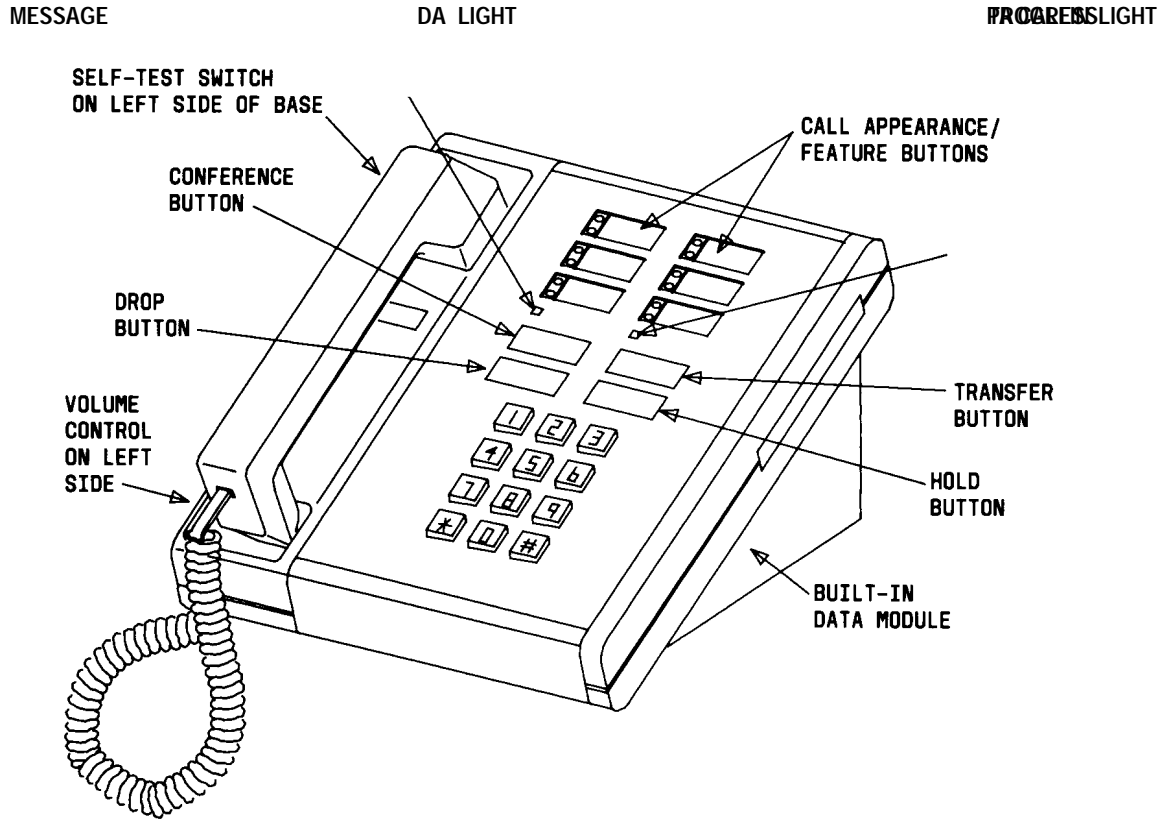

FIGURE 3-16. The 7404D Voice Terminal

7404D Voice Terminal

The 7404D is a multi-appearance digital voice terminal which provides simultaneous voice/asynchronous data transmission. All the transmission is done over the same two pairs of wire.

The 7404D voice terminal can be equipped with one of two different optional cartridges. The Z300B cartridge provides a display of voice call related and personal service information on an attached data terminal. The Z300C cartridge provides an interface between an AT&T PC (or compatible) with the PC/PBX Connection application program and the DEFINITY G2 or System 85 DCP.

The 7404D voice terminal was discontinued in February 1989, but will be supported until February 1994.

Applications

The 7404D voice terminal can be used with the DEFINITY G1, G2, G3, System 75, and System 85. Typical applications of the 7404D voice terminal are users who have data terminals or a PC that requires a small selection of lines and features.

Physical Description

Dimensions

Note: The following dimensions for the 7404D voice terminal are approximate.

Width = 7 inches

Depth (front to back) = 8-3/4 inches

Height (maximum with handset in place) = 5-1/2 inches

Thickness of housing = 1-1/2 inches

Features

Four Fixed Feature Buttons

- CONFERENCE button
- DROP button

- TRANSFER button
- HOLD button

Message Light

The green Message light goes on when a message is left for the user. It goes off when the user retrieves the message.

Data Light

The Data light goes on when a data call is in progress.

Call Appearance/Feature Buttons

The 7404D voice terminal has six call appearance/feature buttons. Adjacent to each button is a pair of red and green indicator lights.

Self-Test

The 7404D voice terminal is equipped with a self-test for its buttons and tone ringer. The self-test switch is located on the left side of the base.

Other Physical Features

Handset

The 7404D voice terminal is equipped with an R-type handset.

Dial pad

The 7404D voice terminal is equipped with a 12-button touch-tone dial pad.

Jacks

The 7404D voice terminal housing contains three jacks. The handset cord jack is just under the left side of the housing. The handset contains a jack for the handset cord. The LINE jack is on the rear housing. There is a EIA RS-232C receptacle on the rear of the voice terminal that is used to connect an associated data terminal.

Cords

Three cords are supplied with the 7404D voice terminal: a coiled 7-foot modular handset cord, 7-foot modular line cord and an AC power cord. Optional longer cords are available: a 12-foot handset cord; 14-foot and 25-foot line cords.

Ringling

The 7404D voice terminal has electronic tone ringing with patterns that are set at administration. The volume control is on the left side of the housing.

Mounting Options

The 7404D voice terminal comes equipped with a nonadjustable data stand.

Color Options

The 7404D voice terminal was available in black and misty cream.

Distance Limitations

The maximum distances the 7404D voice terminal can be located from the system cabinet is shown in the following table.

SYSTEM	PORT BOARD	NOMINAL MAXIMUM RANGE IN FEET (METERS) (SEE NOTE)	
		24 AWG	26 AWG
SYSTEM 85	SN270B	3,400 (1,034)	2,200 (671)
	TN754	3,400 (1,034)	2,200 (671)
DEFINITY G2	SN270B	3,400 (1,034)	2,200 (671)
	TN754	3,400 (1,034)	2,200 (671)
DEFINITY G1 & G3 SYSTEM 75	TN754	3,400 (1,034)	2,200 (671)

Note: These ranges can be extended to 5,000 feet (1524 m) for 24 AWG wire and 4,000 feet (1219 m) for 26 AWG wire with the use of a Data Link Protector (DLP). Refer to **EXPOSED PORT PROTECTION**.

Power Requirements

The 7404D voice terminal requires a three prong 115-volt AC outlet not under the control of a wall switch for power. A built in power supply converts the 115 volts to the DC power required. A 3-wire AC power cord is provided with the voice terminal. No external power adjuncts are required.

Power Failure Operation

The 7404D voice terminal cannot be used as an emergency station during power failure transfer conditions.

FCC Registration

The 7404D voice terminal is not FCC registered.

Hearing Aid Compatible

This voice terminal is compatible with the inductively coupled hearing aids prescribed by the FCC.

7404D Equipment Price Element Code (PECs)

The 7404D voice terminal and optional components was ordered with the following PECs:

- Basic voice terminal—3181-VDS
- Handset cord (12 feet)—2725-01L COL09
- Line cord (14 feet, silver)—2725-07N COL18
- Line cord (25 feet, silver)—2725-07S COL18
- Messaging Cartridge (Z300B)—31810
- PC/PBX Feature Cartridge (Z300C)—31815

Adjuncts

The 7404D voice terminal cannot be equipped with an external adjunct. The data base contains a slot where optional cartridges can be installed to provide different features. These cartridges are identified in the introduction paragraph of this section.

Additional Documents

The following documents contain additional information relating to the 7404D voice terminal:

- *System 85 7404D Voice Terminal User's Guide, 555-103-708*
- *System 75 7404D Voice Terminal User's Guide, 555-200-705*
- *DEFINITY Generic 1 and Generic 2, System 75, and System 85 Terminals and Adjuncts Installation and Test, 555-015-104*

7405D VOICE TERMINAL

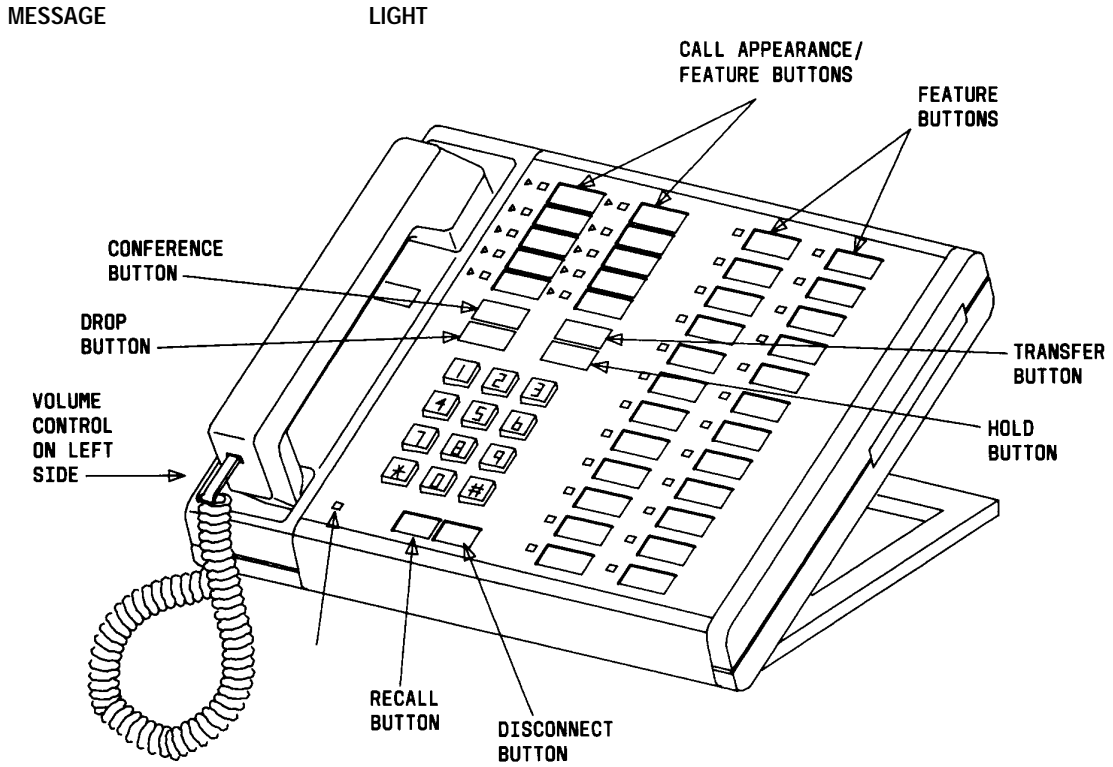

FIGURE 3-17. The 7405D Voice Terminal

7405D Voice Terminal

The 7405D voice terminal is a multi-appearance digital voice terminal which allows features to be added as the user needs them. The Digital Display can be added to provide access to the Message Center. A Digital Terminal Data Module or 7400B can be added to enable the user of a 7405D voice terminal to transmit or receive data with an associated data terminal.

The basic voice terminal provides 10 call appearance/feature buttons with lights that can be assigned to call appearances or system features. It has 24 programmable feature buttons and six fixed feature buttons. The 7405D can also have a function key module which adds 24 feature buttons and a call coverage module (when no display module is used) which adds 20 call appearance/feature buttons.

The 7405D voice terminal was discontinued in February 1990, but will be supported until February 1996.

Applications

The 7405D voice terminal can be used with the DEFINITY G1, G2, G3, System 75, and System 85. Typical applications of the 7405D voice terminal are secretaries, executives, managers and answering positions that require a large selection of lines, features, or data transmissions.

Physical Description

Dimensions

Note: The following dimensions for the 7405D voice terminal are approximate.

Width = 10-1/4 inches

Depth (front to back) = 8-3/4 inches

Height (maximum with handset in place) = 6-1/4 inches

Thickness of housing = 1-1/2 inches

Features

Six Fixed Feature Buttons

- CONFERENCE button
- DROP button
- TRANSFER button
- HOLD button
- DISCONNECT button
- RECALL button

Message Light

The green Message light goes on when a message is left for the user. It goes off when the user retrieves the message.

Call Appearance/Feature Buttons

The 7405D voice terminal has 10 call appearance/feature buttons. Adjacent to each button is a pair of red and green indicator lights.

Feature-only Buttons

The 7405D voice terminal has 24 feature-only buttons. Adjacent to each button is a green status light.

Self-Test

The 7405D voice terminal is equipped with a self-test for its buttons and tone ringer. The self-test switch is located on the left side of the base.

Other Physical Features

Handset

The 7405D voice terminal is equipped with a R-type handset.

Dial pad

The 7405D voice terminal is equipped with a 12-button touch-tone dial pad.

Jacks

The 7405D voice terminal housing contains three jacks. The handset cord jack is just under the left side of the housing. The handset contains a jack for the handset cord. The LINE and OTHER jacks are on the rear housing.

Cords

Three cords are supplied with the 7405D voice terminal: a coiled 7-foot modular handset cord and 7-foot modular line cord. Optional longer cords are available: a 12-foot handset cord; 14-foot and 25-foot line cords.

Ringling

The 7405D voice terminal has electronic tone ringling. The volume control is on the left side of the housing.

Mounting Options

The 7405D voice terminal comes equipped with an adjustable desk stand.

Color Options

The 7405D voice terminal was available in black and misty cream. Since it has become discontinued, it is only available in black.

Distance Limitations

The maximum allowable distance the 7405D voice terminal can be located from the switch cabinet is shown in the following table.

SYSTEM	PORT BOARD	NOMINAL MAXIMUM RANGE IN FEET (METERS) (SEE NOTE)	
		24 AWG	26 AWG
SYSTEM 85	SN270B	3,400 (1,034)	2,200 (671)
	TN754	3,400 (1,034)	2,200 (671)
DEFINITY G2	SN270B	3,400 (1,034)	2,200 (671)
	TN754	3,400 (1,034)	2,200 (671)
DEFINITY G1 & G3 SYSTEM 75	TN754	3,400 (1,034)	2,200 (671)

Note: These ranges can be extended to 5,000 feet (1524 m) for 24 AWG wire and 4,000 feet (1219 m) for 26 AWG wire with the use of a Data Link Protector (DLP). Refer to **EXPOSED PORT PROTECTION**.

Power Requirements

The 7405D voice terminal receives power from the system and does not require any external power supply. Additional power is required when the 7405D voice terminal is equipped with any adjuncts. Refer to the **ADJUNCT POWER** section of this manual.

Power Failure Operation

The 7405D voice terminal cannot be used as an emergency station during power failure transfer conditions.

FCC Registration

The 7405D voice terminal is not FCC registered.

Hearing Aid Compatible

This voice terminal is compatible with the inductively coupled hearing aids prescribed by the FCC.

7405D Equipment Price Element Code (PECs)

The 7405D voice terminal and optional components was ordered with the following PECs:

- Basic voice terminal—3175-40D/CLR
- Handset cord (12 feet)—2725-01L COL09
- Line cord (14 feet, silver)—2725-07N COL18
- Line cord (25 feet, silver)—2725-07S COL18

Adjuncts

The following adjuncts can be used with this voice terminal:

- S101A Speakerphone or 500A Headset Adapter and a standard headset
- S201A Speakerphone
- C401A or C401B Call Coverage Module or D401A or D401B Digital Display Module (but not both simultaneously)
- F401A Function Key Module
- Z701A Digital Terminal Data Module
- 7400B Data Module

Additional Documents

The following documents contain additional information relating to the 7405D voice terminal:

- *System 85 7405D Voice Terminal User's Guide*, 555-103-709
- *System 75 7405D Voice Terminal User's Guide*, 555-200-704
- *DEFINITY Generic 1 and Generic 2, System 75, and System 85 Terminals and Adjuncts Installation and Test*, 555-015-104

7406D, 7406BIS, and 7406 Plus VOICE TERMINALS

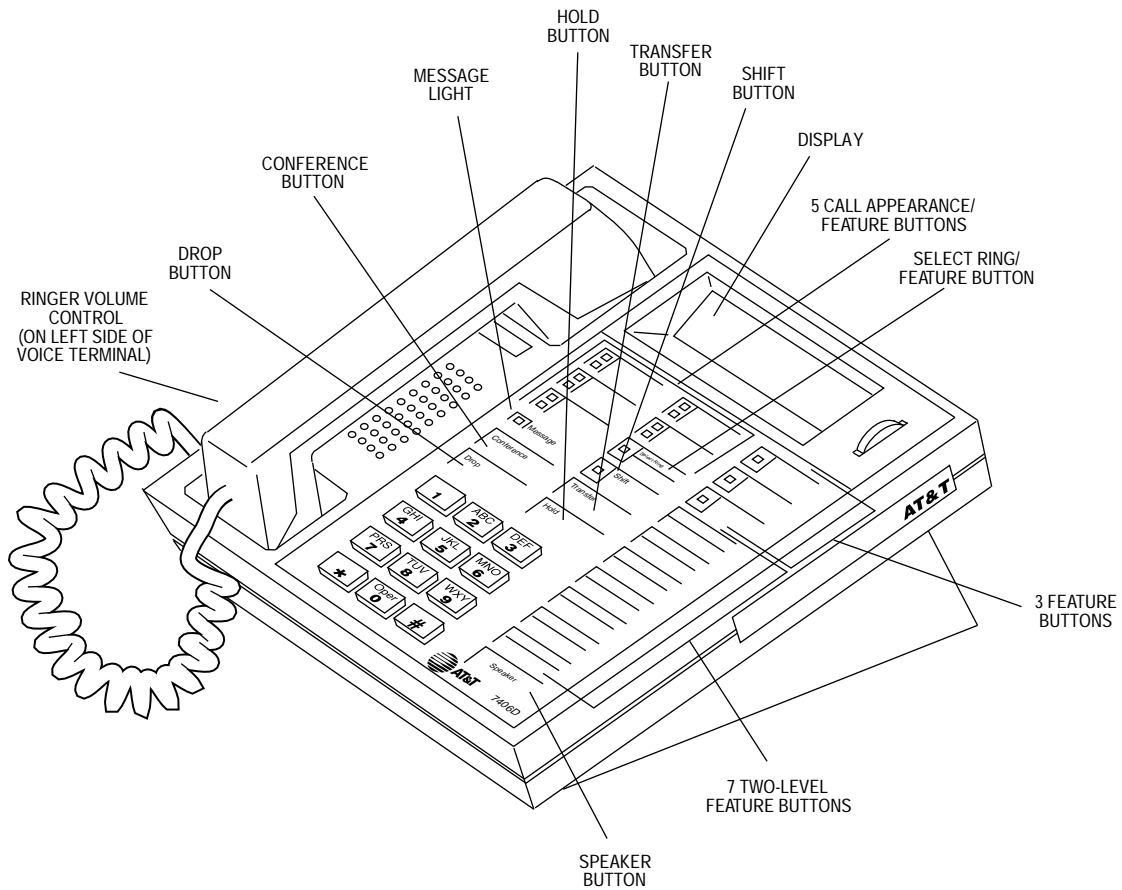

FIGURE 3-18. The 7406D (7406D01A or 7406D03A) Voice Terminal with Display

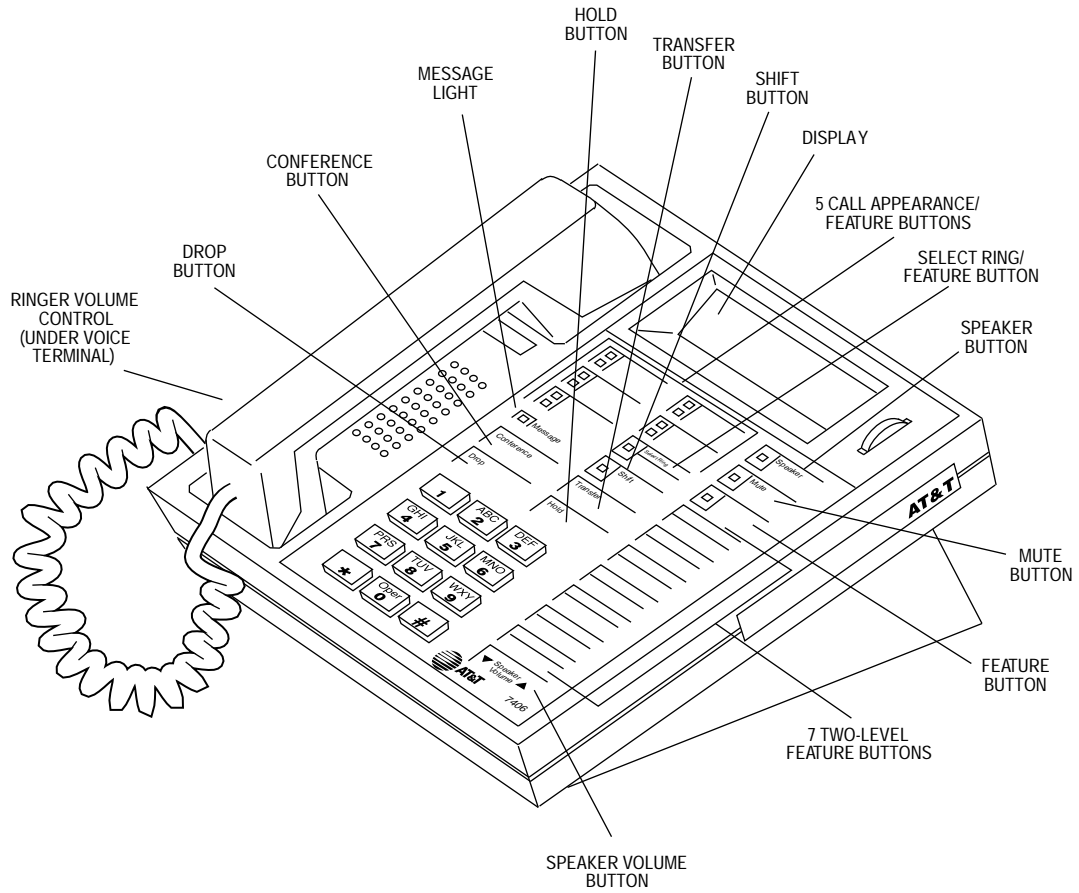

FIGURE 3-19. The 7406BIS (7406D05A) Voice Terminal with Display

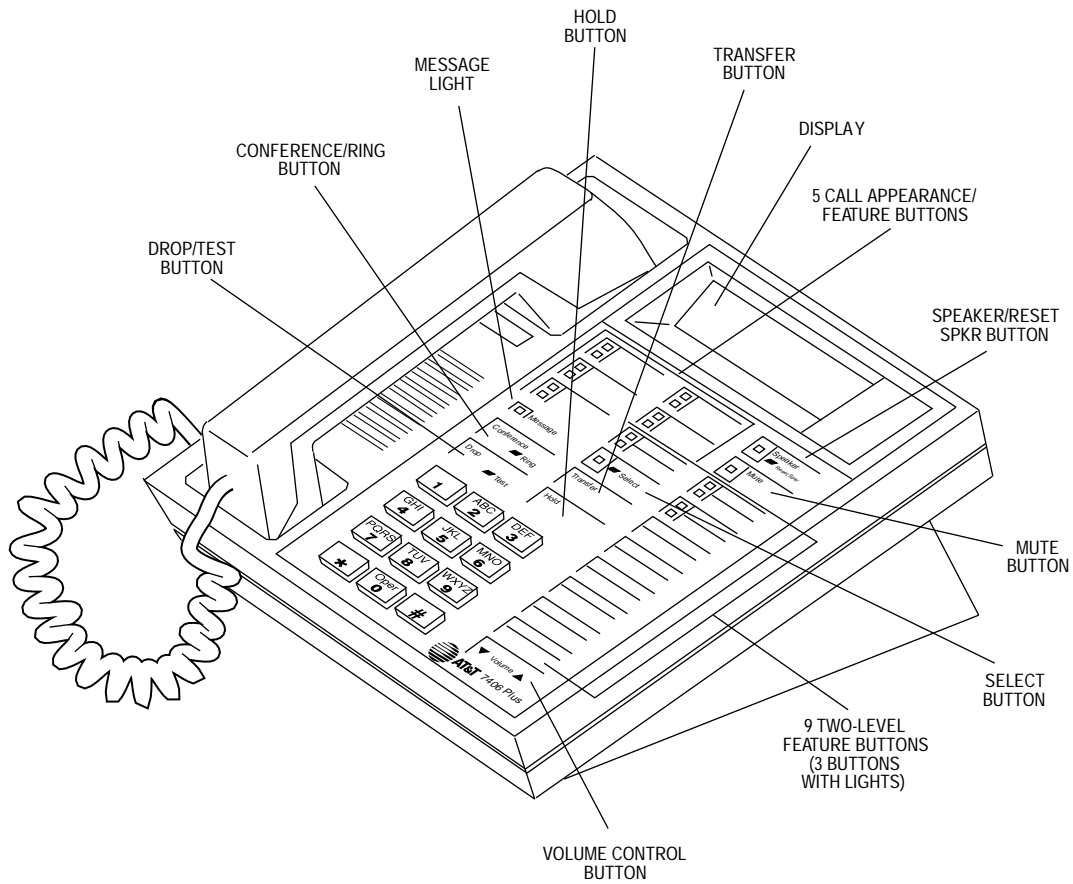

FIGURE 3-20. The 7406 Plus (7406D07A) Voice Terminal with Display

7406D, 7406BIS, and 7406 Plus Voice Terminals

The 7406D (four versions), 7406BIS (two versions), and 7406 Plus (two versions) multi-appearance digital voice terminals are described in the following table and in the following information.

VERSION	2 x 24 CHARACTER DISPLAY	DATA CAPABILITY WITH THE FOLLOWING	BUILT-IN SPEAKERPHONE
7406D01A	Yes	Z703AL1 / 7400B	No
7406D02A	No*	Z703AL1 / 7400B	No
7406D03A	Yes	7400B	No
7406D04A	No	7400B	No
7406D05A	Yes	7400B	Yes
7406D06A	No	7400B	Yes
7406D07A	Yes	7400B	Yes
7406D08A	No	7400B	Yes

* Display features can be used on a data terminal if equipped with Z703AL1 DSU.

The **7406D** (which includes the **7406D01A**, **7406D02A**, **7406D03A**, and **7406D04A** versions)—has five call appearance/feature buttons, each with a red in-use light and a green status light, seven shiftable (2-level) programmable feature buttons with no lights, four programmable feature buttons with a green light, four fixed feature buttons (CONFERENCE, TRANSFER, DROP, and HOLD), a SHIFT button with a green light, a SPEAKER button, and a green Message light.

The **7406BIS** (which includes the **7406D05A** and **7406D06A** versions)—has five call appearance/feature buttons, each with a red in-use light and a green status light, seven shiftable (2-level) programmable buttons with no lights, two programmable feature buttons with a green light, four fixed feature buttons (CONFERENCE, TRANSFER, DROP, and HOLD), a SHIFT button with a green light, a SPEAKER button with a green light, a MUTE button with a red light, a SPEAKER VOLUME “arrow” button, and a red Message light.

The **7406 Plus** (which includes the **7406D07A** and **7406D08A** versions)— are the newest 7406 sets. The 7406 Plus voice terminal has five call appearance/feature buttons, each with a red in-use light and a green status light, three shiftable (2-level) programmable feature buttons with a green light, six shiftable (2-level) programmable feature buttons without lights, four fixed feature buttons (CONFERENCE, TRANSFER, DROP, and HOLD), a SELECT button with a green light, a SPEAKER/RESET SPKR button with a green light, a MUTE button with a red light, a VOLUME “arrow” button, and a red Message light.

Note: The 7406D01A through 7406D06A are no longer being manufactured. The 7406D08A will be discontinued as of January 1, 1995. Therefore, during 1995, only the 7406D07A will be generally available.

Applications

The 7406D, 7406BIS, and 7406 Plus voice terminals can be used with the DEFINITY Communication System, System 75, and System 85. These 7406 digital voice terminals are the least expensive digital voice terminals with a display that AT&T offers. Typical applications of the 7406D, the 7406BIS, and the 7406 Plus voice terminal are users who have a need for calling party display capabilities or with data terminals requiring a large number of features.

The 7406D, 7406BIS, and 7406 Plus voice terminals can also provide the user with simultaneous voice and data communications: The 7406D (7406D01A–7406D04A) are equipped with a data stand; the 7406BIS (7406D05A and 7406D06A) and the 7406 Plus (7406D07A and 7406D08A) can be connected to a 7400B Data Module. With the 7406BIS and 7406 Plus voice terminals, PC platform products can be useful in providing voice capabilities since these screen-based products can greatly enhance the telephone capabilities of these voice terminals.

Physical Features

Dimensions

Note: The following dimensions listed here for the 7406D, 7406BIS, and 7406 Plus voice terminals are approximate.

Width = 8 1/2 inches

Depth (front to back) = 8 3/4 inches

Height (maximum with handset in place) = 6 1/4 inches

Thickness of housing = 1 1/2 inches

Feature Buttons

The 7406D, 7406 BIS, and 7406 Plus voice terminals have the following buttons and features:

Four Standard Fixed Feature Buttons

The **7406D**, **7406BIS**, and **7406 Plus** have the following four standard fixed feature buttons:

- CONFERENCE or CONFERENCE/RING button
- DROP or DROP/TEST button
- TRANSFER button
- HOLD button

Message light

The **7406D**, **7406BIS**, and the **7406 Plus** have a Message light. The Message light goes on when a message is left for the user. It goes off when the user has retrieved the message.

SHIFT button (on 7406D and 7406BIS)

The **7406D** and **7406BIS** (7406D01A—7406D06A) voice terminals have a SHIFT button which allows programming and use of a second feature or phone number for the seven double-level buttons. When the user presses the SHIFT button (and the light next to the button is on), the top-level feature on the shiftable (2-level) button can be used. (When the SHIFT button light is off, the feature assigned to the lower half of the shiftable button can be used.)

SELECT RING button (on 7406D and 7406BIS)

The **7406D** and **7406BIS** (7406D01A—7406D06A) voice terminals have a SELECT RING button which is used for selecting a personalized ringing pattern. (There are eight different patterns to choose from.)

SELECT button (on 7406 Plus only)

The **7406 Plus** (7406D07A and 7406D08A) voice terminals have a SELECT button which can be used in four different ways:

- Used with a 2-level feature button to access the top-labeled feature
- Used with the DROP/TEST button to initiate a self-test of your voice terminal
- Used with the CONFERENCE/RING button to select your own personalized ring from among eight available patterns
- Used with the SPEAKER/RESET SPKR button to perform an acoustic test of the environment and adjust the speakerphone to the surrounding acoustic environment for optimal performance.

Call Appearance/Feature Buttons

The **7406D**, **7406BIS**, and **7406 Plus** voice terminals have five call appearance/feature buttons.

One-level Feature-only and Two-level Feature-only Buttons

The **7406D** (7406D01A—7406D04A) voice terminals have three buttons that can be used for one feature each, with a green light, and seven double-level feature buttons without lights. There is also a Select Ring/Feature button with the Select Ring option on the top level; another feature can be administered on the bottom level.

The **7406BIS** (7406D05A and 7406D06A) voice terminals have one single-level feature button with a green light and seven double-level feature buttons without lights. There is also a Select Ring/Feature button with the Select Ring option on the top level; another feature can be administered on the bottom level.

The **7406 Plus** (7406D07A and 7406D08A) voice terminals have three double-level feature buttons, each with a green light. These voice terminals also have six double-level feature buttons without lights.

Speakerphone (on 7406BIS and 7406 Plus)

The **7406BIS** and **7406 Plus** (7406D05A—7406D08A) voice terminals are equipped with a built-in speakerphone. The Speakerphone capability allows a user to engage in a hands-free conversation with the far-end party. The speakerphone can be turned off or on (on the 7406BIS voice terminal, use the **SPEAKER** button; on the 7406 Plus voice terminal, use the **SPEAKER/RESET SPKR** button), can be muted (use the **MUTE** button), and the volume can be raised and lowered (use the Volume “arrow” button).

The Speakerphone feature on the **7406 Plus** also allows the user to adjust the speakerphone for optimal performance. By pressing the **SELECT** button and then the **SPEAKER/RESET SPKR** button (if the voice terminal is set for the Speakerphone feature), the user hears a set of tones as the speakerphone performs an acoustic test of the environment. When the tones stop, the speakerphone has finished adjusting itself and is ready for use. The user *must* reset the speakerphone in any one of three instances: whenever the voice terminal is moved to another place (even in the same room), whenever the green light next to the **SPEAKER/RESET SPKR** button is fluttering, and, when, in the unlikely event, the speakerphone is making a squealing sound.

On the **7406D** voice terminals, the volume control for the speaker is a sliding control also used for the tone ringer volume. On the **7406BIS** voice terminal, the volume control button is labeled **SPEAKER VOLUME** and double arrows, one for raising the volume level and one for lowering the volume; on the **7406 Plus** voice terminal, the volume control button is labeled with the word **VOLUME** and the double arrows for raising and lowering the volume.

Loudspeaker/Spokesman/Speaker Feature

The **7406D** (7406D01A—7406D04A) voice terminals are equipped with a built-in, listen-only loudspeaker/Spokesman® capability. Use the **SPEAKER** button for turning on and off the loudspeaker.

The **7406BIS** and the **7406 Plus** (7406D05A—7406D08A) voice terminals come with a built-in speakerphone that can be optioned for Spokesman operation. (Since changing the internal jumper setting requires removing the back of the voice terminal, converting the voice terminal Speakerphone feature to the Speaker feature should be done *only* by qualified service personnel.) These voice terminals are shipped with the Speakerphone setting in place.

The Spokesman capability allows a user to engage in a one-way conversation with the far-end. Specifically, the user can only listen to the far-end; the user is not able to transmit his voice over the Spokesman. To speak with the far-end, the user must use the handset.

With the **7406D** and **7406BIS** voice terminals, the handset and Spokesman capability can be used simultaneously. With the **7406 Plus** voice terminal, the handset and speaker *cannot* be used at the same time.

MUTE button (on 7406BIS and 7406 Plus)

The **7406BIS** and the **7406 Plus** (7406D05A—7406D08A) voice terminals are equipped with a MUTE button. This button is a fixed feature button with a red status light. The MUTE button turns off the microphone of the built-in speakerphone or the handset so that a person can converse with another person in the room without the other party listening in.

VOLUME button (on 7406BIS and 7406 Plus)

The **7406BIS** (7406D05A and 7406D06A) voice terminal has a SPEAKER VOLUME “arrow” button on the bottom right side of the faceplate which controls the volume of the built-in speakerphone. The left side of the VOLUME button lowers the volume; the right side of the button raises the volume.

The **7406 Plus** (7406D07A and 7406D08A) voice terminal also has a VOLUME “arrow” button on the bottom right side of the faceplate. However, this button has a double function. When the user is using the speakerphone, the VOLUME button controls the volume of the speakerphone; at all other times, the button controls the volume of the tone ringer.

If the 7406BIS or 7406 Plus voice terminal has a display (the 740605A and 7406D07A voice terminals only), the display will show a “bar array” that indicates the volume setting.

Self-Test

Two of the **7406D** voice terminals (the 7406D03A and 7406D04A) and the **7406BIS** voice terminals (7406D05A and 7406D06A) are equipped with a self-test. On these voice terminals, the Self-Test feature is performed by pressing the SHIFT button and then the DROP button.

With the **7406 Plus** (7406D07A and 7406D08A) voice terminals, the user presses the SELECT button and then the DROP/TEST button to initiate a self-test for the voice terminal.

During the self-test, all the lights go on, the ringer sounds, and, if the voice terminal has a display, the display characters are lit. The self-test ends when the user releases the DROP or DROP/TEST button.

Other Physical Features

Handset

The **7406D**, **7406BIS**, and **7406 Plus** voice terminals are equipped with an R-type handset.

Dial pad

The **7406D**, **7406BIS**, and **7406 Plus** voice terminals are equipped with a 12-button touch-tone dial pad. On the **7406 Plus** voice terminal, the letters “Q” and “Z” have been added to the appropriate dial pad keys for directory access, and the “5” button on your dial pad has raised bars for visually-impaired users.

Jacks

The **7406D**, **7406BIS**, and **7406 Plus** voice terminals’ housing contains three jacks. The Handset cord jack is just under the left side of the housing. The Line jack and the Speakerphone/headset adapter jack are on the back of the voice terminal.

Cords

Two cords are supplied with the **7406D**, **7406BIS** and 7406 Plus voice terminals: a coiled 9-foot handset cord and a 7-foot line cord.

Optional longer cords are available: a 12-foot handset cord; 14-foot and 25-foot line cords.

Ringling

The **7406D**, **7406BIS**, and the **7406 Plus** voice terminals have electronic tone ringling. With the Personalized Ringling feature, the user can select any one of eight different ringling patterns.

On the **7406D** and **7406BIS** (7406D01A—7406D06A) voice terminals, the volume control is on the left side of the housing.

On the **7406 Plus** (7406D07A and 7406D08A), tone ringer volume is controlled by the VOLUME “arrow” button. When the speakerphone is active, the VOLUME button controls the volume of the speakerphone; at all other times, the button controls the volume of the tone ringer.

Mounting Options

Two of the **7406D** voice terminals (7406D01A and 7406D02A) come equipped with a nonadjustable desk stand, an optional data stand, or can be wall-mounted (without data capabilities).

Two of the **7406D** voice terminals (7406D03A, 7406D04A), the **7406BIS** (7406D05A, 7406D06A), and the **7406 Plus** (7406D07A, and 7406D08A) voice terminals come with a nonadjustable desk stand only. An optional wall mount kit is available.

Color Options

The **7406D**, **7406BIS**, and **7406 Plus** voice terminals are available in black and misty cream.

Distance Limitations

The maximum allowable distances of a 7406D or a 7406 Plus voice terminal from the DEFINITY G1, G3, System 75, or System 85 cabinet are shown in the following table.

SYSTEM	PORT BOARD	NOMINAL MAXIMUM RANGE IN FEET (METERS) (SEE NOTE)	
		24 AWG	26 AWG
System 85	SN270B	3,400 (1,034)	2,200 (671)
	TN754	3,400 (1,034)	2,200 (671)
DEFINITY G2	SN270B	3,400 (1,034)	2,200 (671)
	TN754	3,400 (1,034)	2,200 (671)
DEFINITY G1 & G3 System 75	TN754	3,400 (1,034)	2,200 (671)

Note: These ranges can be extended to 5,000 feet (1524 m) for 24 AWG wire and 4,000 feet (1219 m) for 26 AWG wire with the use of a Data Link Protector (DLP). Refer to the **EXPOSED PORT PROTECTION** section in this manual.

Power Requirements

The 7406D, 7406BIS, and 7406 Plus voice terminals receive power from the system and do not require any external power supply. Additional power is required when these voice terminals are equipped with any adjuncts or the Z703AL1 data stand. Refer to the **ADJUNCT POWER** section of this manual.

Switch Administration

Aliasing

The 7406 voice terminals must be aliased in the following way:

If you are administering this system:	For this type of voice terminal:	The voice terminal must be administered as:
System 75, R1V1 System 85, R2V1, V2, V3	7406D 7406BIS 7406 Plus	a 7405D voice terminal (See CAVEATS below)
System 75, R1V2 or above DEFINITY G1 & G3 System 85, R2V4 or above DEFINITY G2	7406D 7406BIS	itself
System 75, R1V2 or above DEFINITY G1 & G3 System 85, R2V4 or above DEFINITY G2	7406 Plus	a 7406D voice terminal <i>or</i> 7406BIS voice terminal

CAVEATS: For System 75, R1V1 and System 85, R1V2, V3, and V4, the following caveats apply:

7406D02A, 7406D04A, 7406D06A, 7406D08A aliased as 7405D;

7406D02A, 7406D04A, 7406D06A, 7406D08A w/7400B Data Module aliased
as 7405 w/ Data Module;

7406D01A, 7406D03A, 7406D05A, 7406D07A aliased as 7405D w/Digital Display Module;

7406D01A, 7406D03A, 7406D05A, 7406D07A w/7400B Data Module aliased
as 7405D w/Data Module and Digital Display Module;

7406D01A and 7406D02A w/Z703A DSU aliased as 7405D w/Data Module and Digital Display
Module.

Button Numbering

The 7406D and 7406 Plus voice terminal button diagrams on the following pages will help you administer the 7406D, 7406BIS, and the 7406 Plus voice terminals on a System 75 and DEFINITY G1 and G3, and on a System 85 and DEFINITY G2. In **Figures 4 through 7**:

- The numbers on the five administrable call appearance and feature buttons correspond to button assignments on Page 2 of the voice terminal administration screen forms
- The numbers on the administrable feature-only buttons correspond to feature button assignments on Page 3 of the voice terminal administration screen form.

Figures 4 and 5 refer to the button numbering for the 7406D and 7406BIS voice terminals; **Figures 6 and 7** refer to the 7406 Plus voice terminal.

If you need more information, refer to *DEFINITY Communications System Generic 3 Implementation*, and *DEFINITY Communications System Generic 2 Administration of Features and Hardware* for your specific system.

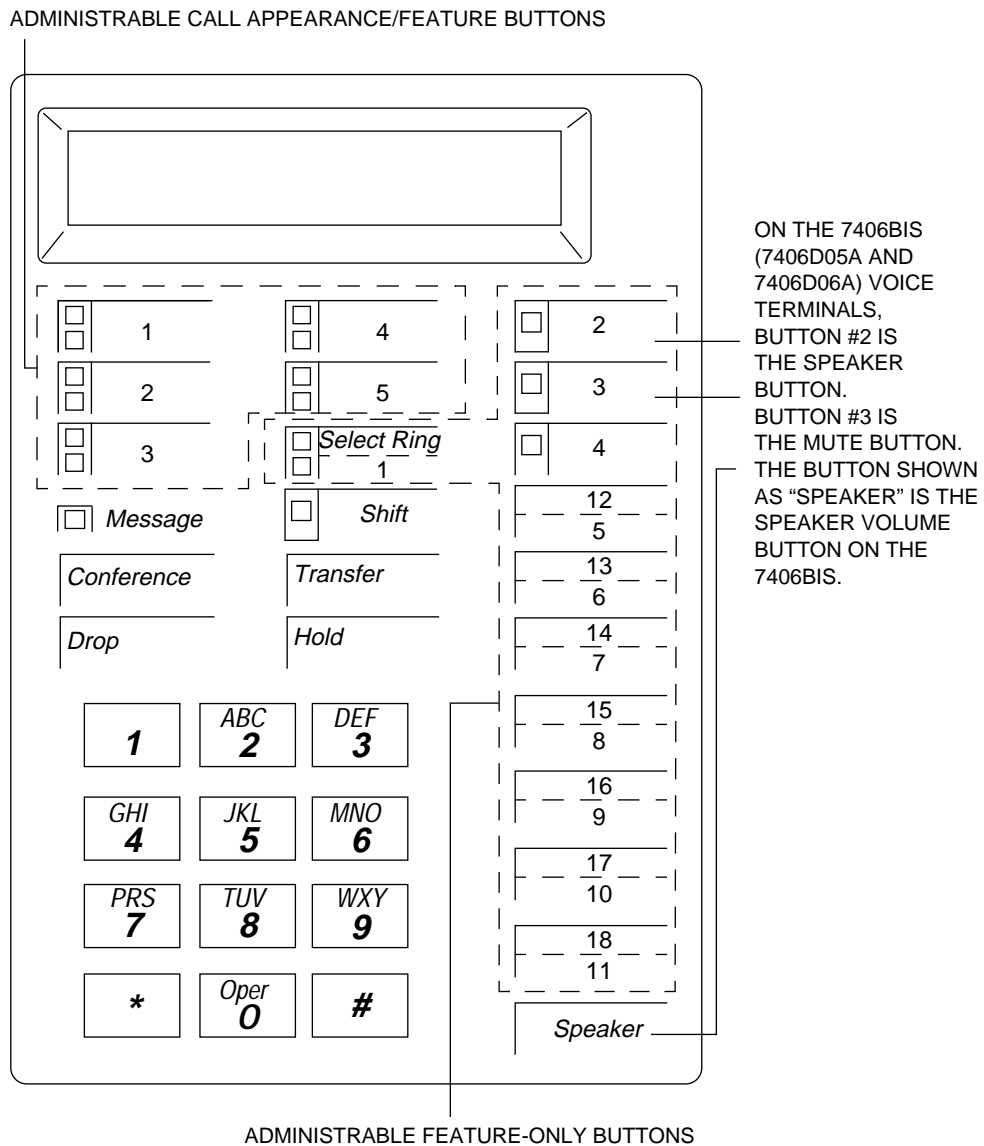
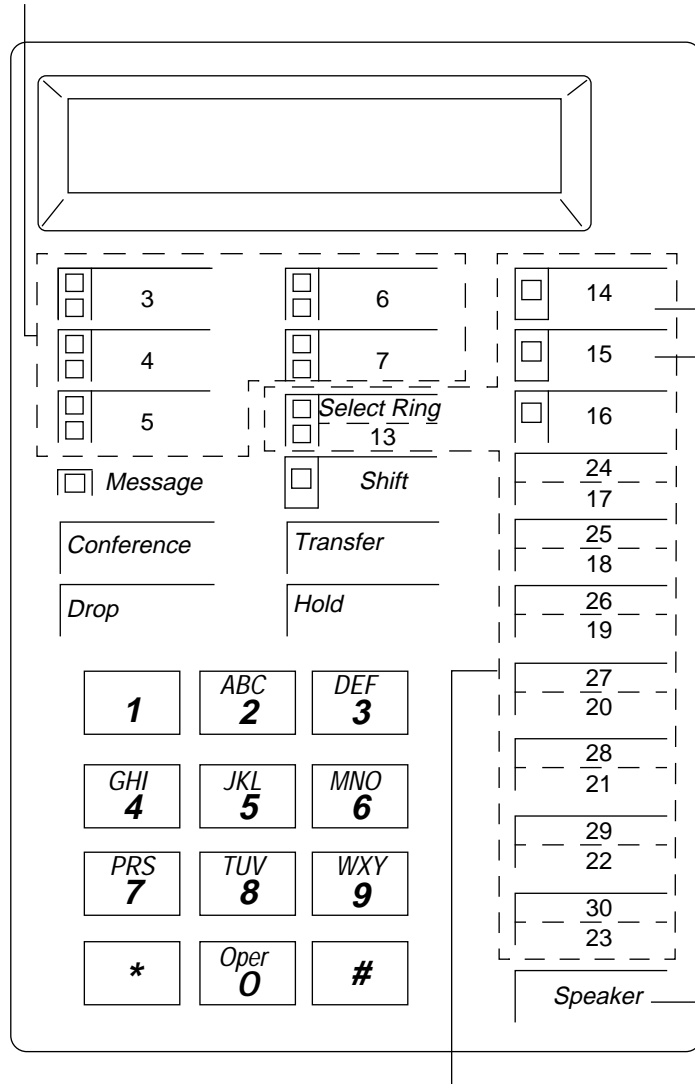

FIGURE 3-21. Button Numbering for Administering the 7406D and 7406BIS Voice Terminals Connected to a System 75 or a DEFINITY G1 or G3 Switch

ADMINISTRABLE CALL APPEARANCE/FEATURE BUTTONS



ON THE 7406BIS (7406D05A AND 7406D06A) VOICE TERMINALS, BUTTON #14 IS THE SPEAKER BUTTON. BUTTON #15 IS THE MUTE BUTTON. THE BUTTON SHOWN AS "SPEAKER" IS THE SPEAKER VOLUME BUTTON ON THE 7406BIS.

ADMINISTRABLE FEATURE-ONLY BUTTONS

NOTE: THE HOLD BUTTON IS BUTTON #1. THE MESSAGE LIGHT IS BUTTON #2.

FIGURE 3-22. Button Numbering for Administering the 7406D and 7406BIS Voice Terminals Connected to a System 85 or a DEFINITY G2 Switch

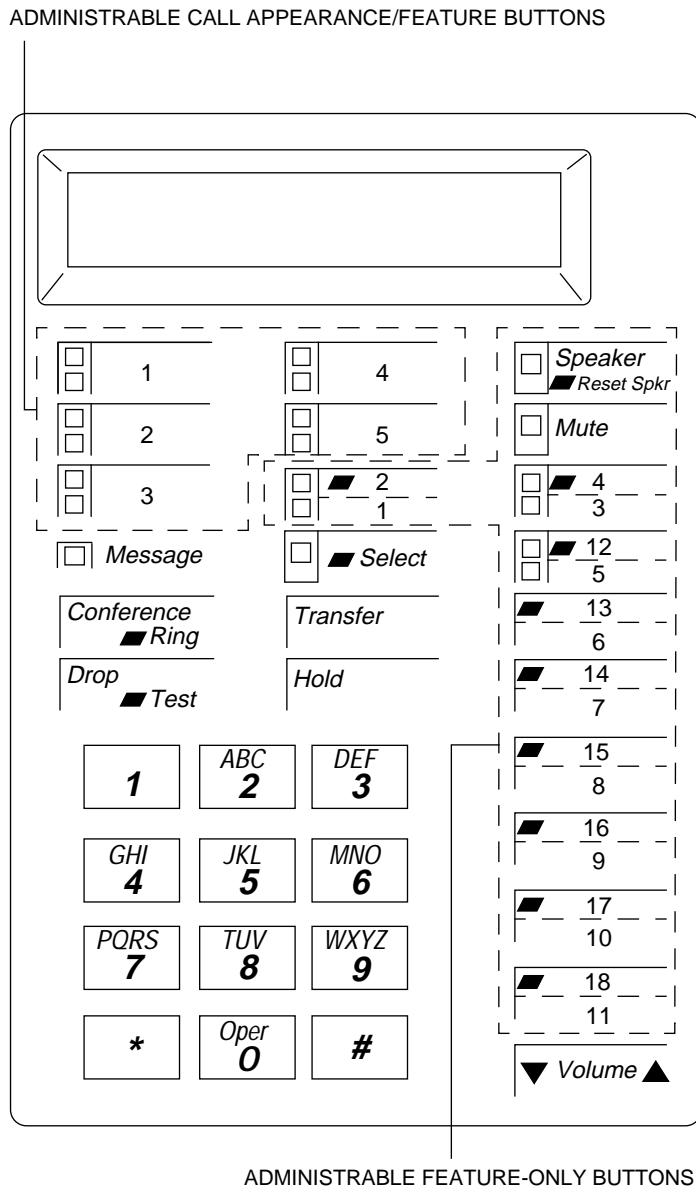
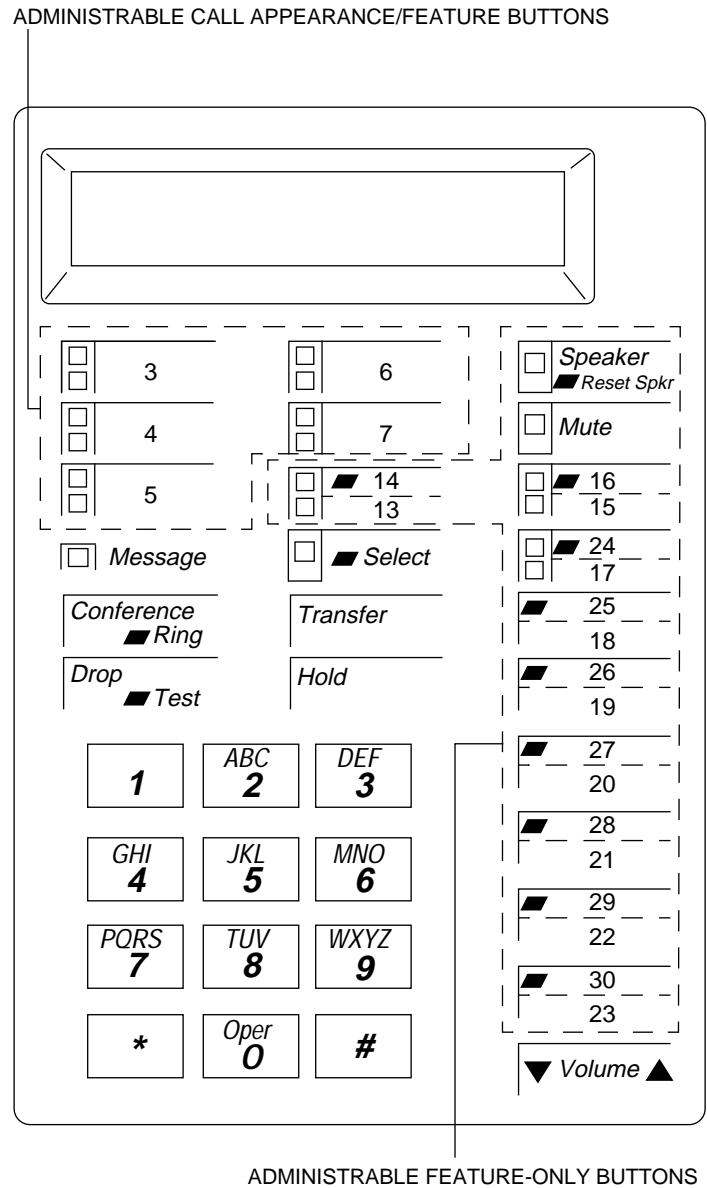

FIGURE 3-23. Button Numbering for Administering the 7406 Plus Voice Terminal Connected to a System 75 or a DEFINITY G1 or G3 Switch



NOTE: THE HOLD BUTTON IS BUTTON #1. THE MESSAGE LIGHT IS BUTTON #2.

FIGURE 3-24. Button Numbering for Administering the 7406 Plus Voice Terminal Connected to a System 85 or a DEFINITY G2 Switch

Power Failure Operation

The 7406D, 7406BIS, and 7406 Plus voice terminals cannot be used as an emergency station during power failure transfer conditions.

FCC Registration

These voice terminals are FCC-registered along with the switch (as a system), but do not have a separate FCC registration label.

UL and CSA Approval

These voice terminals have been tested and have met the Underwriters Laboratories (UL) Standards UL 1459 and have also met the Canadian Standards Association (CSA) Standards CSA-C22.2 No.225-M90.

Hearing Aid Compatibility

The 7406D, 7406BIS, and 7406 Plus voice terminals are compatible with the inductively coupled hearing aids prescribed by the FCC.

7406D/7406BIS Equipment PECs & COMCODES

The 7406D01A—7406D06A voice terminals and components can be ordered with the following Price Element Codes (PECs) and COMCODES:

- Basic **7406D01A** voice terminal with display (and with data stand)
PEC: 3182-LCD (Black=COL09; Misty Cream=COL22)
COMCODE: Black= 103976536; Misty Cream=103976601
- Basic **7406D02A** voice terminal without display (with data stand)
PEC: 3183-BDT (Black=COL09; Misty Cream=COL22)
COMCODE: Black=105206585; Misty Cream=105206593
- Basic **7406D03A** voice terminal with display (without data stand)
PEC: 3182-LDM (Black=COL09; Misty Cream=COL22)
COMCODE: Black=105675417; Misty Cream=105675425
- Basic **7406D04A** voice terminal without display (without data stand)
PEC: 3183-LDM (Black=COL09; Misty Cream=COL22)
COMCODE: Black=105675433; Misty Cream=105675441

- **Basic 7406D05A** voice terminal with display with built-in speakerphone
PEC: 3182-BIS (Black=COL09; Misty Cream=COL22)
COMCODE: Black=105703441; Misty Cream=105703458
- **Basic 7406D06A** voice terminal without display with built-in speakerphone
PEC: 3183-BIS (Black=COL09; Misty Cream=COL22)
COMCODE: Black=105703466; Misty Cream=105703474
- **Handset**
PEC: 3152-006 (Black=COL09; Misty Cream=COL22)
COMCODE: Black=105519086; Misty Cream=105520787
- **Handset cord (9 feet)**
COMCODE: Black=105635429; Misty Cream=105635437
- **Handset cord (12 feet)**
PEC: 2725-01L (Black=COL09; Misty Cream=COL22)
COMCODE: Black=102401445; Misty Cream=104211339
- **Line cord (7 feet, silver)**
COMCODE: 103786778
- **Line cord (14 feet, silver)**
PEC: 2725-07N COL18
COMCODE: 103786802
- **Line cord (25 feet, silver)**
PEC: 2725-07S COL18
COMCODE: 103786828
- **Graphic panel (for the 7406D01A, 7406D02A, 7406D03A, and 7406D04A)**
COMCODE: Black=846344331; Misty Cream=846344349
- **Graphic panel (for the 7406D05A and 7406D06A)**
COMCODE: Black=846365203; Misty Cream=846365211
- **Button designation strip**
PEC: 31823 (Package of 25) (Black=CLR09; Misty Cream=CLR22)
COMCODE: Black=845783687; Misty Cream=845783760

- **Display bezel (for display-equipped sets)**
COMCODE: Black=846100501; Misty Cream=846781970
- **Blank bezel (for sets without display)**
COMCODE: Black=846100519; Misty Cream=845752218
- **Wall mount kits**
(for mounting the 7406D without display)
COMCODE: 31821

(for mounting the 7406D with display)
COMCODE: 31820

(for mounting the 7406BIS)
COMCODE: 31830

7406 Plus Equipment PECs and COMCODES

The 7406 Plus voice terminal and components can be ordered with the following PECs and COMCODES:

- **Basic 7406D07A** with display with built-in speakerphone
PEC: 3182-PLS (Black=COL09; Misty Cream=COL22)
COMCODE: Black=106202443; Misty Cream=106202450
- **Basic 7406D08A** without display with built-in speakerphone
PEC: 3183-PLS (Black=COL09; Misty Cream=COL22)
COMCODE: Black=106202468; Misty Cream=106202476
- **Handset**
PEC: 3152-006
COMCODE: Black=105519086; Misty Cream=105520787
- **Handset cord (9 feet)**
COMCODE: Black=105635429; Misty Cream=105635437
- **Handset cord (12 feet)**
PEC: 2725-01L (Black=COL09; Misty Cream=COL22)
COMCODE: Black=102401445; Misty Cream=104211339
- **Line cord (7 feet, silver)**
COMCODE: 103786778
- **Line cord (14 feet, silver)**
PEC: 2725-07N COL18
COMCODE: 103786802
- **Line cord (25 feet, silver)**
PEC: 2725-07S COL18
COMCODE: 103786828
- **Graphic panel**
COMCODE: Black=846517134; Misty Cream=846517142
- **Button designation cards**
PEC: 31827 (Package of 25 cards)
Single card COMCODE: 846519056
25 cards COMCODE: 846518124
200 cards COMCODE: 846518132
500 cards COMCODE: 846518140
- **Display bezel (for display-equipped sets)**
COMCODE: Black=846534055; Misty Cream=846534063

- **Blank bezel (for sets without display)**
COMCODE: Black=846534097; Misty Cream=846534105
- **Wall mount kit**
COMCODE: 106304298

Adjuncts

The following adjuncts can be used with this voice terminal:

- S101A Speakerphone (no longer orderable)
- S201A Speakerphone
- CS201A Speakerphone
- 7400B Data Module
- 500A Headset Adapter (and a standard headset; see “Headsets” below)
- R6 Amplifier Handset (PEC: 3152-002)
- R8 Noisy Location Handset (PEC: 3152-003)
- R2H Standard Handset (PEC: 3152-006)
- Shoulder Rest

Headsets

A list of compatible headsets, consisting of both modular and plug prong base units and selection of headpieces, appears in “Headset Adapters” in the **Adjuncts** section (behind the **Adjuncts** tab) later in this manual.

Additional Documents

The following documents contain additional information relating to the 7406D, 7406BIS, and 7406 Plus voice terminals: (Use the 9-digit number listed after each document to order the book from the GBCS Publications Fulfillment Center.)

- *7406 Voice Terminal Installation Instructions*, 555-015-108
- *System 75 7406D Voice Terminal User's Guide*, 555-200-719
- *DEFINITY Communications System Generic 1 7406D Voice Terminal User's Guide*, 555-204-719

- *DEFINITY Communications System Generic 2 and System 85 7406D Voice Terminal User's Guide, 555-104-702*
- *System 75 7406BIS Voice Terminal User's Guide, 555-200-737*
- *DEFINITY Communications System Generic 1 7406BIS User's Guide, 555-204-737*
- *DEFINITY Communications System Generic 2 and System 85 7406BIS User's Guide, 555-104-721*
- *DEFINITY Communications System Generic 1 and System 75 7406 Plus Voice Terminal User's Guide, 555-204-741*
- *DEFINITY Communications System Generic 2 and System 85 7406 Plus Voice Terminal User's Guide, 555-104-741*

The following document is shipped with every 7406 Plus voice terminal:

- *7406 Plus Voice Terminal Installation Instructions, 555-015-126*

The following document is included with the 7406D and 7406BIS voice terminals wall kit:

- *7406BIS Wall Kit Voice Terminal Installation Instructions, 555-015-122*

The following document is included with the 7406 Plus voice terminal wall kit:

- *7406 Plus Voice Terminal Wall Kit Installation Instructions, 555-015-133*

format -dqm4 -mdefinity -rF1 new.7407

7407D, Enhanced 7407D, and 7407 Plus VOICE TERMINALS

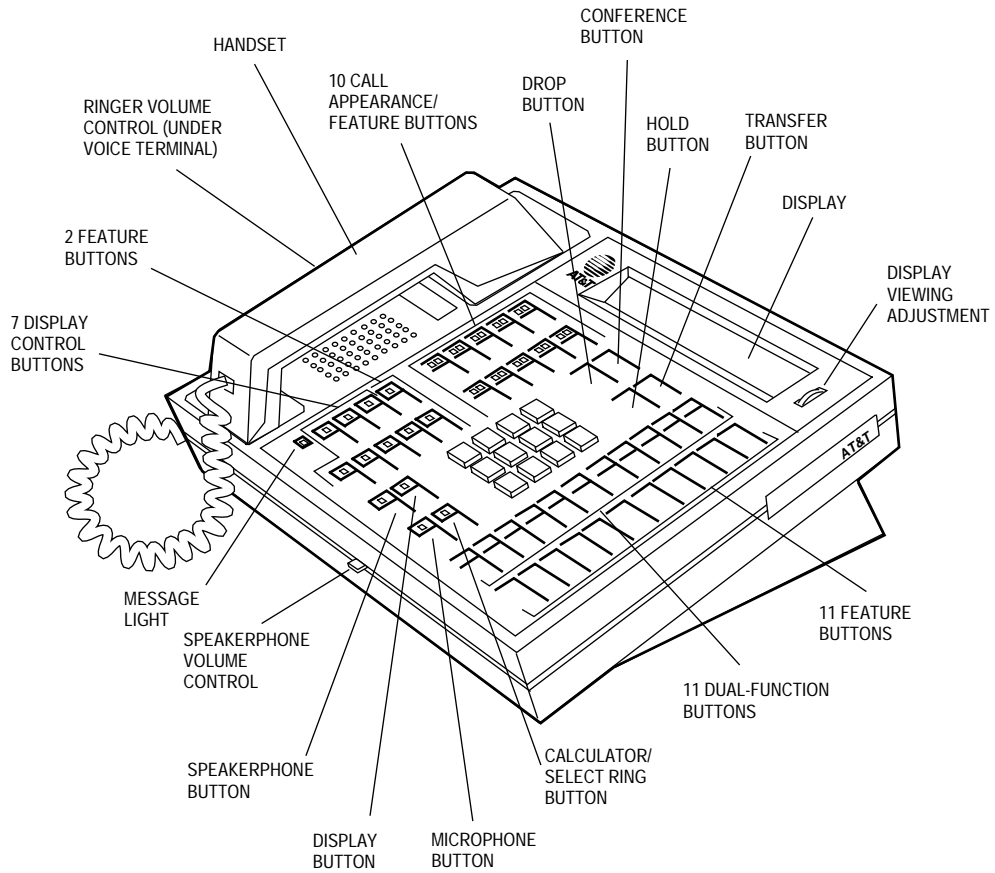

FIGURE 3-25. The 7407D (7407D01B) Voice Terminal

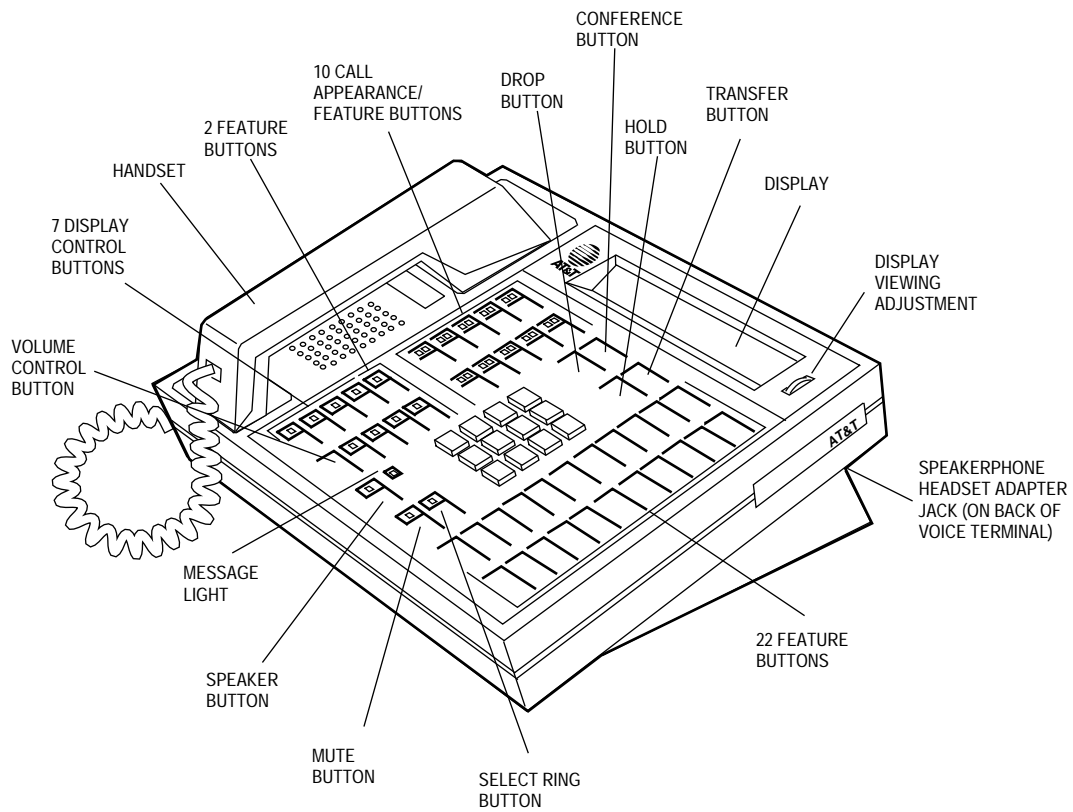

FIGURE 3-26. The Enhanced 7407D (7407D02C) Voice Terminal

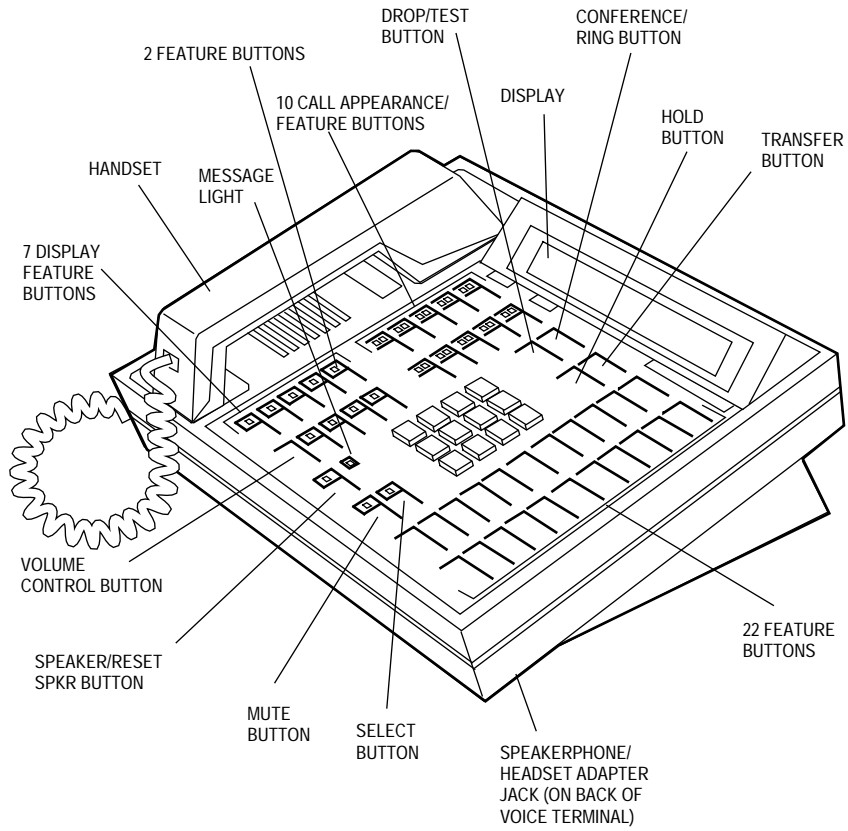

FIGURE 3-27. The 7407 Plus (7407D02D) Voice Terminal

7407D, Enhanced 7407D, and 7407 Plus Voice Terminals

The 7407D, Enhanced 7407D, and 7407 Plus voice terminals are multi-appearance digital voice terminals which provide digital voice, display, and data capabilities (the latter with the 7400B Plus Data Module). There are three versions of the 7407D voice terminal. A brief description of each of these versions is listed below:

- The **7407D (the 7407D01B)**—offers 10 call appearance/feature buttons, each with a red in-use light and a green status light, four standard fixed feature buttons (CONFERENCE, DROP, HOLD, and TRANSFER), three fixed feature buttons with an associated light (CALCULATOR/SELECT RING, SPEAKERPHONE, and MICROPHONE), nine programmable feature buttons with lights (the two uppermost buttons can be used for voice or display features, the lower seven for display features), 11 dual-function buttons, 22 programmable feature-only buttons without lights, a Message light, a DISPLAY button that turns the display on and off, personalized ringing, a built-in speakerphone, a 2-line by 40-character liquid crystal display, and a built-in calculator. This voice terminal also provides the user the flexibility of adding a data stand to provide data communications. Data access can also be provided by the addition of the PC/PBX Connection Card to any AT&T compatible PC or by use of a 7400B Plus Data Module. This set is AC powered.
- The **Enhanced 7407D (the 7407D02C)**—offers 10 call appearance buttons, each with a red in-use light and green status light, four standard fixed feature buttons (CONFERENCE, DROP, HOLD, and TRANSFER), three fixed feature buttons with an associated light (SELECT RING, SPEAKER, and MUTE), 22 programmable feature-only buttons without lights, nine programmable feature buttons with one light each (the uppermost two buttons can be used for voice or display features, the lower seven for display features), a Message light, personalized ringing, a built-in speakerphone, a connection for an adjunct speakerphone or headset, a speakerphone with spokesman and Mute option, and a 2-line by 40-character “super-twist” liquid crystal display. Data access can be provided by the addition of the PC/PBX Connection Card to any AT&T compatible PC or by use of a 7400B Plus Data Module. This set is powered from the switch.
- The **7407 Plus (the 7407D02D)**—offers 10 call appearance buttons, each with a red in-use light and a green status light, four standard fixed feature buttons (CONFERENCE, DROP, HOLD, and TRANSFER), three fixed feature buttons with one light each (SELECT, SPEAKER/RESET SPKR, and MUTE), nine feature buttons with one light each (the uppermost two buttons can be used for voice or display features, the lower seven buttons for display features), 22 flexible feature buttons with no lights, a Message light, personalized ringing, a built-in speakerphone with a reset and listen-only option, and a built-in 2-line by 40-character “super-twist” liquid crystal display. Data access can be provided by the addition of the PC/PBX Connection Card to any AT&T compatible PC or by use of a 7400B Plus Data Module. This voice terminal is powered from the switch.

Note: The 7407D01B and the 7407D02C are no longer being manufactured.

Applications

The 7407D, Enhanced 7407D, and 7407 Plus voice terminals can be used with the DEFINITY Communications System G1, G2, G3, System 75, and System 85. Typical applications of the 7407D, Enhanced 7407D, and the 7407 Plus voice terminal are managers, executives, or secretaries who need the robust, 2-line by 40-character display capability or with data terminals requiring a large number of features and lines.

Special Operational Characteristics

The 7407D (7407D01B) voice terminal has an R1/R2 single-option toggle switch on the back of the stand; the Enhanced 7407D (7407D02C), and 7407 Plus (7407D02D) voice terminals have a 3-option DIP switch that can be accessed from the back of the stand, although, on both voice terminals only two of the options can be used. The DIP switch options can be changed with a simple tool.

Switch Options for the 7407D and Enhanced 7407D

The following list describes the settings on the toggle switch on the 7407D (7407D01B) voice terminal and the DIP switch settings on the Enhanced 7407D (7407D02C) voice terminals:

- Since the 7407D and the Enhanced 7407D have 2-line displays, the single-option R1/R2 toggle switch on the 7407D voice terminal and Switch 1 on the DIP switch settings on the Enhanced 7407D voice terminal must be activated according to the vintage of the supporting PBX.

The 7407D voice terminal option switch is shipped in the OFF position; the Enhanced 7407D voice terminal is shipped with Switch 1 in the R2 position. These positions are the correct setting for most PBX's.

Use the table on the next page to determine your PBX's release and version for setting the following switches:

- The R1/R2 switch on the 7407D01B voice terminal.
- Switch 1 on the 7407D02C voice terminal.

If the voice terminal is connected to:			Set R1/R2 to:	Set Switch 1 to:
System	Release	Version	Switch setting	Switch setting
System 75	1	1	R1	On
System 75	1	2 and above	R2	Off
System 85	1	All	R1	On
System 85	2	1	R1	On
System 85	2	2 and above	R2	Off
DEFINITY Generic 1 & G3			R1	Off
DEFINITY Generic 2			R1	Off

- **Switch 2** on the **Enhanced 7407D** (7407D02C) voice terminal controls the Spokesman option. The microphone associated with the Speakerphone can be disabled, which changes Speakerphone functionality to the Spokesman function leaving the handset active.

The Enhanced 7407D voice terminal is shipped with Switch 2 in the Speakerphone position (with the microphone enabled). This corresponds to the OFF position.

DIP Switch Options for the 7407 Plus

For the 7407 Plus (7407D02D) voice terminal, the 3-position DIP switch should be set in the following way:

- Initially, **Switch 1** is set to the OFF position. However, according to the release and version of the System 75 or 85 to which the voice terminal is connected, you may need to change Switch 1 to the **ON** position. Check the following table for this information.

If the voice terminal is connected to:			Set Switch 1 to:
System	Release	Version	Switch Setting
System 75	1	1	On
System 75	1	2 and above	Off
System 85	1	All	On
System 85	2	1	On
System 85	2	2 and above	Off
DEFINITY Generic 1			Off
DEFINITY Generic 2			Off

Note: If this switch is not set correctly, the display will not work properly. For example, the call appearance display, usually on the top line, may appear on the second line instead.

- **Switch 2** is set for the Speakerphone feature (to the OFF position). If the voice terminal is to be set for the Speaker (listen-only) feature, set Switch 2 to the ON position.

Note: In order to allow the system to recognize this change in the setting, you must disconnect the voice terminal and then plug it in again.

- **Switch 3**, on the 7407 Plus voice terminal, is not to be used at this time.

Physical Features

Dimensions

Note: The dimensions given here for the 7407 voice terminals are approximate.

Width = 12 inches

Depth (front to back) = 8 1/2 inches

Height (maximum with handset in place) = 6 1/4 inches

Thickness of housing = 1 1/2 inches

Features

Four Standard Fixed Feature Buttons

- CONFERENCE or CONFERENCE/RING button
- DROP or DROP/TEST button
- TRANSFER button
- HOLD button

CALCULATOR/SELECT RING button (on 7407D only)

This button is only on the **7407D (7407D01B)** voice terminal. It toggles the 11 dual-function buttons between calculator functions on the left side of the buttons (the CALCULATOR/SELECT RING light is on) and features administered on the right side of the buttons (the CALCULATOR/SELECT RING light is off). The button can also be used with the PR (Personalized Ring) button to select one of eight possible personalized ringing patterns.

SELECT RING button (on Enhanced 7407D only)

This button is on the **Enhanced 7407D (7407D02C)** voice terminal. It toggles between the Select Ring function (selecting a personalized ringing pattern from eight available patterns) and Self-Test function (tests the lights, ringer, and display).

SELECT button (on the 7407 Plus only)

The **7407 Plus** (7407D02D) voice terminal has a SELECT button which can be used in three different ways:

- Used with the DROP/TEST button to initiate a self-test of your voice terminal (which tests the lights, tone ringer, and display);
- Used with the CONFERENCE/RING button to select your own personalized ring from among eight available patterns;
- Used with the SPEAKER/RESET SPKR button to perform an acoustic test of the environment and adjust the speakerphone to the surrounding acoustic environment for optimal performance.

Message light

The Message light goes on when a message is left for the user. It goes off when the user retrieves the message or when the message is erased. On the **7407D** (7407D01B) voice terminal, the Message light is green; on the **Enhanced 7407D** and the **7407 Plus** voice terminals, the Message light is red.

Call Appearance/Feature Buttons

The **7407D**, **Enhanced 7407**, and **7407 Plus** voice terminals have 10 call appearance/feature buttons.

Feature-only Buttons on the 7407D (7407D01B)

The **7407D** (7407D01B) voice terminal has the following sets of feature buttons:

- 11 feature buttons in the rightmost column, all without lights, which can be used for features only.
- 11 dual-function buttons without lights, in the second column from the right are used as dual-function (calculator) buttons.
 - When the CALCULATOR/SELECT RING button is active (the green light next to the CALCULATOR/SELECT RING button is on), the top button, labeled “PR,” is in the Select Ring mode for programming a personalized ringing pattern; the lower 10 buttons have standard hand calculator functions (which are labeled on the left of the button). These button assignments cannot be changed.
 - When the CALCULATOR/SELECT RING button is off (the green light next to the CALCULATOR/SELECT RING button is off), all 11 of these dual-function buttons have optional features (which are labeled on the right of the button). These features are assigned by the System Manager.
- nine feature buttons on the bottom left, each with a green light. The two upper buttons are for voice features. The lower seven buttons are for display control functions and/or features.

Feature-only Buttons on the Enhanced 7407D (7407D02C)

The **Enhanced 7407D** (7407D02C) voice terminal has the following sets of feature buttons:

- 22 feature buttons in the rightmost column, all without lights
- nine feature buttons on the bottom left, each with a green status light. The two upper buttons are for voice features. The lower seven buttons are for display control functions and/or features.

Feature-only Buttons on the 7407 Plus (7407D02D)

The **7407 Plus** (7407D02D) voice terminal has the following sets of feature buttons:

- 22 feature buttons in the rightmost column, all without lights
- nine feature buttons on the bottom left, each with a green light. The two upper buttons are for voice features. The lower seven buttons are for display control functions and/or features.

Speakerphone (Listen and Speak) Feature

The **7407D**, **Enhanced 7407D**, and **7407 Plus** voice terminals are equipped with a built in speakerphone. The Speakerphone capability allows a user to engage in a hands-free 2-way conversation with the far-end party. The speakerphone can be turned off or on (use the SPEAKERPHONE button on the 7407D, the SPEAKER button on the Enhanced 7407D, and the SPEAKER/RESET SPKR button on the 7407 Plus), can be muted (use the MICROPHONE button on the 7407D; use the MUTE button on the Enhanced 7407D and 7407 Plus), and the speakerphone volume can be controlled, on the 7407D, with a slide switch, or on the Enhanced 7407D and 7407 Plus, with the VOLUME “arrow” button.

The **7407 Plus** (7407D02D) voice terminal has an S201A-type speakerphone which allows the user to adjust the speakerphone for optimal performance. By pressing the SELECT button and then the SPEAKER/RESET SPKR button (if the voice terminal is set for the Speakerphone feature), the user hears a set of tones as the speakerphone performs an acoustic test of the environment. When the tones stop, the speakerphone has finished adjusting itself and is ready for use. The user should reset the speakerphone whenever the voice terminal is moved to another place (even in the same room), whenever the green light next to the SPEAKER/RESET SPKR button is fluttering, and in the unlikely event that the speakerphone is making a squealing sound.

Speaker (Listen-only) Feature

The **7407 Plus** voice terminal can be optioned for the Speakerphone (listen and speak) *or* the Speaker (listen-only) feature. The **Enhanced 7407D** voice terminal can be set for the Speakerphone or the Spokesman feature. (With the latter feature, the user can use the speaker and the handset simultaneously). In order to turn on and off the speaker, use the SPEAKER button on the Enhanced 7407D, or the SPEAKER/RESET SPKR button on the 7407 Plus.

The Speaker (listen-only) and Spokesman capability allows a user to engage in a one-way conversation with the far-end. Specifically, the user can only listen to the far-end; the user is not able to transmit his voice over the speaker. To speak with the far-end, the user must use the handset.

With the **Enhanced 7407D** voice terminal, the handset and Speaker capability can be used simultaneously. If you are using a **7407 Plus**, you *cannot* use the handset and speaker at the same time.

These voice terminals are shipped with the Speakerphone setting in place, but the necessary DIP switch setting can be changed so that the voice terminal operates with the Speaker or Spokesman feature instead.

MICROPHONE button (on 7407D only)

On the **7407D** (7407D01B) voice terminal, the MICROPHONE button turns the speakerphone microphone on and off.

MUTE button (on the Enhanced 7407D and 7407 Plus)

On the **Enhanced 7407D** (7407D02C) and **7407 Plus** (7407D02D) the red MUTE button disables the transmitter of the speakerphone or the handset depending on which is activated at that time.

VOLUME control button (on Enhanced 7407D and 7407 Plus)

The **Enhanced 7407D** (7407D02C) and **7407 Plus** (7407D02D) voice terminals have a VOLUME “arrow” button. This button has a double function. When there is a call active on the speaker or speakerphone, the VOLUME button controls the volume of the speakerphone; at all other times, the button controls the volume of the tone ringer.

When the user sets the volume for the speaker or the tone ringer, the display on the voice terminal shows a “bar array” that indicates the volume setting.

Self-Test (on Enhanced 7407 and 7407 Plus)

The **7407D**, **Enhanced 7407D** (7407D02C), and **7407 Plus** (7407D02D) voice terminals are equipped with a self-test.

On the **7407D** (7407D01B) voice terminal, the user can test the lights, ringer, and display by pressing the Self-Test button under the left side of the set.

On the **Enhanced 7407D** (7407D02C) voice terminal, the user presses the SELECT RING button and then the DROP button in order to initiate a self-test of the voice terminal. On the **7407 Plus** (7407D02D) voice terminal, the user presses the SELECT button and then the DROP/TEST button to start the voice terminal self-test.

During the self-test, all the lights go on, the ringer sounds, and the display character positions are lit. On the Enhanced 7407D and the 7407 Plus voice terminals, the self-test ends when the user releases the DROP or DROP/TEST button. On the 7407D voice terminal, the lights stay lit for a few seconds and then go off.

Display

The **7407D**, **Enhanced 7407D**, and **7407 Plus** voice terminals are equipped with a built-in, 2-line, 40-character per line, liquid crystal display. The **7407D** voice terminal has a standard, “twisted,” pneumatic display; the **Enhanced 7407D** and **7407 Plus** voice terminals have a “super-twist” display.

DISPLAY button (on 7407D only)

This button is found only on the **7407D** (7407D01B) voice terminal. It turns the display on and off.

Display Adjustment Control (on 7407D and Enhanced 7407D)

On the **7407D** (7407D01B) and **Enhanced 7407D** (7407D02C) voice terminals there is a thumbwheel which adjusts the viewing contrast of the display.

Other Physical Features

Handset

The **7407D**, **Enhanced 7407D**, and **7407 Plus** voice terminals are equipped with an R-type handset.

Dial pad

The **7407D**, **Enhanced 7407D**, and **7407 Plus** voice terminals are equipped with a 12-button touch-tone dial pad. On the **7407 Plus** (7407D02D) voice terminal the letters “Q” and “Z” have been added to the appropriate dial pad keys for directory access, and the “5” button on the dial pad has raised bars for visually-impaired users.

Jacks

The **7407D** (7407D01B) voice terminal's housing contains a Handset cord jack just under the left side of the housing, and a Line jack on the back of the voice terminal. There is an RS-232C connector on the optional data stand.

The **Enhanced 7407D** (7407D02C) and the **7407 Plus** (7407D02D) voice terminals' housing contains a Handset cord jack just under the left side of the housing and a Line jack and Speakerphone/headset adapter jack on the back of the voice terminal.

Cords

Three cords are supplied with the **7407D** (7407D01B) voice terminal: a coiled 9-foot modular handset cord, 7-foot modular line cord and an AC power cord.

Two cords are supplied with the **Enhanced 7407D** (7407D02C) and **7407 Plus** (7407D02D) voice terminal: a coiled 9-foot modular handset cord and a 7-foot modular line cord.

Optional longer cords are available: a 12-foot handset cord; 14-foot and 25-foot line cords.

Ringling

The **7407D**, **Enhanced 7407D**, and **7407 Plus** voice terminals have electronic tone ringling that can be personalized with eight possible ringling patterns selected with the Select Ring feature. On the **Enhanced 7407D** (7407D02C) and **7407 Plus** voice terminals, the ringling volume of the second call appearance is automatically set to muted ringling.

On the **7407D** (7407D01B) voice terminal, the volume control is on the left side of the housing.

On the **Enhanced 7407D** (7407D02C) and **7407 Plus** (7407D02D) voice terminals, the volume is controlled by the VOLUME control button on the front of the voice terminal. The left side of the button lowers the volume; the right side of the button raises the volume. If a call is active on the speaker or speakerphone, the VOLUME control button adjusts the speaker or speakerphone. At all other times, the VOLUME control button controls the loudness of the tone ringer. The display screen shows a “bar array” to reflect the selected volume.

Mounting Options

The **7407D** (7407D01B) comes equipped with a nonadjustable desk stand or an optional data stand.

The **Enhanced 7407D** (7407D02CB) and **7407 Plus** (7407D02D) voice terminals come equipped with a nonadjustable desk stand. The optional data stand cannot be used with these voice terminals.

Color Options

The **7407D**, **Enhanced 7407D**, and **7407 Plus** voice terminals are available in black and misty cream.

Distance Limitations

The maximum distances the 7407D, Enhanced 7407D, and 7407 Plus voice terminals can be located from the system cabinet are shown in the table below.

SYSTEM	PORT BOARD	NOMINAL MAXIMUM RANGE IN FEET (METERS) (SEE NOTE)	
		24 AWG	26 AWG
System 85	SN270B	3,400 (1,034)	2,200 (671)
	TN754	3,400 (1,034)	2,200 (671)
DEFINITY G2	SN270B	3,400 (1,034)	2,200 (671)
	TN754	3,400 (1,034)	2,200 (671)
DEFINITY G1 & G3 System 75	TN754	3,400 (1,034)	2,200 (671)

Note: These ranges can be extended to 5,000 feet (1524 m) for 24 AWG wire and 4,000 feet (1219 m) for 26 AWG wire with the use of a Data Link Protector (DLP). Refer to the **EXPOSED PORT PROTECTION** section.

Power Requirements

The **7407D** (7407D01B) voice terminal requires a 3-prong 115-volt AC outlet for power. (This outlet cannot be under the control of a wall switch.) A built-in power supply converts the 115 volts to the DC power required. A 3-wire AC power cord is provided with the voice terminal. No external power adjuncts are required.

The **Enhanced 7407D** (7407D02C) and **7407 Plus** (7407D02D) voice terminals receive power from the system and do not require any external power supply. Additional power is required when these voice terminals are equipped with any adjuncts. Refer to the **ADJUNCT POWER** section of this manual.

Switch Administration

Aliasing

The 7407 voice terminals must be aliased in the following way:

If you are administering this system:	For this type of voice terminal:	The voice terminal must be administered as:
System 75, R1V1 System 85, R2V1	7407D Enhanced 7407D 7407 Plus	a 7405D with digital display module
System 75, R1V2 or above DEFINITY G1 & G3 System 85, R2V2 or above DEFINITY G2	7407D	itself
System 75, R1V2 or above DEFINITY G1 & G3 System 85, R2V2 or above DEFINITY G2	Enhanced 7407D 7407 Plus	a 7407D voice terminal

Note: On the **7407D** (7407D01B) voice terminal, the second column of 11 buttons from the right are dual-function buttons. On the left side of the button, there is a fixed calculator (or personalized ring) feature. (These *cannot* be reassigned.) These calculator/select ring features can be used when the CALCULATOR/SELECT RING button is active, and the button light is on.

The features labeled on the right side of these 11 dual-function buttons *can be* administered with system features. These administered features can be used when the CALCULATOR/SELECT RING button is not active, and the button light is off.

Button Numbering

The following button diagrams of the 7407D and the 7407 Plus voice terminals will help you administer these voice terminals on a System 75 and DEFINITY G1, and on a System 85 and DEFINITY G2. **Figures 4 and 5** refer to the 7407D; **Figures 6 and 7** refer to the Enhanced 7407D voice terminal; **Figures 8 and 9** refer to the 7407 Plus voice terminal.

If you need more information, refer to *DEFINITY Communications System Generic 3 Implementation*, and *DEFINITY Communications System Generic 2 Administration of Features and Hardware*.

Button Assignments 1 - 10

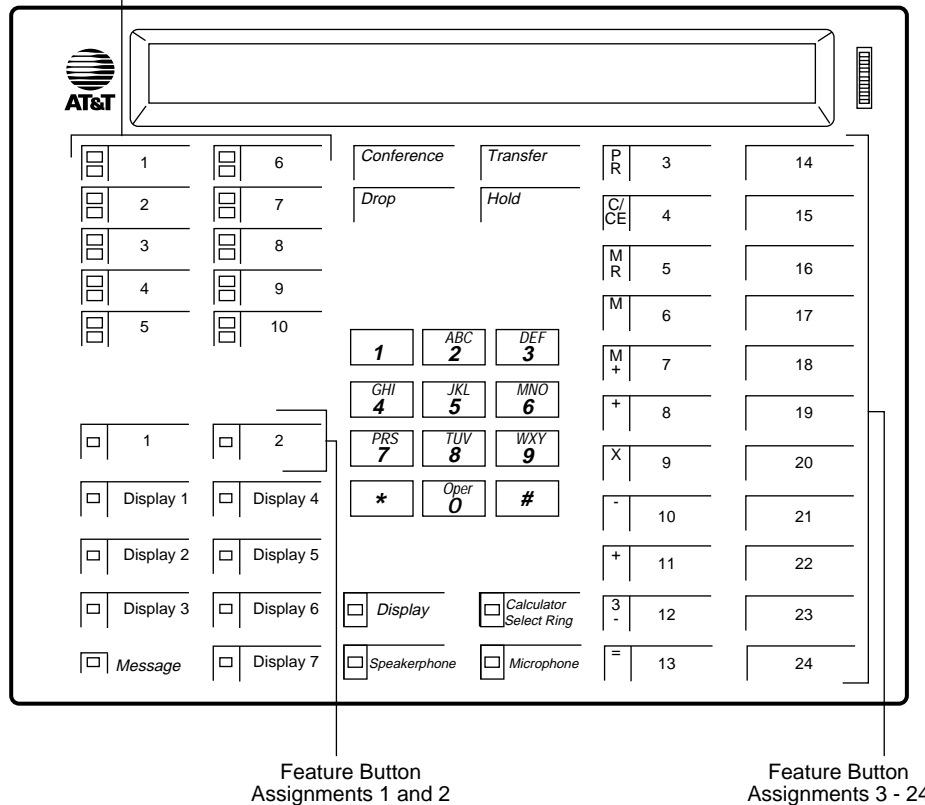
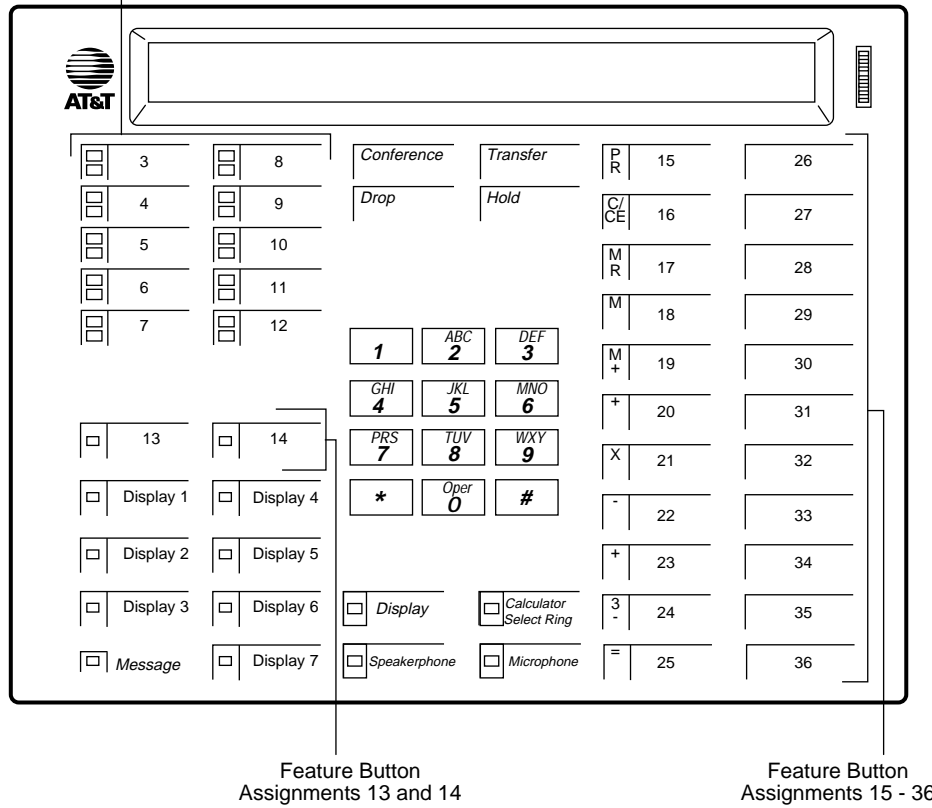

FIGURE 3-28. Button Numbering for Administering the 7407D (7407D01B) Voice Terminal Connected to a System 75 or a DEFINITY G1 or G3 Switch

Button Assignments 3 - 12



NOTE: THE HOLD BUTTON IS BUTTON #1. THE MESSAGE LIGHT IS BUTTON #2.

FIGURE 3-29. Button Numbering for Administering the 7407D (7407D01B) Voice Terminal Connected to a System 85 or a DEFINITY G2 Switch

Button Assignments 1 - 10

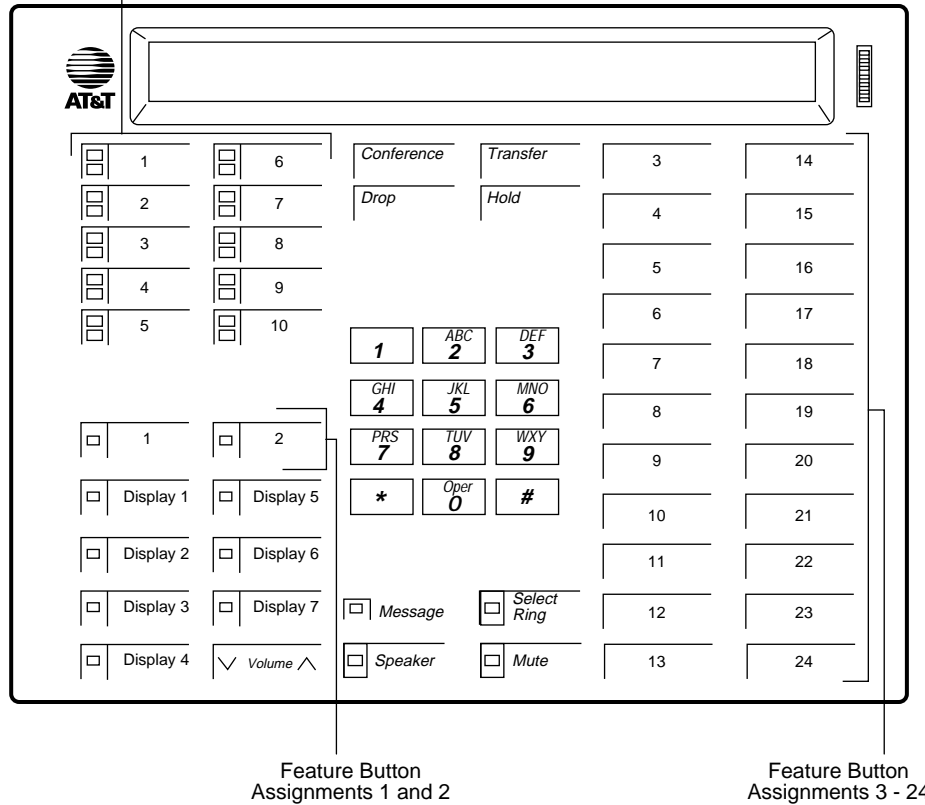
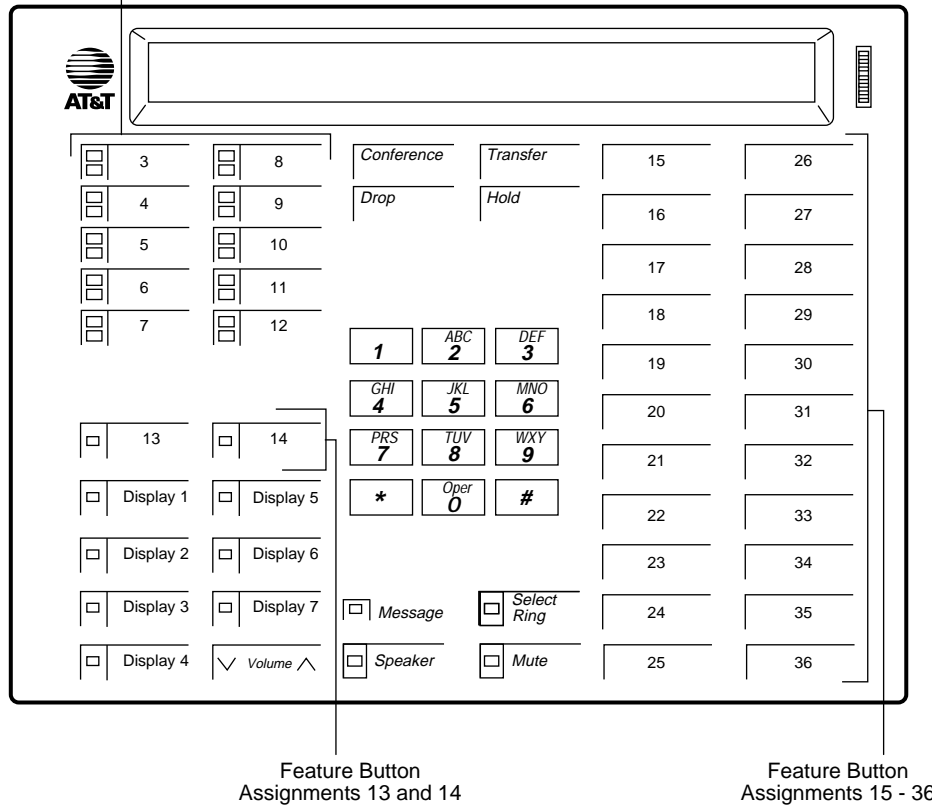

FIGURE 3-30. Button Numbering for Administering the Enhanced 7407D (7407D02C) Voice Terminal Connected to a System 75 or a DEFINITY G1 or G3 Switch

Button Assignments 3 - 12



NOTE: THE HOLD BUTTON IS BUTTON #1. THE MESSAGE LIGHT IS BUTTON #2.

FIGURE 3-31. Button Numbering for Administering the Enhanced 7407D (7407D02C) Voice Terminal Connected to a System 85 or a DEFINITY G2 Switch

Button Assignments 1 - 10

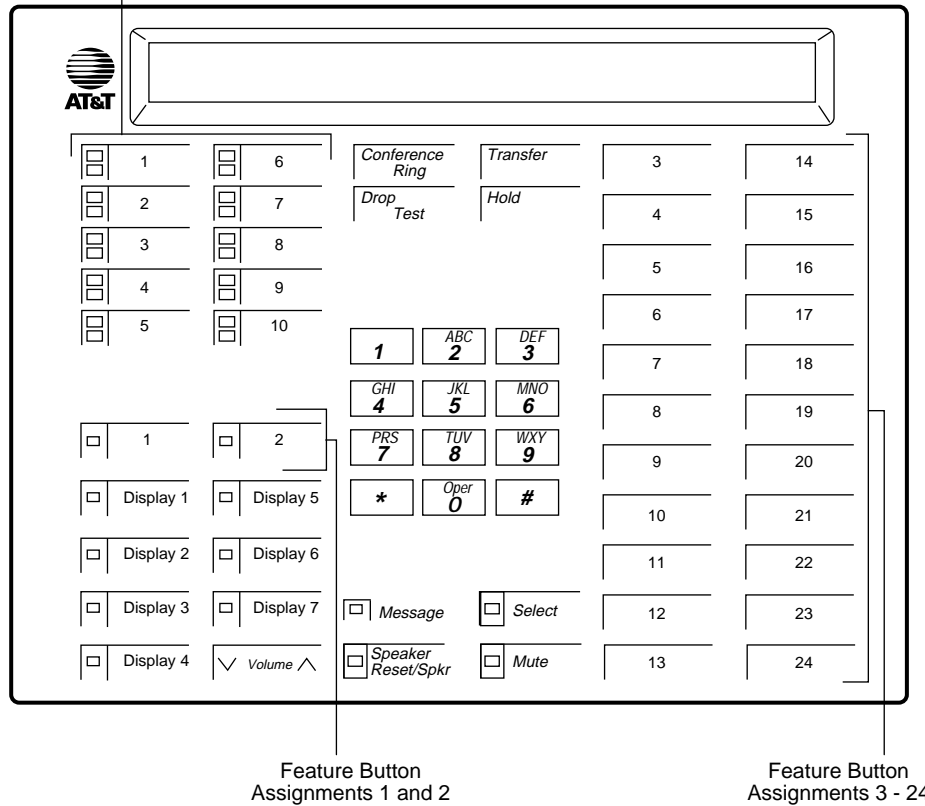
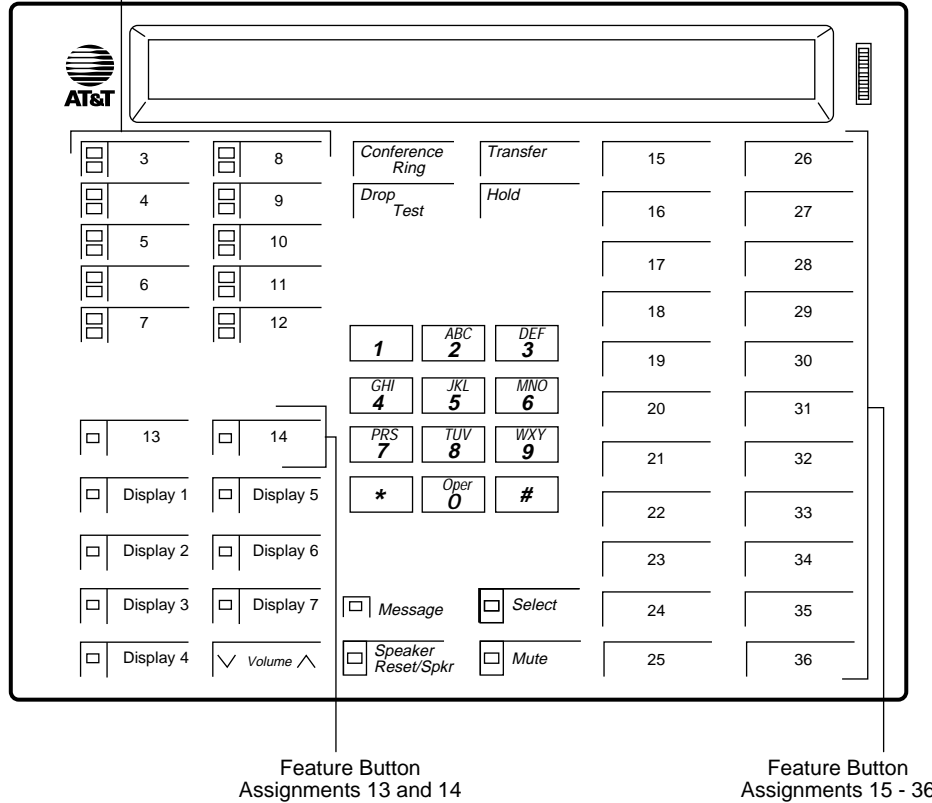

FIGURE 3-32. Button Numbering for Administering the 7407 Plus Voice Terminal Connected to a System 75 or a DEFINITY G1 or G3 Switch

Button Assignments 3 - 12



NOTE: THE HOLD BUTTON IS BUTTON #1. THE MESSAGE LIGHT IS BUTTON #2.

FIGURE 3-33. Button Numbering for Administering the 7407 Plus Voice Terminal Connected to a System 85 or a DEFINITY G2 Switch

Power Failure Operation

The 7407D, Enhanced 7407D, and 7407 Plus voice terminals cannot be used as an emergency station during power failure transfer conditions.

FCC Registration

These voice terminals are FCC-registered along with the switch (as a system), but do not have a separate FCC registration label.

UL and CSA Approval

These voice terminals have been tested and have met the Underwriters Laboratories (UL) Standards UL 1459. In addition, the Enhanced 7407D and the 7407 Plus voice terminals have also met the Canadian Standards Association (CSA) Standards CSA-C22.2 No.225-M90.

Hearing Aid Compatible

These voice terminals are compatible with the inductively coupled hearing aids prescribed by the FCC.

7407D/Enhanced 7407D Equipment PECs & COMCODES

The **7407D** (7407D01B) and **Enhanced 7407D** (7407D02C) voice terminals and optional components can be ordered with the following Price Element Codes (PECs) and COMCODES:

- **Basic 7407D01B** voice terminal
PEC: 3180-IDT (Black=COL09; Misty Cream=COL22)
COMCODE: Black=103983904; Misty Cream=103983938
- **Basic 7407D02C** voice terminal
PEC: 3180-PPS (Black=COL09; Misty Cream=COL22)
COMCODE: Black=105733521; Misty Cream=105733539
- **Handset**
COMCODE: Black=105519086; Misty Cream=105520787

- **Handset cord (9 feet)**
COMCODE: Black=105635429; Misty Cream=105635437
- **Handset cord (12 feet)**
PEC: 2725-01L (Black= COL09; Misty Cream=COL22)
COMCODE: Black=102401445; Misty Cream=104211339
- **Line cord (7 feet, silver)**
COMCODE: 103786778
- **Line cord (14 feet, silver)**
PEC: 2725-07N COL18
COMCODE: 103786802
- **Line cord (25 feet, silver)**
PEC: 2725-07S COL18.
COMCODE: 103786828
- **Display Bezel**
COMCODE: Black=846151876; Misty Cream=846151884
- **Button designation card**
PEC: 81004 (Package of 25)
Single COMCODE: 846342038
Pack of 25 COMCODE: 846342046
Tractor Feed COMCODE: 846342020.

7407 Plus Equipment PECs and COMCODES

The **7407 Plus** (7407D02D) voice terminal and optional components can be ordered with the following PECs and COMCODES:

- **Basic 7407D02D Voice Terminal**
PEC: 3180-PLS (Black=COL09; Misty Cream=COL22)
COMCODE: Black=106281520; Misty Cream=106281538
- **Handset**
COMCODE: Black=105519086; Misty Cream=105520787
- **Handset cord (9 feet)**
COMCODE: Black=105635429; Misty Cream=105635437

- **Line cord (7 feet)**
COMCODE: 103786778
- **Line cord (14 feet, silver)**
PEC: 2725-07N COL18
COMCODE: 103786802
- **Line cord (25 feet, silver)**
PEC: 2725-07S COL18
COMCODE: 103786828
- **Button designation card**
PEC: 81004 (Package of 25)
COMCODE: (Single card) Black=846604791; Misty Cream=846604809
COMCODE: (Pack of 25 Sheets) Black=846692333; Misty Cream=846692325
COMCODE: (Tractor Feed, 200 Sheets) Black=846604817; Misty Cream=846604825.

Adjuncts

The following adjuncts can be used with these voice terminals:

Note: Any adjunct equipment connected to the 7407 sets needs auxiliary power, except for the 7400B Plus Data Module, which is AC powered.

- S101A Speakerphone (7407D02C and 740702D)
- S201A Speakerphone (7407D02C and 7407D02D)
- 500A Headset Adapter (used with the 7407D02C and 7407D02D)
(and a standard headset; see “Headsets” below)
- 7400B Data Module

Headsets

A list of compatible headsets, consisting of both modular and plug prong base units and selection of headpieces, appears in “Headset Adapters” in the **Adjuncts** section (behind the **Adjuncts** tab) later in this manual.

Additional Documents

The following documents contain additional information relating to the 7407D, Enhanced 7407D, and 7407 Plus voice terminal: (Use the 9-digit number listed after each document to order the book from the GBCS Publications Fulfillment Center.)

- *System 75 7407D Voice Terminal User's Guide*, 555-200-716
- *DEFINITY Communications System Generic 1 7407D Voice Terminal User's Guide*, 555-204-716
- *DEFINITY Communications System Generic 2 and System 85 7407D Voice Terminal User's Guide*, 555-104-705
- *System 75 Enhanced 7407D (7407D02C) Voice Terminal User's Guide*, 555-200-738
- *DEFINITY Communications System Generic 1 Enhanced 7407D (7407D02C) Voice Terminal User's Guide*, 555-204-738
- *DEFINITY Communications System Generic 2 and System 85 Enhanced 7407 (7407D02C) Voice Terminal User's Guide*, 555-104-723
- *DEFINITY Communications System Generic 1 and System 75 7407 Plus Voice Terminal User's Guide*, 555-204-742
- *DEFINITY Communications System Generic 2 and System 85 7407 Plus Voice Terminal User's Guide*, 555-104-742

The following instructions are shipped with every 7407 Plus voice terminal:

- *7407 Plus and 7444 Voice Terminals Installation Instructions*, 555-015-129.

7410D and 7410 Plus VOICE TERMINALS

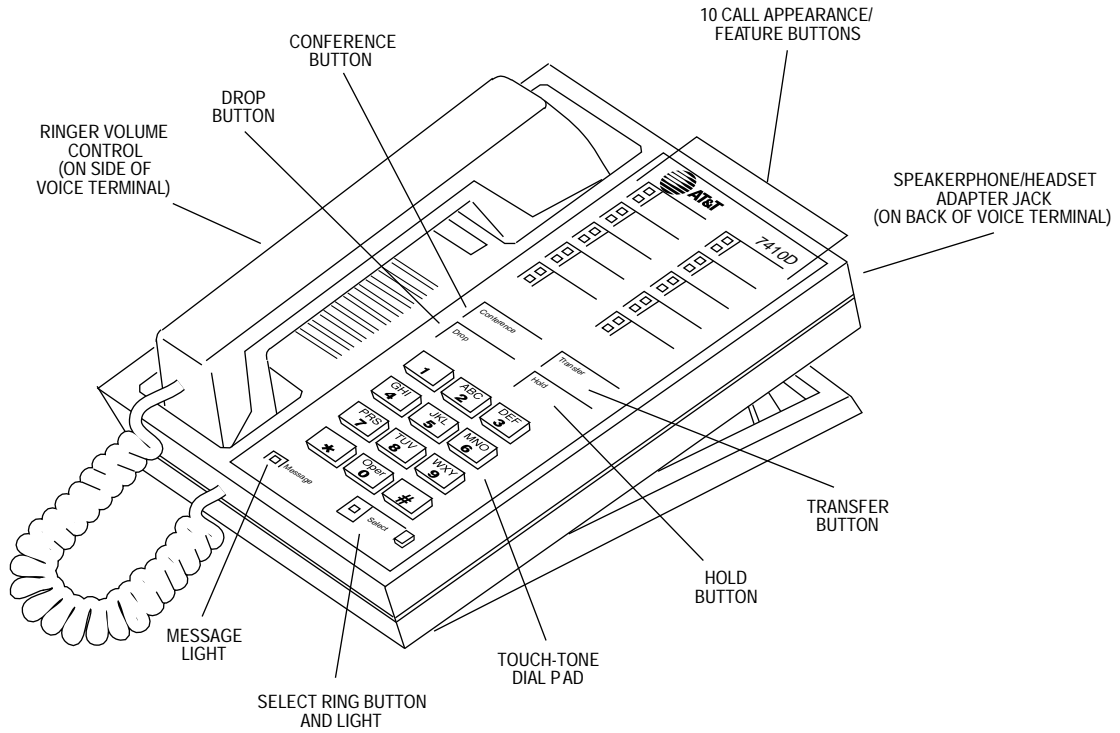

FIGURE 3-34. The 7410D (7410D01A) Voice Terminal

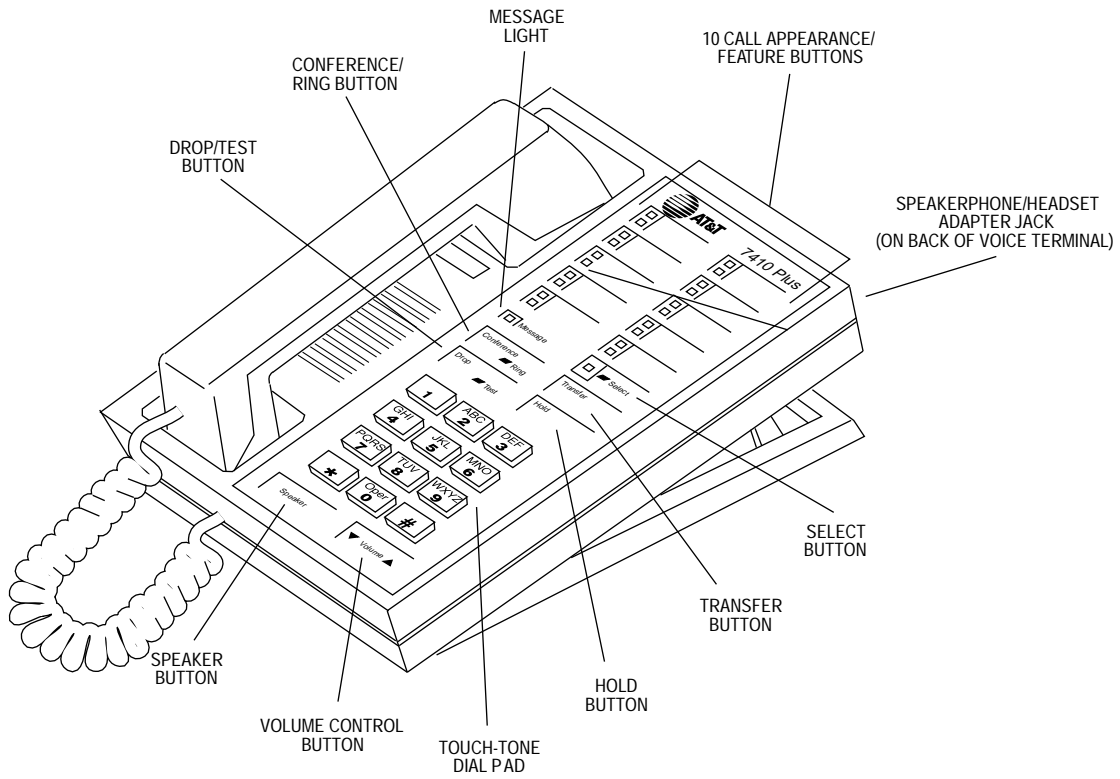

FIGURE 3-35. The 7410 Plus (7410D02A) Voice Terminal

7410D and 7410 Plus Voice Terminals

The **7410D (7410D01A)** and **7410 Plus (7410D02A)**, the newest 7410 set) are both multi-appearance digital voice terminals with 10 line appearances, four standard fixed feature buttons and a Select Ring button. The 7410D and 7410 Plus voice terminals also provide a Message light, Ringer Volume control, a Speakerphone/headset adapter jack on the back of the voice terminal for connecting adjunct equipment, and, with the Select Ring feature, there are eight possible programmable ringing patterns. A Self-Test feature can be activated to test the lights and tone ringer on the voice terminal. In addition, the 7410 Plus (7410D02A) provides a Speaker feature for listening-only functions.

Note: The 7401D01A is no longer being manufactured.

Applications

The 7410D (7410D01A) and 7410 Plus (7410D02A) voice terminals can be used with the DEFINITY Communications System G1, G2, G3, System 75, and System 85. These voice terminals are especially suitable for managers, executive secretaries, and other office support personnel who require access to multiple lines for call handling, call coverage, bridging, conferencing, and sophisticated voice communications.

The 7410D and 7410 Plus voice terminals can also provide simultaneous voice and data communications with the 7400B Data Module. PC platform products can also be useful in providing voice capabilities since these screen-based products can greatly enhance the telephone capabilities of these basic voice terminals.

Physical Features

Dimensions

Note: The following dimensions for the 7410D and 7410 Plus voice terminals are approximate.

Width = 6 3/8 inches

Depth (front to back) = 8 3/4 inches

Height (maximum with handset in place) = 5 1/2 inches

Thickness of housing = 1 1/2 inches

Features

Four Standard Fixed Feature Buttons

- CONFERENCE or CONFERENCE/RING button
- DROP or DROP/TEST button
- TRANSFER button
- HOLD button

Message Light

The Message light goes on when a message is left for the user. It goes off when the user retrieves the message. On the **7410D** voice terminal, the Message light is green; on the **7410 Plus** voice terminal, the Message light is red.

SELECT RING button (on 7410D)

On the **7410D** (7410D01A) voice terminal has a SELECT RING button, which the user can press along with the “ * ” key on the dial pad to select one of eight personalized ringing patterns. The SELECT RING button along with the DROP button is also used to perform a self-test of the lights and tone ringer on the voice terminal. The SELECT RING button has a green status light associated with it.

SELECT button (on 7410 Plus)

The **7410 Plus** (7410D02A) voice terminal has a SELECT button which can be used in two ways:

- When used with the CONFERENCE/RING button, the user can select a personalized ring from eight ringing patterns.
- When used with the DROP/TEST button, the user can initiate a self-test of the lights and ringer on the voice terminal.

Call Appearance/Feature Buttons

The **7410D** and **7410 Plus** voice terminals have 10 call appearance/feature buttons. Each of these buttons has a red in-use light and a green status light.

SPEAKER button (on 7410 Plus)

The **7410 Plus** (7410D02A) voice terminal has a SPEAKER button which allows the user to place calls while on-hook, to monitor calls on which the user has been put on hold, or retrieve

messages without lifting the handset. However, the Speaker feature is for listening only. In order to speak to the other party, the user must use the handset (the speaker must be off).

VOLUME control button (on 7410 Plus)

When the speaker is active on the **7410 Plus** voice terminal speaker, the VOLUME control button affects the loudness of the Speaker (listen-only) feature.

At all other times (when the speaker is not being used), the VOLUME control button affects the volume of the tone ringer.

Other Physical Features

Handset

The **7410D** and the **7410 Plus** voice terminals are equipped with an R-type handset.

Dial pad

The **7410D** and **7410 Plus** voice terminals are equipped with a 12-button touch-tone dial pad. On the **7410 Plus** voice terminal the letters “Q” and “Z” have been added to the appropriate dial pad keys for directory access, and the “5” button on the dial pad has raised bars for visually-impaired users.

Jacks

The **7410D** and **7410 Plus** voice terminals’ housing contains three jacks. On the **7410D** voice terminal, the Handset cord jack is located on the front of the housing; on the **7410 Plus** voice terminal, this jack is on the back of the housing near the front. The Line jack and the Speakerphone/headset adapter jack on both voice terminals are on the back of the voice terminal.

Cords

Two cords are supplied with the **7410D** (7410D01A) and the **7410 Plus** (7410D02A) voice terminal: a coiled 9-foot modular handset cord and a 7-foot D8W 8-conductor modular line cord.

Optional longer cords are available: a 12-foot handset cord; 14-foot and 25-foot line cords.

Ringling

The **7401D** and **7401 Plus** voice terminals have electronic tone ringling. With the Personalized Ringling feature, the user can choose any one of eight different ringling patterns.

The volume control on the **7410D** (7410D01A) voice terminal is on the left side of the housing.

The volume on the **7410 Plus** (7410D02A) voice terminal can be controlled with the VOLUME “arrow” button on the front of the voice terminal.

Mounting Options

The **7410D** and **7410 Plus** voice terminals comes equipped with a desk stand or can be wall-mounted.

Color Options

The **7410D** and **7410 Plus** voice terminals are available in black and misty cream.

Distance Limitations

The maximum allowable distances of a 7410D or a 7410 Plus voice terminal from the DEFINITY G1, G2, G3, System 75, or System 85 cabinet are shown in the following table.

SYSTEM	PORT BOARD	NOMINAL MAXIMUM RANGE IN FEET (METERS) (SEE NOTE)	
		24 AWG	26 AWG
System 85	SN270B	3,400 (1,034)	2,200 (671)
	TN754	3,400 (1,034)	2,200 (671)
DEFINITY G2	SN270B	3,400 (1,034)	2,200 (671)
	TN754	3,400 (1,034)	2,200 (671)
DEFINITY G1 & G3 System 75	TN754	3,400 (1,034)	2,200 (671)

Note: These ranges can be extended to 5,000 feet (1524 m) for 24 AWG wire and 4,000 feet (1219 m) for 26 AWG wire with the use of a Data Link Protector (DLP). Refer to the **EXPOSED PORT PROTECTION** section in this manual.

Power Requirements

The 7410D and 7410 Plus voice terminals receive power from the system and do not require any external power supply. Additional external power is required when the 7410D and 7410 Plus voice terminals are equipped with any adjuncts, such as an external speakerphone. Refer to the **ADJUNCT POWER** section of this manual.

Switch Administration

Aliasing

The 7410 voice terminals must be aliased in the following way:

If you are administering this system:	For this type of voice terminal:	The voice terminal must be administered as:
System 75, R1V1, V2, V3 System 85, R2V1, V2, V3, V4 DEFINITY G1 & G3	7410D 7410 Plus	a 7403D voice terminal
DEFINITY G2	7410D	itself
DEFINITY G2	7410 Plus	a 7410D voice terminal

Button Numbering

The following button diagrams of the 7410D and 7410 Plus voice terminals will help you administer both of these voice terminals connected to a System 75 or DEFINITY G1 and G3 and to a System 85 or DEFINITY G2.

In these figures, the button numbers on the 10 administrable call appearance and feature buttons (on both the 7410D and the 7410 Plus voice terminals) correspond to button assignments on Page 2 of the voice terminal administration screen form.

Figures 3 and 4 show button numbering for the 7410D (7410D01A) voice terminal; **Figures 5 and 6** show button numbering for the 7410 Plus (7410D02A) voice terminal.

If you need more information, refer to *DEFINITY Communications System Generic 3 Implementation*, and *DEFINITY Communications System Generic 2 Administration of Features and Hardware*.

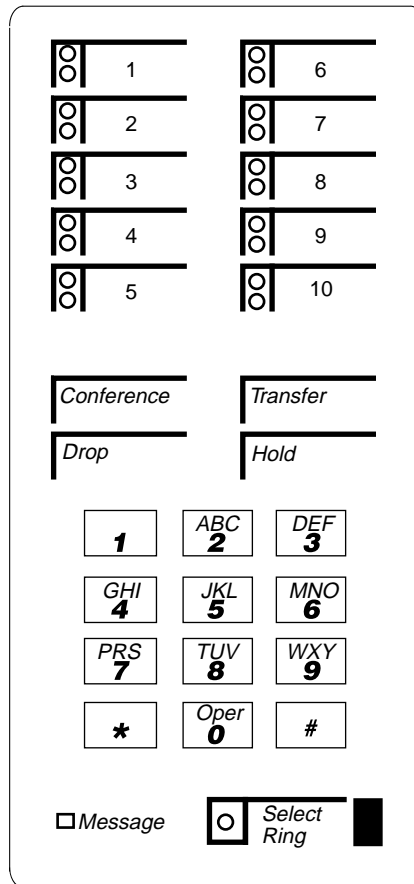
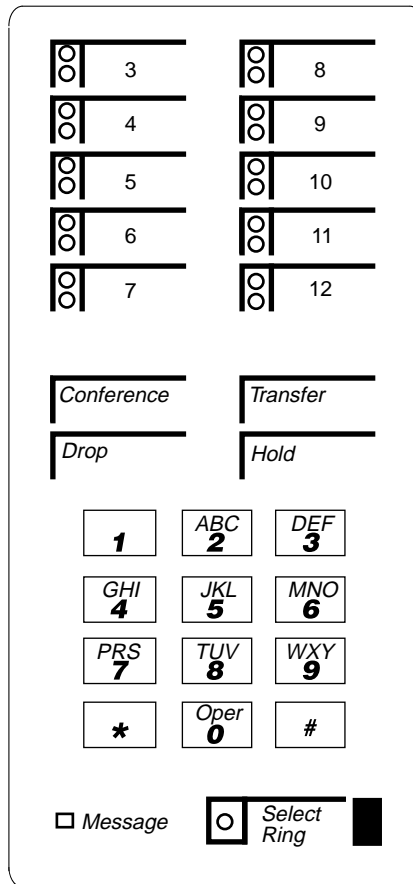

FIGURE 3-36. Button Numbering for Administering the 7410D Voice Terminal Connected to a System 75 or a DEFINITY G1 or G3 Switch



NOTE: THE HOLD BUTTON IS BUTTON # 1. THE MESSAGE LIGHT IS BUTTON # 2.

FIGURE 3-37. Button Numbering for Administering the 7410D Voice Terminal Connected to a System 85 or a DEFINITY G2 Switch

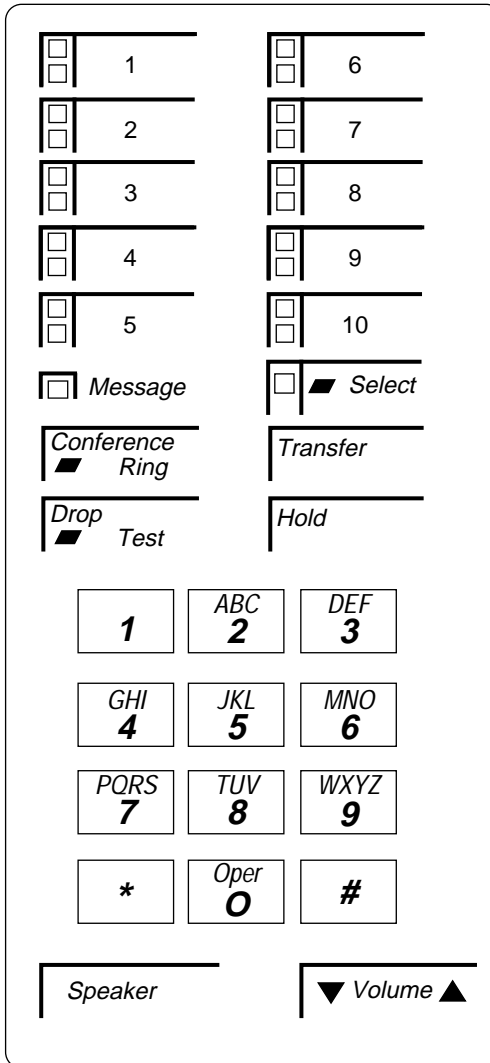
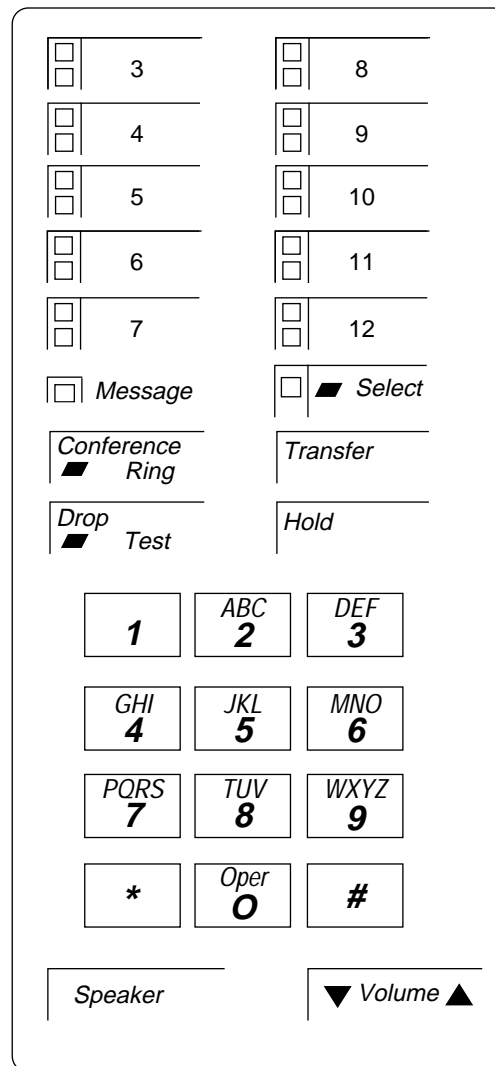

FIGURE 3-38. Button Numbering for Administering the 7410 Plus Voice Terminal Connected to a System 75 or a DEFINITY G1 or G3 Switch



NOTE: THE HOLD BUTTON IS BUTTON #1. THE MESSAGE LIGHT IS BUTTON #2.

FIGURE 3-39. Button Numbering for Administering the 7410 Plus Voice Terminal Connected to a System 85 or a DEFINITY G2 Switch

Power Failure Operation

The 7410D and 7410 Plus voice terminals cannot be used as an emergency station during power failure transfer conditions.

FCC Registration

These voice terminals are FCC-registered along with the switch (as a system), but do not have a separate FCC registration label.

UL and CSA Approval

These voice terminals have been tested and have met the Underwriters Laboratories (UL) Standards UL 1459 and have also met the Canadian Standards Association (CSA) Standards CSA-C22.2 No.225-M90.

Hearing Aid Compatible

These voice terminals are compatible with the inductively coupled hearing aids prescribed by the FCC.

7410D Equipment with PECs and COMCODES

The 7410D (7410D01A) voice terminal and components can be ordered with the following PECs and COMCODES:

- **Basic 7410D** voice terminal
PEC: 3186-15D (Black=COL09; Misty Cream=COL22)
COMCODE: Black=105418636; Misty Cream=105418677
- **Handset**
COMCODE: Black=105157291; Misty Cream=105158885
- **Handset cord (9 feet)**
COMCODE: Black=102803327; Misty Cream=104211305
- **Handset cord (12 feet, black)**
PEC: 2725-01L (Black=COL09; Misty Cream=COL22)
COMCODE: Black=102401445; Misty Cream=104211339
- **Line cord (9 feet)**
COMCODE: 103786778

- **Line cord (14 feet, silver)**
PEC: 2725-07N (COL18)
COMCODE: 103786802
- **Line cord (25 feet, silver)**
PEC: 2725-07S (COL18)
COMCODE: 103786828
- **Graphic panel**
COMCODE: Black=846118016; Misty Cream=846118024
- **Button designation card**
(Package of 50)
PEC: 31861
COMCODE: 846131977
- **Desk stand/Wall mount assembly**
COMCODE: 846028546

7410 Plus Equipment PECs and COMCODES

The 7410 Plus (7410D02A) voice terminal and components can be ordered with the following PECs and COMCODES:

- Basic **7410D02A** voice terminal
PEC: 3186-PLS (Black=COL09; Misty Cream=COL22)
COMCODE: Black=106224470; Misty Cream=106224488
- **Handset**
COMCODE: Black=105519086; Misty Cream=105520787
- **Handset cord (9 feet)**
COMCODE: Black=105635429; Misty Cream=105635437
- **Handset cord (12 feet)**
PEC: 2725-01L (Black=COL09; Misty Cream=COL22)
COMCODE: Black=102401445; Misty Cream=104211339
- **Line Cord (7 feet, silver)**
COMCODE: 103786778
- **Line cord (14 feet, silver)**
PEC: 2725-07N (COL18)
COMCODE: 103786802
- **Line cord (25 feet, silver)**
PEC: 2725-07S (COL18)

COMCODE: 103786828

- **Button designation card**
 - PEC: 31866 (Package of 50 cards)
 - Single sheets COMCODE: 846523892
 - Pack of 50 COMCODE: 846523900
 - Tractor feed, 200 Sheets COMCODE: 846551448
 - Tractor feed, 500 Sheets COMCODE: 846551455
- **Faceplate**
 - (Package of 50)
 - PEC: 31864 (Black=COL09; Misty Cream=COL22)
 - COMCODE: Black=846551414, Misty Cream=846585677
- **Desk stand/Wall mount assembly**
 - COMCODE: 846028546.

Adjuncts

The following adjuncts can be used with this voice terminal:

- S101A Speakerphone (no longer orderable)
- S201A Speakerphone
- CS201A Speakerphone
- 7400B Data Module
- 500A Headset Adapter (and a standard headset: see “Headsets” below)
- R6 Amplifier Handset (PEC: 3152-002)
- R8 Noisy Location Handset (PEC: 3152-003)
- R2H Standard Handset (PEC: 3152-019)
- Shoulder Rest

Headsets

A list of compatible headsets, consisting of both modular and plug prong base units and selection of headpieces, appears in “Headset Adapters” in the **Adjuncts** section (behind the **Adjuncts** tab) later in this manual.

Additional Documents

The following documents contain additional information relating to the 7410D and 7410 Plus voice terminals: (Use the 9-digit number listed after each document to order the book from the GBCS Publications Fulfillment Center.)

- *7410D Voice Terminal Installation Instructions*, 555-015-102
- *System 75 7410D Voice Terminal User's Guide*, 555-200-732
- *DEFINITY Communications System Generic 1 7410D Voice Terminal User's Guide*, 555-204-727
- *DEFINITY Communications System Generic 2 and System 85 7410D Voice Terminal User's Guide*, 555-104-716
- *DEFINITY Communications System Generic 1 and System 75 7410 Plus Voice Terminal User's Guide*, 555-204-743
- *DEFINITY Communications System Generic 2 and System 85 7410 Plus Voice Terminal User's Guide*, 555-104-743

The following document is shipped with every 7410 Plus voice terminal:

- *7401 Plus and 7410 Plus Voice Terminals Installation Instructions*, 555-015-128

7434D VOICE TERMINAL

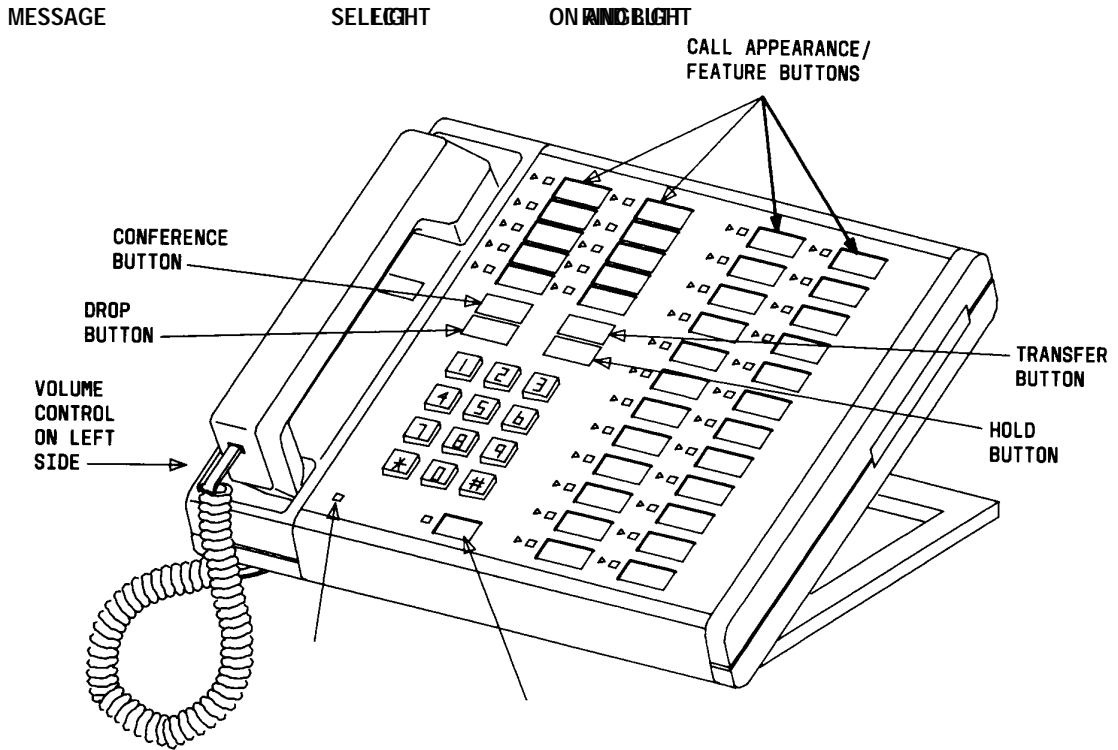

FIGURE 3-40. The 7434D Voice Terminal

7434D Voice Terminal

The 7434D is a multi-appearance digital voice terminal. It is an improved descendant of the 7405D, which it resembles physically and functionally. The 7434D voice terminal has more call appearance capacity (DEFINITY G2 only) than the 7405D and is lower in both cost and power consumption. It connects to a digital line port in the system cabinet. The 7434D voice terminal supports an adjunct display module or a call coverage module.

Applications

The 7434D voice terminal can be used with DEFINITY G1, G2, G3, System 75 or System 85. It is an appropriate terminal for users who handle numerous calls and who need button access to a wide variety of features. For example, the 7434D voice terminal, with its large number of administrable buttons, can use the Abbreviated Dialing feature for reaching many frequently called parties. The buttons of the 7434D voice terminal can also be assigned for bridging calls at other stations. Typical users are secretaries, managers, salespeople, buyers, answering groups, and call covering positions. The 7434D can provide simultaneous voice and data communications via the PC/PBX connection or 7400B Data Module.

Physical Description

Dimensions

The following dimensions for the 7434D voice terminal are approximate.

Width = 10-1/2 inches

Depth (front to back) = 8-3/4 inches

Height (maximum with handset in place) = 6-1/2 inches

Thickness of housing = 1-1/2 inches

Features

Standard Fixed Feature Buttons

- CONFERENCE button

- TRANSFER button
- DROP button
- HOLD button

Note: The DISCONNECT and RECALL buttons found on some earlier 7400 Series voice terminals have been removed from the 7434D voice terminal. A RECALL button can be assigned on an administrable button if needed.

- SELECT RING button—a special fixed feature button that has two functions:

When used with the * dial pad key, it allows the user to select one of eight personalized ringing patterns for incoming calls.

When used with the DROP button, it allows the user to test the lights, ringer, and display module (if installed) of the voice terminal. The Select Ring test function replaces the Self-Test switch found on most other terminals.

The associated Select Ring light goes on steadily when the button is pressed to activate either function. It winks when the user is stepping through the ringing patterns.

Administrable Buttons

The 7434D voice terminal has 34 call appearance/feature buttons (R2V1 and R2V2 only), each equipped with a triangular red light and a square green status light. Usually, at least three of these buttons (the top three in the leftmost column) are administered as call appearances for the terminal's primary extension number, where calls are placed and answered. The rest of the buttons can be used for more call appearances (including bridged appearances of other stations' extensions) and features. Buttons administered for features have only their status lights active.

Message light

The green light goes on when a message is left for the terminal user. It goes off when the user retrieves the message.

Other Physical Features

Handset

The 7434D voice terminal is equipped with an R-type handset.

Dial pad

The 7434D voice terminal is equipped with a 12-button touch-tone dial pad.

Jacks

The 7434D voice terminal housing contains three jacks. The handset cord jack is just under the left front edge of the housing. It is identified by a picture of a handset molded into the plastic. The LINE jack and the OTHER jack (for adjunct connections) are on the bottom center of the housing. The handset contains a jack for the handset cord.

Cords

Two cords are supplied with the 7434D voice terminal: a coiled 7-foot modular handset cord and a 7-foot modular line cord. Optional longer cords are available: a 12-foot handset cord; 14-foot and 25-foot line cords.

Ringling

The 7434D voice terminal has electronic tone ringling with patterns that can be selected via the SELECT RING button. The volume control is on the left side of the housing.

Mounting Options

The 7434D voice terminal comes equipped with a nonadjustable desk stand. A wall mounting kit can be ordered.

Color Options

The 7434D voice terminal is available in two colors: black with silver faceplate and misty cream with gray faceplate.

Distance Limitations

The maximum allowable distances of a 7434D voice terminal from the DEFINITY G1, G2, G3, System 75, or System 85 cabinet are shown in the table below.

SYSTEM	PORT BOARD	NOMINAL MAXIMUM RANGE IN FEET (METERS) (SEE NOTE)	
		24 AWG	26 AWG
SYSTEM 85	SN270B	3,400 (1,034)	2,200 (671)
	TN754	3,400 (1,034)	2,200 (671)
DEFINITY G2	SN270B	3,400 (1,034)	2,200 (671)
	TN754	3,400 (1,034)	2,200 (671)
DEFINITY G1 & G3 SYSTEM 75	TN754	3,400 (1,034)	2,200 (671)

Note: These ranges can be extended to 5,000 feet (1524 m) for 24 AWG wire and 4,000 feet (1219 m) for 26 AWG wire with the use of a Data Link Protector (DLP). Refer to the **EXPOSED PORT PROTECTION** section.

Power Requirements

The 7434D voice terminal is phantom-powered from the system cabinet, or from a local power supply, on the digital pairs of the line wiring. Adjuncts connected to the 7434D voice terminal require auxiliary power and do not impose a drain on the voice terminal supply. Refer to the **ADJUNCT POWER** section of this manual.

Power Failure Operation

The 7434D voice terminal cannot be used as an emergency station during power failure transfer conditions.

FCC Registration

The 7434D voice terminal is not FCC registered.

Hearing Aid Compatible

This voice terminal is compatible with the inductively coupled hearing aids prescribed by the FCC.

7434 Equipment Price Element Codes (PECs)

The 7434D voice terminal and optional components can be ordered with the following PECs:

- Basic voice terminal (black)—3187-39D MNT03
- Basic voice terminal (black) wall mounted—3187-39D MNT13
- Basic voice terminal (misty cream)—3187-39D MNT08
- Basic voice terminal (misty cream) wall mounted—3187-39D MNT18
- Handset cord (12 feet, black)2725-01L COL09
- Handset cord (12 feet, misty cream)—2725-01L COL20
- Line cord (14 feet, silver)2725-07N COL18
- Line cord (25 feet, silver)2725-07S COL18

Adjuncts

The following adjuncts can be used with the 7434D voice terminal:

- S101A Speakerphone *or* 500A Headset Adapter
- S201A Speakerphone *or* 500A Headset Adapter
- C401A or C401B Call Coverage Module *or* D401A or D401B Digital Display Module
- 7400B Data Module

Auxiliary power is required when any adjuncts are added to the basic voice terminal.

Additional Documents

The following documents contain additional information relating to the 7434D voice terminal:

- *7434D Voice Terminal Installation Guide*, 555-015-103
- *DEFINITY Generic 1 7434D Voice Terminal User's Guide*, 555-204-733
- *System 75 7434D Voice Terminal User's Guide*, 555-200-733
- *DEFINITY Generic 2 and System 85 7434D Voice Terminal User's Guide*, 555-104-709
- *DEFINITY Generic 1 and Generic 2, System 75, and System 85 Terminals and Adjuncts Installation and Test*, 555-015-104

7444D VOICE TERMINAL

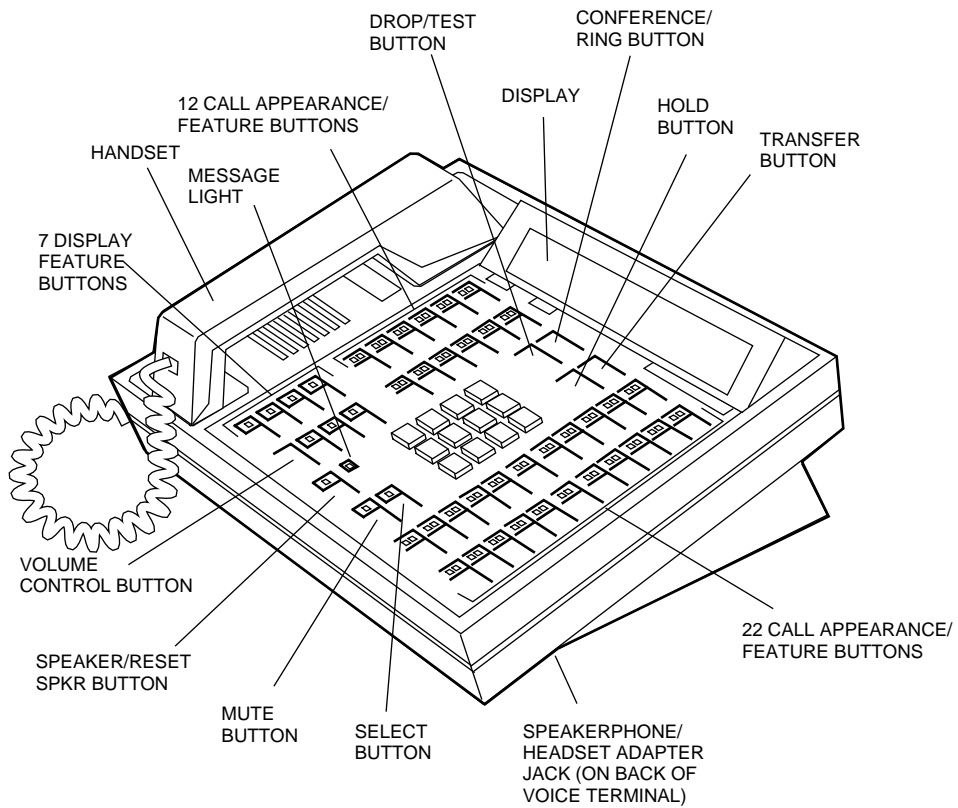

FIGURE 3-41. The 7444 Voice Terminal

7444 Voice Terminal

The 7444 voice terminal is a multi-appearance digital voice terminal, similar to the 7434 voice terminal. The 7444 offers 34 call appearance/feature buttons, each with a red in-use light and a green status light, four standard fixed feature buttons (CONFERENCE, DROP, HOLD, and TRANSFER), three fixed feature buttons with one light each (SELECT, SPEAKER/RESET SPKR, and MUTE), seven display feature buttons with one light each, a Message light, personalized ringing, a built-in speakerphone with a reset option, and a built-in 2-line by 40-character vacuum fluorescent display. Data access can be provided by the addition of the PC/PBX Connection Card to any AT&T compatible PC or by use of the 7400B Plus Data Module. This voice terminal connects to a digital line port in the system cabinet and is powered from the switch.

Important: In order to use the display on the 7444 voice terminal, you must connect an auxiliary power supply to the voice terminal. An MSP-1 Power Supply is recommended. For information about the MSP-1, see the section titled **ADJUNCT POWER**.

Applications

The 7444 voice terminal can be used with the DEFINITY Communications System G1, G2, G3, System 75 or System 85. It is an appropriate terminal for users who handle numerous calls and who need button access to a wide variety of features. For example, the 7444 voice terminal, with its large number of administrable buttons, can use the Abbreviated Dialing feature for reaching many frequently called parties. The buttons of the 7444 voice terminal can also be assigned for bridging calls at other stations. Typical users are secretaries, managers, salespeople, buyers, answering groups, and call covering positions. The 7444 can provide simultaneous voice and data communications via the PC/PBX connection or 7400B Plus Data Module.

Physical Description

Dimensions

Note: The dimensions given here for the 7444 voice terminal are approximate.

Width = 12 inches

Depth (front to back) = 8 3/4 inches

Height (maximum with handset in place) = 6 1/4 inches

Thickness of housing = 1 1/2 inches

Features

Four Standard Fixed Feature Buttons

- CONFERENCE/RING button
- DROP/TEST button
- TRANSFER button
- HOLD button

SELECT button

The SELECT button can be used in three different ways: (The green light next to the SELECT button goes on steadily when the SELECT button is activated.)

- Used with the CONFERENCE/RING button to select one of eight personalized ringing patterns for incoming calls;
- Used with the DROP/TEST button to initiate the Self-Test feature which tests the lights, ringer, and display;
- Used with the SPEAKER/RESET SPKR button to perform an acoustic test of the environment and adjust the speakerphone to the surrounding acoustic environment for optimal performance.

Message light

The red Message light goes on when a message is left for the voice terminal user. The light goes off when the user retrieves the message or when the message is erased.

Call Appearance/Feature Buttons

The 7444D voice terminal has 34 call appearance/feature buttons, each equipped with a red in-use and a green status light. Usually, at least three of these buttons (the top three in the leftmost column) are administered as call appearances for the terminal's primary extension number, where calls are placed and answered. The rest of the buttons can be used for more call appearances (including bridged appearances of other stations' extensions) and features. Buttons administered for features have only their status lights active.

Seven Display Feature Buttons (with a green status light)

The 7444 has seven administrable display feature buttons, each with a green status light. These buttons can be used for only display features, such as Inspect.

Speakerphone (Listen and Speak) Feature

The 7444 voice terminal is equipped with a built-in S201A-type speakerphone. The Speakerphone capability allows a user to engage in a hands-free 2-way conversation with the far-end party. The speakerphone can be turned off or on with the SPEAKER/RESET SPKR button, can be muted with the MUTE button, and the volume can be controlled with the VOLUME “arrow” button.

The SPEAKER/RESET SPKR button also allows the user to adjust the speakerphone for optimal performance. By pressing the SELECT button and then the SPEAKER/RESET SPKR button (if the voice terminal is set for the Speakerphone feature), the user hears a set of tones as the speakerphone performs an acoustic test of the environment. When the tones stop, the speakerphone has finished adjusting itself and is ready for use. The user should reset the speakerphone whenever the voice terminal is moved to another place (even in the same room), whenever the green light next to the SPEAKER/RESET SPKR button is fluttering, and in the unlikely event that the speakerphone is making a squealing sound (in this last case, tones will not be heard during a call).

Speaker (Listen-only) Feature

The 7444 voice terminal can be optioned for the Speakerphone (listen and speak) *or* the Speaker (listen-only) feature. Use the SPEAKER/RESET SPKR button on the front of the voice terminal for turning on and off the speaker or speakerphone.

The voice terminal is shipped with the Speakerphone setting in place, but, the necessary DIP switch setting can be changed so that the voice terminal operates with the Speaker feature instead. In this case, the S2 switch should be set to the ON position, so that the voice terminal will operate with the Speaker (listen-only) feature.

The Speaker (listen-only) capability allows a user to engage in a one-way conversation with the far-end. Specifically, the user can only listen to the far-end; the user is not able to transmit his voice over the speaker. To speak with the far-end, the user must use the handset which turns off the speaker.

MUTE button

The MUTE button disables the transmitter of the speakerphone or the handset depending on which is activated at that time. A red light next to the MUTE button goes on when the Mute feature is activated.

VOLUME control button

The 7444 voice terminal has a VOLUME “arrow” button. This button has a double function. When the user is on a call, the VOLUME button controls the volume of the speaker or speakerphone, whichever is being used; when the user is not using the speaker or speakerphone, the

VOLUME control button adjusts the tone ringer.

When the user sets the volume for the speaker or speakerphone or for the tone ringer, the display on the voice terminal shows a “bar array” that indicates the volume setting.

Self-Test

By pressing the SELECT button and then the DROP/TEST button, the user can initiate a test of the lights, ringer, and display on the voice terminal.

Display

The 7444 voice terminal is equipped with a built-in, 2-line, 40-character per line vacuum fluorescent display.

Other Physical Features

Handset

The 7444 voice terminal is equipped with an R-type handset.

Dial pad

The 7444 voice terminal is equipped with a 12-button touch-tone dial pad. The letters “Q” and “Z” have been added to the appropriate dial pad keys for directory access, and the “5” button on your dial pad has raised bars for visually-impaired users.

Jacks

The 7444 voice terminal housing contains a Line jack and Speakerphone/headset adapter jack on the back of the voice terminal and a Handset cord jack just under the left front edge of the housing.

Cords

Two cords are supplied with the 7444 voice terminal: a coiled 9-foot modular handset cord and a 7-foot modular line cord.

Optional longer cords are available: a 12-foot handset cord; 14-foot and 25-foot line cords.

Ringling

The 7444 voice terminal has electronic tone ringing with eight possible ringing patterns that can be selected with the SELECT button and the CONFERENCE/RING button. The loudness of the tone ringer can be controlled by the VOLUME “arrow” button. (The user must not be on a speakerphone call. If the user is using the speakerphone, the VOLUME “arrow” button controls the volume of the speakerphone.)

Mounting Options

The 7444 voice terminal comes equipped with a nonadjustable desk stand. This voice terminal cannot be wall-mounted.

Color Options

The 7444 voice terminal is available in black and misty cream.

Distance Limitations

The maximum allowable distances of a 7444 voice terminal from the DEFINITY G1, G2, G3, System 75, or System 85 cabinet are shown in the table below.

SYSTEM	PORT BOARD	NOMINAL MAXIMUM RANGE IN FEET (METERS) (SEE NOTE)	
		24 AWG	26 AWG
SYSTEM 85	SN270B	3,400 (1,034)	2,200 (671)
	TN754	3,400 (1,034)	2,200 (671)
DEFINITY G2	SN270B	3,400 (1,034)	2,200 (671)
	TN754	3,400 (1,034)	2,200 (671)
DEFINITY G1 & G3 SYSTEM 75	TN754	3,400 (1,034)	2,200 (671)

Note: These ranges can be extended to 5,000 feet (1524 m) for 24 AWG wire and 4,000 feet (1219 m) for 26 AWG wire with the use of a Data Link Protector (DLP). Refer to the **EXPOSED PORT PROTECTION** section.

Power Requirements

The 7444 voice terminal is phantom-powered from the system cabinet on the digital pairs of the line wiring.

In order to use the display on the 7444 voice terminal, you must connect an auxiliary power source to the voice terminal. An MSP-1 Power Supply is recommended.

Switch Administration

Aliasing

The 7444 voice terminals must be aliased in the following way:

If you are administering this system:	The 7444 voice terminal must be administered as:
System 75, R1V1	a 7405D voice terminal (with display) (See CAVEATS below)
System 75, R1V2 and R1V3	a 7405D voice terminal (with display) or a 7407D voice terminal (See CAVEATS below)
System 85, R2V1	a 7405D voice terminal (with display) (See CAVEATS below)
System 85, R2V2 through R2V4	a 7405D voice terminal (with display) or a 7407D voice terminal (See CAVEATS below)
DEFINITY G1 & G3	a 7434 voice terminal (with display) or a 7407 voice terminal (See CAVEATS below)
DEFINITY G2	a 7434 voice terminal (with display) or a 7407 voice terminal (See CAVEATS below)

CAVEATS: If the 7444 voice terminal is administered as a 7405D or a 7407D, the following caveats apply:

- Only 10 call appearance buttons can be administered with two lights, a red and a green light.
- If the voice terminal is administered as a 7407D, the S1 switch on the back of the 7444 voice terminal must be in the OFF position.

When the 7444 voice terminal is administered as a 7405D or a 7434 voice terminal, the following caveats apply:

- The S1 switch on the back of the 7444 voice terminal must be in the ON position.
- Only one line of the display will show switch-related information.

When a 7444 is administered as a 7434, DEFINITY G1 and G3 allows a maximum of 10 appearances of the primary line while DEFINITY G2 allows a maximum of 12 appearances. Each switch handles appearances of other lines (that is, lines used in Bridging, Call Pickup, etc.) in a different manner. Information about administering these appearances can be found in switch documentation and help screens.

If there is a 7400B or 7400B Plus Data Module attached to the 7444 voice terminal, the voice terminal must be administered with display *and* with data module.

Button Numbering

The following button diagrams of the 7444 voice terminal will help you administer it with a System 75 and DEFINITY G1 or G3, and with a System 85 and DEFINITY G2. **Figure 2** refers to the 7444 voice terminals connected to a System 75 or DEFINITY G1 or G3; **Figure 3** refers to the 7444 voice terminal connected to a System 85 or DEFINITY G2.

If you need more information, refer to *DEFINITY Communications System Generic 1 Implementation*, and *DEFINITY Communications System Generic 2 Administration of Features and Hardware*.

Button Assignments 1 - 10



* If aliased as a 7434, the feature button assignments are numbered 11 - 34

FIGURE 3-42. Button Numbering for Administering the 7444 Voice Terminal Connected to a System 75 or a DEFINITY G1 or G3 Switch

Button Assignments 3 - 12

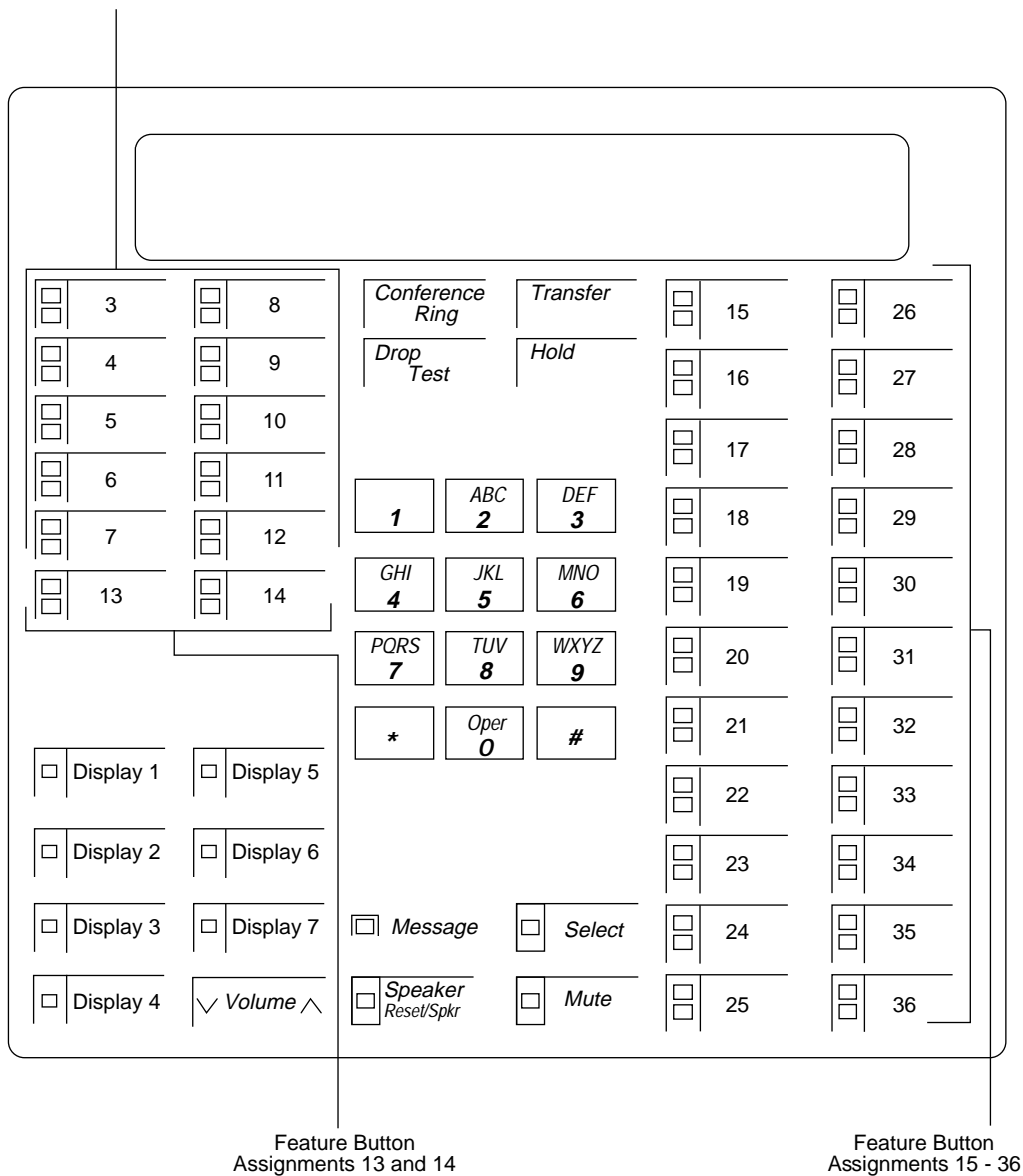

NOTE: THE HOLD BUTTON IS BUTTON #1. THE MESSAGE LIGHT IS BUTTON #2.

FIGURE 3-43. Button Numbering for Administering the 7444 Voice Terminal Connected to a System 85 or a DEFINITY G2 Switch

Power Failure Operation

The 7444 voice terminal cannot be used as an emergency station during power failure transfer conditions.

FCC Registration

This voice terminal is FCC-registered along with the switch (as a system), but does not have a separate FCC registration label.

UL and CSA Approval

This voice terminal has been tested and has met the Underwriters Laboratories (UL) Standards UL 1459 and have also met the Canadian Standards Association (CSA) Standards CSA-C22.2 No.225-M90.

Hearing Aid Compatible

This voice terminal is compatible with the inductively coupled hearing aids prescribed by the FCC.

7444 Equipment PECs and COMCODES

The 7444D voice terminal and optional components can be ordered with the following Price Element Codes (PECs) and COMCODES:

- **Basic 7444 voice terminal**
PEC: 3187-VFD (Black=COL09; Misty Cream=COL22)
COMCODE: Black=106200579; Misty Cream=106200587
- **Handset**
COMCODE: Black=105519086; Misty Cream=105520787
- **Handset cord (9 feet)**
COMCODE: Black=105635429; Misty Cream=105635437
- **Handset cord (12 feet)**
PEC: 2725-01L (Black=COL09; Misty Cream=COL22)
COMCODE: Black=102401445; Misty Cream=104211339
- **Line Cord (7 feet)**
COMCODE: 103786778

- **Line cord (14 feet, silver)**
PEC: 2725-07N COL18
COMCODE: 103786802
- **Line cord (25 feet, silver)**
PEC: 2725-07S COL18
COMCODE: 103786828
- **Button designation card**
PEC: 81005 (Package of 25)
Single COMCODE: Black=846604759; Misty Cream=846604767
Pack of 25 Sheets COMCODE: Black=846692341; Misty Cream=846692358
Tractor Feed, 200 Sheets COMCODE: Black=846604775; Misty Cream=846604783

Adjuncts

The following adjuncts can be used with the 7444 voice terminal:

Note: Auxiliary power is required when any adjuncts are added to the basic voice terminal, except for the 7400B Plus Data Module which is AC powered. An MSP-1 Power Supply is recommended.

- S101A Speakerphone (no longer orderable)
- S201A Speakerphone
- CS201A Speakerphone
- 7400B Plus Data Module
- 500A Headset Adapter (and a standard headset; see “Headsets” below)
- Shoulder Rest

Headsets

A list of compatible headsets, consisting of both modular and plug prong base units and selection of headpieces, appears in “Headset Adapters” in the **Adjuncts** section (behind the **Adjuncts** tab) later in this manual.

Additional Documents

The following documents contain additional information relating to the 7444 voice terminal: (Use the 9-digit number listed after each document to order the book from the GBCS Publications Fulfillment Center.)

- *DEFINITY Communications System Generic 1 and System 75 7444 Voice Terminal User's Guide, 555-204-744*
- *DEFINITY Communications System Generic 2 and System 85 7444 Voice Terminal User's Guide, 555-104-744*

The following instructions are shipped with every 7444 voice terminal:

- *7407 Plus and 7444 Voice Terminals Installation Instructions, 555-015-129.*

8403 VOICE TERMINAL

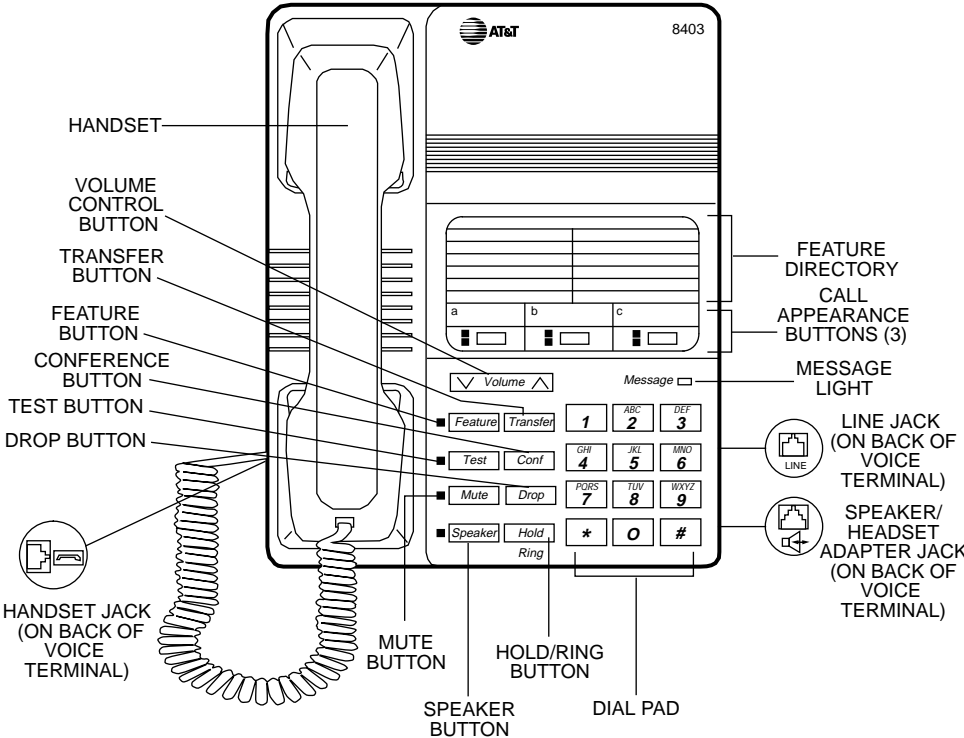

FIGURE 3-44. The 8403 Voice Terminal

8403 Voice Terminal

The 8403 voice terminal is a multi-appearance digital telephone with three call appearance buttons, Conference, Transfer, Drop, and Hold buttons, a TEST button, a blue FEATURE button which allows you to access 12 system features assigned by the System Manager and to choose from among eight different ringing patterns, a MUTE button, a SPEAKER button which accesses a 1-way, listen-only speaker, a red Message light, and a Volume control button.

The 8403 can be used in either a 4-wire or 2-wire environment. For more information, see the section on "Wiring Information."

Applications

The 8403 voice terminal can be used with the DEFINITY Communications System G1, G2, G3, System 75, and System 85. This voice terminal is especially suitable for general office workers with low call volumes, manufacturing, warehousing, guard and/or reception areas, or office desks.

The 8403 voice terminal can also provide simultaneous voice and data communications with the 7400B Plus Data Module. PC platform products can also be useful in providing voice capabilities since these screen-based products can greatly enhance the telephone capabilities of these basic voice terminals.

Physical Features

Dimensions

Note: The dimensions described here for the 8403 voice terminal are approximate:

Width = 7 3/4 inches

Depth (front to back) = 9 7/16 inches

Height (maximum with handset in place) = 5 1/2 inches

Thickness of housing = 1 1/2 inches

Features

Eight Fixed Feature Buttons

The 8403 has the following eight fixed feature buttons:

- CONFERENCE button (labeled CONF)
- DROP button
- TRANSFER button
- A red HOLD button
- A blue FEATURE button
- MUTE button
- SPEAKER button
- TEST button

The Feature Button

The blue FEATURE button allows the dial pad to serve as 12 feature buttons without indicators. These features are accessed by pressing the FEATURE button and then one of the 12 dial pad keys. The Feature Directory on the faceplate on the top of the telephone lists the features administered at **F1** through **F9**, **F***, **F0**, and **F#**.

The FEATURE button can also be used with the HOLD button to select your own personalized ring from among eight available patterns.

Feature Directory

The 8403 voice terminal has a Feature Directory card, which has space for 12 features assigned by the System Manager. These features are labeled **F1** through **F9**, **F***, **F0**, and **F#**.

Call Appearance Buttons

The 8403 voice terminal has three call appearance buttons. Each of the buttons has a red light and a green status light.

Message Light

The red Message light goes on when a message is left for the user. It goes off when the user retrieves the message or when the message is erased.

SPEAKER Button

The 8403 voice terminal is set for the 1-way, listen-only Speaker feature. The user can only listen to the far-end. To speak with the other party, the user must use the handset which turns off the speaker.

MUTE button

The MUTE button is a fixed feature button with a red status light. The MUTE button turns off the microphone of the handset so that a person can converse with another person in the room without the other party listening in.

VOLUME Control button

The 8403 voice terminal has a VOLUME “arrow” button on the front of the set. This button has several functions. When the user is using the 1-way speaker, the VOLUME button controls the volume of the speaker. When the user is on a call using the handset, the VOLUME button controls the volume of the handset. When the voice terminal is idle, the button controls the volume of the tone ringer.

TEST button

When the voice terminal is initially powered up, the green light next to the TEST button flashes if the link with the PBX is not (or not yet) operational. The light changes to steady green when the voice terminal is able to communicate with the PBX. After the voice terminal is powered up, you can press the TEST button to test the lights on your voice terminal.

Other Physical Features***Handset***

The 8403 voice terminal is equipped with a K-type handset.

Dial pad

The 8403 voice terminal is equipped with a 12-button touch-tone dial pad. The letters “Q” and “Z” have been added to the appropriate dial pad keys for directory access, and the “5” button on the dial pad has raised bars for visually-impaired users.

Jacks

The 8403 voice terminal's housing has a Line jack and a Handset cord jack located on the back of the housing. There is also a Speakerphone/headset adapter jack on the back of the set to which the user can connect adjunct equipment.

Cords

Two cords are supplied with the 8403: a coiled 9-foot handset cord and a 7-foot line cord.

Optional longer cords are available: a 12-foot handset cord, and 14-foot and 25-foot line cords.

Ringling

The 8403 voice terminal has electronic tone ringling. With the Select Ring feature, the user can choose any one of eight different ringling patterns. The set has a Volume control button which controls the loudness of the ringer, the speaker, and the handset.

Mounting Options

The 8403 voice terminal comes equipped with a nonadjustable desk stand. However, the user may choose to remove the stand and then mount the voice terminal on the wall.

Color Options

The 8403 voice terminal is available in black and AT&T white.

Wiring Information

The 8403 voice terminal works in both 4-wire and 2-wire DCP configurations. The table below describes the pins on an 8400-Series voice terminal LINE jack.

LINE INTERFACE			
PIN	PAIR	NAME	DESCRIPTION
1	2	OD1	4-Wire Output
2	2	OD2	4-Wire Output
3	3	ID1	4-Wire Input
4	1	U-T	2-Wire (Tip)
5	1	U-R	2-Wire (Ring)
6	3	ID2	4-Wire Input
7	4	P1-	Adjunct Power -48V
8	4	P2+	Adjunct Power Common

Notes: Regardless of which configuration is in use, ALL wiring between the PBX and the terminal MUST consist of twisted-pairs, including the modular line cord. The line cord must be a D8W, which consists of 4 twisted-pairs, or an AT&T approved equivalent.

Twisted-pair wiring is used to make lines less sensitive to crosstalk. Therefore, failure to use twisted pair wiring may result in less-than-optimum performance of the terminal and may also contribute to problems with the line.

An 8-wire modular cord MUST be used for all 4-wire and any 2-wire installations requiring auxiliary power.

Important: You do NOT need to change any settings on the voice terminal for 2-wire or 4-wire installations. The voice terminal is able to detect whether it is in a 2-wire or a 4-wire configuration.

For 2-wire operation, if you need to plug the voice terminal into a 4-pin or 6-pin wall jack, instead of a standard 8-pin modular jack, refer to the "Line Interface" table to insure that the wires from the 4-pin or 6-pin wall jack are connected to the correct pins on the terminal "LINE" jack.

In order for the terminal to function properly in either 2-wire or 4-wire installations, there must be NO INTERCONNECTIONS between the wire pairs used for 2-wire and 4-wire operations. Bridging or paralleling of these pairs can result in damage to the terminal or can cause the PBX circuit pack to remove power to the terminal.

REMOVE ALL CONNECTIONS BETWEEN PAIRS BEFORE CONNECTING THE TERMINAL.

4-WIRE installations MUST ONLY have PBX connections on pair 2 and pair 3 and, if necessary, auxiliary power must be connected to pair 4.

2-WIRE installations MUST ONLY have PBX connections on pair 1 and, if necessary, auxiliary power must be connected to pair 4.

Distance Limitations

The following circuit packs can be used with all of the 8400-Series sets.

Circuit Pack	2/4-Wire	Will support these switches
TN2181 - 16-port	2-wire	G3V3, G3V2
TN754b - 8-port	4-wire	All switches except System 85
TN754 - 8-port	4-wire	All switches except System 85
TN413 - 8-port	4-wire	International System 75
SN 270 and SN270B - 4-port	4-wire	System 85 R2V2 - R2V4

In 4-wire operation, the voice terminal must be within 5,000 feet of the PBX using 22-gauge or 24-gauge wire, and within 4,000 feet of the PBX using 26-gauge wire.

In 2-wire operation, the voice terminal must be within 5,500 feet of the PBX using 22-gauge wire, within 3,500 feet of the PBX using 24-gauge wire, and within 2,200 feet of the PBX using 26-gauge wire.

Power Requirements

The 8403 voice terminal receives power from the system and does not require any external power supply. Additional external power IS required when the 8403 voice terminal is equipped with any adjuncts, such as an external speakerphone. In this instance, an MSP-1 Power Supply is recommended. Refer to the **Adjunct Power** section of this manual for information on the MSP-1 Power Supply.

Switch Administration

Aliasing

Use the following table for administering the 8403 voice terminal:

If you have this System	and this Release	(which can support this type of operation)	administer the 8403 as a
System 75	R1V1 — R1V3	4-wire only	7405
System 85	R2V2 — R2V4	4-wire only	7405
Internat'l System 75	IR1V4, etc.	4-wire only	7405
DEFINITY G1		4-wire only	7405
Global DEFINITY '91		4-wire only	7405
DEFINITY G2V1		4-wire only	7405
DEFINITY G2V2		4-wire only	7405
DEFINITY G3i, G3r, G3s, G3vs		4-wire only	7405
DEFINITY G3V2		2- or 4-wire	7405
DEFINITY G3V3		2- or 4-wire	8403

Button Numbering

The following button diagrams of the 8403 voice terminal will help you administer both of these voice terminals connected to a System 75 or DEFINITY G1 and G3 and to a System 85 or DEFINITY G2.

Figure 2 shows button numbering for the 8403 connected to a System 75/DEFINITY G1 and G3.

Figure 3 shows button numbering for the 8403 connected to a System 85/DEFINITY G2.

If you need more information, refer to *DEFINITY Communications System Generic 3 Implementation*, and *DEFINITY Communications System Generic 2 Administration of Features and Hardware*.

If administered as a 7405D, F1 through F7 are administered as "BUTTON ASSIGNMENTS" 4 through 10.

F8, F9, F*, F0, and F# are administered as "FEATURE BUTTON ASSIGNMENTS" 1 through 5.

If administered as itself, administer F1 through F9, F*, F0, and F# as "FEATURE BUTTON ASSIGNMENTS" 1 through 12.

Call appearance buttons a, b, and c are administered as call appearance "BUTTON ASSIGNMENTS" 1, 2, and 3.

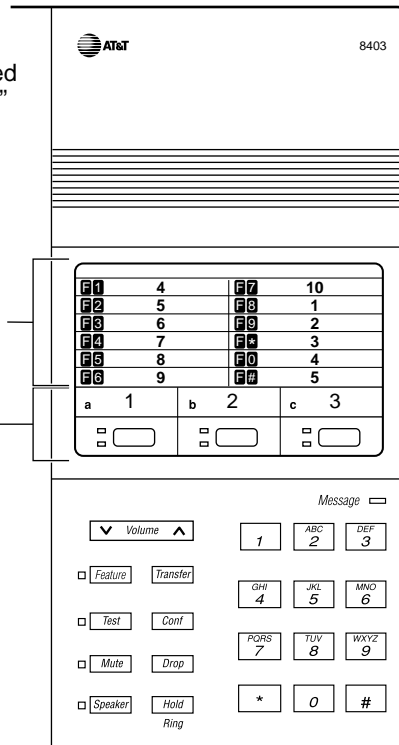

FIGURE 3-45. Button Numbering for Administering the 8403 Voice Terminal Connected to a System 75 or a DEFINITY G1 or G3 Switch

If administered as a 7405D, F1 through F7 are administered as "BUTTON ASSIGNMENTS" 6 through 12.

F8, F9, F*, F0, and F# are administered as "FEATURE BUTTON ASSIGNMENTS" 13 through 17.

If administered as itself, administer F1 through F9, F*, F0, and F# as "FEATURE BUTTON ASSIGNMENTS" 1 through 12.

Call appearance buttons a, b, and c are administered as call appearance "BUTTON ASSIGNMENTS" 3, 4, and 5.

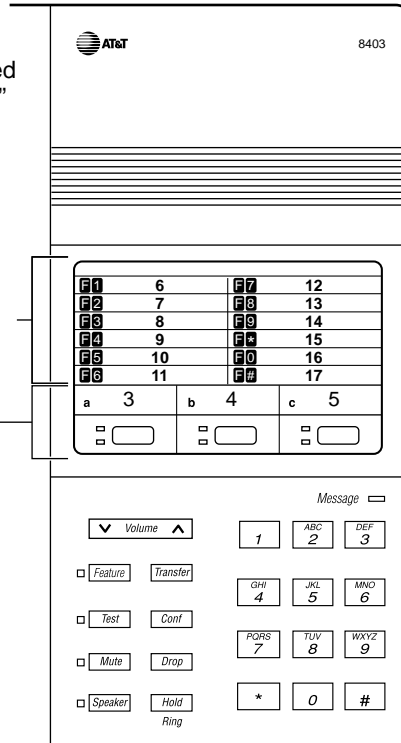

FIGURE 3-46. Button Numbering for Administering the 8403 Voice Terminal Connected to a System 85 or a DEFINITY G2 Switch

Power Failure Operation

The 8403 voice terminal cannot be used as an emergency station during power failure transfer conditions.

FCC Registration

The 8403 voice terminal is FCC-registered along with the switch (as a system), but does not have a separate FCC registration label.

UL and CSA Approval

This voice terminal has been tested and has met the Underwriters Laboratories (UL) Standards UL 1459 and has also met the Canadian Standards Association (CSA) Standards CSA-C22.2 No.225-M90.

Hearing Aid Compatible

This voice terminal is compatible with the inductively coupled hearing aids prescribed by the FCC.

8403 Equipment PECs & COMCODES

The 8403 (8403D01A) voice terminal and components can be ordered with these Price Element Codes (PECs) and COMCODES:

- **Basic 8403 (8403D01A) Voice Terminal**
 - Black 8403 Set PEC: 3233-03B
COMCODE: 106705106;
 - White 8403 Set PEC: 3233-03W
COMCODE: 106705114
- **K2S1 Handset**
COMCODE: Black=106050065; White=106053408
- **K2S6 Handset (available late 1994 or early 1995)**
COMCODE: Black=107180549; White=107181471
- **K6S2-003 (Black) Amplifier Handset**
COMCODE: 105581896
- **Handset cord (9 feet)**
COMCODE: Black=105635429; White=105701809

- **Line cord (7 feet)**
COMCODE: 103786778
- **Line cord (14 feet, silver)**
PEC: 2725-07N (COL18)
COMCODE: 103786828
- **Line cord (25 feet, silver)**
PEC: 2725-07S (COL18)
COMCODE: 103786802
- **Designation Card Cover**
PEC: 32306
COMCODE: 846506780
- **Button Designation Cards**
Tractor Feed For 25 Sets, 5 Sheets
PEC: 32307
COMCODE: 847167962

Tractor Feed, For 100 Sets, 20 Sheets
PEC: 32308
COMCODE: 847167970

Adjuncts

The following adjuncts can be used with the 8403 voice terminal:

- S101A Speakerphone (no longer orderable)
- S201A Speakerphone
- CS201A Speakerphone
- 7400B Plus Data Module
- 500A Headset Adapter (and a standard headset; see “Headsets” below)
- K6S2 Amplifier Handset
- Shoulder Rest

Headsets

A list of compatible headsets, consisting of both modular and plug prong base units and selection of headpieces, appears in "Headset Adapters" in the **Adjuncts** section (behind the **Adjuncts** tab) later in this manual.

Additional Documents

The following documents contain additional information relating to the 8403 voice terminal: (Use the 9 digit number listed after each document to order that book from the AT&T GBCS Publications Fulfillment Center.)

- *8403, 8410, and 8434 Voice Terminals Instructions for Installation, Switch Administration, and Programming the Options*, 555-015-164
- *DEFINITY Communications System Generic 1 and 3 and System 75 8403 Voice Terminal User's Guide*, 555-230-761
- *DEFINITY Communications System Generic 1 and 3 and System 75 8403 Voice Terminal Quick Reference Guide*, 555-230-762
- *DEFINITY Communications System Generic 2 and System 85 8403 Voice Terminal User's Guide*, 555-104-761
- *DEFINITY Communications System Generic 2 and System 85 8403 Voice Terminal Quick Reference Guide*, 555-104-762

8410 VOICE TERMINAL

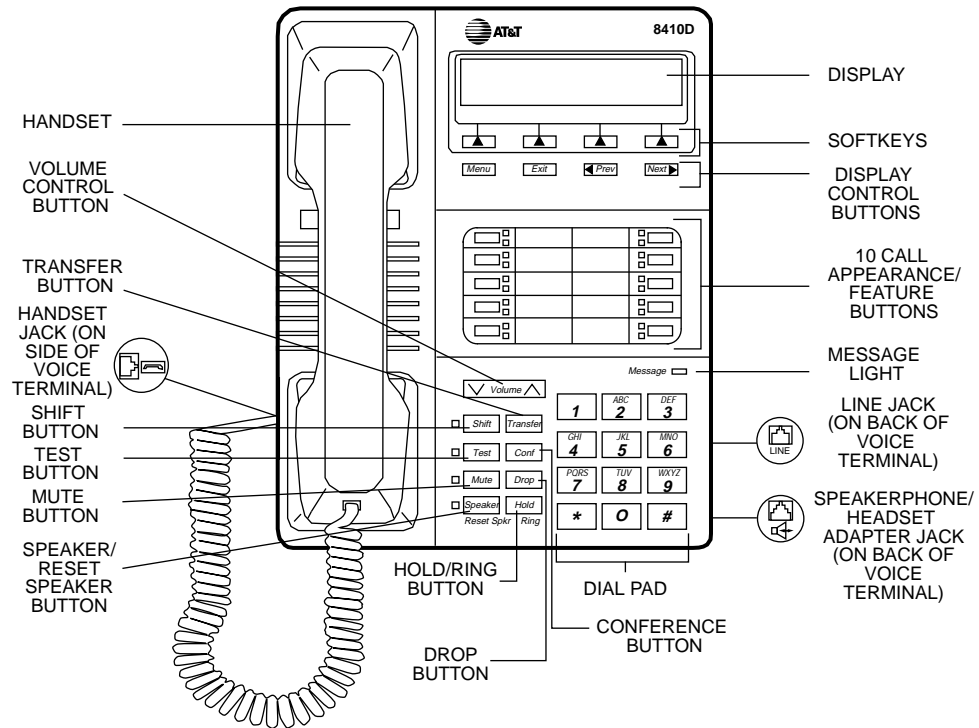

FIGURE 3-47. 8410D Voice Terminal (With Display)

8410 Voice Terminal

The 8410 voice terminal is a multi-appearance digital telephone with 10 call appearance/feature buttons, four standard fixed feature buttons (CONFERENCE, DROP, HOLD, and TRANSFER), a blue SHIFT button, a MUTE button, a SPEAKER button which can access either a 2-way speakerphone or a 1-way, listen-only speaker, a TEST button, and a Volume control button.

There are 2 varieties of the 8410 voice terminal: the 8410B (8410D02A) is the basic set, without a display; the 8410D (8410D01A) has a built-in 2-line by 24-character display. Those users who have an 8410D with display can access 12 features with the softkeys and display control buttons. These 12 features can be used *in addition to* the features on the call appearance/feature buttons.

The 8410 voice terminal can work in both 4-wire and 2-wire environments. For more information, see "Wiring Information."

Applications

The 8410 voice terminal can be used with the DEFINITY Communication System G1, G2, G3, System 75, and System 85. This type of voice terminal is especially suitable for managers, executive secretaries, and other office support personnel who require access to multiple lines for call handling, call coverage, bridging, conferencing, and sophisticated voice communications. The display set can be used by those who have a need for calling party display capabilities or who require a large number of voice terminal features.

The 8410 voice terminals can also provide the user with simultaneous voice and data communications. The 8410 can be connected to a 7400B Plus Data Module. With the 8410 voice terminal, PC platform products can be useful in providing voice capabilities since these screen-based products can greatly enhance the telephone capabilities of these voice terminals.

Physical Features

Dimensions

Note: The dimensions described here for the 8410 voice terminal are approximate:

Width = 7.8 inches

Depth (front to back) = 9.5 inches

Height (maximum with handset in place) = low position, 5.265 inches
high position, 6.625 inches

Features

Eight Fixed Feature Buttons

The 8410 has the following eight fixed feature buttons:

- CONFERENCE (labeled CONF) button
- DROP button
- TRANSFER button
- A red HOLD button
- A blue SHIFT button
- MUTE button
- SPEAKER button
- TEST button

The SHIFT Button

The blue SHIFT button on the set can be used in the following ways: (The red light next to the SHIFT button goes on steadily when the button is activated.)

- Used with the HOLD button to select your own personalized ring from among eight available patterns
- Used with the SPEAKER button to perform an acoustic test of the environment and adjust the speakerphone to the surrounding acoustic environment for optimal performance.

Call Appearance/Feature Buttons

The 8410 voice terminal has 10 call appearance/feature buttons, each equipped with a red and a green status light. Usually, at least three of these buttons are administered as call appearances for the terminal's primary extension number, where calls are placed and answered. The rest of the buttons can be used for more call appearances (including bridged appearances of other stations' extensions) and features. Buttons administered for features have only their status lights active.

Message Light

The red Message light goes on when a message is left for the user. It goes off when the user retrieves the message or when the message is erased.

Speakerphone

The 8410 voice terminal is equipped with a built-in speakerphone. (The voice terminal can be optioned for a 1-way, listen-only speaker instead.) The Speakerphone capability allows a user to engage in a hands-free conversation with the far-end party. The speakerphone can be turned on or off with the SPEAKER button; can be muted with the MUTE button, and the volume can be raised and lowered with the VOLUME “arrow” button.

The Speakerphone feature also allows the user to adjust the speakerphone for optimal performance. By pressing the blue SHIFT button on the set and then the SPEAKER button (if the voice terminal is set for the Speakerphone feature), the user hears a set of tones as the speakerphone performs an acoustic test of the environment. When the tones stop, the speakerphone has finished adjusting itself and is ready for use. The user *must* reset the speakerphone in any of three instances: whenever the voice terminal is moved to another place (even in the same room), whenever the red light next to the SPEAKER button is fluttering, and, when, in the unlikely event, the speakerphone is making a squealing sound.

Speaker (Listen-Only) Feature

Although the 8410 voice terminal is shipped from the factory with the terminal set for the Speakerphone feature, the 8410 voice terminal can be optioned instead for a 1-way, listen-only speaker. If this is the case, use the SPEAKER button on the front of the voice terminal for turning on and off the speaker.

The Speaker (listen-only) capability allows a user to engage in a 1-way conversation with the far-end. Specifically, the user can only listen to the far-end. To speak with the far-end, the user must use the handset which turns off the speaker. The Speaker function may also be disabled.

MUTE button

The MUTE button is a fixed feature button with a red status light. The MUTE button turns off the microphone of the built-in speakerphone or the handset so that a person can converse with another person in the room without the other party listening in.

VOLUME Control button

The 8410 voice terminal has a VOLUME “arrow” button on the front of the set. This button has several functions. When the user is using the speakerphone or the 1-way speaker, the VOLUME button controls the volume of the speaker. When the user is on a call using the handset, the VOLUME button controls the handset volume. When the voice terminal is idle, the button controls the volume of the tone ringer.

When the user sets the volume for the speaker, speakerphone, handset, or the tone ringer, the display on the 8410D voice terminal shows a “bar array” that indicates the volume setting.

TEST button

When the voice terminal is initially powered up, the green light next to the TEST button flashes if the link with the PBX is not (or not yet) operational. The light changes to steady green when the voice terminal is able to communicate with the PBX. After the voice terminal is powered up, you can press the TEST button to test the lights and the display on your voice terminal.

Display

The display on the 8410D set has two lines with 24 characters on each line. The display, along with the softkeys and the display control buttons, can be used to access 12 softkey features (the default softkey features and the alternative softkey features are listed under “Softkeys”).

Display Control Buttons

These 4 buttons are labeled **Menu**, **Exit**, **◀ Prev**, and **Next ▶** .

- The **Menu** button is used to enter Softkey Mode and access the 12 softkey features.
- The **Exit** button is used for exiting a display feature and returning to Normal (call-handling) Mode.
- The **◀ Prev** and **Next ▶** buttons can be used to help you go back and forth through the feature option screens.

Softkeys

The four buttons located below the display and labeled with arrows correspond to features listed on the second line of the display screen. (There are four features on each feature option screen.) The user can access any of the 12 features by pressing the softkey below the feature abbreviation.

Below is a list of the 12 default softkey features assigned to the 8410 and the order in which they appear.

TABLE 3-E. Default Softkey Features on the 8410

ABBREVIATION	FEATURE
First Screen	
LWC	Leave Word Calling
CnLWC	Cancel Leave Word Calling
AutCB	Automatic Callback
Timer	Timer
Second Screen	
CFrwd*	Call Forward
CPark**	Call Park
TmDay	Time/Date
PCall	Priority Calling
Third Screen	
Prog	Abbreviated Dialing Program
Pause	Abbreviated Dialing Special Function Pause
Mark	Abbreviated Dialing Special Function Mark
Wait	Abbreviated Dialing Special Function Wait

* On DEFINITY Generic 2 or System 85 switches, this feature is named Call Forward – Follow Me.

** On DEFINITY G2 and System 85, there is no Call Park feature that can be assigned to a feature button. In order to have the Call Park function on a softkey or hard button, administer the button as an Abbreviated Dial button and program the Call Park trunk group access code onto it. This button can then be labeled "Call Park." In addition, on a DEFINITY G2 or System 85, the Recall feature must be administered on a standard feature button.

On 8410D voice terminals (8410 terminals with a display) connected to a DEFINITY G3V3 or later, the System Manager can choose to administer alternate features for use with the softkeys. The following table lists the alternate softkey features, those features that can be substituted for the default softkey features listed on the previous page.

Note: With G3V3 and later switches, the system can download *BLANK* softkey labels for positions where there are no features administered.

TABLE 3-F. Alternate Softkey Features on the 8410

ABBREVIATION	FEATURE
AD	Abbreviated Dialing buttons (can be multiple AD buttons)
Cnslt	Consult
Count	ACD Stroke Count
CPkup	Call Pickup
Dir*	Directory
Excl	Manual Exclusion
HFAns**	Internal Auto Answer
IAuto	Intercom Auto
IDial	Intercom Dial
Inspt	Inspect
Last	Last Number Dialed
RngOf	Ringer Off
SAC	Send All Calls
SFunc	Abbreviated Dialed Special Function

TABLE 3-F (continued).
Alternate Softkey Features on the 8410

ABBREVIATION	FEATURE
Spres	Abbreviated Dialing Special Function Suppress
Stats	View (ACD) Statistics
Stop	Abbreviation Dialing Indefinite Wait or Stop
View***	Stored Number

* A CALL DISPLAY button should be administered, if access to System Directory is provided. It is also desirable for a NEXT DISPLAY button to be administered. This feature is *not* available on DEFINITY G2 or System 85.

** This feature is available only on DEFINITY G3V2 (or later) switches.

*** This feature is *not* available on DEFINITY G2 or System 85.

Other Physical Features

Handset

The 8410 voice terminal is equipped with a K-type handset.

Dial pad

The 8410 voice terminal is equipped with a 12-button touch-tone dial pad. The letters “Q” and “Z” have been added to the appropriate dial pad keys for directory access, and the “5” button on the dial pad has raised bars for visually-impaired users.

Jacks

The 8410 voice terminal's housing has a Line jack located on the back of the housing, and a Handset cord jack located on the side of the set. There is also a Speakerphone/headset adapter jack to which the user can connect adjunct equipment.

Cords

Two cords are supplied with the 8410: a coiled 9-foot handset cord and a 7-foot line cord.

Optional longer cords are available: a 12-foot handset cord, and 14-foot and 25-foot line cords.

Ringling

The 8410 voice terminal has electronic tone ringling with eight possible ringling patterns that can be selected with the SHIFT button and the HOLD button. The loudness of the tone ringer can be controlled by the VOLUME “arrow” button. (The user must NOT be on a speakerphone call. If the user is using the speakerphone, the VOLUME “arrow” button controls the volume of the speakerphone.)

Mounting Options

The 8410 voice terminal comes equipped with a 2-position desk stand. This stand can also be removed so the user can mount the set on the wall.

Color Options

The 8410 voice terminal is available in black and AT&T white.

Wiring Information

The 8410 voice terminal works in both 4-wire and 2-wire DCP configurations. The table below describes the pins on an 8400-Series voice terminal LINE jack.

LINE INTERFACE			
PIN	PAIR	NAME	DESCRIPTION
1	2	OD1	4-Wire Output
2	2	OD2	4-Wire Output
3	3	ID1	4-Wire Input
4	1	U-T	2-Wire (Tip)
5	1	U-R	2-Wire (Ring)
6	3	ID2	4-Wire Input
7	4	P1-	Adjunct Power -48V
8	4	P2+	Adjunct Power Common

Notes: Regardless of which configuration is in use, ALL wiring between the PBX and the terminal MUST consist of twisted-pairs, including the modular line cord. The line cord must be a D8W, which consists of 4 twisted-pairs, or an AT&T approved equivalent.

Twisted-pair wiring is used to make lines less sensitive to crosstalk. Therefore, failure to use twisted pair wiring may result in less-than-optimum performance of the terminal and may also contribute to problems with the line.

An 8-wire modular cord MUST be used for all 4-wire and any 2-wire installations requiring auxiliary power.

Important: You do NOT need to change any settings on the voice terminal for 2-wire or 4-wire installations. The voice terminal is able to detect whether it is in a 2-wire or a 4-wire configuration.

For 2-wire operation, if you need to plug the voice terminal into a 4-pin or 6-pin wall jack, instead of a standard 8-pin modular jack, refer to the "Line Interface" table to insure that the wires from the 4-pin or 6-pin wall jack are connected to the correct pins on the terminal "LINE" jack.

In order for the terminal to function properly in either 2-wire or 4-wire installations, there must be NO INTERCONNECTIONS between the wire pairs used for 2-wire and 4-wire operations. Bridging or paralleling of these pairs can result in damage to the terminal or can cause the PBX circuit pack to remove power to the terminal.

REMOVE ALL CONNECTIONS BETWEEN PAIRS BEFORE CONNECTING THE TERMINAL.

4-WIRE installations MUST ONLY have PBX connections on pair 2 and pair 3 and, if necessary, auxiliary power must be connected to pair 4.

2-WIRE installations MUST ONLY have PBX connections on pair 1 and, if necessary, auxiliary power must be connected to pair 4.

Distance Limitations

The following circuit packs can be used with all of the 8400-Series sets.

Circuit Pack	2/4-Wire	Will support these switches
TN2181 - 16-port	2-wire	G3V3, G3V2
TN754b - 8-port	4-wire	All switches except System 85
TN754 - 8-port	4-wire	All switches except System 85
TN413 - 8-port	4-wire	International System 75
SN 270 and SN 270B - 4-port	4-wire	System 85 R2V2 - R2V4

In 4-wire operation, the voice terminal must be within 5,000 feet of the PBX using 22-gauge or 24-gauge wire, and within 4,000 feet of the PBX using 26-gauge wire.

In 2-wire operation, the voice terminal must be within 5,500 feet of the PBX using 22-gauge wire, within 3,500 feet of the PBX using 24-gauge wire, and within 2,200 feet of the PBX using 26-gauge wire.

Power Requirements

The 8410 voice terminal receives power from the system and does not require any external power supply. Additional external power IS required when the 8410 voice terminal is equipped with any adjuncts, such as an external speakerphone. In this instance, an MSP-1 Power Supply is recommended. Refer to the **Adjunct Power** section of this manual for information on the MSP-1 Power Supply.

Switch Administration

Aliasing

Use the following table for administering the 8410B (the basic) voice terminal:

If you have this System	and this Release	(which can support this type of operation)	administer the 8410B as a
System 75	R1V1 — R1V3	4-wire only	7403D
System 85	R2V2 — R2V4	4-wire only	7403D
Internat'l System 75	IR1V4, etc.	4-wire only	7403D
DEFINITY G1		4-wire only	7403D
Global DEFINITY '91		4-wire only	7410D
DEFINITY G2V1		4-wire only	7410D
DEFINITY G2V2		4-wire only	7410D
DEFINITY G3i, G3r, G3s, G3vs		4-wire only	7410D
DEFINITY G3V2		2- or 4-wire	7410D
DEFINITY G3V3		2- or 4-wire	8410B

Use the following table for administering the 8410D voice terminal (with display):

If you have this System	and this Release	(which can support this type of operation)	administer the 8410D as a
System 75	R1V1 — R1V3	4-wire only	7405D+D
System 85	R2V2 — R2V4	4-wire only	7405D+D
Internat'l System 75	IR1V4, etc.	4-wire only	7405D+D
DEFINITY G1	R1V4	4-wire only	7405D+D
Global DEFINITY '91		4-wire only	7405D+D
DEFINITY G2V1		4-wire only	7405D+D
DEFINITY G2V2		4-wire only	7405D+D
DEFINITY G3i, G3r, G3s, G3vs		4-wire only	7405D+D
DEFINITY G3V2		2- or 4-wire	7405D+D
DEFINITY G3V3		2- or 4-wire	8410D

Button Numbering

The following button diagrams of the 8410 voice terminal will help you administer both of these voice terminals connected to a System 75 or DEFINITY G1 and G3 and to a System 85 or DEFINITY G2.

Figure 2 shows button numbering for the 8410 connected to a System 75/DEFINITY G1 and G3. **Figure 3** shows button numbering for the 8410 connected to a System 85/DEFINITY G2.

If you need more information, refer to *DEFINITY Communications System Generic 3 Implementation*, and *DEFINITY Communications System Generic 2 Administration of Features and Hardware*.

If the 8410D is administered as a 7405D, administer the 12 softkey features on "FEATURE BUTTON ASSIGNMENTS" 2 through 13; administer the Normal feature on Button #1.

If the 8410D is administered as itself, administer the 12 softkey features on "SOFTKEY BUTTON ASSIGNMENTS" 1 through 12.

The 10 call appearance/feature buttons are administered as "BUTTON ASSIGNMENTS" 1 through 10.

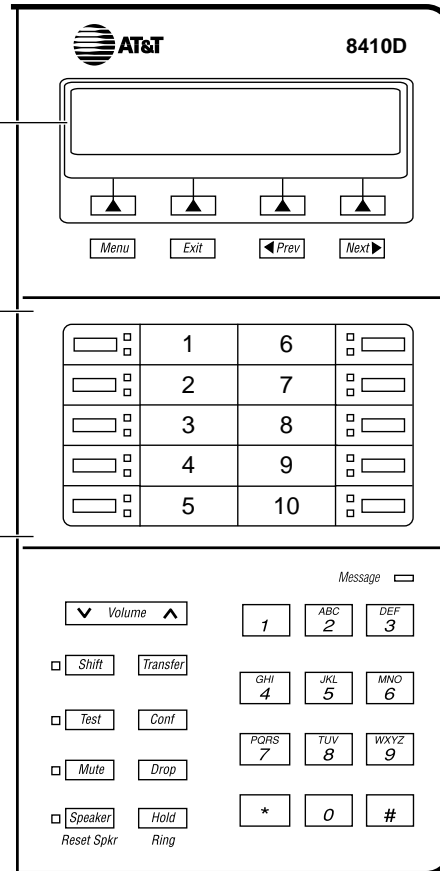

FIGURE 3-48. Button Numbering for Administering the 8410 Voice Terminal Connected to a System 75 or a DEFINITY G1 or G3 Switch

If the 8410D is administered as a 7405D, administer the 12 softkey features on "FEATURE BUTTON ASSIGNMENTS" 14 through 25; administer the Normal feature on Button #13.

If the 8410D is administered as itself, administer the 12 softkey features on "SOFTKEY BUTTON ASSIGNMENTS" 1 through 12.

The 10 call appearance/feature buttons are administered as "BUTTON ASSIGNMENTS" 3 through 12.

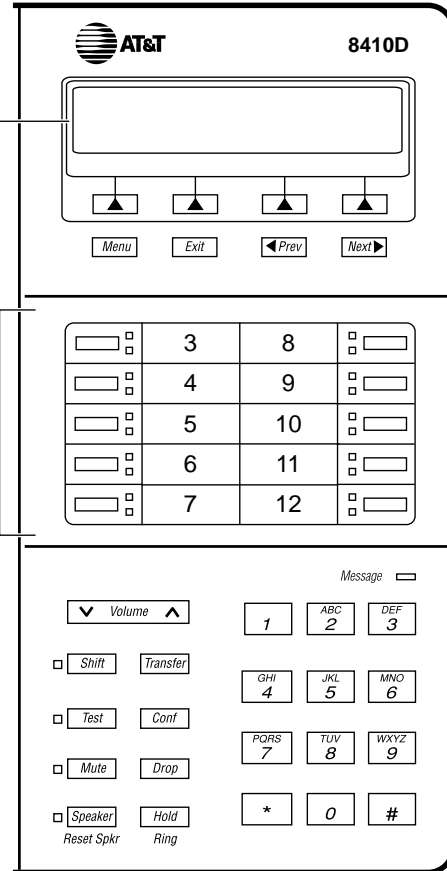

FIGURE 3-49. Button Numbering for Administering the 8410 Voice Terminal Connected to a System 85 or a DEFINITY G2 Switch

Power Failure Operation

The 8410 voice terminal cannot be used as an emergency station during power failure transfer conditions.

FCC Registration

The 8410 voice terminal is FCC-registered along with the switch (as a system), but does not have a separate FCC registration label.

UL and CSA Approval

The 8410 voice terminal has been tested and has met the Underwriters Laboratories (UL) Standards UL 1459 and has also met the Canadian Standards Association (CSA) Standards CSA-C22.2 No.225-M90.

Hearing Aid Compatible

The 8410B and 8410D voice terminals are compatible with the inductively coupled hearing aids prescribed by the FCC.

8410 Equipment PECs & COMCODES

The 8410B and 8410D voice terminals and components can be ordered with these Price Element Codes (PECs) and COMCODES:

- **Basic 8410B** (8102D02A) Voice Terminal
 - Black 8410B Set PEC: 3234-04B
COMCODE: 106790454;
 - White 8410B Set PEC 3234-04W
COMCODE: 106790462
- **8410D** (8410D01A) Voice Terminal (with built-in display)
 - Black 8410D Set PEC: 3235-05B
COMCODE: 106705122
 - White 8410D Set PEC: 3235-05W
COMCODE: 106705130
- **K2S1 Handset**
 - COMCODE: Black=106050065; White=106053408

- **K2S6 Handset (available late 1994 or early 1995)**
COMCODE: Black=107180549; White=107181471
- **K6S2-003 (Black) Amplifier Handset**
COMCODE: 105581896
- **Handset cord (9 feet)**
COMCODE: Black=105635429; White=105701809
- **Line cord (7 feet)**
COMCODE: 103786778
- **Line cord (14 feet, silver)**
PEC: 2725-07N (COL18)
COMCODE: 103786828
- **Line cord (25 feet, silver)**
PEC: 2725-07S (COL18)
COMCODE: 103786802
- **Designation Card Cover**
PEC: 32309
COMCODE: 846320216
- **Button Designation Card**
Tractor Feed For 25 Sets, 3 Sheets (12 cards per sheet)
PEC: 32310
COMCODE: 847161817

Tractor Feed For 100 Sets, 9 Sheets (12 Cards per Sheet)
PEC: 32311
COMCODE: 847161916

Laser Printer Forms (8 1/2"x11")
67 Sheets (6 Cards per Sheet)
PEC: 32312
COMCODE: 847065497

Adjuncts

The following adjuncts can be used with the 7401 Plus (7401D02A) voice terminal:

- S101A Speakerphone (no longer orderable)
- S201A Speakerphone
- CS201A Speakerphone
- 7400B Plus Data Module
- 500A Headset Adapter (and a standard headset; see “Headsets” on next page)
- K6S2 Amplifier Handset
- Shoulder Rest

Headsets

A list of compatible headsets, consisting of both modular and plug prong base units and selection of headpieces, appears in “Headset Adapters” in the **Adjuncts** section (behind the **Adjuncts** tab) later in this manual.

Additional Documents

The following documents contain additional information relating to the 8410 voice terminal: (Use the 9 digit number listed after each document to order that book from the AT&T GBCS Publications Fulfillment Center.)

- *8403, 8410, and 8434 Voice Terminals Instructions for Installation, Switch Administration, and Programming the Options*, 555-015-164
- *DEFINITY Communications System Generic 1 and System 75 8410 Voice Terminal User's Guide*, 555-230-763
- *DEFINITY Communications System Generic 1 and 3 and System 75 8410 Quick Reference Guide*, 555-230-764
- *DEFINITY Communications System Generic 2 and System 85 8410 Voice Terminal User's Guide*, 555-104-763
- *DEFINITY Communications System Generic 2 and System 85 8410 Quick Reference Guide*, 555-104-764

8434 and 8434DX VOICE TERMINAL

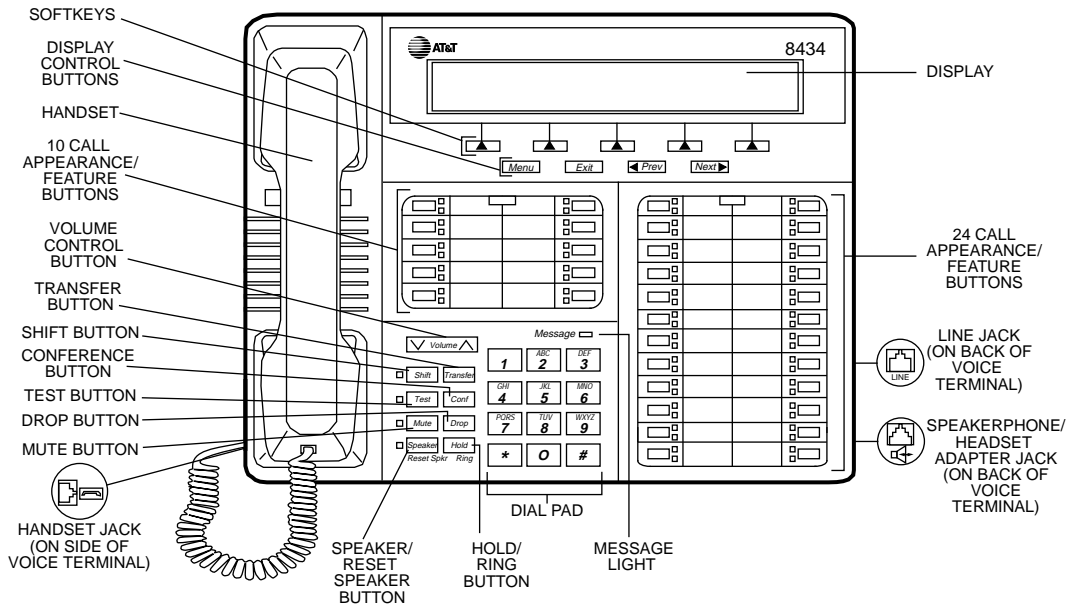

FIGURE 3-50. 8434 Voice Terminal

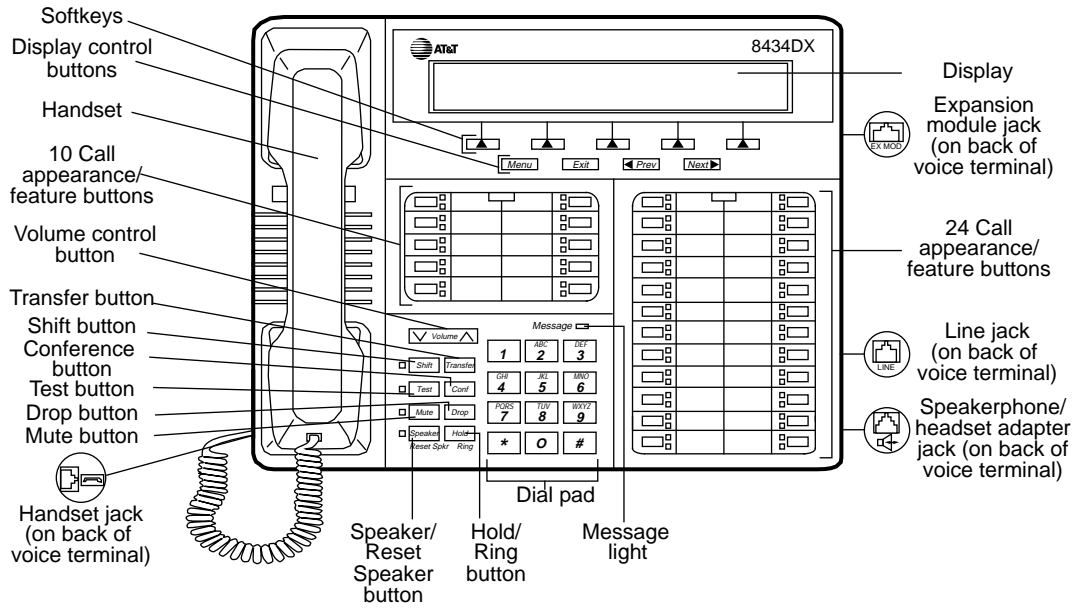

FIGURE 3-51. 8434DX Voice Terminal

8434 and 8434DX Voice Terminal

The basic 8434 (8434D01A) and the enhanced 8434DX (8434D02A) voice terminals are multi-appearance digital voice terminals which offer 34 call appearance/feature buttons, each with a red light and a green status light, four standard fixed feature buttons (CONFERENCE, DROP, HOLD, and TRANSFER), a MUTE button, a SPEAKER button which accesses either a 2-way speakerphone or a 1-way listen-only speaker, a TEST button, a SHIFT button, a red Message light, personalized ringing, a built-in speakerphone with a reset option, and a built-in 2-line by 40-character VFD display. The 8434 and 8434DX also have five softkeys and four display control buttons which allow the user to access 15 features. These softkey features can be used *in addition* to the features on the call appearance/feature buttons.

The 8434 and 8434DX voice terminals can be used in both a 4-wire and a 2-wire environment. For more information, see “Wiring Information.”

Important: In order to use the display on the 8434 or 8434DX voice terminal and to use an 801A expansion module connected to the 8434DX, you must connect an auxiliary power supply to the voice terminal. An MSP-1 Power Supply is recommended.

The 801A Expansion Module can be connected to the 8434DX voice terminal to provide 24 additional call appearance/feature buttons. The 801A can be used **ONLY** with the 8434DX voice terminal and the terminal must be connected to a DEFINITY G3V3.3 (or later) switch. For more information about this module, see the section on the 801A Expansion Module behind the tab labeled **Adjuncts**.

Note: The basic 8434 (8434D01A) voice terminal is no longer manufactured.

Applications

The 8434 and 8434DX voice terminals can be used with the DEFINITY Communications System G1, G2, G3, System 75 or System 85. These terminals are appropriate terminals for users who handle numerous calls and who need button access to a wide variety of features. For example, the 8434 and 8434DX voice terminals, with their large number of administrable buttons, can use the Abbreviated Dialing feature for reaching many frequently called parties. The buttons of the 8434 and 8434DX voice terminals can also be assigned for bridging calls at other stations. Typical users are secretaries, managers, salespeople, buyers, answering groups, and call covering positions.

The 8434 and 8434DX voice terminals can also provide the user with simultaneous voice and data communications. The 8434 and 8434DX can be connected to a 7400B Plus Data Module in a 4-wire environment, or to an 8400B Plus Data Module in a 2-wire environment. With the 8434 and 8434DX voice terminals, PC platform products can be useful in providing voice capabilities since these screen-based products can greatly enhance the telephone capabilities of these voice terminals.

Physical Description

Dimensions

Note: The dimensions given here for the 8434 and 8434DX voice terminals are approximate.

Width = 12.5 inches

Depth (front to back) = 10.25 inches

Height (maximum with handset in place) = 5.6 inches

Features

Eight Fixed Feature Buttons

- CONFERENCE (labeled CONF) button
- DROP button
- TRANSFER button
- A red HOLD button
- A blue SHIFT button
- MUTE button
- SPEAKER button
- TEST button

The SHIFT button

The blue SHIFT button can be used in two different ways: (The red light next to the SHIFT button goes on steadily when the button is activated.)

- Used with the HOLD button to select your own personalized ringing patterns from among eight available patterns.
- Used with the SPEAKER button to perform an acoustic test of the environment and adjust the speakerphone to the surrounding acoustic environment for optimal performance.

Call Appearance/Feature Buttons

The 8434 and 8434DX voice terminals have 34 call appearance/feature buttons, each equipped with a red and a green status light. Usually, at least three of these buttons are administered as call appearances for the terminal's primary extension number, where calls are placed and answered. The rest of the buttons can be used for more call appearances (including bridged appearances of other stations' extensions) and features. Buttons administered for features have only their status lights active.

Message light

The red Message light goes on when a message is left for the voice terminal user. The light goes off when the user retrieves the message or when the message is erased.

Speakerphone (Listen and Speak) Feature

The 8434 and 8434DX voice terminals are equipped with a built-in speakerphone. The Speakerphone capability allows a user to engage in a hands-free 2-way conversation with the far-end party. The speakerphone can be turned off or on with the SPEAKER button, can be muted with the MUTE button, and the volume can be controlled with the VOLUME "arrow" button.

The Speakerphone feature also allows the user to adjust the speakerphone for optimal performance. By pressing the SHIFT button and then the SPEAKER button (if the voice terminal is set for the Speakerphone feature), the user hears a set of tones as the speakerphone performs an acoustic test of the environment. When the tones stop, the speakerphone has finished adjusting itself and is ready for use. The user should reset the speakerphone whenever the voice terminal is moved to another place (even in the same room), whenever the red light next to the SPEAKER button is fluttering, and in the unlikely event that the speakerphone is making a squealing sound (in this last case, tones will not be heard during a call).

Speaker (Listen-only) Feature

Although the 8434 and 8434DX voice terminals are shipped from the factory with the terminal set for the Speakerphone feature, the 8434 and 8434DX voice terminals can be optioned instead for a 1-way, listen-only speaker. If this is the case, use the SPEAKER button on the front of the voice terminal for turning on and off the speaker.

The Speaker (listen-only) capability allows a user to engage in a 1-way conversation with the far-end. Specifically, the user can only listen to the far-end. To speak with the far-end, the user must use the handset which turns off the speaker. The Speaker function may also be disabled.

MUTE button

The MUTE button disables the transmitter of the speakerphone or the handset depending on which is activated at that time. A red light next to the MUTE button goes on when the Mute feature is activated.

VOLUME control button

The 8434 and 8434DX voice terminals have a VOLUME “arrow” button. This button has several functions. When the user is on a call using the speaker or speakerphone, the VOLUME button controls the volume of the speaker or speakerphone, whichever is being used. When the user is on a call using the handset, the VOLUME button controls the handset volume. When the voice terminal is idle, the VOLUME control button adjusts the tone ringer.

When the user sets the volume for the speaker, speakerphone, handset, or the tone ringer, the display on the voice terminal shows a “bar array” that indicates the volume setting.

TEST button

When the voice terminal is initially powered up, the green light next to the TEST button flashes if the link with the PBX is not (or not yet) operational. The light changes to steady green when the voice terminal is able to communicate with the PBX. After the voice terminal is powered up, you can press the TEST button to test the lights and the display on your voice terminal.

Display

The 8434 and 8434DX voice terminals are equipped with a built-in, 2-line by 40-character VFD display.

Display Control Buttons

These four buttons are labeled **Menu**, **Exit**, **◀ Prev**, and **Next ▶** .

- The **Menu** button is used to enter Softkey Mode and access the 15 softkey features.
- The **Exit** button is used for exiting a display feature and returning to Normal (call-handling) Mode.
- The **◀ Prev** and **Next ▶** buttons can be used to help you go back and forth through the feature option screens.

Softkeys

The five buttons located below the display and labeled with arrows correspond to features listed on the second line of the display screen. (There are five features on each feature option screen.) The user can access any of the 15 features by pressing the softkey below the feature abbreviation.

Below is a list of the 15 default softkey features assigned to the 8434 and 8434DX and the order in which the features appear.

TABLE 3-G. Default Softkey Features on the 8434 and 8434DX

ABBREVIATION	FEATURE
First Screen	
LWC	Leave Word Calling
CnLWC	Cancel Leave Word Calling
Cnslt	Consult
AutCB	Automatic Callback
Timer	Timer
Second Screen	
CFrwd*	Call Forward
CPark**	Call Park
Excl	Manual Exclusion
TmDay	Time/Date
PCall	Priority Calling
Third Screen	
Prog	Abbreviated Dialing Program
Pause	Abbreviated Dialing Special Function Pause
Spres	Abbreviated Dialing Special Function Suppress
Mark	Abbreviated Dialing Special Function Mark
Wait	Abbreviated Dialing Special Function Wait

* On DEFINITY Generic 2 or System 85 switches, this feature is named Call Forward – Follow Me.

** On DEFINITY G2 and System 85, there is no Call Park feature that can be assigned to a feature button. In order to have the Call Park function on a softkey or hard button, administer the button as an Abbreviated Dial button and program the Call Park trunk group access code onto it. This button can then be labeled "Call Park." In addition, on a DEFINITY G2 or System 85, the Recall feature must be administered on a standard feature button.

On 8434 and 8434DX voice terminals connected to a DEFINITY G3V3 or later, the system manager can choose to administer alternate features for use with the softkeys. The following table lists the alternate softkey features, those features that can be substituted for the default softkey features listed on the previous page.

Note: With G3V3 and later switches, the system can download *BLANK* softkey labels for positions where there are no features administered.

TABLE 3-H. Alternate Softkey Features on the 8434 and 8434DX

ABBREVIATION	FEATURE and DESCRIPTION
AD	Abbreviated Dialing buttons (can be multiple AD buttons)
Count	ACD Stroke Count
CPkup	Call Pickup
Dir*	Directory
HFAns**	Internal Auto Answer
IAuto	Intercom Auto
IDial	Intercom Dial
Inspt	Inspect
Last	Last Number Dialed
RngOf	Ringer Off
SAC	Send All Calls
SFunc	Abbreviated Dialed Special Function
Stats	View (ACD) Statistics
Stop	Abbreviation Dialing Indefinite Wait or Stop
View***	Stored Number

* A CALL DISPLAY button should be administered, if access to System Directory is provided. It is also desirable for a NEXT DISPLAY button to be administered. This feature is *not* available on DEFINITY G2 or System 85.

** This feature is available only on DEFINITY G3v2 (and later) switches.

*** This feature is *not* available on DEFINITY G2 or System 85.

Other Physical Features

Handset

The 8434 and 8434DX voice terminals are equipped with a K-type handset.

Dial pad

The 8434 and 8434DX voice terminals are equipped with a 12-button touch-tone dial pad. The letters “Q” and “Z” have been added to the appropriate dial pad keys for directory access, and the “5” button on your dial pad has raised bars for visually-impaired users.

Jacks

The 8434 and 8434DX voice terminals’ housing contains a Line jack and Speakerphone/headset adapter jack on the back of the voice terminal and a Handset cord jack on the side of the housing. The 8434DX has an Expansion Module (“EX MOD”) jack on the back of the voice terminal to allow connection of an 801A expansion module.

Cords

Two cords are supplied with the 8434 and 8434DX voice terminals: a coiled 9-foot modular handset cord and a 7-foot modular line cord.

Optional longer cords are available: a 12-foot handset cord; 14-foot and 25-foot line cords.

Ringling

The 8434 and 8434DX voice terminals have electronic tone ringling with eight possible ringling patterns that can be selected with the SHIFT button and the HOLD button. The loudness of the tone ringer can be controlled by the VOLUME “arrow” button. (The user must NOT be on a speakerphone call. If the user is using the speakerphone, the VOLUME “arrow” button controls the volume of the speakerphone.)

Mounting Options

The 8434 and 8434DX voice terminals come equipped with a nonadjustable desk stand. These voice terminals *cannot* be wall-mounted.

Color Options

The 8434 and 8434DX voice terminals are available in black and AT&T white.

Wiring Information

The 8434 and 8434DX voice terminals work in both 4-wire and 2-wire DCP configurations. The table below describes the pins on an 8400-Series voice terminal LINE jack.

LINE INTERFACE			
PIN	PAIR	NAME	DESCRIPTION
1	2	OD1	4-Wire Output
2	2	OD2	4-Wire Output
3	3	ID1	4-Wire Input
4	1	U-T	2-Wire (Tip)
5	1	U-R	2-Wire (Ring)
6	3	ID2	4-Wire Input
7	4	P1-	Adjunct Power -48V
8	4	P2+	Adjunct Power Common

Notes: Regardless of which configuration is in use, ALL wiring between the PBX and the terminal MUST consist of twisted-pairs, including the modular line cord. The line cord must be a D8W, which consists of 4 twisted-pairs, or an AT&T approved equivalent.

Twisted-pair wiring is used to make lines less sensitive to crosstalk. Therefore, failure to use twisted pair wiring may result in less-than-optimum performance of the terminal and may also contribute to problems with the line.

An 8-wire modular cord MUST be used for all 4-wire and any 2-wire installations requiring auxiliary power.

Important: You do NOT need to change any settings on the voice terminal for 2-wire or 4-wire installations. The voice terminal is able to detect whether it is in a 2-wire or a 4-wire configuration.

For 2-wire operation, if you need to plug the voice terminal into a 4-pin or 6-pin wall jack, instead of a standard 8-pin modular jack, refer to the "Line Interface" table to insure that the wires from the 4-pin or 6-pin wall jack are connected to the correct pins on the terminal "LINE" jack.

In order for the terminal to function properly in either 2-wire or 4-wire installations, there must be NO INTERCONNECTIONS between the wire pairs used for 2-wire and 4-wire operations. Bridging or paralleling of these pairs can result in damage to the terminal or can cause the PBX circuit pack to remove power to the terminal.

REMOVE ALL CONNECTIONS BETWEEN PAIRS BEFORE CONNECTING THE TERMINAL.

4-WIRE installations MUST ONLY have PBX connections on pair 2 and pair 3 and, if necessary, auxiliary power must be connected to pair 4.

2-WIRE installations MUST ONLY have PBX connections on pair 1 and, if necessary, auxiliary power must be connected to pair 4.

Distance Limitations

The following circuit packs can be used with all of the 8400-Series sets.

Circuit Pack	2/4-Wire	Will support these switches
TN2181 - 16-port	2-wire	G3V3, G3V2
TN754b - 8-port	4-wire	All switches except System 85
TN754 - 8-port	4-wire	All switches except System 85
TN413 - 8-port	4-wire	International System 75
SN 270 and SN 270B - 4-port	4-wire	System 85 R2V2 - R2V4

In 4-wire operation, the voice terminal must be within 5,000 feet of the PBX using 22-gauge or 24-gauge wire, and within 4,000 feet of the PBX using 26-gauge wire.

In 2-wire operation, the voice terminal must be within 5,500 feet of the PBX using 22-gauge wire, within 3,500 feet of the PBX using 24-gauge wire, and within 2,200 feet of the PBX using 26-gauge wire.

Power Requirements

The 8434 and 8434DX voice terminals are phantom-powered from the system cabinet on the digital pairs of the line wiring.

In order to use the display on the 8434 or 8434DX voice terminal or, with the 8434DX, connect and use an 801A expansion module, you must connect an auxiliary power source to the voice terminal. An MSP-1 Power Supply is the recommended local power supply; the 1145A and 1145B1 are recommended bulk power supplies.

Switch Administration

Aliasing

Use the following table to administer the 8434 and 8434DX voice terminals:

Note: The voice terminal can be administered so it can access the softkey features OR it can be administered so that it has access to more coverage buttons.

If you have this System	and this Release	(which can support this type of operation)	administer the 8434 or 8434DX as a
System 75	R1V1 — R1V3	4-wire only	7405D+D+F
System 85	R2V2 — R2V4	4-wire only	7405D+D+F
Internat'l System 75	IR1V4, etc.	4-wire only	7405D+D+F
DEFINITY G1		4-wire only	7405D+D+F
Global DEFINITY '91		4-wire only	7405D+D+F or 7434+D
DEFINITY G2V1		4-wire only	7405D+D+F or 7434+D
DEFINITY G2V2		4-wire only	7405D+D+F or 7434+D
DEFINITY G3i, G3r, G3s, G3vs		4-wire only	7405D+D+F or 7434+D
DEFINITY G3V2		2- or 4-wire	7405D+D+F or 7444
DEFINITY G3V3		2- or 4-wire	8434D

Key to Abbreviations:

+D = with Display Module

+F = with Feature Key Module

CAVEATS:

The 8434 and 8434DX may be aliased as a 7405+D+F to support features on all systems. However, in this case, while all the call appearance/feature buttons AND the softkey features will be functional, there can be a maximum of only 10 call appearances. On the 7405, the Display Module is a 1-line display, and thus the 1-line display option should be selected.

On some systems, the 8434 and 8434DX can be aliased as a 7434+D or a 7444 to support coverage. In this case, there can be up to 34 call appearances (including bridged call appearances), but the 15 softkey features will NOT be functional because the Feature Key Module is not allowed with the 7434 or 7444. On the 7434, the Display Module is a 1-line display, and thus the 1-line display option should be selected. If the set is administered as a 7444, it can be optioned for a 2-line display.

For switch administration procedures for an 8434DX voice terminal with an expansion module connected to it, see the 801A Expansion Module information in the section titled **Adjuncts**.

Button Numbering

The following button diagrams of the 8434 and 8434DX voice terminal will help you administer it with a System 75 and DEFINITY G1 or G3, and with a System 85 and DEFINITY G2.

Figure 3 refers to the 8434 and 8434DX voice terminal connected to a System 75 or DEFINITY G1 or G3;

Figure 4 refers to the 8434 and 8434DX voice terminal connected to a System 85 or DEFINITY G2.

If you need more information, refer to *DEFINITY Communications System Generic 1 Implementation*, and *DEFINITY Communications System Generic 2 Administration of Features and Hardware*.

If administered as a 7405D, administer the 15 softkey features as "FEATURE MODULE BUTTON ASSIGNMENTS" 2 through 16. Administer the Normal feature on Button #1 on the "DISPLAY BUTTON ASSIGNMENTS" screen.

If administered as itself, administer the 15 softkey features on "SOFTKEY BUTTON ASSIGNMENTS" 1 through 15.

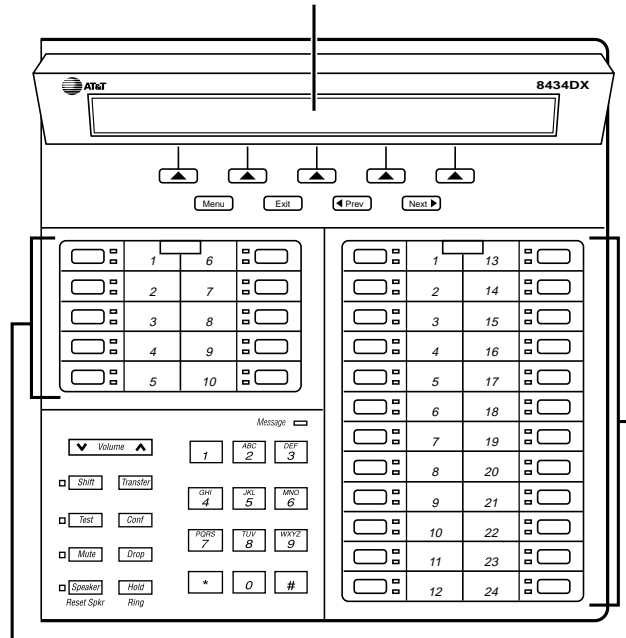

The 10 call appearance/feature buttons in the left 2 columns are administered as "BUTTON ASSIGNMENTS" 1 through 10.

The 24 call appearance/feature buttons in the right 2 columns are administered as "FEATURE BUTTON ASSIGNMENTS" 1 through 24.

(On the 7434 or 7444, these buttons are labeled "BUTTON ASSIGNMENTS" and numbered 11 through 34).

FIGURE 3-52. Button Numbering for Administering the 8434 and 8434DX Voice Terminal Connected to a System 75 or a DEFINITY G1 or G3 Switch

If administered as a 7405D, administer the 15 softkey features as "FEATURE MODULE BUTTON ASSIGNMENTS" 2 through 16. Administer the Normal feature on Button #1 on the "DISPLAY BUTTON ASSIGNMENTS" screen.

If administered as itself, administer the 15 softkey features on "SOFTKEY BUTTON ASSIGNMENTS" 1 through 15.

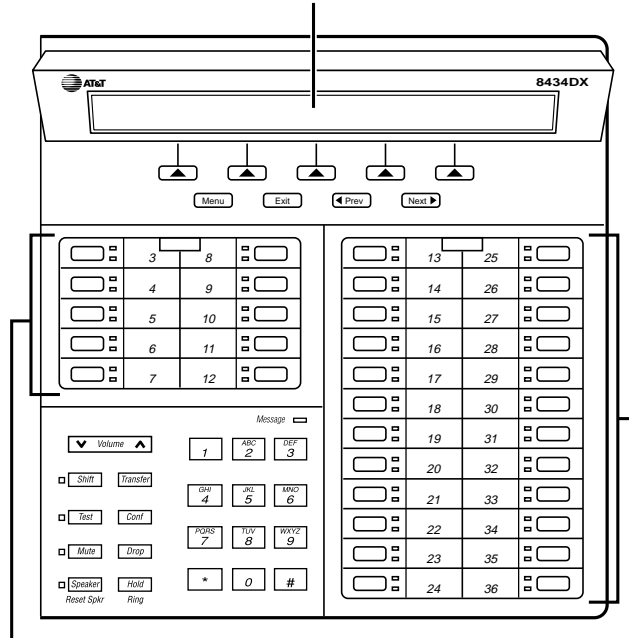

The 10 call appearance/feature buttons in the left 2 columns are administered as "BUTTON ASSIGNMENTS" 3 through 12.

The 24 call appearance/feature buttons in the right 2 columns are administered as "FEATURE BUTTON ASSIGNMENTS" 13 through 36.

(On the 7434 or 7444, these buttons are labeled "BUTTON ASSIGNMENTS" and numbered 11 through 34).

FIGURE 3-53. Button Numbering for Administering the 8434 and 8434DX Voice Terminal Connected to a System 85 or a DEFINITY G2 Switch

Power Failure Operation

The 8434 and 8434DX voice terminals cannot be used as an emergency station during power failure transfer conditions.

FCC Registration

These voice terminals are FCC-registered along with the switch (as a system), but do not have a separate FCC registration label.

UL and CSA Approval

These voice terminals have been tested and have met the Underwriters Laboratories (UL) Standards UL 1459 and have also met the Canadian Standards Association (CSA) Standards CSA-C22.2 No.225-M90.

Hearing Aid Compatible

These voice terminals are compatible with the inductively coupled hearing aids prescribed by the FCC.

8434 and 8434DX Equipment PECs and COMCODES

The 8434 and 8434DX voice terminals and optional components can be ordered with the following Price Element Codes (PECs) and COMCODES:

- Basic **8434** (8434D01A) voice terminal
 - Black 8434 Set PEC: 3236-06B
COMCODE: 106790439
 - White 8434 Set PEC: 3236-06W
COMCODE: 106790447
- Enhanced **8434DX** (8434D02A) voice terminal
 - Black 8434DX Set PEC: 3236-06B
COMCODE: 107239436
 - White 8434DX Set PEC: 3236-06W
COMCODE: 107239444
- **K2S1 Handset**
 - COMCODE: Black=106050065; White=106053408

- **K2S6 Handset**
COMCODE: Black=107180549; White=107181471
- **K6S2-003 (Black) Amplifier Handset**
COMCODE: 105581896
- **Handset cord (9 feet)**
COMCODE: Black=105635429; White=105701809
- **Line Cord (7 feet)**
COMCODE: 103786778
- **Line cord (14 feet, silver)**
PEC: 2725-07N COL18
COMCODE: 103786802
- **Line cord (25 feet, silver)**
PEC: 2725-07S COL18
COMCODE: 103786828
- **Small Designation Card Cover (for 10 buttons on left of terminal)**
PEC: 32309
COMCODE: 846320216
- **Large Designation Card Cover (for 24 buttons on right of terminal)**
PEC: 32314
COMCODE: 847037553
- **Small Button designation card (for 10 buttons on left of terminal)**
Tractor Feed For 25 Sets, 3 Sheets (12 cards per sheet)
PEC: 32310
COMCODE: 847161817

Tractor Feed For 100 Sets, 9 Sheets (12 Cards per Sheet)
PEC: 32311
COMCODE: 847161916
- **Large Button designation card (for 24 buttons on right of terminal)**
Tractor Feed For 25 Sets, 13 Sheets (2 cards per sheet)
PEC: 32315
COMCODE: 847141504

Tractor Feed For 100 Sets, 50 Sheets (2 cards per sheet)
PEC: 32316
COMCODE: 847168747

Adjuncts

The following adjuncts can be used with the 8434 and 8434DX voice terminals:

Note: Auxiliary power is required when any adjuncts are added to the voice terminal, except for the 7400B Plus Data Module which is AC powered. For auxiliary power, an MSP-1 Power Supply is recommended.

- An 801A Expansion Module can be connected to an 8434DX voice terminal connected to a DEFINITY G3V3.3 (or later) switch.
- S101A Speakerphone (no longer orderable)
- S201A Speakerphone
- CS201A Speakerphone
- 7400B Plus Data Module in a 4-wire environment;
8400B Plus Data Module in a 2-wire environment
- 500A Headset Adapter (and a standard headset; see “Headsets” on next page)
- K6S2 Amplifier Handset
- Shoulder Rest

Headsets

A list of compatible headsets, consisting of both modular and plug prong base units and selection of headpieces, appears in “Headset Adapters” in the **Adjuncts** section (behind the **Adjuncts** tab) later in this manual.

Additional Documents

The following documents contain additional information relating to the 8434DX voice terminal: (Use the 9-digit number listed after each document to order that book from the AT&T GBCS Publications Fulfillment Center.)

- *8400-Series Voice Terminals Instructions for Installation, Switch Administration, and Programming the Options*, 555-015-165
- *DEFINITY Communications System Generic 1 and 3 and System 75 8434 Voice Terminal User's Guide*, 555-230-765
- *DEFINITY Communications System Generic 1 and 3 and System 75 8434 Voice Terminal Quick Reference Guide*, 555-230-766

- *DEFINITY Communications System Generic 2 and System 85 8434 Voice Terminal User's Guide, 555-104-765*
- *DEFINITY Communications System Generic 2 and System 85 8434 Voice Terminal Quick Reference Guide, 555-104-766*
- *DEFINITY Communications System Generic 1 and 3 and System 75 8434DX Voice Terminal User's Guide, 555-230-856*
- *DEFINITY Communications System Generic 1 and 3 and System 75 8434DX Voice Terminal Quick Reference Guide, 555-230-857*
- *DEFINITY Communications System Generic 2 and System 85 8434DX Voice Terminal User's Guide, 555-104-767*
- *DEFINITY Communications System Generic 2 and System 85 8434DX Voice Terminal Quick Reference Guide, 555-104-768*
- *801A Expansion Module Instruction Manual, 555-015-136*

CALLMASTER® AND CALLMASTER® II & III VOICE TERMINALS

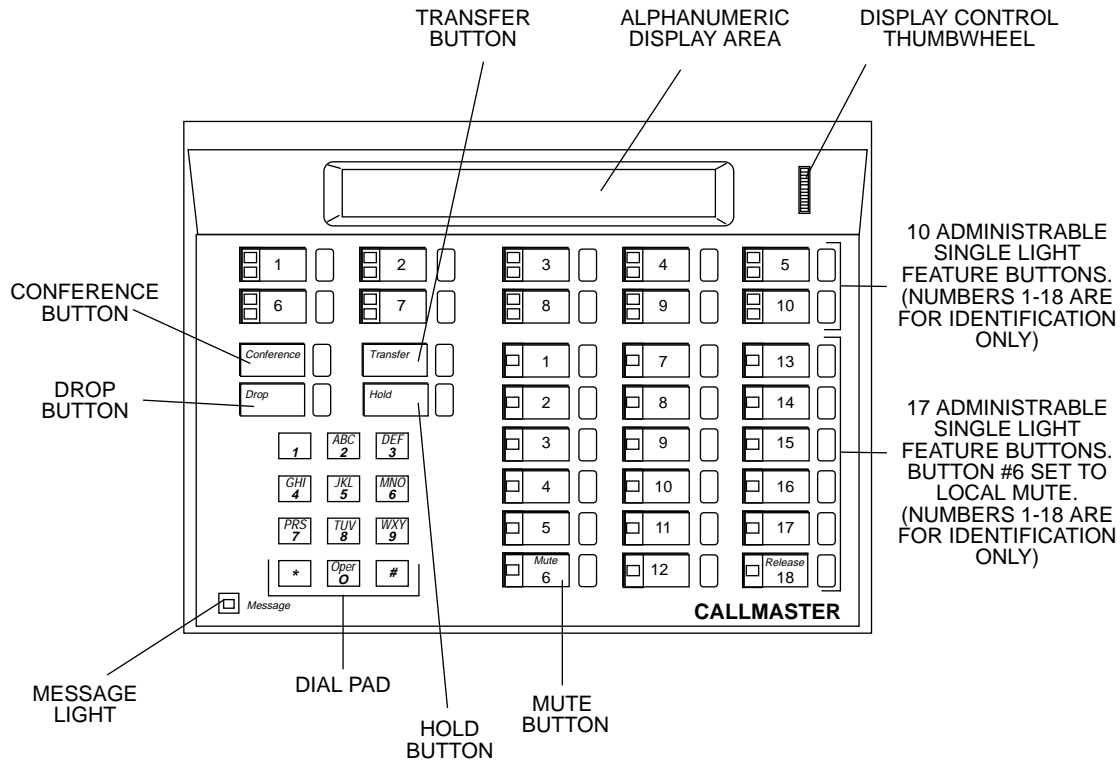

FIGURE 3-54. The 602 CALLMASTER Voice Terminal with Optional Handset

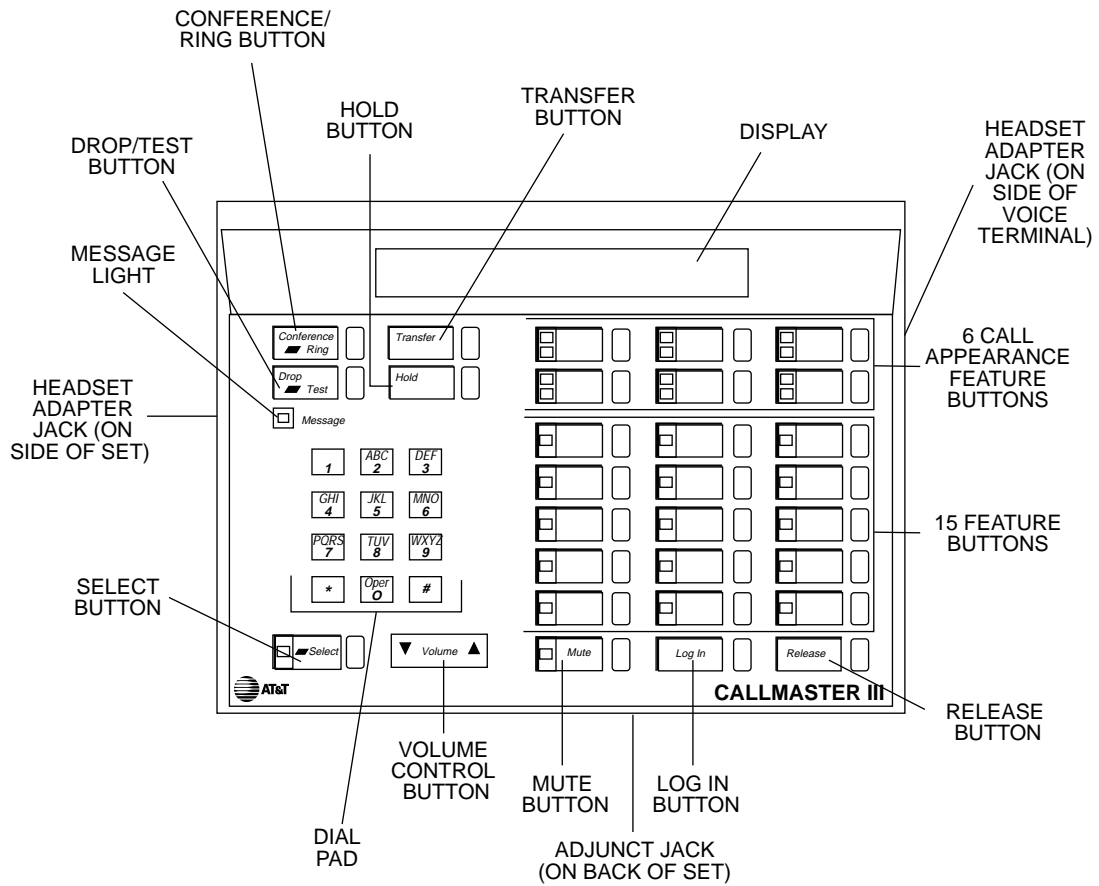

FIGURE 3-2. The CALLMASTER II and CALLMASTER III Voice Terminal

CALLMASTER® and CALLMASTER® II and III Voice Terminals

The CALLMASTER® is a multi-appearance digital voice terminals used primarily as a Call Management or Automatic Call Distribution (ACD) position. This voice terminal is equipped with a 2-line by 40-character display that can be used to provide information on incoming and outgoing calls. The unit can be programmed to enter an After-Call Work State following each call for the completion of service paperwork and can be configured for zip tone operation where calls follow one another in a rapid sequence.

There are several types of CALLMASTER voice terminals: the 602 CALLMASTER, the 603D CALLMASTER called the CALLMASTER II, and the 603E CALLMASTER called the CALLMASTER III. The **602 CALLMASTER** comes in two models: the 602A and the 602D. Although both of these models are the same in appearance, the 602D CALLMASTER has a Recorder Interface which allows you to connect the voice terminal to a recording device so that you can record all voice interactions. The 602A does *not* have a recording interface.

The **CALLMASTER II** comes with Recorder Interface to record voice interactions. The **CALLMASTER III** comes without Recorder Interface. However, both the CALLMASTER II and the CALLMASTER III are identical in appearance; For easy identification, the model number is printed on a sticker on the bottom of the voice terminal.

The **602 CALLMASTER** has four fixed features (CONFERENCE, DROP, HOLD, and TRANSFER), 10 call appearance/feature buttons, each with a red and green light, 17 feature-only buttons, each with a green status light, a Message light, a MUTE button, and a 2-line by 40-character display. The front panel of the 602 CALLMASTER drops down to reveal a SELF-TEST button, a Ringer-volume control, and a 1-2 switch which can be set only by an installer.

The **CALLMASTER II and III** models have four fixed features (CONFERENCE, DROP, HOLD, and TRANSFER), six call appearance/feature buttons, each with a red and green light, 15 feature-only buttons, each with a green status light, a Message light, a MUTE button, a SELECT button, a LOG IN and RELEASE button used for processing ACD calls, and a 2-line by 40-character supertwist liquid crystal display.

On the two sides of the 602 CALLMASTER and the CALLMASTER II and III, there is a headset jack in which you can plug in a headset or, if special adapters are used, a handset. On the rear of the **602 CALLMASTER**, there is a jack for an optional kneewall adapter. You can plug two headsets or two handsets into this adapter. (Both headsets or handsets must be the same model.)

Applications

The 602 CALLMASTER and the CALLMASTER II and III voice terminals can be used with the DEFINITY G1, G2, G3, System 75 (R1V3 or later), and System 85 (R2V2 or later). These voice terminals are especially suitable for Call Management or ACD call-handling positions.

Special Operational Characteristics

The CALLMASTER voice terminals do not have a physical switchhook or handset cradle (although a handset cradle kit can be ordered separately). These sets are on-hook when there is no headset plugged physically into either of the two headset jacks. The voice terminals are off-hook when one or more headsets are plugged into one of the headset jacks.

The Recorder Interface

The 602D CALLMASTER and CALLMASTER II provide a recorder interface which is designed for recording calls on a standard analog tape recorder. [A recorder with AGC (Automatic Gain Control) is recommended on the CALLMASTER II with Recorder Interface.] With this interface, a warning tone (a soft beep repeated every 15 seconds) notifies the agent and the calling party that the call is being recorded. *Be aware that this tone may be a legal requirement.* To generate this warning tone while using the Service Observing feature to monitor calls, the split supervisor must activate the listen/talk mode and remain in this mode while the call is being recorded.

Note: The default setting for the Recorder Interface and the Recording Warning Tones on the **CALLMASTER II with Recorder Interface** is “Enabled.” However, the interface and the warning tones can also be disabled. For directions on disabling these two features, or to enable them again, see “Programming the Options” (555-015-161).

Physical Description

Dimensions

Note: The following dimensions for the CALLMASTER are approximate.

Width = 11 inches

Depth (front to back) = 8-1/2 inches

Height = 5-1/2 inches

Features

Four Fixed Feature Buttons

The 602 CALLMASTER and CALLMASTER II and III have the following fixed feature buttons:

- CONFERENCE or CONFERENCE/RING button
- DROP or DROP/TEST button
- TRANSFER button
- HOLD button

Message Light

The Message light goes on when a message is left for the user. It goes off when the user retrieves the message. On the **602 CALLMASTER**, the Message light is green; on the **CALLMASTER II and III**, the Message light is red.

Call Appearance/Feature Buttons

The **602 CALLMASTER** voice terminal has 10 call appearance/feature buttons; the **CALLMASTER II and III** have six call appearance/feature buttons. Each of these buttons has a red appearance light and a green status light stacked to the left of the button. These buttons can be used as call appearances or for features that are assigned during administration.

Feature-Only Buttons

The **602 CALLMASTER** voice terminal has 17 feature buttons; the **CALLMASTER II and III** have 15 feature buttons. Each button has a green status light associated with it. These buttons can be used for features assigned during administration.

MUTE Button

All CALLMASTER sets have a MUTE button, a fixed feature button. The Mute feature allows the user to be in a listen-only mode. On the **602 CALLMASTER**, the MUTE button light is green; on the **CALLMASTER II and III**, the light next to the MUTE button is red.

Note: Although the default setting for the Mute feature is “Enabled,” the Mute feature can also be disabled. For directions on disabling the Mute feature, or enabling it again, see “Programming the Options” (555-015-161).

SELECT button

The **CALLMASTER II and III** voice terminals have a SELECT button that can be used in two different ways: (The green light next to the SELECT button goes on steadily when the SELECT button is activated.)

- Used with the CONFERENCE/RING button to select one of eight personalized ringing patterns for incoming calls;
- Used with the DROP/TEST button to initiate the Self-Test feature which tests the lights, ringer, and display.

VOLUME control button

The **602 CALLMASTER** has a volume control slide switch behind the front panel. This slide switch controls the volume of the tone ringer.

The **CALLMASTER II and III** terminals have a VOLUME “arrow” button with a double function. When the user is on a call, the VOLUME button controls the volume of incoming transmission on the headset or handset whichever is being used; when the user is not on a call, the VOLUME control button adjusts the tone ringer. When the user sets the volume for the headset or handset or for the tone ringer on the CALLMASTER II and III, the display on the voice terminal shows a “bar array” that indicates the volume setting.

LOG IN and RELEASE buttons

On the **CALLMASTER II and III**, the LOG IN and RELEASE buttons are located in the bottom row of feature buttons. These buttons *must* be used for these two ACD features: the Log in feature and the Release feature. *No other feature should be administered on these buttons.*

Self-Test

On the **602 CALLMASTER**, the user presses and holds down a SELF-TEST button behind the front panel of the set to perform a self-test of the lights, display, and the ringer.

On the **CALLMASTER II and III**, the user presses the SELECT button and then presses and holds down the DROP/TEST button to initiate a test of the lights, ringer, and display on the voice terminal.

Display

All CALLMASTER voice terminals have a 2-line by 40-character per-line display located at the top of the faceplate. This allows the user to retrieve personal messages or display queue status without losing call identification. The terminal displays call appearance-related information on the first line. All non-call appearance-related and local information is displayed on the second line of the display.

The **602 CALLMASTER** has a display contrast thumbwheel which can be rotated to make the display contrast darker or lighter.

Note: The **CALLMASTER II and III** can be optioned for a 1-line *or* a 2-line display. The 2-line (by 40 characters) format is the expected normal usage. The 1-line format is needed only when CALLMASTER II or III is administered as a 7405D with a D401 display, as a 7406D, or as any other set with a 1-line display format. The default is the 2-line display. To change this setting, see “Programming the Options” (555-015-161).

Other Physical Features

Headsets

The CALLMASTER voice terminals are designed to use carbon miked headsets. A maximum of two headsets can be connected at the same time. The quality of transmission may be affected if different types of headsets are used together.

Handset

An optional K-type handset kit is available for the CALLMASTER voice terminals. This kit contains a handset cradle, a handset, and the required adapter. The handset plugs into the headset jack and functions as though a headset was being used. This handset does not provide switchhook capabilities.

Dial pad

The CALLMASTER voice terminals are equipped with a 12-button touch-tone dial pad.

Jacks

The CALLMASTER voice terminals' housing contains three jacks. The mounting cord jack is located on the rear of the unit. Two PJ327 type (2-prong) jacks allow the headset or optional handset to be plugged into either side of the unit. The **CALLMASTER II and III** also have an Adjunct jack located on the back of the voice terminal.

Cords

A D8W-87 line cord (7 feet long) is provided with all CALLMASTER voice terminals.

Kneewell Adapter (602 CALLMASTER only)

An optional adapter is available for connecting two headsets or handsets to the **602 CALLMASTER**. This adapter allows the handset or headset to be connected without the cords running across the top of the desk.

Ringling

The CALLMASTER voice terminals have electronic tone ringling with patterns that are set at administration.

Mounting Options

The CALLMASTER voice terminals are only available as a desk model. It cannot be wall mounted.

Color Options

The **602 CALLMASTER** is available in black and misty cream. The **CALLMASTER II and III** sets are available in black, misty cream, and white.

Distance Limitations

The maximum allowable distances the CALLMASTER voice terminals can be located from the DEFINITY G1, G2, G3, System 75, or System 85 cabinet is shown in the table below.

SYSTEM	PORT BOARD	NOMINAL MAXIMUM RANGE IN FEET (METERS) (SEE NOTE)	
		24 AWG	26 AWG
DEFINITY G2	SN270B	3,400 (1,034)	2,200 (671)
SYSTEM 85	TN754	3,400 (1,034)	2,200 (671)
DEFINITY G1 & G3	TN754	3,400 (1,034)	2,200 (671)
SYSTEM 75			

Note: These ranges can be extended to 5,000 feet (1524 m) for 24 AWG wire and 4,000 feet (1219 m) for 26 AWG wire with the use of a Data Link Protector (DLP). Refer to **EXPOSED PORT PROTECTION**.

In 2-wire installations, the CALLMASTER III can be connected to a TN2181 port board.

Power Requirements

The CALLMASTER voice terminals receive power from the system and do not require any external power supply. However, adjunct equipment connected to the CALLMASTER II or III needs its own power supply.

Switch Administration

The 602 CALLMASTER and CALLMASTER II and III can be used with DEFINITY G1, G2, G3, System 75 (R1V3) and System 85 (R2V2 through R2V4). The **602 CALLMASTER** can be administered as itself. The **CALLMASTER II** and the **CALLMASTER III** must then be aliased as a 602 CALLMASTER.

Button Numbering

The following button diagrams of the 602 CALLMASTER and CALLMASTER II and III voice terminals will help you administer both of these voice terminals connected to a System 75 (R1V3 or later) or DEFINITY G1 and G3 and to a System 85 (R2V2 or later) or DEFINITY G2.

Figures 3 and 4 show button numbering for the 602 CALLMASTER voice terminal; Figures 5 and 6 show button numbering for the CALLMASTER II and III voice terminal.

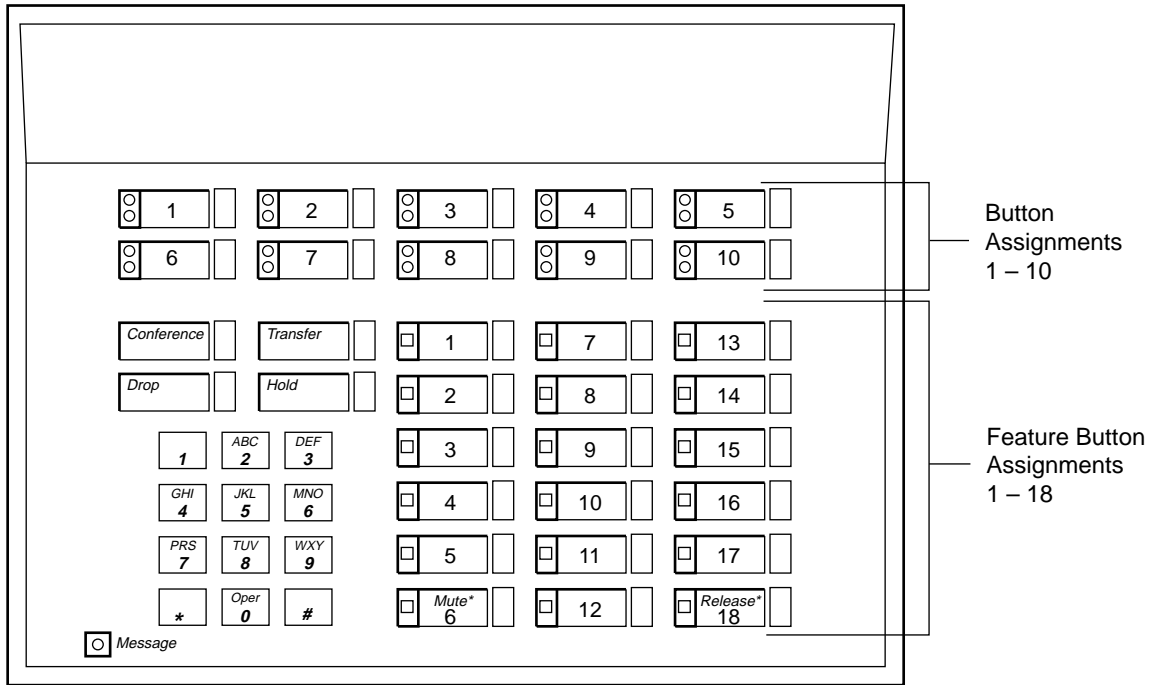

* FEATURE BUTTON #6 IS PREASSIGNED AS A MUTE BUTTON. IT IS RECOMMENDED THAT FEATURE BUTTON #18 BE ADMINISTERED AS A RELEASE BUTTON.

FIGURE 3-3. Button Numbering for Administering the 602 CALLMASTER Voice Terminal Connected to a System 75 or a DEFINITY G1 or G3 Switch

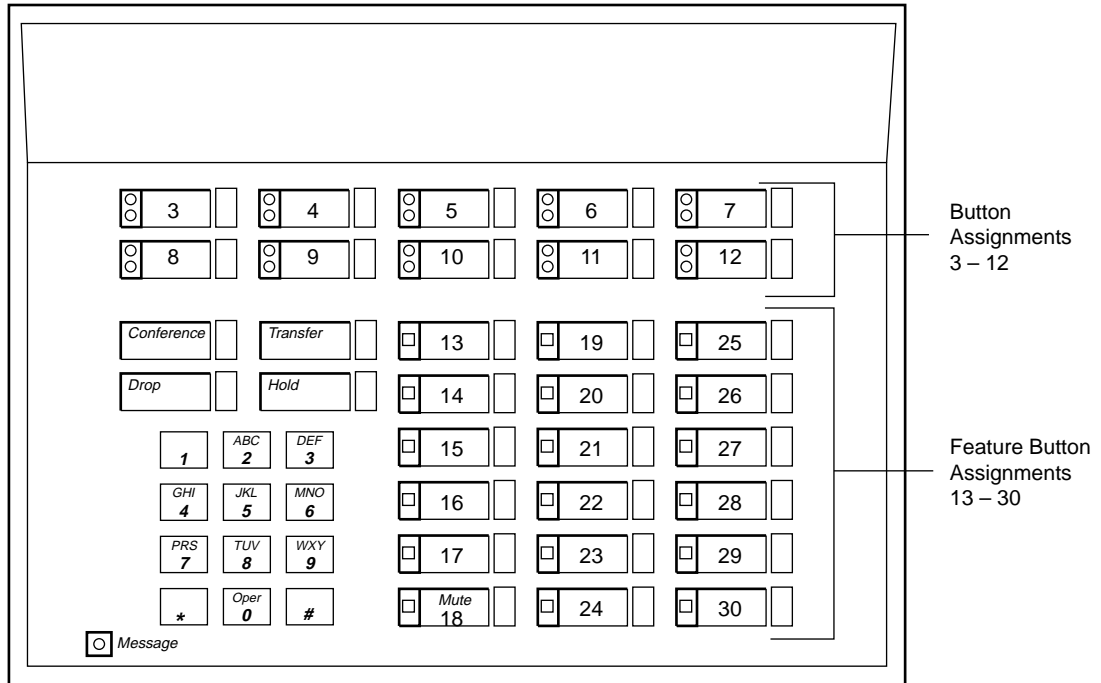

NOTE: THE HOLD BUTTON IS BUTTON #1. THE MESSAGE LIGHT IS BUTTON #2.
THE MUTE BUTTON IS BUTTON #18.

FIGURE 3-4. Button Numbering for Administering the 602 CALLMASTER Voice Terminal Connected to a System 85 or a DEFINITY G2 Switch

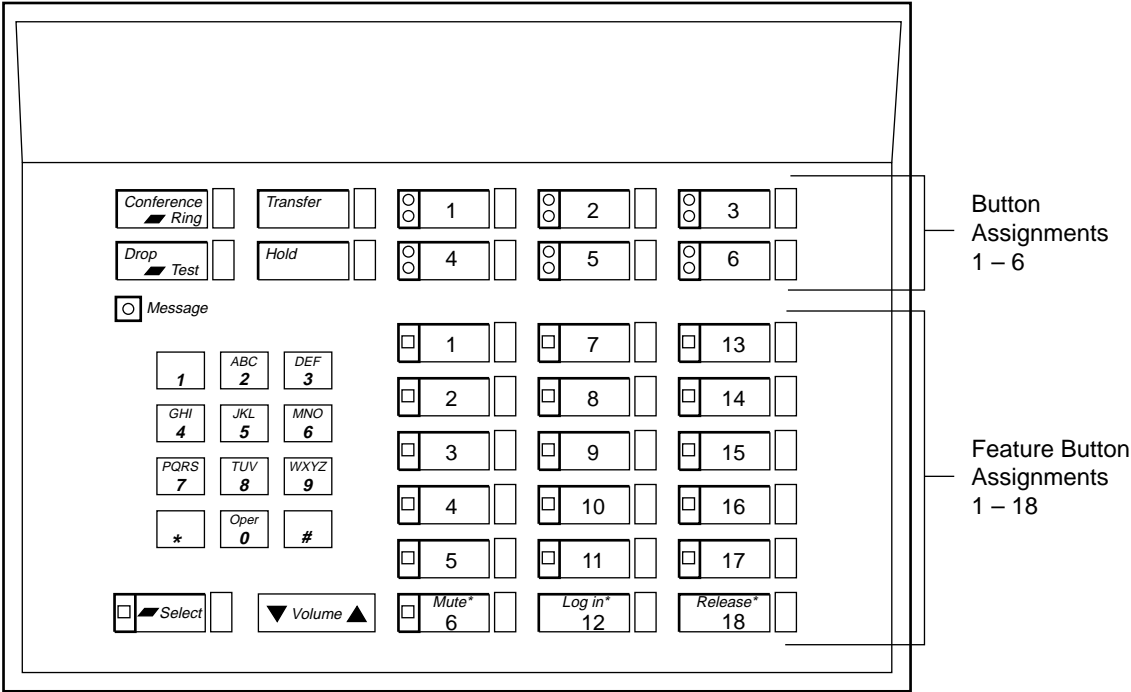

*FEATURE BUTTON #6 IS PREASSIGNED AS A MUTE BUTTON. ADMINISTER FEATURE BUTTON #12 AS A LOG IN BUTTON AND FEATURE BUTTON #18 AS A RELEASE BUTTON.

FIGURE 3-5. Button Numbering for Administering the CALLMASTER II or CALLMASTER III Voice Terminal Connected to a System 75 or a DEFINITY G1 or G3 Switch

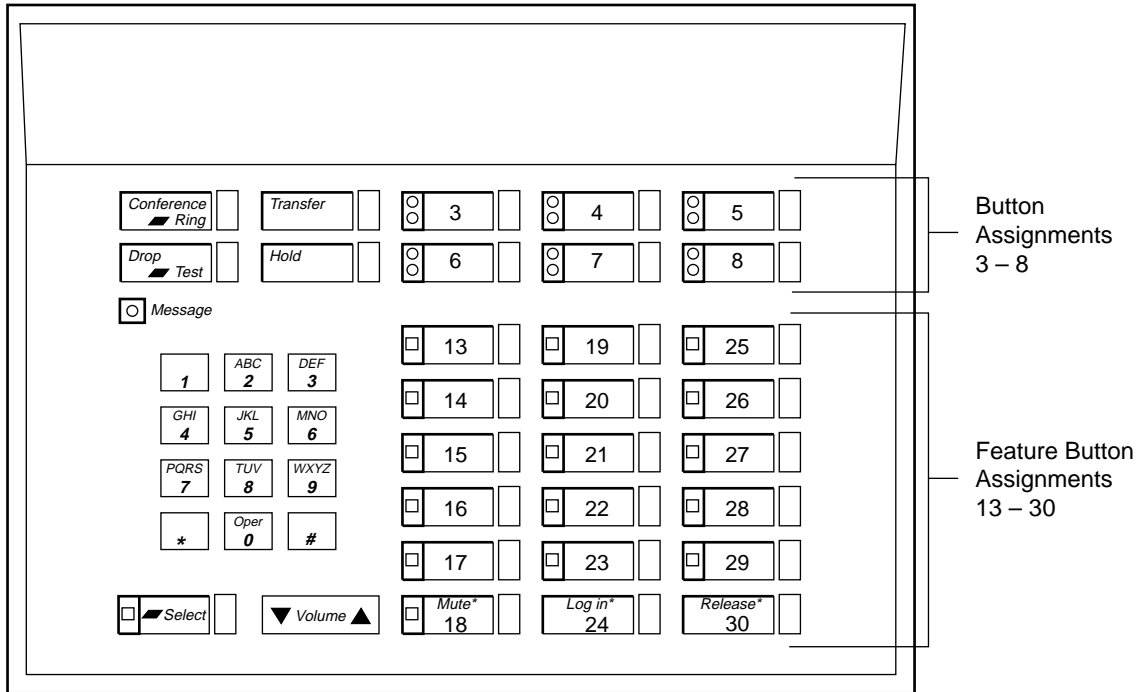

NOTE: THE HOLD BUTTON IS BUTTON #1. THE MESSAGE LIGHT IS BUTTON #2.
 THE MUTE BUTTON IS BUTTON #18. THE LOG IN BUTTON IS BUTTON #24.
 THE RELEASE BUTTON IS BUTTON #30.

FIGURE 3-6. Button Numbering for Administering the CALLMASTER II or CALLMASTER III Voice Terminal Connected to a System 85 or a DEFINITY G2 Switch

Power Failure Operation

The CALLMASTER voice terminals cannot be used as an emergency station during power failure transfer conditions.

FCC Registration

The CALLMASTER voice terminals are not FCC registered.

CALLMASTER Equipment Price Element Code (PECs)

The CALLMASTER voice terminals and optional components can be ordered with the following PECs:

- Basic **602A1 CALLMASTER** voice terminal
 - Black—3179-001 CLR03
 - Misty cream—3179-001 CLR22
- Basic **602D1 CALLMASTER** voice terminal
 - Black—3179-002 CLR03
 - Misty cream—3179-002 CLR22
- Basic **CALLMASTER II** voice terminal with Recorder Interface
 - Black—3179-102 CLR03; COMCODE: 106693294
 - Misty cream—3179-102 CLR22; COMCODE: 106693302
 - White—3179-102 CLR10; COMCODE: 107316960
- Basic **CALLMASTER III** voice terminal without Recorder Interface
 - Black—3179-103 CLR03; COMCODE: 107316978
 - Misty cream—3179-103 CLR22; COMCODE: 107316994
 - White—3179-103 CLR10; COMCODE: 107316986
- **Button Designation Strips** (for CALLMASTER II and III)
 - Package of 25 (silver): 846753099
 - Package of 25 (international gray): 846953115
 - Package of 200 (silver): 846953107
 - Package of 200 (international gray): 846953123
- **Handset D-Kit #182083** (black, for CALLMASTER II and III)
 - COMCODE: 105514798
- **Handset D-Kit #182084** (misty cream, for CALLMASTER II and III)
 - COMCODE: 105514806

- **Handset D-Kit #182835** (white, for CALLMASTER II and III)
COMCODE: 107318438
- **Knewell Adapter** (for 602 CALLMASTER)—31791
- **Headsets**—(See PEC 3122 for carbon compatible types)

Adjuncts

The following adjunct can be used with the 602 and CALLMASTER II and III voice terminals:

- 7400B Plus Data Module

The following adjuncts can be used with the CALLMASTER II and III:

- S101A and 201A Speakerphone
- 507A Adapter
- 500A Headset Adapter (and a standard headset; see “Headsets” below)

Headsets

A list of compatible headsets, consisting of both modular and plug prong base units and selection of headpieces, appears in “Headset Adapters” in the **Adjuncts** section (behind the **Adjuncts** tab) later in this manual.

Additional Documents

The following documents contain additional information relating to the CALLMASTER voice terminals:

- *DEFINITY Generic 2 and System 85 CALLMASTER Voice Terminal User's Guide*, 555-015-716
- *DEFINITY CALLMASTER II and CALLMASTER III Voice Terminal User and Installation Instructions*, 555-015-168
- *DEFINITY CALLMASTER II and CALLMASTER III Voice Terminal Instructions for Programming the Options*, 555-015-169
- *DEFINITY Generic 1 and Generic 3 Automatic Call Distribution (ACD) Agent Instructions*, 555-230-722
- *DEFINITY Generic 1 and Generic 3 Automatic Call Distribution (ACD) Supervisor Instructions*, 555-204-724

500 SERIES TELEPHONE

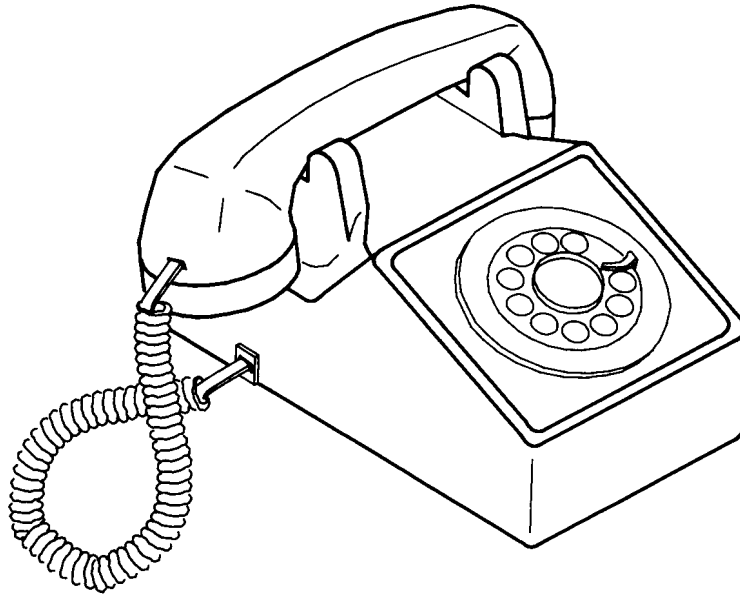

FIGURE 3-7. The 500 Series Telephone

500 Series Telephone

The 500 telephone is a single appearance analog rotary dial telephone which provides cost-effective service wherever it is located. It provides limited access to features because the rotary dial has no * or # positions.

Applications

The 500 telephone can be used with the DEFINITY G1, G2, G3, System 75, and System 85. This telephone is especially suitable for manufacturing, warehousing, guard stations, or power failure locations.

Physical Description

Dimensions

Note: The following dimensions are approximate.

Width = 7 inches

Depth (front to back) = 8-3/4 inches

Height (maximum with handset in place) = 5-1/2 inches

Physical Features

Handset

The 500 telephone is equipped with a G-type handset.

Dial pad

The 500 telephone is equipped with a 10-hole rotary dial.

Jacks

The 500 telephone housing contains two jacks. The handset cord jack is on the left side of the telephone. The mounting cord jack is on the back of the telephone. The handset contains a jack for the handset cord.

Cords

Two cords are supplied with the 500 telephone: a coiled 7-foot modular handset cord and a 7-foot modular line cord. Optional longer cords are available: a 12-foot handset cord; 14-foot and 25-foot line cords.

Ringling

The 500 telephone has a mechanical bell type ringer. The volume control is on the bottom of the telephone.

Mounting Options

The 500 telephone is desk mounted only.

Color Options

The 500 telephone is available in ivory, black, and beige.

Distance Limitations

The maximum allowable distances of a 500 telephone from the DEFINITY G1, G2, G3, System 75, or System 85 cabinet are shown in the table below.

SYSTEM	PORT BOARD	NOMINAL MAXIMUM RANGE IN FEET (METERS)	
		24 AWG	26 AWG
SYSTEM 85	SN229	3,500 (1,067)	3,500 (1,067)
	SN228B	15,000 (4,572)	9,000 (2,743)
DEFINITY G2	SN229	3,500 (1,067)	3,500 (1,067)
	SN228B	15,000 (4,572)	9,000 (2,743)
	TN742	20,000 (6,100)	13,000 (3,962)
	TN746	3,100 (945)	2,000 (610)
DEFINITY G1 & G3 SYSTEM 75	TN742	20,000 (6,100)	13,000 (3,962)
	TN769	20,000 (6,100)	13,000 (3,962)
	TN746	3,100 (945)	2,000 (610)

Power Requirements

The 500 telephone is powered by the tip and ring leads. It does not require any external power supply.

Power Failure Operation

The 500 telephone can be used as an emergency station during power failure transfer conditions.

FCC Registration

The 500 telephone is FCC registered.

500 Series Equipment Price Element Code (PECs)

The 500 telephone and optional components can be ordered with the following PECs:

- Basic telephone (black)—3100-0RD COL09
- Basic telephone (beige)—3100-0RD COL11
- Basic telephone for use with the 4A speakerphone (black)—3100-2RD COL09
- Basic telephone for use with the 4A speakerphone (beige)—3100-0RD COL11
- Handset cord (12 feet, black)—2725-01L COL09
- Line cord (14 feet, silver)—2725-07N COL18
- Line cord (25 feet, silver)—2725-07S COL18

Adjuncts

The following adjuncts can be used with the optional 500SM telephone:

- 4A Speakerphone
- Z34A-WA Message Waiting Indicator

Additional Documents

The following documents contain additional information relating to the 500 Voice Terminal:

- *DEFINITY Generic 1 and Generic 2, System 75, and System 85 Terminals and Adjuncts Installation and Test*, 555-015-104.

2500 SERIES TELEPHONES

Figure 1. The 2500 Desk Model

Figure 2. The 2554 Wall Model

Figure 3. The 2500 Telephone with Message Waiting Adjunct

2500 Series Telephones

The 2500-series telephone consists of single appearance analog telephones with conventional touch-tone dialing. It provides access to features through the use of the * or # dial pad keys and the appropriate feature access codes. The 2500-series telephones is made up of several telephones that are basically the same but are equipped with small different attributes.

The 2500 DMGC, 2500 YMGK, 2500 MMGL, and the 2500 YMGL are covered in separate sections of this chapter; all the others are covered here.

Applications

The 2500-series telephone can be used with the DEFINITY G1, G2, G3, System 75, and System 85. This voice telephone is especially suitable for manufacturing, warehousing, guard stations, or power failure locations.

Physical Description

Dimensions

Note: The following dimensions are approximate.

Width = 7 inches

Depth (front to back) = 8-3/4 inches

Height (maximum with handset in place) = 5-1/2 inches

RECALL button

The 2500 MMGK is equipped with a Timed Recall button. This button provides access to a second dial tone (if provided) without disconnecting the first call.

Other Physical Features

Handset

Most 2500-series telephones are equipped with a G-type handset; however, some newer versions have the hearing aid compatible K-type handset.

Dial pad

The 2500-series telephone is equipped with a 12-button touch-tone dial pad.

Jacks

The 2500-series telephone housing contains two jacks. The handset cord jack is on the left side of the telephone. The mounting cord jack is on the back of the telephone. The handset contains a jack for the handset cord. The 2514 CM contains a jack for optional equipment.

Cords

Two cords are supplied with the 2500-series telephone: a coiled 7-foot modular handset cord and a 7-foot modular line cord. Optional longer cords are available: a 12-foot handset cord; 14-foot and 25-foot line cords.

Ringling

The 2500-series telephone has a bell type ringer. The volume control on the desk set is located on the bottom of the telephone. The volume control on the wall-mounted set is located on the upper right side of the telephone.

Mounting Options

The 2500-series telephones are all desk mounted with the exception of the 2554 MMGJ which is wall-mounted only.

Color Options

The 2500-series telephones are available in several colors. Check the PEC code section here for the colors of each individual version.

Distance Limitations

The maximum allowable distances of a 2500-series telephone from the DEFINITY G1, G2, G3, System 75, or System 85 cabinet are shown in the table below.

SYSTEM	PORT BOARD	NOMINAL MAXIMUM RANGE IN FEET (METERS)	
		24 AWG	26 AWG
SYSTEM 85	SN229	3,500 (1,067)	3,500 (1,067)
	SN228B	15,000 (4,572)	9,000 (2,743)
DEFINITY G2	SN229	3,500 (1,067)	3,500 (1,067)
	SN228B	15,000 (4,572)	9,000 (2,743)
	TN742	20,000 (6,100)	13,000 (3,962)
	TN746	3,100 (945)	2,000 (610)
DEFINITY G1 & G3 SYSTEM 75	TN742	20,000 (6,100)	13,000 (3,962)
	TN769	20,000 (6,100)	13,000 (3,962)
	TN746	3,100 (945)	2,000 (610)

Power Requirements

The 2500-series telephone is powered by the tip and ring leads. It does not require any external power supply.

Power Failure Operation

The 2500-series telephone can be used as an emergency station during power failure transfer conditions.

FCC Registration

The 2500-series telephone is FCC registered.

Price Element Code (PECs)

The 2500 Series Voice Terminals and optional components can be ordered with the following PECs:

- 2500 MMGJ basic telephone (black)—3101-EDB COL09
- 2500 MMGJ basic telephone (beige)—3101-EDB COL11
- 2500 MMGJ basic telephone (ivory)—3101-EDB COL12
- 2500 MGK basic telephone (black)—3101-ETR COL09
- 2500 MGK basic telephone (misty cream)—3101-ETR COL22
- 2554 MMGJ basic telephone (black)—3101-EMW COL09
- 2554 MMGJ basic telephone (misty cream)—3101-EMW COL09
- 2500 SM basic telephone (black)—3101-2TD COL09
- 2500 SM basic telephone (beige)—3101-2TD COL11
- 2500 SM basic telephone (ivory)—3101-2TD COL12
- 2504 CM basic telephone (ivory)—3100-T4W
- 2514 CM basic telephone (black)—3100-TJE COL09
- 2514 CM basic telephone (beige)—3100-TJE COL11
- 2514 CM basic telephone (ivory)—3100-TJE COL12
- Handset cord (12 feet, black)—2725-01L COL09
- Line cord (14 feet, silver)—2725-07N COL18
- Line cord (25 feet, silver)—2725-07S COL18

Adjuncts

The following adjuncts can be used with the optional 2500 SM telephone:

- 4A Speakerphone
- Z34A-WA Message Waiting Indicator

2500 DMGC TELEPHONE

MESSAGE

RECALL
WAITING LIGHT

ON
RECALL

CONTROL

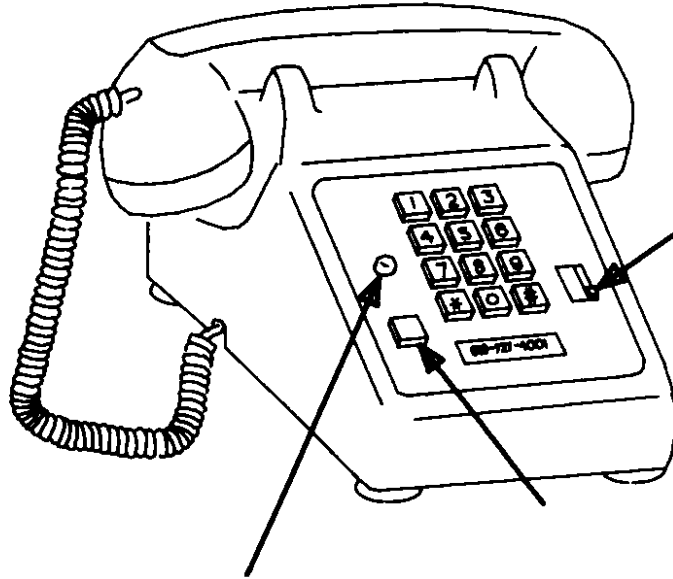

FIGURE 3-8. The 2500 DMGC Telephone

2500 DMGC Telephone

The 2500 DMGC telephone is a single appearance analog telephone with conventional touch-tone dialing. It provides access to features through the use of the * or # dial pad keys and the appropriate feature access codes. The 2500 DMGC telephone is equipped with RECALL button, Message Waiting light and a 3-position volume control.

Applications

The 2500 DMGC telephone can be used with the DEFINITY G1, G2, G3, System 75, and System 85. This telephone is especially suitable for manufacturing, warehousing, guard stations, or power failure locations.

Physical Description

Dimensions

Note: The following dimensions are approximate.

Width = 7 inches

Depth (front to back) = 8-3/4 inches

Height (maximum with handset in place) = 5-1/2 inches

RECALL button

The RECALL button performs the same function as flashing the switchhook.

Message light

The red Message light blinks when you have a message.

Other Physical Features

Handset

The 2500 DMGC telephone is equipped with a G-type handset.

Dial pad

The 2500 DMGC telephone is equipped with a 12-button touch-tone dial pad.

Jacks

The 2500 DMGC telephone housing contains two jacks. The handset cord jack is on the left side of the telephone. The mounting cord jack is on the back of the telephone. The handset contains a jack for the handset cord.

Cords

Two cords are supplied with the 2500 DMGC telephone: a coiled 7-foot modular handset cord and a 7-foot modular line cord. Optional longer cords are available: a 12-foot handset cord; 14-foot and 25-foot line cords.

Ringling

The 2500 DMGC has electronic tone ringling. The 3-position volume control is located on the faceplate of the telephone.

Mounting Options

The 2500 DMGC telephone is desk-mounted.

Color Options

The 2500 DMGC telephone is available in black or ivory.

Distance Limitations

The maximum allowable distances of a 2500 DMGC telephone from the DEFINITY G1, G2, System 75, or System 85 cabinet are shown in the table below.

SYSTEM	PORT BOARD	NOMINAL MAXIMUM RANGE IN FEET (METERS)	
		24 AWG	26 AWG
SYSTEM 85	SN229	3,500 (1,067)	3,500 (1,067)
	SN228B	15,000 (4,572)	9,000 (2,743)
DEFINITY G2	SN229	3,500 (1,067)	3,500 (1,067)
	SN228B	15,000 (4,572)	9,000 (2,743)
	TN742	20,000 (6,100)	13,000 (3,962)
	TN746	3,100 (945)	2,000 (610)
DEFINITY G1 & G3 SYSTEM 75	TN742	20,000 (6,100)	13,000 (3,962)
	TN769	20,000 (6,100)	13,000 (3,962)
	TN746	3,100 (945)	2,000 (610)

Power Requirements

The 2500 DMGC telephone is powered by the tip and ring leads. It does not require any external power supply.

Power Failure Operation

The 2500 DMGC telephone can be used as an emergency station during power failure transfer conditions.

FCC Registration

The 2500 DMGC telephone is FCC registered.

2500 DMGC Equipment Price Element Code (PECs)

The 2500 DMGC Voice Terminals and optional components can be ordered with the following PECs:

- 2500 DMGC basic telephone (black)—3178-SYSB
- 2500 DMGC basic telephone (ivory)—3178-SYSI
- Handset cord (12 feet, black)—2725-01L COL09
- Line cord (14 feet, silver)—2725-07N COL18
- Line cord (25 feet, silver)—2725-07S COL18

Adjuncts

The 2500 DMGC telephone is not compatible with any adjuncts.

Additional Documents

The following documents contain additional information relating to the 2500 DMGC Voice Terminal:

- *DEFINITY Generic 1 and Generic 2, System 75, and System 85 Terminals and Adjuncts Installation and Test*, 555-015-104.

2500 YMGK TELEPHONE

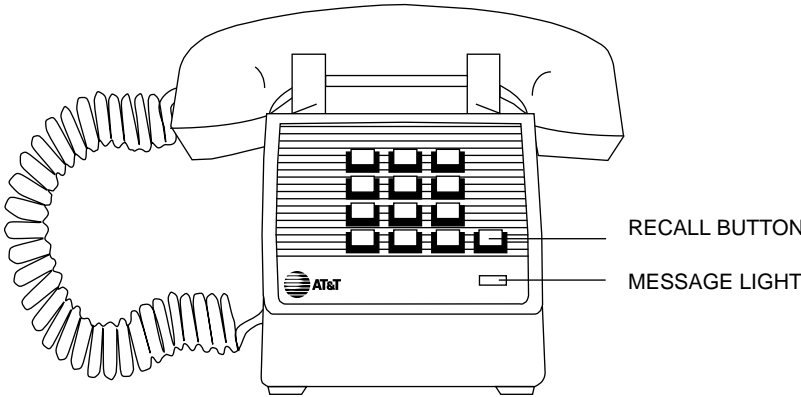

FIGURE 3-9. The 2500 YMGK Telephone

2500 YMGK Telephone

The 2500 YMGK telephone is a single appearance analog telephones with conventional touch-tone dialing. It is equipped with a RECALL button and a Message Waiting light. It provides access to features through the use of the * or # dial pad keys and the appropriate feature access codes.

Applications

The 2500 YMGK telephone can be used with the DEFINITY G1, G2, G3, System 75, and System 85. This telephone is especially suitable for manufacturing, warehousing, guard stations, or power failure locations.

Physical Description

Dimensions

Note: The following dimensions for the 2500 YMGK telephone are approximate.

Width = 7 inches

Depth (front to back) = 8-3/4 inches

Height (maximum with handset in place) = 5-1/2 inches

Features

RECALL button

The RECALL button performs the same function as flashing the switchhook.

Message light

The red Message light flashes when a message has been left, and flutters when a call is being received.

Other Physical Features

Handset

The 2500 YMGK telephone is equipped with a K-type handset.

Dial Pad

The 2500 YMGK telephone is equipped with a 12-button touch-tone dial pad.

Jacks

The 2500 YMGK telephone housing contains two jacks. The handset cord jack is on the left side of the telephone. The mounting cord jack is on the back of the telephone. The handset contains a jack for the handset cord.

Cords

Two cords are supplied with the 2500 YMGK telephone: a coiled 7-foot modular handset cord and a 7-foot modular line cord. Optional longer cords are available: a 12-foot handset cord; 14-foot and 25-foot line cords.

Ringling

The 2500 YMGK telephone has electronic tone ringer. The volume control is located on the bottom of the telephone.

Mounting Options

The 2500 YMGK telephone is desk-mounted.

Color Options

The 2500 YMGK telephone is available in black or misty cream.

Distance Limitations

The maximum allowable distances of a 2500 YMGK telephone from the DEFINITY G1, G2, G3, System 75, or System 85 cabinet are shown in the table below.

SYSTEM	PORT BOARD	NOMINAL MAXIMUM RANGE IN FEET (METERS)	
		24 AWG	26 AWG
SYSTEM 85	SN229	3,500 (1,067)	3,500 (1,067)
	SN228B	15,000 (4,572)	9,000 (2,743)
DEFINITY G2	SN229	3,500 (1,067)	3,500 (1,067)
	SN228B	15,000 (4,572)	9,000 (2,743)
	TN742	20,000 (6,100)	13,000 (3,962)
	TN746	3,100 (945)	2,000 (610)
DEFINITY G1 & G3 SYSTEM 75	TN742	20,000 (6,100)	13,000 (3,962)
	TN769	20,000 (6,100)	13,000 (3,962)
	TN746	3,100 (945)	2,000 (610)

Power Requirements

The 2500 YMGK telephone is powered by the tip and ring leads. It does not require any external power supply.

Power Failure Operation

The 2500 YMGK telephone can be used as an emergency station during power failure transfer conditions.

FCC Registration

The 2500 YMGK telephone FCC registration number is AS593M-17899-TE-T.

2500 YMGK Equipment Price Element Code (PECs)

The 2500 YMGK telephones and optional components can be ordered with the following PECs:

- 2500 YMGK basic telephone (black)—3178-NHL COL003
- 2500 YMGK basic telephone (misty cream)—3178-NHL COL022
- Handset cord (12 feet, black)—2725-01L COL09
- Line cord (14 feet, silver)—2725-07N COL18
- Line cord (25 feet, silver)—2725-07S COL18

Adjuncts

The 2500 YMGK telephone is not compatible with any adjuncts.

Additional Documents

The following documents contain additional information relating to the 2500 YMGK Voice Terminal:

- *DEFINITY Generic 1 2500 YMGK User's Guide*, 555-204-734
- *System 75 2500 YMGK User's Guide*, 555-200-734
- *DEFINITY Generic 2 and System 85 2500 YMGK User's Guide*, 555-104-717.

2500 MMGL and 2500 YMGL TELEPHONES

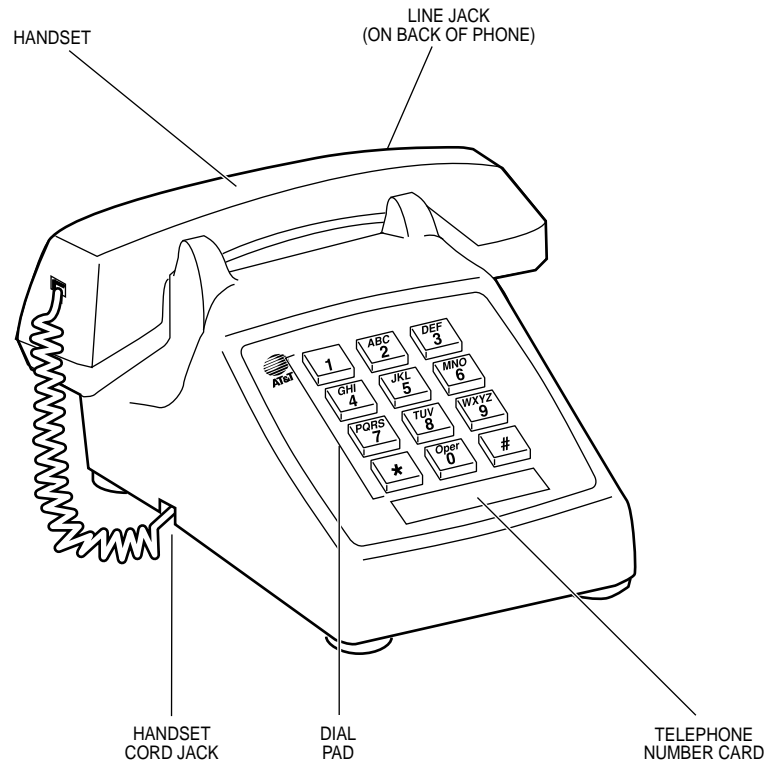

FIGURE 3-10. The 2500 MMGL Telephone

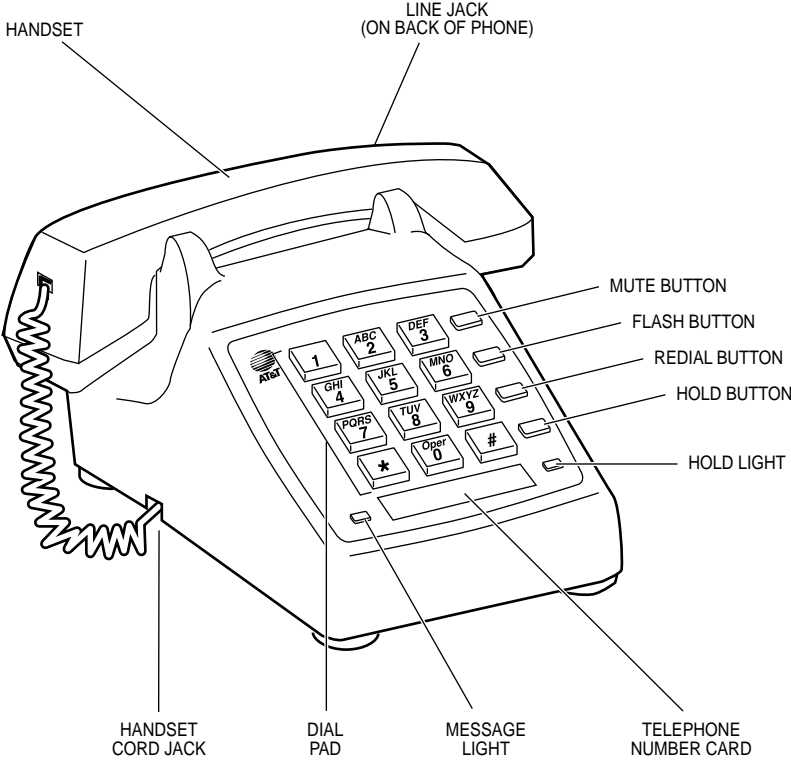

FIGURE 3-11. The 2500 YMGL Telephone

2500 MMGL and 2500 YMGL Telephones

The two newest 2500 telephones are the 2500 MMGL and the 2500 YMGL telephones. All other 2500 telephones previously available will be manufacture discontinued beginning in June, 1994. Like the original 2500 sets, the new 2500 telephones are single appearance analog telephones with conventional touch-tone dialing. The 2500 MMGL has NO feature buttons. The 2500 YMGL telephone is equipped with a FLASH button, a Message Waiting light, a REDIAL button, a HOLD button, and a MUTE button. Both telephones provide access to features through the use of the * or # dial pad keys and the appropriate feature access codes. On both telephones, the user can select either Touch-Tone or Pulse dialing, whichever is appropriate. There is also a 2-position Positive Disconnect Switch which ensures faster, cleaner termination of calls when the user presses the switchhook.

Applications

The 2500 MMGL and 2500 YMGL telephones can be used with the DEFINITY G1, G2, G3, System 75, and System 85. These two 2500 telephones are especially suitable for manufacturing, warehousing, guard stations, or power failure locations.

Physical Description

Dimensions

Note: The following dimensions for both the 2500 MMGL and the 2500 YMGL telephones are approximate.

Width = 5.37 inches

Depth (front to back) = 9 inches

Height (maximum with handset in place) = 3.81 inches

Features on the 2500 YMGL

The 2500 YMGL has four fixed feature buttons:

- MUTE button

- FLASH button
- REDIAL button
- HOLD button

MUTE button

Pressing and holding the MUTE button down blocks your conversation from being heard by the other party.

FLASH button

The FLASH button performs the same function as flashing the switchhook; that is, it provides access to system features or use of custom calling services that require a press of the switchhook.

REDIAL button

The REDIAL button is used to dial the last number dialed (up to 28 digits).

HOLD button

The HOLD button is used to put a call on hold. Below the HOLD button, there is a red light. When the user puts a call on hold, the light goes on.

Message light

The red Message light flashes when a message has been left, and flutters when a call is being received. The telephones recognize either LED or neon message waiting signals.

Positive Disconnect

The Positive Disconnect switch on the bottom of the telephone has two positions: ON and OFF.

- The ON position hangs up the telephone for approximately two seconds, even if the switchhook depression is less. This prevents inadvertent switchhook flashes. To initiate switchhook flash in this mode, press the FLASH button.
- In the OFF position, the switchhook will function normally.

Other Physical Features (on Both 2500 Telephones)

Handset

Both 2500 telephones are equipped with a K-type handset.

Dial Pad

Both 2500 telephones are equipped with a 12-button touch-tone dial pad. On both telephones, the letters “Q” and “Z” have been added to the appropriate dial pad keys, and the “5” button on the dial pad has raised bars for visually-impaired users.

Jacks

Both of these 2500 telephones contain two jacks. The handset cord jack is on the left side of the telephone. The line cord jack is on the right rear of the set. The handset also contains a jack for the handset cord.

Cords

Two cords are supplied with both of these 2500 telephones: a coiled 6-foot modular handset cord and a 7-foot modular line cord. Optional longer cords are available: a 12-foot handset cord, and 14-foot and 25-foot line cords.

Ringling

Both 2500 telephones have an electronic tone ringer. There is a 3-position ringer volume control located on the bottom of the telephone.

Mounting Options

Both of these 2500 telephones can only be desk-mounted. They *cannot* be wall-mounted.

Color Options

Both of these 2500 telephones are available in black or misty cream.

Distance Limitations

The maximum allowable distances of a 2500 telephone from the DEFINITY G1, G2, G3, System 75, or System 85 cabinet are shown in the table below.

SYSTEM	PORT BOARD	NOMINAL MAXIMUM RANGE IN FEET (METERS)	
		24 AWG	26 AWG
SYSTEM 85	SN229	3,500 (1,067)	3,500 (1,067)
	SN228B	15,000 (4,572)	9,000 (2,743)
DEFINITY G2	SN229	3,500 (1,067)	3,500 (1,067)
	SN228B	15,000 (4,572)	9,000 (2,743)
	TN742	20,000 (6,100)	13,000 (3,962)
	TN746	3,100 (945)	2,000 (610)
	TN746B	3,100 (945)	2,000 (610)
DEFINITY G1 & G3 SYSTEM 75	TN742	20,000 (6,100)	13,000 (3,962)
	TN769	20,000 (6,100)	13,000 (3,962)
	TN746	3,100 (945)	2,000 (610)

Power Requirements

Both 2500 telephones are powered by the tip and ring leads. These telephones do not require any external power supply.

Switch Administration

Both 2500 telephones must be administered in the following ways:

- If the 2500 MMGL or 2500 YMGL telephone is connected to a System 75 or DEFINITY G1 or G3, it must be administered as a 2500 analog telephone.
- If either of the 2500 telephones is connected to a System 85 or DEFINITY G2, it can be administered as an analog line.

Power Failure Operation

Both 2500 telephones can be used as an emergency station during power failure transfer conditions.

FCC Registration

Both 2500 telephones are FCC-registered.

UL and CSA Approval

This voice terminal has been tested and has met the Underwriters Laboratories (UL) Standards UL 1459 and have also met the Canadian Standards Association (CSA) Standards CSA-C22.2 No.225-M90.

Hearing Aid Compatible

This voice terminal is compatible with the inductively coupled hearing aids prescribed by the FCC.

2500 MMGL and 2500 YMGL Equipment Price Element Codes (PECs)

The 2500 MMGL and YMGL telephones and optional components can be ordered with the following PECs:

- 2500 MMGL basic telephone (black)—3101-KBD COL003
- 2500 MMGL basic telephone (misty cream)—3101-KBD COL022
- 2500 YMGL basic telephone (black)—3101-KFD COL003
- 2500 YMGL basic telephone (misty cream)—3101-KFD COL022
- Handset cord (12 feet, black)—2725-01L COL09
- Handset cord (12 feet, misty cream)—2725-01L COL022
- Line cord (14 feet, silver)—2725-07N COL18
- Line cord (25 feet, silver)—2725-07S COL18

8101 TELEPHONE

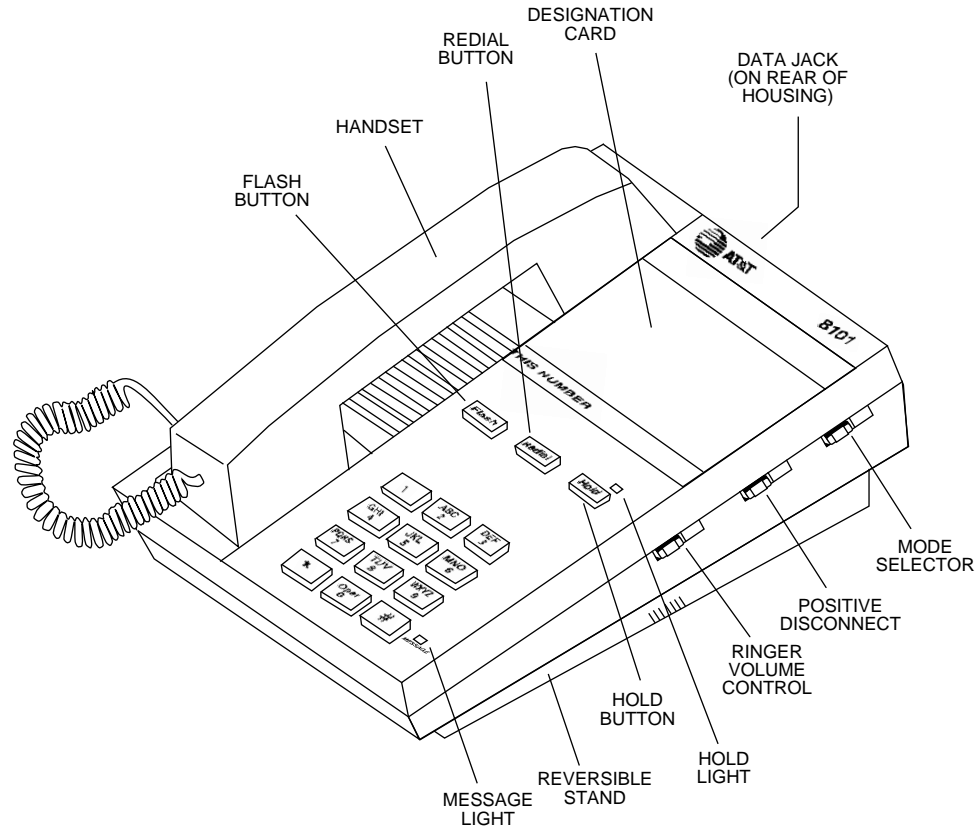

FIGURE 3-12. The 8101 Telephone

8101 Telephone

The 8101 telephone is a single-line analog model that requires one tip and ring pair for operation. This telephone contains automatic redial, a Message light, a HOLD button with a single light, a designation card on which you can write frequently-dialed numbers and extensions, selectable personalized ringing pattern, and a Data jack. The 8102 telephone allows access to system features with the FLASH button and appropriate dial codes.

Applications

The 8101 telephone can be used with the DEFINITY Communications System G1, G2, G3, System 75, and System 85. This telephone has local phone features, but can also be used for the system features with the FLASH button.

Physical Description

Dimensions

Note: The dimensions listed here for the 8101 telephone are approximate.

Width = 6 3/4 inches

Depth (front to back) = 9 1/2 inches

Height (maximum with handset in place) = 3 1/2 inches

Thickness of housing = At the top of the telephone, the thickness measures 1 5/8 inches; at the bottom of the telephone, the thickness measures 1 inch.

Feature Buttons

Fixed Feature Buttons

The 8101 telephone has the following fixed feature buttons:

- FLASH button

For using features such as Conference with business communications systems.

- REDIAL button

Can be used for redialing the last number dialed from the dial pad, either an extension or an outside number. The number redialed can be up to 20 digits.

- HOLD button

Used for putting a call on hold. If users want to put a call on hold and place another call, they must use the system Hold feature by using the FLASH button.

Message Light

The red Message light flashes when a message is left for the user. It goes off when the user retrieves the message. The Message light also serves as a visual ringing indicator by flashing quickly while the telephone is ringing.

Designation Card

On the front of the 8101, there is a designation card on which the user can write frequently-dialed telephone numbers and extensions.

Other Physical Features

Ringing

The 8101 telephone has electronic tone ringing. The ringer volume control is a 3-position switch on the right side of the housing.

Positive Disconnect

The 8101 has a switch with which the user can select positive disconnect or turn it off. In the ON position, this switch hangs up the phone for approximately two seconds, even if the switchhook depression is for a shorter duration. This action prevents inadvertent switchhook flashes. To initiate a switchhook flash in this mode, the FLASH button must be pressed. In the OFF position, switchhook functioning is normal.

Mode Selector

The 8101 telephone has a 2-position switch which allows the user to select either rotary pulse or touch tone dialing.

Mounting Options

The 8101 telephone comes equipped with a non-adjustable desk stand which can be turned upside-down and used for wall mounting the telephone.

Jacks

The 8101 telephone has a Line jack on the back of the telephone for connecting a line cord, and a Handset cord jack for connecting the handset. This telephone also has a Data jack for connecting a device such as a modem to the telephone.

Handset

The 8101 telephone is equipped with a K-type handset.

Dial pad

The 8101 telephone is equipped with a 12-button touch-tone dial pad. The letters "Q" and "Z" have been added to the appropriate dial pad keys for directory access, and the "5" button on your dial pad has raised bars for visually-impaired users.

Cords

Two cords are supplied with the 8101 telephone: a coiled 9-foot modular handset cord and a 7-foot modular line cord.

Color Options

The 8101 telephone is available in black and AT&T white.

Distance Limitations

The maximum allowable distances of an 8101 telephone from the DEFINITY G1, G2, G3, System 75, or System 85 cabinet are shown in the table below.

SYSTEM	PORT BOARD	NOMINAL MAXIMUM RANGE IN FEET (METERS)	
		24 AWG	26 AWG
System 85	SN229	6,500 (1,981)	4,100 (1,246)
	SN228B	6,500 (1,981)	4,100 (1,246)
DEFINITY G2	SN229	6,500 (1,981)	4,100 (1,246)
	SN228B	6,500 (1,981)	4,100 (1,246)
	TN742	15,200 (4,633)	10,000 (3,050)
	TN746	3,000 (915)	2,000 (610)
DEFINITY G1 & G3 System 75	TN742	15,200 (4,633)	10,000 (3,050)
	TN769	15,200 (4,633)	10,000 (3,050)
	TN746	3,000 (915)	2,000 (610)

Power Requirements

The 8101 voice terminal receives power from the system and does not require any external power supply.

Switch Administration

The 8101 telephone must be administered in the following ways:

- If the 8101 telephone is connected to a System 75 or DEFINITY G1 or G3, it must be administered as a 2500 analog telephone.
- If the 8101 telephone is connected to a System 85 or DEFINITY G2, it can be administered as an analog line.

Power Failure Operation

The 8101 telephone can be used as an emergency station during power failure transfer conditions.

Ringer Equivalency Numbers

The Ringer Equivalency Number for the 8101 telephone is: REN 0.4A, 0.8B.

FCC Registration

The 8101 telephone is FCC registered (AS5CHN-20714-MT-E).

Hearing Aid Compatible

This telephone is compatible with the inductively coupled hearing aids prescribed by the FCC.

8101 Telephone PECs and COMCODES

The 8101 telephone and optional components can be ordered with the following Price Element Codes and COMCODES:

- **Basic 8101 telephone**
PEC: 3192-101 (Black=COL09; White=COL10)
COMCODE: Black=106272289; White=106272297
- **Handset**
COMCODE: Black=107136800; White=106063408
- **Handset cord (9 feet)**
COMCODE: Black=107154262; White: 107154270
- **Line cord (7 feet)**
COMCODE: 107123069

- **Line cord (14 feet, silver)**
PEC: 2725-07N (COL18)
COMCODE: 103786802
- **Line cord (25 feet, silver)**
PEC: 2725-07S (COL18)
COMCODE: 103786828
- **Designation strips**
PEC: 31941 (Package of 25)
COMCODE: 847367539

PEC: 31942 (Package of 100)
COMCODE: 847367547
- **Designation card covers**
COMCODE: 847173937

Adjuncts

The 8101 telephone does not have an Adjunct equipment jack and therefore will not support any adjuncts.

Additional Documents

The following documents contain additional information relating to the 8101 telephone: (Use the 9-digit number listed after each document to order the book from the GBCS Publications Fulfillment Center.)

- *DEFINITY Communications System Generic 1, 2, and 3 (System 75, 85) 8101, 8102, and 8110 Telephones User's Guide*, 555-204-746
- *System 75, System 85, DEFINITY Communications System Generic 1 and 3 and 2, 8101, 8102, and 8110 Telephones Quick Reference Guide*, 555-230-773
- *8101, 8102, and 8110 Telephones Instructions for Installation and Switch Information*, 555-230-771.

8102 AND 8102M TELEPHONES

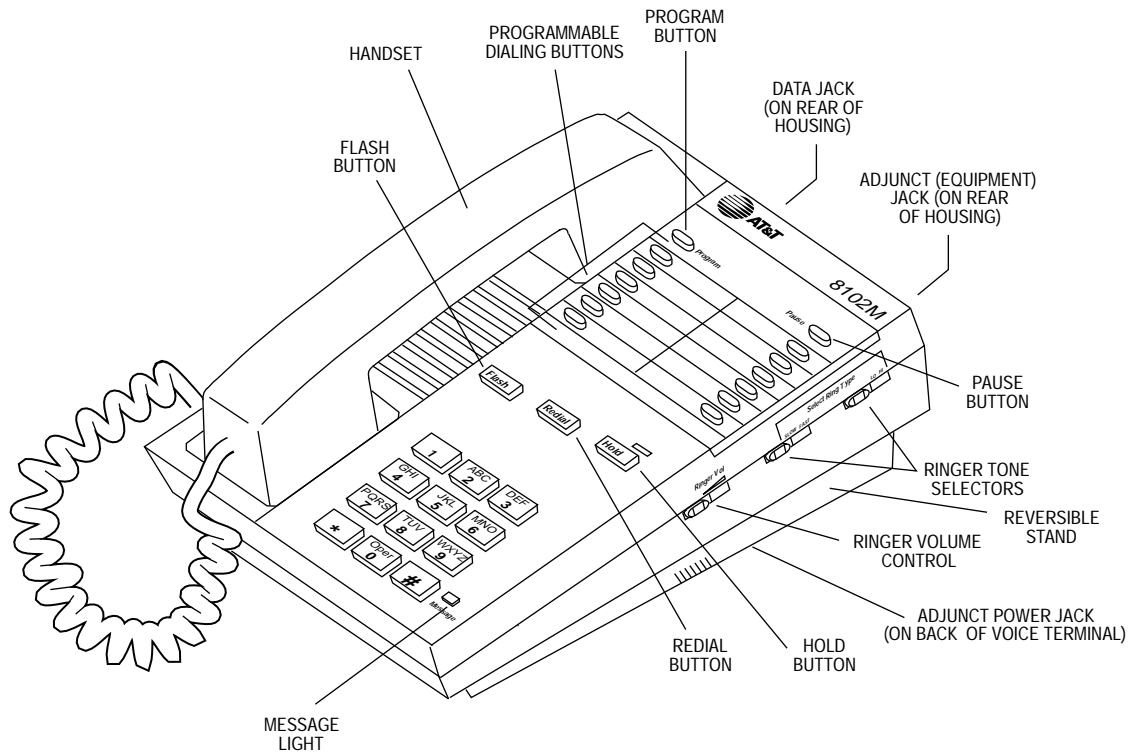

**FIGURE 3-13. The 8102 and 8102M Telephone
(The 8102M is shown here)**

8102 and 8102M Telephones

The basic 8102 (which includes the 8102A01A and 8102A01B) and the modified 8102M (8102A01C) telephones are single-line analog sets that require one tip and ring pair for operation. These telephones are exactly the same in appearance: each contains 12 programmable dialing buttons, automatic redial, selected personalized ringing pattern, a Message light, a HOLD button, a Data jack, and an Adjunct jack. The 8102 and 8102M telephones also allow access to system features with the FLASH button and appropriate dial codes.

Note: In late 1995, the basic 8102 telephone will no longer be manufactured. Only the 8102M will be available.

Applications

The 8102 and 8102M telephones can be used with the DEFINITY Communications System G1, G2, G3, System 75, and System 85. These telephones have local phone features, but can also be used, with the FLASH button, for system features. The 8102 and 8102M telephones can be converted to a hotel/motel telephone for the lodging industry. The converted telephone has 10 pre-programmed buttons which enable users easy communication with assigned numbers within the hotel/motel, such as the front desk or housekeeping service, for instance.

Physical Description

Dimensions

Note: The dimensions listed here for the 8102 and 8102M telephones are approximate.

Width = 6 3/4 inches

Depth (front to back) = 9 1/2 inches

Height (maximum with handset in place) = 3 1/2 inches

Thickness of housing = At the top of the telephone, the thickness measures 1 5/8 inches; at the bottom of the telephone, the thickness measures 1 inch.

Feature Buttons

Fixed Feature Buttons

The 8102 and 8102M telephones have the following fixed feature buttons:

- FLASH button

For using features such as Conference with business communications systems, and for custom calling features if the user is using the telephone at home.

- REDIAL button

Can be used for redialing the last number dialed from the dial pad, either an extension or an outside number. The number redialed can be up to 20 digits.

With the (Redial) Auto-Pause feature, the telephone can be programmed to insert pauses after a dial access code (such as 9) in a redialed number. If the user usually waits a short period to obtain a second dial tone after dialing an access code, this waiting time can be set by programming the automatic pause between the system access code and the telephone number. The (Redial) Auto-Pause feature will help eliminate misdialing.

- HOLD button

Used for putting a call on hold. If users want to put a call on hold and place another call, they must use the system Hold feature by using the FLASH button.

Message Light

The red Message light flashes when a message is left for the user. It goes off when the user retrieves the message. The Message light also serves as a visual ringing indicator by flashing quickly while the telephone is ringing.

Programmable Dialing Buttons

The 8102 and 8102M telephones provide 12 programmable dialing buttons on which the user can store frequently dialed telephone numbers or feature codes. To use these preprogrammed features, the user merely lifts the handset and then presses the appropriate programmable dialing button.

PROGRAM and PAUSE buttons

Both of these buttons are used for storing numbers on the preprogrammed dialing buttons on the upper half of the faceplate of the telephone. The PAUSE button can be used to insert a one half second pause/delay into a telephone number stored on a programmable dialing button or into a dialing access code in the Auto-Pause feature of Redial.

Other Physical Features

Ringling

The 8102 and 8102M telephones have electronic tone ringing. The ringer volume control is a 3-position switch on the right side of the housing.

The user can also use a Tone Selector (labeled "LO HI") for selecting one of two tone ringer frequencies or a second Tone Selector (labeled "SLOW FAST") for selecting one of two tone ringer modulation rates. Both Tone Selector switches are on the right side of the telephone.

Mounting Options

The 8102 and 8102M telephones come equipped with a non-adjustable desk stand which can be turned upside-down and used for wall mounting the telephone.

Jacks

The 8102 and 8102M telephones have a Line jack on the back of the telephone for connecting a line cord, and a Handset cord jack for connecting the handset. These telephones also have a Data jack for connecting a device such as a modem to the telephone.

The 8102 and 8102M telephones have an Adjunct (equipment) jack which allows the connection of a speakerphone to the telephone and an adjunct power jack for connecting an auxiliary power source for using the adjunct equipment.

Handset

The 8102 and 8102M telephones are equipped with a K-type handset.

Dial pad

The 8102 and 8102M telephones are equipped with a 12-button touch-tone dial pad. The letters "Q" and "Z" have been added to the appropriate dial pad keys for directory access, and the "5" button on your dial pad has raised bars for visually-impaired users.

Cords

Two cords are supplied with the 8102 and 8102M telephones: a coiled 9-foot modular handset cord and a 7-foot modular line cord.

Color Options

The 8102 and 8102M telephones are available in black and AT&T white.

Distance Limitations

The maximum allowable distances of an 8102 or 8102M telephone from the DEFINITY G1, G2, G3, System 75, or System 85 cabinet are shown in the table below.

SYSTEM	PORT BOARD	NOMINAL MAXIMUM RANGE IN FEET (METERS)	
		24 AWG	26 AWG
System 85	SN229	6,500 (1,981)	4,100 (1,246)
	SN228B	6,500 (1,981)	4,100 (1,246)
DEFINITY G2	SN229	6,500 (1,981)	4,100 (1,246)
	SN228B	6,500 (1,981)	4,100 (1,246)
	TN742	15,200 (4,633)	10,000 (3,050)
	TN746	3,000 (915)	2,000 (610)
DEFINITY G1 & G3 System 75	TN742	15,200 (4,633)	10,000 (3,050)
	TN769	15,200 (4,633)	10,000 (3,050)
	TN746	3,000 (915)	2,000 (610)

Power Requirements

The 8102 and 8102M telephones must have auxiliary power for adjunct equipment when such equipment is connected.

Switch Administration

The 8102 and 8102M telephones must be administered in the following ways:

- If the 8102 or 8102M telephone is connected to a System 75 or DEFINITY G1 or G3, it must be administered as a 2500 analog telephone.
- If the 8102 or 8102M telephone is connected to a System 85 or DEFINITY G2, it can be administered as an analog line.

Note: The programmable dialing buttons are programmed individually on the telephone; they are *not* administrable from the switch.

Administration of Hidden Features

For procedures on administering the hidden features on the 8102M (*to be done ONLY by the system administrator*) such as

- Reprogramming the Hold Feature
- Administering the Timed Disconnect Feature
- Locking the Programmable Dialing Buttons

refer to the *8102M and 8110M Telephones Quick Reference Guide* which comes in the box with the 8102M.

Power Failure Operation

The 8102 or 8102M telephone can be used as an emergency station during power failure transfer conditions.

Ringer Equivalency Numbers

The Ringer Equivalency Number for the 8102 telephone is: 0.5A & 1.6B. For the 8102M the Ringer Equivalency Number is: 1.5B & 0.8A.

FCC Registration

The 8102 and 8102M telephones are FCC registered (A5SUSA-65132-MT-E).

Hearing Aid Compatible

These telephones are compatible with the inductively coupled hearing aids prescribed by the FCC.

8102 and 8102M Telephones PECs and COMCODES

The 8102 and 8102M telephones and optional components can be ordered with the following Price Element Codes and COMCODES:

- **Basic 8102** (8102A01A and 8102A01B) telephone
PEC: 3192-001 (Black=COL09; White=COL10)
COMCODE: Black=106272305; White=106272313
- **Modified 8102M** (8102A01C) telephone
PEC: 3192-001 (Black=COL09; White=COL10)
COMCODE: Black=107538357; White=107538365
- **Handset**
COMCODE: Black=106050065; White=106053408
- **Handset cord (9 feet)**
COMCODE: Black=105635429; White: 105701809
- **Line cord (7 feet)**
COMCODE: 103732541
- **Line cord (14 feet, silver)**
PEC: 2725-07N (COL18)
COMCODE: 103786802
- **Line cord (25 feet, silver)**
PEC: 2725-07S (COL18)
COMCODE: 103786828
- **Button designation card**
PEC: 31932 (Package of 25)
PEC: 31938 (Tractor Feed)
Single Sheet COMCODE: 846562700
25 Sheets COMCODE: 846562718
Tractor Feed COMCODE: 846562726
- **Designation card covers**
PEC: 31937 (package of 25)
COMCODE: 106523236

- **Repertory Dial buttons (Programmable dialing buttons)**
(These buttons can be used to replace lost buttons or to replace the two buttons removed for hotel/motel conversion.)
(Package of 80)
PEC: 31936
COMCODE: 106503238
- **Security designation card and cover**
(These cards and covers are for concealing the PROGRAM and PAUSE buttons and the two topmost programmable dialing buttons so that unauthorized changes cannot be made to the programmable dialing assignments.)
(Package of 25 cards and clear plastic designation card covers)
PEC: 31931
COMCODE: 106248370
- **Stands**
(These stands can be used to replace damaged or broken stands.)
(Package of 5)
PEC: 31933
COMCODE: 106503204

Adjuncts

The 8102 and 8102M telephones can be equipped with one of the following adjuncts:

- S101A Speakerphone (not orderable)
- S201A Speakerphone

Additional Documents

The following documents contain additional information relating to the 8102 and 8102M telephones: (Use the 9-digit number listed after each document to order the book from the GBCS Publications Fulfillment Center.)

- *DEFINITY Communications System Generic 1, Generic 2, and Generic 3, System 75 and System 85 8101, 8102, 8102M, 8110, 8110M Telephones User's Guide, 555-230-774*

The following instructions are shipped with every 8102 telephone:

- *8102 and 8110 Telephones User's Manual, 555-015-131.*

The following instructions are shipped with every 8102M telephone:

- *8102M and 8110M Telephones Quick Reference Guide*

8110 and 8110M TELEPHONES

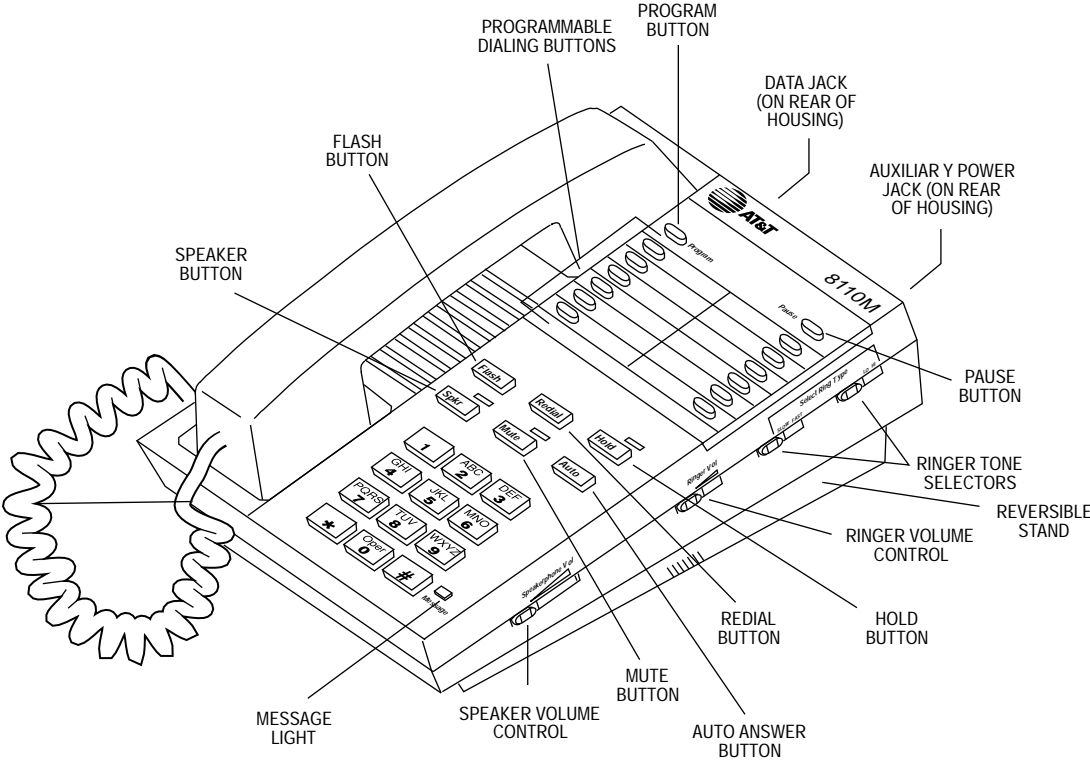

**FIGURE 3-14. The 8110 and 8110M Telephones
(The 8110M is shown here)**

8110 and 8110M Telephones

The basic 8110 (which includes the 8110A01A, 8110A01B, and 8110A01C) and the modified 8110M (8110A01D) telephones are single-line analog sets that require one tip and ring pair for operation. These telephones are exactly the same in appearance: each contains 12 programmable dialing buttons with a PROGRAM and PAUSE button for programming, automatic redial, selected personalized ringing pattern, a flashing red Message light, and a Hold button. They also have a built-in speakerphone with Mute capability and the Automatic Answer (and disconnect) feature. The 8110 and 8110M telephones also allow access to system features via the Flash button and appropriate dial codes.

Note: In late 1995, the basic 8110 will no longer be manufactured. Only the 8110M will be available.

Applications

The 8110 and 8110M telephones can be used with the DEFINITY Communications System G1, G2, G3, System 75, and System 85. These telephones have local phone features, but can also be used for system features via the Flash button. With the D-182363 Kit of Parts, the 8110 and 8110M telephones can be converted to a hotel/motel telephone for the lodging industry. The converted telephone has 10 preprogrammed buttons (with the PROGRAM and PAUSE buttons and two uppermost programmable dialing buttons concealed). The programmable dialing buttons enable users easy communication with assigned numbers within the hotel/motel, such as the front desk or housekeeping service. These telephones can also be used in any unsecured location where hiding the Program and Pause buttons is desirable.

Physical Description

Dimensions

Note: The dimensions listed here for the 8110 and 8110M telephones are approximate.

Width = 6 3/4 inches

Depth (front to back) = 9 1/2 inches

Height (maximum with handset in place) = 3-1/2 inches

Thickness of housing = At the top of the telephone, the thickness measures 1-5/8 inches; at the bottom of the telephone, the thickness measures 1 inch.

Features

Fixed Feature Buttons

The 8110 and 8110M telephones have the following fixed feature buttons:

- FLASH button

For using features such as Transfer or Conference with business communications systems, and for custom calling features if the user is using the telephone at home.

- REDIAL button

Can be used for redialing the last number dialed from the dial pad, either an extension or an outside number. The number redialed can be up to 20 digits.

With the (Redial) Auto-Pause feature, the telephones can be programmed to insert pauses after a dial access code (such as 9) in a redialed number. If the user usually waits a short period to obtain a second dial tone after dialing an access code, this waiting time can be set by programming the automatic pause between the system access code and the telephone number. The (Redial) Auto-Pause feature will help eliminate misdialing.

- HOLD button

Used for putting a call on hold. If users want to put a call on hold and place another call, they must access the system Hold feature by using the Flash button.

- Speakerphone button (labeled SPKR)

Used for 2-way conversation with another party without lifting the handset.

Speaker volume is controlled by using the Speaker volume control switch on the right side of the telephone.

- MUTE button

Used for turning off the microphone of the built-in speakerphone or the handset.

- Auto Answer button (labeled AUTO)

Used for enabling calls to be automatically answered a call without lifting the handset. For those who require speakerphone functionality without use of the Auto-Answer feature, the Auto-Answer button can be removed and replaced with a flat cap cover shipped with each 8110 and 8110M telephone.

Message Light

The red Message light flashes when a message is left for the user. It goes off when the user retrieves the message. The Message light also serves as a visual ringing indicator by flashing quickly while the telephone is ringing.

Programmable Dialing Buttons

The 8110 and 8110M telephones provide 12 programmable dialing buttons on which the user can store frequently dialed telephone numbers or feature codes. Twenty elements can be stored on one button (digits and characters, such as a # or * or Pause or Flash). To use these pre-programmed features, the user merely lifts the handset (the user may choose, instead, to press the SPEAKER button to turn on the speakerphone) and then press the appropriate programmable dialing button.

PROGRAM and PAUSE buttons

Both of these buttons are used for storing numbers on the pre-programmed dialing buttons on the upper half of the faceplate of the telephone. The PAUSE button can be used to insert one or more one half-second pause/delay into a telephone number stored on a programmable dialing button or into a dialing access code in the (Redial) Auto-Pause feature.

Other Physical Features***Ringing***

The 8110 and 8110M telephones have electronic tone ringing. The ringer volume control is a 3-position switch on the right side of the housing.

The user can also use a Tone Selector (labeled "LO HI") for selecting one of two tone ringer frequencies and a second Tone Selector (labeled "SLOW FAST") for selecting one of two tone ringer modulation rates. Both Tone Selector switches are on the right side of the telephone.

Mounting Options

The 8110 and 8110M telephones come equipped with a desk stand which can be turned upside-down and used for wall mounting the telephone.

Jacks

The 8110 and 8110M telephones have a Line jack on the back of the telephone for connecting a line cord, and a Handset cord jack for connecting the handset. These telephones also have a Data jack on the rear of the telephone for connecting a device such as a modem or a personal FAX to the telephone.

Note: The 8110 and 8110M telephones have no connector for the S201A Speakerphone or 500A Headset Adapter.

The 8110 and 8110M telephones also have an auxiliary power jack which can be used for improving the performance of the built-in speakerphone on long loops where there is limited power available from the line. In certain circumstances, other than extended loop lengths, it may also be necessary to use adjunct power.

Handset

The 8110 and 8110M telephones are equipped with a K-type handset. A K-type amplified handset can also be used with these telephones.

Dial pad

The 8110 and 8110M telephones are equipped with a 12-button touch-tone dial pad. The letters "Q" and "Z" have been added to the appropriate dial pad keys for directory access, and the "5" button on the dial pad has raised bars for visually-impaired users.

Cords

Two cords are supplied with the 8110 and 8110M telephones: a coiled 9-foot modular handset cord and a 7-foot modular line cord.

Color Options

The 8110 and 8110M telephones are available in black and AT&T white.

Distance Limitations

The maximum allowable distances of an 8110 or 8110M telephone from the DEFINITY G1, G2, G3, System 75, or System 85 cabinet are shown in the table below.

SYSTEM	PORT BOARD	NOMINAL MAXIMUM RANGE IN FEET (METERS)		
		22 AWG	24 AWG	26 AWG
System 85 DEFINITY G2	SN228 SN228B SN229	12,000 (3,660)	8,000 (2,440)	5,000 (1,525)
System 75 DEFINITY G1 & G3	TN746B TN742 TN769	19,000 (5,795)	12,000 (3,660)	7,500 (2,287)
	TN746*	3,900 (1,189)	2,500 (762)	1,500 (457)

*Auxiliary power necessary at all operating distances.

Power Requirements

It is recommended that the 8110 and 8110M telephones have auxiliary power (9V DC, 100 mA) to improve the performance of the speakerphone under the following conditions:

Note: Use with the TN746 circuit pack requires auxiliary power (in the form of a power adapter) at all loop lengths. On System 85 and DEFINITY G2, the line must be administered as Data Restricted to allow for the automatic disconnect feature.

<p>If you are using:</p> <p>Circuit Pack TN742</p> <p>Circuit Pack TN769</p>	<ul style="list-style-type: none"> • When loop length exceeds: <ul style="list-style-type: none"> ▶ 16,000 feet (22 gauge) ▶ 10,000 feet (24 gauge) ▶ 6,300 feet (26 gauge) <i>or</i> • When loop resistance exceeds 256 ohms <i>or</i> • When loop current is less than 26 mA
<p>If you are using:</p> <p>Circuit Pack SN229</p>	<ul style="list-style-type: none"> • When loop length exceeds: <ul style="list-style-type: none"> ▶ 11,000 feet (22 gauge) ▶ 7,000 feet (24 gauge) ▶ 4,400 feet (26 gauge) <i>or</i> • When loop resistance exceeds 180 ohms <i>or</i> • When loop current is less than 26 mA
<p>Any installation</p>	<p>When loop current is less than 26 mA</p>
<p>Any installation</p>	<p>When another analog telephone is bridged with the 8110 or 8110M telephone</p>

Switch Administration

The 8110 and 8110M telephones must be administered in the following ways:

- If the 8110 or 8110M telephone is connected to a System 75 or DEFINITY G1 or G3, it must be administered as a 2500 analog telephone.
- If the 8110 or 8110M telephone is connected to a System 85 or DEFINITY G2, it can be administered as an analog line.

Note: The programmable dialing buttons are programmed individually on the telephone; they are *not* administrable from the switch.

Administration of Hidden Features

For procedures on administering the hidden features on the 8110M (*to be done ONLY by the system administrator*) such as

- Reprogramming the Hold Feature
- Administering the Timed Disconnect Feature
- Locking the Programmable Dialing Buttons

refer to the *8102M and 8110M Telephones Quick Reference Guide* which comes in the box with the 8110M.

Power Failure Operation

The 8110 or 8110M telephone can be used as an emergency station during power failure transfer conditions. If the telephone is over 3,000 feet from the cabinet, the telephone will not work properly.

Ringer Equivalency Numbers

The Ringer Equivalency Number for the 8110 telephone is: 0.5A & 1.6B. For the 8110M telephone the Ringer Equivalency Number is: 0.6A & 1.6B.

FCC Registration

The 8110 and 8110M telephones are FCC registered (A5SUSA-18602-MT-E).

Hearing Aid Compatible

These telephones are compatible with the inductively coupled hearing aids prescribed by the FCC.

8110 and 8110M Telephones Equipment PECs and COMCODES

The 8110 and 8110M telephones and components can be ordered with the following Price Element Codes (PECs) and COMCODES:

- **Basic 8110** (8110A01A, 8110A01B, and 8110A01C) telephone
PEC: 3193-001 (Black=COL09; White=COL10)
COMCODE: Black=106272321; White=106272339
- **Modified 8110M** (8110A01D) telephone
PEC: 3193-001 (Black=COL09; White=COL10)
COMCODE: Black=107535841; White=107535858
- **Handset**
COMCODE: Black=106050065; White=106053408
- **Handset cord**
COMCODE: Black=105635429; White: 105701809
- **Line cord (7 feet)**
COMCODE: 103732541
- **Line cord (14 feet, silver)**
PEC: 2725-07N (COL18)
COMCODE: 103786802
- **Line cord (25 feet, silver)**
PEC: 2725-07S (COL18)
COMCODE: 103786828
- **Button designation card**
PEC: 31932 (Package of 25)
PEC: 31938 (Tractor Feed)
Single Sheet COMCODE: 846562700
25 Sheets COMCODE: 846562718
Tractor Feed COMCODE: 846562726

- **Designation card covers**
PEC: 31937
COMCODE: 106523236
- **Repertory Dial buttons (Programmable dialing buttons)**
(These buttons can be used to replace lost buttons or to replace the two buttons removed for hotel/motel conversion.)
(Package of 80)
PEC: 31936
COMCODE: 106503238
- **Security designation card and cover**
(These cards and covers are for concealing the PROGRAM and PAUSE buttons and the two topmost programmable dialing buttons so that unauthorized changes cannot be made to the programmable dialing assignments.)
(Package of 25 cards and clear plastic designation card covers)
PEC: 31931
COMCODE: 106248370
- **Stands**
(These stands can be used to replace damaged or broken stands.)
(Package of 5)
PEC: 31933
COMCODE: 106503204
- **Speakerphone power adapter**
(This local power is necessary when reaching limitations for loop length or when using the TN746 circuit pack.)
PEC: 31930
COMCODE: 106460470
- **Auto-Answer buttons**
(These buttons can be used to replace lost buttons or to restore the Auto-Answer feature if it has been deactivated.)
(Package of 25)
PEC: 31935
COMCODE: 106503212
- **Auto Answer flat caps**
(These caps are designed to cover the Auto-Answer button opening when the Auto-Answer button has been removed.)
(Package of 25)
PEC: 31934
COMCODE: 106503220

Adjuncts

A **K-type Noisy Environment Handset** (PEC: 31052A) can also be purchased and connected to the 8110 or 8110M telephone.

Note: Neither the 8110 nor the 8110M telephone has a connector for the S201A or S203 Speakerphone or the 500A Headset Adapter.

Additional Documents

The following documents contain additional information relating to the 8110 and 8110M telephones: (Use the 9-digit number listed after each document to order the book from the GBCS Publications Fulfillment Center.)

- *DEFINITY Communications System Generic 1, Generic 3, and System 75, DEFINITY Generic 2 and System 85 8101, 8102, 8102M, 8110, 8110M Telephones User's Guide, 555-230-774*

The following instructions are shipped with every 8110 telephone:

- *8102 and 8110 Telephones User's Manual, 555-015-131.*

The following instructions are shipped with every 8110M telephone:

- *8102M and 8110M Telephones Quick Reference Guide*

ISDN 7505 MODULAR TERMINAL

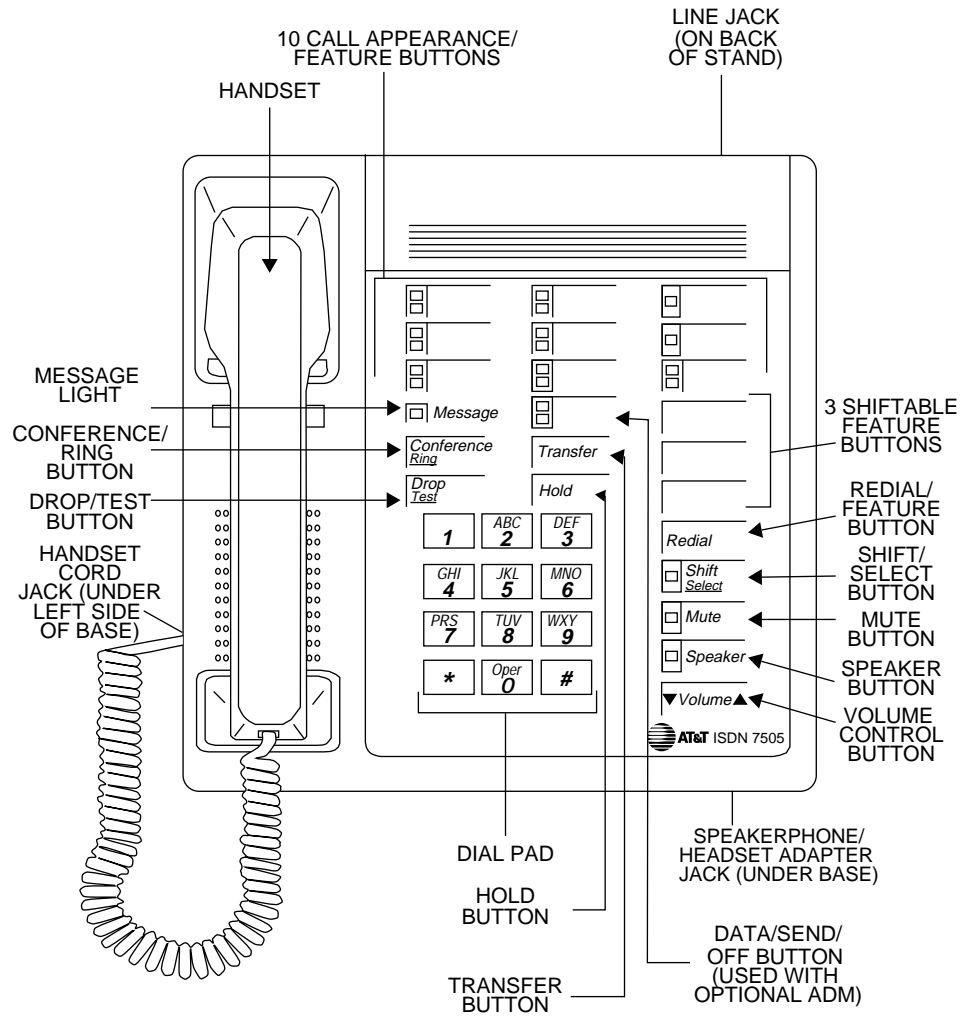

FIGURE 3-15. The 7505 Asynchronous Data Modular Terminal

ISDN 7505 Modular Terminal

The 7505 Modular Terminal is used with the Integrated Services Digital Network (ISDN) communication system through a 4-wire "T"-interface. The modular 7505 is a voice terminal when equipped with a Voice Only Module (VOM). As a telephone, it offers programmable buttons, fixed feature buttons, a Message light, touch-tone dialing, and a built-in, programmable speakerphone or SPOKESMAN loudspeaker. The speakerphone can be programmed at the terminal by the user for one of three states: On, Disabled, or SPOKESMAN loudspeaker. The 7505 can be equipped with an optional Asynchronous Data Module (ADM) that provides the user with simultaneous voice and data capabilities. The 7505 equipped with the ADM offers the same voice capabilities as the 7505 equipped with the VOM, plus it allows attached data terminals or personal computers to send and receive data through the digital network.

Note: The 7505 voice terminal is no longer being manufactured.

Applications

The 7505 modular terminal can be used with the DEFINITY G1, G2 and G3. Typical applications of the 7505 are users requiring a large number of line appearances with or without data capabilities.

Physical Description

Dimensions

The following dimensions for the 7505 terminal are approximate.

Width = 8-3/4 inches

Depth (front to back) = 8-1/2 inches

Height (maximum with handset in place) = 6-1/4 inches

Features

Eight Fixed Feature Buttons

The 7505 is equipped with eight fixed feature buttons. Three of the buttons are dual purpose buttons that are used with the SELECT button to perform other functions.

- CONFERENCE/RING button
- DROP/TEST button
- TRANSFER button
- HOLD button
- SPEAKER button
- MUTE button
- REDIAL/or feature button
- SELECT button

Message Light

The red Message light goes on when a message is left for the user. It goes off when the user retrieves the message.

Call Appearance/Feature buttons

The 7505 has nine or 10 call appearance buttons. These same 10 buttons, when properly administered, can be used for activating features. One of these buttons is used as a DATA/SEND/OFF button if the set has data capability.

Feature-Only Button

The 7505 has three buttons that are used for features. When used with the SELECT button these buttons can be used for three additional custom features. In addition to these three buttons, the REDIAL button provides another custom feature button.

Self-Test

The 7505 has a local self-test. When used with the SELECT button, the DROP/TEST button begins and ends the self-test.

MUTE button

Pressing the MUTE button mutes the handset or the speakerphone, whichever is active. The red light next to the MUTE button goes on. The user is placed in a listen-only mode.

Loudspeaker

The 7505 has a built-in, programmable SPOKESMAN loudspeaker. The SPEAKER button is used to turn the loudspeaker on and off. The Volume arrow buttons control the volume of the loudspeaker.

Speakerphone

The 7505 has a built-in, programmable speakerphone. The SPEAKER button is used to turn the speakerphone on and off. The green light next to the SPEAKER button goes on when the speakerphone is on. The Volume arrow buttons control the volume of the speakerphone.

Other Physical Features***Handset***

The 7505 is equipped with an R-type handset.

Dial pad

The 7505 is equipped with a 12-button touch-tone dial pad.

Jacks

The 7505 housing contains three jacks. The Handset jack is located on the bottom of the 7505. This jack can also be identified by the adjacent handset symbol. The Line jack is located on the back of the 7505. The Adjunct jack, used for connection to the optional adjuncts, is located on the bottom of the terminal. This jack can also be identified by the adjacent speaker symbol. If the optional ADM is provided, there is an EIA RS-232D Interface connector provided on its back.

Cords

Two cords are supplied with the 7505: a coiled 9-foot modular handset cord and a line cord. An optional 12-foot handset cord is available.

Ringling

The 7505 has electronic tone ringling with patterns that can be selected by using the SELECT and CONFERENCE/RING buttons. The volume is controlled by the volume "arrow" buttons.

Mounting Options

The 7505 comes equipped with a non-adjustable desk stand.

Color Options

The base of the 7505 is always black. The top of the 7505 is available in misty cream or black.

Distance Limitations

The maximum signaling distance from the port board to the work location jack based on DIW 24 AWG cable is:

- Terminating resistor in work location 1900 feet
- Terminating resistor in satellite closet 1600 feet

Power Requirements

The 7505 requires an auxiliary power supply. The power supply can be provided at a central location or may be collocated with the 7505. If the auxiliary power supply fails or loses its power, the 7505 will provide basic voice service with the phantom power provided by the switch.

Terminating Resistor

A 440A4 Terminating Resistor adapter is required with the 7505. The 440A4 can be located at the work location or in the satellite closet.

Power Failure Operation

The 7505 cannot be used as an emergency station during power failure transfer conditions.

FCC Registration

The 7505 modular terminal is not FCC registered.

Hearing Aid Compatible

This voice terminal is compatible with the inductively coupled hearing aids prescribed by the FCC.

7505 Equipment Price Element Code (PECs)

The 7505 modular terminal and optional components can be ordered with the following PECs:

- ISDN 7505 Voice Only Modular Terminal—3195-VOM
- ISDN 7505 Asynchronous Data Modular Terminal—3195-ADM
- 440A4 Terminating Resistor—2709-A59
- ADM Upgrade Kit—31955
- VOM Feature Package 2 Upgrade Kit—31969
- ADM Feature Package 2 Upgrade Kit—31970

Adjuncts

The following adjuncts can be used with the 7505 modular terminal:

- 500A Headset Adapter (and a standard headset; see “Headsets” below)
- S101A Speakerphone
- S201A Speakerphone

Headsets

A list of compatible headsets, consisting of both modular and plug prong base units and selection of headpieces, appears in “Headset Adapters” in the **Adjuncts** section (behind the **Adjuncts** tab) later in this manual.

Additional Documents

The following documents contain additional information relating to the 7505 modular terminal:

- *DEFINITY Generic 1 7505, 7506, and 7507 Voice Terminal User's Guide*, 555-204-750
- *DEFINITY Generic 2 ISDN 7505, 7506, and 7507 Terminal User's Guide*, 555-104-719
- *ISDN 7505 Modular Terminal and ISDN 7506 Display Terminal User's Manual*, 555-021-714
- *ISDN 7505 Asynchronous Data Module User's Guide*, 555-021-716
- *Integrated Services Digital Network (ISDN) Terminal Installation and Test User's Manual*, 555-021-101

ISDN 7506 DISPLAY TERMINAL

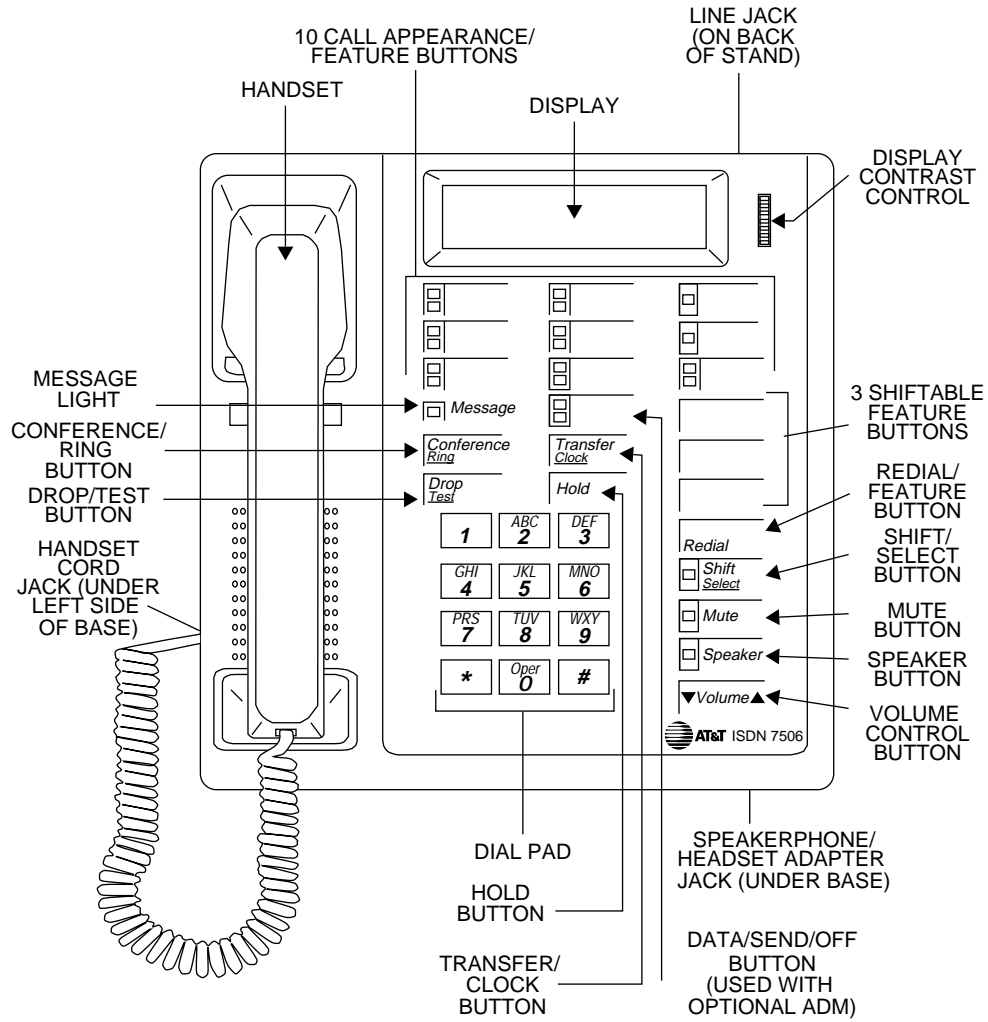

FIGURE 3-16. The 7506 Asynchronous Data Modular Display Terminal

ISDN 7506 Display Terminal

The 7506 Display terminal is used with the Integrated Services Digital Network (ISDN) communication system through a 4-wire "T"-interface. The modular 7506 is a voice terminal when equipped with a Voice Only Module (VOM). As a telephone, it offers programmable buttons, fixed feature buttons, a Message light, touch-tone dialing, and a built-in, programmable speakerphone or SPOKESMAN loudspeaker. The speakerphone can be programmed at the terminal by the user for one of three states: On, Disabled, and SPOKESMAN loudspeaker. The 7506 can be equipped with an optional Asynchronous Data Module (ADM) that provides the user with simultaneous voice and data capabilities. The 7506 equipped with the ADM offers the same voice capabilities as the 7506 equipped with the VOM, plus it allows attached data terminals or personal computers to send and receive asynchronous data through the digital network. Both versions of the 7506 display terminal are equipped with a two-line, 24-character display.

Note: The 7506 voice terminal is no longer being manufactured.

Applications

The 7506 display terminal can be used with the DEFINITY G1, G2, and G3. Typical applications of the terminal are users requiring a large number of line appearances with or without data. It is particularly useful for middle managers.

Physical Description

Dimensions

Note: The following dimensions for the 7506 terminal are approximate.

Width = 8-3/4 inches

Depth (front to back) = 8-1/2 inches

Height (maximum with handset in place) = 6-1/4 inches

Features

Eight Fixed Feature Buttons

The 7506 display terminal is equipped with eight fixed feature buttons. Four of the buttons are dual purpose buttons that are used with the SELECT button to perform other functions.

- CONFERENCE/RING button
- DROP/TEST button
- TRANSFER/CLOCK button
- HOLD button
- SPEAKER button
- MUTE button
- REDIAL/or feature button
- SELECT button

Message Light

The red Message light goes on when a message is left for the user. It goes off when the user retrieves the message.

Call Appearance/Feature buttons

The 7506 display terminal has nine or 10 call appearance buttons. These same 10 buttons, when properly administered, can be used for activating features. One of these buttons is used as a DATA/SEND/OFF button if the set has data capability.

Feature Button

The 7506 display terminal has three buttons that are used for features. When used with the SELECT button, these buttons can be used for three additional custom features. In addition to these buttons, the REDIAL button provides another custom feature button.

Display

The number being dialed, the time and date, and information concerning incoming calls and message retrieval are shown on the display. The viewing contrast is adjusted with the Display Contrast Control wheel located to the right of the display.

Self-Test

The 7506 display terminal has a local self-test. When used with the SELECT button, the DROP/TEST button begins and ends the self-test.

Loudspeaker

The 7506 display terminal has a built-in, programmable SPOKESMAN loudspeaker. The SPEAKER button is used to turn the loudspeaker on and off. The volume arrow buttons control the volume of the loudspeaker.

Speakerphone

The 7506 display terminal has a built-in, programmable speakerphone. The SPEAKER button is used to turn the speakerphone on and off. The green light next to the SPEAKER button goes on when the speakerphone is active. The volume arrow buttons control the volume of the speakerphone.

MUTE button

Pressing the MUTE button mutes the handset or the speakerphone, whichever is active. The red light next to the MUTE button goes on. The user is placed in a listen-only mode.

Other Physical Features

Handset

The 7506 is equipped with an R-type handset.

Dial pad

The 7506 is equipped with a 12-button touch-tone dial pad.

Jacks

The 7506 housing contains three jacks. The Handset jack is located on the bottom of the 7506 terminal. The Line jack is located on the back of the 7506 terminal. The Adjunct jack, used for connection to the optional adjuncts, is located on the bottom of the terminal. If the optional ADM is provided, there is an EIA RS-232D Interface connector provided on its back.

Cords

Two cords are supplied with the terminal: a coiled 9-foot modular handset cord and a line cord. An optional 12-foot handset cord is available.

Ringling

The 7506 display terminal has electronic tone ringling with patterns that can be selected by using the SELECT and CONFERENCE/RING buttons in sequence. The volume is controlled by the volume arrow buttons.

Mounting Options

The 7506 display terminal comes equipped with a nonadjustable desk stand.

Color Options

The base of the 7506 is always black. The top of the 7506 is available in misty cream or black.

Distance Limitations

The maximum signaling distance from the port board to the work location jack based on DIW 24 AWG cable is:

- Terminating resistor in work location—1900 feet
- Terminating resistor in satellite closet—1600 feet

Power Requirements

The 7506 display terminal requires an auxiliary power supply. The power supply can be provided at a central location or may be collocated with the 7506 display terminal. If the auxiliary power supply fails or loses its power, the 7506 display terminal will provide basic voice service with the phantom power provided by the switch.

Terminating Resistor

A 440A4 Terminating Resistor adapter is required with the 7506 display terminal. The 440A4 can be located at the work location or in the satellite closet.

Power Failure Operation

The 7506 display terminal cannot be used as an emergency station during power failure transfer conditions.

FCC Registration

The 7506 display terminal is not FCC registered.

Hearing Aid Compatible

This voice terminal is compatible with the inductively coupled hearing aids prescribed by the FCC.

7506 Equipment Price Element Code (PECs)

The 7506 display terminal and optional components can be ordered with the following PECs:

- ISDN 7506 Voice Only Modular Display Terminal—3196-VOM
- ISDN 7506 Asynchronous Data Modular Display Terminal—3196-ADM
- 440A4 Terminating Resistor—2709-A59
- ADM Upgrade Kit—31955
- VOM Feature Package 2 Upgrade Kit—31969
- ADM Feature Package 2 Upgrade Kit—31970

Adjuncts

The following adjunct can be used with the 7506 display terminal:

- 500A Headset Adapter (and a standard headset; see “Headsets” below)
- S101A Speakerphone
- S201A Speakerphone

Headsets

A list of compatible headsets, consisting of both modular and plug prong base units and selection of headpieces, appears in “Headset Adapters” in the **Adjuncts** section (behind the **Adjuncts** tab) later in this manual.

Additional Documents

The following documents contain additional information relating to the 7506 display terminal:

- *DEFINITY Generic 1 7505, 7506, 7507 Voice Terminals User's Guide, 555-204-750*
- *DEFINITY Generic 2 ISDN 7505, 7506, 7507 Terminal User's Guide, 555-104-719*
- *ISDN 7505 Modular Terminal and ISDN 7506 Display Terminal User's Guide, 555-021-714*
- *ISDN 7506 Asynchronous Data Module User's Guide, 555-021-716*
- *Integrated Services Digital Network (ISDN) Terminal Installation and Test User's Manual, 555-021-101*

ISDN 7507 DISPLAY TERMINAL

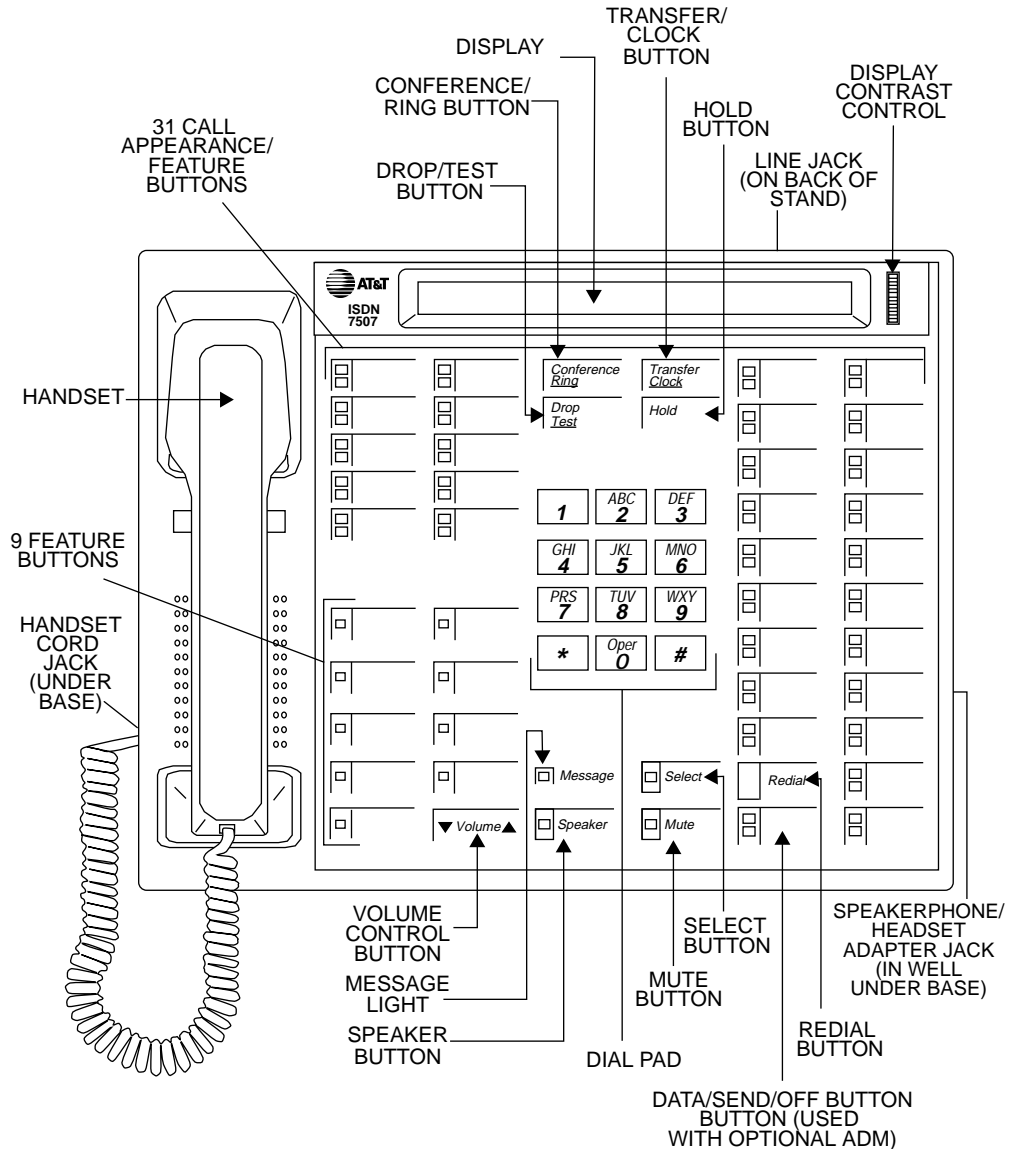

FIGURE 3-17. The 7507 Asynchronous Data Modular Display Terminal

ISDN 7507 Display Terminal

The 7507 Display terminal is used with the Integrated Services Digital Network (ISDN) communication system through a 4-wire "T"-interface. The modular 7507 is a voice terminal when equipped with a Voice Only Module (VOM). As a telephone it offers programmable buttons, fixed feature buttons, Message light, touch-tone dialing, and a built-in, programmable speakerphone or SPOKESMAN loudspeaker. The speakerphone can be programmed at the terminal by the user for one of three states: On, Disabled, and SPOKESMAN loudspeaker. The 7507 can be equipped with an optional Asynchronous Data Module (ADM) that provides the user with simultaneous voice and data capabilities. The 7507 equipped with the ADM offers the same voice capabilities as the 7507 equipped with the VOM, plus it allows attached data terminals or personal computers to send and receive data through the digital network. The terminal is equipped with a 2-line, 40-character display.

Note: The 7507 voice terminal is no longer being manufactured.

Applications

The 7507 display terminal can be used with the DEFINITY G1, G2, and G3. Typical applications of the display terminal are users requiring a large number of line appearances with or without data capabilities. It is particularly useful for secretary/receptionist positions and executives.

Physical Description

Dimensions

Note: The following dimensions for the 7507 terminal are approximate.

Width = 12 inches

Depth (front to back) = 8-3/4 inches

Height (maximum with handset in place) = 5-1/4 inches

Features

Eight Fixed Feature Buttons

The 7507 display terminal is equipped with eight fixed feature buttons. Three of the buttons are dual purpose buttons that are used with the SELECT button to perform other functions.

- CONFERENCE/RING button
- DROP/TEST button
- TRANSFER/CLOCK button
- HOLD button
- SPEAKER button
- MUTE button
- REDIAL button
- SELECT button

Message Light

The red Message light goes on when a message is left for the user. It goes off when the user retrieves the message.

Call Appearance/Feature buttons

The 7507 display terminal has 30 or 31 call appearance buttons. These same 31 buttons, when properly administered, can be used for activating features. One of these buttons is used as a DATA/SEND/OFF button if the set has data capability.

Feature Button

The 7507 display terminal has nine buttons that are used for features. When used with the SELECT button, these buttons can be used for nine additional custom features. In addition to these buttons, the REDIAL button provides another custom feature button.

Display

The number being dialed, the time and date, and information concerning incoming calls and message retrieval are shown on the display. The viewing contrast is adjusted with the Display Contrast Control wheel located to the right of the display.

Self-Test

The 7507 display terminal has a local self-test. When used with the SELECT button, the DROP/TEST button begins and ends the self-test.

Loudspeaker

The 7507 display terminal has a built-in, programmable SPOKESMAN loudspeaker. The SPEAKER button is used to turn the loudspeaker on and off. The Volume arrow buttons control the volume of the loudspeaker.

Speakerphone

The 7507 display terminal has a built-in, programmable speakerphone. The SPEAKER button is used to turn the speakerphone on and off. The green light next to the SPEAKER button goes on when the speakerphone is active. The Volume arrow buttons control the volume of the speakerphone.

MUTE button

Pressing the MUTE button mutes the handset or the speakerphone, whichever is active. The red light next to the MUTE button goes on. The user is placed in a listen-only mode.

Other Physical Features***Handset***

The 7507 display terminal is equipped with an R-type handset.

Dial pad

The 7507 display terminal is equipped with a 12-button touch-tone dial pad.

Jacks

The 7507 display terminal housing contains three jacks. The Handset jack is located on the bottom of the terminal. This jack can also be identified by the adjacent handset symbol. The Line jack is located on the back of the terminal. The Adjunct jack, used for connection to the optional adjuncts, is located on the bottom of the terminal. This jack can also be identified by the adjacent speaker symbol. If the optional ADM is provided, there is an EIA RS-232D Interface connector provided on its base.

Cords

Two cords are supplied with the 7507 display terminal: a coiled 9-foot modular handset cord and a line cord. An optional 12-foot handset cord is available.

Ringling

The 7507 display terminal has electronic tone ringling with patterns that can be selected by using the SELECT and CONFERENCE/RING buttons in sequence. The volume is controlled by the Volume arrow buttons.

Mounting Options

The 7507 display terminal comes equipped with a nonadjustable desk stand.

Color Options

The base of the 7507 display terminal is always black. The top of the 7507 display terminal is available in misty cream or black.

Distance Limitations

The maximum signaling distance from the port board to the work location jack based on DIW 24 AWG cable is:

- Terminating resistor in work location—1900 feet
- Terminating resistor in satellite closet—1600 feet

Power Requirements

The 7507 display terminal requires an auxiliary power supply. The power supply can be provided at a central location or may be collocated with the 7507 display terminal. If the auxiliary power supply fails or loses its power, the 7507 display terminal will provide basic voice service with the phantom power provided by the switch.

Terminating Resistor

A 440A4 Terminating Resistor adapter is required with the 7507 display terminal. The 440A4 can be located at the work location or in the satellite closet.

Power Failure Operation

The 7507 display terminal cannot be used as an emergency station during power failure transfer conditions.

FCC Registration

The 7507 display terminal is not FCC registered.

Hearing Aid Compatible

This voice terminal is compatible with the inductively coupled hearing aids prescribed by the FCC.

7507 Equipment Price Element Code (PECs)

The 7507 display terminal and optional components can be ordered with the following PECs:

- ISDN 7507 Voice Only Modular Display Terminal—3197-VOM
- ISDN 7507 Asynchronous Data Modular Display Terminal—3197-ADM
- 440A4 Terminating Resistor—2709-A59
- ADM Upgrade Kit—31955
- VOM Feature Package 2 Upgrade Kit—31969
- ADM Feature Package 2 Upgrade Kit—31970

Adjuncts

The following adjunct can be used with the 7507 display terminal:

- 500A Headset Adapter (and a standard headset; see “Headsets” below)
- S101A Speakerphone
- S201A Speakerphone

Headsets

A list of compatible headsets, consisting of both modular and plug prong base units and selection of headpieces, appears in “Headset Adapters” in the **Adjuncts** section (behind the **Adjuncts** tab) later in this manual.

Additional Documents

The following documents contain additional information relating to the 7507 Display terminal:

- *DEFINITY Generic 1 7505, 7506, 7507 Voice Terminals User's Guide*, 555-204-750
- *DEFINITY Generic 2 ISDN 7505, 7506 7507 Terminal User's Guide*, 555-104-709
- *ISDN 7507 Display Terminal User's Manual*, 555-021-715
- *ISDN 7507 Asynchronous Data Module User's Guide*, 555-021-716
- *Integrated Services Digital Network (ISDN) Terminal Installation and Test User's Manual*, 555-021-101

ISDN 8503T VOICE TERMINAL

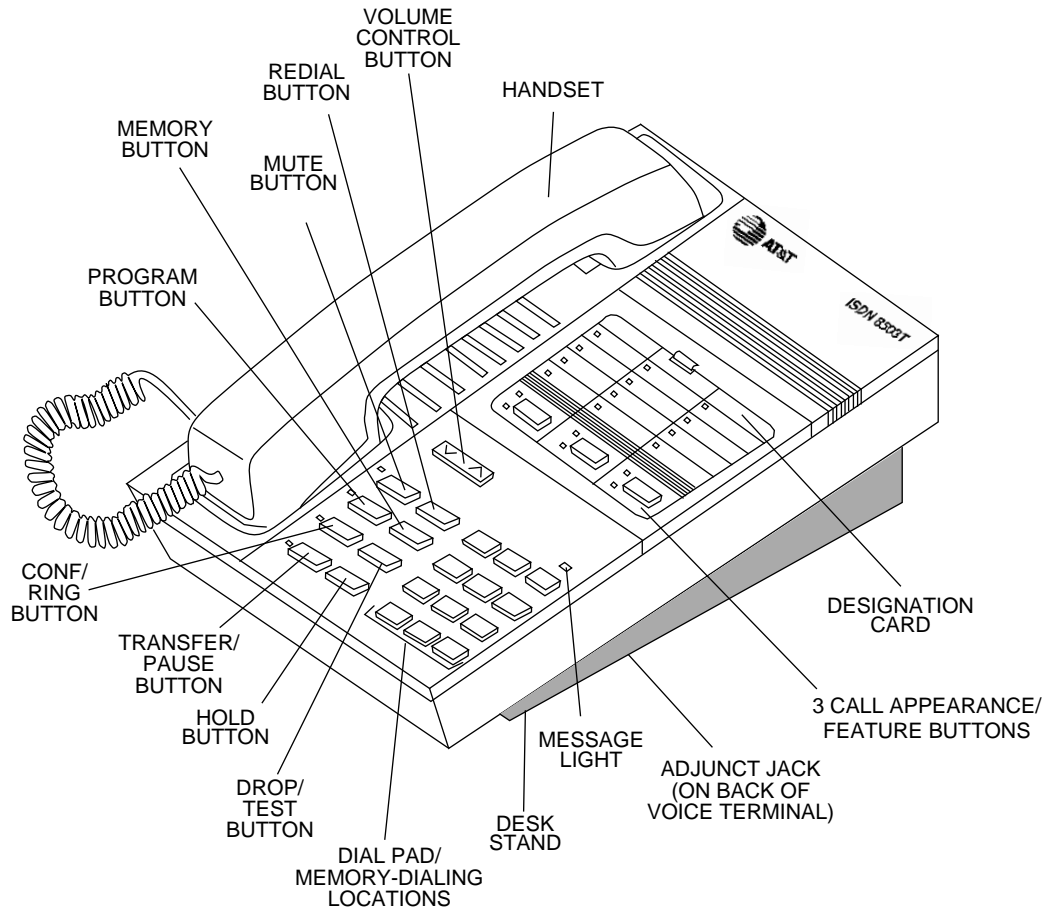

FIGURE 3-18. The Desk-mounted ISDN 8503T Voice Terminal

ISDN 8503T Voice Terminal

The 8503T voice terminal is a non-modular set used with the Integrated Services Digital Network (ISDN) communication system through a 4-wire "T"-interface. This voice terminal offers the following: 4 standard fixed feature buttons, a Message light, three call appearance/flexible feature buttons, each with a red and green light, 12 programmable memory-dialing locations on the dial pad keys, a PROGRAM button for storing numbers at the memory-dialing locations and a MEMORY button for dialing these programmed numbers or codes, the Redial feature, the Mute feature, eight possible personalized ringing patterns selected with the Select Ring feature, high fidelity audio capabilities (bandwidth from .3 to 3.8 kHz) with the K-type handset, and touch-tone dialing. This set does not provide data capabilities.

Applications

The 8503T voice terminal can be used with the DEFINITY G2 and G3. Typical applications of the 8503T voice terminal are users handling a low volume of voice-only calls, staff workers and lower level managers, as well as lobbies and conference rooms.

Physical Description

Dimensions

Note: The dimensions given here for the 8503T voice terminal are approximate.

Width = 7 3/4 inches

Depth (front to back) = 9 1/2 inches

Height (maximum with handset in place)

The desk-mounted model = 5 1/4 inches

The wall-mounted model = 4 1/2 inches

Four Standard Fixed Features

- CONF/RING button
- DROP/TEST button
- TRANSFER/PAUSE button
- HOLD button

Message Light

The red Message light goes on when a message is left for the user. This light goes off when the user retrieves the message.

Call Appearance/Feature buttons

The 8503T voice terminal has three call appearance/flexible feature buttons, each with a red light and a green status light. Although the buttons can accommodate *either* call appearances or administered features, it is highly suggested that all three of these call appearance/feature buttons be used for call appearances.

Twelve Programmed Memory Locations

The dial pad can be used for storing and dialing frequently dialed telephone numbers, emergency numbers, or feature access codes. In order to store these numbers or codes at each of the 12 memory-dialing locations, the user presses the PROGRAM button, dials the telephone number to be stored, presses the MEMORY button, and then the appropriate dial pad key (1 through 9, 0, *, and #). To dial the number, the user presses the MEMORY button and the dial pad key where that number is stored. Up to 16 digits can be stored at a memory-dialing location.

PROGRAM button

The PROGRAM button can be used in three different ways: (when the voice terminal is in program mode, the red light beside the PROGRAM button is on.)

- Used to enter programming mode and store frequently dialed telephone numbers, emergency numbers, or feature access codes on each of the 12 dial pad keys (memory-dialing locations).

Note: The user can press the TRANSFER/PAUSE button, while the voice terminal is in program mode, to insert a one and one half-second pause/delay in the telephone number to be stored in a memory-dialing location. For example, the user might place a one and one half-second pause between the dialing access code (such as 9) and the outside telephone number.

- Used with the CONF/RING button to select one of eight possible personalized ringing patterns
- Used with the DROP/TEST button to initiate a self-test of the voice terminal lights and ringer.

Note: If the user picks up on an incoming call while the voice terminal is in program mode, the voice terminal will automatically exit program mode.

MEMORY button

When the user presses the MEMORY button and one of the 12 dial pad keys (memory-dialing locations), while off-hook, the voice terminal automatically dials the number or access code stored on that dial pad key.

The user can clear a memory-dialing location by entering program mode, and then pressing the MEMORY button and the appropriate dial pad key on which the number or code is stored.

REDIAL button

With the Redial feature, the user can redial the telephone number last dialed from the dial pad. (The handset must be off-hook.) Up to 37 digits can be redialed.

MUTE button

While on a call, the user can press the MUTE button (the red light next to the button goes on), so the user can converse with someone in the same room without the other party hearing the conversation. The user is placed in listen-only mode. To disable the feature, the user presses the MUTE button a second time (the red light goes off).

Volume control button

When the user is on a call, the Volume “arrow” button raises or lowers the volume on the handset. When the handset is on-hook, this button raises or lowers the ringer volume.

Self-Test

The 8503T voice terminal is equipped with a Self-Test feature. When the user presses the PROGRAM button and then the DROP/TEST button, while on-hook, the user can test the button lights and the ringer.

Other Physical Features

Handset

The 8503T voice terminal is equipped with a K-type wideband handset. With the 8503T voice terminal, this handset has high fidelity audio capabilities.

A K-type Noisy Environment Handset (PEC: 31052A) can also be purchased and connected to the 8503T voice terminal.

Dial pad

The 8503T voice terminal is equipped with a standard 12-button touch-tone dial pad for dialing telephone numbers or accessing features.

The dial pad keys can also be used as memory-dialing locations. By pressing the PROGRAM button to enter program mode, the user can store a programmed number or access code on each of the 12 dial pad keys (memory-dialing locations). With the MEMORY button, the user can dial these programmed numbers.

Ringling

The 8503T voice terminal has electronic tone ringing with eight possible personalized ringing patterns that can be selected by pressing the PROGRAM button and then the CONF/RING button, while on-hook. Ringer volume is controlled by the Volume “arrow” button when the voice terminal is on-hook.

Jacks

The 8503T voice terminal housing contains three jacks. The Handset cord jack, for connecting the handset to the voice terminal, is located on the bottom of the housing, near the front of the voice terminal. The Line jack, for connecting the line cord to the voice terminal, is located on the bottom (left center) of the voice terminal. The Adjunct jack, which is located on the bottom of the voice terminal directly below the Line jack, is used for connecting optional adjunct equipment such as an S201A Speakerphone or a 500A Headset Adapter to the voice terminal.

Cords

Two cords are supplied with the 8503T voice terminal: a coiled 9-foot modular Handset cord and a 7-foot Line cord. An optional 12-foot Handset cord is available.

ROM cartridge

A ROM cartridge is installed in each voice terminal, but is easily removed and replaced so that the firmware can always be updated. The cartridge can be removed from the bottom of the housing by pressing the tab on the cartridge and then lifting it from the housing. The cartridge can be inserted into the housing by pressing the tab on the cartridge and then pressing it down into the bottom of the housing.

Mounting Options

The 8503T voice terminal comes equipped with a desk stand. However, the desk stand can be removed, and the voice terminal can be mounted on the wall.

Color

The 8503T voice terminal is available in AT&T black or AT&T white.

Distance Limitations

For DEFINITY G2 and G3, in which multipoint configuration is used, the maximum signaling distance possible from the port board to the work location jack is: (The terminating resistor should be within 250 feet of the work location; the distances listed are applicable for up to two voice terminals.)

- If 24 AWG cable is used = 1600 feet
- If 26 AWG cable is used = 1330 feet

Power Requirements

Phantom or Auxiliary Power

The 8503T voice terminal can receive power from the switch or from an auxiliary power supply. The installer can select the type of power used by setting two jumpers on the bottom of the voice terminal under a sliding plate between the Line jack and the Adjunct jack. A pictorial representation of the jumpers is located to the right of the sliding plate. These jumpers are labeled PHAN (phantom power) and AUX (auxiliary power). The voice terminal is shipped in the PHAN position. You must verify that the jumper settings are set correctly for your configuration.

Note: The power jumpers must be set *only* by qualified service personnel.

- PHAN (phantom power) should be selected when power is provided by the PBX. When the jumpers are set to PHAN, less than one Watt of power will be drawn from the switch to support normal operation.
- AUX (auxiliary power) should be selected when power is provided in the closet. When the jumpers are set to AUX, the 8503T voice terminal will operate on a nominal 40 or 48 Vdc, UL-listed Communications Circuit Power source.

Terminating Resistors

The terminating resistor jumpers are located on the bottom of the voice terminal under a sliding plate between the Line jack and Adjunct jack. These jumpers enable (ON) or bypass (OFF) the terminating resistor. The set is shipped with the jumpers in the OFF position bypassing the terminating resistor. You must verify that the jumper settings are set correctly for your configuration.

Note: The terminating resistor jumpers must be set *only* by qualified service personnel.

- The terminating resistor jumpers must be set to OFF when the set is in a point-to-point configuration and the terminating resistor is in the closet or a 440A4 is connected on the line.
- The terminating resistor jumpers must be set to ON when the set is in a point-to-point configuration and the terminating resistor is *not* in the closet or a 440A4 is *not* connected to the line.
- The terminating resistor jumpers must be set to OFF when the set is in a multipoint configuration and the terminating resistor is in the closet, a 440A4 is connected on the line, or the jumper is set to ON in one of the other sets on the line.
- The terminating resistor jumpers must be set to ON when the set is in a multipoint configuration and the terminating resistor is *not* in the closet, a 440A4 is not connected on the line, or the jumper is not set to ON in any of the other sets on the line.

Switch Administration

The 8503T voice terminal should be administered as an ISDN 7505 voice terminal.

Note: The three call appearance/feature buttons can be used for call appearances or features, but, for most effective use of the voice terminal, it is strongly suggested that all three buttons be administered for call appearances.

Power Failure Operation

The 8503T voice terminal cannot be used as an emergency station during power failure transfer conditions.

FCC Registration

The 8503T voice terminal is FCC registered.

Hearing Aid Compatible

This voice terminal is compatible with the inductively coupled hearing aids prescribed by the FCC.

8503T Equipment PECs and COMCODES

The 8503T voice terminal and optional components can be ordered with the following Price Element Codes (PECs) and COMCODES:

- **ISDN 8503T Voice Terminal**
PEC: 3114-001 (AT&T Black=COL09; AT&T White=COL10)
COMCODE: AT&T Black=106604341; AT&T White=106604358
- **Handset**
PEC: 31149 (Black=COL09; White=COL10)
COMCODE: Black=106050065; White=106053408
- **Handset cord (9 feet)**
COMCODE: Black=105635429; White=105701809
- **Handset cord (12 feet)**
PEC: 2725-01L (AT&T Black=COL09; AT&T White=COL10)
COMCODE: AT&T Black=102401445; AT&T White=104211339
- **Line cord (7 feet)**
PEC: 2725-07G
COMCODE: 103786778
- **Designation card**
PEC: 31140
COMCODE: 846558039.

Adjuncts

The following adjuncts can be used with the 8503T voice terminal:

- 500A Headset Adapter (and a standard headset; see “Headsets” below)
- S101A Speakerphone (no longer orderable)
- S201A Speakerphone

Headsets

A list of compatible headsets, consisting of both modular and plug prong base units and selection of headpieces, appears in “Headset Adapters” in the **Adjuncts** section (behind the **Adjuncts** tab) later in this manual.

Additional Documents

The following documents contain additional information relating to the 8503T voice terminal: (Use the 9-digit number listed after each document to order the book from the AT&T GBCS Publications Fulfillment Center.)

- *ISDN 8503T Voice Terminal User's Manual*, 555-021-726
- *DEFINITY Generic 3 ISDN 8503T Voice Terminal User's Guide*, 555-204-747
- *DEFINITY Generic 2 ISDN 8503T Voice Terminal User's Guide*, 555-104-747
- *Integrated Services Digital Network (ISDN) Terminal Installation and Tests*, 555-021-101

ISDN 8510T VOICE/DATA TERMINAL

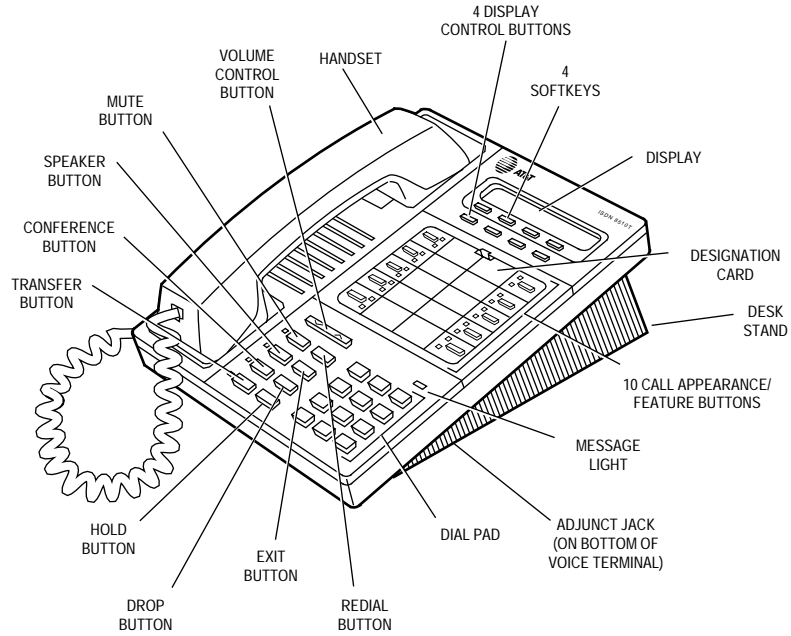

FIGURE 3-19. The ISDN 8510T Voice/Data Terminal

ISDN 8510T Voice/Data Terminal

The 8510T voice/data terminal is used with the Integrated Services Digital Network (ISDN) communication system through a 4-wire "T"-interface. The 8510T voice/data terminal offers the following: 10 call appearance/feature buttons, each with a red and green status light, buttons for the Mute, Redial, Conference, Drop, Transfer, and Hold features (the MUTE, SPEAKER, CONF, and TRANSFER buttons have a red light next to them), a Speakerphone which can also be optioned as a listen-only Speaker, a Volume control, the K-type handset which offers improved acoustic quality, an Adjunct jack for adjunct equipment, and touch-tone dialing. Four softkeys (the keys with arrows printed on them) and four display control buttons located below a 2-line by 24-character liquid crystal display can be used to access such features as a personal Directory, a Call Log which lists the most recent incoming and outgoing calls, the Self-Test feature, and a personalized ringing pattern for the terminal.

Applications

The 8510T voice/data terminal can be used with the DEFINITY G2 and G3. It can be used as a voice terminal, data terminal, or a video phone. For the last two applications, you will need to install a special (data or video) board in the 8510T voice terminal.

Physical Description

Dimensions

Note: The dimensions given here for the 8510T voice/data terminal are approximate.

Width = 7 3/4 inches

Depth (front to back) = 9 1/2 inches

Height (maximum with handset in place)

The desk-mounted model = 5 1/4 inches

The wall-mounted model = 4 1/2 inches

Nine Fixed Features

- CONF button
- DROP button
- TRANSFER button
- HOLD button
- MUTE button
- SPEAKER button
- EXIT button
- REDIAL button
- VOLUME control button

Message Light

The red Message light goes on when a message is left for the user. This light goes off when the user retrieves the message.

Call Appearance/Feature buttons

These 10 buttons are devoted *either* to handling incoming and outgoing calls (call appearances) and are labeled with the exchange (numbers) and extension number *or* they can be used as feature buttons to access voice features such as Call Forward or Send All Calls; these are labeled with the feature name. Each of these 10 call appearance/feature buttons has a red light, which indicates the selected line and a green light which indicates the status of that line or feature.

REDIAL button

With the Redial feature, the user can redial the telephone number last dialed from the dial pad. (The handset must be off-hook, or the speaker must be active.) Up to 37 digits can be redialed.

Speakerphone (Listen and Speak) Feature

The 8510T voice/data terminal is equipped with a built-in S201A-type speakerphone. The Speakerphone capability allows a user to engage in a hands-free 2-way conversation with the far-end party. The speakerphone can be turned off or on with the SPEAKER button; it can be muted with the MUTE button, and the volume can be controlled with the VOLUME “arrow” button.

With the softkeys, the user can adjust the speakerphone for optimal performance. The user hears a set of tones as the speakerphone performs an acoustic test of the environment. When the tones stop, the speakerphone has finished adjusting itself and is ready for use. The user should reset the speakerphone whenever the voice terminal (or the table or desk on which the terminal is situated) is moved to another place (even in the same room).

Speaker (Listen-only) Feature

The 8510T voice/data terminal can be optioned for the Speakerphone (listen and speak) *or* the Speaker (listen-only) feature. (The voice terminal is shipped with the Speakerphone setting in place.)

The Speaker (listen-only) capability allows a user to engage in a one-way conversation with the far-end. The user can only listen to the far-end; the user is not able to transmit his voice over the speaker. Use the SPEAKER button on the front of the voice terminal for turning on and off the speaker or speakerphone. To speak with the far-end, the user must use the handset. Lifting the handset turns off the speaker.

MUTE button

While on a call, the user can press the MUTE button (the red light next to the button goes on), so the user can converse with someone in the same room without the other party hearing the conversation. The user is placed in listen-only mode. To disable the feature, the user presses the MUTE button a second time (the red light goes off). The Mute function works only with the handset or with the built-in speakerphone.

EXIT button

The EXIT button is used for exiting a softkey feature and returning to Normal call-handling Mode.

VOLUME control button

When the user is on a call using the speakerphone, the VOLUME “arrow” button raises or lowers the volume on the speakerphone. Likewise, when the user is on a call using the handset, the VOLUME control changes the receive level of the handset. When the handset is on-hook and the speakerphone is off, this button raises or lowers the ringer volume and tones such as the confirmation and error tone.

Softkeys

The four buttons located below the display and labeled with arrows (), correspond to words on the display screen. Softkeys are used along with display control keys to access the following features:

- Setting the clock
- Setting the speakerphone
- Adding, editing, and deleting the numbers and associated names in the voice terminal Directory
- Viewing a Directory entry and then placing a call to the number currently shown on the display screen
- Using to quickly place a call to a number located in your Directory
- Using the Call Log to view incoming and/or outgoing calls
- Choosing to display an indicator when new calls are logged
- Locking and unlocking the Directory, Call Log, and all softkey functions
- Changing or removing your password
- Initiating a self-test of the voice terminal’s lights, ringer, buttons, and dial pad keys
- Selecting the contrast level for the display
- Selecting a personalized ringing pattern
- Setting the rate at which the display messages are shown on the screen
- Adding confirmation or error tones to display messages
- Setting the number of names on a Directory page
- On an 8510 voice/data terminal, setting data features (See page 6 for more information on data features)

Display control buttons

These four buttons are labeled **Menu**, **Dir**, **◀ Prev**, and **Next ▶** .

- **Menu** is used to access the main softkey menu.
- **Dir** allows you to quickly access Directory entries in order to place a call.
- **◀ Prev** and **Next ▶** can be used to help you go back and forth through menu options, to add, edit, or search for an entry in your Directory, and to view entries in your Call Log.

Other Physical Features

Handset

The 8510T is equipped with a K-type handset.

A K-type Noisy Environment Handset (PEC: 31052A) can also be purchased and connected to the 8510T terminal.

Dial pad

The 8510T is equipped with a standard 12-button touch-tone dial pad for dialing telephone numbers or accessing features. The letters “Q” and “Z” have been added to the appropriate dial pad keys for directory access, and the “5” button on your dial pad has raised bars for visually-impaired users.

Kickstand

The kickstand on the bottom of the terminal can be lifted from the desktop stand or can be left level with the bottom of the terminal. The user should check which kickstand adjustment allows the best viewing angle of the display.

Note: When the kickstand is raised or lowered, the speakerphone should be re-calibrated to compensate for the new position.

Ringling

The 8510T has electronic tone ringing with eight possible personalized ringing patterns that can be selected through the softkeys and the display control buttons. Ringer volume is controlled by the VOLUME “arrow” button when the terminal is on-hook.

Jacks

The 8510T voice/data terminal housing contains three jacks. The Handset cord jack, for connecting the handset to the terminal, is located on the bottom of the housing, near the front of the terminal. The Line jack, for connecting the line cord to the terminal, is located on the bottom (left center) of the terminal. The Adjunct jack, which is located on the bottom of the voice terminal directly below the Line jack, is used for connecting optional adjunct equipment such as an S201A Speakerphone or a 500A Headset Adapter to the terminal.

Note: When an ADB (board) is installed in the 8510T terminal for data operations, the RS232 jack is visible on the rear of the set for connecting data equipment. When a TMI board is installed in the 8510T, two jacks are visible on the rear of the set: the RS232 for the data connection and an 8-pin round connector for connection of a video cable.

Cords

Two cords are supplied with the 8510T: a coiled 9-foot modular Handset cord and a 7-foot Line cord. An optional 12-foot Handset cord is available.

ADB and TMI Boards

An Asynchronous Data Board (ADB) can be installed in the 8510T for data applications. A TMI (Telephone Multimedia Interface) board can be installed if the 8510T is to be used as a video terminal.

Mounting Options

The 8510T comes equipped with a desk stand. However, the desk stand can be removed, and the terminal can be mounted on the wall. If you choose to wall-mount the voice terminal, use the instructions included in the 8510T Voice Terminal Wall Mounting Kit (Comcode: 106614894).

Color

The 8510T is available in AT&T black or AT&T white.

Data Features

- Asynchronous full-duplex operation at data rates from 1200 bits per second (bps) to 57.6 kilobits per second (kbps) through an EIA-232 interface.
- Circuit switched data communication over 56 or 64 kbps facilities via industry standard V.120 rate adaption protocol.
- Circuit switched data communication over 64 kbps facilities via AT&T's Digital Multiplexed Interface (DMI) Mode 2 or Mode 3 rate adaption protocols.
- API allows a PC to control all aspects of the set's interaction with the user and with the network.
- The four softkeys and four display control buttons located below the liquid crystal display can be used to access data features such as view current options, change options, answer a data call, place a data call, reset a locked data set, and selecting to display a data indicator.
- A user friendly command interface with on-screen help, nine programmable named data memory numbers, and four programmable data option profiles.
- An expanded Hayes AT command set interface for compatibility with applications which require this command format.
- Remote and local loopback tests.

For more information about the data features on an 8500-Series terminal, see the *ISDN 8500 Series Display Terminal ADM User's Manual*, 555-021-730.

Distance Limitations

For DEFINITY G2, and G3, in which multipoint configuration is used, the maximum signaling distance possible from the port board to the work location jack is: (The terminating resistor should be within 250 feet of the work location; the distances listed are applicable for up to two voice/data terminals.)

- If 24 AWG cable is used = 1600 feet
- If 26 AWG cable is used = 1330 feet

Power Requirements

Phantom or Auxiliary Power

The 8510T can receive power from the switch or from an auxiliary power supply.

Note: A voice/data set should be auxiliary powered only.

The installer can select the type of power used by placing the two power jumpers over the correct set of pins.

The power option jumpers are located at the bottom center of the terminal. On the right side of the pins, on the plastic housing, you will see the label **POWER** and a diagram of the correct settings. The jumpers are labeled **PHAN** (phantom power) and **AUX** (auxiliary power). The terminal is shipped in the AUX position. You must verify that the jumper settings are set correctly for your configuration.

Note: The power jumpers must be set *only* by qualified service personnel.

- PHAN (phantom power) should be selected when power is provided by the PBX. When the jumpers are set to PHAN, in idle condition, less than one Watt of power will be drawn from the switch. The power option resistors are set to PHAN if each of the two jumpers covers the two top pins in each set. (The bottom pin in each set is left uncovered.)
- AUX (auxiliary power) should be selected when power is provided in the closet. When the jumpers are set to AUX, the 8510T will operate on a nominal 40 or 48 Vdc, UL-listed Communications Circuit Power source. The power option resistors are set to AUX if each of the two jumpers covers the two lower pins in each set. (The top pin in each set is left uncovered.)

Important: It is a requirement that 8510T voice only terminals in a multipoint configuration (two or more terminals per port) be auxiliary powered. If used **ONLY** in a point-to-point configuration (one terminal per port), 8510T terminals may be phantom powered. When used in a mixed point-to-point and multipoint configuration, all 8510T terminals **MUST** be auxiliary powered.

If a phantom powered 8510T is moved from an existing point-to-point to a multipoint configuration, the power jumper must be changed from PHAN to AUX, and the terminal connected to an auxiliary power source. The terminal will still work in the PHAN mode, but the power jumper must still be changed. Exceeding the phantom power capacity will trip the breaker in the carrier, causing a loss of service.

Recommended power supplies are the MSP-1 (local) Power Supply and the 1145A Bulk Power Supply.

Terminating Resistors

The terminating resistor jumpers are located on the upper left side on the bottom of the terminal. Above the pins, on the plastic housing, you will see the label **TERM RESISTOR** and a diagram of the correct settings.

These jumpers enable (ON) or bypass (OFF) the terminating resistor. The set is shipped with the jumpers in the OFF position bypassing the terminating resistor. You must verify that the jumper settings are set correctly for your configuration.

Note: The terminating resistor jumpers must be set *only* by qualified service personnel.

- The terminating resistor jumpers must be set to OFF when the set is in a point-to-point configuration and the terminating resistor is in the closet or a 440A4 is connected on the line. When set to OFF, each of the two terminating resistor jumpers covers the two top pins in each set. (The bottom pin in each set is left uncovered.)
- The terminating resistor jumpers must be set to ON when the set is in a point-to-point configuration and the terminating resistor is *not* in the closet or a 440A4 is *not* connected to the line. When set to ON, each of the two terminating resistor jumpers covers the two lower pins in each set. (The top pin in each set is left uncovered.)
- The terminating resistor jumpers must be set to OFF when the set is in a multipoint configuration and the terminating resistor is in the closet, a 440A4 is connected on the line, or the jumper is set to ON in one of the other sets on the line. When set to OFF, each of the two terminating resistor jumpers covers the two top pins in each set. (The bottom pin in each set is left uncovered.)
- The terminating resistor jumpers must be set to ON when the set is in a multipoint configuration and the terminating resistor is *not* in the closet, a 440A4 is *not* connected on the line, or the jumper is not set to ON in any of the other sets on the line. When set to ON, each of the two terminating resistor jumpers covers the two lower pins in each set. (The top pin in each set is left uncovered.)

Switch Administration

- An 8510T voice terminal connected to a DEFINITY G2 should be aliased as a 7507 voice terminal.
- An 8510T voice terminal connected to a DEFINITY G3 can be administered as itself.
- An 8510T data terminal connected to a DEFINITY G2 or G3 should be aliased as a 7507 with data.

Button Numbering

- When the terminal is connected to a DEFINITY G3, the 10 call appearance/feature buttons should be administered as “BUTTON ASSIGNMENTS” 1 through 10. The Normal feature (the Exit button) should be administered on Button #11.
- When the terminal is connected to a DEFINITY G2, the 10 call appearance/feature buttons should be administered as “BUTTON ASSIGNMENTS” 3 through 12. The Normal feature (the Exit button) should be administered on Button #13.

The Service Profiler ID (SPID)

When ISDN terminals are initially installed, a unique SPID number must be entered into the terminal. This number identifies the terminal to the network. Usually, the system manager provides the SPID for each terminal in the system. Use the following procedure for entering the SPID in an ISDN 8510T terminal.

1. Press and then press .
2. Dial the numbers, “43” (ID).
3. Press on the dial pad.
4. Enter digits from the dial pad for a new SPID number. If, at any point, you make a mistake, press to erase the number and re-enter the SPID.
5. When the SPID number is correct, press on the dial pad to save the new SPID in the terminal.

Hidden/Craft Features

The *ISDN Terminals Installation and Tests Manual*, Issue 3, 555-021-101, contains information on completing the following tasks for the ISDN 8510T voice/data terminal:

- How to enable or disable the listen-only speaker or the speakerphone
- How to enable Selectable Ring Preference
- How to clear all parameters stored in memory
- How to clear a user's password
- How to set a password known only by the system manager
- How to send or disable Button Number 11

Power Failure Operation

The 8510T cannot be used as an emergency station during power failure transfer conditions.

FCC Registration

The 8510T voice/data terminal is FCC registered as a Class A terminal.

Hearing Aid Compatible

This terminal is compatible with the inductively coupled hearing aids as required by the FCC.

8510T Equipment PECs and COMCODES

The 8510T voice/data terminal and optional components can be ordered with the following Price Element Codes (PECs) and COMCODES:

- **ISDN 8510T Voice Terminal**
 PEC: 3117-001 (AT&T Black=COL09; AT&T White=COL10)
 COMCODE: AT&T Black=106604382; AT&T White=106604390
- **ISDN 8510T Data Terminal**
 PEC: 3117-002 (AT&T Black=COL09; AT&T White=COL10)
 COMCODE: AT&T Black=106604424; AT&T White=106604432
- **ISDN 8510T TMI Terminal**
 COMCODE: AT&T Black=106899982; AT&T White=106899990
- **Handset**
 PEC: 31149 (Black=COL09; White=COL10)
 COMCODE: Black=106050065; White=106053408
- **Handset for Noisy Environments**
 PEC: 31052A (Black=COL09; White=COL10)
- **Handset cord (9 feet)**
 COMCODE: Black=105635429; White=105701809
- **Handset cord (12 feet)**
 PEC: 2725-01L (AT&T Black=COL09; AT&T White=COL10)
 COMCODE: AT&T Black=102401445; AT&T White=104211339
- **Line cord (7 feet)**
 PEC: 2725-07G
 COMCODE: 103786778
- **Designation card**
 PEC: 31170
 COMCODE: 847065467 (package of six 8 1/2" by 11" cards, 67 sheets)
 846819530 (package of tractor feed 9 8" by 17" cards, 34 sheets,
 to be used with LabelMaster)
- **8510 Data Upgrade Kit**
 PEC: 32254A
 COMCODE: 106811979

Adjuncts

The following adjuncts can be used with the 8510T voice/data terminal:

- 500A Headset Adapter (and a standard headset; see “Headsets” below)
- S101A Speakerphone (no longer orderable)
- S201A Speakerphone

Headsets

A list of compatible headsets, consisting of both modular and plug prong base units and selection of headpieces, appears in “Headset Adapters” in the **Adjuncts** section (behind the **Adjuncts** tab) later in this manual.

Additional Documents

The following documents contain additional information relating to the 8510T voice/data terminal: (Use the 9-digit number listed after each document to order that book from the AT&T GBCS Publications Fulfillment Center.)

- *ISDN 8510T Voice Terminal User's Manual*, 555-021-736
- *ISDN 8510T Voice Terminal Quick Reference Guide*, 555-021-735
- *ISDN 8510T Voice Terminal Instructions for Changing the Jumper Settings for the Terminating Resistors and for AUX and PHAN Power Options*, 555-021-738
- *ISDN 8510T Voice Terminal Instructions for Installing the Asynchronous Data Board (ADM) or Telephone Multimedia Interface (TMI) Board*, 555-021-754
- *DEFINITY Generic 3 ISDN 8510T Voice Terminal User's Guide*, 555-230-748
- *ISDN 8500 Series Display Terminal ADM User's Manual*, 555-021-730
- *Integrated Services Digital Network (ISDN) Terminals Installation and Tests*, 555-021-101
- *ISDN Application Programming Interface (API) Programmer's Reference Manual*, 533-705-200.

ISDN 8520T VOICE/DATA TERMINAL

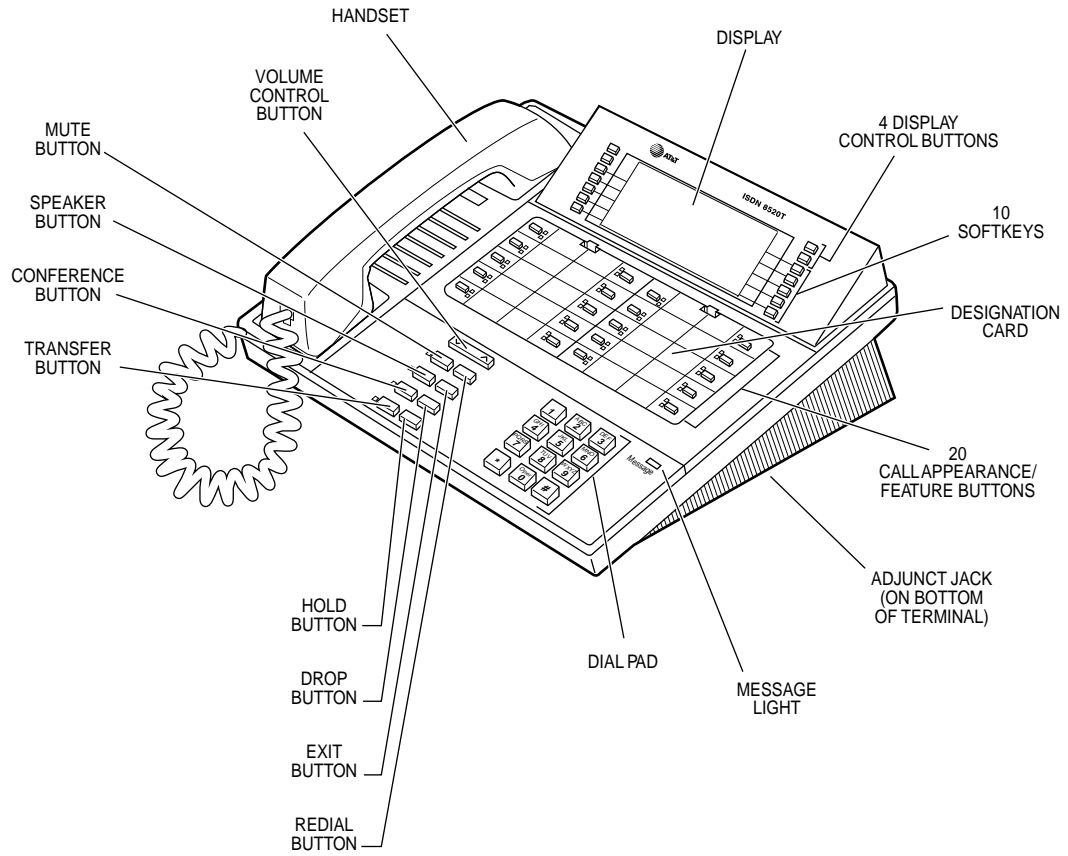

FIGURE 3-20. The ISDN 8520T Voice/Data Terminal

ISDN 8520T Voice/Data Terminal

The 8520T voice/data terminal is used with the Integrated Services Digital Network (ISDN) communication system through a 4-wire "T"-interface. The 8520T voice/data terminal offers the following: 20 call appearance/feature buttons, each with a red and green status light, buttons for the Mute, Redial, Conference, Drop, Transfer, and Hold features (the MUTE, SPEAKER, CONF, and TRANSFER buttons have a red light next to them), a Speakerphone which can also be optioned as a listen-only Speaker, a Volume control, improved acoustic quality with the K-type handset, an Adjunct jack for adjunct equipment, and touch-tone dialing. Ten softkeys and four display control buttons located on either side of the 7-line by 24-character liquid crystal display can be used to access such features as a personal Directory, a Call Log which lists the most recent incoming and outgoing calls, the Self-Test feature, and a personalized ringing pattern for the voice/data terminal.

Applications

The 8520T voice/data terminal can be used with the DEFINITY G2 and G3. It can be used as a voice terminal or a data terminal.

Physical Description

Dimensions

Note: The dimensions given here for the 8520T voice/data terminal are approximate.

Width = 11 1/2 inches

Depth (front to back) = 10 1/4 inches

Height (maximum with handset in place) = 5 3/8 inches

Nine Fixed Features

- CONF button
- DROP button
- TRANSFER button
- HOLD button

- MUTE button
- SPEAKER button
- EXIT button
- REDIAL button
- VOLUME button

Message Light

The red Message light goes on when a message is left for the user. This light goes off when the user retrieves the message.

Call Appearance/Feature buttons

These 20 buttons are devoted *either* to handling incoming and outgoing calls (call appearances) and are labeled with the exchange (numbers) and extension number *or* they can be used as feature buttons to access voice features such as Call Forward or Send All Calls; these are labeled with the feature name. Each of these 20 call appearance/feature buttons has a red light, which indicates the selected line, and a green light which indicates the status of that line or feature.

REDIAL button

With the Redial feature, the user can redial the telephone number last dialed from the dial pad. (The handset must be off-hook, or the speaker must be active.) Up to 37 digits can be redialed.

Speakerphone (Listen and Speak) Feature

The 8520T voice/data terminal is equipped with a built-in S201A-type speakerphone. The Speakerphone capability allows a user to engage in a hands-free 2-way conversation with the far-end party. The speakerphone can be turned off or on with the SPEAKER button; it can be muted with the MUTE button, and the volume can be controlled with the VOLUME “arrow” button.

With the softkeys, the user can adjust the speakerphone for optimal performance. The user hears a set of tones as the speakerphone performs an acoustic test of the environment. When the tones stop, the speakerphone has finished adjusting itself and is ready for use. The user should reset the speakerphone whenever the voice/data terminal (or the table or desk on which the terminal is situated) is moved to another place (even in the same room).

Speaker (Listen-only) Feature

The 8520T voice/data terminal can be optioned for the Speakerphone (listen and speak) or the Speaker (listen-only) feature. (The terminal is shipped with the Speakerphone setting in place.)

The Speaker (listen-only) capability allows a user to engage in a one-way conversation with the far-end. The user can only listen to the far-end; the user is not able to transmit his voice over the speaker. Use the SPEAKER button on the front of the terminal for turning on and off the speaker or speakerphone. To speak with the far-end, the user must use the handset. Lifting the handset turns off the speaker.

MUTE button

While on a call, the user can press the MUTE button (the red light next to the button goes on), so the user can converse with someone in the same room without the other party hearing the conversation. The user is placed in listen-only mode. To disable the feature, the user presses the MUTE button a second time (the red light goes off). The Mute function works only with the speakerphone and the handset.

EXIT button

The EXIT button is used for exiting a softkey feature and returning to the user-selected Home Screen. The top two lines again show you the time and date and any relevant system information.

VOLUME control button

When the user is on a call using the speakerphone, the VOLUME “arrow” button raises or lowers the volume on the speakerphone. Likewise, when the user is on a call using the handset, the VOLUME control button changes the receive level of the handset. When the handset is on-hook and the speakerphone is off, this button raises or lowers the ringer volume or tones such as the confirmation or error tone.

Softkeys

The 10 unlabeled buttons located on both sides of the display correspond to words on the display screen. Softkeys are used along with display control keys to access the following features:

- Setting the clock
- Setting the speakerphone
- Adding, editing, and deleting the numbers and associated names (and optional group names) in the voice terminal Directory

- Organizing your Directory in alphabetical order or by group name, renaming a group, and moving Directory entries from one group into another
- Searching the Directory for a particular entry, by name or by number, and then placing a call to the number currently shown on the display screen
- Viewing the contents of your Directory, and then editing, deleting, or placing a call to the number currently shown on the display screen
- Using to quickly place a call to a number located in your Directory
- Using the Call Log to view incoming and/or outgoing calls
- Choosing to display an indicator when new calls are logged
- Locking and unlocking any Directory Changes, the Call Log, and all Softkey functions
- Changing or removing your password
- Selecting a home screen, which your display will return to whenever you press
- Initiating a self-test of the voice/data terminal's lights, ringer, buttons, and display
- Selecting the contrast level for the display
- Selecting a personalized ringing pattern
- Selecting the type of display messages shown on the display screen (all messages or only error messages) and setting the rate at which the display messages are shown
- Adding confirmation or error tones to display messages
- Setting the number of names on a Directory page
- Providing Service Information if the terminal is used for data functions
- Choosing if and when the speaker becomes active while placing a voice call using your PC

Display control buttons

These four buttons are labeled **Menu**, **Dir**, **◀ Prev**, and **Next ▶**.

- is used to access the main softkey menu.
- allows you to quickly access Directory entries in order to place a call.
- and can be used to help you go back and forth through menu options, to add, edit, or search for an entry in your Directory, and to view entries in your Call Log.

Other Physical Features

Handset

The 8520T voice/data terminal is equipped with a K-type handset.

A K-type Noisy Environment Handset (PEC: 31052A) can also be purchased and connected to the 8520T terminal.

Dial pad

The 8520T is equipped with a standard 12-button touch-tone dial pad for dialing telephone numbers or accessing features. The letters “Q” and “Z” have been added to the appropriate dial pad keys for directory access, and the “5” button on your dial pad has raised bars for visually-impaired users.

Ringling

The 8520T has electronic tone ringing with eight possible personalized ringing patterns that can be selected through the softkeys and the display control buttons. Ringer volume is controlled by the VOLUME “arrow” button when the terminal is on-hook.

Jacks

The 8520T housing contains three jacks. The Handset cord jack, for connecting the handset to the voice/data terminal, is located on the bottom of the housing, near the front of the terminal. The Line jack, for connecting the line cord to the 8520T, is located on the bottom (left center) of the set. The Adjunct jack, which is located on the bottom of the set directly below the Line jack, is used for connecting optional adjunct equipment such as an S201A Speakerphone or a 500A Headset Adapter to the voice/data terminal.

The RS232 jack on the rear of the set can be used for connecting data equipment.

Cords

Two cords are supplied with the 8520T voice/data terminal: a coiled 9-foot modular Handset cord and a 7-foot Line cord. An optional 12-foot Handset cord is available.

Mounting Options

The 8520T comes equipped with a desk stand. This voice/data terminal cannot be wall-mounted.

Color

The 8520T is available in AT&T black or AT&T white.

Data Features

- Asynchronous full-duplex operation at data rates from 1200 bits per second (bps) to 57.6 kilobits per second (kbps) through an EIA-232 interface.
- X.25 packet switched data communication including receipt of X.29 commands from a remote X.25 host for setting packet switched data parameters.
- Circuit switched data communication over 56 or 64 kbps facilities via industry standard V.120 rate adaption protocol.
- Circuit switched data communication over 64 kbps facilities via AT&T's Digital Multiplexed Interface (DMI) Mode 2 or Mode 3 rate adaption protocols.
- API allows a PC to control all aspects of the set's interaction with the user and with the network.
- The 10 softkeys and four display control buttons located to the left and right of the liquid crystal display can be used to access data features such as view current options, change options, answer a data call, place a data call, reset a locked data set, and selecting to display a data indicator. Note, the first two lines of the 7-line display contain switch information; the remaining five lines contain softkey information.
- A user-friendly command interface with on-screen help, nine programmable named data memory numbers, and four programmable data option profiles.
- An expanded Hayes AT command set interface for compatibility with applications which require this command format.
- Remote and local loopback tests.

For more information about the data features on an 8500-Series terminal, see the *ISDN 8500 Series Display Terminal ADM User's Manual*, 555-021-730.

Distance Limitations

For DEFINITY G2 and G3, in which multipoint configuration is used, the maximum signaling distance possible from the port board to the work location jack is: (the terminating resistor should be within 250 feet of the work location; the distances listed are applicable for up to two voice/data terminals)

- If 24 AWG cable is used = 1600 feet
- If 26 AWG cable is used = 1330 feet

Power Requirements

Auxiliary Power Supply

The 8520T needs auxiliary power from an auxiliary power supply. Recommended power supplies are the MSP-1 (local) Power Supply and the 1145A Bulk Power Supply.

Terminating Resistor

The terminating resistor setting must be set by either a service representative or the system administrator.

- The terminating resistor setting should be set to OUT when the voice/data terminal is in a point-to-point configuration and the terminating resistor is in the closet.
- The terminating resistor setting on the terminal should be set to IN when the voice/data terminal is in a point-to-point configuration and the terminating resistor is *not* in the closet.
- When terminals are part of a multipoint configuration and the terminating resistor is in the closet, all sets should be set to OUT.
- When the terminating resistor is *not* in the closet and the terminals are part of a multipoint configuration, only one of the sets in this configuration needs to be set to IN. All the rest of the sets in this configuration should be set to OUT.

To change the terminating resistor setting, do the following:

1. Press and then .
2. Dial the numbers "87" (TR).

3. The display screen shows you the current terminating resistor setting (IN or OUT). Use the softkeys to toggle between the two settings, whichever is correct for that terminal.
4. When the correct setting is shown on the display screen, press the softkey beside **Done**.

Switch Administration

An 8520T voice/data terminal connected to a DEFINITY G2, G3i, or G3r should be aliased as a 7507 with data.

Button Numbering

- When the terminal is connected to a DEFINITY G3, the 20 call appearance/feature buttons should be administered as “BUTTON ASSIGNMENTS” 1 through 20.

Note: On a DEFINITY G3 switch, the Normal or Exit feature should be administered on Button #21.

- When the terminal is connected to a DEFINITY G2, the call appearance/feature buttons should be administered as “BUTTON ASSIGNMENTS” 3 through 22.

The Service Profiler ID (SPID)

When ISDN terminals are initially installed, a unique SPID number must be entered into the terminal. This number identifies the terminal to the network. Usually, the system manager provides the SPID for each terminal in the system. Use the following procedure for entering the SPID in an ISDN 8520T terminal.

1. Press and then press .
2. Dial the numbers, “43” (ID).
3. Press on the dial pad.
4. Enter digits from the dial pad for a new SPID number. If, at any point, you make a mistake, press to erase the number and re-enter the SPID.
5. When the SPID number is correct, press on the dial pad to save the new SPID in the terminal.

Hidden/Craft Features

For information on the hidden or craft features, those features that can be done only by qualified service personnel, use the procedures listed for the 8510T terminal in the *ISDN Terminals Installation and Tests Manual*, Issue 3, 555-021-101. The section titled **ISDN 8500-Series T-Interface Terminals** in that manual contains information on completing the following tasks for the ISDN 8510T voice/data terminal (the procedures for these tasks can also be used for the 8520T):

- How to enable or disable the listen-only speaker or the speakerphone
- How to enable Selectable Ring Preference
- How to clear all parameters stored in memory
- How to clear a user's password
- How to clear a password known by the system administrator
- How to send or disable Button Number 11

Power Failure Operation

The 8520T cannot be used as an emergency station during power failure transfer conditions.

FCC Registration

The 8520T voice/data terminal is FCC registered as a Class A terminal.

Hearing Aid Compatible

This voice/data terminal is compatible with the inductively coupled hearing aids as required by the FCC.

8520T Equipment PECs and COMCODES

The 8520T voice/data terminal and optional components can be ordered with the following Price Element Codes (PECs) and COMCODES:

- **ISDN 8520T Voice Terminal**
PEC: 3116-001 (AT&T Black=COL09; AT&T White=COL10)
COMCODE: AT&T Black=106906431; AT&T White=106906449

- **Handset**
PEC: 31149 (Black=COL09; White=COL10)
COMCODE: Black=106050065; White=106053408
- **Handset for Noisy Environments**
PEC: 31052A (Black=COL09; White=COL10)
- **Handset cord (9 feet)**
COMCODE: Black=105635429; White=105701809
- **Handset cord (12 feet)**
PEC: 2725-01L (AT&T Black=COL09; AT&T White=COL10)
COMCODE: AT&T Black=102401445; AT&T White=104211339
- **Line cord (7 feet)**
PEC: 2725-07G
COMCODE: 103786778
- **Designation cards**
 - 6 sheets (each sheet has enough designation cards for 6 sets)
COMCODE: 847244274
 - 18 sheets (each sheet has enough designation cards for 6 sets)
COMCODE: 847244282
 - 68 sheets (each sheet has enough designation cards for 6 sets)
COMCODE: 847244290

Adjuncts

The following adjuncts can be used with the 8520T terminal:

- 500A Headset Adapter (and a standard headset; see “Headsets” below)
- S101A Speakerphone (no longer orderable)
- S201A Speakerphone

Headsets

A list of compatible headsets, consisting of both modular and plug prong base units and selection of headpieces, appears in “Headset Adapters” in the **Adjuncts** section (behind the **Adjuncts** tab) later in this manual.

Additional Documents

The following documents contain additional information relating to the 8520T voice/data terminal: (Use the 9-digit number listed after each document to order that book from the AT&T GBCS Publications Fulfillment Center.)

- *ISDN 8520T Voice Terminal User's Manual*, 555-021-758
- *DEFINITY Generic 3 ISDN 8520T Voice Terminal User's Guide*, 555-230-767
- *ISDN 8500 Series Display Terminal ADM User's Manual*, 555-021-730
- *ISDN Application Programming Interface (API) Programmer's Reference Manual*, 533-705-200.

ISDN 8528T VOICE TERMINAL

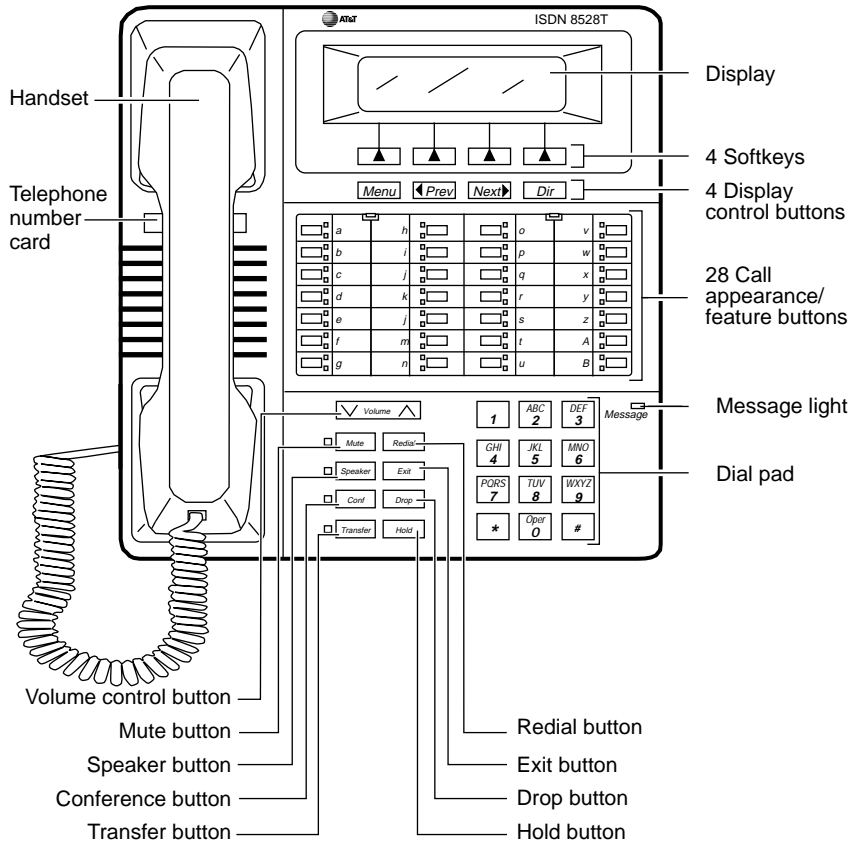

FIGURE 3-21. The ISDN 8528T Voice Terminal

ISDN 8528T Voice Terminal

The 8528T voice terminal is used with the Integrated Services Digital Network (ISDN) communication system through a 4-wire "T"-interface. The 8528T voice terminal offers the following: 28 call appearance/feature buttons, each with a red and green status light, buttons for the Mute, Redial, Conference, Drop, Transfer, and Hold features (the MUTE, SPEAKER, CONF, and TRANSFER buttons have a red light next to them), a Speakerphone which can also be optioned as a listen-only Speaker, a Volume control, the K-type handset which offers improved acoustic quality, an Adjunct jack for adjunct equipment, and touch-tone dialing. Four softkeys (the keys with arrows printed on them) and four display control buttons located below a 2-line by 24-character liquid crystal display can be used to access such features as a personal Directory, a Call Log which lists the most recent incoming and outgoing calls, the Self-Test feature, and a personalized ringing pattern for the terminal.

Applications

The 8528T voice terminal can be used with the DEFINITY G2 and G3.

Physical Description

Dimensions

Note: The dimensions given here for the 8528T voice terminal are approximate.

Width = 11 3/4 inches

Depth (front to back) = 10 3/8 inches

Height (with handset in place) = 5 1/2 inches

Nine Fixed Features

- CONF button
- DROP button
- TRANSFER button
- HOLD button
- MUTE button

- SPEAKER button
- EXIT button
- REDIAL button
- VOLUME control button

Message Light

The red Message light goes on when a message is left for the user. This light goes off when the user retrieves the message.

Call Appearance/Feature buttons

These 28 buttons are devoted *either* to handling incoming and outgoing calls (call appearances) and are labeled with the exchange (numbers) and extension number *or* they can be used as feature buttons to access voice features such as Call Forward or Send All Calls; these are labeled with the feature name. Each of these 10 call appearance/feature buttons has a red light, which indicates the selected line and a green light which indicates the status of that line or feature.

REDIAL button

With the Redial feature, the user can redial the telephone number last dialed from the dial pad. (The handset must be off-hook, or the speaker must be active.) Up to 37 digits can be redialed.

Speakerphone (Listen and Speak) Feature

The 8528T voice terminal is equipped with a built-in S201A-type speakerphone. The Speakerphone capability allows a user to engage in a hands-free 2-way conversation with the far-end party. The speakerphone can be turned off or on with the SPEAKER button; it can be muted with the MUTE button, and the volume can be controlled with the VOLUME “arrow” button.

With the softkeys, the user can adjust the speakerphone for optimal performance. The user hears a set of tones as the speakerphone performs an acoustic test of the environment. When the tones stop, the speakerphone has finished adjusting itself and is ready for use. The user should reset the speakerphone whenever the voice terminal (or the table or desk on which the terminal is situated) is moved to another place (even in the same room).

Speaker (Listen-only) Feature

The 8528T voice terminal can be optioned for the Speakerphone (listen and speak) or the Speaker (listen-only) feature. (The voice terminal is shipped with the Speakerphone setting in place.)

The Speaker (listen-only) capability allows a user to engage in a one-way conversation with the far-end. The user can only listen to the far-end; the user is not able to transmit his voice over the speaker. Use the SPEAKER button on the front of the voice terminal for turning on and off the speaker or speakerphone. To speak with the far-end, the user must use the handset. Lifting the handset turns off the speaker.

MUTE button

While on a call, the user can press the MUTE button (the red light next to the button goes on), so the user can converse with someone in the same room without the other party hearing the conversation. The user is placed in listen-only mode. To disable the feature, the user presses the MUTE button a second time (the red light goes off). The Mute function works only with the handset or with the built-in speakerphone.

EXIT button

The EXIT button is used for exiting a softkey feature and returning to Normal call-handling Mode.

VOLUME control button

When the user is on a call using the speakerphone, the VOLUME “arrow” button raises or lowers the volume on the speakerphone. Likewise, when the user is on a call using the handset, the VOLUME control changes the receive level of the handset. When the handset is on-hook and the speakerphone is off, this button raises or lowers the ringer volume and tones such as the confirmation and error tone.



Softkeys

The four buttons located below the display and labeled with arrows (), correspond to words on the display screen. Softkeys are used along with display control keys to access the following features:

- Setting the clock
- Setting the speakerphone
- Adding, editing, and deleting the numbers and associated names in the voice terminal Directory
- Viewing a Directory entry and then placing a call to the number currently shown on the display screen
- Using  to quickly place a call to a number located in your Directory
- Using the Call Log to view incoming and/or outgoing calls
- Choosing to display an indicator when new calls are logged
- Locking and unlocking the Directory, Call Log, and all softkey functions
- Changing or removing your password
- Initiating a self-test of the voice terminal's lights, ringer, buttons, and dial pad keys
- Selecting the contrast level for the display
- Selecting a personalized ringing pattern
- Setting the rate at which the display messages are shown on the screen
- Adding confirmation or error tones to display messages
- Setting the number of names on a Directory page

Display control buttons

These four buttons are labeled **Menu**, **Dir**, **◀ Prev**, and **Next ▶** .

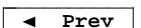
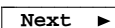
-  is used to access the main softkey menu.
-  allows you to quickly access Directory entries in order to place a call.
-  and  can be used to help you go back and forth through menu options, to add, edit, or search for an entry in your Directory, and to view entries in your Call Log.

Other Physical Features

Handset

The 8528T is equipped with a K-type handset.

A K-type Noisy Environment Handset (PEC: 31052A) can also be purchased and connected to the 8528T terminal.

Dial pad

The 8528T is equipped with a standard 12-button touch-tone dial pad for dialing telephone numbers or accessing features. The letters “Q” and “Z” have been added to the appropriate dial pad keys for directory access, and the “5” button on your dial pad has raised bars for visually-impaired users.

Ringling

The 8528T has electronic tone ringing with eight possible personalized ringing patterns that can be selected through the softkeys and the display control buttons. Ringer volume is controlled by the VOLUME “arrow” button when the terminal is on-hook.

Jacks

The 8528T voice terminal housing contains three jacks. The Handset cord jack, for connecting the handset to the terminal, is located on the bottom of the housing, near the front of the terminal. The Line jack, for connecting the line cord to the terminal, is located on the bottom (left center) of the terminal. The Adjunct jack, which is located on the bottom of the voice terminal directly below the Line jack, is used for connecting optional adjunct equipment such as an S201A Speakerphone or a 500A Headset Adapter to the terminal.

Cords

Two cords are supplied with the 8528T: a coiled 9-foot modular Handset cord and a 7-foot Line cord. An optional 12-foot Handset cord is available.

Mounting Options

The 8528T comes equipped with a desk stand. The terminal cannot be mounted on the wall.

Color

The 8528T is available in AT&T black or AT&T white.

Distance Limitations

For DEFINITY G2, and G3, in which multipoint configuration is used, the maximum signaling distance possible from the port board to the work location jack is: (The terminating resistor should be within 250 feet of the work location; the distances listed are applicable for up to two voice terminals.)

- If 24 AWG cable is used = 1600 feet
- If 26 AWG cable is used = 1330 feet

Power Requirements

The 8510T can receive power from the switch or from an auxiliary power supply.

If a power supply is needed, recommended power supplies are the MSP-1 (local) Power Supply and the 1145A Bulk Power Supply.

Switch Administration

- An 8528T voice terminal connected to a DEFINITY G2 should be aliased as a 7507 voice terminal.
- An 8528T voice terminal connected to a DEFINITY G3 can be administered as itself.

Button Numbering

- When the terminal is connected to a DEFINITY G3, the 10 call appearance/feature buttons should be administered as “BUTTON ASSIGNMENTS” 1 through 28. The Normal feature (the Exit button) should be administered on Button #29.
- When the terminal is connected to a DEFINITY G2, the 10 call appearance/feature buttons should be administered as “BUTTON ASSIGNMENTS” 3 through 30. The Normal feature (the Exit button) should be administered on Button #31.

The Service Profiler ID (SPID)

When ISDN terminals are initially installed, a unique SPID number must be entered into the terminal. This number identifies the terminal to the network. Usually, the system manager provides the SPID for each terminal in the system. Use the following procedure for entering the SPID in an ISDN 8528T terminal.

1. Press and then press .
2. Dial the numbers, "43" (ID).
3. Press on the dial pad.
4. Enter digits from the dial pad for a new SPID number. If, at any point, you make a mistake, press to erase the number and re-enter the SPID.
5. When the SPID number is correct, press on the dial pad to save the new SPID in the terminal.

Power Failure Operation

The 8528T cannot be used as an emergency station during power failure transfer conditions.

FCC Registration

The 8528T voice terminal is FCC registered as a Class A terminal.

Hearing Aid Compatible

This terminal is compatible with the inductively coupled hearing aids as required by the FCC.

8528T Equipment PECs and COMCODES

The 8528T voice terminal and optional components can be ordered with the following Price Element Codes (PECs) and COMCODES:

- **ISDN 8528T Voice Terminal**
PEC: 3xxx-001 (AT&T Black=COL09; AT&T White=COL10)
COMCODE: AT&T Black=107344509; AT&T White=107344517

- **Handset**
PEC: 31149 (Black=COL09; White=COL10)
COMCODE: Black=106050065; White=106053408
- **Handset for Noisy Environments**
PEC: 31052A (Black=COL09; White=COL10)
- **Handset cord (9 feet)**
COMCODE: Black=105635429; White=105701809
- **Handset cord (12 feet)**
PEC: 2725-01L (AT&T Black=COL09; AT&T White=COL10)
COMCODE: AT&T Black=102401445; AT&T White=104211339
- **Line cord (7 feet)**
PEC: 2725-07G
COMCODE: 103786778
- **Designation card**
PEC: 31170
COMCODE: 847065467 (package of six 8 1/2" by 11" cards, 67 sheets)
846819530 (package of tractor feed 9 8" by 17" cards, 34 sheets,
to be used with LabelMaster)
- **8510 Data Upgrade Kit**
PEC: 32254A
COMCODE: 106811979

Adjuncts

The following adjuncts can be used with the 8528T voice terminal:

- 500A Headset Adapter (and a standard headset; see "Headsets" below)
- S101A Speakerphone (no longer orderable)
- S201A Speakerphone

Headsets

A list of compatible headsets, consisting of both modular and plug prong base units and selection of headpieces, appears in "Headset Adapters" in the **Adjuncts** section (behind the **Adjuncts** tab) later in this manual.

Additional Documents

The following documents contain additional information relating to the 8528T voice terminal: (Use the 9-digit number listed after each document to order that book from the AT&T GBCS Publications Fulfillment Center.)

- *ISDN 8528T Voice Terminal User's Manual*, 555-021-776
- *DEFINITY Generic 3 ISDN 8528T Voice Terminal User's Guide*, 555-230-748
- *ISDN 8500 Series Display Terminal ADM User's Manual*, 555-021-730
- *Integrated Services Digital Network (ISDN) Terminals Installation and Tests*, 555-021-101
- *ISDN Application Programming Interface (API) Programmer's Reference Manual*, 533-705-200.

MDC 9000 CORDLESS TELEPHONE

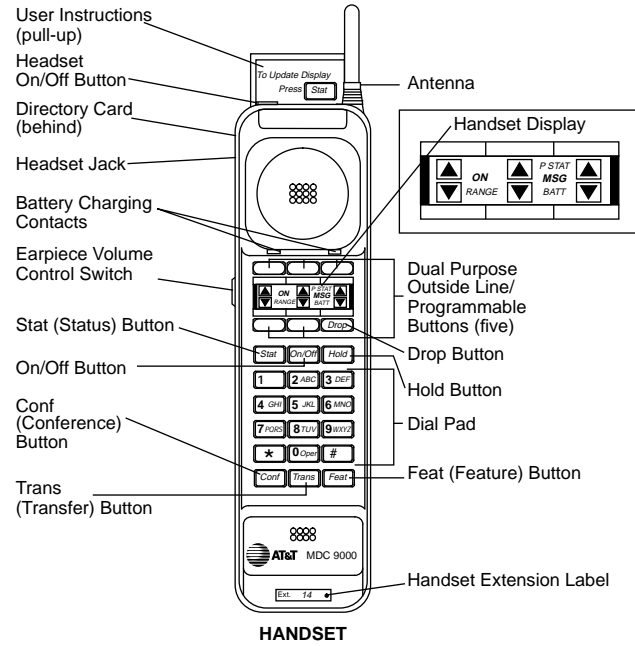

FIGURE 3-22. MDC 9000 Telephone, Top View of Handset, including Enlarged Display Area

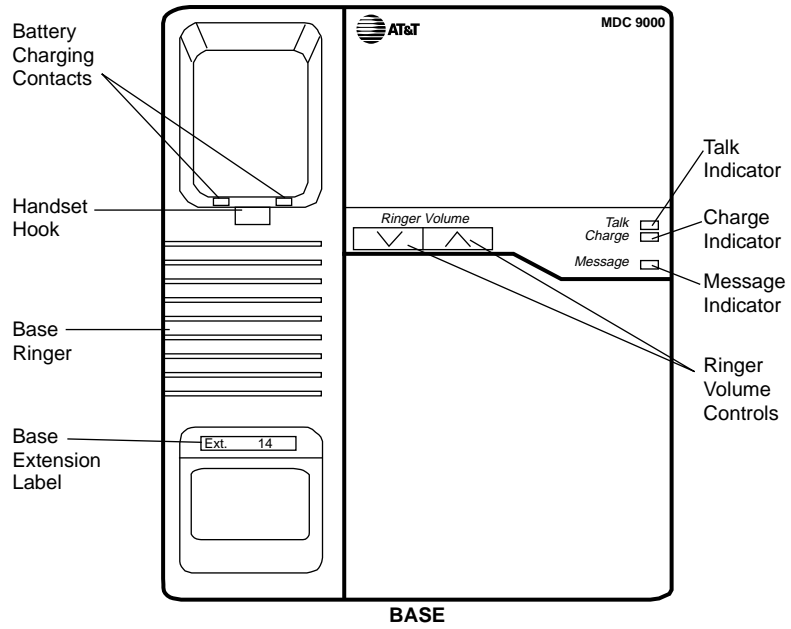

FIGURE 3-23. MDC 9000 Telephone, Top View of Charging Base

MDC 9000 Cordless Telephone

The MDC 9000 Cordless Telephone has two basic parts, the handset and the charging base.

- The handset has line/programmable feature/intercom buttons, Conference, Drop, Hold, Transfer, Status, and Feature buttons, Headset On/Off and Handset On/Off buttons, a LCD display, an earpiece volume control switch, battery charging contacts, a directory card, and a headset jack.
- The charging base has a handset hook, ringer volume controls, battery charging contacts, a Talk indicator, a Charge indicator, a Message indicator, and a base ringer.

In order to provide you with the freedom of mobility, the MDC 9000 is not connected physically (by a line cord or wire from the handset) to the DEFINITY system (or System 75 or System 85). Instead, the MDC 9000 handset communicates by way of a radio link to its radio base, which connects to the telephone system.

Applications

The MDC 9000 Wireless Telephone can be used with the DEFINITY Communication System G1, G2, G3, System 75, and System 85.

Physical Features

Dimensions

Note: The dimensions described here for the MDC 9000 handset and charging base are approximate.

For the Handset:

Width = 2.44 inches

Length = 12.1 inches

Height = 2.3 inches

For the Charging Base:

Width = 7.52 inches

Length = 9.4 inches

Height = 3.43 inches

Handset Features

Fixed Feature Buttons

The MDC 9000 has the following eight fixed feature buttons:

- CONFERENCE (labeled CONF) button
- DROP button
(The DROP button is NOT labeled. It is located in the lower right corner of the LCD display.)
- TRANSFER (labeled TRANS) button
- HOLD button
- FEATURE button (labeled FEAT)
(The FEAT button is not used.)
- STATUS (labeled STAT) button
- Headset On/Off button
- (Handset) ON/OFF button

Outside Line or Intercom/ Programmable Feature Buttons

When labeled with an extension number, these buttons indicate lines used for incoming and outgoing calls (call appearances) and for using the telephone as an intercom; when programmed and labeled with feature names, these buttons access features (feature buttons). In use, the light next to that button is lit; when a call is on hold, it winks.

STAT Button

The Status button (labeled STAT) is used to update all handset visuals if pressed when the STAT indicator appears (the handset is on), and to turn on the display when the handset is off.

(Handset) ON/OFF Button

This button is used for turning the handset on and off. (This button can also turn the headset on and off.)

Headset (ON/OFF Button)

This button is used for turning the headset on and off.

LCD Display

The display provides information on line status, whether the telephone is out of range, whether the battery is low, if you have a message, and when you are in program mode.

Dial Pad

The telephone has a standard 12-button pad for dialing telephone numbers and accessing features.

Directory Card

The set has a directory card for writing or typing names of frequently dialed telephone numbers or extensions. It is located on the bottom of the handset cover.

User Instructions

The set also provides you with a quick reference that you can pull up to review basic procedures for using this telephone's features.

Antenna

The antenna is used for receiving the transmissions from the radio module. This antenna is flexible and is permanently attached to the handset.

Earpiece Volume Control Switch

This volume control is used for sliding between the two earpiece volume control positions, Normal and High.

Battery Charging Contacts

The contacts are used for charging the handset when contact is made with the charging base.

Headset Jack

This jack is used for connecting the headset to the handset.

Charging Base Features

Talk Indicator

This indicator is lit when the handset is off-hook. (The **ON** icon on the handset is also lit.)

Charge Indicator

This indicator is lit when the battery is charging and the handset is properly placed on the base.

Message Indicator

This indicator is lit when you have a message. (**MSG** also appears on the handset display.)

Ringer Volume Controls

This volume control is used for adjusting the base's ringing volume. Press the left button to decrease the ringer volume; press the right button to increase the ringer volume.

Note: When the handset is on the base, only the base rings. Both ring when the handset is out of the base.

Base Ringer

This is the ringer located in the base.

Handset Hook

This hook is used for hanging up the handset in the base.

Battery Charging Contacts



These charging contacts are used for charging the handset when contact is made with the charging base.

Power Cord Jack

This jack is used for connecting the power cord to your telephone. This cord is then plugged into a wall outlet. This jack is located on the other side of the base.

Display Information

The telephone display provides visual call and telephone status information through the following set of icons:

-  or  or  shows the status of the adjacent button. If the triangle and rectangle both appear, you are using that line; if only the rectangle appears, the line is in use.
- **ON** appears when the handset is on.
- **RANGE** flashes to indicate that you are out of range and appears steadily when you have lost communication.
- **P** is not used with DEFINITY or System 75 or System 85.
- **STAT** appears when the status mode is active, refreshing the icons and indicating that you should move closer to the base.
- **MSG** appears when there is a message waiting for you.
- **BATT** appears when the battery is low.

Out-of-Range Indication

While the set is still active, it gives an audible indication (double beep) and visual indication (the **RANGE** icon appears on the LCD display) when the handset is getting out of range.

Distance and Installation Limitations (for the Charging Base)

The MDC 9000 uses radio transmissions to communicate. The range depends on your particular operating environment, and the range can be improved by placing the base in an optimum location. The base can be placed on a desk or mounted on a wall.

Before you install the phone, note the following considerations:

- Mount the base near the center of the area in which the handset will be used, but at least 20 feet away from the phone system switch.
- Install the base within 6 feet of a properly grounded 3-prong electrical outlet that is not controlled by an on/off switch.
- If your phone system uses an uninterruptible power supply, such as a backup generator, be sure to connect the base for the cordless phone to that power supply.

- The base should not share the same power line or be within 6 feet of equipment with microprocessors such as answering machines, personal computers, and fax machines, 900 MHz wireless LANs and other equipment, phone system control units, uninterruptible power supplies, copier machines or electric motors and industrial machinery. A distance of 20 feet is advisable for minimum interference.
- The base should be located at least 3 feet from metal sources. These include metal reinforced ceilings, metal window frames, concrete reinforced with metal, sheet metal walls, steel I-beams, metal studs in walls, screens, and fences.
- Some solid structures, such as moist concrete walls, brick walls, and steel reinforced concrete walls, will inhibit the range.
- If more than one cordless phone is being used, do not place a handset from one cordless phone into the base of another. If this accidentally occurs, place each handset in the correct base for at least 10 seconds.

Switch Administration

Aliasing

For all System 75, System 85, DEFINITY Generic 1, Generic 2, and Generic 3, Versions 1 and 2, the MDC 9000 terminal must be administered as a 7303S Hybrid terminal.

Beginning with DEFINITY Generic 3, Version 3 (or later), the MDC 9000 can be administered as itself.

For the System 85, R2V1 through R2V4 switch which does not accommodate Universal modules, an ANN17B Hybrid pack in conjunction with a DS-1 carrier must be used to connect the switch and the MDC 9000 terminal. On all other switches, including System 75, DEFINITY Generic 1, Generic 2, and Generic 3, a TN62B Hybrid pack must be used with the Universal carrier for this purpose.

Note: A DEFINITY Generic 2 may use either an ANN17B or a TN62B pack. In either case, the latest vintage packs are recommended.

Button Numbering

Only the system manager should administer feature button assignments on the telephone. It is recommended that you not use a feature that requires visuals (that is, the light next to each administrable button) to be updated while the set is turned off, or any feature that may be activated by button depression while the set is turned off (for example, Send All Calls).

Use **Figure 3** for button numbering on the MDC 9000 set when it is connected to a System 75 or DEFINITY Generic 1 or Generic 3 switch. Use **Figure 4** for button numbering on the MDC 9000 set when it is connected to a System 85 or DEFINITY Generic 2 switch.

Note: On System 75 and DEFINITY Generic 1 and 3 switches, button numbering begins with “1,” the button on the upper right of the display. On System 85 and DEFINITY Generic 2, button numbering starts with “3.”

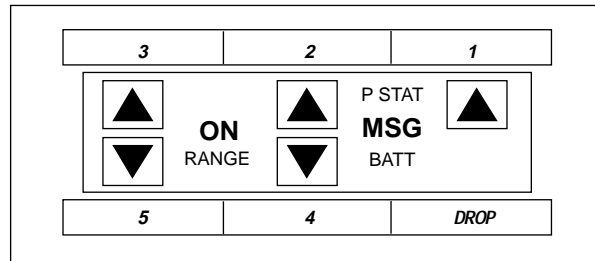

FIGURE 3-24. Button Numbering for a MDC 9000 Connected to System 75 or DEFINITY Generic 1 or 3

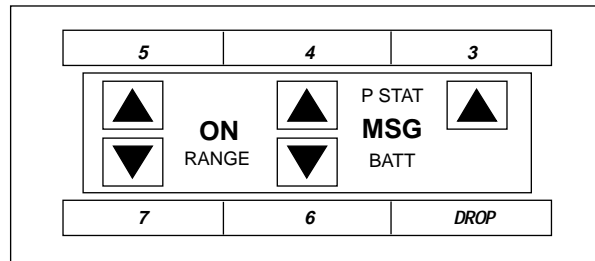

FIGURE 3-25. Button Numbering for a MDC 9000 Connected to System 85 or DEFINITY Generic 2

FCC Registration

The MDC 9000 telephone has been tested and has been found to comply with *FCC Part 15 Rules*.

Hearing Aid Compatibility

This wireless telephone is compatible with inductively-coupled hearing aids.

MDC 9000 Equipment PECs & COMCODES

The MDC 9000 Telephone and components can be ordered with these Price Element Codes (PECs) and COMCODES:

- **MDC 9000**
 - Black Set = PEC: 3203-03B
COMCODE: 106738073;
 - White Set = PEC: 3203-03W
COMCODE: 106739089

- **Headset**
 - PEC: 3122-041

- **Battery Pack**
 - Black PEC: 32036
COMCODE: 106760804
 - White PEC: 32034
COMCODE: 106760812

- **Holster**
 - Gray COMCODE: 846628527
 - Black COMCODE: 846501401

- **Line Cord**
 - 14-foot (From AT&T Catalog Sales) 10095X
(From AT&T Nat'l Parts Sales Center) 32008A
 - 25-foot (From AT&T Catalog Sales) 10096X
(From AT&T Nat'l Parts Sales Center) 32009A
 - 50-foot (From AT&T Catalog Sales) 10097X
(From AT&T Nat'l Parts Sales Center) 32010A
 - 75-foot (From AT&T Catalog Sales) 10098X
(From AT&T Nat'l Parts Sales Center) 32900A
 - 100-foot (From AT&T Catalog Sales) 10094X
(From AT&T Nat'l Parts Sales Center) 32011A

- **Supra RF Headset**
 - PEC: 32030

Additional Documents

The following documents contains additional information relating to the MDC 9000 Cordless Telephone: (Use the 9 digit number listed after each document to order that book from the AT&T GBCS Publications Fulfillment Center.)

- *DEFINITY Generic 1, 2, and 3, System 75 and System 85 MDC 9000 Cordless Telephone User's Guide*, 555-230-769
- *MDC 9000 Cordless Business Telephone Installation Manual*, 503-801-101.

MDW 9000 WIRELESS TELEPHONE

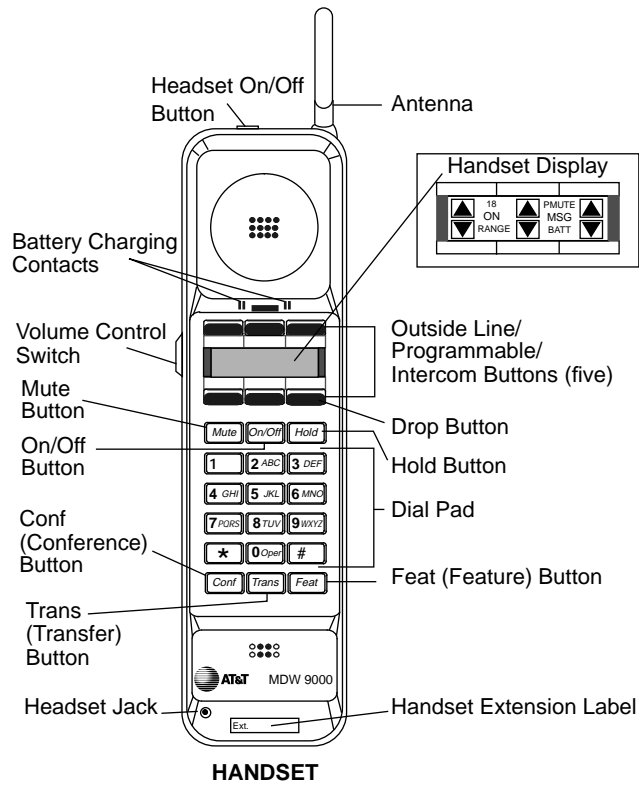

FIGURE 3-26. MDW 9000 Telephone including Enlarged Display Area

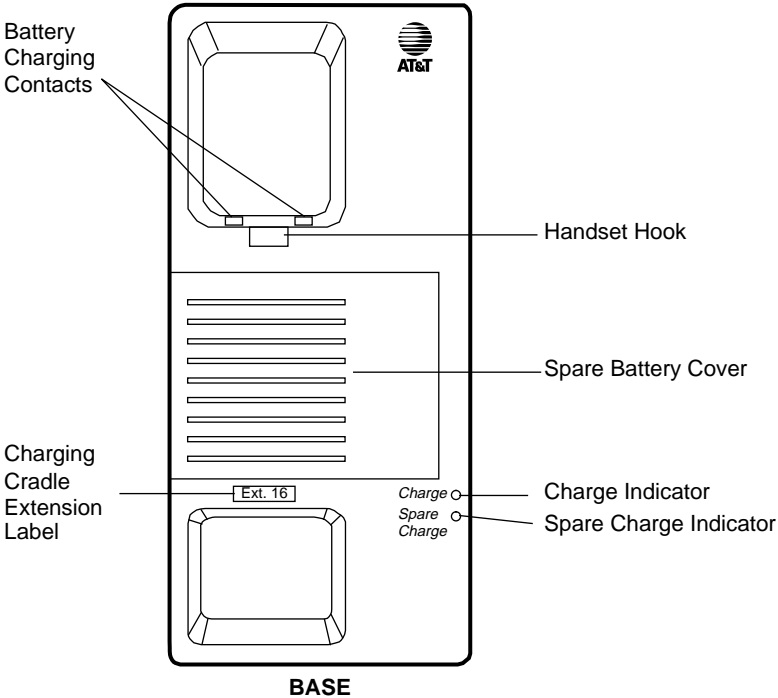

FIGURE 3-27. MDW 9000 Telephone, Top View of Charging Cradle

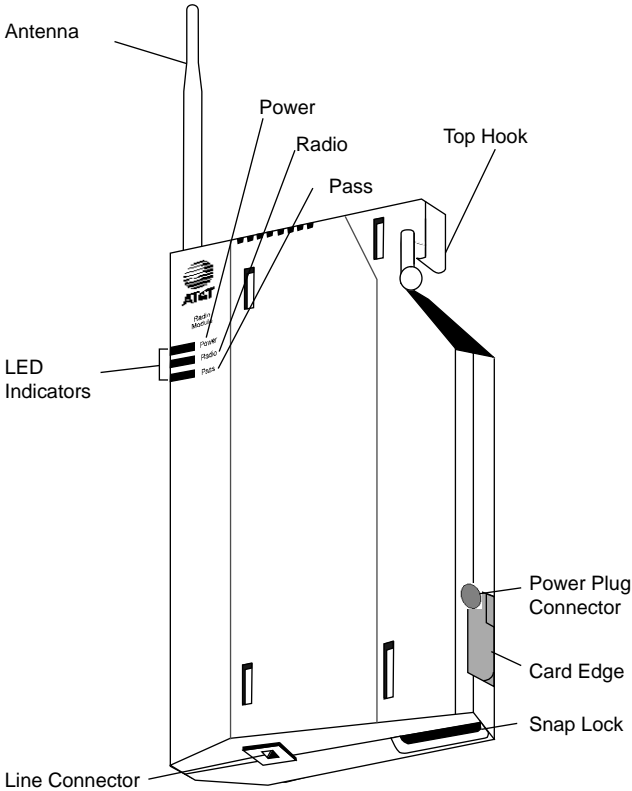

FIGURE 3-28. MDW 9000 Telephone, Radio Module

MDW 9000 Wireless Telephone

The MDW 9000 Wireless Telephone is part of the TransTalk™ 9000 Digital Wireless System family of telephones. This wireless telephone has three basic parts, the handset the charging cradle, and the radio module.

- The handset has line/programmable feature/intercom buttons, Drop, Mute, Hold, Conference, and Transfer buttons, a Headset On/Off button and a Handset On/Off button, a LCD display, a Volume control switch, battery charging contacts, a flexible antenna, and a Headset jack.
- The charging cradle has a handset hook, a spare battery cover, a spare battery garage, and a spare battery charge indicator, and battery charging contacts.
- The radio module has Power, Pass, and Radio indicator lights, a top hook, card edge, and snap lock which connect the radio module to the carrier assembly/backplane, an antenna, and power plug and line connectors.

In order to provide you with the freedom of mobility, the MDW 9000 is not connected physically (by a line cord or wire from the handset) to the DEFINITY system. Instead, the MDW 9000 communicates by way of a radio link to its matched radio module, which, in turn, connects it to the DEFINITY system. The telephone needs merely an electrical outlet, and a test check to make sure that the handset is in range of its matching radio module.

The handset communicates through a matching radio module. When up to six wireless phones are used within a single location, a carrier assembly is required. When the radio modules are placed in the carrier assembly, it is considered a radio base station.

Applications

The MDW 9000 Wireless Telephone can be used with the DEFINITY Communication System G1, G2, G3, System 75, and System 85.

Physical Features

Dimensions

Note: The dimensions described here for the MDW 9000 telephone are approximate.

For the Handset:

Width = 1.5 inches

Length = 10 inches

Height = 2.43 inches

For the Cradle:

Width = 3.94 inches

Length = 9.75 inches

Height = 5.13 inches

For the Radio Module:

Width = 5.5 inches

Length = 12.1 inches

Height = 1.5 inches

Handset Features

Fixed Feature Buttons

The MDW 9000 has the following eight fixed feature buttons:

- CONFERENCE (labeled CONF) button
- DROP button
(The DROP button is NOT labeled. It is located in the lower right corner of the LCD display.)
- TRANSFER (labeled TRANS) button
- HOLD button
- FEATURE button (labeled FEAT)
(The FEAT button is not used.)
- MUTE button
- Headset On/Off button
- (Handset) ON/OFF button

Outside Line or Intercom/ Programmable Feature Buttons

When labeled with an extension number, these buttons indicate lines used for incoming and outgoing calls (call appearances) and for using the telephone as an intercom; when programmed and labeled with feature names, these buttons access features (feature buttons).

MUTE button

The MUTE button is used to turn on and off the microphone associated with the handset *or* the headset.

Headset On/Off Button

This button is used for turning the headset on and off. Located on top of the handset, it is used when the headset jack is in use. At all other times, the Headset On/Off button is deactivated to prevent accidental call termination.

Handset (and Headset) ON/OFF Button

This On/Off button is used for turning the handset on and off. (It can also be used to turn the headset on or off.)

LCD Display

The display provides information on the status of lines and range, battery power, mute usage, etc. (See "Display Information" later in this section.)

Dial Pad

This is the standard 12-button pad for dialing telephone numbers and accessing features.

Volume Control Switch

The Volume control adjusts the receiver volume (higher or lower) when the handset is off-hook and adjusts the ring volume (higher or lower) when the handset is on-hook.

Antenna

The antenna is used for receiving the transmissions from the radio module. This antenna is flexible and is permanently attached to the handset.

Battery Charging Contacts

These contacts are used for charging the handset when contact is made with the charging cradle.

Headset Jack

This jack is used for connecting the headset to the handset.

Charging Cradle Features

Charge Indicator

The green Charging Indicator light on the cradle's faceplate indicates when the handset battery is charging. This LED is labeled **Charge**.

Spare Charge Indicator

The green Charge Indicator light on the cradle's faceplate indicates when the spare battery (in the spare battery garage) is charging. This LED is labeled **Spare Charge**.

Battery Charging Contacts

The battery charging contacts are used for charging the handset when contact is made with the charging cradle.

Handset Hook

This hook is used for hanging up the handset in the cradle.

Spare Battery Cover

The battery cover covers the spare battery garage. It opens by sliding to the left.

Modular Power Pack

This rechargeable, replaceable battery pack provides at least 3 hours of "talk time" and should hold its charge for at least 22 hours. The power pack is located inside the cradle.

Power Cord Jack

This jack is used for connecting the power cord to your charging cradle. This cord is then plugged into a wall outlet. This jack is located on the back of the cradle.

Radio Module Features

Power and Pass Indicator Lights

The Power and Pass lights indicate when the module is powered up and completes its self-diagnostic. The Radio light goes on when the handset is in use.

Top Hook and Card Edge

The top hook and the card edge connect the radio module to the carrier assembly/backplane mounting rod.

Snap Lock

This lock locks the radio module into the carrier assembly.

Antenna

The sturdy and flexible antenna sends signals between the handset and the radio module.

Power Plug Jack



The AC adapter should be inserted into this jack.

Line Jack

The line cord should be inserted into this jack.

Display Information

The LCD Display provides visual call and telephone status information through the following set of icons:

-  or  or  shows the status of the adjacent button. If the triangle and rectangle both appear, you are using that line; if only the rectangle appears, the line is in use.
- **18** appears during Local Test Mode; **0** through **10** can appear during the Wireless Test Mode.
- **ON** appears when the handset is on.
- **RANGE** flashes to indicate that you are out of range and appears steadily when you have lost communication.
- **P** is *not* used with DEFINITY or System 75 or System 85.
- **MUTE** appears when the handset microphone is muted.
- **T** appears when the Wireless Test Mode is active.
- **MSG** appears when there is a message waiting for you.
- **BATT** appears when the battery is low.

Out-of-Range Indication

While the set is still active, it gives an audible indication (double beep) and visual indication (the **RANGE** icon appears on the LCD display) when the handset is getting out of range of the radio module.

Distance and Installation Limitations

The MDW 9000 uses radio transmissions to communicate. The range depends on your particular operating environment. For indoor use, intervening walls will reduce the phone's range. Try to stay away from concentrations of structural metal, such as steel and aluminum, or reinforced concrete.

At least 6 feet is required between the radio module/radio base station and the phone system switch.

Before you install the radio module or radio base station, note the following considerations:

- When positioning the radio module or radio base station, try to place the unit in a central location, relative to the handset usage area. If your switch is located in a distant area, you may have to run line cord from your phone system to the centrally positioned radio module(s). The maximum distance is 1000 feet of 26 gauge cable.
- The radio module or radio base station should not share the same power line or be within 6 feet of equipment with microprocessors such as answering machines, personal computers, and fax machines, or electromagnetic equipment such as electric motors.
- For remote locations, an individual radio module can be installed in that area and attached via line cord to the phone system. IROBS should be used in outdoor area.
- The radio module or radio base station should be placed high on the wall for optimum voice quality and range. Allow at least 1 foot of space between the top of the antenna on the radio module(s) and the ceiling.
- Install the single radio module within 3 feet of either side of, and within 6-8 feet above, a properly grounded 3-prong electrical outlet that is not controlled by an on/off switch.
- Install the radio base stations within 15 feet of either side of, and within 6-8 feet above, a properly grounded 3-prong electrical outlet that is not controlled by an on/off switch.
- If your phone system uses an uninterruptible power supply, such as a backup generator, be sure to connect the radio or radio base station to that power supply.

Switch Administration

Aliasing

For all System 75, System 85, DEFINITY Generic 1, Generic 2, and Generic 3, Versions 1 and 2, the MDW 9000 terminal must be administered as a 7303S Hybrid terminal.

If your MDW 9000 is connected to a DEFINITY Generic 3, Version 3 (or later), the MDW 9000 can be administered as itself.

For the System 85, R2V1 through R2V4 switch which does not accommodate Universal modules,

an ANN17B Hybrid pack in conjunction with a DS-1 carrier must be used to connect the switch and the MDW 9000 terminal. On all other switches, including System 75, DEFINITY Generic 1 and Generic 3, a TN62B Hybrid pack must be used with the Universal carrier for this purpose.

Note: A DEFINITY Generic 2 may use either an ANN17B or a TN62B pack. In either case, the latest vintage packs are recommended.

Button Numbering

Only the system manager should administer feature button assignments on the telephone. It is recommended that you not use a feature that requires visuals (that is, the light next to each administrable button) to be updated while the set is turned off, or any feature that may be activated by button depression while the set is turned off (for example, Send All Calls).

Use **Figure 4** for button numbering on the MDW 9000 set when it is connected to a System 75 or DEFINITY Generic 1 or Generic 3 switch. Use **Figure 5** for button numbering on the MDW 9000 set when it is connected to a System 85 or DEFINITY Generic 2 switch.

Note: On System 75 and DEFINITY Generic 1 and 3 switches, button numbering begins with “1,” the button on the upper right of the display. On System 85 and DEFINITY Generic 2, button numbering starts with “3.”

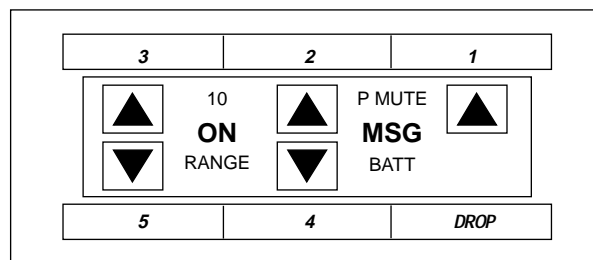

FIGURE 3-29. Button Numbering for an MDW 9000 Connected to a System 75 or DEFINITY Generic 1 or 3

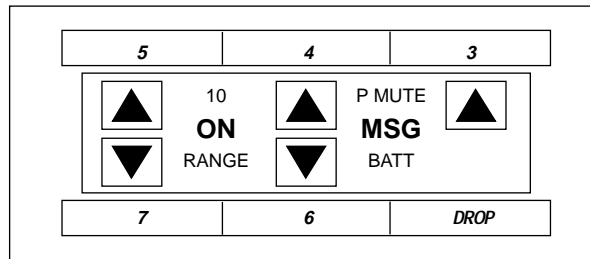

FIGURE 3-30. Button Numbering for an MDW 9000 Connected to a System 85 or DEFINITY Generic 2

FCC Registration

The MDW 9000 telephone has been tested and has been found to comply with *FCC Part 15 Rules*.

Hearing Aid Compatibility

This wireless telephone is compatible with inductively-coupled hearing aids.

UL and CSA Approval

This voice terminal has been tested and has met the Underwriters Laboratories (UL) Standards UL 1459 and have also met the Canadian Standards Association (CSA) Standards CSA-C22.2 No.225-M90.

MDW 9000 Equipment PECs & COMCODES

The MDW 9000 telephone and components can be ordered with these Price Element Codes (PECs) and COMCODES:

- **MDW 9000 (sold separately)**
 - Black = PEC: 3204-01B
COMCODE: 107017022
 - White = PEC: 3204-01B
COMCODE: 107017030
- **MDW 9000 Multiple Unit (sold as a unit)**
 - MDW 9000 Set
 - Black = PEC: 3204-W1B
COMCODE: 107077444
 - White = PEC: 3204-W1W
COMCODE: 107077463
 - Carrier Assembly/Backplane
 - PEC: 3204-CR1
COMCODE: 107073330
- **Headset**
 - PEC: 3122-041
- **Battery Pack**
 - Black PEC: 32036
COMCODE: 106760804
 - White PEC: 32034
COMCODE: 106760812
- **Holster**
 - Gray COMCODE: 846628527
 - Black COMCODE: 846501401
- **8-foot Line Cord**
 - COMCODE: 103786794
- **Charging Cradle**
 - Black = PEC: 107076754
 - White - PEC: 107076762

- **Carrier Assembly**
COMCODE: 107073330
- **Carrier Assembly AC Adapter**
COMCODE: 847224227
- **Radio Module AC Adapter**
COMCODE: 847180890
- **Charging Cradle AC Adapter**
COMCODE: 847180890

Additional Documents

The following documents contain additional information relating to the MDW 9000 Wireless Telephone: (Use the 9 digit number listed after each document to order that book from the AT&T GBCS Publications Fulfillment Center.)

- *DEFINITY Generic 1, 2, and 3, System 75 and System 85 MDW 9000 Wireless Telephone User's Guide*, 555-230-768
- *MDW 9000 Wireless Telephone Installation Manual*, 503-801-111
- *MDW 9000 Wireless Telephone Quick Reference*, 503-801-110.

Other Voice Terminals

Voice Terminals Reusable from Other Systems

The customer may have voice terminals that were used with a previous system that are compatible with System 75 and System 85. The installation of these reusable voice terminals in a System 75 or System 85 is possible, but not recommended.

Advantages of Reusable Terminals

The main advantage of reusable terminals is a modest cost savings.

Disadvantages of Reusable Terminals

Reusable terminals have the following disadvantages:

- No access to data communications
- Incompatible with System 75 and 85 adjuncts
- No alphanumeric displays
- Difficult administration

Models 7302H, 7303H, 7305H01B, and 7305H02B

These MERLIN® communication system voice terminals are similar in appearance and functions to Systems 75 and 85 multi-appearance terminals.

The 7302H is a 5-button voice terminal that can be desk or wall mounted. This set can no longer be ordered.

The 7303H is a 10-button voice terminal that can be desk or wall mounted. This set can no longer be ordered.

The 7305H series is a 34-button voice terminal. This terminal can be equipped with or without different features such as built-in speakerphone or display. Some versions of the 34-button series can be ordered using PEC code 3162 and the appropriate suffix.

Multi-Button Electronic Telephone (MET) Sets

These DIMENSION® PBX voice terminals have some of the capabilities of System 75 and 85 multi-appearance terminals (see **Figure 1**).

The MET sets are available in 10-, 20-, and 30-button versions. These three types of MET sets can be used with DEFINITY G1, G2, G3, System 75, and System 85. The 10-button version can be desk or wall mounted. All the others must be desk mounted. The 10-button version can be equipped with a built-in speakerphone. The MET sets can be ordered using PEC code 3140 and the appropriate suffix.

On the System 85 and DEFINITY G2, the bottom five buttons on a MET set become fixed feature buttons. On a 5-button MET set, that leaves no room for call appearances, therefore the 5-button MET set cannot be used with the System 85 and DEFINITY G2.

Figure 1. 10-Button MET (Desk)

Figure 2. 10-Button MET (Wall)

Figure 3. 10-Button MET with Speakerphone

Figure 4. 20-Button MET (Desk)

Figure 5. 30-Button MET (Desk)

ADJUNCTS

This section describes the devices that can be used with voice terminals to supplement services and features. Information on the controls, buttons, lights, and functions of DEFINITY G1, G2, G3, System 75, and System 85 voice terminal adjuncts is provided here. Adjuncts that are identical in appearance and function, but have different codes, are covered under the same heading. Adjuncts that are basically data modules are covered in the **DATA MODULES** section of this manual.

The adjuncts covered in this section are:

- Call Coverage Modules
- Digital Display Modules
- Function Key Modules
- Headset Adapters
- Message Waiting Indicator
- Speakerphones
- Loudspeaker
- Messaging Cartridge
- Automatic Dialer

CALL COVERAGE MODULE

INDICA

TORLIGHTS

CALL COVERAGE
MODULE

BUTTONS FOR
CUSTOMER-
DESIGNATED
CALL APPEARANCES
AND/OR FEATURES

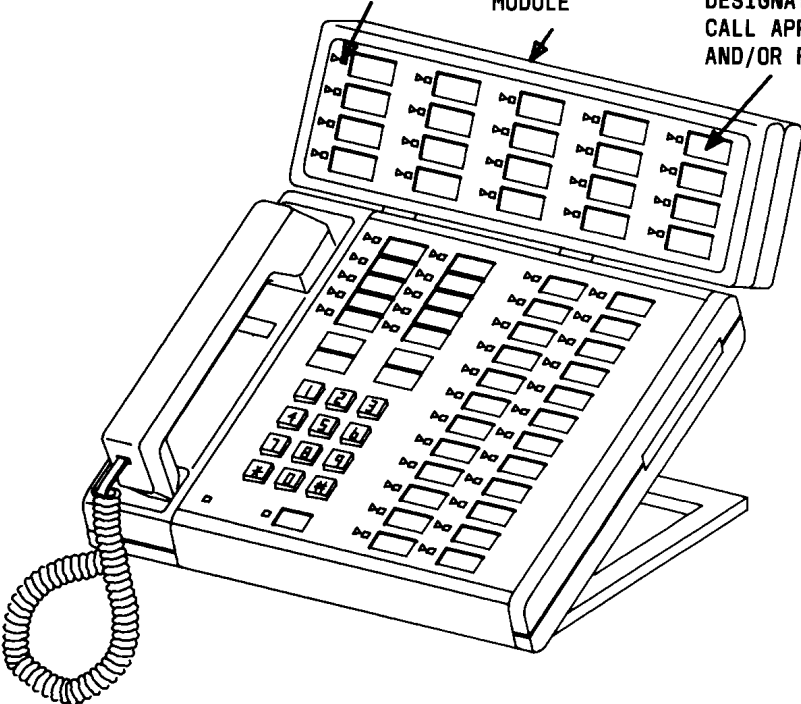

FIGURE 4-1. The C201A Call Coverage Module mounted on a 7434D Voice Terminal

Call Coverage Modules

The C201A Call Coverage Module and the C401A and C401B Call Coverage Module are identical in appearance, operation, and function. The Call Coverage Module provides 20 call appearance/feature buttons to supplement those on the associated voice terminal.

The C201A module and 7205H voice terminal were discontinued in March 1988. The C102A module has also been discontinued.

Applications

The Call Coverage Module can be used with the DEFINITY G1, G2, G3, System 75 and System 85. The C201A is used with the 7205H multi-appearance hybrid voice terminal (System 85 and G2 only), while the C401A and C401B are used with the 7405D and 7434D digital terminals.

Physical Description

Buttons

Each of the 20 call appearance/feature buttons has a triangular red light and a square green status light. The buttons used for features have only their status lights operational. The module buttons can be used for a variety of purposes:

- Bridged appearances of extension numbers of other voice terminals
- Additional appearances of the primary extension number of the voice terminal to which it is attached (up to a total of 12 for both terminal and module)
- Identification of incoming calls for a call coverage answer group, a Direct Department Calling (DDC) group, or a Uniform Call Distribution (UCD) group
- Optional features as designated by the System Manager

Mounting

The Call Coverage Module is mounted to the back of the associated voice terminal at an angle that allows it to be easily used.

Color Options

The Call Coverage Modules are available in black or misty cream.

Power

The C201A Call Coverage Module draws its required power from the system switch through the 7205H voice terminal to which it is attached; no auxiliary power is required. However, when a C401A or C401B module is used with a 7405D or 7434D voice terminal, auxiliary power must be fed through the terminal's mounting cord from one of the sources listed in the **ADJUNCT POWER** section of this manual.

Call Coverage Module PEC Codes

The C201A, C401A, and C401B Call Coverage Modules can be ordered with the following PECs:

- C201A Call Coverage Module—31720 (not orderable)
- C401A Call Coverage Module—31743 (not orderable)
- C401B Call Coverage Module (black)—31743-003
- C401A Call Coverage Module (misty cream)—31743-215 (not orderable)

Considerations

A Call Coverage Module and a Digital Display Module cannot be mounted on the same voice terminal simultaneously. The voice terminal cannot be wall mounted if equipped with the Call Coverage Module.

DIGITAL DISPLAY MODULE

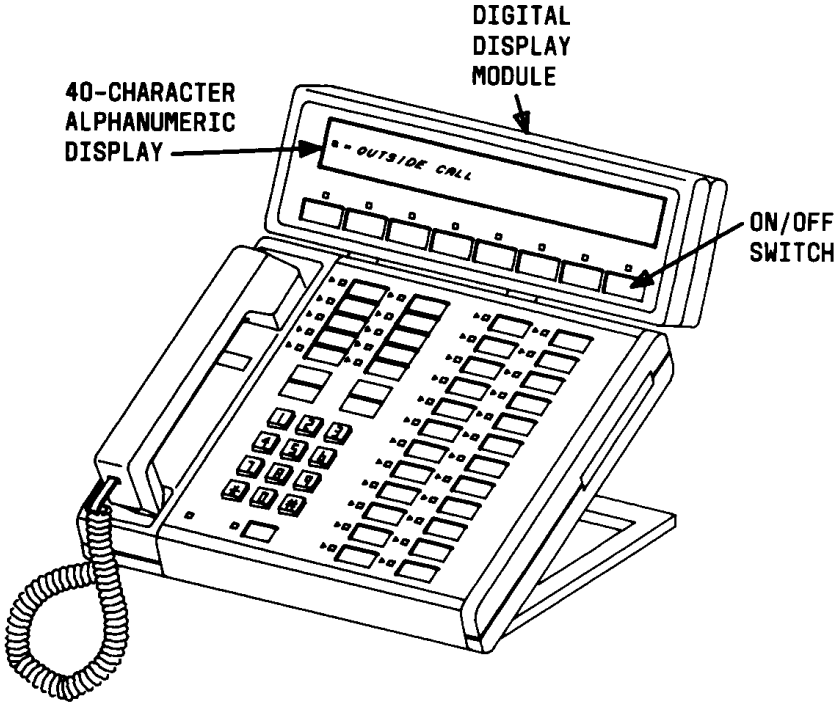

FIGURE 4-2. The D401A Digital Display Module mounted on a 7434D Voice Terminal

Digital Display Module

The D401A and D401B Digital Display Modules add a large easy-to-read 40-character display to the top of the 7405D or 7434D voice terminal. The D401 provides a vacuum-fluorescent display, which is significantly brighter than LCD displays and visible from any angle. It provides prompt retrieval of Leave Word Calling or Message Center messages, can identify incoming calls, both names and number, and perform other functions.

Applications

The Digital Display Module can be used with a DEFINITY G1, G2, G3, System 75, and System 85. It is used with the 7405D and 7434D voice terminals. It is particularly useful for receptionists and executives.

Physical Description

Automatic Displays

The D401A/B Digital Display Module automatically provides a visual display of the following call-related information:

- Calling and called party identification
- Calling and called number
- Call coverage status

Auxiliary Displays

In its various auxiliary modes, the Digital Display Module also provides other services:

- Time and date display
- Elapsed time on calls
- Message retrieval
- Display of stored abbreviated dialing numbers
- Access to Integrated Directory (except on System 85 or DEFINITY G2)

Display

A vacuum-fluorescent 40-character alphanumeric display that presents numerical digits, uppercase and lowercase letters, and punctuation marks.

On/Off Switch

The **On/Off** switch turns the module on and off. The associated green status light goes on when the module is on and is dark when the module is off.

Assignable Function Buttons

Seven additional buttons with associated green status lights. The System Manager assigns these buttons to display the control functions.

Display Functions

The following display functions are available on buttons (the actual labeling on some buttons is shortened). If more than seven buttons are required, the additional buttons may be assigned on the associated voice terminal.

- **Normal Mode**—used to place the display in the Normal mode. In this mode, the display provides call-related information automatically.
- **Inspect Mode**—used to place the display in the Inspect mode to permit the user to see caller identification on an incoming or held call while active on another call.
- **Message Retrieval**—used to place the display in the Message Retrieval mode. This mode is used to retrieve messages for the voice terminal on which the module is mounted.
- **Coverage Message Retrieval**—used to place the display in the Coverage Message Retrieval mode. This mode is used by coverage agents to retrieve messages for other terminals.
- **Next**—used in Message Retrieval mode to step from one message to the next; also used in the Integrated Directory feature to display the next name (except on System 85 or DEFINITY G2).
- **Delete Message**—used in Message Retrieval mode to delete messages.
- **Make Call**—used in Message Retrieval mode to automatically initiate a call to the caller identified by the last displayed message (for internal calls only); also used to automatically call internal extension numbers displayed by the Integrated Directory feature (except on System 85 or DEFINITY G2).
- **Integrated Directory (except on System 85 or DEFINITY G2)**—used to place the display in the Integrated Directory mode. In this mode, the system directory can be searched by entering the desired name with the dial pad, and names with their corresponding extension numbers will be displayed.

- **Stored Number**—used to enable inspection of numbers stored in abbreviated dialing (AD) lists or on individual AD buttons, or stored by the Last Number Dialed feature. On System 85, this function is available on some versions of R2V3 and R2V4, and G2.
- **Timer**—used to start or stop the elapsed timer function on the display module; displays hours, minutes, and seconds.
- **Date/Time**—used to place the display in the Time of Day and Date mode. This mode initiates a display of the current time of day and the date.

Other Physical Features

Mounting Options

The Digital Display Module is mounted to the back of the associated voice terminal at an angle that allows it to be easily used.

Color Options

The Digital Display Module is black or misty cream.

Power

The Digital Display Module requires auxiliary power from an external source. The **ADJUNCT POWER** section of this manual lists the recommended power supplies for the module alone or in combination with other adjuncts.

Digital Display Module PEC Codes

The D401A Digital Display Module can be ordered with the following PECs:

- D401A Digital Display Module—31742
- D401B Digital Display Module(black)—31742-003
- D401B Digital Display Module (misty cream)—31742-215

Considerations

A Digital Display Module and a Call Coverage Module cannot be mounted on the same voice terminal simultaneously. The voice terminal cannot be wall mounted if equipped with the Digital Display Module.

FUNCTION KEY MODULE

ST

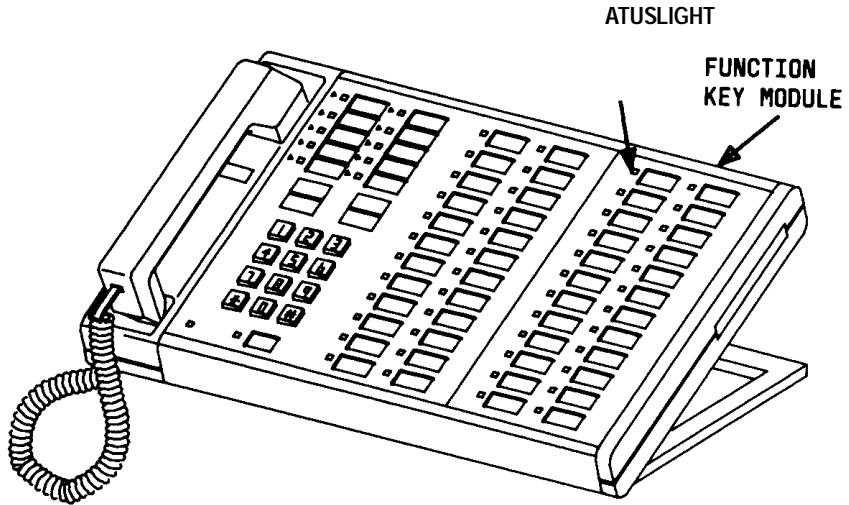

FIGURE 4-3. The F201 or F401A Function Key Module mounted on a 7405D Voice Terminal

Function Key Modules

The Function Key Module greatly extends the feature access capability of the voice terminal where it is used. The module provides 24 buttons that can be assigned only to features. The F201A Function Key Module and the F401A Function Key Module are identical in appearance, operation, and function. Both the F201A and F401A function key modules have been manufacture discontinued.

Applications

The Function Key Module can be used with the DEFINITY G1, G2, G3, System 75, and System 85. The F201A is used with the 7205H multi-appearance hybrid voice terminal (System 85 and G2 only), while the F401A is used with the 7405D digital terminal.

Physical Description

Feature buttons

The module provides 24 buttons that can only be assigned features. Each button has a square green status light.

Mounting Options

As the illustration shows, the module attaches to the right side of the voice terminal, adjacent to the terminal's two columns of feature buttons. If a Digital Terminal Data Module is also installed, it must be mounted on the right side of the Function Key Module.

Color Options

The Function Key Module is silver.

Power

The F201A Function Key Module draws its required power from the system switch through the 7205H voice terminal to which it is attached; no auxiliary power is required. However, when an F401A module is used with a 7405D digital terminal, auxiliary power must be fed through the terminal's mounting cord from one of the sources listed in the **ADJUNCT POWER** section of this manual.

Considerations

Either a Digital Terminal Data Module, a Call Coverage Module, or a Digital Display Module can be mounted on the same terminal with a Function Key Module.

Digital Terminal Data Module PEC Codes

The F201A and F401A Function Key Modules were ordered using the following PECs:

- F401A Function Key Module—31744
- F201A Function Key Module—31721

801A EXPANSION MODULE

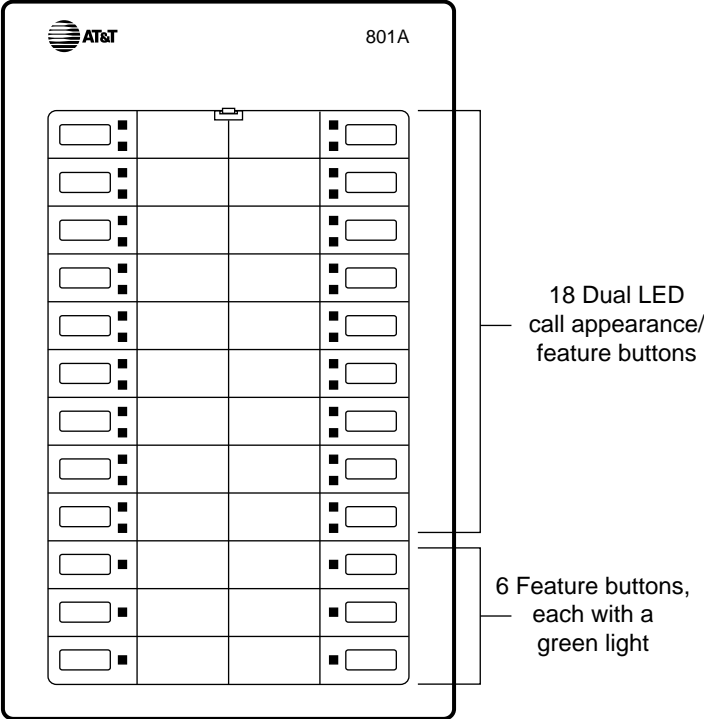

FIGURE 4-4. The 801A Expansion Module

801A Expansion Module

The 801A Expansion Module is an optional device which can be connected to an 8434DX (8434D02A) voice terminal to extend the number of call appearance and feature buttons available on the voice terminal.

IMPORTANT: This expansion module can be connected ONLY to an 8434DX model connected to a DEFINITY G3V3.3 (or later) switch. The 8434DX has an Ex Mod jack (labeled "EX MOD") to which the 801A can be connected. Before installing the expansion module to an 8434DX, make sure that the set is labeled "8434DX," has the "EX MOD" jack on the bottom of the set, and is connected to a DEFINITY G3V3.3 (or later) switch.

Applications

At this time, the 801A Expansion Module can be connected only to an 8434DX voice terminal.

Physical Description

Buttons

The expansion module has 24 buttons arranged in two columns.

- The top 18 buttons (that is, the top nine buttons in each column) have a red and a green light next to them. These buttons can be used for call appearances or features.
- The bottom six buttons (that is, the last three buttons in each column) have a single green status light next to them. These buttons can be used for features only.

Mounting

The 801A Expansion Module is connected to an 8434DX voice terminal with a DW-67AP cord. This cord is plugged into the LINE jack on the voice terminal and then plugged into the TELSET jack on the expansion module.

Color Options

The Expansion Module is available in black or AT&T white.

Power

The expansion module requires auxiliary power.

- The only suitable stand-alone power supply is the MSP-1.

Note: Since the 8434DX voice terminal requires auxiliary power, it is likely that an MSP-1 will already be connected to the 8434DX terminal.

- Suitable bulk power supplies are the 1145A and the 1145B1.

Administering the Expansion Module

The 8434DX with an attached expansion module can be used ONLY with systems such as a DEFINITY G3V3.3 or later that allow native support. That is, the 8434DX MUST BE ADMINISTERED AS ITSELF, not aliased as any other type of voice terminal.

On the first station administration screen of the 8434DX, put a “Y” (for Yes) next to the “Expansion Module?” entry. On the last page of the administration screens, type the telephone or extension numbers or feature names next to the appropriate expansion module buttons in the following sequence.

Note: You can place ONLY features on expansion module Buttons #10, 11, 12, 22, 23, and 24. You CANNOT administer these buttons as call appearances.

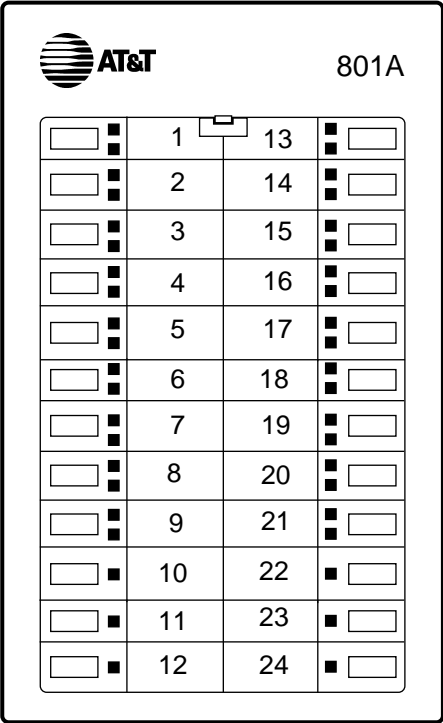

FIGURE 4-2. Button Numbering for Administering the 801A Expansion Module

801A Expansion Module PEC Codes

The 801A Expansion Module can be ordered with the following PECs:

- Black ZE801A-003 Expansion Module—32300
Comcode: 106702921
White ZE801A-264 Expansion Module—32301
Comcode: 106702764
- 2-foot D6AP-87 line cord
Comcode: 105644744

Additional Documents

The following document is shipped with the expansion module. Additional copies are available from the Publications Fulfillment Center in Crawfordsville, IN.

- *801A Expansion Module Instruction Manual*, 555-015-136

HEADSET ADAPTERS

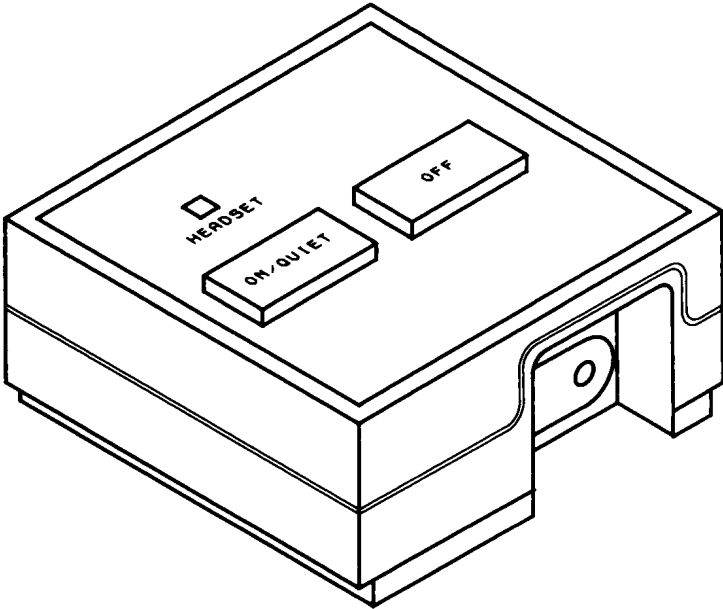

FIGURE 4-3. The 500A Headset Adapter

Headset Adapters

Two adapters are available to allow the use of standard headsets with voice terminals connected to the DEFINITY, System 75 and System 85 switches. The 500A and the 502A Headset Adapters are identical in appearance, operation, and function but different in internal circuitry.

Applications

The 500A and 502A headset adapters can be used with the DEFINITY G1, G2, G3, System 75, and System 85. The 500A adapter can be used with single-line Models 7103A, 7102A, and 7102A Plus and multi-appearance Models 7203H, 7205H, 7403D, 7405D, 7406D, 7406BIS, 7406 Plus, Enhanced 7407D, 7407 Plus, 7410D, 7410 Plus, 7434D, 7444, 8403, 8410, 8434, and 8102 voice terminals/telephones and the 6508, 7505, 7506, 7507, 8503T, 8510T, and 8520T ISDN terminals. The 502A adapter is intended for use with multi-appearance Models 7303S and 7305S voice terminals only.

Physical Description

Features

On/Quiet Switch

This dual-purpose switch is used to:

- Turn on the adapter connecting the headset to the voice terminal. Pressing the **On** switch is equivalent to going off-hook with the handset.
- Disable the transmitter of the headset temporarily for privacy.

Off Switch

Turns off the adapter and disconnects the headset. Pressing the **Off** switch is equivalent to going on-hook with the handset.

Headset jack

Used to connect the double phone plug of the headset.

Headset Light

Indicates when the headset is active.

Other Physical Features

Cords

A modular cord is needed for connecting the headset adapter to the associated voice terminal. The cord carries audio signals between the adapter and the terminal and power for the adapter.

Mounting Options

The headset adapter is mounted close to its associated voice terminal.

Color Options

The 500A headset adapter is silver while the 502A is black.

Power

The 500A Headset Adapter requires either AC or DC auxiliary power from one of the sources listed in the **ADJUNCT POWER** section of this manual. Power, from the source supply, is applied by way of the voice terminal's mounting cord and the adapter's connecting cord. The 502A draws its power from the system switch through the associated voice terminal.

Considerations

The use of a headset provides hands-free terminal operation with more privacy than a speakerphone. A headset is especially convenient for users who must frequently type or look up information during calls.

Note: A speakerphone and a headset adapter cannot be connected to the same voice terminal simultaneously.

The following are typical headsets (consisting of either modular or plug prong base units and choice of headpieces) that can be connected to the 500A, the new 500A1, and the 502A adapters:

- Plug Prong Base Unit
PEC: 3122-010
Black
- Modular Base Unit
PEC: 3122-020
Black/modular
- Starset Headpiece
PEC: 3122-030
Black/behind the ear

Important: Plug Prong Base Units require a headset adapter.

- Supra Headpiece
PEC: 3122-040
Black/over the ear
- Mirage Headpiece
PEC: 3122-050
Black/behind the ear
- Supra Noise-Cancelling Headpiece
PEC: 3122-060
Black/over the ear

Headset PEC Codes

The 500A and 502A headset adapters can be ordered using the following PECs:

- 500A Headset Adapter—3122-001
- 502A Headset Adapter—3164-HFA

MESSAGE WAITING INDICATOR

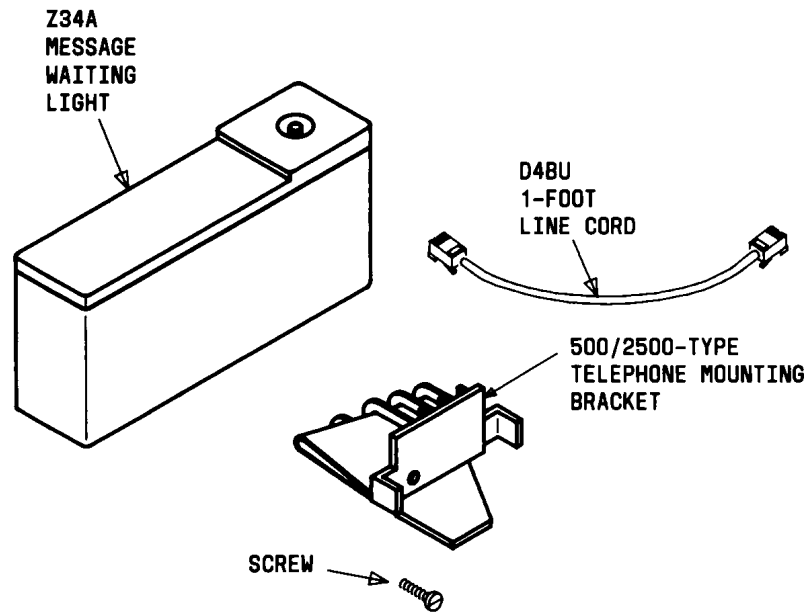

FIGURE 4-4. The Z34A Message Waiting Indicator

Message Waiting Indicator

The Z34A Message Waiting Indicator is an adjunct that can be attached to analog voice terminals to allow these terminals to take advantage of the Leave Word Calling feature or message retrieval via AUDIX.

Applications

The Z34A Message Waiting Indicator can be used with the DEFINITY G1, G2, G3, System 75, and System 85. It is used with the Model 2500 voice terminal.

Physical Description

Light

The Z34A contains a red light that flashes automatically when a message has been left for the terminal user.

Other Physical Features

Mounting Options

The Z34A mounts on the right side of the voice terminal and is electrically connected between the terminal's line jack and the wall jack.

Color Options

The Z34A is available in ultra light gray only.

Power

The Z34A Message Waiting Indicator receives its power from the same tip and ring leads as its associated voice terminal receives its power.

Message Waiting Indicator PEC Codes

The Z34A can be ordered using the following PEC code:

- Z34A Message Waiting Indicator—3152-004A

4A, S101A, AND S102A SPEAKERPHONES

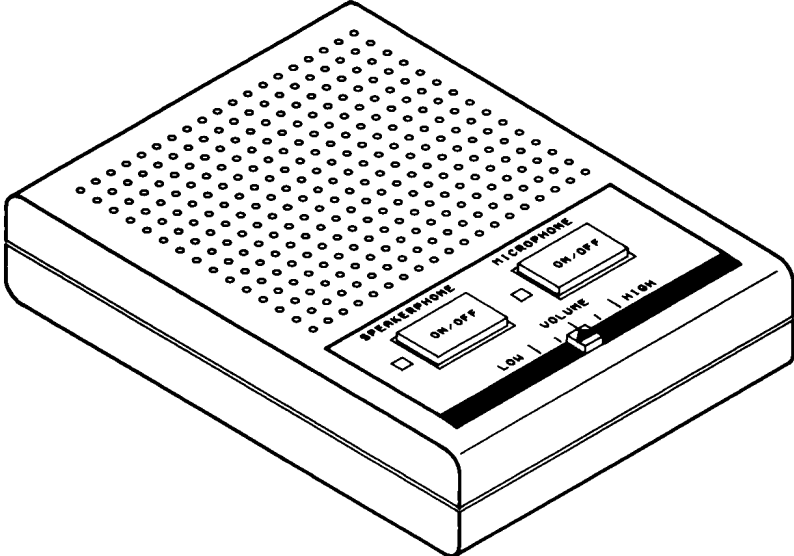

FIGURE 4-5. The S101A and S102A Speakerphones

4A, S101A, and S102A Speakerphones

Speakerphones are available for providing total voice terminal operation without the use of the handset. Turning on the speakerphone is equivalent to lifting the voice terminal handset when placing or answering a call. Turning off the speakerphone is equivalent to hanging up the handset. The microphone switch temporarily cuts off transmission to the distant party during a call.

Applications

The speakerphones can be used with the DEFINITY G1, G2, G3, System 75, and System 85. The S101A Speakerphone can be used with the single-line Models 7103A and 7102A and multi-appearance Models 7203H, 7205H, 7403D, 7405D, 7406D, 7406BIS, 7406 Plus, Enhanced 7407D, 7407 Plus, 7410D, 7410 Plus, 7434D, 7444, 8403, 8410, 8434, and 8102 voice terminals/telephones, and the 6508, 7505, 7506, 7507, 8503T, and 8510T ISDN terminals. The S102A is intended for use with multi-appearance Models 7303S and 7305S voice terminals only. The 4A speakerphone is used only with the basic 2500-series terminals and METs on an "in place" basis.

Physical Description

S101A and S102A Speakerphones

On/Off button

There is a nonlocking **On/Off** button and adjacent green light for the speakerphone.

On/Off button

There is also a nonlocking **On/Off** button and adjacent green light for the microphone.

Sliding volume control

The volume of the speaker is controlled by this slide switch.

Cord

A modular cord for connecting the speakerphone to the associated voice terminal; the cord carries audio signals between the speakerphone and the terminal and power for the speakerphone.

Color

The S101A and S102A speakerphones are silver.

4A Speakerphone

ON or QUIET button

This nonlocking button turns the speakerphone on (same as going off-hook). This button is also used to place the speakerphone in a listen-only mode.

OFF button

This locking button turns the speakerphone off (same as going on-hook).

Volume

The volume of the speaker is controlled by this knob.

Color Options

The 4A Speakerphone is available in avocado, black, white, beige, and ivory.

Power

The S101A and S102A Speakerphone requires either AC or DC auxiliary power from one of the sources listed the **ADJUNCT POWER** section of this manual. Power from the source supply is applied by way of the voice terminal's mounting cord and the speakerphone's connecting cord. The S102A draws its power from the system switch through the associated voice terminal; it does not require an auxiliary power source.

The 4A Speakerphone requires auxiliary power from one of the sources listed in the **ADJUNCT POWER** section of this manual. The power from the source supply is applied to the loudspeaker set and the transmitter through an adapter or connecting block provided with the 4A Speakerphone.

Considerations

A speakerphone and a headset adapter cannot be connected to the same voice terminal simultaneously.

Speakerphone PEC Codes

The speakerphones can be ordered by using the following PEC codes:

- S101A Speakerphone—31711 (not orderable)
- S102A Speakerphone—31730 (not orderable)
- 4A Speakerphone (Avocado)—3120-02W-COL01
- 4A Speakerphone(Black)—3120-02W-COL09
- 4A Speakerphone (White)—3120-02W-COL10
- 4A Speakerphone (Beige)—3120-02W-COL11
- 4A Speakerphone (Ivory)—3120-02W-COL12

S201A AND S202A SPEAKERPHONES

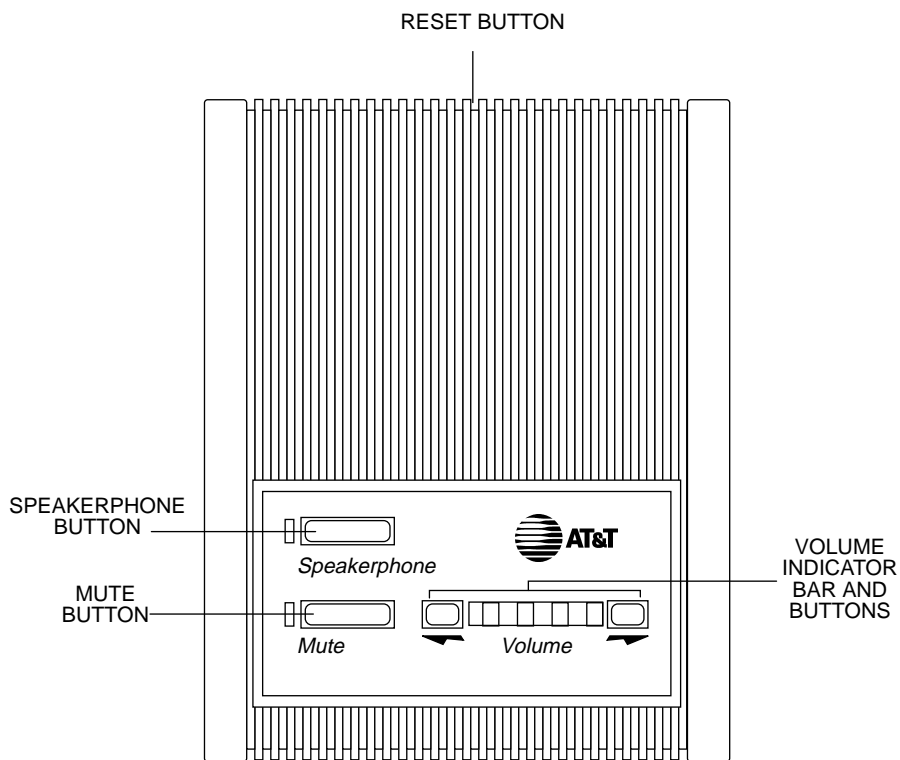

FIGURE 4-6. The S201A and S202A Speakerphones

S201A and S202A Speakerphones

The S201A and S202A speakerphones are available for providing total voice terminal operation without the use of the handset. Turning on the speakerphone is equivalent to lifting the voice terminal handset when placing or answering a call. Turning off the speakerphone is equivalent to hanging up the handset. The Mute switch temporarily cuts off transmission to the distant party during a call. The S201A and S202A speakerphones automatically adapt to room acoustics, thereby dramatically improving the sound quality.

Applications

These speakerphones can be used with the DEFINITY G1, G2, G3, System 75, and System 85. The S201A Speakerphone can be used with the single-line Models 7103A, 7102A, and 7102 Plus and multi-appearance Models 7203H, 7205H, 7403D, 7405D, 7401 Plus, 7406D, 7406BIS, 7406 Plus, Enhanced 7407, 7407 Plus, 7410D, 7410 Plus, 7434D, 7444, 8403, 8410, 8434, and 8102 voice terminals/telephones, and the 7505, 7506, and 7507, 8503T, and 8510T ISDN terminals. The S202A is intended for use with multi-appearance Models 7303S and 7305S voice terminals only.

Physical Description

Feature Buttons

Speakerphone button

This locking button turns the speakerphone on and off. When the green light is on, the speakerphone is on.

Mute button

This nonlocking button and its red light are for the microphone. When the light is on, the microphone is muted.

Volume control

The volume of the speaker is controlled by the volume buttons associated with the arrows. The lights on the volume indicator bar shows the selected volume level.

Reset button

The RESET button automatically performs an acoustic test of the environment.

Other Physical Features

Cord

A modular cord connects the speakerphone to the associated voice terminal. This cord carries audio signals between the speakerphone and the terminal and power for the speakerphone.

Jack

A modular jack is located on the rear of the speakerphone.

Color Options

The S201A and S202A speakerphones can be misty cream or black.

Power

The S201A Speakerphone requires either AC or DC auxiliary power from one of the sources listed in the **ADJUNCT POWER** section of this manual. Power from the source supply is applied by way of the voice terminal's mounting cord and the speakerphone's connecting cord. A 24 volt, 7.5 Va AC transformer with a 400 B2 adapter is packed with the S201A Speakerphone. The transformer may be located up to 125 feet from the speakerphone. The S202A Speakerphone draws power from the associated telephone. Do not use the 2102D wall transformer due to incorrect voltage.

Considerations

A speakerphone and a headset adapter cannot be connected to the same voice terminal simultaneously.

S201A and S202A Speakerphone PEC Codes

The speakerphones can be ordered by using the following PEC codes:

- S201A Speakerphone—3152-007A
- S202A Speakerphone—3152-008A

S203A SPEAKERPHONE

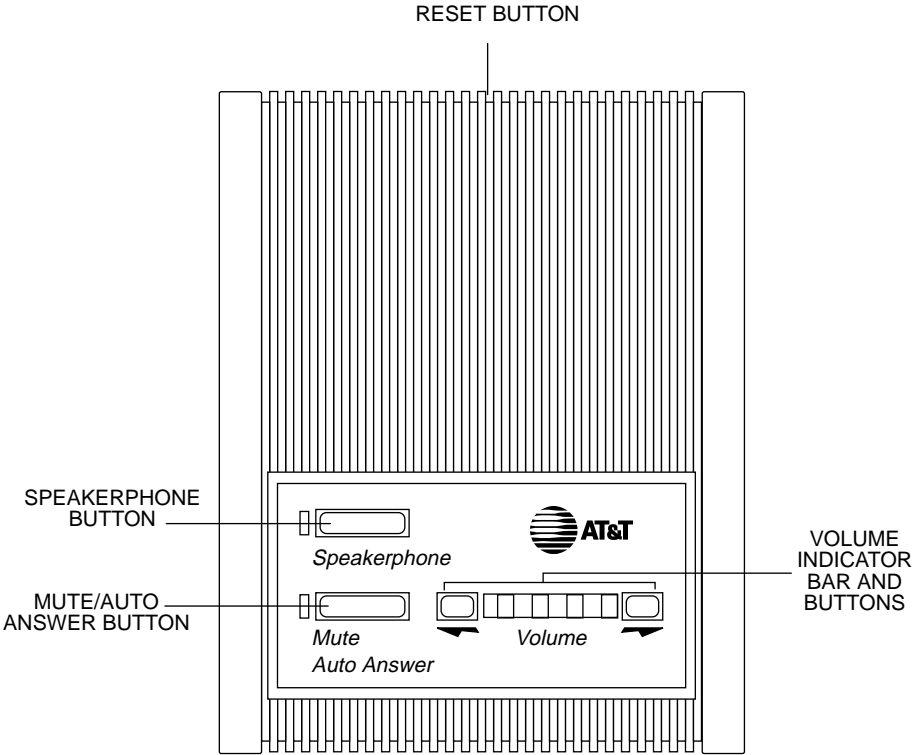

FIGURE 4-7. The S203 Speakerphone

S203A Speakerphone

The S203A Speakerphone is an analog speakerphone with Auto-Answer and Automatic Disconnect capabilities. The S203A can be used in conjunction with any single-line analog set (an additional 267A2 bridging adapter is included for this arrangement) or as a stand-alone unit. When it is used in a stand-alone operation, the S203A provides no dialing functionality. When the Auto-Answer feature is enabled, an incoming call will cause the S203A to automatically go off-hook and emit a special tone that is heard by both the calling and called parties. This tone indicates that the call has been automatically answered. The S203A Speakerphone automatically adapts to room acoustics, thereby dramatically improving the sound quality.

Note: This speakerphone is available with a wall-mounting bracket.

Applications

The S203A Speakerphone can be used with the DEFINITY G1, G2, G3, System 75 and System 85. Its Auto-Answer and Auto-Disconnect capabilities make it very suitable for environments where hands-free mode of answering is desirable. Such scenarios include hospital emergency rooms, laboratories, nursing homes, storerooms, and warehouses.

Physical Description

Note: The following dimensions are approximate.

Dimensions

Width = 4-3/4 inches

Depth (front to back) = 6-1/8 inches

Height = 2-1/4 inches

Feature Buttons

Speakerphone with light

This non-locking switch turns the S203A on and off. The green light goes on when the speakerphone is on.

Mute/Auto Answer with light

This button toggles between the Mute and Auto-Answer features. When the speakerphone is on, the button functions as a Mute button; the red light is on. When the speakerphone is off, the button functions as the Enable/Disable button for the Auto-Answer feature; when the Auto-Answer feature is enabled, the light flashes.

Two Volume buttons

These two nonlocking buttons are labeled with arrows. Between these two buttons is a row of 10 green lights that indicate the loudness. When the S203A is on, each depression of an up/down button causes the loudspeaker volume to be raised or lowered and a light on the right end of the string of illuminated lights to be turned on or off.

Recalibrate button

The Recalibrate button is located on the rear of the S203A Speakerphone. When this button is pressed (or when the S203A is powered up), the S203A executes an acoustical calibration of its environment. It is necessary to recalibrate the S203A each time it has been moved or its surroundings have been altered.

Other Physical Features

Jacks

The S203A Speakerphone has a 8-pin modular phone connector on the rear.

Color Options

The S203A Speakerphone can be misty cream or black.

Mounting Options

The S203A Speakerphone is desk mounted.

Power

The S203A Speakerphone is powered from an external AC transformer through two pins of the eight pin jack on the rear of the unit. A PS3081096 Wall transformer with a 304B adapter is provided with the S203A. The S203A requires AC power. DO NOT use the 2012D Wall transformer or any DC powering arrangement.

Bridging

Software bridging (that is, translating an extension number to appear on both an analog and digital port) *is not recommended* when using the S203A Speakerphone because it directly affects the functionality and operations of both the telephone and the S203A. Automatic disconnect may not work as documented. Transferring a call from one digital phone that has an S203A as an adjunct, to another digital phone may not work as documented.

FCC Registration

The S203A Speakerphone is FCC registered (AS5USA-61382-SP-N Ringer Equivalence 0.4A, 0.9B USOC Jack RJ11C, RJ11W).

S203A Price Element Codes (PECs)

The S203A Speakerphone can be ordered with the following PEC:

- S203A Speakerphone—3131-008

107-TYPE LOUDSPEAKER

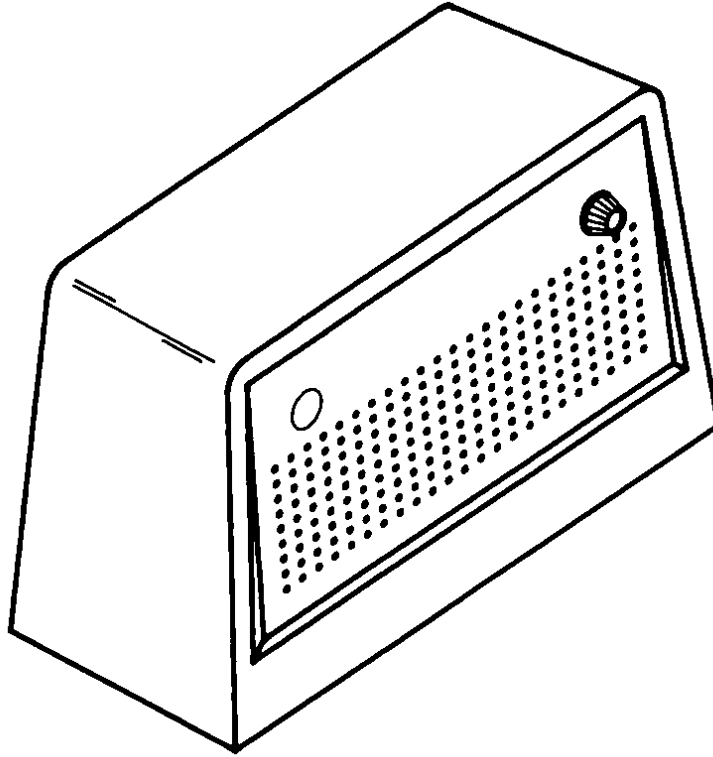

FIGURE 4-8. The 107-Type Loudspeaker

Loudspeaker

The 107-Type Loudspeaker amplifies the received voice signal. This allows the user to hear better in a noisy environment.

Applications

The loudspeaker can be used with the DEFINITY G1, G2, G3, System 75, and System 85. It is used only with 2500-type voice terminals on "in place" basis. It is particularly useful in a conference room or noisy room.

Physical Description

Dimensions

Note: The following dimensions are approximate.

Width = 5-3/4 inches

Depth (front to back) = 3-3/4 inches

Height = 4 inches

Features

Volume control

The loudspeaker is equipped with a rotary volume control.

ON/OFF switch

The ON/OFF switch turns the loudspeaker on and off when placed in the appropriate setting.

Power

The 107-Type Loudspeaker requires an external AC or DC power source. This power may be provided by an 2012D Transformer, 18-volt AC terminals of an available power plant, or a 24-volt DC key system battery.

MESSAGING CARTRIDGE

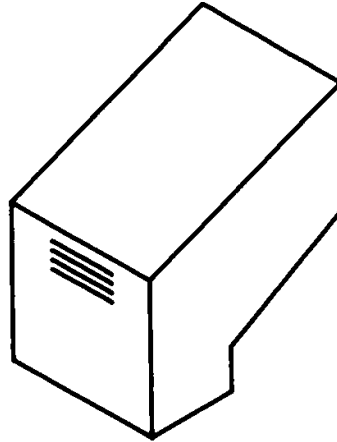

FIGURE 4-9. The Messaging Cartridge

Messaging Cartridge

This adjunct can be added to a 7404D Voice Terminal to provide displays on an associated data terminal. The messaging cartridge plugs into the bottom of the 7404D Voice Terminal. The basic messaging cartridge generates displays of call-related and personal-service information only. The 7404D Messaging Cartridge was discontinued in July 1990.

Applications

The messaging cartridge is used with a 7404D voice terminal that is equipped with a data terminal. The 7404D and messaging combination can be used with a DEFINITY G1, G2, G3, or System 75 or System 85. The messaging cartridge is discontinued.

Considerations

A selection of the following display functions must be assigned to letter keys on the keyboard of the associated data terminal:

- Normal Mode
- Inspect
- Message Retrieval
- Next
- Make Call
- Delete Message
- Date/Time

Messaging Cartridge Price Element Codes (PECs)

The messaging cartridge was ordered using the following PECs:

- Messaging Feature Cartridge—31810

2870A1 AUTOMATIC DIALER

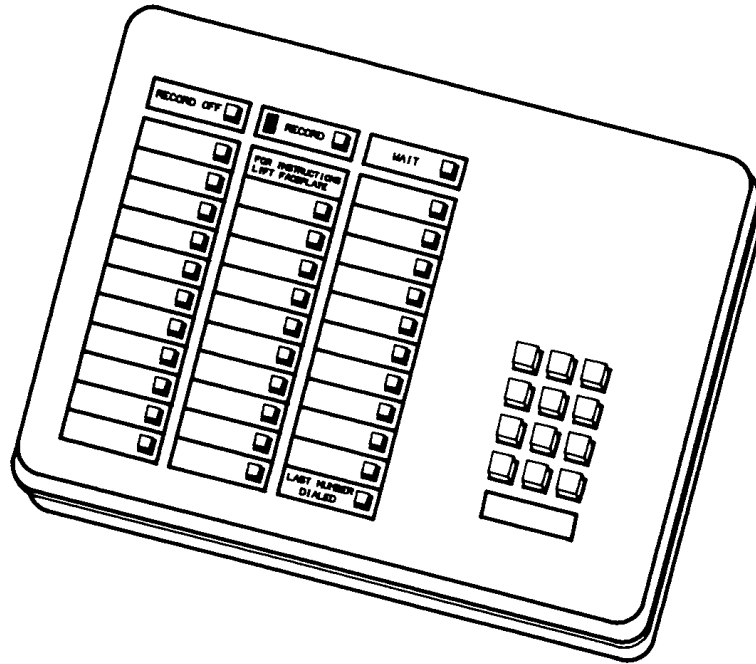

FIGURE 4-10. The 2870A1 Automatic Dialer

Automatic Dialer

The 2870A1 Automatic Dialer is an optional add-on adjunct for a MET set that is provided on an “in place” basis only. The dialer provides the capability to record and automatically dial 31 numbers of up to 15 digits each. It also provides last number dialed (manually) memory and the capability to pause for subsequent dial tones during automatic dialing (WAIT input).

Applications

The automatic dialer can be used with the DEFINITY G1, G2, G3, System 75, and System 85. It is particularly useful for applications where several numbers must be repeatedly dialed.

Physical Description

Features

Programmable buttons

The automatic dialer has 31 buttons on which telephone numbers of up to 15 digits can be stored for one button dialing.

Four Fixed function buttons

- Record Off
- Record (Equipped with an Indicator)
- Wait
- Last Number Dialed

Other Physical Features

Dial pad

The automatic dialer is equipped with a 12-button touch-tone dial pad.

Power

The 2870A1 Automatic Dialer requires auxiliary power from an external source. Refer to the **ADJUNCT POWER** section of this manual for the recommended power supply.

Automatic Dialer PEC codes

The 2870A1 Automatic Dialer can be ordered using the following PECs:

- 2870A1 Automatic dialer (Silver)— 3113-030FPC01
- 2870A1 Automatic dialer (Teak)— 3113-030FPC02
- 2870A1 Automatic dialer (Walnut)— 3113-030FPC03

DATA MODULES

This section describes the devices that provide a data communications interface. Information on the data modules and other related data equipment used with DEFINITY G1, G2, G3, System 75, and System 85 is provided here. The devices in this section provide data interface functions such as modems, protocol converters, and data units.

The data modules covered in this section are:

- 7400A Data Module
- 7400B and 7400B Plus Data Module
- 7500B Data Module
- ISDN Asynchronous Data Module (ADM)
- Digital Terminal Data Module (DTDM)
- Z702AL1 Data Service Unit (DSU)
- 703A Data Service Unit (DSU)
- DEFINITY High Speed Link (HSL)
- Processor Data Module (PDM)
- Trunk Data Module (TDM)
- Modular Processor Data Module (MPDM)
- Modular Trunk Data Module (MTDM)
- 3270 Data Module
- Asynchronous Data Unit (ADU)
- Multiple Asynchronous Data Unit (MADU)
- DCIU Interface Units
- 2500-Series Data Service Unit (DSU)

7400A DATA MODULE

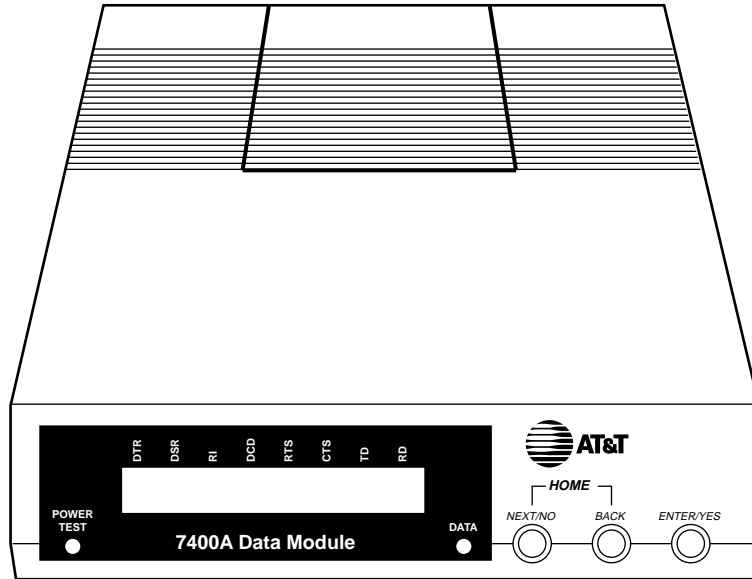

FIGURE 5-1. The 7400A Data Module

7400A Data Module

The 7400A Data Module is a full duplex asynchronous data module designed to replace both the TDM (MTDM) and PDM (MPDM) for asynchronous applications. The 7400A provides a DCP interface to the PBX and an RS-232-D (formerly RS-232-C) interface to Digital Terminal Equipment (DTE) such as host computers, personal computers, and terminals or DCE modems in external modem pool installation.

Applications

The 7400A Data Module can be used with the DEFINITY G1, G2, G3, System 75, and System 85. It can be used in the modem pooling feature or for host access.

Physical Description

Dimensions

Note: The following dimensions are approximate.

Width = 7 inches

Depth (front and rear) = 8-3/4 inches

Height = 1-3/4 inches

Lights

POWER/TEST light

This red light goes on when the 7400A data module is on and flashes during all tests.

DATA light

This green light goes on during a data call and flashes when receiving an incoming call.

Display

The 16-character LCD display shows the status, option information, test information, and also information about the RS-232-D interface of the data module.

NEXT/NO, BACK, and ENTER/YES buttons

These buttons are used to view and set data communication options and functions, adjust the contrast of the display, and to conduct tests.

Jacks

The 7400A data module is equipped with the following jacks.

- PORT 1 (EIA RS-232-C or -D)
- PHONE (not used)
- LINE (to switch) (RJ-45)
- POWER

Mounting Options

The 7400A data module can be configured as a stand-alone unit or in a multiple-mount housing. (The multiple-mount housing **must** be used if D-lead modems are used in the modem pool. The multiple-mount can also be used to support Hayes-compatible modems.)

Color Options

The 7400A data module is available in misty cream only.

Tests

The 7400A data module supports the following test and maintenance features:

- Self-test
- Local loopback and remote loopback
- Local Loop self test and remote loop self test
- DCP looparound
- Maintenance activate
- Make busy
- Manual on-hook/off-hook

Features

The basic features of the 7400A data module are:

- DCP mode 2 operation only
- Full-duplex, 10-bit start/stop, asynchronous operation
- Asynchronous data rates of 0.3, 1.2, 2.4, 4.8, 9.6, and 19.2 kbps
- Even, odd mark, and space parity options
- Automatic answer option
- Signal loss disconnect option
- Autobaud
- Autoparity
- Long-break and triple-break disconnect options

Data features for modem pooling applications include:

- EIA RS-232-D DTE interface, enhanced with CI2 and CH2 leads
- Interface for D-lead control modems
- Interface for Hayes-compatible modems

Data features for host or terminal applications include:

- EIA RS-232-D DCE interface
- Keyboard dialing and Hayes user interface emulation option
- Answer only
- Cyclic Ring-indicator option
- Ignore DTR input option

Power

The stand-alone 7400A Data Module operates with power from a WP90110 L7 AC power converter. This is a modular AC to DC adapter that is normally plugged into a wall outlet. The Z77A Data Mounting has a built-in power supply for powering data modules in the multiple-mount arrangement.

Considerations

The 7400A Data Module will not support the following:

- Linked operation with associated DCP telephone
- Synchronous Data transmission
- Asynchronous User Interface (AUI)
- DCP Mode 0, 1, 3, and Mode 2/3 adaptive

FCC Registration

No digital phones or data modules are FCC registered. The 7400A data module meets Part 15 Class A requirements and is labeled as such.

7400A Data Module Price Element Codes (PEC)

The 7400A Data Module can be ordered using the following PECs:

- 7400A Data Module—2171-ADM
- Stand-alone Power Supply—21625
- 7400A Multiple Mounting—21626

Additional Documents

The following documents contain additional information relating to the 7400A Data Module:

- *7400A Data Module User's Manual*, 555-020-706
- *7400A Data Module Installation Guide*, 555-020-708
- *System 85 Application Notes for External Modem Pooling*, 555-109-005
- *System 85 Application Notes for Host Access Operation*, 555-109-004
- *System 75 Application Notes for External Modem Pooling*, 555-209-016
- *System 75 Application Notes for Host Access Operation*, 555-209-015

7400B and 7400B Plus DATA MODULE

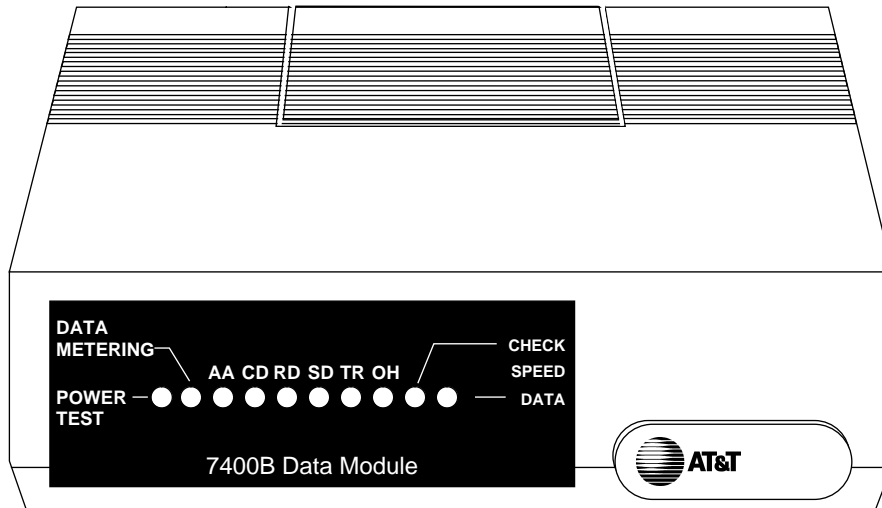

FIGURE 5-2. The 7400B Plus Data Module

7400B and 7400B Plus Data Module

The 7400B and 7400B Plus Data Modules are full-duplex asynchronous, Hayes® Compatible data modules that provide for simultaneous voice-data communications at the desk top over standard twisted pair wiring. The 7400B data module has been discontinued; however, the 7400B Plus data module has all of the basic characteristics of the 7400B, with the following added benefits:

- Supports the semicolon dial modifier, which enables an automatic return to the command mode after dialing a data call;
- Offers a storable S7 register, which supports increased call set-up time;
- Offers the voice dial capability, which provides the ability to dial a voice call from the PC package in the attached PC.

Both of these data modules replace the existing PDM (MPDM) for asynchronous communication, DTDM, and data stands for 7406D and 7407D voice terminals (703A DSU and 702AL1) and the 7404D integrated voice/data phone.

In the linked mode, the 7400B and 7400B Plus data modules provide for simultaneous voice data communications over standard twisted pair wiring. In this mode, the 7400B and 7400B Plus data modules can be used with all DCP voice terminals to provide data service. The 7400B Plus provides the voice dial feature for all DCP voice terminals *except* the following:

- 7403D voice terminal (all models)
- 7404D voice terminal (all models)
- 7405D voice terminal (all models)
- 7407D01A voice terminal

Applications

The 7400B and 7400B Plus data modules can be used with the DEFINITY Communications System G1, G2, G3, System 75, and System 85. The data modules are used as a DCE for host access services, PC, or terminal (DTE) connectivity (see **Figure 2**).

Figure 2 shows a diagram of the connections between the 7400B or 7400B Plus and the data terminal, the digital voice terminal, and the switch.

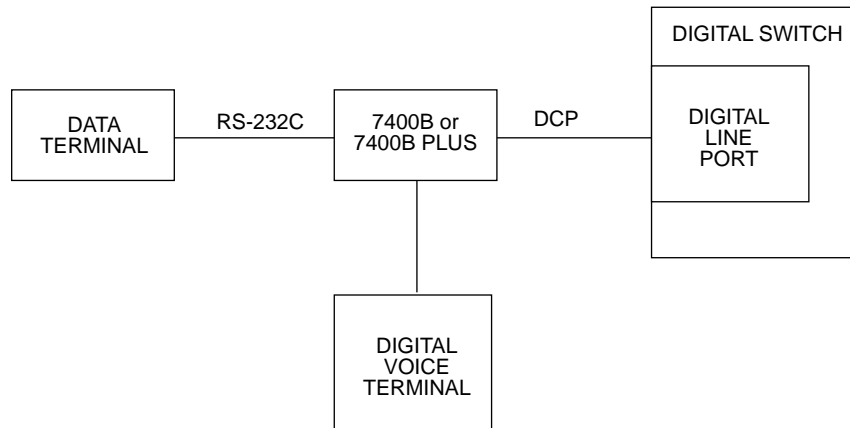

FIGURE 5-2. Block Diagram of the 7400B Interface

Physical Description

Dimensions

Note: The following measurements for the 7400B and 7400B Plus data module are approximate.

Width = 7 inches

Depth (front and rear) = 8 3/4 inches

Height = 1 3/4 inches

Lights

- POWER/TEST light

The red POWER/TEST light goes on when AC power is supplied to the 7400B or 7400B Plus data module and flashes during all tests. This light, together with the DATA light, also flashes if there is a DCP line problem.

- DATA light

The green DATA light goes on during a data call. This light, together with the POWER/TEST light, flashes if there is a DCP line problem.

- Other lights

The eight other lights show the RS-232 status information, the status of two options, and call status information. These lights are red.

Jacks

The 7400B and 7400B Plus data modules are equipped with the following jacks:

- Port 1 (RS-232-C or -D)
- PHONE (to voice terminal) (RJ-45)
- LINE (to switch) (RJ-45)
- POWER.

Mounting Options

The 7400B and 7400B Plus data modules can be desk-mounted as a stand-alone unit.

Color Options

The 7400B and 7400B Plus data modules are available only in misty cream.

Tests

The 7400B and 7400B Plus data modules support the following test and maintenance features:

- Local Loopback and Remote Loopback
- Local Loopback Self Test and Remote Loop Self Test
- DCP Looparound
- Self-Test
- Make Busy on Local Loop

Features

The 7400B and 7400B Plus data modules have the following basic features:

- DCP mode 2 operation only
- Full-duplex, 10-bit start/stop, asynchronous operation
- Asynchronous data rates of 0.3, 1.2, 2.4, 4.8, 9.6, and 19.2 kbps
- Even, odd, mark, and space parity options

- Autobaud and autoparity
- Linked operation with the associated DCP voice terminal
- Data metering

Data metering allows the data module and associated terminal to operate at higher speeds than the far-end data point.

- Supports the semicolon modifier which enables an automatic return to the command mode after dialing a data call (for 7400B Plus).
- Voice Dial (for 7400B Plus)

This feature allows you to initiate voice calls from your PC using the dial command “atdp number.” These calls must be terminated manually, however.

- Speakerphone Activation before Dialing (for 7400B Plus)

For terminal dialed voice calls, you can delay speakerphone activation until after a call is dialed. You would not hear touch tones or dial tone in this case.

- Wait Time for Carrier (for 7400B Plus)

The number stored in the S7 register establishes the time the 7400B Plus data module will wait for call set up to be completed. This number can be set for any value up to a maximum of 255 seconds (with a default to 60 seconds).

Data features for host or terminal applications include:

- EIA RS-232-D DCE interface
- Hayes SMARTMODEM 2400 user interface emulation

Power

The stand-alone 7400B and 7400B Plus data modules operate with power from a WP91508L5 AC power converter. This is a modular AC to DC adapter that is normally plugged into a wall outlet. The data module allows phantom power to be transmitted to the attached DCP voice terminal even if AC power to the data module is interrupted.

Setting Options

After removal of the top access panel of the data module during installation, it is important to verify that the eight option switches are set to provide the desired features.

- **SW1-1 With/Without Telephone Option**

This switch must be set to ON for operation *without* an associated telephone.

This switch must be set to OFF for operation *with* an associated telephone.

- **SW1-2** (Not used)
- **SW1-3** (Not used)

- **SW1-4** (Not used)
- **SW1-5 Data Metering Option**

When this switch is set to ON, the data module and associated terminal can operate at higher speeds than the far-end data point. This switch is usually set to OFF.
- **SW1-6 Suppress Touch-Tone/Dial Tone (for 7400B Plus)**

Leave this switch set to OFF if the user prefers listening to Touch-Tones as voice calls are being dialed. Set the switch to ON if the user wants to suppress Touch-Tones. If the user is using a speakerphone, ringing will be heard after the call has been made.
- **SW1-7 Speakerphone Enable/Disable Option (for 7400B Plus)**

Leave this switch set to OFF if the user wants the speakerphone to turn on automatically when the terminal is used to make a voice call. Set the switch to ON if there is no speakerphone or if the user wants to disable the speakerphone automatic activation feature.
- **SW1-8 Make Busy on Local Loop Option**

This switch should be set to ON if the user wants the telephone line to appear busy when the local loopback test feature is used to check the interface between the data module and the terminal.

Notes for Use with PC Packages

The 7400B Plus voice and data feature has been tested with the following PC communication packages:

- CARBON COPY Plus V5.1
- Crosstalk® XVI V3.71
- Crosstalk Mk.4 V1.1
- Hot Line V2.2 (voice dialing packages)
- HyperACCESS® V3.32
- MicroPhone V1.5 (MacIntosh package)
- PC TOOLS Deluxe V6 (voice dialing packages)
- Procomm Plus® V1.1B
- Relay Gold® V3.0
- SideKick V1.5 and SideKick Plus® (voice dialing packages)
- Smartcom II V2.2
- Smartcom II V3.1
- Smartcom III V1.1
- Smarterm 240 V3.0a

- Terra Nova® V1.1.1
- White Knight V11 (MacIntosh package)

For those PC packages used to dial voice calls, the modem configuration must be set to PULSE (P) (even though the 7400B Plus will use Touch-Tone for voice calls). If given a choice, set modem type to HAYES.

Note: While the 7400B Plus supports simultaneous voice and data, the packages listed here support *alternate voice/data dialing only*. Voice dialing packages interfere with data operation by remapping the COM port or by hanging up the data call.

You *can* dial a data call while on a voice call. In all cases, the linked telephone will work.

FCC Registration

These data modules are not FCC registered. The 7400B and 7400B Plus data modules meet Part 15 Class A requirements and are labeled as such.

7400B Data Module PEC Codes

The 7400B and 7400B Plus data modules can be ordered using the following Price Element Codes (PECs):

- **7400B Plus Data Module**
PEC: 2172-101
COMCODE: 106545841

Note: The 7400B Plus data module comes with a stand-alone power supply.

Additional Documents

The following documents contain additional information relating to the 7400B and 7400B Plus data modules:

- *AT&T 7400B Data Module User's Guide*, 555-020-707
- *AT&T 7400B Plus Data Module User's Guide*, 555-020-710
- *DEFINITY Communications System Generic 1 and System 75 R1V2 Through R1V3 7400B Data Module Application Notes*, 555-209-017
- *7400B Data Module PC Applications Guide*, 555-035-203

8400B Plus DATA MODULE

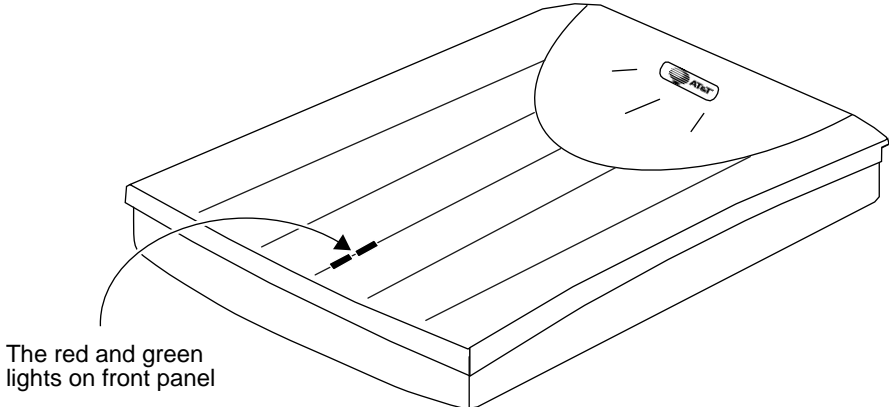

FIGURE 5-3. The 8400B Plus Data Module

8400B Plus Data Module

Like the 7400B Plus data module, the 8400B Plus Data Module is a full-duplex asynchronous, data module that provides for simultaneous voice-data communications at the desktop over standard twisted pair wiring. However, it has been designed explicitly to work, in the linked mode, with 2-wire DEFINITY Digital Communications Protocol (DCP) circuits. That is, this data module is a data service link between a Data Terminal Equipment (DTE) device, a 2-wire voice terminal such as the 8400-Series voice terminals, and an AT&T DEFINITY Communications System G3V2 or later switch.

At the desk, the 8400B Plus data module provides asynchronous communication speeds ranging from 0.3 to 19.2 kbps. The 8400B Plus data module's ability to emulate a Hayes compatible modem interface makes it compatible with many standard PC communications packages that use Hayes Command sets. In addition, the 8400B Plus data module provides a voice dial capability that allows you to initiate voice calls from a PC using industry standard "auto-dialer" PC communications packages.

Applications

The 8400B Plus data module can be used with the DEFINITY Communications System G3V2 or later. The data module is used as a DCE for host access services, PC, or terminal (DTE) connectivity. The PC or other terminal device is connected to the 8400B Plus data module using a standard EIA-232-D cable and, if needed, the supplied M9/F25 Adapter, an adapter which allows connection from a 9-pin jack to a 25-pin jack. A DCP interface (using a D8W-type modular telephone cord) is used to connect the 8400B Plus data module to the digital PBX.

The 8400B Plus data module may be optioned for use either with or without a telephone. In the stand-alone case, the 8400B Plus data module supports data service only. Otherwise, the 8400B Plus data module provides simultaneous data and voice service. The 8400B Plus works with all DCP voice terminals that support 2-wire operations (such as the 8400-Series voice terminals), to provide simultaneous data and voice service.

The voice dial feature allows you to dial a voice call without touching the telephone. Depending on your communications package, you may also store telephone numbers on a PC and recall them for dialing, log phone calls for easy billing, and take notes for later reference during a telephone conversation. In addition, the 8400B Plus data module can be used to automatically turn on the speakerphone of the voice terminal when a voice call is dialed from your terminal device.

Figure 2 shows a standard configuration in the United States, using a telephone and separate power supply. **Figure 3** shows a standard international configuration using a telephone and separate power supply. Both the U.S. Configuration and the International Configuration may be installed using a closet power supply as shown in **Figure 4**. This last installation eliminates the need for the separate power supply.

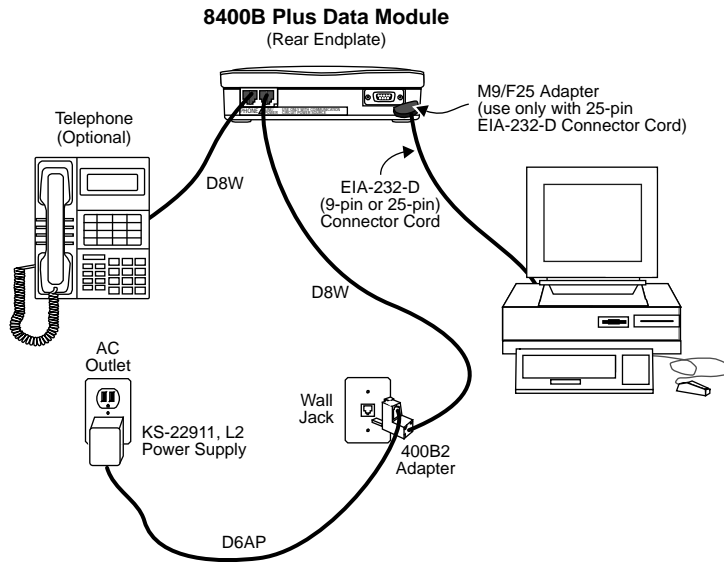

FIGURE 5-2. Typical Installation of the U.S. Configuration, including Telephone and Separate Power Supply

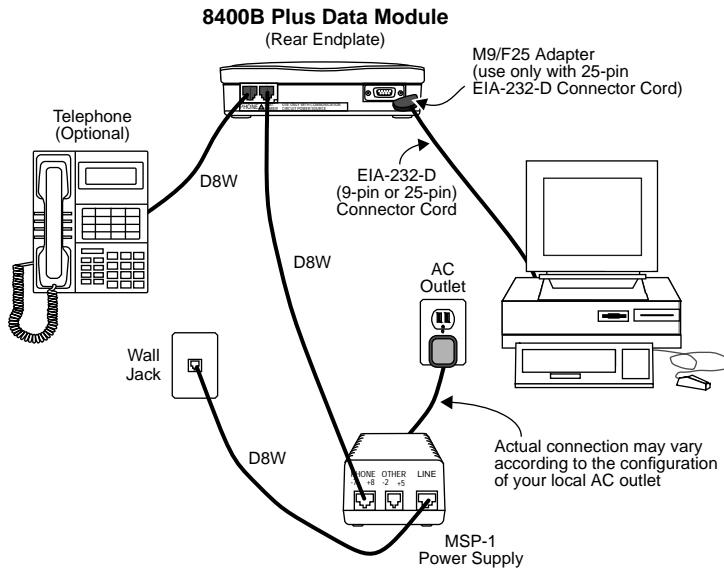

FIGURE 5-3. Typical Installation of the International Configuration, including Telephone and Separate Power Supply

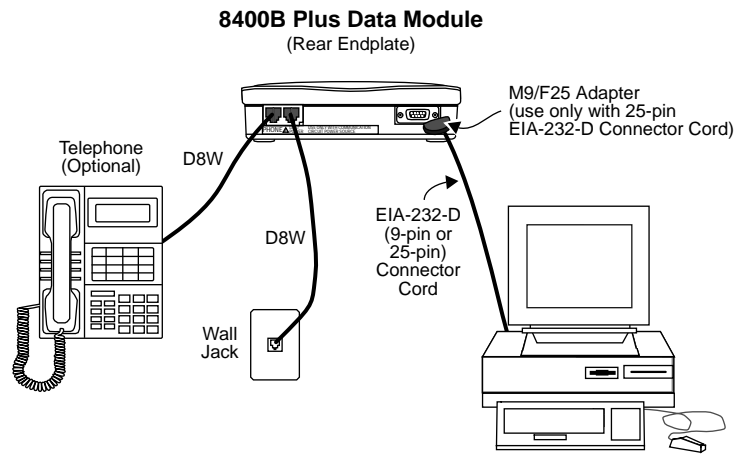

FIGURE 5-4. Typical Installation of the U.S. and International Configuration, including Telephone and Closet Power Supply

Physical Description

Dimensions

Note: The following measurements for the 8400B Plus data module are approximate.

Width = 5 inches

Depth (front and rear) = 7 3/4 inches

Height = 1 1/4 inches

Lights

The front panel of the 8400B Plus has two lights, one red light and one green light. These lights indicate the status of the set during normal operation and the result of self-tests when initially powered.

When power is first applied to the 8400B Plus data module, the unit performs a self-test to verify that it is in working order. During the self-test, both lights will remain ON. When the self-test is complete, the green light turns OFF.

- If self-test passed, the red light will remain ON. This indicates that your 8400B Plus data module is installed and ready for data communications operation.

- If self-test failed, the red light will FLASH* three times, and then remain ON.

Other light indications are:

- **Idle in Normal Mode** — The green light is OFF; the red light is ON — This is the unit's normal mode if no active data call exists.
- **Incoming Call** — The green light FLASHES; the red light is ON — This indicates an incoming call.
- **Active Data Call** — Both the green and red lights are ON — This indicates an active data call.
- **Test Modes (Other Than Self-Test)** — Both green and red lights FLASH — This indication shows that the data module is in test mode.
- **Memory Error Mode** — The green light is OFF; the red light FLASHES — This indicates that the unit is defective. Call the AT&T Technical Service Center at 1 800 242-2121.
- **Switch Link Down** — The green light WINKS** ; the red light emits an INVERTED WINK*** — This indication shows that the unit is unable to communicate with the PBX. Restore the connection between the 8400B Plus and the PBX wall jack.
- **Phone Link Down** — The green light emits an INVERTED WINK; the red light WINKS — This indicates that the unit is unable to communicate with the telephone. Restore the connection between the 8400B Plus and the telephone.

Jacks

The 8400B Plus data module is equipped with the following jacks:

- **PHONE** — This connector accepts one end of the D8W telephone line cord used to connect a 2-wire voice terminal to the 8400B Plus data module.
- **LINE/POWER** — This connector accepts one end of the D8W telephone cord that connects the 8400B Plus data module and either:
 - ▶ a PBX wall jack already powered by a closet supply, or
 - ▶ a power supply, which is connected to the PBX wall jack.
- **EIA CONNECTOR INTERFACE** — This connector provides an interface between the 8400B Plus data module and the terminal (DTE) device.
 - ▶ If the communications port on the terminal device is a 9-pin interface, use a cord with DB9 male connectors on each end to connect the data module to the terminal device.

* A *Flash* is a repeated pattern of 500 ms ON and 500 ms OFF.

** A *Wink* is a repeating pattern of 750 ms ON and 250 ms OFF.

*** An *Inverted Wink* is a repeating pattern of 250 ms ON and 750 ms OFF.

- ▶ If the communications port on the terminal device is a 25-pin interface, use a 25-pin EIA-232-D cord, plus the supplied M9/F25 Adapter to connect the data module to the terminal device.

Mounting Options

The 8400B Plus data module can be desk-mounted.

Color Options

The 8400B Plus data module is available only in black.

Tests

The 8400B Plus data module supports the following test and maintenance features:

- Local Loopback and Remote Loopback
- Local Loopback Self Test and Remote Loop Self Test
- DCP Looparound
- Self-Test
- Make Busy on Local Loop

Features

The 8400B Plus data module has the following basic features:

- Nonvolatile, read-write memory for storing installation options, two data options profiles, and up to four telephone numbers
- Full-duplex, 10-bit start/stop, asynchronous operation
- Asynchronous data rates of 0.3, 1.2, 2.4, 4.8, 9.6, and 19.2 kbps
- Even, odd, mark, and space parity options
- Autobaud and autoparity
- Linked operation with the associated DCP voice terminal
- An *AT* command interface that emulates a Hayes 2400 Smartmodem and supports the following:
 - ▶ storage of the wait time for carrier detect interval (S-register *S7*)

The number stored in the *S7* register establishes the time the 8400B Plus data module will wait for call set up to be completed. This number can be set for any value up to a maximum of 255 seconds (with a default to 60 seconds).

- ▶ voice call origination from your PC using the *ATDP* command (however, these calls must be terminated manually).
- Data metering which allows the data module and associated terminal to operate at higher speeds than the far-end data point.
- Supports the semicolon modifier which enables an automatic return to the command mode after dialing a data call.
- Speakerphone Activation before Dialing
For terminal dialed voice calls, you can delay speakerphone activation until after a call is dialed. You would not hear touch tones or dial tone in this case.
- Power-up self-test
- Local and remote loopback tests with test duration timer
- Voice terminal powered by the PBX is not affected if AC power is removed from the 8400B Plus data module.

Data features for host or terminal applications include:

- EIA/RS-232-D DCE interface
- Hayes SMARTMODEM 2400 user interface emulation

Power

An AT&T power supply unit is shipped with each 8400B Plus data module. This unit connects to a grounded AC outlet, and provides a connection between the PBX wall jack and the 8400B Plus data module. The power supply unit provides the necessary operating voltages for the 8400B Plus data module.

Setting Options

There are 28 S-registers in the 8400B Plus data module. Twenty-two S-registers are used to store configuration parameters; one is used to store installation options, and the remaining five are unused. Eleven registers can be stored in nonvolatile memory, which will be restored when the unit is powered up. There are two sets of stored registers, or profiles. When the 8400B Plus is first powered on, the values that were last stored in the S-registers are the values in effect until *AT* commands are issued to change them.

You can check the current value stored in all S-registers with the *&V* command. To look at the contents of just one register, use the command *Smm?* where “mm” is the number of the S-register. The data module will return 3-digits, representing the decimal value of the specified S-register.

To change the value in any one S-register directly, use the command *Smm=nnn* where “mm” is the number of the S-register and “nnn” is the number you wish to place in the register.

For a full description of all 28 S-registers, see Appendix C in the *8400B Plus Data Module User's*

Guide, 555-020-708.

Notes for Use with PC Packages

Like the 7400B Plus, the 8400B Plus is able to use the following PC communication packages:

- CARBON COPY Plus V5.1
- Crosstalk® XVI V3.71
- Crosstalk Mk.4 V1.1
- Hot Line V2.2 (voice dialing packages)
- HyperACCESS® V3.32
- MicroPhone V1.5 (MacIntosh package)
- PC TOOLS Deluxe V6 (voice dialing packages)
- Procomm Plus® V1.1B
- Relay Gold® V3.0
- SideKick V1.5 and SideKick Plus® (voice dialing packages)
- Smartcom II V2.2
- Smartcom II V3.1
- Smartcom III V1.1
- Smarterm 240 V3.0a
- Terra Nova® V1.1.1
- White Knight V11 (MacIntosh package)

For those PC packages used to dial voice calls, the modem configuration must be set to PULSE (P) (even though the 8400B Plus will use Touch-Tone for voice calls). If given a choice, set modem type to HAYES.

Note: While the 8400B Plus supports simultaneous voice and data, the packages listed here support *alternate voice/data dialing only*. Voice dialing packages interfere with data operation by remapping the COM port or by hanging up the data call.

You *can* dial a data call while on a voice call. In all cases, the linked telephone will work.

FCC Registration

These data modules are not FCC registered. The 8400B Plus data module meets Part 15 Class A requirements and is labeled as such.

8400B Plus Data Module PEC Codes

The 8400B Plus data module can be ordered in the United States using the following Price Element Codes (PECs):

- **8400B Plus Data Module**
PEC: 2172-2WB
COMCODE: 407444835

This package contains the data module, a D8W telephone cord, an M9/F25 Adapter, and an adjunct power kit containing a 400B2 Adapter, a D6AP-87 cord, and a KS-22911.L2 power supply.)

Note: The 8400B Plus data module comes with a stand-alone power supply. However, it can also be closet powered.

Additional Documents

The following documents contain additional information relating to the 8400B Plus data module:

- *AT&T 8400B Plus Data Module User's Guide, 555-020-709*

7500B DATA MODULE

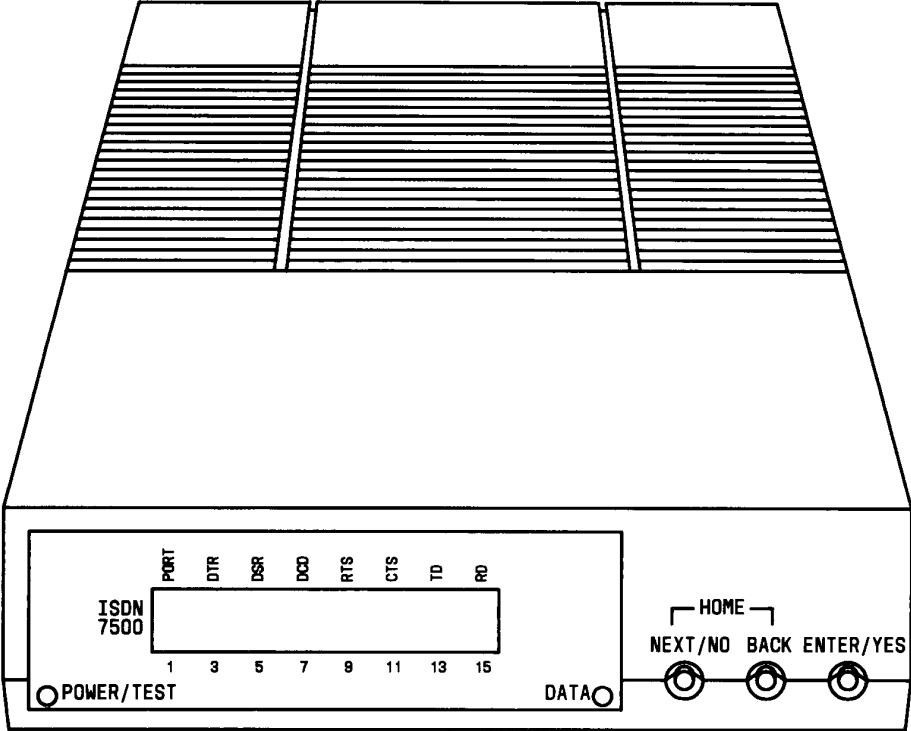

FIGURE 5-5. The 7500B Data Module

7500B Data Module

The 7500B Data Module is a terminal adapter primarily intended for connecting data terminal equipment (DTE) or data communications equipment (DCE) to the ISDN network. It can be configured in a number of ways to allow the attached DTE and DCE to send and receive data through the digital network. The 7500B has no voice functions.

Applications

The 7500B Data Module can be used with the DEFINITY G2 through a 4-wire "T"-interface. It is used by the customer who wants to connect his DCE and DTE with DTE, DCE, or host processor at another location using an ISDN network. The 7500B data module cannot be used in a modem pooling or Host Access arrangement on DEFINITY G2.

Physical Description

Dimensions

Note: The following dimensions are approximate.

Width = 7 inches

Depth (front and rear) = 8-3/4 inches

Height = 1-3/4 inches

Lights

POWER/TEST Light

This red light goes on when the 7500B data module is on and flashes during all tests.

DATA Light

This green light goes on when a data call is in progress. It flashes during self-test and when receiving an incoming data call that has not been answered.

Display

The 16-character LCD display shows the status information and option settings.

NEXT/NO, BACK, and ENTER/YES buttons

These buttons are used to step through each menu, set data communication options and functions, and adjust the contrast of the display.

Jacks

The 7500B data module is equipped with the following jacks.

- LINE—used to connect the 7500B to the ISDN telephone network
- PHONE—(not used)
- POWER—used to connect the 7500B to its DC power supply. The power supply is connected in turn to a standard AC receptacle.
- COMMUNICATIONS PORT 1 AND 2—Port 1 is used to connect the 7500B to a data terminal, computer or modem. Depending upon which enhancement board is installed, port 2 can be used to connect automatic calling equipment (RS-366 interface) or a data terminal equipment with a V.35 interface.

Mounting Options

The 7500B data module can be configured as a stand-alone unit or in a multiple-mount housing.

Color Options

The 7500B data module is available in misty cream only.

Features

Using the available hardware and software options, the 7500B data module can be configured as an asynchronous DCE or a synchronous DCE. The capabilities of the different configurations are shown on the next page.

Asynchronous DCE Features

- EIA RS-232D interface
- Circuit switched data communications. Data options can be changed and data calls can be setup via commands from the EIA-432D interface
- Ability to change options without dropping a data call
- Automatic or manual answering of incoming data calls
- Data rates of 0.3, 1.2, 2.4, 4.8, 9.6, and 19.2 kbps
- Asynchronous full-duplex operation
- RS-366 Automatic Calling Unit (ACU) interface (requires Multiple Enhancement Board)
- Hayes AT interface support.

Synchronous DCE Features

The synchronous DCE features with the Multipurpose Enhancement Board are as follows:

- EIA RS-232D interface
- Circuit switched or nailed-up data communication
- Data rates of 1.2, 2.4, 4.8, 9.6, 19.2, 56, and 64 kbps Full-duplex operation at all speeds
- Synchronous half-duplex emulation at 1.2 to 56 kbps
- Automatic answering of incoming data calls
- RS-366 Automatic Calling Unit (ACU) interface
- Autodial

The synchronous DCE features with the High Speed Synchronous Enhancement Board are as follows:

- V.35 interface
- Circuit switched or nailed-up data communication
- Data rates of 48, 56, and 64 kbps
- Full-duplex operation at all speeds
- Synchronous half-duplex emulation at 56 kbps only
- Automatic answering of incoming data calls
- Autodial

Distance Limitations

The maximum signaling distance from the port board to the work location jack based on DIW 24 AWG cable is:

- Terminating resistor in work location—1,900 feet
- Terminating resistor in satellite closet—1,600 feet.

Power Requirements

The stand-alone 7500B Data Module operates with power from a modular AC to DC adapter that is normally plugged into a wall outlet. When the 7500B is used in a multiple mount arrangement, a built-in power supply is provided in the 77A Data Mounting.

Terminating Resistor

A 440A4 Terminating Resistor adapter is required with the 7500B. The 440A4 can be located at the work location or in the satellite closet.

FCC Registration

The 7500B data module is not FCC registered.

Additional Documents

The following documents contain additional information relating to the 7500B Data Module:

- *7500B Data Module User's Manual*, 555-021-717

ISDN Asynchronous Data Module (ADM)

The ISDN ADM is used in conjunction with an ISDN 7505, 7506, or 7507 voice terminal to provide integrated voice/data. With the ADM, an attached data terminal or personal computer can send and receive data through the switch. This unit mounts in the base of the voice terminal and is used instead of the Voice Only Module (VOM). The VOM cannot be upgraded to an Asynchronous Data Module.

Physical Description

- The ISDN ADM is a printed circuit board built into the ISDN 7505, 7506, and 7507 Voice Terminal.
- Data and EIA RS-232-D connections.

An EIA RS-232-D and an 8-pin modular jack are located on the back of the ADM.

Features

The ISDN ADM offers the following features:

- Speed
Data rates of 0.3, 1.2, 2.4, 4.8, 9.6, and 19.2 kbps
- Full-duplex
- Asynchronous
- DATA/SEND/OFF button with two indicator lights; allows alternative data call setup from dial pad
- Data call setup from an ASCII keyboard through an EIA RS-232-D interface
- Ability to change options without dropping the data call
- Automatic or manual answering of incoming calls
- Remote and local loopback test
- Local mode operation for option setting and call control via terminal keyboard
- Hayes AT interface support

Power Requirements

Refer to the Power Requirements description in the ISDN 7505, 7506, and 7507 Voice Terminal section of this manual.

Price Element Codes (PECs)

Refer to the PEC list in the ISDN 7505, 7506, and 7507 Voice Terminal section of this manual.

Additional Documents

The following document contains information relating to the ISDN ADM:

- *ISDN Asynchronous Data Module Feature Package 2 User's Manual, 555-021-716*

DIGITAL TERMINAL DATA MODULE (DTDM)

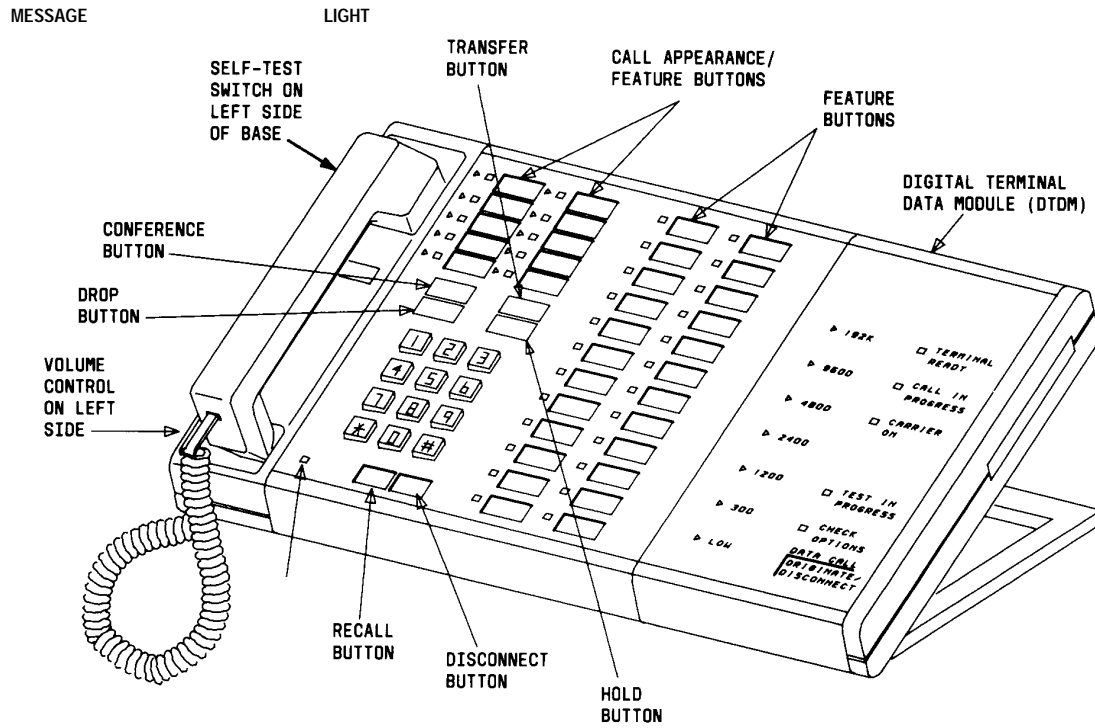

FIGURE 5-6. Digital Terminal Data Module mounted on a 7405D Voice Terminal

Digital Terminal Data Module (DTDM)

The DTDM provides a DCE interface to a DTE device that is connected to the DTDM (see **Figure 2** below) and allows the DTE to communicate with the switch through the voice terminal and its mounting cord. Data calls and voice calls can be carried on simultaneously, or data calls can be initiated independently of voice calls. The DTDM and the digital voice terminal integrate data and voice into the DCP interface with the system digital switch. The voice terminal user can continue to access all voice features while the module is active on a data call.

Addition of a DTDM allows an in-place 7403D or 7405D voice terminal to be upgraded for data communications at low cost.

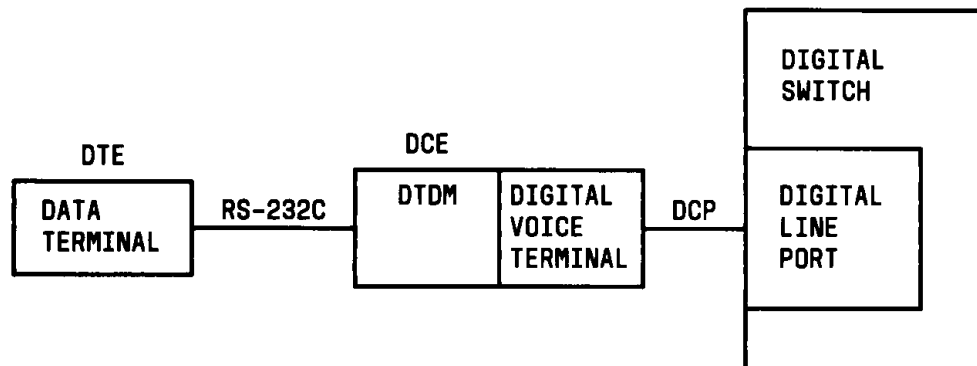

FIGURE 5-2. Block Diagram of DTDM Interfaces

Physical Description

The DTDM is contained in a molded plastic housing styled to match the associated voice terminal. Status lights, switches, and controls are located on the faceplate and behind a hinged side cover.

Dimensions

Note: The following dimensions are approximate.

Width = 4-3/4 inches

Depth (front to back) = 8-3/4 inches

Thickness = 1-1/2 inches

Lights

The DTDM is equipped with the following lights.

- Terminal Ready
- Call in Progress
- Carrier On
- Test in Progress
- Check options
- Receive Data
- Send data
- Test Result

Speed Indicator lights

The DTDM is equipped with seven indicator lights that show the speed at which the DTDM is operating.

Switches

Speed selector switch

The thumbwheel speed selector switch (located behind the side cover) selects data rates of LOW, 0.3, 1.2, 2.4, 4.8, 9.6, or 19.2 kbps.

Test switch

The Self-Test and Local Loop/Remote loop switches are located behind the side cover.

Option switches

The seven option switches are located behind the side cover.

Data Call Switch

The DTDM is equipped with a Data Call Switch labeled Originate and Disconnect.

Mounting Options

The DTDM is physically mounted to a 7403D or 7405D voice terminal. It attaches to the right side of the voice terminal. The entire unit can be desk or wall mounted with one exception: if the voice terminal is equipped with a Function Key Module, Call Coverage Module or Digital Display Module and a DTDM, it cannot be wall mounted.

Color Options

The DTDM is available only in silver.

Features

The DTDM offers the following features:

- Synchronous and asynchronous operation
- Half- and full-duplex operation
- Data transmission at standard rates up to 19.2 kbps
- Automatic answer option
- Self-test
- Remote and local loopback

Power

The DTDM requires auxiliary power from one of the sources listed in the **ADJUNCT POWER** section of this manual.

FCC Registration

The DTDM is not FCC registered.

DTDM Equipment PEC Codes

The DTDM can be ordered using the following PECs:

- Digital Terminal Data Module for 7403D—31745MTG05
- Digital Terminal Data Module for 7405D—31745MTG06
- Digital Terminal Data Module for 7405D and Function Key Module—31745MTG07
- Digital Terminal Data Module for 7405D and Call Coverage Module or Digital Display Module—31745MTG08
- Digital Terminal Data Module for 7405D and Function Key Module, and Call Coverage Module or Digital Display Module—31745MTG09

Additional Documents

The following documents contain additional information relating to the DTDM:

- *System 75 and System 85 DTDM User's Guide*, 999-700-027
- *DEFINITY Generic 1 and Generic 2, System 75, and System 85 Terminals and Adjuncts Installation and Test*, 555-015-104

Z702AL1 DATA SERVICE UNIT (DSU)

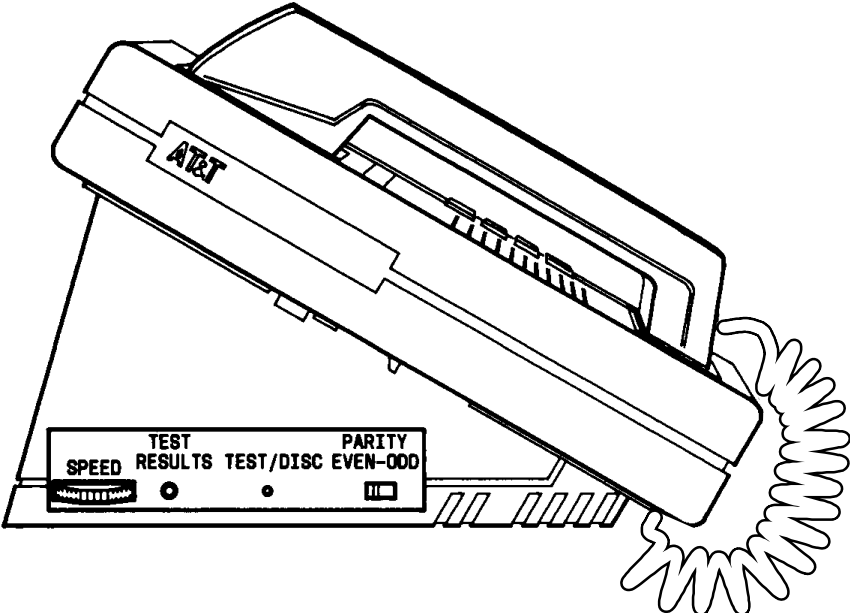

FIGURE 5-3. The Optional Z702AL1 Data Service Unit shown with 7407D01B Voice Terminal

Z702AL1 Data Service Unit (DSU)

The Z702AL1 DSU, when connected to the 7407D01B voice terminal, allows the user to transmit and receive voice and data over the same standard two pair of wires. The DSU provides the RS-232-C connection the data terminal needs to communicate with other data equipment without separate lines or modems. (See **Figure 2** below.) The DSU supports asynchronous, full duplex operation.

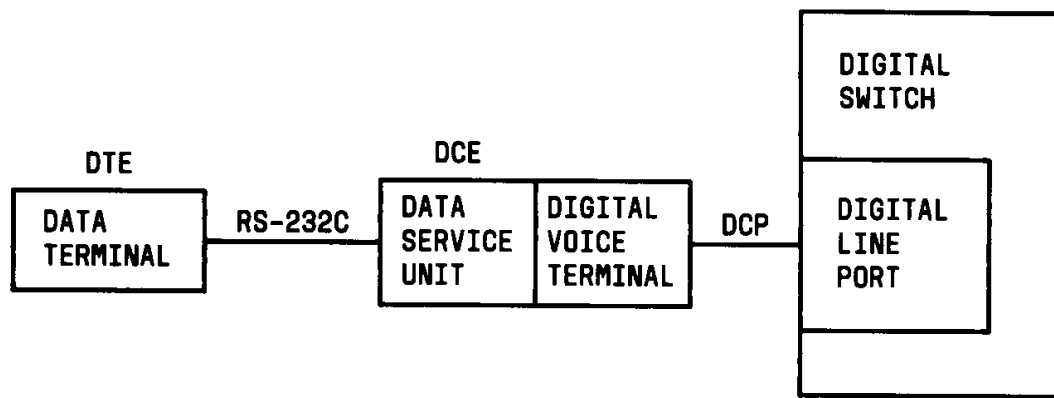

FIGURE 5-2. Block Diagram of Z702AL1 Data Service Unit Interfaces

Applications

The Z702AL1 DSU can be used with a 7407D01B voice terminal connected to a DEFINITY G1, G2, or G3 system, System 75, and System 85. Typical applications are users with data terminals requiring a large number of features and lines.

Features

The Z702AL1 DSU provides the following features:

- Selector for standard data rates of 0.3, 1.2, 2.4, 4.8, 9.6, and 19.2 kbps
- Asynchronous full duplex operation
- Automatic data call answering
- Data terminal keyboard dialing

- Data terminal keyboard disconnect
- Simultaneous voice operation
- Self-Test or Disconnect button
- Data Terminal Equipment (DTE) RS-232-C interface

Physical Description

Data Speed wheel

The Data Speed wheel selects the speed of operation. It is located on the right side of the DSU.

Self-Test light

The Self-Test light is located on the right side of the DSU.

Self-test or disconnect button

The Self-Test or Disconnect button is located on the right side of the DSU.

Parity switch

The parity switch is located on the right side of the DSU.

Mounting Options

The optional Z702AL1 DSU Data Module Base is installed on the 7407D01B voice terminal.

Color Options

The DSU is available in black only.

Power

The Z702AL1 DSU is powered by the 7407D01B which, in turn, is powered by a 110-volt AC wall receptacle.

Z702AL1 DSU PEC Codes

The Z702AL1-DSU can be ordered using the following PEC:

- Z702AL1 DSU—31800A

Additional Documents

The following documents contain additional information relating to the DSU:

- *DEFINITY Generic 2 and System 85 7407D Voice Terminal User's Guide*, 555-104-705
- *System 85 Application Notes*, 555-102-515
- *System 75 Application Notes*, 555-209-006
- *DEFINITY Generic 1 7407D Voice Terminal User's Guide*, 555-204-716
- *System 75 7407D Voice Terminal User's Guide*, 555-200-716
- *DEFINITY Generic 1 and Generic 2, System 75, and System 85 Terminals and Adjuncts Installation and Test*, 555-015-104

703A DATA SERVICE UNIT (DSU)

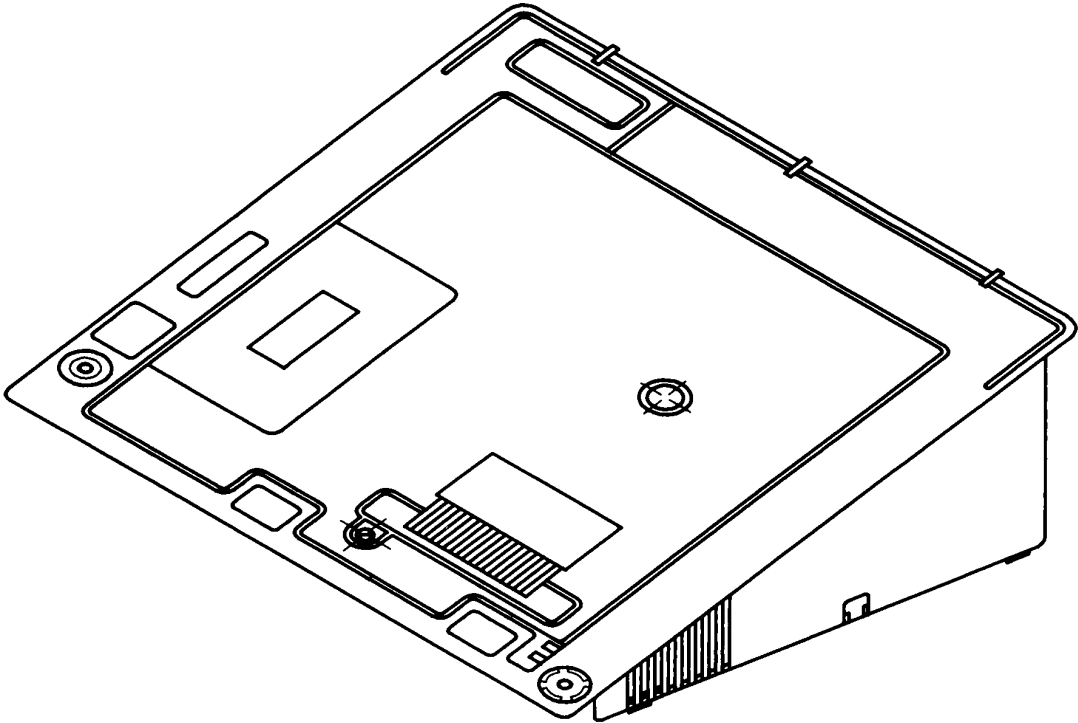

FIGURE 5-3. The 703A Data Service Unit

703A Data Service Unit (DSU)

The 703A Data Service Unit (DSU) is used with the 7406D voice terminal to provide asynchronous data communications through the switch. The DSU replaces the desk stand under the 7406D voice terminal and allows a data terminal (such as 610 BCT) to be connected to the 7406D and data calls to be made to and from the switch. (See **Figure 2** below.)

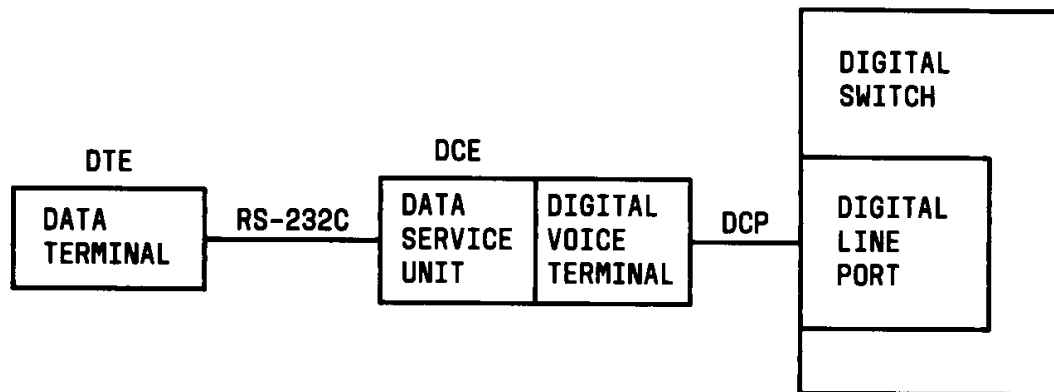

FIGURE 5-2. Block Diagram of 703A Data Service Unit

Applications

The 703A DSU can be used with 7406D voice terminal connected to a DEFINITY G1, G2, G3, System 75, or System 85. Typical applications are users with data terminals requiring a large number of features.

Features

The 703A DSU provides the following features:

- Selector for standard data rates of 0.3, 1.2, 2.4, 4.8, 9.6, and 19.2 kbps.
- Asynchronous full-duplex operation
- Automatic answering of data calls
- Data terminal keyboard dialing
- Parity switch (even / odd)

- Disconnect sequence switch (escape, break)
- Quiet option switch
- Button for self-test and data call disconnect
- Simultaneous voice operation
- Speed matching to a lower speed of remote data endpoint
- Remote loop test (from a distant data module)
- EIA RS-232-C interface
- Appearance of dialed number on the DTE screen (7406D02A only) during data call setup with the ASCII DTE
- Display features for the 7406D02A on the attached CRT

Physical Appearance

Option switches

The option switches for setting the operating speeds, disconnect sequence, and parity are located on the bottom of the DSU.

Self-Test button

The Self-Test button is located on the rear of the data stand adjacent to the RS-232-C connector. It is recessed and can be depressed with a pointed object such as a straightened paper clip.

Jacks

The DSU contains four jacks. The handset cord jack is on the bottom of the DSU housing just under the left side of the housing. The mounting cord jack and the audio cord jack are on the bottom of the DSU housing just under the rear of the housing. The RS-232-C connector is on the rear of the DSU.

Mounting Options

The optional 703A Data Service Unit Data Module Base is installed on the 7406D Voice Terminal. When the 7406D is equipped with the DSU, it cannot be wall mounted.

Color Options

The DSU is available in black only.

Power

The 703A DSU requires an external power source. Refer to the **ADJUNCT POWER** section of this manual for the correct power source.

703 DSU Price Element Codes (PECs)

The 703A DSU can be ordered using the following PEC:

- 703A Data Stand—31824A

Additional Documents

The following documents contain additional information relating to the 703A DSU:

- *DEFINITY Generic 2 and System 85 7406D Voice Terminal User's Guide*, 555-104-702
- *DEFINITY Generic 1 7406D Voice Terminal User's Guide*, 555-204-719
- *System 75 7406D Voice Terminal User's Guide*, 555-200-719
- *DEFINITY Generic 1 and Generic 2, System 75, and System 85 Terminals and Adjuncts Installation and Test*, 555-015-104.

DEFINITY® High Speed Link

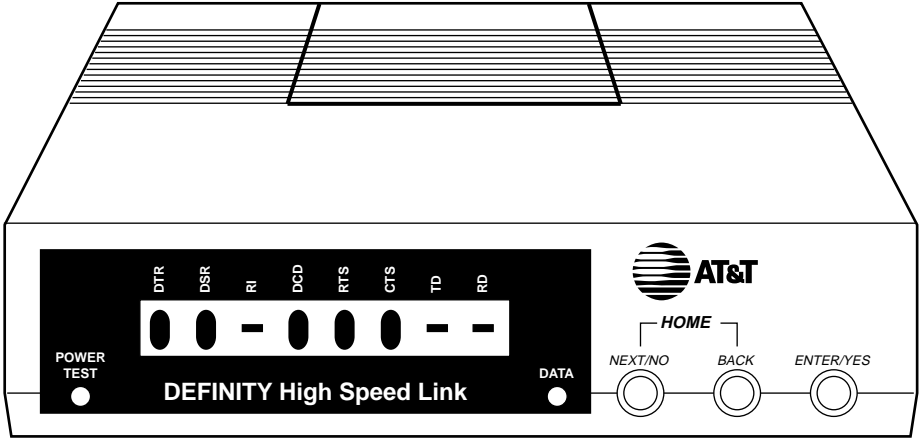

FIGURE 5-3. The DEFINITY High Speed Link

DEFINITY High Speed Link

The DEFINITY High Speed Link (HSL) is a data service unit that allows data equipment to access the data services of System 75 and System 85 and DEFINITY switches. It is used where the integration of voice and data is not required. The High Speed Link supports synchronous data transmission at speeds of 56 and 64 kbps, and provides a link to high speed data networks.

The DEFINITY High Speed Link provides access to various switched and dedicated (private) data networks, including Group 4 Fax, Video Teleconferencing, LAN Interconnect, and Cluster Controller/Front-End Processor Connections.

Physical Description

Dimensions

Note: The following dimensions are approximate.

Width = 7 inches

Depth (front and rear) = 9-1/4 inches

Height = 1-3/4 inches

Weight = 1 pound 5 ounces

Lights

POWER/TEST light

This red light goes on steadily when there is power to the High Speed Link; winks during all tests; and flashes with the DATA light for line fault indication.

DATA light

This green light goes on steadily indicating a data call is in progress; flashes when receiving an incoming call; and flashes with the POWER/TEST light for line fault indication.

Display

This 16-character LCD display shows the start-up sequence, status, option information, and test information.

NEXT/NO, BACK, and ENTER/YES buttons

These buttons are used to step forward and backward through the menus. These buttons are also used for executing functions.

Tests

The DEFINITY High Speed Link supports the following tests and maintenance features:

- Self-test
- Local loopback
- Data loopback
- Remote loopback (V.54 and AT&T proprietary protocol)
- Remote loopback with self-test
- DCP looparound test
- DDS latching/non-latching loopback

Connectors

The following connectors are located on the rear panel of the High Speed Link:

- RS-366/RS-232 (user must provide interface cable)
- V.35 (user must provide interface cable)
- LINE (cord shipped with set)
- POWER (for single installations, power is provided by a separately ordered stand-alone power supply— PEC 21625; for rack mounted installations, power is included with the Z77A Data Mounting— PEC 21626)

Mounting Options

The High Speed Link can be used as a stand-alone unit. It can also be installed in a Z77A multiple-mount rack.

Color Options

The DEFINITY High Speed Link is available in misty cream only.

Features

The basic features of the DEFINITY High Speed Link are:

- DCP operation up to 5,000 feet from the switch
- Super-twist LCD and three push-buttons for displaying status, setting options, controlling tests, storing telephone numbers, originating and manually answering calls
- Two LEDs for power, incoming calls, data mode, test mode and fault indications
- V.35 internally timed, synchronous interface for 56 kbps half duplex operation, 56 kbps full duplex operation, and 64 kbps full duplex operation
- RS-366 ACU interface for originating data calls
- RS-232 AT command interface with autobaud for originating and disconnecting calls
- Test features for system fault isolation
- Non-volatile memory for storing an option profile and four telephone numbers
- Reset options for easy loading of default options
- Data inversion option for compatibility with older 64 kbps DCP data modules
- Automatic or manual answer option
- DTR lead ignore option for operation with terminals that normally interface with private line DCE equipment
- DSR lead ON option for operation with terminals that normally interface with private line DCE equipment
- Optional DTR lead activated dial feature for stored number dialing
- Permanent connection option for operation in private line applications
- Memory cartridge interface for firmware upgrades

Applications

Administration

The High Speed Link is administered and/or aliased as a Modular Processor Data Module (MPDM). Routing, trunking and other administration considerations mirror those of the MPDM. The uses of the High Speed Link are compatible with those of an MPDM.

Switched Requirements

The following sections describe switched requirements.

Releases for Switched Applications

The switch releases which support the applications of the High Speed Link are:

- System 75 R1V2 or later
- System 85 R2V3 or later
- DEFINITY G1, G2, and G3

All versions of the switch do not provide the same level of support. The biggest difference is in the type of network access arrangement that is supported.

Switched Endpoints

The Data Terminal Equipment (DTE) must be capable of communicating at 56 kbps or 64 kbps. Proper switched operation requires that the DTE supports a Data Terminal Ready (DTR) lead on its V.35 interface. The DTR lead provides the signal to the High Speed Link that it is ready to receive or originate a call. Before the High Speed Link can originate (dial) or answer a call, the DTR lead must be asserted (high) by the DTE. In addition, the DTE uses the DTR lead to signal the High Speed Link to drop a call. This is accomplished by turning off its DTR lead.

Switched Applications

Switched applications are applications using the switched network. ACCUNET Switched Digital Services (SDS) and Software Defined Data Network (SDDN) are examples of switched applications. See **Figure 2** for an example of a switched configuration. For additional information on switched applications, implementations, and administration, refer to the *DEFINITY High Speed Link User's Manual*, 555-020-711, Appendix D: Applications and Switch Administration.

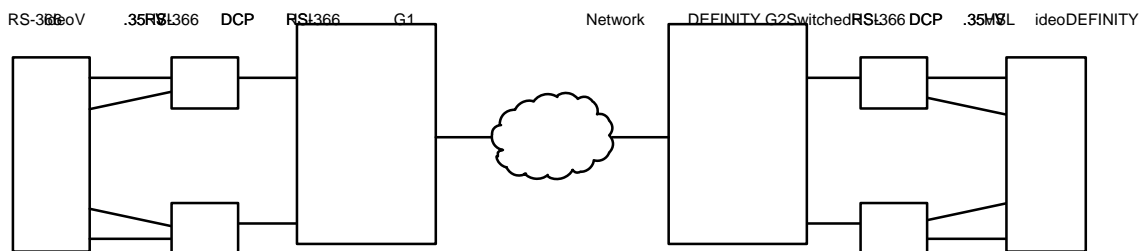

FIGURE 5-2. Switched Network Application

Permanent (Private Line) Requirements

The following sections describe Permanent (Private Line) requirements.

Releases for Permanent Applications

Permanent applications require the switch to establish and maintain the connection. The switch release and corresponding feature that support permanent connections are:

- System 75 R1V2 or later - Permanent Switched Call (PSC)
- System 85 R2V4 or later - Dedicated Switch Connection (DSC)
- Generic 1 - Administered Connection (AC) or Permanent Switched Call (PSC)
- Generic 2 - Dedicated Switch Connection (DSC)
- Generic 3 - Administered Connection (AC)

These various switch features provide different levels of support for permanent applications. DEFINITY G3 provides the broadest level of support with the Administered Connection Feature. The Permanent Switch Call in S75/G1 and the Dedicated Switch Connection in S85/G2 provide a subset of that functionality.

Permanent Endpoints

If Data Terminal Equipment (DTE) does not support the DTR lead, then the DTR IGNORE option must be used. This will allow a permanent connection to be established and maintained.

Permanent Applications

A permanent connection uses a DS0 channel on a private T1 between sites, or a DS0 channel on a DS1 to a private digital network such as ACCUNET Spectrum of Digital Services (ASDS). See **Figure 3** for an example of a Front End Processor/Cluster Controller application in a permanent connection configuration. For additional information on permanent applications, implementations, and administration, refer to the *DEFINITY High Speed Link User's Manual*, 555-020-711, Appendix D: Applications and Switch Administration.

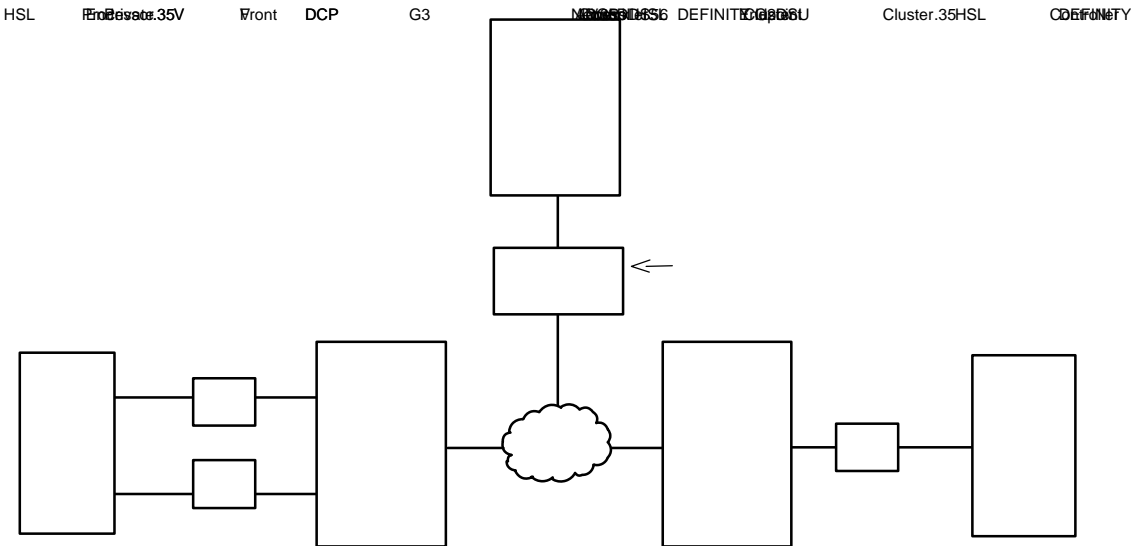

FIGURE 5-3. Permanent (Private Line) Applications

Power

The DEFINITY High Speed Link is powered by an external power supply. The connection to the power supply uses a six position male connector with one pin removed for polarization.

Power requirements:

- AC Voltage— 104 to 129 volts
- Frequency— 57 to 63 Hz
- Power Consumption— 9 watts

Considerations

The DEFINITY High Speed Link will not support the following:

- Asynchronous data transmission
- Integrated voice and data

FCC Registration

Digital phones and data modules are not FCC registered. The DEFINITY High Speed Link meets FCC Part 15 approval, and is labeled as such.

High Speed Link Price Element Codes (PEC)

The DEFINITY High Speed Link can be ordered using the following PECs:

- DEFINITY High Speed Link
PEC 2161-201
COMCODE: 106654478
- Stand-alone Power Supply— PEC 21625
- Z77A Data Mounting (rack with power for up to 8 HSL units)
PEC 21626, Attribute 1— Z77A with WP90780L2 digital line installation harness
PEC 21626, Attribute 6— Z77A only

Additional Documents

The following document contains additional information relating to the DEFINITY High Speed Link:

- *DEFINITY High Speed Link User's Manual, 555-020-711.*

PROCESSOR DATA MODULE (PDM)

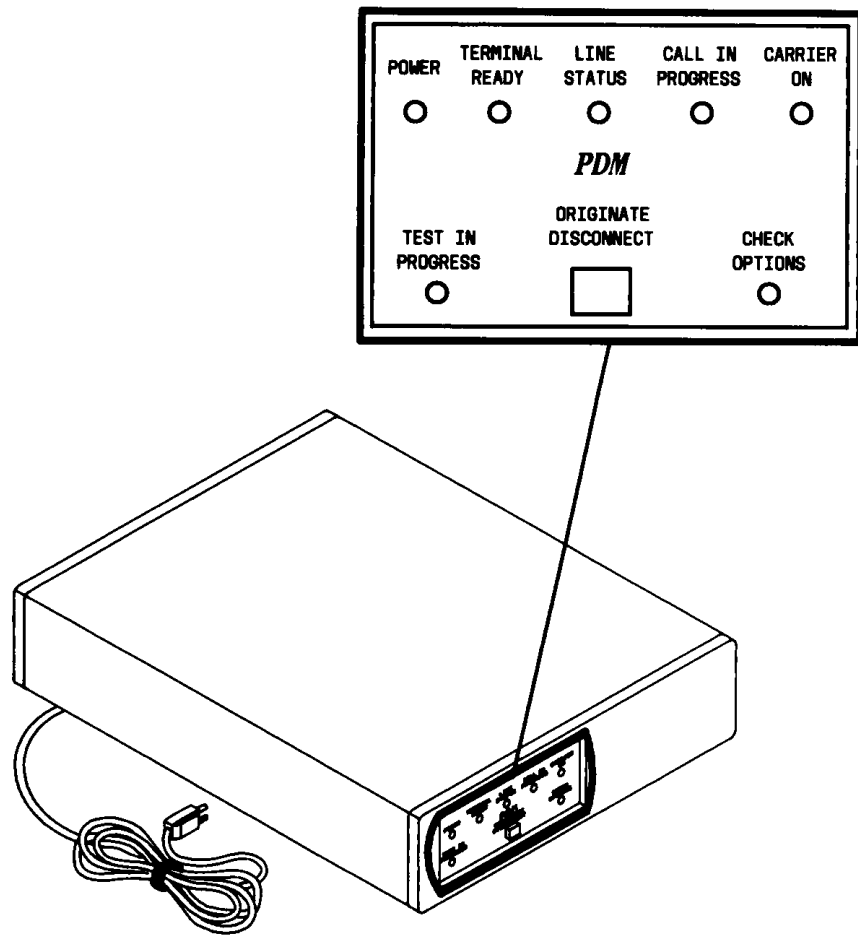

FIGURE 5-4. The Processor Data Module (stand-alone model)

Processor Data Module (PDM)

The Processor Data Module (PDM) provides a DCE interface for connection to data terminals, Station Message Detail Recording (SMDR) output device, on-premises administration terminal, Applications Processor (AP), Call Management System (CMS), Property Management System (PMS), Audio Information Exchange (AUDIX), and host computers. It also provides a DCP interface for connection to the digital switch.

The PDM can no longer be ordered. It has been replaced by the MPDM.

Features

The PDM offers the following features:

- Synchronous or asynchronous operation
- Full- or half-duplex operation for data calls up to 56 kbps
- Full-duplex operation for data calls at 64 kbps
- Data transmission at standard rates up to 19.2 kbps
- Automatic answer option
- Self-test

Physical Description

Switches

- Originate/Disconnect
This switch is located on the front panel. It is used when originating and disconnecting from a call.
- Self-Test
This switch is located behind the front faceplate. Pressing this button performs the self-test.
- LOC LOOP/REM LOOP
This switch is located behind the faceplate. It is used to perform the Local loop test or Remote loop test.
- Options
The option switches are located behind the front faceplate. There are 30 option switches, 25 for options, and 5 spares.

Lights

- Power
- Terminal Ready
- Line Status
- Call in Progress
- Carrier on
- Test in Progress
- Check option
- Test Result
- Send Data
- Receive Data

Mounting Options

The PDM can be configured either in a stand-alone or multiple mounted version. The stand-alone version is installed in a 70A Data Mounting aluminum housing that is equipped with plastic front and rear covers. A maximum of eight PDMs can be installed in the 71A Data Mounting.

The stand-alone version can be mounted on a surface or desk top near the associated data terminal. The multiple mount is normally contained in an auxiliary cabinet.

Power

Both mounting arrangements require power from a 115-volt AC receptacle to power the PDM(s).

PDM Equipment Price Element Code (PEC)

The PDM cannot be ordered; therefore, no PEC is available.

Additional Documents

The following documents contain additional information relating to the PDM:

- *Processor Data Module User's Guide*, 999-700-028
- *DEFINITY Generic 1 and Generic 2, System 75, and System 85 Terminals and Adjuncts Installation and Test*, 555-015-104

TRUNK DATA MODULE (TDM)

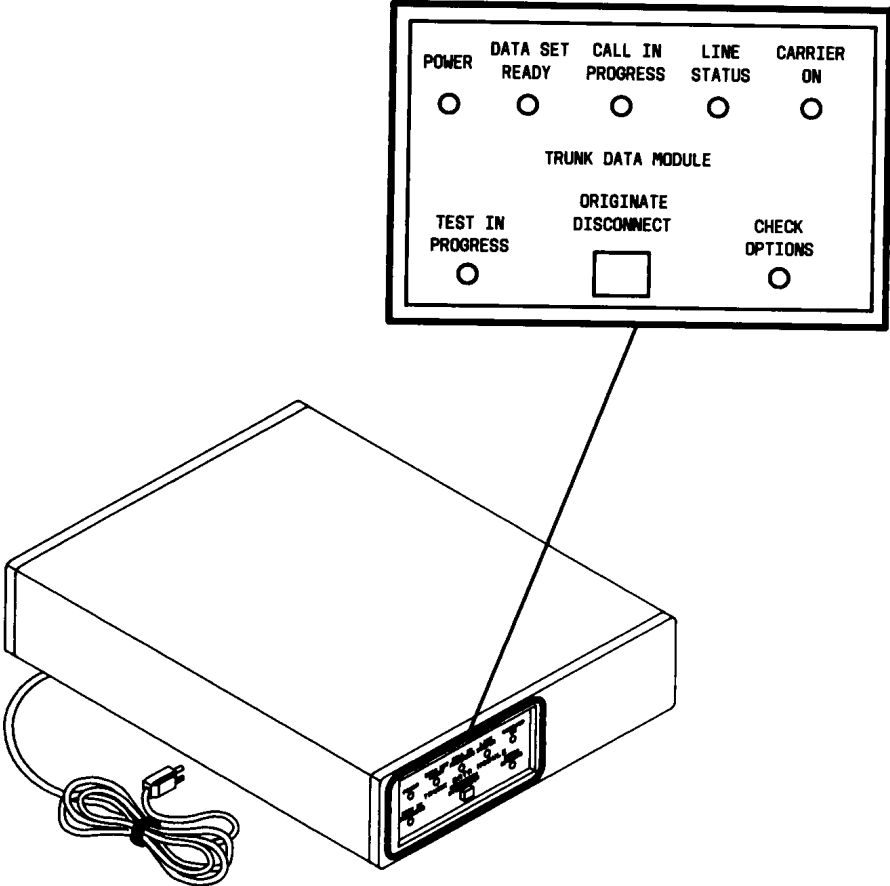

FIGURE 5-5. The Trunk Data Module (stand-alone model)

Trunk Data Module (TDM)

The Trunk Data Module (TDM) provides an RS-232-C DTE interface for connection to off-premises private line trunk facilities or a switched network telecommunications network and a DCP interface for connection to the digital switch.

The TDM can serve as part of a conversion resource for modem pooling. The conversion resource performs the analog-to-digital and digital-to-analog conversions that allow the analog and DCP data endpoints to communicate. A single conversion resource consists of a modem and a TDM connected at the RS-232-C interface.

The TDM can no longer be ordered. It has been replaced by the MTDM.

Features

The TDM offers the following features:

- Synchronous or asynchronous operation
- Full- or half-duplex
- Selected standard data rates up to 19.2 kbps
- Automatic answer
- Self-test

Physical Description

Switches

- Originate/Disconnect
This switch is located on the front panel. It is used when originating and disconnecting from a call for test purposes.
- Self-Test
This switch is located behind the front faceplate. Pressing this button performs the self-test.
- LOC LOOP/REM LOOP
This switch is located behind the faceplate. It is used to perform the Local loop test or Remote loop test.
- Options
The option switches are located behind the front faceplate. There are 30 option switches, 24 for options, and 6 spares.

Lights

- Power
- Data Set Ready
- Line Status
- Call in Progress
- Carrier on
- Test in Progress
- Check option
- Test Result
- Send Data
- Receive Data

Mounting Options

The TDM can be configured either in a stand-alone or in a multiple mounted version. The stand-alone version is installed in a 70A Data Mounting aluminum housing that is equipped with plastic front and rear covers. A maximum of eight TDMs may be installed in the 71A Data Mounting.

The stand-alone version can be mounted on a surface or desk top near the associated data equipment. The multiple-mounting carrier unit is normally installed in an auxiliary cabinet.

Power

Both mounting arrangements require power from a 115-volt AC receptacle to power the TDM.

TDM Equipment Price Element Codes (PEC)

The TDM is no longer orderable; therefore, no PEC is available.

Additional Documents

The following documents contain additional information relating to the PDM:

- *Trunk Data Module User's Guide*, 999-700-029
- *DEFINITY Generic 1 and Generic 2, System 75, and System 85 Terminals and Adjuncts Installation and Test*, 555-015-104.

MODULAR TRUNK DATA MODULE (MTDM)

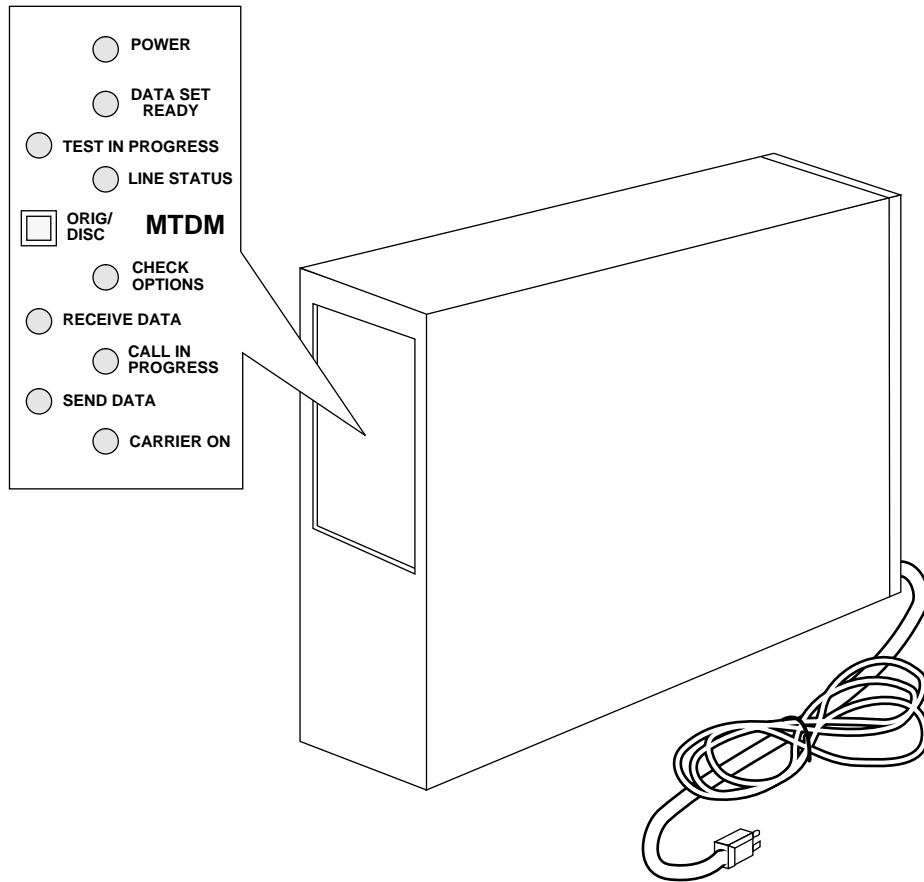

FIGURE 5-6. The MTDM, the Stand-alone model

Modular Trunk Data Module (MTDM)

Similar in appearance and function to the TDM, the MTDM is a multi-purpose data module configured to provide the digital switch interface to off-premises private line trunk facilities or a switched network telecommunications network. The MTDM may also serve as a conversion resource for modem pooling.

The MTDM can be configured to support the Data Call Setup, Modem Pooling, or Off-Premises Data-Only Extensions features. In addition to the standard data transmission rates supported by previous versions of the TDM (0.3, 1.2, 2.4, 4.8, 9.6, and 19.2 kbps), the MTDM supports data rates of 56 and 64 kbps for downloading and other high speed data transfer requirements.

Features

The MTDM offers the following features:

- Selected rates up to 64 kbps
- Asynchronous rates up to 19.2 kbps
- Synchronous operation at 56 kbps and 64 kbps
- Full- or half-duplex operation up to 56 kbps
- Full-duplex at 64 kbps
- Self-test
- Automatic answer
- Private line and switched modes

Physical Description

Functional elements

- Main module—Comes in one version that is common to all modular modules and provides the basic digital interface and protocol conversion functions.
- Interface module—Provides an RS-232-C interface

Switches

- ORIG/DISC

This switch is located on the front panel. It is used when originating and disconnecting from a call for test purposes.

- Self-Test

This switch is located behind the front faceplate. Pressing this button performs the self-test.

- LOC LOOP/REM LOOP

This switch is located behind the faceplate. It is used to perform the Local loop test or Remote loop test.

- Options

The option switches are located behind the front faceplate. There are two Dual In-line Package switches, one a 10-position, the other a 12-position, located behind the front faceplate. Nineteen of the switches are used to set the options. The other three are spares reserved for future use.

Lights

- Power
- Data Set Ready
- Line Status
- Call in Progress
- Carrier on
- Test in Progress
- Check option
- Test Result
- Send Data
- Receive Data

Mounting Options

The MTDM can be configured either in a stand-alone or a multiple mounted version. The stand-alone version is contained in a 70A Data Mounting aluminum housing that is equipped with plastic front and rear covers. A maximum of eight MTDMs may be installed in the 71A Data Mounting.

The stand-alone version can be mounted on a surface or desk top near the associated data equipment. The multiple-mounting carrier unit is normally installed in an auxiliary cabinet.

Power

Both mounting arrangements require power from a 115-volt AC receptacle to power the MTDM.

MTDM Equipment Price Element Codes (PECs)

The MTDM can be ordered using the following PECs:

- MTDM—2162TDM
- RS232C Interface card—21621
- Stand-alone housing—21702
- 71A Multiple mount—21711

Additional Documents

The following documents contain additional information relating to the MTDM:

- *Modular Trunk Data Module User's Guide*, 999-700-301
- *DEFINITY Generic 1 and Generic 2, System 75, and System 85 Terminals and Adjuncts Installation and Test*, 555-015-104.

3270 DATA MODULE

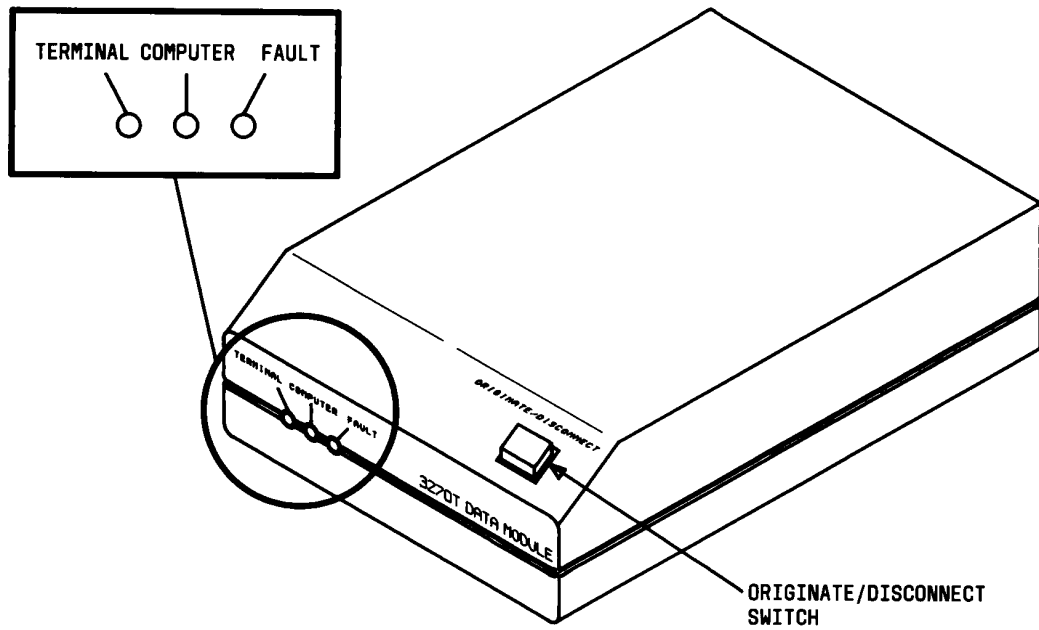

FIGURE 5-7. The 3270A or 3270T Data Module

3270 Data Module

The 3270 Data Module provides a Category A coaxial DCE interface for connection to 3270-type data terminals or a cluster controller. It also provides a DCP interface for connection to the digital switch.

The 3270 Data Module is available in the following three models:

- 3270T (Terminal) Connects to a Category A 3270-type terminal, such as the IBM 3278 Information Delivery System. The 3270T Data Module must connect through the switch to a 3270C (Controller) Data Module.
- 3270A (Asynchronous) Provides the same function as the 3270T Data Module. It also allows the 3270-type terminal to emulate a DEC VT100 or AT&T's Information Systems asynchronous terminal.
- 3270C (Controller) Connects an IBM 3274 or 3276 cluster controller to the switch. A 3270C Data Module (See **Figure 2**) can contain as many as eight ports.

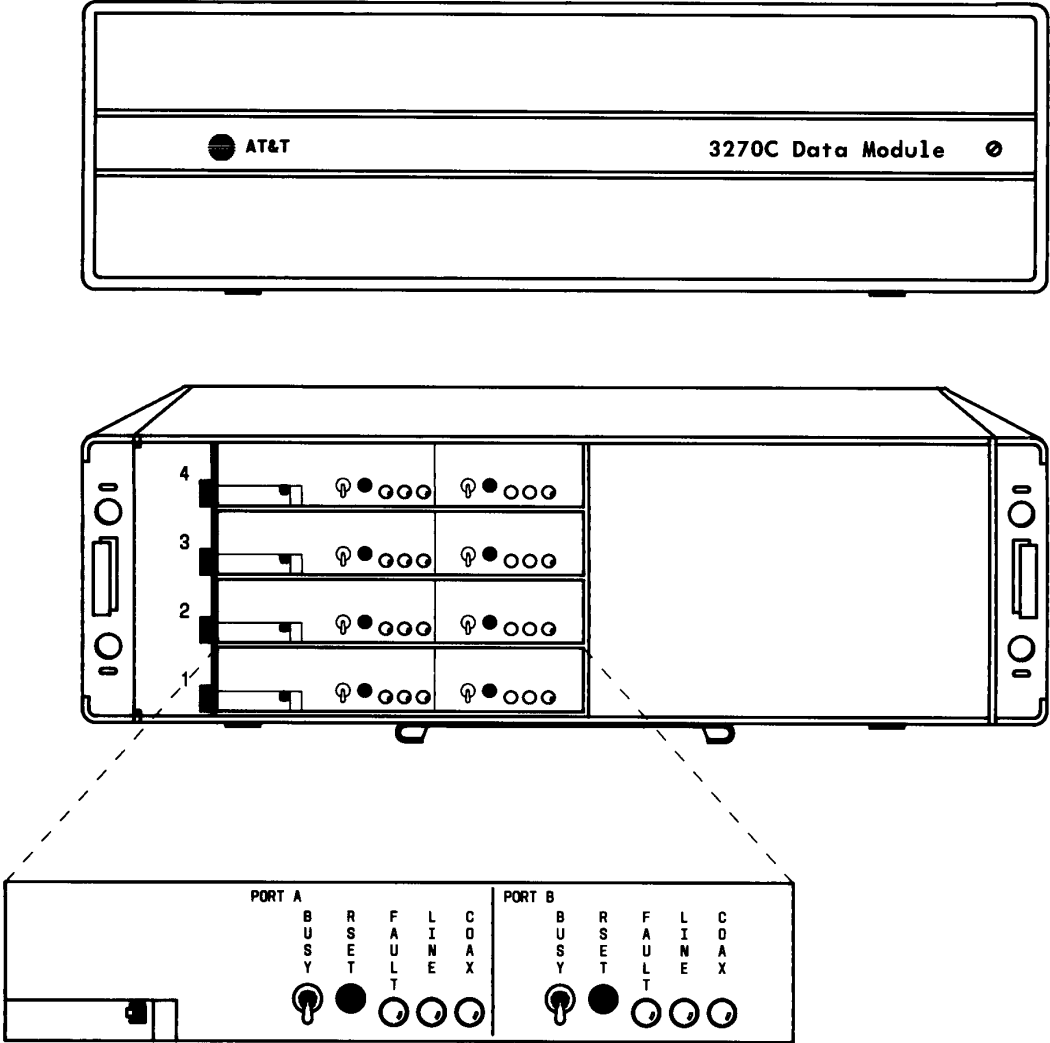

FIGURE 5-2. 3270C Data Module

The 3270A and 3270T

Dimensions

Note: The following dimensions are approximate.

Width = 5-3/4 inches

Depth (front to back) = 9-1/4 inches

Height = 1-1/2 inches

Lights

- Terminal
- Computer
- Fault

Switches

- Orig/Disc—located on the front
- Reset—located on the rear

Connectors

- Power
- Terminal
- Aux Phone
- Wall Jack

Mounting Options

The 3270A and 3270T are desk mounted near the terminal with which it is used.

Cords

A D8W-87 cord is provided with the data module. The coaxial cable with BNC male connectors for use between the data module and the terminal is customer provided. If an analog telephone is to be connected, the required modular cord must be provided with the telephone.

Power

An external power supply and the required cord is provided with the data module. The power supply requires a 115-volt AC wall receptacle not under the control of a wall switch.

The 3270C

Dimensions

Note: The following dimensions are approximate.

Width = 19 inches

Depth (front to back) = 16-1/2 inches

Height = 5-3/4 inches

Lights

There are two sets of the following lights on the front panel of the data module:

- Coax
- Line
- Fault

Switches

There are two sets of the following lights on the front panel of the data module:

- Busy
- Reset

Connectors

- Power
- DCP
- Port

The port connectors are labeled 1A, 2A, 3A, 4A, 1A, 1B, 1C, and 1D.

Mounting Options

The data module assembly may be stacked, wall mounted, or rack mounted near the cluster controller to which it is connected.

Cords

A 7-1/2 foot AC power cord is provided with the unit. A 25-pair cable for the connection to the DCP connector must be ordered separately. The coaxial cable with BNC connectors for connection to the cluster controller must be provided by the customer.

Power

All of the mounting arrangements require power from a 115-volt AC receptacle to power the data module.

3270 Equipment Price Element Codes (PECs)

The 3270 Data Modules can be ordered using the following PECs:

- 3270A Data Module—2168-A10 (not orderable)
- 3270T Data Module—2167-T10 (not orderable)
- 3270C Data Module—2166-C10
- 3270C Data Module Circuit Card—21660

Additional Documents

The following documents contain additional information relating to the 3270 data module:

- *3270 Data Module User Manual*, 555-030-701
- *DEFINITY Generic 1 and Generic 2, System 75, and System 85 Terminals and Adjuncts Installation and Test*, 555-015-104.

ASYNCHRONOUS DATA UNIT (ADU)

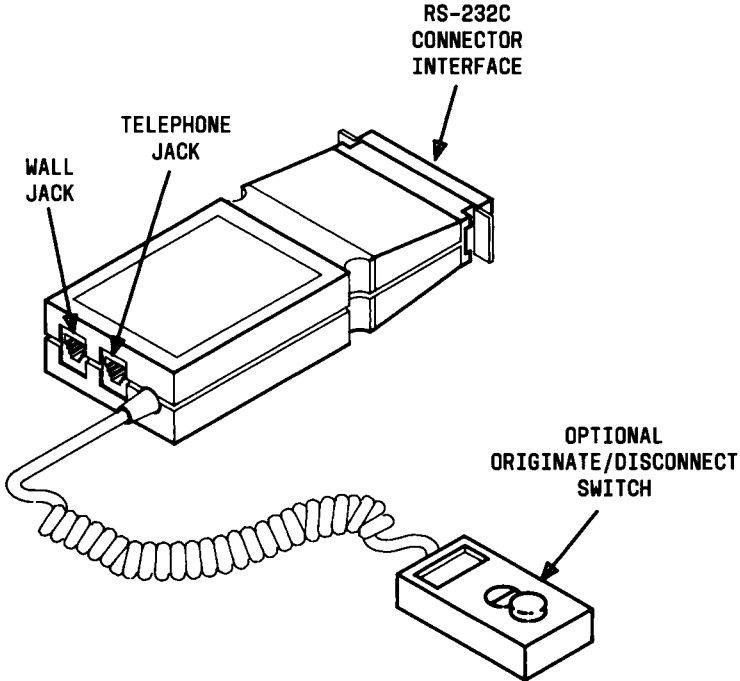

FIGURE 5-3. The Z3A Asynchronous Data Unit

Asynchronous Data Unit (ADU)

The Z3A ADU is a small DCE-type limited-distance modem that allows direct connection between RS-232 equipment and the system digital switch. Used in conjunction with the Data Line circuit pack (System 75, DEFINITY G1 and G2) or the EIA Port circuit pack (System 85), the ADU completes the direct link between the system switch and EIA terminals, printers, and host computer ports. In these applications, DTE devices can access the switch without using a separate data module or modem. The ADU is installed at the device end of the EIA connection. ADUs can also be hard-wired in pairs with other ADUs to interface data terminals directly to a host computer. This application is typical when access to the host is not made through the system.

Features

- Speed
Standard data rates from 0.3 to 19.2 kbps and non standard data rates below 1.8 kbps. The auto adjust option will automatically match the transmission speed to the attached RS-232.
- Full-duplex
- Asynchronous
- Built-in protection against voltage surges.

Physical Description

Dimensions

Note: The following dimensions are approximate.

Width = 2-1/4 inches

Depth = 4-3/4 inches

Height = 1 inch

Switch

An optional Originate/Disconnect switch can be used with the Z3A1, Z3A2, and Z3A4 ADUs.

Jacks

- Originate/Disconnect

The Z3A1/2/4 are equipped with a jack used to connect the optional Originate/Disconnect switch.

- Telephone

The Z3A1/2/4 are equipped with modular jack to connect the optional analog telephone.

- Data and RS-232 connections.

Refer to the following table for the different data and RS-232 connections.

ADU MODEL	CONNECTOR TO RS-232	DATA CONNECTOR
Z3A1	25-pin plug on 3-foot cable	Modular
Z3A2	25-pin plug (no cable)	Modular
Z3A3	110-type patch cord	110-type patch cord
Z3A4	25-pin receptacle on 3-foot cable	Modular

Power

Under certain conditions the ADU is powered by the attached RS-232 equipment. When the power provided by the RS-232 is inadequate (± 7 volts are required on pins 20 and 2), an external power transformer, adapter, and patch cord are required.

Z3A Data Module Price Element Codes (PECs)

The Z3A Data Module and optional components can be ordered with the following PECs:

- Z3A1 Asynchronous Data Module—2169-001
- Z3A2 Asynchronous Data Module—2169-002
- Z3A3 Asynchronous Data Module—2169-003
- Z3A4 Asynchronous Data Module—2169-004
- Originate/Disconnect Switch—21692
- ADM Mounting Trough—21693

Additional Documents

The following document contains information relating to the Z3A Data Module.

- *Asynchronous Data Unit Z3A User Manual*, 555-401-701

DCIU Interface Units

The three interface units used in a DEFINITY G2 and System 85 DCIU link are the 105A Isolating Data Interface (IDI), the 48250 Local Distribution Service Unit (LDSU), and the 2500-Series Data Service Unit (DSU).

105A Isolating Data Interface (IDI)

The IDI is a miniature connection unit for point to point, synchronous, full-duplex operation between the DCIU and an external processor. The DCIU and the external processor can be a maximum of 400 feet apart. Only one IDI is required in each DCIU link.

Some of the features of the IDI are:

- No options or adjustments
- 0.3 through 19.2 kbps
- Uses DCIU timing
- Powered from the EIA control signals

48250 Local Distribution Service Unit

The LDSU interfaces the System 85 DCIU with an external processor. It provides the required isolation between the DCIU and the external processor. Two LDSUs per external processors are required.

Each LDSU contains:

- A transmitter with filtering and modulation—allows data transmission at speeds from 2.4 kbps up to 19.2 kbps
- A receiver with equalization, demodulation, clock recovery, and signal presence detection accepts incoming data from a 150 ohm line
- A regulated DC power supply for the required DC voltage
- An EIA RS-232-C interface

Each LDSU requires a 120-volt AC source.

2500-Series DSU

The 2500-Series DSU can be used as a Local Area Data Set for distances over 400 feet. Refer to the 2500-Series DSU section of this document under the **DATA MODULE** tab for the information on the DSU.

2500-Series Data Service Unit (DSU)

The 2500-Series DSUs allow the user's computer or Data Terminal Equipment (DTE) to communicate with remotely located equipment using Digital Data Service network lines. The DSU integrates all Channel Service Unit (CSU) and DSU functions into one unit and connects between the network interface and the user's DTE.

The DSU can operate as a point-to-point Local Area Data Set (LADS). It is used when the DCIU and external processor are more than 400 feet apart. Two DSUs per external processor are required.

Physical Description

- Stand-alone Dimensions (approximate)
 - Width = 5-3/4 inches
 - Depth (front to back) = 9-5/8 inches
 - Height = 2 inches
- Multiple Mounting Dimensions (approximate)
 - Width = 23 inches
 - Depth (front to back) = 20 inches
 - Height = 7 inches

Features

- Full-duplex
- Synchronous operation
- Asynchronous operations with certain limitations when used as a LAD
- Three color test and status LCD panel
- Multi test functions
- Two color test and Status/Fault indicator
- User selectable options
- Mounting

The 2500-Series DSU can be stand-alone or multiple mounted. The stand-alone units can be wall or desk mounted. The multiple mounted units are mounted in a multiple-mount housing that can house up to eight DSUs.

- Operating Speeds

The 2556A, 2556B, and 2556C operate at 56 kbps. The 2596A, 2596B, and 2596C have

selectable subrates of 2.4, 4.8, or 9.6 kbps. When used as a LAD, they can also be optioned for 19.2 and 64 kbps operation.

Power

The stand-alone units are provided with a WP90131-L2 power pack. This power pack is plugged into a 115-volt AC wall receptacle not under the control of a wall switch. The multiple-mount housing is provided with a 6-foot power cord that is plugged into a 115-volt AC wall receptacle not under control of a wall switch. Each DSU that is to be mounted into the multiple-mount housing is equipped with a WP90131-L1 power pack that is plugged into the power strip on the rear of the housing.

Distance limitations

The 2556A, 2556B, and 2556C DSUs may be located a maximum distance of 50 feet from the DTE. The 2596A, 2596B, and 2596C DSUs may be located a maximum distance of 100 feet from the DTE.

2500-Series DSU Price Element Codes (PECs)

The 2500-Series DSUs and optional components can be ordered using the following PECs:

- 2556A Data Service Unit—2225-56A
- 2596A Data Service Unit—2225-96A
- 2556B Data Service Unit—2225-56B
- 2596B Data Service Unit—2225-96B
- 2556C Data Service Unit—2225-56C
- 2596C Data Service Unit—2225-96C
- 2500-Series Multiple-Mounting Housing—22253
- 2600-Series Multiple-Mounting Housing—22263

Additional Documents

The following document contains additional information relating to the 2500-Series Data Service Unit:

- *2500-Series Data Service Unit User's Manual*, 999-100-188

PC PLATFORMS (PC/PBX AND PC/ISDN) AND APPLICATION SOFTWARE

This section describes the devices that provide the ability to bring the PC and telephone together in a partnership of integrated voice and data.

The platforms and software covered in this section are:

- PC/PBX Platform
- PC/PBX MicroChannel Architecture Platform
- PC/ISDN Platform
- PC/PBX Connection
- E78 Plus/ISDN Software

PC Platforms (PC/PBX and PC/ISDN)

Today, professional PC users seek to realize the promise of desktop computing productivity by accessing multiple data sources—local and remote, internal and external. AT&T PC Platforms provide both a high speed connection to the PC and an open software interface for creating applications that use the connection.

Overview

The PC platforms are “open platforms” that allow software developers to build applications that take advantage of ISDN capabilities. The three platforms (PC/PBX, PC/PBX MicroChannel Architecture, and PC/ISDN) support a common data Applications Programming Interface (API) that provides applications portability between the DCP protocol and the ISDN-BRI. The common API protects DEFINITY system customers who have invested in DCP while providing a large installed DCP base for third party applications as well as the growing BRI market.

Platforms

The PC/PBX and PC/PBX MicroChannel Architecture platforms can be used with the DEFINITY G1, G2, G3, System 75, and System 85. The PC/ISDN platform can be used with the DEFINITY G2 and G3, and the AT&T 5ESS (Generic 5E4.2 and 5E5) switches. The platforms are particularly useful for building applications for those users who wish to use their PCs as a terminal for a host computer or wish to have their PC communicate with other PCs.

The connection between the PC and PBX can be either:

- Digital Communications Protocol (DCP) interface—the protocol for System 75, System 85, DEFINITY G1, G2, and G3
- ISDN Basic Rate Interface (BRI)—available with DEFINITY G2 and G3, and 5ESS switches.

Physically, an expansion card is inserted in the PC and connected to the PBX via unshielded twisted pair wiring. A separate card is needed for DCP and BRI. Since these cards feature a voice port, they also support integrated voice-data applications as well as data networking.

PC/PBX and PC/PBX MicroChannel Platforms

The PC/PBX platforms provide standalone PC users with a fully integrated networking solution that brings the benefits of high-speed, error free digital communications to the desktop. The PC/PBX platform supports existing configurations in which both the voice terminal and the PC are connected to the PBX via a single DCP line.

The PC/PBX MicroChannel Architecture platform is the same as the PC/PBX platform, but is intended for use with the IBM PS/2 Model 50 and above.

Applications

The platforms are ideal for professionals and managers who perform many different tasks during the day. The platform architecture permits different PC applications to access its resources alternatively or simultaneously. The PC/PBX Platforms support the 7400 Series voice terminals.

Potentially, a user could hold a voice conversation, be asynchronously connected to a host or PC, or conduct a 64 kbps 3270 session to a mainframe over a single twisted-pair connection. This eliminates the need for such multiple PC communications adapters as modems and coax cards.

Capabilities

Used in conjunction with PC applications software, the PC/PBX Platform provides the hardware architecture at the desktop for:

- High-speed PC-to-PC communication
- Access to asynchronous host environments
- Access to the synchronous 3270 environment
- Advanced telephone management capabilities

The PC/PBX Platform can also run the PC/PBX Connection software for integrating voice and data applications at the desktop. Thus, the platform supports all of the following:

- Synchronous communication via 3270 emulation with file transfer capabilities
- Asynchronous communication via VT[®] 100, VT102, and 4410 terminal emulation at speeds up to 19.2 kbps
- Digital Multiplexed Interface (DMI) connectivity at 64 kbps
- High-speed PC-to-PC communication for error-free file transfers at speeds up to 64 kbps via such standard asynchronous file transfer protocols as XMODEM and KERMIT

- Advanced phone management capabilities including:
 - ▶ Incoming call identification
 - ▶ Personal directory with up to 32,000 entries
 - ▶ Keyboard dialing
 - ▶ Messaging
 - ▶ Call log and notes
 - ▶ Switch feature access
 - ▶ Multiple call appearances

PC/PBX Price Element Code (PEC)

The PC/PBX platform package can be ordered using PEC 8302-101. The PC/PBX MicroChannel Architecture platform package can be ordered using PEC 8302-105.

These packages contain:

- An interface card for the PC
- System software—a device driver and hardware/software diagnostic utilities
- Installation and Reference guide

PC/ISDN Platform

The PC/ISDN platform provides standalone PC users with a fully integrated network solution in an ISDN environment. Supporting the full “2B+D” BRI, the platform brings to the desktop the benefits of high-speed, error-free digital communications.

Applications

The platform is ideal for professionals and managers who perform many different tasks during the day. The platform architecture permits different PC applications to access its resources alternatively or simultaneously. The PC/ISDN Platform supports the ISDN-BRI 7500 Series voice terminals.

Potentially, a user could hold a voice conversation, be asynchronously connected to a host or PC, or conduct a 64 kbps 3270 session to a mainframe over a single twisted-pair connection. This eliminates the need for such multiple PC communications adapters as modems and coax cards.

Capabilities

Used in conjunction with PC applications software, the PC/PBX Platform provides the hardware architecture at the desktop for:

- High-speed PC-to-PC communication
- Access to asynchronous host environments
- Access to the synchronous 3270 environment
- Advanced telephone management capabilities

In addition, the PC/ISDN Platform supports the capabilities of the ISDN-BRI 7500 Series voice terminals including:

- Conference, Transfer, Hold, and Drop
- Up to 254 call appearances
- Display and light indicator control supported from the application
- On-board digital signal processing for Dual Tone Multi-Frequency (DTMF or Touch-Tone) generation

PC/ISDN Price Element Codes (PEC)

The PC/ISDN platform package can be ordered using PEC 8302-104. This package contains:

- An interface card for the PC
- System software—a device driver, downloadable firmware, and utilities
- Installation and Reference Guide

Additional Documents

The following documents contain additional information relating to the PC platforms.

- *PC/ISDN Interface Software Developers Guide*, 555-016-103
- *PC/PBX Platform Installation and Reference*, 555-016-101
- *PC/ISDN Platform Installation and Reference*, 555-016-102

PC/PBX Connection

This product offers the users of AT&T PCs and IBM compatible PCs the voice and data capabilities of a fully integrated voice and data workstation.

Applications

The PC/PBX Connection application software can be used with DEFINITY G1, G2, G3, System 75, and System 85. It is particularly useful for those users who wish to use their PCs as a terminal for a host computer or wish to have their PC communicate with other PCs. It is targeted to "power" telephone users who want to eliminate many pieces of equipment from their desk.

Capabilities

The PC/PBX Connection can be used to perform the following activities:

- Dial calls from a PC keyboard
- Use customized telephone features from a keyboard
- Set up a personal telephone directory, search the directory, and dial voice and data calls from the directory (it can contain up to 32,000 entries)
- Know when telephone messages were received, read the messages on the screen, and have the system automatically dial calls to people who have left messages
- Log all incoming and outgoing voice and data calls and recall them on the PC
- Use voice terminal and speakerphone or voice terminal with built-in speakerphone to make hands-free calls
- Use security feature to keep directory and message information private
- Use a PC as a terminal connected to a variety of host computers (synchronous and asynchronous)
- Transfer files between a PC and another PC or host computer
- Set up "script programs" to have the system perform certain data functions

Moreover, voice and data functions can be used simultaneously, and other PC applications can be run while running PC/PBX connection in the background.

PC/PBX Price Element Codes (PECs)

The PC/PBX Connection can be ordered using the following PECs:

- PC/PBX Connection Software—1211-101
- PC/PBX Connection Hardware (PC/PBX Platform)—8302-101
- PC/PBX Connection Hardware (PC/PBX MicroChannel Platform)—8302-105

Additional Documents

The following documents contain additional information relating to the PC/PBX Connection:

- *PC/PBX Connection Release 3 Documentation Set, 555-016-715*
- *PC/PBX Connection Installation and Reference, 555-016-201*
- *PC/PBX Platform Installation and Reference, 555-016-101*

E78 Plus/ISDN Software

The E78 Plus/ISDN is a 3270 terminal emulation and file transfer package for micro-mainframe connectivity. However, its use in remote applications was, until recently, limited because of low-speed connections between locations. Now, used with any of the AT&T PC Platforms, E78 Plus/ISDN provides full 3270 emulation with switched connections through the AT&T DEFINITY Communications System using either DCP or ISDN-BRI at speeds of 64 kbps.

Applications

The E78 Plus/ISDN software can be used with DEFINITY G1, G2, G3, System 75, System 85, and 5ESS switch. It is particularly useful for those PC users who wish to download large amounts of data stored on central site mainframes to their desktop environment for processing and/or storage. The high-speed connection permits a PC user to transfer a large file quickly from a remote mainframe. Therefore, it is possible for users to download large quantities of data for desktop processing and analysis on a daily basis.

Physical Description

The E78 Plus/ISDN provides a variety of transfer programs (for example, IRMAlink FT/TSO, FT/CMS, and FT/3270) to quickly and safely transfer text and binary files. These programs offer both menu and command-line operation in all major mainframe environments.

On the host side, an AT&T 3270C Data Module must reside between the cluster controller and switch. The PC must be equipped with either PC/ISDN Platform (BRI) Release 1.0 or later or PC/PBX Platform (DCP) Release 3.01 or later software.

Capabilities

The E78 Plus/ISDN software can be used to perform the following activities:

- High-speed (64 kbps) connectivity
- Eliminate the need for costly remote controllers
- Allow terminals to access applications on hosts that are not networked, thereby reducing the number of terminals required
- Transfer a large file quickly from a remote mainframe
- Integrate with PC/PBX Connection to provide simultaneous voice and data connectivity.

In addition, E78 Plus/ISDN provides productivity extras professionals expect, such as:

- **Keyboard Macros.** Frequently repeated commands and complex data strings can be stored on the keyboard. The same key can store different macros for DOS and 3270 emulation.
- **Keyboard Remap.** This utility lets the user easily modify keyboard layouts and create new ones for new applications.
- **Hot Keys.** Convenient hot keys allow the user to do things quickly—switch between PC and emulation sessions, jump to a file transfer menu, access DOS, or get help.
- **Save and Print Screens.** The user can capture screens, as needed: in a disk file, PC internal memory or at a printer.

E78 Price Element Codes (PECs)

The E78 Plus/ISDN software can be ordered using PEC 1211-102.

Additional Documents

The E78 Plus/ISDN documentation is not available through the AT&T GBCS Publications Fulfillment Center. Documentation is provided with the purchased product.

Blank Templates for Model Design

The Software Associate can use the following blank templates to create models for administering groups of terminals at a customer site.

Use the following procedures for filling out these forms.

1. In each button space write the telephone number, extension, feature code, or feature to be administered on that button. Note that some of the voice terminals have double-level buttons on which you can designate 2 features.
2. If the model design is to be used on other voice terminals, write the Model Name at the top of the form beside **Model Name**.
3. Fill in your name by **Software Associate**.
4. Write the numbers and letters of the project code beside **Project Code**.
5. When the customer has approved the button assignments designated on the templates, have the customer sign the form beside **Customer Approval**.
6. Beside **Date**, write the date that the customer signed the form.

The following voice terminal templates are available for your use:

- 7402 Plus
- 7406D
- 7406 BIS
- 7406 Plus
- 7407D
- Enhanced 7407D
- 7407 Plus
- 7410D
- 7410 Plus
- 7434D
- 7444
- 8403
- 8410D
- 8434
- 602 CALLMASTER
- CALLMASTER II and III (603)
- ISDN 7505
- ISDN 7506

- ISDN 7507
- ISDN 8503T
- ISDN 8510T
- ISDN 8520T

Index

105A Isolating Data Interface (IDI), 5-91
 2012D Power Supply, 2-31
 2500 DMGC Telephone, 3-329
 2500 DMGC Terminal, 3-329
 2500 Telephone, 3-323
 2500 YMGK Telephone, 3-335
 3270 Data Module, 5-79
 329A Power Supply, 2-31
 346A Modular Bulk Power Supply, 2-31
 353 Power Supply, 2-31
 48250 Local Distribution Service Unit (LDSU), 5-91
 4A Speakerphone, 4-35
 500 Telephone, 3-317
 500A Headset Adapter, 4-25
 502A Headset Adapter, 4-25
 703A Data Service Unit (DSU), 5-49
 7101A Voice Terminal, 3-17
 7102 Plus Voice Terminal, 3-25
 7102A Voice Terminal, 3-25
 7103A Fixed Feature Voice Terminal, 3-33
 7103A Programmable Voice Terminal, 3-41
 7104A, 3-49
 7104A Voice Terminal, 3-49
 7104A Voice Terminal with Message Waiting Adjunct, 3-49
 7203H, 3-57
 7203H Voice Terminal, 3-57
 7205H, 3-65
 7205H Voice Terminal, 3-65
 7303S, 3-73
 7303S Voice Terminal, 3-73
 7305S, 3-81
 7305S Voice Terminal, 3-81
 7400A Data Module, 5-5
 7401 Plus, 3-91
 7401 Plus Voice Terminal, 3-91
 7401D, 3-91
 7401D Voice Terminal, 3-91
 7403D, 3-121
 7403D Voice Terminal, 3-121
 7404D, 3-129
 7404D Voice Terminal, 3-129
 7405D, 3-137
 7405D Voice Terminal, 3-137
 7434D, 3-215

7434D Voice Terminal, 3-215
 7500B Data Module, 5-29
 7505 Modular Terminal, 3-381
 7506, 3-389
 7506 Display Terminal, 3-389
 7507 Display Terminal, 3-397
 85B1-49 Power Unit, 2-31
 945 Bulk Power Supply, 2-31
 95B1 Power Unit, 2-31

A

Adjunct Power Requirements, 2-12
 Adjunct Wall Mounting, 2-11
 Adjuncts, 4-1
 ADM, 5-33
 Administrable Buttons, 2-5
 Administration, 2-39
 ADU, 5-87
 Advantages of Digital Terminals Over Hybrid, 2-2
 Analog Voice Terminals, 2-1
 Asynchronous Data Module, 5-33
 Asynchronous Data Unit, 5-87

B

Buttons, 2-4

C

C201A Call Coverage Module, 4-5
 C401A Call Coverage Module, 4-5
 C401B Call Coverage Module, 4-5
 Call Appearance/Feature Buttons, 2-5
 Call Coverage Module, 4-5
 Call Progress Tones, 2-18
 CALLMASTER Digital Voice Terminal, 3-301
 Common Facilities, 2-4

D

D401A Digital Display Module, 4-9
Data Communications Equipment, 2-14
Data Modules, 5-1
Data Terminal Equipment (DTE), 2-14
DCE, 2-14
DCP, 2-14
DEFINITY High Speed Link, 5-55
Desk/Wall Mounting Arrangements, 2-10
Digital Communications Protocol (DCP), 2-14
Digital Display Module, 4-9
Digital Terminal Data Module, 5-37
Digital Voice Terminals, 2-2
DTDM, 5-37
DTE, 2-14

E

External Ringing Tones, 2-19
External Tones, 2-9

F

F201A Function Key Module, 4-15
F410A Function Key Module, 4-15
Facilities Common to All Voice Terminals, 2-4
Feature Buttons, 2-6
Fixed Feature Buttons, 2-4
Function Key Modules, 4-15

H

Handset Tones, 2-9
Headset Adapter, 4-25
Hybrid Voice Terminals, 2-2

I

Indicator Lights, 2-7
In-Use Light, 2-7
ISDN 7505, 3-381

ISDN 7507, 3-397

L

Light Signals, 2-20
Lights, 2-7

M

Merlin Voice Terminals, 3-487
Message Light, 2-8
Message Waiting Adjunct on 7104A
 Voice Terminal, 3-49
Message Waiting Indicator, 4-31
Messaging Cartridge, 4-55
MET Sets, 3-488
Modular Trunk Data Module, 5-73
Mounting Arrangements, 2-10
MTDM, 5-73
Multi-Appearance Voice Terminals, 2-2

P

PC/ISDN, 6-1
PC/PBX, 6-1
PDM, 5-65
Personalized Ringing, 2-19
Platforms, 6-1
Processor Data Module, 5-65
Protocols, 2-14

R

Reusable Voice Terminals, 3-487

S

S101A Speakerphone, 4-35
S102A Speakerphone, 4-35
S201A Speakerphone, 4-41
S202A Speakerphone, 4-41

S203A Speakerphone, 4-45
Single-Line Voice Terminal with Display, 3-49
Single-Line Voice Terminals, 2-1
Smart Set, 3-49
Speakerphone, 4-35, 4-41
Status Light, 2-7

T

Tones, 2-9
Tones Specifications, 2-18
Trunk Data Module (TDM), 5-69

W

Wall Mounting, 2-10

Z

Z34A Message Waiting Adjunct on 7104A
Voice Terminal, 3-49
Z34A Message Waiting Indicator, 4-31
Z702AL1 Data Service Unit (DSU), 5-43

