



1983

BMW 633CSi

Electrical

Troubleshooting

Manual

BMW of North America, Inc.
Montvale, New Jersey

FOREWORD

In the interests of continuing technical development work we reserve the right to modify designs and equipment.

Printed in USA

© Copyright BMW of North America, Inc.
January 1983

Not to be reproduced wholly or in part
without written permission of
BMW of North America, Inc.

PN 01 00 1 467 793

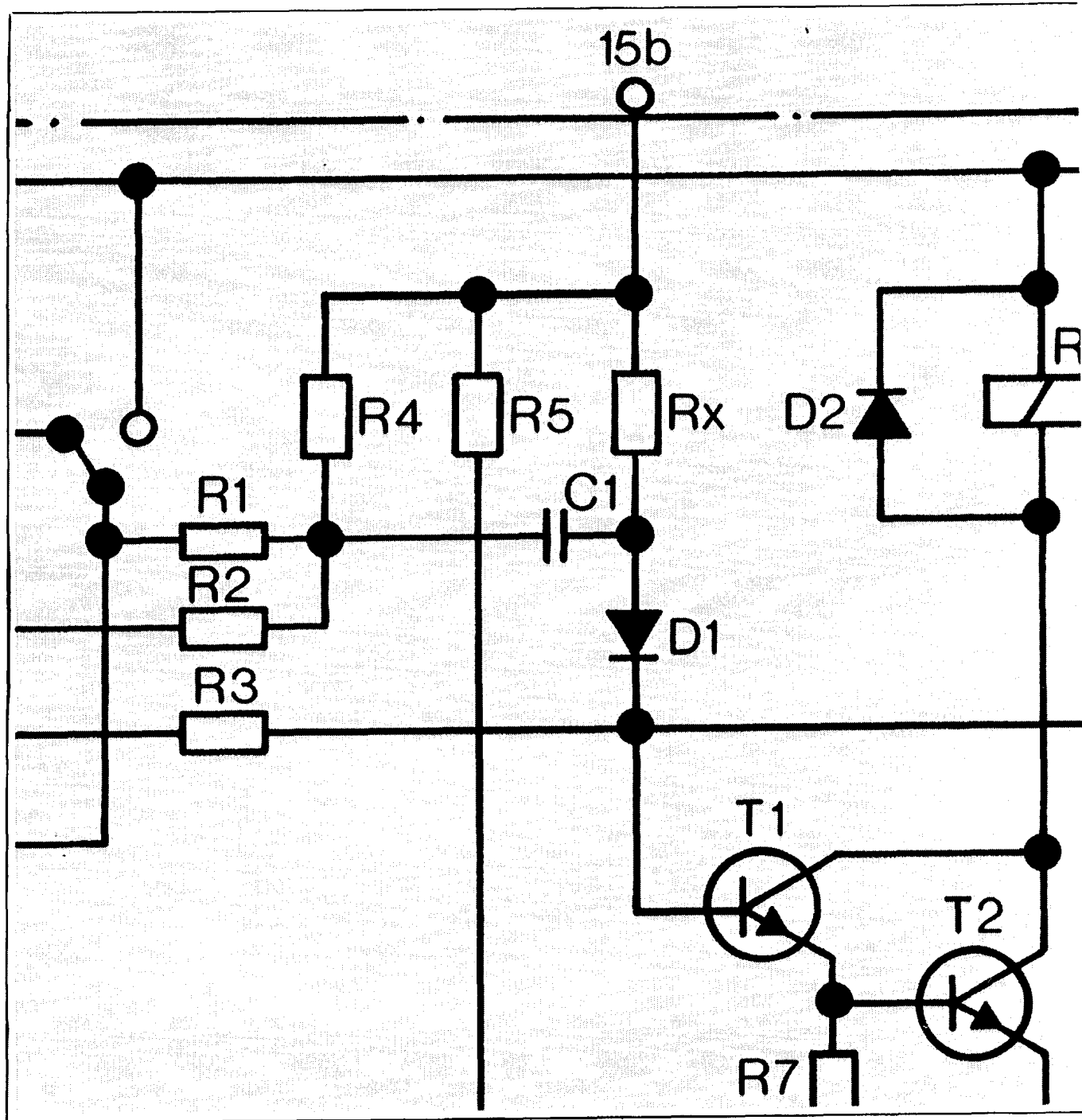

1983
 BMW 633CSi
 Electrical
 Troubleshooting
 Manual

CONTENTS

Index	2
How To Use This Manual	3
Symbols	4
Wire Size Conversion Chart ...	5
Systematic Troubleshooting ...	6
Diagnostic Connector	101
Power Distribution Box	102
Fuse Data	103
Schematic Diagrams	104
Component Charts and Figures	201

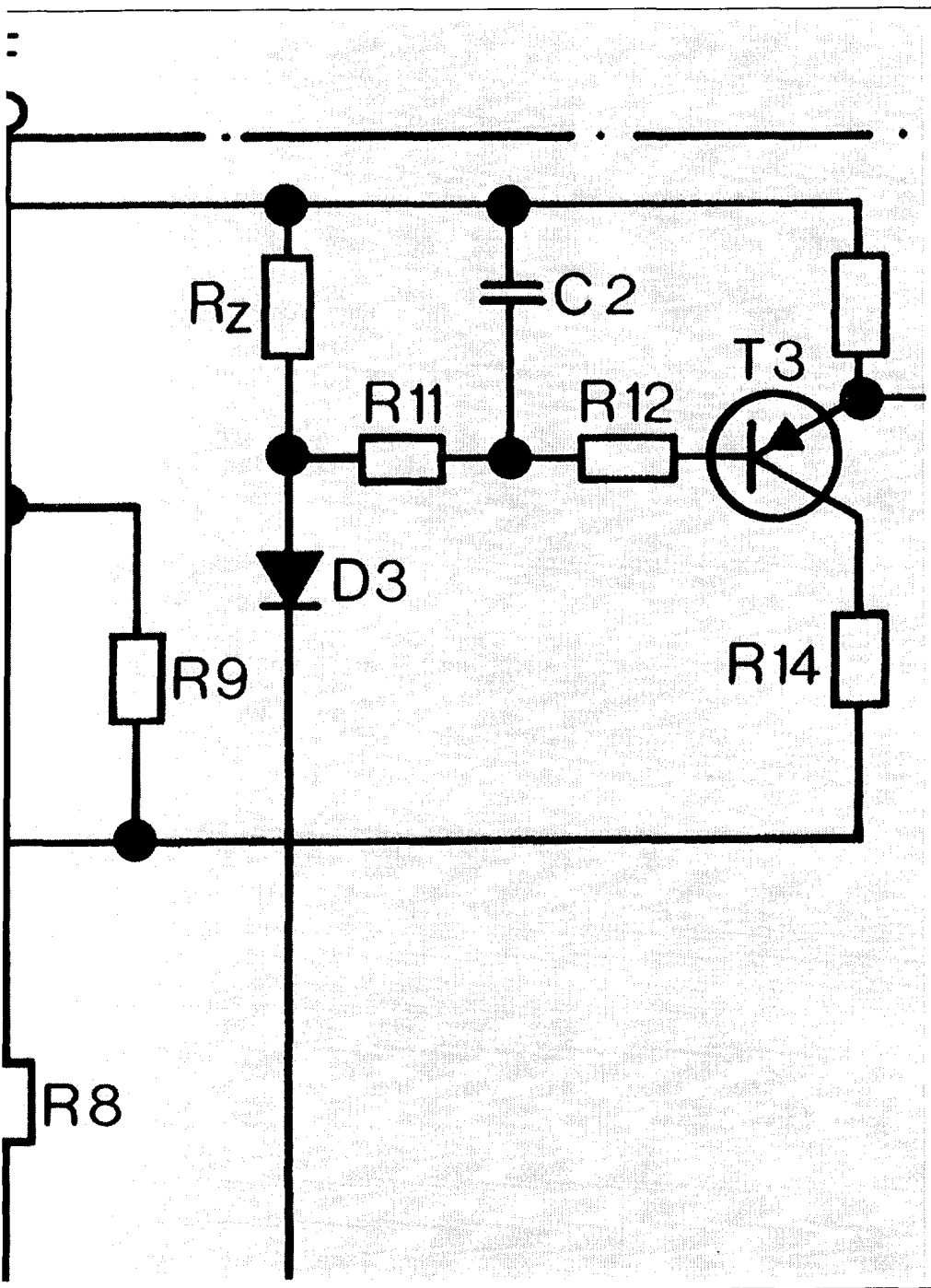

Index—Alphabetical Listing of Electrical Circuits

	SCHEMATIC PAGE		SCHEMATIC PAGE
Accessory Connector	157	Lights (continued)	
Active Check Control	123	—Hazard Warning	130
Air Conditioning	149	—Headlights	128
Auxiliary Fan	148	—Interior	127
Brake Lining Warning	126	—License	133
Central Locking	144	—Rear Marker	133
Charging System	109	—Stoplights	134
Cigar Lighter	139	—Tail	132
Cruise Control	134	—Turn	130
Diagnostic Connector	101	—Transmission Range	136
Evaporative Control	111	—Trunk	133
Fuel Control	114	—Underhood	132
Fuel Delivery	111	—Visor	136
Fuel Gauge	119	On-Board Computer	116
Fuse Data	103	Power Antenna	147
Gauges	118	Power Distribution	104
Ground Distribution	153	Power Distribution Box	102
Heater	149	Power Mirrors	146
Heated Door Lock	140	Power Windows	142
Horn	140	Radio	147
Idle Speed Control	112	Rear Defogger	141
Ignition	113	Seatbelt Warning	115
Ignition Key Warning	115	Service Interval Indicator	121
Lights		Speedometer	118
—Backup	138	Start	110
—Dash	136	Sunroof	152
—Fog	128	Warning Indicators	118
—Front Park	132	Windshield Washer Jet Heaters	158
—Glove Box	139	Wiper/Washer	122

The purpose of this manual is to show electrical schematics in a manner that makes electrical troubleshooting easier. Electrical components which work together are shown together on one schematic. The Wiper-Washer schematic, for example, shows all of the electrical components in one diagram. At the top of the page is the fuse (positive) that powers the circuit. The flow of current is shown through all wires, connectors, switches, and motors to ground (negative) at the bottom of the page.

Within the schematic, all switches and sensors are shown "at rest," as though the Ignition Switch were off. For identification, component names are underlined and placed next to or above each component. Notes are included, describing how switches and other components work.

The power distribution schematic shows the current feed through all the connections from the Battery and Alternator to each fuse and the Ignition and Light Switches. If the Power Distribution schematic is combined with any other circuit schematic, a complete picture is made of how that circuit works. The Ground Distribution schematics show how several circuits are connected to common grounds.

All wiring between components is shown exactly as it exists in the vehicle; however, the wiring is not drawn to scale. To aid in understanding electrical operation, wiring inside complicated components has been simplified. The "Solid State" label designates electronic components.

WIRE SIZE CONVERSION CHART	
METRIC (CROSSSECTIONAL AREA IN MM ²)	AWG (AMERICAN WIRE GAUGE)
.5	20
.75	18
1	16
1.5	14
2	14
2.5	12
4	10
6	8
8	8
16	4
20	4
25	2
32	2

WIRE INSULATION	
ABBREVIATIONS	COLOR
BK	BLACK
BR	BROWN
RD	RED
YL	YELLOW
GN	GREEN
BU	BLUE
VI	VIOLET
GY	GRAY
WT	WHITE
PK	PINK

4 SYMBOLS

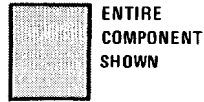

ENTIRE COMPONENT SHOWN

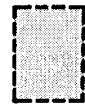

PART OF A COMPONENT SHOWN



COMPONENT WITH SCREW TERMINALS



SOLID STATE (INCLUDES ONLY ELECTRONIC PARTS)

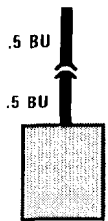

CONNECTOR ON COMPONENT LEAD (PIGTAIL)

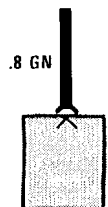

CONNECTOR ATTACHED TO COMPONENT



COMPONENT CASE IS DIRECTLY ATTACHED TO METAL PART OF CAR (GROUNDED)

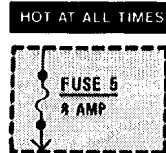

INDICATES THAT FUSE 5 IS ALWAYS SUPPLIED WITH POWER

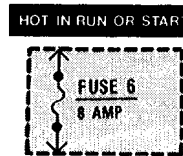

INDICATES THAT FUSE 6 IS SUPPLIED WITH POWER WITH THE IGNITION SWITCH IN THE RUN OR START POSITIONS

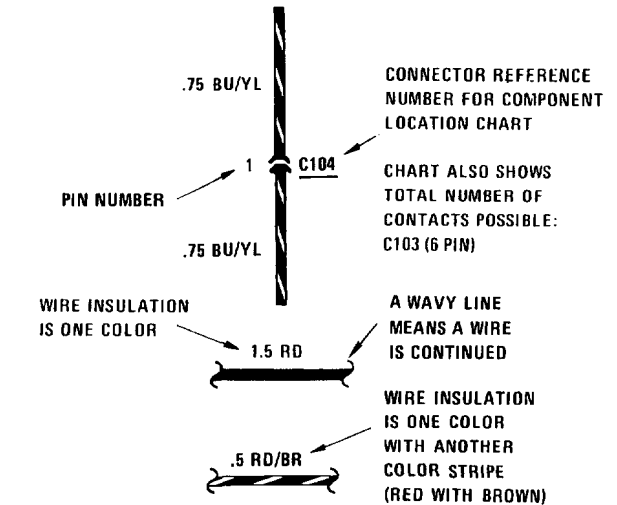
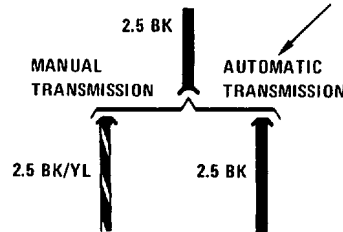

CONNECTOR REFERENCE NUMBER FOR COMPONENT LOCATION CHART

CHART ALSO SHOWS TOTAL NUMBER OF CONTACTS POSSIBLE: C103 (6 PIN)

A WAVY LINE MEANS A WIRE IS CONTINUED

WIRE INSULATION IS ONE COLOR WITH ANOTHER COLOR STRIPE (RED WITH BROWN)

WIRE SIZE IN MM²

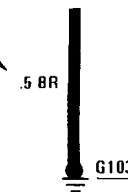

WIRE IS ATTACHED TO METAL PART OF CAR (GROUNDED) GROUND IS NUMBERED FOR REFERENCE ON COMPONENT LOCATION CHART

OTHER CIRCUITS THAT SHARE A GROUND ARE SHOWN IN GROUND DISTRIBUTION



DIODE CURRENT CAN FLOW ONLY IN THE DIRECTION OF THE ARROW

CIRCUIT REFERENCE - A WIRE WHICH CONNECTS TO ANOTHER CIRCUIT

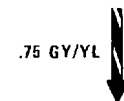

ACTIVE CHECK CONTROL

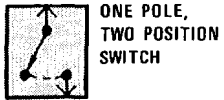

ONE POLE,
TWO POSITION
SWITCH

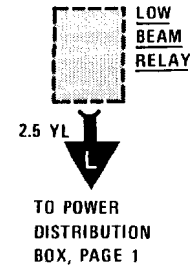
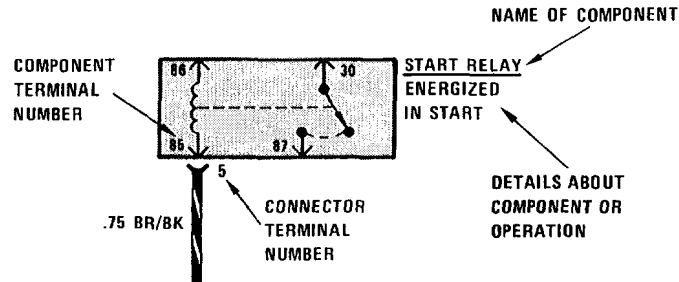

LOW
BEAM
RELAY

CURRENT PATH IS CONTINUED AS LABELED. THE ARROW SHOWS DIRECTION OF CURRENT FLOW AND IS REPEATED WHERE CURRENT PATH CONTINUES.

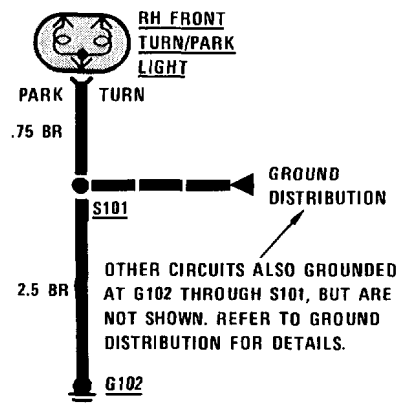
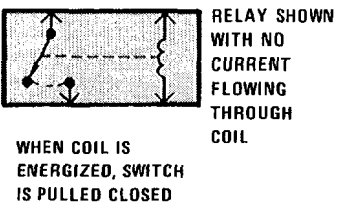
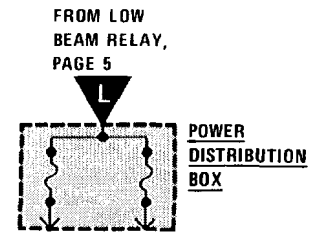
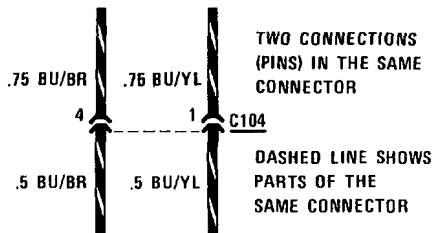
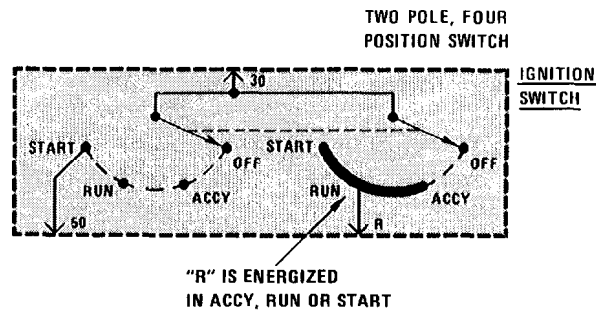
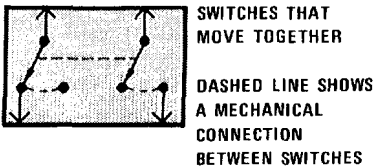

6 SYSTEMATIC TROUBLESHOOTING

TROUBLESHOOTING PROCEDURE

1. Verify the Problem

Operate the problem circuit to check the accuracy of the complaint. Note the symptoms of the inoperative circuit.

2. Analyze the Problem

Refer to the schematic of the problem circuit in the ETM. Determine how the circuit is supposed to work by tracing the current path(s) from the power feed through the circuit components to ground. Then based on the symptoms you noted in step 1 and your understanding of circuit operation, identify one or more possible causes of the problem.

3. Isolate the Problem

Make circuit tests to prove or disprove the preliminary diagnosis made in step 2. Keep in mind that a logical simple procedure is the key to efficient troubleshooting. Test for the most likely cause of failure first. Try to make tests at points which are easily accessible.

4. Repair the Problem

Once the specific problem is identified, make the repair using the proper tools and safe procedures.

5. Check the Problem

Operate the circuit to check for satisfactory circuit operation. Good repair practice calls for rechecking all circuits you have worked on.

TROUBLESHOOTING TOOLS

Isolating the problem (Step 3 of TROUBLESHOOTING PROCEDURES) requires the use of a **voltmeter** and/or **ohmmeter**. A voltmeter measures voltage at selected points in a circuit. An ohmmeter measures a circuit's resistance to current flow. It has an internal battery that provides current to the circuit under test. Disconnect the car battery when using an ohmmeter because the battery voltage will cause the ohmmeter to give false readings. Also, do not use an ohmmeter on solid-state components. The voltage that the ohmmeter applies to the circuit could damage these components.

TROUBLESHOOTING TESTS

Voltage Test

This test measures voltage in a circuit. By taking measurements at several points (terminals or connectors) along the circuit, you can isolate the problem.

To take a voltage measurement, connect the negative lead of the voltmeter to the battery's negative terminal or other known good ground. Then connect the positive lead of the voltmeter to the point you want to test. The voltmeter will measure the voltage present at that point in the circuit.

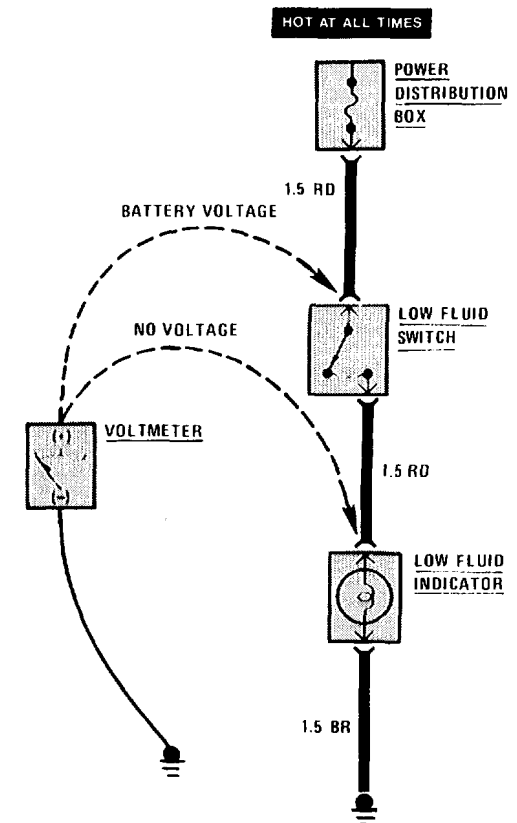

Voltage Test

Voltage Drop Test

Wires, connectors, and switches are designed to conduct current with a minimum loss of voltage. A voltage drop of more than one volt indicates a problem.

To test for voltage drop, connect the voltmeter leads to connectors at either end of the circuit's suspected problem area. The positive lead should be connected to the connector closest to the power source. The voltmeter will show the voltage drop between these two points.

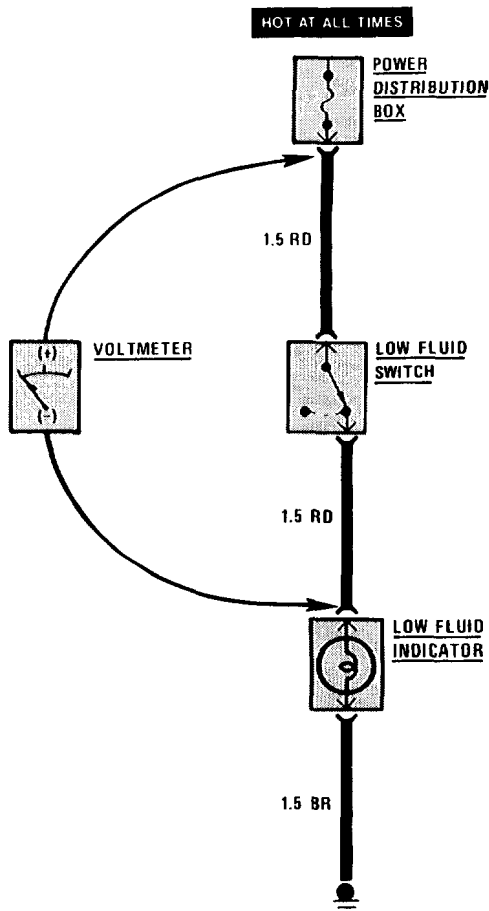

Voltage Drop Test

Continuity Test

To perform a continuity test, first disconnect the car battery. Then adjust the ohmmeter to read zero while holding the leads together. Connect the ohmmeter leads to connector or terminals at either end of the circuit's suspected problem area. The ohmmeter will show the resistance across that part of the circuit.

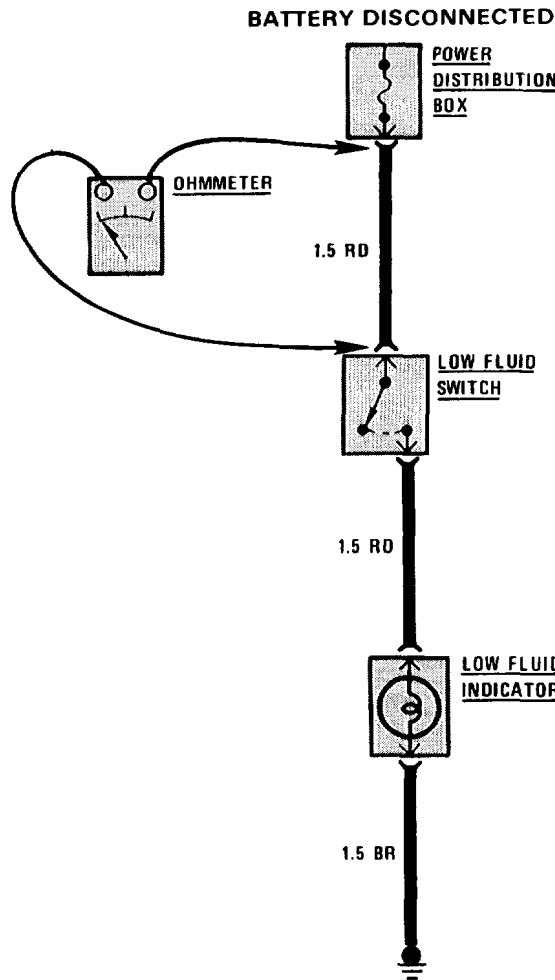

Continuity Test

Short Test Using Voltmeter

Remove the blown fuse and disconnect the load. Connect the voltmeter leads to the fuse terminals. The positive lead should be connected to the terminal closest to the power source.

Starting near the POWER DISTRIBUTION BOX, move the wire harness back and forth and watch the voltmeter reading. If the voltmeter registers a reading, there is a short to ground in the wiring. Somewhere in the area of the harness being moved, the wire insulation is worn away and the circuit is grounding.

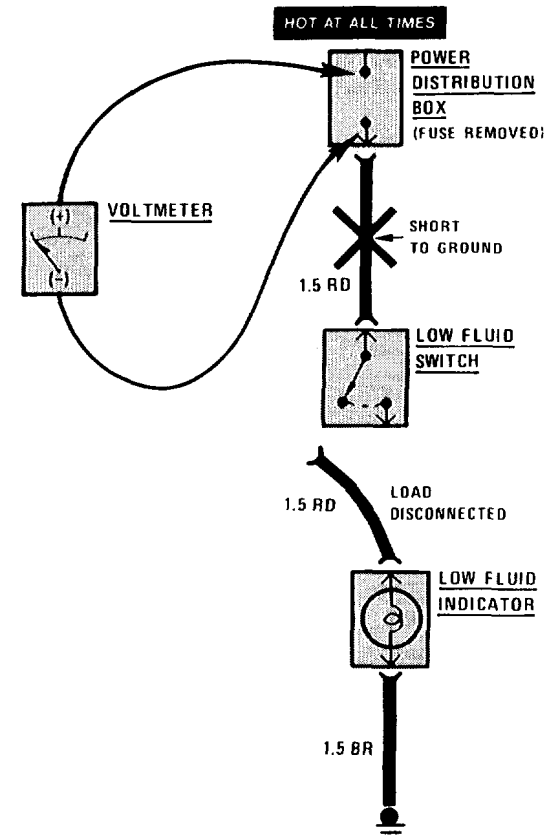

Short Test Using Voltmeter

8 SYSTEMATIC TROUBLESHOOTING

Short Test Using Ohmmeter

Disconnect the battery. Adjust the ohmmeter to read zero while holding the leads together. Remove the blown fuse and disconnect the load. Connect one lead of the ohmmeter to the fuse terminal that is closest to the load. Connect the other lead to a known good ground.

Starting near the POWER DISTRIBUTION BOX, move the wire harness back and forth and watch the ohmmeter reading. Low or no resistance indicates a short to ground in the wiring. Infinitely high resistance indicates no short.

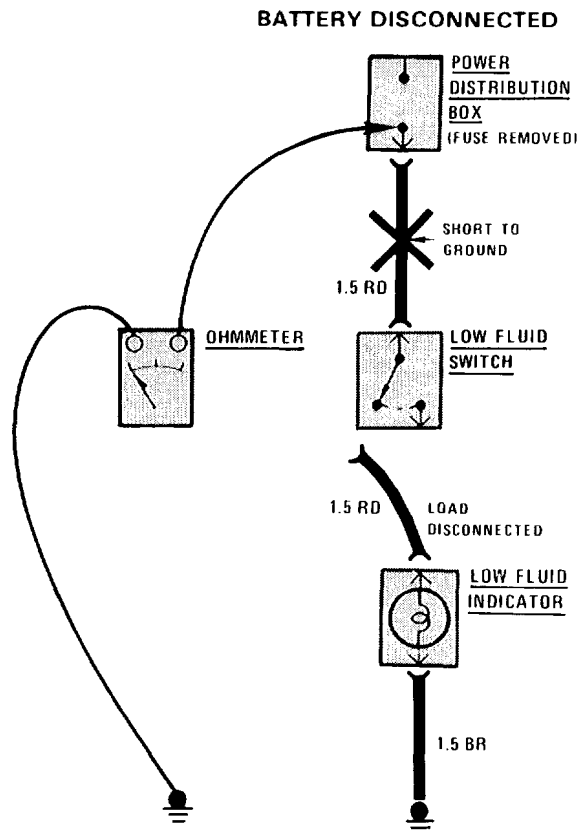

Short Test Using Ohmmeter

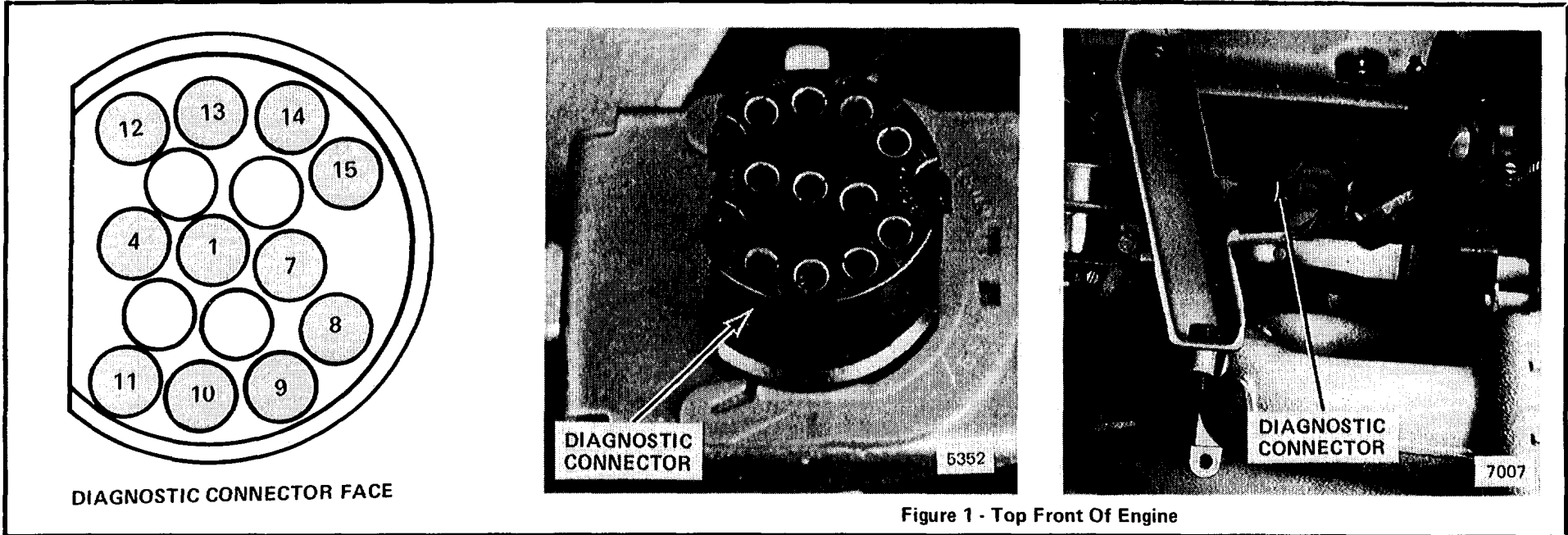

Figure 1 - Top Front Of Engine

PIN	WIRE SIZE	WIRE COLOR	CIRCUIT AND COMPONENT CONNECTED
1	1.5	BR	Ground Distribution, G103
4	.5	BR/WT	Gauges/Warning Indicators, Coolant Temperature Sender.
7	.5	WT/BU	Service Interval Indicator, Service Interval Processor (Reset).
8	.5	YL	Ignition, TDC Sensor.
9		SHIELD	Ignition, TDC Sensor.
10	.5	BK	Ignition, TDC Sensor.
11	2.5	BK/YL	Start, Start Signal.
12	.75	BU	Charge System, Alternator.
13	.75	BK	Ignition, Ignition Coil.
14	2.5	RD	Charge System, Alternator.
15	1.5	GN/YL	Idle Speed Control, Idle Speed Control Unit.

102 POWER DISTRIBUTION BOX

NOTE

On some cars, the position of the Fuel Pump and Purge Valve Relays may be the opposite of what is shown. Check relay wire colors for positive identification.

PURGE VALVE RELAY

FUEL PUMP RELAY

MAIN RELAY

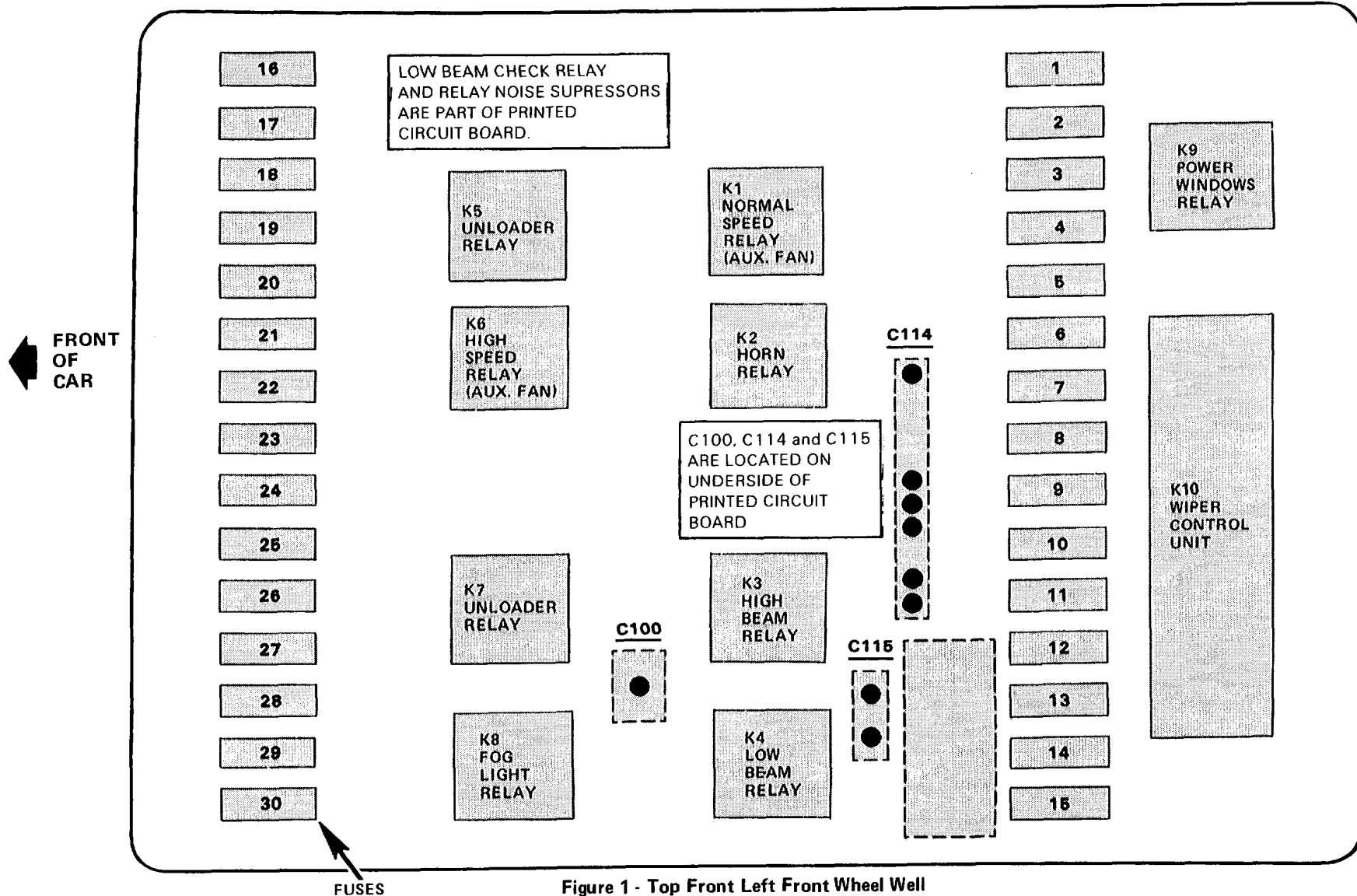

Figure 1 - Top Front Left Front Wheel Well

FUSE NO.	SIZE/ COLOR	CIRCUIT PROTECTED
1	7.5A (BR)	Headlights (also fuses 2, 13, 14).
2	7.5A (BR)	Headlights (also fuses 1, 13, 14).
3	25A (WT)	Auxiliary Fan.
4	15A (LT BU)	Lights: Turn/Hazard Warning (also fuse 24).
5	25A (WT)	Wiper/Washer, Windshield Washer Jet Heater.
6	7.5A (BR)	Active Check Control (also fuse 10, 12, 22, 23, 27); Cruise Control (also fuse 17); Stoplights.
7	15A (LT BU)	Horn.
8		Not Used.
9	7.5A (BR)	Idle Speed Control (also fuse 17).
10	7.5A (BR)	Active Check Control (also fuses 6, 12, 22, 23, 27); On-Board Computer (also fuses 12, 27); Speedometer/Gauges/Warning Indicators (also fuse 27); Brake Lining Warning; Service Interval Indicator (also fuse 27).
11	15A (LT BU)	Fuel Delivery.
12	7.5A (BR)	Active Check Control (also fuse 6, 10, 22, 23, 27); On-Board Computer (also fuses 10, 27); Radio (also fuses 21, 28, Radio In-Line Fuse); Warning Indicators.
13	7.5A (BR)	Headlights (also fuses 1, 2, 14).
14	7.5A (BR)	Headlights (also fuses 1, 2, 13).
15		Not Used.
16	30A (LT GN)	Heating/Air Conditioning.
17	15A (LT BU)	Auxiliary Fan; Back Up Lights; Cruise Control (also fuse 6); Lights: Dash/ Transmission Range (also fuse 23); Heater/Air Conditioning; Idle Speed Control (also fuse 4); Interior Lights (also fuse 21); Power Mirrors; Seatbelt Warning.
18	30A (LT GN)	Auxiliary Fan.
19	30A (LT GN)	Sunroof.

FUSE NO.	SIZE/ COLOR	CIRCUIT PROTECTED
20	25A (WT)	Rear Defogger (also fuse 23).
21	7.5A (BR)	Auto-Charging Flashlight; Glove Box Light; Interior Lights (also fuse 17); Radio (also fuses 12, 28, Radio In-Line Fuse); Trunk Light.
22	7.5A (BR)	Active Check Control (also fuses 6, 10, 12, 23, 27); Lights: Front Park/Rail (also fuse 20).
23	7.5A (BR)	Active Check Control (also fuses 6, 10, 12, 22, 27); Rear Defogger (also fuse 20); Lights: Front Park/Tail/Underhood (also fuse 22); Lights: Visor/Dash (also fuse 17); Lights: Rear Marker/License.
24	15A (LT BU)	Ignition key Warning; Lights: Turn/Hazard Warning (also fuse 4).
25	25A (WT)	Power Distribution
26	25A (WT)	Power Distribution
27	25A (WT)	Active Check Control; Central Locking; Speedometer/Gauges/Warning Indicator (also fuse 10); Heated Door Lock; On-Board Computer (also fuses 10, 22); Service Interval Indicator (also fuse 10).
28	25A (WT)	Cigar Lighter; Power Antenna (also fuses 12, 21, Radio In-Line Fuse).
29	7.5A (BR)	Fog Lights (also fuse 30).
30	7.5A (BR)	Fog Lights (also fuse 29).
Power Window Circuit Breaker	25	Power Windows.

104 POWER DISTRIBUTION

(For Component Locations See Page 208)

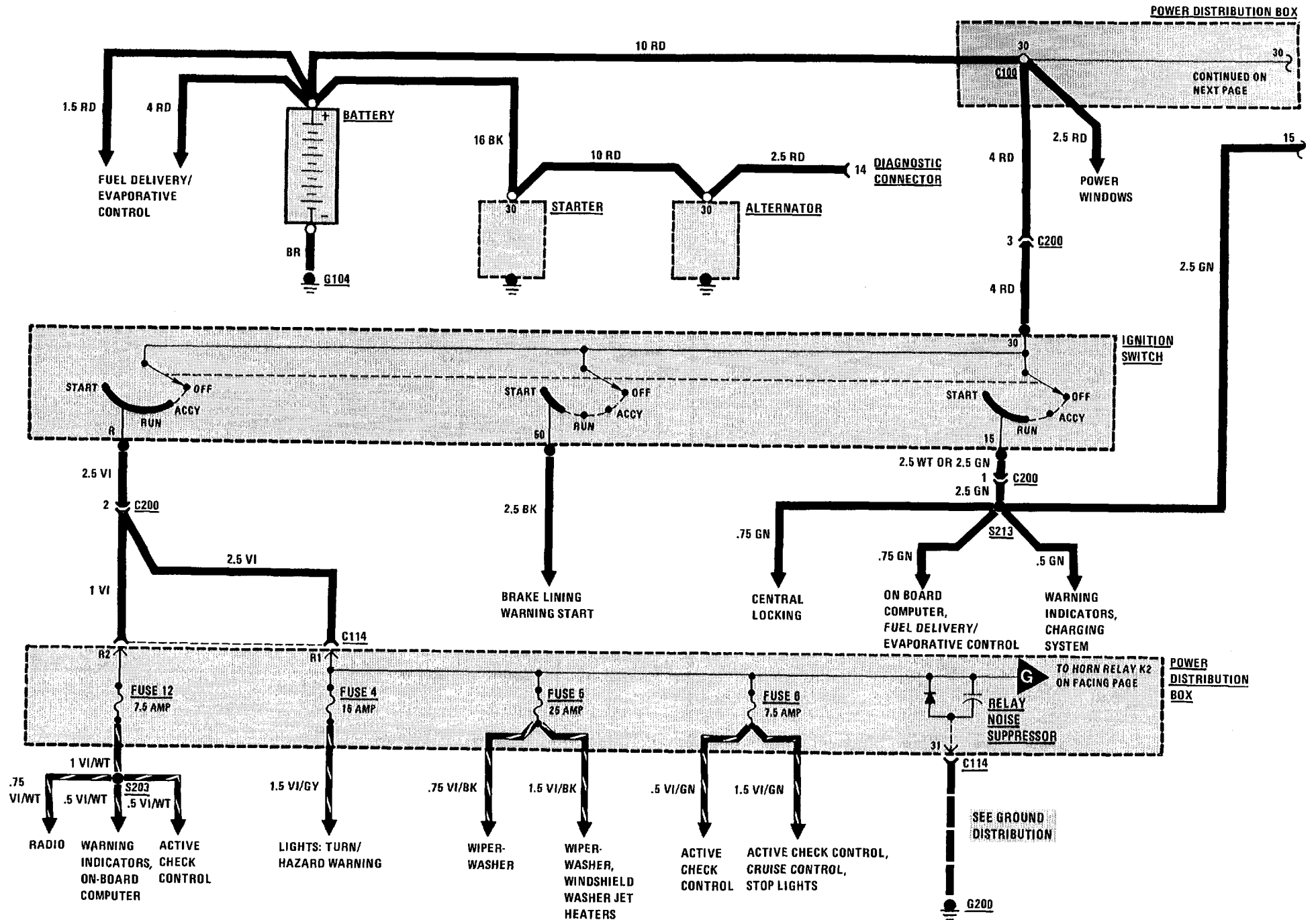

(For Component Locations See Page 208)

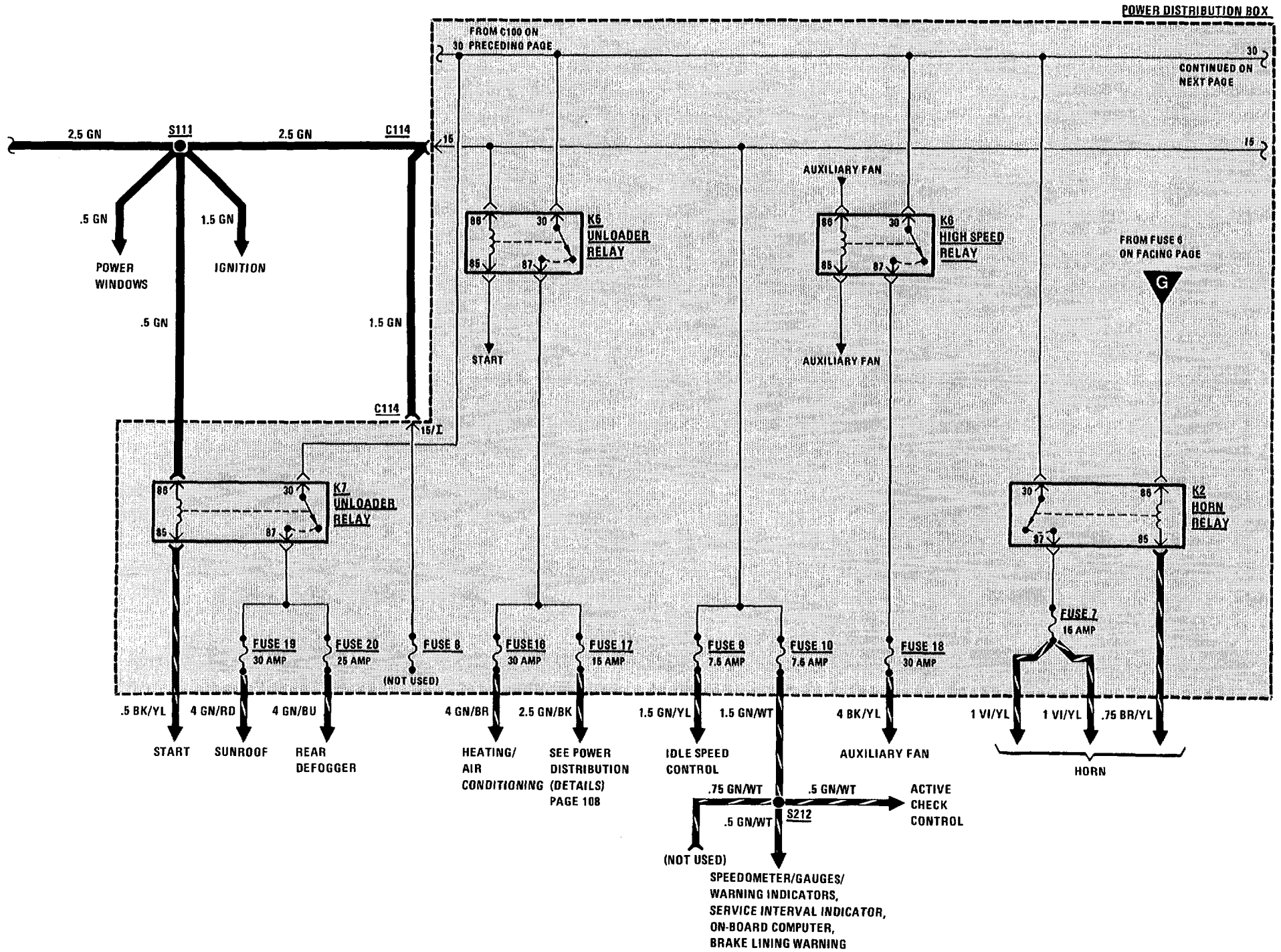

106 POWER DISTRIBUTION

(For Component Locations See Page 208)

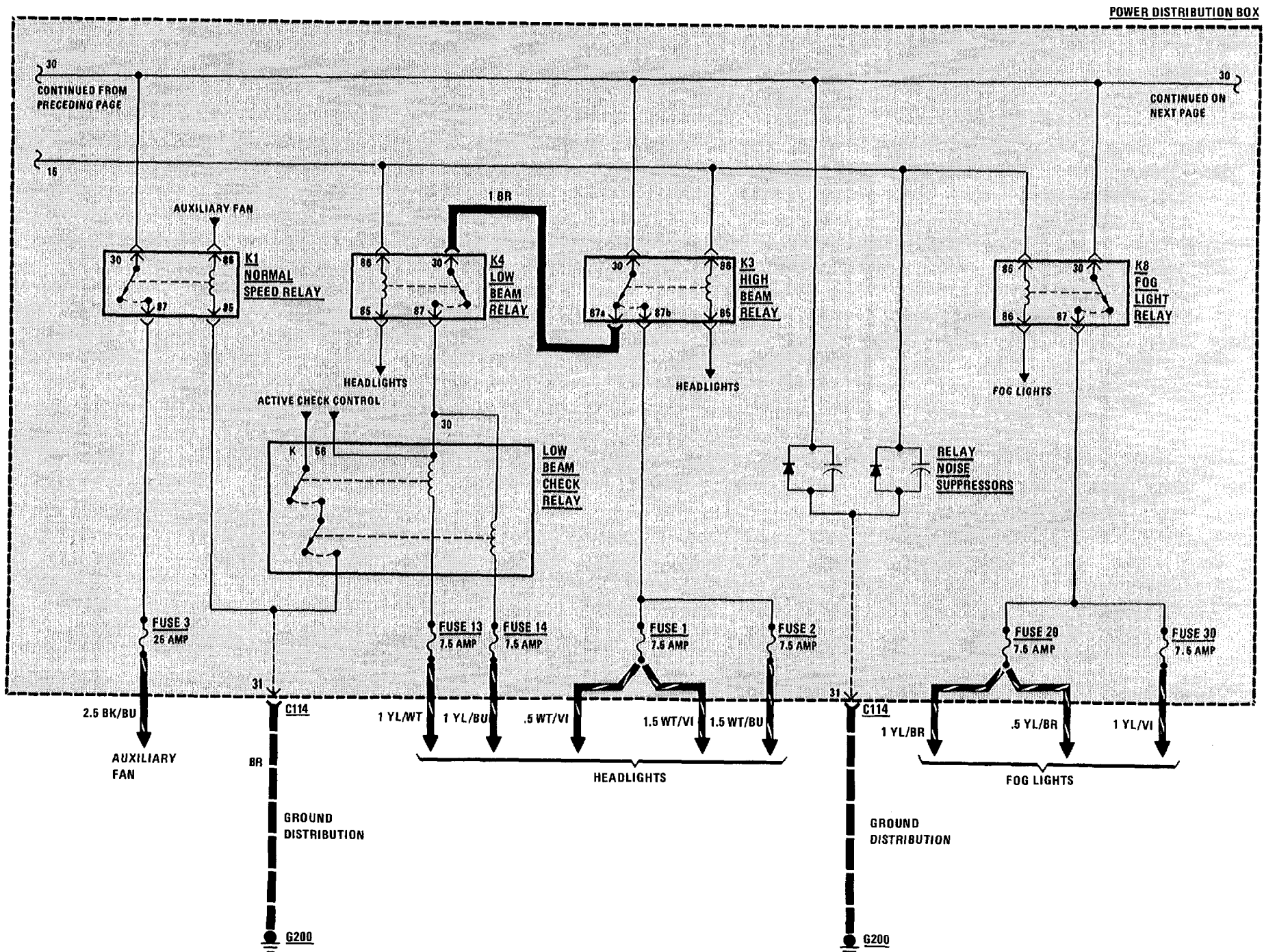

(For Component Locations See Page 208)

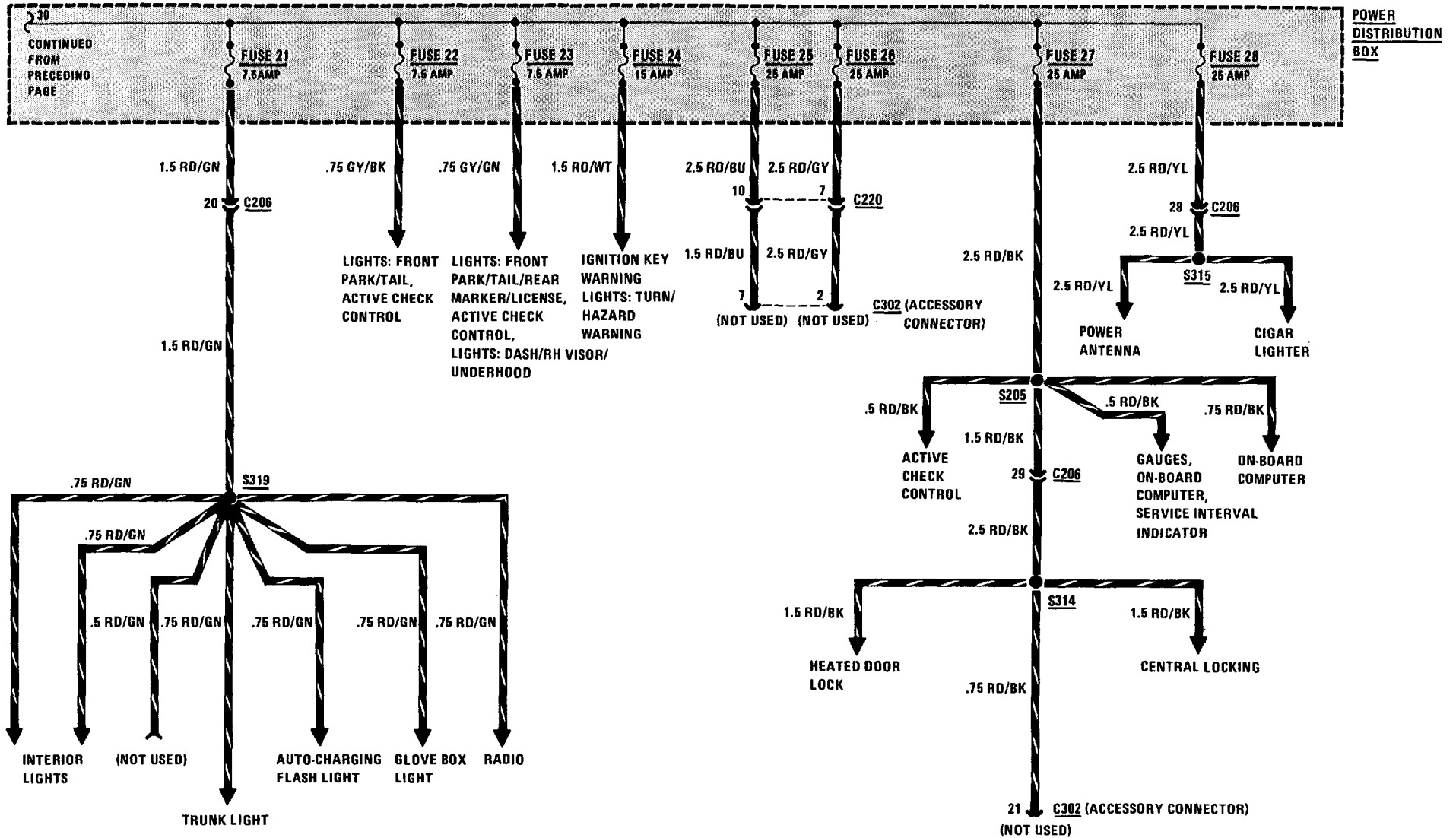

108 POWER DISTRIBUTION (DETAILS)

(For Component Locations See Page 208)

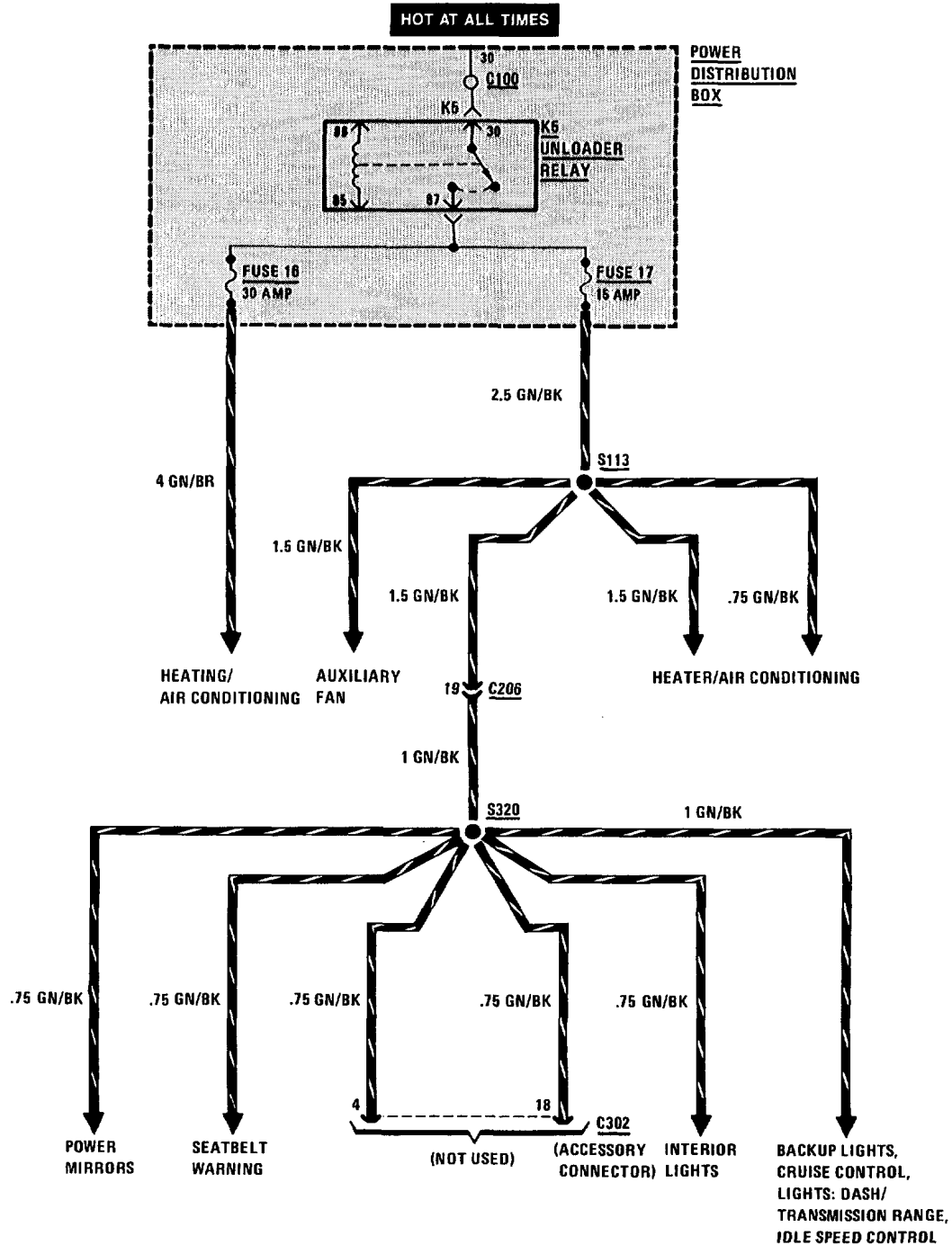

CHARGING SYSTEM 109

(For Component Locations See Page 202)

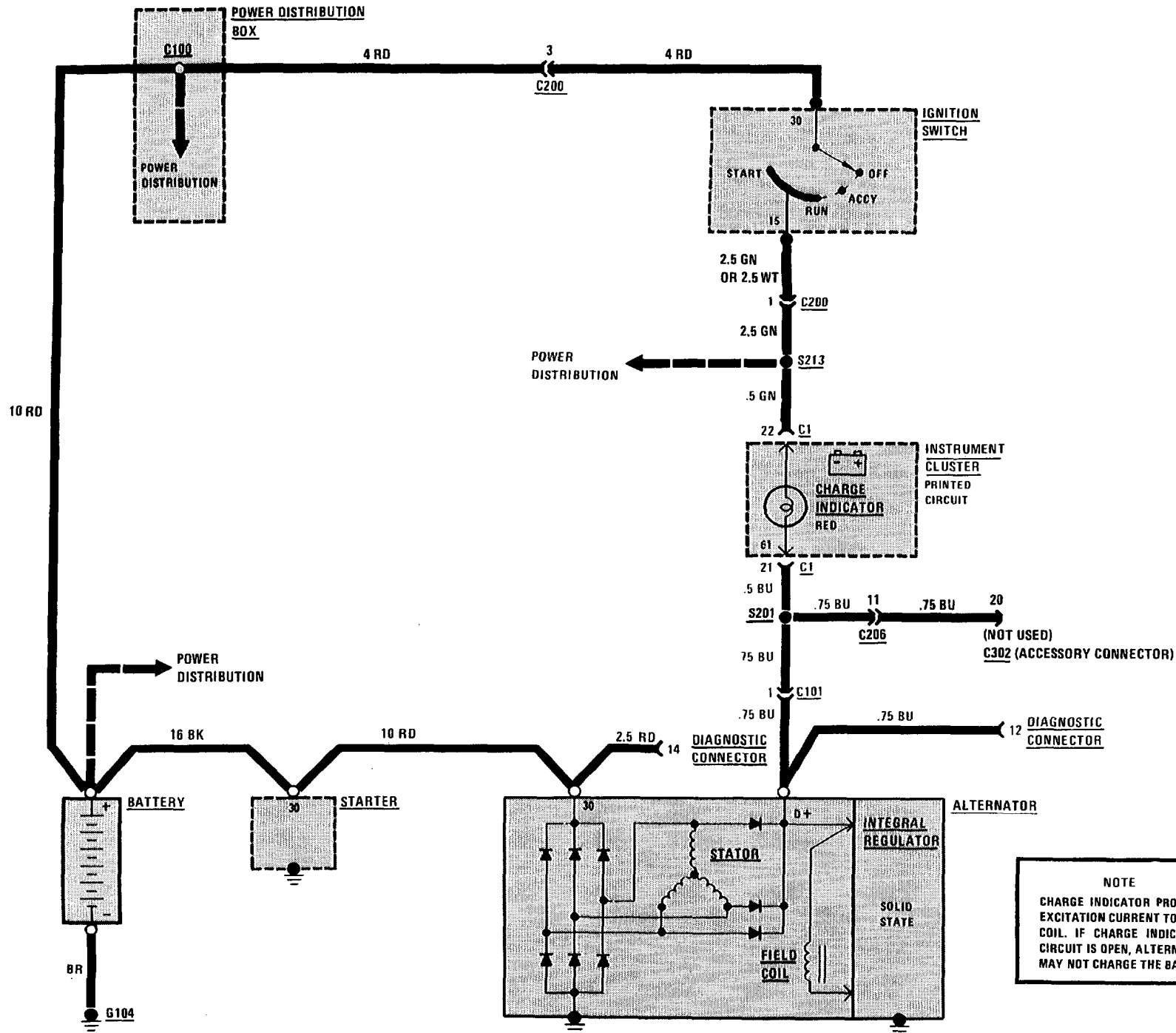

NOTE
 CHARGE INDICATOR PROVIDES EXCITATION CURRENT TO FIELD COIL. IF CHARGE INDICATOR CIRCUIT IS OPEN, ALTERNATOR MAY NOT CHARGE THE BATTERY.

110 START

(For Component Locations See Page 211)

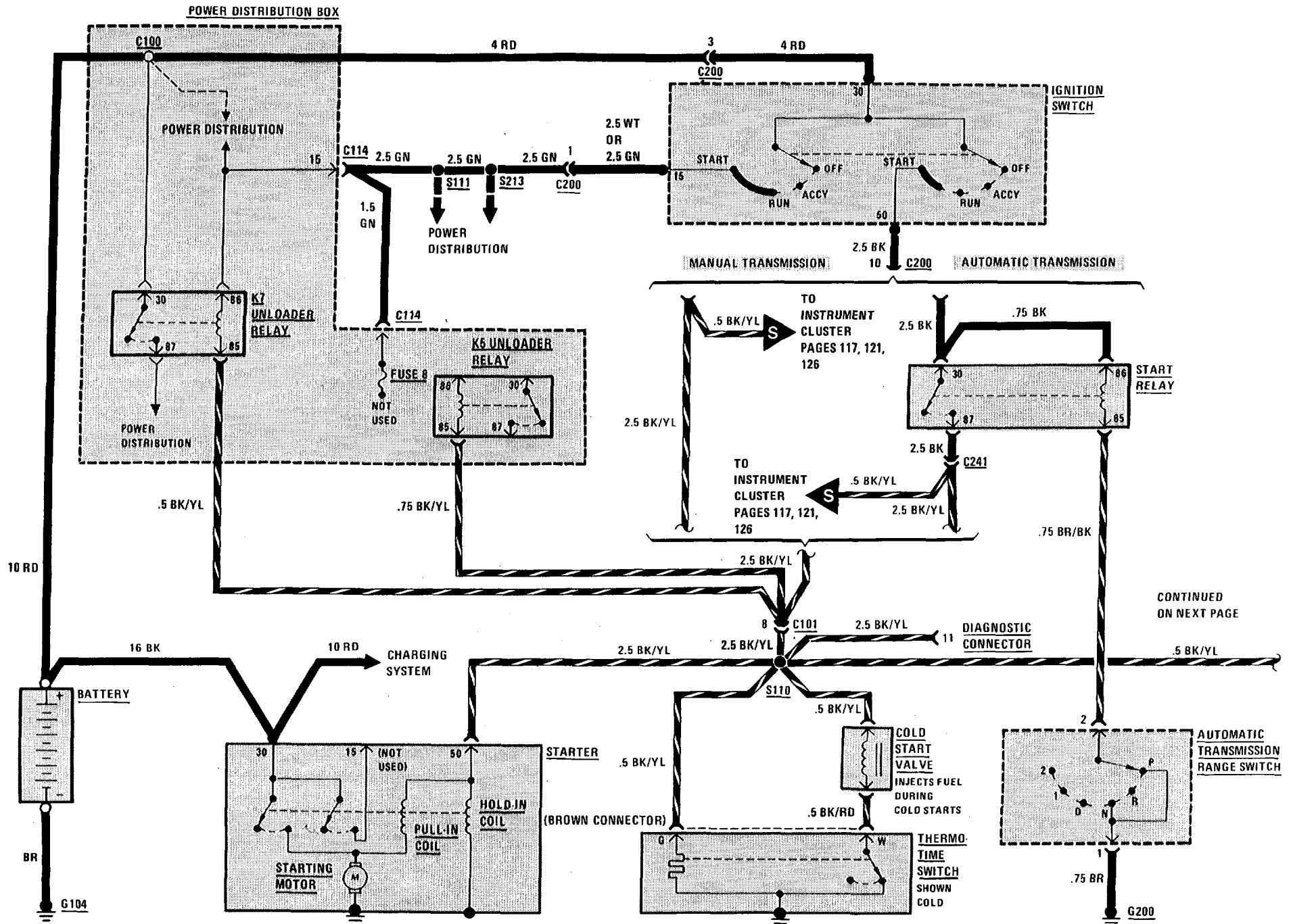

FUEL DELIVERY/EVAPORATIVE CONTROL 111

(For Component Locations See Page 203)

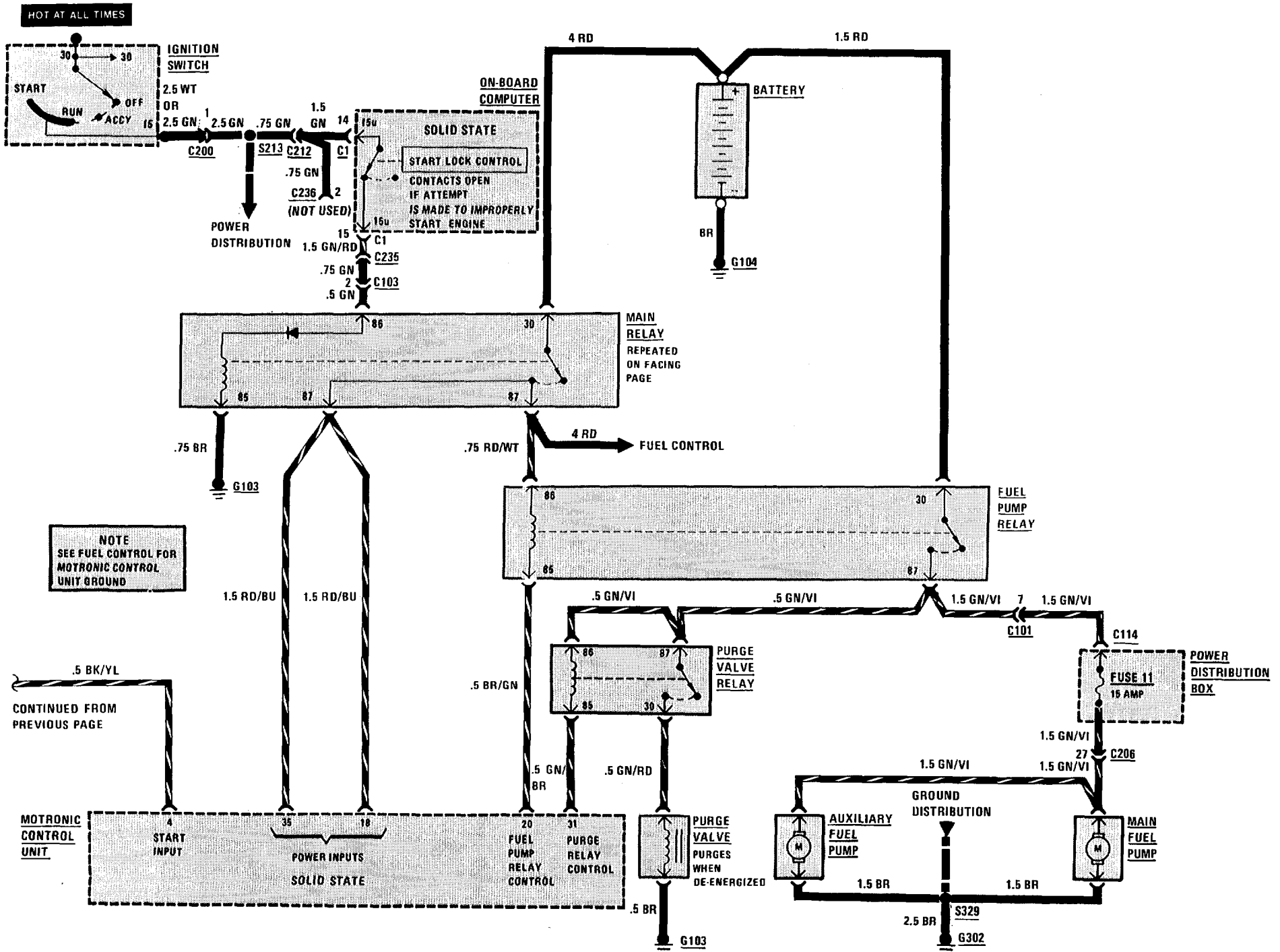

112 IDLE SPEED CONTROL

(For Component Locations See Page 205)

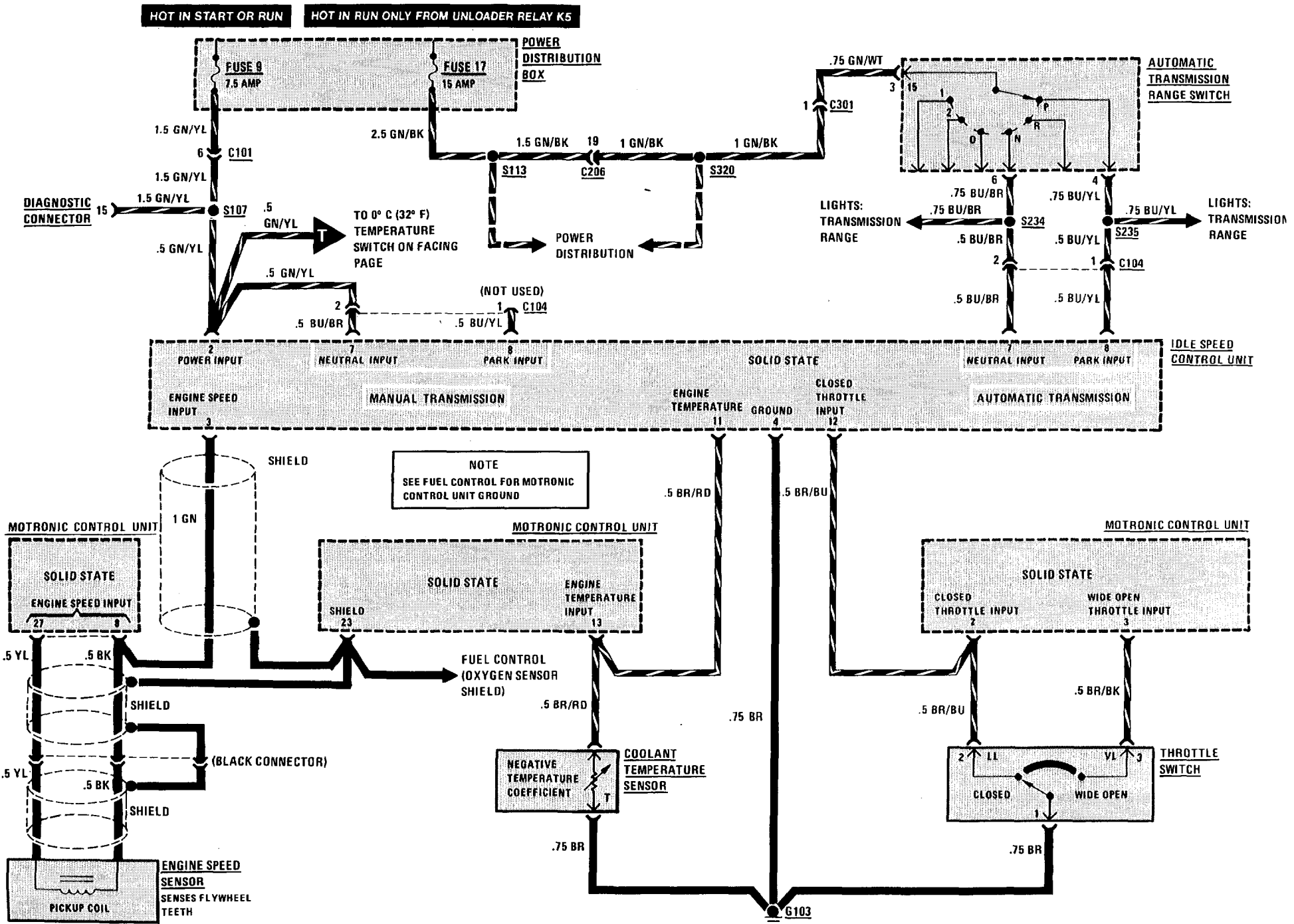

(For Component Locations See Page 205)

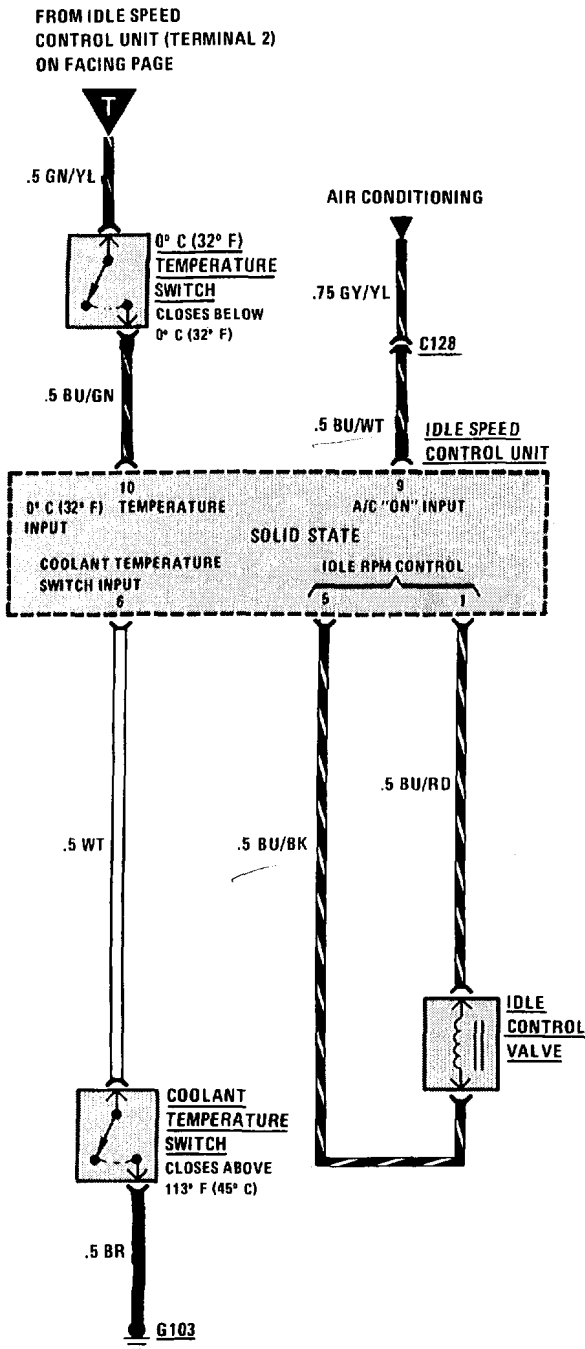

(For Component Locations See Page 205)

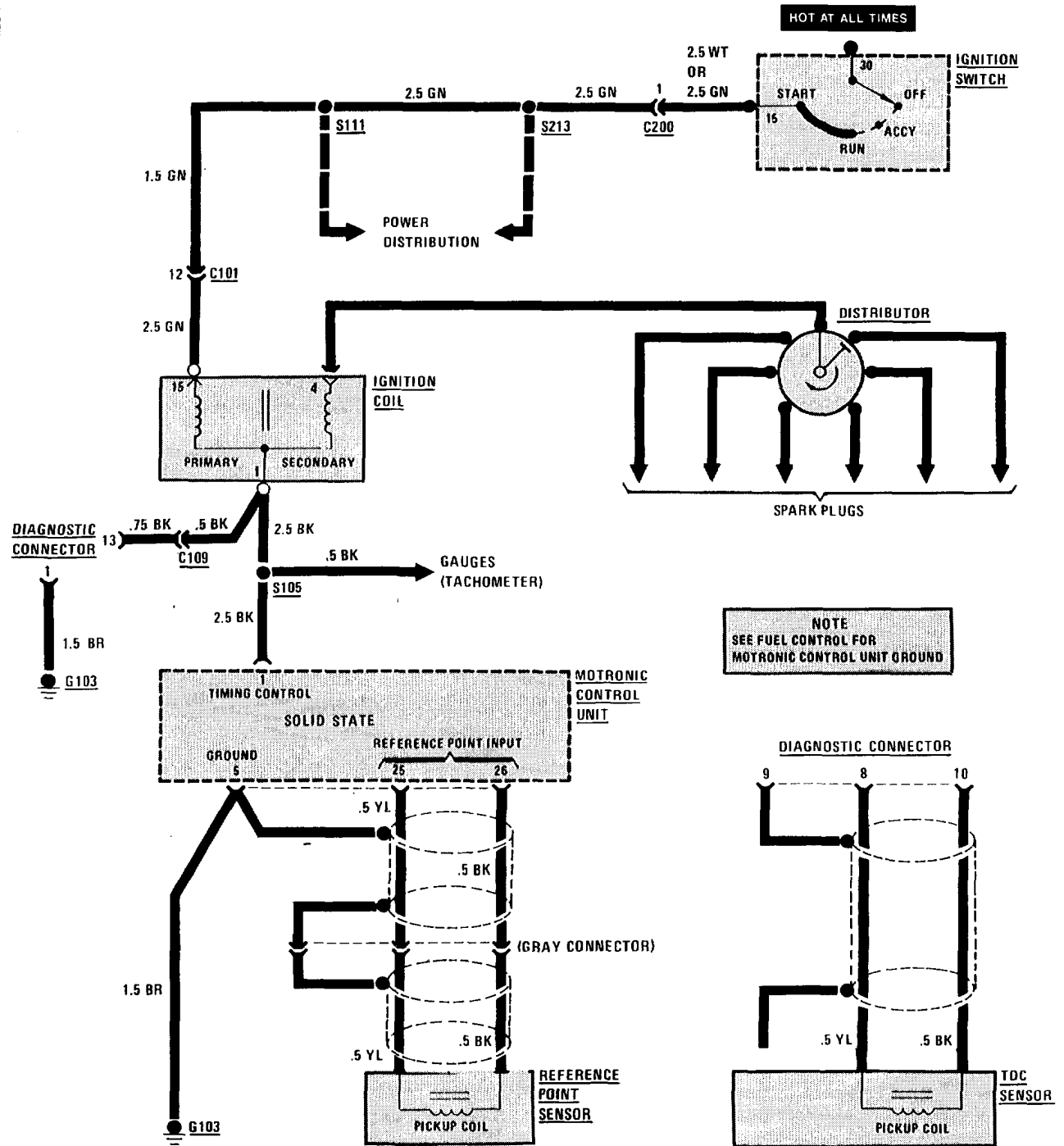

114 FUEL CONTROL

(For Component Locations See Page 203)

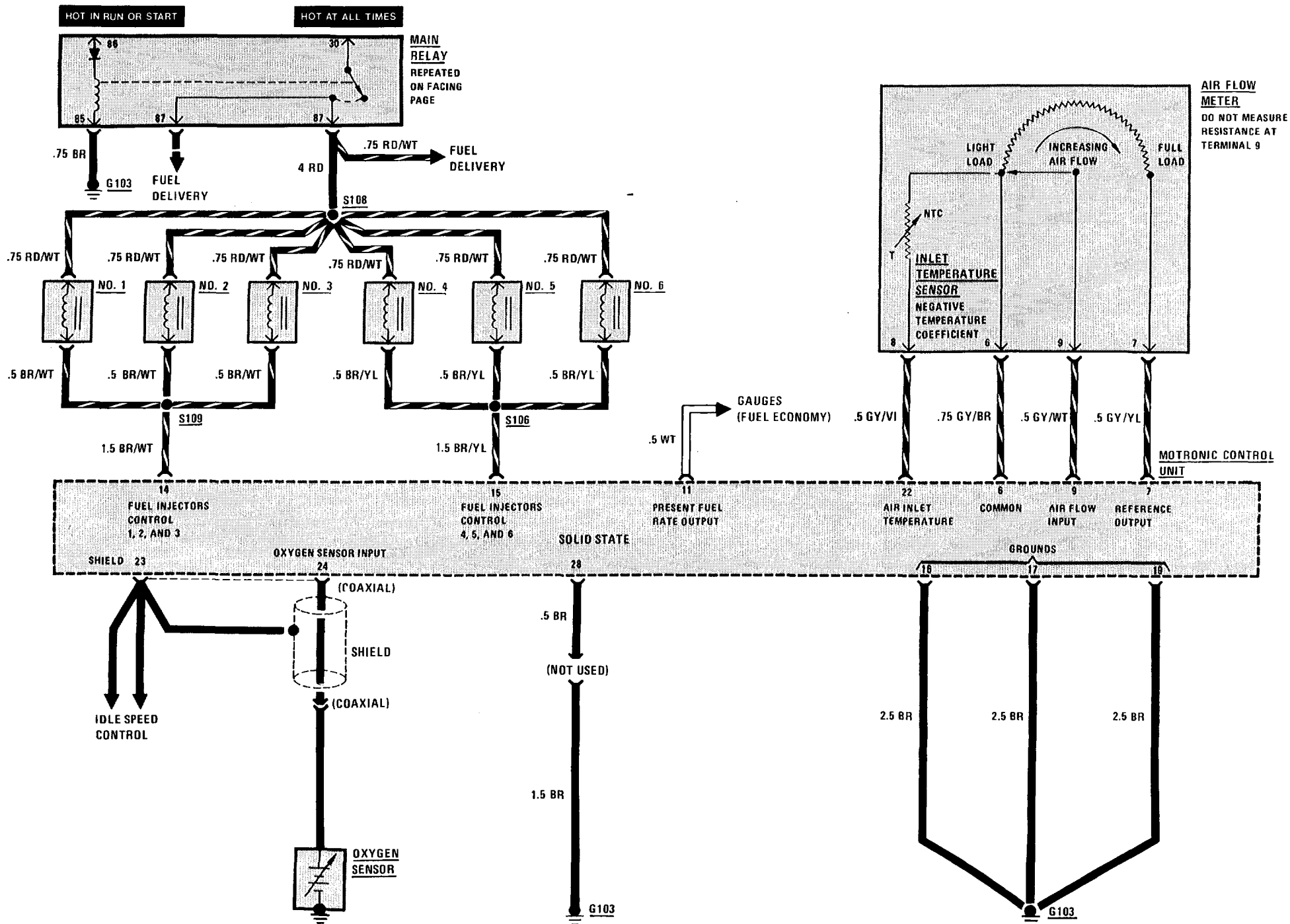

(For Component Locations See Page 206)

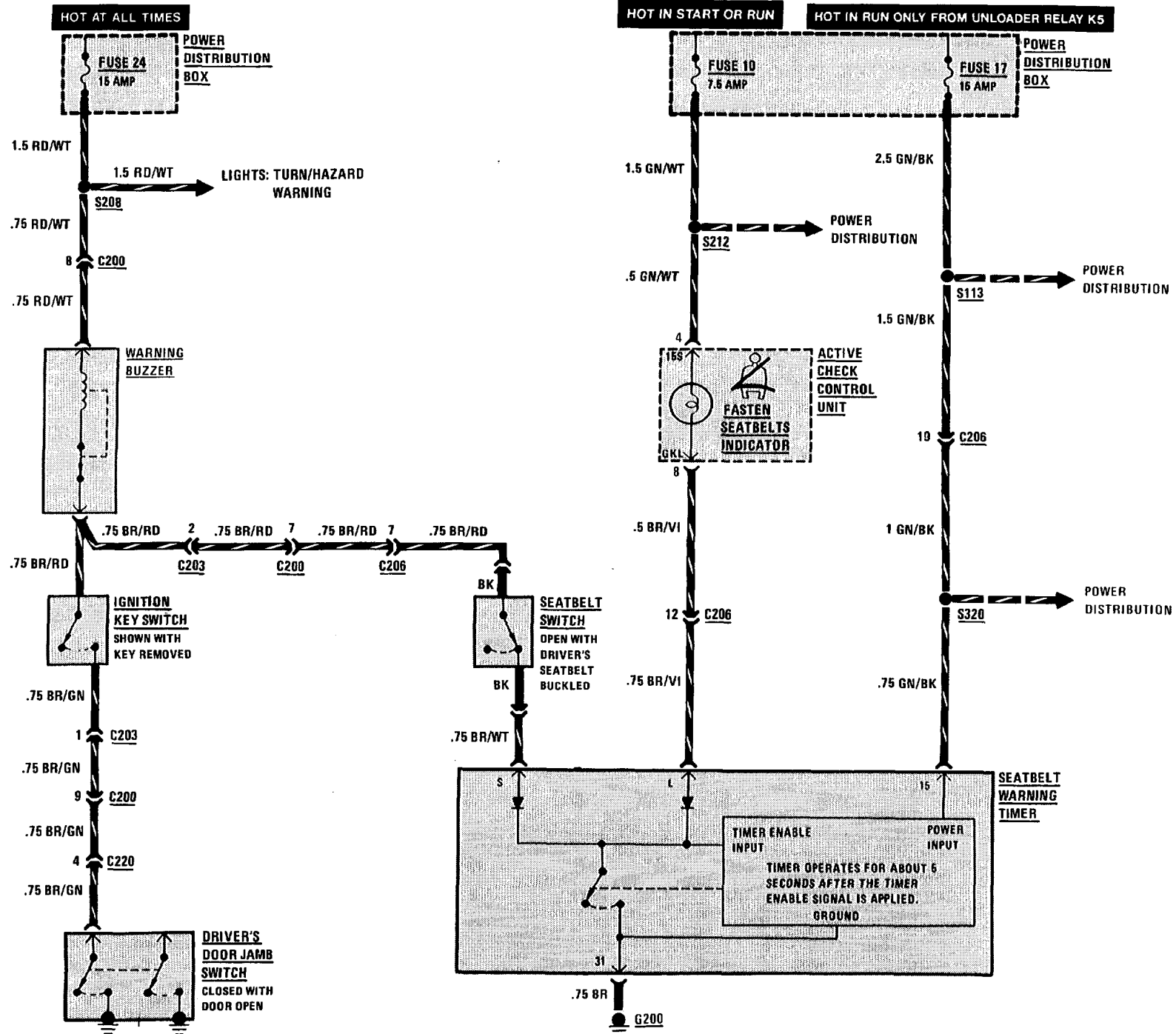

116 ON-BOARD COMPUTER

(For Component Locations See Page 208)

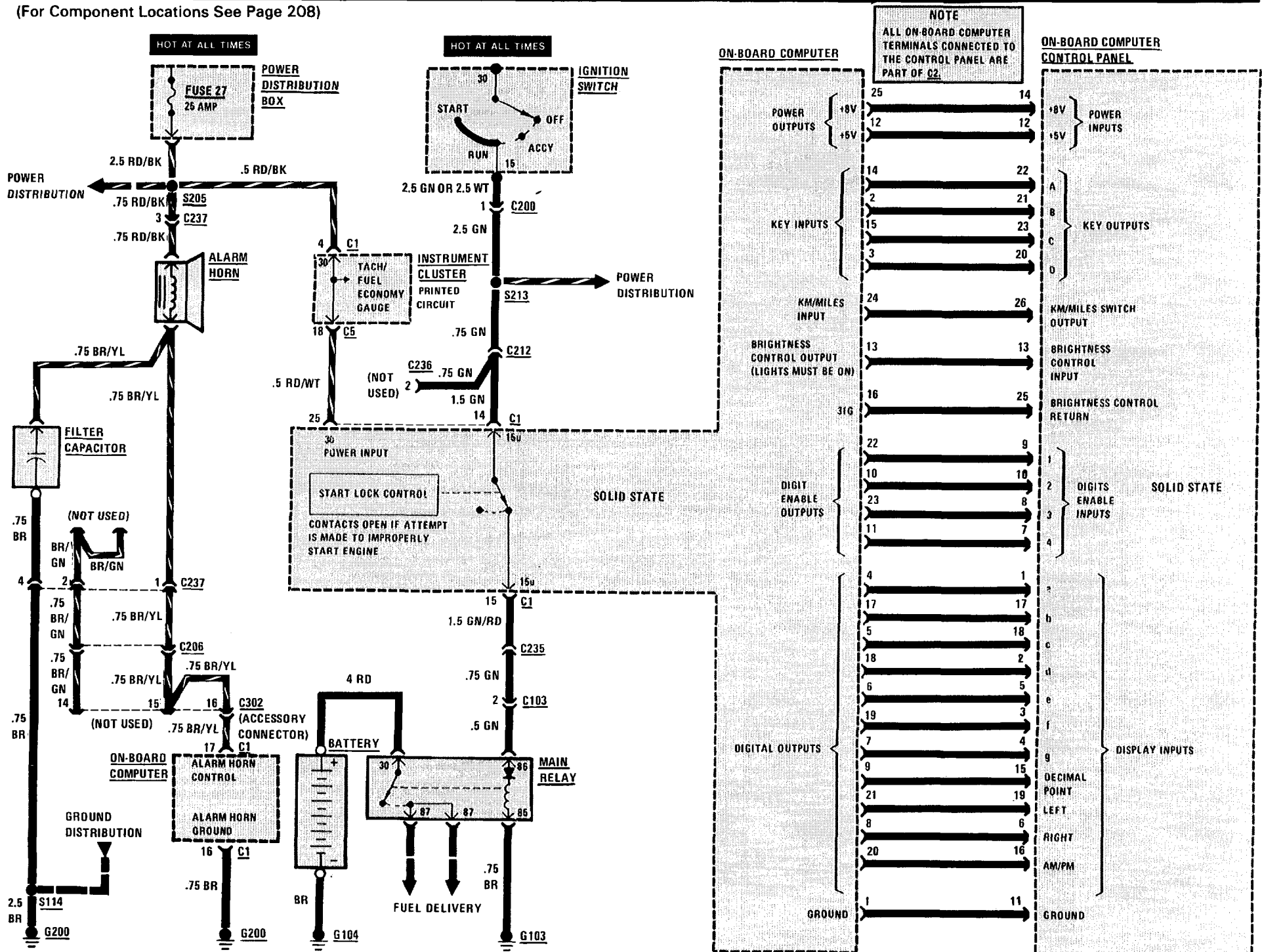

(For Component Locations See Page 208)

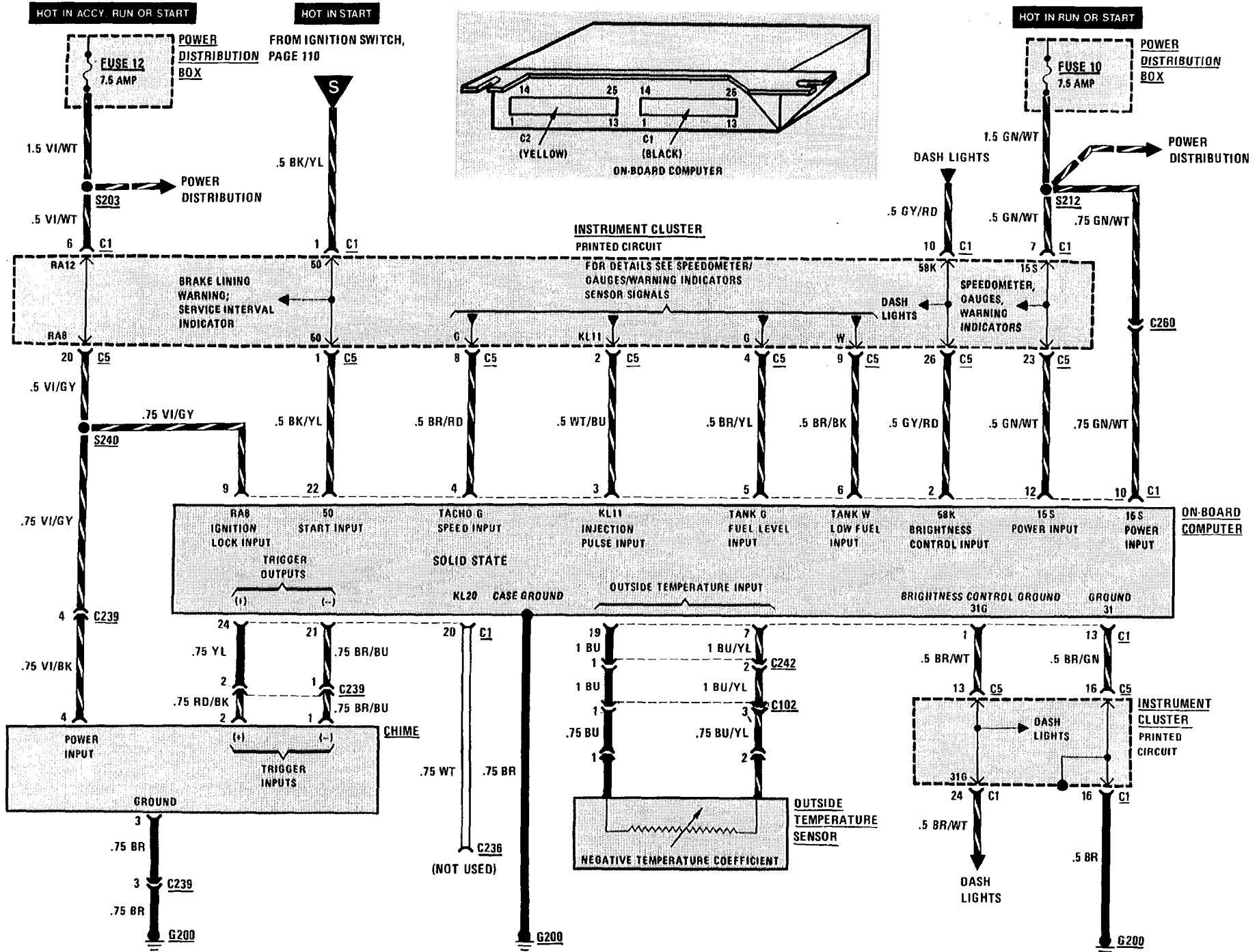

118 SPEEDOMETER/GAUGES/WARNING INDICATORS

(For Component Locations See Page 210)

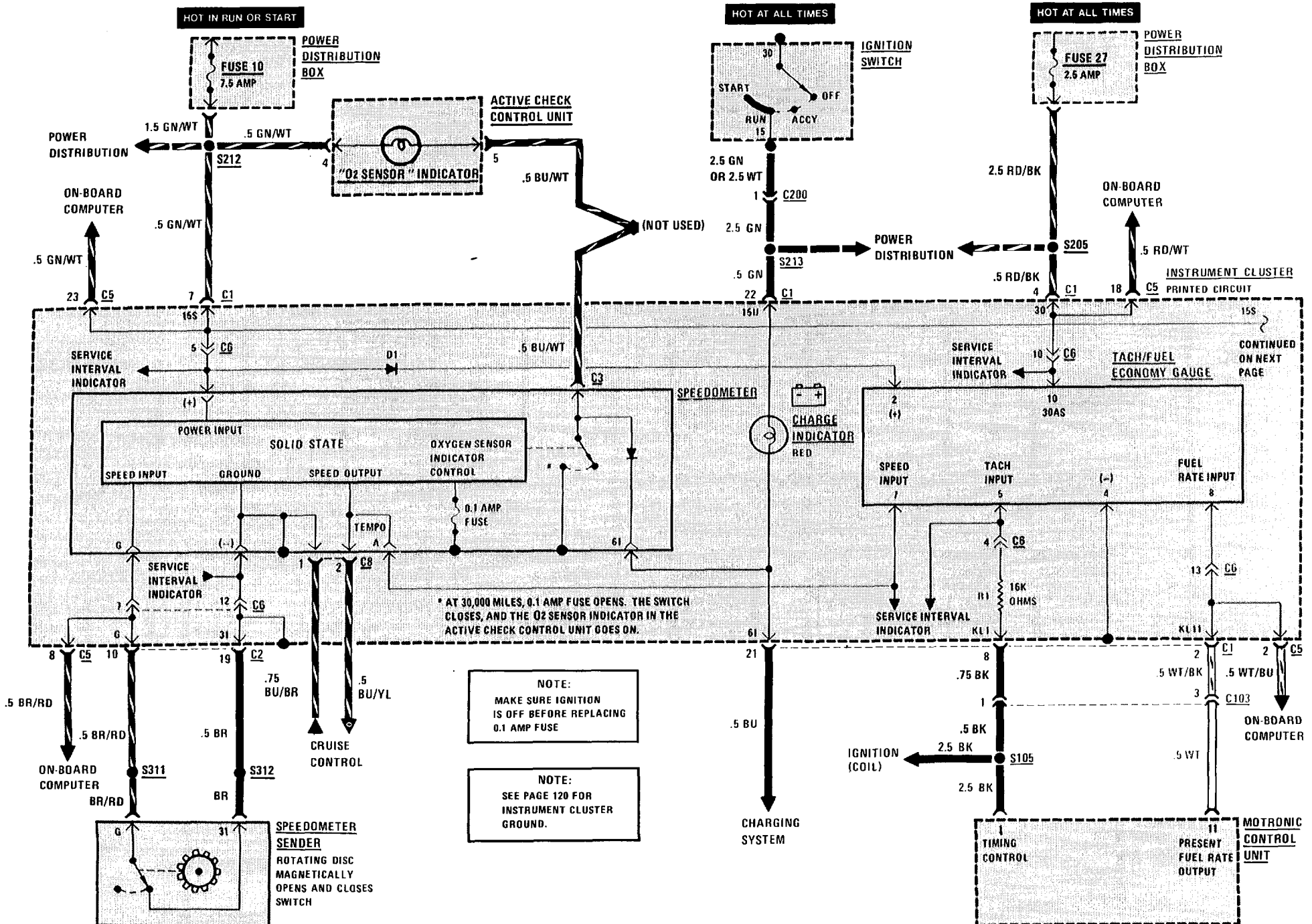

(For Component Locations See Page 210)

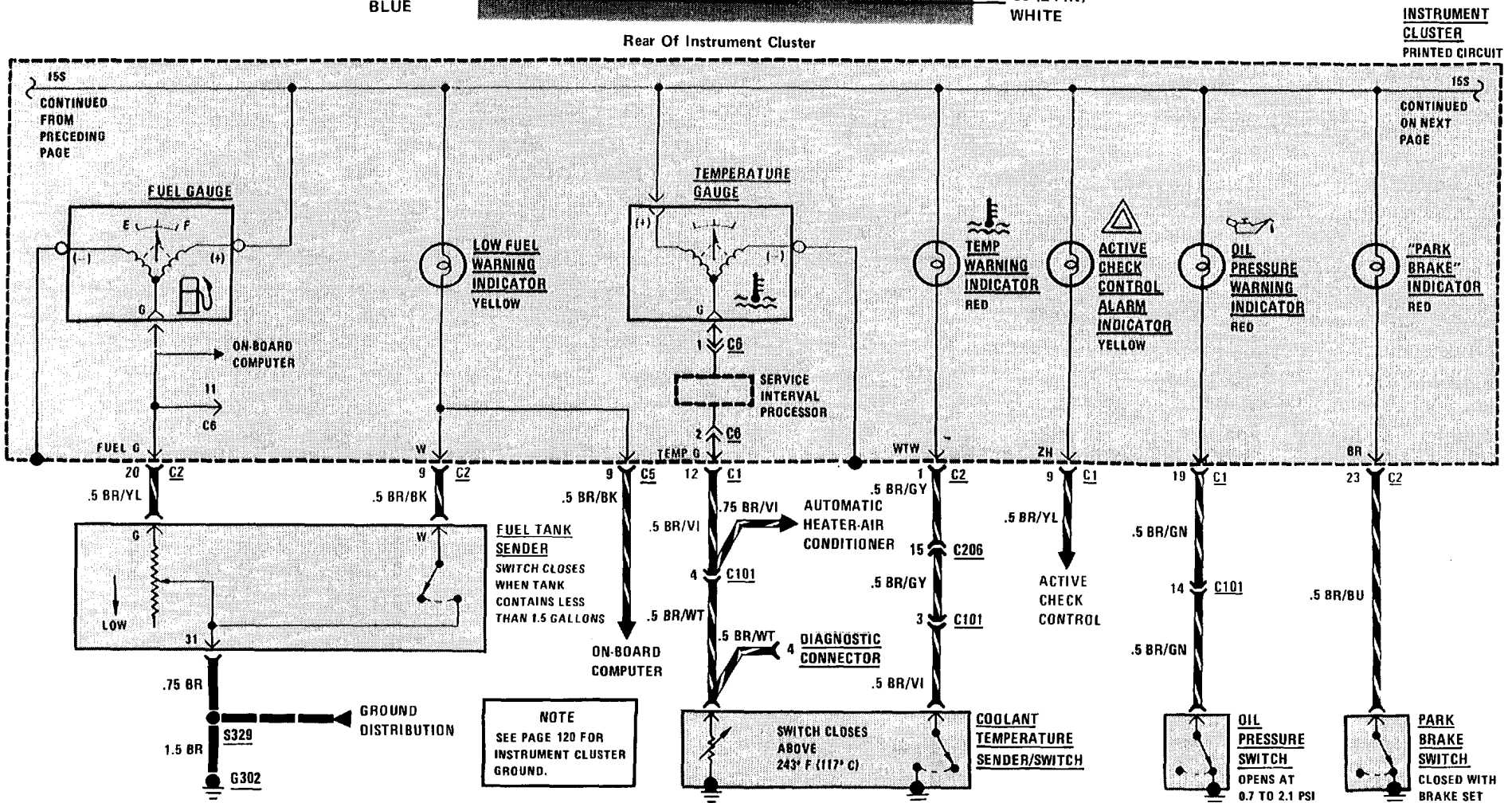
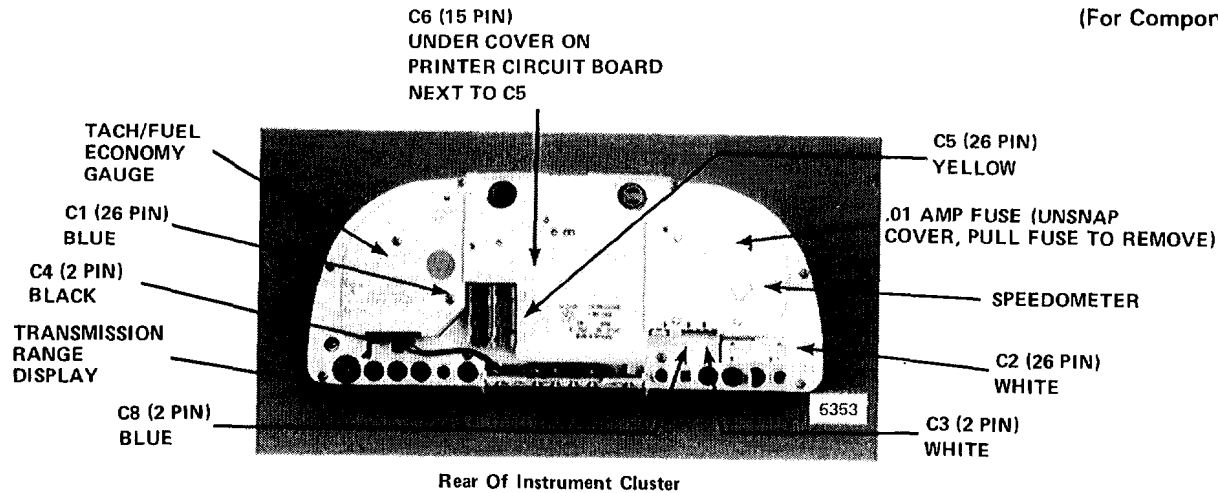

120 WARNING INDICATORS

(For Component Locations See Page 210)

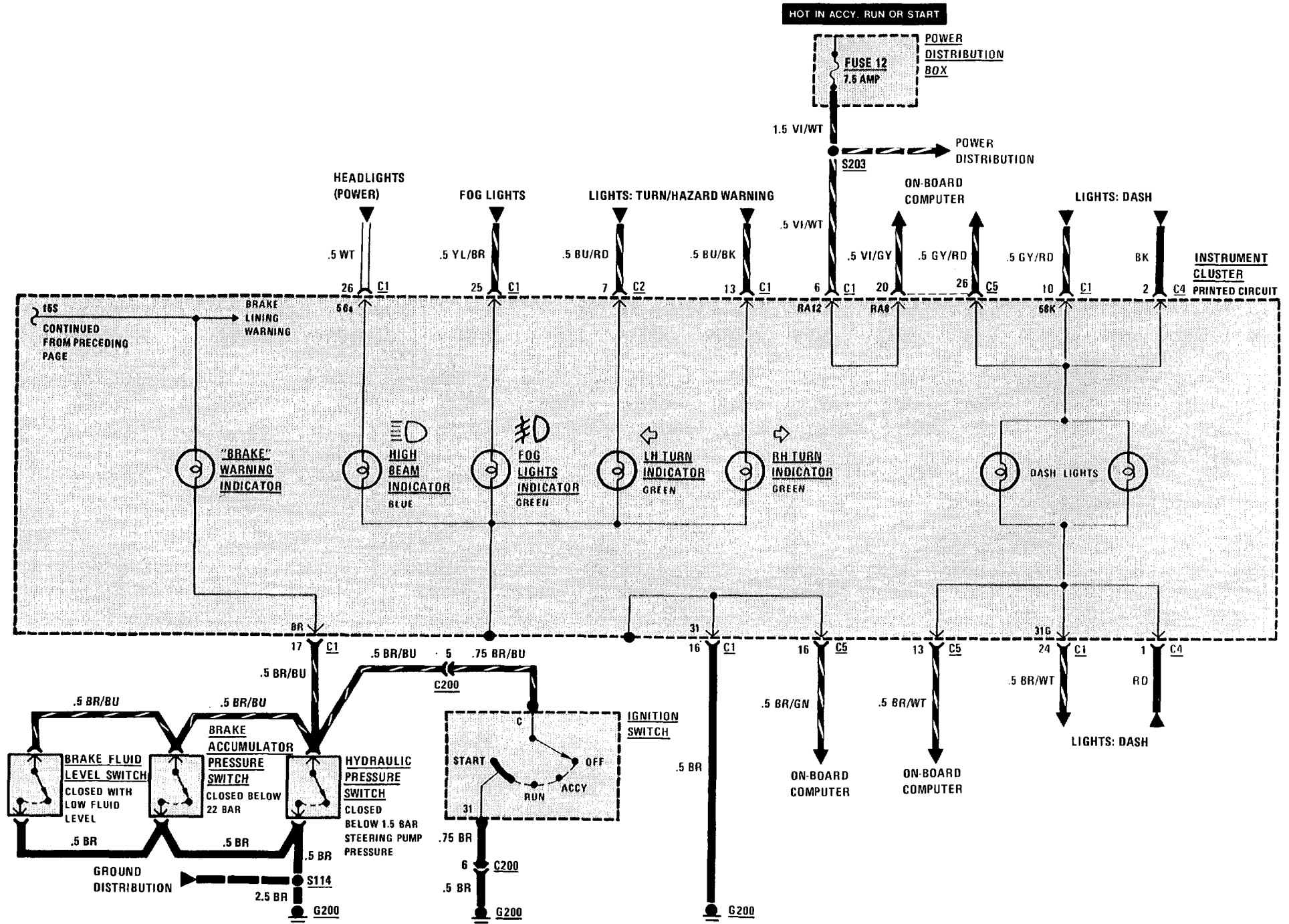

SERVICE INTERVAL INDICATOR 121

(For Component Locations See Page 210)

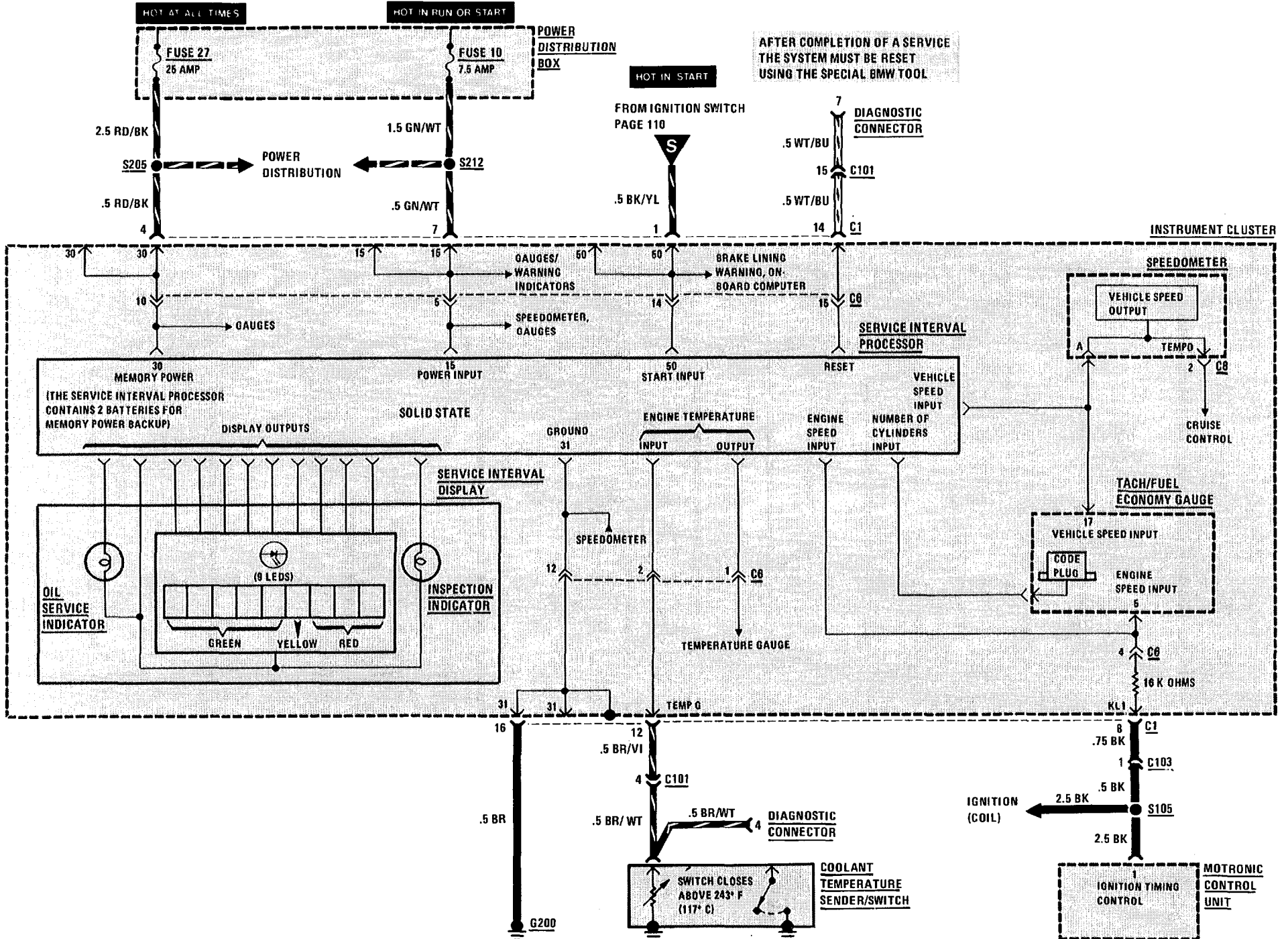

122 WIPER/WASHER

(For Component Locations See Page 212)

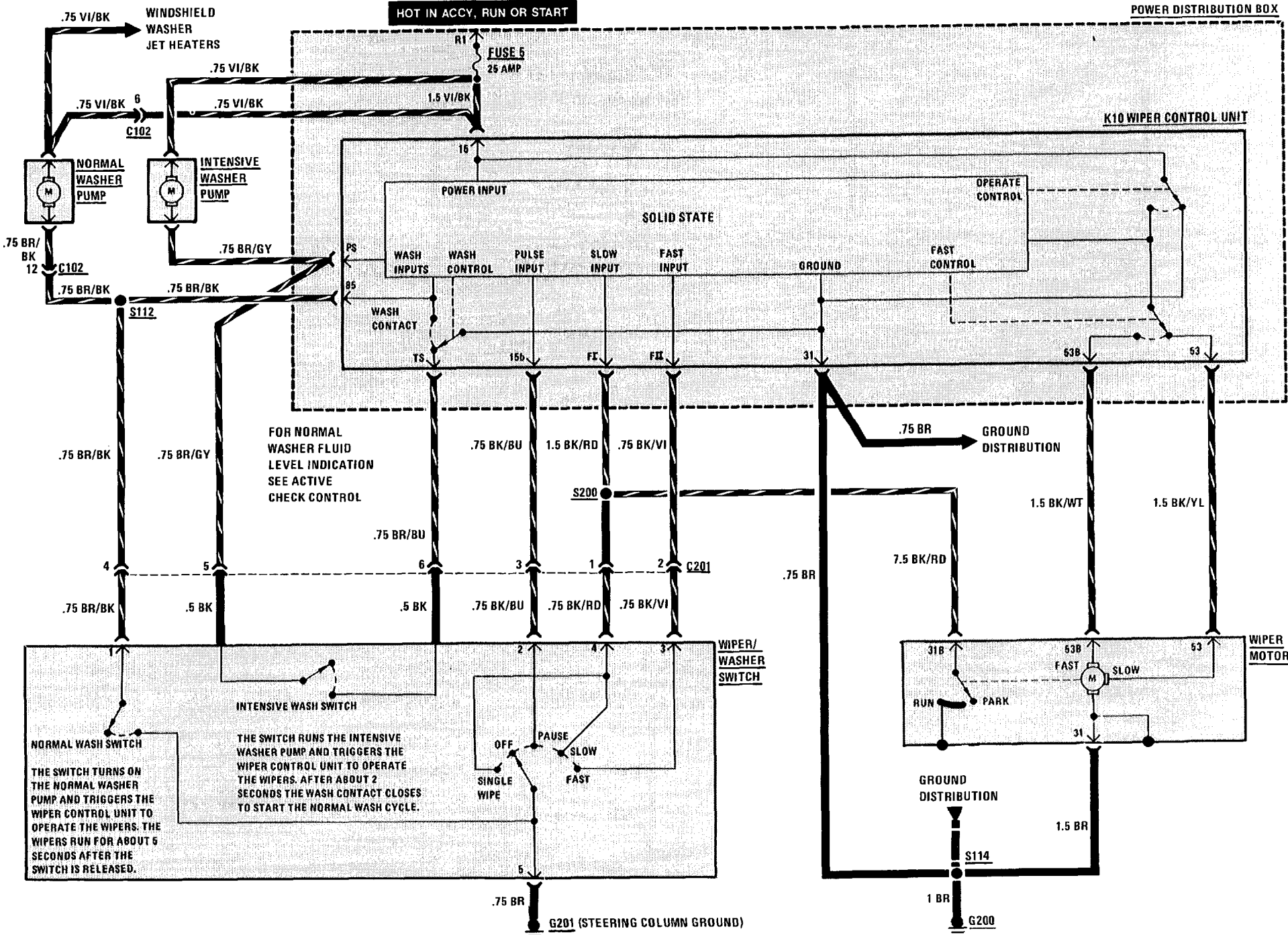

(For Component Locations See Page 201)

ACTIVE CHECK CONTROL

1. When the Ignition Switch is initially placed in "Run," the Active Check Control Arm Indicator flashes, and the Active Check Control Unit Brake Light LED and panel light illuminate for test purposes. Depressing the brake pedal clears the display.
2. When the Ignition Switch is placed in "Run," fault monitoring begins. To monitor the low beams, rear lights, or license lights, those circuits must be on. The brake lights are monitored only while the brake pedal is depressed.
3. When a fault occurs, the alarm indicator flashes, the appropriate LED fault indicator lights, and the panel light goes on for five seconds. Depressing the test button will clear the alarm indicator, but the LED fault indicator remains on.

4. To test the unit, depress the test button. The LED fault indicators and the panel lights should go on.

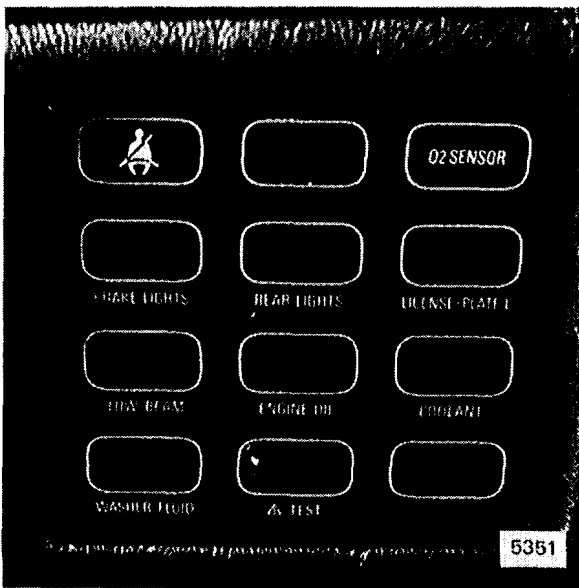
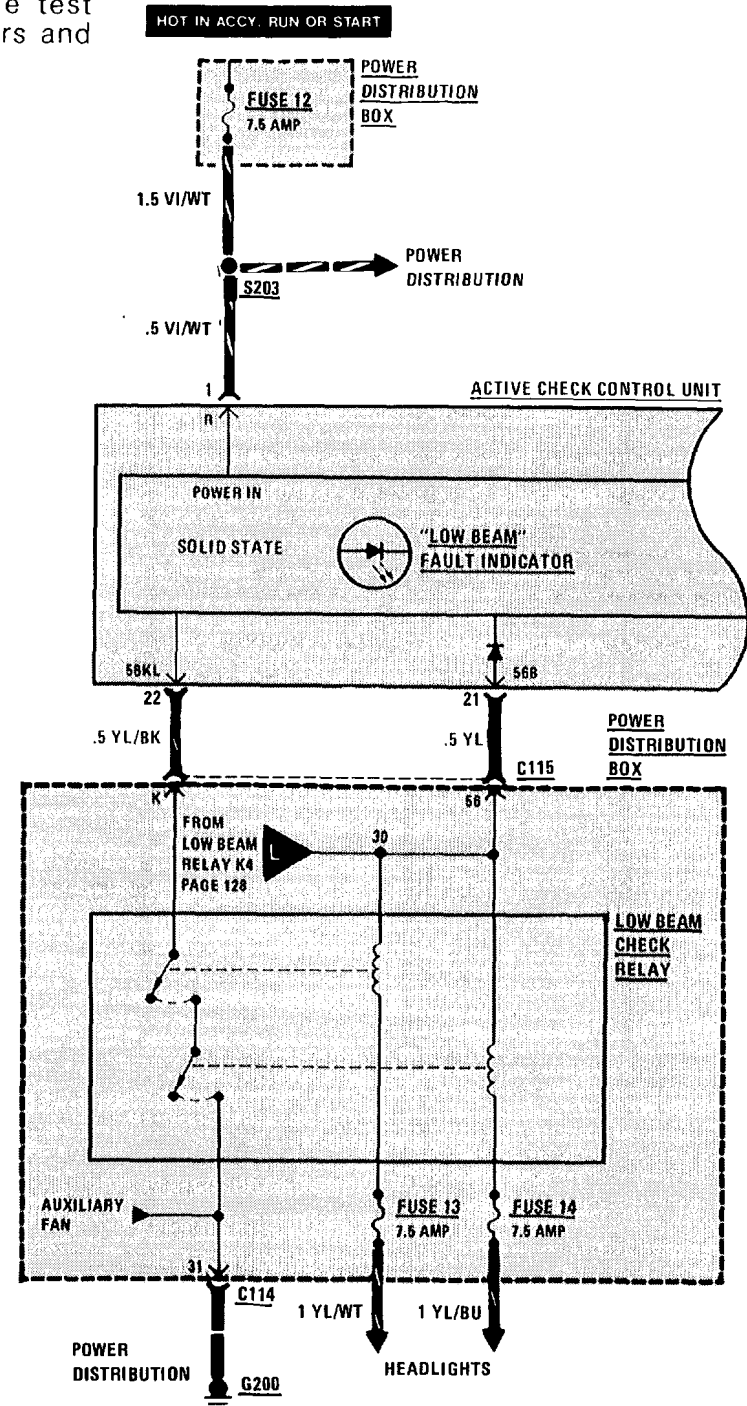
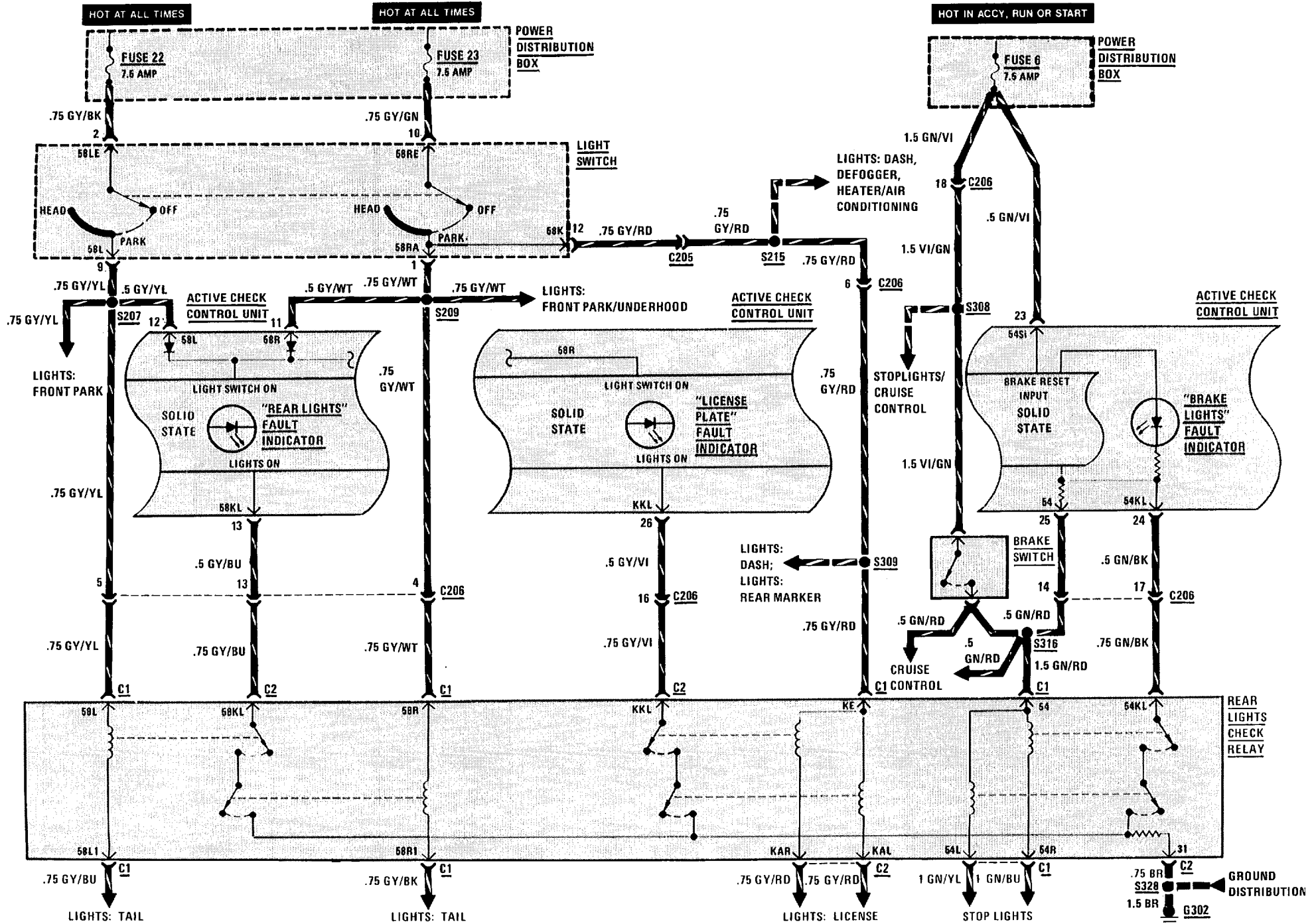

Figure 1 - Active Check Control Unit (Dash, Left Of Steering Column)



124 ACTIVE CHECK CONTROL

(For Component Locations See Page 201)



ACTIVE CHECK CONTROL 125

(For Component Locations See Page 201)

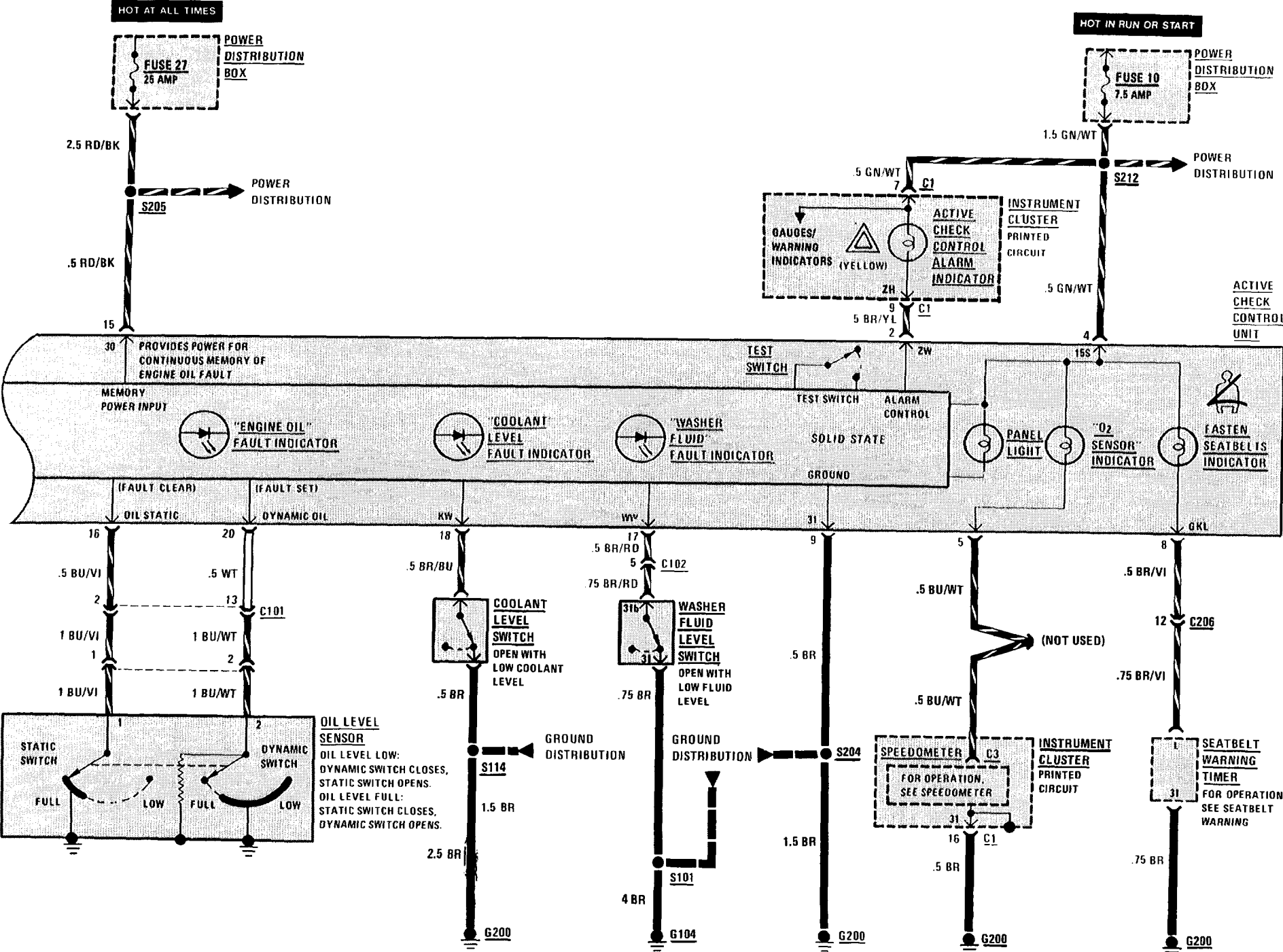

126 BRAKE LINING WARNING

(For Component Locations See Page 202)

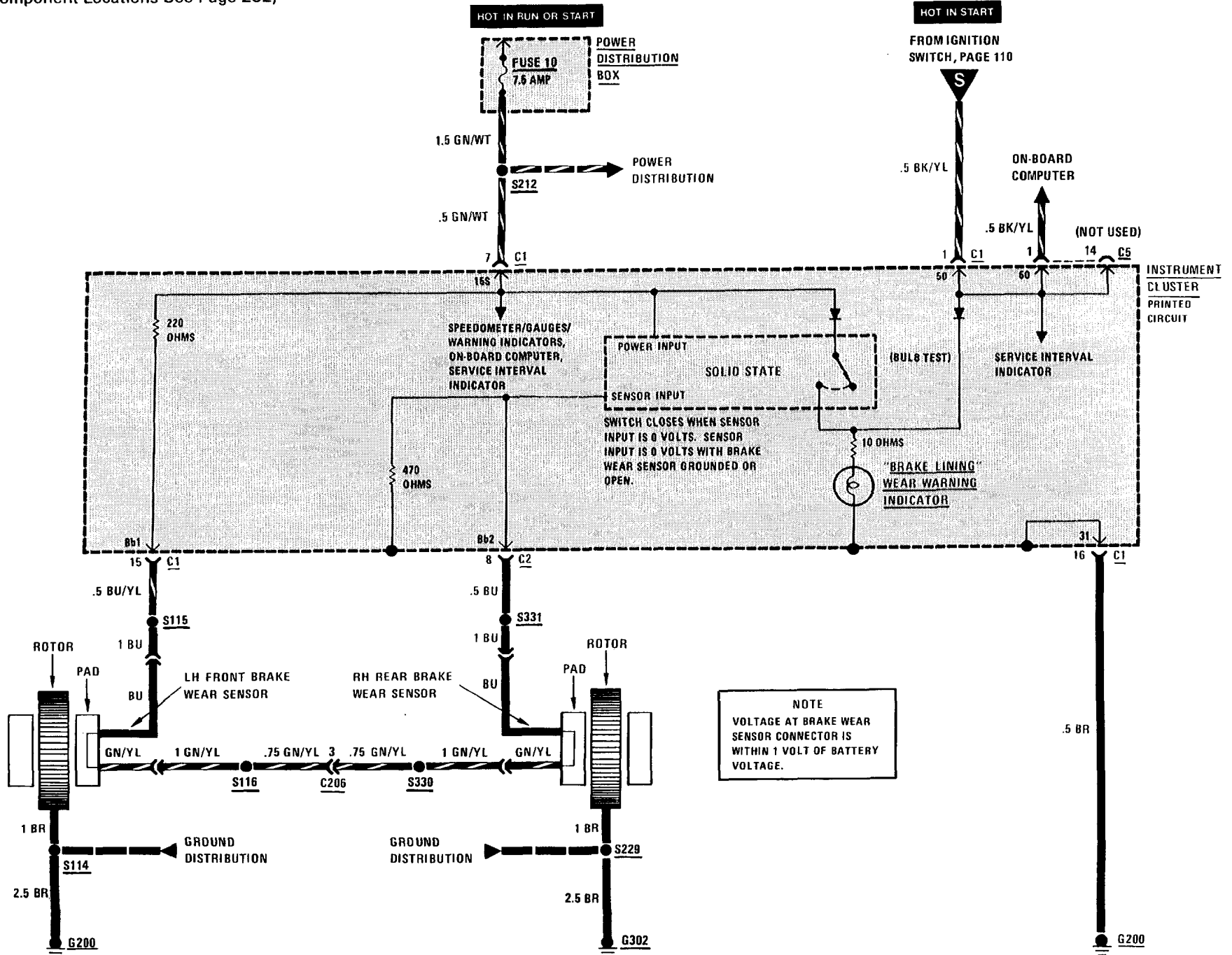

(For Component Locations See Page 206)

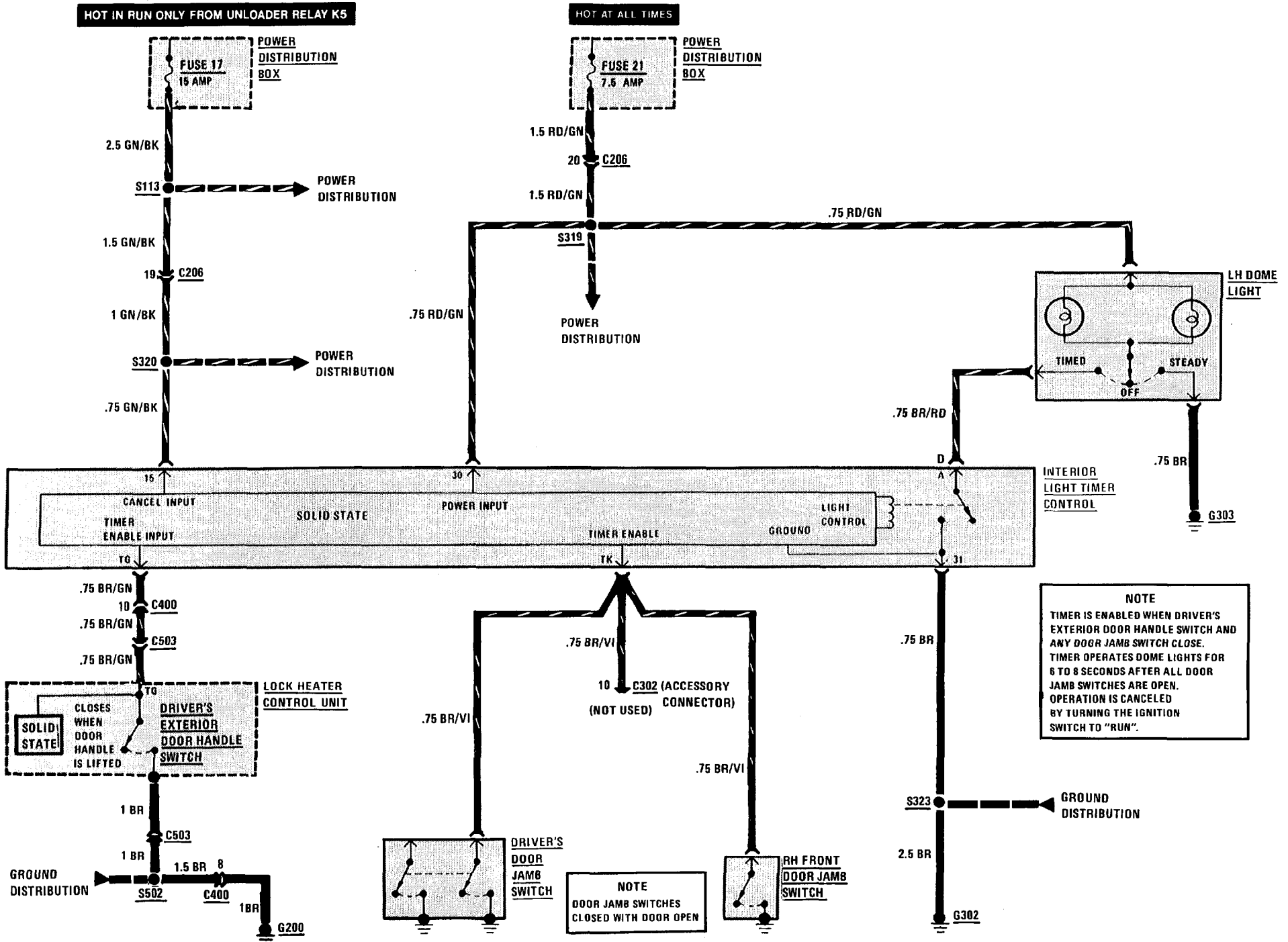

128 HEADLIGHTS (CONTROL)/FOG LIGHTS

(For Component Locations See Page 203)

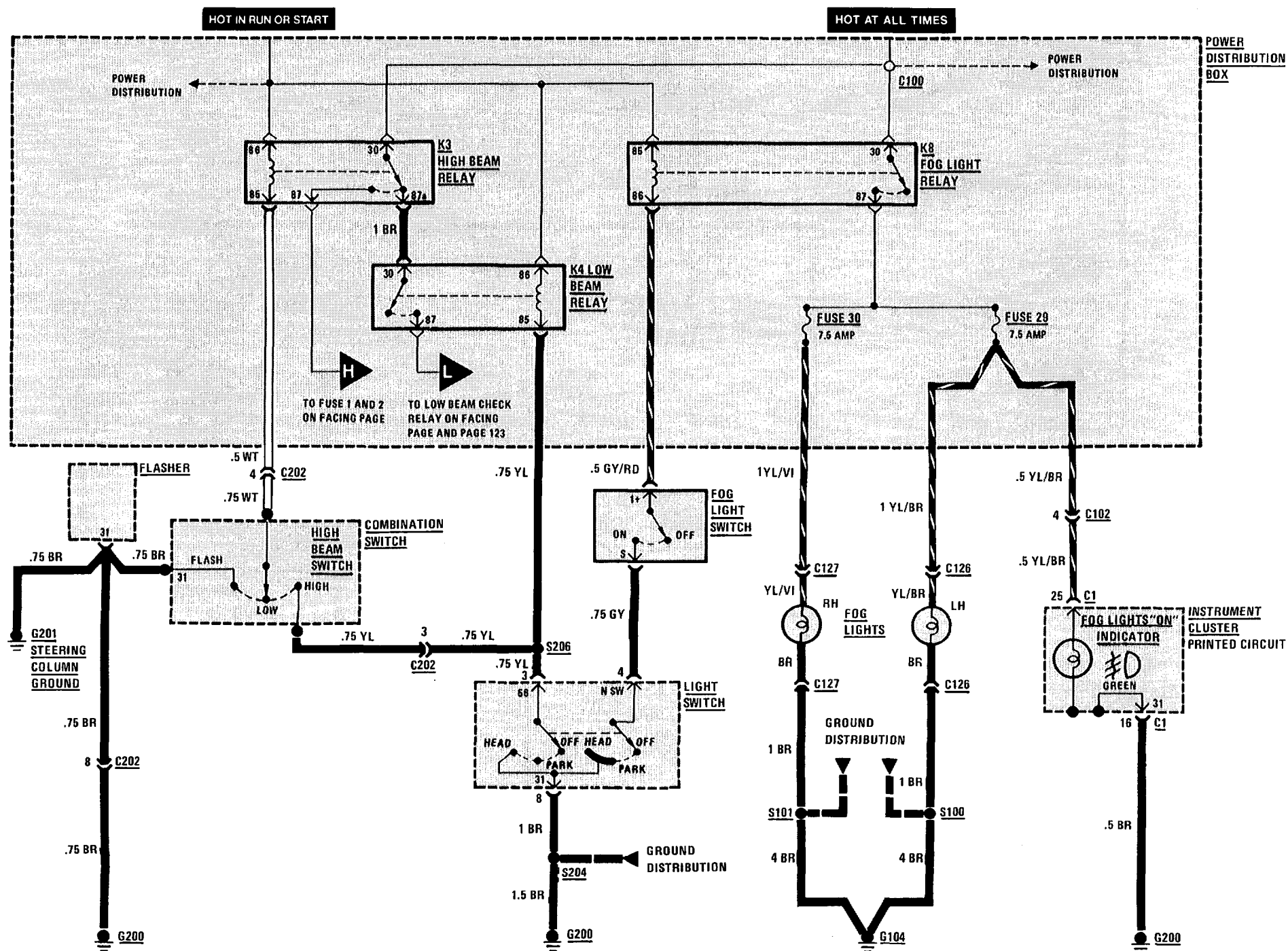

(For Component Locations See Page 203)

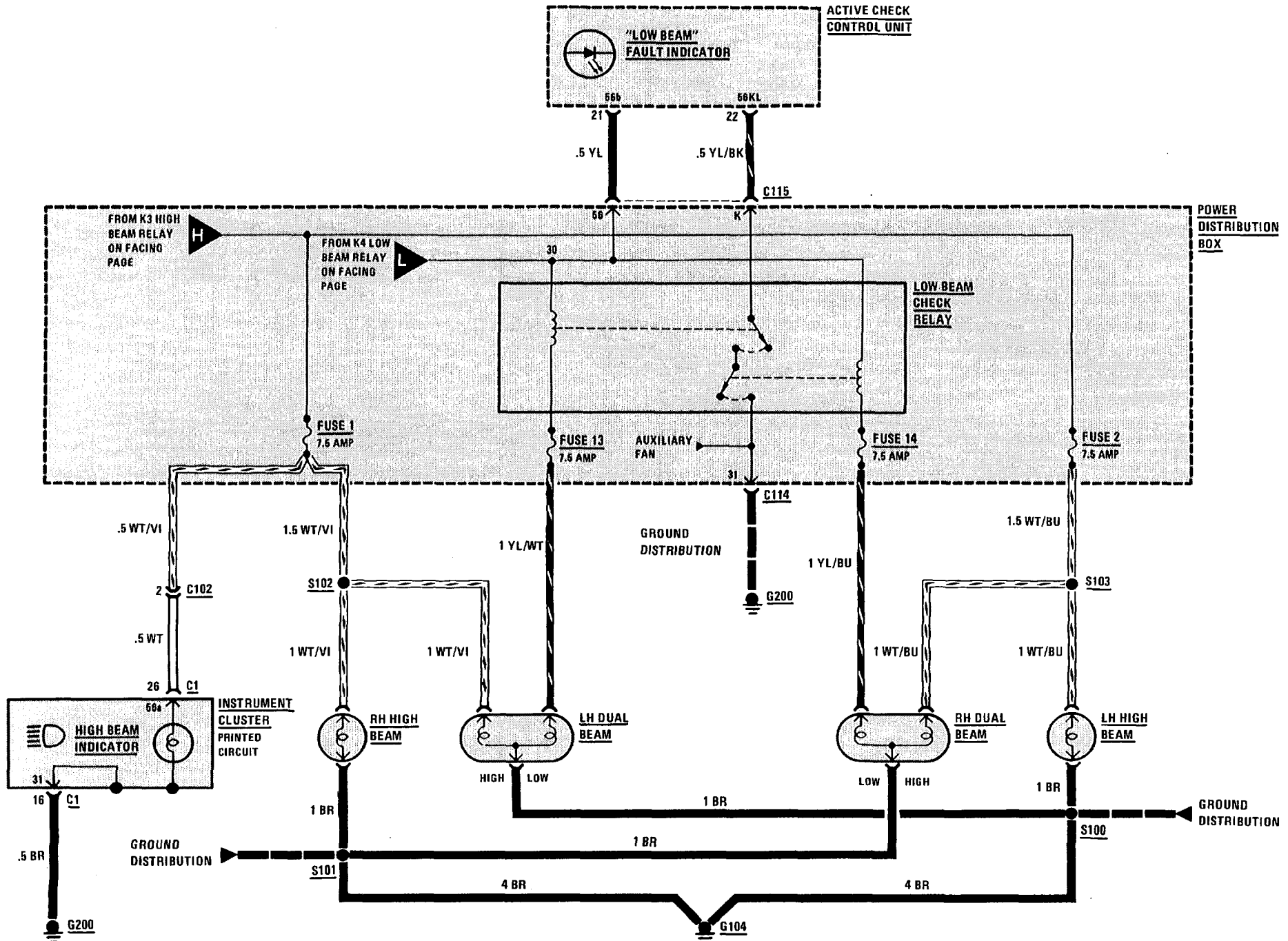

130 LIGHTS: TURN/HAZARD WARNING

(For Component Locations See Page 207)

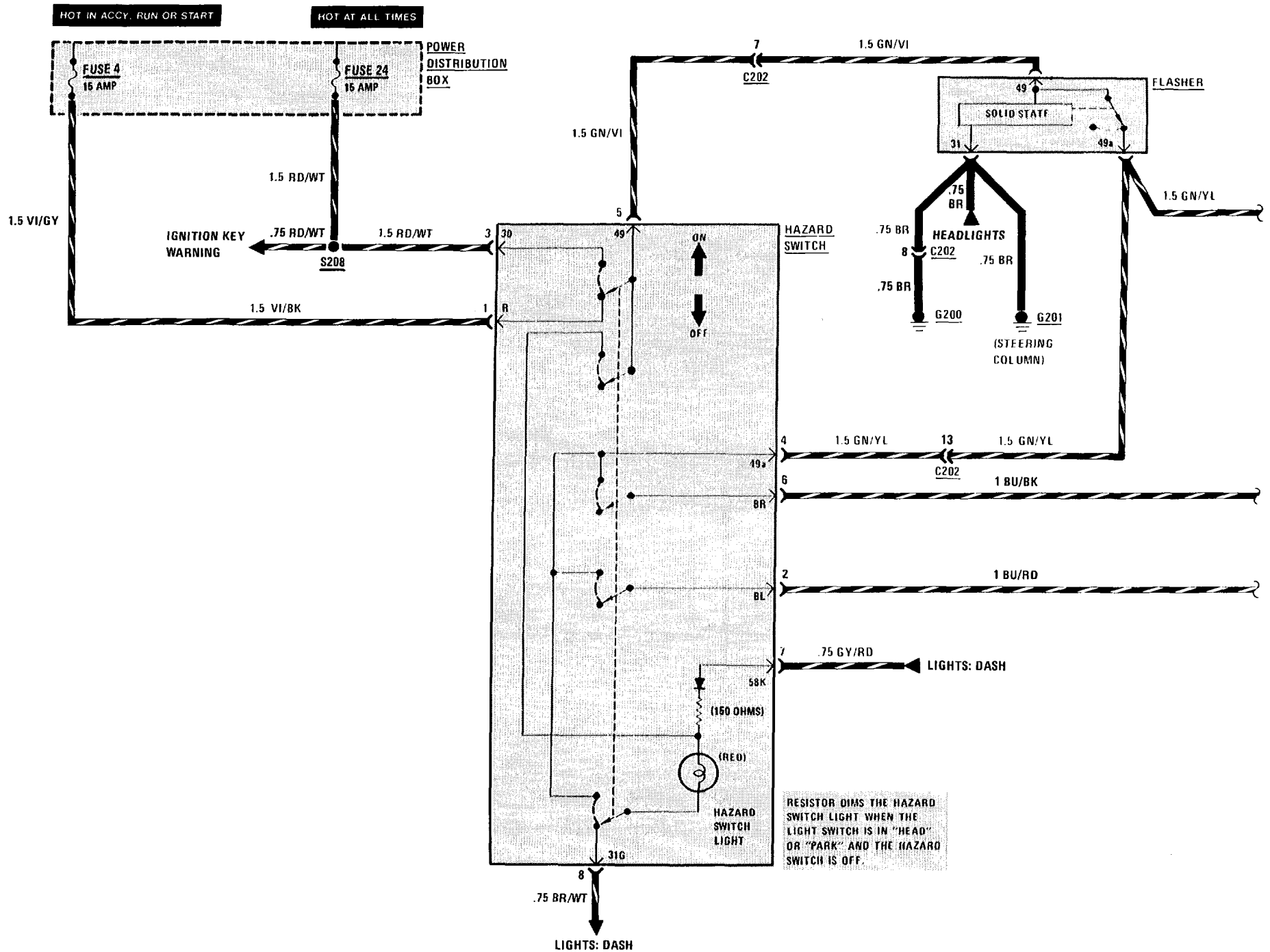

LIGHTS: TURN/HAZARD WARNING 131

(For Component Locations See Page 207)

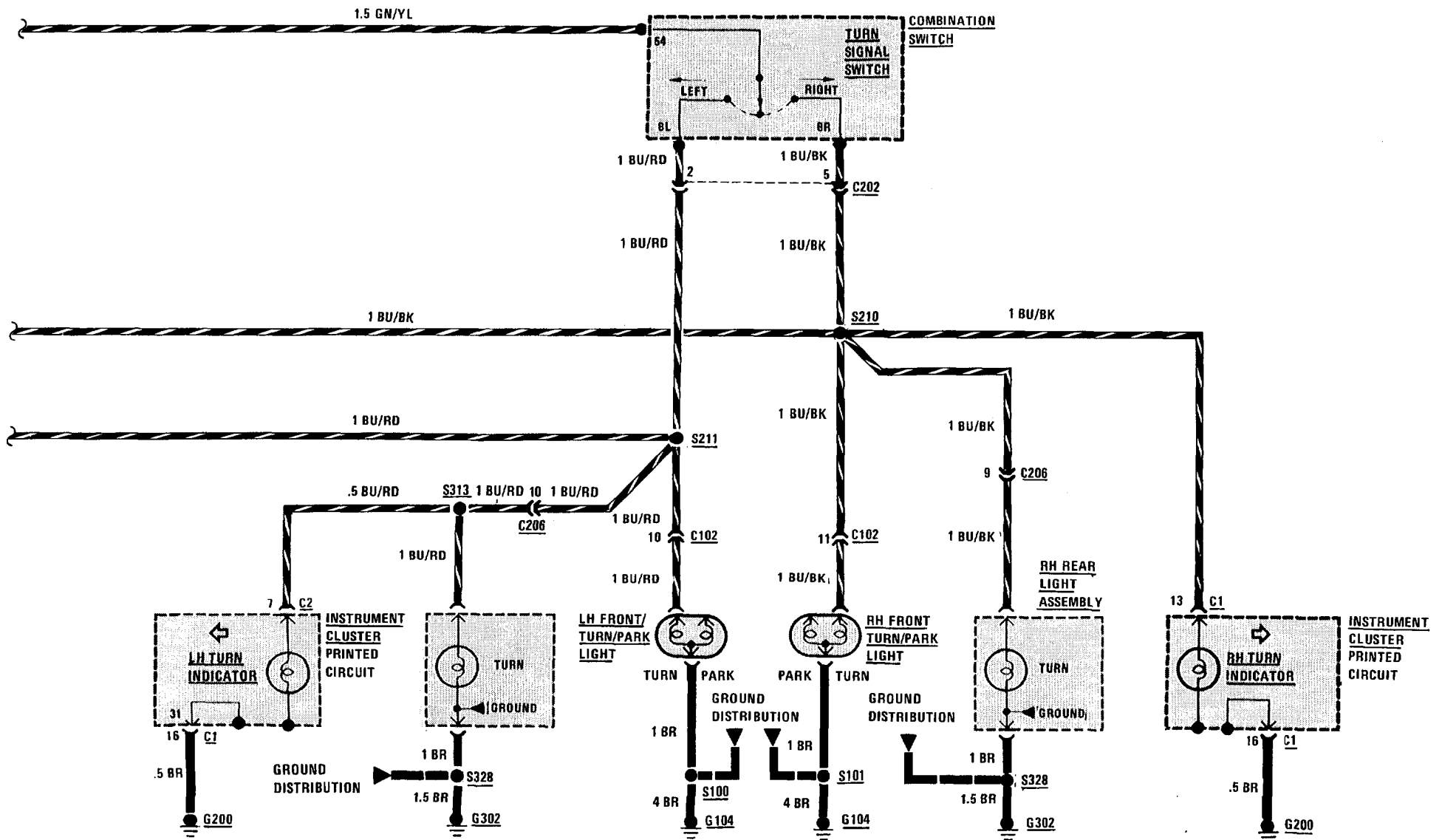

132 LIGHTS: FRONT PARK/TAIL/UNDERHOOD

(For Component Locations See Page 206)

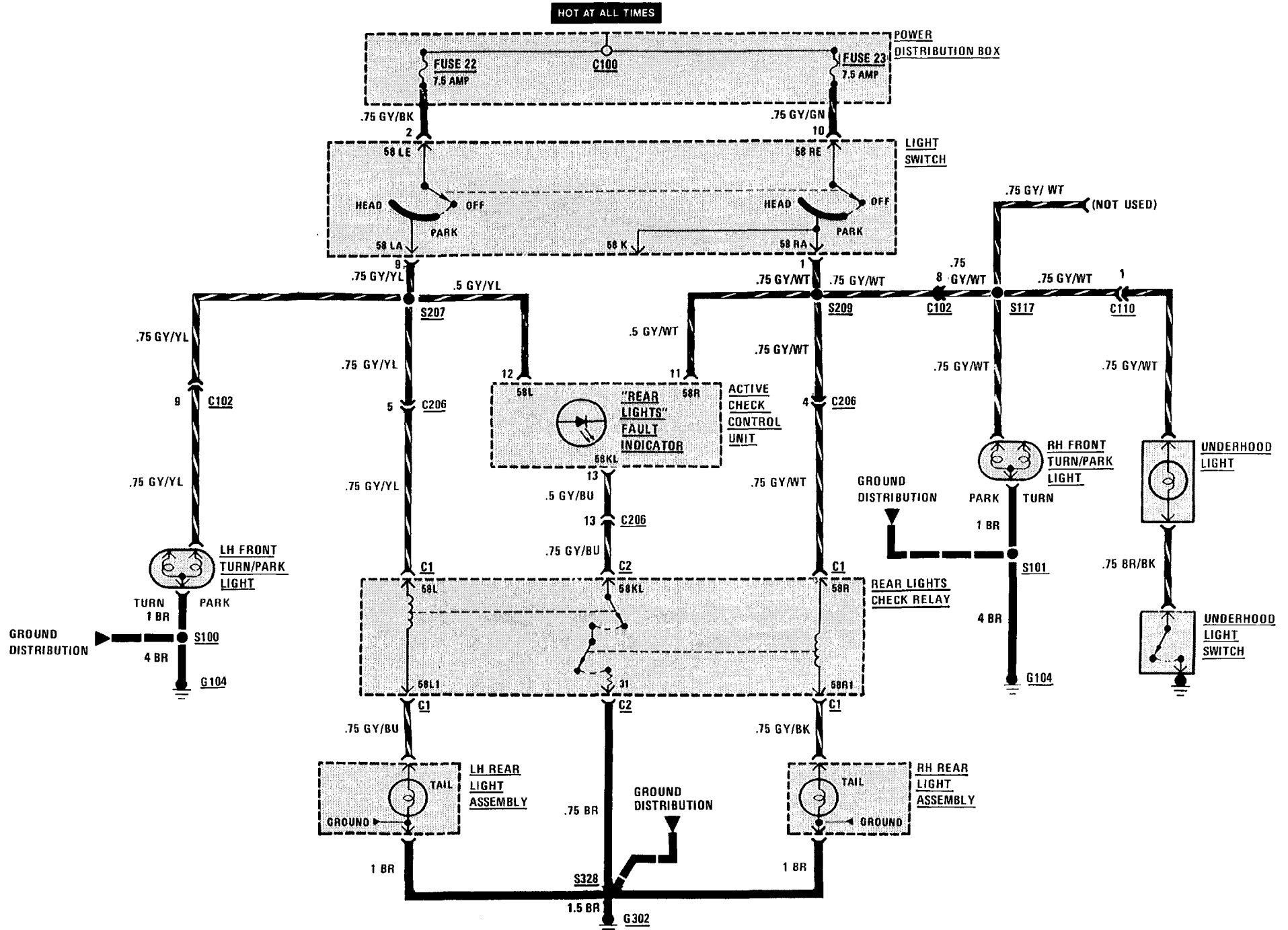

LIGHTS: REAR MARKER/LICENSE

(For Component Locations See Page 207)

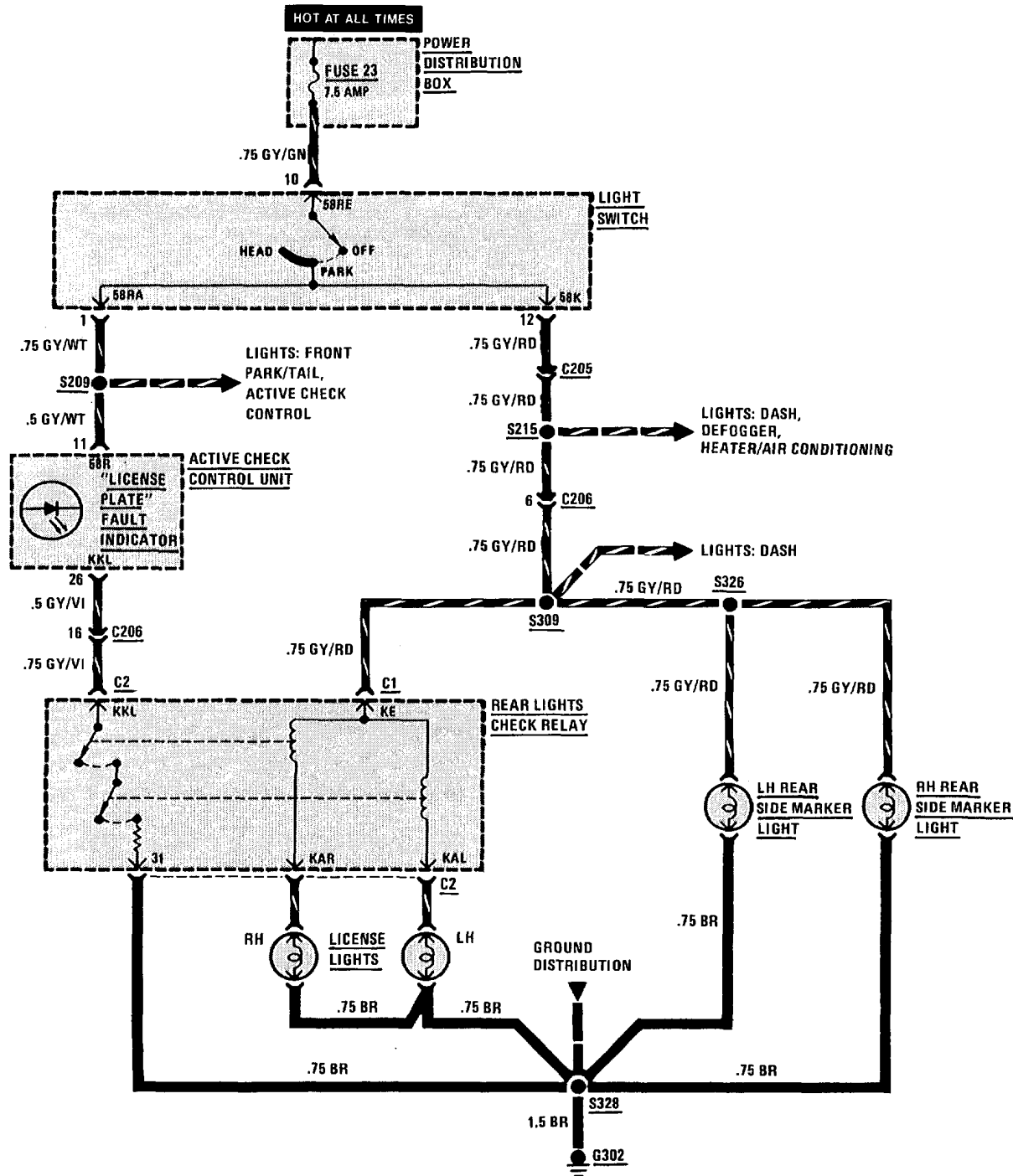

TRUNK LIGHT 133

(For Component Locations See Page 207)

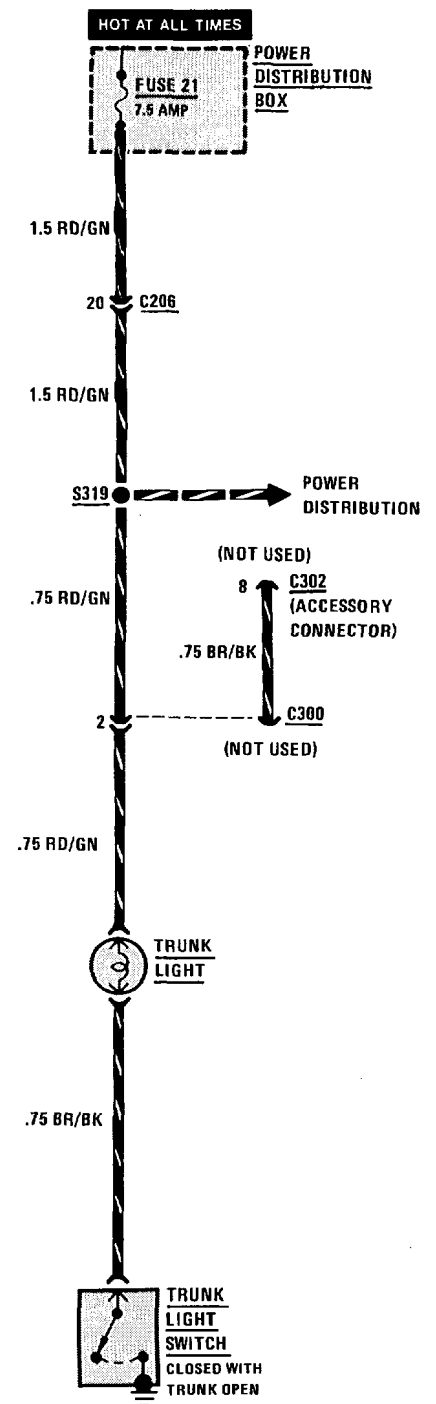

134 STOPLIGHTS/CRUISE CONTROL

(For Component Locations See Page 211)

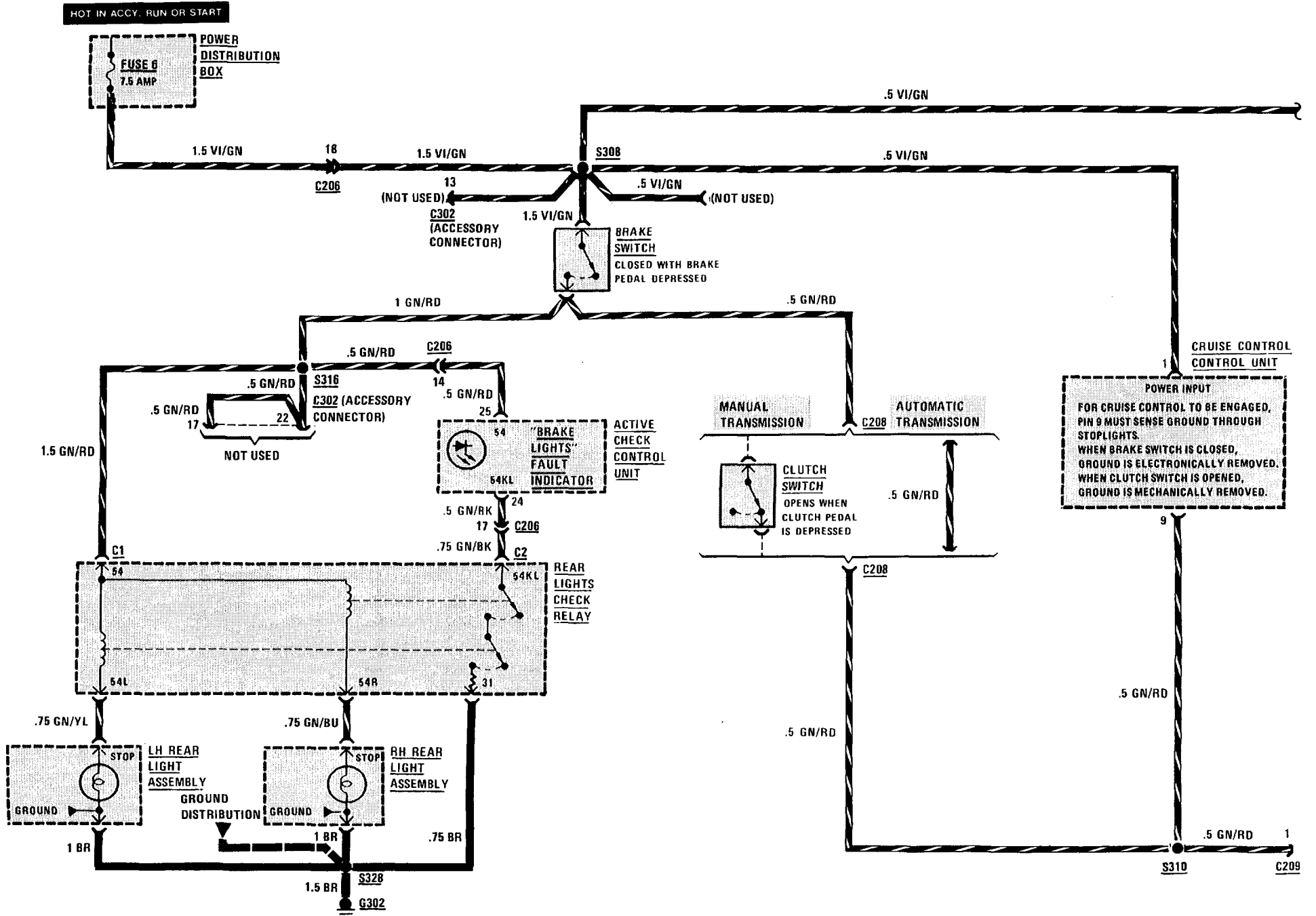

STOPLIGHTS/CRUISE CONTROL 135

(For Component Locations See Page 211)

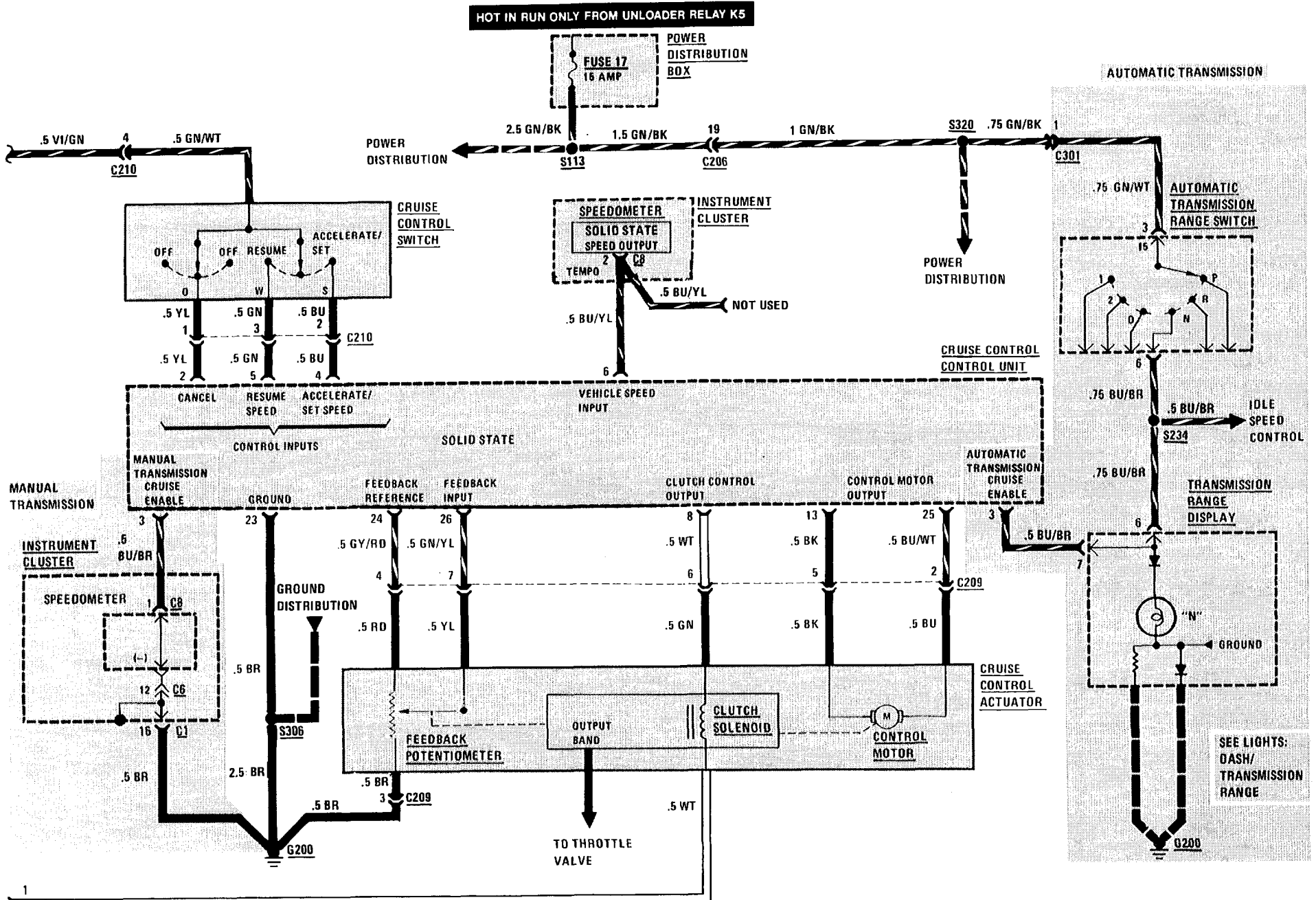

136 LIGHTS: DASH/TRANSMISSION RANGE/RH VISOR

(For Component Locations See Page 207)

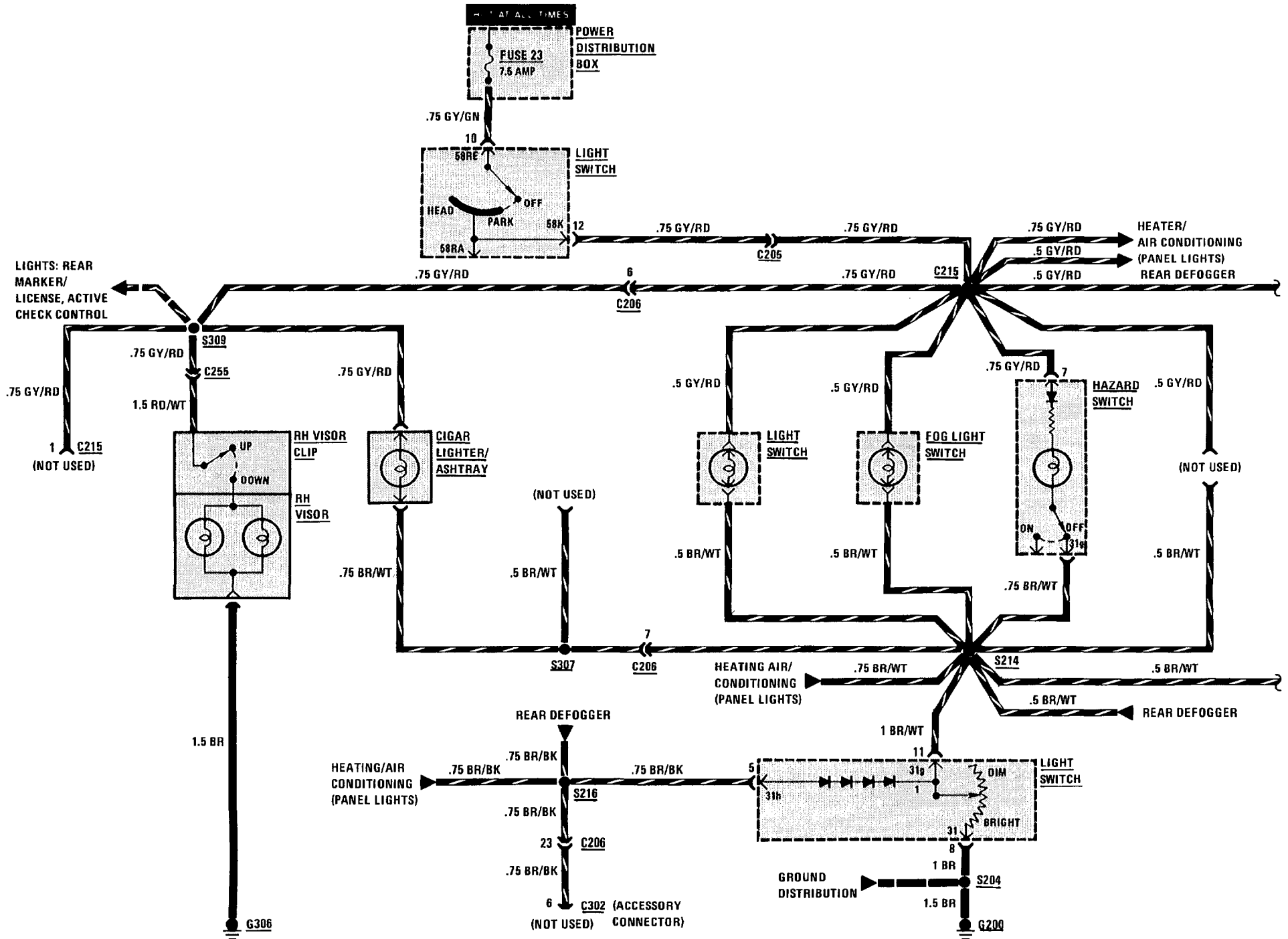

LIGHTS: DASH/TRANSMISSION RANGE 137

(For Component Locations See Page 207)

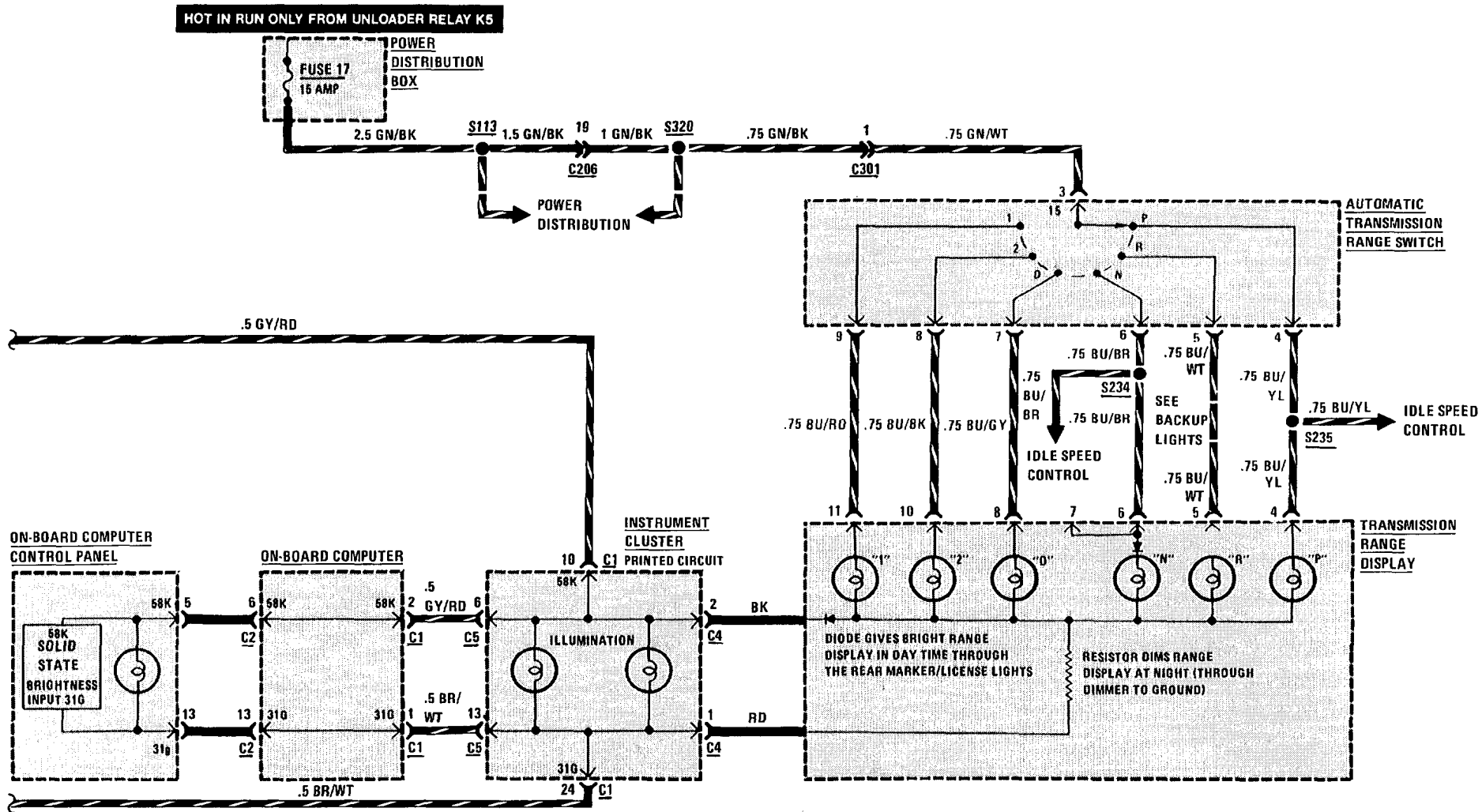

138 BACKUP LIGHTS

(For Component Locations See Page 201)

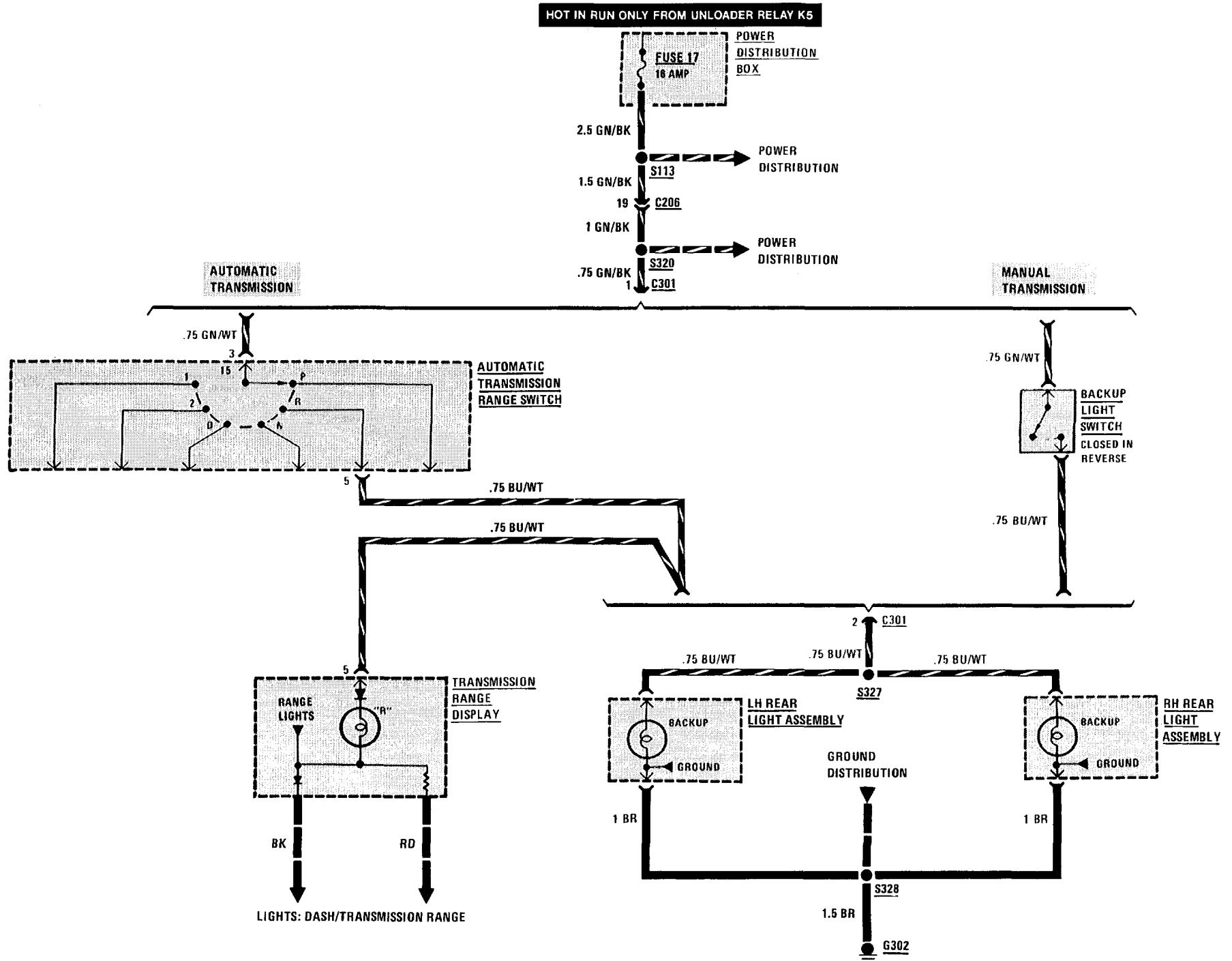

CIGAR LIGHTER/GLOVE BOX LIGHT/AUTO-CHARGING FLASHLIGHT 139

(For Component Locations See Page 202)

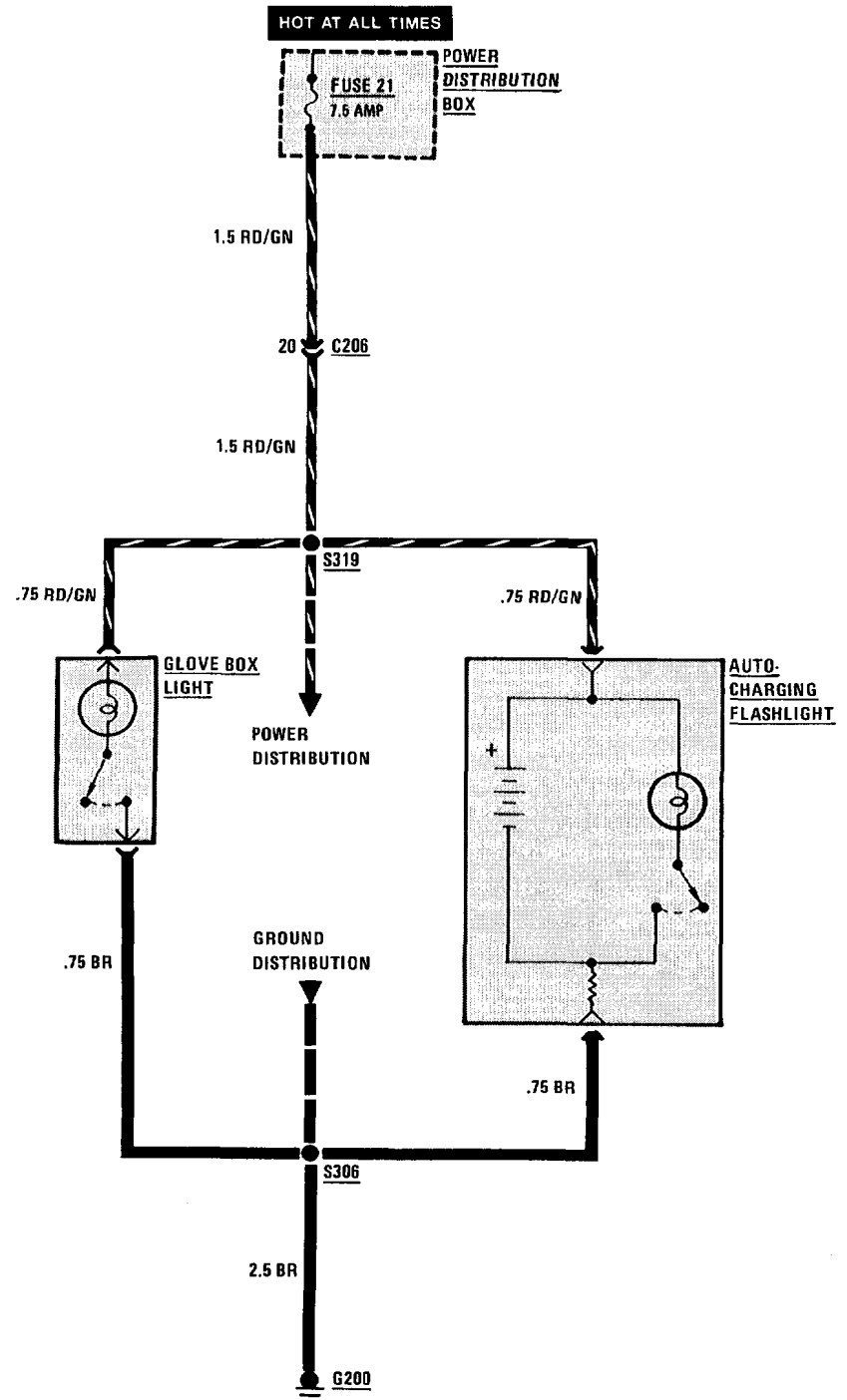
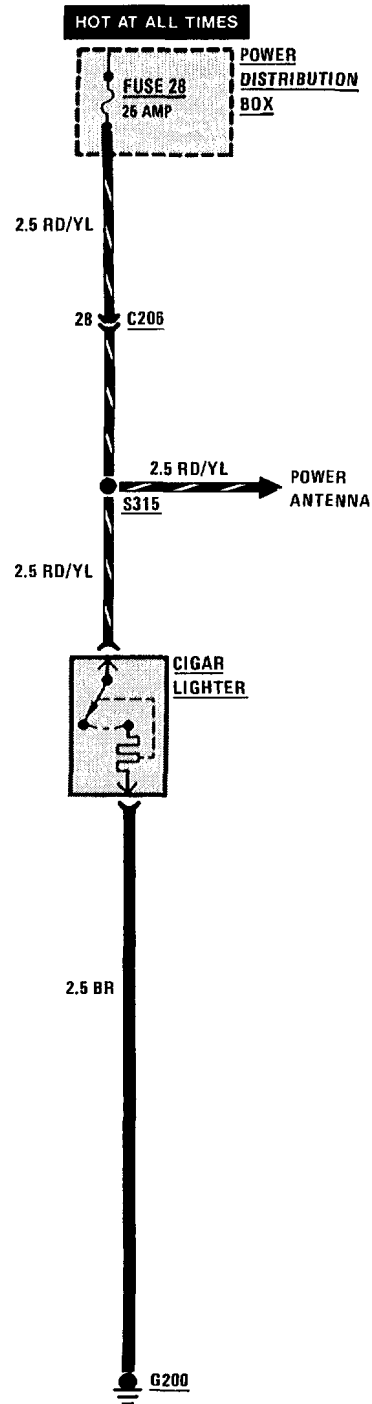

(For Component Locations See Page 204)

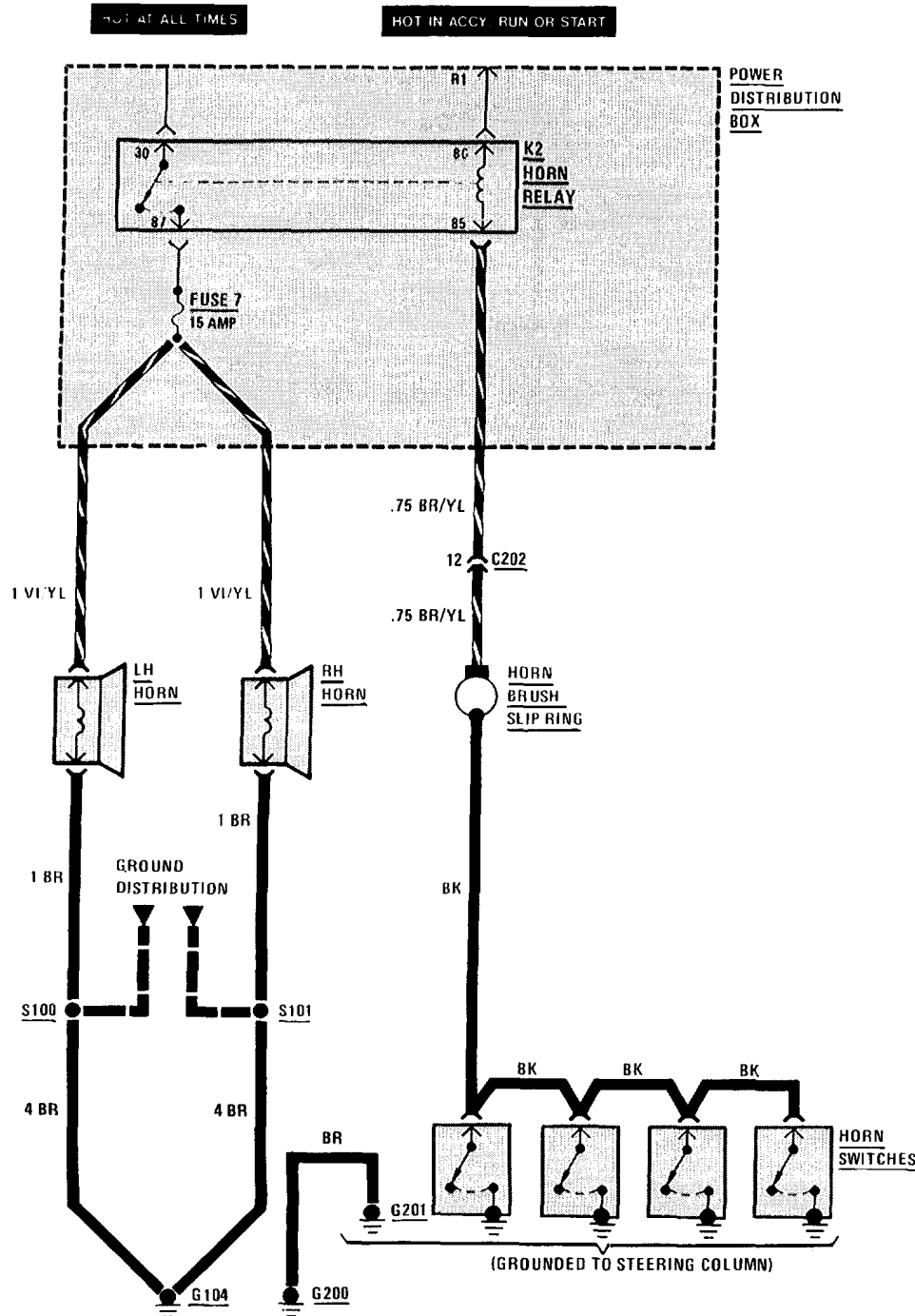

(For Component Locations See Page 204)

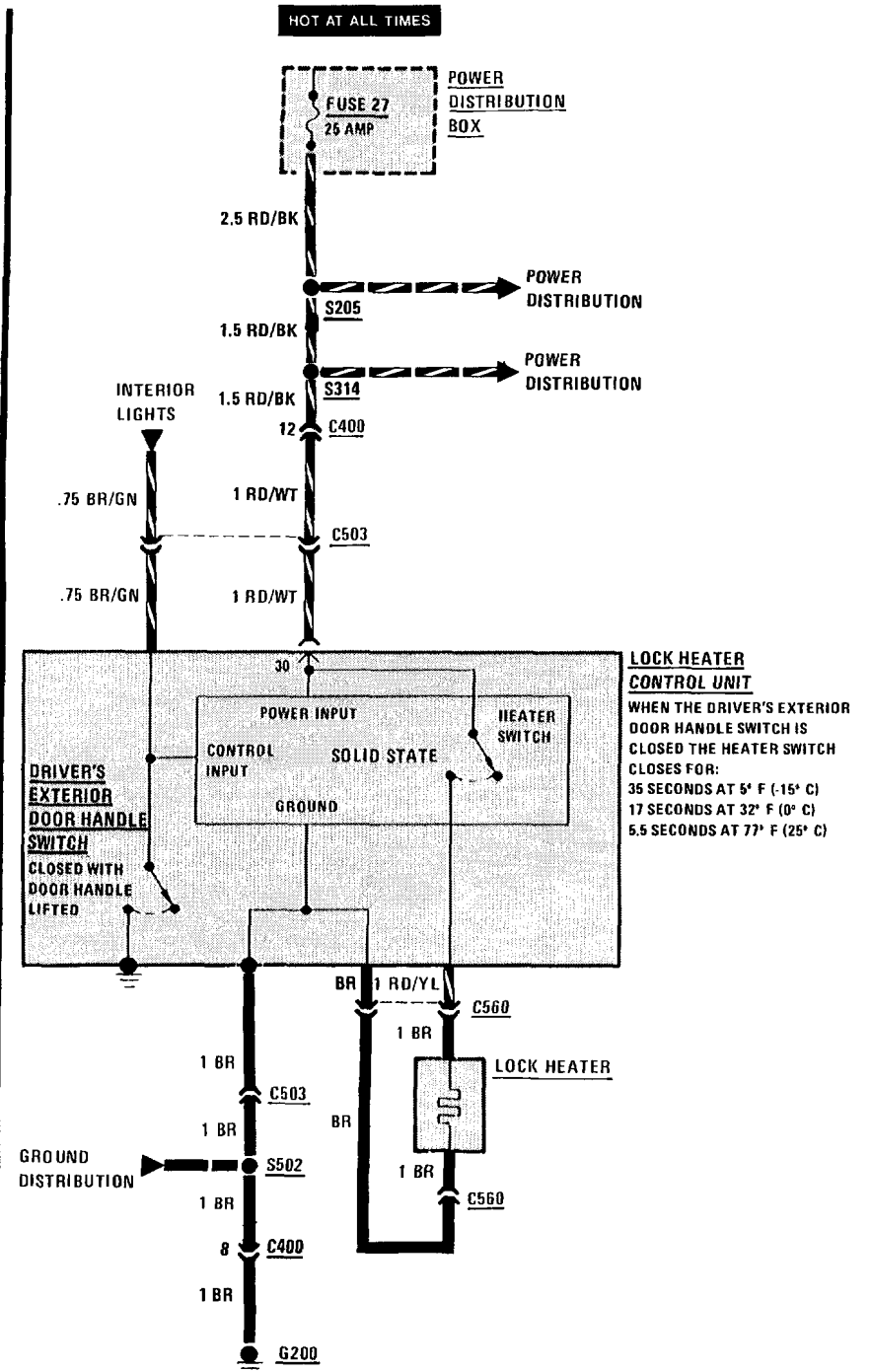

WHEN THE DRIVER'S EXTERIOR DOOR HANDLE SWITCH IS CLOSED THE HEATER SWITCH CLOSSES FOR:
 35 SECONDS AT 5° F (-15° C)
 17 SECONDS AT 32° F (0° C)
 5.5 SECONDS AT 77° F (25° C)

REAR DEFOGGER 141

(For Component Locations See Page 210)

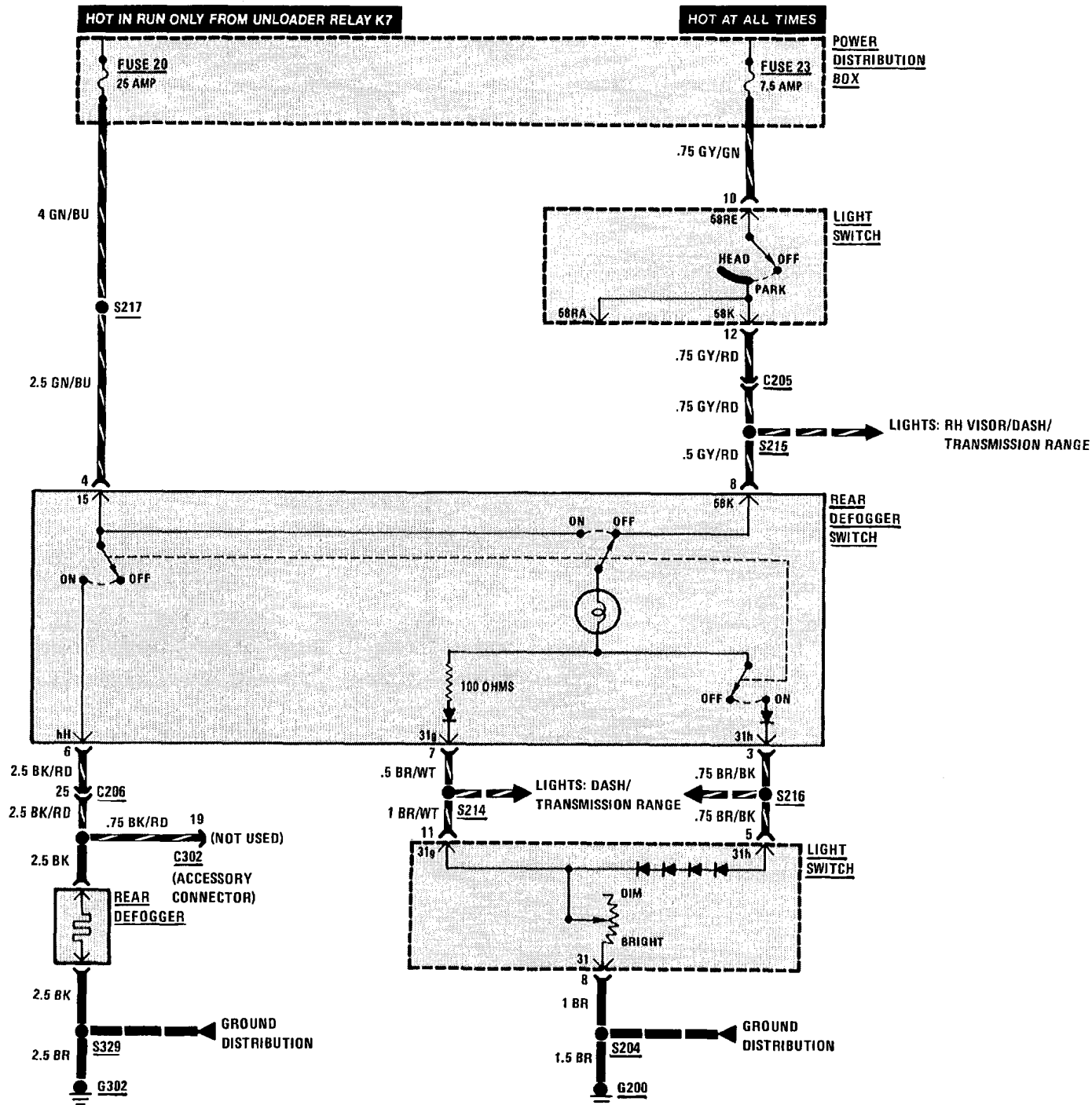

142 POWER WINDOWS

(For Component Locations See Page 209)

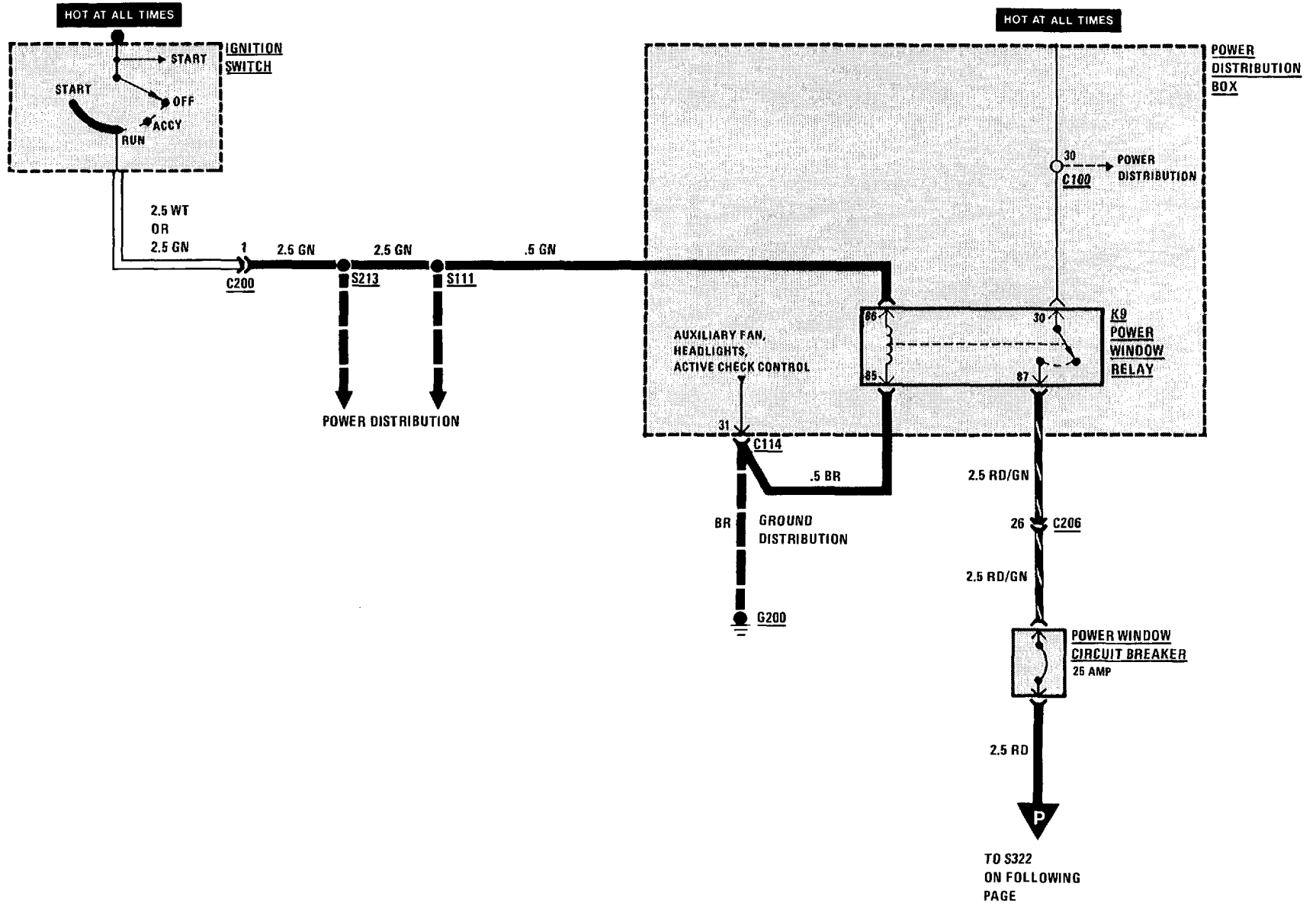

(For Component Locations See Page 209)

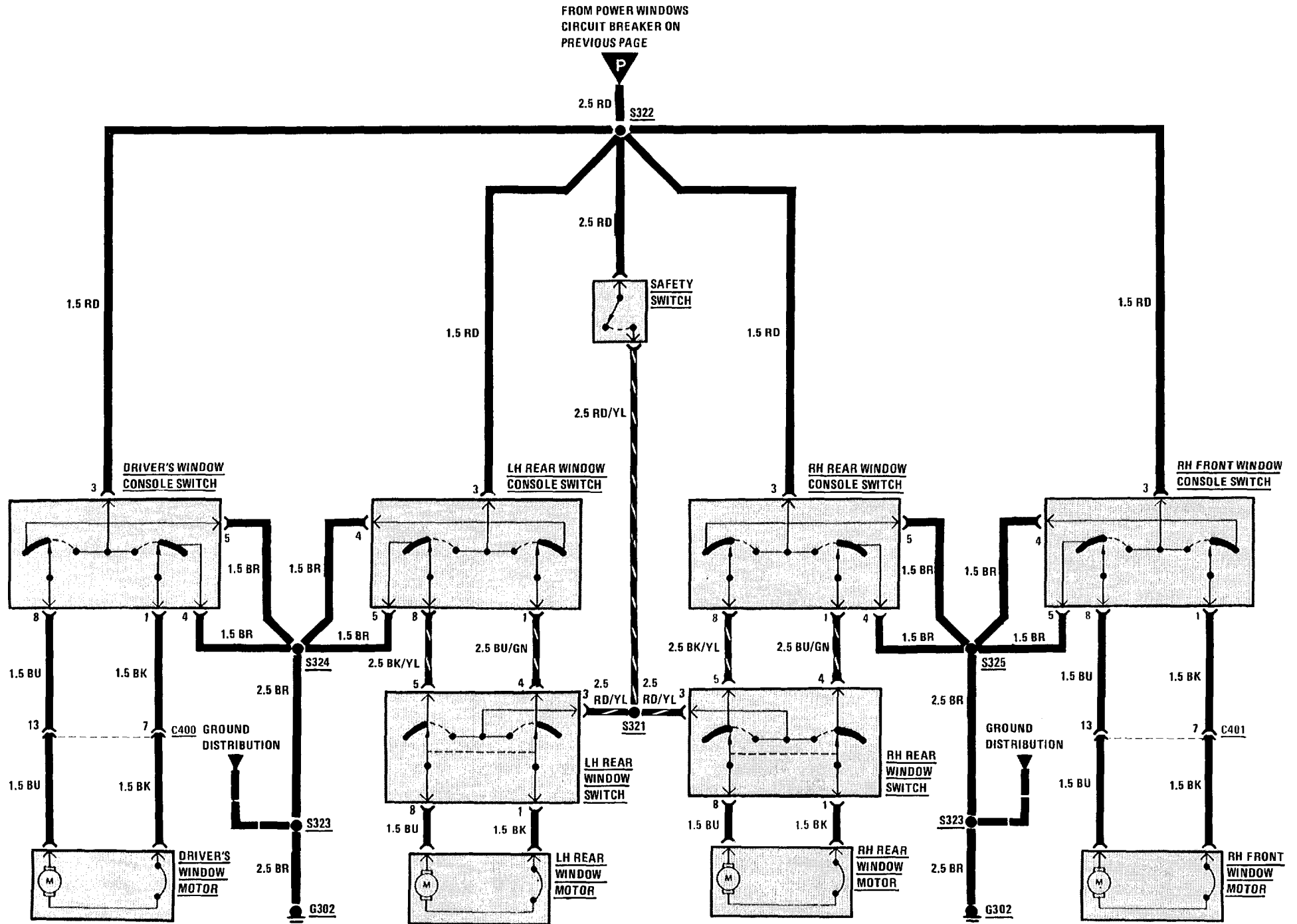

144 CENTRAL LOCKING

(For Component Locations See Page 202)

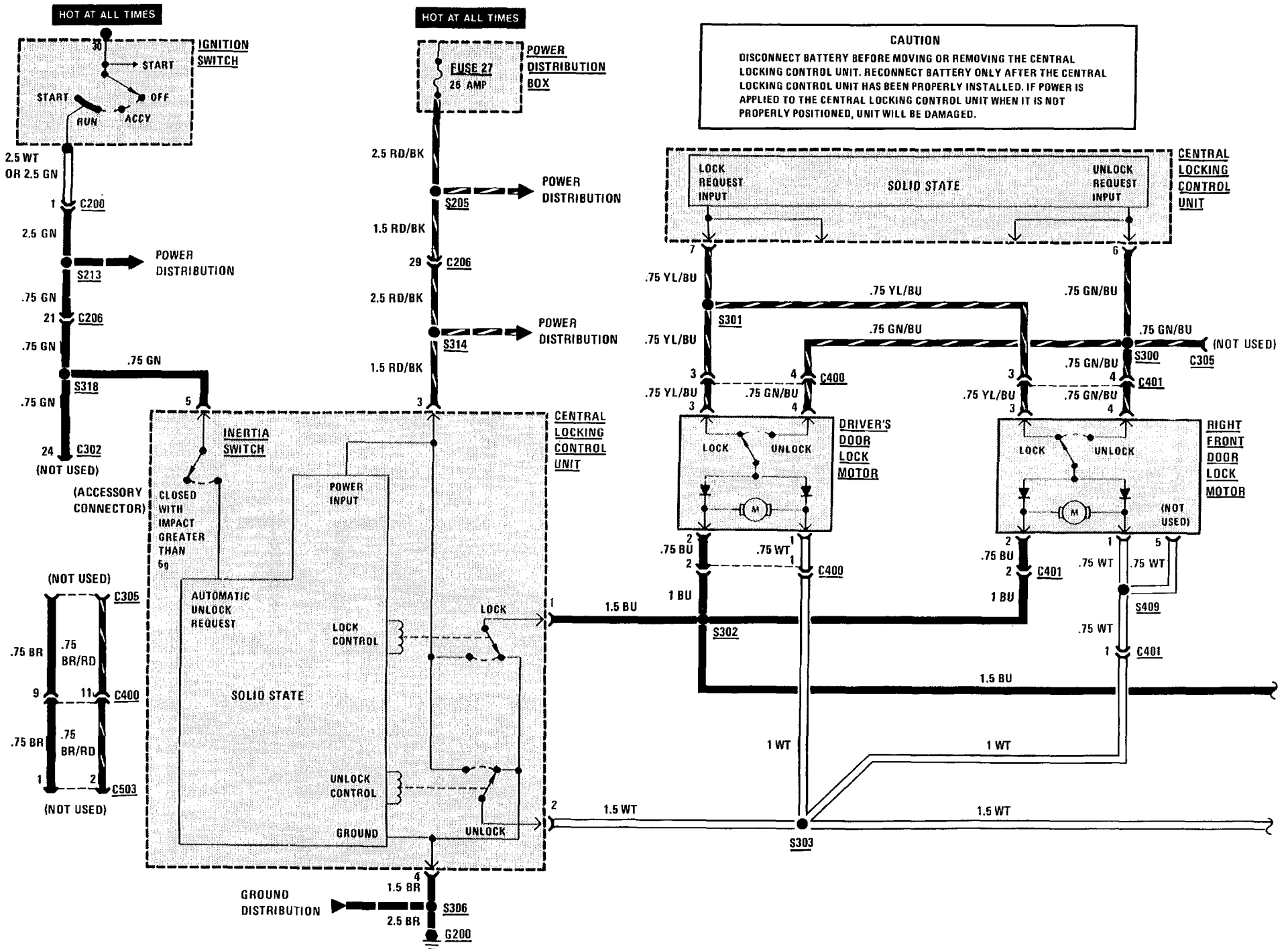

CENTRAL LOCKING 145

(For Component Locations See Page 202)

CAUTION
DO NOT OPERATE THE SYSTEM MORE THAN 8 TIMES IN QUICK SUCCESSION TO PREVENT DAMAGE TO THE CONTROL UNIT.

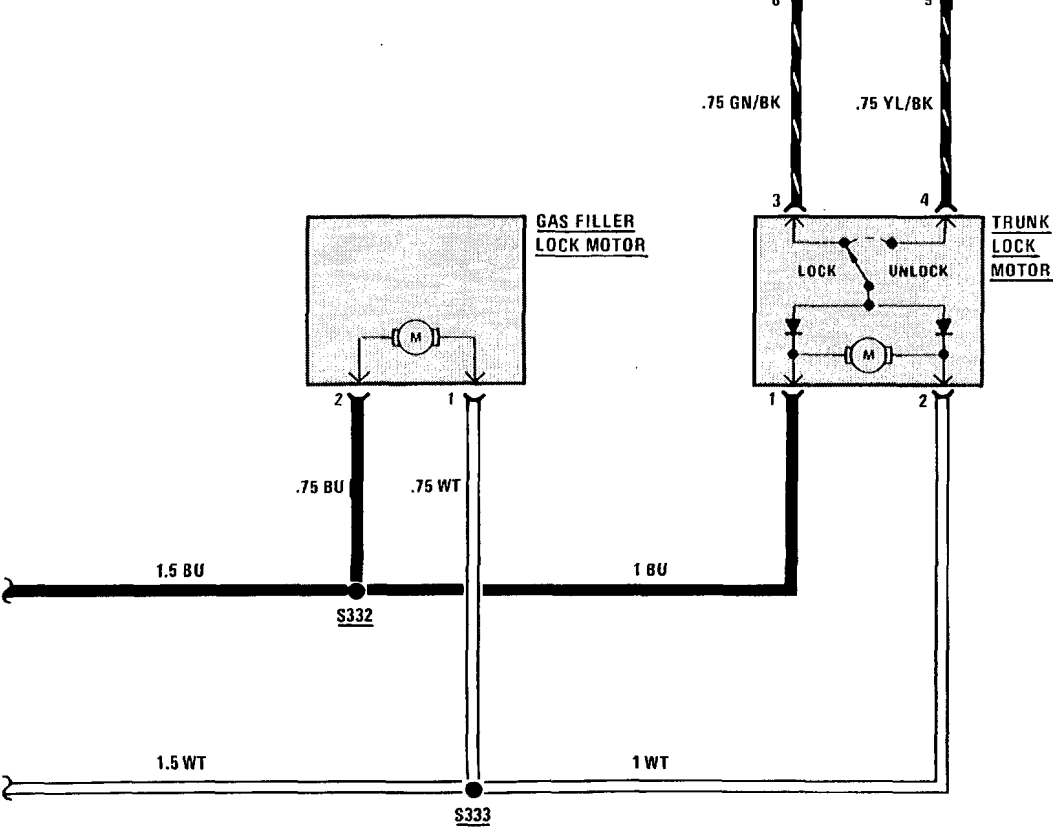
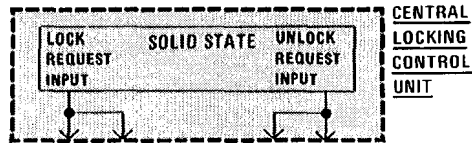

146 POWER MIRRORS

(For Component Locations See Page 209)

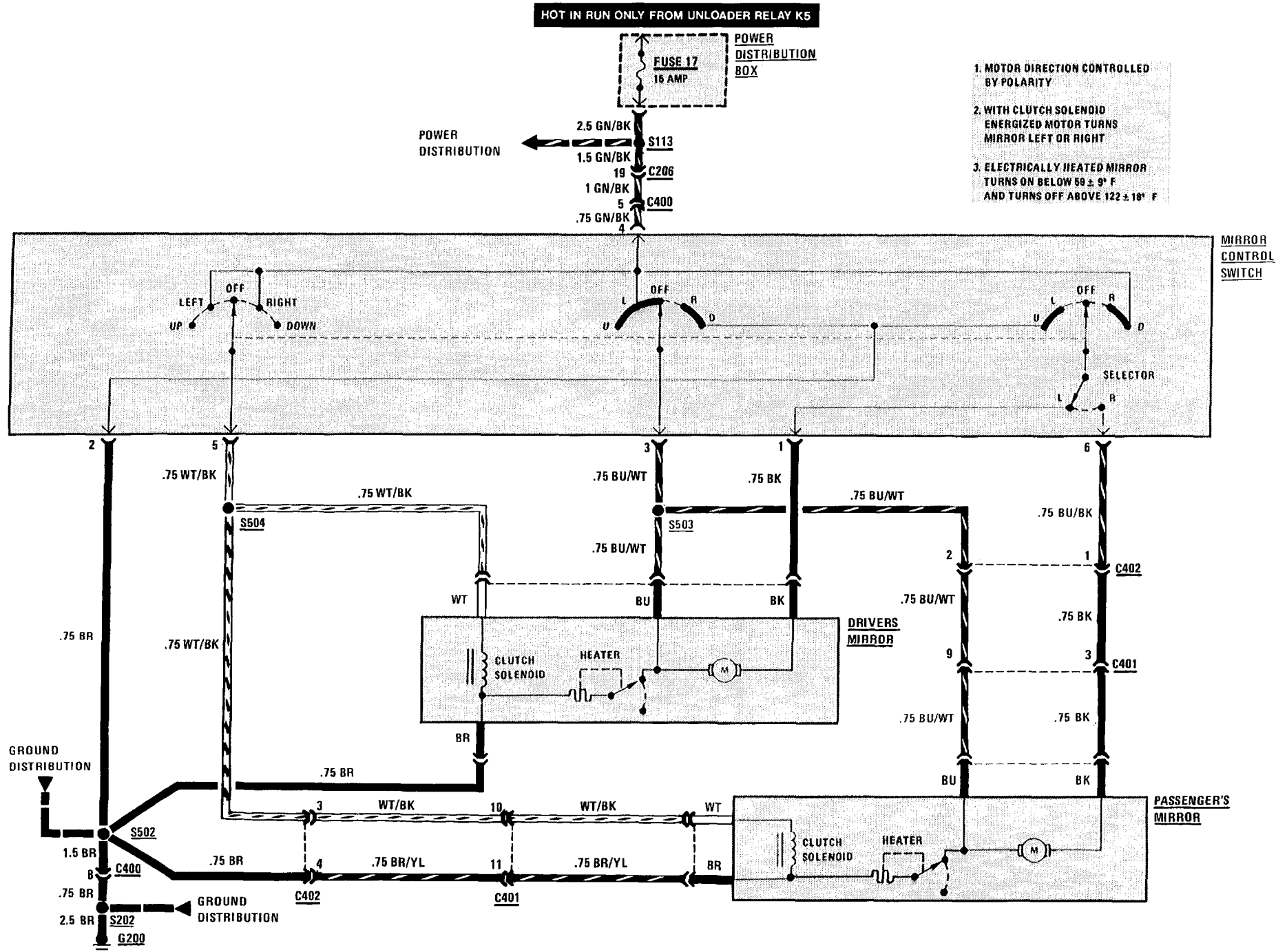

(For Component Locations See Page 209)

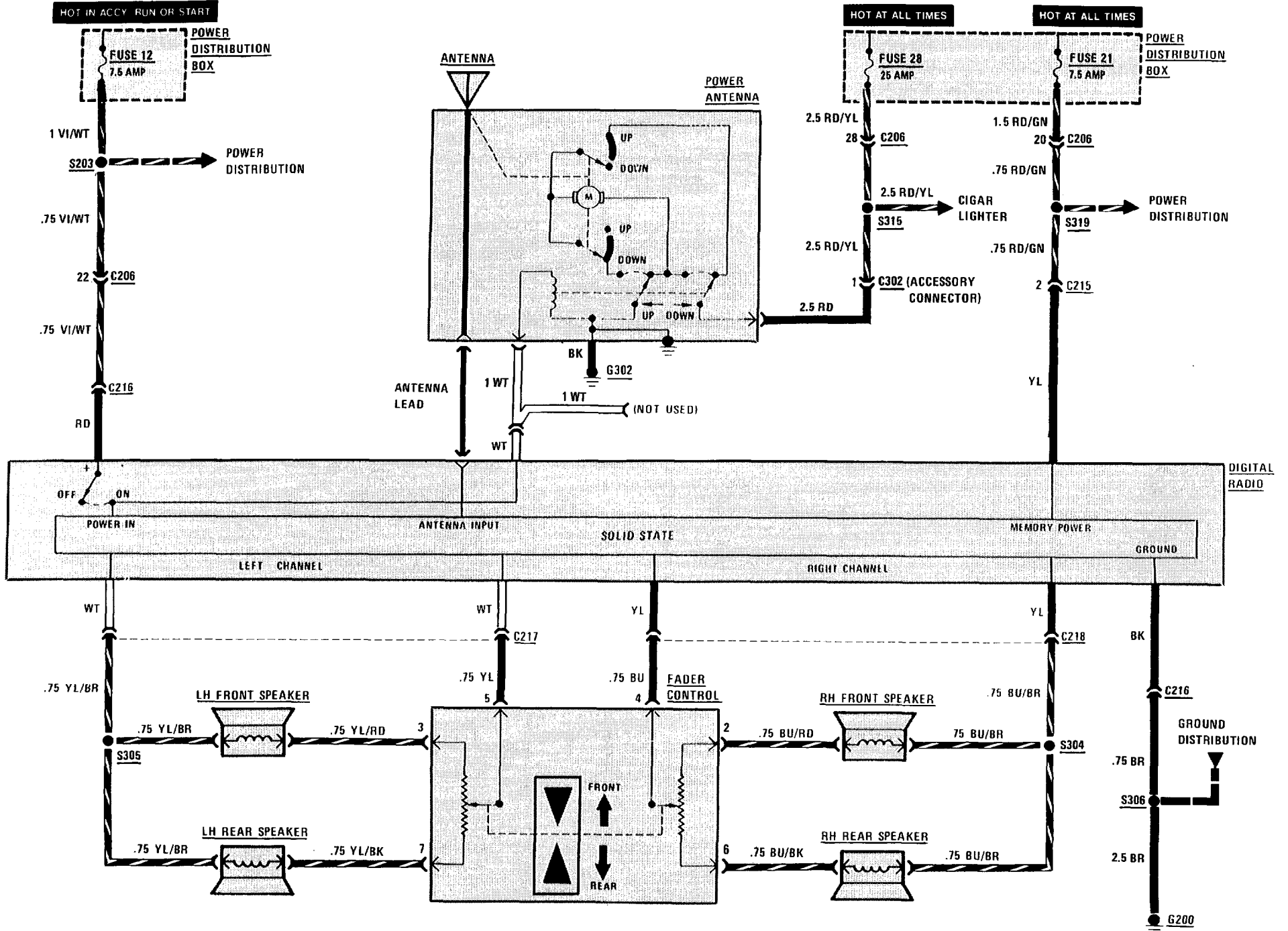

148 AUXILIARY FAN

(For Component Locations See Page 201)

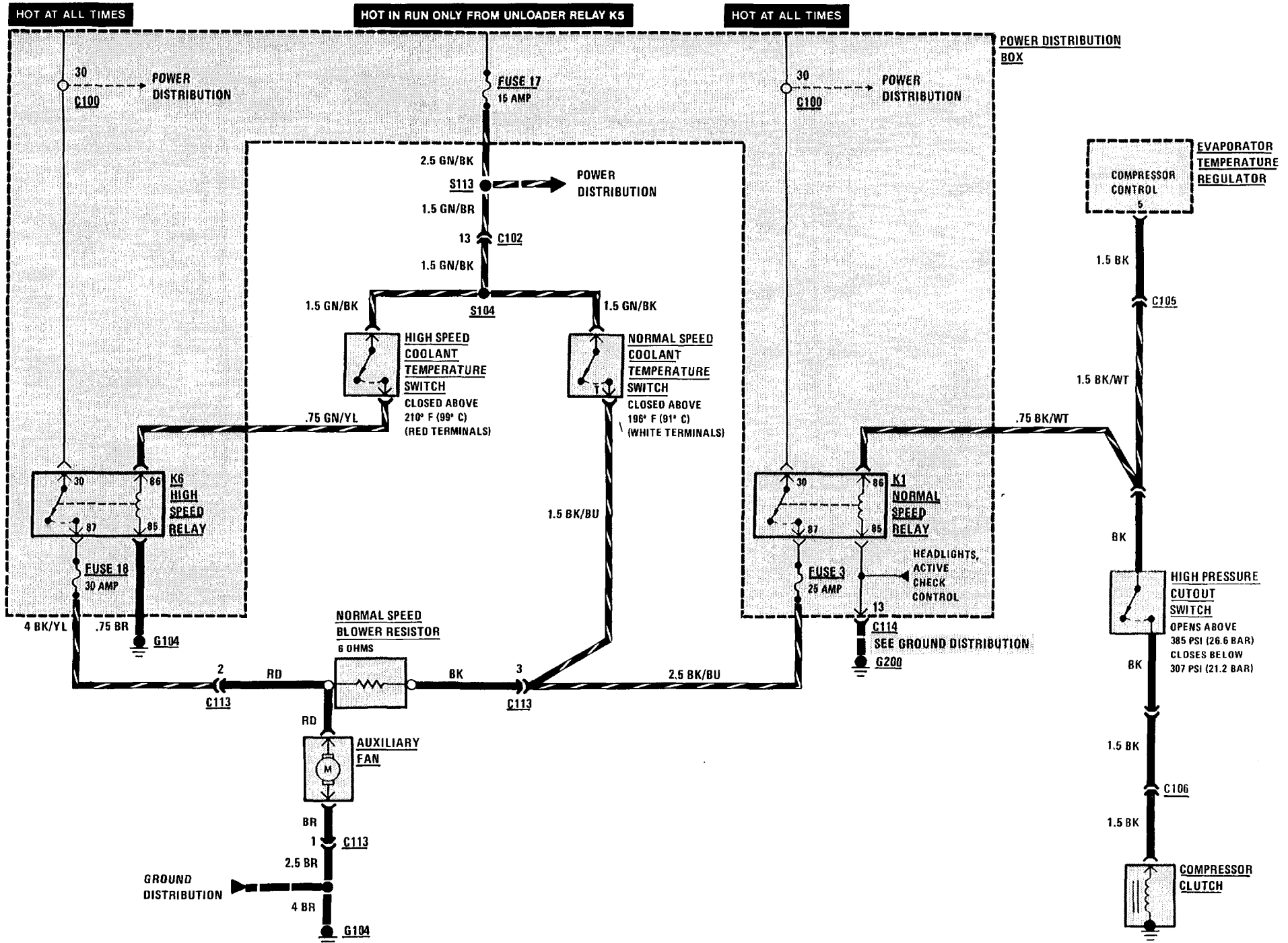

(For Component Locations See Page 204)

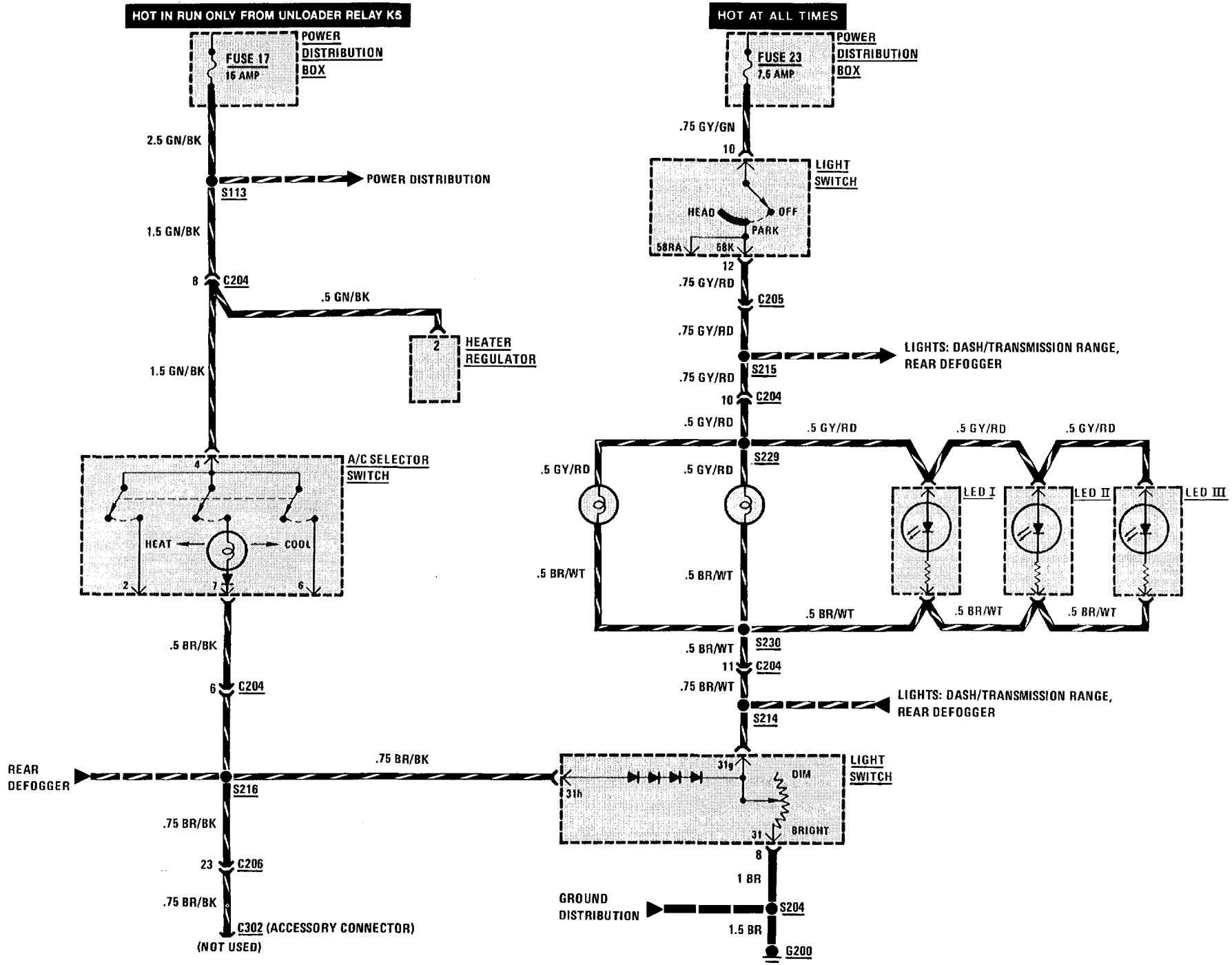

(For Component Locations See Page 204)

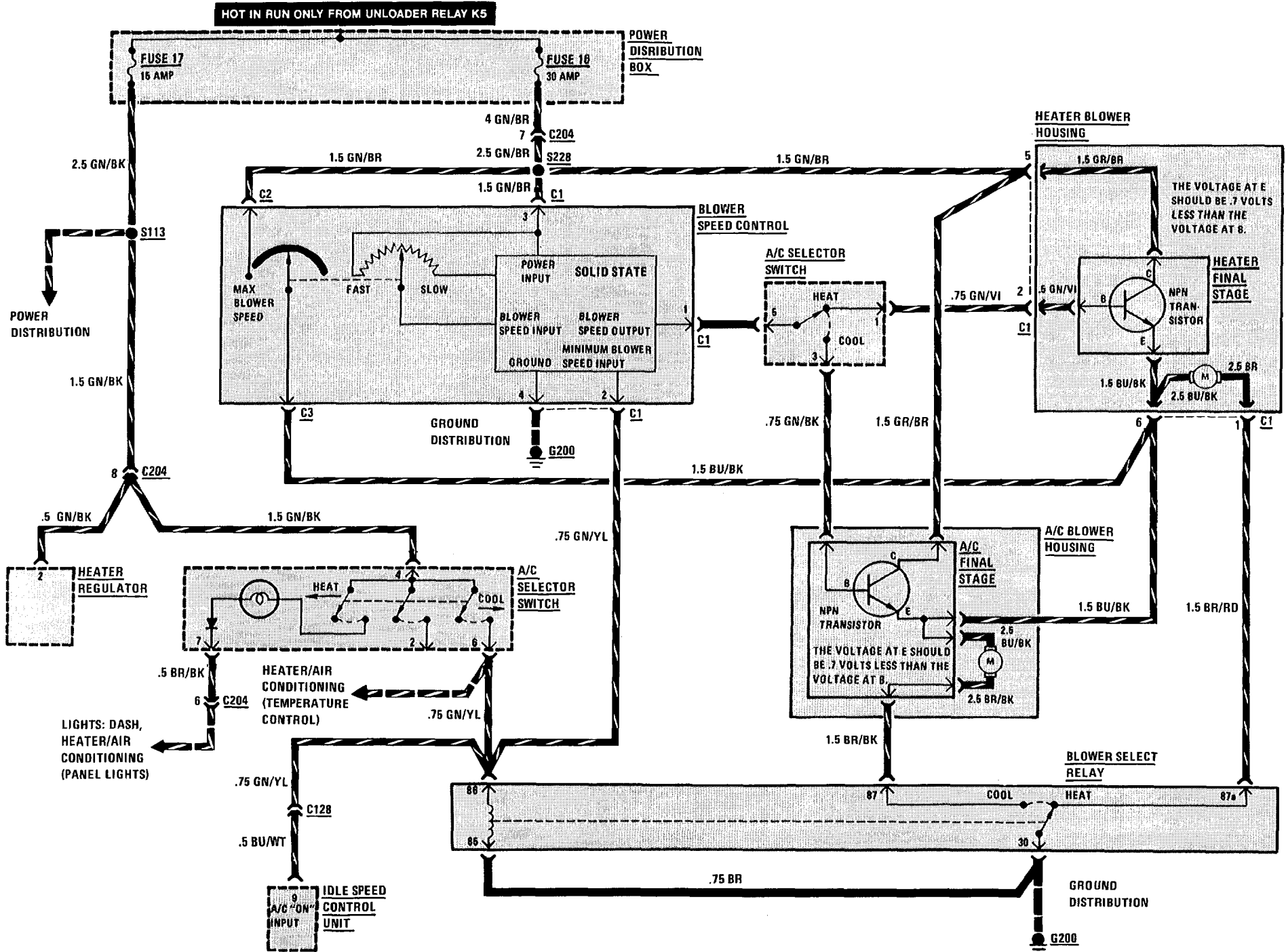

152 SUNROOF

(For Component Locations See Page 212)

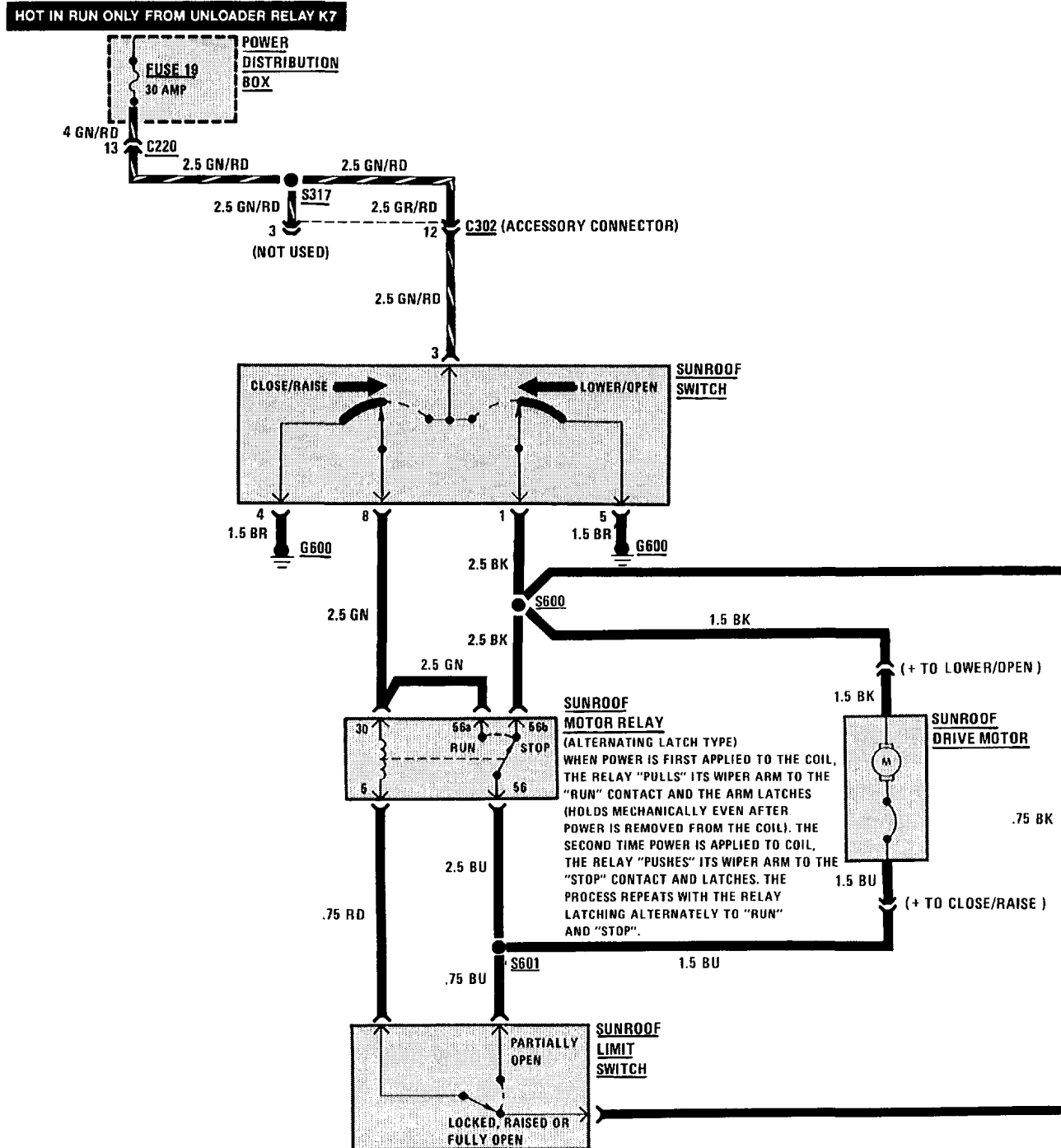

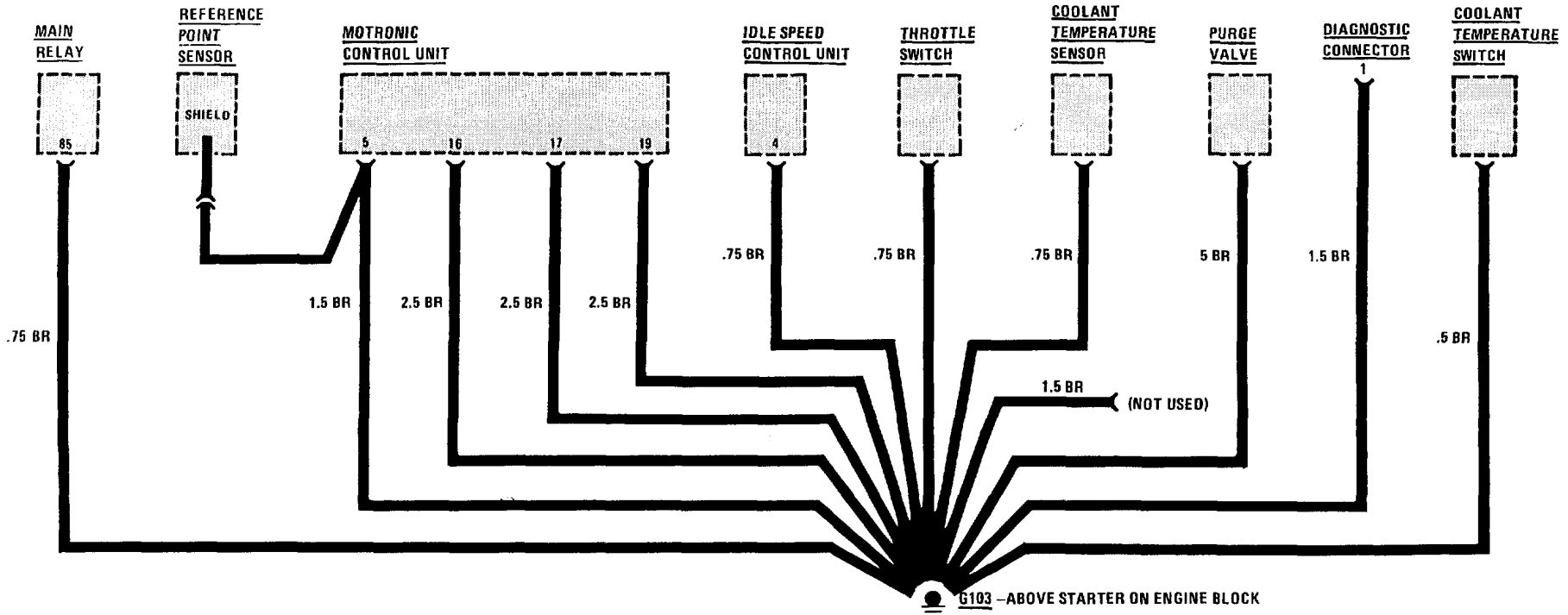
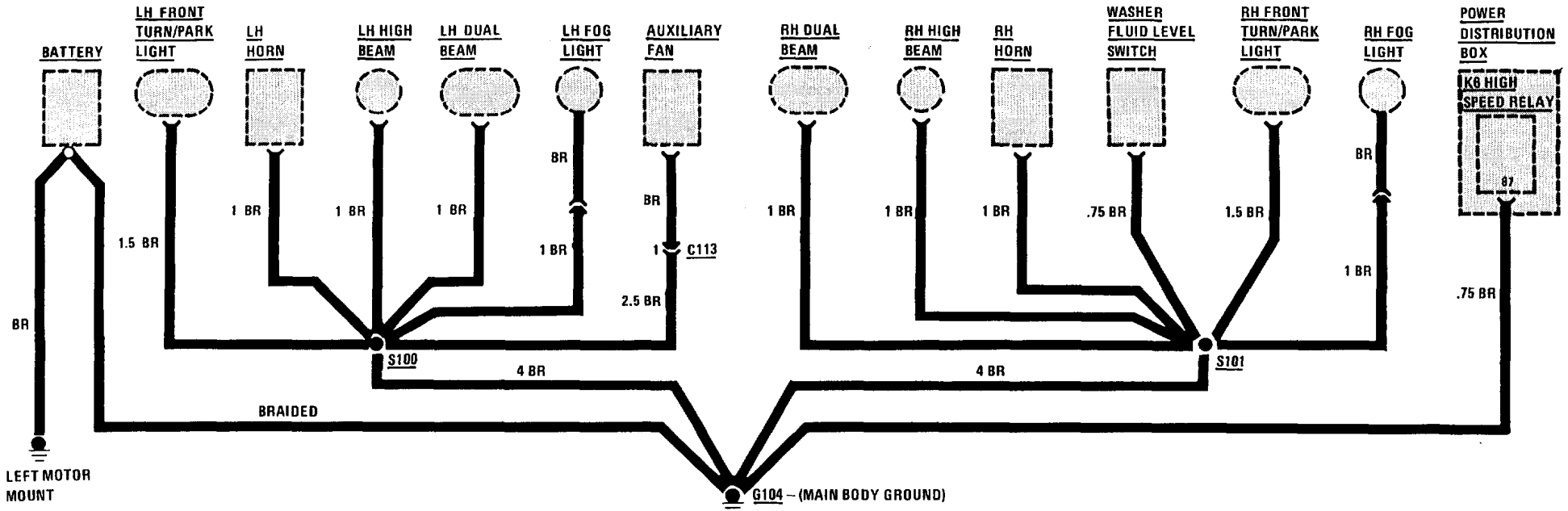

154 GROUND DISTRIBUTION (G200)

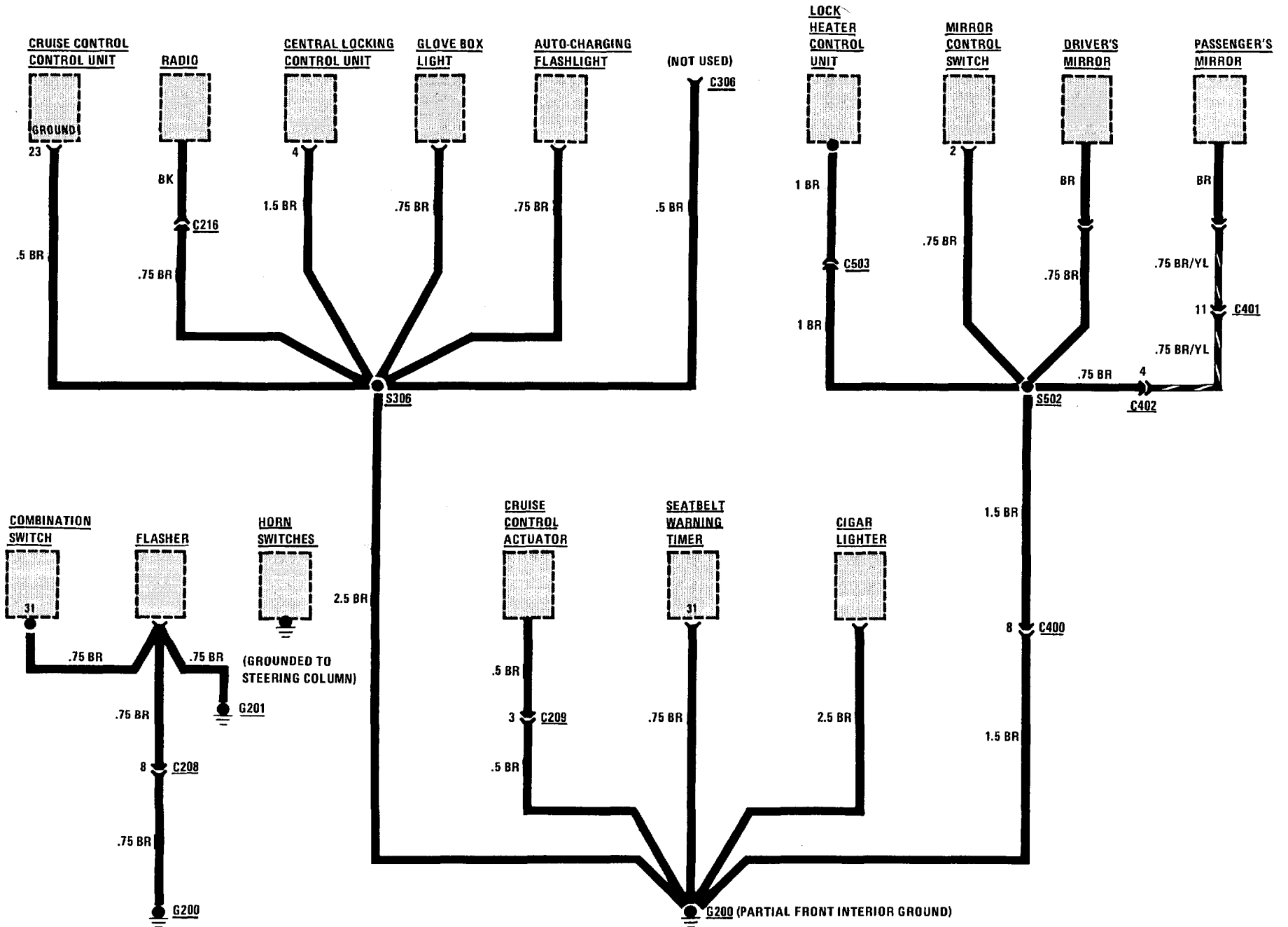

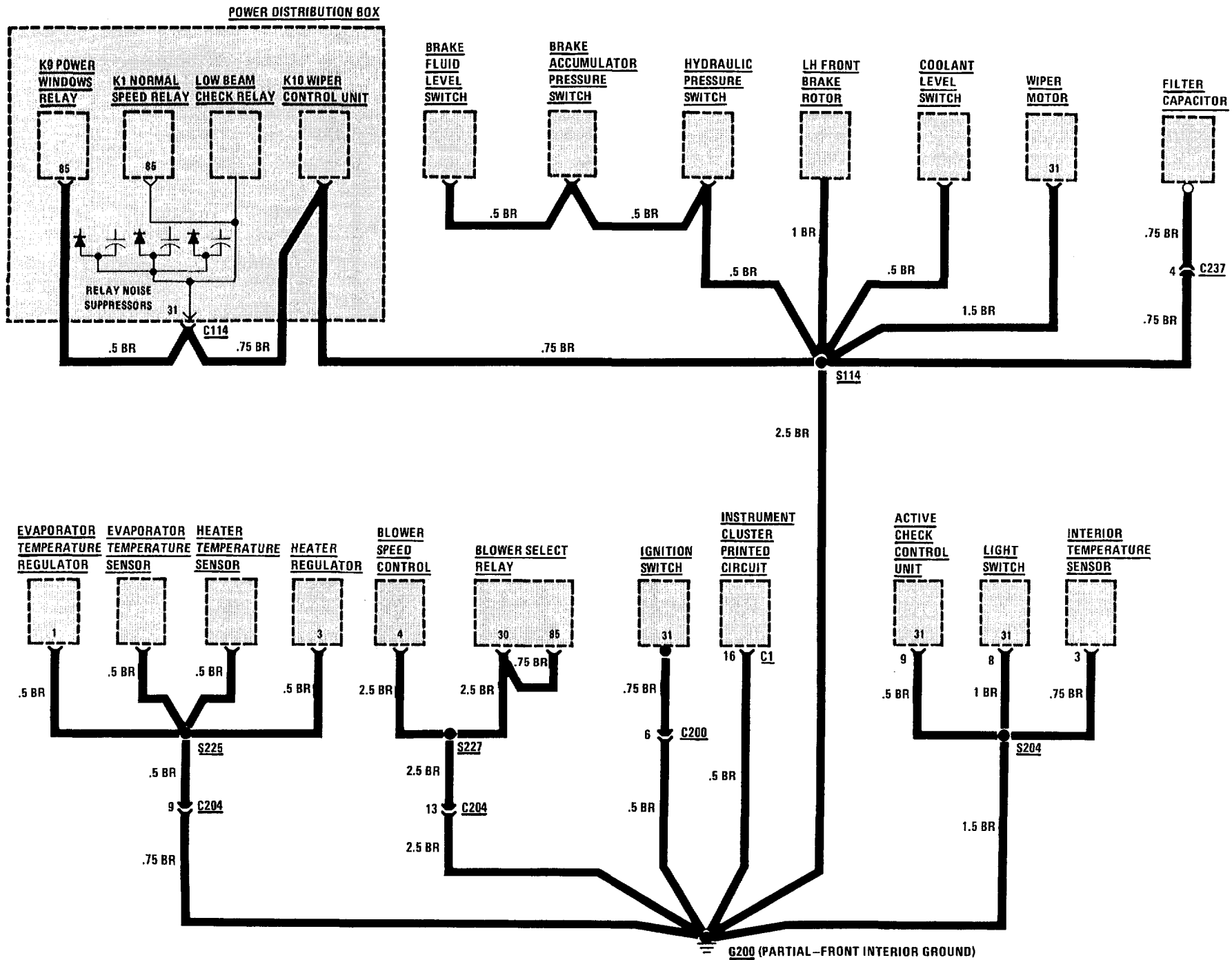

156 GROUND DISTRIBUTION (G302, G303)

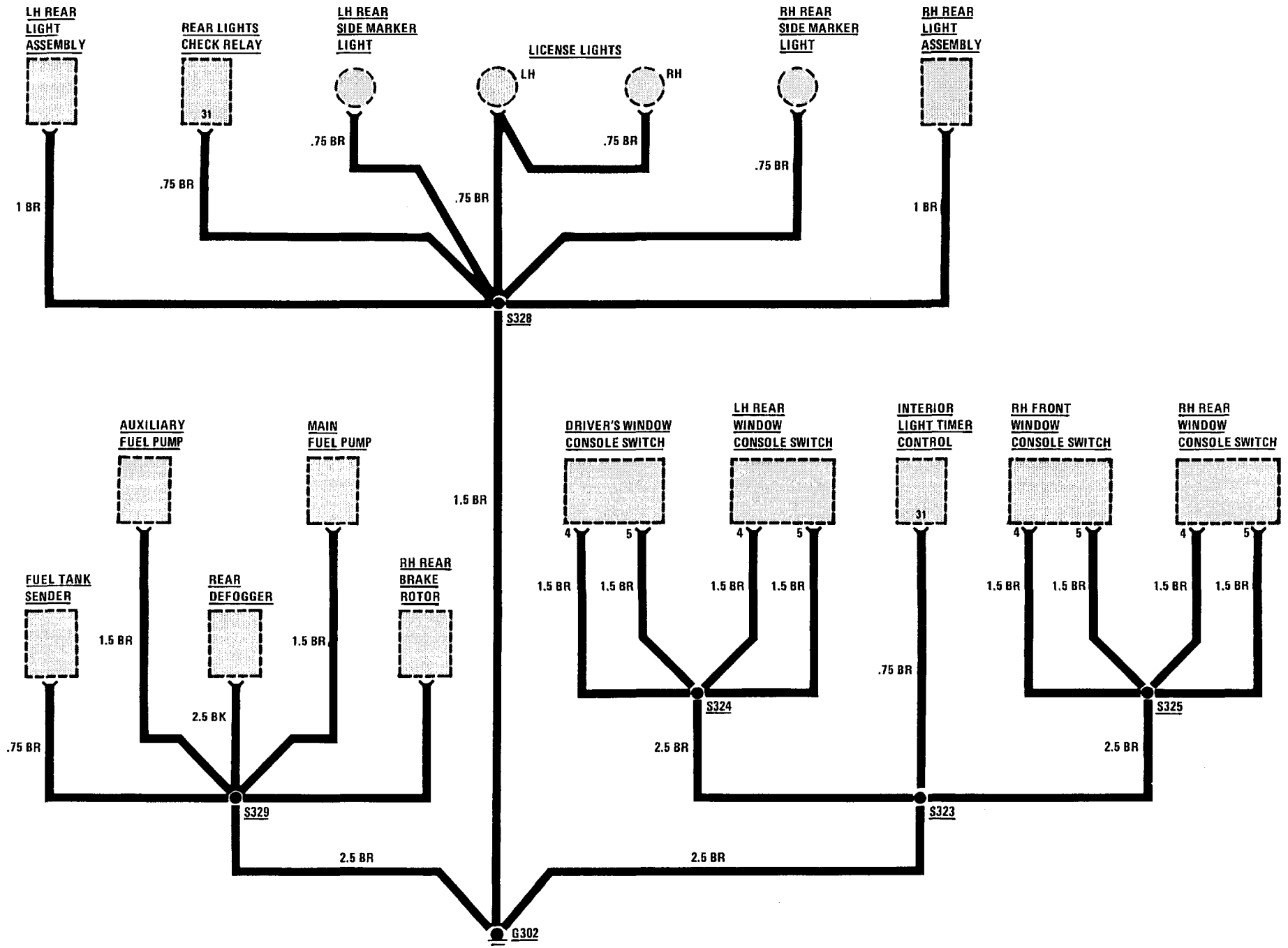

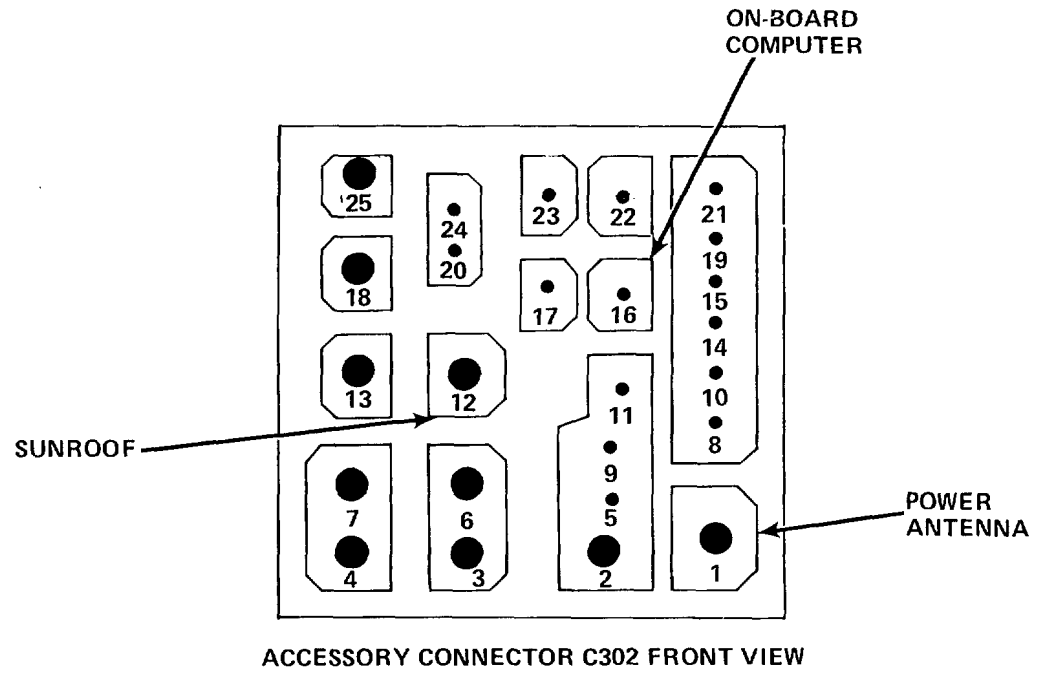
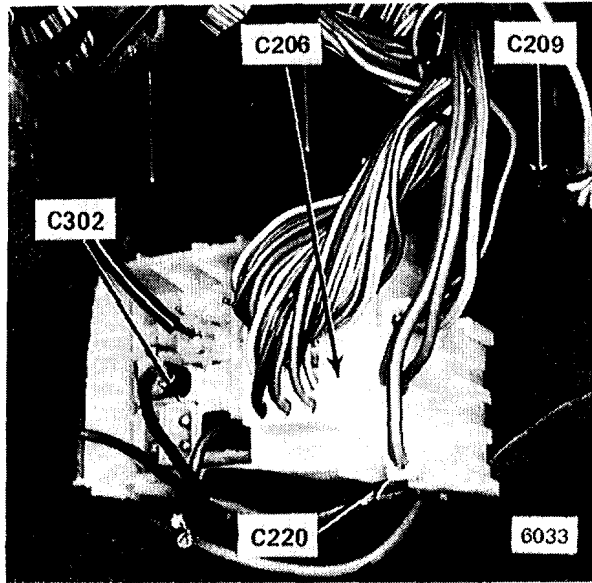
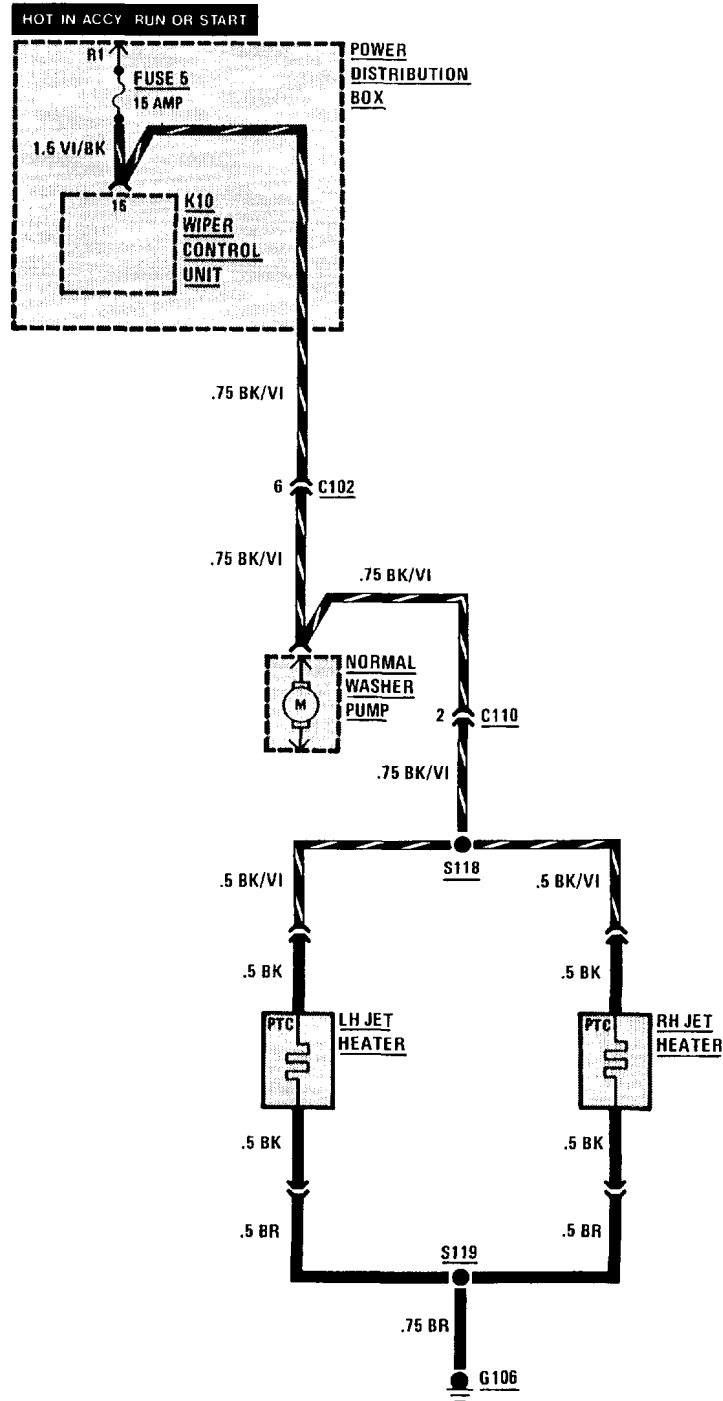

Figure 1 - Under Left Side Of Dash

158 WINDSHIELD WASHER JET HEATERS

(For Component Locations See Page 212)



ACTIVE CHECK CONTROL

Brake Switch	Above brake pedal	213-5
Coolant Level Switch	Top of coolant reservoir	202-1
Oil Level Sensor	Bottom of engine oil pan	
Power Distribution Box	Top front of left front wheel well	102-1
Rear Lights Check Relay	In trunk, left of rear panel center support	210-2
Seatbelt Warning Timer	Under LH dash, on body electrical bracket.....	214-3
Washer Fluid Level Switch	Ahead of right front wheel well, in reservoir	207-2
C101 (17 pin)	On right side of power distribution box	204-1
C102 (12 pin)	In power distribution box	
C205 (1 pin)	Under left side of dash	203-2
C206 (29 pin)	Under LH dash, on body electrical bracket.....	157-1
G104 (Main Body Ground)	Left fender, behind headlights	201-1
G200 (Front Interior Ground) ..	On dash frame, left of steering column.....	203-2
G302 (Rear Interior Ground) ..	Under left rear seat	212-2

AUXILIARY FAN

Evaporator Temp. Regulator ...	On left side of heater-A/C unit.....	213-6
High Pressure Cut-out Switch .	On receiver-dryer.....	206-2
High Speed Coolant Temp. Switch	Upper right side of radiator (red terminal)	208-1
Normal Speed Blower Resistor.	Ahead of radiator, on auxiliary fan shield	
Normal Speed Cool. Temp. Switch	Upper right side of radiator (white terminal).....	208-1
Power Distribution Box	Top front of left front wheel well	102-1
C102 (12 pin)	In power distribution box	
C105 (1 pin)	Right of right front shock tower	209-2
C106 (1 pin)	Behind right headlights	
C113 (3 pin)	Left side of auxiliary fan shield	
G104 (Main Body Ground)	Left fender, behind headlights	201-1
G200 (Front Interior Ground) ..	On dash frame, left of steering column.....	203-2

BACKUP LIGHTS

Auto. Trans. Range Switch	On left side of shift lever	
Backup Light Switch.....	On left side of manual transmission	
Power Distribution Box	Top front of left front wheel well	102-1
C206 (29 pin)	Under LH dash, on body electrical bracket.....	157-1
C301 (2 pin)	In center console, ahead of shift lever	
G302 (Rear Interior Ground) ..	Under left rear seat	212-2

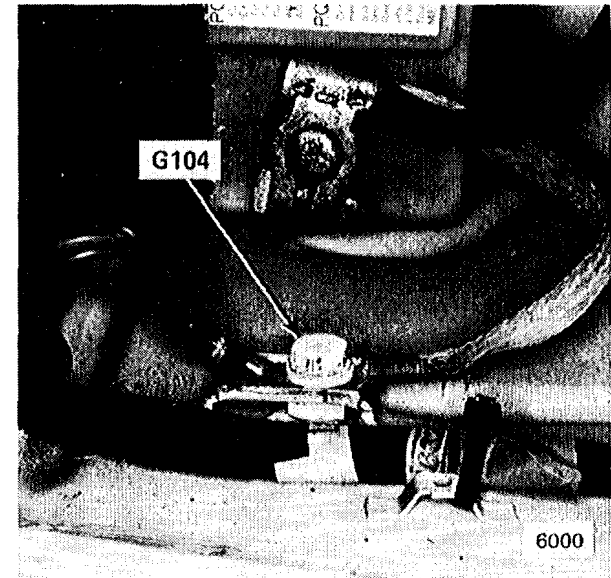

Figure 1 - Inner Fender, Left Of Battery



Figure 2 - Right Of Left Front Wheel Well

BRAKE LINING WARNING

Power Distribution Box	Top front of left front wheel well	102-1
C206 (29 pin)	Under LH dash, on body electrical bracket	157-1
G200 (Front Interior Ground) ...	On dash frame, left of steering column	203-2
G302 (Rear Interior Ground) ...	Under left rear seat	212-2

CENTRAL LOCKING

Central Locking Control Unit ...	Under dash, left of top of glove box	213-1
Door Lock Motors	In each door	
Gas Filler Lock Motor	In trunk, behind right rear wheel well	211-1
Ignition Switch	In upper part of steering column	
Power Distribution Box	Top front of left front wheel well	102-1
Trunk Lock Motor	In trunk, in trunk lock support	
C200 (10 pin)	Under LH dash, on LH side of steering column	214-1
C206 (29 pin)	Under LH dash, on body electrical bracket	157-1
C302 (Accessory Connector) ..	Under LH dash, on body electrical bracket	157-1
C305 (4 pin)	Under left side of dash	213-5
C400 (13 pin)	Under dash, above trunk release lever	214-4
C401 (13 pin)	Right of glove box, above speaker grill	206-1
C503 (8 pin)	In driver's door	
G200 (Front Interior Ground) ..	On dash frame, left of steering column	203-2

CHARGING SYSTEM

Diagnostic Connector	Top middle of engine	101-1
Ignition Switch	In upper part of steering column	
Power Distribution Box	Top front of left front wheel well	102-1
Starter	Lower rear left side of engine	
C101 (17 pin)	On right side of power distribution box	204-1
C200 (10 pin)	Under LH dash, on LH side of steering column	214-1
C206 (29 pin)	Under LH dash, on body electrical bracket	157-1
C302 (Accessory Connector) ..	Under LH dash, on body electrical bracket	157-1
G104 (Main Body Ground)	Left fender, behind headlights	201-1

CIGAR LIGHTER/GLOVE BOX LIGHT/AUTO-CHARGING FLASHLIGHT

Power Distribution Box	Top front of left front wheel well	102-1
C206 (29 pin)	Under LH dash, on body electrical bracket	157-1
G200 (Front Interior Ground) ..	On dash frame, left of steering column	203-2

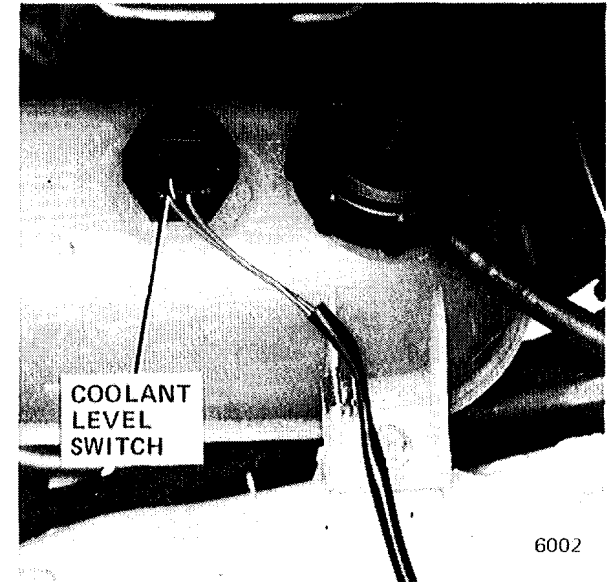

Figure 1 - Right Of Left Front Wheel Well

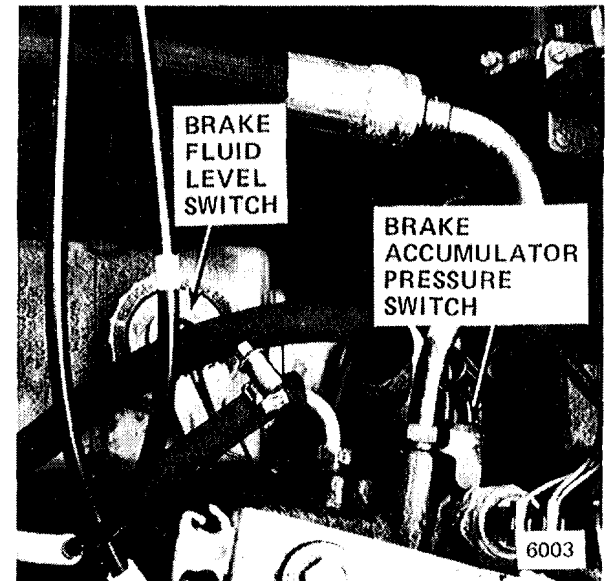

Figure 2 - Left Rear Corner Of Engine Compartment

FUEL CONTROL

Air Flow Meter.....	Top right side of engine	205-1
Main Relay	On right side of power distribution box	102-1
Motronic Control Unit	Under right side of dash, above glove box.....	211-2
Oxygen Sensor	Rear of engine, in exhaust manifold.....	204-2
G103 (Engine Ground).....	Top rear of engine	205-1

FUEL DELIVERY/EVAPORATIVE CONTROL

Auxiliary Fuel Pump	Under trunk, top right side of fuel tank	
Fuel Pump Relay	On right side of power distribution box	102-1
Ignition Switch.....	In upper part of steering column	
Main Fuel Pump	Under car, ahead of left rear axle	
Main Relay	On right side of power distribution box ..	102-1
Motronic Control Unit	Under right side of dash, above glove box.....	211-2
On-Board Computer	Under left dash, on dash frame.....	203-2
Power Distribution Box	Top front of left front wheel well	102-1
Purge Valve	On right inner fender, behind headlights	206-2
Purge Valve Relay.....	On right side of power distribution box	102-1
C101 (17 pin).....	On right side of power distribution box	204-1
C103 (3 pin)	Under right side of dash, above glove box.....	212-1
C200 (10 pin).....	Under LH dash, on LH side of steering column	214-1
C206 (29 pin).....	Under LH dash, on body electrical bracket.....	157-1
C212 (1 pin)	Left side of dash, behind instrument cluster	
C235 (1 pin)	Left side of dash, behind instrument cluster	
C236 (2 pin)	Under left side of dash, on-board computer	
G103 (Engine Ground).....	Top rear of engine	205-1
G104 (Main Body Ground)....	left fender, behind headlights.....	201-1
G302 (Rear Interior Ground) ..	Under left rear seat	212-2

HEADLIGHTS (CONTROL/POWER)/FOG LIGHTS (CONTROL/POWER)

Combination Switch	On LH side of steering column	
Flasher.....	Upper left side of steering column	
Power Distribution Box	Top front of left front wheel well	102-1
C102 (12 pin).....	In power distribution box	
C126 (2 pin)	Behind left side of front spoiler	
C127 (2 pin)	Behind right side of front spoiler	
C202 (13 pin).....	Under LH dash, on LH side of steering column	214-1
G104 (Main Body Ground)....	Left fender, behind headlights	201-1
G200 (Front Interior Ground) ..	On dash frame, left of steering column.....	203-2
G201 (Column Ground).....	Upper left side of steering column	

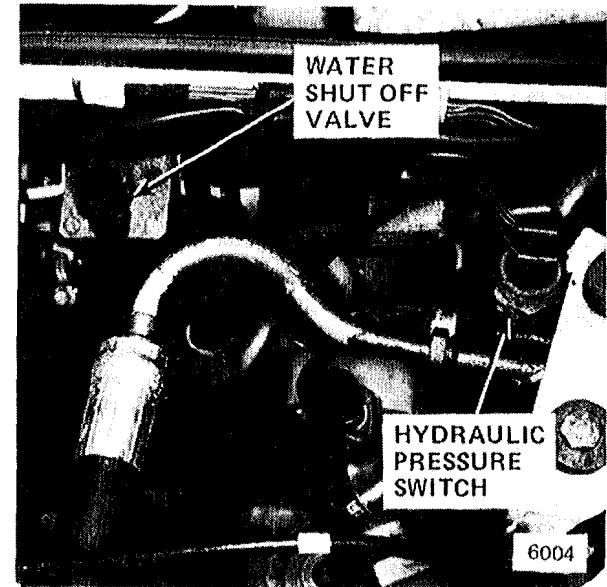

Figure 1 - Left Rear Corner Of Engine Compartment

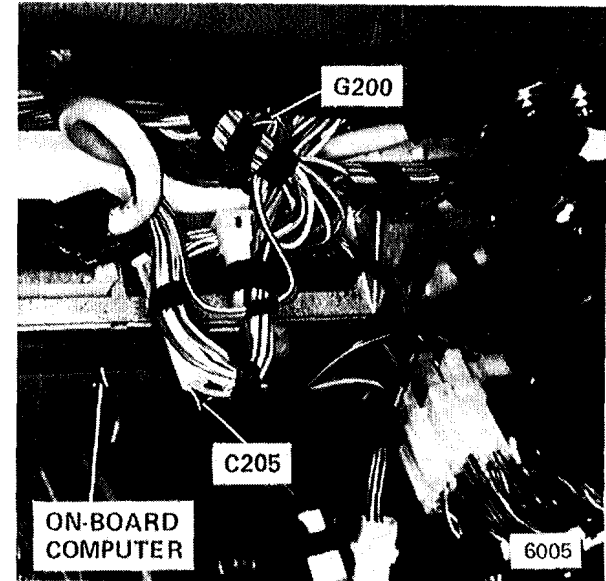

Figure 2 - Under Dash, Left Of Steering Column

HEATER/AIR CONDITIONING

A/C Blower Housing	Behind center console	
Blower Select Relay	Under dash, left of glove box	213-1
Evaporator Temp. Regulator ...	On left side of heater-A/C unit	213-6
Evaporator Temperature Sensor	In center console, below radio	
Heater Blower Housing	Behind center console	
Heater Regulator	Behind temperature select control	
Heater Temperature Sensor ...	On left side of heater-A/C unit	213-6
High Pressure Cut-out Switch	On receiver-dryer	206-2
Idle Speed Control Unit	Under right side of dash, above glove box	211-2
Interior Temperature Sensor ...	In left under dash cover	213-4
Power Distribution Box	Top front of left front wheel well	102-1
Water Shutoff Valve	Center rear of engine compartment	203-1
C105 (1 pin)	Right of right front shock tower	209-2
C106 (1 pin)	Behind right headlights	209-1
C128 (1 pin)	Under right side of dash, above glove box	213-2
C204 (13 pin)	Behind center console	
C205 (1 pin)	Under left side of dash	203-2
C206 (29 pin)	Under LH dash, on body electrical bracket	157-1
C302 (Accessory Connector) ..	Under LH dash, on body electrical bracket	157-1
G200 (Front Interior Ground) ..	On dash frame, left of steering column	203-2

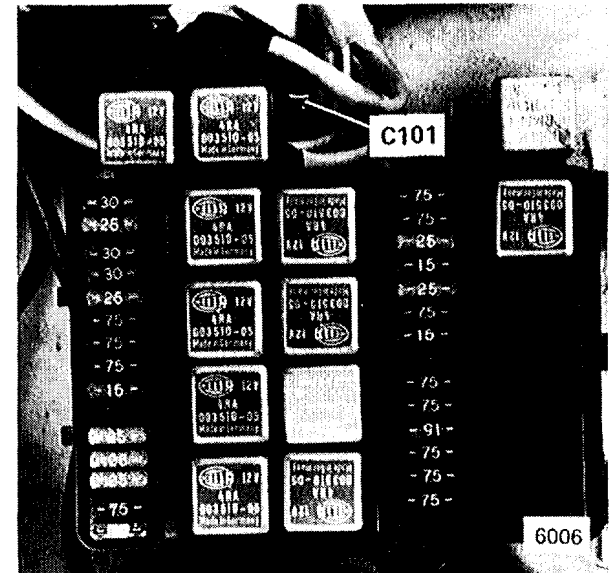

Figure 1 - Top Of Left Front Wheel Well

HORN/HEATED DOOR LOCK

Horn Brush/Slip Ring	Under hub of steering wheel	
Horn Switches	Under hub of steering wheel	
Lock Heater	In left front door	
Lock Heater Control Unit	In left front door	
Power Distribution Box	Top front of left front wheel well	102-1
C202 (13 pin)	Under LH dash, on LH side of steering column	214-1
C400 (13 pin)	Under dash, above trunk release lever	214-4
C503 (8 pin)	In driver's door	
C560 (2 pin)	In driver's door	
G104 (Main Body Ground)	Left fender, behind headlights	201-1
G200 (Front Interior Ground)	On dash frame, left of steering column	203-2
G201 (Column Ground)	Upper left side of steering column	

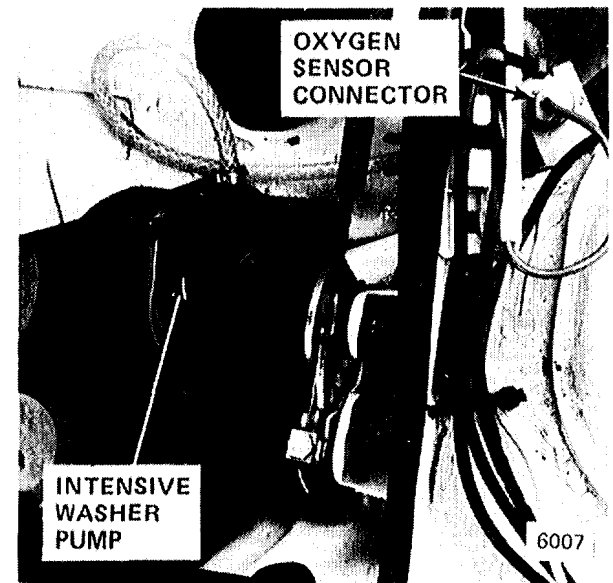

Figure 2 - Below Right Side Of Windshield

IDLE SPEED CONTROL

0°C (32°F) Temperature Switch	Right side ventilation air inlet	205-2
Auto. Trans. Range Switch	On left side of shift lever	
Coolant Temperature Sensor	Front of engine, top of thermostat housing	214-5
Coolant Temperature Switch	Front of engine, top of thermostat housing	214-5
Diagnostic Connector	Top middle of engine	101-1
Engine Speed Sensor	On transmission bell housing	205-1
Idle Control Valve	Top center of engine	214-6
Idle Speed Control Unit	Under right side of dash, above glove box	211-2
Motronic Control Unit	Under right side of dash, above glove box	211-2
Power Distribution Box	Top front of left front wheel well	102-1
Throttle Switch	Top LH side of engine, below throttle body	214-6
C101 (17 pin)	On right side of power distribution box	204-1
C104 (2 pin)	Under right side of dash, above glove box	213-2
C128 (1 pin)	Under right side of dash, above glove box	213-2
C206 (29 pin)	Under LH dash, on body electrical bracket	157-1
C301(2 pin)	In center console, ahead of shift lever	
G103 (Engine Ground)	Top rear of engine	205-1

IGNITION

Diagnostic Connector	Top middle of engine	101-1
Ignition Coil	On right wheel well, behind headlights	207-1
Ignition Switch	In upper part of steering column	
Motronic Control Unit	Under right side of dash, above glove box	211-2
Reference Point Sensor	On transmission bell housing	205-1
TDC Sensor	Above crankshaft vibration damper	
C101 (17 pin)	On right side of power distribution box	204-1
C109 (1 pin)	Taped to harness, near ignition coil	
C200 (10 pin)	Under LH dash, on LH side of steering column	214-1
G103 (Engine Ground)	Top rear of engine	205-1

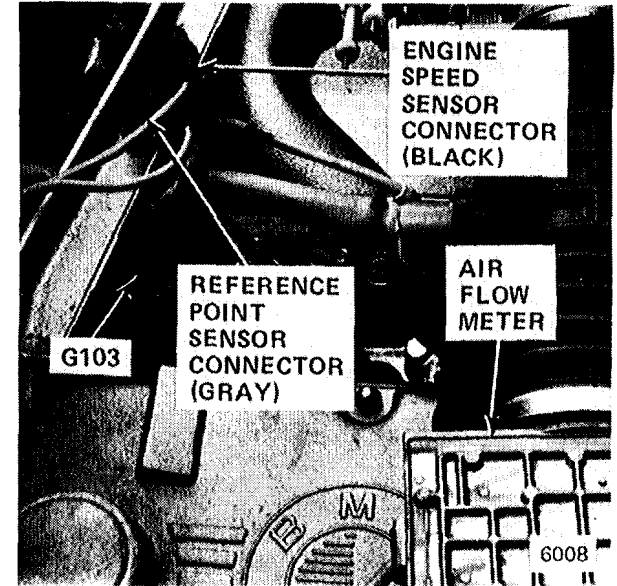

Figure 1 - Top Rear Of Engine

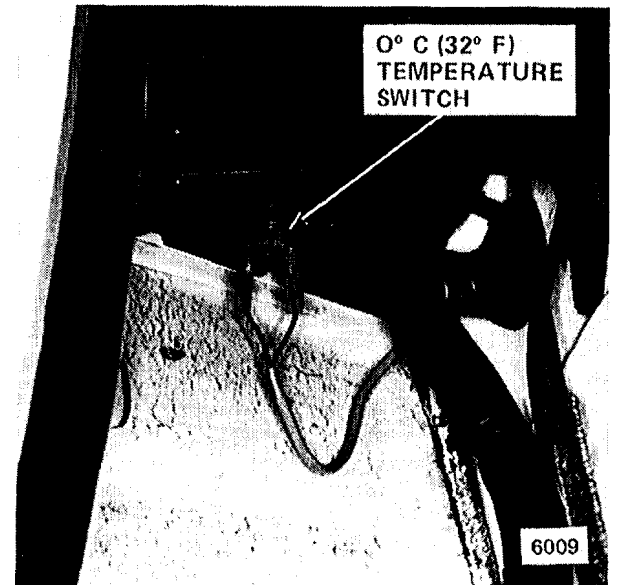

Figure 2 - Below Center Of Windshield

IGNITION KEY WARNING/SEATBELT WARNING

Ignition Key Switch.....	In upper part of steering column	
Power Distribution Box	Top front of left front wheel well	102-1
Seatbelt Switch	In driver's seatbelt buckle	
Seatbelt Warning Timer	Under LH dash, on body electrical bracket.....	214-3
C200 (10 pin)	Under LH dash, on LH side of steering column	214-1
C203 (2 pin)	Above steering column lower cover	
C206 (29 pin)	Under LH dash, on body electrical bracket.....	157-1
C220 (13 pin)	Under LH dash, on body electrical bracket.....	157-1
G200 (Front Interior Ground) ..	On dash frame, left of steering column.....	203-2

INTERIOR LIGHTS

Interior Light Timer Control ...	Under LH dash, on body electrical bracket.....	214-3
Lock Heater Control Unit	In left front door	
Power Distribution Box	Top front of left front wheel well	102-1
C206 (29 pin)	Under LH dash, on body electrical bracket.....	157-1
C302 (Accessory Connector),..	Under LH dash, on body electrical bracket.....	157-1
C400 (13 pin)	Under dash, above trunk release lever.....	214-4
C503 (8 pin)	In driver's door	
G200 (Front Interior Ground) ..	On dash frame, left of steering column.....	203-2
G302 (Rear Interior Ground)...	Under left rear seat	212-2
G303	Above left B pillar	

LIGHTS: FRONT PARK/TAIL/UNDERHOOD

Power Distribution Box	Top front of left front wheel well	102-1
Rear Lights Check Relay	In trunk, left of rear panel center support	210-2
Underhood Light Switch	Left of right hood hinge	
C102 (12 pin)	In power distribution box	
C110 (2 pin)	Ahead of right headlights cover	
C206 (29 pin)	Under LH dash, on body electrical bracket.....	157-1
G104 (Main Body Ground)	Left fender, behind headlights	201-1
G302 (Rear Interior Ground)...	Under left rear seat	212-2

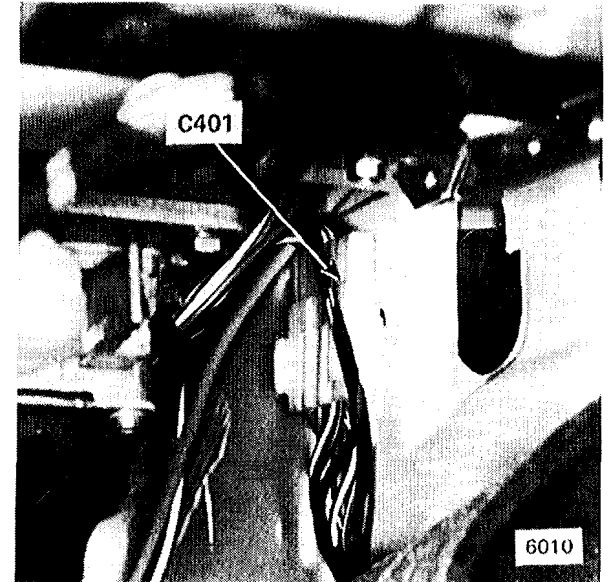

Figure 1 - Behind Dash, Right Of Glove Box

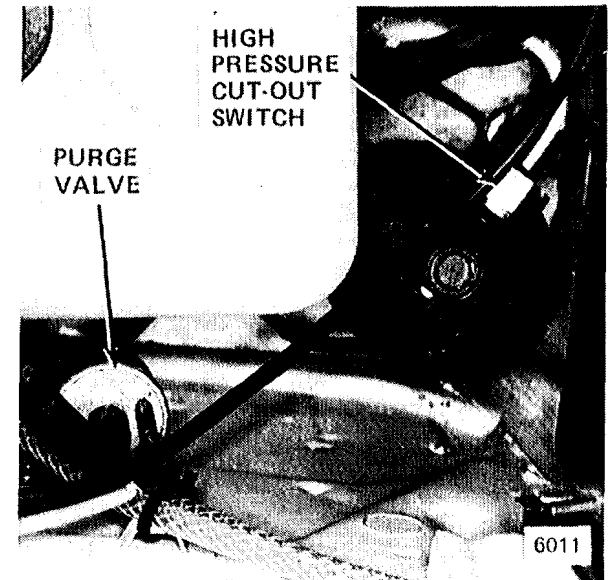

Figure 2 - Behind Right Headlights

LIGHTS: REAR MARKER/LICENSE/TRUNK

Power Distribution Box	Top front of left front wheel well	102-1
Rear Lights Check Relay	In trunk, left of rear panel center support	210-2
Trunk Light Switch	In trunk lid, near trunk lock	
C205 (1 pin)	Under left side of dash	203-2
C206 (29 pin)	Under LH dash, on body electrical bracket	157-1
C300 (2 pin)	Base of left trunk hinge	210-1
C302 (Accessory Connector) ..	Under LH dash, on body electrical bracket	157-1
G302 (Rear Interior Ground) ..	Under left rear seat	212-2

LIGHTS: TURN/HAZARD WARNING

Combination Switch	On LH side of steering column	
Flasher	Upper left side of steering column	
Power Distribution Box	Top front of left front wheel well	102-1
C102 (12 pin)	In power distribution box	
C202 (13 pin)	Under LH dash, on LH side of steering column	214-1
C206 (29 pin)	Under LH dash, on body electrical bracket	157-1
G104 (Main Body Ground)	Left fender, behind headlights	201-1
G200 (Front Interior Ground) ..	On dash frame, left of steering column	203-2
G201 (Column Ground)	Upper left side of steering column	
G302 (Rear Interior Ground) ..	Under left rear seat	212-2

LIGHTS: VISOR/DASH/TRANSMISSION RANGE

Auto. Trans. Range Switch	On left side of shift lever	
On-Board Computer	Under left dash, on dash frame	203-2
Power Distribution Box	Top front of left front wheel well	102-1
C205 (1 pin)	Under left side of dash	203-2
C206 (29 pin)	Under LH dash, on body electrical bracket	157-1
C215 (2 pin)	Behind radio	
C255 (1 pin)	Ahead of idle speed control unit	
C301 (2 pin)	In center console, ahead of shift lever	
C302 (Accessory Connector) ..	Under LH dash, on body electrical bracket	157-1
G200 (Front Interior Ground) ..	On dash frame, left of steering column	203-2
G306	Top of right A pillar	

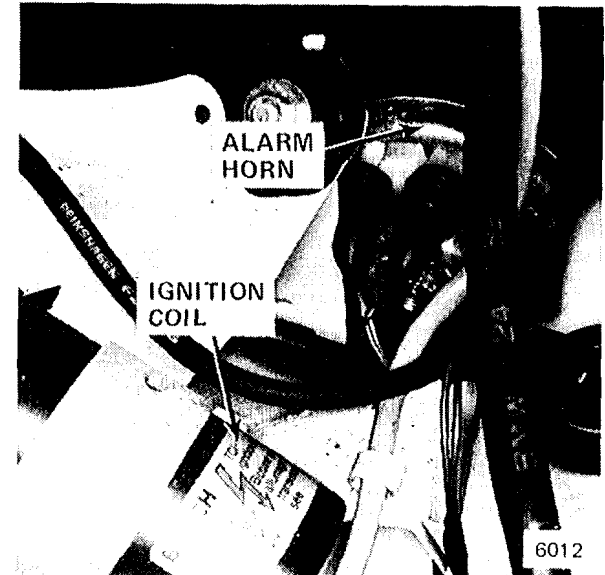

Figure 1 - Ahead Of Right Front Wheel Well

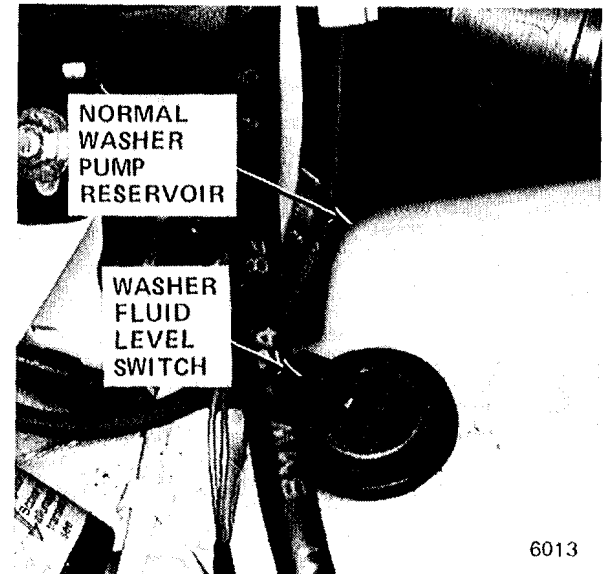

Figure 2 - Ahead Of Right Front Wheel Well

ON-BOARD COMPUTER

Alarm Horn	Below air flow meter intake	208-2
Chime	Under dash, left of top of glove box	213-3
Filter Capacitor	RH front wheel well, behind coolant reservoir	208-2
Ignition Switch.....	In upper part of steering column	
Main Relay	On right side of power distribution box	102-1
On-Board Computer	Under left dash, on dash frame.....	203-2
Outside Temperature Sender ..	Under front bumper, left side	
Power Distribution Box	Top front of left front wheel well	102-1
C102 (12 pin).....	In power distribution box	
C103 (3 pin)	Under right side of dash, above glove box.....	212-1
C200 (10 pin).....	Under LH dash, on LH side of steering column	214-1
C206 (29 pin).....	Under LH dash, on body electrical bracket.....	157-1
C212 (1 pin)	Left side of dash, behind instrument cluster	
C235 (1 pin)	Left side of dash, behind instrument cluster	
C236 (2 pin)	Under left dash, above on-board computer	
C237 (4 pin)	Right of left shock tower taped to harness	
C239 (4 pin)	Ahead of instrument cluster	
C242 (2 pin)	Ahead of on-board computer	
C260 (1 pin)	Left side of dash, behind instrument cluster	
C302 (Accessory Connector) ..	Under LH dash, on body electrical bracket.....	157-1
G103 (Engine Ground).....	Top rear of engine	205-1
G104 (Main Body Ground)....	Left fender, behind headlights	201-1
G200 (Front Interior Ground) ..	On dash frame, left of steering column.....	203-2

POWER DISTRIBUTION

Diagnostic Connector.....	Top middle of engine.....	101-1
Power Distribution Box	Top front of left front wheel well	102-1
Starter	Lower rear left side of engine	
C200 (10 pin).....	Under LH dash, on LH side of steering column	214-1
C206 (29 pin).....	Under LH dash, on body electrical bracket.....	157-1
C220 (13 pin).....	Under LH dash, on body electrical bracket.....	157-1
C302 (Accessory Connector) ..	Under LH dash, on body electrical bracket.....	157-1
G104 (Main Body Ground)....	Left fender, behind headlights	201-1
G200 (Front Interior Ground) ..	On dash frame, left of steering column.....	203-2

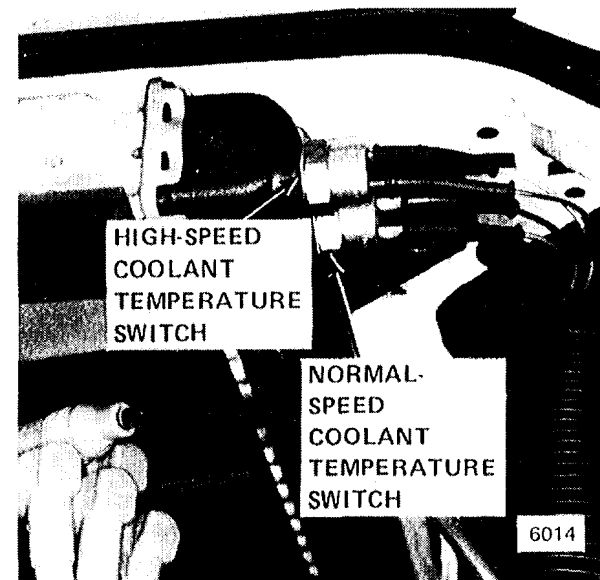

Figure 1 - Top Right Side Of Radiator

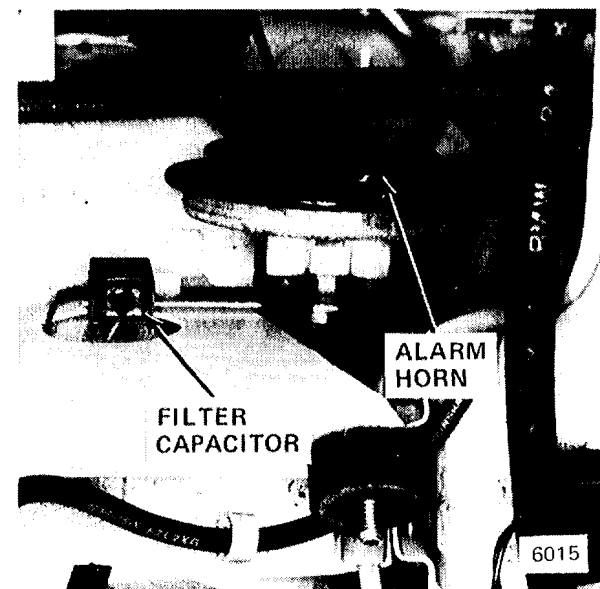

Figure 2 - Ahead Of Right Front Wheel Well

POWER MIRRORS

Power Distribution Box	Top front of left front wheel well	102-1
C206 (29 pin)	Under LH dash, on body electrical bracket	157-1
C400 (13 pin)	Under dash, above trunk release lever	214-4
C401 (13 pin)	Right of glove box, above speaker grill	206-1
C402 (6 pin)	Under dash, above trunk release lever	214-4
G200 (Front Interior Ground)	On dash frame, left of steering column	203-2

POWER WINDOWS

Ignition Switch	In upper part of steering column	
Power Distribution Box	Top front of left front wheel well	102-1
Power Window Circuit Breaker	On LH under dash cover	
Window Motors	Behind paneling, below window	
C200 (10 pin)	Under LH dash, on LH side of steering column	214-1
C206 (29 pin)	Under LH dash, on body electrical bracket	157-1
C400 (13 pin)	Under dash, above trunk release lever	214-4
C401 (13 pin)	Right of glove box, above speaker grill	206-1
G200 (Front Interior Ground) ..	On dash frame, left of steering column	203-2
G302 (Rear Interior Ground) ...	Under left rear seat	212-2

RADIO/POWER ANTENNA

Power Distribution Box	Top front of left front wheel well	102-1
C206 (29 pin)	Under LH dash, on body electrical bracket	157-1
C215 (2 pin)	Behind radio	
C216 (2 pin)	Behind radio	
C217 (2 pin)	Behind radio	
C218 (2 pin)	Behind radio	
C302 (Accessory Connector) ..	Under LH dash, on body electrical bracket	157-1
G200 (Front Interior Ground) ..	On dash frame, left of steering column	203-2
G302 (Rear Interior Ground) ..	Under left rear seat	212-2

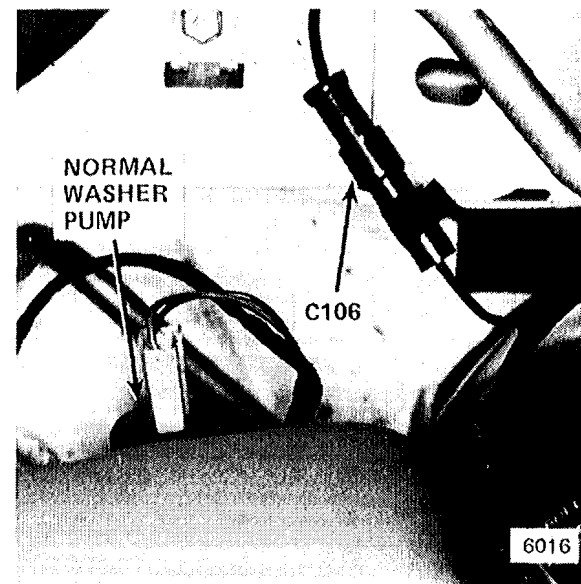

Figure 1 - Ahead Of Right Front Wheel Well

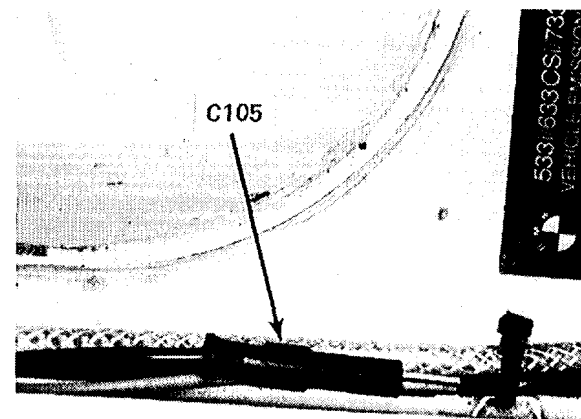

Figure 2 - Top Of Right Front Wheel Well

210 COMPONENT LOCATIONS

REAR DEFOGGER

Power Distribution Box	Top front of left front wheel well	102-1
C205 (1 pin)	Under left side of dash	203-2
C206 (29 pin)	Under LH dash, on body electrical bracket.....	157-1
C302 (Accessory Connector) ..	Under LH dash, on body electrical bracket.....	157-1
G200 (Front Interior Ground) ..	On dash frame, left of steering column.....	203-2
G302 (Rear Interior Ground) ..	Under left rear seat	212-2

SERVICE INTERVAL INDICATOR

Coolant Temperature		
Sender/Switch	Front of engine, on thermostat housing	214-5
Diagnostic Connector.....	Top middle of engine.....	101-1
Motronic Control Unit	Under right side of dash, above glove box.....	211-2
Power Distribution Box	Top front of left front wheel well	102-1
C101 (17 pin).....	On right side of power distribution box	204-1
C103 (3 pin)	Under right side of dash, above glove box.....	212-1
G200 (Front Interior Ground) ..	On dash frame, left of steering column.....	203-2

SPEEDOMETER/GAUGES/WARNING INDICATORS

Brake Accum. Prés. Switch	Right of left front shock tower	202-2
Brake Fluid Level Switch	To left of engine, on brake fluid reservoir	202-2
Coolant Temperature		
Sender/Switch	Front of engine, on thermostat housing	214-5
Diagnostic Connector.....	Top middle of engine.....	101-1
Fuel Tank Sender	Under trunk, top right side of fuel tank	
Hydraulic Pressure Switch.....	Right of left front shock tower	203-1
Ignition Switch.....	In upper part of steering column	
Oil Pressure Switch	Left rear end of cylinder head	
Park Brake Switch.....	In shift console, at base of parking brake	
Power Distribution Box	Top front of left front wheel well	102-1
Speedometer Sender	In rear of differential	
C101 (17 pin).....	On right side of power distribution box	204-1
C103 (3 pin)	Under right side of dash, above glove box.....	212-1
C200 (10 pin).....	Under LH dash, on LH side of steering column	214-1
C206 (29 pin)	Under LH dash, on body electrical bracket.....	157-1
G200 (Front Interior Ground) ..	On dash frame, left of steering column.....	203-2
G302 (Rear Interior Ground) ..	Under left rear seat	212-2

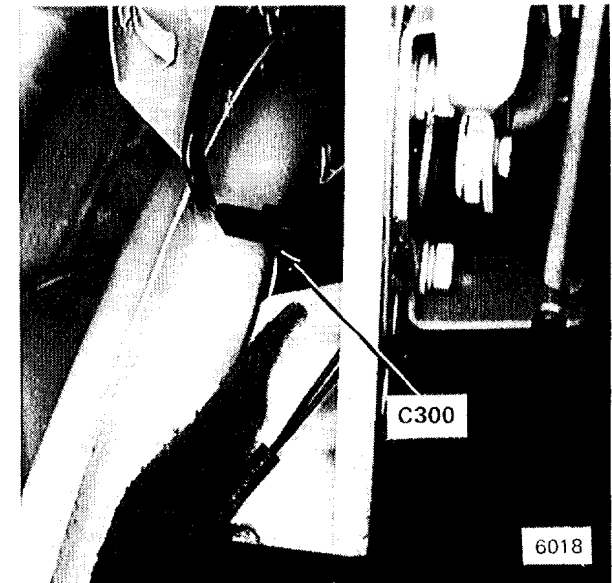

Figure 1 - Left Of Left Trunk Hinge

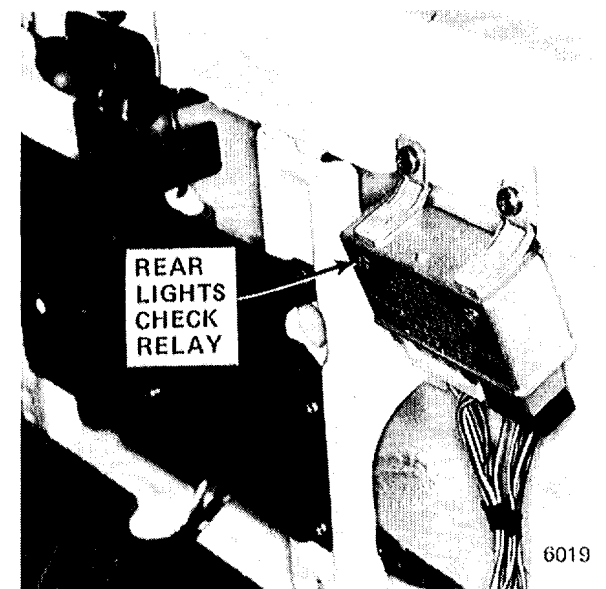

Figure 2 - Rear Panel Of Trunk

START

Auto. Trans. Range Switch	On left side of shift lever	
Cold Start Valve	Between intake ports 3 and 4	
Diagnostic Connector	Top middle of engine	101-1
Ignition Switch	In upper part of steering column	
Power Distribution Box	Top front of left front wheel well	102-1
Start Relay	Under LH dash, on body electrical bracket	
Starter	Lower rear left side of engine	
Thermo Time Switch	Front of engine, top of thermostat housing	214-5
C101 (17 pin)	On right side of power distribution box	204-1
C200 (10 pin)	Under LH dash, on LH side of steering column	214-1
C241 (1 pin)	Under LH dash, near body electrical bracket	
G104 (Main Body Ground)	Left fender, behind headlights	201-1
G200 (Front Interior Ground) ..	On dash frame, left of steering column	203-2

STOPLIGHTS/CRUISE CONTROL

Auto. Trans. Range Switch	On left side of shift lever	
Brake Switch	Above brake pedal	213-5
Clutch Switch	Above clutch pedal	213-5
Cruise Control Actuator	Below hydraulic fluid reservoir	201-2
Cruise Control Control Unit . . .	Under dash, left of top of glove box	213-3
Power Distribution Box	Top front of left front wheel well	102-1
Rear Lights Check Relay	In trunk, left of rear panel center support	210-2
C206 (29 pin)	Under LH dash, on body electrical bracket	157-1
C208 (2 pin)	Above clutch pedal	214-2
C209 (7 pin)	Under LH dash, ahead of body electrical bracket	157-1
C210 (4 pin)	Under LH dash, on LH side of steering column	214-1
C301 (2 pin)	In center console, ahead of shift lever	
C302 (Accessory Connector) ..	Under LH dash, on body electrical bracket	157-1
G200 (Front Interior Ground) ..	On dash frame, left of steering column	203-2
G302 (Rear Interior Ground) ..	Under left rear seat	212-2

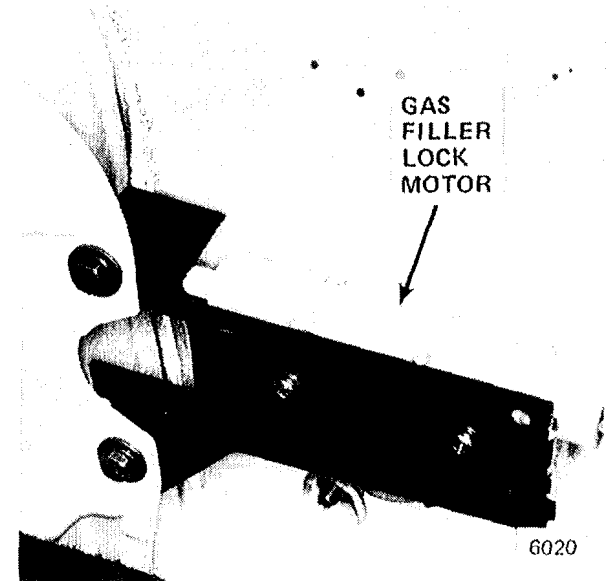

Figure 1 - Rear Of Right Rear Wheel Well



Figure 2 - Behind Dash, Above Glove Box

212 COMPONENT LOCATIONS

SUNROOF

Power Distribution Box	Top front of left front wheel well	102-1
Sunroof Drive Motor	Above headliner, above rear view mirror	
Sunroof Limit Switch	Above headliner, above rear view mirror	
Sunroof Motor Relay	Above headliner, above rear view mirror	
C220 (13 pin)	Under LH dash, on body electrical bracket	157-1
C302 (Accessory Connector) ..	Under LH dash, on body electrical bracket	157-1
G600	Above headliner, above rear view mirror	

WINDSHIELD WASHER JET HEATERS

Jet Heaters	On washer jet nozzles	
Normal Washer Pump	Bottom of normal washer pump reservoir	209-2
Power Distribution Box	Top front of left front wheel well	102-1
C102 (12 pin)	In power distribution box	
C110 (2 pin)	Ahead of right headlights cover	
G106	Near normal washer pump reservoir	

WIPER/WASHER

Intensive Washer Pump	Behind right front shock tower	204-2
Normal Washer Pump	Bottom of normal washer pump reservoir	209-2
Power Distribution Box	Top front of left front wheel well	102-1
Wiper Motor	Under left side fresh air intake cowl	
C102 (12pin)	In power distribution box	
C201 (6 pin)	Under LH dash, on LH side of steering column	214-1
G200 (Front Interior Ground) ..	On dash frame, left of steering column	203-2
G201 (Column Ground)	Upper left side of steering column	

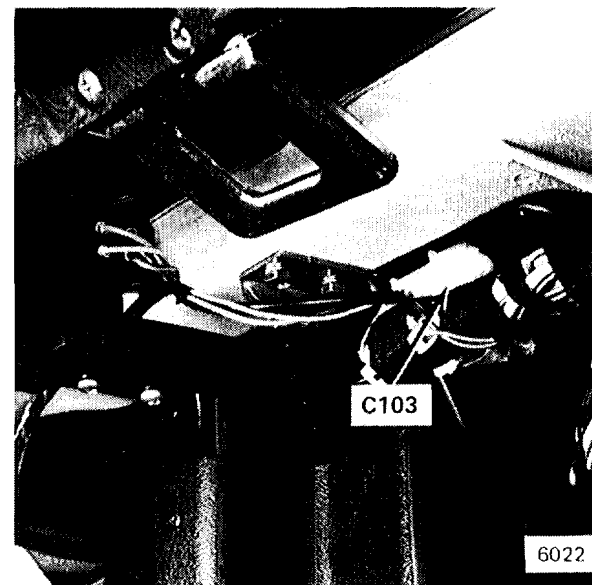

Figure 1 - Behind Dash, Above Left Side Of Glove Box

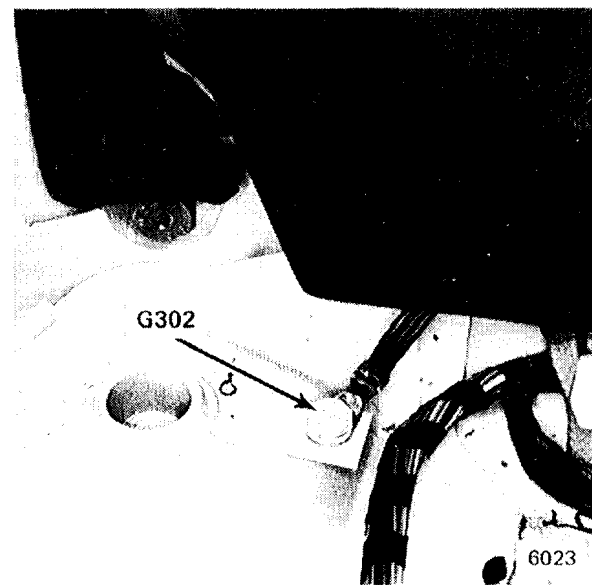

Figure 2 - Under Left Rear Seat

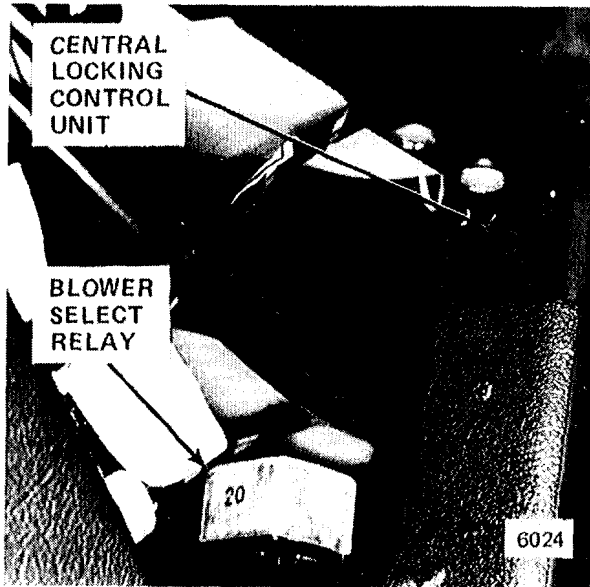

Figure 1 - Behind Dash, Left Of Glove Box



Figure 3 - Behind Dash, Left Of Glove Box

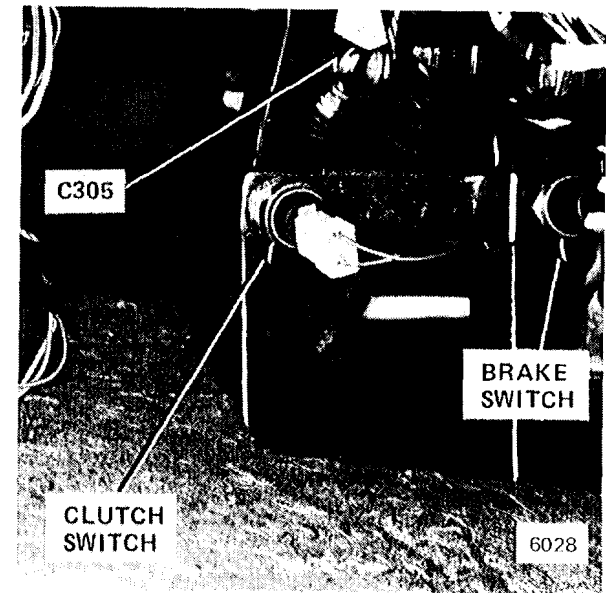

Figure 5 - Driver's Footwell, Above Brake Pedal

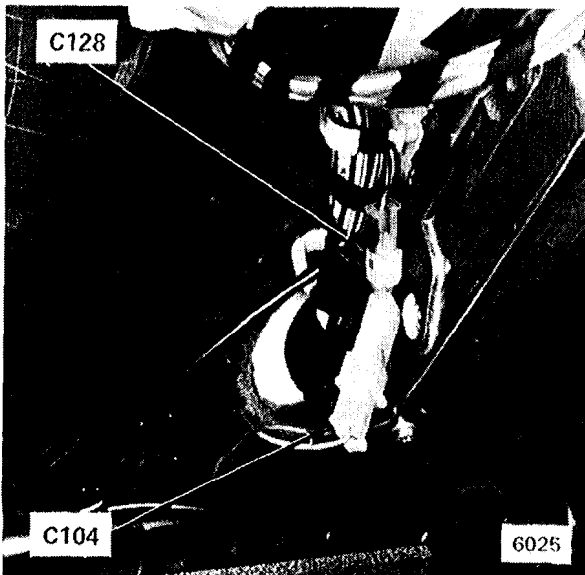

Figure 2 - Behind Dash, Above Left Side Of Glove Box

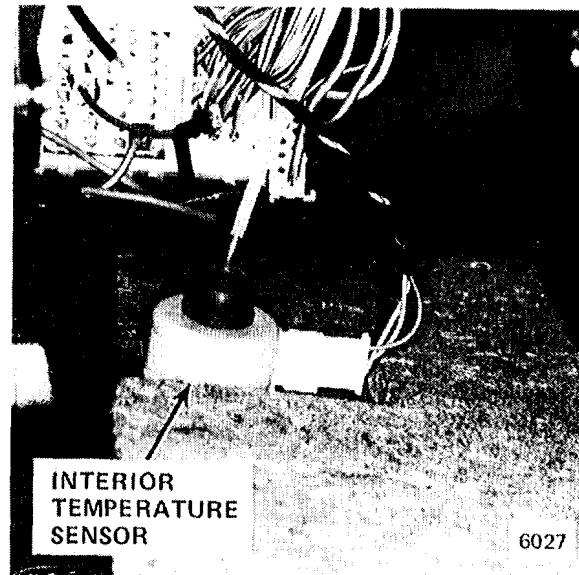

Figure 4 - Behind Dash, Left Of Steering Column

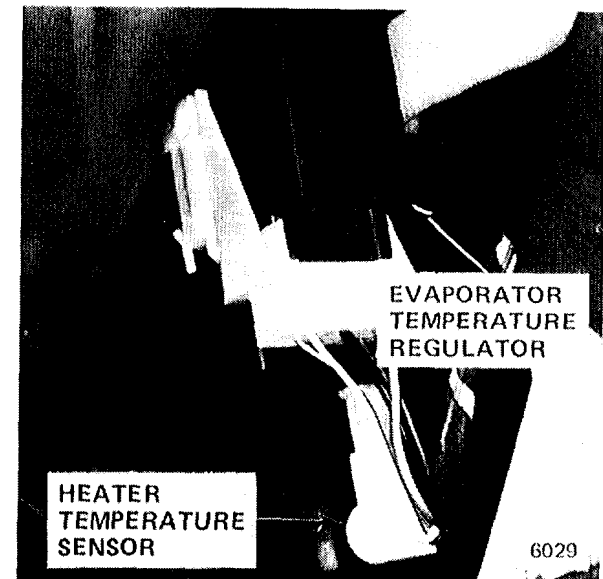

Figure 6 - Behind Left Side Of Console

214 COMPONENT LOCATIONS

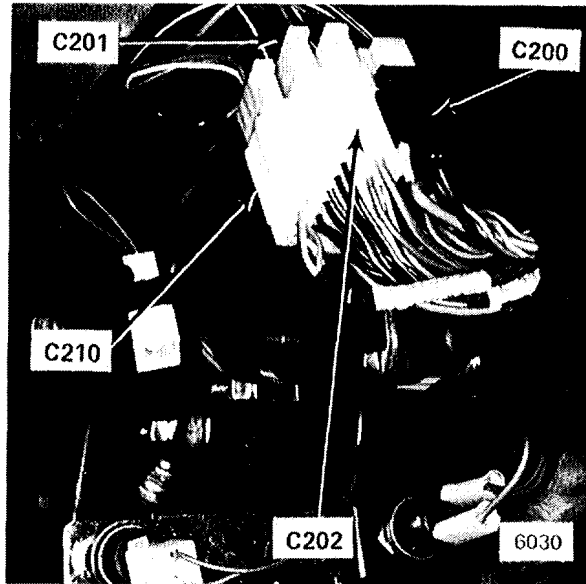

Figure 1 - Driver's Footwell, Above Brake Pedal

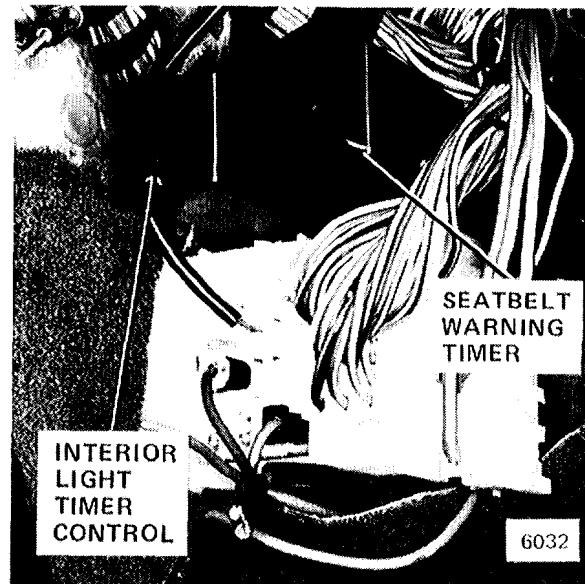

Figure 3 - Under Left Side Of Dash

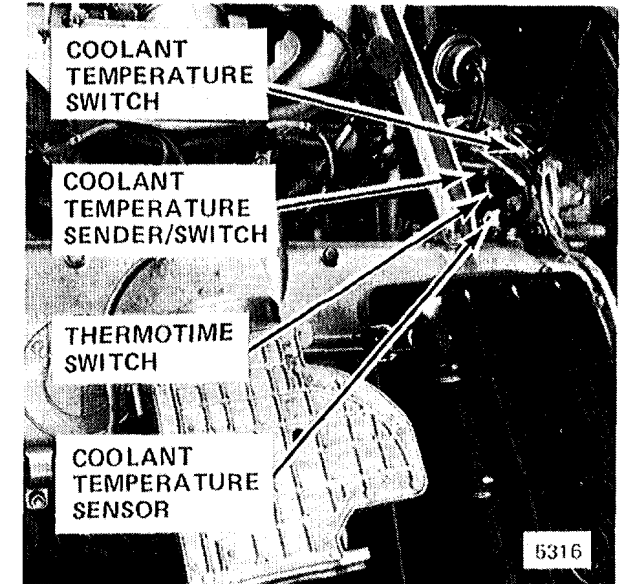

Figure 5 - Top Front Of Engine



Figure 2 - Driver's Footwell, Above Brake Pedal

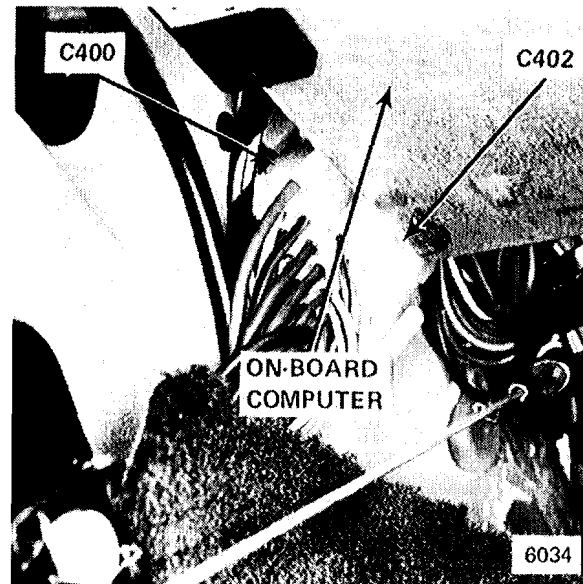

Figure 4 - Behind Dash, Above Left Front Speaker

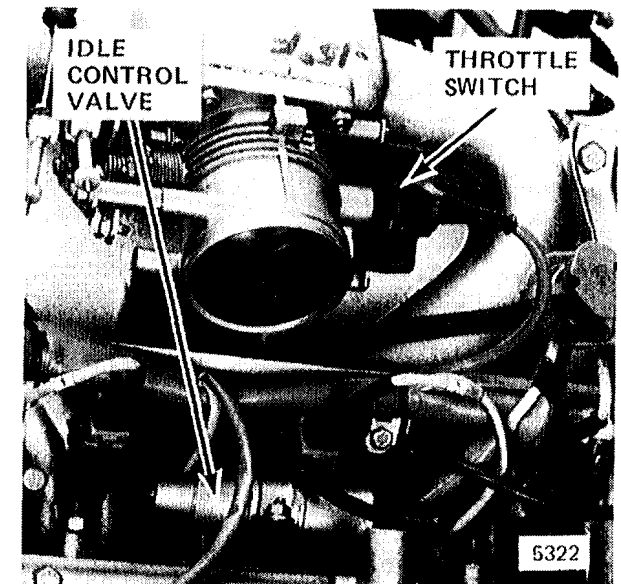

Figure 6 - Top Center Of Engine