

Owner's Manual
for Vehicle



The Ultimate
Driving Machine



645Ci **Owner's Manual for Vehicle**

Congratulations, and thank you for choosing a BMW.

Thorough familiarity with your vehicle will provide you with enhanced control and security when you drive it. We therefore have this request:

Please take the time to read this Owner's Manual and familiarize yourself with the information that we have compiled for you before starting off in your new vehicle. It contains important data and instructions intended to assist you in gaining maximum use and satisfaction from your BMW's unique range of technical features. The manual also contains information on maintenance designed to enhance operating safety and contribute to maintaining the value of your BMW throughout an extended service life.

This Owner's Manual should be considered a permanent part of this vehicle. It should stay with the vehicle when sold to provide the next owner with important operating, safety and maintenance information.

This manual is supplemented by a Service and Warranty Information Booklet for US models or a Warranty and Service Guide Booklet for Canadian models. We wish you an enjoyable driving experience.

BMW AG

© 2004 Bayerische Motoren Werke
Aktiengesellschaft
Munich, Germany
Reprinting, including excerpts,
only with the written consent of
BMW AG, Munich.
Order No. 01 41 0 157 980
US English II/04, 04 03 460
Printed in Germany
Printed on environmentally friendly paper,
bleached without chlorine, suitable for recycling.

Contents

The fastest way to find specific topics is to use the index, refer to page 197.

Using this Owner's Manual

- 4 Notes
- 7 Reporting safety defects

At a glance

- 10 Cockpit
- 16 Control Center
- 20 Voice command system

Controls

- 26 Opening and closing
- 42 Adjustments
- 51 Transporting children safely
- 54 Driving
- 64 Everything under control
- 75 Technology for comfort, convenience and safety
- 85 Lamps
- 88 A congenial climate
- 94 Practical interior accessories

Driving tips

- 102 Things to remember when driving

Navigation

- 108 Starting navigation system
- 110 Destination entry
- 118 Destination guidance
- 122 What to do if ...

Entertainment

- 126 On/off and tone
- 130 Radio
- 137 CD player and CD changer

Communications

- 144 Telephoning
- 155 TeleService, BMW Assist

Mobility

- 162 Refueling
- 164 Wheels and tires
- 170 Under the hood
- 174 Maintenance
- 176 Rules and regulations
- 178 Replacing components
- 183 Giving and receiving assistance

Reference

- 190 Technical data
- 194 Short commands of the voice command system
- 197 Everything from A to Z

Notes

Using this Owner's Manual

We have made every effort to ensure that you are able to find what you need in this Owner's Manual as quickly as possible. The fastest way to find specific topics is to use the detailed index at the back of the manual. If you wish to gain an initial overview of your vehicle, you will find this in the first chapter.

Should you want to sell your BMW some day, please remember to hand over the Owner's Manual as well; it is an important component of your vehicle.

Additional sources of information

Should you have any other questions, your BMW center will be glad to advise you at any time.

You can find information on BMW, e.g. technology, on the Internet at www.bmwusa.com.

Symbols used



Indicates precautions that must be followed precisely in order to avoid the possibility of personal injury and serious damage to the vehicle.

◀ Marks the end of a specific item of information.



Indicates information that will assist you in gaining the optimum benefit from your vehicle and enable you to care more effectively for your vehicle.



Refers to measures that can be taken to help protect the environment.

* Indicates special equipment, country-specific equipment and optional extras when available.

"..." Identifies Control Display texts used to select individual functions.

Symbols on vehicle components



Indicates that you should consult the relevant section of this Owner's Manual for information on a particular part or assembly.

The individual vehicle

On purchasing your BMW, you have decided in favor of a model with individualized equipment and features. This Owner's Manual describes the entire array of options and equipment available with a specific BMW model.

Please bear in mind that the manual may contain information on accessories and equipment that you have not specified for your own vehicle. Sections describing options and special equipment are marked by asterisks * to assist you in identifying possible differences between the descriptions in this manual and your own vehicle's equipment.

Should your BMW be equipped with features or accessories not described in this manual, please consult the enclosed Supplementary Owner's Manual(s).

Editorial notice

BMW pursues a policy of continuous, ongoing development that is conceived to ensure that our vehicles continue to embody the highest quality and safety standards combined with advanced, state-of-the-art technology.

For this reason, it is possible that the features described in this Owner's Manual could differ from those on your vehicle. Nor can errors and omissions be entirely ruled out. You are therefore asked to appreciate that no legal claims can be entertained on the basis of the data, illustrations or descriptions in this Owner's Manual.

For your own safety

Fuels

 Use unleaded gasoline only. Fuels containing up to and including 10% ethanol or other oxygenates with up to 2.8% oxygen by weight – that is, 15% MTBE or 3% methanol plus an equivalent amount of co-solvent – will not void the applicable warranties with respect to defects in materials or workmanship. Field experience has indicated significant differences in fuel quality – volatility, composition, additives, etc. – among gasolines offered for sale in the United States and Canada. The use of poor-quality fuels may result in drivability, starting and stalling problems, especially under certain environmental conditions such as high ambient temperature and high altitude. Should you encounter drivability problems which you suspect could be related to the fuel you are using, we recommend that you respond by switching to a recognized high-quality brand. Failure to comply with these recommendations may result in unscheduled maintenance. Follow the relevant safety rules when you are handling gasoline. ◀

Maintenance and repair

 Advanced technology, e.g. the use of modern materials and high-performance electronics, requires specially adapted maintenance and repair methods. Therefore, only have corresponding work on your BMW carried out by a BMW center or a workshop that works according to BMW repair procedures with correspondingly trained personnel. If work is carried out improperly there is a danger of consequential damage and the related safety risks. ◀

Parts and accessories

 For your own safety, use genuine parts and accessories approved by BMW.

When you purchase accessories tested and approved by BMW and Genuine BMW Parts, you simultaneously acquire the assurance that they have been thoroughly tested by BMW to ensure optimum performance when installed on your vehicle. BMW warrants these parts to be free from defects in material and workmanship. BMW will not accept any liability for damage resulting from installation of parts and accessories not approved by BMW. BMW cannot test every product made by other manufacturers to verify if it can be used on a BMW safely and without risk to either the vehicle, its operation, or its occupants.

Genuine BMW Parts, BMW Accessories and other products approved by BMW, together with professional advice on using these items, are available from all BMW centers.

Installation and operation of non-BMW approved accessories such as alarms, radios, amplifiers, radar detectors, wheels, suspension components, brake dust shields, telephones – including operation of any portable phone from within the vehicle without using an externally mounted antenna – or transceiver equipment, for instance, CBs, walkie-talkie, ham radio or similar accessories, may cause extensive damage to the vehicle, compromise its safety, interfere with the vehicle's electrical system or affect the validity of the BMW Limited Warranty. Refer to your BMW center for additional information. ◀

 Maintenance, replacement, or repair of the emission control devices and systems may be performed by any automotive repair establishment or individual using any certified automotive part. ◀

Service and warranty

We recommend that you read this publication thoroughly.

Your BMW is covered by the following warranties:

- ▷ New Vehicle Limited Warranty
- ▷ Rust Perforation Limited Warranty
- ▷ Federal Emissions System Defect Warranty
- ▷ Federal Emissions Performance Warranty
- ▷ California Emission Control System Limited Warranty.

Detailed information about these warranties is listed in the Service and Warranty Information Booklet for US models or in the Warranty and Service Guide Booklet for Canadian models.

Reporting safety defects

The following only applies to vehicles owned and operated in the US.

If you believe that your vehicle has a defect which could cause a crash or could cause injury or death, you should immediately inform the National Highway Traffic Safety Administration (NHTSA) in addition to notifying BMW of North America, LLC, P.O. Box 1227, Westwood, New Jersey 07675-1227, Telephone (800) 831-1117.

If NHTSA receives similar complaints, it may open an investigation, and if it finds that a safety defect exists in a group of vehicles, it may order a recall and remedy campaign. However, NHTSA cannot become involved in individual problems between you, your dealer, or BMW of North America, LLC.

To contact NHTSA, you may either call the Auto Safety Hotline toll-free at 1-800-424-9393 (or 366-0123 in Washington, D.C. area) or write to: NHTSA, U.S. Department of Transportation, Washington, D.C. 20590. You can also obtain other information about motor vehicle safety from the Hotline.





At a glance



This overview of buttons, switches and displays is intended to serve as a source of orientation in your vehicle's operating environment. The section will also assist you in becoming acquainted with the control concepts and options available for operating the various systems.

Cockpit

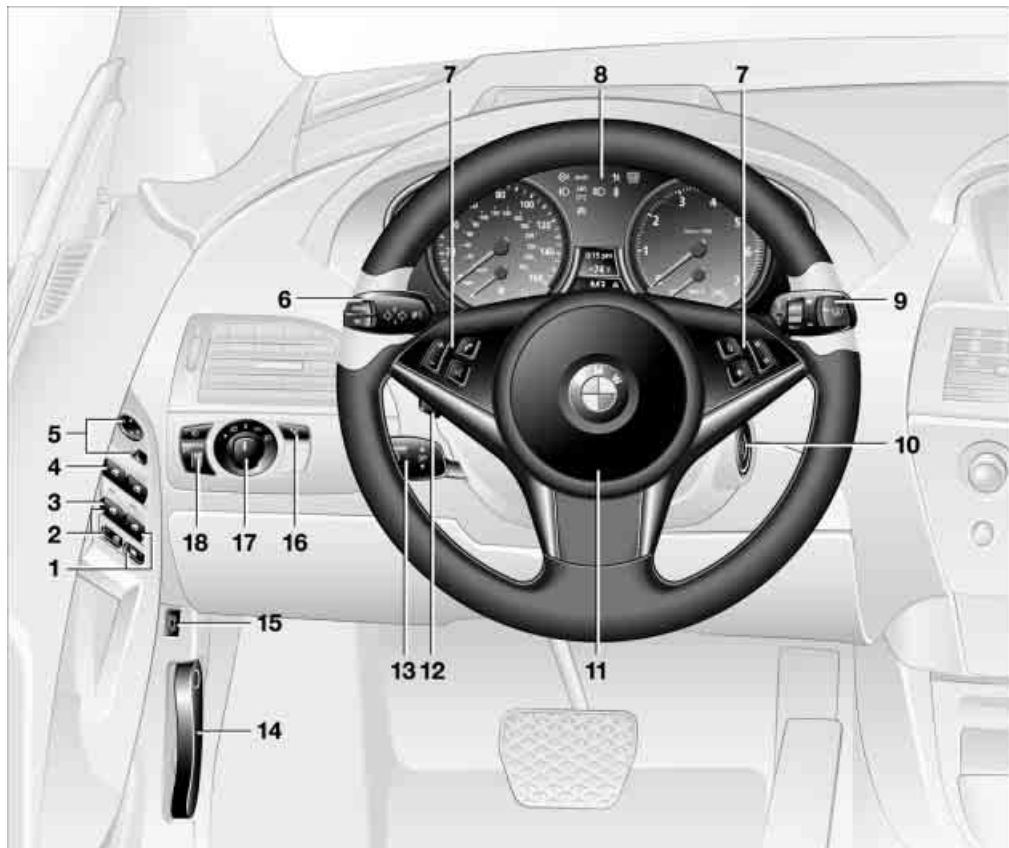
All around the steering wheel: controls and displays



14V03127CMA

- | | |
|---|--|
| <p>1 Convertible: opening and closing rear window 35</p> <p>2 Convertible: opening and closing windows together 34</p> <p>3 Convertible: opening and closing back windows 34</p> <p>4 Opening and closing front windows 33</p> <p>5 Adjusting exterior mirrors 48</p> | <p>6  Turn signals 60</p> <p> High beams, headlamp flasher 86</p> <p> Roadside parking lamps 86</p> <p>CHECK Check Control 66</p> <p>BC Computer 69</p> |
|---|--|

7 Buttons on the steering wheel



Portable phone:

- ▷ Press briefly:
Accept call or terminate call as well as dial if an entry has been selected from "A - Z", "Top 8", "Redial", "Received calls" or "Missed calls"
- ▷ Press longer: redial



Volume



Voice command system



Fast forward/reverse

- ▷ Radio
Press briefly: change radio station
Press longer: manual tuning or automatic station-search function scan
- ▷ CD
Press briefly: select track
Press longer: fast forward/reverse
- ▷ Portable phone
Press briefly: select entry in "A - Z", "Top 8", "Redial", "Received calls" or "Missed calls"





Individually programmable 49



Individually programmable 49

8 Instrument cluster 12

9  Windshield wipers 61

 Rain sensor 61

10 Ignition lock 54

11 Horn: the entire surface

12  Steering wheel heater 49

 Steering wheel adjustment 48

13  Cruise control 63



14 Releasing the engine hood 170

15 Opening the luggage compartment lid 30

16 Head-Up Display 83

17  Parking lamps 85

 Low beams 85

 Automatic headlamp control 85
 Adaptive Head Light 86

18  Instrument lighting 87

 Front fog lamps 86

Instrument cluster

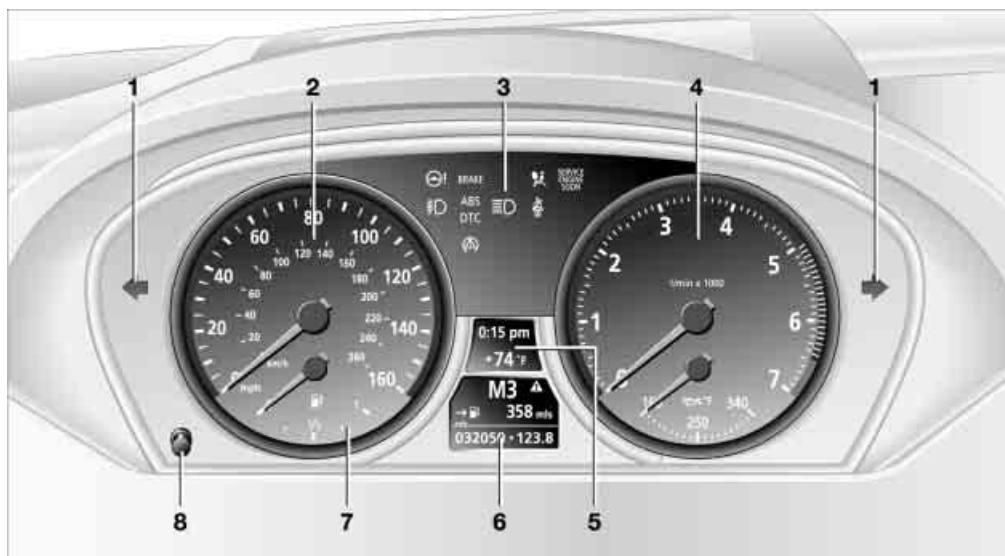

- 1 Indicator lamps for turn signals [13](#)
- 2 Speedometer with display of speed for cruise control [63](#)
- 3 Fixed indicator and warning lamps [13](#)
- 4 Tachometer [64](#)
and engine oil thermometer [65](#)
- 5 Display for
 - ▷ Variable indicator and warning lamps [66](#)
 - ▷ Speed for cruise control [63](#)
 - ▷ Time/date [64](#)
 - ▷ Outside temperature [64](#)
- 6 Display for
 - ▷ Automatic transmission with Steptronic [58](#)
 - ▷ SMG Sequential manual transmission [57](#)
 - ▷ Dynamic Driving Control [59](#)
 - ▷ Computer [69](#)
 - ▷ Date and remaining distance for service requirement [65](#)
 - ▷ Odometer and trip odometer [64](#)
 - ▷ Check Control message present [66](#)
- 7 Fuel gauge [65](#)
- 8 Resetting the trip odometer to zero [64](#)

Indicator and warning lamps

Technology that monitors itself

The indicator and warning lamps identified by the ● symbol are subjected to an operation check each time you switch on the ignition or start the engine. They each light up once for different periods of time.

When a malfunction occurs in a monitored system, the corresponding lamp will either fail to go out when the engine is started, or it will come on again during normal driving, usually accompanied by a Check Control message. You will find more details on the specified pages.

Fixed indicator and warning lamps



Turn signals 60



Active steering ● 80



Brake system ●
With handbrake engaged 55
With handbrake released 78, 173
With other warning lamps 78



Brake system for Canadian models



Airbags ● 81



Service Engine Soon ● 176
If the indicator lamp comes on either continuously or intermittently, this indicates a malfunction the emissions-related electronic systems.
Although the vehicle remains operational, you should have the systems checked by your BMW center at the earliest possible opportunity



Service Engine Soon indicator lamp for Canadian models



Front fog lamps 86



ABS Antilock Brake System ● 78



DTC Dynamic Traction Control 78



High beams/headlamp flasher 86



Please fasten safety belt ● 47



DSC Dynamic Stability Control ● 78



Check Gas Cap 162
Lamp for US models

Colors

The indicator and warning lamps can light up in different colors and combinations.









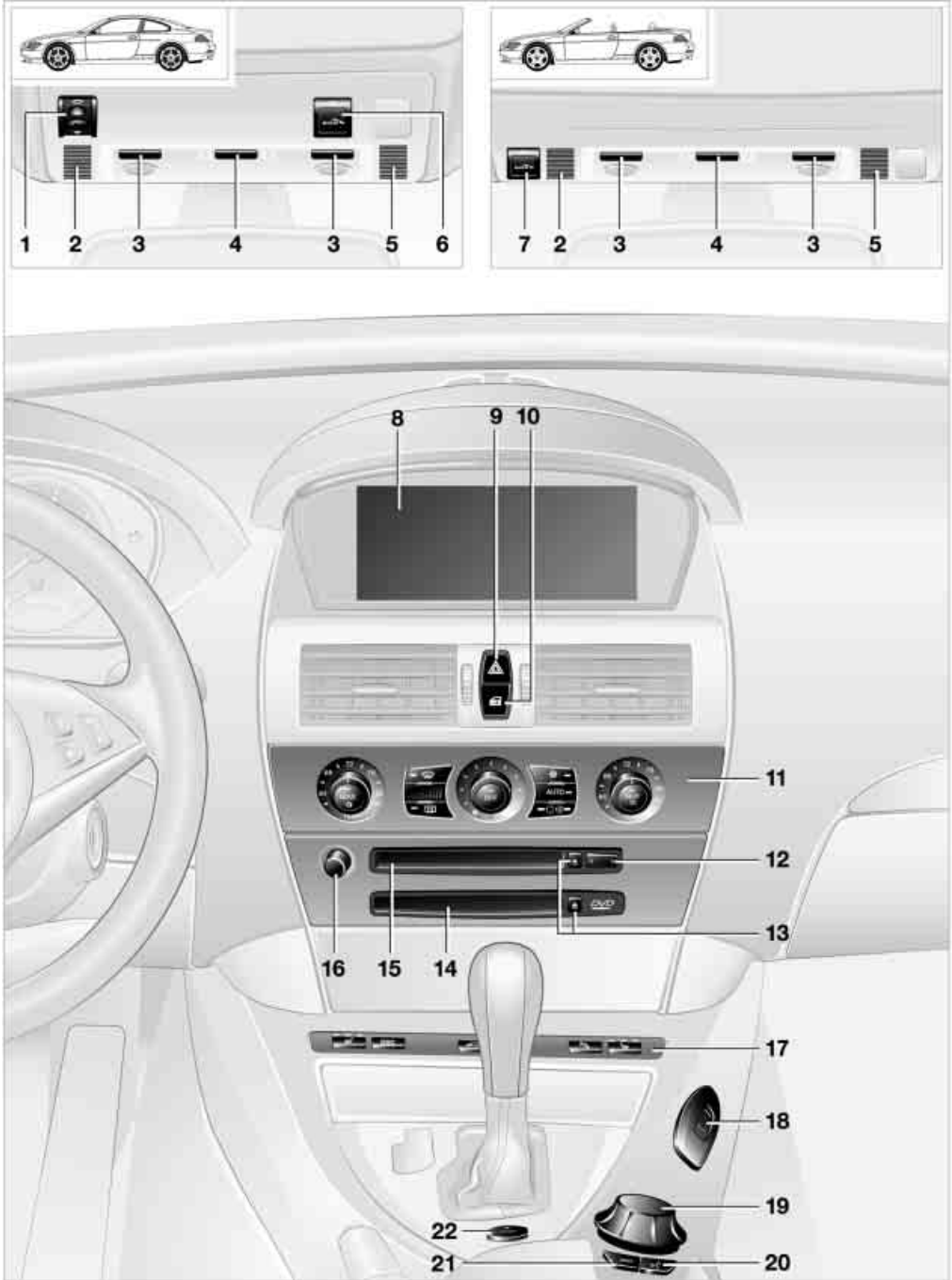





- ▷ Red:
Stop immediately
or
important reminder
- ▷ Red and yellow:
Continue to drive; drive cautiously
- ▷ Yellow:
Have the system checked at the earliest opportunity
or
for your information
- ▷ Green or blue:
For your information.

Variable indicator and warning lamps

On the display 5 of the instrument cluster, other indicator and warning lamps appear as necessary. Pay attention to the instructions of the accompanying Check Control messages, also refer to page 66.

All around the center console: controls and displays



- 1 Coupe: glass roof, electric with raise function 35
- 2 Microphone for portable phone 146
Convertible: microphone on steering column*
- 3 Reading lamps 87
- 4 Interior lamps 87
- 5 Microphone for voice command system 20
Convertible: microphone on steering column*
- 6 Coupe: initiating an emergency call 183
- 7 Convertible: initiating an emergency call 183
- 8 Control Display 16
Displays for menu guidance
- 9 Hazard warning flashers
- 10 Central locking system 29
- 11 Automatic climate control 88
 -  Temperature setting, left/right 89
 -  Automatic air distribution and volume 89
 -  Cooling function 89
 -  AUC Automatic recirculated-air control 89
 -  Maximum cooling 89
 -  Residual heat mode 90
 -  Switching off automatic climate control 90
 -  Air volume 89
 -  Defrosting windows 89
 -  Rear window defroster 88
- 12 Button for
 - ▷ Station scan 126
 - ▷ Track scan 138
- 13 Ejecting
 - ▷ Navigation DVD 108
 - ▷ Audio CD 126
- 14 Drive for navigation DVD 108
- 15 Drive for audio CD 126
- 16 Switching sound output for Entertainment on/off and adjusting the volume 126
- 17  Heated seats 47
-  PDC Park Distance Control 75
-  DSC Dynamic Stability Control 77
-  Convertible: opening the convertible top 38
-  Convertible: closing the convertible top 38
- 18 Bracket for cup holder 97
- 19 Controller 16
Horizontal movement in four directions, turn or press
- 20 Activating voice command system 20
- 21 Opening the start menu on the Control Display 17
- 22 Dynamic Driving Control 59

Control Center

The Control Center groups the functions of a large number of switches. This means that these functions can be operated from a central position. The following section provides an introduction to the principle of the menu guidance. How you control the individual functions is described in the context of the relevant equipment.

Controls



- 1 Controller: you navigate through the menus of the Control Center and make adjustments by turning, pressing and moving it to the left, right, forwards or backwards
- 2 The start menu can be opened from any menu with this button
- 3 Control Display

When you turn the controller, you feel a clicking. This helps you to select the desired menu item.

 To avoid posing an unnecessary hazard due to inattention, both to your own vehicle's occupants and to other road users: never attempt to use the controls or make entries unless traffic and road conditions allow. ◀

Menu overview

You can call up all the functions in the Control Center using five menu items.

Communication

- ▷ Portable phone
- ▷ BMW Assist or TeleService.

Navigation or onboard information

- ▷ Navigation system
- ▷ Onboard information, e.g. for display of the average fuel consumption.

Entertainment

- ▷ Radio
- ▷ CD player and CD changer.

Climate

- ▷ Air distribution
- ▷ Independent ventilation.

i menu

- ▷ Switching off the Control Display
- ▷ Traffic information
- ▷ Tone and display settings
- ▷ Settings for your vehicle, e.g. for central locking or settings for entertainment or your portable phone
- ▷ Display of the maintenance requirement and dates for statutory emission and vehicle inspections.

Menu guidance

As of ignition key position 1, the following message appears on the Control Display:

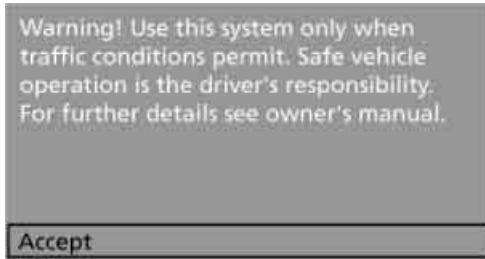

Confirm the message by pressing the controller; the start menu is opened.

Start menu

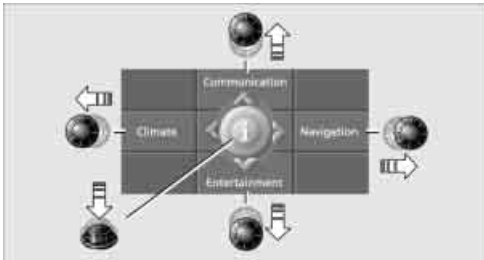

Via the start menu, you can open four menus by moving the controller to the left, right, forwards or backwards. Pressing the controller opens the **i** menu.

Opening start menu

MENU

Press button.

To open the start menu from the **i** menu:

MENU

Press the button twice.

Displays in menu

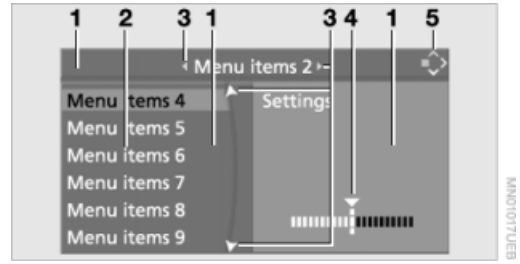

- 1 In menus, you can change fields to select the menu items they contain or to make adjustments. The active field is brighter than the others
- 2 Menu items are usually grouped in horizontal or vertical lists
- 3 Arrows indicate that other menu items can be selected in lists, but these are not visible at the moment
- 4 Adjustments are displayed in diagrams or as numbers
- 5 A symbol indicates the last selected menu item of the start menu:

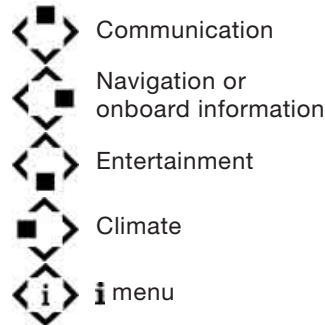

Selecting menu items and making adjustments

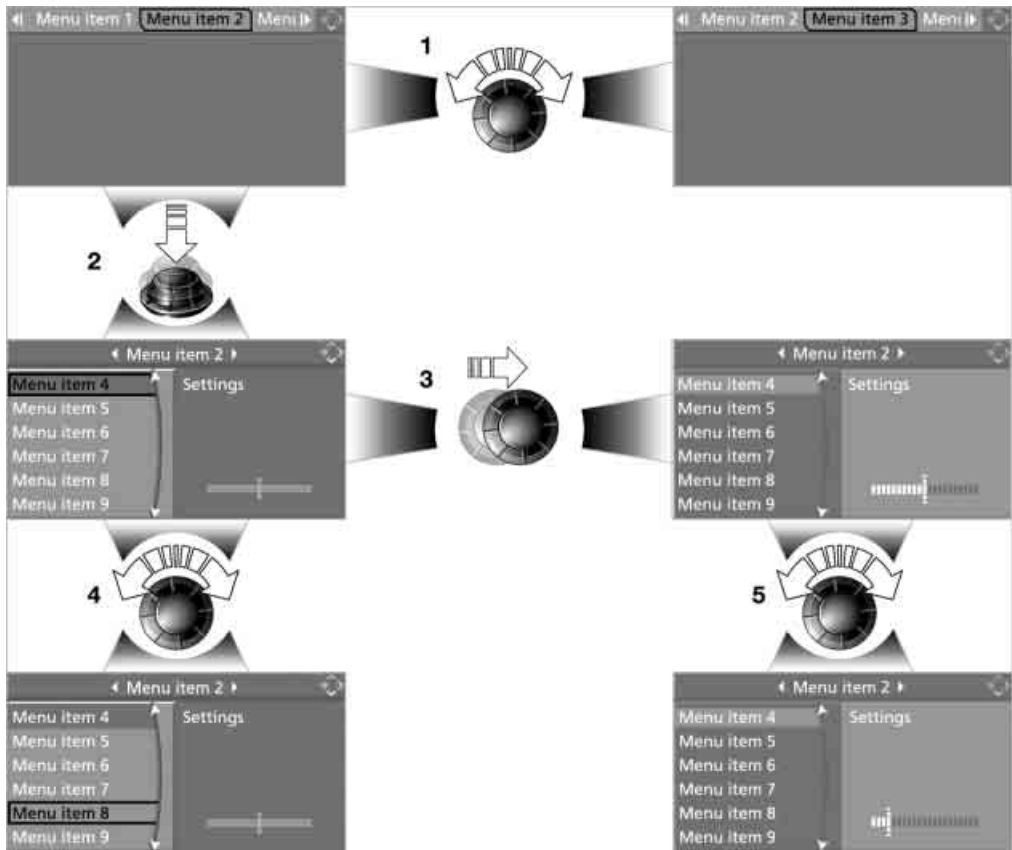

VENUS0000254M

- 1 To select individual menu items: turn the controller. The marking moves. Menu items shown in white can be selected
- 2 To activate menu items selected with the marking: press the controller. In the current field, new menu items are displayed or a function is executed
- 3 To change the current field: move the controller to the left, right, forwards or backwards and let go.
To change the current menu: move the controller to the left, right, forwards or backwards and hold for longer than approx. 2 seconds. The menu in the relevant direction is opened
- 4 To select menu items, cf. 1: turn the controller. The marking moves
- 5 To make adjustments: turn the controller. A graphical display, numerical values or text displays change. The adjustment is applied if you change to another field or into another menu

Status information

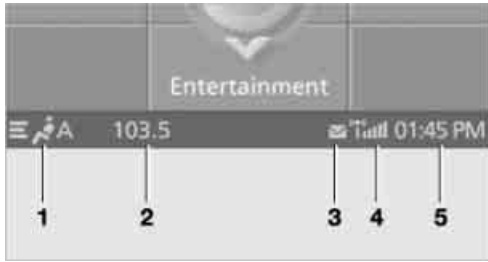

- 1 Manual or automatic air distribution for driver and passenger side
- 2 Display for Entertainment: Radio or CD,
■ sound output for Entertainment off.
Display for telephone:
"Car Phone", "Portable" or no network
- 3 ■ new entries present in "Missed calls",
✉ text message/SMS received,
▲ roaming active
- 4 📞 Telephoning and emergency call possible
- 5 Current time

Other displays:

If information is issued by the Check Control or inputs are made using the voice command system, a text message appears here on the Control Display.

Assistance window*



Additional information can be displayed in the assistance window:

- ▷ The computer or the travel computer
- ▷ The travel route in vehicles with navigation system
- ▷ The current location.

To select the display in the assistance window:

1. Move the controller to the right to change to the assistance window and press the controller



2. Select a menu item
3. Press the controller.

Switching Control Display on/off

To switch off the Control Display:

1. Open the start menu
2. Press the controller to open the **i** menu
3. Select "Display off" and press the controller.

The status information continues to be displayed.



To switch on the Control Display:
Press the controller.

Voice command system*

The concept

The voice command system allows you to control operation of various vehicle systems without ever removing your hands from the steering wheel.

Individual menu items on the Control Display can be spoken as commands. Operation via the controller is not required.

The voice command system transforms your oral commands into control signals for the selected systems and provides support in the form of instructions or questions.

The voice command system includes a special microphone.

The microphone is located:

- ▷ On the Coupe near the interior rearview mirror, refer to page 14
- ▷ On the Convertible near the interior rearview mirror, refer to page 14, or on the steering column.

Precondition

The set language of the Control Center and of the voice command system should match so that the commands to be spoken can be identified more easily. Setting the language of the Control Center, refer to page 73.

Symbols used

-  Indicates voice commands in this Owner's Manual which are to be spoken word for word.

Voice commands

Activating voice command system



Briefly press the  button on the steering wheel or in the center console.



-  This symbol on the Control Display and an acoustic message indicate that you can enter voice commands.



The text or numbers that the voice command system has registered will appear on the Control Display.

 This symbol appears on the Control Display when you can enter additional voice commands.

If there are no other voice commands, operate the equipment using the Control Center.

Terminating or canceling voice command system

Press the  button on the steering wheel or in the center console or

 ›Cancel‹.

Voice commands

To open the start menu:

 ›Main menu‹.

You can have a list of the respectively possible voice commands read off; this list is dependent on the menu item selected on the Control Display.

For example, if you have selected "CD", the possible voice commands for operating the CD player and the CD changer will be read off:

 ›Options‹ or ›Help‹.

There are often a number of commands to run a function, e.g.:

 ›Radio on‹ or ›Switch on radio‹.

With short commands you can carry out certain functions directly, regardless of which menu item is selected, refer to page 194.

An example: selecting a track

1. If necessary, switch on sound output for Entertainment
2. Press the  button in the steering wheel or in the center console.

 3. ›Entertainment‹.
The system issues:
››Entertainment‹‹



 4. ›CD‹.
The system issues:
››CD‹‹



 5. Select a track, e.g.:
›Track 1‹.
The system issues:
››Track 1‹‹.



Notes

 Do not use the voice command system in emergency situations. In stress situations, voice and pitch can change. ◀

 The portable phone can also be operated by voice control, refer to page 151. ◀

For voice commands, bear the following in mind:

- ▷ Issue the commands fluently and at normal volume, avoiding excessive emphasis and pauses
- ▷ Always speak commands with the pronunciation of the voice command system, as otherwise, for example, foreign radio stations will not be understood
- ▷ For entries in the voice-activated phone book, only use names in the language of the voice command system and no abbreviations
- ▷ Keep the doors, windows and glass roof or convertible top closed to prevent interference from ambient noise
- ▷ Avoid other sources of noise in the vehicle while speaking, and ask other vehicle occupants to refrain from talking while you are using the system.



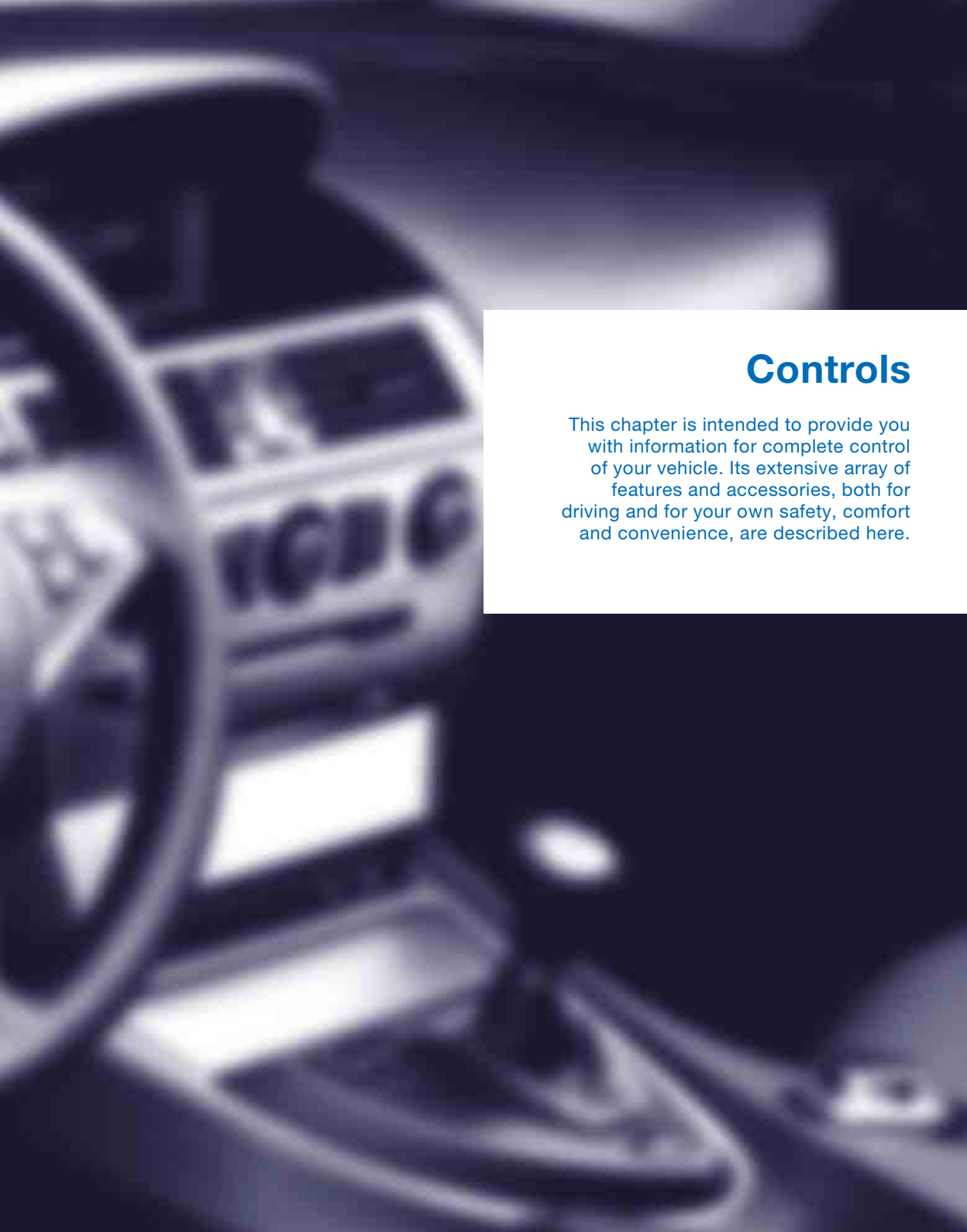

Controls

This chapter is intended to provide you with information for complete control of your vehicle. Its extensive array of features and accessories, both for driving and for your own safety, comfort and convenience, are described here.

Opening and closing

The key set

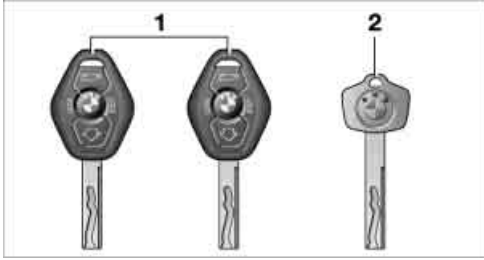

- 1 Master keys with remote control. They specify the functions of the Key Memory. In the process individual functions of your vehicle can behave differently depending on the key used, see further below.

To differentiate, you can mark the keys with remote controls using the color-coded decals you received on taking delivery of the vehicle



There is an extended-life battery in every master key with remote control which is charged automatically in the ignition lock as you drive.

If you have any master keys with remote control that are not used on a regular basis, you should therefore remember to recharge these units by using them to drive the vehicle for an extended period at least every six months, also refer to page 28. ◀

- 2 Spare key for storage in a safe place, such as in your wallet. The locks for the luggage compartment lid and the hotel function, refer to page 30, cannot be operated with this key. This is an advantage in a hotel, for example. The key is not intended for constant use

Replacement keys

Additional or replacement keys are available at your BMW center.

Key Memory

How the system functions

Doubtless you have often reflected on how great it would be if you could configure your vehicle's various adjustment settings to meet your own personal requirements. BMW has designed several freely selectable options into the vehicle during its development. You can set these as desired via the Control Center.

You can have up to four different basic settings adjusted for four different persons for the specific keys. The only requirement is that each person uses his or her own master key with remote control.

When your vehicle is unlocked with the remote control, the vehicle recognizes the individual key by means of a data exchange and makes adjustments accordingly.

Examples of Key Memory functions

- ▷ Automatic adjustment of the driver's seat
- ▷ Locking the vehicle after moving off
- ▷ When unlocking with the remote control, either unlock only the driver's door or the entire vehicle
- ▷ Activating visual warning for PDC Park Distance Control
- ▷ Resetting volume setting.

Central locking system

The concept

The central locking system is ready for operation whenever the driver's door is closed. This simultaneously engages and releases the locks on the following:

- ▷ Doors
- ▷ Compartment in the front center console

- ▷ Luggage compartment lid
- ▷ Fuel filler door.

The central locking system can be operated from the outside

- ▷ via the remote control
- ▷ via the door lock

and from inside via the button for the central locking system.

If operated from the inside, the fuel filler door and the compartment in the front center console are not locked, refer to page 29.

The anti-theft system is automatically activated whenever you activate the central locking system from outside the vehicle. It prevents the doors from being unlocked using the safety lock buttons or door handles. The alarm system is armed/disarmed at the same time.

In the event of an accident, the central locking system unlocks automatically. The hazard warning flashers and interior lamps also switch on.

Opening and closing: from outside

Using the remote control

When you lock/unlock the vehicle, you simultaneously activate/deactivate the anti-theft system, arm/disarm the alarm system, and switch the interior lamps on/off.

 Protect the remote control against unauthorized use by handing over only the spare key, for example when using hotel valet parking. ◀



You can find more detailed information on the alarm system on page 32.

 Because any persons or animals left unattended in a parked vehicle could lock the doors from the inside, you should always keep the remote control with you; this precaution ensures that you will remain able to unlock the vehicle from the outside at all times. ◀

Unlocking

Use the  button to unlock the vehicle depending on the setting:

Control Center, for principle details, refer to page 16:

1. Open the  menu
2. Select "Vehicle settings" and press the controller
3. Select "Door locks" and press the controller
4. Select "Central locking" and press the controller
5. Select "Unlock button" and press the controller
6. Select a menu item:
 - ▷ "All doors"
Press the  button once to unlock the entire vehicle
 - ▷ "Driver's door only"
Press the  button once to unlock only the driver's door and the fuel filler door.
Press the button twice to unlock the entire vehicle



7. Press the controller.

Depending on which key you have used to open the vehicle, the last adjustment is applied.

Convenience opening mode

Press the  button once briefly and then keep it pressed:

- ▷ Coupe: the windows are opened, the glass roof is raised, and the sliding panel moves back approx. 2 in/5 cm
- ▷ Convertible: the windows and the convertible top are opened.

Locking and securing

Press the  LOCK button.

Switching on interior lamps

Press the  LOCK button if the vehicle is locked.

You can also use this function to locate your vehicle in parking garages etc.

Panic mode*

By pressing and holding the  button for more than approx. two seconds, you can trigger the alarm system in response to any impending danger.

To switch off the alarm: press any of the buttons.

Opening luggage compartment lid

Press the  button:

The luggage compartment lid opens, regardless of whether it was previously locked or unlocked.

 A previously locked luggage compartment lid is also locked after closing.

Coupe: the luggage compartment lid swings to the rear and upwards when opened. Make sure there is sufficient free space. ◀

Setting confirmation signals

You can have unlocking or locking the vehicle confirmed.

Control Center, for principle details, refer to page 16:

1. Open the  menu
2. Select "Vehicle settings" and press the controller
3. Select "Door locks" and press the controller
4. Select "Confirmation" and press the controller
5. Select the desired signal



6. Press the controller.
 -  The signals are switched on.

Malfunctions

Local radio waves can disrupt the function of the remote control.

Should the remote control fail to operate owing to interference of this kind, you can respond by using the master key to unlock your vehicle at one of the doors.

If it is no longer possible to lock the vehicle via the remote control, the battery is discharged. Use this remote control during an extended drive; this will recharge the battery, refer to page 26.

For US owners only

The transmitter and receiver units comply with part 15 of the FCC/Federal Communication Commission regulations. Operation is governed by the following:

FCC ID: LX8766S
 LX8766E
 LX8CAS

Compliance statement:

This device complies with part 15 of the FCC Rules. Operation is subject to the following two conditions:

- ▷ This device may not cause harmful interference, and
- ▷ this device must accept any interference received, including interference that may cause undesired operation.

 Any unauthorized modifications or changes to these devices could void the user's authority to operate this equipment. ◀

Using door lock

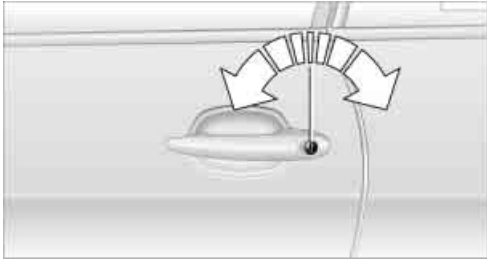

One turn of the key in the driver's door lock unlocks the driver's door only. Turning the key a second time unlocks all of the remaining doors, the luggage compartment lid and the fuel filler door.

Convenience operation

The windows, the glass roof on the Coupe, the rear window and top on the convertible can also be operated via the door lock:

- ▷ To open:
With the door closed, turn the key to the Unlock position and hold it there
- ▷ To close:
With the door closed, turn the key to the Lock position and hold it there.

 Watch during the closing process to be sure that no one is injured. Releasing the key stops the operation. ◀

Manual operation

In the event of an electrical malfunction, you can turn the key all the way to the right or left in the door lock to lock or unlock the driver's door.

Opening and closing: from inside

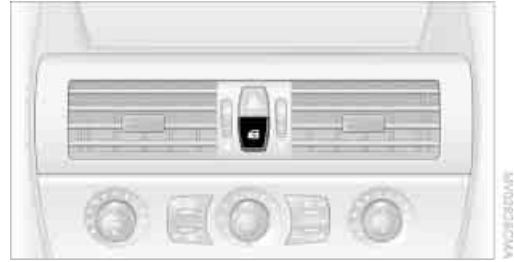

You can operate the central locking system with this button when the doors are closed. This only unlocks or locks the doors and luggage compartment lid, but the anti-theft system is not activated. The fuel filler door remains unlocked to enable refueling, as does the compartment in the front center console to ensure access to personal items.

You can also make the following settings:

- ▷ The central locking system automatically locks the vehicle as soon as you drive off
- ▷ The central locking system automatically locks the vehicle after a short time when no door has been opened.

Control Center, for principle details, refer to page 16:

1. Open the  menu
2. Select "Vehicle settings" and press the controller
3. Select "Door locks" and press the controller
4. Select "Central locking" and press the controller
5. Select "Lock after driving" or "Relock door if not opened"



6. Press the controller.
 - The setting is selected.

Depending on which key you have used to open the vehicle, the last adjustment is applied.

Unlocking and opening doors

- ▷ Either unlock both doors together with the button for the central locking system and then pull the door handle above the armrest or
- ▷ pull the door handle for each door twice: the first pull unlocks the door, and the second one opens it.

Locking doors

- ▷ Use the central locking button to lock both of the doors simultaneously, or
- ▷ press down the safety lock button of the desired door. To prevent you from being locked out, the open driver's door cannot be locked using the safety lock button.

 Because any persons or animals left unattended in a parked vehicle could lock the doors from the inside, always take the master key with remote control with you to ensure that you will remain able to unlock the vehicle from the outside whenever the need arises. ◀

Hotel function

The hotel function locks the compartment in the front center console and the luggage compartment lid individually and disconnects them from the central locking system. The spare key, refer to page 26, does

not fit the lock for the hotel function. If you then only hand over the spare key, e.g. in a hotel, no access is possible to the luggage compartment lid or to the compartment in the front center console.

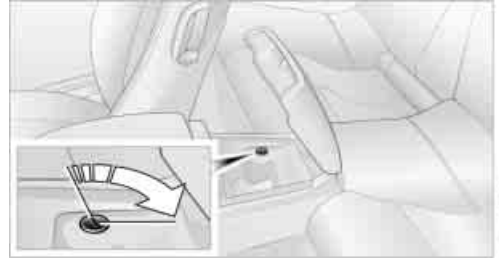

Turn the key to the right, refer to illustration, and remove.

The hotel function is only activated after subsequent locking or unlocking of the vehicle. This locks the luggage compartment lid and the compartment in the front center console and disconnects them from the central locking system.

In the event of an electrical malfunction

For manual unlocking, turn the master key all the way to the right:
The compartment in the front center console is unlocked.

 If unlocking was manual, the lock has to be returned to the home position, i.e. all the way back to the left, before setting the hotel function again. ◀

Luggage compartment lid

 Coupe: the luggage compartment lid swings to the rear and upwards when opened. Make sure there is sufficient free space. ◀

Opening from inside

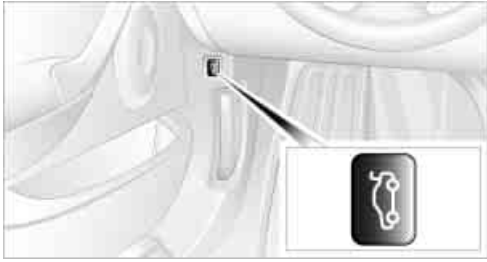

Press the button:
The luggage compartment lid opens unless the hotel function is activated, see above.

Opening from outside

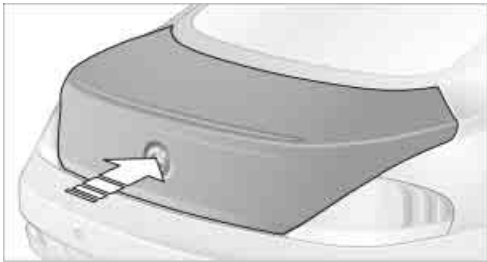

Press the upper half of the BMW emblem or the  button on the remote control:
The luggage compartment lid opens.

In the event of an electrical malfunction



The luggage compartment lid lock is located under the BMW emblem. Only the master keys with remote control, refer to page 26, match the luggage compartment lid lock.

Turn the master key to the right as far as it will go:

The luggage compartment lid opens.

 If you use the key to unlock the luggage compartment lid while the alarm system is armed, the alarm will be triggered. Switching off the alarm, refer to page 32. ◀

Emergency release



This lever releases the luggage compartment lid from inside the luggage compartment.

Closing



The handle recesses on the interior trim of the luggage compartment lid make it easier to pull down.

 Make sure that the closing path of the luggage compartment lid is clear, as otherwise injuries may result.

Operate the vehicle only when the luggage compartment lid is completely closed. Otherwise, exhaust fumes could penetrate the interior of the vehicle. ◀

If special circumstances should make it absolutely necessary to operate the vehicle with the lid open:

1. Coupe: close both windows as well as the glass roof
Convertible: with closed top, close all windows
2. Adjust the automatic climate control to supply a high air volume, refer to page 89.

Luggage compartment

There are four lashing eyes on the inner corners of the luggage compartment for securing luggage nets or securing straps to fix luggage in position.

Also refer to Cargo loading, page 104.

Convertible: increasing luggage compartment capacity

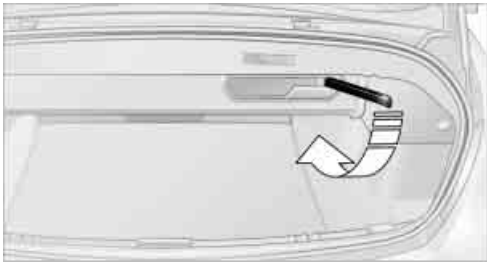

With the convertible top closed, you can enlarge the luggage compartment capacity:

To do so, unfold the handle and press it downwards in the direction of travel, refer to arrow. This folds the convertible top compartment floor upwards.

Before opening the convertible top, run this procedure in reverse order.

- ▶ The convertible top cannot be opened if the convertible top compartment floor is folded up. ◀

Alarm system

The concept

The vehicle alarm system responds:

- ▶ When a door, the hood, or the luggage compartment lid is opened
- ▶ To movement in the vehicle interior: interior motion sensor
- ▶ To changing of the vehicle's tilt if someone attempts to steal the wheels or tow the vehicle
- ▶ To interruption of battery voltage.

The system responds to unauthorized vehicle entry and attempted theft by simultaneously activating:

- ▶ An acoustic alarm, which lasts for a period of approx. 30 seconds
- ▶ The hazard warning flashers for approx. 5 minutes
- ▶ The high beams, which flash on and off in the same rhythm.

Arming and disarming alarm system

When you lock or unlock the vehicle, either with the remote control or at the door lock, the alarm system is armed or disarmed at the same time.

The system indicates that it has been correctly armed by switching on the hazard warning flashers for a single cycle and by emitting an acoustic signal.

You can also open the luggage compartment lid with the system armed using button  on the remote control, refer to page 28. When you close the lid, it is secured again.

Switching off alarm

- ▶ Unlock the vehicle using the remote control, refer to page 27
- ▶ or turn the ignition key to position 1.

Indicator lamp displays



- ▷ The indicator lamp below the interior rearview mirror flashes continuously: the system is armed
- ▷ The indicator lamp flashes on locking: door(s) or luggage compartment lid are not completely closed. Even if you do not close the alerted area, the system begins to monitor the remaining areas, and the indicator lamp flashes continuously after approx. 10 seconds. However, the interior motion sensor is not activated
- ▷ The indicator lamp goes out on unlocking: no manipulation or attempted intrusions have been detected in the period since the system was armed
- ▷ The indicator lamp flashes on unlocking before the remote control is inserted in the ignition lock, but for no more than roughly 5 minutes: an attempted entry has been detected in the period since the system was armed.

Following triggering of an alarm, the indicator lamp will flash continuously.

Tilt alarm sensor and interior motion sensor

Tilt alarm sensor

Monitors the inclination of the vehicle. The alarm system reacts, for example, if someone attempts to steal the wheels or tow the vehicle.

Interior motion sensor

Coupe:

In order for the interior motion sensor to function properly, the windows and glass roof must be completely closed.

Convertible:

Monitors the interior up to the height of the seat cushions. This means that the alarm system, including the interior motion sensor, is armed even if the convertible top is open. Falling objects, e.g. leaves, can trigger false alarms, refer to Avoiding unintentional alarms.

Avoiding unintentional alarms

The tilt alarm sensor and interior motion sensor may be switched off at the same time. This is how you prevent unintentional alarms, e.g. in the following situations:

- ▷ In garages with elevator ramps
- ▷ During transport on automobile transport trains
- ▷ If animals are to remain in the vehicle.

Switching off tilt alarm sensor and interior motion sensor

Press the  LOCK button on the remote control once again directly after locking.

The indicator lamp lights up briefly and then flashes continuously. The tilt alarm sensor and the interior motion sensor are switched off until the vehicle is unlocked and locked again.

Windows

 To prevent injuries, exercise care when closing the windows and keep them in your field of vision until they are shut.

When leaving the vehicle, always remove the ignition key and close the doors to prevent children from operating the windows and injuring themselves etc. ◀

Coupe: opening and closing windows



Ignition key as of position 1:

- ▷ Press the switch up to the resistance point:
The window continues to move downwards as long as you continue to hold the switch
- ▷ Briefly press the switch beyond the resistance point:
The window moves downwards automatically. Briefly press the switch again to stop the opening movement.

You can close the windows in the same manner by pulling the switch.

Convertible: opening and closing windows

Individually



Ignition key as of position 1:

- ▷ Press the switch up to the resistance point:
The window continues to move downwards as long as you continue to hold the switch

- ▷ Briefly press the switch beyond the resistance point:
The window moves downwards automatically. Briefly press the switch again to stop the opening movement.

You can close the windows in the same manner by pulling the switch. The rear windows cannot be closed automatically with one touch.

Together



Ignition key as of position 1:

1. Briefly press button **1**:
The LEDs in button **1** and at switch **2** light up
2. Press switch **2**:
 - ▷ Up to the resistance point:
All the windows move downwards as long as you continue to press the switch.
You can close the windows in the same manner by pulling the switch
 - ▷ Briefly press the switch beyond the resistance point:
All the windows move downwards automatically. Briefly press the switch again to stop the opening movement.

Briefly press button **1** again to deactivate the function. The LEDs go out.

Rear window



Ignition key as of position 1:

1. Briefly press button 1:
The LEDs in button 1 and at switch 2 light up
2. Press switch 2:
 - ▷ Up to the resistance point:
The rear window continues to move downward as long as you continue to hold the switch. You can close the rear window in the same manner by pulling the switch
 - ▷ Briefly press the switch beyond the resistance point:
The rear window moves downwards automatically. Briefly press the switch again to stop the opening movement.

Briefly press button 1 again to deactivate the function. The LEDs go out.

 The rear window opens and closes automatically when you open or close the convertible top. ◀

After switching off ignition

You can still operate the windows:

- ▷ Ignition key in position 1 for approx. 15 minutes
- ▷ In position 0 or with the ignition key removed for approx. 1 minute, as long as a door has not been opened.

To open, press the switch beyond the resistance point.

 When leaving the vehicle, remove the master key with remote control and close the doors, as otherwise children could operate the windows and injure themselves etc. ◀

For information on using the convenience operation mode at the door lock or with the remote control, refer to page 27 or 29.

Anti-trapping mechanism

If the closing force rises beyond a pre-defined threshold during closing, the system will immediately stop moving the window prior to lowering it slightly.

 Convertible: the back windows and rear window are not equipped with an anti-trapping mechanism. ◀

 Despite the anti-trapping mechanism, you should always inspect the front side window's travel path prior to closing it, as the safety feature might fail to detect certain kinds of obstructions, such as very thin objects, and the window would continue closing.

Pulling the switch beyond the resistance point and holding it limits the response of the anti-trapping mechanism. Under these conditions, the window will respond to forces beyond a defined threshold by only opening a few inches/millimeters.

If you again pull the switch past the resistance point and hold it in position within a period of roughly 4 seconds, the anti-trapping mechanism will be deactivated. ◀

Accessories in window area

After installing any accessory – such as a clamp-on antenna for a portable phone – within the window's travel range, you will need to have the system reinitialized for use under the new conditions. Please contact your BMW center for assistance.

Coupe: Glass roof, electric with raise function*

 To prevent injuries, exercise care when closing the glass roof and keep it in your field of vision until it is shut. When leaving the vehicle, always remove the key and close the doors, as otherwise children could operate the roof and injure themselves etc. ◀

Raising and closing glass roof



Ignition key as of position 1:

- ▷ Briefly press the switch for raising the roof:
The roof opens and the sliding panel moves back approx. 2 in/5 cm
- ▷ Press the switch twice beyond the resistance point toward the rear:
The roof opens and the sliding panel moves completely back
- ▷ To close, briefly press the switch or push it twice beyond the resistance point toward the front:
The roof and sliding panel close.

Opening and closing sliding panel

Ignition key as of position 1:

- ▷ Push the switch up to the resistance point in the desired direction:
The sliding panel continues to move as long as you continue to hold the switch
- ▷ Push the switch beyond the resistance point in the desired direction:
The sliding panel moves automatically. Briefly press the switch again in any direction to stop the movement.

After switching off ignition

You can still operate the roof:

- ▷ Ignition key in position 1 for approx. 15 minutes
- ▷ In position 0 or with the ignition key removed for approx. 1 minute, as long as a door has not been opened.

For information on using the convenience operation mode at the door lock or with the remote control, refer to page 27 or 29.

Anti-trapping mechanism

If the glass roof encounters resistance when closing from the raised position, the closing action is interrupted and the glass roof opens.

If the sliding panel encounters resistance when closing within approx. 8 in/20 cm, the closing action is interrupted and the sliding panel opens approx. 8 in/20 cm.



Despite the anti-trapping mechanism, you should always inspect the roof's travel range prior to closing it, as the safety feature might fail to detect certain kinds of obstructions, such as very thin objects, and the roof would continue closing. The anti-trapping mechanism for closing the glass roof is deactivated if the switch is pressed beyond the resistance point and held there. The closing action is immediately interrupted when you release the switch. ◀

Following interruptions in electrical power supply

After disconnecting the battery, it can occur that the glass roof does not move. The system has to be initialized. Should this occur, please have the roof initialized at your BMW center.

Manual operation

In the event of an electrical malfunction, you can operate the panorama glass roof and the sliding panel manually.

Glass roof

1. Remove cover on headliner in front of rear window. To do this, first detach the cover at the rear on both sides and then disengage by pulling downward firmly
2. Insert the Allen wrench supplied with the onboard tool kit in the opening provided, refer to arrow.

Convertible: top

The fully automatic convertible top combines secure weather protection with simple and convenient operation.

So that you get the maximum pleasure from your convertible, here are a few tips:

- ▷ It is recommended that you close the convertible top when the vehicle is parked. The closed convertible top not only protects the passenger compartment against unforeseen weather damage, it also represents a certain protection against theft. Nonetheless, even if the convertible top is closed, only keep valuables in the locked luggage compartment
- ▷ Do not attach luggage rack systems to the convertible top
- ▷ At temperatures below 14 °F / -10 °C, do not operate the convertible top, as otherwise damage can occur.

! Do not leave the soft top in the convertible top compartment for longer than one day when wet, as otherwise damage from moisture can occur.

Do not place any objects on the convertible top, as otherwise if the top was to be operated, they would fall off and lead to damage or injury.

Never move the convertible top when the rollover protection system is raised. Driving without having completed the opening or closing action can lead to damage or injury.

Do not place hands in the top mechanism during the opening and closing action. Keep children away from the travel path of the convertible top.

For safety reasons, only operate the convertible top when the vehicle is at a standstill. ◀

▷ If you have initiated top operation with the vehicle at a standstill and then drive off, e.g. at a traffic light, you can continue the initiated operation up to a speed of 20 mph/30 km/h.

To do so, press and hold the corresponding button. ◀

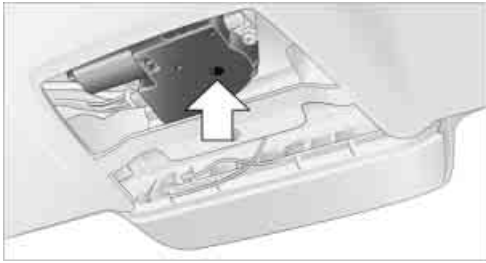

3. Turn the Allen wrench and move the glass roof in the desired direction.

Sliding panel

1. Lower the cover downwards, if necessary using the screwdriver from the onboard tool kit at the positions indicated, refer to page 178



2. Insert the Allen wrench supplied with the onboard tool kit in the opening provided

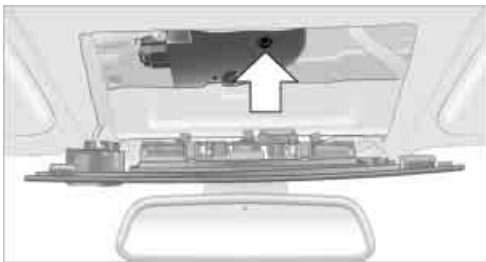

3. Turn the Allen wrench and move the sliding panel in the desired direction.

 Partial vacuums that occur at higher speeds in the passenger compartment can make the convertible top flap. Use the ventilation controls to increase the air supply so that no partial vacuum occurs in the vehicle. ◀

 To close the electrically activated side windows while the vehicle is being driven, always close the rear windows or all four windows simultaneously first, as otherwise the windows cannot close tightly at higher speeds. ◀

Prior to opening and closing

- ▷ Read carefully and comply with the safety precautions that appear above
- ▷ Ensure that the convertible top compartment floor in the luggage compartment is folded down, refer to page 32, as otherwise the convertible top cannot be opened
- ▷ Ensure that the luggage compartment lid is closed.

Opening and closing

As of ignition key position 1, with the vehicle stationary:

 So as not to place an excessive load on the battery, only operate the convertible top with the engine running, if possible.

Before closing the convertible top, remove foreign bodies from the windshield frame, as these might inhibit closing of the convertible top. ◀



- 1 Closing
- 2 Indicator lamp
- 3 Opening

 If the opening or closing action is not completed, the luggage compartment lid cannot be opened.

When the button for top operation is pressed, the side windows move downwards slightly; the rear window is lowered completely.

If you hold the button pressed for longer than 2 seconds after completion of the opening or closing action and the LED has gone out, the side windows and rear window move once again. ◀

Indicator lamp

In the following situations, a message is displayed on the Control Display and an acoustic signal sounds in addition to the indicator lamp:

- ▷ During convertible top operation, the LED lights up green. It goes out as soon as the opening or closing action is completed
- ▷ If the indicator lamp flashes red when you release the button, the opening or closing action is not completed
- ▷ If the indicator lamp lights up red with the button pressed, the convertible top compartment floor is folded up or a fault has occurred. The convertible top cannot be moved.

Interruption

The automatic sequence of movements is interrupted immediately if the button for top operation is released. The sequence can be continued in the desired direction using the button.

 If the opening or closing action is interrupted for a longer period by releasing the button, the convertible top remains in that position for approx. 15 minutes before it slowly moves to a stable position. The sequence can be continued using the buttons.

Do not interrupt and continue the closing action several times in succession, as otherwise the fully automatic top mechanism can be damaged.

If the opening or closing action is interrupted, it can happen that the luggage compartment lid cannot be opened. ◀

Convenience operation using remote control and driver's door lock

Refer to pages 27 and 29.

Manual closing in the event of an electrical malfunction

 Only close the convertible top manually if absolutely necessary; never open it manually. The convertible top compartment lid cannot be locked in the event of an electrical malfunction and would open while the vehicle is being driven. Improper handling can lead to damage. ◀

Before closing

1. Open the luggage compartment lid
2. Take the Allen wrench and screwdriver from the onboard tool kit
3. Lever out the two buttons in the luggage compartment with the screwdriver and then pull firmly. The convertible top compartment lid is unlocked

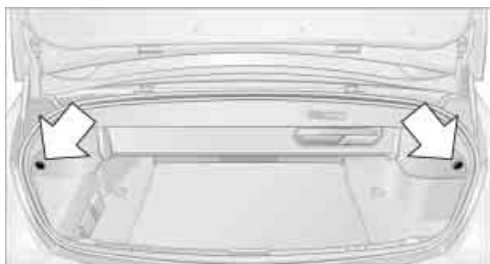

4. Close the luggage compartment lid
5. Move the side windows downwards slightly; fully lower the rear window. If the rear window cannot be opened using the switch, it must be lowered manually:



Lever out the cover between the rear head restraints. To do so, place the screwdriver as close as possible to the lock element, as shown in the illustration.

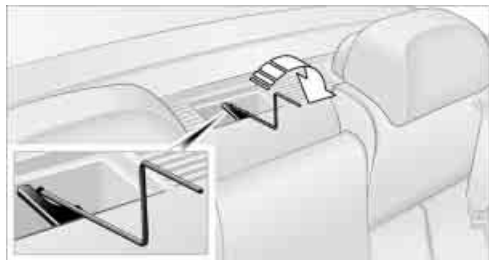



Carefully insert the Allen wrench in the opening and turn firmly in the direction indicated by the arrow until the rear window is completely open.

Closing

 Perform the following work steps with the assistance of a second person and with the doors open to prevent injury and damage to the convertible top. ◀

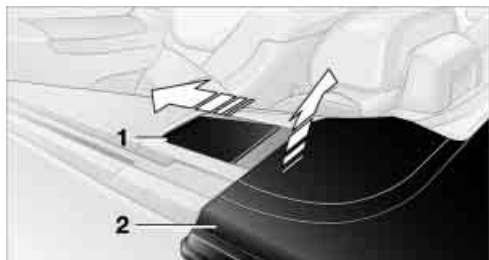
1. Push the cover **1** on the left and right of the side panel forwards. Reach into the resulting openings and raise the convertible top compartment lid **2** as far as it will go



2. Hold the convertible top at each side frame, arrow 3, with both hands
 Lifting the convertible top at parts other than the side frame can damage it. ◀
3. Both persons lift on both sides simultaneously, arrows 4, and swing the top forwards. In doing so, keep the convertible top compartment lid open, arrow 5, e.g. with your shoulder

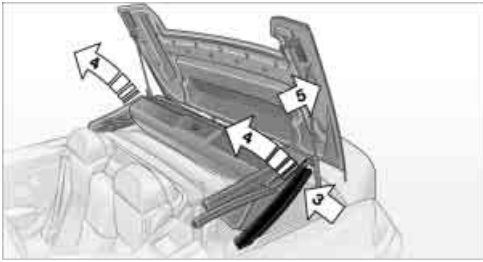

4. Raise the two convertible top ends as far as they will go, arrow 6, and close the convertible top compartment lid, arrow 7
 Do not raise the convertible top ends until after the convertible top has been swung forward, as otherwise damage can occur. ◀

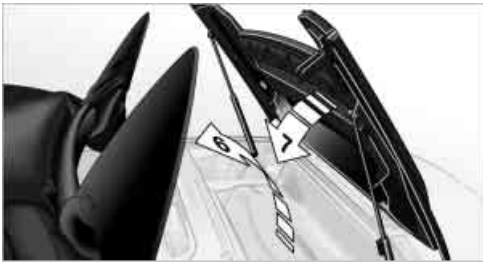

5. Fold the convertible top ends downwards onto the convertible top compartment lid
6. From the interior, take out the cover in the center of the front top frame; use the screwdriver if necessary
7. Insert the Allen wrench in the appropriate opening



8. From the outside, both persons pull the front convertible top frame downwards and on both sides simultaneously as far as possible
9. Turn the Allen wrench in the direction of the arrow until the front convertible top frame locks with the windshield frame. The rear convertible top ends are pressed automatically onto the convertible top compartment lid and close tightly with tension
10. If necessary, close the rear window again manually in the same way as above.

Wind deflector*

The wind deflector keeps the air movement in the passenger compartment at a low level when the convertible top is open, this enabling pleasant driving even at higher speeds. You can conveniently stow it in the luggage compartment when it is not needed.

Before fitting

1. Take the wind deflector from the protective sleeve
2. Unfold the wind deflector
3. Press together the locking mechanism on the left side until it snaps into place



4. Push out the securing pin **1** on the right side of the wind deflector until it snaps into place

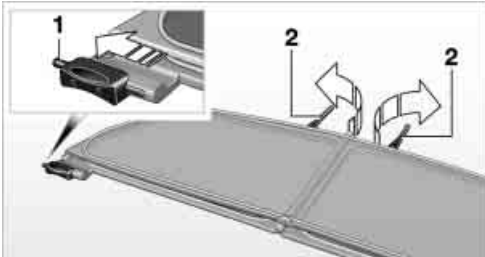

5. Unfold the rear mounts **2**.

Fitting

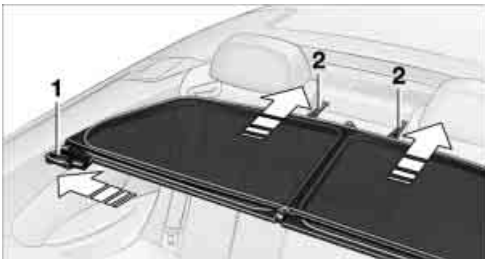

1. Insert the wind deflector with the securing pin **1** in the appropriate opening on the right side of the vehicle
2. Guide the rear mounts **2** into the reception points
3. Push the securing pin **3** on the left side until it snaps into place in the appropriate opening, refer to arrow

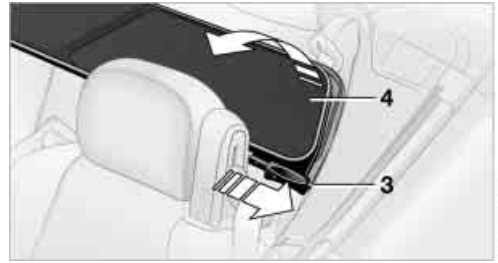

4. Fold up the upper half **4** of the wind deflector.

⚠ With wind deflector fitted: do not incline the front seat backrests too far backwards if the seat is to be moved back to the end position, as otherwise the wind deflector will be damaged. ◀

Removing

The same as fitting, but in reverse order.

Folding up



Push the handle of the securing pin on the left side of the vehicle all the way back and release the locking mechanism.

Adjustments

Sitting safely

The ideal sitting position can make a vital contribution to relaxed, fatigue-free driving. The sitting position also plays an important role together with the safety belts and airbags in providing occupants with maximum levels of passive safety in an accident. To ensure that the safety systems operate with optimal efficiency, we strongly urge you to observe the instructions contained in the following section.

For additional information on transporting children safely, refer to page 51.

Sitting safely with airbags

 Always maintain an adequate distance between yourself and the airbags. Always hold the steering wheel by its rim with hands at the 9 o'clock and 3 o'clock positions, to minimize the risk of injuries to your hands and arms in the event of airbag deployment.

No one and nothing is to come between the airbags and the seat occupant.

Do not use the cover of the front airbag on the front passenger side as a storage area. Make sure that the front passenger is sitting correctly and does not rest feet or legs on the instrument panel, otherwise leg injuries can occur if the knee and front airbags are triggered.

Never let an occupant's head rest near or on a side airbag because the inflating airbag could cause a serious or fatal injury. ◀

Even if you adhere to all the instructions injuries resulting from contact with airbags cannot be fully excluded, depending on the circumstances. The ignition and inflation noise may provoke a mild – usually temporary – hearing loss in extremely sensitive individuals.

For airbag locations and additional information on airbags, refer to page 81.

Sitting safely with safety belts

Fasten your safety belt before starting any trip. Airbags complement the safety belt as an additional safety device, but they do not represent a substitute.

Your vehicle has four seats that are all equipped with a safety belt.

 At all times, occupants should sit upright and be properly restrained: infants and small children in appropriate child-restraint systems; larger children and adults using the safety belts.

Never allow more than one person to wear a single safety belt. Never allow infants or small children to ride in a passenger's lap. Expectant mothers should always wear their safety belts, taking care to position the lap belt against the lower hips, where it will not exert pressure against the abdominal area.

Do not route the belt across your neck, or run it across sharp edges. Be sure that the belt does not become caught or jammed. Avoid twisting the belt while routing it firmly across the hips and shoulder. Do not allow the belt to rest against hard or fragile objects. Otherwise, in the event of a frontal impact, a loose lap belt could slide over your hips, leading to abdominal injury. Avoid wearing clothing that prevents the belt from fitting properly and pull the lap belt periodically to readjust the tension across your shoulder in order to avoid a reduction in the retention effect of the safety belt. ◀

For instructions on operating safety belts, refer to page 47.

Seats

Note before adjusting

⚠ Never attempt to adjust your seat while operating the vehicle. The seat could respond with unexpected movement, and the ensuing loss of vehicle control could lead to an accident.

On the front passenger side as well, do not tilt the backrest too far toward the rear while driving. Failure to observe this precaution can prevent the belt from providing effective protection against injury, as the passenger could slide under the belt in an accident.

Make sure that the footwell behind the driver's and front passenger's seat is empty and unobstructed. If you fail to do so, any persons or objects behind the seat could be injured or damaged by a rearward movement of the seat. ◀

Also observe the instructions regarding damage to the safety belt on page 47.

⚠ Convertible: with the wind deflector fitted, do not incline the front seat backrests too far backwards if the seat is to be moved back to the end position, as otherwise the wind deflector will be damaged. ◀

Seat adjustment

⚠ To ensure that the safety systems continue to provide optimized protection, please observe the adjustment instructions above. ◀



- 1 Inclination
- 2 Longitudinal direction
- 3 Height

- 4 Backrest
- 5 Convertible: head restraints, refer to page 45

With the sports seat*, you can also adjust the thigh support manually:

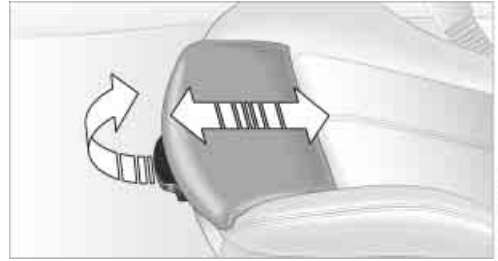

Pull the lever and move the thigh support in a longitudinal direction.

Lumbar support* adjustment



You can also adjust the contours of the backrest to obtain additional support in the lumbar region.

The upper hips and spinal column receive supplementary support to help you maintain a relaxed, upright sitting position.

- ▷ Press the switch forwards or backwards: increase or decrease curvature
- ▷ Press the switch up or down: shift curvature at top or bottom.

Seat, mirror and steering wheel memory

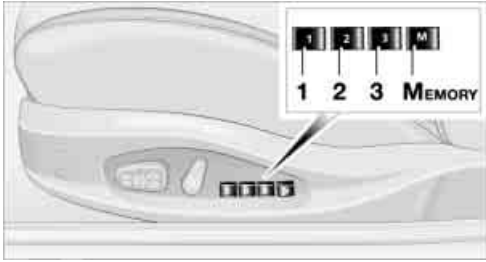

You can store and select three different adjustment settings for the driver's seat, exterior mirrors and steering wheel.

The adjustment of the lumbar support is not stored in the memory.

Storing

Ignition key as of position 1:

1. Adjust the desired seat, exterior mirror and steering-wheel positions
2. Press **MEMORY** button:
The indicator lamp in the button lights up
3. Press the desired memory button **1**, **2** or **3**:
The indicator lamp goes out.

Calling up automatically

You have two possibilities:

- ▷ Calling up on unlocking the vehicle
- ▷ Calling up on opening the driver's door.

If you want to call up the last driver's seat, exterior mirror and steering wheel position, proceed as follows:

Control Center, for principle details, refer to page 16:

1. Open the **i** menu
2. Select "Vehicle settings" and press the controller
3. Select "Door locks" and press the controller
4. Select "Central locking" and press the controller

5. Select "Last seat pos." and press the controller
6. Select "After unlocking" or "After opening door"



7. Press the controller.

Depending on which key you have used to open the vehicle, the last adjustment is applied.

! When using this Key Memory feature, always make sure that the footwell behind the driver's seat is empty and unobstructed. If you fail to do so, any persons or objects behind the seat could be injured or damaged by a rearward movement of the seat. ◀

Calling up manually

! Do not call up a position from the memory while the vehicle is moving. There is a risk of accident from unexpected movement of the seat or steering wheel. ◀

Convenience mode

1. Open the driver's door after unlocking or turn the ignition key to position 1
2. Briefly press the desired memory button **1**, **2** or **3**.

The system immediately cancels the adjustment procedure when you press one of the seat adjustment switches or use one of the memory buttons.

The adjusting procedure for the steering wheel is immediately interrupted if you operate the switch for the steering wheel adjustment in any direction, refer to page 48.

Safety feature

1. Close the driver's door and turn the ignition key to position 0 or 2
2. Press the desired memory button **1**, **2** or **3** and maintain pressure until the adjustment process has been completed.

If you press the **MEMORY** button accidentally:

Press the button again; the indicator lamp goes out.

Tilt function, passenger-side mirror

Automatic curb monitor

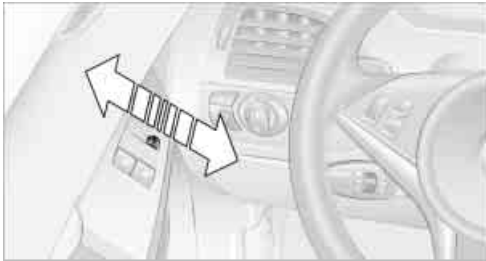

Activating

1. Select the driver's exterior mirror with the switch
2. When you engage reverse gear or selector-lever position R, the exterior mirror glass on the front passenger side tilts downward slightly. This allows the driver to see the area immediately adjacent to the vehicle – such as a curb – when parking, etc.

Deactivating

Slide the mirror selection switch to the passenger's side position.

Front head restraints

 Head restraints reduce the risk of spinal injury in the event of an accident. Adjust the head restraints so that they are centered roughly at the level of your ears. ◀

Coupe

Adjusting the height

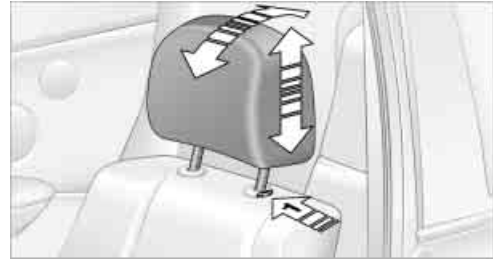

- ▷ To raise: pull
 - ▷ To lower: press.
-  To reach the lowest position, press the button, refer to arrow **1**. ◀

Adjusting tilt angle

Swivel the head restraints.

Removal

1. Pull the head restraint upwards to the stop
2. Press the button, arrow **1**, and remove the head restraint.

Installation

Push the head restraint into the supports.

Convertible

Adjusting height

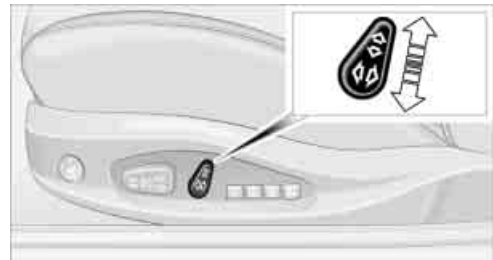

- ▷ To raise: move the switch upwards
- ▷ To lower: move the switch downwards.

Adjusting tilt angle

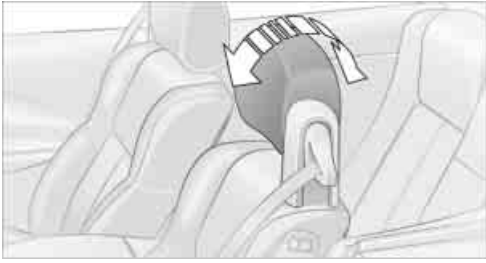

Swivel the head restraints.

Entry to the rear

⚠ Before moving off, fold back both seat backrests. Otherwise, there is a risk of accident from unexpected movement. ◀

Coupe: releasing backrest

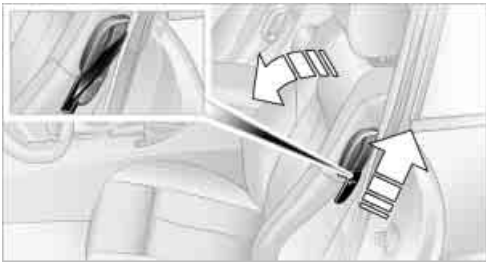

Pull the lever upwards and fold the backrest forwards.
The lever is designed in such a way that the safety belt can be stored there. This enables you to fasten the safety belt more conveniently.

Convertible: releasing backrest

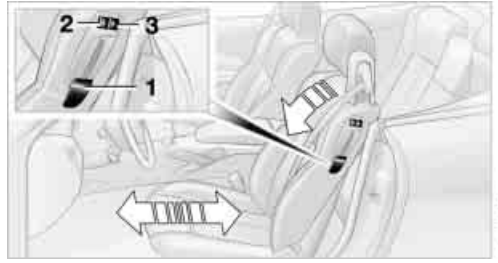

The belt system integrated in the seat ensures easier entry in the rear.

1. Pull lever **1** upwards and fold the backrest forwards
2. Press and hold button **2** until the seat has moved to the desired position
3. After entry to the rear, fold back the backrest and lock it in place
4. Press and hold button **3**. The seat moves back to its previous position. If you release button **3** before this, the seat stops in its current position.

▶ You can lock the backrest in place when it is folded forward. This is useful, for example, when you get into the vehicle when it is parked on a hill. Press the backrest until it audibly locks into place. To fold it back, you do not have to use lever **1** to release it. ◀

🔒 Lock backrest warning lamp:
Lights up when the backrest is not locked. At the same time, an additional message appears on the Control Display.

Safety belts

Fasten your safety belt before starting any trip. Airbags complement the safety belt as an additional safety device, but they do not represent a substitute.



Fastening

Make sure you hear the latch plate engage in the belt buckle.



Please fasten safety belt warning lamp:

Lights up until the driver and front passenger have fastened their safety belts. Depending on the model, a signal* sounds or a message* appears on the Control Display at the same time.

The warning is also issued when the driver or front passenger removes his or her safety belt while driving.



The warning can also take place if objects are placed on the passenger seat. ◀

Releasing

1. Hold the belt firmly
2. Press the red button in the belt buckle
3. Guide the belt into its reel.

The shoulder strap's anchorage point will be in the correct position for adults of every build if the seat is correctly adjusted, refer to page 43.

Damage to safety belts



If the safety belts are damaged or stretched in an accident: have the entire belt system, including the tensioning mechanisms, replaced at your BMW center. Have the belt anchorage points inspected for damage at the same time. Failure to observe this precaution may prevent the safety belts from effectively providing optimal protection when needed. ◀

Heated seats



The system regulates the temperatures of the seat cushion and backrest.

The temperature setting progresses one step through its control sequence each time you press the button.

To switch off:

Maintain pressure on the button for several seconds.

Mirrors

Adjusting exterior mirrors



Armrest in the driver's door:

- 1 4-way adjustment
- 2 Switching to the other mirror or automatic curb monitor, refer to page 45

⚠ To prevent the exterior mirrors from being damaged due to the width of the vehicle, always fold them in by hand before entering an automatic car wash. ◀

You can also adjust the mirrors manually if necessary by pressing against the outer edges of their lenses.

Storing the mirror positions, refer to Seat, mirror and steering wheel memory, page 44.

⚠ The mirror on the passenger's side features a lens with a more convex surface than the mirror installed on the driver's side. When estimating the distance between yourself and other traffic, bear in mind that the objects reflected in the mirror are closer than they appear. This means that estimations of the distance to following traffic should not be regarded as precise. ◀

Automatic functions

- ▷ Both exterior mirrors are automatically heated in ignition key position 2
- ▷ The interior and exterior mirrors dim depending on the light occurring when the vehicle is being driven forward*.

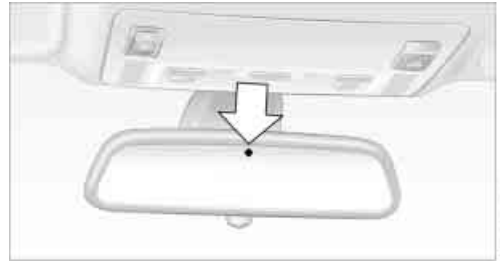

There are two photocells in the interior mirror to control the automatic dimming of the interior mirror. One is integrated within the mirror's lens, refer to arrow, while the other is located at an offset position on the rear of the mirror housing.

For trouble-free operation, keep the photocells clean and do not cover the area between the interior rearview mirror and the windshield. Do not attach any kind of stickers on the windshield in front of the mirror, either.

Steering wheel adjustment

⚠ Do not adjust the steering wheel while the vehicle is moving. There is a risk of accident from unexpected movement. ◀

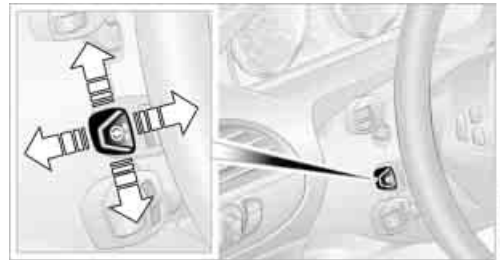

The steering wheel can be adjusted in four directions.

Storing the steering-wheel position, refer to Seat, mirror and steering wheel memory, page 44.

Automatic steering wheel adjustment

In conjunction with seat, mirror and steering wheel memory.

The steering wheel automatically moves as high up and far forward as possible to ease driver entry and exit before then returning to the standard position or stored memory setting.

This automatic feature is governed by the driver's door and the ignition lock.

Steering wheel heater*



In ignition key position 2, press the button. The indicator lamp within the button lights up when the steering wheel heater is in operation.

Programming button function

Depending on your vehicle's equipment, an individual function can be assigned to each of the two programmable function buttons in the steering wheel.



Control Center, for principle details, refer to page 16:

1. Open the **i** menu
2. Select "Vehicle settings" and press the controller
3. Select "Steering wheel buttons" and press the controller.

A list with different functions is displayed:

- ▷ "Navigation"
Voice instructions for the navigation system
- ▷ "Air recirculation on / off"
In this mode, you can continuously block the supply of outside air, refer to AUC Automatic recirculated-air control on page 89
- ▷ "Mute on / off"
Mutes the audio sources
- ▷ "Screen on / off"
Switches the Control Display on/off
- ▷ "Short cut / Telephone"
Display/hide phone book
- ▷ "Next entertainment source"
Changes audio source

4. Select the desired function



5. Press the controller
6. Select button if necessary



7. Press the controller.

Depending on which key you have used to open the vehicle, the last adjustment is applied.

You can operate the selected function using the corresponding button.

Operating function

Briefly press the corresponding button on the steering wheel.

Voice instructions of navigation system:

- ▷ Switch voice instructions on/off:
Maintain pressure on the button for several seconds
- ▷ Repeat the last voice instruction:
Briefly press the button
- ▷ To prevent the navigation system from interrupting other audio sources, such as a news program or traffic bulletin, you can cancel the voice instructions:
Press the button briefly during an instruction.

Transporting children safely

The right place for children

Children always in the rear

Accident research shows that the safest place for children in a vehicle is in the rear seat.

Older children should be tightly secured with a safety belt, after they have outgrown a booster seat that is appropriate for their age, height and weight.

Child-restraint system in the rear

 Children under 13 years of age and children less than 5 ft/150 cm tall should always ride in the rear and the restraint systems should be secured with the vehicle's safety belts. ◀

Younger children should be secured in an appropriate forward-facing child-restraint system that has first been properly secured. We strongly urge you to carefully read and comply with the instructions for installation and use provided by the child-restraint's manufacturer whenever you use such a device.

All rear sitting positions in your vehicle meet the recommendations of SAE J1819, an industry-recommended practice for securing child-restraint systems in motor vehicles.

Exception for front passenger seat

 Should it become necessary to use a child-restraint system on the front passenger seat, the airbags on the passenger's side must be deactivated. Deactivating the passenger airbags is only possible on the Coupe. Your BMW center will be glad to advise you. ◀

 Never install a rearward-facing child-restraint system in the front passenger seat of this vehicle if the passenger airbag is not deactivated. If you do so, the child could be severely injured when the airbag is triggered.

Your vehicle is equipped with an airbag supplemental restraint system for the front passenger. Because the backrest on any rearward-facing child-restraint system – of the kind designed for infants under 1 year and 20 lbs./9 kg – would be within the airbag's deployment range, you should never mount such a system in the front passenger seat, since the impact of the airbag against the child restraint's backrest could lead to serious or fatal injuries. ◀

Installing child-restraint systems

Before installing any child-restraint system or child seat, read the following:

 Observe the child-restraint system manufacturer's instructions for installation and use. Otherwise the degree of protection can be reduced. After an accident, have all parts of the child-restraint system and of the relevant vehicle safety belt system checked by a BMW center and replaced if necessary. ◀

Commercially-available child-restraint systems are designed to be secured with a lap belt or with the lap belt portion of a combination lap/shoulder belt. Improperly or inadequately installed restraint systems can increase the risk of injury to children. Always read and follow the instructions that come with the system.

Child seat security

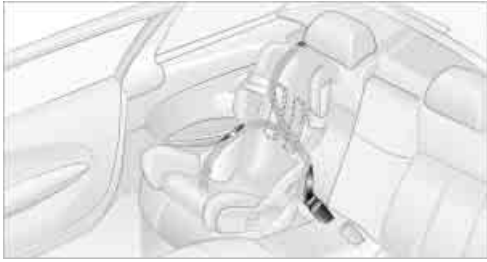

All of the rear belt retractors and the front passenger's safety belt can be locked for mounting and securing child-restraint systems.

Information regarding this is located near the buckle latch of each safety belt.

To lock safety belt

Pull the entire length of the belt from the belt retractor. Allow the reel to retract the belt somewhat and engage the buckle, then tighten the belt against the child-restraint system. The retraction mechanism is now locked.

To unlock safety belt

Release the buckle, remove the child-restraint system and allow the belt retractor to reel the belt completely in.

Coupe: child-restraint system with tether strap

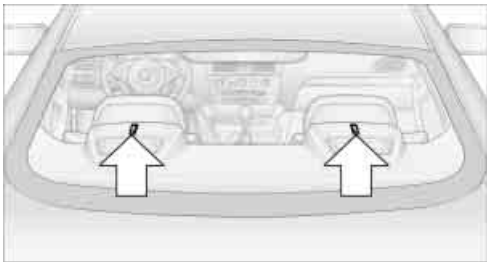

If you use a child-restraint system with a tether strap, two additional tether anchor points have been provided – refer to the arrows in the illustration. Depending on the location selected for sitting in the rear passenger area, attach the tether strap to

the corresponding anchorage point to secure the child-restraint system, as shown in the illustration below.

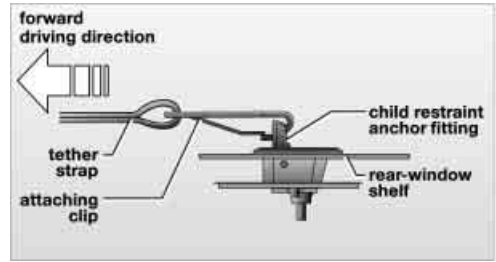

Each sitting position is fitted with a head restraint.

The head restraint must be adjusted into the lowest possible position. Pass the tether strap over the head restraint.

Adjust the tether strap according to the child-restraint manufacturer's instructions. ◀

LATCH child-restraint fixing

LATCH: Lower Anchor and Tethers for Children.

The rear outer sitting positions are provided with anchors for a LATCH child-restraint fixing.

To fit the LATCH child-restraint fixing, follow the operating and safety instructions of the system manufacturer. ◀

Access to anchorage points

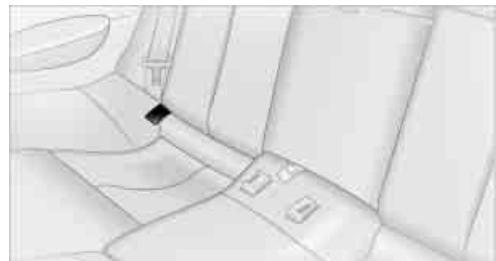

The illustrations show the right rear seat as an example. The outer anchorage points for the LATCH child-restraint fixing are identified by flags.

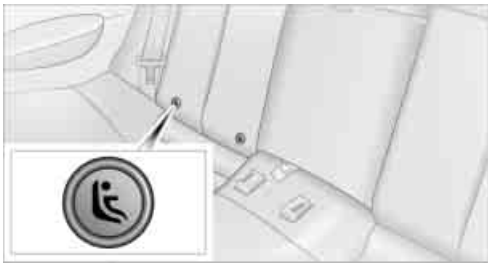

Canadian models only:
The anchorage points for the LATCH child-restraint fixing are identified by buttons.

Installation guide

The installation guide makes it easier to fit the LATCH child-restraint fixing and at the same time protects the surface of the seats.

 The installation guide is available at your BMW center. Always observe the related operating instructions and safety precautions. ◀

1. Pull the belt away from the area of the child-restraint fixing

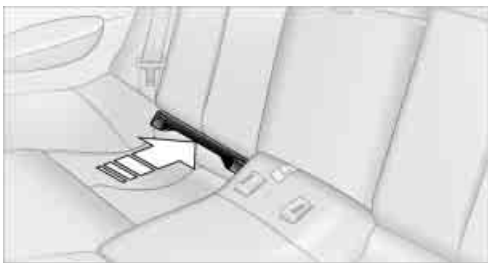

2. Firmly press the installation guide into the gap between the upholstery on seat and backrest, continuing until the two funnel-shaped guides snap into place in the LATCH support braces in the seat.

Pull the installation guide to remove.

Driving

Ignition lock

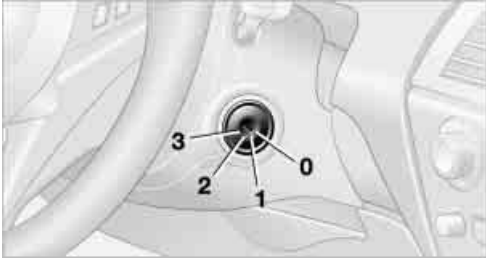

0 Steering locked

The key can only be inserted or removed in this position.

After removing the key, turn the steering wheel slightly until it locks.

Interlock on automatic transmission

- ▷ Only move the selector lever from position P with the engine running
- ▷ To turn the key back to position 0 or to remove it, first select the selector lever position P.

1 Steering unlocked

A slight steering wheel movement often makes it easier to turn the key from 0 to 1. Individual current consumers are ready for operation.

2 Ignition switched on

All vehicle systems are ready for operation.

3 Start engine

Starting engine

 Do not run the engine in closed rooms, as otherwise the inhaling of toxic exhaust gases can cause unconsciousness and death. The exhaust gases contain carbon monoxide, an odorless and colorless, but highly toxic gas.

Never leave an unattended vehicle with the engine running, as such a vehicle represents a potential safety hazard.

To prevent the vehicle from rolling, always select idle position or position N and apply the handbrake before leaving the vehicle with the engine running. ◀

When starting the engine, do not press the accelerator pedal.

Do not allow the engine to warm up by leaving it running while the vehicle remains stationary. Instead, begin to drive immediately at a moderate engine speed.

Special starting conditions

Press the accelerator pedal halfway down when starting if

- ▷ the engine fails to start on the first attempt, for instance, if it is very hot or cold
- ▷ the engine is started at very low temperatures, below approx. +5 °F / -15 °C, at high altitudes, over 3,300 ft/1,000 m.

 Avoid frequent starting in quick succession or repeated start attempts in which the engine does not start. Otherwise, the fuel is not burned or inadequately burned and there is a danger of overheating and damaging the catalytic converter. ◀

Manual transmission

1. Apply the handbrake
2. Gearshift lever in idle position
3. Press the clutch pedal

 If the clutch pedal is not depressed, the engine will not start. ◀

4. Start the engine.

Do not terminate the starting operation too early, but after approx. 20 seconds at the latest. When the engine starts, let go of the ignition key immediately.

SMG Sequential manual transmission and automatic transmission

Your BMW is equipped with the convenience starting feature. Here, it is sufficient to turn the ignition key only briefly to position 3 'Start engine' and to let go of it right away. The system responds by automatically engaging the starter for a certain period and allowing it to run until the engine starts, after which it then disengages automatically.

SMG Sequential manual transmission

1. Press the brake pedal
2. Engage selector-lever position N
3. Start the engine.

 If the engine does not start, engage the last gear selected again, refer to instrument cluster display, and then engage selector-lever position N. ◀

Automatic transmission with Steptronic

1. Press the brake pedal
2. Engage selector-lever position P or N
3. Start the engine.

Switching off engine

 Do not remove the ignition key while the vehicle is rolling, as otherwise the steering wheel lock would engage while steering.

When leaving the vehicle, remove the ignition key and lock the steering. When parking on a downhill incline, apply the handbrake, as otherwise the vehicle could roll away. ◀

Manual transmission

1. Turn the ignition key to position 1 or 0
2. Engage first or reverse gear.

SMG Sequential manual transmission

1. Engage a drive position
2. Turn the ignition key to position 1 or 0. A signal sounds if the idle position N is engaged on stopping the engine.

Automatic transmission with Steptronic

1. Engage selector-lever position P
2. Turn the ignition key to position 1 or 0.

Handbrake

The handbrake is primarily intended to prevent the vehicle from rolling while parked; it brakes the rear wheels.

Indicator lamp

 The indicator lamp lights up, and an acoustic signal also sounds when starting off. The handbrake is engaged.

 Indicator lamp for Canadian models.

Engaging

The lever locks into place automatically; the indicator lamp in the instrument cluster lights up as of ignition key position 1.



Releasing

Pull slightly upwards, press the button and lower the lever.

 If exceptional circumstances should make it necessary to engage the handbrake while the vehicle is in motion,

do not pull it too strongly. In doing so, continuously press the button of the handbrake lever.

Strong application of the handbrake can lead to overbraking of the rear axle and associated 'fishtailing' of the vehicle rear end.

The brake lamps do not light up when the handbrake is engaged.

Vehicles with manual or SMG transmission: When parking on inclines, engage the handbrake, as even engaging the first or reverse gear might not under certain circumstances secure the vehicle against moving.

Vehicles with automatic transmission: Engage selector-lever position P. ◀

 To prevent corrosion and one-sided braking action, occasionally engage the handbrake lightly when the vehicle is slowly coming to a standstill if the traffic conditions are suitable. ◀

Manual transmission



 While shifting gear in the 5th/6th gear level, press the gearshift lever to the right, as otherwise engine damage could occur from inadvertently engaging a gear in the 3rd/4th gear level.

On inclines, do not hold the vehicle with the clutch; use the handbrake. Otherwise there is high clutch wear. ◀

Reverse gear

Select only when the vehicle is completely stationary. When pressing the gearshift lever to the left, overcome some resistance.

The backup lamps automatically switch on in ignition key position 2.

SMG Sequential manual transmission*

The concept

The SMG Sequential manual transmission is an automated manual transmission in which an electro-hydraulic system handles the clutching and gear changes.

You operate the SMG using the selector lever in the center console and two shift paddles on the steering wheel.

It offers the following functions:

- ▷ Choice of manual or automatic mode: Sequential mode or Drive mode
- ▷ Options of two drive programs: Normal or Sport, refer to page 59
- ▷ Protection against incorrect gearshifts and automatic shift down at minimum engine speed, also in the Sequential mode
- ▷ Kickdown function in the Drive mode
- ▷ Acceleration assistant, refer to page 60.

The SMG is operational in ignition key position 2.

Selector-lever positions



The current selector-lever position is displayed on the center console.

- ▷ R: Reverse gear
- ▷ N: Neutral, idle

- ▷ One-touch function for Sequential mode
 - +: manual upshifts
 - : manual downshifts
- ▷ D: Drive mode.

 N is automatically engaged if the driver's door is opened with the engine running and neither pedals, shift paddles nor the selector lever are operated. This is indicated by an acoustic signal and the flashing display N in the instrument cluster. ◀

Gear display



R N 1 to 6

The currently engaged gear is displayed, in the Drive mode preceded by a D.

Shiftlock

Press the brake pedal before shifting out of N; the shift command will not be executed unless the brake is applied.

R Reverse

Select only when the vehicle is completely stationary.

Sequential mode

After every engine start, as soon as the selector lever is pushed to the right and the brake pedal is pressed, the Sequential mode is activated.

The gear is changed using the shift paddles or selector lever.

Driving off is also possible in second gear, e.g. when the roadway is icy.

D Drive mode

In the Drive mode, all forward gears are shifted automatically.

To switch from Sequential to Drive mode: Briefly press the selector lever to the right towards D.

Kickdown:

For rapid acceleration, e.g. overtaking, press the accelerator pedal as far down as it will go: you achieve maximum acceleration.

To switch back to the Sequential mode: briefly press the selector lever back to the right towards D or change the current gear using the shift paddles or selector lever.

 Start off quickly on slopes. Do not hold the vehicle on a hill by applying the throttle, but engage the handbrake instead. Otherwise overheating can occur in the area of the transmission. ◀

Gear changes

Using selector lever

- ▷ To shift up, briefly press the selector lever towards +
- ▷ To shift down, briefly press towards –.

Using shift paddles on steering wheel

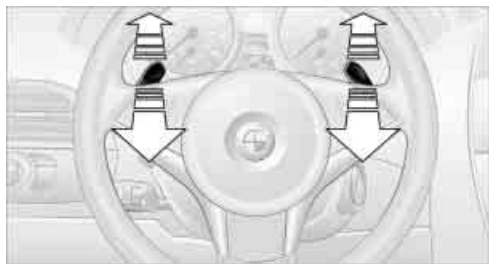

- ▷ To shift up, pull one of the shift paddles
- ▷ To shift down, press.

In the following situations, the SMG in the Sequential mode assists you:

- ▷ Upshifts and downshifts are executed only when they will result in a plausible combination of engine and vehicle

speed; thus, for example, a downshift that would cause the engine to overrev will not be executed by the system

- ▷ When the vehicle is stationary, the transmission automatically downshifts into first gear
- ▷ Shortly before dropping below a gear-dependent minimum speed, the transmission downshifts automatically even without your intervention.

Malfunction



The warning lamp lights up and a message appears on the Control Display. There is a malfunction in the transmission system. Avoid high loads. While it will remain still possible to move the selector lever to any desired position, the transmission will revert to operation in its default mode with only a limited number of forward gears.

Have the system checked as soon as possible.

Information on jump-starting and towing begins on page 185.

Overheating



The warning lamp lights up and a message appears on the Control Display. In addition, an acoustic signal sounds. Overheating in the area of the transmission. If possible, stop or drive off quickly so that the system can cool down.

Automatic transmission with Steptronic*

In addition to the fully automatic mode, you can also shift manually with Steptronic, refer to page 59.

Selector-lever positions

P R N D M/S + -

Possible displays



P R N D DS M1 to M6

The selector lever position is indicated, and in the manual mode the gear currently engaged.

Changing selector-lever positions



An interlock prevents inadvertent gear-shifts into selector-lever positions R and P. To cancel the interlock, press the button on the front of the selector lever knob, refer to arrow.

Shiftlock

Press the brake pedal before shifting out of P or N; the shift command will not be executed unless the brake is applied.

To prevent the vehicle from creeping after you select a driving position, maintain pressure on the brake pedal until you are ready to start.



To prevent the vehicle from rolling, always select selector-lever position P and engage the handbrake before leaving the vehicle with the engine running. Never leave an unattended vehicle with the engine running, as such a vehicle represents a potential safety hazard. ◀

P Parking

Select only when the vehicle is completely stationary. The rear wheels are blocked.

R Reverse

Select only when the vehicle is completely stationary.

N Neutral

E.g. engage in car washes. The vehicle can roll.

D Drive, automatic position

Position for normal vehicle operation. All forward gears are available. Under normal operating conditions, fuel consumption is lowest when driving in position D.

Kickdown

The kickdown mode provides maximum acceleration:
Press the accelerator pedal beyond the full-throttle resistance point.

M/S manual operation and Sport program



Move the selector lever from position D to the left into gearshift gate M/S:

The sport program is activated and DS appears in the instrument cluster. This position is recommended for a performance-oriented driving style. It is engaged automatically when the Dynamic Driving Control is activated, see below.

When the selector lever is moved slightly towards + or -, the Steptronic shifts gear and manual operation is activated. The instrument cluster shows M1 through M6.

Upshifts and downshifts are executed only when they will result in a plausible combination of engine and vehicle speed; thus, for example, a downshift that would cause the engine to overrev will not be executed by the system. The selected gear appears briefly in the instrument cluster, followed by the current gear.

To use the automatic function again, move the selector lever to the right into position D.

Malfunction



The warning lamp lights up and a message appears on the Control Display. There is a malfunction in the transmission system. Avoid heavy loads.

While it will remain still possible to move the selector lever to any desired position, the transmission will revert to operation in its default mode with only a limited number of forward gears. Have the system checked as soon as possible.

Towing, refer to page, 185, jump-starting, refer to page 185.

Dynamic Driving Control

The Dynamic Driving Control makes it possible for your BMW to react in an even more sports-oriented manner at the push of a button:

- ▷ The engine responds more spontaneously to accelerator pedal movements
- ▷ The steering conveys a feeling of even better contact with the road surface
- ▷ Cruise control:
The stored speed you call up is reached more quickly.

Additionally with SMG:

- ▷ Gearshifts are faster
- ▷ The engine speed range is used optimally in the Drive mode.

With automatic transmission:

- ▷ The Sport program is activated.

Activating system



With ignition key in position 2

Press the SPORT button.
The LED in the button lights up and SPORT is displayed in the instrument cluster.

Deactivating system

- ▷ Press the SPORT button again or
- ▷ engage reverse gear or
- ▷ switch off the engine.

The LED in the button and SPORT in the instrument cluster go out.

Acceleration assistant with SMG

The acceleration assistant enables optimized vehicle acceleration at racing car level on road surfaces with good adhesion when starting off.

 Do not use the acceleration assistant too often, as otherwise components will wear prematurely. ◀

1. Activate the Dynamic Driving Control
2. Press the DSC button, refer to page 77, for longer than three seconds
3. Press the accelerator pedal down fully: kickdown. The ideal starting-off engine speed is set.

 To maintain driving stability, drive with the DSC on whenever possible. ◀

Turn signals/ headlamp flasher

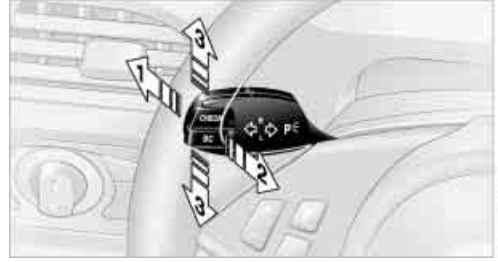

- 1 High beams
- 2 Headlamp flasher
- 3 Turn signals

Using turn signals

Move the lever beyond the resistance point. It then returns to the center position when released. Press the lever as far as the resistance point to switch off the turn signals.

 If the indicator lamp flashes faster than usual, a turn signal has failed. ◀

Signaling briefly

Press the lever as far as the resistance point and hold there if necessary. It then returns to the center position when released.

Triple turn signal activation

Press the lever as far as the resistance point; the turn signals flash three times. You can activate or deactivate this function.

Control Center, for principle details, refer to page 16:

1. Open the  menu
2. Select "Vehicle settings" and press the controller
3. Select "Lighting" and press the controller
4. Select "Triple turn signal activation" and press the controller.

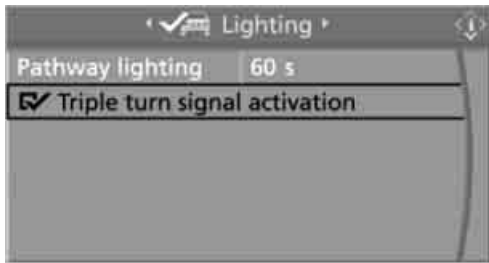

Triple turn signal activation is activated.

Wiper system



- 1 Standard wiper speed: briefly press once.
The system automatically reverts to operation in the intermittent mode whenever the vehicle is stationary.
Fast wipe: briefly press twice or press beyond the resistance point.
The system automatically reverts to operation in the standard wipe mode whenever the vehicle is stationary
- 2 Switching off wipers or for brief wipe
- 3 Activating/deactivating rain sensor
- 4 Cleaning windshield and headlamps
- 5 Adjusting rain sensor sensitivity level

The lever automatically returns to its initial position when released.

Cleaning windshield and headlamps

The system sprays washer fluid against the windshield and activates the wipers for a brief period.

When the vehicle lighting system is switched on, the headlamps are also

cleaned at regular and appropriate intervals.

⚠ Do not use the washers if there is any danger that the fluid will freeze on the windshield. If you do so, your vision could be obscured. To avoid freezing, use a washer fluid antifreeze, refer to Washer fluid.

Avoid activating the washer when the reservoir is empty, as damage to the pump could result. ◀

Windshield washer nozzles

The windshield washer nozzles are automatically heated in ignition key position 2.

Rain sensor

The rain sensor controls windshield wiper operation depending on the amount of rain. The rain sensor is located on the windshield, directly in front of the interior rear-view mirror.

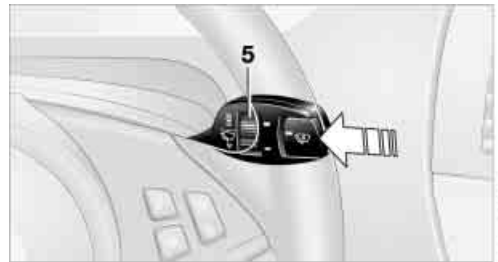

Activating rain sensor

As of ignition key position 1, briefly press the button. The indicator lamp in the button lights up. The wipers will always respond by completing at least one sweep of the windshield.

Adjusting rain sensor sensitivity level

Turn the serrated dial **5**.

Deactivating rain sensor

Press the button again. The indicator lamp goes out.

The rain sensor is automatically deactivated when you switch off the ignition.

 Deactivate the rain sensor when passing through an automatic car wash. Failure to do so could result in damage caused by undesired wiper activation. ◀

Washer fluid

 Washer fluid antifreeze is flammable. Always keep it well away from sparks and open flames, and store it in tightly closed containers well out of the reach of children. Always observe the instructions for use provided on the containers. ◀

Washer fluid reservoir

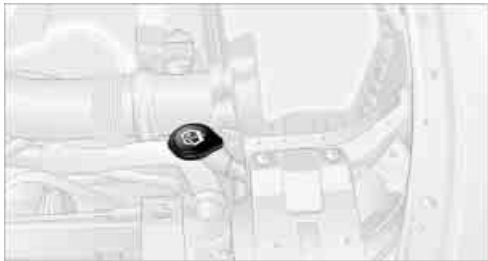

Capacity approx. 5.3 US quarts/5 liters
Fill with water and – if required – with a washer antifreeze, according to manufacturer's recommendations.

 In order to keep to the mixture ratio, mix the washer fluid before filling. ◀

Cruise control

The concept

The cruise control is available for use at speeds of approx. 20 mph/30 km/h and higher. The vehicle maintains and stores the speed that you set using the lever mounted on the steering column.

 Do not use the cruise control when driving on winding roads, in heavy traffic or in poor road conditions – e.g. snow, rain, ice, loose road surface – that do not permit a constant speed. ◀

One lever for all functions

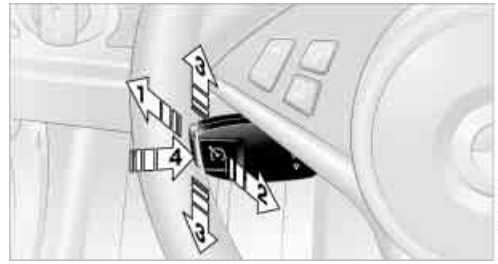

1 Maintaining and storing speed, accelerating

Press the lever up to the resistance point: The system maintains and stores the current vehicle speed. The display **1** in the speedometer indicates this regulated speed, refer to page 63. Every time you briefly press the lever, the vehicle's speed increases by roughly 1 mph/1 km/h.

Press the lever up to the resistance point and hold it:

The vehicle accelerates without pressure on the accelerator pedal. The system maintains and stores your current speed as soon as you release the lever.

Press the lever beyond the resistance point:

Increases the speed by 5 mph/10 km/h.

The vehicle may accelerate beyond the regulated speed on steep downhill stretches where the engine's braking effect alone may not be sufficient to slow the vehicle. Speed can drop on uphill grades if the engine output is insufficient.

2 Maintaining and storing speed, decelerating

Pull the lever:

Functions are the same as **1**, only the vehicle speed is reduced.

3 Interrupting cruise control

With the cruise control active, briefly press the lever up or down.

In addition, cruise control is interrupted automatically

- ▷ when you apply pressure to the brake pedal
- ▷ when you press down the clutch pedal or engage position N of the automatic transmission/SMG
- ▷ when DSC comes on.

4 Recalling stored speed

Briefly press button **4**: the vehicle accelerates to and maintains the stored speed.

Deactivating system

When the ignition is switched off, the system is deactivated and the stored speed is deleted.

Displays in instrument cluster



- 1 Display for stored speed with cruise control activated
- 2 Digital speedometer. Briefly displays the selected speed

Everything under control

Odometer, outside temperature display, clock



When the ignition is off you can briefly activate the time, outside temperature and odometer displays by pressing the knob **3** at the lower left of the instrument cluster.

Outside temperature display, clock, date 1

The outside temperature and the time are displayed from ignition key position 1 onwards.

You can set the measurement unit °F or °C on the Control Display, refer to Measurement units on page 72.

To call up the date:

Briefly press the CHECK button on the turn indicator lever, refer to page 69.

Setting the time and date, refer to page 73.

Ice warning

A signal sounds when the outside temperature falls to roughly +37.5 °F/+3 °C; this is accompanied by a message.

 Please bear in mind that the ice warning does nothing to alter the fact that black ice may be present on roads at temperatures higher than +37.5 °F/+3 °C, e.g. on bridges and shaded roads. ◀

Odometer and trip odometer 2

To reset the trip odometer to zero:
Press button **3** in the instrument cluster.

Tachometer



The white-striped advance warning field, arrow **1**, changes depending on the engine temperature. The segments disappear in sequence as the engine warms to its normal operating temperature.

Avoid allowing the engine speed to rise as far as the advance warning field whenever possible.

Engine speeds in the red warning field, arrow **2**, must be avoided.

In this range, the fuel supply is interrupted to protect the engine.

Engine oil thermometer



The engine oil temperature is between approx. 160 °F/70 °C and approx. 340 °F/170 °C during normal operation. If the engine oil temperature is too high, a message appears on the Control Display.

Fuel gauge



Fuel tank capacity: approx. 18.5 US gallons/70 liters, including the reserve capacity of approx. 2.1 gallons/8 liters. You can find information on refueling on page 162.

If the tilt of the vehicle varies for a longer period, when you are driving in mountainous areas, for example, the indicator may fluctuate slightly.

After the reserve quantity has been reached, a message appears for a short time on the Control Display; the remaining range is shown in the computer. Below a range of approx. 30 miles/50 km, the message remains on the Control Display.

 Refuel as soon as possible once your cruising range falls below 30 miles/50 km, as otherwise engine functions are not ensured and damage can occur. ◀

Service requirement display

In instrument cluster



The remaining distance to be driven, the date for the next maintenance as well as the date entered for the state emission or vehicle inspection are displayed briefly as of ignition key position 2, if the date is imminent.

 Your BMW Service Advisor will determine your vehicle's current service requirements by reading out the data stored in the vehicle key. ◀

On Control Display

You can view additional information on service and maintenance procedures on the Control Display.

Control Center, for principle details, refer to page 16:

1. Open the **i** menu
2. Select "Service" and press the controller
3. Select "Service requirements" and press the controller
4. Select "Status" and press the controller.

The display shows a list of selected service and maintenance procedures, as well as legally mandated official inspections.

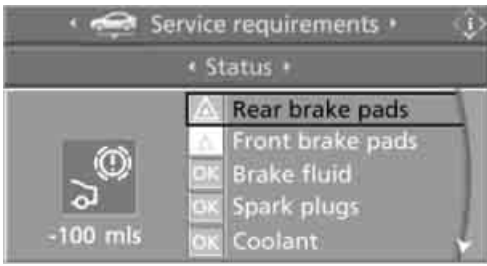

Symbols

- The service deadline has already passed.
- The deadline for service or an official inspection is approaching. Please fix a service appointment.
- No service is currently required.

You can request more detailed information on every entry.



Select the entry and press the controller.

To exit the menu:

Select and press the controller.

Entering dates for state emission and vehicle inspections

Make sure the date in the Control Center is always set correctly, refer to page 73, as otherwise the effectiveness of CBS Condition Based Service is not ensured.

Control Center, for principle details, refer to page 16:

1. Open the menu
2. Select "Service" and press the controller
3. Select "Service requirements" and press the controller

4. Select "Status" and press the controller
5. Select "Emission inspect." or "State inspection" and press the controller

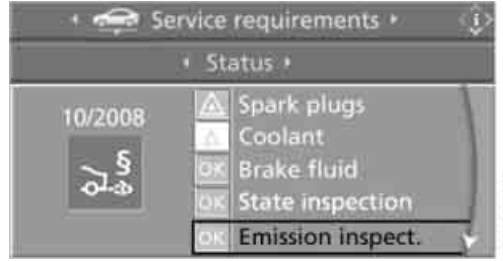

6. Select "Set service date" and press the controller. The month is highlighted
7. Turn the controller to make the adjustment



8. Press the controller to apply the setting. The year is highlighted
9. Turn the controller to make the adjustment
10. Press the controller to apply the setting. The date entry is stored.

To exit the menu:

Select and press the controller.

Check Control

The concept

The Check Control monitors functions in the vehicle and issues a message if there is a malfunction in the monitored systems.

Supplementary messages on the Control Display are intended to assist you in assessing the severity of malfunctions; they provide you with the information you need to decide on the best way to respond.

Display of a message



▲ means that a Check Control message is present.

Information and malfunction reports are indicated by an illuminated indicator or warning lamp symbol.



At the same time, a gong sounds and a text message appears on the Control Display.

Supplementary instructions

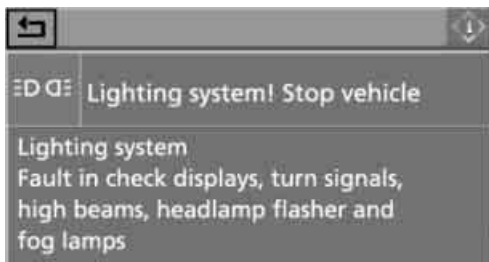

Messages are assigned one of two priority ratings:

Priority 1

These messages and malfunction reports are signaled by a gong. If a number of malfunctions occur simultaneously, they are displayed in succession. These messages cannot be deleted, and they remain on the

display until the problem is corrected. Supplementary information can also appear on the Control Display.

To exit the menu:

Select and press the controller.

Priority 2

These status messages and malfunction reports are indicated by the gong and displayed for approx. 20 seconds.

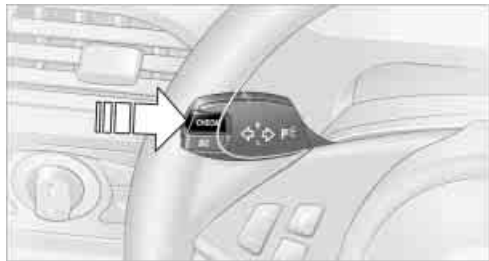

To hide a displayed message: briefly press the CHECK button on the turn signal lever.

Check Control symbol and message on Control Display

Depending on the status of the monitored systems, various symbols are displayed:

- No malfunctions are present in the monitored systems.
- Malfunctions are present in the monitored systems.
- Depending upon how serious the problem is, a supplementary message may also appear on the Control Display.

The symbols also indicate the status of the service requirement display, refer to page 66.

Calling up stored messages on Control Display

Using CHECK button

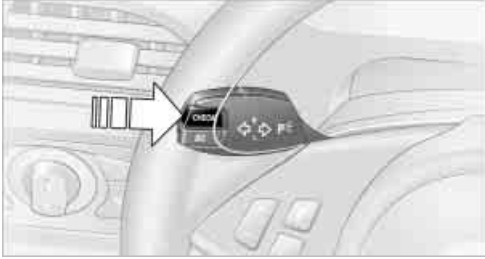

1. Press the button longer:
The first stored message is displayed
2. Briefly press the button:
A new message appears each time you briefly press the button.

Using Control Center

Control Center, for principle details, refer to page 16:

1. Press button.

MENU

The start menu is opened



2. Press the controller to open the **i** menu
3. Select "Service" and press the controller
4. Select "Check Control messages" and press the controller. The stored messages appear on the display
5. Select the desired message and press the controller.

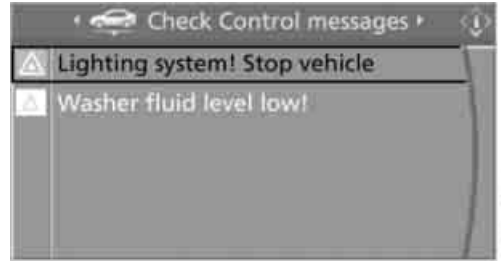

The display disappears automatically after a short time.

To exit the menu immediately:
Select  and press the controller.

Displays after completion of trip

Malfunction reports generated during the trip are shown consecutively when you switch off the ignition.

Before the display disappears, you can display the messages once again. Press the CHECK button for approx. 2 seconds.

If several messages are present, you can continue to briefly press the CHECK button to view them in succession.

The display

- ▷ cancels itself automatically after a brief period
- ▷ can be canceled by again pressing the CHECK button for approx. 2 seconds.

Computer

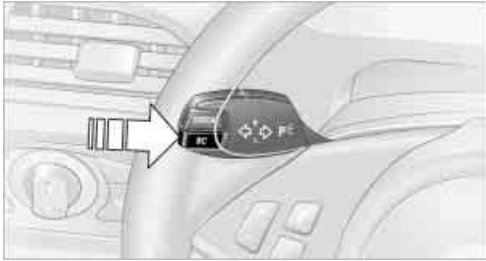

Mode selection

As of ignition key position 1, you can use the BC button in the turn signal lever to call up computer information in the instrument cluster.

A new function appears each time you briefly press the BC button.

Displays in instrument cluster



The display sequence:

- ▷ Cruising range
- ▷ Average speed
- ▷ Average fuel consumption.

Cruising range

Displays the estimated cruising range available with the remaining fuel. The system calculates the cruising range based on operating conditions over the last 20 miles/30 km and the amount of fuel remaining in the tank.

 Always refuel as soon as possible once your cruising range falls to below 30 miles/50 km, as otherwise engine functions are not ensured and damage can occur. ◀

Average fuel consumption

The average fuel consumption is calculated for the time during which the engine is running.

You can use the Control Display to view your fuel consumption rate over two different distances, refer to Computer or Trip computer.

To reset the average fuel consumption: press the BC button in the turn signal lever for approx. 2 seconds.

Average speed

Periods with the vehicle parked and the engine off are not included in the calculations of average speed.

To reset the average speed: press the BC button in the turn signal lever for approx. 2 seconds.

Displays on Control Display

You can also call up the computer via the Control Center, for principle details, refer to page 16:

1. Press button.

MENU

The start menu is opened



2. Move the controller to the right to open "Navigation".
On vehicles without navigation system: open "Car Data"
3. Select "Car Data" and press the controller.

You can choose between two display options:

- ▷ Computer

- ▷ Trip computer, suitable e.g. for a vacation trip.

Computer

Select "Onboard info" and press the controller.



- ▷ Estimated time of arrival at destination:
 - ▷ Entering a distance manually in the computer, see below
 - ▷ Entering a destination in the navigation system, refer to page 110
- ▷ Cruising range
- ▷ Distance to destination:
 - ▷ Entering a distance manually in the computer, see below
 - ▷ Entering a destination in the navigation system, refer to page 110
- ▷ Average speed
- ▷ Average fuel consumption.

Trip computer

Select "Trip computer" and press the controller.



- ▷ Departure time
- ▷ Driving time
- ▷ Elapsed distance
- ▷ Average speed

- ▷ Average fuel consumption.

To switch the trip computer on/off and reset all the values:

1. Select "Set" and press the controller
2. Select the desired menu item
3. Press the controller.

Entering a distance manually

Control Center, for principle details, refer to page 16:

1. Open "Navigation".
On vehicles without navigation system: open "Car Data"
2. Select "Car Data" and press the controller
3. Select "Onboard info" and press the controller
4. Select "Dist. to destination" and press the controller



5. Turn the controller to select the distance to your destination. When doing so, maintain a slight resistance if necessary if a greater difference is to be entered
6. Press the controller to apply the setting.
With the destination guidance switched on, the distance is given automatically.

Display options

You can display the computer or the trip computer in the assistance window.

Control Center, for principle details, refer to page 16:

1. Move the controller to the right to change to the assistance window and press the controller



2. Select a menu item:
 - ▷ "Onboard info"
 - ▷ "Trip computer"
3. Press the controller.



Speed limit

You can enter a speed and a Check Control message indicates when you have reached this speed. This enables you, for example, to receive warnings if you exceed a speed limit in an urban area.

You are only warned of reaching this speed a second time if you again drive at least 3 mph/5 km/h slower.

Entering, changing

Control Center, for principle details, refer to page 16:

1. Open "Navigation".
On vehicles without navigation system: open "Car Data"
2. Select "Car Data" and press the controller
3. Select "Limit" and press the controller
4. Select the speed and press the controller

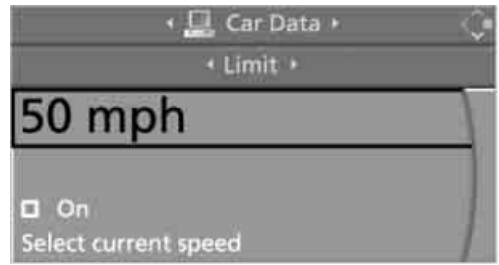

5. Turn the controller to set the limit. When doing so, maintain a slight resistance if necessary if a greater difference is to be entered
6. Press the controller to apply the setting.

Applying your current speed as limit

Control Center, for principle details, refer to page 16:

1. Open "Navigation".
On vehicles without navigation system: open "Car Data"
2. Select "Car Data" and press the controller
3. Select "Limit" and press the controller
4. Select "Select current speed" and press the controller. The system applies your current speed as the limit.

Activating limit

Control Center, for principle details, refer to page 16:

1. Open "Navigation".
On vehicles without navigation system: open "Car Data"
2. Select "Car Data" and press the controller
3. Select "Limit" and press the controller
4. Select "On" and press the controller.
 Limit is activated.

Stopwatch

Control Center, for principle details, refer to page 16:

1. Open "Navigation".
On vehicles without navigation system: open "Car Data"
2. Select "Car Data" and press the controller
3. Select "Stopwatch" and press the controller.



Starting and stopping

- ▷ Select "Start" and press the controller. The stopwatch starts at the displayed time
- ▷ Select "Reset" and press the controller. The stopwatch is reset and it restarts if it was running beforehand
- ▷ Select "Stop" and press the controller. This stops the timer.

Taking an intermediate time reading

Select "Interim time" and press the controller. This intermediate time appears below the ongoing primary stopwatch count.

- ▷ All of the remaining functions remain available at all times while the stopwatch is running. The stopwatch continues operation in the background. ◀

Settings on Control Display

Brightness of Control Display

The brightness is automatically adapted to the ambient lighting conditions. However, you can change the base setting.

Control Center, for principle details, refer to page 16:

1. Press button.

MENU

The start menu is opened



2. Press the controller to open the **i** menu
3. Select "Display settings" and press the controller
4. Select "Brightness" and press the controller
5. If necessary, move the controller to the right to select "Display Offset"
6. Turn the controller until the desired setting is selected.



Depending on which key you have used to open the vehicle, the last adjustment is applied.

Measurement units

You can change the measurement units for consumption, distances, temperature and pressure.

1. Open the **i** menu
2. Select "Display settings" and press the controller
3. Select "Units" and press the controller

4. Select the menu item to be set

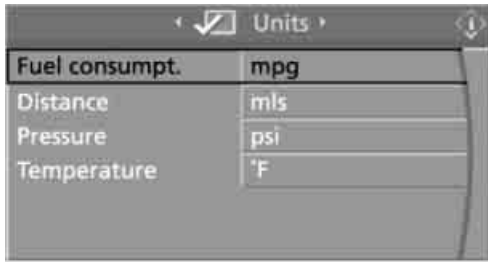

5. Press the controller
6. Select the desired measurement unit and press the controller.

Depending on which key you have used to open the vehicle, the last settings are applied.

Language on Control Display

The language on the Control Display can be set.

Control Center, for principle details, refer to page 16:

1. Open the **i** menu
2. Select "Display settings" and press the controller
3. Select "Languages" and press the controller
4. Select "Text language" and press the controller. You can select a different language for the text displays

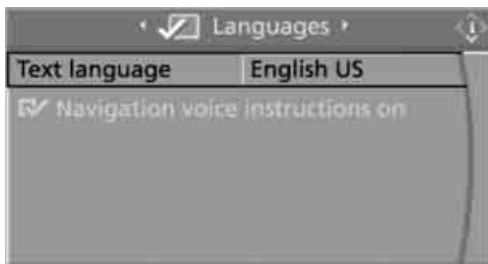

5. Select the desired language and press the controller.

Depending on which key you have used to open the vehicle, the last adjustment is applied.

Setting time

Control Center, for principle details, refer to page 16:

1. Open the **i** menu
2. Select "Display settings" and press the controller
3. Select "Time" and press the controller
4. Select "Set time" and press the controller. The hours are selected

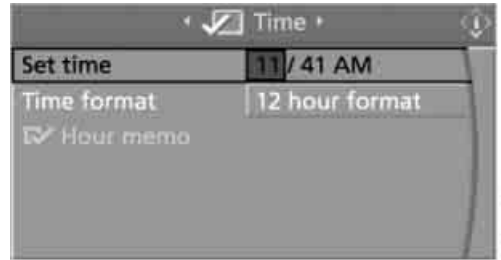

5. Turn the controller to set the hours
6. Press the controller to apply the setting. The next adjustment is highlighted
7. Make the remaining adjustments. After the last adjustment, the time is stored.

12h/24h mode

The mode can be set.

1. Select "Time format" and press the controller
2. Select the desired mode and press the controller.

Depending on which key you have used to open the vehicle, the last adjustment is applied.

Switching on hour signal*

You will hear three tones just before each full hour.

Select "Hour memo" and press the controller.

- The hour signal is activated.

Setting date

Control Center, for principle details, refer to page 16:

1. Open the **i** menu
2. Select "Display settings" and press the controller
3. Select "Date" and press the controller
4. Select "Set date" and press the controller. The first section of the date display is highlighted, here the day

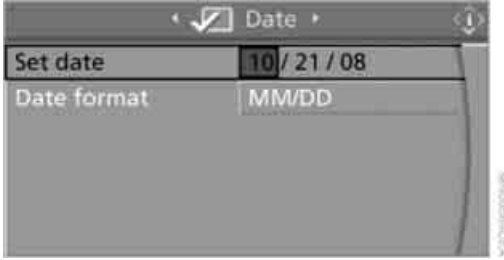

5. Turn the controller to make the adjustment
6. Press the controller to apply the setting. The next adjustment is highlighted
7. Make the remaining adjustments. After the last adjustment, the date is stored.

Changing date format

The date format can be set.

1. Select "Date format" and press the controller
2. Select the desired format and press the controller.

Depending on which key you have used to open the vehicle, the last adjustment is applied.

Technology for comfort, convenience and safety

PDC Park Distance Control*

The concept

The PDC assists you when you are parking. Signal tones and a visual display* indicate the current distance to an object behind or in front of your vehicle. To measure the distance, there are four ultrasonic sensors in each bumper. The sensors at the front and at the two rear corners have a range of approx. 20 in/50 cm; the rear middle sensors have approx. 5 ft/1.50 m.

 PDC is a parking aid that can indicate objects when they are approached slowly, as is usually the case when parking. Avoid approaching an object at high speed, as otherwise the physical circumstances would mean that the system warning was too late. ◀

Automatic mode

In ignition key position 2, the system automatically assumes operational status after a few seconds each time you engage reverse gear or selector-lever position R.

 Wait this short period before driving. ◀
The system is automatically deactivated once the vehicle travels approx. 165 ft/50 m or exceeds a speed of roughly 20 mph/30 km/h; the indicator lamp goes out. You can reactivate the system manually as needed.

Manual mode

With the ignition key in position 2, press the button; the indicator lamp lights up.



Deactivating manual mode

Press the button again; the indicator lamp goes out.

Signal tones

The signal indicating the distance to the nearest obstacle is directional. Thus, an object detected to the left rear of the vehicle will be indicated by a signal tone from the left rear speaker, etc. As the distance between vehicle and object decreases, the intervals between the tones become shorter. The signal tone becomes continuous once the distance to the nearest object falls to below roughly 1 ft/30 cm.

The warning signal is canceled after approx. 3 seconds if you are moving parallel to a wall.

Malfunctions

The indicator lamp within the button flashes and a message appears on the Control Display. PDC has failed. Switch off PDC. Have the system checked.

As a preventive measure, keep the sensors clean and free of ice or snow in order to ensure that they will continue to operate effectively.

PDC with visual warning*

You also enjoy the option of having the system show distances to objects on the Control Display. The Control Display will also

indicate the presence of objects in green before they are close enough to generate a signal tone.

Control Center, for principle details, refer to page 16:

1. Press button.



The start menu is opened



2. Press the controller to open the **i** menu
3. Select "Vehicle settings" and press the controller
4. Select "PDC" and press the controller
5. Select "Monitor display on" and press the controller.

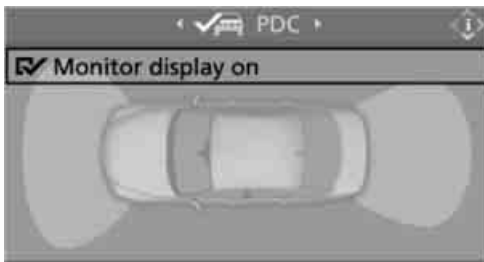

The PDC screen is activated.

The display appears on the Control Display as soon as PDC is activated.

Depending on which key you have used to open the vehicle, the last adjustment is applied.

System limits

 Even with PDC, final responsibility for estimating the distance between the vehicle and any obstructions always remains with the driver. Even when sensors are involved, there is a blind spot in which

objects cannot be detected. The system is also subject to the physical limits that apply to all forms of ultrasonic measurement, such as those encountered with thin and wedge-shaped objects, etc. Low objects already displayed, e.g. a curb, can also disappear from the detection area of the sensors again before a continuous tone sounds.

Loud noises from outside and inside your vehicle may prevent you from hearing the PDC signal tone. ◀

 Do not apply high pressure spray to the sensors for a prolonged period of time. Keep the spray at least 4 in/10 cm away from the sensors. ◀

Driving stability control systems

Your BMW is equipped with an extended array of systems designed to enhance and maintain vehicle stability under extreme conditions. The following section describes these functions based on ABS and DSC.

ABS Antilock Brake System

ABS enhances active safety by preventing the wheels from locking under braking.

ABS is operational every time you start the engine. ABS includes the functions CBC Cornering Brake Control and EBV Electronic brake-force distribution.

CBC Cornering Brake Control

It provides further enhancements in vehicle stability and steering response during lane changes and cornering at high rates of lateral acceleration.

EBV Electronic brake-force distribution

EBV controls the brake system's application pressure at the rear wheels to ensure stable deceleration.

DSC Dynamic Stability Control

DSC optimizes vehicle stability during acceleration and when starting from a full stop, as well as optimizing traction. The system recognizes any tendency for the vehicle to assume an unstable attitude such as oversteer or understeer; it then counteracts this tendency with a combination of graduated reductions in engine torque and selective braking intervention at individual wheels. DSC provides optimal stability within the limits defined by the laws of physics.

The DSC is operational every time you start the engine. DSC includes the functionality of the DTC Dynamic Traction Control and DBC Dynamic Brake Control, see below.

Indicator lamp



The indicator lamp goes out soon after you start the engine.

The indicator lamp flashes:

DSC controls the drive and braking forces. The indicator lamp stays lit: DSC has been switched off via the button.

DTC Dynamic Traction Control

In special driving states, e.g. in deep snow, DTC ensures maximum forward momentum. The gain in forward momentum also involves a reduction in driving stability. DTC is active up to approx. 45 mph/70 km/h, whereas DSC is only effective to a limited degree.

You may find it useful to briefly activate DTC under the following special circumstances:

- ▷ When rocking the vehicle and starting off in deep snow or on loose road surfaces
- ▷ When ascending snow-covered hills, and when driving in deep or on hard-packed snow
- ▷ When driving with snow chains.

Activating DTC



- ▷ Press the DSC button briefly; the DTC indicator lamp in the instrument cluster lights up continuously.

Deactivating DTC again

Press the DSC button briefly again; the DTC indicator lamp in the instrument cluster goes out.

Switching off DSC



Press the DSC button until the DSC indicator light in the instrument cluster lights up continuously, however not longer than approx. 10 seconds. DSC and DTC are deactivated. In addition, the stability promoting intervention of the active steering is deactivated, refer to page 80.

A message appears on the Control Display. Please note any supplementary information that appears there.

- ▷ To maintain optimal stability, drive with the system on whenever possible. ◀

Reactivating DSC

Press the DSC button briefly; the indicator lamp in the instrument cluster goes out.

 The laws of physics cannot be repealed, even with DSC. An appropriate driving style always remains the responsibility of the driver. Therefore, do not reduce the additional safety margin again by taking risks. ◀

DBC Dynamic Brake Control

When you apply the brakes rapidly, this system automatically produces the maximum braking force boost and thus helps to achieve the shortest braking distance during panic stops. This system exploits all of the benefits provided by ABS.

Do not reduce the pressure on the brake pedal for the duration of the brake application. When the brake pedal is released, DBC is deactivated.

Malfunctions of driving stability control systems

 The brake system warning lamp lights up in red, appearing together with the indicator lamps for ABS and DSC. A message appears on the Control Display. Driving stability control and ABS have failed. Conventional braking efficiency remains available without limitations.

 While you may continue, you should remember to proceed cautiously and drive defensively while avoiding full brake applications.

Have the system checked as soon as possible.

 Display of the previously described malfunction on Canadian models.





 The DSC warning lamp lights up. DSC and DTC have failed. The stability maintenance functions are no longer available. The vehicle will remain completely operational, however, without DSC.

Have the system checked as soon as possible.

 The warning lamp for the brake system lights up yellow and a message appears on the Control Display.

DBC has failed.

Have the system checked as soon as possible.

 Display of the previously described malfunction on Canadian models.

Active roll stabilization*

The concept

Active roll stabilization minimizes body roll and optimizes vehicle stability during cornering and evasive maneuvers.

Dynamic stabilizers at the front and rear axles form the basis for active roll stabilization. Suspension compliance adapts to suit driving conditions, varying from performance-oriented during cornering to smooth and comfort-oriented when the vehicle is proceeding in a straight line. During vehicle operation, the system continuously runs through closed-loop control cycles lasting only fractions of a second.

The system assumes operational status each time you start the engine.

Malfunction

 The warning lamp lights up and a message appears on the Control Display. There is a malfunction in the system. Have the system checked as soon as possible.

 If there is a malfunction in the system, please remember to adapt your speed accordingly, especially in curves. The suspension will be noticeably softer and the vehicle will display a greater tendency to tilt during cornering and in crosswinds.

If a message stating that you should stop appears on the Control Display, stop and switch off the engine as soon as possible. In this case the oil level in the reservoir may

have dropped below the minimum, possibly owing to a leak in the hydraulic system. Do not continue driving. Contact your BMW center. ◀

Flat Tire Monitor

The concept

The Flat Tire Monitor keeps track of the inflation pressures in the four tires as you drive. The system provides an alert whenever the inflation pressure drops significantly in relation to the pressure in another tire.

The check of the tire inflation pressure is based on monitoring the relative speeds of the wheels. A flat tire is detected and reported on the basis of a deviation in certain speed ratios.

Functional requirement

To ensure reliable operation, the system should have been initialized with the correct tire inflation pressure.

System limits

 The Flat Tire Monitor cannot indicate sudden severe tire damage caused by outside factors and does not detect a natural, even pressure drop in all four tires. ◀

In the following situations, the system could be delayed or malfunction:

- ▷ When you are driving on snow-covered or slippery road surfaces
- ▷ In the case of performance-oriented driving: slip on the drive wheels, high lateral acceleration
- ▷ False alarms and undetected loss of pressure may occur when you are driving with snow chains fitted
- ▷ If the Flat Tire Monitor was not initialized after the last inflation pressure correction, false alarms indicating a flat tire that is not present are possible or pressure loss might not be detected.

Initializing system

 Perform the initialization immediately after correcting the inflation pressure, after changing a tire or changing a wheel or all wheels. A drive is necessary for this purpose. ◀

Control Center, for principle details, refer to page 16:

1. Start the engine, but do not drive off
2. Open the **i** menu
3. Select "Vehicle settings" and press the controller
4. Select "FTM" and press the controller

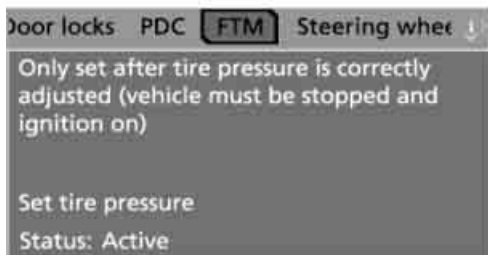

5. Select "Set tire pressure" and press the controller

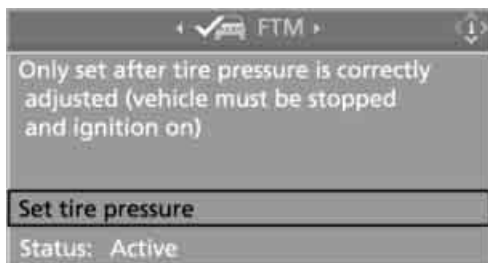

6. Select "Yes" and press the controller
7. Drive off.

The message "Initializing" is displayed.

It takes a few minutes before the Flat Tire Monitor can detect and report a flat tire and "Status: Active" is displayed.

If a flat tire is detected during initialization, a message appears on the Control Display.

 When driving with snow chains, do not initialize the system. ◀

Report of a flat tire



The warning lamp lights up in red and a message appears on the Control Display. In addition, an acoustic signal sounds. There is a flat tire or extensive inflation pressure loss.

1. Cautiously reduce the vehicle speed to below 50 mph/80 km/h. Avoid sudden braking and steering maneuvers. Do not exceed a vehicle speed of 50 mph/80 km/h



Due to the reinforcement on the side walls of the run-flat tires, inflation pressure loss can not usually be recognized from the outside, refer to Run-flat tires on page 168. ◀

2. To continue driving, comply with the instructions for driving with damaged tires on page 168.

Malfunction



The warning lamp lights up yellow and a message appears on the Control Display. The Flat Tire Monitor has a malfunction or has failed. Have the system checked as soon as possible.

Active steering*

The concept

The active steering is a system that actively varies the steering angle of the front wheels in relation to the steering wheel movements.

When you are driving in the low road speed range, e.g. in a town or when parking, the steering angle of the wheels is reinforced, i.e. the steering becomes very direct. In the higher speed range, on the other hand, the steering angle of the wheels is reduced more and more. This improves the handling capability of your BMW over the entire speed range.

In critical situations, the system can make targeted changes to the steering angle provided by the driver and thus stabilize the vehicle before the driver intervenes.

Malfunction



The fixed warning lamp lights up. The active steering is no longer operational. In the low speed range, greater steering wheel movement is necessary. Have the system checked.

If the warning lamp lights up during the first engine starting following a power supply interruption, the system must be activated with initialization.

Initializing system

1. Start the engine
2. With the vehicle stationary, turn the steering wheel from the straight-ahead position to the left as far as it will go and then back to the straight-ahead position
3. Switch off the engine.

When you start the engine again, all the functions of the active steering are available once again.

Brake Force Display

The two-stage brake lamps light up in two stages depending on how strongly you brake.



- ▷ Normal braking:
The brake lamps and the third brake lamp go on
- ▷ Heavy braking and braking with ABS:
In addition, the light area of the rear brake lamps is enlarged, refer to illustration.

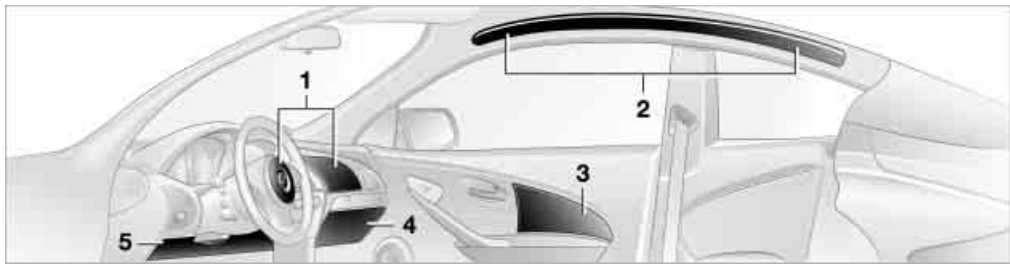

The following airbags are located under the marked covers:

- 1 Front airbags for driver and front passenger
- 2 Coupe: head airbags
- 3 Front side airbags
- 4 Knee airbag for front passenger
- 5 Knee airbag for driver

Protective effect

The front airbags help protect the driver and front passenger by responding to frontal impacts in which safety belts alone cannot provide adequate restraint. When needed, the head and side airbags help provide protection in the event of a side impact. The side airbags help restrain the side of the occupant's upper torso, and the head airbags help support the head while also helping provide protection against any objects penetrating into the passenger compartment.

The airbags are deliberately not triggered in every impact situation, e.g. less severe accidents, certain rollover conditions, or rear-end collisions.

For information on the correct sitting position, refer to page 42.

Even if you adhere to all the instructions injuries resulting from contact with airbags cannot be fully excluded, depending on the circumstances. The ignition and inflation noise may provoke a mild hearing loss in extremely sensitive individuals. This effect is usually only temporary.



Do not apply adhesive materials to the cover panels of the airbags, cover them or modify them in any other way. Do not attempt to remove the airbag retention system from the vehicle. Never modify or tamper with either the wiring or the individual components in the airbag system. This category includes the upholstery in the center of the steering wheel, on the instrument panel, the side trim panels on the doors and on the Coupe the roof pillars along with the sides of the headliner. Do not attempt to remove or dismantle the steering wheel.

Do not touch the individual components directly after the system has been triggered, because there is a danger of burns. If you note any indication of system malfunction, if you desire to have an airbag deactivated, or if the airbag retention system is triggered in response to an accident, you should always entrust all inspection, repair and dismantling operations to your BMW center. Unprofessional attempts to service the system could lead to failure in an emergency or undesired airbag activation, either of which could result in personal injury. ◀

Airbag warning information is also provided on the sun visors.

Airbag system operational



The airbag warning lamp in the instrument cluster indicates the operational readiness of the entire airbag system and the safety belt tensioners as of ignition key position 1. The warning lamp goes out after a few seconds.

Airbag system malfunction

⚠ Have the airbag system checked immediately if a malfunction occurs, as otherwise there is a danger of the system not responding in the expected manner to an impact occurring within its normal response range. ◀

⚠ There is a malfunction in the airbag system when:

- ▷ The warning lamp does not light up as of ignition key position 1
- ▷ The warning lamp remains on continuously
- ▷ The warning lamp lights up while the vehicle is being driven.

Convertible: Rollover protection system

The rollover protection system is automatically activated in the event of an accident or a critical driving situation, extreme inclination on the longitudinal or transverse axis, or loss of ground contact. The rollover bars located behind the rear head restraints move out within fractions of a second.

As a supplement to the rollover bar integrated in the windshield frame, the rollover protection system ensures that all vehicle occupants have the necessary headroom.

⚠ Always keep the path of movement of the rollover protection system clear. In less severe accidents, you are protected by the fastened safety belt and, depending on the severity of the accident, the belt tensioner and the multistage airbag restraint system. ◀

Lowering

If the protection function was not required after automatic activation, the rollover protection system can be lowered again. No tools are necessary for this purpose.

1. Press the release backwards and hold in that position



2. Press the rollover bar halfway down from above
3. Let go of the release
4. Press the rollover bar down until it snaps into place



5. Use the same procedure for the second rollover bar.

Have the rollover protection system checked after unexpected triggering.

 Never move the convertible top when the rollover protection system is raised.

No changes of any nature may be made to the individual components of the rollover protection system and wiring. Work on the rollover protection system may only be performed at a BMW center. Unprofessional attempts to service the system can lead to failure or malfunction. For a system check and to ensure long-term functioning, you must comply with the maintenance intervals of the service requirement display. ◀

Head-Up Display*

The concept

With the Head-Up Display important information is projected into the driver's field of view, e.g. navigation instructions. This enables you to take in this information without looking away from the road.



Switching on/off

Ignition key in position 2:

Press the button to activate or deactivate this system.



- 1 Navigation instructions
- 2 Display for cruise control
- 3 Speed

Selecting displays

Control Center, for principle details, refer to page 16:

1. Press button.



The start menu is opened



2. Press the controller to open the **i** menu
3. Select "Display settings" and press the controller
4. Select "HUD selection" and press the controller
5. Select desired information of Head-Up Display



- Press the controller.
 - The information appears on the Head-Up Display.

Depending on which key you have used to open the vehicle, the last adjustment is applied.

Adjusting brightness

The brightness of the display is automatically adapted to the ambient lighting conditions. However, you can change the base setting.

With the low beams switched on, the brightness can also be adjusted with the serrated dial of the instrument lighting.

Control Center, for principle details, refer to page 16:

- Open the **i** menu
- Select "Display settings" and press the controller
- Select "Brightness" and press the controller



- If necessary, move the controller to the left to select "Head-Up Display Offset"
- Turn the controller until the desired setting is selected.

Depending on which key you have used to open the vehicle, the last adjustment is applied.

Notes

The recognizability of the displays in the Head-Up Display is influenced by:

- Sunglasses with certain polarization filters
- Certain seating positions

- Objects on the cover of the Head-Up Display
- Wet road surface and unfavorable lighting conditions.

If the image is distorted, please have the base setting checked at a BMW center.

Special windshield

The windshield is part of the system. The shape of the windshield complies with the requirements of the Head-Up Display to enable a precise display. A film in the windshield prevents the double images from being displayed.

To have the windshield replaced, contact a BMW center.

Care instructions

You can find everything you need to know on this topic by consulting the Caring for your vehicle brochure.

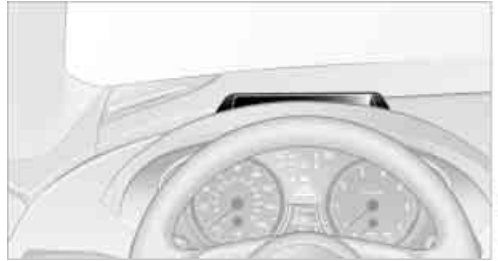

- !** Only clean the cover of the Head-Up Display with a soft, non-abrasive cloth or a display cleaning cloth, as otherwise damage may result. ◀

Lamps

Parking lamps/low beams



Parking lamps

 With the switch in this position, the front, rear and side vehicle lighting is switched on. You can use the parking lamps for parking. For lighting on one side for parking as an additional feature, refer to page 86.

Low beams

 When you switch off the ignition with the headlamps on, the headlamps go out, and only the parking lamps remain on.

Pathway lighting

After parking the vehicle and switching off the headlamps, operating the headlamp flasher activates the low beams. You can set the duration on the Control Display or deactivate the function.

Control Center, for principle details, refer to page 16:

1. Open the **i** menu
2. Select "Vehicle settings" and press the controller
3. Select "Lighting" and press the controller
4. Select "Pathway lighting" and press the controller

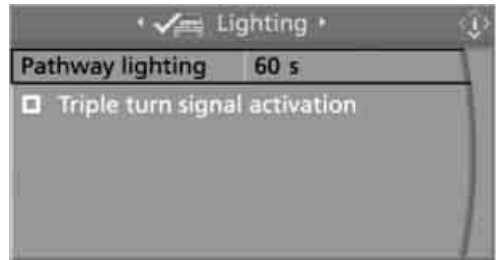

5. Turn the controller to select the corresponding duration
6. Press the controller to apply the setting.

Lights on warning

If you turn the ignition key to position 0, an acoustic signal sounds when you open the driver's door for a few seconds to remind you that the lamps have not yet been switched off. At the same time a message appears on the Control Display.

Daytime driving lamps*

If you wish, you can leave the light switch in the low-beam position.

Always observe all applicable laws governing the use of daytime driving lamps.

You can switch on the parking lamps when needed using the standard procedure described under Parking lamps.

Automatic headlamp control

 When you set the switch to this position, the system activates and switches on and off the low beams in response to changes in ambient light conditions, for instance, in a tunnel, at dawn and dusk, and in rain and snow. The LED next to the symbol is illuminated when the low beams are on.

 The low beams remain on independent of the ambient lighting conditions when you switch on the fog lamps. With the daytime driving lamps activated, the low beams are always switched on in

this switch position with the ignition key in position 2. ◀

 The automatic headlamp control cannot serve as a substitute for your personal judgment in determining when the lamps should be switched on in response to ambient lighting conditions. For example, the system cannot detect fog. To avoid safety risks, you should always switch on the lamps manually under these conditions. ◀

Adaptive Head Light*

The concept

Adaptive Head Light is a variable headlamp control system that enables better illumination of the road surface. Depending on the steering angle and other assumptions, the light from the headlamp follows the course of the road.

Activating Adaptive Head Light

 In ignition key position 2, turn the light switch to the position 'Automatic headlamp control', refer to page 85.

So that oncoming traffic is not dazzled, Adaptive Head Light is

- ▷ not active when the vehicle is reversing
- ▷ only active toward passenger's side when stopped.

Malfunction

The LED beside the symbol for automatic headlamp control flashes. The Adaptive Head Light has a malfunction or has failed. Have the system checked as soon as possible.

High beams/roadside parking lamps

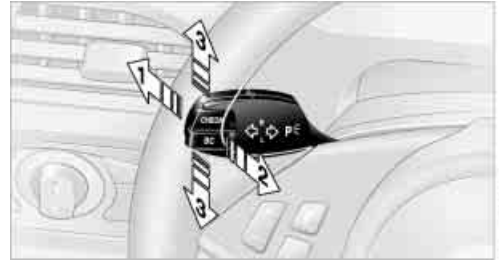

- 1 High beams
- 2 Headlamp flasher
- 3 Roadside parking lamps

Roadside parking lamps, left or right*

You also enjoy the option of lighting up just one side of your vehicle when parking. When using this function, comply with national regulations:

With the ignition switched off, press the lever in the desired direction **3**, past the resistance point.

Fog lamps



 The parking lamps or low beams must be switched on for the fog lamps to operate. The green indicator lamp lights up whenever the fog lamps are on.

The fog lamps are switched off whenever the high beams are switched on.

 If the automatic headlamp control is activated, the low beams will come on automatically when you switch on the fog lamps. ◀

Instrument lighting



Turn the serrated dial to adjust the illumination intensity.

Interior lamps

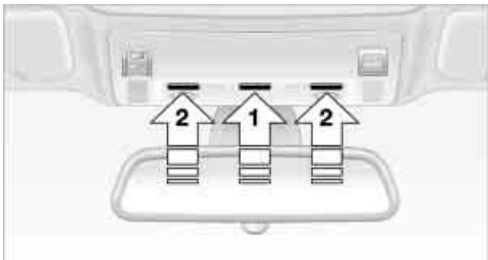

Control of the interior lamps, footwell lamps, door entry lighting, courtesy lamps* and sill panel lighting* is automatic.

Switching interior lamps on and off manually

Briefly press button **1**.

If you want the interior lamps to remain off continuously, maintain pressure on the button for approx. 3 seconds.

To revert to normal operation, briefly press the button.

Reading lamps

The reading lamps are beside the interior lamp.

You can turn them on and off using the buttons **2** located next to the lamps.

 To avoid discharging the battery, all of the vehicle's interior lamps are automatically extinguished approx. 15 minutes after the ignition is switched off. ◀

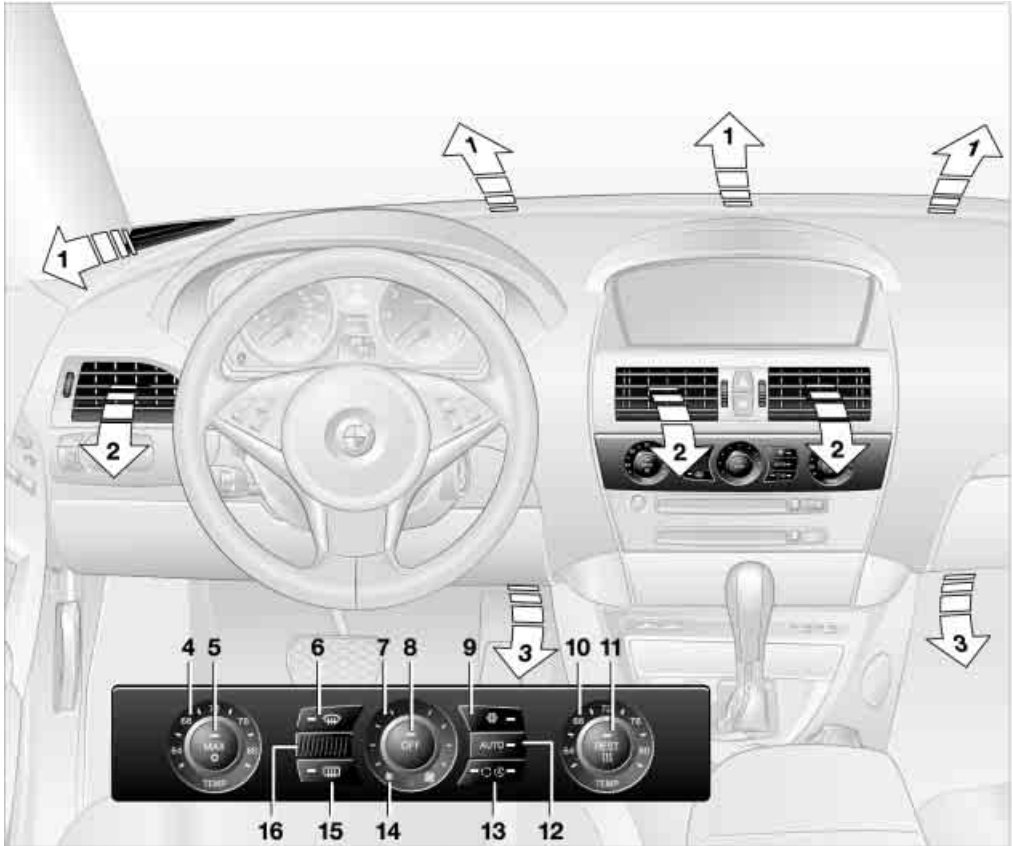

A congenial climate



WV020210300A

- | | |
|---|---|
| <ul style="list-style-type: none"> 1 Airflow directed toward the windshield and side windows 2 Air for the upper body region
The serrated dials allow you to open and close the air supply vent outlets through an infinitely-variable range. The levers change the direction of the airflow. You can find more information on adjusting for draft-free ventilation on page 92 3 Air to footwell 4 Setting the temperature, left side of passenger compartment 5 Maximum cooling | <ul style="list-style-type: none"> 6 Defrosting windows and removing condensation 7 Adjusting the air volume manually 8 Switching off automatic climate control 9 Switching cooling function on and off manually 10 Setting the temperature, right side of passenger compartment 11 Residual heat mode 12 AUTO program 13 Outside air/AUC Automatic recirculated-air control/recirculated air |
|---|---|

14 Indicator lamp for independent ventilation

- ▷ Activation time set:
The indicator lamp  comes on
- ▷ Independent ventilation switched on:
The indicator lamp  flashes

15 Rear window defroster**16** Air grill for interior temperature sensor – please keep clear and unobstructed

All other setting options for the automatic climate control can be found at "Climate" and in the **i** menu on the Control Display, refer to pages 90 and 91.

The current setting for air distribution is displayed on the Control Display.

A congenial climate

To use the automatic function, press the AUTO button. Select an interior temperature you find pleasant.

The following section contains more detailed information on the available setting options.

The cooling function is only possible with the engine running.

AUTO program

 The AUTO program adjusts the air distribution to the windshield and side windows, towards the upper body and footwell as well as the air volume, while also using your preselected temperature setting as the basis for adjusting the interior climate to adapt to external seasonal influences.

The cooling function comes on automatically when you select the AUTO program. At the same time, a condensation sensor controls the program in such a way that window condensation is prevented as far as possible.

Temperature adjustment

The figures on the display provide a general indication of interior temperature. A pleasant adjustment is 72 °F/22 °C. When you start the vehicle, this

system ensures that the selected temperature is achieved as quickly as possible. It then maintains this temperature, regardless of the season.

Defrosting windows and removing condensation

This program quickly removes ice and condensation from the windshield and front side windows.

Adjusting air volume manually

You can adjust the air volume by turning. You can reactivate the automatic mode for the air volume with the AUTO button.

Switching cooling function on and off manually

The cooling function cools and dehumidifies the incoming air before also reheating it as

required, according to the temperature setting. Depending on the weather, the windshield may fog over briefly when the engine is started.

The cooling function comes on automatically when you select the AUTO program.

Maximum cooling

This program quickly provides maximum cooling.

The system switches to the recirculated-air mode and the air flows at maximum air volume only from the vent outlets for the upper body area. For this reason you should ensure that these vent outlets are open before selecting this program.

AUC Automatic recirculated-air control

You can respond to unpleasant odors or pollutants in the immediate environment by temporarily suspending the supply of outside air. The system then recirculates the air cur-

rently within the vehicle. AUC executes this function automatically.

Press the button repeatedly to run through the following control sequence:

- ▷ Indicator lamps off: outside air flows into the vehicle continuously
- ▷ Right indicator lamp on, AUC mode: the system detects pollutants in the outside air and responds by blocking the supply of outside air when required. Depending upon air quality requirements, in the automatic mode the system alternates between its outside-air and recirculated-air modes
- ▷ Left indicator lamp on, recirculated-air mode: the supply of outside air into the vehicle is continuously blocked.

 If condensation starts to form on the inside window surfaces during operation in the recirculated-air mode, you should switch it off while also increasing the air volume as required.

The recirculated-air mode should not be used over a longer period of time, as the air quality inside the vehicle deteriorates continuously. ◀

Residual heat mode



If you press this button with the engine switched off, the system uses the warmth stored in the engine to heat the interior, for instance, while the vehicle is stationary at a school to pick up a child. You can adjust the automatic climate control settings as of ignition key position 2.

Provided that the engine has warmed to its normal operating temperature and the battery is charged, you can use this function for up to 15 minutes after switching off the ignition. The LED within the button lights up to confirm compliance with both of these conditions.

Switching off automatic climate control



The air volume, the heater and the cooling function are all switched off. You can restart the automatic climate control by pressing any of its buttons except the REST button.

Settings using Control Center

Ignition key:

- ▷ On vehicles with separate drives for audio CDs and navigation DVDs, ignition key in position 2
- ▷ On vehicles with one drive for audio CDs, ignition key in position 1.

Control Center, for principle details, refer to page 16:

1. Press button.



The start menu is opened



2. Move the controller to the left to open "Climate".

You can set the following:

- ▷ Separate air distribution for driver and front passenger
- ▷ Adapting the temperature in the upper body region
- ▷ Intensity of the AUTO program.

Manual air distribution

You can combine your air distribution yourself and also individually adjust the air temperature in the upper body area.

1. Select "Vent settings and press the controller
2. Select "AUTO and press the controller. The manual air distribution is switched on
3. Select the desired field by moving the controller and turn the controller to adjust the air distribution.



- 1 Airflow directed toward the windshield and side windows, driver's side only
- 2 Airflow for the upper body
- 3 Air to footwell

To select the front passenger area:
Move the controller to the right.

Automatic air distribution

1. Select "Vent settings and press the controller
2. Select "AUTO" and press the controller.



The automatic air distribution is switched on.

The program handles adjustment of the air distribution, separately for the driver and passenger side.

To switch on the automatic air distribution for the front passenger:
Move the controller to the right.

Adapting temperature in upper body region

1. Select "Vent settings and press the controller
2. Select the field by moving the controller and turn the controller to adjust the air distribution.



Setting intensity of AUTO program

To meet your individual needs, you can weaken or strengthen the intensity of the automatic climate control.

Control Center, for principle details, refer to page 16:

1. Open the **i** menu
2. Select "Vehicle settings" and press the controller
3. Select "Climate control" and press the controller
4. Select "Automatic programs" and press the controller
5. Select the desired intensity

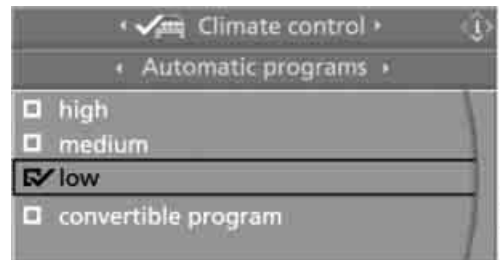

6. Press the controller.

Convertible program

When the convertible top is opened, the convertible program can also be selected. In the convertible program, the automatic

climate control is optimized for driving with the convertible top open. In addition, the air supply is increased as the speed increases. If the convertible program has been selected, it is automatically active every time the top is opened.

 The effect of the convertible program can be greatly enhanced if the wind deflector is fitted. ◀

Ventilation

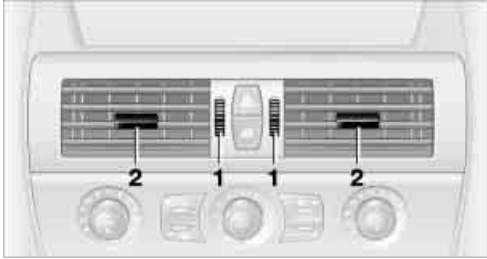

You can use the serrated dials **1** to open and close the vent outlets through an infinitely-variable range, while the levers **2** allow you to adjust the airflow direction.

 Do not drop any foreign bodies into the vent outlets, as otherwise these could be catapulted outwards and lead to injuries. ◀

Ventilation for cooling

Adjust the vent outlets to direct the flow of cool air in your direction, for instance, if the interior has become too warm, etc.

Draft-free ventilation

Set the vent outlets so that the air flows past you and is not directed straight at you.

Microfilter/activated-charcoal filter

The microfilter removes dust and pollen from the incoming air. The activated-charcoal filter provides additional protection by filtering gaseous pollutants from the outside air. Your BMW center replaces this combined filter as a standard part of your scheduled maintenance.

You can select a display of more detailed information in the service requirement display, refer to page 65.

Independent ventilation

The independent ventilation blows air into the passenger compartment to lower interior temperatures.

The independent ventilation is controlled using the Control Center. You can set two different times for the system to start.

The independent ventilation remains on for 30 minutes. It can also be switched on and off directly. Since the system uses a substantial amount of electrical current, you should refrain from activating it twice in succession without allowing the battery to be recharged in normal operation between use.

The independent ventilation is ready for use at any outside temperature up to ignition key position 1.

The air emerges through the upper body region vent outlets in the instrument panel. These vent outlets must be open for the system to operate.

Switching on and off directly

Control Center, for principle details, refer to page 16:

1. Open "Climate"
2. Select "Ventilation" and press the controller
3. Select "Automatic ventilation" and press the controller
4. Select "Parked car ventilation" and press the controller.

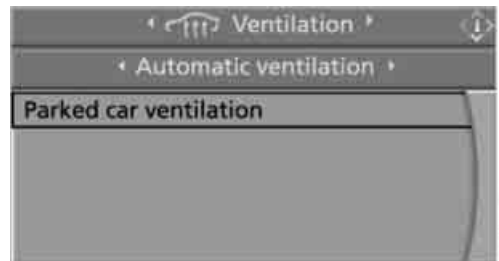

Preselecting activation times

Control Center, for principle details, refer to page 16:

1. Open "Climate"
2. Select "Ventilation" and press the controller
3. Select "Activation time" and press the controller

 The two preselected activation times should differ by at least 31 minutes. ◀

4. Move the controller to the left or right to select "Time 1" or "Time 2"
5. Select the time and press the controller. The first time setting is highlighted



6. Turn the controller to make the adjustment
7. Press the controller to apply the setting. The next adjustment is highlighted
8. Make the remaining adjustments. After the last adjustment, the time is stored.

Activating activation timer

Move the controller to the left or right to select "Time 1" or "Time 2" and press the controller.



 The activation time is activated.

 The independent ventilation is only available for activation within the subsequent 24 hours. After that, the time must be reactivated. ◀

Practical interior accessories

Integrated universal remote control*

The concept

The integrated universal remote control replaces up to three different hand-held transmitters for various items of radio-controlled equipment such as door openers and house alarm systems. The integrated universal remote control registers and stores signals from the original hand-held transmitters.

The signal of an original hand-held transmitter can be programmed on one of the three memory buttons **1**. Then the respective device can be actuated with the memory button **1** programmed for its use with the ignition key in position 2. The indicator lamp **2** flashes to confirm transmission of the signal.

If you sell your vehicle one day, delete the saved programs beforehand for your own security, refer to page 95.

 To prevent possible damage or injury, before programming or using the integrated universal remote control, always inspect the immediate area to make certain that no people, animals or objects are within the travel range of the device. Also, comply with the safety precautions of the original hand-held transmitter. ◀

Checking compatibility

 If you see this symbol on the packaging or in the manual supplied with the original hand-held transmitter, it is safe to assume that it is compatible with the integrated universal remote control.

If you have additional questions, please consult your BMW Sports Activity Vehicle Center or call 1-800-355-3515.

You can also visit these websites:
www.bmwusa.com or
www.homelink.com.

HomeLink is a registered trademark owned by Johnson Controls, Inc.

Programming

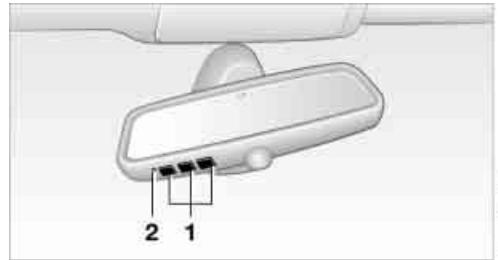

- 1** Memory buttons
- 2** Indicator lamp

Fixed-code hand-held transmitters

1. Ignition key in position 2
2. When using for the first time: press both outer buttons **1** for approx. 20 seconds, maintaining pressure until the indicator lamp **2** starts to flash. The three memory buttons **1** are cleared
3. Hold the original hand-held transmitter at a distance of approx. 2 in/5 cm to 8 in/20 cm to the memory buttons **1**

 The required distance between the hand-held transmitter and the memory buttons **1** depends on the relevant system of the original hand-held transmitter used. ◀

4. Simultaneously press the transmit button on the original hand-held transmitter and the desired memory button **1** on the integrated universal remote control. Initially, the indicator lamp **2** flashes slowly. Release both buttons as soon as the indicator lamp **2** flashes rapidly. If the indicator lamp **2** does not flash rapidly after approx. 15 seconds, change the distance
5. To program other original hand-held transmitters, repeat steps 3 and 4.

The corresponding memory button **1** is now programmed with the signal of the original hand-held transmitter.

The equipment can be used in ignition key position **2**.

 If the device cannot be operated after repeated programming, check whether the original hand-held transmitter uses an alternating-code system. Here, either read the instructions for the original hand-held transmitter or hold down the programmed memory button **1** of the integrated universal remote control. If the indicator lamp **2** on the integrated universal remote control flashes rapidly for a short time then lights up for approx. 2 seconds, this indicates that the original hand-held transmitter uses an alternating-code system. In the case of an alternating-code system, program the memory buttons **1** as described at Alternating-code hand-held transmitters. ◀

Alternating-code hand-held transmitters

To program the integrated universal remote control, consult the Operating Instructions for the equipment to be set. You will find information there on the possibilities for synchronization.

When programming hand-held transmitters that employ an alternating code, please observe the following supplementary instructions:

 Programming will be easier with the aid of a second person. ◀

1. Park your vehicle within the range of the remote-controlled equipment
2. Program the integrated universal remote control as described above at Fixed-code hand-held transmitters
3. Locate the button at the receiver of the equipment to be set, e.g. on the drive
4. Press the button on the receiver of the equipment to be set. After step 4, you have approx. 30 seconds for step 5

5. Press the programmed memory button **1** of the integrated universal remote control three times.

The corresponding memory button **1** is now programmed with the signal of the original hand-held transmitter.

 If you have any additional questions, please contact your BMW center. ◀

Clearing memory buttons

Press both outer buttons **1** of the integrated universal remote control for approx. 20 seconds, maintaining pressure until the indicator lamp **2** starts to flash. All three memory buttons are cleared.

The memory of individual memory buttons **1** cannot be cleared.

Glove compartment

Opening

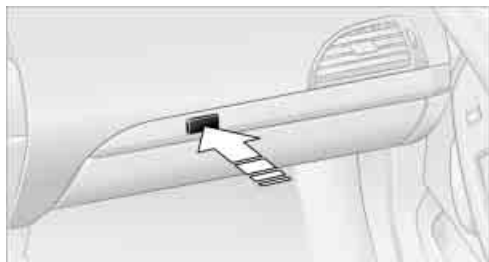

Press button. The glove compartment opens automatically and the lamps come on.

Closing

Fold the cover up.

 To prevent injury in the event of an accident while the vehicle is being driven, close the glove compartment immediately after use. ◀

Rechargeable flashlight*

The flashlight is located on the left side of the glove compartment. The flashlight can remain there continuously.

 Be sure that the flashlight is switched off when it is inserted into its holder. Failure to comply with this precaution could lead to overcharging and damage. ◀

Center armrest

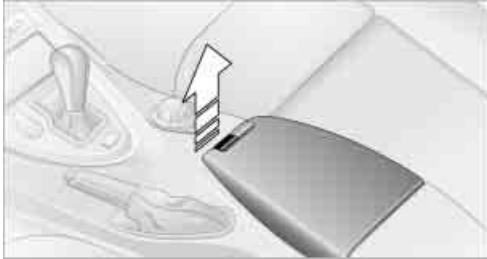

A storage compartment is located in the armrest between the front seats. This compartment is integrated in the central locking system and can also be locked separately using the hotel function, refer to page 30.

To open the cover:
Pull the left button. The cover opens and can be folded upwards.

Depending on the version, there can be a corresponding cradle* for the telephone or portable phone.

Height adjustment

The center armrest can be set in 2 stages.

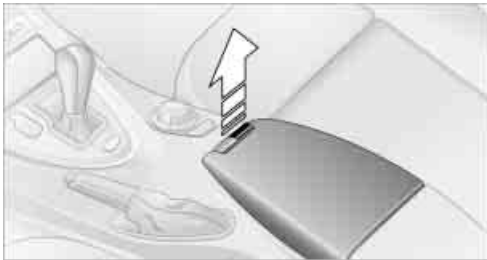

Pull the right button:
Move the armrest upwards or downwards and lock it in the desired position.

Storage compartments

Storage compartment behind center armrest

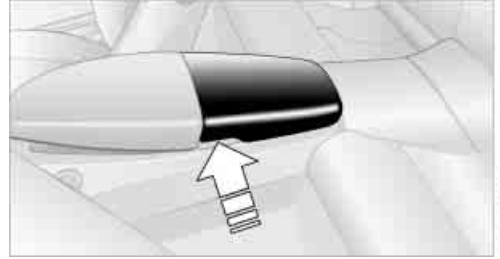

To open, raise the cover at the left or right edge. The compartment contains the cup holder and the lock for the hotel function, refer to page 30.

Other compartments and nets

Other compartments are in the doors as well as in the front center console*. Ticket pockets are located in the sun visors.

Storage nets are located on the backrests of the front seats and in the passenger footwell*.

Another storage option is located in the luggage compartment in the right side panel. If you wish, this is also suitable for storing the onboard documentation.

Coupe: clothes hooks

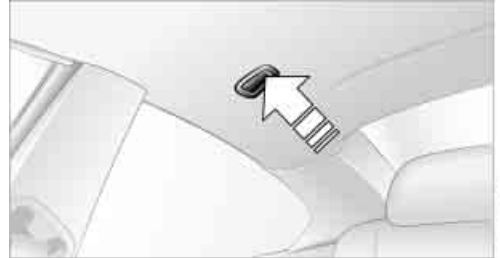

To fold down, press at the top edge.

 When suspending clothing from the hooks, ensure that it will not obstruct the driver's vision. Do not hang heavy objects on the hooks. If you do so, they

could cause personal injury to occupants during braking or evasive maneuvers. ◀

Cup holders



The compartment of the rear center console contains a built-in and removable cup holder.



The removable cup holder can be inserted in the side of the center console.

 Do not place glass containers in the cup holders. This would lead to an increased risk of injury in the event of an accident. ◀

Ashtray

Opening

Press the trim strip of the cover.

Emptying



Press the opened cover beyond the resistance point, refer to arrow: The ashtray rises for removal.

Cigarette lighter



In ignition key position 2, press in the cigarette lighter.

Remove as soon as the lighter jumps back out.

 Hold or touch the hot cigarette lighter by the knob only. Holding or touching it in other areas could result in burns. Always remove the ignition key when you leave the vehicle so that, for example, children are unable to use the cigarette lighter and burn themselves. ◀

Socket

In ignition key position 2, the lighter socket can be used to plug in hand flashlights, car vacuum cleaners, etc., with power ratings of up to approx. 200 W at 12 V. Avoid damaging the socket due to inserting plugs of different shapes or sizes.

Socket

In front passenger footwell



Access to the socket:
Fold the cover upwards.

Ski bag*

Designed for safe, convenient transport of up to 2 pairs of standard skis or one snowboard.

The ski bag itself plus the additional capacity provided by the luggage compartment make it possible to transport skis with a length of up to 6.9 ft/2.10 m.

Loading

1. Press the button downwards and pull the filler element forwards

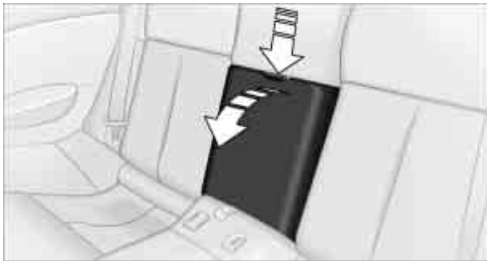

2. Extend the ski bag between the front seats. The zipper allows more convenient access to stored objects and can also be left open to allow the ski bag to dry
3. Press the button in the luggage compartment

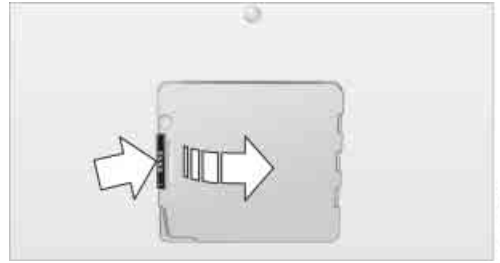

4. Open the loading flap and use the magnetic holder to secure it to the rear panel.

To store the ski bag, perform the above steps in reverse order.

- ▶ Ensure that the skis are clean before loading them into the bag. Take care to avoid damage from sharp edges. ◀

Securing load

After loading, secure the ski bag and its contents. To do so, tighten the retaining belt at the buckle.

- ⚠ Secure the ski bag in this way. If you fail to do so, it could move around and endanger occupants during braking or evasive maneuvers. ◀

- ▶ To refit the filler element, insert the two steps in the strip and press back the filler element. Make sure that you do not damage the rear seat upholstery. ◀





Driving tips

This section is designed to provide you with extra support by supplying information useful in dealing with specific driving and operating conditions.

Things to remember when driving

Break-in procedures

To ensure that your vehicle continues to provide optimized economy of operation throughout an extended service life, we request that you devote careful attention to the following section.

Engine and differential

Up to 1,200 miles/2,000 km: You should attempt to vary both vehicle and engine speeds. Until the break-in period has been completed, you should also refrain from exceeding an engine speed of 4500 rpm or a driving speed of 100 mph/160 km/h.

Always obey all official speed limits.

Avoid full-throttle operation and use of the transmission's kickdown mode during these initial miles.

Once you have driven 1,200 miles/2,000 km, the engine and vehicle speeds can be gradually increased.

SMG Sequential manual transmission

Do not use the acceleration assistant during the break-in period, refer to page 60.

Tires

Due to technical factors associated with their manufacture, tires do not achieve their full traction potential until after an initial break-in period. Therefore, drive reservedly during the first 200 miles/300 km.

Brake system

Brakes require an initial break-in period of approx. 300 miles/500 km to achieve optimized contact and wear patterns between brake pads and rotors.

Clutch

The function of the clutch is only at its optimized level after a distance driven of approx. 300 miles/500 km. During this break-in period, engage the clutch gently.

After component replacement

You should also comply with these break-in procedures should the components mentioned above need to be replaced at a later point.

General driving notes

Hot exhaust system

 Extreme temperatures occur at the catalytic converter on this and every catalyst-equipped vehicle. Do not remove the heat shields installed adjacent to various sections of the exhaust system, and never apply undercoating to them. When driving, standing at idle and while parking, take care to avoid possible contact between the hot exhaust system and any highly flammable materials such as hay, leaves, grass, etc. Such contact could lead to a fire, and with it the risk of serious property damage as well as personal injury. ◀

Parking vehicle

Condensation forms in the air conditioner system during operation, and then exits under the vehicle. Traces of condensed water under the vehicle are thus normal.

Before driving into a car wash

Fold in the exterior mirrors manually, as otherwise they could be damaged due to the width of the vehicle.

Hydroplaning

 When driving on wet or slushy roads, reduce road speed. If you do not, a wedge of water can form between tires and

road surface. This phenomenon is referred to as hydroplaning, and is characterized by a partial or complete loss of contact between the tires and the road surface, ultimately undermining your ability to steer and brake the vehicle. ◀

The risk of hydroplaning increases as the tread depth of the tires decreases, also refer to Tire tread on page 167.

Driving through water

 Do not drive through water on the road if it is deeper than 1 ft/30 cm, and then only at walking speed at the most. Otherwise, the vehicle's engine, the electrical systems and the transmission may be damaged. ◀

Braking safely

Your BMW is equipped with ABS as standard. The best way to achieve optimized braking response from the ABS is to apply maximum pressure to the brake pedal in situations where this is required: panic stops. Since the vehicle maintains steering responsiveness, you can nevertheless avoid possible obstacles with a minimum of steering effort.

Pulsation at the brake pedal combines with sounds from the hydraulic circuits to indicate to the driver that ABS is in its active mode.

 Do not drive with your foot resting on the brake pedal. Even light but consistent pedal pressure can lead to high temperatures, brake wear and possibly even brake failure. ◀

Driving in wet conditions

While driving in wet conditions and in heavy rain, it is a good idea to apply light pressure to the brake pedal every few miles. Monitor traffic conditions to ensure that this maneuver does not endanger other road users. The heat generated in this process helps dry the pads and rotors to ensure that full braking efficiency will then be available when you need it.

Hills

 To prevent overheating and thus reduced efficiency of the brake system, downshift to a gear in which only minimal brake applications are needed when descending long or steep downhill stretches. Even light but consistent pedal pressure can lead to high temperatures, brake wear and possibly even brake failure. ◀

You can further enhance the engine's braking effect by selecting a lower gear in the automatic transmission's manual mode, downshifting as far as first gear on extremely steep stretches, refer to page 59. This strategy helps you avoid placing excessive loads on the brake system.

 Never drive with the clutch pressed or allow the vehicle to coast with the transmission in Neutral – or with the engine switched off – there is no engine braking when the transmission is in Neutral, and no power assist for brakes and steering when the engine is not running. Never allow floor mats, carpets or any other objects to protrude into the area around the accelerator and brake pedals and obstruct their movement. ◀

Corrosion on brake rotors

When the vehicle is driven only occasionally, during extended periods when the vehicle is not used at all, and in operating conditions where brake applications are less frequent, there is an increased tendency for corrosion to form on rotors, while contaminants accumulate on the brake pads. This occurs because the minimum pressure which must be exerted by the pads during brake applications to clean the rotors is not reached.

Should corrosion form on the brake rotors, the brakes will tend to respond with a pulsating effect that even extended application will fail to cure.

Mobile communication devices in vehicle

 BMW advises against using mobile communication devices, e.g. portable phones, in the inside of the vehicle without a direct connection to an external antenna. Otherwise, the vehicle electronics and mobile communication device can influence one another. It is not ensured that the waves emitted during transmission are led out of the vehicle interior. ◀

Cargo loading

 To avoid loading the tires beyond their approved carrying capacity, never overload the vehicle. Overloading can lead to overheating and increases the rate at which damage develops inside the tires. The ultimate result can assume the form of a sudden air loss. ◀

Determining loading limit



1. Locate the following statement on your vehicle's placard*:

 The combined weight of occupants and cargo should never exceed XXX lbs. or YYY kg, as otherwise the vehicle may be damaged and unstable driving conditions may result. ◀

2. Determine the combined weight of the driver and passengers that will be riding in your vehicle
3. Subtract the combined weight of the driver and passengers from XXX lbs. or YYY kg

4. The resulting figure equals the available amount of cargo and luggage load capacity.
For example, if the XXX amount equals 1400 lbs. and there will be five 150-lbs. passengers in your vehicle, the amount of available cargo and luggage load capacity is 650 lbs.:
1400 lbs. minus 750 lbs. = 650 lbs.
5. Determine the combined weight of luggage and cargo being loaded on the vehicle. That weight may not safely exceed the available cargo and luggage load capacity calculated in step 4
6. If your vehicle will be towing a trailer, part of the load from your trailer will be transferred to your vehicle. Consult the manual for transporting a trailer to determine how this may reduce the available cargo and luggage load capacity of your vehicle.

Load

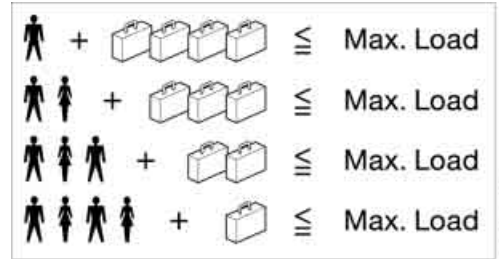

The permitted load is the total of the weight of occupants and cargo/luggage. The greater the weight of occupants, the less cargo/luggage can be transported.

Stowing cargo

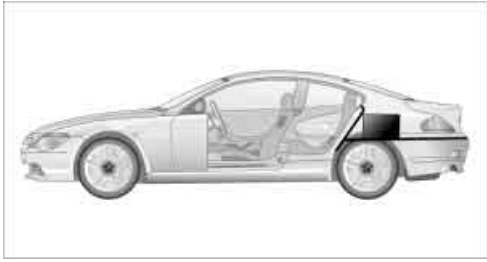

- ▶ Load heavy cargo as far forward and as low as possible, placing it directly behind the bulkhead behind the rear seats
- ▶ Cover sharp edges and corners.

Securing cargo

- ▶ Use the luggage net* or securing straps to hold down small and lightweight luggage and cargo

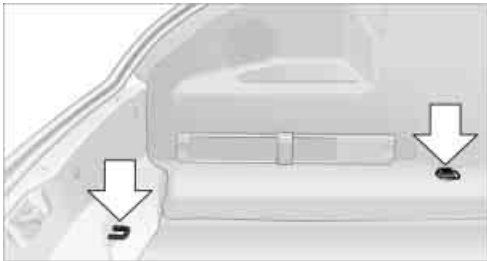

- ▶ Heavy-duty cargo straps* for securing larger and heavier objects are available at your BMW center. Four lashing eyes fitted in the luggage compartment are used to secure these heavy-duty cargo straps, refer to arrows
- ▶ Please observe the special instructions supplied with the heavy-duty cargo straps.

 Always position and secure the load as described above. If you do not, it can even endanger the passengers during braking or evasive maneuvers.

Never exceed either the approved gross vehicle weight or either of the approved axle loads, refer to page 190, as excessive loads can pose a safety hazard, and may

also place you in violation of freeway safety laws.

You should never transport heavy or hard objects unsecured in the passenger compartment, as they could fly around and even pose a safety hazard to the vehicle's occupants during abrupt braking or evasive maneuver. ◀

Pad on base of luggage compartment

If required, you can use the pad e.g. to transport dirty or soiled objects. The rubberized side is washable and has an anti-slip effect.





Navigation

This chapter describes how you can enter destinations and specify your route so that your navigation system guides you reliably to your destination.

Starting navigation system*

Your navigation system can use satellites to ascertain the precise position of your vehicle and guide you reliably to any destination you enter.

Navigation DVD

Special navigation DVDs are required; these are available from your BMW center.

Inserting navigation DVD



1. Insert the navigation DVD with the labeled side up
2. Allow approx. 8 seconds for the system to scan the data from the DVD.

Removing navigation DVD

1. Press button 1.
The DVD is ejected from the navigation computer
2. Remove the DVD.

Opening navigation

! Enter data only when the vehicle is stationary, and always obey the traffic regulations and road signs in the event of any contradiction between traffic and road conditions and the instructions issued by the navigation system. If you do not observe this precaution, you may be in violation of the law, and can endanger vehicle occupants and other road users. ◀

Control Center, for principle details, refer to page 16:

1. Press button.

MENU

The start menu is opened



2. Move the controller to the right to open "Navigation"
3. Select "Navigation" and press the controller.



Display in assistance window

You can display the route or the current position in the assistance window. This display remains visible even if you switch to another application.

1. Move the controller to the right to enter the assistance window



2. Press the controller. Other menu items are displayed
3. Select the desired view of the route or "Current position"



4. Press the controller.

The contents of the assistance window is continually updated as you drive.

Displaying current position

Control Center, for principle details, refer to page 16:

1. Select "Navigation" and press the controller
2. Select "Current position" and press the controller.

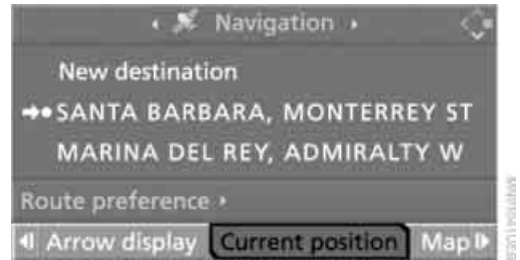

The current position of your BMW is displayed.

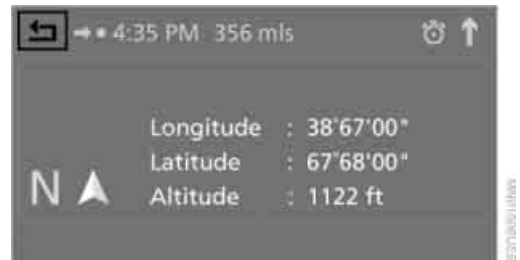

If the navigation system is unable to identify a town or city, your current map coordinates will appear.

To exit the menu:

Select  and press the controller.

You can also have the current position displayed on a map, refer to page 120.

Destination entry

In entering your destination you can select from among the following options:

- ▷ Entering a destination manually, see below
- ▷ Selecting destination using information, refer to page 113
- ▷ Selecting from among recent destinations, refer to Destination list, page 113
- ▷ Selecting destination from address book, refer to page 114.

After selecting your destination you can proceed to start the destination guidance, refer to page 118.

Entering a destination manually

The system supports the wordmatch principle to make it easier for you to enter the names of streets or towns/cities. This enables input of different spellings and supplements your input automatically so that stored names can be applied as destinations as quickly as possible.

Control Center, for principle details, refer to page 16:

1. Select "Navigation" and press the controller
2. Select "New destination" and press the controller



3. Select "Enter address" and press the controller.

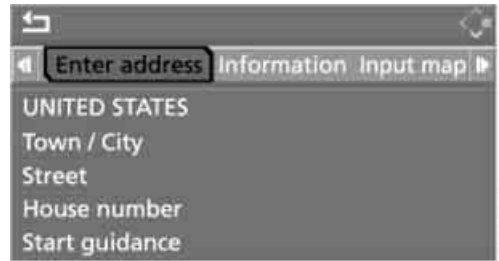

The system also supports you with the following features:

- ▷ If you do not enter a street, the system will guide you to the downtown area of a town or city
- ▷ You can skip the entry of country and locality if the current entries are being retained for your new destination
- ▷ The commands of the voice command system for destination entry differ from those of the individual menu items on the Control Display. You can have the system list the possible voice commands, refer to page 21.

Selecting country of destination

1. Select "State / Province" or the displayed country and press the controller. A list of available countries appears on the display



2. Select the country of destination and press the controller.

In order to be able to start the destination guidance, at least the city of destination or its zip code must be entered.

Entering town/city of destination or zip code

1. Select "Town / City" or the displayed town/city and press the controller
2. To enter the town/city of destination: Select the first letter and press the controller.

A list of all towns/cities starting with this letter appears on the Control Display.

To enter the zip code:

Select digits individually and press the controller, then select the zip code and press the controller.

The corresponding town/city of destination is displayed

3. If necessary, enter other letters of the town/city of destination.

The list gradually grows smaller each time you enter a new letter.

To enter blanks:

Select **_** and press the controller.

To delete the last letter entered:

Move the controller to the right to select **←|** and press the controller



4. Select the town/city name from the list and press the controller.

Entering street, house number and intersection

1. Select "Street" or the displayed street and press the controller
2. For instructions on entry, refer to Entering town/city of destination.



After the street you can also enter the intersection or the house number.

The intersection is entered in the same way as the street.

To enter the house number:

1. Select "House number" and press the controller

2. Enter the house number: Select the individual digits and press the controller.

To delete entered digits or letters:

Move the controller to the right to select **←|** and press the controller

3. Select the house number and press the controller.

Only house numbers stored for the street on the navigation DVD can be entered.

Starting destination guidance with manual destination entry

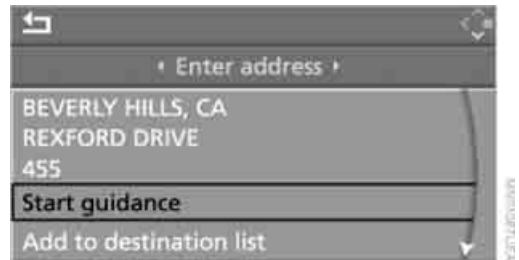

Select "Start guidance" and press the controller.

Destination guidance starts immediately.

If destination guidance is not to be started immediately:

Select "Add to destination list" and press the controller.

The destination is saved in the destination list, refer to page 113.

Selecting destination using map

If you only know the location of the town/city or street, the system offers you a map. You can use the cursor to limit the destination in the map and then apply it into the destination guidance.

Control Center, for principle details, refer to page 16:

1. Select "Navigation" and press the controller
2. Select "New destination" and press the controller



3. Select "Input map" and press the controller.

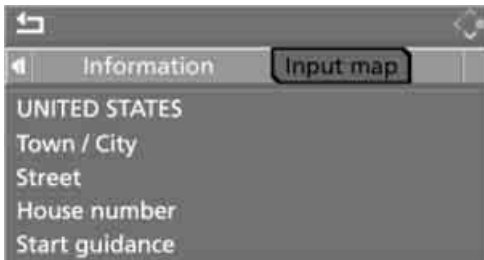

A section of a map is displayed on the Control Display:

- ▷ During destination guidance, around the current destination
- ▷ With the destination guidance deactivated, around the last destination entered

4. Move the controller in the desired direction to localize your destination. The controller can be moved to the left, right, forwards, backwards and also diagonally.



The aim can be applied in a scale below 1 mile/2 km as destination or saved. To adjust the scale: Turn the controller

5. Press the controller. The selected town/city of destination and other menu items are displayed
6. Select the desired menu item:
 - ▷ closes "Input map"
 - ▷ "Start route guidance" switches the destination guidance on
 - ▷ "Show current position" places the current position back in the center of the map
 - ▷ "Show destination position" places the current destination in the center of the map
 - ▷ "Return to map" switches back to "Input map"

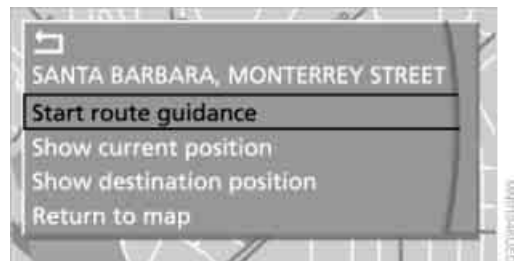

7. Press the controller.

Selecting destination using information

You can obtain a display of selected destinations for towns/cities and apply them into the destination guidance, e.g. hotels, sights or hospitals.

Control Center, for principle details, refer to page 16:

1. Select "Navigation" and press the controller
2. Select "New destination" and press the controller
3. Select "Information" and press the controller

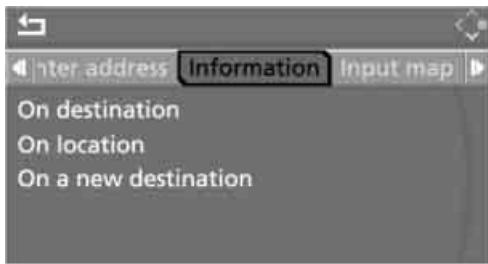

4. Select the destination town/city or country:
 - ▷ "On destination"
 - ▷ "On location"
 - ▷ "On a new destination"The display for entering a town/city appears on the Control Display. Select the desired town/city and press the controller

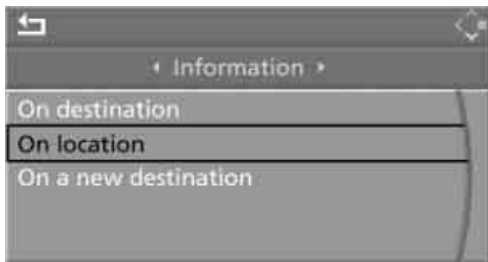

5. Press the controller
6. Select the desired type of destination, such as "Hotels and restaurants"

7. Press the controller.
A list with a maximum of ten destinations, sorted by distance, is displayed on the Control Display
8. Select a destination and press the controller
9. Select a menu item:
 - ▷ To apply the address in the destination list and start the destination guidance:
Select "Select as destination" and press the controller
 - ▷ To set up a telephone connection:
Select "Call" and press the controller.

To exit the menu:

Select  and press the controller.

Destination list

The destination list shows the last 20 entered destinations as well as the current destination of the destination guidance. The current destination is highlighted by this symbol .

Control Center, for principle details, refer to page 16:

1. Select "Navigation" and press the controller
2. Select a destination and press the controller



3. The selected destination can be edited:
 - ▷ To start destination guidance:
Select "Start guidance".
 The destination guidance is started

- ▷ To display information on the destination:
Select "Information on destination"
- ▷ To change the entry:
Select "Edit", for operation, refer to Entering town/city of destination or zip code, page 111
- ▷ To delete the entry:
Select "Delete entry"
- ▷ To delete all entries:
Select "Delete list". Destination guidance is switched off
- ▷ To store the entry:
Select "Add to address book"

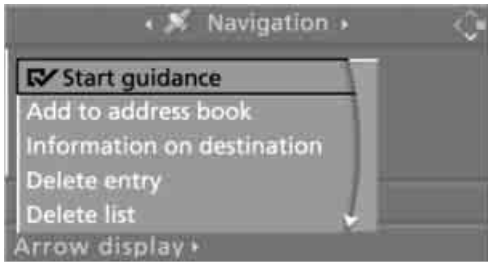

4. Press the controller.

Address book

Opening address book

Control Center, for principle details, refer to page 16:



Select "Address book" and press the controller.

Storing destinations in address book

You can save approx. 100 destinations in the address book.

Control Center, for principle details, refer to page 16:

1. Select "Address book" and press the controller
2. Select "New address" and press the controller

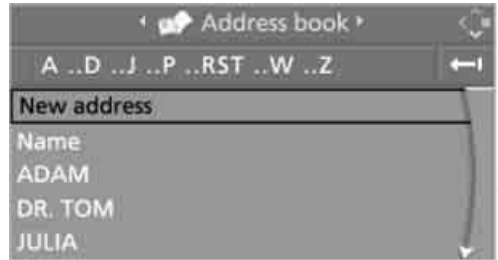

3. Select "Enter address yourself" and press the controller
4. Enter name and address
5. Select "Store in address book" and press the controller.
The entry is stored in the address book.

You can also save a destination from the destination list in the address book, refer to page 113.

Storing current position

The current position can be adopted into the address book:

Control Center, for principle details, refer to page 16:

1. Select "Address book" and press the controller
2. Select "New address" and press the controller

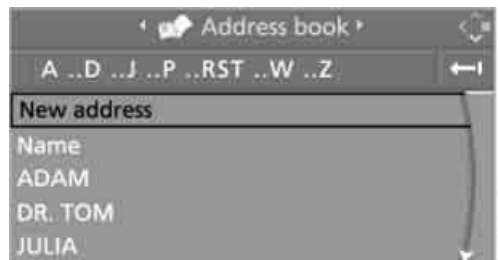

3. Select "Apply location as address" and press the controller.
The given name can be changed. For operation, refer to Entering a destination manually, page 110
4. Select "Store in address book" and press the controller.

You can also enter your current position in the address book after leaving the sector covered by the navigation DVD. In this case, you must enter a name.

Selecting destinations from address book

Control Center, for principle details, refer to page 16:

1. Select "Address book" and press the controller.
The stored entries are displayed on the Control Display



2. Select the entry and press the controller.

To start destination guidance:

Select "Start guidance" and press the controller.

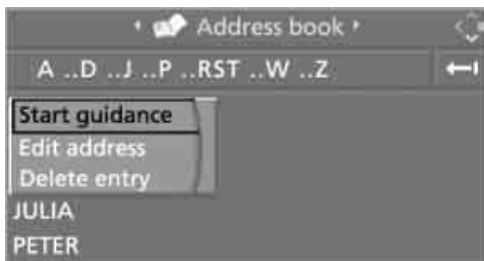

Changing destinations from address book

Control Center, for principle details, refer to page 16:

1. Select "Address book" and press the controller
2. Select the entry and press the controller
3. Select "Edit address" and press the controller



4. Change the entry.

For operation, refer to Entering a destination manually, page 110

Deleting individual destinations from address book

Control Center, for principle details, refer to page 16:

1. Select "Address book" and press the controller
2. Select the entry and press the controller
3. Select "Delete address" and press the controller.



Deleting all destinations from address book

Control Center, for principle details, refer to page 16:

1. Open the start menu
2. Press the controller to open the **i** menu
3. Select "Vehicle settings" and press the controller
4. Select "Delete data" and press the controller

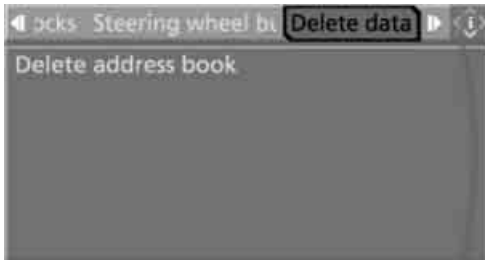

5. Select "Delete address book" and press the controller
6. Select "Yes" and press the controller.

Route selection

You can influence the calculated route by choosing certain route criteria.

Changing route criteria

Control Center, for principle details, refer to page 16:

1. Select "Navigation" and press the controller
2. Select "Route preference" and press the controller.

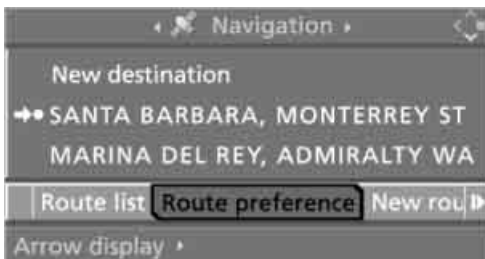

The various criteria are listed on the Control Display

3. Select a route criterion for the route:
 - ▷ "With highways"
 - Freeways and major traffic arteries are given priority
 - ▷ "Avoid highways"
 - Freeways are avoided where possible
 - ▷ "Fast route"
 - Shortest time using combination of smallest possible distance and sections where fast driving is possible
 - ▷ "Short route"
 - Shortest distance without consideration of the time
4. Press the controller.

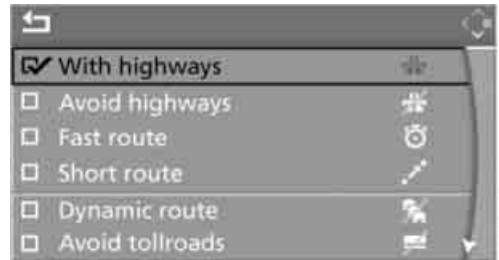

- The route criterion is highlighted
5. If necessary, select an additional route criterion and then press the controller:
 - ▷ "Dynamic route"
 - The route is planned around or through traffic obstructions
 - ▷ "Avoid tollroads"
 - Tollroads are avoided where possible
 - ▷ "Avoid ferries"
 - Ferries are avoided where possible.

To exit the menu:

Select and press the controller.

The route is planned according to fixed rules. These vary according to the different kinds of roads stored on the map DVD. As a result, the routes recommended by the navigation system may not always be the same ones that you would choose based on personal experience.

You can change the choice of route whenever the destination guidance is active.

Wordmatch principle

The system supports the wordmatch principle to make it easier for you to enter the names of streets or towns/cities. The system runs ongoing checks, comparing your destination entries with the data stored on the navigation DVD as the basis for instant response. The user benefits include:

- ▷ Names of specific locations can also vary from the official versions provided that the spelling of the entry corresponds to a standard form used in another country.

Example:

Instead of 'München', you can also enter the English spelling 'Munich' or the Italian spelling 'Monaco'

- ▷ When you are entering the names of towns/cities and streets the system will complete them automatically as soon as enough letters are available to ensure unambiguous identification
- ▷ The system only accepts name entries beginning with letters that are stored on the navigation DVD. The system will not accept nonexistent names and addresses.

Destination guidance

Starting destination guidance

Control Center, for principle details, refer to page 16:

1. Select "Navigation" and press the controller
2. Select the destination from the destination list and press the controller or enter a new destination, refer to page 110



3. Select "Start guidance" and press the controller.

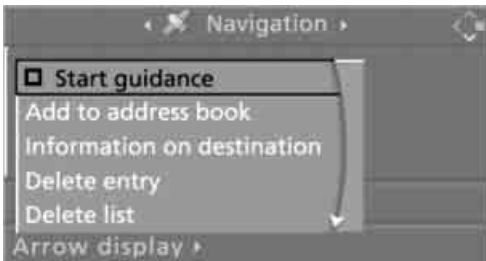

The destination guidance is started.

➔● indicates the current destination.

After the route has been calculated, destination guidance is indicated by arrows or a route map on the Control Display.



- 1 Estimated time of arrival
- 2 Distance to the destination on the calculated route
- 3 Route criterion
- 4 Switch voice instructions on/off

During destination guidance, you can operate other equipment using the Control Center at any time. You are informed of a required change in direction by means of voice instructions in good time prior to every intersection.

To exit the menu:

Select and press the controller.

Terminating/continuing destination guidance

Control Center, for principle details, refer to page 16:

➔● indicates the current destination.

1. Select the current destination and press the controller



2. Select "Start guidance" and press the controller.
 - The destination guidance is switched off.

When you park the vehicle before reaching the entered destination, upon restarting you will see the question "Continue guidance to dest.?".

To restart destination guidance:
Select "Yes" and press the controller.

Destination guidance through voice instructions

Switching voice instructions on/off

Control Center, for principle details, refer to page 16:

1. Open the start menu
2. Press the controller to open the **i** menu
3. Select "Display settings" and press the controller
4. Select "Languages" and press the controller

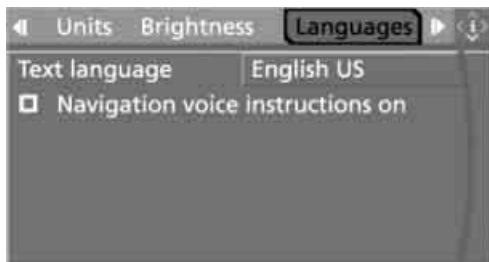

5. Select "Navigation voice instructions on" and press the controller.

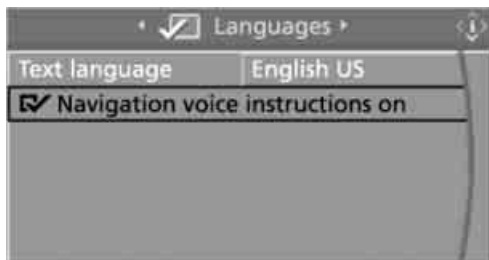

The voice instructions are switched on.

Depending on which key you have used to open the vehicle, the last adjustment is applied.

Repeating and canceling voice instructions

With the programmable keys in the steering wheel, you can also make the following settings, refer to page 49:

- ▷ Repeat the voice instruction
- ▷ Cancel the voice instruction
- ▷ Switching voice instructions on/off.

Adjusting volume

1. Repeat the last voice instruction, if required
2. Turn the button during the voice instruction to select the desired volume.

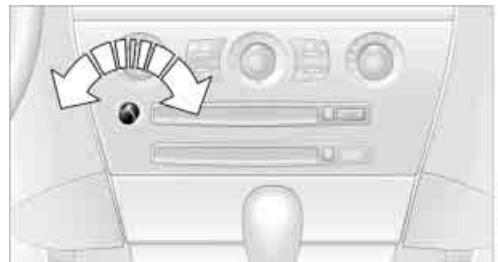

This volume is independent of the volume of the audio and video sources.

Depending on which key you have used to open the vehicle, the last adjustment is applied.

Displaying route

You have the option of displaying various views of the route during destination guidance.

Displaying arrow view

1. Select "Navigation" and press the controller
2. Select "Arrow display" and press the controller.

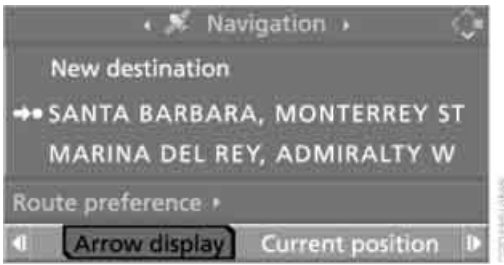

Displaying route map

You can have your current position displayed on a map. After starting the destination guidance, the planned route is shown on the map.

1. Select "Navigation" and press the controller
2. Select "Map, facing north" or "Map, direction of travel"

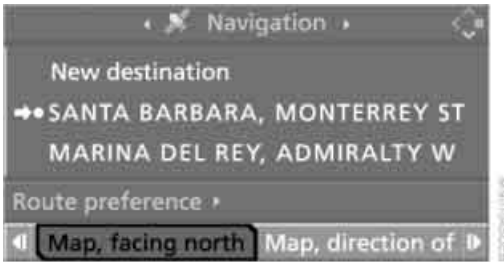

3. Press the controller.

At scales of less than 300 miles/500 km, you enjoy the option of deciding whether to orient the map to north or toward your current direction of travel. From 300 miles/500 km, the map always points toward north.

Changing scale

Turn the controller. On the Control Display, a scale display appears and the scale is changed.

Displaying towns/cities and streets of route

You can have the names of streets and towns/cities on your route displayed whenever the destination guidance is active.

The distances remaining to be traveled on each individual road and directional arrows are also displayed.

Control Center, for principle details, refer to page 16:

1. Select "Navigation" and press the controller
2. Select "Route list" and press the controller.

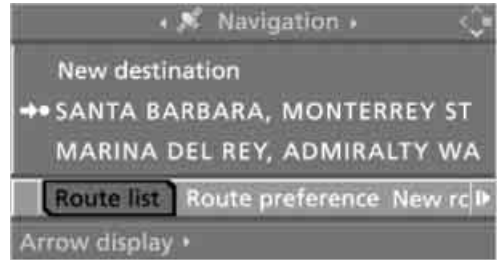

To exit the menu: Select  and press the controller.

Bypassing route sections

During destination guidance, you can revise the navigation system's route recommendations to avoid particular stretches of road. Enter the number of miles/kilometers that you want to travel before returning to the original route.

Control Center, for principle details, refer to page 16:

1. Select "New route" and press the controller

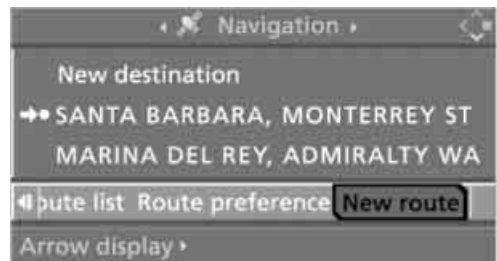

2. Turn the controller to enter the desired number of miles/kilometers and press the controller.

To exit from the menu without changing the route:

Select  and press the controller

3. "Calculate" is used to recalculate the route.

What to do if ...

What to do if ...

- ▷ you request the current position of your vehicle, but do not receive a precise display?

The system is unable to receive enough GPS signals at your current position owing to obstructions, your current position is not yet available on your navigation DVD, or the system is in the process of calculating your current position. As a rule, reception is guaranteed under a clear sky

- ▷ the destination guidance does not apply a destination?
The data of the destination is not stored on the navigation DVD that is loaded. Select a destination that is as close as possible to the original
- ▷ the destination guidance does not apply an address without the street name?
On the navigation DVD, no downtown area can be determined for the city or town entered. Enter any street, or a destination such as the railway station etc., then start the destination guidance

- ▷ you want to enter a destination for the destination guidance, but it is not possible to select the letters for your desired entry?

The destination data is not recorded on the navigation DVD that is loaded. In this case, the system will not offer you any letters to choose from. Select a destination that is as close as possible to the original

- ▷ the system stops furnishing directions on which way to turn as you approach intersections?
You are driving in an area that has not yet been completely recorded on the navigation DVD. Instead of an arrow indicating a turn, you will see an arrow which indicates the general direction of your planned route. Or you have left the recommended route and the system requires a few seconds to calculate a new recommended route
- ▷ the battery has been disconnected?
It will take approx. 10 minutes for the system to resume operation.





Entertainment

Operation of the radio and CD as well as their tone settings are described in this chapter.

On/off and tone

The following equipment has shared controls and setting options:

- ▷ Radio Business
- ▷ CD player
- ▷ CD changer*.

Controls

The audio sources can be operated using:

- ▷ Buttons on the CD player
- ▷ Control Center
- ▷ Buttons on the steering wheel, refer to page 11.

Buttons on CD player

The layout of the buttons can vary depending on your vehicle's equipment.

Equipment with single drive:

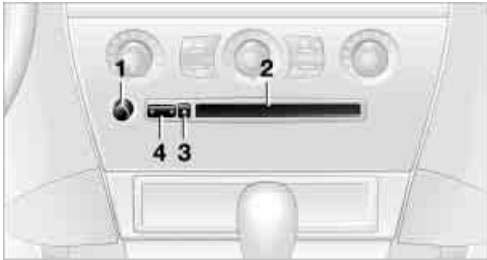

Equipment with two drives:

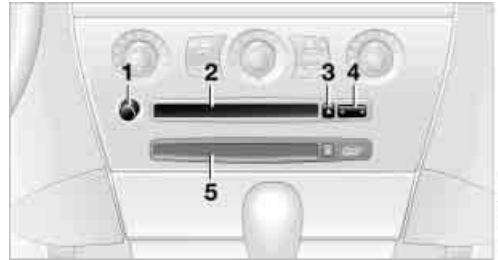

- 1 Sound output for Entertainment on/off, volume
 - ▷ Press: switch on/off. When you switch on, the last set radio station or CD track is played
 - ▷ Turn: adjust volume
- 2 Drive for audio CD
- 3 Eject CD
- 4 Station scan/track scan
 - ▷ Change radio station
 - ▷ Select track for CD player and CD changer
- 5 Drive for navigation DVD

Operation using Control Center

Control Center, for principle details, refer to page 16:

1. Press button.



The start menu is opened



2. Move the controller backwards to open "Entertainment".



You have the following choices:

- ▷ "FM" or "AM": radio reception
- ▷ "WB": calling up Weather Band station
- ▷ "SAT": selecting satellite radio
- ▷ "CD": selecting CD player or CD changer
- ▷ "Set": depending on each audio source, other settings can be made, e.g. on the radio: updating stations with best reception, storing stations, setting the tone, playing stations.

Switching on/off

To switch the sound output for Entertainment on/off:

Press button 1 on the CD player.

🔊 This symbol on the Control Display indicates that sound output is switched off.

Adjusting volume

Turn button 1 until the desired volume has been reached.

Depending on which key you have used to open the vehicle, the last adjustment is applied.

Adjusting tone

You can alter various tone settings, e.g. treble and bass, or the speed-dependent volume. This changes the setting for all audio sources.

Depending on which key you have used to open the vehicle, the last settings are applied.

Changing tone settings

Control Center, for principle details, refer to page 16:

1. Press button.



The start menu is opened



2. Press the controller to open the i menu
3. Select "Entertainment settings" and press the controller



4. Select "Audio" and press the controller.



The tone settings can also be selected if you have opened "Entertainment": Select "Set" or "Tone" and press the controller.

Treble and bass

1. Select "Treble / Bass" and press the controller



2. Move the controller to the left or right to select "Treble" or "Bass"



3. Turn the controller until the desired setting is selected.

Balance and fader

You can set the right/left and front/rear volume balance in the same manner as "Treble / Bass".

Speed-dependent volume

The speed-dependent volume control automatically increases the volume with increasing speed. You can set various stages for the increase in volume.

1. Select "Speed volume" and press the controller



2. Turn the controller. The adjustment is applied; the field can be changed.



Professional LOGIC7 HiFi System*

You can select a spatial sound effect that improves the spatial acoustics in all frequency ranges.

1. Select "LOGIC7" and press the controller



2. Select "Concert hall" and press the controller.
LOGIC7 spatial sound is switched on.



To switch off spatial sound:
Select "Off" and press the controller.

LOGIC7 and the LOGIC7 logo are registered trade marks of Lexicon, Inc., a company of the Harman International Group.

Equalizer*

You can set individual sound frequency ranges:

1. Select "Equalizer" and press the controller



2. Move the controller to the left or right to select the desired frequency range



3. Turn the controller until the desired setting is selected.

Resetting tone settings

You can reset all tone settings except "Speed volume" to the standard default settings.

1. Open the start menu
2. Press the controller to open the **i** menu
3. Select "Entertainment settings" and press the controller
4. Select "Audio" and press the controller
5. Select "Reset" and press the controller.



Radio

Your radio provides reception of the FM and AM wavebands.

Listening to the radio

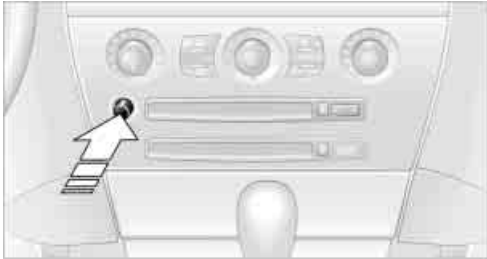

Press the button if the sound output is switched off.

Control Center, for principle details, refer to page 16:

1. Press button.

MENU

The start menu is opened



2. Move the controller backwards to open "Entertainment"
3. Select "FM" or "AM"



4. Press the controller.

Stations are shown on the Control Display on the basis of various selection criteria, e.g. "Presets".

If no station is displayed, update the stations with the best reception, refer to page 132.

Changing station



Turn the controller.

In addition to the stations currently displayed, you can have stations with another selection criterion displayed.

You can choose from the following selection criteria:

- ▷ "Autostore":
The six strongest stations, refer to page 132
- ▷ "Presets":
Stations you have stored, refer to page 132.

To change between these different selection criteria of stations:

1. Move the controller forwards to change fields
2. Select a selection criterion



3. Press the controller.

Buttons on CD player



Briefly press the button for the corresponding direction.

The system switches to the next displayed station.

Playing stations, scan

The system automatically plays a brief sample from each of the stations on the current waveband.

Control Center, for principle details, refer to page 16:

1. Select "FM" or "AM"
2. Press the controller
3. Press the controller. Other menu items are displayed
4. Select "Scan" and press the controller.

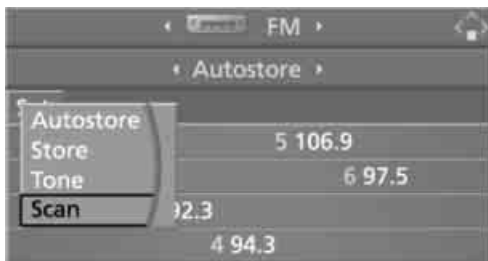

Scan starts.

To stop the scan:

1. Press the controller once again
 2. Select "Scan" and press the controller.
- This cancels the scan search, and the radio remains on the current station.

Buttons on the CD player:



To start the scan, press the button for a longer period.

To stop the scan, press the button briefly.

Selecting frequency manually

Control Center, for principle details, refer to page 16:

1. Select "FM" or "AM"
2. Press the controller
3. Move the controller forwards to change fields
4. Select "Manual" and press the controller



5. Turn the controller to set a certain frequency.

Buttons on the CD player:

In "Manual", you can set stations that are received in addition to those displayed.



To start the scan, press the button for a longer period.

The scan mode begins with the currently selected frequency.

The system plays a brief sample from each radio station.

To stop the scan at the desired frequency or station:
Press button.

Updating stations with best reception

If you are on a longer journey and leave the transmission range of the stations originally set, you can update the list of stations with the best reception.

Control Center, for principle details, refer to page 16:

1. Select "FM" or "AM"
2. Press the controller
3. Move the controller forwards to change fields
4. Select "Autostore" and press the controller



5. Press the controller.
Other menu items are displayed
6. Select "Autostore" and press the controller.



The display of the stations with the strongest reception is updated. The stations are displayed based on their frequencies.

Storing stations

Control Center, for principle details, refer to page 16:

1. Select "FM" or "AM"
2. Select the desired station.
"Set" has been selected



3. Press the controller.
Other menu items are displayed
4. Select "Store" and press the controller.



"Presets" is displayed

5. Turn the controller until the desired memory location is selected.
The number of the memory location appears beside the name or frequency of the station
6. Press the controller.
The station is stored.



The stations of the last selection criterion are displayed once again after a short time. Depending on which key you have used to open the vehicle, other stored stations are displayed.

Changing a memory location

Control Center, for principle details, refer to page 16:

1. Select "Presets" and press the controller
2. Select the desired station
3. Press the controller. Other menu items are displayed
4. Select "Store" and press the controller



5. Turn the controller until the desired memory location is selected. The number of the memory location appears beside the name or frequency of the station
6. Press the controller. The station is stored.

RDS Radio Data System

RDS transmits additional information in the FM frequency range. RDS stations have the following properties:

- ▷ In the case of broadcasting networks that transmit over a number of frequencies, there is an automatic switch to the frequency with the best reception quality
- ▷ If the reception conditions are good, the station names are shown on the Control Display. If the reception is weak or disrupted, it can take some time before the station names appear.

Weather Band*

Weather Radio is a service of the National Oceanic and Atmospheric Administration – NOAA – of the U.S. Department of Commerce. Weather messages are repeated every four to six minutes and are routinely revised every one to three hours, or more frequently if needed. Most of the stations operate 24 hours daily. During severe weather, National Weather Service forecasters can interrupt the routine weather broadcasts and substitute special warning messages. If you have a question concerning NOAA Weather Radio, please contact your nearest National Weather Service Office, or write to National Weather Service – Attn: W/OM11 –, National Oceanic and Atmospheric Administration, 1325 East-West Highway, Silver Spring, MD. 20910.

Selecting Weather Band

Control Center, for principle details, refer to page 16:

1. Select "WB" and press the controller



2. Select the Weather Band station and press the controller.

It can occur that the Weather Band station is not available in some regions.

Satellite radio*

You can receive up to 100 different channels with high tone quality.

The channels are offered to you in predefined combinations. To receive the channels of your choice, you must have this combination enabled.

 You may experience signal drops and muting events related to this new technology. ◀

Enabling or disabling channels

Control Center, for principle details, refer to page 16:

1. Press button.

MENU

The start menu is opened



2. Move the controller backwards to open "Entertainment"
3. Select "SAT"



4. Press the controller.

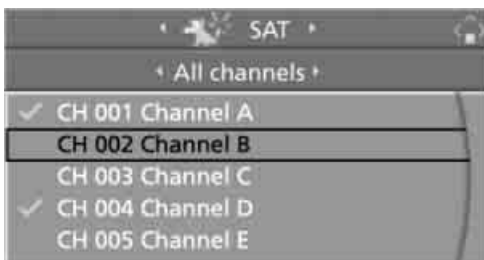

The channels are displayed.

✓ These channels are enabled.

Enabling

1. Select a channel that has not yet been enabled and press the controller. A telephone number and the electronic serial number, ESN, are displayed

 The electronic serial number is required to enable or disable. ◀

2. To have the channels enabled: Dial the telephone number or, in the case of equipment with two drives, select the telephone number and press the controller.

Disabling

1. Select an enabled channel and press the controller

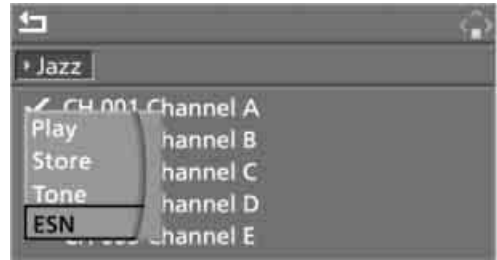

1. Select "ESN" and press the controller. A telephone number and the electronic serial number, ESN, are displayed

 The electronic serial number is required to disable. ◀

2. To have the channels disabled: Dial the telephone number or, in the case of equipment with two drives, select the telephone number and press the controller.

Selecting and storing channel

1. Select "SAT" and press the controller.



Channels are shown on the Control Display sorted on the basis of various selection criteria

2. Select a menu item:
 - ▷ "Presets":
Up to twelve channels you have stored
 - ▷ "All channels"
 - ▷ "Categories":
All channels sorted by category, e.g. news, jazz



3. Press the controller
4. If "Categories" has been selected:
Select the desired category and press the controller.

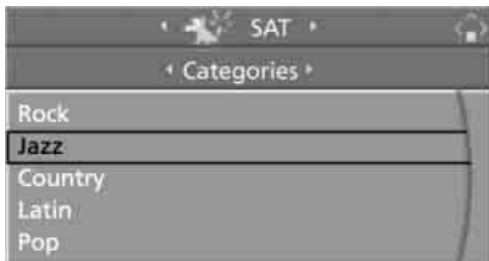

The channels of this category are displayed

5. ✓ Select a channel marked with this symbol

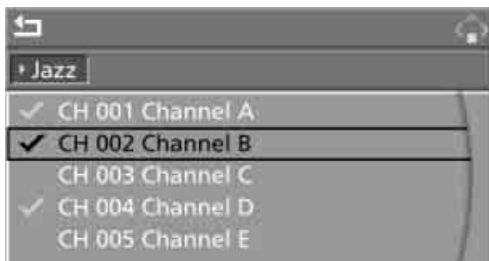

6. Press the controller.
Other menu items are displayed
7. Select "Play" and press the controller.

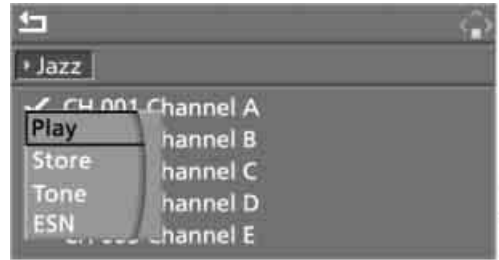

Additional information

The name of the channel and additional information on the current track are displayed, e.g. the name of the artist.



- 1 Artist
- 2 Track
- 3 Album*

Storing channel

1. Select desired channel
2. Press the controller.
Other menu items are displayed
3. Select "Store" and press the controller.

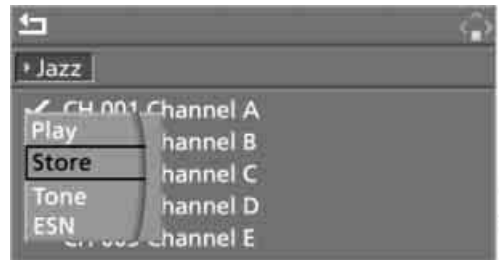

"Presets" is displayed

- Turn the controller to select a memory location and press the controller.

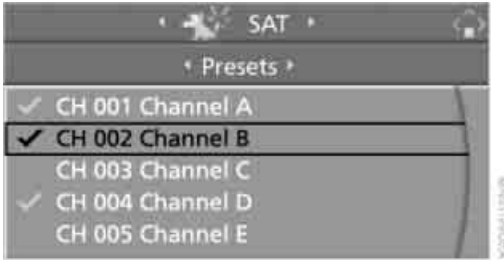

The channel is stored. The stations of the last selection criterion are displayed once again after a short time.

Changing channel with buttons on CD player



Briefly press the button for the corresponding direction.

The system switches to the next enabled channel.

Notes

When there is a signal blockage or the transmission is suspended momentarily for more than 4 seconds, a message appears on the Control Display.

 Service may be interrupted or unavailable for specific reasons such as environmental or topographic conditions and others that Satellite Radio cannot directly control.

Signal may not be available under tunnels, in parking garages, next to tall buildings, nearby trees with dense foliage, nearby mountains or other possible strong sources of radio interference.

Service should resume normally after the source of signal unavailability has been cleared. ◀

CD player and CD changer*

Listening to CDs

Starting CD player



Equipment with two drives:
The upper drive is for audio CDs.

Insert the CD with the labeled side facing upwards.

Playback starts automatically if the sound output is on.

Currently not available:

The CD player can also play CDs with an MP3 content. Depending on the directory and file structure, it may take up to 50 seconds to read in the data.

To start playback when there is already a CD in the drive:

Control Center, for principle details, refer to page 16:

1. Press button.

MENU

The start menu is opened



2. Move the controller backwards to open "Entertainment"

3. Select "CD" and press the controller



4. On vehicles with a CD changer, select "CD" and press the controller to start the CD player.

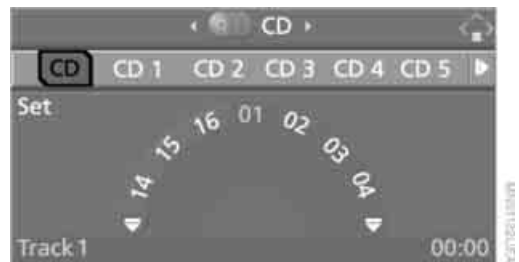

To eject the CD, press the button on the CD player:



The CD emerges slightly from the drive.

Starting CD changer

1. Fill the CD magazine and insert, refer to page 140
2. Control Center, for principle details, refer to page 16:
Press button.

MENU

The start menu is opened



3. Move the controller backwards to open "Entertainment"
4. Select "CD" and press the controller
5. Select the desired CD and press the controller.

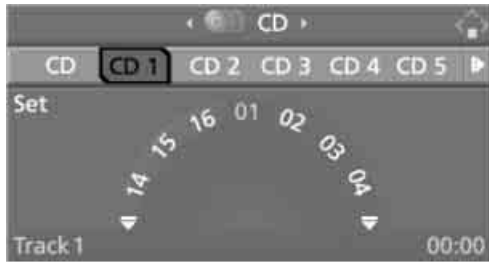

At the end of the last track, the next CD will be selected.

If new CDs have been placed in the CD magazine, playback starts with the lowest CD, e.g. CD 1, track 1.

The CD magazine's load status is indicated on the Control Display.

Selecting a track

Buttons on the CD player:



Press the button for the corresponding direction repeatedly, continuing until you reach the desired track on the current CD. The CD will start play at the start of the track. The track is displayed on the Control Display.

Control Center, for principle details, refer to page 16:

Select a track by turning the controller.



If you have a CD with MP3 content:

1. Select directory if necessary

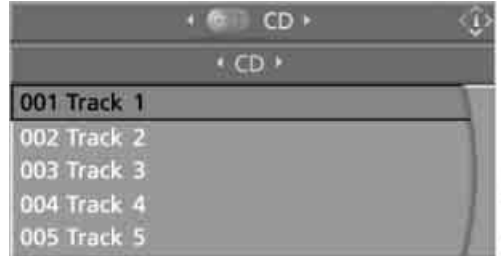

2. Select the music track and press the controller

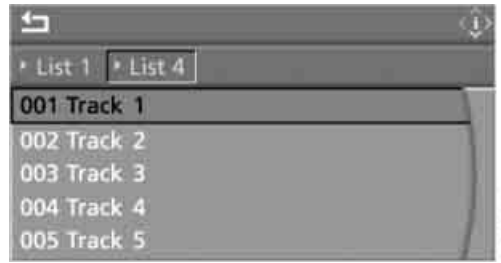

3. Select "play" and press the controller.

To change the directory:
Select directory and press the controller.

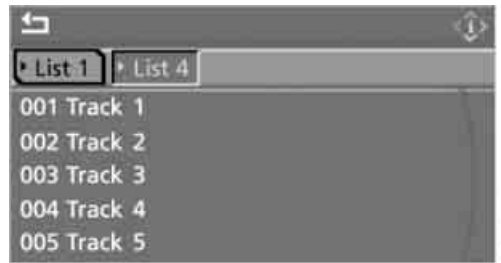

To exit the menu:
Select and press the controller.

Repeating a track

Control Center, for principle details, refer to page 16:

1. Select "Set" and press the controller.
Other menu items are displayed



2. Select "Repeat" and press the controller.

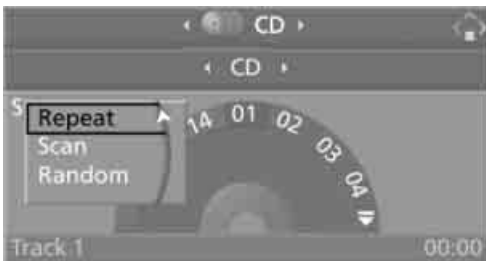

The current music track on the CD is repeated.

To stop repetition:
Press the controller, select "Repeat" and press the controller.

If you have a CD with MP3 content:

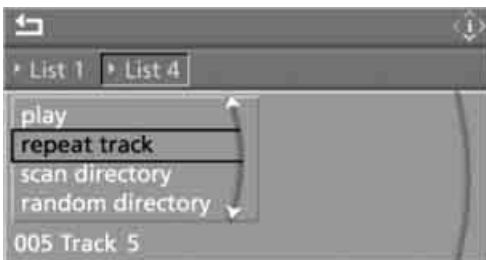

1. Select the current music track and press the controller
2. Select "repeat track" and press the controller.

The current music track on the CD is repeated.

To stop repetition:
Press the controller, select "repeat track" and press the controller.

Track sample scan

The system automatically plays a brief sample from each of the tracks on the current CD.

Control Center, for principle details, refer to page 16:

1. Select "Set" and press the controller.
Other menu items are displayed
2. Select "Scan" and press the controller.

To stop the scan:

1. Press the controller once again
2. Select "Scan" and press the controller.

This cancels the scan, and the selected track remains.

If you have a CD with MP3 content:

1. Select the current music track and press the controller
2. Select "scan directory" and press the controller.

The system automatically plays a brief sample from each of the tracks in the current directory.

To stop the scan:

1. Press the controller once again
2. Select "scan directory" and press the controller.

This cancels the scan, and the selected track remains.

Random play sequence

In this mode, the music tracks on the current CD are played once in a random sequence.

Control Center, for principle details, refer to page 16:

1. Select "Set" and press the controller. Other menu items are displayed
2. Select "Random" and press the controller.

To stop the random mode:

Press the controller, select "Random" and press the controller.

If you have a CD with MP3 content:

1. Select the current music track and press the controller
2. Select "random directory" and press the controller.

In this mode, the music tracks in the current directory are played once in a random sequence.

To stop the random mode:

Press the controller, select "random directory" and press the controller.

Fast forward/reverse

Buttons on the CD player:



Press and hold the button for the corresponding direction.

The tracks can be heard, but the sound is distorted.

CD magazine

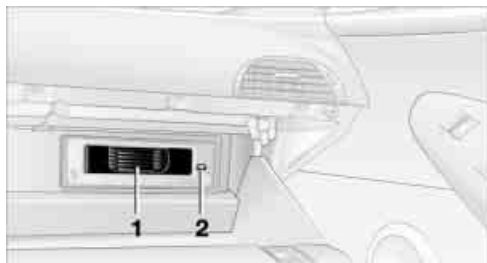

The BMW CD changer for six CDs is installed in the glove compartment.

Removing CD magazine

To insert or remove CDs from the CD magazine 1, you must first remove it from the CD changer:

1. Press button 2.
The CD magazine 1 is ejected
2. Remove the CD magazine.

Inserting/removing CDs from CD magazine



When inserting or removing CDs, remember to always only grasp them on the edge, taking care to avoid touching the data side with its mirror finish.

To insert:

Insert the CD in a CD slot with the labeled side facing upwards.

To remove:

Pull out the desired drawer, refer to arrow, and remove the corresponding CD.

Inserting CD magazine

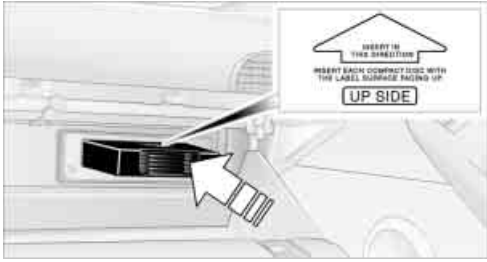

Push in the CD magazine as far as possible in the direction of the arrow.

The CD changer automatically reads in the inserted CDs and is then ready for operation.

Notes

For correct playback of MP3 content, the MP3 data should have been produced with the Fraunhofer codec.

Good playback quality is achieved with a data transfer rate of 192 kBit/s, however it should be at least 128 kBit/s.

Safety notes

 The BMW CD drives are Class 1 laser products. Do not operate if the cover is damaged, otherwise severe eye damage can result.

Do not use self-recorded CDs with labels applied as these can become detached during playback due to the development of heat and cause irreparable damage to the device.

Only use round CDs with a standard diameter of 4.7 in/12 cm and do not play CDs with an adapter, e.g. maxi CDs, as otherwise the CDs or the adapter can jam and may no longer be ejected.

Do not use a combined CD/DVD, e.g. DVD^{Plus}, as otherwise the CD/DVD can jam and is no longer ejected. ◀

Malfunctions

To prevent illegal CD copying, manufacturers often use copy protection. This can mean that some CDs cannot be played or only to a limited extent. In this case, please contact the CD dealer or manufacturer.

You may experience playback problems, such as skips, when using CD-Rs/CD-RWs that you have copied at home.

If the CD that you have loaded in the drive does not play, check to ensure that the CD has been inserted correctly and inspect it for signs of defects.

High levels of humidity can lead to condensation on the laser's scan lens and temporarily prevent it from reading the CD.

Keep CDs away from magnetic fields as created, e.g., by loudspeakers.

Always hold CDs by the edges; do not touch the reflecting CD memory surface.

Care instructions

You can find everything you need to know on this topic by consulting the Caring for your vehicle brochure.



Communications

This chapter summarizes how you operate your BMW portable phone via the Control Center or voice control and how you use BMW Assist or TeleService.

Telephoning

Safety notes

For your own safety

Your car phone makes life more convenient in many ways, and can even save lives in an emergency. While you should consult your portable phone's separate Owner's Manual for a detailed description of safety precautions and information, we request that you direct your particular attention to the following:

Adjustments

 To avoid posing a danger to yourself and other road users, never adjust the system settings unless your vehicle is stationary. ◀

Using the phone in your vehicle

 Using a portable phone while driving is now illegal in many states and cities. Always use your hands-free system, or stop your vehicle in an area where you will not pose a safety hazard to other road users. ◀

Vehicles and portable phones

 Do not use your phone within a garage, or near an open hood. The air in these areas could contain fuel vapors, and the portable phone might generate sparks that could result in burns. This same precaution applies to open luggage compartment lids on vehicles equipped for operation using natural gas or hydrogen, and to all vehicles with luggage compartment-mounted batteries. ◀

Antenna

 When using the phone, ensure that all persons in the area are at least 20 in/50 cm from the antenna. Never use your BMW portable phone if the antenna is damaged. Contact between your skin and a

damaged antenna can result in minor burns.

If the antenna is damaged, have it replaced immediately. ◀

Special environmental conditions

 Always switch off your BMW portable phone in areas where blasting work is being conducted with explosives. The phone signals could potentially act as a high-frequency transmitter and set off explosions.

Always switch off your BMW portable phone in areas where an increased explosion danger is present. This category includes gas stations along with fuel and chemical storage depots, etc., and all areas in which the air can contain fuel, chemicals or metal particles. Under these conditions, your BMW portable phone could conceivably generate sparks that could lead to a fire or explosion. Always observe all legal regulations governing the use of portable phones in the vicinity of gas stations, chemical factories and other areas where an explosion potential exists. Never use your BMW portable phone in aircraft; do not use this portable phone in hospitals, care centers or at other locations where medical equipment may be in operation, such as accident sites, etc. Your wireless service provider can furnish you with more detailed information on legal regulations governing the use of your phone. ◀

Medical equipment

 Portable phones can generate interference capable of preventing hearing aids and cardiac pacemakers from operating correctly. If you or any occupant of the vehicle use such equipment, consult a physician or the manufacturer of the equipment to determine whether it is adequately shielded against high-frequency energy. ◀

Batteries

 Never attempt to dismantle your BMW portable phone or its battery. Use only approved battery types – the wrong battery can destroy your portable phone.

To avoid possible short circuits, after removing a battery you should never allow it to come into contact with metallic surfaces of any kind. ◀

Disposing of used batteries

 Return used batteries to a recycling collection point or to your BMW center. ◀

Care instructions

You can find what you need to know about caring for your portable phone in the Caring for your vehicle brochure and in the separate portable phone Owner's Manual.

Operating options

You can operate the BMW portable phone* with:

- ▷ The steering wheel, refer to page 11
- ▷ The Control Center, refer to page 146
- ▷ Voice control, refer to page 151.

Telephoning with car phone: BMW Assist calls

You can use the car phone via the hands-free system for BMW Assist calls.

When the status information "Car Phone" is displayed in "Communication", only BMW Assist calls are possible.

Activating the BMW portable phone*

Requirements for portable phones with SIM card:

- ▷ Enter a Personal Identification Number, PIN, if necessary
- ▷ Remove all keypad locks, refer to separate Owner's Manual.

Before starting off, place the BMW portable phone in the cradle. If a connection to BMW Assist has been established, you cannot use the BMW portable phone until this connection has been terminated.

Inserting portable phone

1. Press button 1
2. To adjust the cradle to the portable phone: Slide the switch 2 toward the front or rear if necessary

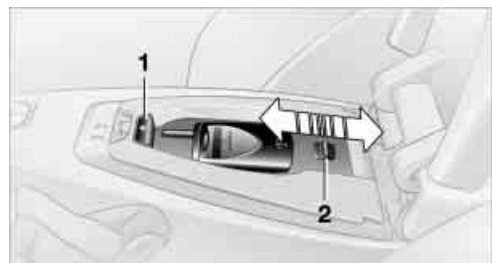

3. If necessary, remove the protective cap from the antenna connector on the back of the portable phone
4. Insert the portable phone with the antenna completely retracted
5. Press the cradle downwards.

When the status information "Portable" is displayed in "Communication", you can operate the BMW portable phone via the vehicle.

Removing portable phone

Press button 1.

 For information on operating your portable phone, please consult the separate Owner's Manual. ◀

Hands-free system

Coupe:



Convertible:



The hands-free microphone is located near the interior rearview mirror or on the steering column.

The hands-free system is activated whenever you establish or receive a call using:

- ▷ The button on the steering wheel
- ▷ The Control Center
- ▷ Voice control.

Volume adjustment



Turn the button during a call to select the desired volume.

This volume for the hands-free system is maintained, even if the other audio sources are set to minimum volume.

Depending on which key you have used to open the vehicle, the last adjustment is applied.

Operation using Control Center

The following functions can be used via the Control Center as soon as the BMW portable phone has been laid in the cradle:

- ▷ Entering unlock code
- ▷ Dialing a phone number
- ▷ Phone book
- ▷ Top 8
- ▷ Redialing
- ▷ Displaying accepted calls
- ▷ Displaying missed calls
- ▷ Text messages/SMS.

Control Center, for principle details, refer to page 16:

1. Press button.

MENU

The start menu is opened



2. Move the controller forwards to open "Communication".

Entering unlock code

if you are asked to enter the Unlock Code by a message on the Control Display:

1. Select "Phone" and press the controller



2. To enter the unlock code: select letters and digits individually and press the controller.

Each letter or digit of the unlock code is displayed on the Control Display with an asterisk.

To delete an incorrect digit:

Move the controller to the right to select  and press the controller

3. Select "Confirm unlock code" and press the controller.



Receiving calls

If you have the phone number of the caller stored in the phone book and the phone number is transmitted, the entry is displayed.

Accepting a call



Select "Accept" and press the controller.

Rejecting a call

Select "Reject" and press the controller. The caller is diverted to your mailbox if this has been activated.

Calling

Dialing phone numbers

1. Select "Phone" and press the controller



2. Select "Dial" and press the controller

3. To enter the phone number: select digits individually and press the controller. Always enter the complete phone number consisting of area code and phone number.

To delete an incorrect digit:

Move the controller to the right to select  and press the controller

4. Select "Dial number" and press the controller.



Ending a call

1. If necessary, select the telephone number



2. Press the controller. Other menu items are displayed
3. Select "End call" and press the controller.



Phone book

After inserting the portable phone in the cradle, the phone book is transferred from the portable phone into the vehicle. This also applies to portable phones with a SIM card; the phone book of the SIM card will not be transferred. Loading the phone book can take several minutes.

Dialing from phone book

1. Select "Phone" and press the controller



2. Select "A - Z" and press the controller. An alphabetical listing of all the entries in the phone book appears on the Control Display.

To run a targeted search for an entry, select the first letter of the entry and press the controller.

The first entry that starts with this letter is displayed

3. Select the desired entry



4. Press the controller. Other menu items are displayed
5. Select "Call" and press the controller. The system dials the number.

If different phone numbers are stored in the portable phone under one name, e.g. office and home, the name is shown once for each phone number.

Adding digits to phone numbers

You can add other digits to a phone number stored in the phone book, e.g. to call a specific extension:

1. Select "Phone" and press the controller
2. Select "A - Z" and press the controller
3. Select the desired entry

4. Press the controller.
Other menu items are displayed
5. Select "Add digits" and press the controller
6. To supplement the phone number:
select digits individually and press the controller
7. Select "Dial number" and press the controller.

Lists

Your phone stores phone numbers you have dialed and calls you missed. If the caller is entered in the phone book, the name of the caller is displayed instead of the phone number.

You can select the desired subscriber from the list and establish the connection.

Four lists are available:

- ▷ "Top 8".
The eight numbers called most frequently via the list "A - Z" are automatically stored in the Top 8 list. The number called most often appears at the top of the list
- ▷ "Redial".
The last eight phone numbers you have dialed are automatically stored. The last number dialed is at the top of the list
- ▷ "Received calls".
The phone numbers of the last eight calls accepted while the portable phone was in its cradle are stored. Here, it must be possible for the telephone number of the caller to be sent
- ▷ "Missed calls".
The phone numbers of the last eight calls not accepted while the portable phone was in its cradle are stored. Here, it must be possible for the telephone number of the caller to be sent.

Dialing from a list

To select an entry and establish a connection:

1. Select "Phone" and press the controller
2. Select the list:

- ▷ "Top 8"
- ▷ "Redial"
- ▷ "Received calls"
- ▷ "Missed calls"



3. Press the controller
4. Select the desired entry



5. Press the controller.
Other menu items are displayed
6. Select "Call" and press the controller.
The system dials the number.

Deleting individual entries

1. Select the desired entry from the list
2. Press the controller.
Other menu items are displayed
3. Select "Delete" and press the controller.
The entry is deleted.



Deleting entire list

1. Select an entry from the list
2. Press the controller.
Other menu items are displayed
3. Select "Delete all numbers" and press the controller.
The list is deleted.



Touch tone dialing

Touch tone numbers are required for access to network services or to control devices, e.g. remote access to an answering machine.

This function can only be used during a call.

1. Establish a connection



2. Press the controller.
Other menu items are displayed
3. Select "Keypad" and press the controller
4. Select the desired digits and press the controller.
Each digit is sent immediately.



Text messages/SMS

✉ The symbol on the Control Display shows that you have received a new text message. The symbol is no longer displayed after there are no unread text messages.

The number of text messages that can be stored depends on the memory capacity of your BMW portable phone.

Displaying text messages/SMS

1. Select "SMS" and press the controller.



The list of received text messages is displayed on the Control Display.

✉ The symbol indicates unread text messages

2. Select the desired text message and press the controller.
The text message is displayed.

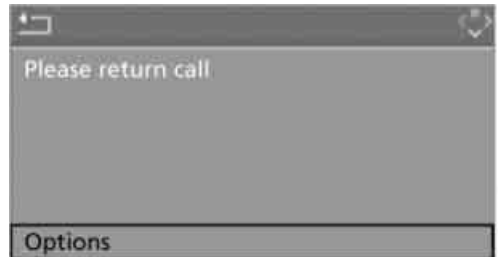

To close the text message:
Move the controller forwards to select  and press the controller.

Calling sender

1. Select the desired text message and press the controller.
The text message is displayed
2. Select "Options" and press the controller
3. Select "Call sender" and press the controller.
The selected sender is called.

Deleting text messages/SMS



1. Select the desired text message and press the controller.
The text message is displayed
2. Select "Options" and press the controller
3. Select "Delete" and press the controller.
The text message of the portable phone is deleted.

Operation by voice control*

The concept



You can operate your portable phone without having to remove your hands from the steering wheel. The system operates on the basis of voice commands that you learn easily after using them a few times. In addition, you are also supported by instructions or questions.

Symbols used

-  ›...‹ Identifies voice commands.
-  ››...‹‹ Identifies instructions generated by the system.

Voice commands

In ignition key position 2:

1. Briefly press the  button on the steering wheel.
A sound signal indicates operating readiness
2. Speak voice commands.
To have the system list the voice commands possible in each case:
 ›Help‹.

Canceling operation via voice control

Briefly press the  button on the steering wheel or

 ›Cancel‹.

In dialogs where text of any kind can be spoken, e.g. a name, canceling is only possible using the  button. Voice control dialog is automatically interrupted when an incoming call is received.

Voice commands

In addition to the commands described in this Owner's Manual, alternative commands are often possible for the same functions, e.g.:

 ›Dial name‹ or ›Name‹.

Digits from zero to nine are understood.

You can say each digit individually or group them into a sequence of three to five digits to speed up the process.

An example: dialing a phone number

Start the dialog:

Briefly press the  button on the steering wheel.

Voice command	Response
›Dial number‹	››Please say the number‹‹
e.g. ›123 456 7890‹	››123 456 7890. Continue?‹‹
›Dial‹	››Dialing number‹‹

Volume adjustment

You can adjust the volume for the instructions from the system:

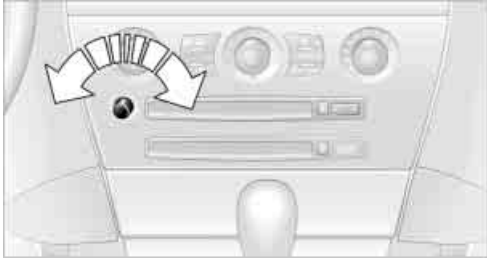

Turn the button during an instruction to select the desired volume.

This volume for the instructions is maintained, even if the other audio sources are set to minimum volume.

Depending on which key you have used to open the vehicle, the last adjustment is applied.

First steps

Entering unlock code

You can protect your BMW portable phone against misuse with a four-digit unlock code.

-  1. ›Input unlock code‹.
The dialog for entering the unlock code is started
2. Speak unlock code
3. ›Send unlock code‹.

Correcting unlock code

After the sequence of digits has been repeated by the system, the unlock code can be corrected.

-  1. ›Correct number‹.
The block of digits is deleted
2. Speak the new unlock code on request
3. ›Send unlock code‹.

Deleting unlock code

-  ›Delete number‹.

Canceling operation

-  ›Cancel‹.

Calling

Dialing a phone number

-  1. ›Dial number‹.
The dialog for establishing a telephone connection is called up
2. Say the phone number.
For telephone calls abroad, say ›Plus‹ and then the country code
3. ›Dial‹.
The connection to the desired subscriber is established.

Correcting phone number

After the last spoken sequence of digits has been repeated by the system, you can delete this sequence of digits.

-  ›Correct number‹
The digits are deleted.

The command ›Correct number‹ can be repeated as often as you like.

Deleting input

›Delete‹ is used to delete all the digits entered so far.

Voice phone book

You can create a voice phone book with up to 50 phone numbers and names. The names and phone numbers in the voice phone book are independent of the memory of your BMW portable phone.

Storing an entry

An entry always consists of a name and phone number.

-  1. ›Save name‹.
The dialog for storing a name is called up
- 2. Speak name and repeat entry upon request.
The duration of the name in the phone book must not exceed approx. 2 seconds
- 3. Speak the phone number upon request
- 4. To save the phone number:
›Save‹.

Selecting an entry

The connection to the phone number of the selected entry is established.

-  1. ›Dial name‹.
The dialog for selecting an entry is called up
- 2. Speak the name on request
- 3. Confirm the prompt with ›Yes‹.

Reading out and selecting entries

You can have all the entries of your voice phone book read out in the order of input and select a certain entry to establish a connection:

-  1. ›Read phone book‹.
The dialog for reading the phone book is called up
- 2. ›Dial number‹ when the desired entry is read out.

Redialing

›Redial‹ dials the last phone number dialed.

Deleting an entry

You can delete any entry from the voice phone book.

-  1. ›Delete name‹.
The dialog for deleting an entry is called up
- 2. Speak the name on request
- 3. Confirm the prompt with ›Yes‹.

Deleting all entries

›Delete phone book‹ deletes all entries in the phone book.

-  1. ›Delete phone book‹.
The dialog for deleting the phone book is called up
- 2. Confirm the prompt with ›Yes‹
- 3. Confirm the repeated prompt with ›Yes‹.

Notes



The voice commands were available in English on going to print. Other languages are currently not available.

To operate the portable phone via the voice command system, refer to page 20. ◀

Important for voice commands

For voice commands, bear the following in mind:

- ▷ Issue the commands fluently and at normal volume, avoiding excessive emphasis and pauses
- ▷ Keep the doors, windows and glass roof closed to prevent interference from ambient noise
- ▷ Avoid other sources of noise in the vehicle while speaking, and ask other vehicle occupants to refrain from talking while you are using the system.

TeleService

TeleService supports you in communicating with your BMW center. The installed car phone can be used to transmit data on the service status of your vehicle or on legally mandated inspections directly to your BMW center. This is the same data that is also stored for CBS Condition Based Service in the ignition key. Your BMW center can then contact you, and you can make an appointment that suits you while you are still on the road. Your advantage is that your BMW center can prepare in advance for the required maintenance work. The functions of TeleService are country-specific: the data on the service status of your vehicle or on legally mandated inspections is transmitted on a country-specific basis either automatically before they fall due or simultaneously when you call your BMW center. Your BMW center will be glad to provide more detailed information.

BMW Assist

BMW Assist provides you – in addition to TeleService – with other services, e.g. the position data of your vehicle can be transferred to the BMW Assist emergency call center if an emergency call is started.

Many functions of BMW Assist depend on the individually agreed contract. The data transmission, e.g. of CBS Condition Based Service, is different in individual countries.

The subscriber agreement must be completed successfully before using the BMW Assist services.

Requirements

The installed car phone is logged on to a portable telephone network. This network must be able to transmit the services.

To transmit position data, the vehicle must be able to determine the current position. This is displayed on the Control Display. In order to enable and update TeleService or BMW Assist, a GPS signal must be present.

Enabling TeleService or BMW Assist

For you to be able to use the services of TeleService or BMW Assist, these must be enabled.

Leave the ignition key in position 1 during the entire operation.

Control Center, for principle details, refer to page 16:

1. Press button.

MENU

The start menu is opened



2. Press the controller to open the **i** menu
3. Select "Communication interface" and press the controller
4. Select "BMW Service settings" and press the controller



5. Select "Service Status" and press the controller



6. Select "Enable services" and press the controller.
TeleService and, if applicable, BMW Assist is enabled; data exchange with the service center starts.

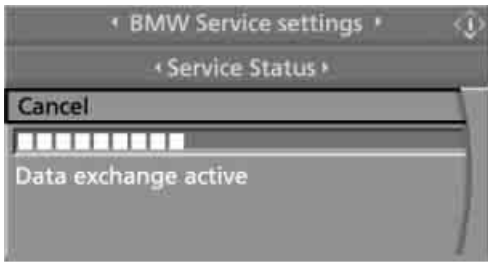

Enabling takes a few minutes. The status is displayed on the Control Display. If you open another menu, the enable process continues to run in the background.

☑ These services are enabled.

Services offered

The following special aspects apply to the services of TeleService and BMW Assist:

- ▷ The range of services offered is country-dependent
- ▷ Voice contact is established or data are transferred in dependence on the equipment and the country. In some countries, both are possible
- ▷ The data that is transferred can be the vehicle data, your current position or the data of CBS Condition Based Service.

Automatic service notification*

The data on the service status of your vehicle or on legally mandated inspections is transmitted automatically directly to your BMW center prior to the due date. You can check when the BMW center is notified.

Control Center, for principle details, refer to page 16:

1. Open the start menu
2. Press the controller to open the **i** menu
3. Select "Service" and press the controller
4. Select "Service requirements" and press the controller

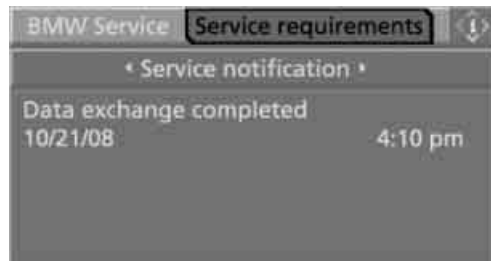

5. Select "Service notification" and press the controller.

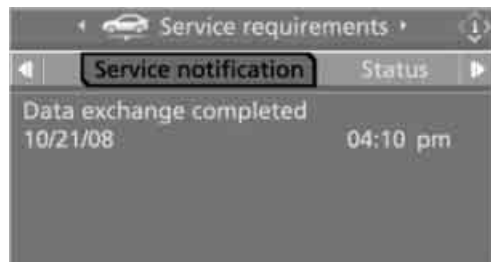

Breakdown assistance

You can call Roadside Assistance* of the BMW Group should you require help in the event of a breakdown.

Control Center, for principle details, refer to page 16:

1. Open the start menu
2. Press the controller to open the **i** menu
3. Select "Service" and press the controller

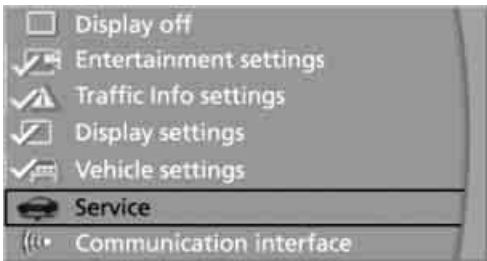

4. Select "BMW Service" and press the controller



5. Select "Roadside Assistance" and press the controller.

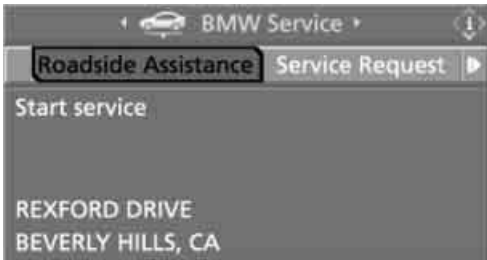

If the current position can be determined, the current vehicle location is displayed

6. Select "Start service" and press the controller.

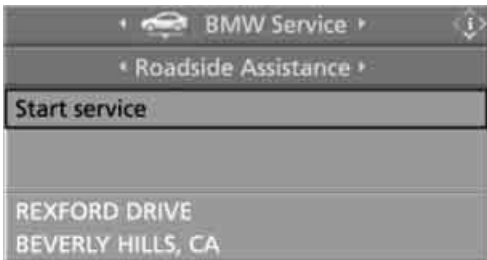

Contact to Roadside Assistance will be established.

Setting up contact to your BMW center or BMW Customer Relations

You can contact your BMW center, e.g. to arrange a service appointment.

For information related to your vehicle, call the BMW Customer Relations.

Control Center, for principle details, refer to page 16:

1. Open the start menu
2. Press the controller to open the **i** menu
3. Select "Service" and press the controller
4. Select "BMW Service" and press the controller
5. Select the desired BMW center
 - ▷ "Service Request"
 - ▷ "Customer Relations"

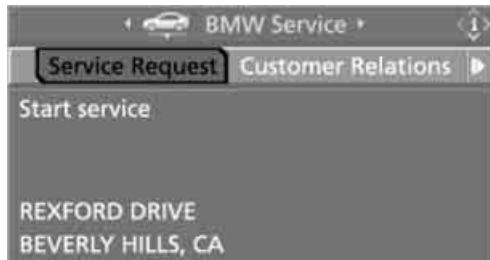

6. Press the controller
7. Select "Start service" and press the controller.

Contact to the desired BMW center is established.

Adapting TeleService or BMW Assist

Displaying and updating services

You will be informed about the changes in the scope of TeleService or BMW Assist. In this case, you should update the services.

Control Center, for principle details, refer to page 16:

1. Open the start menu
2. Press the controller to open the **i** menu
3. Select "Communication interface" and press the controller
4. Select "BMW Service settings" and press the controller
5. Select "Service Status" and press the controller.

You will be informed about the current scope of TeleService or BMW Assist.

These services are enabled

6. Select "Update services" and press the controller.

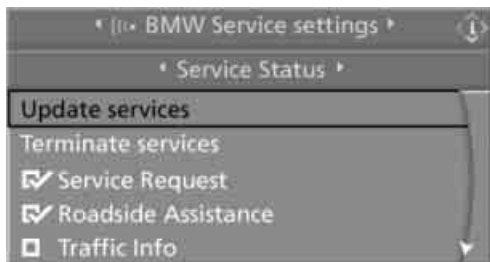

Roaming

So that you are able to use the services of TeleService or BMW Assist in other countries, the foreign providers must support them.

In addition, the services offered must be transmitted to your vehicle. You can do this in the following ways:

- ▷ Update services
- ▷ Enable roaming.
The range of foreign services is transferred automatically. This can involve additional costs.

To enable roaming:

1. Open the start menu
2. Press the controller to open the **i** menu
3. Select "Communication interface" and press the controller
4. Select "BMW Service settings" and press the controller
5. Select "Profile" and press the controller
6. Select "Roaming" and press the controller.
 Roaming is enabled.

Terminating services

If you terminate the services, your vehicle will not be equipped to contact the BMW Assist call center. When an emergency call is initiated, the telephone connection to the general emergency number is established.

Control Center, for principle details, refer to page 16:

1. Open the start menu
2. Press the controller to open the **i** menu
3. Select "Communication interface" and press the controller
4. Select "BMW Service settings" and press the controller
5. Select "Service Status" and press the controller
6. Select "Terminate services" and press the controller.

Use of TeleService or BMW Assist is blocked. To lift the block, re-enabling is required, refer to page 155. This does not affect the contractual agreements.

Automatic service notification can be disabled separately. Contact your BMW center for assistance.

Enable TeleService and, if applicable, BMW Assist once again to re-establish.

Displaying vehicle data

When TeleService or BMW Assist is activated, the colored designation, the license plate and the vehicle identification number of your vehicle can be displayed.

Control Center, for principle details, refer to page 16:

1. Open the start menu
2. Press the controller to open the **i** menu
3. Select "Communication interface" and press the controller
4. Select "BMW Service settings" and press the controller
5. Select "Profile" and press the controller.



To adapt the color designation and the license plate number, contact your BMW center.

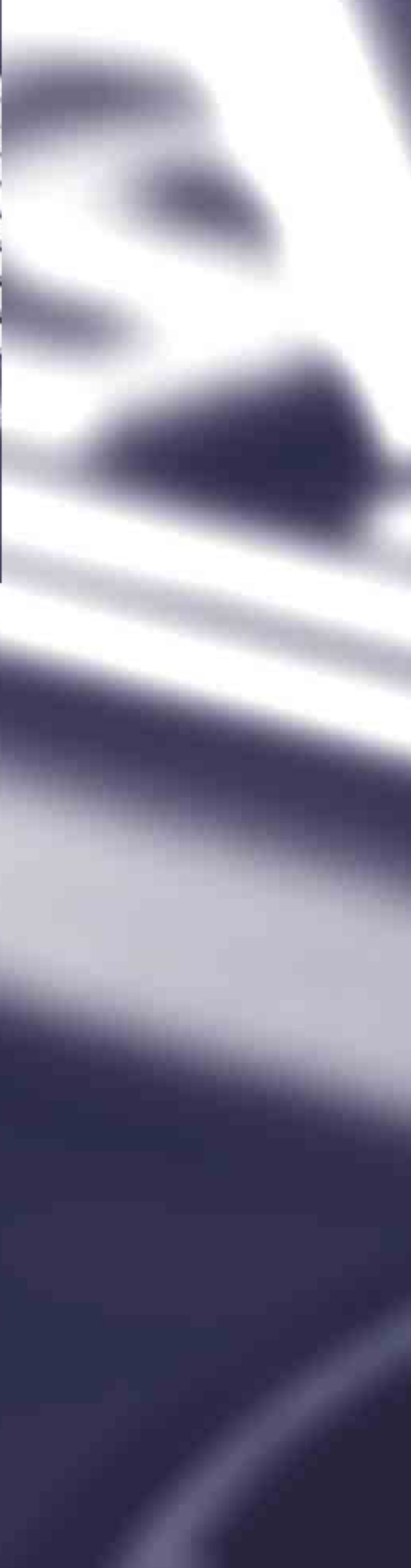
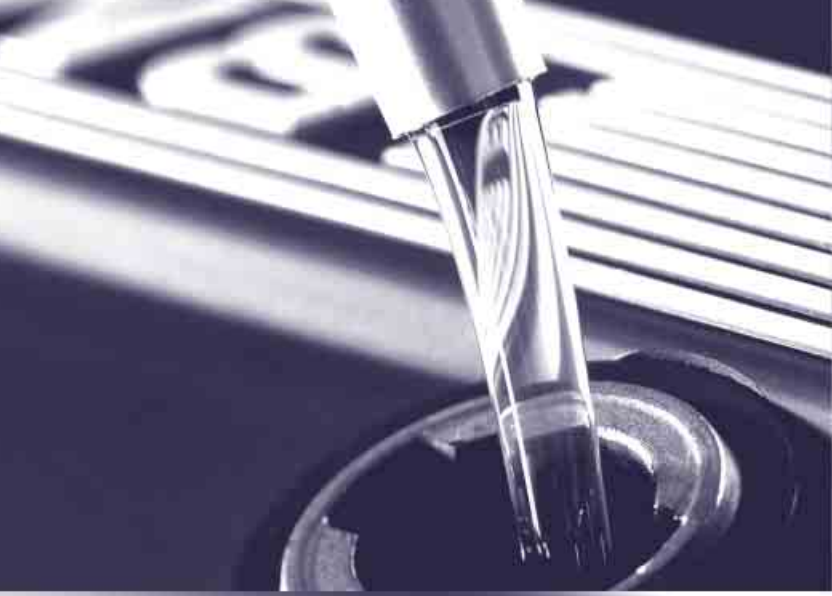



Mobility

This section helps you maintain your mobility by supplying important information on vital topics including fuels and lubricants, wheels and tires, service, maintenance and how to deal with any problems that may occur.

Refueling

⚠ Always switch off the engine before refueling. If you do not, fuel cannot be filled into the tank and a message on the Control Display will appear. ◀

⚠ Always observe all applicable precautions and regulations when handling fuels. Never carry spare fuel containers in your vehicle. Whether empty or full, these containers can leak, cause an explosion, and lead to fire in the event of a collision. ◀

Observe following when refueling

⚠ When handling fuels always observe any safety guidelines posted at the filling station. ◀



Fuel filler door

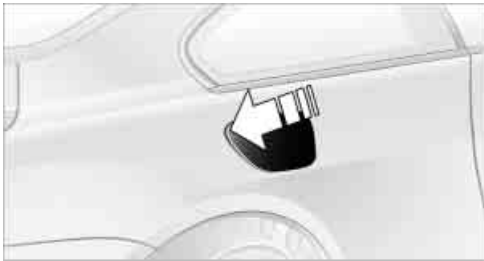

To open and close: briefly press the rear edge of the fuel filler door.

Put the fuel filler cap in the bracket attached to the fuel filler door.

When refueling, insert the filler nozzle completely into the filler pipe. Lifting the filler nozzle during refueling

- ▷ results in premature pump shutoff
- ▷ can lead to reduced efficiency in the fuel-vapor recovery system.

The fuel tank is full when the filler nozzle clicks off the first time.

Manual release

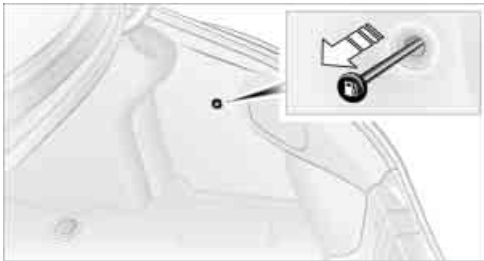

In the event of an electrical malfunction in the system, you can release the fuel filler door manually:

In the luggage compartment, pull the knob with the gas pump symbol on the right side panel.

Fuel tank capacity

Approx. 18.5 US gallons/70 liters, including the reserve capacity of approx. 2.1 gallons/8 liters.

⚠ Refuel as soon as possible once your cruising range falls below 30 miles/50 km, as otherwise engine functions are not ensured and damage can occur. ◀

Closing fuel filler cap

Fit the cap and turn it clockwise until you clearly hear a click.

⚠ Close the fuel filler cap carefully after refueling, continuing until a click is heard. While closing, be sure not to squeeze the strap which is fastened to the cap. A loose or missing cap will activate the message Check Gas Cap* on the Control Display. ◀



Warning lamp* lights up.
Fuel filler cap is not properly closed
or is missing. Check whether the
fuel filler cap is properly closed.

Fuel specifications

The engine uses lead-free gasoline only.

Required fuel

Premium Unleaded Gasoline,
Minimum Octane Rating: 91.

Minimum Octane Rating corresponds to
the Anti Knock Index AKI and is deter-
mined according to the so-called (R+M)/
2 method.



Do not use leaded gasoline, as other-
wise the lambda probe and catalytic
converter will be permanently damaged. ◀

Use high-quality brands

Field experience has indicated significant
differences in fuel quality: volatility, compo-
sition, additives, etc., among gasolines
offered for sale in the United States and
Canada. Fuels containing up to and includ-
ing 10% ethanol or other oxygenates with
up to 2.8% oxygen by weight, that is,
15% MTBE or 3% methanol plus an equiv-
alent amount of co-solvent, will not void
the applicable warranties with respect to
defects in materials or workmanship.



The use of poor-quality fuels may
result in drivability, starting and stall-
ing problems, especially under certain
environmental conditions such as high
ambient temperature and high altitude.
Should you encounter drivability problems
which you suspect could be related to the
fuel you are using, we recommend that you
respond by switching to a recognized high-
quality brand.

Failure to comply with these recommenda-
tions may also result in unscheduled main-
tenance. ◀

Wheels and tires

Tire inflation pressure

Information for your safety

It is not merely the tire's service life, but also driving comfort and – to a great extent – driving safety that depend on the condition of the tires and the maintenance of the specified tire pressure.

 Check the tire inflation pressure regularly and correct it if necessary: at least every two weeks and before beginning a longer trip. If you fail to observe this precaution, you may be driving on tires with incorrect tire pressures, a condition that can not only compromise your vehicle's stability, but also lead to tire damage and the risk of an accident. ◀

Checking tire inflation pressure

Only check tire inflation pressure when the tires are cold. This means after a maximum of 1.25 miles/2 km driving or when the vehicle has been parked for at least 2 hours. When tires are warm, the tire inflation pressure increases.

 After correcting the inflation pressure(s), always reinitialize the Flat Tire Monitor, refer to page 79. ◀

Inflation pressures for original tires



The tires must be at ambient temperature. The inflation pressures, provided on a label affixed to the B-pillar, are visible when the driver's door is open.

Inflation pressure for other tire sizes





The tables below provide all the correct inflation pressures for the specified tire sizes at ambient temperature.

 For correct identification of the right tire inflation pressure for your tires, observe the specifications for the corresponding tire size. ◀

Observe tire size





The specified pressures apply to tire sizes approved by BMW and recommended tire makes; your BMW center will be glad to provide information.

645Ci Coupe

Tire size	Pressure specifications in psi/kPa			
	max. 			
All pressure specifications in the table are indicated in psi/kilopascal with cold tires – cold = ambient temperature				
245/45 R 18 96 V,H M+S	29/200	32/220	33/230	39/270
Front: 245/45 R 18 96 W	29/200	–	33/230	–
Rear: 275/40 R 18 99 W	–	32/220	–	39/270
Front: 245/40 R 19 94 W	29/200	–	33/230	–
Rear: 275/35 R 19 96 W	–	32/220	–	39/270
Front: 245/35 R 20 91 Y	29/200	–	33/230	–
Rear: 275/30 R 20 93 Y	–	32/220	–	39/270

More details on the permitted load and weights can be found on page [190](#).

645Ci Convertible

Tire size	Pressure specifications in psi/kPa			
	max. 			
All pressure specifications in the table are indicated in psi/kilopascal with cold tires – cold = ambient temperature				
245/45 R 18 96 V,H M+S	32/220	38/260	39/270	46/320
Front: 245/45 R 18 96 W	32/220	–	39/270	–
Rear: 275/40 R 18 99 W	–	38/260	–	46/320
Front: 245/40 R 19 94 W	32/220	–	39/270	–
Rear: 275/35 R 19 96 W	–	38/260	–	46/320
Front: 245/35 R 20 91 Y	32/220	–	39/270	–
Rear: 275/30 R 20 93 Y	–	38/260	–	46/320

More details on the permitted load and weights can be found on page [190](#).

Tire identification marks

Knowledge of the labeling on the side of the tire makes it easier to identify and choose the right tires.

Tire size

e.g. 205/60 R 15 91 W

Nominal width in mm _____

Aspect ratio in % _____

Radial type _____

Rim diameter in inches _____

Load rating not on ZR tires _____

Speed rating before R on ZR tires _____

Speed letter

T = up to 118 mph/190 km/h

H = up to 131 mph/210 km/h

V = up to 150 mph/240 km/h

W = up to 167 mph/270 km/h

Y = up to 186 mph/300 km/h

Tire Identification Number

Tires with DOT codes meet the guidelines of the U.S. Department of Transport.

DOT code:

e.g. DOT xxxx xxx 1204

Manufacturer code for tire make _____

Tire size and tire design _____

Tire age _____

Tire age

The tire's date of manufacture is indicated on the sidewall:

DOT ... 1204 indicates that a tire was manufactured in week 12 of the year 2004.

BMW recommends for various reasons, including beginning brittleness, replacing all tires after 6 years at the latest, even if a tire age of 10 years is possible.

Uniform Tire Quality Grading

Quality grades can be found where applicable on the tire sidewall between tread shoulder and maximum section width.

For example:

Treadwear 200 Traction AA

Temperature A

DOT Quality Grades

Treadwear

Traction AA A B C

Temperature A B C



All passenger car tires must conform to Federal Safety Requirements in addition to these grades. ◀

Treadwear

The treadwear grade is a comparative rating based on the wear rate of the tire when tested under controlled conditions on a specified government test course.

For example, a tire graded 150 would wear one and one-half, 1 1/2, times as well on the government course as a tire graded 100.

The relative performance of tires depends upon the actual conditions of their use, however, and may depart significantly from the norm due to variations in driving habits, service practices and differences in road characteristics and climate.

Traction

The traction grades, from highest to lowest, are AA, A, B, and C.

Those grades represent the tire's ability to stop on wet pavement as measured under controlled conditions on specified government test surfaces of asphalt and concrete. A tire marked C may have poor traction performance.



The traction grade assigned to this tire is based on straight-ahead braking traction tests, and does not include acceleration, cornering, hydroplaning, or peak traction characteristics. ◀

Temperature

The temperature grades are A, the highest, B, and C, representing the tire's resistance to the generation of heat and its ability to dissipate heat when tested under controlled conditions on a specified indoor laboratory test wheel.

Sustained high temperature can cause the material of the tire to degenerate and reduce tire life, and excessive temperature can lead to sudden tire failure. The grade C corresponds to a level of performance which all passenger car tires must meet under the Federal Motor Vehicle Safety Standard No. 109. Grades B and A represent higher levels of performance on the laboratory test wheel than the minimum required by law.

 The temperature grade for this tire is established for a tire that is properly inflated and not overloaded. Excessive speed, underinflation, or excessive loading, either separately or in combination, can cause heat buildup and possible tire failure. ◀

RSC – run-flat tires

You will recognize run-flat tires by a circular symbol containing the letters RSC on the side of the tire, refer to page 168.

M+S

Winter and all-season tires. These have better winter properties than summer tires.

Tire condition

Before driving off, inspect your tires for tread wear, signs of damage and foreign objects lodged in the tread, and check the tread depth.

Minimum tread depth

The tread depth should not drop below 0.12 in/3 mm, although, for example, European legislation only specifies a minimum tread depth of 0.063 in/1.6 mm. At tread depths below 0.12 in/3 mm there is an

increased risk of high-speed hydroplaning, even when only small amounts of water are present on the road surface.

As winter tires display a noticeable loss in their ability to cope with cold-weather driving conditions once the tread wears to below 0.157 in/4 mm, to ensure continued safety you should always have such tires replaced.

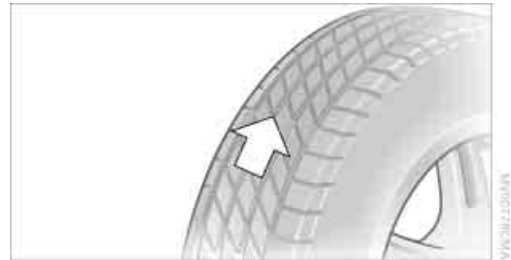

Wear indicators at the tread-groove base, refer to arrow, are distributed over the tire's circumference and are marked on the side of the tire with TWI – Tread Wear Indicator. These indicators signal at a tread depth of 0.063 in/1.6 mm that the legal wear limit has been reached. The tread is then no longer visible at these points.

Tire damage

 Due to low-profile tires, please note that wheels, tires and suspension parts are more susceptible to road hazard and consequential damages.

Unusual vibrations encountered during normal vehicle operation can indicate tire failure or some other vehicle defect. This can, for example, be caused by driving over curbs. These kinds of problems may also be signaled by other changes in vehicle response, such as a strong tendency to pull to the left or right.

In these cases, immediately reduce speed. Drive cautiously to the nearest BMW center or tire dealer or, if necessary, have the vehicle towed there.

Tire damage, extending to sudden and complete loss of pressure in extreme cases, can pose a potentially lethal safety hazard for the vehicle's occupants and other road users alike. ◀

Run-flat tires



You will recognize run-flat tires by a circular symbol containing the letters RSC on the side of the tire.

Run-flat tires consist of self-contained tires and special rims. The tire reinforcement ensures that the tire retains some residual safety in the event of pressure drop and driving remains possible to a restricted degree.

Continuing driving with a damaged tire

Driving on run-flat tires with tire damage can continue, depending on the vehicle load and the severity of the tire damage, at a maximum speed of 50 mph/80 km/h.

You can estimate the possible mileage for continued driving on the basis of the following general indications:

- ▷ With low load:
1 to 2 persons without luggage:
Approx. 155 miles/250 km
- ▷ With medium load:
2 persons, luggage compartment full, or
4 persons without luggage:
Approx. 94 miles/150 km
- ▷ With full load:
4 persons, luggage compartment full:
Approx. 30 miles/50 km.

 Drive reservedly and do not exceed a speed of 50 mph/80 km/h. In the event of pressure loss, vehicle handling changes. This includes reduced track stability in braking, extended braking distance and altered natural steering characteristics. If unusual vibrations occur while the vehicle is being driven, this can indicate final failure

of the damaged tire. Reduce speed and stop as soon as possible. Do not continue driving. Contact your BMW center. ◀

New wheels and tires

You can find out the right wheel-tire combination from your BMW center. It is another vital factor in ensuring reliable operation of various vehicle systems such as ABS and DSC. Have the wheel and tire assemblies balanced every time either a wheel or a tire is replaced.

 Only have new wheels and tires mounted by a specialist. If this work is performed inexpertly, there is a danger of damage and associated safety risks. ◀

Retreaded tires

 BMW does not recommend the use of retread tires, as otherwise driving safety may be reduced. Possible variations in the design and the age – which could be substantial – of the carcasses can lead to unusually rapid wear. ◀

The right wheels and tires

 BMW recommends that you use only wheel and tire combinations that BMW has tested and approved for your particular vehicle. Variations in factors such as manufacturing tolerances mean that even wheels and tires with identical official size ratings could actually have different dimensions than the approved units – these differences could lead to body contact, and with it the risk of severe accidents. If non-approved wheels and tires are used, BMW cannot evaluate their suitability, and therefore cannot be held liable for driving safety. ◀

To maintain good handling and vehicle response, use only tires of a single tread configuration from a single manufacturer. After a flat tire, always remember to have the specified wheel and tire combination remounted on the vehicle as soon as possible.

Recommended tire sizes and makes

BMW tests certain tire brands for each tire size, classifies them as road-safe and approves them. You can find out about these at specialized dealers or at your BMW center. Observe any country-specific regulations, e.g. on making a corresponding entry in the vehicle documents.

The factory-mounted tires have been specially selected to provide optimized performance when installed on your vehicle; if properly cared for, they will provide a combination of safety and excellent ride comfort.

Run-flat tires

In the event of replacement, use run-flat tires, refer to page 168, as there is no spare wheel available for flats.



For safety reasons, BMW recommends that you do not have damaged run-flat tires repaired; they should be replaced. ◀

Special characteristics of winter tires

BMW recommends winter tires for use in cold winter driving conditions. Although all-season M+S tires provide better winter traction than summer tires, they generally fail to provide the same levels of cold-weather performance as winter tires.

Run-flat tires

If you switch from summer to winter tires, or vice versa, use run-flat tires, refer to page 168, as in the event of a flat tire there is no spare tire available. Your BMW center will be glad to advise you.

Observing speed ratings



Never exceed the maximum speed for which the winter tires are rated. Unprofessional attempts by laymen to service tires can lead to damage and accidents. Have this work performed by skilled professionals only. The technicians at your BMW center will be glad to assist you with

the required professional knowledge and specialized equipment. ◀

Storage

Always store wheels and tires in a cool, dry place with as little exposure to light as possible. Always protect tires against all contact with oil, grease and fuels. Do not exceed the maximum tire inflation pressure indicated on the side wall of the tire.

Snow chains*

BMW only tests certain snow chains, classifies them as road-safe and approves them. Consult your BMW center for more information. BMW recommends using these approved, narrow-link snow chains. These snow chains are approved exclusively for use in pairs on the rear wheels with the tire size 245/45 R 18.

Observe the manufacturer's instructions when mounting snow chains. Do not exceed a vehicle speed of 30 mph/ 50 km/h with the chains mounted.



Do not initialize the Runflat Indicator after mounting snow chains.

When you are driving with snow chains, it can be beneficial to switch off DSC briefly, refer to page 77. ◀

Under the hood

⚠ Never attempt to perform any service or repair operations on your vehicle without the required, professional technical training. If you are unfamiliar with the service procedures and precautions, always have any required work on your vehicle carried out at your BMW center. If this work is performed inexpertly, there is a danger of damage and associated safety risks. ◀

Hood

Releasing



Pull the lever located under the left side of the instrument panel.

Opening

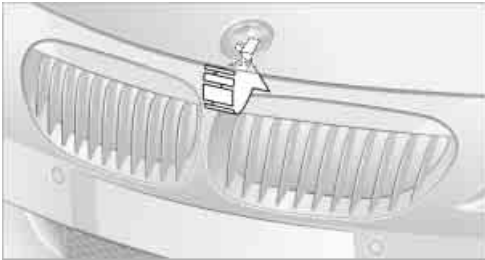

Press the release handle and open the engine hood.

Closing

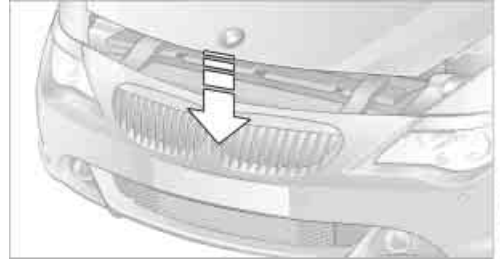

Close the hood from a height of approx. 16 in/40 cm with momentum. It must be clearly heard to engage.

⚠ Make sure that the closing path of the engine hood is clear, as otherwise injuries may result.

If you see any signs that the hood is not completely closed while you are driving your vehicle, you should stop at once and close it securely. ◀

Engine compartment

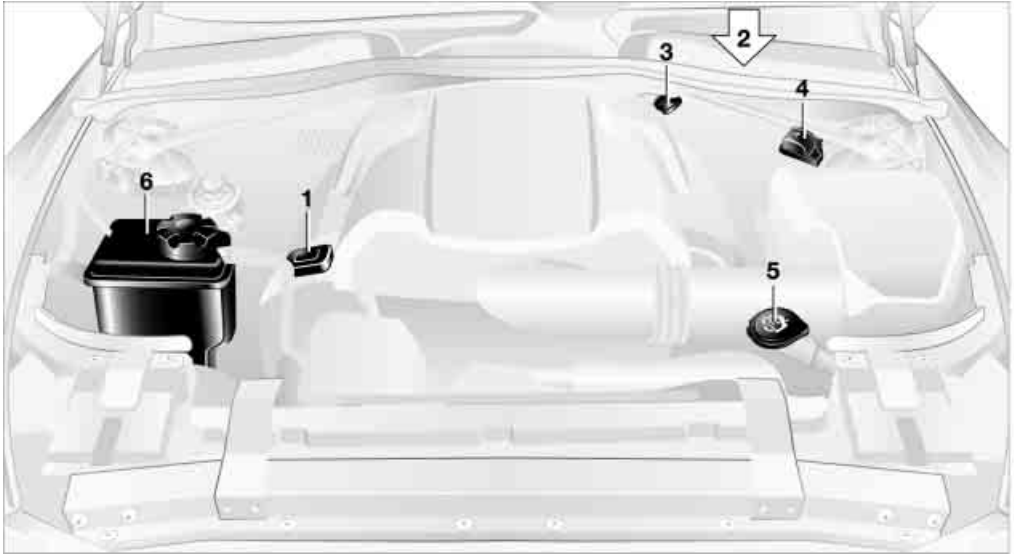

- 1 Filler neck for engine oil, refer to Topping up engine oil
- 2 Brake fluid reservoir, located beneath the microfilter cover, refer to page 173
- 3 Dipstick for engine oil, refer to Checking oil level
- 4 Starting-aid terminal, refer to page 184
- 5 Washer fluid reservoir of the headlamp and windshield cleaning systems, refer to page 62
- 6 Expansion tank for coolant, refer to page 172

3. Carefully push the dipstick all the way into the guide tube and pull it out again
4. The oil should extend to between the two marks on the dipstick.

The engine oil consumption is dependent on driving style and driving conditions.

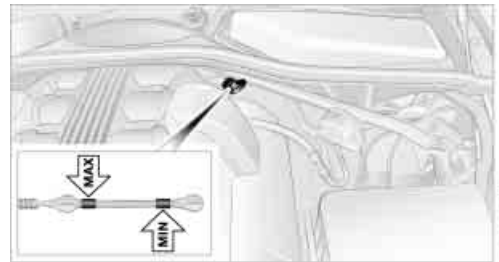

The oil quantity between the centers of the two marks on the dipstick, refer to arrows, is approx. 1.6 US quarts/1.5 liters. Do not fill beyond the upper mark on the dipstick. Excess oil can damage the engine.

Engine oil

Checking oil level

1. Park the vehicle on a level surface with the engine at operating temperature
2. After approx. 5 minutes, pull the dipstick **3** out and wipe it off with a clean lint-free cloth, paper towel, or similar material

Topping up engine oil

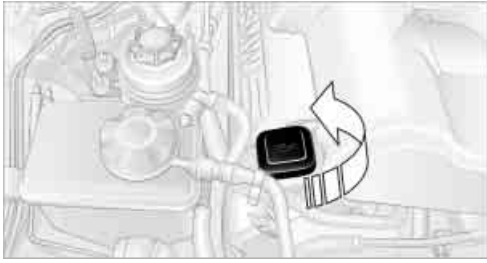

Wait until the level has dropped to just on the lower dipstick mark before adding oil. In this area a message also appears on the Control Display.

⚠ Store oil, grease etc., well out of the reach of children; always observe all warning labels on the containers. ◀

Specified engine oils

The quality of the engine oil selected has critical significance for the operation and service life of an engine. BMW continuously approves specific oils after confirming their suitability for use in its vehicles with extensive testing.

Use only approved BMW High Performance Synthetic Oil.

If you are unable to obtain BMW High Performance Synthetic Oil, you can add small amounts of another synthetic oil between oil changes. Use only oils with the API SH specification or higher.

▶ Ask your BMW center for details concerning the specific BMW High Performance Synthetic Oil or synthetic oils which have been approved. ◀

You can also call BMW of North America at 1-800-831-1117 or visit this website: www.bmwusa.com to obtain this information.

⚠ BMW engines are designed to operate without additives, and their use could even lead to damage in some cases. ◀

Viscosity ratings

Viscosity is the oil flow rating as defined in SAE classes.

The selection of the correct SAE class depends on the climatic conditions in the area where you typically drive your BMW.

▶ Approved oils are in SAE classes 5W-40 and 5W-30. ◀

These oils may be used for driving in all ambient temperatures.

Coolant

⚠ Do not add coolant to the cooling system when the engine is hot. Escaping coolant can cause burns. ◀

Coolant consists of water and the addition of antifreeze and anticorrosion agent. Not all commercially available additives are suitable for your BMW. Ask your BMW center for suitable additives.

⚠ Only use suitable additives, as otherwise engine damage may result. The additives present a health hazard; observe the instructions on the containers. ◀

♻ Always observe all applicable environmental rules and regulations when disposing of used coolant additives. ◀

Checking coolant level

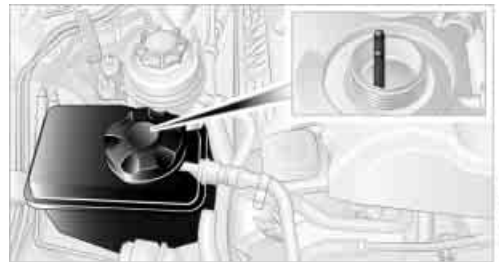

1. The engine must be at ambient temperature
2. Turn the cap of the expansion tank counterclockwise to allow any accumulated pressure to escape, then continue turning to open

3. The coolant level is correct when the measuring range of the fill level indicator is at the level of the upper edge of the filler neck, also refer to the drawing next to the filler neck
4. If the coolant is low, slowly add coolant up to the specified level – do not overfill
5. Turn the cap until you hear a click
6. Have the reason for the coolant loss eliminated as soon as possible.



For your own safety: use only brake pads that BMW has approved for your particular vehicle model. As BMW cannot assess the suitability of other brake pads for use on your vehicle, BMW is unable to assume continued responsibility for the vehicle's operating safety if non-approved pads are installed. ◀

Brake system

Malfunction

Brake fluid



The warning lamp lights up in red in spite of the handbrake being released; a message appears on the Control Display.

Stop the vehicle immediately.

The brake fluid in the reservoir has fallen to below the minimum level. At the same time, a significantly longer brake pedal path is noticeable. Have the system checked immediately by a BMW center.



Warning lamp for Canadian models.



When you continue driving, an increased brake pedal path can be necessary, and significantly longer braking distances might be required. Please adapt your driving style accordingly. ◀

Brake pads



The warning lamp lights up in red in spite of the handbrake being released; a message appears on the Control Display. The brake pads have reached their minimum pad thickness.

Have the brake pads replaced as soon as possible.



Warning lamp for Canadian models.

Maintenance

The BMW maintenance system

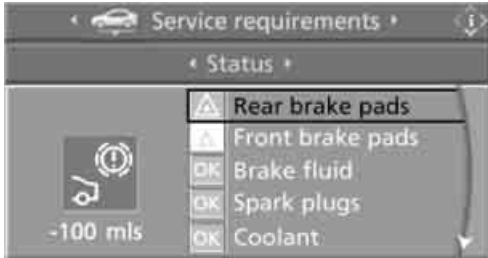

The BMW maintenance system supports the preservation of the traffic and operating safety of your BMW. The service schedule also includes operations related to the vehicle's comfort and convenience features, such as replacement of the filters for the inside air. The ultimate objective is to ensure economical maintenance by providing the ideal service for your vehicle.

Should the day come when you decide to sell your BMW, you will find that a complete dealer service history is an asset of inestimable value.

CBS Condition Based Service

Sensors and special algorithms take the different driving conditions of your BMW into account. Condition Based Service uses this to determine the current and future maintenance requirement. By letting you define a service and maintenance regimen that reflects your own individual requirements, the system builds the basis for trouble-free driving.

The service requirement display, refer to page 65, individually displays the time or distance remaining for selected maintenance work and any legally required intervals:

- ▷ Engine oil
- ▷ Brakes, front and rear separately
- ▷ Microfilter/activated-charcoal filter

- ▷ Brake fluid
- ▷ Spark plugs
- ▷ Vehicle check
- ▷ Legally required tests depending on local regulations.

Your vehicle stores this information continuously in the master key while the vehicle is being driven. After accessing the data stored in the master key, your BMW Service Advisor can suggest precisely the right array of service procedures for your own individual vehicle. You should therefore hand over to the BMW Service Advisor the key you last used to drive when you take your vehicle for service.

 Make sure the date in the Control Center is always set correctly, refer to page 74, as otherwise the effectiveness of CBS Condition Based Service is not ensured. ◀

Service and Warranty Information Booklet for US models and Warranty and Service Guide Booklet for Canadian models

Please consult your Service and Warranty Information Booklet for US models and Warranty and Service Guide Booklet for Canadian models for additional information on service requirements.

 Have service and repair operations performed at your BMW center. Take the time to ensure that these service procedures are confirmed by entries in your vehicle's Service and Warranty Information Booklet for US models and Warranty and Service Guide Booklet for Canadian models. These entries verify that your vehicle has received the specified regular maintenance, and may also be required when submitting warranty claims. ◀

Care

Important information on care and maintenance of your BMW is contained in the Caring for your vehicle brochure.

Rules and regulations

California laws

Proposition 65 Warning

California laws require us to issue the following warning:

 Engine exhaust and a wide variety of automobile components and parts, including components found in the interior furnishings in a vehicle, contain or emit chemicals known to the State of California to cause cancer and birth defects and reproductive harm. In addition, certain fluids contained in vehicles and certain products of component wear contain or emit chemicals known to the State of California to cause cancer and birth defects or other reproductive harm.

Battery posts, terminals and related accessories contain lead and lead compounds. Wash your hands after handling.

Used engine oil contains chemicals that have caused cancer in laboratory animals. Always protect your skin by washing thoroughly with soap and water. ◀

Event Data Recorders

Your vehicle may be equipped with one or more sensing and diagnostic modules or a recording device capable of recording or transmitting certain vehicle data or information. In addition, if you have a Subscription Service Agreement for the BMW Assist system, certain vehicle information may be transmitted or recorded in order to provide such services.

OBD connector



The Onboard Diagnostic OBD interface socket is located on the left of the driver's side under the instrument panel and under a cover.

The cover has the letters OBD on it.

The purpose of the OBD system is to ensure proper operation of the emission control system for the vehicle's lifetime. The system monitors emission-related components and systems for deterioration and malfunction.



An illuminated indicator lamp informs you of the need for service, not of the need to stop the vehicle. However, the systems should be checked by your BMW center at the earliest possible opportunity.



Display of the previously described malfunction on Canadian models.

Under certain conditions, the indicator lamp will blink or flash. This indicates a rather severe level of engine misfire. When this occurs, you should reduce speed and consult the nearest BMW center as soon as possible. Severe engine misfire over only a short period of time can seriously damage emissions control components, especially the catalytic converter.

 When the fuel filler cap is not properly tightened, the OBD system can detect the vapor leak and the indicator lamp will light up. If the filler cap is subsequently tightened, the indicator lamp should go out within a few days. ◀

Replacing components

Onboard tool kit

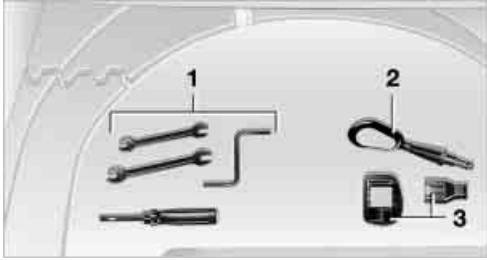

The onboard tool kit **1**, the screw-in tow fitting **2** and spare fuses and a pair of plastic tweezers **3** are stored in the luggage compartment. Fold up the cover located under the floor mat.

Windshield wiper blades

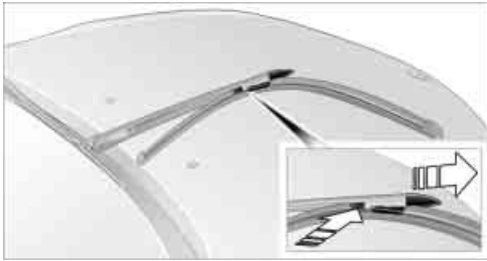

To replace, fold the wiper arm up and hold. Press the locking lugs together while pushing the wiper blade out of the detent toward the front.

Lamps and bulbs

Lamps and bulbs make an essential contribution to vehicle safety. Therefore, comply fully with the following instructions during bulb replacement. If you are not familiar with the specified procedures, have the replacements carried out at your BMW center.

 Never touch the glass on new bulbs with your bare fingers, as even minute amounts of contamination will burn into the bulb's surface and reduce its service life. Use a clean cloth, napkin etc., or hold the bulb by its metal socket. ◀

You can obtain a selection of replacement bulbs at your BMW center.

 When working on the lighting system you should always switch off the lights affected to prevent short circuits. To avoid possible injury or equipment damage when changing bulbs, observe any instructions provided by the bulb manufacturer. ◀

When performing maintenance on the headlamps, comply with the instructions in the separate Caring for your vehicle brochure.

 In the case of bulbs where the replacement is not described, please consult your BMW center. ◀

Xenon lamps

The service life of these lamps is very long and the probability of a failure is very low, provided that they are not switched on and off an unusual number of times. In the unlikely event that one of these lamps should fail, you can continue driving under poor visibility conditions by switching on your fog lamps and proceeding carefully, where allowed by law.

 To avoid the risk of potentially fatal injuries: owing to the extremely high voltages at which these units operate, service work on the xenon lighting system should only be carried out by a BMW center. ◀

High beams, parking lamps

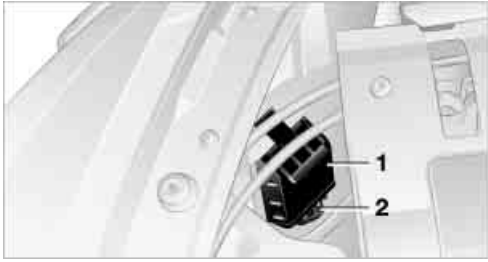

The illustration shows the front left side of the engine compartment.

High beams

Bulb 55 watts, H 7

1. Remove the cover cap **1** by pressing the tab and removing the cover cap upward
2. Press the bulb holder from above to release it
3. Remove the bulb holder
4. Remove and replace the bulb.

Parking lamps

Bulb 10 watts



Bulb holder and reflector are one unit and are replaced together. ◀

1. Turn the bulb holder **2** to the right and remove
2. Press the detent on the plug connector, pull off the bulb holder and replace.

Front turn signal, sidemarker

Your BMW is equipped with two turn signal lamps per side in the front. Turn signal lamp 1 can be replaced via the engine compartment, and turn signal lamp 2 via the wheel well.

Turn signal lamp 1

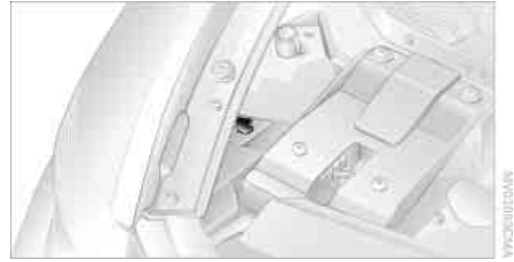

Bulb 21 watts, WY 21 SV

The illustration shows the front right side of the engine compartment.

1. The lever shown:
 - ▷ Right turn signal: press downwards
 - ▷ Left turn signal: press upwards
2. Remove the bulb holder towards the rear
3. Remove and replace the bulb.

Turn signal lamp 2

Bulb 21 watts, WY 21 SV

The bulb of the turn signal lamp 2 can be replaced via a cover at the front of the wheel well.

The illustration shows the left side of the vehicle.

1. Turn the steering all the way to lock to obtain access to the cover, refer to illustration
2. Remove the cover by unscrewing the two bolts with an open-end wrench from the onboard tool kit



3. Location of the bulb holder of turn signal lamp 2, refer to arrow

- Turn the bulb holder to the left and pull out
- Remove and replace the bulb.

Sidemarkers

Bulb 5 watts, WY5W ST

The bulb can be replaced via a cover at the front of the wheel well, refer to the description for turn signal lamp 2.

- The bulb holder of the sidemarker lamp is located toward the outside of the vehicle next to the bulb holder of turn signal lamp 2
- Turn the bulb holder to the left and pull out
- Remove and replace the bulb.

Side turn signals

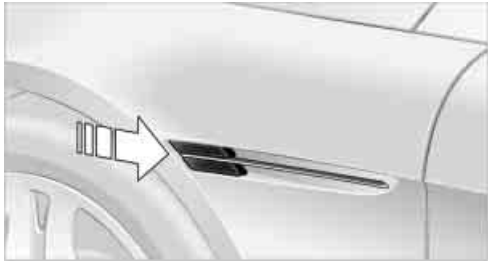

Bulb 5 watts, WY 5 W

- Press against the front edge of the lamp with the tip of your finger, then push it to the rear, release the detent at the front and take it off the trim strip
- Turn the bulb holder 90° to the left and remove
- Remove and replace the bulb.

Tail lamps

▶ The roadside parking, rear and brake lamps are LEDs. The backup lamps are fitted with longlife bulbs. Please contact a BMW center in case of a malfunction. ◀

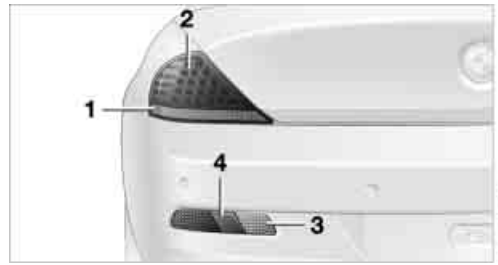

- Turn signal
- Roadside parking, rear and brake lamp
- Backup lamp
- Reflector

Rear turn signals



Bulb 21 watts, PY 21 W

The illustration shows the recess on the left side of the luggage compartment.

- Remove the cover
- Unclip the bulb holder and remove
- Apply gentle pressure to the bulb while turning it to the left for removal and replacement.

License plate lamps



Bulb 5 watts, WY 5 W

1. Push a screwdriver from the left under the lamp and lever up the lamp to the right
2. Turn the bulb holder 90° to the left and remove
3. Remove and replace the bulb.

Light-emitting diodes LEDs

Light-emitting diodes installed behind translucent lenses serve as the light source for many of the controls and displays in your vehicle. These light-emitting diodes, which operate using a concept similar to that applied in conventional lasers, are officially designated as Class 1 light-emitting diodes.

 Do not remove the covers, and never stare into the unfiltered light several hours, as irritation of the retina could result. ◀

Changing a wheel

Your BMW is equipped with run-flat tires as standard. An immediate wheel change in the event of a flat tire is therefore no longer required.

You will recognize run-flat tires by a circular symbol containing the letters RSC on the side of the tire, refer to Run-flat tires on page 167.

If you switch from summer to winter tires, or vice versa, use only run-flat tires, as in the event of a flat there is no spare tire available. Your BMW center will be glad to advise you.

Also refer to New wheels and tires, page 168.

Car jacking points

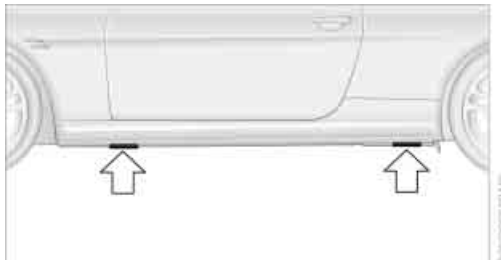

The jacking points for the car jack are located in the positions shown.

 You can obtain a suitable car jack as an accessory at your BMW center. ◀

Battery

Battery care

The battery is 100 % maintenance-free, i.e., the electrolyte will last for the life of the battery when the vehicle is operated in a temperate climate.

Your BMW center will be glad to advise in all matters concerning the battery.

Charging battery

Only charge the battery in the vehicle via the terminals in the engine compartment with the engine switched off. For the connections, refer to Jump-starting on page 184.

Disposal

 Have old batteries disposed of by your BMW center or hand them in to a recycling center. Maintain the battery in an upright position for transport and storage. Always restrain the battery to prevent it from tipping over during transport. ◀

Power cut

After a temporary power cut, e.g. with a discharged battery, the features of some equipment are limited and it has to be reinitialized. Individual settings are also lost and have to be updated:

- ▷ Active steering
The system is deactivated and has to be initialized, refer to page 80. Until then, greater steering wheel movement is required
- ▷ Seat, mirror and steering wheel memory
The position must be newly stored, refer to page 44
- ▷ Time and date
The settings must be updated, refer to page 73
- ▷ Radio
Radio stations have to be stored again, refer to page 132
- ▷ Navigation system
Wait to see what happens with the functional capability, refer to page 122.

In luggage compartment

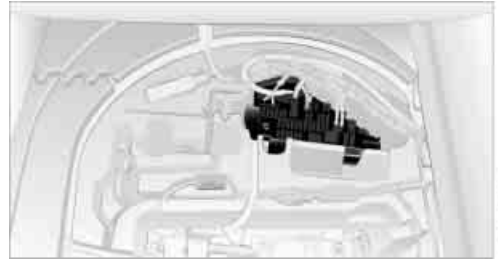

Fold up the cover under the floor mat and remove the bracket for the onboard tool kit. Information on the fuse assignment **1** and additional fuses **2** are provided there.

Fuses

 Never attempt to repair a blown fuse, and do not replace a defective fuse with a substitute of another color or amperage rating, as this could lead to overloading of the wiring, ultimately resulting in a fire in the vehicle. ◀

Information on the fuse assignment is located below the bracket for the onboard tool kit, see below.

In glove compartment

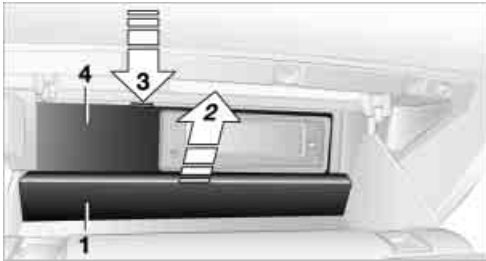

1. Press the button on the back in the center of partition **1** and pull out the partition upwards, arrow **2**
2. Press the coupling downwards, arrow **3**, and fold the lid **4** forwards.

Giving and receiving assistance

Emergency call*

Conditions for an emergency call:

- ▷ Ignition key as of position 1
- ▷ The car phone is logged on to a portable telephone network
- ▷ The emergency call system is operable.

Coupe: emergency call button.



Convertible: emergency call button.



Initiating an emergency call

1. To open the protective cover of the emergency call button:
Briefly press the protective cover
2. Press the emergency call switch for at least 2 seconds.

The indicator lamp in the button lights up. As soon as the voice connection to the BMW Assist response center has been established, the indicator lamp flashes.

If conditions allow, remain in the vehicle until the connection has been established. You will then be able to provide a detailed description of the situation.

If the current location of your vehicle can be determined with vehicles with an activated BMW Assist, it will be transmitted to the BMW Assist response center.

Activating BMW Assist, refer to page 155.

If the indicator lamp flashes, but you are unable to hear the BMW Assist response center through the hands-free system, this could indicate, for instance, that the hands-free system is no longer operational. However, the BMW Assist response center may then still be able to hear you.

Under certain conditions, an emergency call is started automatically immediately after a severe accident. The automatic emergency call is not affected by the button being pressed.

 For technical reasons, the emergency call cannot be guaranteed under unfavorable conditions. ◀

Warning triangle*

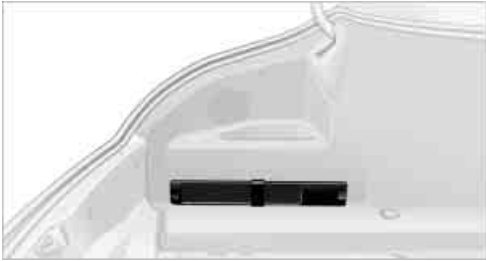

The warning triangle can be found in the luggage compartment on the left side.

 Comply with legal requirements requiring you to carry a hazard warning triangle in the vehicle. ◀

First-aid kit*

The first-aid kit is located in the filler element of the rear seat backrest.

1. Press the button downwards
2. Remove the filler element in a forward direction

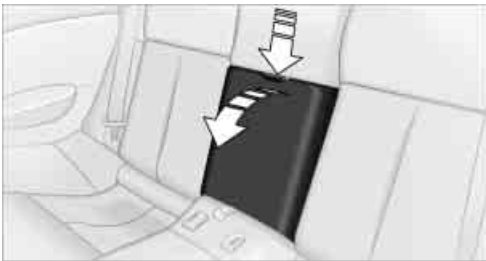

3. Remove the first-aid kit.



 To refit the filler element, insert the two steps in the strip and press back the filler element. Make sure that you do not damage the rear seat upholstery. ◀

 Some of the articles contained in the first-aid kit have a limited service life. For this reason, check the expiration dates of each of the items regularly and replace any whose expiration dates have passed. You can find replacements in any pharmacy.

Comply with legal requirements requiring you to carry a first-aid kit in the vehicle. ◀

Roadside Assistance*

The Roadside Assistance of the BMW Group offers you breakdown assistance around the clock, including on weekends and public holidays.

The phone numbers of the Roadside Assistance in your home country can be found in the BMW Dealer Directory.

In the case of vehicles with BMW Assist or TeleService, you can call the Roadside Assistance of the BMW Group directly for breakdown assistance via the Control Center, refer to page 156.

Jump-starting

When your battery is discharged, you can use two jumper cables to start your BMW with power from the battery in a second vehicle. You can also use the same method to help start another vehicle. Use only jumper cables with fully-insulated clamp handles.

 To avoid the risk of potentially fatal injury, always avoid all contact with electrical components while the engine is running. Carefully adhere to the following sequence, both to prevent damage to one or both vehicles, and to guard against possible personal injuries. ◀

Preparing

1. Check whether the battery of the other vehicle has a voltage of 12 Volts and approximately the same capacitance in Ah. This information can be found on the battery
2. Switch off the engine of the vehicle providing assistance
3. Switch off any consumer units in both vehicles.

 There must not be any contact between the bodies of the two vehicles, as otherwise there is a danger of shorting. ◀

Connecting jumper cables

 To avoid personal injury from sparks, always observe this sequence when connecting jumper cables. ◀



On your BMW, the so-called starting-aid terminal in the engine compartment serves as the battery positive terminal, also refer to engine compartment essentials on page 171. The symbol + is embossed on the cover.

1. Fold open the cover of the BMW starting-aid terminal. To do so, pull the tab
2. Attach one end of the jumper cable plus/+ to the positive terminal of the battery or a starting-aid terminal of the vehicle providing assistance
3. Attach the second end of the cable to the positive terminal of the battery or to a starting-aid terminal of the vehicle to be started

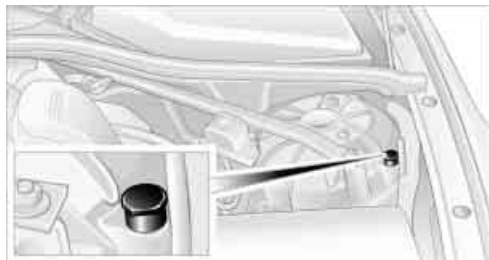

Your BMW has a special nut as body ground or negative pole.

4. Attach one end of the jumper cable minus/- to the negative terminal of the battery or to an engine or body ground of the vehicle providing assistance
5. Attach the second end of the cable to the negative terminal of the battery or to the engine or body ground of the vehicle to be started.

Starting engine

1. Start the engine on the support vehicle and allow it to run for several minutes at increased speed
2. Start the engine on the other vehicle in the usual way.
If the first start attempt is not successful, wait a few minutes before another attempt in order to allow the discharged battery to recharge
3. Let the engines run for a few minutes
4. Disconnect the jumper cables by reversing the connection sequence

If required, have the battery inspected and recharged at your BMW center.

 Never use spray fluids to start the engine. ◀

Towing and tow-starting

 Always observe all applicable towing laws and regulations. ◀

 Never allow passengers to ride in a towed vehicle for any reason. ◀

Using tow fitting

The threaded tow fitting is stored in the tool kit mounted on the inside of the luggage compartment under the floor mat, refer to page 178, and should always remain in the vehicle. It can be screwed in at the front or rear of the BMW.

⚠ To avoid damage to the tow fitting and the vehicle, observe the following: only use the tow fitting that comes with the vehicle and screw it in as far as possible. Only use the tow fitting to tow on the roadway. Avoid heavy lateral loading of the tow fitting, e.g. do not lift the vehicle by the tow fitting. ◀

Access to screw thread

Rectangular cover in bumper:
Press the arrow symbol of the cover.

Front

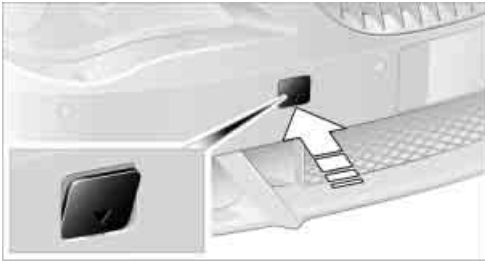

Rear



Being towed

⚠ Even if there is a failure in the electrical system, make sure that the ignition key is in position 1, as otherwise the steering wheel could lock and it would be impossible to steer the vehicle. There is no power assist with the engine stopped. This

then requires increased effort for braking and steering. The active steering is deactivated; when stopped and in the low speed range greater steering wheel movements are required. ◀

Switch on the hazard warning flashers depending on the local regulations. If the electrical system fails, mark the vehicle to be towed, e.g. with a sign or warning triangle in the rear window.

Vehicles with manual transmission

Gearshift lever in idle position

Vehicles with automatic transmission

Selector lever in position N.

⚠ Do not exceed a towing speed of 45 mph/70 km/h and a towing distance of 90 miles/150 km, as otherwise the automatic transmission may be damaged. ◀

Vehicles with SMG Sequential manual transmission

With the ignition switched on, engage selector-lever position N, then switch off the ignition.

Towing methods

In some countries, towing with tow bars or ropes in public traffic is not permitted. Familiarize yourself with all regulations on towing in the respective country.

With tow bar

⚠ The towing vehicle may not be lighter than the vehicle to be towed, as otherwise it will not be possible to control vehicle response. ◀

The tow fittings used should be on the same side on both vehicles. Should it prove impossible to avoid mounting the tow bar at an offset angle, please observe the following:

- ▷ Clearance and maneuvering capability will be strictly limited in corners

- ▷ When mounted at an angle, the tow bar will exert lateral forces, tending to push the vehicle sideways.

 Secure the tow bar on the tow fitting only. Otherwise damage could result on other vehicle parts. ◀

With tow-ropes

When starting off in the towing vehicle, make sure that the tow-ropes are taut.

 To avoid jerking and the associated stresses on vehicle components when towing, always use nylon ropes or nylon straps. Secure the tow rope on the tow fitting only. Otherwise damage could result on other vehicle parts. ◀

With tow truck

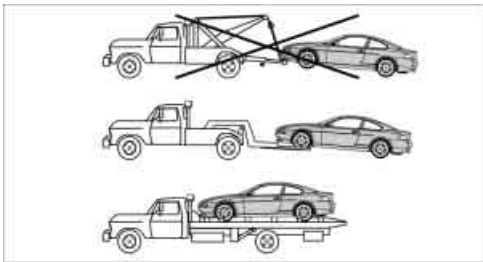

Have the BMW transported with a tow truck with a so-called lift bar or on a load bed.

 Do not lift vehicle by tow fitting or body and chassis parts, as otherwise damage may result. ◀

Tow-starting

 Do not tow-start vehicles with an automatic transmission. Jump-starting, refer to page 184. ◀

Only tow-start vehicles with a catalytic converter with the engine cold. It is better to jump-start the engine, refer to page 184.

1. Switch on the hazard warning flashers, comply with country-specific regulations
2. Turn the ignition key to position 2

3. Engage the 3rd gear, vehicles with SMG, see below
4. Have the vehicle tow-started with the clutch pedal completely depressed and slowly release the clutch. After the engine starts, depress the clutch pedal completely again
5. Stop at a suitable location, remove the tow bar or rope and switch off the hazard warning flashers
6. Have the vehicle checked.

Vehicles with SMG Sequential manual transmission:

1. Tow-start in selector lever position N
2. Select sequential mode. The correct gear will be selected and engaged automatically.



Reference

This is where to look to find information on any desired topic as quickly as possible.

This chapter includes the section with technical data, the short commands of the voice command system as well as the manual's index.

Technical data

Engine specifications

		645Ci
Displacement	cu in/cm ³	268.4/4,398
Number of cylinders		8
Maximum output at engine speed	hp rpm	325 6,100
Maximum torque at engine speed	lb ft/Nm rpm	330/450 3,600

Weights

		645Ci Coupe	645Ci Convertible
Curb weight	lbs./kg		
with manual transmission		3,781/1,715	4,178/1,895
with automatic transmission / SMG		3,792/1,720	4,189/1,900
Approved gross weight	lbs./kg		
with manual transmission		4,619/2,095	4,960/2,250
with automatic transmission / SMG		4,630/2,100	4,971/2,255
Load	lbs./kg	838/380	772/350
Approved front axle load	lbs./kg	2,271/1,030	2,381/1,080
Approved rear axle load	lbs./kg	2,513/1,140	2,381/1,080
Luggage compartment capacity	cu ft/l	15.9/450	10.6/300
Convertible: with convertible top compartment floor up, refer to page 32		–	12.4/350

Never exceed either the approved axle loads or the gross vehicle weight.

Coupe: dimensions

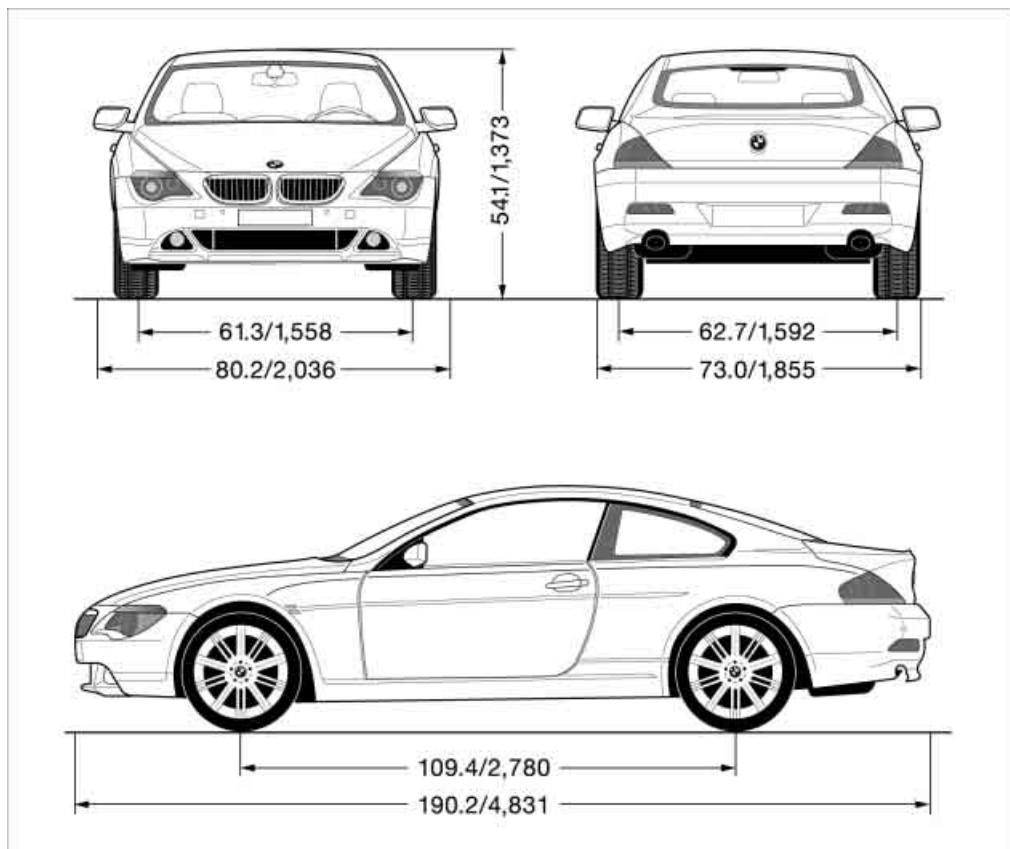

AMERICAN

All dimensions in inches/mm. Minimum turning circle diameter: 37.4 ft/11.4 m.

Convertible: dimensions

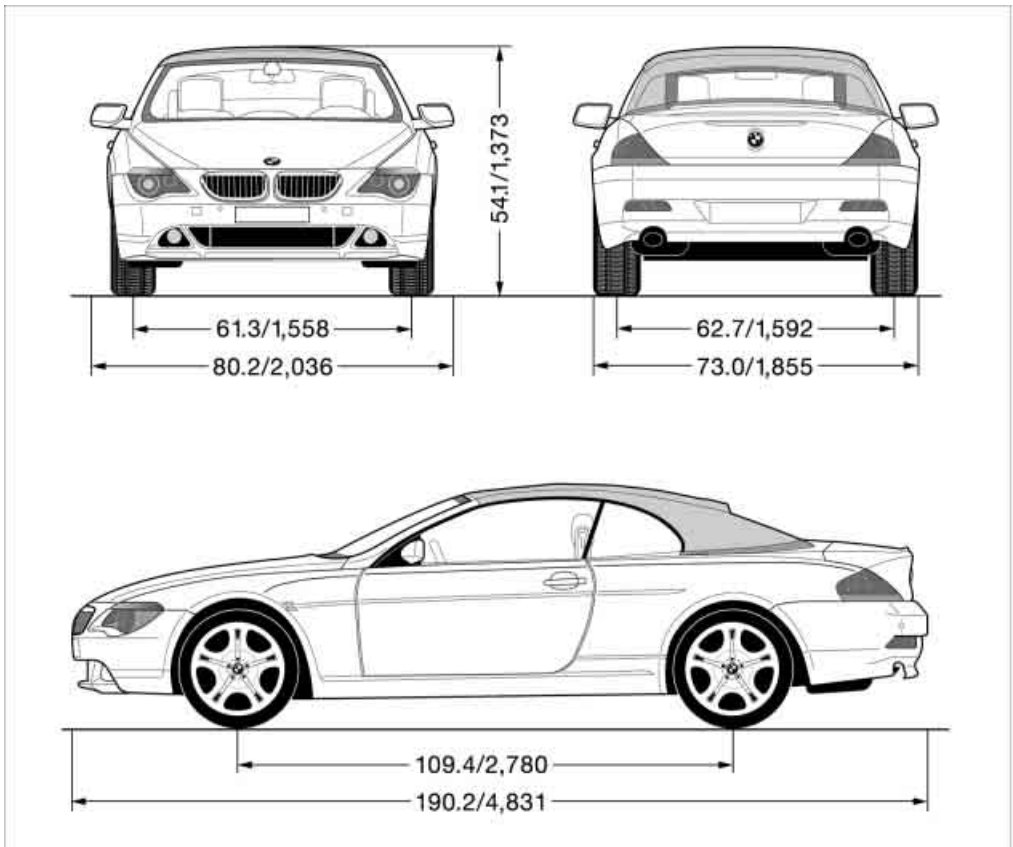

All dimensions in inches/mm. Minimum turning circle diameter: 37.4 ft/11.4 m.

Capacities

			Notes
Fuel tank	gal/liters	approx. 18.5/70	Fuel specification: page 163
Reserve	gal/liters	approx. 2.1/8	
Window and headlamp washer system	quarts/liters	approx. 5.3/5	For details: page 62
Engine oil and filter change	quarts/liters	8.5/8	BMW High Performance Synthetic Oil Oil grades: page 172

Short commands of the voice command system*

With short commands you can carry out certain functions directly, regardless of which menu item is selected.

The following lists important short commands of the voice command system.

Communication

Function	Command
Opening the telephone 146	›Phone‹
Dialing phone number 147	›Dial number‹
Displaying the phone book 148	›A to Z‹
Selecting from the phone book 148	›Dial name‹
Displaying "Top 8" 149	›Top 8‹
Redialing 149	›Redial‹
Displaying "Received calls" 149	›Received calls‹
Displaying "Missed calls" 149	›Missed calls‹
Displaying "SMS" 150	›SMS‹
Opening BMW Assist 155	›BMW Assist‹

Navigation

Function	Command
Displaying the current position 109	›Current Position‹
Opening the destination entry 110	›New destination‹
Displaying "Input map" 112	›Input map‹
Opening "Information" 113	›Destination input with Information on location‹
Displaying the destination list 113	›Last destinations‹
Displaying the address book 114	›Address book‹ or ›Destination from address book‹
Displaying the route criteria 116	›Route preference‹
Displaying the arrow view 119	›Map Arrow display‹
Displaying the route map 120	›Map view‹ ›Map facing north‹ or ›Map direction of travel‹
Changing scale 120	›Scale ... kilometers‹
Displaying streets and town/cities of the route 120	›Route list‹

Onboard information

Function	Command
Displaying the computer 70	›Onboard info‹
Displaying the trip computer 70	›Trip computer‹
Opening the speed limit 71	›Limit‹
Opening the stopwatch 72	›Stopwatch‹

Entertainment

Function	Command
Opening the tone setting 127	›Tone‹
Switching on radio 130	›Radio on‹
Opening "FM" 130	›FM‹
Opening "AM" 130	›AM‹
Opening "All stations" 130	›FM All stations‹
Selecting the radio station 130	›Station‹ name
Opening "Presets" 130	›FM presets‹ or ›AM presets‹
Selecting stored stations 130	›Station ...‹
Opening "Manual" 131	›FM manual‹ or ›AM manual‹
Manual station selection 131	›Frequency 87 ... 107 Point 0 ... 9‹
Opening the radio station with the best reception 132	›AM Autostore‹
Opening "CD" 137	›CD‹
Selecting a CD 137	›CD 1...6‹
Selecting a track 138	›Track ...‹

Climate

Function	Command
Opening "Vent settings" 90	›Vent settings‹
Opening "Parked car ventilation" 92	›Parked car operation‹
Opening "Automatic ventilation" 92	›Automatic ventilation‹
Displaying the activation times 93	›Activation time‹

i menu

Function	Command
Opening "Door locks" 27, 29	›Door locks‹
Opening "Steering wheel buttons" 49	›Steering wheel buttons‹
Opening "Lighting" 60, 85	›Light settings‹
Opening "Communication interface" 155	›Communication interface‹
Opening "BMW Service settings" 155	›BMW Service settings‹
Opening "BMW Service" 157	›BMW center‹
Opening "Service requirements" 65, 156	›Service requirements‹
Opening "Service" 65, 156	›Service‹
Displaying "Check Control messages" 68	›Check Control messages‹
Opening "Display settings" 72	›Display settings‹
Adjusting the brightness of the Control Display 72	›Brightness‹
Opening "Units" 72	›Units‹
Opening "Languages" 73, 119	›Language‹
Opening "Time" 73	›Time‹
Opening "Date" 74	›Date‹
Opening "Climate control" 91	›Climate control‹
Opening "PDC" 75	›PDC‹
Opening "FTM" 79	›FTM‹
Opening "Entertainment settings" 127	›Entertainment settings‹

Index

"..." Indicates texts on the Control Display for the selection of functions, pointing out where these are located.

A

- ABS Antilock Brake System 76
 - malfunction 78
 - warning lamp 13, 78
- Acceleration assistant with SMG 60
- Accessories, refer to
 - Your individual vehicle 5
- Activated-charcoal filter 92
- "Activation time" for independent ventilation 93
- Activation times 93
 - entering 93
- Active roll stabilization 78
- Active steering 80
 - initializing the system 80
 - warning lamp 13, 80
- Adapting the temperature in the upper body region 91
- Adaptive brake lamps, refer to Brake Force Display 80
- Adaptive Head Light 86
- "Add digits" for portable phone 149
- "Address book" for navigation 114
- Address for navigation
 - deleting 115
 - entering 110
 - selecting 115
 - storing current location 114
- "Add to destination list" 111
- Adjusting the temperature with automatic climate control 89
- Adjusting the thigh support 43
- "After opening door" 44
- "After unlocking" 44
- Airbags 81
 - deactivating, Coupe 51
 - indicator lamp 82
 - sitting safely 42
- Air distribution
 - automatic 89
 - manual 90
- Airing, refer to
 - Ventilation 92
- Air recirculation, refer to
 - Automatic recirculated-air control 89
- "Air recirculation on / off" 49
- Air vents, refer to
 - Ventilation 88
- Air volume 89
- AKI, refer to Fuel specifications 163
- Alarm system 32
 - avoiding unintentional alarms 33
 - interior motion sensor 33
 - switching off alarm 32
 - switching off tilt alarm sensor and interior motion sensor 33
 - tilt alarm sensor 33
- All around the center console 14
- All around the steering wheel 10
- "All channels" 135
- "All doors" 27
- All-season tires, refer to
 - Winter tires 169
- Altering stretch of road 120
- "AM", reception range 127, 130
- Antenna for portable phone 144
- Antifreeze
 - coolant 172
 - washer fluid 62
- Antilock Brake System, ABS 76
- Anti-theft alarm system, refer to Alarm system 32
- Anti-theft system 27
- Anti-trapping mechanism
 - glass roof 36
 - power windows 35
- Approved axle loads, refer to Weights 190
- Approved gross vehicle weight, refer to Weights 190
- Armrest, refer to
 - Center armrest 96
- Arrival time, refer to
 - Computer 70
- Arrival time, refer to
 - Starting destination guidance 118
- "Arrow display" 119
- Ashtray 97
- Assistance systems, refer to Driving stability control systems 76
- Assistance window 19
- AUC Automatic recirculated-air control 89
- "Audio" 128
- Audio 126
 - adjusting the tone 127
 - controls 126
 - switching on/off 126
 - volume 127

- Automatic
 - air distribution 89
 - air volume 89
 - cruise control 62
 - curb monitor 45
 - headlamp control 85
 - service notification 156
 - station search 131
 - steering wheel adjustment 49
 - storing stations 132
 - Automatic car wash 102
 - also refer to the Caring for your vehicle brochure
 - Automatic climate control 88
 - automatic air distribution 89
 - convertible program 91
 - settings using Control Center 90
 - switching off 90
 - "Automatic programs" 91
 - Automatic recirculated-air control, AUC 89
 - Automatic transmission with Steptronic 58
 - convenience start 55
 - Dynamic Driving Control 59
 - interlock 54
 - kickdown 59
 - selector lever interlock 58
 - shiftlock 58
 - starting engine 55
 - towing 186
 - tow-starting 187
 - warning lamp 59
 - "Automatic ventilation" 92
 - AUTO program with automatic climate control 89
 - "Autostore" on the radio 130, 132
 - "AUTO" with automatic climate control 91
 - Average fuel consumption 69
 - setting units 72
 - Average speed 69
 - "Avoid ferries" for navigation 116
 - Avoid freeways for navigation 116
 - "Avoid highways" for navigation 116
 - Avoiding unintentional alarms 33
 - "Avoid tollroads" for navigation 116
 - Axle loads, refer to Weights 190
 - "A - Z" 148
- B**
- Backrests, refer to Seats 43
 - Backup lamps, refer to Reverse gear 56
 - replacing the bulbs 180
 - Balance, refer to Adjusting the tone 128
 - Balance adjustment in audio mode
 - right/left 128
 - Bass, refer to Adjusting the tone 127
 - "Bass", refer to Adjusting the tone 128
 - Battery 181
 - in the remote control 26
 - jump-starting 184
 - Being towed 186
 - Belts, refer to Safety belts 47
 - Beverage holder, refer to Cup holders 97
 - Black ice, refer to Ice warning 64
 - Blower, refer to Air volume 89
 - BMW Assist 155
 - enabling 155
 - services offered 156
 - BMW maintenance system 174
 - "BMW Service" 157
 - "BMW Service settings" 155
 - Bore, refer to Engine data 190
 - Bottle holder, refer to Cup holders 97
 - Brake Assistant, refer to DBC Dynamic Brake Control 78
 - Brake fluid 173
 - warning lamp 173
 - Brake Force Display 80
 - Brake hydraulic system 173
 - Brake lamps
 - replacing the bulbs 180
 - two-stage brake lamps 80
 - Brake pads 173
 - break-in procedure 102
 - Brake pedal, refer to Brakes 103
 - Brake rotors 103
 - Brakes 103
 - ABS Antilock Brake System 76
 - brake fluid 173
 - Brake Force Display 80
 - brake pads 102, 173
 - break-in procedure 102
 - handbrake 55
 - Brake system 102
 - brake fluid level 173
 - brake pads 173
 - brake rotors 103
 - break-in procedure 102
 - warning lamp 13, 78, 173
 - Brake wear warning
 - brake pads 173
 - warning lamp 173
 - Breakdown assistance 156
 - Breakdown services, refer to Roadside Assistance 184
 - Breaking-in the clutch 102
 - Breaking-in the differential 102
 - Break-in procedures 102
 - "Brightness" 72
 - Buttons on the steering wheel 11

C

California laws

- Event Data Recorders 176
- Proposition 65 Warning 176

"Call" 148

Call

- accepting 147
- display accepted 149
- ending 148
- in absence 149
- starting 147

Calling

- from phone book 148
- from the Top 8 list 149
- redialing 149

- refer to telephone Owner's Manual 96

"Call sender" 151

Can holder, refer to

Cup holders 97

Capacities 193

Car battery, refer to

Battery 181

Car care, refer to the Caring for your vehicle brochure

Car-care products, refer to the Caring for your vehicle brochure

"Car data" 69

Care 175

Cargo, securing 105

Caring for artificial leather, refer to the Caring for your vehicle brochure

Caring for leather, refer to the Caring for your vehicle brochure

Caring for light-alloy wheels, refer to the Caring for your vehicle brochure'

Caring for plastic, refer to the Caring for your vehicle brochure

Caring for the carpet, refer to the Caring for your vehicle brochure

Caring for the vehicle finish, refer to the Caring for your vehicle brochure'

Car jacking points 181

Car keys, refer to

Key set 26

Car phone 145

- location, refer to

Center armrest 96

- refer to

Portable phone 144

- refer to separate

Owner's Manual

Car radio, refer to

Radio 130

Car wash 102

- also refer to the Caring for your vehicle brochure

Catalytic converter, refer to Exhaust system 102

"Categories" 135

CBC Cornering Brake

Control 76

CBS Condition Based

Service 174

"CD" 127, 137

CD changer 137

- adjusting the tone 127

- controls 126

- fast forward/reverse 140

- installation location 140

- playing a track 139

- random play

sequence 140

- repeating a track 139

- selecting a CD 137

- selecting a track 138

- switching on/off 126

- volume 127

CD player 137

- adjusting the tone 127

- controls 126

- fast forward/reverse 140

- playing a track 139

- random play

sequence 140

- repeating a track 139

- selecting a track 138

- switching on/off 126

- volume 127

Center armrest

- adjusting the height 96

- front 96

Center console 14

"Central locking" 27

Central locking system 26

- from inside vehicle 29

Changes, technical, refer to

For your own safety 6

Changing a wheel 181

Changing the language on

Control Display 73

Changing the

measurement units on the

Control Display 72

Changing wheels 181

CHECK button 68

Check Control 66

"Check Control

messages" 68

Check Gas Cap 162

Checking the air pressure,

refer to Tire inflation

pressure 164

Child's seats, refer to

Child-restraint

systems 52

Child-restraint system 51

Chrome parts, care, refer

to the Caring for your

vehicle brochure

Cigarette lighter 97

Cleaning, refer to the

Caring for your vehicle

brochure

Cleaning windshield, refer

to Wiper system 61

"Climate" 90

"Climate control" 91

Clock 64

- 12/24 hour mode 73

- setting time and date 73

Closing

- from inside 29

- from outside 27

Clothes hooks, Coupe 96

Cockpit 10

Cold start, refer to

Starting the engine 54

"Communication" 146

"Communication interface" 155
 Compact disc
 – refer to CD changer 137
 – refer to CD player 137
 Computer 69
 – clock, 12/24 hour mode 73
 – displays on Control Display 69
 – hour signal 73
 "Concert hall" 128
 Condition Based Service, CBS 174
 "Confirmation" 28
 Confirmation signals for locking and unlocking 28
 "Confirm unlock code" 147
 Connecting a vacuum cleaner
 – refer to Lighter socket 97
 – refer to Power socket 97
 Consumption display, refer to Average fuel consumption 69
 "Continue guidance to dest.?" 119
 Control Center 16
 – adjusting the brightness 72
 – assistance window 19
 – automatic climate control 90
 – changing settings 18, 72
 – changing the menu page 18
 – confirming selection or entry 18
 – controller 16
 – display, menus 16
 – language selection 73
 – menu guidance 17
 – menu item selection 18
 – operating elements 16
 – selecting units of measurement and display format 72
 – setting time and date 73
 – start menu 17
 – status information 19
 – symbols 17

Control Display 16
 Controller, refer to Control Center 16
 Controls, refer to Cockpit 10
 Convenience operation
 – convertible top 27, 29
 – glass roof 27, 29
 – windows 27, 29
 Convenience start, refer to Starting engine 54, 55
 Convertible program for automatic climate control 91
 Convertible top 37
 – care, refer to the Caring for your vehicle brochure
 – convenience operation 29
 – emergency closing 39
 – manual closing in the event of an electrical malfunction 39
 – opening and closing 38
 Coolant 172
 – level 172
 Cooling, maximum 89
 Cornering Brake Control, CBC 76
 Country of destination for navigation 110
 Courtesy lamps 87
 Cruise control 62
 Cruising range 69
 Cup holders 97
 Curb weight, refer to Weights 190
 "Current position" 109
 Current position
 – displaying 109
 – entering 114
 – storing 114
 "Customer Relations" 157
 Cylinders, refer to Engine data 190

D

Dashboard, refer to Cockpit 10
 Data 190
 – capacities 193
 – dimensions 191
 – engine 190
 – weights 190
 "Date" 74
 Date 64
 – setting 74
 "Date format" 74
 Daytime driving lamps 85
 DBC Dynamic Brake Control 78
 Deactivating front passenger airbag, Coupe 51
 Decommissioning the vehicle, refer to the Caring for your vehicle brochure
 Defect
 – convertible top 39
 – door lock 29
 – fuel filler door 162
 – glass roof 36
 – luggage compartment lid 30, 31
 – SMG Sequential manual transmission 58
 Defrosting windows 89
 Defrosting windows and removing condensation 89
 Defrosting windshield, refer to Defrosting windows 89
 Defrost position, refer to Defrosting windows 89
 "Delete address book" for navigation 116
 "Delete address" for navigation 115
 "Delete all numbers" for portable phone 150
 "Delete data" for navigation 116
 "Delete" for portable phone 149

Destination address
– deleting 115
– entering 110
Destination for navigation
– destination list 113
– entry 110
– selecting from address book 115
– selecting using information 113
– storing 114
Destination guidance 118
– bypassing route sections 120
– canceling voice instructions 50
– changing specified route 116
– displaying route 119
– distance and arrival 118
– interrupting 118
– starting 118
– terminating/continuing 118
– voice instructions 119
– volume of voice instructions 119
Destination list 113
Destinations recently driven to 113
"Dial" for portable phone 147
"Dial number" 147
Digital clock 64
Dimensions
– Convertible 192
– Coupe 191
Dipstick for engine oil 171
Directional indicators, refer to Turn signals 60
Direction announcements, refer to Voice instructions 119
Direction instructions, refer to Voice instructions 119
Directory, refer to Phone book 148
Directory for navigation, refer to Address book 114
Disc brakes 103

Displacement, refer to Engine data 190
Display, refer to Control Center 16
"Display off" 19
Displays, refer to Instrument cluster 12
"Display settings" 72
Displays on the windshield, refer to Head-Up Display 83
Disposal, vehicle battery 181
Distance, refer to Computer 70
Distance to destination, refer to Computer 70
Distance warning, refer to PDC Park Distance Control 75
"Dist. to destination" 70
Door entry lighting 87
Door keys 26
Door lock 29
"Door locks" 27
Doors
– manual operation 29
– remote control 27
DOT Quality Grades 166
Draft-free ventilation 92
"Driver's door only" 27
Driving lamps, refer to Parking lamps/low beams 85
Driving notes 102
Driving route, refer to Displaying the route 119
Driving stability control systems 77
Driving through water 103
Driving tips, refer to Driving notes 102
Drying the air, refer to Cooling function 89
DSC Dynamic Stability Control 77
– indicator lamp 13, 77
DTC Dynamic Traction Control 77
– activating 77
– indicator lamp 13, 77

DVD for navigation 108
Dynamic Brake Control, DBC 78
Dynamic Driving Control 59
"Dynamic route" for navigation 116
Dynamic Stability Control, DSC 77
Dynamic Traction Control, DTC 77

E

Easy Entry, refer to Entry to the rear 46, 52
EBV Electronic brake-force distribution 76
"Edit address" for navigation 115
Eject button, refer to Buttons on CD player 126
Electrical malfunction
– automatic transmission with Steptronic 59
– convertible top 39
– door lock 29
– driver's door 29
– fuel filler door 162
– glass roof 36
– luggage compartment lid 31
– SMG Sequential manual transmission 58
Electric steering wheel adjustment 48
Electronic brake-force distribution, EBV 76
Emergency assistance, refer to Roadside Assistance 184
Emergency call 183
Emergency operation, refer to Manual operation
– convertible top 39
– door lock 29
– driver's door 29
– fuel filler door 162
– glass roof 36
– luggage compartment lid 30, 31

- Emergency services, refer to Roadside Assistance [184](#)
 - "Emission inspect." [66](#)
 - "Enable services" [156](#)
 - "End call" [148](#)
 - Engine
 - break-in procedure [102](#)
 - data [190](#)
 - speed [190](#)
 - starting [54](#)
 - starting difficulties [54](#)
 - switching off [55](#)
 - Engine compartment [171](#)
 - Engine coolant [172](#)
 - Engine hood [170](#)
 - Engine oil
 - checking the oil level [171](#)
 - specified engine oils [172](#)
 - temperature [65](#)
 - temperature gauge [65](#)
 - topping up [172](#)
 - Engine output, refer to Engine data [190](#)
 - Engine speed, refer to Engine specifications [190](#)
 - Engine starting, refer to Starting engine [54](#)
 - "Enter address" for navigation [110](#)
 - Entering activation times of independent ventilation/heating [93](#)
 - Entering destination [111](#)
 - Entering the address [110](#)
 - Entering the intersection [111](#)
 - Entering the town/city for navigation [111](#)
 - Entering zip code for navigation [111](#)
 - "Entertainment" [127](#)
 - "Entertainment settings" [127](#)
 - Entry map for destination [112](#)
 - Entry to the rear [46](#)
 - "Equalizer", refer to Adjusting the tone [129](#)
 - "ESN" [134](#)
 - ESP Electronic Stability Program, refer to DSC Dynamic Stability Control [77](#)
 - Exhaust system [102](#)
 - Exterior mirrors [48](#)
 - automatic dimming feature [48](#)
 - automatic heating [48](#)
 - Eye for towing, refer to Tow fitting [186](#)
- F**
- Fader, refer to Adjusting the tone [128](#)
 - Failure messages, refer to Check Control [66](#)
 - False alarms, refer to Avoiding unintentional alarms [33](#)
 - False alarms with Flat Tire Monitor [79](#)
 - Fastening safety belts, refer to Safety belts [47](#)
 - Fastest route for navigation [116](#)
 - "Fast route" for navigation [116](#)
 - First aid, refer to First-aid kit [184](#)
 - First-aid kit [184](#)
 - First-aid pouch, refer to First-aid kit [184](#)
 - Flashing on locking/unlocking [28](#)
 - Flashlight, refer to Rechargeable flashlight [95](#)
 - Flat tire
 - Flat Tire Monitor [79](#)
 - run-flat tires [80](#), [168](#)
 - Flat Tire Monitor [79](#)
 - false alarms [79](#)
 - initializing the system [79](#)
 - limits of system [79](#)
 - malfunction [80](#)
 - warning lamp [80](#)
 - Flooding, refer to Water on roads [103](#)
 - "FM", reception range [127](#), [130](#)
 - FM, waveband [130](#)
 - Fog lamps [86](#)
 - indicator lamp [86](#)
 - Folding up the convertible top compartment floor, convertible [32](#)
 - Footwell lamps [87](#)
 - Forward, fast
 - CD changer [140](#)
 - CD player [140](#)
 - For your own safety [6](#)
 - Front airbags [81](#)
 - Front head restraints [45](#)
 - Front seat adjustment [43](#)
 - "FTM" [79](#)
 - Fuel
 - average consumption [69](#)
 - display [65](#)
 - fuel specifications [163](#)
 - high-quality brands [163](#)
 - quality [163](#)
 - tank capacity [162](#)
 - Fuel display, refer to Fuel gauge [65](#)
 - Fuel filler door [162](#)
 - releasing in the event of an electrical malfunction [162](#)
 - Fuel gauge [65](#)
 - Fuel specifications [163](#)
 - Fuses [182](#)
- G**
- Garage-door opener, refer to Integrated universal remote control [94](#)
 - Gasoline
 - refer to Fuel specifications [163](#)
 - refer to Required fuel [163](#)
 - Gasoline display, refer to Fuel gauge [65](#)
 - Gear changes
 - automatic transmission with Steptronic [58](#)
 - SMG Sequential manual transmission [57](#)

- Gear display
 - automatic transmission with Steptronic 58
 - SMG Sequential manual transmission 57
- Gearshift lever
 - automatic transmission with Steptronic 58
 - manual transmission 56
 - SMG Sequential manual transmission 56
- General driving notes 102
- Glass roof, electric with raise function 35
 - closing in the event of an electrical malfunction 36
 - convenience operation 29
 - remote control 27
- Glove compartment 95
- GPS navigation, refer to Navigation system 108
- Grills, refer to Ventilation 88
- Gross vehicle weight, refer to Weights 190

H

- Handbrake 55
 - indicator lamp 13, 55
- Hands-free system 14, 146
- Hazard warning flashers 15
- Head airbags 81
- Headlamp control, automatic 85
- Headlamp flasher 60
- Headlamps
 - care, refer to the Caring for your vehicle brochure
 - cleaning, refer to Wiper system 61
 - replacing the bulbs 178
- Head Light, refer to Adaptive Head Light 86
- Head-Up Display 83
- Heated mirrors 48
- Heated rear window 89
- Heated seats 47
- Heated steering wheel 49

- Heating
 - exterior mirrors 48
 - interior 88
 - rear window 89
 - residual heat mode 90
 - seats 47
 - steering wheel 49
- Heating with engine switched off, refer to Residual heat mode 90
- Heavy cargo, refer to Securing the load 105
- Height, refer to Dimensions 191
- Height adjustment
 - seats 43
 - steering wheel 48
- High beams 86
 - headlamp flasher 86
 - indicator lamp 13
 - replacing the bulbs 178
- Hills 103
- Holder for cups 97
- Horn 10
- Hotel function 30
- Hot exhaust system 102
- "Hour memo" 73
- "House number" for destination entry 111
- Hydraulic Brake Assistant, refer to DBC Dynamic Brake Control 78
- Hydroplaning 102
 - also refer to Minimum tread depth 167

I

- Ice warning 64
- iDrive, refer to Control Center 16
- Ignition key 26
- Ignition key positions, refer to Ignition lock 54
- Ignition lock 54
- Increasing luggage compartment capacity, Convertible 32

- Independent ventilation
 - activating activation timer 93
 - setting the activation time 93
 - switching on and off directly 92
- Indicator/warning lamps
 - ABS Antilock Brake System 13, 78
 - active steering 13, 80
 - airbags 13, 82
 - brake system 13, 78
 - DSC Dynamic Stability Control 13, 77
 - DTC Dynamic Traction Control 13, 77
 - fastening safety belts 13, 47
 - Flat Tire Monitor 80
 - fog lamps 11, 86
- Indicator and warning lamps, overview 13
- Individual button assignment options on the steering wheel 49
- Individual settings, refer to Key Memory 26
- Inflation pressure, refer to Tire inflation pressure 164
- Inflation pressure monitoring, refer to Flat Tire Monitor 79
- Information
 - on another location 113
 - on current location 113
 - on destination location 113
 - "Information" for navigation 113
 - "Information on destination" 114
- Initiating an emergency call 183
- "Input map" 112
- Installation location
 - CD changer 140
 - portable phone 145

Instructions for navigation system, refer to
 Voice instructions 119
 Instrument cluster 12
 Instrument illumination, refer to Instrument lighting 87
 Instrument lighting 87
 Instrument panel, refer to Instrument cluster 12
 Instrument panel lighting, refer to Instrument lighting 87
 Integrated universal remote control 94
 Interesting destination 113
 "Interim time" 72
 Interior lamps 87
 – remote control 28
 Interior mirror, automatic dimming feature 48
 Interior rearview mirror 48
 Interlock, refer to Steering locked 54
 Interlock on automatic transmission 54
 Intermittent mode of the wipers 61

J

Jacking points 181
 Joystick, refer to Control Center 16
 Jump-starting 184

K

Key Memory 26
 "Keypad" 150
 Keys 26
 Kickdown
 – automatic transmission with Steptronic 59
 – SMG Sequential manual transmission 57
 Knock control 163

L

Lamps, refer to Parking lamps/low beams 85
 Lamps and bulbs 178
 "Languages" 73
 – for navigation 119
 Lashing down loads, refer to Securing the load 105
 Lashing eyes, refer to Securing the load 105
 Last destinations, refer to Destination list 113
 "Last seat pos." 44
 LATCH child-restraint fixing 52
 LEDs light-emitting diodes 181
 Length, refer to Dimensions 191
 Letter symbol with portable phone 150
 License plate lamps, replacing bulbs 180
 Light-emitting diodes LEDs 181
 Lighter 97
 Lighter socket 97
 "Lighting" 60, 85
 Lighting
 – instruments 87
 – vehicle, refer to Lamps 85
 Lights on warning 85
 Light switch 85
 "Limit" 71
 Loading
 – securing the load 105
 – stowing cargo 105
 – vehicle 104
 Location, navigation drive 108
 "Lock after driving" 29
 Lock buttons in the doors, refer to Locking 30
 Locking
 – from inside 30
 – from outside 28
 Locking and unlocking doors
 – from inside 29
 – from outside 27

"LOGIC7", refer to Adjusting the tone 128
 Low beams 85
 – automatic 85
 – replacing the bulbs 178
 Lower back support, refer to Lumbar support 43
 Luggage compartment
 – capacity 190
 – emergency release 31
 – hotel function 30
 – increasing the capacity, Convertible 32
 – opening/closing, refer to Luggage compartment lid 31
 – opening from inside 31
 – opening from outside 31
 – opening with remote control 28
 Luggage compartment lid 30
 – emergency operation 31
 – emergency release 31
 – opening from inside 31
 – opening from outside 31
 – opening with remote control 28
 – unlocking manually 31
 Lumbar support 43
 LW, waveband 130

M

M+S tires, refer to Winter tires 169
 Maintenance, refer to the Service and Warranty Information Booklet for US models or to the Warranty and Service Guide Booklet for Canadian models 174
 Maintenance system 174
 Malfunction warnings, refer to Check Control 66
 Manual air distribution 90
 Manual mode with automatic transmission with Steptronic 59
 "Manual" on the radio 131

Manual operation
– convertible top 39
– door lock 29
– driver's door 29
– fuel filler door 162
– glass roof 36
– luggage compartment lid 30, 31
Manual transmission 56
Map
– changing scale 120
– destination entry 112
– facing north 120
"Map, direction of travel" 120
"Map, facing north" 120
Master key with remote control 26
Maximum cooling 89
Maximum speed with winter tires 169
Memory
– refer to Key Memory 26
– refer to Seat, mirror and steering wheel memory 44
Menus, refer to
 Control Center 16
Microfilter 92
Microphone
– for hands-free system 146
– for portable phone 14
– for voice command system 14
Mirrors 48
– automatic curb monitor 45
– dimming feature 48
– heating 48
– memory, refer to Seat, mirror and steering wheel memory 44
"Missed calls" 149
Missed calls 149
Mobile communication devices in vehicle 104
Monitor, refer to
 Control Center 16
"Monitor display on" 76

Most recent portable phone numbers 149
Multifunction steering wheel MFL 11
Multifunction switch
– refer to Turn signals/headlamp flasher 60
– refer to Wiper/washer system 61
Music track, finding 139
"Mute on / off" 49
MW, waveband 130

N

"Navigation" 108
Navigation destination
– manual entry 110
– selecting via map 112
Navigation drive, location 108
Navigation DVD 108
Navigation system 108
– address book 114
– bypassing route sections 120
– destination entry 110
– destination guidance in assistance window 109
– destination list 113
– displaying current position 109
– entering a destination manually 110
– looking for interesting destination 113
– navigation DVD 108
– route display 119
– route list 120
– selecting destination using information 113
– selecting destination using map 112
– selecting route criteria 116
– starting 108
– starting destination guidance 118
– terminating/continuing destination guidance 118
– voice instructions 119
– volume adjustment 119

"Navigation voice instructions on" 119
Neck support, refer to
 Front head restraints 45
"New address" for navigation 114
"New destination" 110, 112
"New route" 120
New wheels and tires 168
"Next entertainment source" 49
Nozzles
– refer to Ventilation 88
– refer to Windshield washer nozzles 61
Nylon rope, refer to Tow-starting and towing 185

O

OBD connector 176
Octane numbers, refer to
 Fuel specifications 163
Odometer 64
Oil
– additives 172
– capacity 193
– consumption 171
– dipstick 171
– level 171
– specified engine oils 172
Oil change intervals
– refer to Service requirement display 65
– refer to the Service and Warranty Information Booklet for US models or to the Warranty and Service Guide Booklet for Canadian models 174
Old batteries, refer to
 Disposal 181
"On a new destination" for navigation 113
Onboard computer, refer to
 Control Center 16
"Onboard information" 70
Onboard tool kit 178
"On destination" 113
"On location" 113

- Opening and closing
 - from inside 29
 - from outside 27
 - rear window 35
 - using door lock 29
 - using the remote control 27
- Operation via voice control for portable phone 151
 - adjusting volume 152
 - canceling 151
 - correcting phone number 153
 - correcting unlock code 152
 - dialing a phone number 152
 - entering unlock code 152
 - making a call 152
 - redialing 153
 - voice commands 151
 - voice phone book 153
- "Options" for portable phone 151
- Orientation menu, refer to Start menu 17
- Output, refer to Engine data 190
- Outside air, refer to AUC Automatic recirculated-air control 89
- Outside temperature display 64
 - changing unit of measurement 72
 - in the computer 72

P

- Panic mode 28
- Park Distance Control, PDC 75
- Parking, vehicle 55
- Parking aid, refer to PDC Park Distance Control 75
- Parking brake, refer to Handbrake 55
- Parking lamps/low beams 85
 - replacing the bulbs 178, 180

- Parts and accessories, refer to Your individual vehicle 5
- Passenger-side mirror tilt function 45
- "Pathway lighting" 85
- Pathway lighting 85
- "PDC" 76
- PDC Park Distance Control 75
- "Phone" 147
- Phone book 146
- Phone numbers
 - deleting in the phone book 149
 - dialing 147
 - most recent numbers 149
 - selecting in the phone book 149
 - Top 8 149
- Plasters, refer to First-aid kit 184
- "play" in audio mode 138
- Please fasten safety belt warning lamp 47
- Pollen, refer to Microfilter/activated-charcoal filter 92
- Portable phone
 - accepted calls 149
 - adjusting volume 146
 - battery 145
 - calling 147
 - call termination 148
 - codes 147
 - entering unlock code 147
 - hands-free system 146
 - installation position 96
 - missed calls 149
 - operation using Control Center 146
 - phone book 148
 - redialing 149
 - refer also to separate Owner's Manual
 - SMS 150
 - Top 8 149
 - touch tone dialing 150
 - use in vehicle, refer to Mobile communication devices in vehicle 104

- Position
 - displaying 109
 - storing 114
- Power cut 181
- Power failure, refer to Power cut 181
- Power windows, refer to Windows 34
- "Presets" on the radio 130, 135
- Pressure, tires 164
- Pressure monitoring of tires, refer to Flat Tire Monitor 79
- "Profile" 158
- Protective function, refer to Anti-trapping mechanism
 - glass roof 36
 - windows 35

R

- Radio
 - adjusting tone 127
 - Autostore 132
 - controls 126
 - playing stations 131
 - satellite radio 133
 - selecting frequency manually 131
 - selecting waveband 126, 130
 - station search 131
 - station selection 130
 - station with best reception 132
 - storing stations 132
 - switching on/off 126
 - volume 127
 - Weather Band 133
- Radio-control key, refer to Master key with remote control 26
- Rain sensor, refer to Wiper system 61
- "Random", random sequence generator 140
- "random directory" in audio mode 140

Random play
– CD changer **140**
– CD player **140**
Reading lamps **87**
Rear lamps, refer to
Tail lamps **180**
Rearview mirror **48**
Rear window defroster **89**
"Received calls" **149**
Receiving level of portable phone, refer to Status information **19**
Reception
– quality **133**
– radio stations **133**
– regional station **132**
Rechargeable flashlight **95**
Recirculated-air mode, refer to AUC Automatic recirculated-air control **89**
Recirculation of air, refer to AUC Automatic recirculated-air control **89**
Reclining seat, refer to Backrest **43**
Recording times, refer to Stopwatch **72**
"Redial" for portable phone **149**
Redialing with portable phone **149**
Refueling **162**
Releasing, engine hood **170**
"Relock door if not opened" **29**
Remaining distance
– refer to Computer **70**
– refer to Cruising range **69**
Remote control **26**
– garage-door opener **94**
– luggage compartment lid **28**
– malfunctions **28**
"Repeat" in audio mode **139**
"repeat track" in audio mode **139**
Replacement fuses **182**

Replacement of tires, changing a wheel **181**
Replacing bulbs, refer to Lamps and bulbs **178**
Replacing wheels/tires **168**
Reporting an accident, refer to Initiating an emergency call **183**
Reporting safety defects **7**
Reserve warning, refer to Fuel gauge **65**
"Reset"
– for stopwatch **72**
– in audio mode **129**
Residual heat mode **90**
Restraint systems
– for children **51**
– refer to Safety belts **47**
Retreaded tires **168**
Reverse, fast
– CD changer **140**
– CD player **140**
Reverse gear
– automatic transmission with Steptronic **59**
– manual transmission **56**
– SMG Sequential manual transmission **57**
Road map **120**
"Roadside Assistance" **157**
Roadside Assistance **184**
Roadside parking lamps **86**
"Roaming" **158**
Rollover protection system on Convertible **82**
– lowering **82**
Rope, refer to Towing and tow-starting **185**
Rotary pushbutton, refer to Control Center **16**
Route
– bypassing sections **120**
– changing **116, 120**
– display **120**
– displaying map **120**
– displaying the arrow view **119**
– list **120**
– selecting **116**
– selecting criteria **116**

"Route list" for navigation **120**
Route map **119**
"Route preference" **116**
Route selection **116**
Run-flat tires **168**
– continuing driving with a damaged tire **168**
– flat tire **80**
– tire inflation pressure **164, 168**
– tire replacement **168, 169**
– winter tires **169**

S

Safety belts **47**
– damage **47**
– sitting safely **42**
– warning lamp **47**
Safety belt tensioners, refer to Safety belts **47**
Safety systems
– ABS Antilock Brake System **76**
– airbags **81**
– DSC Dynamic Stability Control **77**
– rollover protection system, convertible **82**
– safety belts **47**
Satellite radio **133**
– activating **134**
– selecting channel **134**
– storing channel **134**
"SAT" on the radio **134**
"Scan"
– playing stations **131**
– playing tracks **139**
Scan
– CD changer **139**
– CD player **139**
– radio **131**
"scan directory" in audio mode **139**
Screen, refer to Control Center **16**
"Screen on / off" **49**
Screw-on valve caps **181**

- Screw thread for tow fitting [186](#)
- Seats [43](#)
 - adjusting [43](#)
 - heating [47](#)
 - memory, refer to Seat, mirror and steering wheel memory [44](#)
 - sitting safely [42](#)
 - sports seat [43](#)
 - storing the setting [44](#)
 - thigh support [43](#)
- Securing load [98](#)
- "Select as destination" [113](#)
- "Select current speed" [71](#)
- Selecting audio sources, refer to Operation using Control Center [126](#)
- Selecting frequency manually [131](#)
- Selecting menu items [18](#)
- Selecting new scale for navigation system display [120](#)
- Selecting route [116](#)
- Selection options with navigation system [116](#)
- Selector lever
 - automatic transmission with Steptronic [58](#)
 - manual transmission [56](#)
 - SMG Sequential manual transmission [56](#)
- Selector lever interlock, refer to Shiftlock
 - automatic transmission with Steptronic [58](#)
 - SMG Sequential manual transmission [57](#)
- Sequential manual transmission, SMG [56](#)
- "Service" [65](#), [156](#)
- Service, refer to
 - Roadside Assistance [184](#)
- Service and Warranty Information Booklet for US models [174](#)
- "Service notification" [156](#)
- "Service Request" [157](#)
- Service requirement display [65](#)
 - also refer to CBS Condition Based Service [174](#)
- "Service requirements" [65](#), [156](#)
- "Service Status" [155](#)
- "Set date" [74](#)
- "Set" in audio mode [127](#)
- "Set service date" [66](#)
- "Set time" [73](#)
- Setting road-speed limit [71](#)
- Settings
 - changing on the Control Display [72](#)
 - configuring, refer to Key Memory [26](#)
- Setting the time, refer to Preselecting activation time [93](#)
- "Set tire pressure" [79](#)
- Shifting gears with automatic transmission with Steptronic [58](#)
- Short commands of the voice command system [194](#)
- "Short cut / Telephone" [49](#)
- Shortest route for navigation [116](#)
- "Short route" for navigation [116](#)
- "Show current position" [112](#)
- "Show destination position" [112](#)
- Side airbags [81](#)
- Side marker lamps, replacing the bulbs [180](#)
- Side turn signals, replacing the bulbs [180](#)
- Sill panel lighting [87](#)
- Sitting safely [42](#)
 - with airbags [42](#)
 - with safety belts [42](#)
- Ski bag [98](#)
- Sliding/tilt roof, refer to
 - Glass roof, electric with raise function [35](#)
- SMG Sequential manual transmission [56](#)
 - acceleration assistant [60](#)
 - convenience start [55](#)
 - Dynamic Driving Control [59](#)
 - gear display [57](#)
 - kickdown [57](#)
 - overheating [58](#)
 - shiftlock [57](#)
 - towing [186](#)
 - tow-starting [187](#)
 - warning lamp [58](#)
- "SMS" [150](#)
- Snow chains [169](#)
- Socket
 - for Onboard Diagnosis interface [176](#)
 - in front passenger footwell [98](#)
 - refer to Cigarette lighter socket [97](#)
- SOS, refer to Initiating an emergency call [183](#)
- Sound output for Entertainment on/off [127](#)
- Spare fuses [182](#)
- Spare key [26](#)
- Special oils, refer to
 - Specified engine oils [172](#)
- Specified engine oils [172](#)
- Speed-dependent volume [128](#)
- Speed limit warning, refer to Speed limit [71](#)
- Speedometer [12](#)
- "Speed volume", refer to
 - Adjusting the tone [128](#)
- Speed with winter tires [169](#)
- Sport program
 - automatic transmission with Steptronic [59](#)
 - Dynamic Driving Control [59](#)
- Stability control, refer to
 - Driving stability control systems [76](#)
- "Start" for stopwatch [72](#)
- "Start guidance" [111](#), [118](#)
- Starting assistance, refer to
 - Jump-starting [184](#)

Starting difficulties
 – jump-starting 184
 – refer to Starting engine 54
 Starting engine 54
 Start menu 17
 "Start route guidance" 112
 "Start service" 157
 "State / Province" for destination entry 110
 "State inspection" 66
 Station, refer to Radio 130
 "Status" 65
 Status of this Owner's Manual at time of printing 5
 Steering wheel 11
 – adjustment 48
 – automatic adjustment 49
 – buttons on steering wheel 11
 – heating 49
 – individual button assignment options 49
 – memory 44
 "Steering wheel buttons" 49
 Steering with variable ratio, refer to Active steering 80
 Steptronic, refer to Automatic transmission with Steptronic 58
 "Stop" for stopwatch 72
 "Stopwatch" 72
 Stopwatch 72
 Storage compartments 96
 "Store in address book" for navigation 114
 "Store" on the radio 132, 135
 Storing current position 114
 Storing sitting position, refer to Seat, mirror and steering wheel memory 44
 Storing tires 169
 Straps, refer to Loading 105
 "Street" for destination entry 111

Stroke, refer to Engine data 190
 Summer tires, refer to Wheels and tires 164
 SW, waveband 130
 Switches, refer to Cockpit 10
 Switching navigation voice instructions on/off 119
 Switching off
 – engine 55
 – interior motion sensor 33
 – tilt alarm sensor 33
 Switching on
 – audio 126
 – CD changer 126
 – CD player 126
 – portable phone 145
 – radio 126
 Switching on hour signal 73
 Switching the cooling function on and off 89
 Swiveling headlamps, refer to Adaptive Head Light 86
 Symbols 4

T

Tachometer 64
 Tail lamps 180
 – replacing the bulbs 180
 Tank capacity, refer to Fuel tank capacity 162
 Target cursor for navigation 112
 Technical changes, refer to For your own safety 6
 Technical data 190
 Telematic 155
 Telephone
 – refer to Portable phone 144
 – refer to separate Owner's Manual
 TeleService 155
 – enabling 155
 – services offered 156
 Temperature adjustment 89
 Temperature display
 – ice warning 64
 – outside temperature 64
 – setting measurement units 64
 Temperature gauge, engine oil 65
 Tempomat, refer to Cruise control 62
 "Terminate services" 158
 "Text language" 73
 The individual vehicle 5
 Tilt function, passenger-side mirror 45
 "Time" 73
 "Time 1" for independent ventilation 93
 "Time 2" for independent ventilation 93
 "Time format" 73
 Timer, refer to Preselecting activation time 93
 Tire pressure monitoring, refer to Flat Tire Monitor 79
 Tire Quality Grading 166
 Tires
 – age 166
 – air loss 80
 – break-in procedure 102
 – changing 168
 – condition 167
 – damage 167
 – flat 168
 – inflation pressure 164
 – new wheels and tires 168
 – pressure monitoring, refer to Flat Tire Monitor 79
 – replacing 168
 – retreaded tires 168
 – run-flat tires 168
 – size 168
 – tread 167
 – wear indicators 167
 – wheel/tire combination 168
 – winter tires 169
 "Tone" 128
 Tone in audio mode
 – adjusting 127
 – middle setting 129

Tools, refer to
 Onboard tool kit **178**
 "Top 8" for portable phone **149**
 Torque, refer to
 Engine specifications **190**
 Touch tone dialing **150**
 Tow fitting **186**
 Towing **185**
 – tow fitting **186**
 – vehicles with automatic transmission **186**
 – vehicles with SMG Sequential manual transmission **186**
 – with tow bar **186**
 – with tow-rope **187**
 – with tow truck **187**
 "Town / City" for destination entry **111**
 Tow-starting **187**
 Tracks
 – random play sequence **139, 140**
 – sample scan **139**
 Track width, refer to
 Dimensions **191**
 Traction control, refer to
 DSC Dynamic Stability Control **77**
 Traffic congestion, refer to
 Bypassing route sections **120**
 Transmission
 – automatic transmission with Steptronic **58**
 – manual transmission **56**
 – SMG Sequential manual transmission **56**
 Transporting children safely **51**
 Transport securing device, refer to
 Securing the load **105**
 Tread depth, refer to
 Minimum tread depth **167**
 "Treble", refer to
 Adjusting the tone **128**
 "Trip computer" **70**

Trip computer **70**
 Trip-distance counter, refer to
 Trip odometer **64**
 "Triple turn signal activation" **60**
 Trip odometer **64**
 Trunk, refer to
 Luggage compartment **30**
 Trunk lid, refer to
 Luggage compartment lid **30**
 Turning circle, refer to
 Dimensions **191**
 Turn signals **60**
 – indicator lamp **13**
 – replacing the bulbs **179**

U

Underbody protection, refer to
 the Caring for your vehicle brochure
 Uniform Tire Quality Grading/UTQR **166**
 "Units" **72**
 Units
 – average fuel consumption **72**
 – temperature **72**
 Universal garage-door opener, refer to
 Integrated universal remote control **94**
 Universal remote control, refer to
 Integrated universal remote control **94**
 "Unlock button" **27**
 Unlock code **147**
 Unlocking
 – from inside **30**
 – from outside **27**
 Unlocking and locking doors, setting
 confirmation signals **28**
 "Update services" **158**

V

Vehicle
 – battery **181**
 – break-in procedure **102**
 – care **175**
 – care, refer to the Caring for your vehicle brochure
 – decommissioning, refer to the Caring for your vehicle brochure
 – dimensions **191**
 – loading **104**
 – parking **55**
 – position, refer to
 Displaying current position **109**
 – washing, refer to the Caring for your vehicle brochure
 – weights **190**
 "Vehicle settings" **27**
 "Ventilation" **92**
 Ventilation **92**
 – draft-free **92**
 – independent ventilation **92**
 Vent outlets of automatic climate control **88**
 "Vent settings" **91**
 Voice command system **20**
 Voice instructions for navigation system **119**
 – muting **50, 119**
 – repeating **50, 119**
 – switching on/off **50, 119**
 – volume **119**
 Voice phone book **153**
 Volume **126**
 – audio sources **126**
 – portable phone **146**
 – setting speed-dependent **128**
 – setting using buttons on steering wheel **11**
 – voice instructions **119**
 Volume adjustment in audio mode, front-to-rear **128**
 Volume of the luggage compartment **190**

W

Warning lamps, refer to
Indicator/warning
lamps 13

Warning messages, refer to
Check Control 66

Warning triangle 184

Warranty and Service
Guide Booklet for
Canadian models 174

Washer fluid
– capacity of the
reservoir 62
– wiper system 62

Washer fluid reservoir 62

Water on roads, refer to
Driving through water 103

Waveband 130

"WB" 127, 133

Wear indicators in tires 167

Weights 190

Wheel/tire combination,
refer to New wheels and
tires 168

Wheelbase, refer to
Dimensions 191

Wheels and tires 164

Width, refer to
Dimensions 191

Wind deflector 40

Windows 33
– convenience
operation 27, 29
– opening and closing,
Convertible 34
– opening and closing,
Coupe 34
– rear window,
Convertible 35

Windshield washer
nozzles 61

Windshield washer system,
refer to Washer/wiper
system 61

Windshield wiper blade
replacement 178

Windshield wipers, refer to
Wiper/washer system 61

Winter tires 169
– setting speed limit 71
– storage 169

Wiper blade
replacement 178

Wiper system 61
– washer fluid 62
– windshield washer
nozzles 61

"With highways" for
navigation 116

Wordmatch principle for
navigation 117

Working in the engine
compartment 170

Wrenches/screwdrivers,
refer to Onboard tool
kit 178

X

Xenon lamps 178
– replacing the bulbs 178

Refueling

To ensure that you always have all the essential data at hand when refueling, we recommend that you fill in the following tables with the specifications and information that apply to your vehicle. Consult the index for individual specifications.

Fuel

Designation

Please enter your preferred fuel here.

Engine oil

Quality

The oil quantity between the middle of the two marks on the dipstick is approx. 1.6 US quarts/1.5 liters.

Tire inflation pressures

	Summer tires Front	Rear	Winter tires Front	Rear
Up to 4 persons				
4 persons plus luggage				

More about BMW

bmwusa.com



The Ultimate
Driving Machine