



M3 Convertible

Thank you for deciding on a BMW M3 Convertible.

Thorough familiarity with your vehicle will provide you with enhanced control and security when you drive it. Therefore, we have one request:

Read the information contained in this Owner's Manual before driving your new BMW M3 Convertible for the first time. It contains important information on vehicle operation that will enable you to make full use of the advanced technical equipment of your BMW M3 Convertible. In addition, you will receive information on vehicle maintenance to help ensure operating and traffic safety as well as the best possible value retention of your BMW. For more detailed information refer to the supplemental manuals.

BMW M also makes decisive contributions toward greater safety in traffic through its BMW driver training.

This Owner's Manual should be considered a permanent part of this vehicle. It should stay with the vehicle when sold to provide the next owner with important operating, safety and maintenance information.

We wish you an enjoyable driving experience.

BMW M

4 Notes

About this Owner's Manual

We have made every effort to ensure that you are able to find what you need in this Owner's Manual as quickly as possible. The fastest way to find certain topics is by using the detailed index at the end. If you wish to gain an initial overview of your vehicle, you will find this in the first chapter.

Should you wish to sell your BMW at some time in the future, please remember to hand over this Owner's Manual to the new owner; it is an important part of the vehicle.

Additional sources of information

Should you have any further questions, your BMW center will be glad to assist at any time.

You can find more information about BMW, for example on its technology, on the Internet at www.bmw.com.

Symbols used



Indicates precautions that must be followed precisely in order to avoid the possibility of personal injury and serious damage to the vehicle.



Contains information that will assist you in gaining the optimum benefit from your vehicle and enable you to care more effectively for your vehicle.



Refers to measures that can be taken to help protect the environment.

◀ Marks the end of a specific item of information.

* Indicates special equipment, country-specific equipment and optional extras when available.



Vehicle Memory, Key Memory, refer to page 64. Identifies functions that can be specifically adapted for a particular key or vehicle. These adjustments can be performed either by yourself or by your BMW center. ▶

© 2003 BMW M GmbH
Munich, Germany

Reprinting, including excerpts, only with the written consent of BMW M GmbH, Munich.

Order No. 01 41 0 157 596

US English VIII/03

Printed in Germany

Printed on environmentally friendly paper,
bleached without chlorine, suitable for recycling.

Notes

Your individual vehicle

On purchasing your BMW, you have decided in favor of a model with individualized equipment and features. This Owner's Manual will describe all of the equipment that the BMW M3 Convertible has to offer you.

We hope you will understand that equipment and features are included that you might not have chosen for your vehicle. You can easily identify any differences with the aid of the asterisk * used to identify all optional equipment and accessories.

If your BMW features equipment that is not described in this Owner's Manual, such as a car radio or telephone, we have enclosed Supplementary Owner's Manuals. We ask you to read these manuals as well.

Status at time of printing

BMW pursues a policy of continuous, ongoing development that is conceived to ensure that our vehicles continue to embody the highest quality and safety standards combined with advanced, state-of-the-art technology. For this reason, the features described in this Owner's Manual could differ from those on your vehicle. Nor can errors and omissions be entirely ruled out. You are therefore asked to appreciate that no claims can be recognized on the basis of the data, illustrations or descriptions in this Owner's Manual.

For your own safety

Fuels



Use unleaded gasoline only. Fuels containing up to and including 10% ethanol or other oxygenates with up to 2.8% oxygen by weight – that is, 15% MTBE or 3% methanol plus an equivalent amount of co-solvent – will not void the applicable warranties respecting defects in materials or workmanship. Field experience has indicated significant differences in fuel quality – volatility, composition, additives, etc. – among gasolines offered for sale in the United States and Canada. The use of poor quality fuels may result in driveability, starting and stalling problems especially under certain environmental conditions, such as high ambient temperature and high altitude. Should you encounter driveability problems which you suspect could be related to the fuel you are using, we recommend that you respond by switching to a recognized high-quality brand.

Failure to comply with these recommendations may result in unscheduled maintenance.

Obey pertinent safety rules when you are handling gasoline. ◀

Maintenance and repair

 Advanced technology, e.g. the use of modern materials and high-performance electronics, requires specially adapted maintenance and repair methods. Therefore, only have corresponding work on your BMW carried out by a BMW center or a workshop that works according to BMW repair procedures with correspondingly trained personnel. If work is carried out improperly there is a danger of consequential damage and the related safety risks. ◀

Parts and accessories

 Important safety information! For your own safety, use genuine parts and accessories approved by BMW.

When you purchase accessories tested and approved by BMW and Original BMW Parts, you simultaneously acquire the assurance that they have been thoroughly tested by BMW to ensure optimum performance when installed on your vehicle.

BMW warrants these parts to be free from defects in material and workmanship.

BMW will not accept any liability for damages resulting from installation of parts and accessories not approved by BMW.

BMW cannot test every product made by other manufacturers to verify if it can be used on a BMW safely and without risk to either the vehicle, its operation, or its occupants.

Original BMW Parts, BMW Accessories and other products approved by BMW, together with professional advice on using these items, are available from all BMW centers.

Installation and operation of non-BMW approved accessories such as alarms, radios, amplifiers, radar detectors,

wheels, suspension components, brake dust shields, telephones – including operation of any portable cellular phone from within the vehicle without using an externally mounted antenna – or transceiver equipment, such as CB, walkie-talkie, ham radio or similar, may cause extensive damage to the vehicle, compromise its safety, interfere with the vehicle's electrical system or affect the validity of the BMW Limited Warranty. Contact your BMW center for additional information.

Do not use key or remote control to lock doors or luggage compartment with anyone inside the car. Refer to the Owner's Manual for more details. ◀

 Maintenance, replacement, or repair of the emission control devices and systems may be performed by any automotive repair establishment or individual using any certified automotive part. ◀

Symbol on vehicle parts

 Indicates that you should consult the relevant section of this Owner's Manual for information on a particular part or assembly.

Notes

Service and warranty

This manual is supplemented by a Service and Warranty Information Booklet for US models or a Warranty and Service Guide Booklet for Canadian models.

We recommend that you read this publication thoroughly.

Your BMW is covered by the following warranties:

- ▷ New Vehicle Limited Warranty
- ▷ Rust Perforation Limited Warranty
- ▷ Federal Emissions System Defect Warranty
- ▷ Federal Emissions Performance Warranty
- ▷ California Emission Control System Limited Warranty.

Detailed information about these warranties is listed in the Service and Warranty Information Booklet for US models or in the Warranty and Service Guide Booklet for Canadian models.

Reporting safety defects

The following only applies to vehicles owned and operated in the US.

If you believe that your vehicle has a defect which could cause a crash or could cause injury or death, you should immediately inform the National Highway Traffic Safety Administration NHTSA in addition to notifying BMW of North America, LLC, P.O. Box 1227, Westwood, New Jersey 07675-1227, telephone toll-free 1-800-831-1117.

If NHTSA receives similar complaints, it may open an investigation, and if it finds that a safety defect exists in a group of vehicles, it may order a recall and remedy campaign. However, NHTSA cannot become involved in individual problems between you, your dealer, or BMW of North America, LLC.

To contact NHTSA, you may either call the Auto Safety Hotline toll-free at 1-800-424-9393 or 366-0123 in the Washington, D.C. area, or write to: NHTSA, U.S. Department of Transportation, Washington, D.C. 20590. You can also obtain other information about motor vehicle safety from the Hotline.

Contents

Notes

- About this Owner's Manual 4
- Additional sources of information 4
- Symbols used 4
- Your individual vehicle 5
- Status at time of printing 5
- For your own safety 5
- Symbol on vehicle parts 6
- Service and warranty 7
- Reporting safety defects 7

Overview

- Cockpit 14
- Instrument cluster 16
- Indicator and warning lamps 18
- Buttons in steering wheel 22
- Hazard warning triangle* 23
- First-aid kit* 23
- Refueling 24
- Fuel specifications 25
- Tire inflation pressure 25

Controls and features

Opening and closing:

- Keys 30
- Central locking system 30
- Opening and closing – via the remote control 31
- Opening and closing – via the door lock 33
- Opening and closing – from the inside 34
- Luggage compartment lid 35
- Luggage compartment 37
- Electric power windows 38
- Convertible top 39
- Wind deflector* 44

To adjust:

- Safe seating position 46
- Seats 47
- Power seat adjustment 47
- Head restraints 48
- Entering the rear 49
- Safety belts 50
- Seat and mirror memory 51
- Seat heating* 52
- Steering wheel 53
- Mirrors 53

Passenger safety systems:

- Airbags 55
- Transporting children safely 58
- Rollover protection system 62
- Vehicle Memory, Key Memory 64

Contents

Controls and features

Driving:

- Ignition lock 65
- Starting the engine and driving off 66
- Switching off the engine 68
- Parking brake 68
- Manual transmission 69
- Sequential M gearbox with Drivelogic* 70
- Turn signal indicator/Headlamp flasher 75
- Washer/wiper system/Rain sensor* 76
- Cruise control 77

Everything under control:

- Odometer 79
- Tachometer 79
- Engine oil temperature 79
- Fuel gauge 80
- Engine coolant temperature gauge 80
- Service interval display 81
- Check Control 81
- Clock 82
- Computer 83

Technology for safety and driving convenience:

- Park Distance Control (PDC)* 85
- Dynamic Stability Control DSC 86
- Flat Tire Monitor 87
- M Engine dynamics control 90
- Brake force display 90

Lamps:

- Parking lamps/Low beams 91
- Instrument lighting 92
- High beams/Standing lamps 92
- Fog lamps 93
- Interior lamps 93
- Reading lamps 93

Controlling the climate for pleasant driving:

- Automatic climate control 96

Interior conveniences:

- Glove compartment 101
- Storage compartments 101
- Cellular phone* 102
- Ashtray, front* 103
- Ashtray, rear* 103

Loading and transporting:

- Ski bag* 104
- Cargo loading 106
- Roof-mounted luggage rack for the hardtop* 108

Operation, maintenance

Special operating instructions:

- Break-in procedures 112
- General driving notes 113
- Antilock Brake System (ABS) 114
- Brake system 114
- Hardtop* 115

Wheels and tires:

- Tire inflation pressure 118
- Tire condition 118
- Tire replacement 119
- Wheel and tire combinations 121
- Winter tires 122
- Snow chains* 122

In the engine compartment:

- Hood 123
- Engine compartment essentials 124
- Washer fluids 126
- Engine oil 126
- Coolant 128
- Brake fluid 129

Maintenance:

- The BMW Maintenance System 130

Laws and regulations:

- California Proposition 65 warning 132
- OBD interface socket 132

Contents

Owner service procedures

Replacement procedures:

- Onboard tool kit 136
- Windshield wiper blades 136
- Lamps and bulbs 137
- Repairing a flat tire 140
- Battery 144
- Fuses 145

Giving and receiving assistance:

- Receiving assistance 146
- Jump-starting 147
- Towing the vehicle 148

Technical data

- Engine data 154
- Dimensions 155
- Weights 156
- Capacities 157

Index

- Everything from A to Z 160



Overview

Controls and features

Operation, maintenance

Owner service procedures

Technical data

Index



14 Cockpit

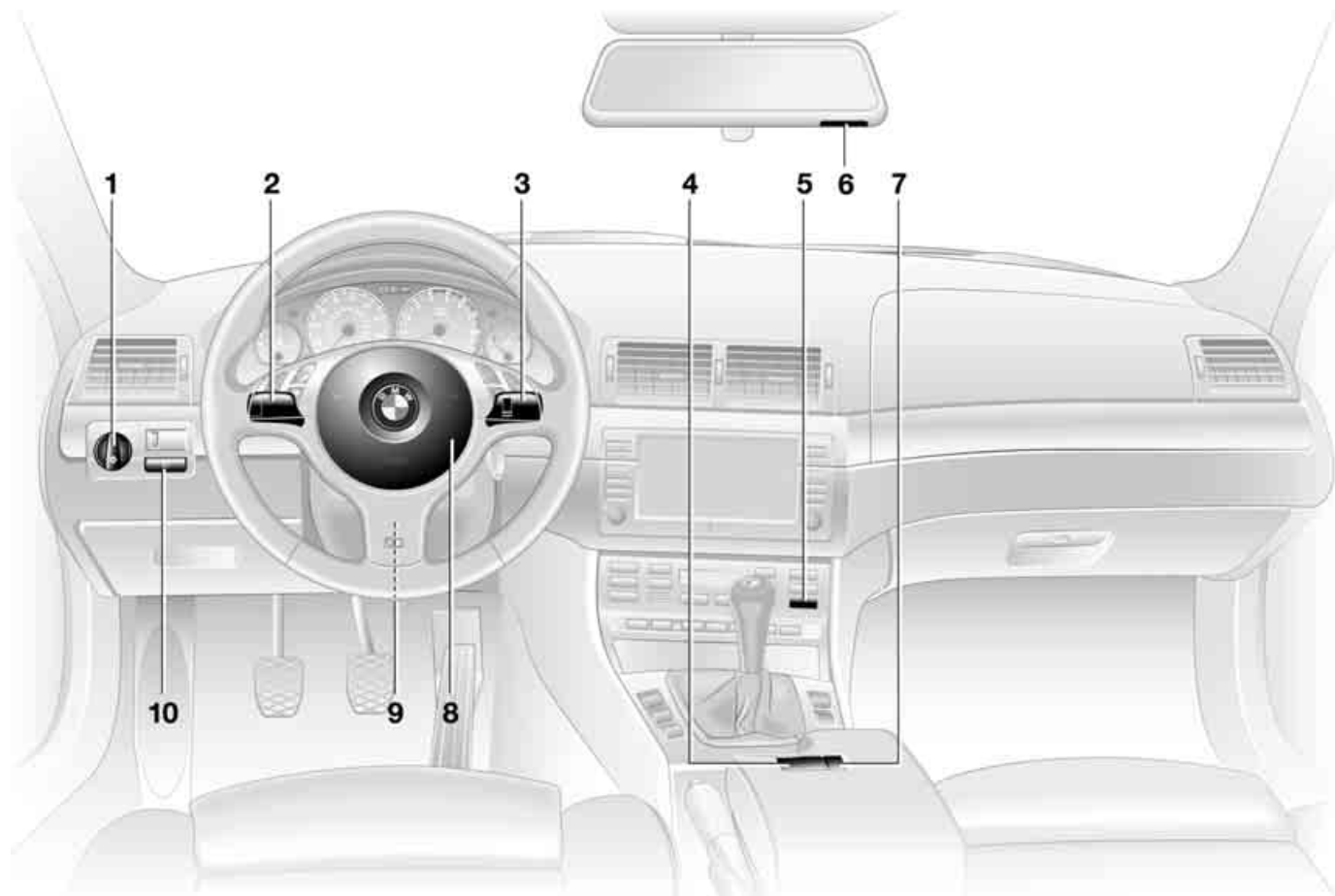

Cockpit

- 1 Parking lamps/Low beams 91
- 2 ▷ Turn signal indicators 75
 - ▷ Standing lamps 92
 - ▷ High beams 92
 - ▷ Headlamp flasher 75
 - ▷ Computer 83
- 3 Washer/wiper system/Rain sensor 76
- 4 Hazard warning flashers
- 5 Rear window defroster 99
- 6 ▷ Initiating an emergency call 146
 - ▷ Mobile Service 146
- 7 Central locking system 30
- 8 Horn: the entire surface
- 9 Steering wheel adjustment 53
- 10 Fog lamps 93

16 Instrument cluster

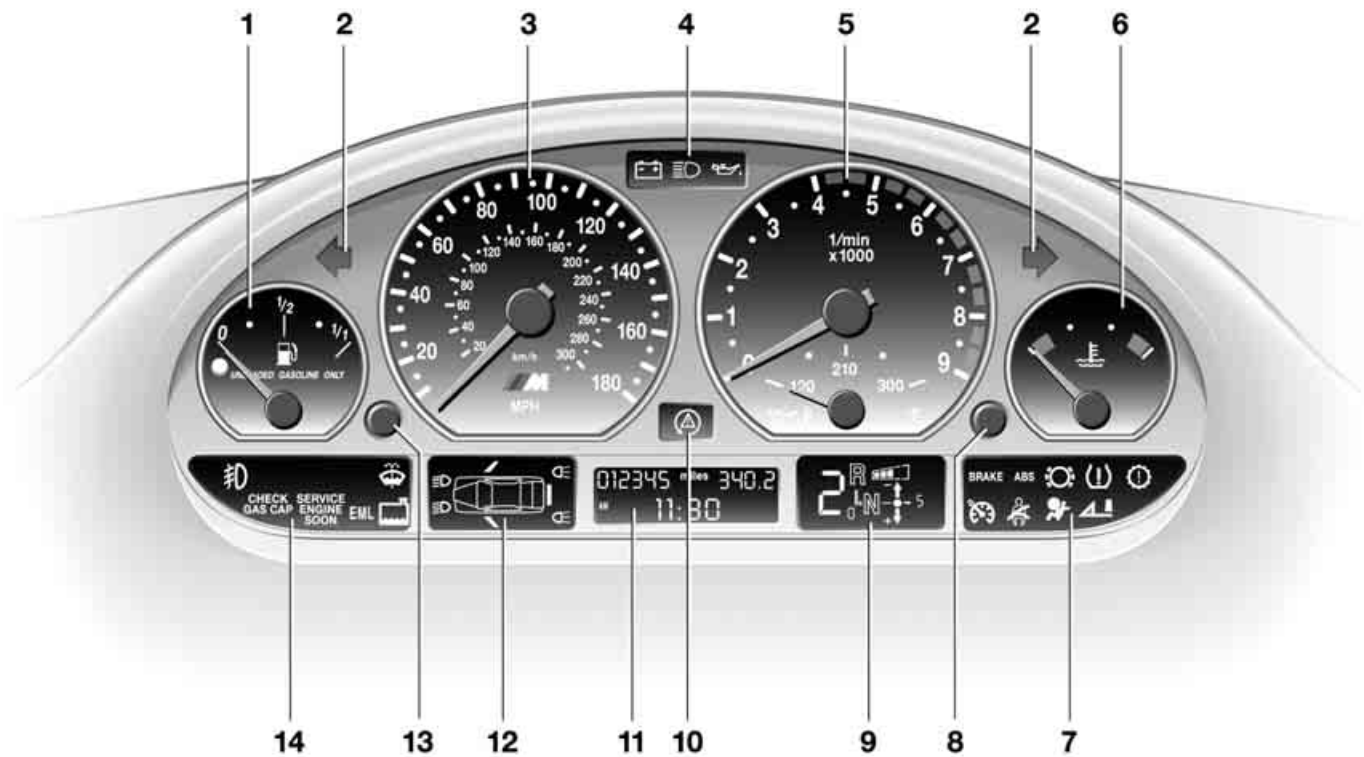

Instrument cluster

- 1 Fuel gauge 80
- 2 Turn signal indicator 20
- 3 Speedometer
- 4 Indicator and warning lamps 18 to 21
- 5 Tachometer and engine oil temperature gauge 79
- 6 Engine coolant temperature gauge 80
- 7 Indicator and warning lamps 18 to 21
- 8 Control button for
 - ▷ Clock 82
 - ▷ Unit of measure of outside temperature display 83
- 9 Display for sequential M gearbox with Drivelogic 71
- 10 Indicator lamp for Dynamic Stability Control (DSC) 86
- 11 Display for
 - ▷ Trip odometer 79
 - ▷ Clock 82
 - ▷ Service interval 81
 - ▷ Computer 83
- 12 Check Control 81
- 13 Trip odometer, reset to zero 79
- 14 Indicator and warning lamps 18 to 21

18 Indicator and warning lamps

Technology that monitors itself

Indicator and warning lamps that are identified by ● are tested for proper functioning whenever the ignition key is turned. They each light up once for different periods of time.

If a fault should occur in one of these systems, the corresponding lamp does not go out after the engine is started, or it lights up while the vehicle is moving. You will see how to react to this below.

Red: stop immediately

 Battery charge current ●
The battery is no longer being charged. There is a malfunction of the alternator drive belt or in the charging circuit of the alternator. Please contact the nearest BMW center.

 If the drive belt is defective, stop and switch off the engine immediately to prevent overheating and serious engine damage. If the drive belt is defective, increased steering effort is also required. ◀

 Engine oil pressure ●
An alarm sounds at the same time. Stop vehicle immediately and switch off engine. Check the engine oil level and top up as required. If the oil level is correct: please contact the nearest BMW center.

 Do not continue driving, as the engine could sustain serious damage from inadequate lubrication. ◀

 Flat Tire Monitor ●
In addition, an acoustic signal is sounded: there is a flat tire. Reduce speed and carefully come to a stop. Avoid sudden braking and steering maneuvers. For additional information: refer to page 87

 Brake warning lamp ●
If the lamp comes on when the parking brake is not engaged: check the brake fluid level. Before driving further, be sure to comply with the instructions on pages 114 and 129.

 Brake warning lamp for Canadian models.

Red: an important reminder

 Brake warning lamp ●
Comes on when the parking brake is engaged – an additional acoustic signal sounds when starting off. For additional information: refer to page 68

 Brake warning lamp for Canadian models.

 Lock backrest/Please fasten safety belts ●
Comes on together with an acoustic signal until the safety belts are fastened. Flashes when the backrest is not locked.

For additional information on locking the backrest, refer to page 49
For additional information on safety belts: refer to page 50

 Airbags ●
Please have the system inspected at your BMW center. For additional information: refer to page 55

Indicator and warning lamps

Red and yellow: continue driving cautiously

BRAKE The brake warning lamp comes on together with the yellow indicator lamps for ABS ● and DSC:

ABS The entire ABS, CBC and DSC control system has failed. Continue to drive; drive cautiously and defensively and avoid full brake applications. Please have the system checked by your BMW center as soon as possible.

For additional information: refer to pages [86](#), [114](#)

 Indicator and warning lamps CBC, ABS and DSC for Canadian models.



Orange: consult the nearest BMW center

 Sequential M gearbox with Drivelogic

If the indicator lamp fails to go out after the engine is started, or if it comes on during normal driving: this indicates a malfunction in the system. Please consult the nearest BMW center.

Indicator lamp flashes: a system overload has occurred.

For additional information: refer to page [74](#)

Yellow: check as soon as possible

 Engine oil level

Comes on while driving and is accompanied by an alarm: the engine oil level has fallen to the absolute minimum; refill as soon as possible. Do not drive more than 30 miles/50 km before refilling.

For additional information: refer to page [126](#)



Engine oil level

Comes on after the engine has been shut off and is accompanied by an alarm: add engine oil at your earliest opportunity such as when you stop to refuel

For additional information: refer to page [126](#)



Brake pads ●

Have the brake pads checked. For additional information: refer to page [114](#)



Flat Tire Monitor ●

The Flat Tire Monitor has been deactivated, either at the button or in response to a system malfunction. In the event of a malfunction, have the system checked by your BMW center. For additional information: refer to page [87](#)



Dynamic Stability Control DSC ●

The indicator lamp flashes and an acoustic signal sounds: the system is active and governs drive and braking force.

If the indicator lamp fails to go out after the engine is started, or if it comes on during normal driving and stays on: DSC has been deactivated, either at the

20 Indicator and warning lamps

button or in response to a system malfunction. In the event of a malfunction, have the system checked by your nearest BMW center.

For additional information: refer to page [86](#)

 Dynamic Brake Control (DBC) ●
Malfunction in DBC system. Conventional braking efficiency is available and unrestricted.

Have the system checked and repaired at your BMW center as soon as possible.

For additional information: refer to page [114](#)

 Dynamic Brake Control (DBC) warning lamp for Canadian models.

 Add washer fluid
The washer fluid is too low. Top off the fluid at the earliest opportunity.

For additional information: refer to page [126](#)

 SERVICE ENGINE SOON ●
If the indicator lamp comes on either continuously or intermittently, this indicates a fault in the emissions-related electronic systems.

Although the vehicle remains operational, you should have the systems checked by your BMW center at the earliest possible opportunity.

For additional information: refer to page [132](#)

 Service Engine Soon indicator lamp for Canadian models.

 Engine electronics ●
There is a fault in the electronic engine-management system. You can continue to drive with reduced engine output or engine speed. Please have the system inspected at your BMW center.

 Add coolant
Coolant level too low, top up as soon as possible.

For additional information: refer to page [128](#)

 CHECK GAS CAP* ●
This indicator lamp comes on when the gas cap is loose or missing.

Close the gas cap tightly: refer to page [24](#)



Rollover protection system ●
The rollover protection system is deactivated due to a malfunction. Please have the system inspected immediately at your BMW center. For additional information: refer to page [62](#)

Green: for your information



Turn signal indicator
Flashes when turn signals are on. Rapid flashing: indicates a system malfunction. For additional information: refer to page [75](#)



Cruise control
Lights up when the cruise control is activated. Ready for operation via the buttons in the steering wheel. For additional information: refer to page [77](#)



Front fog lamps
Lights up whenever the fog lamps are on. For additional information: refer to page [93](#)

Indicator and warning lamps

Blue: for your information



High beams

Comes on when the high beams are on or the headlamp flasher

is actuated.

For additional information: refer to pages [75](#), [92](#)

22 Buttons in steering wheel

These buttons let you operate the following functions quickly and without being distracted from traffic conditions:

- ▷ Selected radio functions
- ▷ The cruise control
- ▷ Selected telephone functions.*

 The controls are active only when the corresponding systems and accessories are switched on. ◀



Press briefly:

Accept incoming call, start dialing, terminate call.



Switch between phone and radio, cassette and CD.



Forward:

- ▷ Radio
Press briefly: next station in station memory
Extended pressure: station search

- ▷ CD
Press briefly: jump to next track
Extended pressure: search function in track
- ▷ Cassette
Press briefly: jump to next track or stop fast forward
Extended pressure: fast forward
- ▷ Phone
Scan personal phone book.



Rewind: same functions as forward.



Volume.



Cruise control: select a stored setting.



Cruise control: store and accelerate + or decelerate and store -.

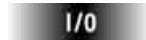

Cruise control: activate/interrupt/deactivate.

Hazard warning triangle*



The hazard warning triangle is stored ready to use in the luggage compartment lid inside the toolbox for the onboard tool kit.

To open the container, loosen the wing nut.

 Always observe all legal regulations requiring a warning triangle to be carried in the vehicle. ◀

First-aid kit*

23



The first-aid kit is located under the front passenger's seat.

To open: pull the handle and fold the cover down.

To fasten: fold the cover up and press it until the tab engages.

 Several of the items contained in the first-aid kit have a limited service life. For this reason, check the expiration dates of each of the items regularly, and replace any with passed dates. You can acquire replacements in any drugstore or pharmacy. Always observe all legal regulations requiring a first-aid kit to be carried in the vehicle. ◀



 When handling fuels, comply with all of the applicable safety precautions posted at the service station. Never carry spare fuel containers in your vehicle. Whether empty or full, these containers can leak, cause an explosion, or lead to fire in the event of a collision. ◀

Fuel filler door

 Always switch off the engine before refueling, as it is not possible to add fuel with the engine running, and attempts may also trigger the SERVICE ENGINE SOON lamp. ◀

Press on the rear edge of the fuel filler door to open and close it.

If an electrical malfunction occurs, you can unlock the fuel filler door manually: Pull the knob with the fuel pump symbol on the right trim panel of the luggage compartment.

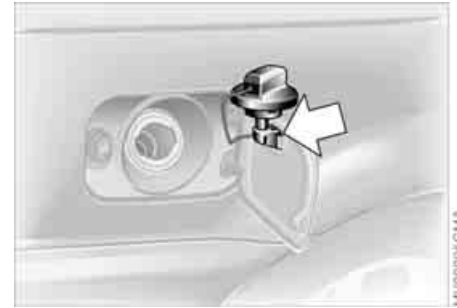

Simple and environmentally friendly

 Open the gas cap carefully to prevent fuel from spraying out. Fuel spray may cause injury. ◀

Keep the gas cap in the bracket attached to the fuel filler door.

When refueling, insert the filler nozzle completely into the filler pipe. Lifting the nozzle during refueling

- ▷ results in premature pump shutoff
- ▷ and will reduce the effect of the vapor recovery system on the pump.

The fuel tank is full when the filler nozzle shuts off the first time.

Refueling

 Close the gas cap carefully after refueling until a click is heard. While closing, be sure not to squeeze the strap which is fastened to the cap. A loose or missing cap will activate the CHECK GAS CAP* lamp. ◀

Fuel tank capacity

▷ Approx. 16.6 gal./63 liters, of which
▷ approx. 2.1 gal./8 liters are reserve capacity.

 Do not drive to the last drop of fuel. This can prevent the engine from operating properly and result in damage. ◀

Fuel specifications

The engine uses lead-free gasoline only.

Required fuel:

- ▷ Premium Unleaded Gasoline, min. 91 AKI.
AKI = Anti Knock Index

 Never use leaded fuel, as it would cause permanent and irreversible damage to the oxygen sensor and the catalytic converter. ◀

Tire inflation pressure

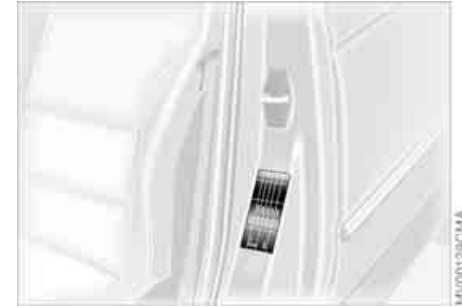

Checking tire pressures

Tire pressures in psi/kilopascal are shown on the driver's door post and are visible when the door is open.

Only check the tire inflation pressures of cold tires. This means after driving a maximum of 1.25 miles/2 km or after the vehicle has been parked for at least 2 hours. Warm tires have higher inflation pressures.

In the following tire inflation pressure table, all pressures are specified in the standard units of pressure, psi and kilopascal, and apply to cold tires, i.e. tires at ambient temperature.

After correcting the tire inflation pressure, reinitialize the Flat Tire Monitor so that it can monitor the tire inflation pressure, refer to page 87.

26 **Tire inflation pressure**



Check the tire pressures on a regular basis – at least twice a month – and before every extended journey. If this is not done, incorrect tire pressures can cause driving instability and tire damage, ultimately resulting in accidents. ◀

Comply with tire approval specifications

The inflation pressures in the table apply to BMW-approved tire sizes and tire manufacturers. Your BMW center will be glad to supply this information. Other pressures may be required for tires made by other manufacturers.

Your vehicle is equipped with tires which not only meet US standards, but also European standards. We recommend the exclusive use of BMW approved tires.

Tire inflation pressure

BMW	Tires All pressure specifications in the table are indicated in psi/kilopascal with cold tires – cold = ambient temperature				
	225/45 ZR 18	33/230	–	41/280	–
	255/40 ZR 18	–	35/240	–	48/330
M3	225/40 ZR 19	33/230	–	41/280	–
	255/35 ZR 19	–	35/240	–	48/330
	225/45 R 17 91 H M+S	33/230	38/260	36/250	46/320
	225/40 R 18 92 V M+S	36/250	38/260	39/270	51/350



Overview

Controls and features

Operation, maintenance

Owner service procedures

Technical data

Index

Overview

Controls

Maintenance

Repairs

Data

Index



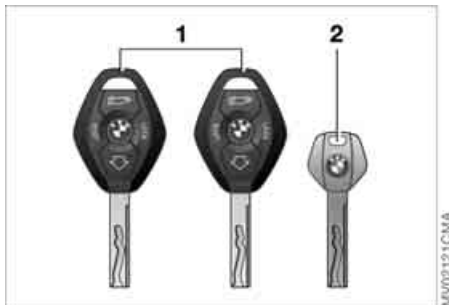

The key set

- 1 Master keys with remote control unit – these keys determine the functions of the Key Memory. Refer to page 64. You can mark the individual keys for subsequent identification by applying the colored decals that you received when accepting delivery of your vehicle

▷ In every master key with remote control there is an extended-life battery that is charged automatically in the ignition lock as you drive. For this reason, if you have a master key with remote control that is otherwise not used, use that key at least once every year while driving for an extended period to charge the battery. ◀

- 2 Spare key – for storage in a safe place, such as in your wallet. This key is not intended for constant use. The luggage compartment lid and the glove compartment cannot be locked and unlocked with this key. This is useful for valet parking, for example.

Central locking system

The concept

The central locking system engages and releases the following locks at the same time:

- ▷ doors
- ▷ luggage compartment lid
- ▷ fuel filler door and
- ▷ glove compartment.

The central locking system is ready for operation whenever the driver's door is closed.

The central locking system can be operated

- ▷ from outside via the door lock and using the remote control
- ▷ from inside via the central locking system button.

If it is operated from inside, the fuel filler door will not be locked, refer to page 34.

Operating it from outside simultaneously activates the anti-theft system, which prevents the doors from being unlocked via the door lock buttons or the door release handles.

The central locking system unlocks automatically in the event of an accident. In addition, the hazard warning flashers and interior lamps come on.

Opening and closing – via the remote control

The concept

The remote control also provides two additional functions beyond the central locking feature:

- ▷ Switch on the interior lamps, refer to page 32.

With this function you can also search for your vehicle – when parked in an underground garage, for instance

- ▷ Open the luggage compartment lid, refer to page 32.

The luggage compartment lid will open slightly, regardless of whether it was locked or unlocked.

Whenever you unlock or lock the vehicle, you simultaneously deactivate/activate the anti-theft system and switch the interior lamps on/off.



You can have a signal set to confirm that the vehicle's locks have engaged securely. ◀

Master keys with remote control



Since passengers or animals remaining in the vehicle might be able to lock the doors from the inside, always take the vehicle's keys with you so that the vehicle can be opened again from the outside at any time. ◀



If it is no longer possible to lock the vehicle via the remote control, the battery is discharged. Use this key while driving for an extended period in order to recharge the battery. To prevent unauthorized use of the remote control, surrender only the spare key when leaving the vehicle for valet parking, for example.

In the event of a system malfunction, please contact your BMW center. You can also obtain replacement keys there. ◀



- 1 Unlocking and convenience opening
- 2 Locking and securing, turning on interior lamps,
- 3 Opening luggage compartment lid

To release



Press button to unlock the driver's door only.



Press the button twice in order to unlock the entire vehicle. ◀

Convenience opening mode

Press and hold button. The windows and the fully-automatic convertible top open.

32 Opening and closing – via the remote control

To lock and secure



Press button.

To switch on the interior lamps



After locking the vehicle, press button again.

To open the luggage compartment lid



Press button.

The lid will open slightly, no matter whether it was locked or unlocked.

 If the luggage compartment lid was locked, it will be locked again after it is reclosed.

Before and after a trip, be sure that the luggage compartment lid has not been opened unintentionally. ◀

External systems

Locally, external systems or devices may interfere with remote control functions.

If this should occur, you can still open and close the vehicle using the master key in both the door and luggage compartment locks.

For US owners only

The transmitter and receiver units comply with part 15 of the FCC Federal Communications Commission regulations. Operation is governed by the following:

FCC ID:

- ▷ LX8EWS
- ▷ LX8FZVS
- ▷ LX8FZVE.

Compliance statement:

This device complies with part 15 of the FCC Rules. Operation is subject to the following two conditions:

- ▷ This device may not cause harmful interference, and
- ▷ this device must accept any interference received, including interference that may cause undesired operation.

 Any unauthorized modifications to these devices could void the user's authority to operate the equipment. ◀

Opening and closing – via the door lock



▷ To fasten: with the door closed, hold the key in the Lock position.

 Whenever closing the windows or sliding/tilt sunroof you should always monitor their path and progress to ensure that no one is injured. Releasing the key stops the operation. ◀

Manual operation

In the event of electrical malfunction

Turn the key all the way to the left or right to unlock or lock the driver's door.

Turning the key in the door lock once unlocks the driver's door, the fuel filler door and the glove compartment.

Turning the key a second time unlocks the passenger's door and the luggage compartment lid.



You can have a signal set to confirm that the vehicle's locks have engaged securely. ◀

Convenience operation

With the door closed you can also operate the power windows and the convertible top with the door lock.

▷ To open: with the door closed after turning the key for the second time, hold the key in the Unlock position

34 Opening and closing – from the inside



You can use this button to control the central locking system whenever the doors are closed. The doors and luggage compartment lid are unlocked or locked only. The anti-theft system is not activated.

 If only the driver's door was unlocked from the outside and you press the button, then, with the driver's door still open, the passenger's door, the luggage compartment lid, the fuel filler door and the glove compartment will unlock, too. If the driver's door is closed, it will be locked. ◀

 If you desire, the central locking system can be activated automatically as soon as you begin to drive. You may also have this adjusted so that it is specific to keys. ◀

To unlock and open the doors

1. Press the button for the central locking system
2. Pull the release handle above the armrest on the door you wish to open

or

pull the release handle for any door twice: to unlock and open the door.

To lock

- ▷ Either use the central locking button to lock all doors at once
- or
- ▷ press the individual door lock buttons down. As an added design feature to prevent the driver from being inadvertently locked out of the vehicle, the driver's door lock button will not engage as long as the door is open.

 Since passengers or animals remaining in the vehicle might be able to lock the doors from the inside, always take the vehicle's keys with you so that the vehicle can be opened again from the outside at any time. ◀

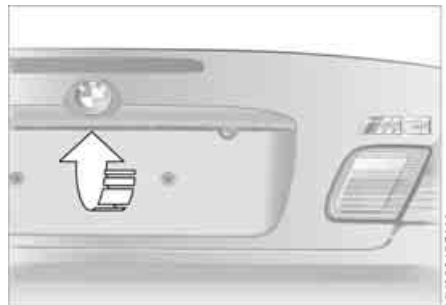
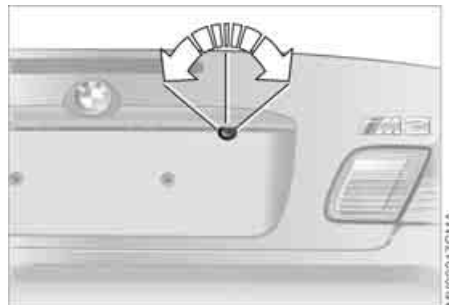

The lock

Only the master keys fit in the lock for the luggage compartment lid, refer to page 30.

To secure separately

Lock the glove compartment using the master key.

The luggage compartment lid is locked and disconnected from the central locking system. This feature can be used to prevent unauthorized access to the luggage compartment when you surrender the spare key only, refer to page 30. This can be advantageous for valet parking, for example.

To open from the outside

Press the button in the handle recess: the luggage compartment lid opens slightly.

The luggage compartment is lit when the luggage compartment lid is opened.

Manual operation

In the event of electrical malfunction Turn the master key to the right as far as it will go, the luggage compartment lid will open slightly.

The luggage compartment lid is locked again as soon as you close the lid.

To open from the inside

If the luggage compartment lid has not been locked separately, you can open it with this button in the footwell on the driver's side when the vehicle is stationary.

36 Luggage compartment lid

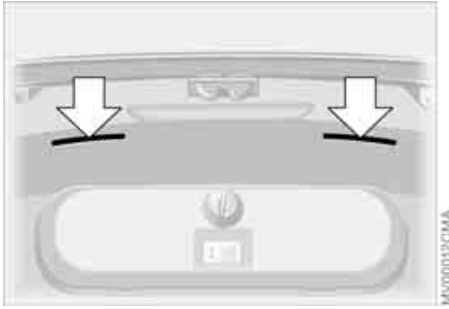



Nevertheless, should it be absolutely necessary to operate the vehicle with the luggage compartment lid open, with closed convertible top:

1. Close all windows
2. Greatly increase the quantity of air from the automatic climate control system, refer to page 98.

To close

The handle recesses in the interior trim panel of the luggage compartment lid make it easier to pull the lid down.

 To avoid injuries, be sure that the travel path of the luggage compartment lid is clear when it is closed, following the same precautions as with all closing procedures. ◀

 Operate the vehicle only when the luggage compartment lid is completely closed. Otherwise, exhaust fumes could penetrate the interior of the vehicle. ◀



Emergency release

This lever releases the luggage compartment lid from the luggage compartment's interior.

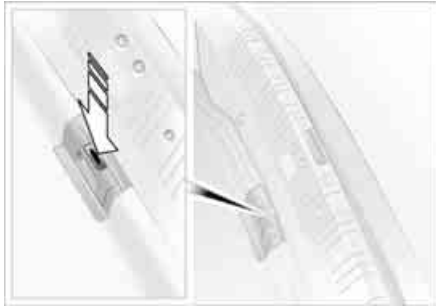

To fold up and secure the floor panel

1. Pull up at the handle and fold the panel up
2. Press the button to release the hanger from the handle

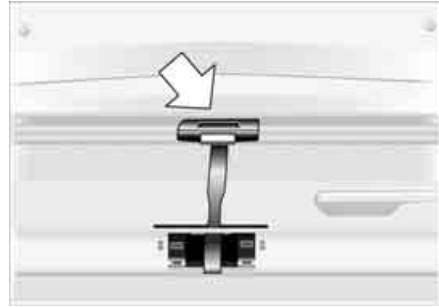

3. Hook the handle into the rubber seal of the drip rail.

 Carefully replace the hanger in its holder when lowering the floor panel back down. ◀

The fittings at the corners of the luggage compartment provide you with a convenient means of attaching luggage nets* and flexible straps for securing luggage.

Refer also to Cargo loading on page [106](#).

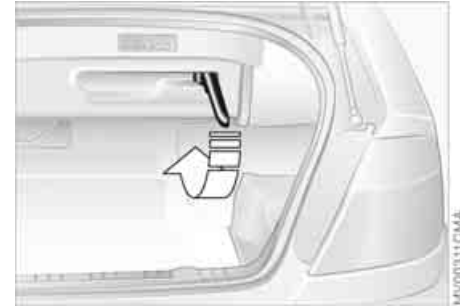

Enlarging luggage compartment

With the convertible top closed, you can enlarge the luggage compartment. To do this, flip the handle outward and press it down and toward the front of the vehicle. The convertible top compartment panel is now raised and secured.

To fold down the convertible top compartment panel

To open the convertible top, the convertible top compartment panel must be lowered. To do this, fold out the handle and pull opposite the direction of travel.

38 Luggage compartment

 When opening the convertible top, refer to page 39, make sure that the convertible top compartment panel is folded down in the luggage compartment; otherwise you may damage something. ◀

Electric power windows



You can close the windows in the same manner by pulling the switch. The rear windows do not close automatically.

To open and close windows

 When leaving the vehicle, always remove the ignition key from the lock and remember to close the doors to prevent children from operating the power windows and injuring themselves, etc. ◀

With the ignition key in position 1 or higher

- ▷ Press the switch until you feel resistance: the window continues to move as long as you continue to press the switch
- ▷ Press the switch briefly past the pressure point: the window moves automatically. Touching the switch again stops the opening cycle.



Operating all windows at once

With the ignition key in position 1 or higher

- ▷ Press the switch until you feel resistance: all of the windows will continue to lower as long as you continue to press the switch
- ▷ Press the switch briefly past the pressure point: all windows will move automatically. Pressing the switch again stops the opening cycle.

You can close the windows in the same manner by pulling the switch. The windows cannot be closed automatically using this switch.

For the convenience mode via the remote control or the door lock, refer to page 31 or 33.

After the ignition has been switched off

After the ignition has been switched off: you can still use the electric power windows for up to 15 minutes, as long as no one opens any of the doors.

Protective function

If the closing force of a front window exceeds a certain value as the window is being closed, the closing procedure is immediately interrupted and the window opens again slightly.



Despite this protective function, you must still make sure that there are no obstacles within the closing range of the windows. Otherwise, it cannot be guaranteed that the closing procedure will be interrupted in certain cases, e.g. when very thin objects are in the closing range.

This protective function is deactivated when the switch is pulled past the resistance point and held there. ◀

After power loss

After the battery has been disconnected, the protective function must be reinitialized. Please contact your BMW center.

The completely automatically operated convertible top combines assured protection against the elements with simple and easy handling.

To gain maximum satisfaction from your convertible, please observe the following:

- ▷ It is advisable to close the convertible top when the vehicle is being parked. The closed convertible top not only protects the passenger compartment from unforeseeable damage from the weather, it also provides a certain degree of theft protection. In addition, keep valuables only in the locked luggage compartment, even when the convertible top is closed
- ▷ Never mount a roof-mounted luggage rack on the convertible top
- ▷ At temperatures below 14 °F / -10 °C do not operate the convertible top to prevent damage.



Never store the convertible top in its compartment for more than one day while it is wet to avoid permanent damage from moisture. ◀



Do not lay objects on the convertible top, as they could fall off when it moves, causing vehicle damage or personal injury. ◀

40 Convertible top

 Driving when the opening or closing process has not been completed can cause vehicle damage or personal injuries.

Do not reach into the convertible top mechanism during opening and closing. Keep children away from the moving parts of the convertible top during operation. ◀

 If possible, only operate the convertible top with the vehicle stopped, as otherwise the process may be interrupted.

If you set the convertible top in motion with the vehicle stationary and then have to start suddenly – for instance, at a traffic light – you can still complete the operation by driving as slowly as possible and again pressing and maintaining pressure on the button. ◀

 To close the electric power windows while driving, always be sure to first close either the rear windows, or all 4 windows at the same time, otherwise, at high speed, the windows may not close tightly. ◀

 At higher speeds, the ensuing vacuum in the passenger compartment can cause the convertible top to begin fluttering. Increase the air supply via the ventilation controls so that a vacuum does not occur in the vehicle. ◀

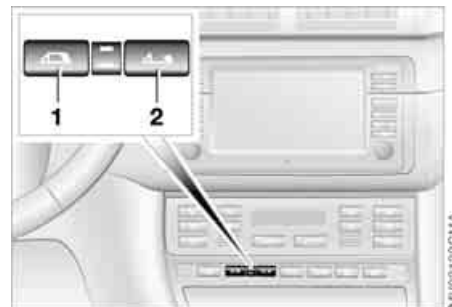

Opening and closing

1 To close

2 To open

 To avoid placing unnecessary loads on the battery, you should avoid operating the top when the engine is switched off.

Before closing the convertible top, remove any objects from the windshield frame that could keep the convertible top from closing properly. ◀

With the ignition key in position 1 or higher, and with the vehicle stationary

1. Read and comply with the preceding safety precautions

Convertible top

2. Ensure that the convertible top compartment panel in the luggage compartment is folded down, see page 37; otherwise, it will not be possible to open the convertible top
3. Make sure that the luggage compartment lid is closed
4. Press and hold the corresponding button for convertible top operation.

 The luggage compartment lid cannot be opened while the convertible top is in motion. ◀

 During convertible top operation the rear window moves toward the passenger compartment. To prevent injuries, make sure that the closing path of the convertible top is unobstructed. ◀

 After having been stored for an extended period of time in the convertible top compartment, e.g. during the winter months because the hardtop was being used, you may have to support the convertible top by hand when closing it for the first time. If the convertible top should halt right before the closing phase is completed, press against the front part of the convertible top frame from the outside to help the closing process along. Keep pressing the button while doing so until the top starts up again on its own. ◀

Indicator lamps

- ▷ The red indicator lamp is lit whenever the convertible top is in motion. It goes out as soon as the opening or closing operation has been completed
- ▷ If the red indicator lamp flashes after the button is released, the convertible top has not yet been opened or closed completely. You can resume operation in the desired direction by pressing the button again
- ▷ If the yellow indicator lamp lights up continuously with the button pressed, the convertible top compartment panel has been raised and the top cannot be moved.

The side windows move down slightly whenever the button for operating the convertible top is pressed.

They will go back up if you keep holding the button down for more than 2 seconds after the opening or closing process has been completed and the indicator lamp has gone out.

Interruption

The convertible top stops moving immediately when the button is released. You can resume operation in the desired direction by pressing the button again

 Do not close the side windows using the power window switches if the convertible top has not been closed completely. Otherwise, the side windows may not seal properly with the rubber seals of the convertible top. ◀

If the opening or closing operation is interrupted by releasing the buttons, the convertible top remains in the respective position for 15 minutes before it slowly moves into a stable position. The operation can be continued by pressing the buttons.

42 Convertible top

 Do not repeatedly interrupt and resume the closing operation, as otherwise the fully-automatic convertible top mechanism could be damaged. ◀

In certain cases, the luggage compartment lid cannot be opened if the opening or closing operation has been interrupted.

 Operate the convertible top manually in emergency situations only to avoid causing damage due to incorrect operation. ◀

Convenience operation via remote control and driver's door lock

Refer to pages [31](#) and [33](#).



Closing manually in the event of an electrical malfunction

- 1 Emergency operation
- 2 Allen wrench
- 3 Recess

 Only operate the convertible top manually to close it. Never open it manually since the convertible top compartment lid cannot be locked and would open during driving. ◀

 Manual closing is best carried out by two persons from outside with the driver's door open and the driver's seat folded forward. No one is to be in the rear seat while you are doing this. ◀

1. Remove the center piece between the rear seats. Take the trim off of the guide rod and flip it forward
2. Press down hard on the emergency lock 1 – see previous illustration. After a brief pause, the mechanisms for the convertible top compartment lid will be released

 If the mechanism for the convertible top compartment lid does not unlock, then insert the Allen wrench 2 into the recess 3 and turn clockwise to release it. ◀

3. If the luggage compartment lid is closed, open the convertible top compartment lid up as far as the stop will allow



▶ Please consult your BMW center to have the defect corrected. ◀

4. Grasp the convertible top by the lateral guide section – see arrow 1 – and the front convertible top frame – see arrow 2. Lift out the top and swing forward until you encounter a perceptible resistance at a stop. Position the rear convertible top frame vertically and close the convertible top compartment lid. Fold down the rear convertible top frame

 To avoid damaging the side trim, always fold the convertible top forward before folding the rear frame brace up into its vertical position. ◀

5. Use a screwdriver to lift out the cover panel that is in the center of the front convertible top frame
6. Insert the Allen wrench 2 – refer to page 42 – into the recess – see arrow
7. Pull down on the front convertible top frame as far as possible. Close the convertible top further by turning the wrench in a clockwise direction; continue turning until the front convertible top frame is locked to the windshield frame. The rear convertible top frame will automatically be pressed down onto the convertible top compartment lid and, because of the tension, will close completely.

 The closing operation must be completed, as otherwise damage and/or injuries may result. ◀



Position for cleaning

To be able to access the convertible top compartment, lean the rear frame of the convertible top against the cover of the convertible top compartment.

▶ First, use the button for activating the convertible top to unlock the locks of the convertible top compartment. Refer to page 40. ◀

▶ For additional information on vehicle care, refer to the Caring for your vehicle brochure. ◀

Wind deflector*

With the convertible top open, the wind deflector keeps air movement in the passenger compartment to a minimum, thus providing you with a pleasant drive, even at higher speeds. The wind deflector comes in a protective sleeve, and because of its slim dimensions, can be easily stored in the luggage compartment.

Installation

1. Remove wind deflector from the protective sleeve

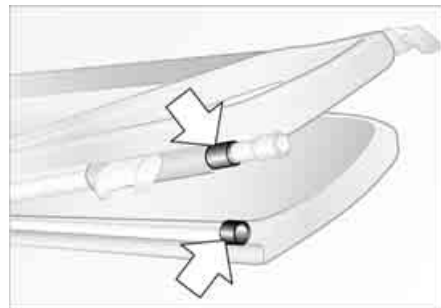

2. Flip out both sides and lock into place. It is essential for the two components marked in the illustration to mesh at this point

Wind deflector*



3. Hold the wind deflector so that the smaller half points toward the front and guide the mounting pin for the side piece into the proper opening
4. Pull back on the mounting pin for the other side piece by using a slide, so that the mounting pin can be guided into the opening provided
5. Unlock the convertible top compartment lid via the convertible top control button, refer to page 40, and open the convertible top compartment lid
6. Flip the back half of the wind deflector backward, so that the mounts are lying on the vehicle

7. Close the convertible top compartment lid via the convertible top control button. The wind deflector is now attached so that it is theft-proof.

 Operate the convertible top compartment lid from above only in order to avoid any pinching. With the wind deflector in place: to avoid damaging the wind deflector never push the front seats all the way back. ◀

Removal

Follow the same procedure as when installing, just reverse the steps.

46 **Safe seating position**

For driving that is relaxed and less likely to cause fatigue, you should select a sitting position that reflects your personal requirements. In combination with the safety belts and airbags, the correct seating position also plays an important role in enhancing occupant safety in the event of an accident. To ensure that the vehicle's safety systems provide you with optimal protection, we request that you direct your careful attention to the following section.

For supplementary information on transporting children, refer to page 58.

Sitting safely with airbags

 Always maintain an adequate distance between yourself and the airbags. Always hold the steering wheel by the rim to keep any chance of injury to hands or arms to an absolute minimum should the airbag be deployed. Never allow any objects, individuals or animals to obstruct the areas between passengers and airbags. Never use the front airbag's cover as a storage tray or support for objects of any kind. Never allow front passengers to rest their feet or legs on the airbag cover. ◀

For airbag locations and additional information on airbags, refer to page 55.

Sitting safely with safety belts

Your vehicle is equipped with four seats, each of which is provided with a safety belt.



Never allow more than one person to wear a single safety belt. Never allow infants or small children to ride in a passenger's lap. Avoid twisting the belt while routing it firmly across the pelvis and shoulder, wear it as snugly against your body as possible. Do not allow the belt to rest against hard or fragile objects in your pockets. Do not route the belt across your neck, or run it across sharp edges. Be sure that the belt does not become caught or jammed. Avoid wearing bulky clothing and pull on the lap belt periodically to retension it over your shoulders. In the event of a frontal impact, a loose lap belt could slide over the hips, leading to abdominal injury. In addition, the safety belt's restraint effectiveness is reduced if the belt is worn loosely. Expectant mothers should always wear their safety belts, taking care to position the lap belt against the lower hips, where it will not exert pressure against the abdominal area. ◀

For information on using the safety belts, refer to page 50.

Seats

When adjusting your seat, always observe the following precautions

 Never try to adjust your seat while operating the vehicle. The seat could respond with an unexpected movement, and the ensuing loss of vehicle control could lead to an accident. Never ride with the backrest reclined to an extreme horizontal angle – important for front passengers to remember. If you do so, there is a risk that you will slide under the safety belt in an accident, thus reducing the protection provided by the safety belt. With the wind deflector in place: Do not push the front seats all the way back, otherwise the wind deflector will be damaged. ◀

Adjusting the seats

- ▷ Power seat adjustment, refer to page 47
- ▷ Head restraint, refer to page 48
- ▷ Entering the rear, refer to page 49

Power seat adjustment



Seat adjustment

- 1 Tilt angle
- 2 Forward/backward adjustment
- 3 Height
- 4 Backrest angle

You can manually adjust the thigh support.

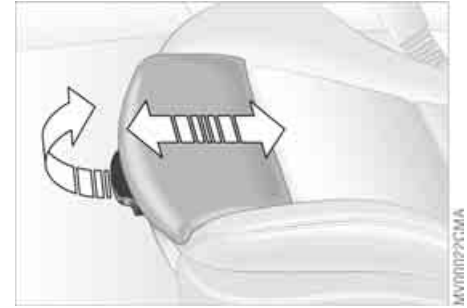

Thigh support

Pull the lever and adjust the position of the cushion for thigh support as desired.



Adjusting the lumbar support*

You can adjust the backrest's contour for additional support in the curvature of your spine's lumbar region.

The upper hips and spinal column receive supplementary support to help you maintain a relaxed, upright position.

- ▷ Increase/decrease curvature: press front/rear of the switch
- ▷ Increase the upper/lower curvature: press the upper/lower end of the switch.

Head restraints

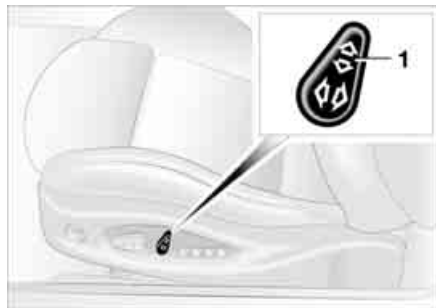

Front head restraints

1 Height

 Head restraints reduce the risk of spinal injury in the event of an accident.

Adjust the head restraint.

When moving the head restraints up or down, do not grab on between the head restraint and the upper edge of the backrest to avoid the possibility of injury. ◀

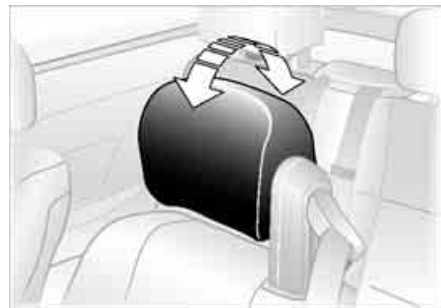

Tilt:

Position the head restraints manually in the preferred position.

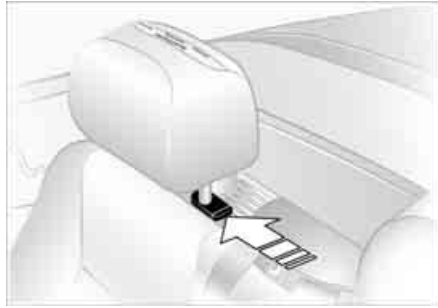

Rear head restraints

 The rear head restraints may only be lowered if there are no passengers in the rear seats. If you do so, you are in violation of the law. Raise the rear head restraints before taking on any passengers in the back. ◀

To completely lower the rear head restraints:

1. Press the button and hold it down
2. Push the head restraint down from above.

Raising the rear head restraints

Raise the head restraints until you hear them click into place.

 Do not remove the rear head restraints as this would damage them. ◀

For further information, please consult your BMW center.

 Do not use the rear head restraints as storage shelves. Always keep the travel path for the roll-over protection system free and clear. Under no circumstances should you put any kind of cover such as an antimacassar on the head restraints, refer also to the labeling on the head restraints. ◀

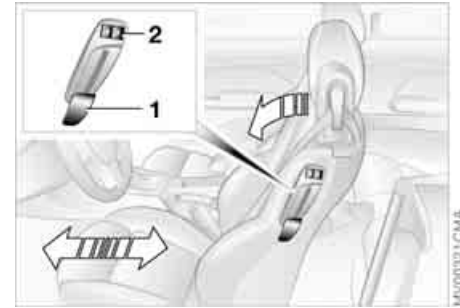

The seat-integrated safety belt system allows for easy access to the rear.

1. Lift the lever 1 up and tilt the backrest forward
2. Press and hold button 2 in driving direction until the seat moves to the desired position
3. After entering the rear, fold back and lock the backrest
4. Press button 2 opposite the direction of travel and hold. The seat moves back into its previous position. If the button 2 is released beforehand, the seat stops in the respective position.

 The seat can be locked into position when it is tilted forward. This is particularly convenient when entering the vehicle on an incline, for example. Press against the backrest until you hear it snap into place. Lever 1 does not have to be released to fold the seat back. ◀

 Lock both backrests while driving, otherwise there is a danger of an unexpected movement causing an accident. ◀

 The indicator lamp in the instrument cluster flashes when the backrest is not locked, refer to page 18.

Safety belts



Always wear your safety belt

Always fasten your safety belt before starting off. As supplemental restraint devices, the airbags are designed to enhance the effectiveness of the safety belts, and not to replace them.

 Before putting your safety belts on in the rear, take them out of the holder. ◀

 Leave the rear safety belts in the holders if they are not needed, in order to avoid unwanted movement from the safety belts at high speeds. ◀

To close

Make sure you hear the lock engage in the belt buckle.

To release

1. Press the red button in the belt buckle
2. Hold the belt
3. Guide the belt back into its reel.

Safety belt height

The front safety belt automatically adapts to your body size via the setting of the head restraint height, refer to page 48.

 If the safety belt system has been subjected to the stresses involved in an accident or otherwise damaged: have the entire safety belt mechanism replaced by your BMW center, including the safety belt tensioner. In addition, have your BMW center inspect the safety belt anchors. If a child-restraint system was in the vehicle during an accident, consult the manufacturer's instructions regarding replacement. ◀

Seat and mirror memory

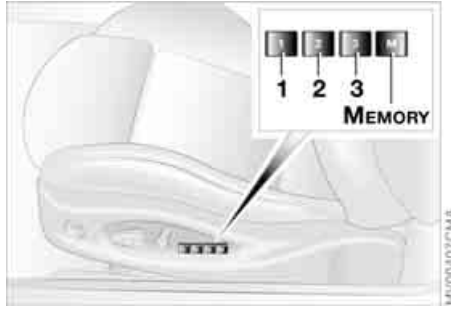

You can store and recall three different driver's seat and outside mirror positions.

▶ Memory will not retain the adjustment made to the lumbar support. ◀

To store

1. Ignition key in position 1 or 2
2. Adjust your seat and outside mirrors to the desired position
3. Press the MEMORY button: the indicator lamp in the button lights up
4. Press memory button 1, 2 or 3, as desired. The indicator lamp goes out.

To select a stored setting

⚠ Do not select a memory position while the vehicle is moving. If you do so, there is a risk of accident from unexpected seat movement. ◀

Driver's door open after unlocking or ignition key in position 1:

- ▷ Briefly press memory button 1, 2 or 3, as desired.

Movement stops immediately when one of the seat-adjustment or memory buttons is operated during the adjustment process.

With the driver's door closed and the ignition key either removed or in position 0 or 2:

- ▷ Press and hold the desired memory button – 1, 2 or 3 – until the adjustment process is completed.

If you press the MEMORY button accidentally: press the button again; the indicator lamp goes out.

👤 You can have this feature programmed so that when you use the remote control from your personalized key to unlock your door, your seat and the exterior mirrors will move into your own preferred positions. ◀

⚠ Before activating the programmed adjustment feature, ensure that the footwell behind the driver's seat is empty and unobstructed. If you fail to do so, persons, animals or objects could be injured or damaged if the seat should move backward. ◀

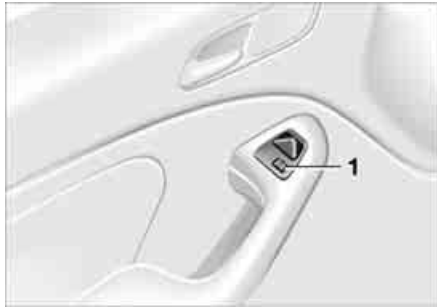

You can deactivate this automatic feature by setting the mirror selection switch to the passenger side position.

Passenger-side exterior mirror tilt function

Automatic curb monitor*

1. Move mirror selector switch 1 to the driver's mirror position
2. When shifting into Reverse, or placing the selector lever in position R, the passenger-side mirror tilts downward. This brings the lower area adjacent to the vehicle – curbs, etc. – into the driver's field of vision while parking.



How far the passenger mirror tilts can be set individually for each ignition key. ◀

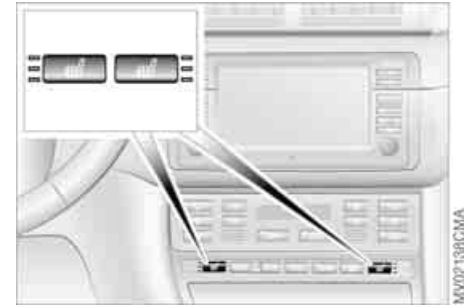

The seat cushion and backrest can be heated with the ignition key in position 2.

You can call up different heating modes by repeatedly pressing the buttons.

You can also switch the higher heating modes off directly:

Press the button and hold it slightly longer.

Steering wheel

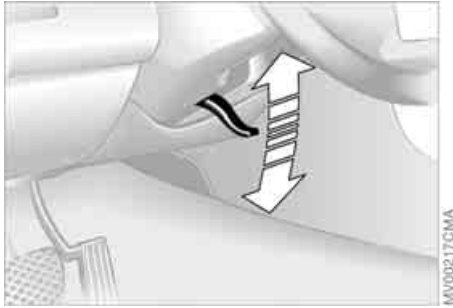

To adjust

⚠ Never attempt to adjust the steering wheel while driving the vehicle – it could respond with unexpected movement, posing a potential accident hazard. ◀

1. Push the locking lever downward
2. Adjust steering column reach and height for your selected seating position
3. Pull the lever back up.

Mirrors

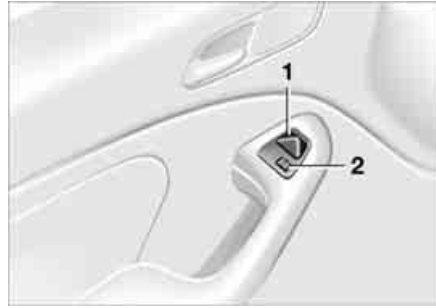

To adjust exterior mirrors

- 1 Switch for 4-way adjustment
- 2 Selection switch for changing between mirrors

To adjust manually

The mirrors can also be adjusted manually:

Press the edges of the lens.

To store the mirror setting, refer to Seat and mirror memory on page 51.

⚠ The passenger-side mirror features a convex lens. When estimating the distance between yourself and other traffic, bear in mind that the objects reflected in the mirror are closer than they appear. This means that estimations of the distance to following traffic should not be regarded as precise. ◀

Electric defrosting

Both mirrors are heated automatically in ignition key position 2.

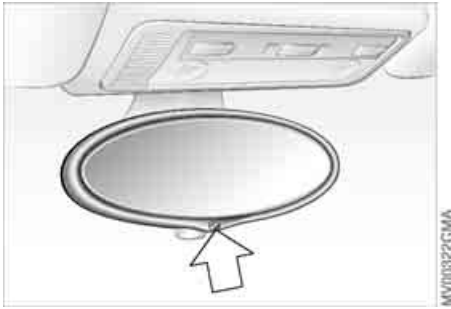

For the mirror to function perfectly, keep the photocells clean and the area between the inside rearview mirror and the windshield free of any obstruction like stickers, etc.

Interior rearview mirror with automatic dimming feature

This mirror automatically responds to ambient light and headlamp glare from following vehicles by dimming through an infinitely variable range and automatically reverts to its clear, undimmed setting whenever you shift into Reverse or move the selector lever into position R.

There are two photocells for automatic dimming. One photocell – see arrow – is positioned in the mirror's frame, while the other is slightly offset on the opposite side of the mirror.

Airbags

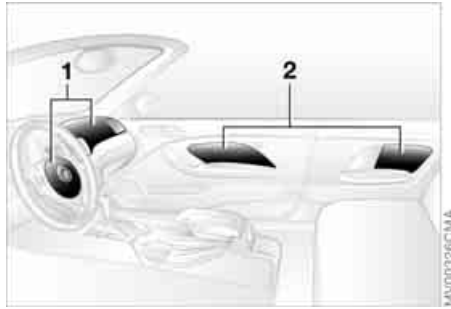

- 1 Front airbags on the driver and passenger sides
- 2 Side airbags on the driver and passenger sides – front and rear*

Protective effect

The front airbags protect the driver and passenger in the event of a head-on collision where the protection provided by the safety belt alone would not be adequate. The side airbags provide protection in the event of a collision from the side. They help support the respective seat occupant's upper body.

For information on the correct sitting position, refer to page 46.

▶ The side airbags in the rear passenger area* of your vehicle may already have been deactivated by a BMW center. You may have them activated if you desire to do so. Please contact your BMW center for additional information. ◀

▶ The airbags will not be triggered in the event of a minor accident, certain vehicle rollover situations or collisions from the rear. ◀

⚠ Do not apply adhesive materials to the cover panels of the airbags, cover them or modify them in any other way. Do not attempt to remove the airbag restraint system from the vehicle. In the event of a malfunction, deactivation or triggered activation – as a response to an accident – of the airbag restraint system, consult your BMW center for inspection, repair or disassembly. Modifications may not be made on either the wiring or the individual components in the airbag system. These include the upholstered covers on the steering wheel, instrument panel, side trim panels of the doors and front roof pillars and on the sides of the headliner. Do not attempt to remove or dismantle the steering wheel. Unprofessional attempts to service the system could lead to failure in an emergency or undesired airbag activation, either of which could result in personal injury. Do not touch the individual components directly after the system has been triggered, as otherwise there is a danger of burns. ◀



At all times, occupants should sit upright and be properly restrained – infants and small children in appropriate child-restraint systems; larger children and adults using the safety belts. Never let an occupant's head rest near or on a side airbag because the inflating airbag could cause a serious or fatal injury. Please note that the word Airbag imprinted on the door trim panel indicates the airbag's location.

Accident research shows that the safest place for children in an automobile is in the rear seat. However, a child sitting in the rear seat and not properly restrained may place his or her head on or near the side airbag, if so equipped. For example, a child – even though belted – may fall asleep with his or her head against the side airbag. It may be difficult for a driver to ensure that children in the rear seat will remain properly positioned at all times and not place their heads on or near the side airbag. Therefore, we recommend that the rear seat side airbags, if provided, be deactivated if you plan to transport children in the rear seat.

The rear seat side airbags may already have been deactivated by a BMW center. If you are uncertain of their status, or wish to have the airbags activated or

deactivated, please contact your BMW center. ◀

Even when all these guidelines are observed, there is still a small residual risk of injuries to the face, hands and arms occurring from airbag deployment in isolated instances.

In sensitive individuals, the ignition and inflation noise may induce a mild hearing loss that is temporary in most cases.

Airbag warning information is also provided on the sun visors.



This is the right way a child should sit in a child restraint when rear side airbags are provided.

Airbags



This is the right way a larger child should sit wearing the seat belt when rear side airbags are provided.

Indicator lamp



The indicator lamp indicates the operational status of the airbag system when the ignition key is in position 1 or higher.

System operational:

- ▷ The indicator lamp comes on briefly when the ignition key is turned to position 1 or higher.

System malfunction:

- ▷ Indicator lamp does not come on or
- ▷ indicator lamp lights up continuously.



If there is a system malfunction, there is a risk that the airbags will not be triggered within their normal response range, even if the level of impact would normally have triggered them. Have your BMW center inspect the airbag system immediately. ◀

 Leave the rear safety belts in the holders if they are not needed to avoid unwanted movement from the safety belts at high speeds. ◀

Commercially available child seats complying with the legal standard are designed to be secured with a seat belt or with the seat belt portion of a combination lap/shoulder belt. Improperly or inadequately installed restraint systems can increase the risk of injury to children. Always read and follow the instructions that come with the system.

Correct location for installing

In your BMW, all seats equipped with a three-point safety belt – except for the driver's seat – are suitable for installing universal child-restraint systems of all age classes and which have been approved for the age group in question.

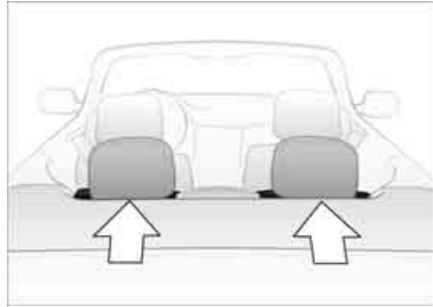

Child-restraint system with tether strap

If you use a child-restraint system with a tether strap, two additional tether anchorage points have been provided.

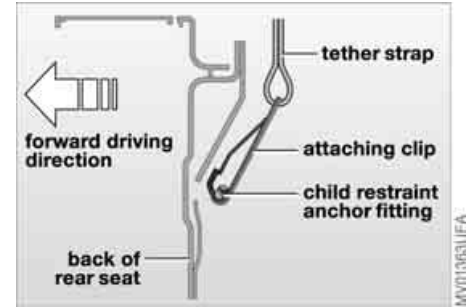

Depending on the location selected for seating in the rear passenger area, attach the tether strap to the corresponding anchorage point to secure the child-restraint system, as shown in the illustration.

1. Open the convertible top compartment lid, refer to page 39
2. Lift the headrest and pass the tether strap between the headrest and the seat back. It is recommended that you return the head restraint back to its lowest possible position
3. Adjust the tether strap according to the child-restraint manufacturer's instructions
4. Close the convertible top compartment panel.

Transporting children safely

It is recommended to cover the child-restraint attaching clip with a soft material to prevent damage to the stored soft top.

 Should a hard top be installed, the fitting of child harness tether strap/s – if child seat is required – is necessary before installation of the hard top. ◀



Before installing any child-restraint device or child seat, please read the following: Never install a rearward-facing child-restraint system in the front passenger seat of this vehicle.

Your vehicle is equipped with an airbag supplemental restraint system for the front passenger. Because the backrest on any rearward-facing child-restraint system – of the kind designed for infants under 1 year and 20 lbs/9 kg – would be within the airbag's deployment range, you should never mount such a device in the front passenger seat, as the impact of the airbag against the child restraint's backrest could lead to serious or fatal injuries.

If it is necessary for a child – not an infant – to ride in the front seat, certain precautions should be taken. First, move the passenger seat as far away from the instrument panel as possible. This important precaution is intended to maximize the distance between the airbag and the child. Older children should be tightly secured with the safety belt after they have outgrown a booster seat that is appropriate for their age, height, and weight.

Younger children should be secured in an appropriate forward-facing child-

restraint system that has first been properly secured with a safety belt. Never install a rearward-facing child-restraint system in the front passenger seat.

We strongly urge you to carefully read and comply with the instructions for installation and use provided by the child restraint's manufacturer whenever you use such a device.

Do not attempt to modify child-restraint systems. If you do this, the protection provided by these systems could be impaired.

Be sure that all occupants – of all ages – remain properly and securely restrained at all times. ◀

All rear seating positions in your vehicle meet the recommendations of SAE J1819, an industry-recommended practice for securing child-restraint systems in motor vehicles.

60 Transporting children safely



The belt cannot be extracted further. Always observe the installation instructions provided by the manufacturer of the child-restraint system.

To unlock the safety belt

Release the safety belt, remove the child seat and retract the safety belt to its end position on the belt retractor.

Securing child-restraint system

All of the rear belt retractors and the front passenger's safety belt can be locked for mounting and securing child-restraint systems.

A label with the appropriate instructions for this is located in the immediate vicinity of the buckle latch of each safety belt.

To lock the safety belt

Extract the entire length of the belt from the inertia reel mechanism. Allow the reel to retract the belt somewhat and engage the buckle, then tighten the belt against the child-restraint system. The retraction mechanism is now locked.

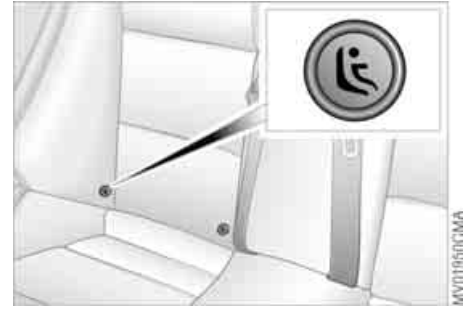

LATCH child-restraint mounting system

LATCH: Lower Anchors and Tether for Children

The left and right rear seats are both equipped with a LATCH child-restraint mounting system.

Transporting children safely

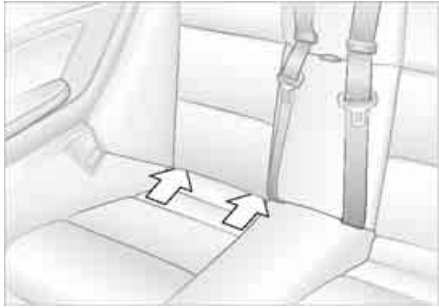

Canadian models only:

The LATCH anchorage points are identified by buttons.

The anchorage points for the LATCH child-restraint system installation are located behind the upholstery at the positions indicated by the arrows.

Carefully slide the brackets through the gaps in the upholstery at the indicated locations.

 Always follow all manufacturer's instructions and observe all safety precautions when installing the LATCH child-restraint mounting system. Leave the rear safety belts in the holders if they are not needed to avoid unwanted movement from the safety belts at high speeds. ◀

To prevent damage to the upholstery, you can purchase an insertion aid* from your BMW center.

Firmly press the insertion aid into the gap between the seat cushion and backrest, continuing until the two guides snap into place on the LATCH brackets in the seat.

The illustration is an example showing the anchorages for a LATCH child-restraint system on the right rear seat.

62 Rollover protection system

In the event of an accident or some other critical driving situation – extreme tilting in the longitudinal or transverse axis, loss of contact with the ground – the rollover protection system will be automatically activated. The protective bars located in the rear head restraints extend within fractions of a second.

In addition to the integrated rollover bar in the windshield frame, the rollover protection system affords all the vehicle occupants necessary headroom.



Always keep the travel path for the rollover protection system free and clear. Under no circumstances should you cover the head restraints. In the event of less serious accidents, the safety belt will protect you and, depending on the severity of the accident, so will the safety belt tensioner and the multi-stage airbag restraint system as well. ◀

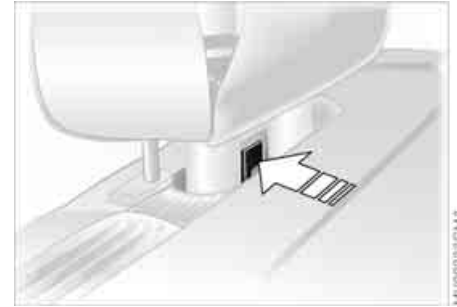

If, after being automatically triggered, the protective function is not needed, then the rollover protection system can be lowered back into place. No special tool is needed for this.

1. Using a screwdriver from the onboard tool kit, remove the cover panel; to do this, position the screwdriver under the notch

2. Push the lever toward the front of the vehicle and keep it in this position

Rollover protection system

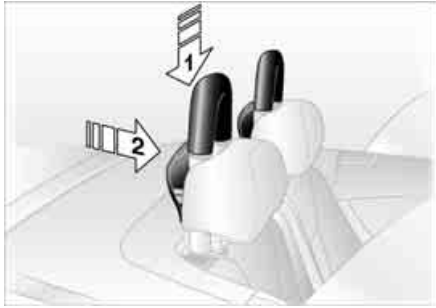

3. Keep pressing down on the protective bar from on top – see arrow 1 – until you hear it click into place
4. Put the cover panel back in place and press down firmly
5. Push the back panel of the head restraint closed – see arrow 2.

Do the same for the second protective bar. If you are not familiar with any of the procedures, consult your BMW center.

Have the rollover protection system checked out by your BMW center after it has been inadvertently triggered.



Do not move the convertible top under any circumstances if the rollover protection system has extended.

Do not use the rear head restraints as storage shelves.

Absolutely no modifications are to be made to any of the rollover protection system's individual components or any of its wiring.

Only your BMW center is to carry out any work on the rollover protection system.

Work done on the system that is carried out improperly could lead to failure in an emergency or accidental activation. Regarding having the system checked to ensure long-term operation: be scrupulous in adhering to the Service Interval Display for maintenance intervals. Every two years at the latest, the rollover protection system must be inspected by a BMW center. ◀

How the system functions

You have probably frequently wished that you could configure individual functions of your vehicles to reflect your own personal requirements. In engineering your vehicle, BMW has provided for a number of options for personal adjustment that can be programmed into your vehicle at your BMW center.

The available configuration data fall into two categories, according to whether their primary orientation is the vehicle – Vehicle Memory – or the individual – Key Memory. You can have up to four different basic settings adjusted for four different persons. The only requirement is that each person uses his or her own remote control key.

When your vehicle is unlocked with the remote control, the vehicle recognizes the individual user by means of a data exchange with the key, and makes adjustments accordingly.

**Distinguishing between keys**

In order for you to be able to distinguish between different keys, colored decals are supplied together with the keys.

What the system can do

Your BMW center can provide you with details on the possibilities that the Vehicle and Key Memory systems offer.



You will see this symbol throughout the Owner's Manual. It is to remind you at appropriate places of the settings that are available to you. ◀

Examples for Vehicle Memory:

- ▷ Various signals that can serve as acknowledgment for locking and

unlocking the vehicle, refer to page 31

- ▷ Activates/deactivates the 'Follow me home' lamps function, to page 91
- ▷ Activates/deactivates daytime driving lamps, refer to page 91
- ▷ Sets the units of measure for displaying time, outside temperature, distance traveled and fuel consumption in the instrument cluster
- ▷ When you shift into Reverse, an acoustic signal indicates that PDC has been activated, refer to page 85
- ▷ Switches on rear window defroster automatically, refer to page 99
- ▷ After giving an ice warning, the onboard computer display returns to the previous setting, refer to page 83.

Examples for Key Memory:

- ▷ Locks the vehicle automatically after you start off, refer to page 34
- ▷ Automatically moves the seat and outside mirror into position for the programmed driver when unlocking the vehicle, refer to page 51
- ▷ Automatic tilting of the passenger-side mirror, refer to Automatic curb monitor, page 52
- ▷ After the engine is started, calls up the last selected driving program for each shifting mode, refer to page 73.

Ignition lock

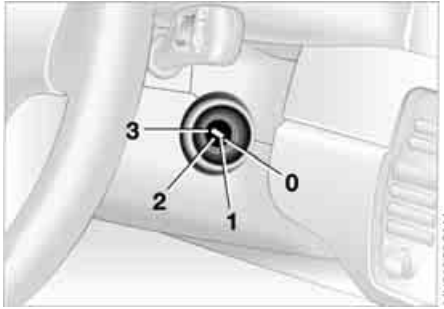

Steering unlocked

You will find that it is often easier to turn the ignition key from position 0 to position 1 when you move the steering wheel slightly to help disengage the lock.

Individual electrical accessories are ready for operation.

Ignition key positions

- 0 Steering locked
- 1 Steering unlocked
- 2 Ignition on
- 3 Start engine

Steering locked

The key can only be inserted and removed in this position.

After removing the key, turn the steering wheel slightly to the left or right until you hear the lock engage.

If the key is not removed, an acoustic signal sounds when the driver door is opened.

 Do not allow the engine to warm up by leaving it running while the vehicle remains stationary. Instead, drive off immediately at a moderate engine speed. ◀

 Do not allow the engine to run in enclosed spaces. Otherwise, breathing the exhaust fumes can lead to unconsciousness and death. The exhaust gases contain carbon monoxide, an odorless and colorless, but highly toxic gas. Do not leave the vehicle unattended with the engine running. An unattended vehicle with a running engine represents a safety hazard. ◀

If the engine does not start on the first attempt – if it is very hot or cold, for instance:

▷ Press the accelerator pedal halfway down while engaging the starter.

Cold starts at very low temperatures below about 5 °F/–15 °C and at high altitudes above 3,300 ft/1,000 m:

▷ On the first start attempt, it may be necessary to engage the starter for a longer period, but no longer than 20 seconds.

 Extended starting attempts, characterized by excessively frequent or long periods with the starter engaged, can damage the catalytic converter. ◀

 When driving, standing at idle or parking the vehicle, take care to avoid contact between the hot exhaust system and flammable materials – grass, hay, leaves, etc. Such contact could lead to a fire, resulting in serious personal injury and property damage. ◀

Manual transmission

1. Engage the parking brake
2. Gearshift lever in idling position
3. Start the engine. Do not press the accelerator pedal. Do not actuate the starter for too short a time. Do not turn it for more than approx. 20 seconds. Release the ignition key immediately when the engine starts.

Sequential M gearbox with Drivelogic

1. Depress footbrake
2. Move selector lever into position N

3. Start the engine. Do not actuate the starter for too short a time. Do not turn it for more than approx. 20 seconds. Release the ignition key immediately when the engine starts
4. Engage a driving position
5. Release footbrake and slowly depress accelerator pedal.

 With the engine running, the gear indicator in the SMG Drivelogic display flashes to indicate that a driving position is engaged with the driver's door open or if the hood is not closed properly, refer to page 71. If neither the pedals, the shift paddles, nor the selector lever are actuated, then the gearbox is automatically taken out of gear after approx. four seconds. It will then be necessary to move the selector lever back to position N before engaging the desired driving position. Driving off is not possible with the hood open. ◀

Starting the engine and driving off



Before exiting the vehicle with the engine running, move the selector lever into position N and apply the parking brake.

Never leave the vehicle unattended with the engine running. An unattended vehicle with a running engine represents a safety hazard. ◀

Engine idle speed is controlled by the engine computer system. Increased speeds at start-up are normal and should decrease as the engine warms up. If engine speed does not decrease, service is required.

To prevent the battery from discharging, always deactivate electrical devices that are not in use. Switch the ignition off when the vehicle is not being driven.

68 Switching off the engine

 You should never remove the ignition key when the vehicle is in motion, as the steering lock could engage. When you leave the vehicle, always remove the ignition key and engage the steering lock. ◀

 Always engage the parking brake when parking on downhill roads. Engaging a gear may not provide adequate resistance to rolling. ◀

Manual transmission

Turn the ignition key to position 1 or 0.

Sequential M gearbox with Drivelogic

If you turn the ignition key to position 1 or 0 with the selector lever in the forward or reverse position, a gear automatically remains engaged.

If you turn the ignition key to position 1 or 0 with the selector lever in position N, a warning tone and the flashing gear indicator in the SMG Drivelogic display remind you that no gear is engaged to secure the vehicle against rolling.

The warning stops after approx. ten seconds. If you move the selector lever into a forward or reverse position during this time, a gear is automatically engaged.

Parking brake

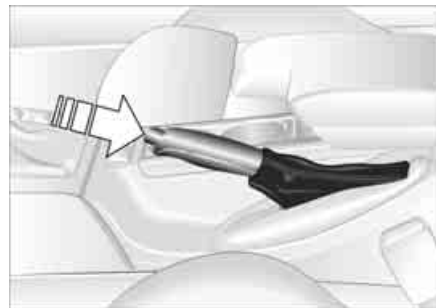

The parking brake is primarily designed to prevent the vehicle from rolling while parked. It operates on the rear wheels.

To engage

The detent engages automatically, and the indicator lamp in the instrument cluster comes on when the ignition key is in position 2, refer to page 18.

To release

Pull up slightly on the lever, press the button and lower the lever.

Parking brake

 If exceptional circumstances make it necessary to engage the parking brake while the vehicle is in motion, do not pull it with excessive pressure. Keep your thumb pressed against the release button while carefully pulling the lever up. Excessive pressure can lead to over-braking and loss of traction – fishtailing – at the rear axle. The brake lamps do not come on when the parking brake is engaged. Always engage the parking brake when parking on slopes and inclined surfaces. Engaging a gear may not provide adequate resistance to rolling, not even in first or reverse gear. ◀

 To avoid corrosion and one-sided braking, apply the parking brake lightly from time to time when coasting to a standstill – at a traffic light, for example – provided that it is safe to do so. ◀

Manual transmission



 When shifting gears in the fifth/sixth gear plane, be sure to press the gearshift lever to the right in order to prevent inadvertent selection of a gear in the third/fourth gear plane. Do not hold the vehicle in place on slopes by slipping or 'riding' the clutch. Use the parking brake instead. Riding the clutch leads to severe and premature clutch wear. ◀

Reverse

Select only when the vehicle is stationary. Press the gearshift lever to the left to overcome the slight resistance.

When you select reverse the backup lamps will light up automatically when the ignition key is in position 2.

The concept

The sequential M gearbox with Drivelogic is an automated manual gearbox with which clutching and shifting is assumed by an electro-hydraulic system.

The SMG Drivelogic is operated via two shift paddles on the steering wheel and the selector lever in the center console.

It offers the following functions:

- ▷ Sequential and automated shifting mode
- ▷ Ability to choose between different driving programs – Drivelogic
- ▷ Gradient assistance, refer to page 73
- ▷ Upshift display and shift lights, refer to page 74
- ▷ RPM matching on downshifts
- ▷ Driving dependent functions:
The respective driving situation, e.g. cornering, mountain driving or braking, is detected by sensors and taken into account for shifting, e.g. to achieve optimum gear selection during deceleration and subsequent acceleration
- ▷ Slip recognition at the rear axle for increasing driving stability, e.g. during downshifting on slippery road surfaces

▷ Operating safety through protection against misshifting.

Under normal operating conditions, fuel consumption is lowest when driving in the first driving program of the automated shifting mode.

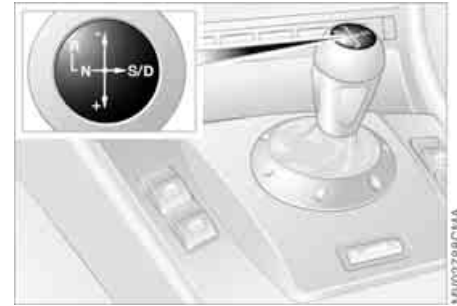

Selector lever positions

R: Reverse position

N: Neutral position

Forward position with one-touch mode:

▷ S: sequential mode

▷ D: automated mode

▷ +: upshifting in sequential mode

▷ -: downshifting in sequential mode.

The SMG Drivelogic is ready for operation from ignition key position two or higher.

For your safety, it is only possible to engage a driving position with the vehicle stopped approx. two seconds after engaging position N with the footbrake depressed – shift-lock function.

Sequential M gearbox with Drivelogic*

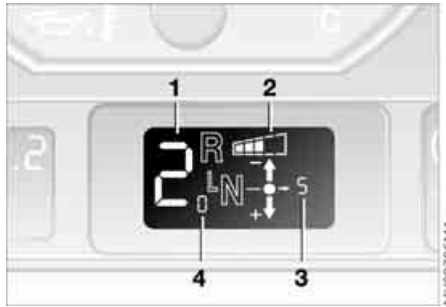

Display in instrument cluster

The selector lever position, currently engaged gear and selected driving program are displayed in the instrument cluster.

- 1 Engaged gear
- 2 Selected driving program, corresponds to the number of illuminated fields, refer to page 73
- 3 Tapping the selector lever to the right switches over into the displayed shift mode
- 4 'D' indicates an activated automated shift mode

R – Reverse position

Only engage with the vehicle stopped or at low speed, e.g. for rocking free in deep snow.

 An intermittent signal tone indicates that the reverse position has been engaged. ◀

N - Neutral

Always engage before starting the engine.

If the driving situation requires, e.g. when downshifting on slippery roads, the SMG Drivelogic automatically disengages and reengages the clutch, i.e. it is not necessary to manually engage position N.

S – Sequential mode

In the sequential mode all forward gears are to be shifted by the driver.

To switch from automated to sequential mode:

- ▷ Tap the selector lever to the right toward 'S' or
- ▷ change gears with the selector lever or the shift paddles on the steering wheel.

You do not need to reduce the throttle for shifting.



Shifting gears with shift paddles on steering wheel:

- ▷ To upshift, briefly pull the right paddle +
- ▷ To downshift, briefly pull the left paddle -.

 Shift paddles with various widths matched to the shape of your hand are available from your BMW center. ◀

Shifting gears with selector lever:

- ▷ To upshift, pull the selector lever backward in the '+' direction
- ▷ To downshift, push the selector lever in the '-' direction.

No automatic upshifting is carried out in the sequential mode.

You accelerate from higher gears, e.g. during passing, by manually downshifting.

In the following situations the SMG Drivelogic anticipates your actions in the sequential mode:

- ▷ Upshifts and downshifts are only executed at appropriate combinations of engine rpm and vehicle speed. For instance, downshifts that would result in excessive engine speed are not executed
- ▷ During a stop the gearbox is automatically downshifted into the first gear so that, e.g. before a traffic light, it is only necessary to accelerate to continue driving
- ▷ As speed diminishes, the gearbox downshifts automatically, without you taking any action, just before the vehicle slows to below each gear's minimum speed.

D - Automated mode

Each time the engine is started, the automated mode is activated as soon as you move the selector lever into the forward driving position.

In the automated mode all forward gears are shifted automatically.

To switch from sequential to automated mode: tap the selector lever to the right toward 'D'. Watch the display in the instrument cluster, refer to page 71.

For rapid acceleration, e.g. during passing, depress the accelerator pedal completely – kickdown. The gearbox now downshifts depending on the selected driving program.

Even in the automated mode, you can help specify the shifting point: if a gear-dependent minimum speed is exceeded, you can upshift by slowly reducing pressure on the accelerator pedal. In the process, the respective driving situation is detected by sensors and taken into account.



Drivelogic

Drivelogic makes various driving programs available to you.

Press the Drivelogic repeatedly until the desired driving program is shown in the SMG display of the instrument cluster, refer to page 71.

In the automated mode you can select from five driving programs ranging from convenience mode/winter operation to sporty and highly dynamic.

In the first automated driving program, starting off takes place in second gear, which is advisable under winter road conditions with ice and snow.

In the sequential mode you can choose from six driving programs ranging from balanced, dynamic driving – 1 – to sporty, puristic driving – 6. The sporty, puristic driving program can only be activated with the Dynamic Stability Control (DSC) deactivated, refer to page 86.

 To maintain vehicle stability, always drive with the DSC activated on whenever possible. ◀

Following each change between the sequential and the automated mode, the last driving program selected in the respective mode is active. Exception: instead of the last selected sequential driving program 6, program 5 is activated only after the engine has been started again.

 Your vehicle is set so that when the engine is started, the last selected driving program saved in your key is activated for each shifting mode. ◀

Gradient assistance

The gradient assistance enables starting off on grades with virtually no roll-back. It can be activated in the sequential and automated mode with the vehicle stopped and can be used for both forward and reverse driving.

 The vehicle may roll slightly before it is held by the gradient assistance after releasing the footbrake. Two seconds after the footbrake is released, the vehicle begins to roll, as it is no longer held with the gradient assistance. ◀

1. Depress footbrake with vehicle stopped
2. Activate the gradient assistance by pulling the left paddle for at least 0.5 seconds. An increase in the engine speed indicates that the gradient assistance is activated

 Briefly pulling the left paddle again deactivates the gradient assistance again. ◀

3. Release the footbrake and start off within two seconds.

The gradient assistance must be reactivated before each use.

Indicator lamp

The gearbox indicator lamp in the instrument cluster goes out after the engine is started.

- ▷ If it does not go out, or if it lights up during driving, a malfunction has occurred. The available functions may be limited under certain circumstances.

Drive carefully and with the Dynamic Stability Control (DSC) activated. Have the system checked by the nearest BMW center

- ▷ If the indicator lamp flashes while driving, the system is overloaded. Avoid high loads until the indicator lamp goes out again permanently.

**Shift lights**

To achieve the best possible vehicle acceleration with a sporty driving style in the sequential mode, shift lights in the instrument cluster indicate the optimum shifting point shortly before the maximum engine speed is reached.

1. When the maximum engine speed is approached, yellow indicator fields – shift lights – in the tachometer light up consecutively to indicate the approaching upshift time
2. Shift at the latest when the last indicator field lights up red.

Tire replacement, snow chains

Following a tire or wheel change and after mounting or removing snow chains, the slip recognition of the SMG Drivelogic must become familiar with the changed condition.

Reinitialize the system afterwards:

1. Move the selector lever into position N on a straight stretch of road at a speed of over 20 mph / 30 km/h
2. Pull both shift paddles for approx. two seconds.

If you do not carry out the initialization, the system automatically learns the changed condition gradually during driving. This can become apparent due to brief opening and closing of the clutch.

Turn signal indicator/Headlamp flasher

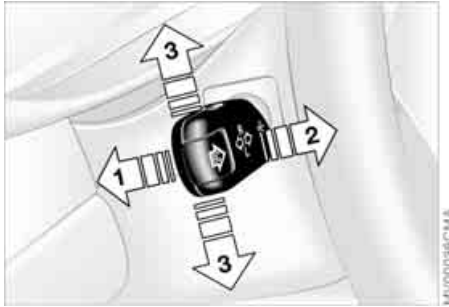

- 1 High beams – blue indicator lamp
- 2 Headlamp flasher – blue indicator lamp
- 3 Turn signal indicator – green indicator lamps accompanied by a periodic clicking sound from the relay

To signal briefly

Press the lever up to but not beyond the detent. It then returns to the center position when released.



If the flashing indicator lamp and the clicking from the relay are both faster than normal, one of the turn signal indicators has failed. ◀



- 0 Wipers retracted
- 1 Intermittent mode or rain sensor
- 2 Normal wipe
- 3 Fast wipe
- 4 Brief wipe
- 5 Rotary dial for control of the wipe interval or the sensitivity of the rain sensor

Intermittent mode

Not on vehicles with rain sensor.

You can select any of four sweep intervals with rotary dial 5. In addition, the wipe interval varies automatically depending on road speed.

Rain sensor

The rain sensor is located on the windshield directly behind the rearview mirror.

To activate the rain sensor:

- ▷ With the ignition key in position 1 or higher, move the lever to position 1. The wipers travel once across the windshield, regardless of the weather
- ▷ You can leave the lever in position 1 at all times. With the ignition key in position 1 or higher, all you then need to do to activate the rain sensor Activate by briefly turning rotary dial 5.

To adjust the sensitivity of the rain sensor: turn rotary dial 5.

To switch off the rain sensor: put lever in position 0.



Turn the rain sensor off in automatic car washes. Failure to do so could result in damage caused by undesired wiper activation. ◀

Normal wiper speed

When the vehicle is stationary, the wipers switch automatically to intermittent wipe – not on vehicles with rain sensor.

Fast wiper speed

When the vehicle is stationary, the wipers operate at normal speed – not on vehicles with rain sensor.



0 Wipers retracted

1 Clean windshield and headlamps

Clean windshield and headlamps*

 Do not use the washers if there is any danger that the fluid will freeze on the windshield, as your vision could be obscured. Always use a windshield washer antifreeze in cold weather. Refer to page 126.

Do not use the washers when the reservoir is empty. This could cause damage to the washer pump. ◀

The system sprays washer fluid against the windshield and activates the wipers for a brief period.

When the vehicle's lighting system is switched on, the headlamps will also be cleaned at reasonable intervals.

Windshield washer nozzles

The windshield washer jets are warmed automatically when the ignition key is in position 2.

You can store and automatically maintain any desired vehicle speed above approx. 20 mph / 30 km/h.

The cruise control is available whenever the engine is running and the system has been activated.

To activate the system

I/O

In ignition key position 2:

Press the button in the steering wheel. The indicator lamp in the instrument cluster comes on, refer to page 20. You can now use the cruise control.

 Do not use cruise control on twisting roads, when high traffic density prevents driving at a constant speed, or when the road surface is slick – snow, rain, ice – or loose – rocks or gravel, sand. ◀

To deactivate the system

I/O

Press the button as often as needed until the indicator lamp in the instrument cluster goes out.

Cruise control is also deactivated when the ignition key is in position 0.

The speed stored in memory is deleted.

To store and maintain speed or to accelerate



Press button + briefly:

The system maintains and stores the current vehicle speed. Every time you tap the button, the speed increases by approx. 0.6 mph / 1 km/h.

Press and hold button +:

The vehicle accelerates without pressure on the accelerator pedal. When you release the button, the system maintains and stores the current speed.

 If on a downhill gradient the engine braking effect is not sufficient, the controlled speed can be exceeded. Speed can drop on uphill grades if the engine output is insufficient. ◀

To decelerate



Press button – briefly:

If you are already driving with activated cruise control, the speed is decreased by approx. 0.6 mph / 1 km/h every time you tap the button.

Press and hold button –:

With the cruise control active, the system automatically reduces the throttle opening to slow the vehicle. When you release the button, the system maintains and stores the current speed.

To interrupt the cruise control



When the system is activated, press the button. The indicator lamp stays on. You can use the cruise control again whenever you want by calling up the speed that was stored last.

In addition, cruise control is interrupted automatically:

- ▷ When the brakes are applied
- ▷ When pressing down the clutch pedal
- ▷ If you exceed or fall below the programmed speed for an extended

period – by depressing the accelerator, for example

- ▷ Sequential M gearbox with Drivelogic 70: when shifting in the sequential mode, refer to page:.

To recall the stored setting



Press the button:

The vehicle accelerates to and maintains the last speed stored.

Odometer



- 1 Odometer
- 2 Trip odometer

Odometer

You can activate the displays shown in the illustration with the ignition key in position 0 by pressing the left button in the instrument cluster.

Trip odometer

To reset the trip odometer to zero, press the left button with the ignition key in position 1 or higher.

Tachometer



Variable pre-warning zone

The yellow pre-warning zone displays current permissible engine speeds, depending on the engine temperature. As the engine temperature climbs, some of the sectors for this pre-warning zones will go out one after the other.

Avoid engine speeds in the early warning zone if possible.

Never allow the engine to operate with the needle in the red overspeed zone of the gauge.

To protect the engine, the fuel supply is interrupted when you approach this sector.

Engine oil temperature

79



The general operating temperature lies between 175 °F/80 °C and 250 °F/120 °C. During high-performance driving, do not exceed a maximum value of 300 °F/150 °C.



Once the indicator lamp stays on continuously, there are still approx. 2 gallons/8 liters of fuel in the fuel tank. Fuel tank capacity approx. 16.6 gal./63 liters.

If the tilt of the vehicle varies – when you are driving in mountainous areas, for example – the needle may fluctuate slightly.

 Fill the fuel tank before it is completely empty. Driving to the last drop of fuel can prevent the engine from operating properly and result in damage. ◀

When you switch on the ignition, the indicator lamp lights up briefly as an operation check.

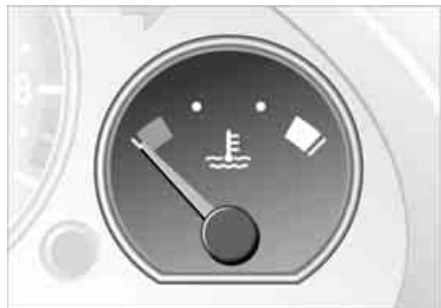

To check the coolant level, refer to page 128.

Blue

The engine is still cold. Drive at moderate engine and vehicle speeds.

Between the blue and red zones

Normal operating range. The needle may rise as far as the edge of the red sector during normal operation.

Red

When you switch on the ignition, the warning lamp comes on briefly as an operation check.

If the lamp comes on while operating the vehicle: the engine has overheated. Switch off the engine immediately and allow it to cool down.

Service interval display



A flashing message and a '-' in front of the number mean that the service interval has already been exceeded by the distance shown on the display. Please contact your BMW center for an appointment.

Remaining distance to next service

The displays shown in the illustration appear for a few seconds when the ignition key is in position 1 or higher or after the engine is started.

The next service due appears with the message OIL SERVICE or INSPECTION, together with the distance remaining in miles – in kilometers in Canada – before the next scheduled service.

The computer bases its calculations of the remaining distance on the preceding driving style.

Check Control

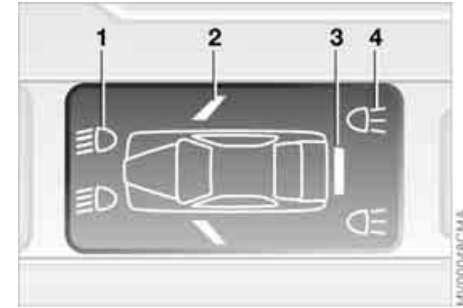

Display

When the ignition key is in position 2, the following information and/or conditions are indicated using symbols until the conditions have been corrected.

- 1 Inspect the low-beam and high-beam headlamps, as well as the parking lamps
- 2 Door open
- 3 Luggage compartment lid open
- 4 Check brake and tail lamps

When you open the driver's door after having turned the ignition key to position 0, you will hear an acoustic signal for a few seconds to remind you that the lamps have not been switched off.

82 Clock

If you wish to have a permanent time display, you can make this adjustment in the car radio display, refer to the Owner's Manual for Radio.

You can set the time of day, and the display for the car radio, as follows.



Every time you press the button, the clock display alternates between the 12-hour and 24-hour mode.

In ignition key position 0: the time is displayed for a few seconds after you press the left button, refer to Odometer on page 79.

Setting



Before the clock can be set, the time must be showing in the instrument cluster display. ◀

With the ignition key in position 1 or higher

To set ahead: turn the right button to the right.

To set back: turn the right button to the left.

The adjustment speed will increase the longer you continue to hold the right button.

To change the display mode: press the right button briefly.

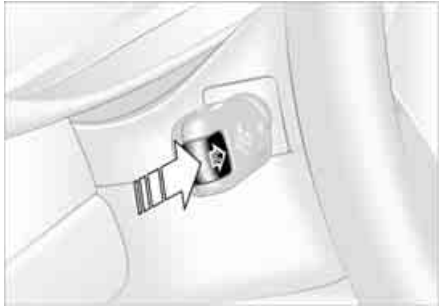

Mode selection

With the ignition key in position 1 and higher, you can use the button in the turn signal lever to retrieve information from the computer for display in the instrument cluster. Each time you press the button briefly in the direction of the steering column, a new function is called up in the display.

The displays appear in the following order:

Time of day, outside temperature, average fuel consumption, cruising range, average vehicle speed.

When the ignition key is in position 1 or higher, the last active setting is displayed.

Outside temperature

You can change the units of measure – °C/°F – for the outside temperature display by pressing the right-hand reset button in the instrument cluster while the temperature display is active. The units of measure – °C/°F – in the temperature display of the automatic climate control change automatically, refer to page 96.

Ice warning

If the outside temperature drops to about 37.5 °F/+3 °C, then the computer will automatically switch to a display of the outside temperature. In addition, a signal sounds as a warning and the display flashes for a brief period.



After giving an ice warning, the display returns to the previous setting. ◀



The ice warning does not alter the fact that surface ice can form at temperatures above 37.5 °F/+3 °C, on bridges or shaded road surfaces, for instance. ◀



Average fuel consumption

If you continue to press and hold the button on the turn signal lever, the average fuel consumption being displayed is recalculated from that point.



If you wish, you can have the average fuel consumption displayed in a different unit of measure. ◀

Range

The computer bases its calculations of the cruising range on the preceding driving style and on the remaining fuel in the tank.



It is important that you refuel when the cruising range falls below approx. 35 miles/50 kilometers. Otherwise, the engine cannot be guaranteed to operate properly and damage may result. ◀

Average speed

If you continue to hold the button on the turn signal lever, the average speed being displayed is recalculated from that point in time.

Any time spent when the vehicle is stationary and the engine is shut off is ignored for the calculation.

Park Distance Control (PDC)*

The concept

PDC assists you when you back into a parking space. Acoustic signals alert you to the momentary distance to an object behind your vehicle. To do this, four ultrasonic sensors in the rear bumper measure the distance to the nearest object. The range for the sensors located at both rear corners ends approx. 2 ft/60 cm behind the bumpers. The range for the two middle sensors is slightly less than 5 ft/1.50 m.

 PDC is a parking aid that can identify objects if they are approached slowly, as is generally the case when parking. Avoid driving towards objects rapidly; due to underlying physical principles, the system may otherwise alert you too late for you to take evasive steps. ◀

The system starts to operate automatically approx. one second after you shift into Reverse or move the selector lever into the R position with the ignition key in position 2.

 Let this short period elapse before driving backwards. ◀

PDC is deactivated when you shift back out of Reverse.



You can have a signal set to confirm that the PDC has been activated. The signal then sounds when you shift into Reverse or move the selector lever into the R position. ◀

Acoustic signals

The distance to the nearest object is indicated by a tone sounding at various intervals. As the distance between vehicle and object decreases, the intervals between the tones become shorter. A continuous tone indicates the presence of an object less than 1 ft/30 cm away.

The warning signal is canceled after approx. three seconds if the distance to the object remains constant during this time – if you are moving parallel to a wall, for instance.

System malfunctions will be indicated by a continuous high-pitched tone when the system is activated the first time. Please have your BMW center resolve the problem.



PDC does not remove the driver's personal responsibility for evaluating the distance between the vehicle and any objects. Even when sensors are involved, there is a blind spot in which objects cannot be detected. This applies especially in those cases where the system approaches the physical limits of ultrasonic measurement, as occurs with tow bars and trailer couplings, and in the vicinity of thin or wedge-shaped objects. Moreover, low objects that have already been detected – such as a curb edge – can disappear out of the detection range of the sensors before a continuous tone sounds.

Loud sources of sound from outside or inside the vehicle could drown out the PDC signal tone. ◀



Keep the sensors clean and free of ice or snow in order to ensure that they will continue to operate effectively.

Do not apply high pressure spray to the sensors for a prolonged period of time. Always maintain a distance of more than 4 in/10 cm. ◀

The concept

DSC maintains vehicle stability, even in critical driving situations.

The system optimizes vehicle stability during acceleration and when starting from a full stop, as well as optimizing traction. In addition, it recognizes unstable vehicle conditions, such as understeering or oversteering, and, within physically feasible limits, helps keeping the vehicle on a steady course by reducing the engine speed and brake applications to the individual wheels.

The system starts up automatically each time you start the engine.



The laws of physics cannot be repealed, even with DSC. The results of driving irresponsibly rest with the driver. We therefore urge you to avoid using the additional safety margin of the system as an excuse for taking risks. Do not make any modifications to the DSC system. Allow only authorized technicians to perform service procedures on the DSC.

At first, you may need some time to become accustomed to this system's intervention. However, it guarantees optimum drive force and at the same time, the best possible vehicle stability. ◀

Indicator lamp



The indicator lamp in the instrument cluster will go out shortly after the ignition has been switched on, refer to page 19.

- ▷ Indicator lamp flashes: the system is active and is controlling the drive torque based on driving conditions
- ▷ If the indicator lamp fails to go out after the engine has been started, or if it comes on during normal driving and stays on: the system has been

deactivated via the button or is defective.

Please consult your BMW center for repairs.

You can continue to drive the vehicle normally without DSC.

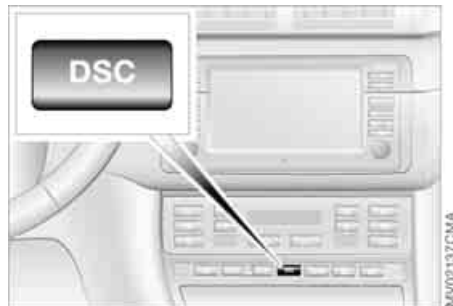

To reactivate the system

Press the button again; the indicator lamp goes out.

To deactivate the system

Press the button; the indicator lamp comes on and stays on.

The vehicle does not execute the stability-enhancement and traction-control functions when DSC is deactivated.

We recommend that you deactivate the system for increased traction:

- ▷ When rocking the vehicle or starting off in deep snow or on loose surfaces
- ▷ When driving with snow chains
- ▷ When driving on snow-covered grades, in deep snow, or on a snow-covered surface that has been packed down from being driven on.

 To maintain vehicle stability, always drive with the system switched on whenever possible. ◀

The concept

As you drive, the Flat Tire Monitor keeps track of pressure levels in all four tires. The system alerts you whenever the inflation pressure of a tire falls significantly below the pressure of another tire.

Controlling the tire pressure is based on monitoring the rpm that the tires have relative to each other. A flat tire is detected and reported because the rpm suddenly deviate drastically from one another.

Functional requirements

In order for the Flat Tire Monitor to learn the correct tire inflation pressure, please do the following:

1. Check the tire inflation pressures in all tires
2. Compare them with the tire inflation pressure table on page 25 and correct them, if necessary
3. Initialize the system.

System limitations

 The Flat Tire Monitor cannot provide you with advance warning of sudden and severe tire damage caused by external factors and does not detect the balanced and very gradual pressure loss that takes place in all four tires over an extended period of time. ◀

On the other hand, the following situations can lead to a delayed detection of pressure loss and even to the system not functioning:

- ▷ Driving on snow-covered or slippery roads
- ▷ Performance-oriented driving: slip at the drive wheels, high levels of lateral acceleration
- ▷ When driving with snow chains, false warnings and undetected pressure losses may occur.

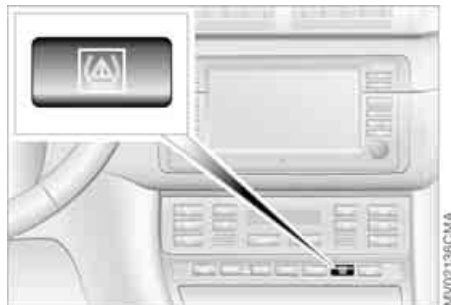

 When driving with snow chains, do not initialize the system. ◀

Initializing the system

 Each time you correct the pressure in a tire, or change a wheel or tire, reinitialize the system immediately afterwards. This requires a bit of driving. ◀

1. Before driving off, start the engine but do not start driving
2. Press the button as long as you need to until the yellow indicator lamp in the instrument cluster lights up for a few seconds
3. Drive off.

It takes a few minutes before the Flat Tire Monitor can detect a flat tire and issue a warning.

Flat Tire Monitor

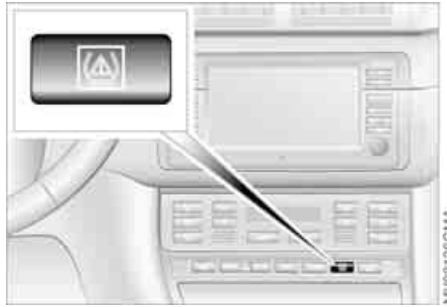

To activate/deactivate the system

The system is automatically activated in ignition key position 2 and consequently is on whenever the vehicle is operated.

To deactivate the system: tap the button; the indicator lamp will light up yellow.

To activate the system: tap the button again; the indicator lamp goes out.

Deactivate the system when snow chains are mounted, since false warnings and undetected losses in pressure are possible under these kinds of conditions.

Flat tire



The indicator lamp in the instrument cluster lights up red. In addition, an acoustic signal is sounded.

1. Carefully reduce speed and come to a stop. Avoid sudden braking and steering maneuvers
2. Determine which wheel is damaged



If this cannot be determined, contact your BMW center. ◀

3. Fix the flat tire using the M Mobility system, refer to page 140.

After replacing the damaged tire, initialize the system.

System malfunction



The indicator lamp in the instrument cluster lights up yellow. The Flat Tire Monitor is malfunctioning or out of order. Please contact your BMW center.



The Sport mode is deactivated every time the engine is started.

The system – Sport mode – will cause the engine to respond more spontaneously to any motion of the accelerator pedal.

Activating/deactivating Sport mode

Activating: with the ignition key in position 2, press the SPORT button. The indicator lamp will come on.



When the system is activated, the vehicle may gain speed without any additional pressure on the accelerator pedal. ◀

Deactivating: press the SPORT button again; the indicator lamp will go out.

Brake force display

The brake force display indicates to the driver of the vehicle behind you how hard you are braking your vehicle.

The display has two levels:

- ▷ Normal braking: the brake lamps among the rear lamps and the center brake lamp light up
- ▷ Hard braking or use of ABS: the tail lamps light up with the same brightness as the brake lamps and thereby intensify the visual effect of the brake lamps.

Parking lamps/Low beams

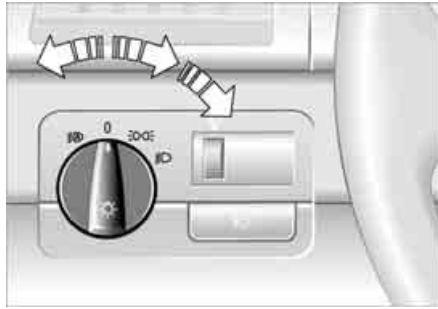

Parking lamps

 The front, rear and side vehicle lighting is switched on. You can use this to signal the position of the vehicle when it is parked. For lighting on one side for parking as an additional feature, refer to page 92.

Low beams

 When you switch the ignition off with the low-beam headlamps on, only the parking lamps will remain on.

Follow me home lamps

When you activate the headlamp flasher after parking the vehicle and switching off the lights, the low beams will come on for a brief period.

 You can also have this function deactivated. ◀

LIGHTS ON warning

Whenever you open the driver's door after having turned the ignition key to position 0, you will hear an acoustic signal for a few seconds to remind you that the lamps have not been switched off.

Daytime driving lamps*

If you desire, the light switch can be left in the low-beam position: when the ignition is switched off, the external lighting is also switched off.

Observe the legal regulations regarding the use of daytime driving lamps.

When required, switch on the parking lamps as usual as described under Parking lamps.

 You can have the activation settings for the daytime driving lamps programmed on your vehicle. ◀

Automatic headlamp control*

 When the switch is in this position, the system automatically responds to changes in ambient light – in tunnels, at dusk, etc. – and to rain and snow by switching the low beams on or off.

 The vehicle's external lamps remain on constantly when you switch on the front fog lamps after the headlamps have come on automatically. ◀

 Automatic headlamp control cannot serve as a substitute for your personal judgement in determining when the lamps should be switched on. For example, the sensors are not able to detect fog. In such situations switch on the lamp manually, as otherwise a safety hazard will result. ◀

 You can have the sensitivity of your vehicle's automatic headlamp control adjusted. ◀

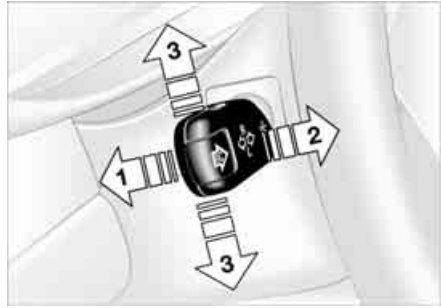
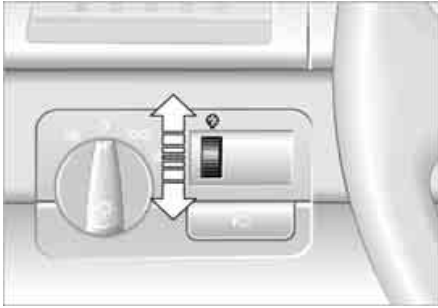

Turn the rotary dial to control the lighting when the parking or low beam lamps are on.

- 1 High beams – blue indicator lamp
- 2 Headlamp flasher – blue indicator lamp
- 3 Standing lamps

Standing lamps, left or right

As an additional feature, you can illuminate your vehicle on either side for parking, if you wish to do so:

With the ignition key in position 0, push the lever in the appropriate direction. The lever engages in the turn signal position.



Front fog lamps



The green indicator lamp in the instrument cluster lights up to indicate that the front fog lamps are on.



If the automatic headlamp control is on, the low beams will come on automatically whenever you activate the front fog lamps. ◀

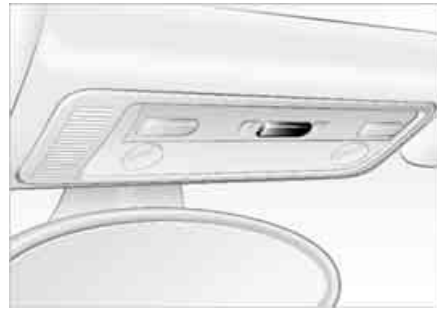

The interior lamps operate automatically.

To switch the interior lamps on and off manually

Press the button briefly.

If you want the interior lamps to remain off all the time, press and hold the button for approx. three seconds.

Press the button briefly to revert to normal operation.



Front reading lamps

Switch on and off with the button adjacent to each lamp.



Rear reading lamps

With the hardtop reading lamps are also located in the rear, refer to page 115. Switch on and off with the button adjacent to each lamp.

 In order to prevent battery discharge, all of the lamps in the vehicle are automatically switched off approx. 15 minutes after you turn the ignition key to position 0. ◀

Light-emitting diodes

Light-emitting diodes (LEDs) installed behind translucent lenses serve as the light sources for many of the controls and displays in your vehicle. These light-emitting diodes are related to conventional lasers, and legislation defines them as light-emitting diodes, Class 1.

 Do not remove the protective lens and avoid staring directly at the unfiltered beam for several hours, as inflammation of the retina could result. ◀

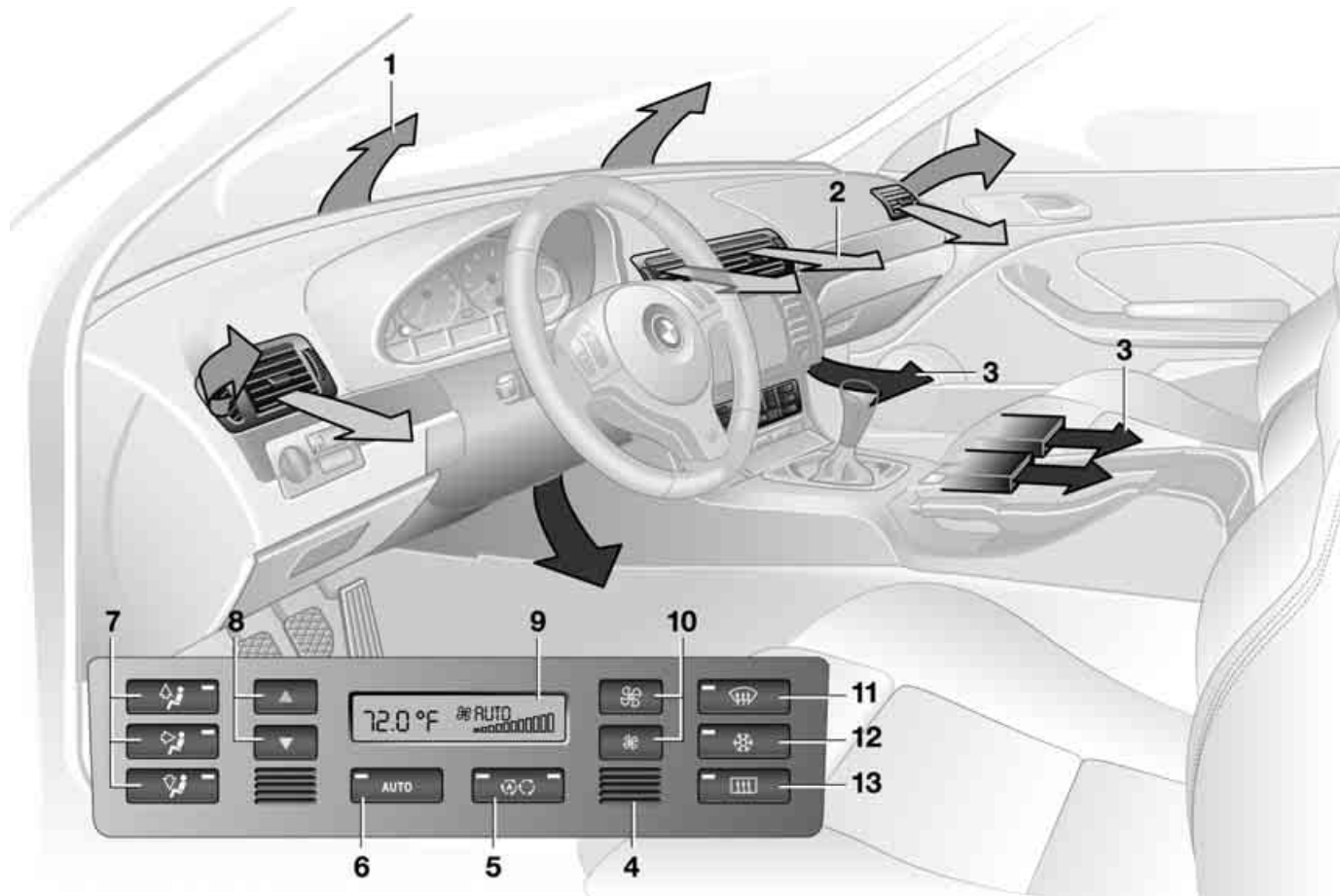

Automatic climate control

- 1 Air onto the windshield and the side windows
- 2 Air for the upper body area [99](#)
- 3 Air to the footwell
- 4 Interior temperature sensor – please keep clear and unobstructed
- 5 Outside air/Automatic recirculated-air control (AUC)/Recirculated air [99](#)
- 6 Automatic air distribution and supply [98](#)
- 7 Individual air distribution [98](#)
- 8 Temperature [98](#)
- 9 Display for temperature and air supply [98](#)
- 10 Air supply/Blower [98](#)
- 11 To defrost windows and remove condensation [98](#)
- 12 Air conditioning [98](#)
- 13 Rear window defroster [99](#)

Tips for pleasant driving

Use the automatic mode – switch on with AUTO button 6. Select the desired interior temperature.

Detailed setting options are described for you in the following sections.





You can make the settings of your vehicle in such a manner that, when you unlock the vehicle with the remote control of your personal key, your own personalized setting for the automatic climate control is initiated. ◀

Automatic air distribution and supply

The AUTO program adjusts the air distribution and the air supply for you and in addition adapts the temperature to external influences – summer, winter – to meet preferences you can specify.

Individual air distribution

You can cancel the AUTO program by selecting specific distribution patterns to suit your own individual requirements. While the AUTO program is then deactivated, the automatic airflow control remains in operation. Air flows onto

the windows , toward the upper body , and into the footwell . You can reactivate the automatic air supply by pressing the AUTO button.

Temperature

The interior temperature that appears in the display panel is a general figure intended for reference purposes. We recommend 72 °F / +22 °C as a comfortable setting, even if the air conditioning is on. When you start the vehicle, the system ensures that the selected temperature is reached as quickly as possible. It then maintains this temperature, regardless of the season.

To select the units of measure °C/°F of the display, refer to page 83.

Air supply/Blower

By pressing the upper or lower button, you can vary the air supply. This deactivates the automatic air supply – the AUTO display disappears from the panel. Nevertheless, the automatic air distribution remains unchanged. You can reactivate the automatic air supply by pressing the AUTO button.

When the lowest blower speed is set and you press the lower button, all of the displays are canceled: the blower, heating and air conditioner are switched off, and the air supply is stopped. You can reactivate the system by pressing any button for the automatic climate control.

To defrost windows and remove condensation

This program quickly removes ice and condensation from the windshield and the side windows.

Air conditioning

The air is cooled and dehumidified and – depending on the temperature setting – rewarmed.

Depending on the weather, the windshield may fog over briefly when the engine is started. Air conditioning helps prevent the windows from fogging up.



Condensation forms during operation of the air conditioning system, which then exits under the vehicle. Traces of condensed water of this kind are thus normal. ◀

Automatic climate control

Outside air/Automatic recirculated-air control (AUC)/ Recirculated air



You can respond to unpleasant external odors or pollutants by temporarily stopping the flow of outside air. The system then recirculates the air currently within the vehicle.

By repeatedly pressing the button, you can select one of three different operating modes.

- ▷ Indicator lamps off: outside air always flowing into the vehicle
- ▷ Left-hand indicator lamp on – automatic mode: the system detects pollutants in the outside air and responds by deactivating the outside airflow as required. The system then recirculates the air currently within the vehicle. Depending on air quality requirements, the system automatically switches between outside air supply and recirculation of the air already within the vehicle
- ▷ Right-hand indicator lamp on: the flow of outside air is permanently blocked. The system recirculates the air already within the vehicle.



If the windows fog over in the recirculated-air mode, switch the recirculated-air mode off and increase the air supply as required. ◀

Rear window defroster



With the convertible top closed or with the hardtop* mounted, press the button. The indicator lamp remains on. The rear window defroster switches off automatically.



You can have your vehicle programmed in such a way that the rear window defroster switches on automatically. This occurs within 5 minutes after starting the engine when outside temperatures are below approx. 39 °F / +4 °C. ◀

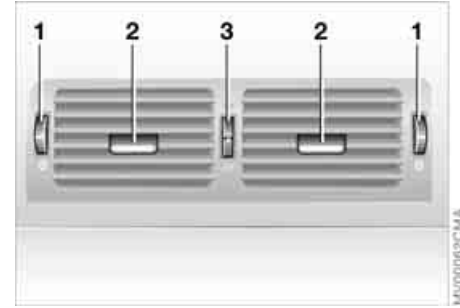

Draft-free ventilation

You can adjust the blower controls for the upper body area to obtain the optimum airflow rates and directions for your personal requirements:

- 1 Rotary dials for opening and closing the vents at any setting desired
- 2 Lever for adjusting airflow direction
- 3 With the rotary dial you can adjust the temperature of the outgoing air:
 - ▷ Turn toward blue – colder
 - ▷ Turn toward red – warmer

Microfilter, activated-charcoal filter

The built-in microfilter removes dust and pollen from the incoming air. The activated-charcoal filter provides additional protection by filtering gaseous pollutants from the outside air. Your BMW center will replace the combined filter as a standard part of your scheduled maintenance. A substantial reduction in airflow indicates that the filter needs to be replaced early.

Glove compartment

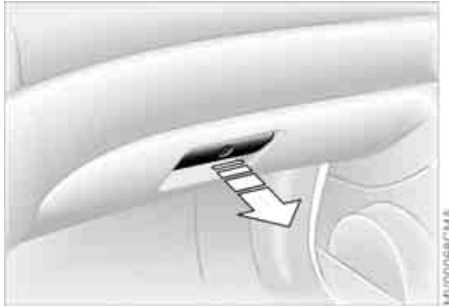

▶ If – for example for valet parking – you turn over only your spare key, refer to page 30, then access to the glove compartment and luggage compartment is not possible. ◀

To open

Pull the handle. The glove compartment will light up.

To close

Fold up cover.



To prevent injury in the event of an accident, close the glove compartment immediately after use. ◀

To lock

Lock with one of the master keys. A master key can also be used for unlocking.

Storage compartments 101

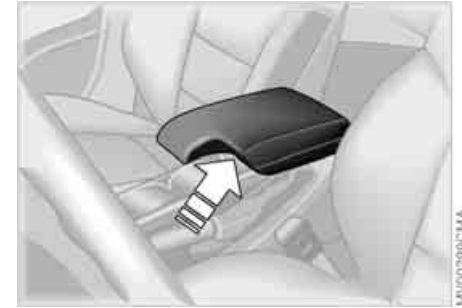

Front center armrest*

To open: press the button and fold up.

Additional compartments and nets

You will find additional storage areas in the doors and in the center console above the ashtray. Storage nets are located on the backrests of the front seats.

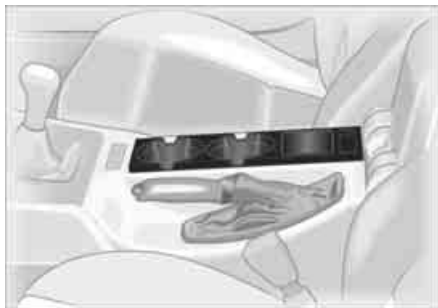

Beverage holders, coin box

A coin box and two beverage holders are provided in the center console.



Storage package*

The following are available for your convenience:

- ▷ Two flip-out power sockets on the rear center console
- ▷ An eyeglasses storage compartment*, not shown, in the center console.



Hands-free system

In vehicles equipped with telephone preparation* or with the communications package*, the cover for the hands-free microphone is located above the interior rearview mirror on the driver side.

For further information on using your cellular phone, refer to the separate Owner's Manual for the telephone.

Ashtray, front*



Press lighter 1 in. As soon as the lighter jumps back out, it can be removed.

Cigarette lighter socket

It can be used for attaching power supplies for flashlights, car vacuum cleaners and other similar appliances up to a rating of approx. 200 watts at 12 volts. Avoid damaging the socket due to inserting plugs of different shapes or sizes.

To empty

Press on the edge of the open cover. you can now pull the ashtray upward for removal.

Extinguishing cigarettes

Tap off the ash and gently press the tip into the funnel.

Cigarette lighter



Hold or touch the hot cigarette lighter by the knob only. Holding or touching it in other areas could result in burns.

The cigarette lighter remains operational when the ignition key has been removed. For this reason, children should never be left in the vehicle unattended. ◀

Ashtray, rear*

103

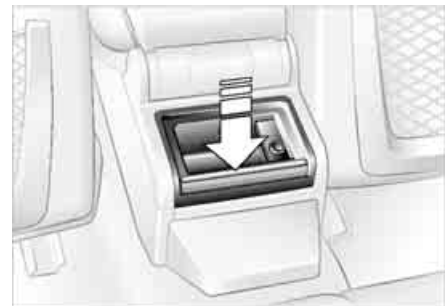

To empty

Press on the edge of the open cover in the opening direction: you can now pull the ashtray upward for removal.

104 Ski bag*

The ski bag allows the safe and clean transport of up to 3 pairs of standard skis or up to two snowboards.

The length of the ski bag and the additional space provided in the luggage compartment make it possible to carry skis up to 6 ft 10 in / 2.10 m long.

Because of the tapered shape of the bag, only two pairs of skis longer than 6 ft 10 in / 2.10 m can be carried.

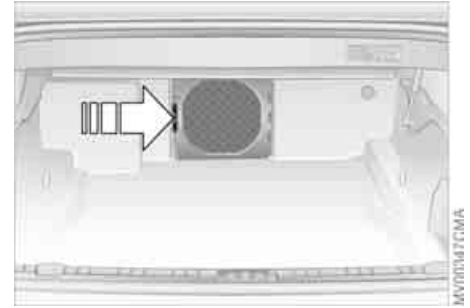
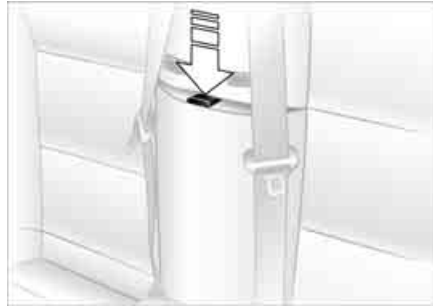

Loading

1. Release the safety belts from their holders
2. Press lever downward and remove the center piece by pulling it forward
3. Extend the ski bag between the front seats. The zipper provides convenient access to stored items. It may be opened to allow the ski bag to dry
4. Press the button in the luggage compartment



5. Secure the cover panel with the magnetic retainer on the rear wall and pull out the ski bag.

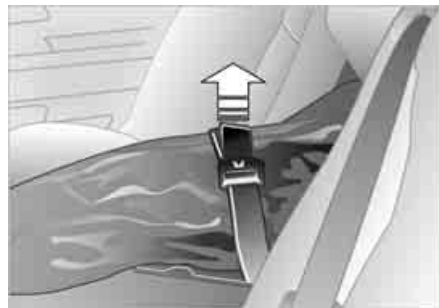

Securing cargo

 Secure skis and any other objects stored in the bag by tightening the retaining strap at the buckle. ◀

 Please be sure that the skis are clean before loading them into the bag. Be careful to avoid damage from sharp edges. ◀

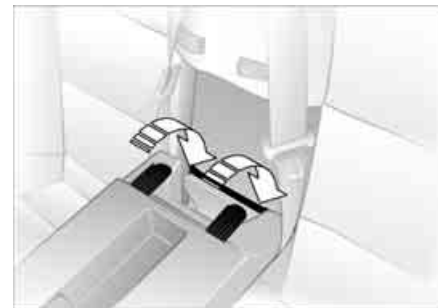

Storing the ski bag

To store the ski bag, perform the above steps in reverse sequence.

 When reattaching the center piece, guide both bars into the guide and press the center piece back into place. Secure the safety belts in their holders again. ◀



Avoid overloading the vehicle so that the permitted load on the tires is not exceeded. Overloading can lead to overheating and internal tire damage. This can result in a sudden loss of tire inflation pressure. ◀

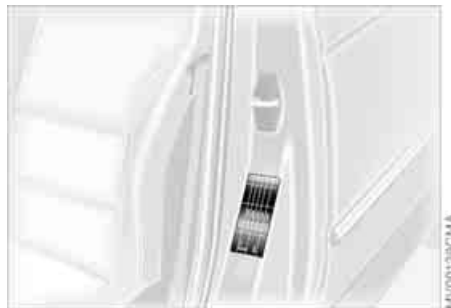

Determining the maximum load

1. Locate the following statement on your vehicle's placard*:



The combined weight of occupants and cargo should never exceed XXX kg or YYY lbs., as this could otherwise result in damage to the vehicle or unstable driving conditions. ◀

2. Determine the combined weight of the driver and passengers that will be riding in your vehicle
3. Subtract the combined weight of the driver and passengers from XXX kilograms or YYY pounds

4. The resulting figure equals the available amount of cargo and luggage load capacity.

For example, if the XXX amount equals 1,400 lbs. and there will be five 150 lbs. passengers in your vehicle, the amount of available cargo and luggage load capacity is 650 lbs.:

1,400 lbs. minus 750 lbs. = 650 lbs.

5. Determine the combined weight of luggage and cargo being loaded on the vehicle. That weight may not safely exceed the available cargo and luggage load capacity calculated in Step 4
6. If your vehicle will be towing a trailer, load from your trailer will be transferred to your vehicle. Consult the manual for transporting a trailer to determine how this may reduce the available cargo and luggage load capacity of your vehicle.

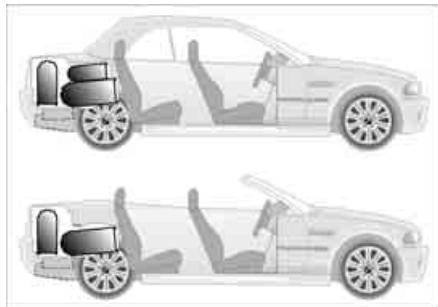

Stowing cargo

- ▷ Load heavy cargo as far forward as possible – directly behind the luggage compartment partition – and as low as possible
- ▷ Cover sharp edges and corners.

▶ You can enlarge the luggage compartment when the convertible top is closed, refer to page 37. To do this you have to fold the convertible top compartment panel up.

We recommend that you always fold the convertible top compartment panel down as soon as you have removed your cargo from the luggage compartment. This way, you can be sure that you can always operate your convertible top at any time.

At the same time, when the top is raised you should fold the convertible top compartment panel back up before stowing large objects in the luggage compartment; this precaution will help reduce the likelihood of damage to either the convertible top compartment or your luggage. ◀



Securing the cargo in the luggage compartment

- ▷ For small, light items, use the rubber-lined, non-skid side of the floor mat or secure using the luggage compartment net* or elastic straps, refer to page 37
- ▷ For large, heavy pieces, see your BMW center for load-securing devices*. Lashing fittings located in the luggage compartment can be used for fastening the load-securing devices.

Comply with the information enclosed with the load-securing devices.

 Always position and secure the load correctly. If you do not, it can endanger the passengers during braking or evasive maneuvers.

Do not exceed the approved gross vehicle weight or the approved axle loads, refer to page 156, otherwise the vehicle's operating safety is no longer assured and the vehicle will not be in compliance with the certification regulations.

Do not stow heavy or hard objects in the passenger compartment without first securing them. Otherwise they would be thrown around during braking and evasive maneuvers and endanger the occupants. ◀

Roof-mounted luggage rack for the hardtop*

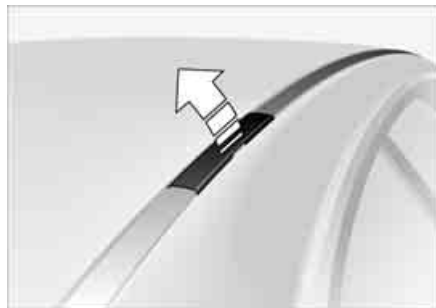

A special roof-rack system is available as an optional extra for your BMW. Please observe the precautions included with the installation instructions.

Anchorage

Access to the mounting points:

To fold up the covers, please use the tool provided with the roof-rack system.

Loading and driving notes

Because roof racks raise the center of gravity of the vehicle when loaded, they exercise a major effect on its handling and steering response.

When loading, be sure to remember not to exceed the approved roof weight or the approved gross vehicle weight or the axle loads. You will find the specifications under Technical data on page 156.

Make sure that the load is not too bulky, and attempt to distribute it evenly. Always load the heaviest pieces first so that they are at the bottom. Make sure that no objects get in the way when the luggage compartment lid is opening or closing.

Secure the roof-mounted luggage correctly and safely to prevent it from shifting or being lost during driving.

Drive smoothly and avoid sudden acceleration or braking. Do not corner at high speeds.



Overview

Controls and features

Operation, maintenance

Owner service procedures

Technical data

Index

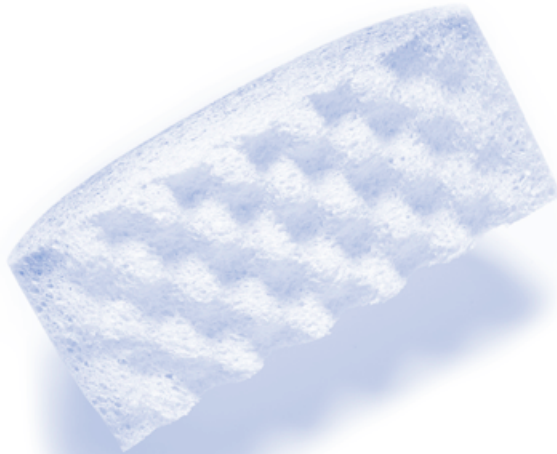

Overview

Controls

Maintenance

Repairs

Data

Index

To ensure that your vehicle continues to provide maximum economy throughout an extended service life, we request that you devote careful attention to the following instructions.



Because of its engineering design, the BMW M3 Convertible is an especially high-quality vehicle. It is in your best interest to follow the break-in tips very closely. Doing this, you will create the basis for a long, optimum service life. ◀

Engine and differential

▷ The first 1,250 miles/2,000 km: drive at varying engine and road speeds, but do not exceed the following engine or road speeds:
5,500 rpm or 105 mph / 170 km/h.

Always obey all official speed limits.

Do not depress the accelerator pedal to the full-throttle position.

Vehicles with SMG Drivelogic, refer to page 70: refrain from using driving program 6 in the sequential mode during the break-in period.

▷ Following the break-in inspection at 1,250 miles/2,000 km, you can gradually increase engine or road speeds.

Please remember to observe the same break-in procedures if either the engine or the differential should have to be replaced later in the course of the vehicle's service life.

Tires

Owing to technical factors associated with their manufacture, tires do not achieve their full traction potential until an initial break-in period has elapsed. We thus ask you to drive with extra care during the first 200 miles/300 km.

Always obey all official speed limits.



When the vehicle is operated on wet or slushy roads, a wedge of water may form between the tire and the road surface. This phenomenon is referred to as hydroplaning, and can lead to partial or complete loss of traction, vehicle control and braking effectiveness. Reduce your speed on wet roads. ◀

Brake system

Approx. 300 miles/500 km must elapse before the brake pads and rotors achieve the optimal pad-surface and wear patterns required for trouble-free operation and an extended service life later on.

To break in the separate parking brake drums, apply the parking brake lightly when coasting to a standstill – at a traffic signal, for instance; use caution to avoid posing a danger to other road users.

You can prevent corrosion in the drums by periodically repeating this procedure.



The brake lamps do not come on when the parking brake is set. Vacuum for the brake system servo unit on your BMW is available only when the engine is running. When you move the vehicle with the engine off – when towing, for example – substantially higher levels of pedal force will be required to brake the vehicle. ◀

Break-in procedures

Clutch

The clutch will also begin to function optimally after about 300 miles/500 km. Drive cautiously during this break-in period and do not press the clutch or shift at high engine speeds.

General driving notes



Brakes: do not drive with your foot resting on the brake pedal. Even light but consistent pedal pressure can lead to high temperatures, brake wear and possibly even brake failure.

Hydroplaning: when driving on wet or slushy roads, reduce vehicle speed. If you do not, a wedge of water may form between the tires and the road surface. This phenomenon is referred to as hydroplaning, and can lead to partial or complete loss of traction, vehicle control and braking effectiveness.

Driving through water: do not drive through water on the road if it is deeper than 1 ft/30 cm, and then only at walking speed. Otherwise, the vehicle's engine, the electrical systems and the transmission may be damaged. ◀

Portable phone in the vehicle

BMW recommends using mobile communications devices, e.g. portable phones, inside the vehicle with a suitable outside antenna. Otherwise, it cannot be ruled out that the vehicle electronics and portable phone may interfere with each other.

The concept

ABS keeps the wheels from locking during braking, thereby enhancing active driving safety.

Braking with ABS

If you are in a situation that requires full braking, you will exploit the full benefits of ABS system if you apply maximum pedal pressure – panic stop. Since the vehicle maintains steering responsiveness, you can avoid possible obstacles with a minimum of steering effort, despite the full brake application.

Pulsation at the brake pedal combined with sounds from the hydraulic circuits indicates to the driver that ABS is in its active mode.

Dynamic Brake Control (DBC)

DBC is included in the DSC, refer to page [86](#).

If you apply the brakes rapidly, this system automatically generates maximum braking force boost and thus helps to achieve the shortest possible braking distance in panic braking situations. All of the benefits of the ABS are exploited under these circumstances.

Do not reduce the pressure on the brake pedal for the duration of the brake application. When the brake pedal is released, the DBC is deactivated.

Cornering Brake Control (CBC)

CBC is an advanced engineering development of ABS. When braking during cornering with high lateral acceleration, or when braking during a lane change, vehicle stability is improved and the steering response is enhanced.

Brake system

Brake fluid level

Low brake fluid level in the reservoir combined with longer than usual pedal travel may indicate a defect in one of the brake system's hydraulic circuits.



Proceed to the nearest authorized BMW center. Higher brake application pressure may be necessary when stopping, and the vehicle may exhibit a slight tendency to pull to one side. Brake distances may even be longer. Please remember to adapt your driving style accordingly. ◀

Disc brakes

Limited vehicle use, extended periods with the vehicle parked or in storage, and operating conditions in which braking is restricted to gentle, low-pressure applications will all increase the tendency for corrosion to form on the rotors; this is often accompanied by a simultaneous accumulation of contamination on the brake pads. The pads must exert a certain minimal level of pressure against the rotors for the disc brakes' inherent self-cleaning effect to remain effective.

If the brake rotors are corroded, they will tend to respond to braking with a pulsating effect that even extended brake applications will fail to cure.

When driving in heavy rain and on wet roads it is useful to apply light pressure to the brake pedal every few miles.

Monitor traffic conditions to ensure that this maneuver does not pose a hazard to you or to other road users. The heat generated in this process helps dry the pads and rotors to ensure that your brake system will respond with undiminished efficiency when you need it.

Extended or steep mountain descents should be driven in the gear in which only minimal periodic brake applications are required. By minimizing the loads placed on the brake system, this strategy helps ensure that optimal brake system response will remain available at all times. Stay within the allowable rpm range. For additional information, refer to page [79](#).



Do not coast with the clutch depressed or with the gearshift lever in idle. Do not coast with the engine switched off. If you do so the engine provides no braking effect and there is no power assist for braking or steering when the engine is not running. ◀

Brake pads



For your own safety: use only brake pads that BMW has released for your particular vehicle model. BMW cannot evaluate non-approved brake pads to determine if they are suitable for use, and therefore cannot ensure the operating safety of the vehicle if they are installed. ◀

It is not necessary to remove the fabric top even in the winter, when the hardtop is generally in constant use. But you can also remove it easily at any time. Before the fabric top is stored in the convertible top compartment, it must be absolutely dry in order to avoid water spots and mildew from forming.

The hardtop offers reading lamps and clothes hooks that can be used just by pressing. It is also possible to mount a luggage rack on the roof. Please consult your BMW center.



When hanging clothing from the hooks, be sure that they will not obstruct the driver's vision. Do not hang heavy objects on the hooks. If you do so, they could cause personal injury during braking or evasive maneuvers. ◀

Two people are required for installation or removal. Work with extreme caution in order to avoid paint damage and damage to the body or hardtop.

To facilitate hardtop installation or removal, you can obtain a specially designed hardtop lift* or hardtop rack* at your BMW center.

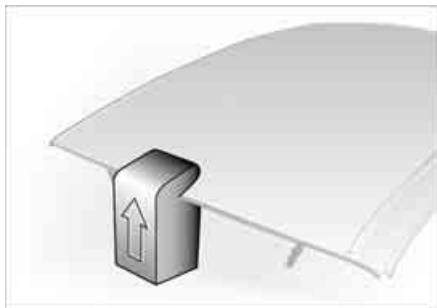

Storage

 Storing the hardtop on the floor: slide the styrofoam block that came with the hardtop onto its center. The arrow on top of the styrofoam block has to be pointing upward when you are doing this. ◀

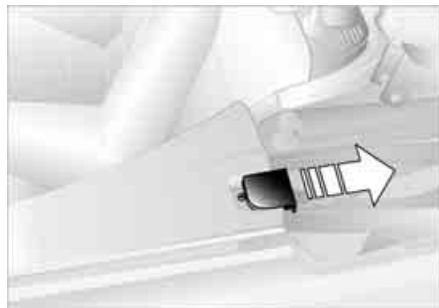

Installation

1. Lower the side windows completely and flip the sun blinds down. If necessary, remove the antenna rod to avoid any damage
2. Open the convertible top compartment lid slightly by pressing the button for the convertible top operation, refer to page 40
3. Remove the trim pieces on both sides by pulling them off toward the back and reclose the convertible top compartment lid

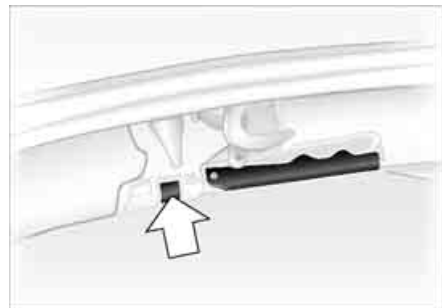

4. Open the two front locking levers on the hardtop. Press on the buttons to do so. The levers will release slightly. Open the levers as far as possible

Hardtop*



5. Before installing, first flip the cover panels that are located underneath the left and right interior lamps down. To do this, press on the slight bump on the cover panel. There is a holder in the cover panel to securely store the trim pieces that have been removed – see arrow 1
6. Open the red release levers as far as the stop will allow – see arrow 2

7. Position the hardtop onto the supports with the help of a second person. Be sure to put the mountings exactly into the proper brackets



Lift the hardtop carefully. Be extremely careful not to shift the seals. Seals that have been shifted out of place or actually pulled out cause leaks. ◀

8. In the back, close the red locking levers by turning to the inside as far as the stop located behind the trim will allow. Flip the cover panels back into place
9. To lock the hardtop in the front, keep pressing on the front locking levers until you hear them engage
10. Check the rubber weather-strip-ping between the windshield frame and the hardtop on both the left and right sides. If it is folded or bent out of place, you should smooth it back into position by hand to ensure secure and reliable sealing.

Removal

Follow the same procedure as when installing, just reverse the steps.

Information for your safety

The factory-approved tires are matched to your vehicle and have been selected to provide optimum safety and driving comfort when used properly.

It is not merely the tire's service life, but also driving comfort and – above all else – driving safety that depend on the condition of the tires and the maintenance of the specified tire pressure.

 Incorrect tire inflation pressure is a frequent cause of tire damage. It also significantly influences the road-holding ability of your BMW. Check tire inflation pressures on a regular basis, refer to page 25, at least every two weeks and before beginning a longer trip. If this is not done, incorrect tire pressures can cause driving instability and tire damage, ultimately resulting in accidents. ◀

Tire condition

wall with TWI – Tread Wear Indicator. At a tread depth of 1/16 in / 1.6 mm, the indicators signal that the legally permissible wear limit has been reached.

Tire tread – tire damage

Inspect your tires frequently for tread wear, signs of damage and for foreign objects lodged in the tread. Check the tread depth.

Tread depth should not be allowed to go below 1/8 in / 3 mm, even though the legally specified minimum tread depth is only 1/16 in / 1.6 mm.

Below 1/8 in / 3 mm tread depth, there is a great risk of hydroplaning, even at relatively moderate speeds and with only small amounts of water on the road. Tread wear indicators in the tread-groove base – see arrow – are distributed around the wheel circumference and are labeled on the tire side-

Tire condition

 Do not drive on a deflated – flat – tire. A flat tire greatly impairs steering and braking response, and can lead to complete loss of control over the vehicle.

Avoid overloading the vehicle so that the permitted load on the tires is not exceeded. Overloading can lead to overheating and internal tire damage. This can result in a sudden loss of tire inflation pressure.

Unusual vibrations encountered during normal vehicle operation can indicate tire failure or some other vehicle defect. This type of problem can be caused by contact with curbs, etc. This is also true for irregularities in the vehicle's handling characteristics, such as a pronounced tendency to pull to the left or right. Should this occur, respond by immediately reducing your speed. Proceed carefully to the nearest BMW center or professional tire center, or have the vehicle towed in to have it, its wheels or its tires inspected.

Tire damage, up to and including blowouts, can endanger the lives of both the vehicle occupants and other road users. ◀

Tire replacement

To maintain good handling characteristics, only use a full set of tires of the same brand and tread configuration.

Comply with the specified tire inflation pressures, and be sure to have the wheel and tire assembly balanced every time you change a tire or wheel.

DOT quality grades

- ▷ Treadwear
- ▷ Traction AA A B C
- ▷ Temperature A B C

 All passenger car tires must conform to Federal Safety Requirements in addition to these grades. ◀

Treadwear

The treadwear grade is a comparative rating based on the wear rate of the tire when tested under controlled conditions on a specified government test course.

For example, a tire graded 150 would wear one and one-half – $1\frac{1}{2}$ – times as well on the government course as a tire graded 100. The relative performance of tires depends upon the actual conditions of their use, however, and may

depart significantly from the norm due to variations in driving habits, service practices and differences in road characteristics and climate.

Traction

The traction grades, from highest to lowest, are AA, A, B and C.

Those grades represent the tire's ability to stop on wet pavement as measured under controlled conditions on specified government test surfaces of asphalt and concrete. A tire marked C may have poor traction performance.

 The traction grade assigned to this tire is based on straight-ahead braking traction tests, and does not include acceleration, cornering, hydroplaning, or peak traction characteristics. ◀

Temperature

The temperature grades are A – the highest – B and C, representing the tire's resistance to the generation of heat and its ability to dissipate heat when tested under controlled conditions on a specified indoor laboratory test wheel.

Sustained high temperature can cause the material of the tire to degenerate and reduce tire life, and excessive temperature can lead to sudden tire failure. The grade C corresponds to a level of performance which all passenger car tires must meet under the Federal Motor Vehicle Safety Standard No. 109. Grades B and A represent higher levels of performance on the laboratory test wheel than the minimum required by law.



The temperature grade for this tire is established for a tire that is properly inflated and not overloaded. Excessive speed, under-inflation, or excessive loading, either separately or in combination, can cause heat buildup and possible tire failure. ◀

Uniform Tire Quality Grading

Quality grades can be found where applicable on the tire sidewall between tread shoulder and maximum section width. For example:

Treadwear 200 Traction AA

Temperature A

Tire age

The date on which the tire was manufactured is indicated by the code on the sidewall:

DOT ... 3603 indicates that the tire was manufactured in week 36 of the year 2003.

BMW recommends the replacement of all tires when the tires are no more than 6 years old, even if a tire life of 10 years is possible.

Following wheel/tire changes

Comply with the specified tire inflation pressures, and be sure to have the wheel and tire assembly balanced every time you change a tire or wheel.

Following wheel and/or tire changes you will need to reinitialize both the sequential M gearbox with Drivelogic and the Flat Tire Monitor, refer to pages [74](#), [88](#).

Wheel and tire combinations

The right choice

 BMW recommends using only wheels and tires that have been approved by BMW for your particular vehicle model, as otherwise body contact and serious accidents can result despite the use of the same nominal size, e.g. due to manufacturing tolerances. If non-approved wheels and tires are used, BMW cannot evaluate their suitability, and therefore cannot be held liable for driving safety. ◀

BMW tests certain tire brands for each tire size, classifies them as road-safe and approves them. Consult your BMW center for more information. Observe any country-specific regulations, e.g. on making a corresponding entry in the vehicle documents.



The correct wheel and tire combination affects different systems such as ABS, DSC, Flat Tire Monitor. The function of these systems is impaired if improper wheel and tire combinations are used. Therefore, only use tires of the same brand and same tread configuration on the vehicle and, for example following a tire failure, restore the approved wheel and tire combination as soon as possible. ◀



The use of rims and lug bolts that do not meet the specifications of the original factory-installed equipment will affect the safe operation of your vehicle and may cause an accident and personal injury. Never mix tires of different design, such as steel-belted radials with radial bias-belted or bias-ply tires, etc. Mixing tire types will adversely affect roadholding and can lead to loss of vehicle control. ◀

Storage

Always store tires in a cool, dry place. Store them away from light whenever possible. Protect the tires against contact with oil, grease and fuel.

Do not exceed the maximum tire inflation pressures specified on the tire sidewall.

Choosing the right tire

BMW recommends the use of winter tires for operation under winter road conditions. While all-season tires – with M+S designation – provide better winter traction than the corresponding summer tires, they generally do not achieve the performance of winter tires.

In the interest of safe tracking and steering response, install radial tires made by the same manufacturer and with the same tread configuration on all four wheels if you elect to mount winter tires.

 When mounting winter wheels, observe the different recesses of the front and rear wheels, as otherwise damage may result. ◀

Do not exceed specified maximum speeds

 Never exceed the maximum speed for which the winter tires are rated.

Unprofessional attempts by laymen to service tires can lead to damage and accidents.

Have this work performed by skilled professionals only. Your BMW center will be glad to assist you with both their expertise and the proper equipment for your vehicle. ◀

Tire condition, tire pressure

At tread depths below approx. 3/16 in / 4 mm, tire performance under winter driving conditions deteriorates noticeably. Worn tires should therefore be replaced for safety considerations.

Comply with the specified tire inflation pressures, and be sure to have the wheel and tire assembly balanced every time you change a tire or wheel.

Snow chains*

Only certain snow chains have been tested by BMW and determined and approved as roadworthy. Consult your BMW center for more information. BMW recommends using only these approved fine-link snow chains. Use them in pairs on winter tires, but only on both rear wheels.

Comply with all manufacturer's safety precautions when mounting the chains. Do not exceed a speed of 30 mph / 50 km/h with snow chains.

After mounting or removing snow chains, always reinitialize the sequential M gearbox with Drivelogic, refer to page 88.

 It is not possible to mount snow chains on tires with 18- and 19-inch wheels.

Deactivate the Flat Tire Monitor when using snow chains. Malfunction warnings and undetected losses in pressure are a possibility when driving with snow chains.

For additional information, refer to page 87. ◀

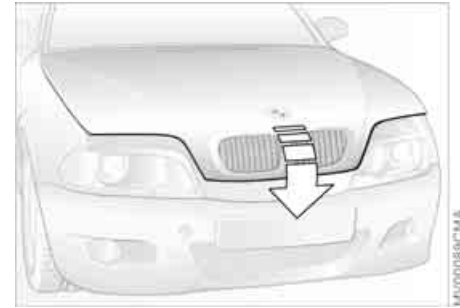
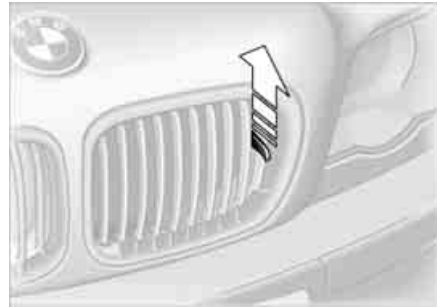
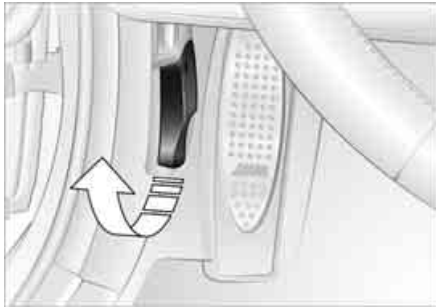

To release

Pull the lever located under the left-hand side of the instrument panel.

⚠ Do not attempt to service your vehicle if you do not have the required technical background. Failure to work in an informed, professional manner when servicing components and materials constitutes a safety hazard for vehicle occupants and other road users. If you are not familiar with the guidelines, BMW recommends that you have the operations performed by your BMW center. ◀

To open

Pull the release handle and open the hood.

▶ It is not possible to drive off using SMG Drivelogic when the hood is open. ◀

To close

Pull the hood downwards and allow the hood to fall from a minimum height of 1 ft/30 cm so that it audibly engages. Check for proper locking by pulling on the hood at the left and right above the headlamps.

⚠ To avoid injuries, be sure that the travel path of the hood is clear when it is closed, following the same safety precautions used in all closing procedures. If you notice while driving that the hood is not completely closed, stop immediately and close it securely. ◀

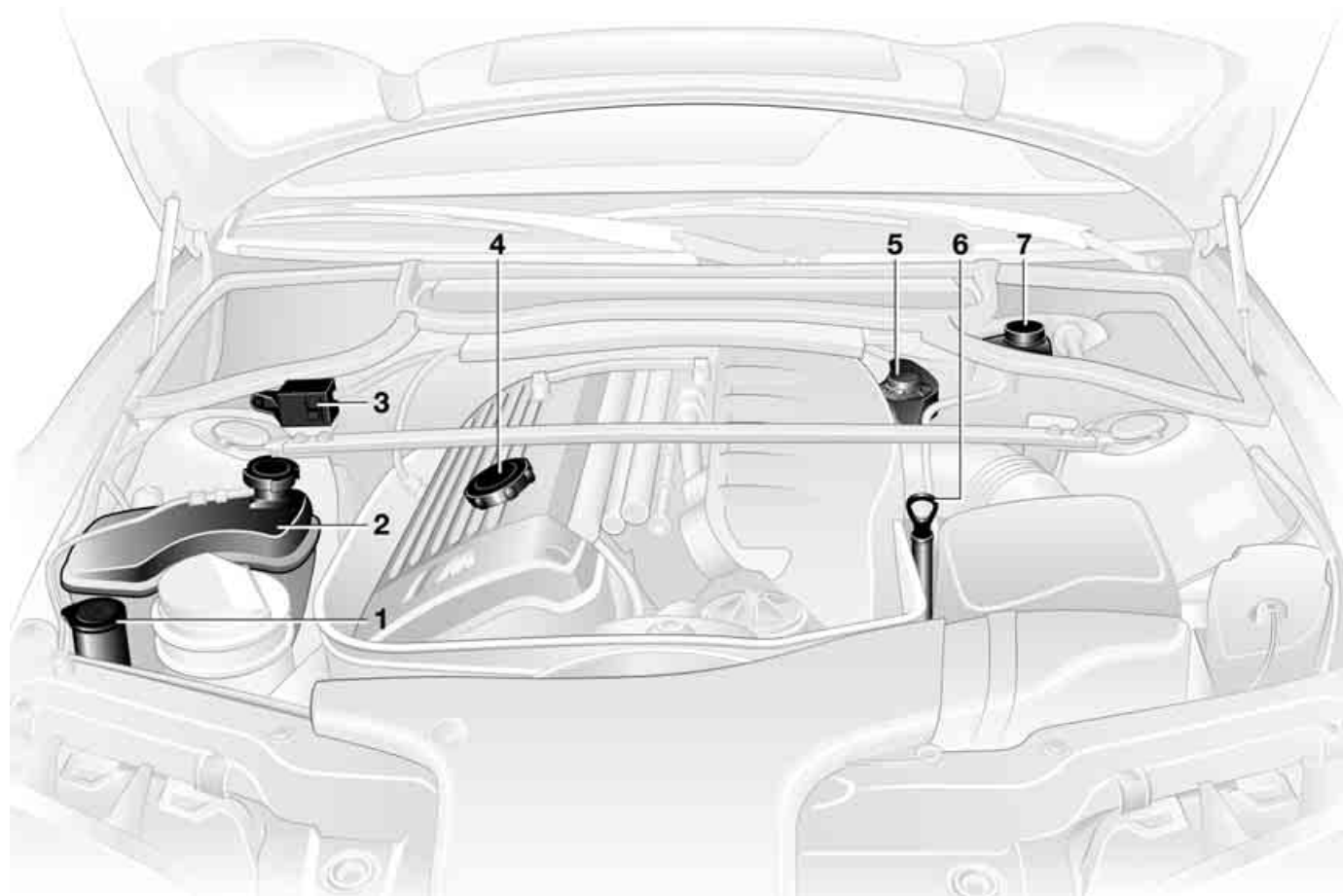

- 1 Filler neck for windshield and headlamp washer cleaning system [126](#)
- 2 Coolant expansion tank [128](#)
- 3 Auxiliary terminal for jump-starting – positive terminal [147](#)
- 4 Engine oil filler neck [127](#)
- 5 Expansion tank for SMG Drivelogic hydraulic unit – checking and possible refilling by your BMW center [70](#)
- 6 Engine oil dipstick [126](#)
- 7 Filler neck for brake fluid [129](#)

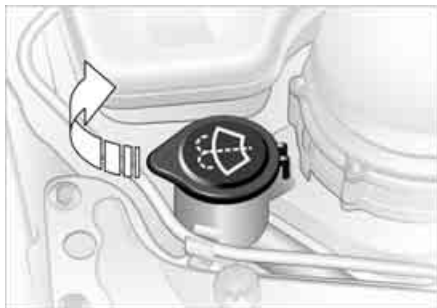

Headlamp* and windshield washer system

Capacity approx.
5.6 US quarts/5.3 liters.

Fill with water and, if required, with a washer antifreeze additive according to manufacturer's recommendations.

 We recommend that you mix the washer fluid before adding it to the reservoir. ◀

 Antifreeze agents for the washer fluid are highly flammable. For this reason, keep them away from sources of flame and store them only in their closed original containers, inaccessible to children. Comply with the instructions on the containers. ◀

Engine oil

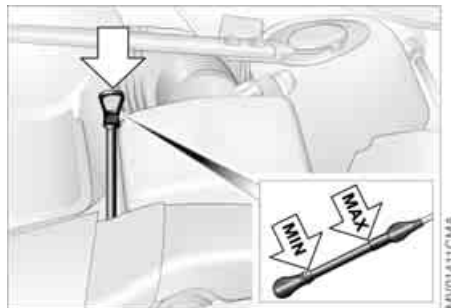

The oil volume between the two marks on the dipstick corresponds to approx. 1.4 US quarts/1.3 liters.

Checking the oil level

1. Park the vehicle on a level surface
2. Switch the engine off after it has reached normal operating temperature
3. After approx. 1 minute, pull the dipstick out and wipe it off with a clean lint-free cloth, paper towel, or similar material
4. Carefully push the dipstick all the way into the guide tube and pull it out again
5. The oil level should be between the two marks on the dipstick.

As with fuel economy, oil consumption is directly influenced by your driving style and vehicle operating conditions.

Engine oil

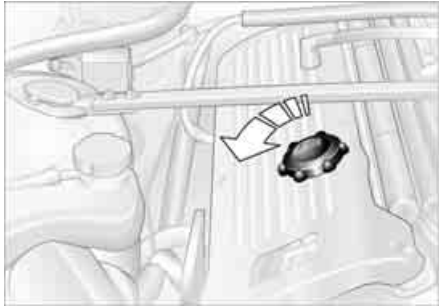

Adding engine oil

Only add engine oil when the oil level has dropped to just above the lower mark on the dipstick.

Do not fill beyond the upper mark on the dipstick. Excess oil will damage the engine.

Before checking the engine oil level after topping up, restart the engine and allow it to run to obtain a correct display. Then proceed as described under Checking the oil level.

! BMW engines are designed to operate without oil additives; the use of additives could lead to damage in some cases. This also applies to the manual transmission, the differential, and the power steering system. ◀

Recommendation: have the oil changed by your BMW center.

! Continuous exposure to used oil has caused cancer in laboratory testing. For this reason, thoroughly wash any areas of skin that come into contact with oil using soap and water. Store oils, grease and similar materials so that they are inaccessible to children. Comply with warning labels and information on containers. ◀

▶ Comply with the applicable environmental laws regulating the disposal of used oil. ◀

Specified engine oils

The quality of the engine oil is extremely important for the function and life of an engine. Based on extensive testing, BMW has approved only certain grades of engine oil.

Use only oils approved for your vehicle model.

▶ Ask your BMW center for details concerning oils that have been approved. You can also call BMW of North America toll-free at 1-800-831-1117 or visit this website: www.bmwusa.com to obtain this information. ◀

Alternative oil types

If a High Performance Synthetic Oil approved by BMW should be unavailable, you may use small volumes of other synthetic oils for topping up between oil changes. The following data must appear on the packaging:

- ▷ Viscosity
 - preferred: SAE 10W-60
 - alternative: SAE 5W-40 or SAE 10W-40
- ▷ Specifications
 - preferred: API SJ/CF
 - alternative: API SJ – also SK, SL, S etc.

Low ambient temperatures

The oils used by BMW at the factory for your vehicle model can be used at virtually any ambient temperature.

However, if the vehicle is exposed to temperatures below $-4\text{ }^{\circ}\text{F}/-20\text{ }^{\circ}\text{C}$ for extended periods, please have your BMW center recommend a suitable oil.

Coolant

 Do not add coolant to the cooling system when the engine is hot. If you attempt to do so, escaping coolant can cause burns.

Antifreeze and anti-corrosion agents are hazardous to health. You should always store them in their closed original containers and in a location inaccessible to children. Antifreeze and anti-corrosion agents are inflammable. For this reason, do not spill them on hot engine parts. They could ignite and cause burns. Comply with the instructions on the containers. ◀

 Comply with the applicable environmental laws regulating the disposal of antifreeze agents with corrosion inhibitor. ◀



Checking coolant level and adding coolant

Check the coolant level when the engine is cold, approx. $68\text{ }^{\circ}\text{F}/+20\text{ }^{\circ}\text{C}$.

1. Open the cap for the expansion tank by turning it slightly counterclockwise to allow accumulated pressure to escape. Then open
2. The coolant level is correct when the upper end of the red float is at least even with the upper edge of the filler neck – refer to the arrow in the illustration – but no more than $3/4\text{ in} / 2\text{ cm}$ above it – that is, up to the second mark on the float. Refer also to the schematic diagram next to the filler neck

3. If necessary, add coolant. If the coolant is low, slowly add coolant until the correct level is reached – do not overfill.

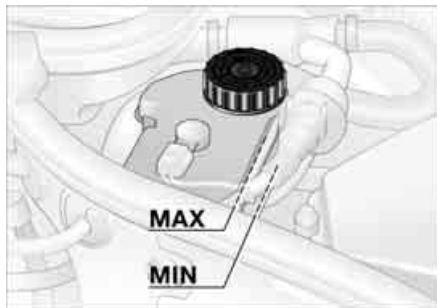

Indicator lamp

BRAKE

The brake warning lamp comes on when the parking brake is not engaged: brake fluid level too low, refer to page 18.



Brake warning lamp for Canadian models.

Adding brake fluid

For adding brake fluid or for determining and correcting the cause of brake fluid loss, consult your BMW center. Your BMW center is familiar with the specifications for factory-approved brake fluids – DOT 4.

Due to loss in brake fluid, pedal travel can lengthen and braking efficiency may be reduced. Refer to the information on page 114.



Brake fluid is hygroscopic, that is, it absorbs moisture from the air over time.

In order to ensure the safety and reliability of the brake system, have the brake fluid changed every two years by a BMW center. Refer also to the Service and Warranty Information Booklet for US models or the Warranty and Service Guide Booklet for Canadian models. Brake fluid is toxic and damages the vehicle's paint. You should always store it in its closed original container and in a location inaccessible to children. Do not spill the brake fluid and do not fill the brake fluid reservoir beyond the MAX mark. The brake fluid could ignite upon contact with hot engine parts and cause serious burns. ◀



Comply with the applicable environmental laws regulating the disposal of brake fluid. ◀



The BMW Maintenance System has been designed as a reliable means of providing maximum driving and operating safety – and as cost-effectively for you as possible. Please keep in mind that regular maintenance is not only necessary for the safety of your vehicle, but also plays a significant role in maintaining the resale value of the vehicle.

Service interval display

While conventional systems rely on distance traveled alone to determine when service is due, the BMW Maintenance System has for years taken the actual

conditions under which the vehicle operates into consideration, because miles can be traveled in many different ways:

For example, 62,000 miles/100,000 km short-distance driving are not equal to the same 62,000 miles/100,000 km of long-distance travel.

The BMW Maintenance System includes the Engine Oil Service and Inspections I and II.

▶ Have a break-in inspection performed at 1,250 miles/2,000 km regardless of the service interval indicated on the display. ◀

Determining the maintenance intervals according to the actual loads on the vehicle covers every kind of operating situation. Minimal-use drivers – those who drive significantly fewer than 6,200 miles/10,000 km annually – should have the engine oil changed at least every 2 years since oil deteriorates over time, regardless of use.

Service and Warranty Information Booklet for US models/Warranty and Service Guide Booklet for Canadian models

For additional information on required maintenance intervals and procedures, please refer to the Service and Warranty Information Booklet for US models, or the Warranty and Service Guide Booklet for Canadian models.

As a precaution against corrosion, it is advisable to have the body checked for damage from rocks or gravel at the same time, depending upon operating conditions.

▶ Have your BMW center perform maintenance and repair. Be sure that all maintenance work is recorded in the Service and Warranty Information Booklet for US models, or in the Warranty and Service Guide Booklet for Canadian models. These entries are your verification for the regular maintenance of your vehicle and are required for the performance of warranty repairs. ◀

Care

You can find everything you need to know on this topic by consulting the separate Caring for your vehicle brochure.

132 California Proposition 65 warning

California laws require us to state the following warning:

 Engine exhaust and a wide variety of automobile components and parts, including components found in the interior furnishings in a vehicle, contain or emit chemicals known to the State of California to cause cancer and birth defects and reproductive harm. In addition, certain fluids contained in vehicles and certain products of component wear contain or emit chemicals known to the State of California to cause cancer and birth defects or other reproductive harm.

Battery posts, terminals and related accessories contain lead and lead compounds. Wash your hands after handling.

Used engine oil contains chemicals that have caused cancer in laboratory animals. Always protect your skin by washing thoroughly with soap and water. ◀

OBD interface socket



The Onboard Diagnostic (OBD) interface socket is located on the left of the driver's side at the bottom of the instrument panel and under a cover. The cover has the letters OBD on it.

The purpose of the OBD system is to assure proper emission-control system operation for the vehicle's lifetime by monitoring emission-related components and systems for deterioration and malfunction.

 An illuminated indicator informs you of the need for service, not that you need to stop the vehicle. However, the systems should be checked by your BMW center at the earliest possible opportunity.

OBD interface socket

If the indicator blinks or flashes, this indicates a high level of engine misfire. Reduce speed and contact your nearest BMW center immediately. Severe engine misfiring for even a short period of time can seriously damage emission-control system components, especially the catalytic converter.



Service Engine Soon warning lamp for Canadian models.



If the gas cap is not on tight enough, the OBD system can detect leaking vapor and the indicator will light up. If the gas cap is then tightened, the indicator will usually go out after a short period of time. ◀

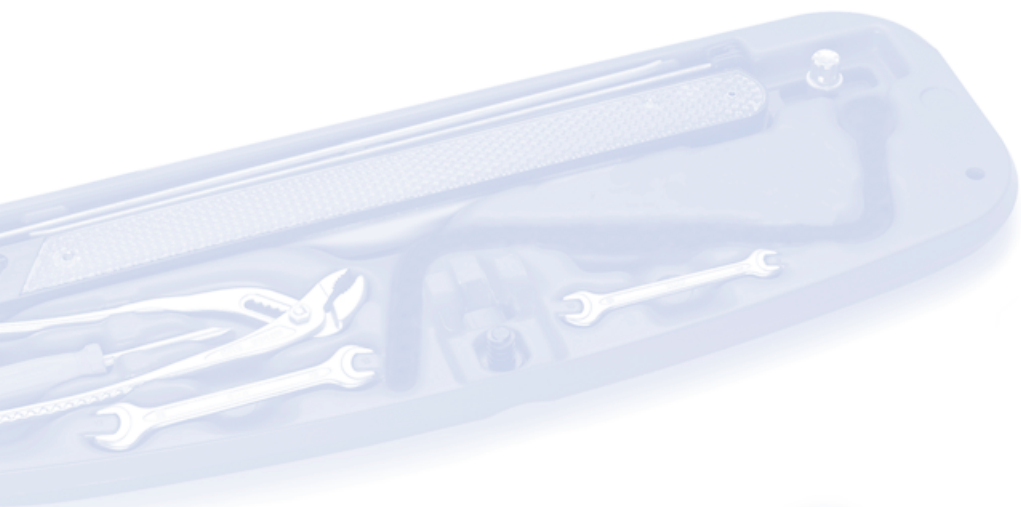



Overview

Controls and features

Operation, maintenance

Owner service procedures

Technical data

Index

Overview

Controls

Maintenance

Repairs

Data

Index



The onboard tool kit is located in the luggage compartment lid.

To open, loosen the wing nut. For storage place of towing eyelet, refer to page 148.

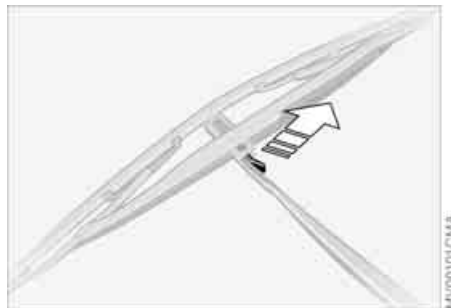

1. Switch off the engine
2. Fold the wiper arm completely out from the windshield
3. Position the wiper blade at an angle and pull the release spring – see arrow
4. Fold the wiper blade down and unhook it toward the windshield
5. Pull the wiper blade past the wiper arm toward the top
6. Insert a new wiper blade and apply pressure until you hear it engage.

Lamps and bulbs

The lamps and bulbs make essential contributions to the safety of your vehicle. Therefore, proceed carefully when handling bulbs. BMW recommends that you have such work performed by your BMW center if you are not familiar with the procedures.

 Do not touch the glass portion of a new bulb with your bare hands since even small amounts of impurities burn in to the surface and reduce the service life of the bulb. Use a clean cloth, paper napkin, or a similar material, or hold the bulb by its metallic base. ◀

A replacement bulb set is available from your BMW center.

 Before working on the electrical system, switch off the electrical accessory you are working on or disconnect the cable from the negative terminal of the battery. Failure to observe this precaution could result in short circuits. To prevent injuries and damage when changing a bulb, be sure to comply with any instructions provided by the bulb manufacturer. ◀

Low beams and high beams

- ▷ Low beams: H7 bulb, 55 watts
- ▷ High beams: H7 bulb, 55 watts

 The H7 bulb is pressurized. Therefore, wear safety glasses and protective gloves. Failure to comply with this precaution could lead to injury if the bulb is damaged. ◀

Please contact a BMW center in case of a malfunction.

Parking lamps

5 watt bulb

Please contact a BMW center in case of a malfunction.

When cleaning the headlamps, please follow the instructions in the Caring for your vehicle brochure.

Xenon lamps*

The service life of these bulbs is very long and the probability of a failure is very low, provided that they are not switched on and off an unusual number of times. If one of these bulbs should nevertheless fail, it is possible to continue driving with great caution using the fog lamps, provided traffic laws in your area do not prohibit this.



Because of the extremely high voltages involved, any work on the xenon lighting system, including bulb-changing, should be carried out by technically qualified personnel only. Otherwise, there is a risk of fatal injury. ◀

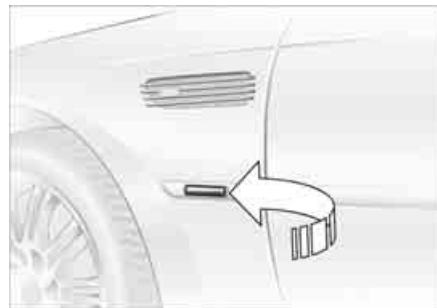
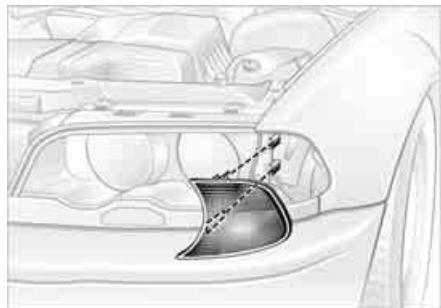
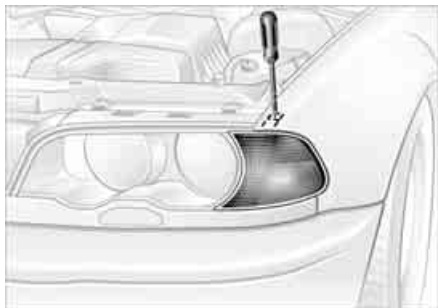

Front turn signal indicators

21 watt bulb

1. Extend a screwdriver through the upper opening, loosen the screw and remove it
2. Remove lamp by pulling it out toward the front
3. Applying light pressure, turn the bulb to the left. Remove and exchange the bulb

4. Insert the 2 pins on the lamp into the guides on the vehicle
5. Slide in the lamp and screw the bulb in place through the upper opening.

Side turn signal indicators

5 watt bulb

1. Press the back edge of the lamp toward the front with the tip of your finger and remove
2. Apply gentle pressure to the bulb while turning it to the left to remove.

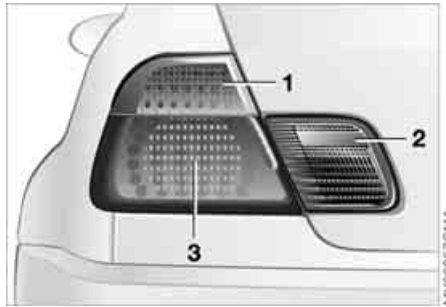

Rear lamps

- 1 Turn signal indicator
- 2 Backup lamp
21 watt bulb
- 3 Tail lamp/brake lamp

 All bulbs in the fender are designed using LED technology. Please contact a BMW center in case of a malfunction. ◀



Bulbs in the luggage compartment lid
1. Using a screwdriver, loosen the clip

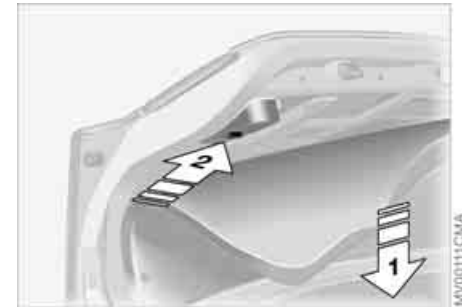

- 2. Fold the trim panel down – see arrow 1. Disengage the bulb holder – see arrow 2 – and remove it
- 3. Applying light pressure, turn the bulb to the left. Remove and exchange the bulb
- 4. Press the bulb holder into position until you hear it engage
- 5. Reinstall the trim with the clip.

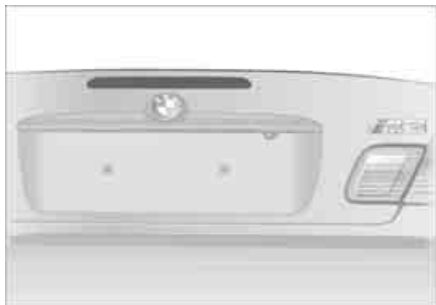

Center high-mount brake lamp

LED strip in luggage compartment lid.

Please contact a BMW center in case of a malfunction.

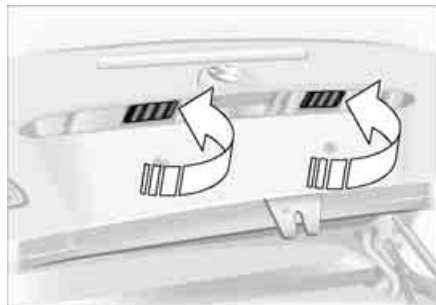

License plate lamps

5 watt bulb

1. Place a screwdriver in the slot and press toward the left to release the lens
2. Replace the bulb.

Repairing a flat tire



Precautions in case of a flat tire:
Stop the vehicle as far as possible from passing traffic; switch on the hazard warning flashers.

Turn the steering wheel to the straight-ahead position and engage the steering lock. Shift into 1st or reverse and engage the parking brake.

All passengers should be outside the vehicle and well away from your immediate working area – behind a guardrail, for instance.

If necessary, set up your warning triangle or portable hazard warning lamp on the roadside at an appropriate distance from the rear of the vehicle. Comply with all safety guidelines and regulations. ◀

M Mobility system

You will find an M Mobility system in your BMW M3 Convertible for repairing flat tires. With this system you can apply a sealing liquid to the inside of the tire that seals off the damaged point and then continue driving.

The M Mobility system makes transporting a spare wheel superfluous, thereby reducing the amount of weight you have to carry around.

Repairing a flat tire

Using the M Mobility system

To repair a flat tire using the M Mobility system, proceed as follows:

- ▷ Preparing the M Mobility system for use, refer to the next column
- ▷ Components of the M Mobility system, refer to page 142
- ▷ Filling with sealant, refer to page 142
- ▷ Distributing sealant, refer to page 143
- ▷ Inflating tire to correct pressure, refer to page 143.

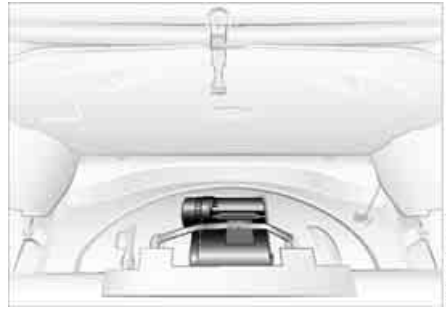

Preparing the M Mobility system for use

The M Mobility system is located in the luggage compartment under the floor panel:

1. Lift the floor panel
2. Loosen the M Mobility system from its storage location.

 Before you use the M Mobility system, read the warnings and danger notices on the device carefully. ◀

If possible, leave the foreign object in the tire.

Pull off the sticker 5, refer to the second column below, for the speed limit and apply it to the steering wheel.

 Please keep in mind that the fluids bottle in the system's sealant container has to be changed every 3 years by your BMW center, if the unit has not been used. ◀



Components of the M Mobility system

- 1 On/Off switch
- 2 Connection hose with manometer for connecting the compressor with the sealant container or to connect the compressor to the wheel
- 3 Manometer for indicating the tire pressure
- 4 Connector hose from the sealant container to the wheel
- 5 Sticker with speed limit
- 6 Plug and cable for the cigarette lighter socket
- 7 Protective gloves, not shown



Filling with sealant

1. Take off the round cover and take out hose 4. Unscrew the valve dust cap from the defective wheel and screw the hose to the valve. Keep the dust cap in a safe place

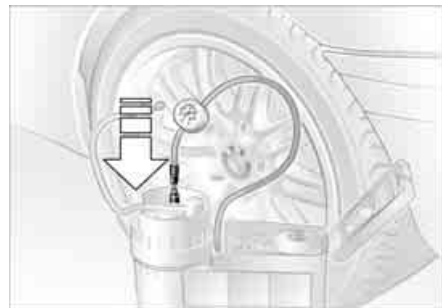

2. Flip open the cover and pull out the enclosed protective gloves. Take out the enclosed hose 2 with the manometer and screw it to the terminal for the sealant container as shown in the illustration
3. Make sure that the system has been switched off, position 0. Take out plug 6 and insert it into the cigarette lighter socket in the passenger compartment, refer to page 103

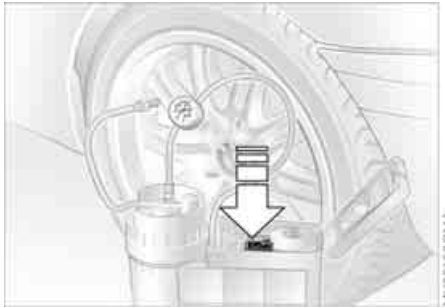

- ▷ Do not exceed a maximum speed of 40 mph / 60 km/h. If possible, keep the vehicle speed above 10 mph / 20 km/h.
Stop in a suitable spot. ◀

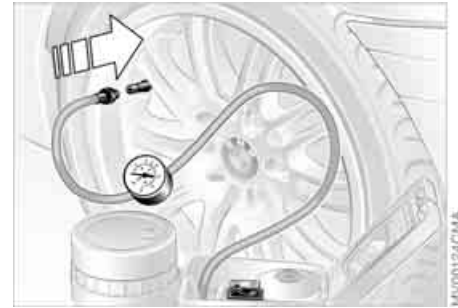

4. Make sure that the screw on the rear of the pressure gauge 3 is tightened down. Turn on the M Mobility system, position I, refer to illustration, and allow minutes to elapse, to let the sealant flow in. It does not matter afterward, what the tire's inflation pressure is
5. Turn the system off.
Disconnect the connector hose from the sealant container and the wheel valve. Stow the M Mobility system in the luggage compartment.

Distributing the sealant

Right afterward, drive at least 1 1/4 miles / 2 km, so that the liquid sealant distributes evenly throughout the inside of the tire.

Inflating tire to correct pressure

1. Take out the hose with the pressure gauge and screw it onto the valve. Take the plug out and plug it into the cigarette lighter socket in the passenger compartment
2. Reset the air pressure to 29 psi/200 kilopascal, and:
 - ▷ Increase tire pressure: switch on the M Mobility System, position I. Switch off the unit briefly to check the current tire pressure
 - ▷ Decrease tire pressure: turn the screw on the back of the manometer, a valve located there will open

 Even if the tire fails to hold the pressure, you should still carry out Step 3 before proceeding to drive the vehicle again, refer to Distributing the sealant for more information. Then repeat Steps 1 through 3.

The use of the M Mobility system may be ineffective if the damaged area in the tire is larger than approx. 1/8 in / 4 mm. Please consult the nearest BMW center if the tire cannot be temporarily repaired with the M Mobility system. ◀

3. Unscrew the hose from the valve and stow the M Mobility system in the luggage compartment. Screw the dust cap onto the valve again.

 Do not exceed the maximum speed limit described below, otherwise it could lead to accidents. ◀

When you start driving again, do not exceed the permissible maximum speed of 45 mph / 80 km/h.

 You will find corresponding instructions for using the M Mobility system on the device. Replace the defective tire as soon as possible and have the new wheel balanced. Reinitialize the Flat Tire Monitor, and refer to page 88 for further information. Have the M Mobility system refilled. Contact your BMW center for this. ◀

Protect valve stems against dirt using screw-on dust caps. Dirty valve stems frequently lead to slow pressure loss.

Battery

 Battery posts, terminals, and related accessories contain lead and lead compounds. Wash hands after handling. ◀

Maintenance

The battery is completely maintenance-free. That means that the original battery acid will normally last for the service life of the battery under moderate climate conditions.

 Please consult your BMW center whenever you have any questions concerning the battery. ◀

Charging the battery

Charge the battery in the vehicle only when the engine is not running. Use the connections provided in the engine compartment. For information on the connections, see Jump-starting, page 147.

Disposal

 Return used batteries to a recycling point or your BMW center. Maintain the battery in an upright position for transport and storage. Secure the battery against tilting in transit. ◀

Fuses

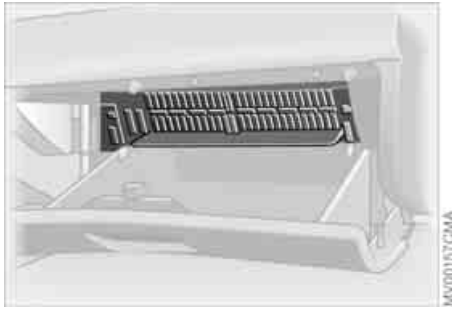

You will find the fuses and information on their respective allocation in the glove compartment behind a panel with two snap clips.

 Do not attempt to repair a blown fuse or replace it with a fuse having a different color or amperage rating. To do this could cause a fire in the vehicle resulting from a circuit overload. ◀

The BMW Group's Mobile Service offers you 24-hour assistance in the event of a breakdown, even on weekends and holidays.

The telephone numbers of the Mobile Service control center in your country are listed in the BMW Dealer Directory.

If your vehicle has the necessary equipment, you can contact the Mobile Service or issue an emergency call using buttons in the interior rearview mirror.

When an emergency call is initiated, a telephone connection is established with the general emergency call center.

In vehicles with activated BMW Assist function, a telephone connection is set up to the BMW Assist emergency call center. If the current location of your vehicle can be determined, this location is transmitted to the BMW Assist emergency call center.

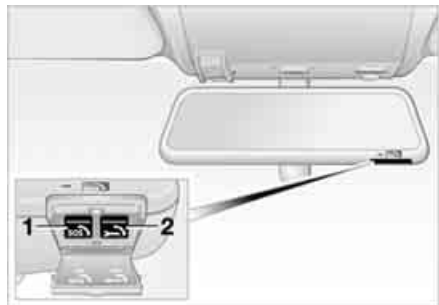

Fold down the cover.

- 1 Emergency call
- 2 Mobile Service

Requirements for initiating an emergency call or contacting Mobile Service:

- ▷ The car phone is registered with a mobile network
- ▷ The emergency call system is operational.

Initiating an emergency call*

Press button 1 for at least 2 seconds.

The indicator lamp above the buttons lights up. As soon as a telephone connection has been set up to the main emergency call center, the indicator lamp flashes.

If the indicator lamp is flashing but you cannot hear the emergency call center, you may still be heard by the emergency call center.



For technical reasons, the emergency call function cannot be guaranteed in certain unfavorable conditions. ◀

If certain requirements are met, an emergency call is automatically initiated after a serious accident. The automatic emergency call will not be hindered by pressing the button.

Mobile Service*

To establish contact with the BMW Group's Mobile Service:

Press button 2 for at least 2 seconds.

The indicator lamp above the buttons lights up. As soon as a telephone connection has been set up with the Mobile Service, the indicator lamp flashes.

Depending on the country you are in, your vehicle's current location will also be transmitted if your vehicle is equipped with an activated BMW Assist function.

Jump-starting

When your battery is discharged, you can use two jumper cables to start your vehicle with power from the battery in a second vehicle. You can also use the same method to help start another vehicle. Use only jumper cables with fully insulated handles on the terminal clamps.

 Do not touch high-voltage wiring and cables on a running engine. Contact with components carrying high voltage can be harmful or fatal. Carefully observe the following instructions to avoid personal injury and/or damage to one or both vehicles. ◀

Preparations

1. Check whether the battery of the support vehicle has 12 volts and approximately the same capacity – measured in Ah. This information is provided on the battery
2. Stop the engine of the support vehicle
3. Switch off all electrical components in both vehicles.

 Make absolutely certain that there is no contact between the bodywork of the two vehicles, otherwise there is a short circuit hazard. ◀

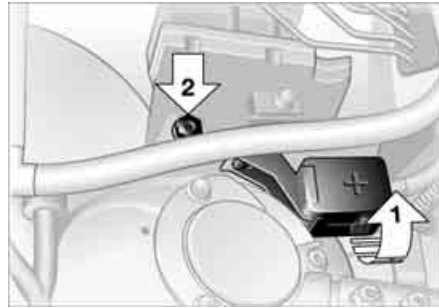

Connecting the jumper cables

 Always adhere to this sequence when connecting jumper cables; failure to observe this procedure can lead to sparks at the battery terminals and pose an injury hazard. ◀

The auxiliary jump-starting terminal located in your BMW's engine compartment acts as the positive battery terminal. Refer to the engine compartment overview on page 124. The cover of this auxiliary terminal is marked with a +.

1. Open the cover of the BMW auxiliary jump-starting terminal. Do so by pulling the tab – see arrow 1

2. Connect one terminal clamp of the plus/+ jumper cable to the positive terminal of the battery or to an auxiliary jump-starting terminal of the support vehicle
3. Connect the second terminal clamp of the plus/+ jumper cable to the positive terminal of the battery or to an auxiliary jump-starting terminal of the vehicle to be started
4. Your BMW is equipped with a special nut – see arrow 2 – to serve as the ground or negative terminal. Attach a terminal clamp of the minus/- jumper cable to the negative terminal of the support vehicle's battery or to a suitable ground on its engine or bodywork
5. Attach the second terminal clamp of the minus/- jumper cable to the negative terminal of the battery or to a suitable ground on the engine or bodywork of the vehicle to be started.

Starting the engine

1. Start the engine of the support vehicle and let it run for several minutes at a slightly elevated engine idle speed

2. Start the engine of the other vehicle as usual.

If the first start attempt is not successful, wait a few minutes before another attempt in order to allow the discharged battery to recharge

3. Allow the engines to run for several minutes
4. Disconnect the jumper cables in reverse sequence.

Have the battery recharged at your BMW center as required.

 Do not use spray starter fluids to start the engine. ◀

Towing the vehicle

 Always observe all applicable towing laws and regulations. ◀

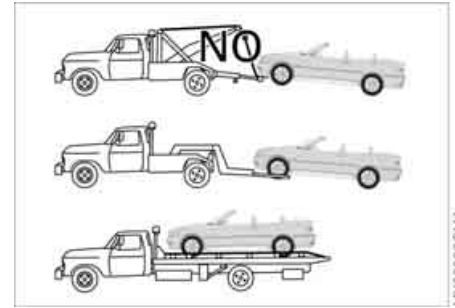

Towing with a commercial tow truck

- ▷ Use wheel lift or flat bed carrier
- ▷ Do not tow with sling-type equipment.

 Never allow passengers to ride in a towed vehicle for any reason. Never attach tie-down hooks, chains, straps, or tow hooks to tie rods, control arms, or any other part of the vehicle suspension, as severe damage to these components will occur, possibly leading to accidents. ◀

Towing the vehicle

Towing the vehicle with the front axle raised

Vehicles with sequential manual gear-box SMG:

While the ignition is on move the selector lever to position N, then turn off the ignition.

Towing eyelet

The screw-in towing eyelet is in the luggage compartment under the floor mat and must remain in the vehicle. It can be attached at the front or rear of the vehicle.

The towing eyelet should not be used to pull a vehicle out of deep snow, mud, sand, etc.

Comply with all applicable towing laws and regulations at all times.

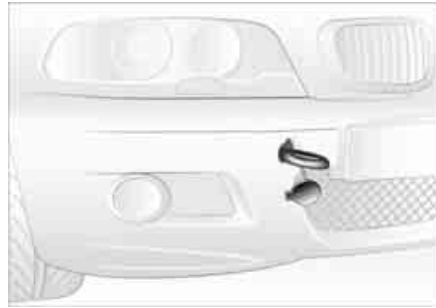

Access to tow sockets

Front:

Press out the cover panel with a screwdriver at the top of the recess.

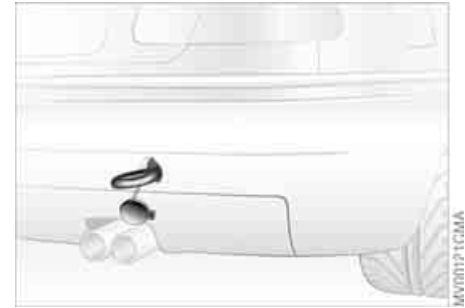

Rear:

Press out the cover panel with a screwdriver at the top of the recess.

⚠ Use only the towing eyelet supplied with the vehicle and screw it in firmly until it stops. Use the towing eyelet for towing on paved roads only. If you do not follow these instructions, the towing eyelet could be torn out and vehicle damage could occur. Do not tow the vehicle by any components of the running gear, or lash them down in any way. If you do, the components could be damaged, possibly leading to accidents. ◀

150 **Towing the vehicle**

 Keep the vehicles in line and avoid towing at an offset angle. Ensure that the towing strap connecting the two vehicles is tight, with no slack, before starting off. ◀

Use only a nylon towing strap to tow the vehicle, since the inherent resilience of this material helps protect both vehicles from sudden jerking movements.

 The towed vehicle should always be the lighter of the two vehicles. If this is not the case, it will not be possible to control vehicle handling. ◀

Tow-starting

For instructions on jump-starting, refer to page [147](#).

Never attempt to use your vehicle to push another vehicle, since damage to the energy-absorbing bumpers could result.

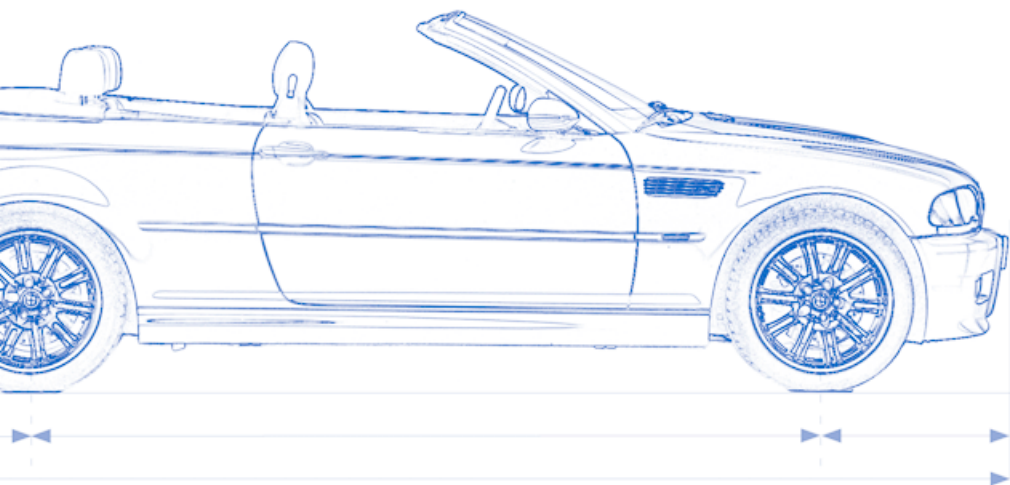

Overview

Controls and features

Operation, maintenance

Owner service procedures

Technical data

Index

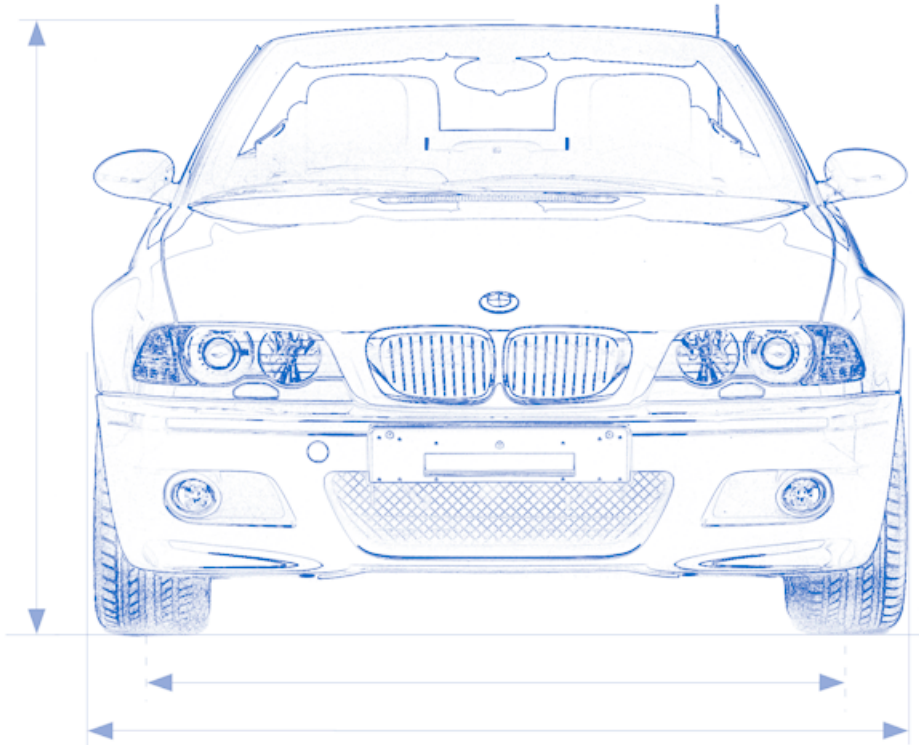

Overview

Controls

Maintenance

Repairs

Data

Index

154 **Engine data**

Displacement	cu in/cm ³	198.1/3,246
Number of cylinders		6
Max. power output at engine speed	hp rpm	333 7,900
Maximum torque at engine speed	lb ft/Nm rpm	262/355 4,900
Compression ratio	ϵ	11.5
Stroke	in/mm	3.58/91
Bore	in/mm	3.43/87
Fuel mixture preparation		Digital electronic engine-management system

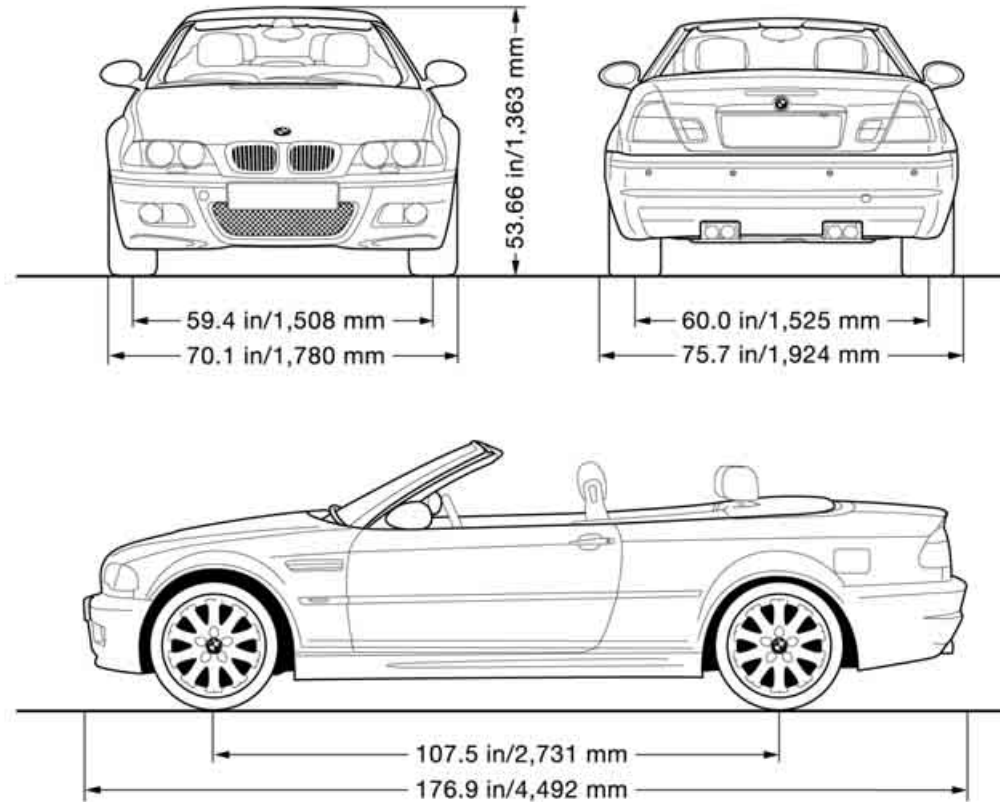

Minimum turning circle dia.: 361 feet/11.0 m.

156 **Weights**

Curb weight	lbs/kg	3,782/1,715
Approved gross vehicle weight	lbs/kg	4,608/2,090
Approved front axle load	lbs/kg	2,183/990
Approved rear axle load	lbs/kg	2,513/1,140
Permissible roof load for the hardtop	lbs/kg	165/75
Luggage compartment capacity	cu ft/l	9.2/260
with the convertible top compartment raised	cu ft/l	10.6/300

Approved axle loads and approved gross vehicle weight must never be exceeded.

			Notes
Fuel tank	gal./liters	approx. 16.6/63	Fuel specification, refer to page 25
Reserve	gal./liters	approx. 2.1/8	
Windshield washer system/ Headlamp cleaning system	quarts/liters	approx. 5.6/5.3	Specifications, refer to page 126
Engine with oil filter change	quarts/liters	approx. 5.8/5.5	Specifications, refer to page 127
Manual transmission	quarts/liters	approx. 1.9/1.8	Oil change during running-in check and during each inspection II
Differential	quarts/liters	approx. 1.2/1.1	Oil change during running-in check and during each inspection II

A B C
P Q R



Overview

Controls and features

Operation, maintenance

Owner service procedures

Technical data

Index

Overview

Controls

Maintenance

Repairs

Data

Index

Everything from A to Z

A

ABS Antilock Brake System [114](#)
indicator lamp [19](#)
Accessories, refer to For your own safety [5](#)
Accident, refer to Emergency call [146](#)
Activated-charcoal filter [100](#)
Adding brake fluid [129](#)
Adding liquid sealant
 Mobility system [142](#)
Additional sources of information [4](#)
Air conditioning mode
 automatic climate control [98](#)
Air distribution
 automatic climate control [98](#)
Air distribution, individual [98](#)
Air outlets, refer to Ventilation [96](#)
Air pressure, refer to Tire inflation pressure [25](#), [118](#)
Air recirculation, refer to Recirculated-air mode [99](#)
Air supply
 automatic climate control [98](#)
Air, drying, refer to Air conditioning mode [98](#)

Airbags [55](#)
 deactivating [55](#)
 indicator lamp [18](#), [57](#)
 sitting safely [46](#)
Airing out, refer to Ventilation [96](#)
AKI, refer to Fuel specifications [25](#)
All-season tires, refer to Winter tires [122](#)
Alternative oils [127](#)
Antifreeze
 coolant [128](#)
 washer fluid [126](#)
Antilock Brake System (ABS) [114](#)
 indicator lamp [19](#)
Anti-theft system [30](#)
Approved axle loads, refer to Weights [156](#)
Approved gross weight, refer to Weights [156](#)
Armrest [101](#)
Artificial leather, refer to the Caring for your vehicle brochure
Ashtray
 front [103](#)
 rear [103](#)
Assistant systems, refer to Dynamic Stability Control (DSC) [86](#)

AUC Automatic recirculated-air control [99](#)
AUTO program, refer to Automatic air distribution [98](#)
Automatic
 air distribution [98](#)
 air supply [98](#)
 cruise control [77](#)
 headlamp control [91](#)
Automatic car wash, refer to the Caring for your vehicle brochure
Automatic climate control [96](#)
Automatic curb monitor [52](#)
Automatic dimming, interior rearview mirror [54](#)
Automatic recirculated-air control (AUC) [99](#)
Automatic windshield washer, refer to Rain sensor [76](#)
Average fuel consumption [84](#)
Average speed [84](#)
Axle loads, refer to Weights [156](#)

B

Backrest
 unlocking [49](#)

Backrest, refer to Seat adjustment [47](#)
Backup lamps [69](#)
 bulb replacement [139](#)
Bandages, refer to First-aid kit [23](#)
Bar, towing [149](#)
Battery [144](#)
 charge [144](#)
 disposal [144](#)
 indicator lamp [18](#)
 jump-starting [147](#)
 remote control [30](#), [31](#)
Battery charge current [18](#)
Battery charge indicator lamp [18](#)
Belts, refer to Safety belts [50](#)
Beverage holders [102](#)
Blower
 automatic climate control [98](#)
BMW Maintenance System [130](#)
BMW sports seat [47](#)
Bore, refer to Engine data [154](#)
Bottle holders, see Beverage holders [102](#)
Brake fluid [129](#)
 indicator lamp [18](#), [129](#)
 level [129](#)

- Brake force display [90](#)
 - Brake hydraulics [114](#)
 - Brake lamps
 - bulb replacement [139](#)
 - indicator lamp, defective lamp [81](#)
 - Brake lights
 - brake force display [90](#)
 - Brake pads [115](#)
 - brake fluid level [18](#), [114](#), [129](#)
 - breaking in [112](#)
 - disc brakes [114](#)
 - Brake rotors
 - brake system [114](#)
 - breaking in [112](#)
 - Brake system
 - brake pads, indicator lamp [19](#)
 - Brake wear warning
 - indicator lamp [19](#)
 - Brakes
 - ABS [114](#)
 - brake fluid [129](#)
 - breaking in [112](#)
 - indicator/warning lamp [18](#), [19](#)
 - parking brake [68](#)
 - Break-in procedures [112](#)
 - Bulb replacement [137](#)
 - Bulb replacement, refer to Lamps and bulbs [137](#)
 - Buttons in steering wheel [22](#)
- ## C
- California Proposition 65 warning [132](#)
 - Can holders, see Beverage holders [102](#)
 - Capacities [157](#)
 - Car battery [144](#)
 - Car care, refer to the Caring for your vehicle brochure
 - Car keys, refer to Keys [30](#)
 - Car radio, refer to the Owner's Manual for Radio
 - Car telephone
 - preparation [102](#)
 - Car telephone, refer to the separate Owner's Manual
 - Car vacuum cleaner, connecting [103](#)
 - Car wash, refer to the Caring for your vehicle brochure
 - Carpet care, refer to the Caring for your vehicle brochure
 - Cassette operation, refer to the Owner's Manual for Radio/Onboard Computer
 - CBC Cornering Brake Control [114](#)
 - warning lamp [19](#)
 - CD changer, refer to the Owner's Manual for Radio/Onboard Computer
 - CD operation, refer to the Owner's Manual for Radio/Onboard Computer
 - Cellular phone [102](#)
 - Center armrest
 - front [101](#)
 - Center high-mount brake lamp
 - bulb replacement [140](#)
 - Central locking system [30](#)
 - button [34](#)
 - passenger compartment [34](#)
 - Check Control [81](#)
 - Check Gas Cap
 - indicator lamp [19](#)
 - Child seats, refer to Child-restraint systems [58](#)
 - Child-restraint mounting system LATCH [60](#)
 - Child-restraint systems [58](#)
 - Cigarette lighter [103](#)
 - Cigarette lighter socket [103](#)
 - Cleaning chrome parts, refer to the Caring for your vehicle brochure
 - Cleaning light alloy wheels, refer to the Caring for your vehicle brochure
 - Cleaning position, convertible top [44](#)
 - Cleaning the vehicle, refer to the Caring for your vehicle brochure
 - Cleaning windshield [77](#)
 - Clock [82](#)
 - 12-/24-hour mode [82](#)
 - setting, refer also to the Owner's Manual for Radio/Onboard Computer
 - Closing
 - from inside [34](#)
 - from outside [31](#)
 - Clothes hooks [113](#)
 - Clutch
 - breaking in [113](#)
 - Cockpit [14](#)
 - Code, refer to the Owner's Manual for Radio/Onboard Computer
 - Coin box [102](#)
 - Cold start, refer to Starting the engine [66](#)
 - Compact disc operation, refer to the Owner's Manual for Radio/Onboard Computer
 - Compression ratio, refer to Engine data [154](#)
 - Computer [83](#)

Everything from A to Z

- Condensation, refer to Air conditioning mode [98](#)
 - Configuring settings, refer to Vehicle Memory, Key Memory [64](#)
 - Connecting a vacuum cleaner, refer to Cigarette lighter [103](#)
 - Consumption, refer to Average fuel consumption [84](#)
 - Control elements, refer to Cockpit [14](#)
 - Convenience operation
 - from outside [33](#)
 - glass sunroof [19](#)
 - windows [31](#)
 - Convertible top [39](#)
 - cleaning position [44](#)
 - convenience operation [31](#), [33](#)
 - electrical malfunction [42](#)
 - emergency operation [42](#)
 - indicator lamps [41](#)
 - opening and closing [40](#)
 - remote control [31](#)
 - Coolant [128](#)
 - indicator lamp [19](#), [80](#)
 - level [128](#)
 - temperature gauge [80](#)
 - Coolant water, refer to Coolant [128](#)
 - Cooling, refer to Temperature [98](#)
 - Copyright [4](#)
 - Cornering Brake Control (CBC) [114](#)
 - warning lamp [19](#)
 - Correct tires [121](#)
 - Cruise control [77](#)
 - indicator lamp [20](#)
 - Cup holders, see Beverage holders [102](#)
 - Curb weight, refer to Weights [156](#)
 - Cylinders, refer to Engine data [154](#)
- D**
- Dashboard, refer to Cockpit [14](#)
 - Data
 - capacities [157](#)
 - dimensions [155](#)
 - engine [154](#)
 - technical [154](#)
 - weights [156](#)
 - Daytime driving lamps [91](#)
 - DBC Dynamic Brake Control [19](#), [114](#)
 - Deep water, refer to Water on roadways [113](#)
 - Defrost position, refer to Defrosting windows [98](#)
 - Defrosting and demisting windows
 - automatic climate control [98](#)
 - Defrosting windows [98](#)
 - Defrosting windshield, refer to Defrosting windows [98](#)
 - Demisting windows
 - automatic climate control [98](#)
 - Determining the maximum load [106](#)
 - Differential
 - breaking in [112](#)
 - Digital clock [82](#)
 - Dimensions [155](#)
 - Dipstick, engine oil [126](#)
 - Disc brakes [114](#)
 - Displacement, refer to Engine data [154](#)
 - Display lighting, refer to Instrument lighting [92](#)
 - Displays, refer to Instrument cluster [16](#)
 - Disposal
 - oil [127](#)
 - vehicle battery [144](#)
 - Distance warning, refer to Park Distance Control (PDC) [85](#)
 - Door key [30](#)
 - Door lock [33](#)
- Doors**
 - emergency operation [33](#)
- Draft-free ventilation [99](#)
 - Drivelogic [73](#)
 - Driving light, refer to Parking lamps/Low beams [91](#)
 - Driving notes [113](#)
 - Dry air, refer to Air conditioning mode [98](#)
 - DSC Dynamic Stability Control [86](#)
 - indicator lamp [19](#), [86](#)
 - DTC Dynamic Traction Control
 - indicator lamp [19](#)
 - Dynamic Brake Control (DBC) [19](#), [114](#)
 - indicator lamp [19](#)
 - Dynamic Stability Control (DSC) [19](#), [86](#)
 - Dynamic Traction Control (DTC)
 - indicator lamp [19](#), [86](#)
- E**
- Easy entry, refer to Entering the rear [49](#)
 - Electric power windows [38](#)
 - Electrical accessories, failure [145](#)

- Electrical malfunction
 - door lock [33](#)
 - driver's door [33](#)
 - fuel filler door [24](#)
 - luggage compartment lid [35](#)
- Electronic Stability Program (ESP), refer to Dynamic Stability Control (DSC) [86](#)
- Emergency call [146](#)
- Emergency operation
 - doors [33](#)
 - driver's door [33](#)
 - fuel filler door [24](#)
 - luggage compartment lid [35](#)
- Emergency release
 - luggage compartment lid [36](#)
- Engine
 - breaking in [112](#)
 - data [154](#)
 - electronics [19](#)
 - indicator lamp [19](#)
 - speed [79](#), [154](#)
 - starting [66](#)
 - switching off [68](#)
- Engine compartment [124](#)
- Engine coolant [128](#)
 - refilling [128](#)
- Engine oil
 - adding [127](#)
 - additives, refer to Adding engine oil [127](#)
 - alternative oils [127](#)
 - capacity [157](#)
 - consumption [126](#)
 - dipstick [126](#)
 - indicator/warning lamp [19](#)
 - quality [127](#)
 - specified oils [127](#)
 - temperature gauge [79](#)
 - types [127](#)
- Engine oil level [19](#)
 - check [126](#)
 - indicator/warning lamp [18](#)
- Engine oil pressure
 - indicator/warning lamp [18](#)
- Engine oil temperature [79](#)
- Engine output, refer to Engine data [154](#)
- Engine speed [79](#), [154](#)
- Entering the rear [49](#)
- Equipment range, refer to the Service and Warranty Information Booklet for US models / Warranty and Service Guide Booklet for Canadian models
- ESP Electronic Stability Program, refer to Dynamic Stability Control (DSC) [86](#)
- Exterior mirrors [53](#)
- Eyeglasses
 - compartment [102](#)
- Eyelet, towing [149](#)
- F**
- Fastening the safety belts [50](#)
- Fault displays [81](#)
- Filling the windshield washer reservoir [157](#)
- First aid, refer to First-aid kit [23](#)
- First-aid kit [23](#)
- Flat tire [140](#)
 - Flat Tire Monitor [87](#)
 - Mobility system [140](#)
 - repairing [140](#)
- Flat Tire Monitor [87](#)
 - activating/deactivating [89](#)
 - indicator lamp [18](#), [19](#), [89](#)
- Flat tire, refer to Tire condition [118](#)
- Fluid reservoir for washer systems [126](#)
- Fog lamps [93](#)
 - indicator/warning lamp [20](#)
- Folding down convertible top compartment panel [37](#)
- Follow me home lamps [91](#)
- Footbrake, refer to General driving notes [113](#)
- Front airbags [55](#)
- Front fog lamps [93](#)
 - indicator/warning lamp [20](#)
- Front seat adjustment [47](#)
- Fuel
 - display [80](#)
 - specifications [25](#)
 - volume [157](#)
- Fuel consumption
 - display [84](#)
- Fuel display, refer to Fuel gauge [80](#)
- Fuel filler door [24](#)
 - release following an electrical malfunction [24](#)
- Fuel level indicator, refer to Fuel gauge [80](#)
- Fuel mixture preparation [154](#)
- Fuel reserve indicator, refer to Fuel gauge [80](#)
- Fuel tank capacity [157](#)
- Fuses [145](#)
- G**
- Gasoline consumption, refer to Average fuel consumption [84](#)
- Gasoline, refer to Fuel specifications [25](#)
- Gear indicator [71](#)
- Gearbox
 - manual transmission [69](#)

Everything from A to Z

Gearbox malfunction
sequential M gearbox with
Drivelogic 74

Gearbox, sequential 70

Gearshift lever
manual transmission 69
sequential M gearbox with
Drivelogic 70

General driving notes 113

Glove compartment 101

Gradient assistance 73

Grills, refer to Ventilation 96

Gross weight, refer to
Weights 156

H

Handbrake, refer to Parking
brake 68

Hands-free system 102

Hardtop 115

Hardtop preparation 115

Hardtop, refer to the sepa-
rate Owner's Manual 115

Hazard warning flashers 14

Hazard warning triangle 23

Head restraints 48

Headlamp cleaning system
cleaning headlamps 77
washer fluid 126, 157

Headlamp control, auto-
matic 91

Headlamp flasher 92
indicator lamp 21

Headlamps
bulb replacement 137
care, refer to the Caring
for your vehicle brochure

Heated mirrors 53

Heated rear window
automatic climate
control 99

Heated seats 52

Heating
exterior mirrors 53
rear window 99
seats 52

Heating and ventilation 96

Heavy loads, refer to Cargo
loading 107

Height adjustment
seats 47
steering wheel 53

Height, refer to
Dimensions 155

High beams 75, 92
bulb replacement 137
headlamp flasher 92
indicator lamp 21

Holder for beverages 102

Hood release 123

Horn 14

Hydraulic brake assistant,
refer to DBC 114

Hydraulic system
brakes 114
Hydroplaning 113

I

Ice warning 83

Ignition 65

Ignition key 30
positions 65

Ignition lock 65

Imprint 4

Indicator lamps 18

Indicator/warning lamp
airbags 18
brakes 18, 19

Check Gas Cap 19

convertible top 41

coolant 19, 80

DSC 19

Flat Tire Monitor
18, 19, 89

fog lamps 20

Please fasten safety
belts 18

reserve 80

rollover protection
system 19

Service Engine Soon 19

Individual air distribution 98

Individual settings, refer to
Vehicle Memory, Key
Memory 64

Inflation pressure monitor-
ing, refer to Flat Tire Moni-
tor 87

Inflation pressure, tires
25, 118

INSPECTION 81

Instrument cluster 16

Instrument lighting 92

Instrument panel 14

Interface socket for onboard
diagnostics (OBD) 132

Interior lamps 93

remote control 32
Interior rearview mirror
automatic dimming
feature 54

Interior temperature
adjusting 98

Intermittent
mode, wipers 76

Interval
display, service 81

J

Jump-starting 147

K

Key Memory 64

Keys 30
with remote control 30

- L**
- Lamp defect [137](#)
- Lamps
 - reading lamps [93](#)
- Lamps and bulbs [137](#)
- Lashing down loads, refer to
 - Cargo loading [106](#)
- Lashing eyelets, refer to
 - Securing cargo [107](#)
- Lashing fittings, refer to
 - Securing cargo [107](#)
- LATCH child-restraint mounting system [60](#)
- Leather care, refer to the
 - Caring for your vehicle brochure
- LEDs light-emitting diodes [94](#)
- Length, refer to
 - Dimensions [155](#)
- License plate lamp
 - bulb replacement [140](#)
- Light switch [91](#)
- Light-emitting diodes (LEDs) [94](#)
- Lighter [103](#)
- LIGHTS ON warning [91](#)
- Lights, refer to Parking lamps/Low beams [91](#)
- Load, refer to Cargo loading [106](#)
- Loading
 - vehicle [106](#)
- Load-securing devices [107](#)
- Lock buttons on doors, refer to Locking [34](#)
- Lock, steering wheel [65](#)
- Locking
 - from inside [34](#)
 - from outside [31](#), [33](#)
- Locking and unlocking doors
 - from inside [34](#)
 - from outside [31](#), [33](#)
- Low beams [91](#)
 - automatic [91](#)
 - bulb replacement [137](#)
 - indicator lamp, defective lamp [81](#)
- Luggage compartment [37](#)
 - capacity [156](#)
 - emergency operation, refer to Manual operation [35](#)
 - floor panel [37](#)
 - increase volume [37](#)
 - lid [35](#)
 - lighting [35](#)
 - opening from outside [35](#)
 - opening, remote control [32](#)
 - opening/closing, refer to Luggage compartment lid [35](#)
 - remote control [32](#)
 - securing separately [35](#)
 - volume [156](#)
- Luggage compartment lid [35](#)
 - emergency operation [35](#)
 - emergency release [36](#)
 - indicator lamp [81](#)
 - opening from inside the vehicle [35](#)
 - opening from outside [35](#)
 - remote control [32](#)
 - unlocking manually [35](#)
- Luggage rack, refer to Roof-mounted luggage rack [108](#)
- Lumbar support [48](#)
- M**
- M Engine dynamics control [90](#)
- M Mobility system [140](#)
- M+S tires, refer to Winter tires [122](#)
- Maintenance [81](#), [130](#)
- Maintenance system [130](#)
- Making telephone calls, refer to the telephone Owner's Manual
- Malfunction
 - convertible top [42](#)
 - door lock [33](#)
 - fuel filler door [24](#)
- Malfunction displays [81](#)
- Manual operation
 - convertible top [42](#)
 - door lock [33](#)
 - driver's door [33](#)
 - fuel filler door [24](#)
 - luggage compartment lid [35](#)
 - power convertible top [42](#)
- Manual transmission [69](#)
- Master keys
 - with remote control [30](#)
- Maximum speed
 - with winter tires [122](#)
- MC operation, refer to the Owner's Manual for Radio/Onboard Computer

Everything from A to Z

MD operation, refer to the Owner's Manual for Radio/Onboard Computer

Memory, refer to Seat and mirror memory [51](#)

Memory, refer to Vehicle Memory, Key Memory [64](#)

Microfilter
automatic climate control [100](#)

Microphone, refer to Cellular phone [102](#)

Mini disc operation, refer to the Owner's Manual for Radio/Onboard Computer

Mirrors [53](#)
automatic curb monitor [52](#)
heated [53](#)
memory, refer to Seat and mirror memory [51](#)

Mobile Service [146](#)

Mobility system [140](#)

Modifications, technical, refer to For your own safety [5](#)

Multifunction steering wheel [22](#)

Multifunction switch
turn signal indicator/headlamp flasher [75](#)
washer/wiper system [76](#)

N

Navigation system, refer to the Owner's Manual for Radio/Onboard Computer

Neck restraints, refer to Head restraints [48](#)

Nets [101](#)

Nozzles, refer to Ventilation [96](#)

Nylon rope, refer to Towing the vehicle [149](#)

O

OBD interface socket [132](#)

Odometer [79](#)

Oil
additives, refer to Adding engine oil [127](#)
alternative oils [127](#)
capacity [157](#)
dipstick [126](#)
quality [127](#)
specified engine oils [127](#)

Oil change interval, refer to Service interval display [130](#)

Oil change intervals, refer to the Service and Warranty Information Booklet for US models / Warranty and Service Guide Booklet for Canadian models

Oil filter change [157](#)

Oil level
checking [126](#)
indicator lamp [18](#)

Oil pressure
indicator lamp [18](#)

OIL SERVICE [81](#)

Oil temperature [79](#)

Oil types [127](#)

Old batteries, refer to Disposal [144](#)

Onboard computer [83](#)

Onboard computer, refer also to the Owner's Manual for Onboard Computer

Onboard tool kit [136](#)

Opening and closing
from inside [34](#)
from outside [31](#)
via door lock [33](#)
via remote control [31](#)

Outlets, ventilation [96](#)

Outside temperature display [83](#)

changing unit of measure [83](#)

P

Paintwork care, refer to the Caring for your vehicle brochure

Park Distance Control (PDC) [85](#)

Parking aid, refer to Park Distance Control (PDC) [85](#)

Parking brake [68](#)
indicator lamp [18](#)

Parking lamps [91](#)
bulb replacement [137](#)

Parking lamps/Low beams [91](#)

Parts and accessories, refer to Your individual vehicle [5](#)

Passenger-side exterior mirror tilt function [52](#)

PDC Park Distance Control [85](#)

Plastic, refer to the Caring for your vehicle brochure

Please fasten safety belts indicator lamp [18](#)

Pollen, refer to Microfilter/activated-charcoal filter [100](#)

Power output, refer to Engine data [154](#)

Power seat [47](#)

Power socket, cigarette lighter [103](#)

Power windows
electric [38](#)

Pressure monitoring, tires
Flat Tire Monitor [87](#)

Pressure, tires [25](#), [118](#)
inflating with Mobility system [143](#)

Protective function
electric power windows [39](#)

R

Radio remote control key,
refer to Master key with
remote control [30](#)

Radio, refer to the Owner's
Manual for Radio

Rain sensor [76](#)

Raising the floor panel [37](#)

Range [84](#)

Reading lamps

rear [94](#)

Rear lamps

bulb replacement [139](#)

indicator lamp, defective
lamp [81](#)

Rear window heating

automatic climate
control [99](#)

Rear-entry assist [49](#)

Rearview mirror [53](#)

Receiving assistance [146](#)

Recirculated-air mode
automatic climate
control [99](#)

Recirculating the air, refer to
Recirculated-air mode [99](#)

Reclining seat, refer to Seat
adjustment [47](#)

Refueling [24](#)
fuel filler door [24](#)

Releasing
hood [123](#)

Remaining distance to ser-
vice [81](#)

Remaining distance, refer to
Range [84](#)

Remote control [31](#)
luggage compartment
lid [32](#)

malfunction [32](#)

Replacement key [31](#)

Replacing lamps, refer to
Lamps and bulbs [137](#)

Replacing tires [119](#)

Reporting safety defects [7](#)

Restraint systems
for children [58](#)

Restraint systems, refer to
Safety belts [50](#)

Reverse gear
manual transmission [69](#)

Rollover protection
system [62](#)
indicator lamp [19](#)

lowering [62](#)

Roof load capacity [156](#)

Roof-mounted luggage
rack [108](#)

Rope, refer to Towing the
vehicle [149](#)

S

Safe seating position [46](#)

Safety belt height adjust-
ment [50](#)

Safety belts [50](#)
height adjustment [50](#)
seat-integrated safety belt
system [49](#)

sitting safely [46](#)

warning lamp [18](#)

Safety systems, refer to
Antilock Brake
System [114](#)

Dynamic Stability Control
(DSC) [86](#)

Screwdriver, refer to
Onboard tool kit [136](#)

Seat adjustment [47](#)
BMW sports seat [47](#)
lumbar support [47](#), [48](#)

power seats [47](#)

Seat belt tensioner, refer to
Safety belts [50](#)

Seat heating [52](#)

Seat memory, refer to Seat
and mirror memory [51](#)

Seat positions, storing [51](#)

Seats [47](#)

Securing cargo [107](#)

Securing child-restraint sys-
tem [60](#)

Securing the vehicle
from inside [34](#)
from outside [31](#), [33](#)

Selector lever
sequential M gearbox with
Drivelogic [70](#)

Selector lever positions
sequential M gearbox with
Drivelogic [70](#)

Sequential M gearbox with
Drivelogic [70](#)
indicator lamp [19](#), [74](#)

Service and Warranty Infor-
mation Booklet [130](#)

SERVICE ENGINE SOON
warning lamp [19](#)

Service interval display
[81](#), [130](#)

Shift lights [74](#)

Shift paddles [71](#)

Side airbags [55](#)

Side turn signal indicators
bulb replacement [138](#)

Sitting safely
with airbags [46](#)
with safety belts [46](#)

Size [155](#)

Ski bag [104](#)

Slipstream deflector, refer to
Wind deflector [44](#)

Everything from A to Z

SMG Drivelogic [70](#)
Smokers' package, refer to
 Ashtray [103](#)
Snow chains [122](#)
SOS, refer to Emergency
 call [146](#)
Spare key [30](#)
Special oils [127](#)
Special oils, refer to Speci-
 fied engine oils [127](#)
Specified engine oils [127](#)
Specified oils [127](#)
Speed
 winter tires [122](#)
Speed gauge, refer to
 Speedometer [16](#)
Speedometer [16](#)
Sport mode [90](#)
Sports seat [47](#)
Stability control, refer to
 Dynamic Stability Control
 (DSC) [86](#)
Standing lamps [92](#)
 bulb replacement [137](#)
Starting difficulties
 jump-starting [147](#)
 temperature [66](#)
Starting help DSC [86](#)
Starting the engine [66](#)
Starting, refer to Starting the
 engine [66](#)

Status of the Owner's Man-
 ual [5](#)
Steering wheel lock [65](#)
Steering wheel, adjusting [53](#)
Storage compartments [101](#)
Storage nets [101](#)
Storing seat positions,
 refer to Seat and mirror
 memory [51](#)
Storing tires [121](#)
Stroke, refer to Engine
 data [154](#)
Surface ice, refer to Ice
 warning [83](#)
Switches, refer to
 Cockpit [14](#)
Switching off
 engine [68](#)
 vehicle [68](#)
Symbols [4](#)
T
Tachometer [79](#)
Tail lamps
 bulb replacement [139](#)
Tail lamps, refer to Rear
 lamps [139](#)
Tank capacity, refer to Fuel
 tank capacity [157](#)
Tank indicator, refer to Fuel
 gauge [80](#)
Technical data [154](#)

Technical modifications [5](#)
Technical modifications,
 refer to For your own
 safety [5](#)
Telephone hookup [102](#)
Telephone, refer to the sep-
 arate Owner's Manual
Television, refer to the
 Owner's Manual for
 Onboard Computer
Temperature
 automatic climate
 control [98](#)
Temperature adjustment [98](#)
Temperature display
 engine coolant [80](#)
 ice warning [83](#)
 outside temperature [83](#)
 setting units [83](#)
Temperature layering [99](#)
Tempomat, refer to Cruise
 control [77](#)
Thigh support area, adjust-
 ing [47](#)
Third brake lamp, refer to
 Center high-mount brake
 lamp [140](#)
Three-point safety belt [50](#)
Tilting passenger-side exte-
 rior mirror [52](#)
Time [82](#)

Tire pressure monitoring,
 refer to Flat Tire
 Monitor [87](#)
Tire replacement [119](#)
Tires
 age [120](#)
 breaking in [112](#)
 condition [118](#), [122](#)
 damage [118](#)
 flat [140](#)
 inflation pressure [25](#), [118](#)
 replacing [119](#)
 size, refer to Wheel and
 tire combinations [121](#)
 storing [121](#)
 tread [118](#)
 treadwear indicator,
 refer to Tire tread – tire
 damage [118](#)
 winter tires [122](#)
Tools, refer to Onboard tool
 kit [136](#)
Torque
 engine [154](#)
Tow sockets for towing eye-
 let [149](#)
Towing bar [149](#)
Towing eyelet [149](#)
Towing rope [149](#)
Towing the vehicle [149](#)
Track width, refer to Dimen-
 sions [155](#)

Transport securing devices,
refer to Securing
cargo 107

Transporting children
safely 58

Trap protection
electric power windows 39

Tread depth, refer to Tire
tread 118

Treadwear indicator in the
tires, refer to Tire tread –
tire damage 118

Treadwear, tires 118

Trip distance recorder, refer
to Trip odometer 79

Trip meter, refer to Trip
odometer 79

Trip odometer 79

Trunk lid, refer to Luggage
compartment lid 35

Trunk lighting, refer to
Luggage compartment
lighting 35

Turn signal indicator 75
bulb replacement 138
indicator lamp 20

Turn signal indicator, side
bulb replacement 138

Turning circle, refer to
Dimensions 155

TV function, refer to the
Owner's Manual for
Onboard Computer

U

Underbody protection, refer
to the Caring for your vehi-
cle brochure

Uniform Tire Quality
Grading 120

Units

average fuel
consumption 84
temperature 83

Unlocking

from inside 34
from outside 31, 33

Upshift indicator, refer to
Shift Lights 74

Using antifreeze 128

V

Vehicle

battery 144
break-in procedures 112
dimensions 155
loading 106
starting 66

switching off 68
washing, refer to the Car-
ing for your vehicle bro-
chure 76

weight 156

Vehicle Memory 64

Vehicle weight 156

Ventilation 96

draft-free 99

Viscosity 127

Voice Input System 22

Voice recognition, refer to
separate Owner's Manual

Volume

luggage compartment 156

W

Warning and indicator
lamps 18

Warning lamp 'Please fas-
ten safety belts' 18

Warning messages 81

Warranty and Service Guide
Booklet 130

Warranty, refer also to sepa-
rate booklet 7

Washer fluid
adding 126, 157

Washer fluid reservoir 126
volume 126

Washer jets, refer to Wind-
shield washer jets 77

Washer/wiper system 76, 77
washer fluid 126

Waste tray, refer to
Ashtray 103

Water on roadways, deep
water 113

Weights 156

Wheel and tire
combinations 121

Wheelbase, refer to Dimen-
sions 155

Wheels and tires 121

Wheelslip control DSC 86

Width, refer to
Dimensions 155

Wind deflector 44

Window condensation
removing 98

Windows
convenience operation
31, 33

remote control 31

Windshield washer
nozzles 77

Everything from A to Z

Windshield washer reservoir

volume, see

Capacities [157](#)

Windshield wiper blades,

replacing [136](#)

Windshield wipers, refer to

Washer/wiper system [76](#)

Winter tires [122](#)

condition [122](#)

storing [121](#)

Wiper blades, replacing [136](#)

Work in the engine compart-

ment [123](#)

X

Xenon lamps

bulb replacement [137](#)

Refueling



To ensure that you always have convenient access to all essential information when you stop for fuel, we recommend that you take the time to fill out the adjoining chart by entering the data that apply to your vehicle. Consult the index for individual specifications.

Fuel

Designation	
-------------	--

Please enter your preferred fuel here.

Engine oil

Quality	
---------	--

The oil quantity between the two marks on the dipstick is approx.
1.4 US quarts/1.3 liters.

Tire inflation pressure

	Summer tires		Winter tires	
	front	rear	front	rear
Up to 2 persons				
4 persons plus luggage				

More about BMW

bmwusa.com



The Ultimate
Driving Machine