



Z4 2.5i
Z4 3.0i

Congratulations, and thank you for choosing a BMW.

Thorough familiarity with your vehicle will provide you with enhanced control and security when you drive it. Therefore, we have one request:

Please take the time to read this Owner's Manual and familiarize yourself with the information that we have compiled for you before starting off in your new BMW. The manual contains important data and instructions intended to assist you in obtaining maximum satisfaction from your BMW's unique array of advanced technical features. It also contains information on vehicle maintenance designed to enhance operating safety while simultaneously helping you to maintain your BMW's value throughout an extended service life. For additional information refer to the supplemental manuals.

This Owner's Manual should be considered a permanent part of this vehicle. It should stay with the vehicle when sold to provide the next owner with important operating, safety and maintenance information.

We wish you an enjoyable driving experience.

BMW AG

© 2003 Bayerische Motoren Werke
Aktiengesellschaft
Munich, Germany
Reprinting, including excerpts, only with the
written consent of BMW AG, Munich.
Order No. 01 41 0 157 498
US English IX/03
Printed in Germany
Printed on environmentally friendly paper,
bleached without chlorine, suitable for recycling.

Contents

The fastest way to find information on special topics is by using the index, refer to page 104.

Using this Owner's Manual

- 4 Notes
- 7 Reporting safety defects

At a glance

- 10 Cockpit

Controls

- 16 Opening and closing
- 27 Adjustments
- 33 Transporting children safely
- 36 Driving
- 46 Lamps
- 48 Everything under control
- 52 Technology for safety and driving convenience
- 58 Controlling the climate for pleasant driving
- 64 Interior conveniences

Driving tips

- 68 Special operating instructions

Mobility

- 74 Refueling
- 75 Wheels and tires
- 81 In the engine compartment
- 86 Maintenance
- 87 Laws and regulations
- 88 Replacement procedures
- 93 Giving and receiving assistance

Reference

- 100 Technical data
- 104 Everything from A to Z

Notes

About this Owner's Manual

We have made every effort to ensure that you are able to find what you need in this Owner's Manual as quickly as possible. The fastest way to find certain topics is by using the detailed index at the end. If you wish to gain an initial overview of your vehicle, you will find what you are looking for in the first chapter.

Should you wish to sell your BMW at some time in the future, please remember to pass the Owner's Manual on to the new owner. The manual represents an important component of the vehicle.

Additional sources of information

If you have additional questions, your BMW center will be glad to advise you.

You can find more information about BMW, for example on its technology, on the Internet under www.bmw.com.

Symbols used



Indicates precautions that must be followed precisely in order to avoid the possibility of personal injury and serious damage to the vehicle.



Contains information that will assist you in gaining the optimum benefit from your vehicle and enable you to care more effectively for your vehicle.



Refers to measures that can be taken to help protect the environment.

◀ Marks the end of a specific item of information.

* Indicates special equipment, country-specific equipment and optional extras when available.



Vehicle Memory, Key Memory, refer to page 31. Identifies functions that can be specifically adapted for a particular key or vehicle. These adjustments can be performed either by yourself or by your BMW center.

Symbol on vehicle parts



Indicates that you should consult the relevant section of this Owner's Manual for information on a particular part or assembly.

Your individual vehicle

On buying your BMW, you have decided in favor of a model with individualized equipment and features. This Owner's Manual describes all models and equipment that BMW offers within the same group.

We hope you will understand that equipment and features are included which you might not have chosen for your vehicle. Any differences can easily be identified since all optional accessories and special equipment are marked with an asterisk *.

If your BMW features equipment not described in this Owner's Manual, for example a car radio or telephone, supplementary Owner's Manuals are enclosed. We ask that you read these manuals as well.

Status of the Owner's Manual

BMW pursues a policy of continuous, ongoing development that is conceived to ensure that our vehicles continue to embody the highest quality and safety standards combined with advanced, state-of-the-art technology. For this reason, the features described in this Owner's Manual could differ from those on your vehicle. Nor can errors and omissions be entirely ruled out. You are therefore asked to appreciate that no claims can be entertained on the basis of the data, illustrations or descriptions in this manual.

For your own safety

Fuels



Use unleaded gasoline only. Fuels containing up to and including 10% ethanol or other oxygenates with up to 2.8% oxygen by weight, i.e. 15% MTBE or 3% methanol plus an equivalent amount of co-solvent, will not void the applicable warranties respecting defects in materials or workmanship. Field experience has indicated significant differences in fuel quality, i.e. volatility, composition, additives, etc., among gasolines offered for sale in the United States and Canada. The use of poor quality fuels may result in driveability, starting and stalling problems especially under certain environmental conditions, such as high ambient temperature and high altitude.

Should you encounter driveability problems that you suspect could be related to the fuel you are using, we recommend that you respond by switching to a recognized high-quality brand.

Failure to comply with these recommendations may result in unscheduled maintenance.

Follow the relevant safety rules when you are handling gasoline. ◀

Maintenance and repair



Advanced technology, e.g. the use of modern materials and high-performance electronics, requires specially adapted maintenance and repair methods. Therefore, only have corresponding work on your BMW carried out by a BMW center or a workshop that works according to BMW repair procedures with correspondingly trained personnel. If work is carried out improperly there is a danger of consequential damage and the related safety risks. ◀

Parts and accessories



For your own safety, use parts and accessories approved by BMW.

When you purchase accessories tested and approved by BMW and Original BMW Parts, you simultaneously acquire the assurance that they have been thoroughly tested by BMW to ensure optimum performance when installed on your vehicle.

BMW warrants these parts to be free from defects in material and workmanship.

BMW will not accept any liability for damage resulting from installation of parts and accessories not approved by BMW.

BMW cannot test every product made by other manufacturers to verify if it can be used on a BMW safely and without risk to either the vehicle, its operation, or its occupants.

Original BMW Parts, BMW Accessories and other products approved by BMW, together with professional advice on using these items, are available from all BMW retailers.

Installation and operation of non-BMW approved accessories such as alarms, radios, amplifiers, radar detectors, wheels, suspension components, brake dust shields, telephones, including operation of any portable cellular phone from within the vehicle without using an externally mounted antenna, or transceiver equipment, e.g. C.B., walkie-talkie, ham radio or similar, may cause extensive damage to the vehicle, compromise its safety, interfere with the vehicle's electrical system or affect the validity of the BMW Limited Warranty. See your BMW center for additional information.

Do not use key or remote control to lock doors or trunk with anyone inside the vehicle. Refer to the Owner's Manual for more details. ◀



Maintenance, replacement or repair of the emission control devices and systems may be performed by any automotive repair establishment or individual using any certified automotive part. ◀

Service and warranty

This manual is supplemented by a Service and Warranty Information Booklet for US models, Warranty and Service Guide Booklet for Canadian models.

We recommend that you read this publication thoroughly.

Your BMW is covered by the following warranties:

- ▷ New Vehicle Limited Warranty
- ▷ Rust Perforation Limited Warranty
- ▷ Federal Emissions System Defect Warranty
- ▷ Federal Emissions Performance Warranty
- ▷ California Emission Control System Limited Warranty.

Detailed information about these warranties is listed in the Service and Warranty Information Booklet for US models, Warranty and Service Guide Booklet for Canadian models.

Reporting safety defects

The following only applies to vehicles owned and operated in the US.

If you believe that your vehicle has a defect which could cause a crash or could cause injury or death, you should immediately inform the National Highway Traffic Safety Administration NHTSA in addition to notifying BMW of North America, LLC, P.O. Box 1227, Westwood, New Jersey 07675-1227, telephone toll-free 1-800-831-1117.

If NHTSA receives similar complaints, it may open an investigation, and if it finds that a safety defect exists in a group of vehicles, it may order a recall and remedy campaign. However, NHTSA cannot become involved in individual problems between you, your retailer, or BMW of North America, LLC.

To contact NHTSA, you may either call the Auto Safety Hotline toll-free at 1-800-424-9393 or 366-0123 in Washington, D.C. area, or write to: NHTSA, U.S. Department of Transportation, Washington, D.C. 20590. You can also obtain other information about motor vehicle safety from the Hotline.





At a glance

The overviews of buttons, switches and displays presented in this chapter will help you find your way around your vehicle. You will also be familiarized with the concepts behind the operation of the features available to you.

Cockpit

Control elements

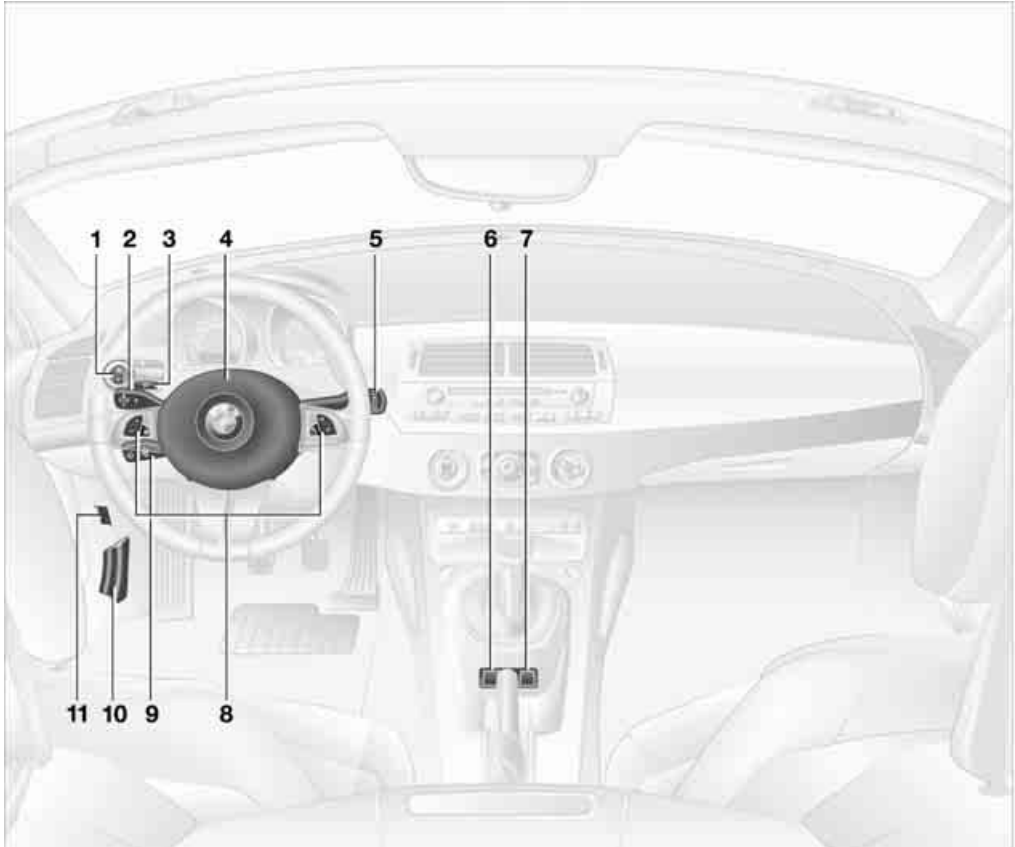

- | | | | | | |
|---|--------------------------|----|---|---------------------------------|----|
| 1 | Parking lamps/Low beams | 46 | 3 | Fog lamps | 47 |
| 2 | ▷ Turn signal indicators | 43 | 4 | Horn | |
| | ▷ Standing lamps | 47 | 5 | Washer/wiper system/Rain sensor | 43 |
| | ▷ High beams | 47 | 6 | Hazard warning flashers | |
| | ▷ Headlamp flasher | 43 | 7 | Central locking system | 18 |
| | ▷ Computer | 50 | | | |

8 Buttons in steering wheel*



Volume



Press briefly:

Accept incoming call, start dialing, terminate call

Extended pressure:

Activate and deactivate voice entry



Switch between telephone and radio or CD



Fast forward/rewind

▷ Radio

Press briefly: next station in station memory

Extended pressure: station search

▷ CD

Press briefly: jump to next track

Extended pressure: fast forward/rewind

▷ Telephone

Scan personal phone book

9 Cruise control [45](#)

10 Hood release [81](#)

11 Luggage compartment lid release [19](#)

Instrument cluster

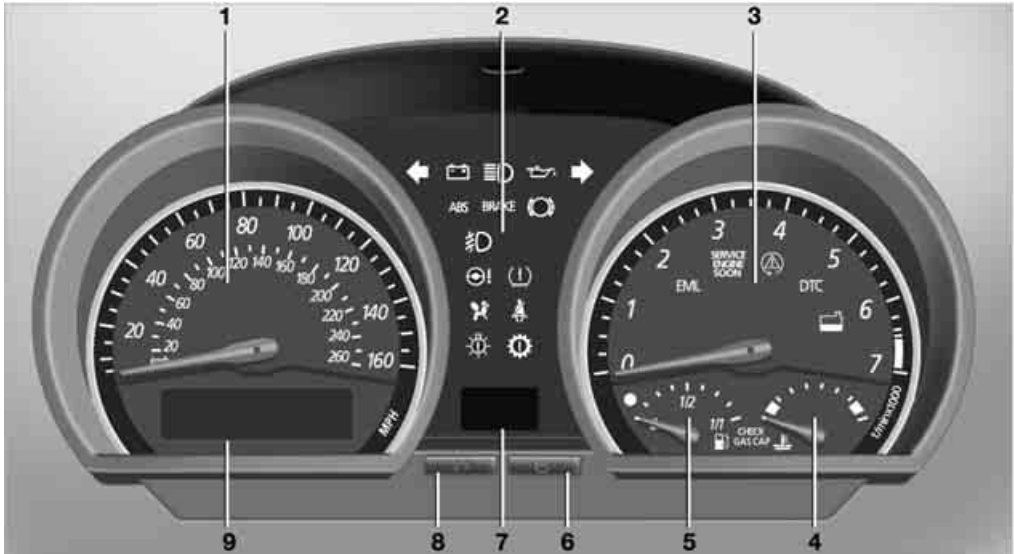

- 1 Speedometer
- 2 Indicator and warning lamps 12
- 3 Tachometer 48
with indicator and warning lamps 12
- 4 Engine coolant temperature gauge 48
- 5 Fuel gauge 48
- 6 Button for
 - ▷ Time 49
 - ▷ Service interval display 49
- 7 Display field for selector lever and program indicator
 - ▷ Automatic transmission 39
 - ▷ Sequential manual gearbox SMG 42
- 8 Button for
 - ▷ Trip odometer, reset to zero 48
 - ▷ Setting time 49
- 9 Display for
 - ▷ Trip odometer/Odometer 48
 - ▷ Clock 49
 - ▷ Service interval 49
 - ▷ Computer 49

Indicator and warning lamps

Technology that monitors itself

Indicator and warning lamps that are identified by ● are tested for proper functioning whenever the ignition key is turned. They each light up once for different periods of time.

If a fault should occur in one of these systems, the corresponding lamp does not go out after the engine is started or it lights up again while the vehicle is moving. The indicated pages provide information on what measures to take.



Please fasten safety belts ● 30



Airbags ● 56



Battery charge current ● 91



Engine oil pressure/Engine oil level/Engine oil sensor ● 83



Parking brake/Chassis control systems/Dynamic Brake Control/Brake fluid ● 38/ 52/ 53/ 85



Parking brake/Chassis control systems/Dynamic Brake Control/Brake fluid for Canadian models ● 38/ 52/ 53/ 85



Antilock Brake System ABS/Chassis control systems ● 54/ 52



Antilock Brake System ABS/Chassis control systems for Canadian models ● 54/ 52



Dynamic Stability Control DSC ● 52



Dynamic Traction Control DTC ● 52



Flat Tire Monitor ● 54



Automatic transmission/Sequential manual gearbox SMG ● 40/ 42



Brake pads ● 70



Add coolant 84



CHECK GAS CAP ● 74



Service Engine Soon ● 87



Service Engine Soon warning lamp for Canadian models ● 87



Defective bulbs 46



Turn signal indicators 43



Fog lamps 47



Headlamp flasher/High beams 43/ 47



Electric Power Steering EPS ● 43



Engine electronics ●
Engine electronics malfunction. You can continue to drive with reduced engine output or engine speed. Please have the system inspected by your BMW center.

Colors

The indicator and warning lamps can light up in various colors and combinations.

The following section explains the significance of the individual colors as well as how you should respond.

- ▷ Red:
Stop the vehicle immediately or an important reminder
- ▷ Red and yellow:
Continue driving cautiously
- ▷ Yellow:
Have the system checked soon or for your information
- ▷ Green:
For your information
- ▷ Blue:
For your information.



The background of the page is a blurred, dark blue-tinted image of a car's interior, showing the dashboard, steering wheel, and center console. The focus is on the text in the white box.

Controls

This chapter provides you with the information you need for complete control over your vehicle. It describes all features used for driving and for ensuring your safety and comfort.

Opening and closing

Keys

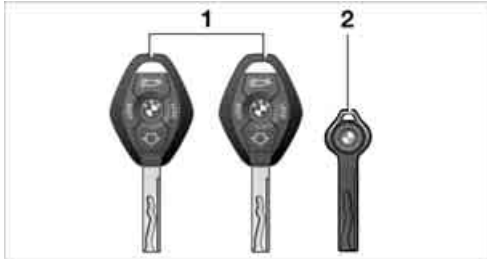

The key set

- 1 Master keys with remote control: they determine the functions of the Key Memory, refer to page 31. You can mark individual keys for subsequent identification by applying the colored decals that you received when accepting delivery of your vehicle

 There is an extended-life battery in every master key that is charged automatically in the ignition lock as you drive.

For this reason, if you have a master key with remote control that is otherwise not used, use that key approximately once a year while driving for an extended period to charge the battery. ◀

- 2 Spare key for storage in a safe place, such as in your wallet. This key does not open the lock of the luggage compartment lid – useful for valet parking, for example. This key is not intended for constant use

Central locking system

The concept

The central locking system is ready for operation whenever the driver's door is closed. The system simultaneously engages and releases the locks on the

- ▷ doors
- ▷ luggage compartment lid
- ▷ fuel filler door
- ▷ storage compartment between the backrests
- ▷ opened manual convertible top.

The central locking system can be operated

- ▷ from outside using the remote control or via the driver's door lock
- ▷ from inside via the central locking system button.

If it is operated from inside, the fuel filler door will not be locked. Refer to page 18.

The anti-theft system is automatically activated whenever you activate the central locking system from outside the vehicle. It prevents the doors from being unlocked with the lock buttons or release handles. The alarm system is also armed.

The central locking system unlocks automatically in the event of an accident. In addition, the hazard warning flashers and interior lamps come on.

Remote control

The concept

The remote control provides two additional functions for central locking.

- ▷ Switching on interior lamps, refer to page 17. With this function, you can also search for the vehicle when parked in an underground garage, for instance
- ▷ Opening the luggage compartment lid separately, refer to page 17. It will open slightly, regardless of whether it was locked or unlocked.

Whenever you unlock or lock the vehicle, you simultaneously deactivate/activate the anti-theft system, disarm/arm the alarm

system and switch the interior lamps on/off.



You can have a signal set to confirm that the vehicle's locks have engaged securely. ◀



Since persons or animals in the vehicle could lock the doors from the inside, always take the vehicle keys with you so that the vehicle can be opened again from the outside at any time. ◀



If it is no longer possible to lock the vehicle via the remote control, the battery is discharged. Use this key while driving for an extended period in order to recharge the battery.

In the event of a system malfunction, please contact your BMW center. You can also obtain replacement keys there. ◀



- 1 To unlock
- 2 To lock and secure, activate interior lamps, disarm tilt alarm sensor and interior motion sensor
- 3 To open the luggage compartment

To unlock



1. Press the button to unlock the driver's door and the fuel filler door
2. Press the button a second time to disengage all vehicle locks.

To lock and secure



Press the button.

To switch on the interior lamps



With the vehicle locked:
Press the button.

To deactivate the tilt alarm* and interior motion sensors*



Press the button a second time immediately after locking.
For additional information, refer to page 26.

To open the luggage compartment



Press the button.

The luggage compartment lid will open slightly, regardless of whether it was locked or unlocked.



Before and after a trip, be sure that the luggage compartment lid has not been opened unintentionally. ◀

Panic mode*: triggering alarm



By pressing the button for 2 to 5 seconds, the alarm can be sounded in the event of danger. The alarm is turned off by pressing the unlocking button 1 again.

Malfunctions

External systems or devices may cause local interference in the functions of the remote control.

Should this occur, you can still open and close the vehicle using the master key in either the door or luggage compartment locks.

For US owners only

The transmitter and receiver units comply with part 15 of the FCC, Federal Communications Commission, regulations. Operation is governed by the following:

FCC ID: LX8EWS
LX8FZVS
LX8FZVE

Compliance statement:

This device complies with part 15 of the FCC Rules. Operation is subject to the following two conditions:

- ▷ This device may not cause harmful interference, and
 - ▷ this device must accept any interference received, including interference that may cause undesired operation.
- ▷ Any unauthorized modifications to these devices could void the user's authority to operate the equipment. ◀

Door lock



One turn of the key in the driver's door lock to unlock the driver's door only and the fuel filler door.

Turn the key a second time to disengage all other vehicle locks.



You can have a signal set to confirm that the vehicle's locks have engaged securely. ◀

Convenience operation

You can also operate the power windows and the fully automatic convertible top via the door lock.

- ▷ To open:
With the door closed, hold the key in the Unlock position
- ▷ To close:
With the door closed, hold the key in the Lock position.



Watch the closing process carefully and be sure that no one is trapped by the closing motion. Releasing the key stops the operation. ◀

Manual operation

In the event of an electrical malfunction

Turn the key all the way to the left or right to unlock/lock the driver's door.

Interior



You can use this button to control the central locking system whenever the doors are closed. The doors and luggage compartment lid are unlocked or locked only. The anti-theft system is not activated.

If only the driver's door was unlocked from the outside and you press the button, then, with the driver's door still open, the luggage compartment lid and the fuel filler door will unlock, too. If the driver's door is closed, it will be locked.



If you desire, the central locking system can be activated automatically as soon as you begin to drive. This can be adjusted to be key-specific. ◀

To unlock and open

- ▷ Either unlock the doors together with the button for the central locking system and then pull each of the release handles above the armrests
or
- ▷ pull the release handle for each door twice: the initial pull unlocks the door, and the second one opens it.

To lock

- ▷ Either use the central locking button to lock both doors at once or
- ▷ press the individual door lock buttons down.

 To prevent the driver from being inadvertently locked out of the vehicle, the driver's door lock button will not engage as long as the door is open. ◀

 Since persons or animals in the vehicle could lock the doors from the inside, always take the vehicle keys with you so that the vehicle can be opened again from the outside at any time. ◀

Luggage compartment lid

To open from the outside

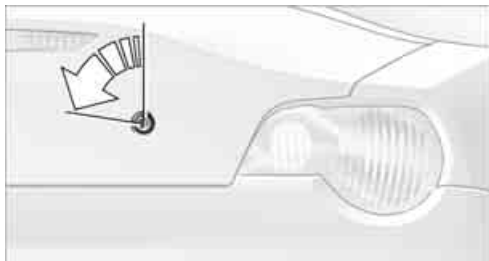

Turn the master key to the left as far as it will go. The luggage compartment lid will open slightly.

If the alarm system is armed, opening the luggage compartment with the key will trigger an alarm; refer also to page 26.

To open from inside the vehicle





If the luggage compartment lid has not been locked separately, you can open it with this button in the footwell on the driver's side when the vehicle is stationary.

To close



The handle recess in the interior trim panel of the luggage compartment lid makes it easier to pull the lid down.

 To avoid injuries, be sure that the travel path of the luggage compartment lid is clear when it is closed, following the same precautions as with all closing procedures. ◀

 Operate the vehicle only when the luggage compartment lid is closed, since exhaust fumes could penetrate into the interior of the vehicle. Should it be absolutely necessary to operate the vehicle with the luggage compartment lid open and with the convertible top closed:

- ▷ Close all windows
- ▷ Increase the air supply from the air conditioner or automatic climate control to a high level. Refer to page 58 or 61. ◀

Luggage compartment

Emergency release



This lever releases the luggage compartment lid from inside the luggage compartment.

To enlarge the luggage compartment

The luggage compartment can be enlarged when the convertible top is closed.

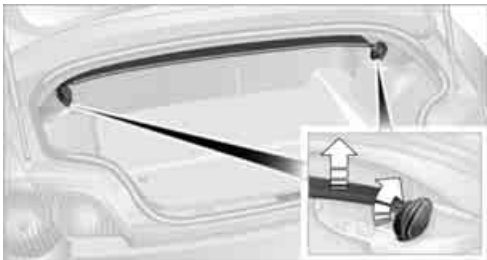

Simultaneously turn the handles on both sides of the luggage compartment outward past the resistance point. The convertible top compartment panel is raised.

Before opening the convertible top: Turn both handles inward. The convertible top compartment panel is lowered.

 Before opening the convertible top, make sure that the convertible top compartment panel has been folded down in the luggage compartment to avoid any possible damage. ◀

Electric power windows

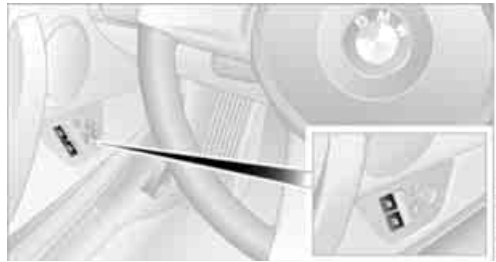

To open and close a window

Ignition key in position 1 or higher

- ▷ Press the switch until you feel resistance: the window continues to move downward as long as you continue to press the switch
- ▷ Press the switch briefly past the pressure point: the window moves downward automatically. Pressing the switch again stops the opening cycle.



If you wish, you can have this special feature activated/deactivated. ◀

You can close the window in the same manner by pulling the switch.

The window on the passenger side does not move upward automatically.

After the ignition has been switched off: You can still use the electric power windows for up to 15 minutes, as long as no one opens any of the doors.

 When leaving the vehicle, always remove the ignition key from the lock and remember to close the doors to prevent children from operating the power windows and injuring themselves, etc. ◀

For convenience operation via the door lock, refer to page 18.

Manual convertible top

The fabric top offers perfect protection against the weather and it can be opened easily and quickly by one person alone.

Here are a few tips so that you get the most out of your BMW:

- ▷ It is advisable to close the convertible top when the vehicle is parked. The closed convertible top not only protects the passenger compartment from unforeseeable damage from the weather, but also provides a certain degree of theft protection
- ▷ In addition, only keep valuables in the locked luggage compartment, even with the convertible top closed
- ▷ When the convertible top is open, the central locking system also locks the release button for the convertible top. The convertible top cannot be operated. This provides better theft protection for valuables stored in the luggage compartment
- ▷ Never mount a roof-mounted luggage rack system on the convertible top.

To open the convertible top

 Operate the convertible top only when the vehicle is stationary. Never store the convertible top for longer than one day while it is wet to avoid permanent damage from moisture. ◀

 Before opening the convertible top, make sure that the convertible top compartment panel in the luggage compartment is lowered to avoid any possible damage; refer to page 20. ◀

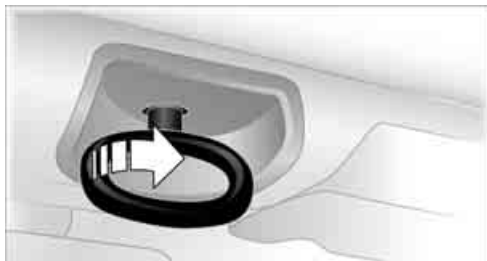

1. Flip the handle out and turn it to the end stop



2. Open the convertible top and push it toward the rear of the vehicle



3. Gently swing the convertible top downward and press until it engages audibly.

To close the convertible top

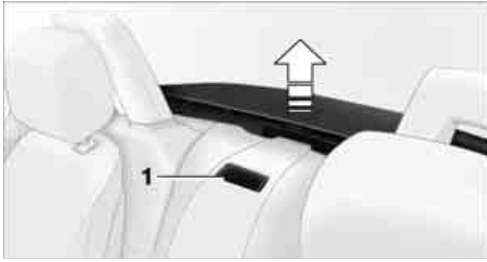

1. Press button **1**
The convertible top is released and moves up slightly
2. Holding on to the handle, pull the convertible top forward onto the windshield frame
3. Turn the handle until it audibly engages.
The convertible top is locked.

▶ At higher speeds, the passenger compartment may develop relatively low air pressure, which can cause the convertible top to begin fluttering. Increase the air supply so that low pressure does not occur in the vehicle. ◀

Fully automatic convertible top*

The fully automatic convertible top combines assured protection against the elements with simple and easy handling.

Here are a few tips so that you get the most out of your BMW:

- ▶ It is advisable to close the convertible top when the vehicle is parked. When closed, the top not only guards the passenger compartment from unforeseeable damage from the weather, but also affords a degree of protection against theft. In addition, only keep valuables in the locked luggage compartment, even with the convertible top closed
- ▶ Never mount a roof-mounted luggage rack system on the convertible top.
- ▶ To prevent damage, do not operate the convertible top at temperatures below 14 °F / -10 °C.

⚠ Never store the convertible top while it is wet to avoid permanent damage from moisture.

Driving when the opening or closing process has not been completed can cause vehicle damage or personal injury. Do not lay objects on the convertible top, since they could fall off when the convertible top is operated and cause damage or injuries.

Do not reach into the convertible top mechanism during opening and closing. Keep children away from the moving parts of the convertible top during operation. ◀

▶ If possible, only operate the convertible top with the vehicle stopped, as otherwise the process may be interrupted. If you set the convertible top in motion while the vehicle is stationary and then have to start suddenly, for instance at a traffic light, you can still complete the procedure by driving as slowly as possible and again holding the corresponding button pressed. ◀

▶ At higher speeds, the passenger compartment may develop relatively low air pressure, which can cause the convertible top to begin fluttering. Increase the air supply so that low pressure does not occur in the vehicle. ◀

Opening and closing



- 1 To close
- 2 To open

▶ If at all possible, only operate the convertible top if the engine is running. This saves unnecessary battery wear. Before closing the convertible top, remove any objects from the windshield frame that

could keep the convertible top from closing properly. ◀

Ignition key in position 1 or higher.
With the vehicle standing.

1. Read and comply with the preceding safety precautions
2. Make sure that the convertible top compartment panel in the luggage compartment is lowered; refer to page 20. Otherwise the convertible top cannot be opened
3. Ensure that the luggage compartment lid is closed
4. Press and hold the corresponding button for convertible top operation.

If the convertible top should halt right before the closing phase is completed, press against the front part of the convertible top frame from the outside to help the closing process along. Keep pressing the button while doing so until the top starts up again on its own.

Indicator lamps

- ▷ The red indicator lamp in the button will light up while the convertible top is in motion. It goes out as soon as the opening or closing operation has been completed
- ▷ If the red indicator lamp in the button flashes after the button has been released, then the opening or closing operation has not yet been completed. The sequence can be continued in the desired direction by pressing this button
- ▷ If the yellow indicator lamp in the button lights up continuously with the button pressed, then the convertible top compartment panel is raised and the convertible top cannot be moved.

The side windows will lower slightly when you press the button for operating the convertible top.

After the opening or closing operation, the side windows will go back up if you keep the button pressed for more than 2 seconds after the indicator lamp has gone out.

Interruption

The automatic sequence will be interrupted immediately if you release the button that operates the top. The sequence can be continued in the desired direction by pressing this button.

 If the convertible top operation has been interrupted, do not close the side windows using the power window buttons. Otherwise the side windows may not close properly against the rubber seal of the convertible top. ◀

 After the convertible top has been stored for an extended period of time in the convertible top compartment, e.g. in the winter months because the hardtop was being used, you may have to support the convertible top by hand when closing it for the first time. ◀

Convenience operation

Driver's door lock

Refer to page 18.

To close manually in the event of an electrical malfunction



1. Pull out the handle in the luggage compartment as far as it will go
2. Turn the handle by 90° until it engages

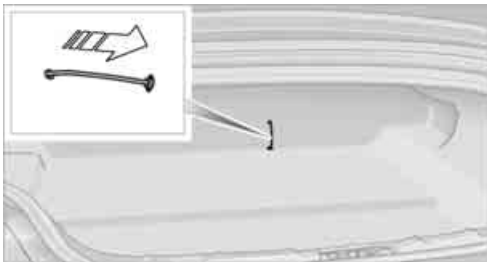

3. Pull on the cord in the luggage compartment panel
The storage compartment between the backrests unlocks, refer also to page 64

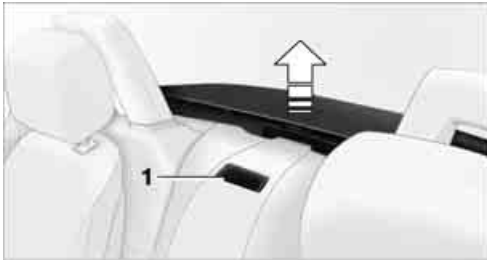

4. Press button **1**
The convertible top is released and moves up slightly



5. Grab the convertible top at its frame and pull it up to the windshield frame



6. Pull out the cover panel that is in the center of the front convertible top frame

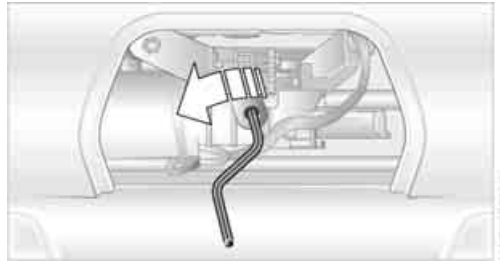

7. Insert the Allen wrench into the hex slot.
The Allen wrench is located in the vehicle tool pouch, refer to page 88
8. Pull the convertible top frame down as far as possible
9. Continue turning the Allen wrench to the left until the convertible top frame has locked onto the windshield frame.

Wind deflector*

With the convertible top open, the wind deflector keeps air movement in the passenger compartment to a minimum, thus providing you with a pleasant drive, even at higher speeds.

Installation



Insert the wind deflector in its proper orientation into the guides **1** provided on the rollover bars.

Refer to the labeling on the wind deflector to determine its proper orientation.

⚠ The wind deflector must engage firmly, as it could otherwise become detached at higher vehicle speeds. ◀

The wind deflector panels **2** in the rollover bars cannot be removed.

Removal



Slide both locks inward and remove the wind deflector.

Clothes hooks



Clothes hooks **1** are located on the wind deflector panels in the rollover bars.

⚠ Do not hang heavy objects on the hooks. If you do, they could endanger the passengers, for example during braking or evasive maneuvers. ◀

Storage

For storage, e.g. to achieve a better view to the rear when the convertible top is closed, there are two brackets on the inside of the luggage compartment lid.



Insert the wind deflector into the brackets.

⚠ Make sure that the wind deflector cannot be damaged by objects in the luggage compartment. ◀

Alarm system*

The concept

The vehicle alarm system responds:

- ▷ When a door, the hood or the luggage compartment lid is opened
- ▷ When attempts are made to start the vehicle
- ▷ To movement inside the vehicle
- ▷ To alterations in the vehicle tilt, e.g. as would occur during attempts to steal the wheels or tow the vehicle
- ▷ To interruption of battery voltage.

The alarm produced by the system in the event of unauthorized vehicle entry and attempted theft depends on the country version:

- ▷ Sounding of an acoustical alarm for 30 seconds
- ▷ Activation of the hazard warning flashers for approx. five minutes.

Arming and disarming the alarm system

When the vehicle is locked or unlocked either via the driver's door lock or with the remote control, the alarm system is simultaneously armed or disarmed.

The hazard warning flashers blink once when the alarm system has been properly armed.



You can have different acknowledgment signals set to confirm arming and disarming. ◀



You can still open the luggage compartment lid when the system is armed by pressing the remote control button, refer to page 17. When it is closed, the lid is once again secured.



Manual operation of the luggage compartment lid triggers the alarm. Refer to page 19. ◀

To cancel an alarm:



Press the button on the remote control, refer to page 16, or turn the ignition key to position 1. Refer to page 36.

Indicator lamp displays



- ▷ The indicator lamp beneath the interior mirror flashes continuously: The system is armed
- ▷ The indicator lamp flashes when it is being armed:
A door, the hood or luggage compartment lid is not completely closed. Even if you do not close the area causing the

alert, the remaining areas are secured and the indicator lamp flashes continuously after 10 seconds.

However, the interior motion sensor is not activated

- ▷ If the indicator lamp goes out as soon as the system is disarmed:
No manipulation or attempted intrusions have been detected in the period since the system was armed
- ▷ If the indicator lamp flashes for 10 seconds when the system is being disarmed:
An attempted entry has been detected in the period since the system was armed.

After an alarm has been triggered, the indicator lamp will flash continuously.

Interior motion sensor*

The system monitors the footwells and the seating areas of the driver and passenger.



Deactivate the interior motion sensor, refer to Avoiding unintentional alarms, if children or animals are to remain in the vehicle. ◀

Avoiding unintentional alarms

The tilt alarm sensor and interior motion sensor can be deactivated at the same time. You can do this to prevent a false alarm from being triggered, for instance in garages with elevator ramps or when the vehicle is transported by train.

Lock the vehicle twice = arm the system:



Press the button on the remote control twice in succession,

or

lock the vehicle twice with the key. Refer to page 18.

The indicator lamp lights up briefly and then flashes continuously. The tilt alarm sensor and the interior motion sensor are deactivated as long as the system is armed.

Adjustments

Safe seating position

For relaxed driving with as little fatigue as possible, you should select a seating position that reflects your personal requirements. In combination with the safety belts and airbags, the correct seating position also plays an important role in enhancing occupant safety in the event of an accident. To ensure that the vehicle's safety systems provide you with optimal protection, we request that you direct your careful attention to the following section.

For supplementary information on transporting children refer to page 33.

Sitting safely with airbags



Always maintain an adequate distance between yourself and the airbags. Always hold the steering wheel by its rim with hands at the 9 and 3 o'clock positions to minimize the risk of injuries to your hands or arms in the event of airbag deployment.

Never allow any objects, individuals or animals to obstruct the areas between passengers and airbags.

Never use the front airbag's cover as a storage tray or support for objects of any kind. Ensure that the passenger is correctly seated, i.e. that no feet or legs are propped against the dashboard. Otherwise, leg injury could result if the knee airbag and front airbag suddenly deployed.

Never let an occupant's head rest near or on a side airbag because the inflating airbag could cause a serious or fatal injury. ◀

Even when all these guidelines are observed, the risk of injury as a result of contact with the airbags cannot entirely be ruled out in some situations. In sensitive individuals, the ignition and inflation noise may induce a mild hearing loss that is temporary in most cases.

For airbag locations and additional information on airbags, refer to page 56.

Sitting safely with safety belts

Always fasten your safety belt before starting off. As supplemental restraint devices, the airbags are designed to enhance the effectiveness of the safety belts, and not to replace them.

Your vehicle offers two sitting positions, each of which is equipped with a safety belt.



At all times, occupants should sit upright and be properly restrained – infants and small children in appropriate child-restraint systems; larger children and adults using the safety belts.

Expectant mothers should always wear their safety belts, taking care to position the lap belt against the lower hips, where it will not exert pressure against the abdominal area.

Never allow more than one person to wear a single safety belt. Never allow infants or small children to ride in a passenger's lap. Do not route the belt across your neck, or run it across sharp edges. Be sure that the belt does not become caught or jammed. Avoid twisting the belt while routing it firmly across the hips and shoulder; wear it as snugly against your body as possible. Do not allow the belt to rest against hard or fragile objects. Otherwise, the lap belt could slide over the hips in the event of a frontal impact, leading to abdominal injury. Avoid wearing bulky clothing and pull on the lap belt periodically to retension it over your shoulders. Otherwise, the restraining effect of the safety belt could be diminished. ◀

For information on using the safety belts, refer to page 30.

Seats

Before adjusting your seat, always observe the following precautions

⚠ Never try to adjust your seat while operating the vehicle. The seat could respond with an unexpected movement, and the ensuing loss of vehicle control could result in an accident.

Never ride with the backrest inclined to an extreme angle – this also applies to the passenger seat. If you do so, there is a risk that you will slide under the safety belt in the event of an accident, thus reducing the protection provided by the safety belt. ◀

In addition, observe the instructions regarding damaged safety belts on page 30.

Seat adjustment

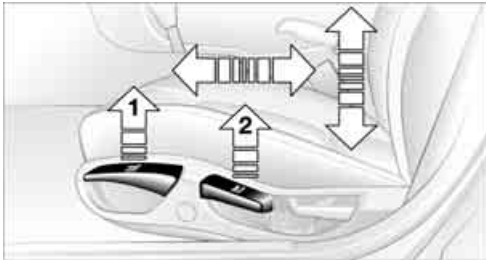

1 Backward/forward

Pull lever **1** and slide the seat into the desired position.

After releasing the lever, move the seat backwards or forwards slightly to ensure that the latch engages securely

2 Height

Pull lever **2** and apply weight to or remove weight from the seat as required

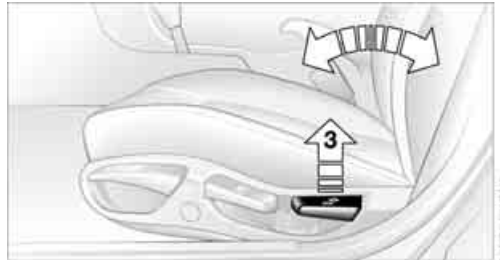

3 Backrest

Pull lever **3** and apply weight to or remove weight from the backrest as required.

Head restraints

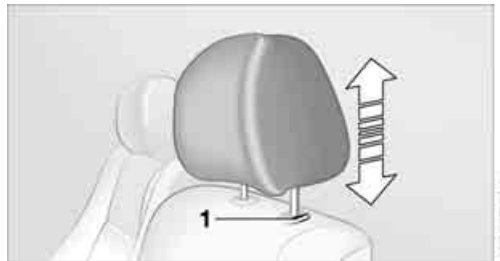

Adjustments

Height: pull or push.

In order to move to the lowest positions, press button **1**.

⚠ Adjust the head restraint so that its center is approximately at the height of your ears. Otherwise, there is a higher risk of injury to the cervical vertebra in the event of an accident. ◀

Removal

Pull the head restraint upward until it stops.

Press button **1** and remove the head restraint.

Installation

Insert the head restraint into the guides.

Seat adjustment: M Sports seat*

You can also adjust the tilt and the thigh support.



1 Tilt upward

Pull the lever repeatedly until the desired tilt has been reached.

2 Tilt downward

Push the lever repeatedly until the desired tilt has been reached.

3 Thigh support

Pull the lever and adjust the position of the cushion for thigh support as desired.

Power seat adjustment*



- 1 Tilt angle
- 2 Backward/forward adjustment
- 3 Height
- 4 Backrest angle

The head restraints are adjusted manually. Refer to page 28.

With the M Sports seat, you can also adjust the thigh support manually, refer to the preceding section.

 Read and comply with the adjustment instructions on page 28. Failure to

do so can result in diminished personal safety. ◀

Seat memory*

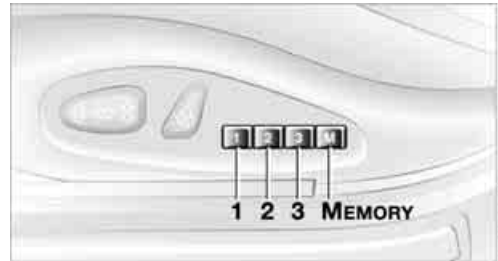

You can store and recall three different driver's seat positions.

To store

Ignition key in position 1 or higher

1. Adjust seat to desired position
2. Press the MEMORY button: the indicator lamp in the button lights up
3. Press memory button 1, 2 or 3: the indicator lamp goes out.

To select a stored setting

 Do not select a memory position while the vehicle is moving. If you do so, there is a risk of accident from an unexpected movement of the seat or steering wheel. ◀

Convenience function

1. Unlock and open the driver's door or turn the ignition key to position 1
2. Press memory button 1, 2 or 3 briefly. Movement stops immediately when one of the seat adjustment or memory buttons is operated during the adjustment process.

Safety function

1. Close the driver's door and turn the ignition key to position 0 or 2
2. Press and hold the desired memory button **1**, **2** or **3** until the adjustment process is completed.

If you press the **MEMORY** button accidentally:

Press the button again; the indicator lamp goes out.

Seat heating*



The seat cushion and backrest can be heated with the ignition key in position 2.

You can call up different heating modes by repeatedly pressing the buttons.

The seat heating can also be switched off from the higher heating modes:

Press the button and hold it slightly longer.

Safety belts

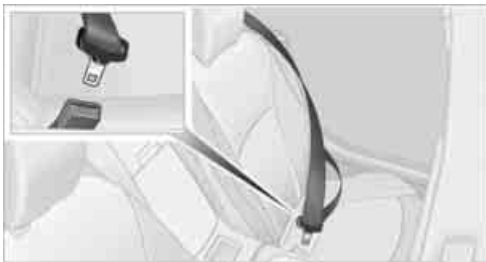

To close

Make sure you hear the lock engage in the belt buckle.



The warning lamp in the instrument cluster lights up for a few seconds or until the safety belts have been fastened. Depending on the vehicle version, an acoustic signal* sounds at the same time.

To unlock the safety belt

1. Press the red button in the belt buckle
2. Hold the belt
3. Guide the belt back into its reel.

The upper belt attachment point is suitable for all body sizes provided that the person is sitting correctly, refer to page 28.

Damaged safety belts



If the safety belts are damaged or stretched in an accident: have the entire belt system, including the tensioning mechanisms, replaced at your BMW center. Have the belt anchorage points inspected for damage at the same time. Failure to observe this precaution may prevent the safety belts from effectively providing optimal protection when needed. ◀

Steering wheel

Adjustments



Never attempt to adjust the steering wheel while driving the vehicle. It could respond with unexpected movement, posing a potential accident hazard. ◀

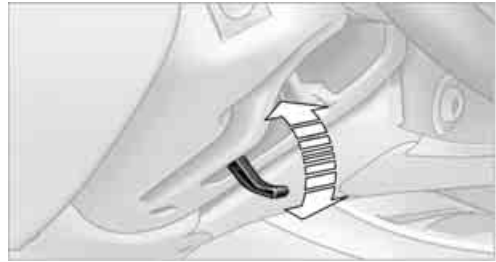

1. Push the locking lever downward
2. Adjust the steering column's reach and height to suit your seat position
3. Pull the lever back in.

Mirrors

To adjust exterior mirrors

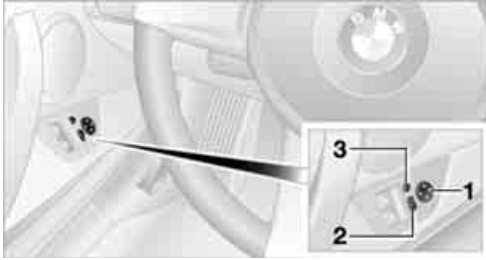

- 1 Switch for 4-way adjustment
- 2 Switch to select between mirrors
- 3 Button* for folding mirrors in and out

Fold the mirrors in and out by pressing the button repeatedly. This can be useful in car washes or narrow streets, for example, or for repositioning mirrors that have been folded forward.

 The mirror can be folded in at driving speeds of up to 18.6 mph / 30 km/h. ◀

To adjust manually

The mirrors can also be adjusted manually: Press on the edges of the lens.

Electric defrosting*

Both mirrors are automatically heated in ignition key position 2.

Interior rearview mirror



To reduce the glare from vehicles behind you when driving at night, turn the rotary knob.

For vehicles without an alarm system: Tilt the small lever forward.

Interior and exterior mirrors with automatic dimming feature*

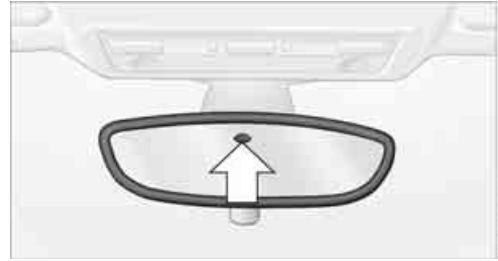

This mirror automatically dims through an infinitely variable range and switches automatically to its clear, undimmed mode whenever you engage reverse gear or place the selector lever in position R.

To ensure that the mirror continues to operate properly, keep the two photocells clean and unobstructed. One photocell is positioned in the mirror's lens, see arrow, while the other is slightly offset on the opposite side of the mirror. Do not obstruct the area between the interior rearview mirror and the windshield; do not apply stickers to the area of the windshield in front of the mirror.

Vehicle Memory, Key Memory

How the system functions

You have probably frequently wished that you could configure individual functions of your vehicle to reflect your own personal requirements. In engineering your vehicle, BMW has incorporated a number of options for personal adjustment that can be programmed into your vehicle at your BMW center.

Vehicle Memory refers to vehicle-oriented settings and Key Memory refers to person-oriented settings. You can have up to four different basic settings adjusted for four different persons. The only requirement is

that each person uses his or her own remote control key.

When your vehicle is unlocked with the remote control, the vehicle recognizes the individual user by means of a data exchange with the key, and makes adjustments accordingly.

Distinguishing between keys



Colored decals were provided with the keys to help you distinguish between the different personal remote control keys.

What the system can do

You can learn about the entire array of features that Vehicle Memory and Key Memory offer you at your BMW center. A few examples follow below:

Examples for Vehicle Memory:

- ▷ Various signals as acknowledgement when locking or unlocking your vehicle: refer to pages 17,, 18
- ▷ Windows are opened automatically, refer to page 20
- ▷ Reminder that the key is still in the ignition switch after the driver's door has been opened, refer to page 37
- ▷ Activation/deactivation of the Follow-me-home function: refer to page 46
- ▷ Activation/deactivation of daytime driving lamps: refer to page 46
- ▷ Sets the units of measure for displaying time, outside temperature, distance traveled and fuel consumption in the instrument cluster, refer to page 50.

Examples for Key Memory:

- ▷ Locking of the vehicle when you start off: refer to page 18
- ▷ Automatically adjusts the driver's seat to the personal programmed settings when the vehicle is unlocked, refer to page 29.



You will see this symbol throughout the Owner's Manual. It is to remind you at appropriate places of the settings that are available to you. ◀



Depending on how the memory functions are configured, the vehicle may be operated differently from what is described in the Owner's Manual. Should you decide to sell your BMW one day, please remember to have the memory functions returned to their original factory settings. ◀

Transporting children safely

Children on the passenger's seat

Deactivating/reactivating passenger airbags

 The passenger airbags must be deactivated before using a rear-facing child-restraint system on the passenger seat, refer also to page 34 for explanation. BMW also recommends that the passenger airbags be deactivated if a child is transported in a front-facing child-restraint system, regardless of the age of the child. If you transport a child in the passenger seat, not an infant in a rear-facing seat, who is properly seated and seat-belted at all times, the potential benefits of airbags deploying in an accident generally outweigh the risks of the child being injured by the force of a deploying airbag.

Therefore, you should deactivate the passenger airbags only if you find it difficult to ensure that the child will remain properly seated and seat-belted at all times.

Always position the passenger seat as far back as possible and at the lowest level. The above warning and recommendations are compatible with regulations established by the National Highway Traffic Safety Administration, NHTSA, permitting the deactivation of passenger airbags by means of an on-off switch for members of certain at-risk groups.

Specifically, the at-risk groups are:

- ▷ Infants in rear-facing infant seats
- ▷ Persons with certain medical conditions
- ▷ Children aged 12 and under in the passenger seat.

NHTSA provides this information via their website, www.nhtsa.dot.gov, or via their Auto Safety Hotline toll-free at 1-800-424-9393 or 366-0123 in Washington, D.C. area. ◀

The concept

Passenger airbags can be deactivated/reactivated with the vehicle ignition key. The key switch is located on the outer passenger's side of the instrument panel.

The passenger airbags can only be deactivated or reactivated with the vehicle standing still, ignition off and the passenger door open.

Deactivation



Deactivation of the passenger airbags system deactivates the passenger front, knee and side airbag. The airbags on the driver side remain active.

Using the vehicle ignition key, turn the key switch to the OFF position. Note, the passenger airbags will remain deactivated with the switch in this position.

 As soon as the reason for the deactivation of the passenger airbags no longer exists, you must reactivate these airbags so that they can deploy in an accident within their normal deployment range. ◀

Reactivating

Using the vehicle ignition key, turn the key switch to the AUTO position.

All airbags in the vehicle are activated and will be triggered under appropriate conditions.

Passenger airbags lamp



The system checks that the airbag system is functioning properly when the ignition key is turned, and the indicator lamp in the central console lights up for several seconds.

- ▷ The indicator lamp lights up continuously when the passenger airbags are deactivated
- ▷ If the passenger airbags are activated, it goes out after several seconds.

⚠ At all times, occupants should sit comfortably upright and be properly restrained, infants and small children in appropriate child-restraint systems; larger children and adults using the safety belts. Please note that the word Airbag imprinted on the door trim panel indicates the airbag's location. ◀

Seat position for children



This is the correct way a larger child no longer using a child-restraint system should sit wearing the safety belt, when the airbag system is activated.

Installing child-restraint systems

Before installing any child-restraint system or child seat, read the following:

⚠ Never install a rear-facing child-restraint system in the passenger seat of this vehicle, unless the passenger airbags have been turned off and the indicator lamp in the center console indicates that the passenger airbags are deactivated. For a child, not an infant, certain precautions should be taken. Position the passenger seat as far back as possible and at the lowest level. This important precaution is intended to maximize the distance between the airbags and the child. Younger children should be secured in an appropriate forward-facing child-restraint system that has first been properly secured. Older children should be tightly secured with a safety belt, sitting with their back against the vehicle seat back. Always ensure that all occupants, of all ages, remain properly and securely restrained at all times. ◀

⚠ Always follow the manufacturer's instructions concerning installation and use; otherwise the system's protective function could be impaired. After an accident, have all parts of the affected safety belt system inspected and/or replaced by your BMW center. ◀

Commercially-available child-restraint systems are designed to be secured with a lap belt or with the lap belt portion of a combination lap/shoulder belt. Improperly or inadequately installed restraint systems can increase the risk of injury to children. Always read and follow the instructions that come with the system.

Child seat security



The passenger's safety belt can be locked for mounting and securing a child-restraint system.

A label with the appropriate instructions for this is located in the immediate vicinity of the buckle latch of the safety belt.

LATCH child-restraint mounting system*

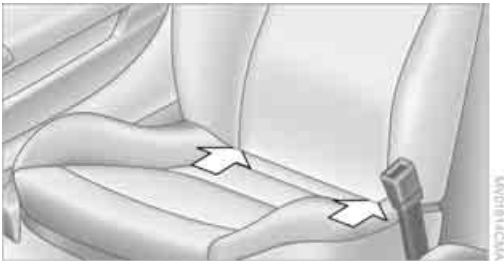

LATCH: Lower Anchors and Tethers for Children

The anchorage points for the LATCH child-restraint system are located at the positions indicated by the arrows.

Carefully slide the brackets through the gaps in the upholstery at the indicated locations, see arrows.

 To mount the LATCH child-restraint system, please follow the manufacturer's operating and safety precautions. ◀

Driving

Ignition lock

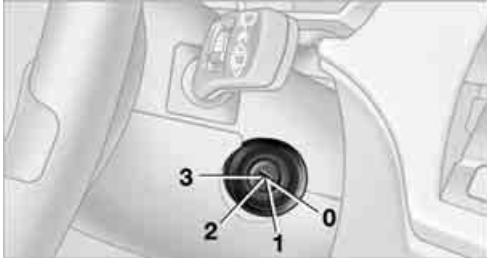

0 Steering locked

This is the only position in which the ignition key can be inserted or removed.

After removing the key, turn the steering wheel slightly to the left or right until the lock engages.

If the key is not removed, an acoustic signal sounds when the driver's door is opened.

 Vehicles with automatic transmission: do not move the selector lever from position P until the engine is running. ◀

Interlock

In order to turn the key back to position 0 or to remove it, move the selector level into position P first.

1 Steering unlocked

You will find that it is often easier to turn the ignition key from position 0 to 1 if you move the steering wheel slightly to help disengage the detent.

Individual electrical equipment and accessories are available for use.

2 Ignition switched on

All systems are operational.

3 Engine started

Engine

Do not allow the engine to warm up while the vehicle is stationary. Instead, begin driving immediately at a moderate engine speed.

Engine idle speed is controlled by the engine computer system. Increased speeds at start-up are normal and should decrease as the engine warms up. If engine speed does not decrease, service is required.

To prevent the battery from discharging, always deactivate electrical devices that are not in use. Switch the ignition off when the vehicle is not being driven.

 Do not allow the engine to run in enclosed spaces. The exhaust gases contain carbon monoxide, an odorless and colorless, but highly toxic gas. Breathing the exhaust gases poses an extreme health risk, and can lead to unconsciousness and death.

Do not leave the vehicle unattended with the engine running. An unattended vehicle with a running engine poses a safety hazard.

When driving, standing at idle and parking the vehicle, take care to avoid contact between the hot exhaust system and flammable materials, e.g. hay, leaves, grass, etc. Such contact could lead to a fire, resulting in serious personal injury and property damage. ◀

Starting the engine

Do not press the accelerator pedal while starting the engine.

 Vehicles with manual transmission: Step on the clutch when starting the vehicle. A lockout prevents the engine from starting if the clutch is not depressed. ◀

 Do not actuate the starter for too short a time, but do not actuate it for more than approx. 20 seconds. Release

the ignition key immediately when the engine starts. ◀

 Extended starting attempts, characterized by excessively frequent or long periods with the starter engaged, can damage the catalytic converter. ◀

If the engine fails to start on the first attempt, for instance if it is very hot or cold:

- ▶ Press the accelerator pedal halfway down.

Cold starts at very low temperatures, starting at approx. 5 °F / -15 °C:

- ▶ Press the accelerator pedal halfway down.
- ▶ On the first start attempt, engage the starter for a longer period, approx. 10 seconds.

Manual transmission

1. Engage the parking brake
2. Gearshift lever in idling position
3. Depress clutch pedal
4. Start the engine.

Automatic transmission

1. Depress footbrake
2. Place selector lever in position P or N
3. Start the engine.

 Before leaving the vehicle with the engine running, place the selector lever in position P and pull the parking brake.

Do not leave the vehicle unattended with the engine running. An unattended vehicle with a running engine poses a safety hazard. ◀

Sequential manual gearbox SMG

1. Depress footbrake
2. Move selector lever to neutral position N
3. Start the engine.

 If the engine does not start, re-engage the gear last selected, refer to the display in the instrument cluster, and

move the selector lever to neutral position N again. ◀

 Before leaving the vehicle with the engine running, place the selector lever in position N and pull the parking brake.

Do not leave the vehicle unattended with the engine running. An unattended vehicle with a running engine poses a safety hazard. ◀

Switching off the engine

 Do not remove the ignition key while the vehicle is still moving. If you did so, the steering lock would engage when the steering wheel is turned.

When you leave the vehicle, always remove the ignition key and engage the steering lock.

Always engage the parking brake when parking on downhill roads. ◀

 You can have an acoustic signal set as a reminder that the ignition key is still in the ignition switch after the driver's door has been opened. ◀

Manual transmission

Turn the ignition key to position 1 or 0.

Automatic transmission

Place the selector lever in position P and turn the ignition key to position 1 or 0.

Sequential manual gearbox SMG

If you turn the ignition key to position 1 or 0 with the selector lever in position R, or in sequential mode, a gear automatically remains engaged.

If you turn the ignition key to position 1 or 0 with the selector lever in neutral position N, a warning tone and the flashing gear indicator in the display remind you that the vehicle is not secured against rolling.

The warning stops after approx. 9 seconds.

 Always engage the parking brake when parking on downhill roads. Engaging a gear may not sufficiently secure the vehicle against rolling. ◀

Parking brake

The parking brake is designed primarily to prevent the vehicle from rolling when parked. It operates against the rear wheels.

Indicator lamp



The indicator lamp lights up when the parking brake is engaged; if you start driving, an acoustic signal is heard as well.



The indicator lamp for Canadian models lights up when the parking brake is engaged; if you start driving, an acoustic signal is heard as well.

To engage

The detent engages automatically and the indicator lamp in the instrument cluster comes on when the ignition key is in position 2.

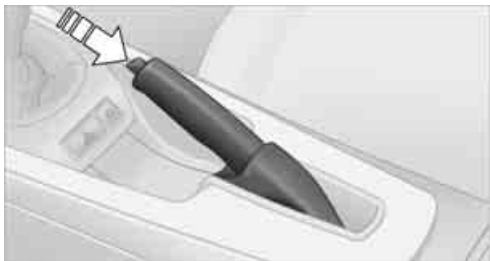

To release

Pull up slightly on the lever, press the button and lower the lever.

⚠ If, in exceptional circumstances, it should be necessary to engage the parking brake while the vehicle is in motion, do not pull it with excessive pressure. Keep the release button on the parking brake lever pressed down while pulling up the lever.

Excessive pressure can lead to overbraking and loss of traction, fishtailing, at the rear axle.

The brake lamps do not come on when the parking brake is engaged. ◀

⚠ Vehicles with manual transmission: Always engage the parking brake

when parking on slopes and inclined surfaces, since shifting into 1st gear or reverse may not provide adequate resistance to rolling. Vehicles with automatic transmission: place the selector lever in position P. ◀



To avoid corrosion and one-sided braking, apply the parking brake lightly from time to time when coasting to a standstill – at a traffic signal, for example – provided that it is safe to do so. ◀

Manual transmission

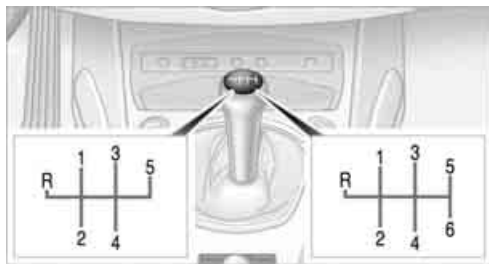

6-gear transmission*

When shifting into 5th or 6th gear, it is important to press the gear shift lever to the right to avoid accidentally engaging 3rd or 4th gear.

Reverse

Select reverse only when the vehicle is stationary. Press the gearshift lever to the left to overcome the resistance.

As you do this, the backup lamps will turn on automatically when the ignition key is in position 2.

⚠ Do not hold the vehicle in place on slopes by slipping or riding the clutch. Use the parking brake instead, otherwise, the ensuing friction to the clutch plates will cause a great deal of wear and tear on the clutch. ◀

Automatic transmission with Steptronic*

You can drive as with a normal automatic transmission. In addition, you can also shift manually.

When you move the selector lever from the D position to the left into the M/S range, the performance-oriented shift programs of the automatic transmission are engaged. As soon as you briefly tap the selector lever in the + or - direction, Steptronic changes the gear. The manual mode is engaged. When you wish to use the automatic transmission mode again, move the selector lever to the right to position D.

Selector lever positions

P R N D M/S + -

Range selection



A detent prevents inadvertent shifting into selector lever positions R and P. To disengage the detent, press the button on the front of the selector lever knob, see arrow.

Shiftlock

While the vehicle is stationary and before shifting out of P or N, depress the footbrake in order to disengage the selector lever's lock mechanism. ◀

Hold the footbrake down until starting off. The vehicle will otherwise start to move when a drive position is engaged. If you leave the vehicle with the engine running, move the selector lever to the P position and apply the parking brake. If you fail to do this, the vehicle could move. Do not leave the vehicle unattended with

the engine running. An unattended vehicle with a running engine poses a safety hazard. ◀

P Park

Select reverse only when the vehicle is stationary. The transmission locks to prevent the rear wheels from turning.

R Reverse

Select reverse only when the vehicle is stationary.

N Neutral

Select only when stopping for an extended period.

D Drive: automatic shift program

This position is designed for driving under all normal operating conditions. All forward gears are available.

Kickdown

In the kickdown mode, you achieve maximum acceleration in position D. Depress the accelerator pedal past the increased resistance point at the full-throttle position.

M/S Manual mode and Sport program



When you change from D to M/S, the Sport program is activated. This is indicated in the gear indicator by SD. The M/S mode is recommended for performance-oriented driving.

With the first brief touch, the automatic transmission shifts from the Sport program to the manual mode.

When you tap the selector lever in the +

direction, the transmission shifts up. When the lever is tapped in the – direction, the transmission shifts down. M1 to M5 appear in the gear indicator.

The Adaptive Transmission Control ATC executes upshifts or downshifts only when the new gear will provide a suitable combination of engine and road speed, e.g. ATC will not execute downshifts if the engine speed is too high. The desired gear will appear briefly in the instrument cluster, followed by the actual gear.

 If you are driving in the manual mode and wish to accelerate rapidly, e.g. to pass another vehicle, shift down manually or with the kickdown function. ◀

Shifting from M/S to selector lever positions P, R and N is possible only by going through position D.

Available indicators



P R N D SD M1 M2 M3 M4 M5

Malfunction

 If the indicator lamp comes on, there is a malfunction in the transmission system.

All of the selector lever positions can continue to be engaged; in the forward drive positions, however, the vehicle will be operating in the fourth gear only.

If this happens, avoid extreme engine loads and consult the nearest BMW center.

 Never work in the engine compartment when a drive gear – forward or reverse – is engaged. If you do so, the vehicle could move. ◀

For jump-starting or towing, refer to the information beginning on page 94.

Sequential manual gearbox SMG*

The concept

The sequential manual gearbox SMG is an automated manual gearbox with which clutching and shifting is assumed by an electro-hydraulic system.

The SMG is operated via two shift paddles on the steering wheel and the selector lever in the center console.

It offers the following functions:

- ▷ Sequential mode: manual mode
- ▷ Drive mode: automated mode
- ▷ Ability to choose between two different driving programs: Standard, Sport, refer to Dynamic Driving Control
- ▷ Operating safety through protection against misshifting
- ▷ Automatic upshifts and downshifts in the drive mode
- ▷ Automatic downshifts at minimum engine rpm
- ▷ Kickdown function in the drive mode
- ▷ Acceleration assistant.

Selector lever positions



The current selector lever position is shown by a light-emitting diode on the center console.

R: Reverse

N: Neutral

Forward position with one-touch functions:

Sequential mode

+ : manual upshifting

- : manual downshifting

D : drive mode.

The SMG is ready for operation in ignition key positions 2 and 3.

 The gearbox is automatically taken out of gear if the driver's door is opened while the engine is running and the driver does not actuate the pedals, the shift paddles or the selector lever.

This is accompanied by an acoustic signal and the flashing gear indicator.

The gear indicator in the instrument cluster displays N.

A driving position can only be engaged when the driver's door is closed.

When the vehicle is unlocked, a buzzing sound in the area of the transmission indicates that the system is ready to operate. ◀

Shiftlock

For your safety, it is only possible to engage a driving position from selector lever position N when the footbrake is depressed.

Please keep in mind while driving

 When driving off on inclines, drive smoothly without pausing. Do not keep the vehicle in place by depressing the accelerator pedal; instead, apply the parking brake. Otherwise, the SMG gearbox could overheat. ◀

R Reverse

Select reverse only when the vehicle is stationary.

N Neutral

Always engage before starting the engine, refer to Starting the engine.

Sequential mode

Each time the engine is started, the sequential mode is activated as soon as

you move the selector lever into the forward driving position.

The gears are shifted via the shift paddles or the selector lever.

It is also possible to drive off in second gear, e.g. on snow-covered roads.

D Drive mode

In the drive mode all forward gears are shifted automatically.

To switch from sequential to drive mode: tap the selector lever to the right toward D.

For rapid acceleration, e.g. during passing, depress the accelerator pedal completely: kickdown.

Kickdown:

In the kickdown mode, you achieve maximum acceleration.

Depress the accelerator pedal past the increased resistance point at the full-throttle position.

To switch back to sequential mode: tap the selector lever again to the right toward D, or change the current gear via the shift paddles or the selector lever.

Shifting gears

With selector lever

- ▷ To upshift, tap the selector lever toward +
- ▷ To downshift, tap the lever toward -.

With shift paddles on steering wheel

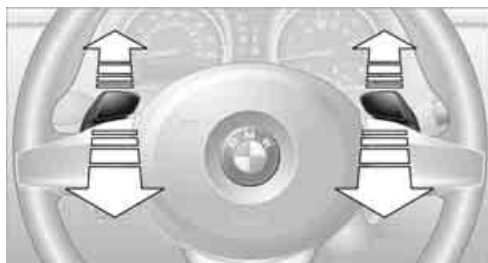

- ▷ To upshift, pull one of the shift paddles
- ▷ To downshift, push the paddle.

You accelerate from higher gears, e.g. during passing, by downshifting manually.

In the following situations, the SMG in the sequential mode assists you:

- ▷ The transmission will only execute upshifts and downshifts that will result in an appropriate combination of vehicle speed and engine rpm. For instance, downshifts that would result in excessive engine speed cannot be executed
- ▷ During a stop the gearbox is automatically downshifted into first gear
- ▷ Shortly before a gear-dependent minimum speed is reached, the gearbox shifts down automatically without you taking any action.

Display in the instrument cluster

Gear indicator



R N 1 2 3 4 5 6 D1 D2 D3 D4 D5 D6

The currently engaged gear, the selected mode, and any possible malfunctions are displayed in the instrument cluster.

Malfunctions

Indicator lamp



If the indicator lamp comes on, there is a malfunction in the transmission system.

All of the selector lever positions can continue to be engaged; however, in the forward drive positions the range of available gears is restricted.

If this happens, avoid extreme engine loads and consult the nearest BMW center.

Warning tone

An acoustic signal sounds if the SMG gearbox overheats; if possible you should either stop or increase your pullaway speed so that the system can cool down.

For jump-starting and towing, refer to the information on page 94.

Driving Dynamic Control

The Driving Dynamic Control feature lets you select between a standard and a sport program.

Sport program

- ▷ The engine responds more spontaneously to any motion of the accelerator pedal
- ▷ The vehicle is steered more directly and traction is enhanced

Additionally with SMG and automatic transmission:

- ▷ The shifting times are reduced
- ▷ The engine speed range is optimally utilized in the drive mode.



Activating the Sport program

In ignition key position 2

Press the SPORT button.

The LED in the button lights up.



With automatic transmission:

The sport program of the automatic transmission is enabled by activating the Driving Dynamic Control system. Thus, the selector lever does not have to be shifted from D to M/S; refer also to page 39. ◀

Deactivating the Sport program

Press the SPORT button again.
The LED in the button goes out.

Acceleration assistant with SMG

The acceleration assistant permits optimum racing-style acceleration on skid-resistant roads.

 Do not use the acceleration assistant too often, as this could cause the vehicle's parts to wear prematurely. ◀

1. Activate the Sport program
2. Press and hold the DSC button for more than three seconds, refer to page 53
3. Depress the accelerator all the way down rapidly: kickdown. The optimum rpm for driving off will be adjusted.

 To maintain vehicle stability, drive with the DSC switched on whenever possible. ◀

Electric Power Steering EPS

The concept

The electric power steering is a direct, sporting steering system that is speed-sensitive.

Power support is reduced with an increase in driving speed.

Indicator lamp

 The indicator lamp stays lit:
The system has malfunctioned or is faulty.

Please have the system inspected by the nearest BMW center.

Steering remains operational.

Turn signal indicators/ Headlamp flasher

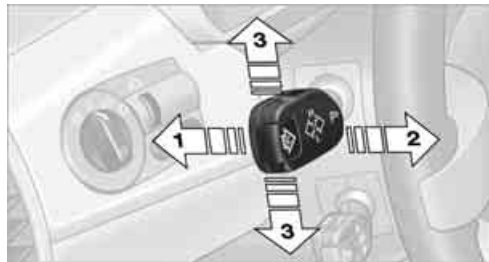

- 1 High beams: blue indicator lamp
- 2 Headlamp flasher: blue indicator lamp
- 3 Turn signal indicator: green indicator lamps accompanied by a periodic clicking sound from the relay

 If the flashing of the indicator lamp and the clicking from the relay are both faster than normal, one of the turn signal indicators has failed. ◀

To signal briefly

Press the lever up to the detent but not beyond. It then returns to the center position when released.

Washer/wiper system and rain sensor*



- 0 Wipers retracted
- 1 Intermittent operation or rain sensor
- 2 Normal wiper speed
- 3 Fast wiper speed
- 4 Brief wiper

- 5** Rotary dial for control of the wipe interval or the sensitivity of the rain sensor

Intermittent operation

Not on vehicles with rain sensor.

You can set the wipe interval over four stages with rotary dial **5**.

In addition, the wipe interval is varied automatically depending on road speed.

Rain sensor

The rain sensor is positioned on the windshield, directly behind the interior rearview mirror.

To activate the rain sensor:

- ▷ With the ignition key in position 1 or higher, move the lever to position **1**. The wipers travel once across the windshield, regardless of the weather.

You can leave the lever permanently in position **1**, it is then only necessary to activate the rain sensor. To do this

- ▷ turn rotary dial **5** briefly.

To adjust the sensitivity of the rain sensor: turn rotary dial **5**.

To deactivate the rain sensor: return lever to position **0**.

 Turn the rain sensor off in automatic car washes. Failure to do so could result in damage caused by undesired wiper activation. ◀

Normal wiper speed

When the vehicle is stationary, the wipers automatically switch to intermittent wipe, not on vehicles with rain sensor.

Fast wiper speed

When the vehicle is stationary, the wipers operate at normal speed, not on vehicles with rain sensor.

Cleaning windshield and headlamps*



0 Wipers retracted

1 Cleaning windshield and headlamps*

 Do not use the washers if there is any danger that the fluid will freeze on the windshield, otherwise vision could be obscured. For this reason, use an anti-freeze agent. Refer to page 83.

Do not use the washers when the reservoir is empty. Otherwise damage to the washer pump could result. ◀

Cleaning the windshield

The system sprays washer fluid against the windshield and activates the wipers for a brief period.

Cleaning the headlamps

When the vehicle's lighting system is switched on, the headlamps are cleaned at reasonable intervals.

Windshield washer nozzles

The windshield washer nozzles are heated automatically* in ignition position 2.

Cruise control*

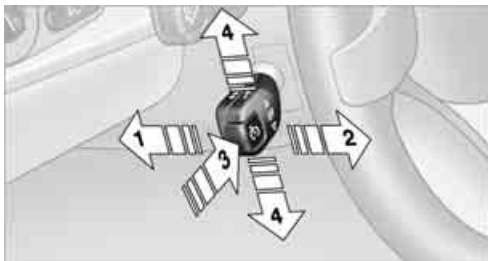

- 1 To maintain and store speed/ to accelerate
- 2 To decelerate
- 3 To recall the stored setting
- 4 To deactivate the system

 Do not use cruise control on twisting roads, when high traffic density prevents driving at a constant speed, when the road surface is slick, e.g. from snow, rain or ice, nor when the road surface is loose, e.g. from rocks or sand. ◀

To maintain and store speed/ to accelerate

You can maintain and store any desired speed above approx. 20 mph / 30 km/h.

Press the lever briefly in direction **1**:
The system maintains and stores the current vehicle speed. Every time you tap the lever, the speed increases by approx. 0.6 mph / 1 km/h.

Hold the lever in position **1**:
The vehicle accelerates without pressure on the accelerator pedal. As soon as you release the lever, the system stores and maintains the current speed.

 If, on a downhill grade, the engine braking effect is not sufficient, the controlled speed can be exceeded. Speed can drop on uphill grades if the engine output is insufficient. ◀

To decelerate

Press the lever briefly in direction **2**:
When the cruise control is active, vehicle

speed is reduced by approx. 0.6 mph / 1 km/h every time you tap the button.

Hold the lever in position **2**:
With the cruise control active, the system automatically reduces the throttle opening to slow the vehicle. As soon as you release the lever, the system stores and maintains the current speed.

To recall the stored setting

Press the lever briefly in direction **3**:
The vehicle accelerates to and maintains the last speed stored.

To deactivate the system

Press the lever briefly in direction **4**:
The cruise control is deactivated immediately.

In addition, the system is automatically deactivated in response to the following conditions:

- ▷ When you apply the brakes
- ▷ When you depress the clutch or move the automatic selector lever from D to N
- ▷ If you exceed or fall below the preset speed for an extended period, for example by depressing the accelerator.

You can recall the speed last stored.

Cruise control is also deactivated when the ignition key is turned to position 0.
The stored speed is cleared in this case.

Lamps

Parking lamps/Low beams

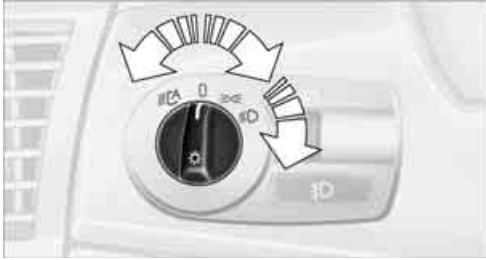

Parking lamps



The front, rear and side vehicle lighting is switched on. You can use the parking lamps to signal the position of the vehicle when it is parked. For information on lighting on one side of the vehicle for parking, which is available as an additional feature, refer to page 47.

Low beams



When you switch off the ignition with the low beam headlamps on, only the parking lamps will remain on.

Defective bulbs



The indicator lamp lights up: At least one bulb of the vehicle's exterior lighting has failed.

For replacing bulbs refer to page 88.

Follow me home lamps

When you activate the headlamp flasher after parking the vehicle and switching off the lights, the low beams will come on for a brief period.



You can also have this function activated/deactivated if you wish. ◀

LIGHTS ON warning

Whenever you open the driver's door after having turned the ignition key to position 0, you will hear an acoustic signal for a few

seconds to remind you that the lamps have not been switched off.

Daytime driving lamps*

If you desire, the light switch can be left in the second position:

When the ignition is switched off, the external lighting is also switched off.



You can have the activation settings for the daytime driving lamps programmed on your vehicle. ◀

Automatic headlamp control*



When the switch is set to this position, the system automatically activates and cancels the low beams in response to changes in ambient light, for example in tunnels, at dusk, and when it is raining or snowing.



The vehicle's external lights remain on constantly when you switch on the front fog lamps after the headlamps have come on automatically. ◀



Automatic headlamp control cannot serve as a substitute for the driver's judgement in determining when the vehicle lights should be switched on. For example, the sensors are not able to detect fog. To avoid safety risks, you should respond to these kinds of low-visibility situations by switching the headlamps on manually. ◀



You can have the sensitivity of your vehicle's automatic headlamp control adjusted. ◀

High beams/Standing lamps

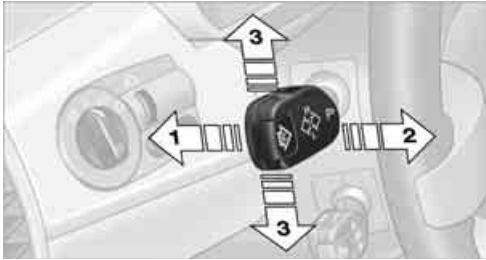

- 1 High beams: blue indicator lamp
- 2 Headlamp flasher: blue indicator lamp
- 3 Standing lamps

Left or right standing lamps*

As an additional feature, you can illuminate your vehicle on either side for parking:

1. Turn the ignition key to position 0 or remove it
2. Turn off the low beams
3. Push the lever in the appropriate turn-signal direction. The lever engages in the turn signal position.

Instrument lighting

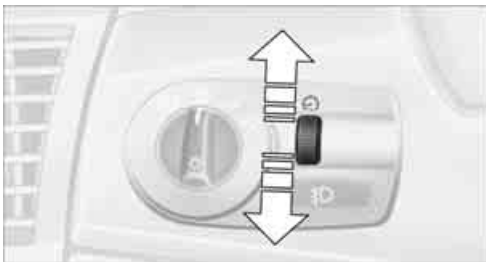

Turn the rotary dial to adjust the illumination intensity.

Fog lamps



Fog lamps*



A green indicator lamp comes on in the instrument cluster to indicate that the front fog lamps are on.



If the automatic headlamp control is on, the low beams will automatically come on whenever you activate the front fog lamps. ◀

Interior lamps

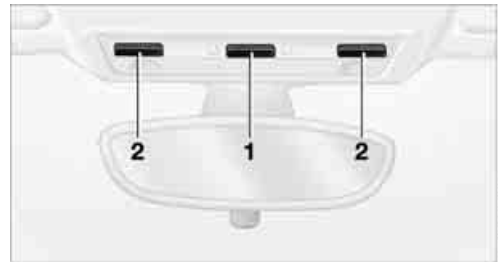

The interior lamps operate automatically.

To switch the interior lamps on and off manually

Press button **1** briefly.

If you would like the interior lamps to remain off all the time, press and hold the button for approx. 3 seconds.

Press the button briefly to revert to normal operation.

Reading lamps*

Switch on and off with button **2** adjacent to each lamp.

Everything under control

Odometer



- 1 Odometer
- 2 Trip odometer

Odometer

With the ignition key in position 0, you can activate the displays shown in the illustration by pressing the button – see arrow – in the instrument cluster.

Trip odometer

To set to zero

Ignition key position 1

Keep the button pressed until the trip odometer counter is set to zero.

Fuel gauge

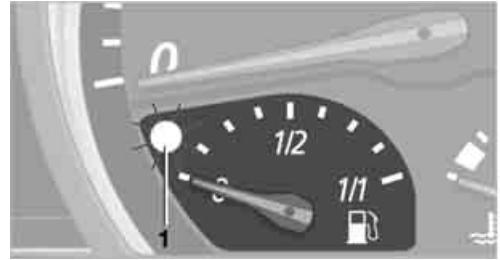

When indicator lamp **1** begins to stay on continuously, there are still approx. 2.1 gallons / 8 liters of fuel in the fuel tank. Tank capacity: approx. 14.5 gallons/ 55 liters.

If the tilt of the vehicle varies, for example when you are driving in mountainous areas, the needle may fluctuate slightly.

! Fill the fuel tank well before it is empty. Driving to the last drop of fuel can prevent the engine from operating properly and result in damage. ◀

When you switch on the ignition, the indicator lamp comes on briefly to indicate an operational check.

Tachometer



Never allow the engine to operate with the needle in the red overspeed sector of the gauge.

To protect the engine, the fuel supply is interrupted when you approach this sector.

Engine coolant temperature gauge



Blue

The engine is still cold. Drive at moderate engine and vehicle speeds.

Between the blue and red zones

Normal operating range. The needle may rise as far as the edge of the red sector during normal operation.

Red

When you switch on the ignition, warning lamp **1** comes on briefly to indicate an operational check.

Comes on while driving:

The engine has overheated. Stop and switch the engine off immediately and allow it to cool down.

For checking the coolant level, refer to page [84](#).

Service interval display



Remaining distance to next service

The displays shown in the illustration appear for a few seconds when the ignition key is in position 1 or after the engine is started.

The next service due appears with the message OIL SERVICE or INSPECTION, together with the distance remaining in miles – in kilometers in Canada – before the next scheduled service.

The computer bases its calculations of the remaining distance on the preceding driving style.

A flashing message and a minus sign in front of the number mean that the service interval has already been exceeded by the distance shown on the display. Please contact your BMW center for an appointment.

Outside temperature



If the vehicle is not equipped with a computer, the display in the instrument cluster always shows the outside temperature.

Clock

If you wish to have a permanent time display, you can have it appear in the car radio display, refer to the Owner's Manual for Radio.

You can set the clock and the time display in the car radio as follows.

To set



Ignition key in position 1 or higher:

Hours

1. Keep button **2** pressed for several seconds until the hours are displayed and the colon flashes
2. Press button **1** repeatedly until the required hour is set

Minutes

3. Press button **2** to switch to the minutes display

4. Press button **1** repeatedly until the required minutes are set
5. Press button **2** to confirm the settings. The set time of day is transferred to the car radio display or appears in the instrument cluster display.

Display mode

In ignition key position 0:
Press button **1**.

The time of day is displayed for several seconds.

Computer*

Mode selection

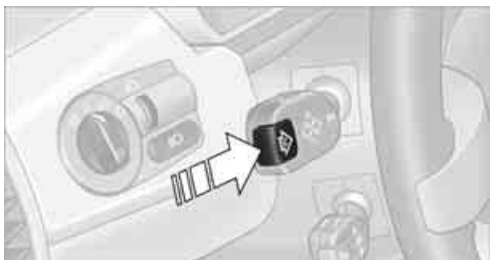

With the ignition key in position 1 or higher, you can use the button in the turn signal lever to retrieve information from the computer for display in the instrument cluster. Every time you press the button briefly in the direction of the steering column, a new function is called up for display.

The displays appear in the following order: time of day, outside temperature, average fuel consumption, cruising range, average vehicle speed.

With the ignition key in position 1 or higher, the last active setting is displayed.



If you wish, you can have all the displays of the following functions shown in another unit of measure. ◀

Outside temperature



To change the units of measure, °F/°C

While the temperature display is active, keep the button in the turn signal lever pressed until the display changes.

Ice warning

If the outside temperature drops to approx. 37.5 °F/3 °C, the computer automatically switches to the outside temperature display.

In addition, a signal sounds and the display flashes for a brief period.

Clock



Setting the 12-hour or 24-hour mode*

If the vehicle is equipped with a computer, you can have the time displayed in either a 12-hour or 24-hour mode.

While the time display is active, press the computer button in the turn signal lever until the display changes.

Average fuel consumption



If you continue to press the button on the turn signal lever, the average fuel consumption last displayed is recalculated from that point in time.

Any time spent when the vehicle is stationary and the engine shut off is ignored in the calculation.

Cruising range

The computer bases its calculations of the cruising range on the preceding driving style and on the remaining fuel in the tank.

 It is important that you refuel when the cruising range falls below approx. 30 miles/50 km. Otherwise, the engine cannot be guaranteed to operate properly and damage may result. ◀

Average speed

If you continue to press the button on the turn signal lever, the average fuel consumption last displayed is recalculated from that point in time.

Technology for safety and driving convenience

Dynamic Stability Control DSC

The concept

This system optimizes driving stability and traction, especially when just starting off, when accelerating or when cornering. It also maintains vehicle stability, even in critical driving situations.

DSC recognizes unstable vehicle conditions, such as understeering or oversteering, and, within physically feasible limits, helps keeping the vehicle on a steady course by reducing engine speed and by brake applications at individual wheels.

The DSC is operational every time you start the engine. It includes the following functions:

- ▷ Automatic Stability Control plus Traction ASC+T
- ▷ Dynamic Traction Control DTC
- ▷ Dynamic Brake Control DBC

 The laws of physics cannot be repealed even with DSC. It will always be the driver's responsibility to drive in a manner that matches road conditions. We therefore urge you to avoid using the additional safety margin of the system as an excuse for taking risks.

Do not make any modifications to the DSC system. Allow only authorized technicians to perform service procedures on the DSC. ◀



Indicator lamps

The indicator lamps in the instrument cluster go out shortly after you switch on the ignition.



 Dynamic Stability Control DSC indicator lamp flashes:
The system is active and governs drive torque and braking forces.

The indicator lamp stays lit: Dynamic Stability Control DSC and Dynamic Traction Control DTC have been switched off via the button.

 Dynamic Traction Control DTC indicator lamp lights up permanently: DTC has been deactivated via the DSC button.

 Dynamic Stability Control DSC indicator lamp flashes:
 Dynamic Traction Control DTC indicator lamp lights up permanently: DTC is actively regulating drive torque and braking forces.

 Interventions to increase stability are being performed to a limited degree only. ◀

 The Dynamic Stability Control DSC indicator lamp and yellow brake warning lamp for Dynamic Brake Control DBC light up continuously:
 Dynamic Stability Control DSC, Dynamic Traction Control DTC and Dynamic Brake Control DBC are malfunctioning.
Have the system repaired at your BMW center.

 Dynamic Stability Control DSC indicator lamp and yellow brake warning lamp for Dynamic Brake Control DBC for Canadian models:



 The vehicle remains completely operational without the DSC, DTC and DBC functions. ◀

In the event of a malfunction, please see your BMW center.



If the brake warning lamp comes on together with the yellow indicator lamps for the Antilock Brake System ABS and the Dynamic Stability Control DSC:



The entire ABS and DSC control system has failed. Continue driving cautiously and defensively. Avoid

hard brake applications. Please have the system checked by your BMW center as soon as possible.



Indicator and warning lamps for Antilock Brake System ABS and Dynamic Stability Control DSC for Canadian models.



Switching off DSC/Activating DTC



Press the DSC button briefly. The DTC indicator lamp comes on and stays on.

DSC has been switched off; DTC is in ready mode.

In the following exceptional circumstances, it may be effective to activate the DTC for a short period:

- ▷ When rocking the vehicle or starting off in deep snow or on loose surfaces
- ▷ When driving on snow-covered grades, in deep snow, or on a snow-covered surface that has been packed down from being driven on
- ▷ When driving with snow chains.

The gain in traction is achieved by a reduction in stabilizing intervention.

Switching off DSC and DTC

Hold the DSC switch down for at least 3 seconds. The DSC indicator lamp stays lit.

In this case, no interventions to increase stability and traction for the engine and brakes are carried out.

 To maintain vehicle stability, drive with the DSC switched on whenever possible. ◀

Reactivating DSC and DTC

Press the button again. The indicator lamp goes out.

 The laws of physics cannot be repealed with DSC. It will always be the driver's responsibility to drive in a manner that matches road conditions. We therefore urge you to avoid using the additional safety margin of the system as an excuse for taking risks. Stabilizing intervention is only performed to a limited degree when the DTC is activated.

Do not make any modifications to the DSC system. Allow only authorized technicians to perform service procedures on the DSC. ◀

Dynamic Brake Control DBC

If you step on the brake rapidly, this system automatically produces maximum braking force boost and thus helps to achieve the shortest possible braking distance during panic stops. All of the benefits of the ABS system are exploited under these circumstances.

Do not reduce the pressure on the brake pedal for the duration of the brake application. When the brake pedal is released, the DBC is deactivated.

Brake force display

The Brake force display indicates to the road user behind you how hard you are braking.

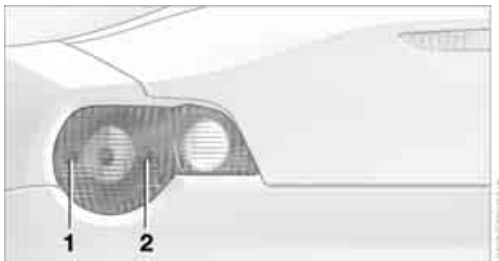

The display has two levels:

- ▷ Normal braking:
Brake lamp **1** lights up on both sides of the vehicle together with the center brake lamp
- ▷ Forceful braking and braking with ABS:
Brake lamps **1** and **2** light up on both vehicle sides together with the center brake lamp.

Antilock Brake System ABS

The concept

ABS keeps the wheels from locking during braking, thereby enhancing active driving safety.

Malfunctions

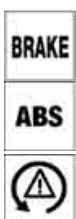

If the yellow indicator lamp for the Antilock Brake System ABS comes on together with the brake warning lamp and the indicator lamp for the Dynamic Stability Control DSC: The entire ABS and DSC control system has failed. Continue driving cautiously and defensively. Avoid hard brake applications. Please have the system checked by your BMW center as soon as possible.

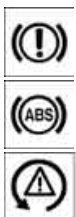

Indicator lamp for the Antilock Brake System ABS with the brake warning lamp and the indicator lamp for the Dynamic Stability Control DSC for Canadian models.

Braking with ABS

If you are in a situation which requires full braking, you will exploit the full benefits of the ABS system if you apply maximum brake pressure: panic stop.

Pulsation at the brake pedal combines with sounds from the hydraulic circuits to indicate to the driver that ABS is in its active mode.

Flat Tire Monitor

The concept

As you drive, the Flat Tire Monitor keeps track of pressure levels in all four tires. The system alerts you whenever the inflation pressure of a tire falls significantly below the pressure of another tire.

The system actually detects pressure loss by monitoring differences in the relative speeds of the four wheels. It interprets variations outside specified limits as severe pressure loss, and then responds by generating a warning.

System requirements

In order for the Flat Tire Monitor to learn the correct tire inflation pressure, please do the following:

1. Check the tire inflation pressures in all tires
2. Compare to the inflation pressure table, refer to page 76, and correct if necessary
3. Initialize the system.

▷ If the system is not initialized, undetected losses in pressure or false warnings that indicate a non-existent flat tire are possible. ◀

System limitations

⚠ The Flat Tire Monitor cannot provide you with advance warning of sudden and severe tire damage caused by external factors and does not detect the balanced and very gradual pressure loss that takes

place in all four tires over an extended period of time. ◀

On the other hand, the following situations can lead to false warning, a delayed detection of pressure loss and even to the system not functioning:

- ▷ Driving on snow-covered or slippery roads
- ▷ Performance-oriented driving: slip at the drive wheels, high levels of lateral acceleration
- ▷ When driving with snow chains, false warnings and undetected pressure losses may occur
- ▷ If the Flat Tire Monitor was not initialized after the last time the tire inflation pressures were corrected, undetected losses in pressure or false warnings that indicate a non-existent flat tire are possible.

Initializing the system

▷ Each time you correct the pressure in a tire, or change a wheel or tire, reinitialize the system immediately afterwards. This requires driving. ◀

1. Start the engine, but do not drive off



2. Press the button as long as you need to until the yellow indicator lamp in the instrument cluster lights up for a few seconds
3. Drive off.

It takes a few minutes before the Flat Tire Monitor can detect a flat tire and issue a warning.

▷ When driving with snow chains, do not initialize the system. ◀

Flat tire warning



The indicator lamp in the instrument cluster lights up in red. This visual alert is accompanied by an acoustic warning signal. There is a flat tire or a significant loss of tire pressure.

1. Carefully reduce your speed to under 50 mph / 80 km/h. Avoid strong braking and steering maneuvers. Do not exceed a maximum speed of 50 mph / 80 km/h.
2. Check the inflation pressure in all four tires as soon as possible.



Because the sides of Run Flat tires are reinforced, a drop in inflation pressure usually cannot be detected from the outside, refer to Run Flat tires on page 80. ◀

3. Before continuing to drive, refer to the notes on page 80.



If the vehicle is not equipped with Run Flat tires, refer to page 80, the standard equipment by design, continuing to drive with a flat tire can result in serious accidents. ◀

System malfunction



The indicator lamp in the instrument cluster lights up yellow. The Flat Tire Monitor is malfunctioning or out of order. Please refer the problem to your BMW center.

Airbags

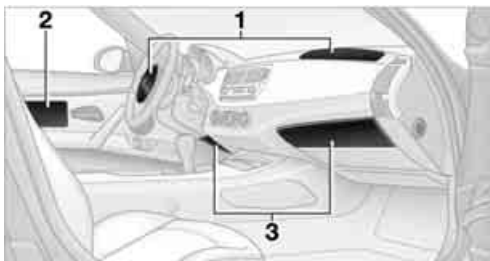

The following airbags are located under the marked covers:

- 1 Front airbags for driver and passenger
- 2 Side airbags for driver and passenger
- 3 Knee airbags for driver and passenger

Protective effect

The front airbags help protect the driver and passenger in the event of a head-on collision where the protection provided by the safety belt alone would not be adequate. The side airbags help provide protection in the event of a collision from the side. Each of the side airbags is designed to help support the seat occupant's upper body. The knee airbags help provide additional protection in the event of a head-on collision.

The airbags are deliberately not triggered in every impact situation, e.g. less severe accidents, certain roll-over conditions, or rear-end collisions.

For information on the correct seating position, refer to page 27.

 Do not apply adhesive materials to the cover panels of the airbags, cover them or modify them in any other way. Do not attempt to remove the airbag retention system from the vehicle. Never modify or tamper with either the wiring or the individual components in the airbag system. This category includes the upholstery in the center of the steering wheel, on the instrument panel, the side trim panels on the doors. Do not attempt to remove or dismantle the steering wheel. Do not touch the individual components

directly after the system has been triggered, because there is a danger of burns. If you note any indication of system malfunction, if you desire to have an airbag deactivated, or if the airbag retention system is triggered in response to an accident, you should always entrust all inspection, repair and dismantling operations to your BMW center.

Unprofessional attempts to service the system could lead to failure in an emergency or undesired airbag activation, either of which could result in personal injury.

To ensure compliance with official safety regulations, please also entrust disposal of airbag generators to a BMW center. ◀

Airbag warning information is also provided on the sun visors.

Automatic deactivation of the passenger airbags

 Before transporting a child on the passenger seat be sure to observe the information/instructions under Transporting children safely, refer to page 33. ◀

Your BMW has a seat occupation detection system. By evaluating the weight on the passenger's seat, the system detects whether or not the seat is occupied by a child in the child-restraint system or an adult.

- ▷ When a child is seated in the child-restraint system, the front, side and knee airbags are automatically deactivated on the passenger's side.
- ▷ When an adult is traveling in the front seat or it is unoccupied, the front, side and knee airbags remain active on the passenger's side.

 Although not desired, it can occur in the case of heavier children that the passenger airbags remain active or, in the case of very light adults or young persons, that the passenger airbags are deactivated. The condition of the passenger airbag system is shown by the indicator lamp in the central console, refer to Indicator lamps below. If the indicator lamp signals that the passenger airbags are active and you wish

them to be deactivated, the airbags have to be deactivated with the vehicle ignition key and the key switch on the outer passenger's side of the instrument panel. Apart from passengers, do not place any additional objects on the passenger seat. Do not fit seat covers, seat cushion padding, ball mats or other items to the passenger seat unless they are specifically recommended by BMW. Do not place any items under the seat. Otherwise, the function of the seat occupation detection could be impaired. ◀

Indicator lamps

Airbag system operational



The airbag indicator lamp in the instrument cluster indicates the operational readiness of the entire airbag system and the safety belt tensioners as of ignition key position 1.

The indicator lamp goes out after a few seconds.



The indicator lamp in the central console signals whether or not the passenger airbag system is activated or deactivated as of ignition key position 1.

▶ This lamp pertains only to the passenger airbag system. ◀

- ▶ The indicator lamp goes out after a few seconds:
The passenger airbags are active, e.g. when an adult is traveling in the vehicle or the seat is unoccupied
- ▶ The indicator lamp lights up continuously:
The passenger airbags are deactivated, e.g. when a child is traveling in the vehicle in the child-restraint system.

For more information on the operating principle of the passenger airbag system and seat occupation detection, refer to Automatic deactivation of the passenger airbags.

Airbag system malfunction

 A system malfunction could prevent the system from responding in the expected manner to an impact occurring within its normal response range. Please have the airbag system inspected immediately at a BMW center. ◀

 There is a fault in the airbag system if the airbag indicator lamp behaves as follows:

- ▶ The indicator lamp does not light up as of ignition key position 1
- ▶ The indicator lamp remains on continuously
- ▶ The indicator lamp lights up while the vehicle is being driven.

Controlling the climate for pleasant driving

Air conditioning

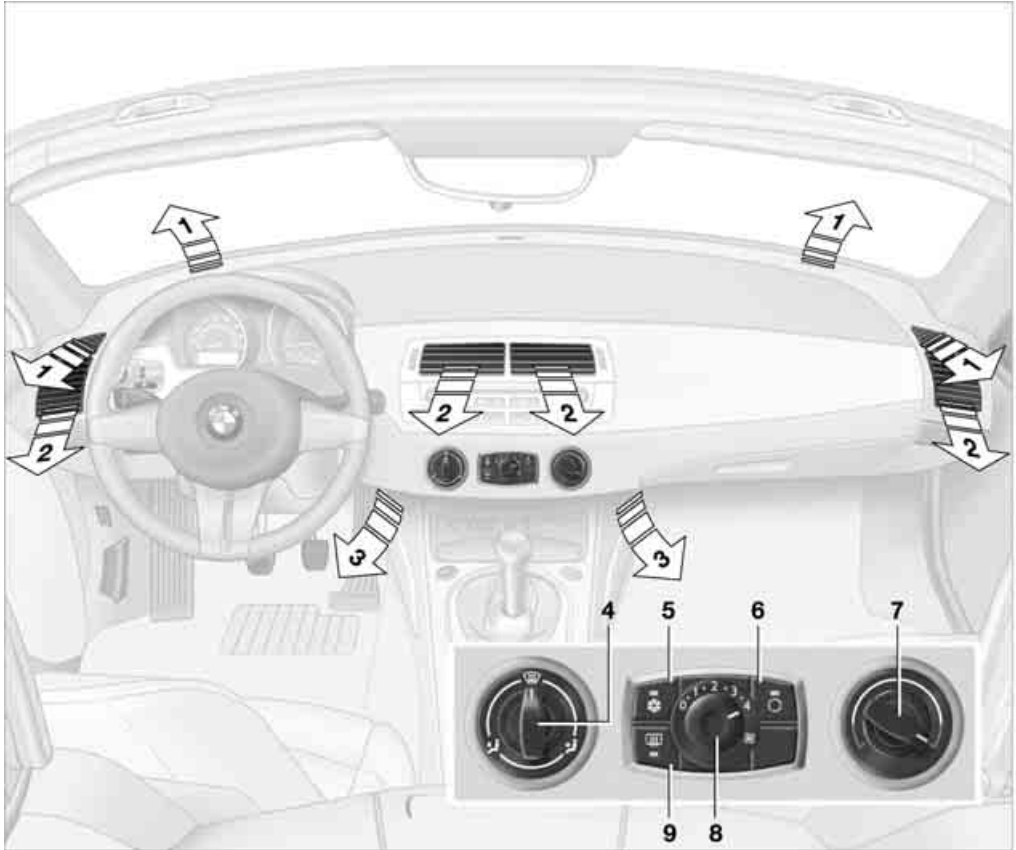



- 1 Air onto the windshield and the side windows
- 2 Air for the upper body area 59
- 3 Air for the footwell
- 4 Air distribution 59

- 5 Air conditioning 59
- 6 Outside-air/recirculated-air mode 59
- 7 Temperature adjustment 59
- 8 Air supply/blower 59
- 9 Rear window defroster 59

Air distribution



You can direct airflow onto the windows , toward the upper body  and into the footwell . All intermediate settings are possible.

Air supply/blower



You can set the blower to 8 different levels. Both heating and ventilation become more effective as the air supply rate is increased.

Turn the rotary control toward zero: The blower and the heating are turned off, and the air supply is stopped.

Temperature



In order to increase the temperature of the passenger compartment, turn to the right toward the red zone.

Air conditioning



The air is cooled and dehumidified and – depending on the temperature setting – rewarmed.

Depending on the weather, the windshield may fog over briefly when the engine is started.

 Condensation forms during operation of the air conditioning system, which then exits under the vehicle. Traces of condensed water on the ground underneath the vehicle are thus normal. ◀

Outside-air/recirculated-air mode



If there are unpleasant odors in the outside air, you can temporarily block the supply of incoming air. The system then recirculates the air currently within the vehicle.

 If the windows fog over in the recirculated air mode, switch this mode off and increase the air supply as required. Do not use the recirculated-air mode continuously over a long period of time as this would otherwise reduce the air quality in the interior of the vehicle. ◀

Rear window defroster



The indicator lamp lights up when the rear window defroster is active. The rear window defroster switches off automatically.

Ventilation

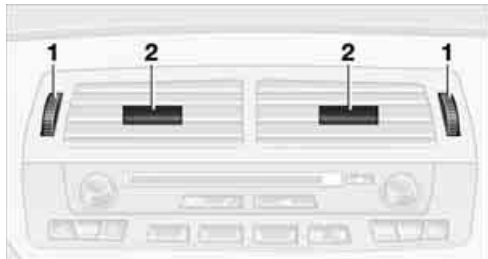

You can adjust the blower controls for the upper body area to obtain the optimum airflow rates and directions for your personal requirements:

- 1 Rotary dials for opening and closing the vents at any setting desired
- 2 Slide for adjusting airflow direction

Microfilter

The built-in microfilter removes dust and pollen from the incoming air and in the recirculated air mode. Your BMW center will replace this filter during the regularly scheduled maintenance. A substantial reduction in airflow indicates that the filter needs to be replaced earlier.

To defrost windows and remove condensation

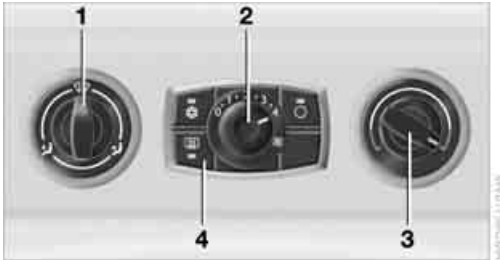

- 1 Turn the rotary control to 
- 2 Turn the rotary blower control for the air supply completely to the right
- 3 Turn the rotary temperature control completely to the right
- 4 To defrost the rear window, switch on the rear window defroster

Automatic climate control*

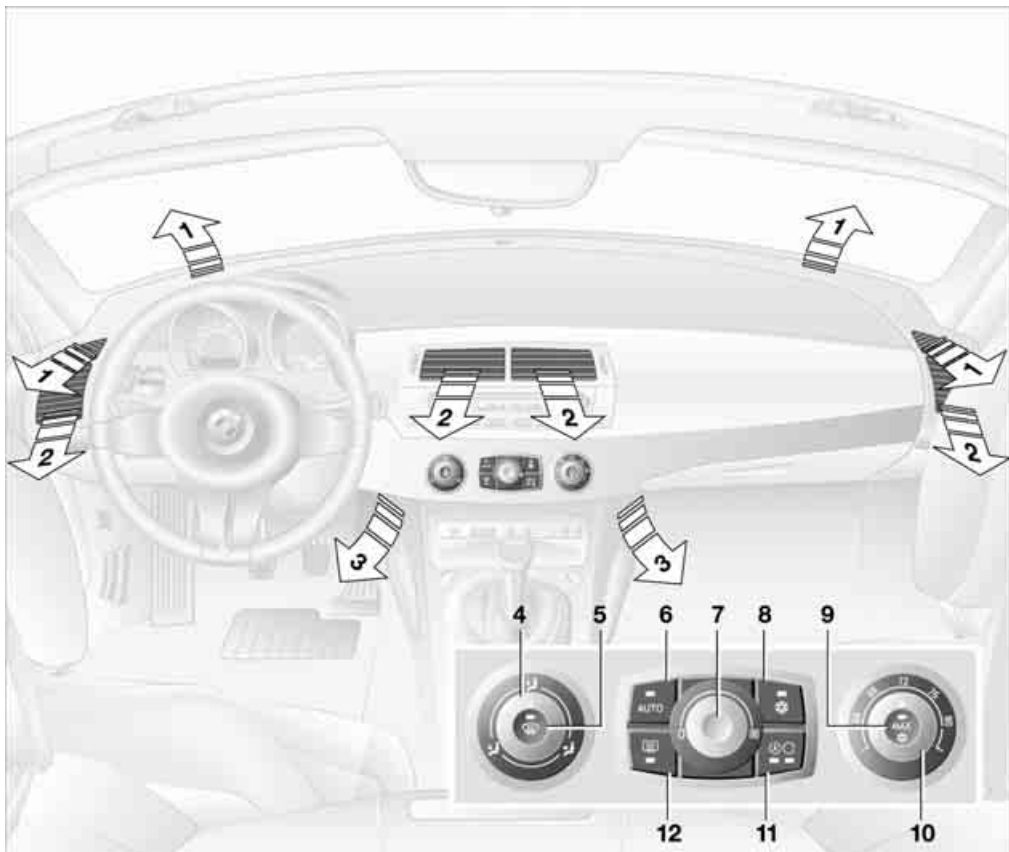

- | | | | |
|---|---|----|---|
| 1 | Air onto the windshield and the side windows | 7 | Air supply/blower 62 |
| 2 | Air for the upper body area 63 | 8 | Air conditioning 59 |
| 3 | Air for the footwell | 9 | Maximum cooling 62 |
| 4 | Individual air distribution 62 | 10 | Temperature 62 |
| 5 | To defrost windows and remove condensation 62 | 11 | Outside air/Automatic recirculated air control AUC/recirculated air mode 63 |
| 6 | Automatic air distribution and air supply 62 | 12 | Rear window defroster 63 |

Tips for pleasant driving

Use the automatic system – switch on with AUTO button **6**. Select the desired interior temperature.

Detailed setting options are described for you below.

Automatic air distribution and supply



The AUTO program assumes the adjustment of the air distribution and air supply for you and in addition adapts the temperature to external influences, summer or winter, to meet preferences you can specify.



In the AUTO program, the air conditioning mode is also turned on at the same time.



The AUTO program functions only to a limited extent when the convertible top is open. ◀

Individual air distribution



You yourself can direct airflow onto the windows , toward the upper body  and into the footwell . The arrow lights up. The automatic air supply remains unchanged. All intermediate settings are possible. By pressing the AUTO button, you can reactivate the air distribution.

Temperature



The interior temperature that appears on the display panel is a general figure intended for reference purposes. When you start the vehicle, the system ensures that the selected temperature is reached as quickly as possible, regardless of the season. It then maintains this temperature.

Air supply/blower



You can set the blower through an infinitely variable range of speeds. This shuts off the automatic air supply. The arrow lights up. The automatic air distribution remains unchanged. You can reactivate the automatic air supply by pressing the AUTO button.

When you turn the rotary control toward zero: the blower, heating and air conditioner are switched off, and the air supply is stopped. You can reactivate the system by turning the control toward the right again.

To defrost windows and remove condensation



This program quickly removes ice and condensation from the windshield and the side windows.

Maximum cooling



Above an outside temperature of 41 °F / +5 °C and with the engine running, you achieve a maximum cooling effect as quickly as possible. At the same time, the air conditioning is turned on.

The temperature is set to the lowest possible value. The system switches into the recirculated air mode and air flows at maximum blower speed from the air outlets only. Therefore, the air outlets must always be open when you select this program.

Air conditioning



The air is cooled and dehumidified and, depending on the temperature setting, rewarmed. Depending on the weather, the windshield may fog over briefly when the engine is started.

The air conditioning system is automatically switched on when you use the AUTO program.



Condensation forms during operation of the air conditioning system, which then exits under the vehicle. Traces of condensed water on the ground underneath the vehicle are thus normal. ◀

Outside air/Automatic recirculated air control AUC/recirculated air mode



You can respond to unpleasant external odors or pollutants by temporarily stopping the flow of outside air. The system then recirculates the air currently within the vehicle.

By repeatedly pressing the button, you can select one of three different operating modes.

- ▷ Indicator lamps off: outside air flows into the vehicle
- ▷ Left-hand indicator lamp on, AUC mode: the system detects pollutants in the outside air and responds by deactivating the outside airflow as required. The system then recirculates the air currently within the vehicle. Depending on air quality requirements, the system automatically switches between outside air supply and recirculation of the air already within the vehicle
- ▷ Right-hand indicator lamp on: the flow of outside air is permanently blocked. The system recirculates the air already within the vehicle.

 If the windows fog over in the recirculated air mode, switch this mode off and increase the air supply as required. Do not use the recirculated-air mode continuously over a long period of time as this would reduce the air quality in the interior of the vehicle. ◀

Rear window defroster



The indicator lamp lights up when the rear window defroster is active. The rear window defroster switches off automatically.

Ventilation

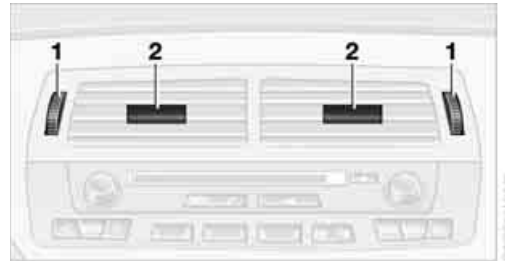

You can adjust the blower controls for the upper body area to obtain the optimum airflow rates and directions for your personal requirements:

- 1 Rotary dials for opening and closing the vents at any setting desired
- 2 Sliders for adjusting airflow direction

Microfilter/activated-charcoal filter

The built-in microfilter removes dust and pollen from the incoming air. The activated-charcoal filter provides additional protection by filtering gaseous pollutants from the outside air. Your BMW center replaces this combined filter as a standard part of your scheduled maintenance. A substantial reduction in airflow indicates that the filter needs to be replaced earlier.

Interior conveniences

Glove compartment

To open

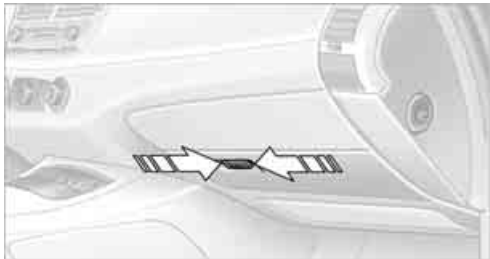

Press the two push buttons together.

To close

Swing the door up.



To prevent injury in the event of an accident, close the glove compartment immediately after use. ◀

Storage compartments

Storage compartment between backrests

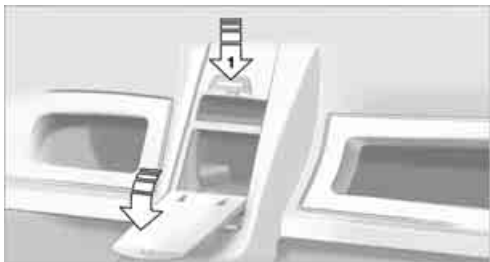

To open

1. Press button; see arrow 1
2. Swing the cover downward.

To close

Swing the door up.

Locking/unlocking

The storage compartment between the backrests is automatically locked and unlocked with the central locking system.

Releasing manually

In the event of an electrical malfunction of the central locking system, you can manually unlock the storage compartment between the seats.

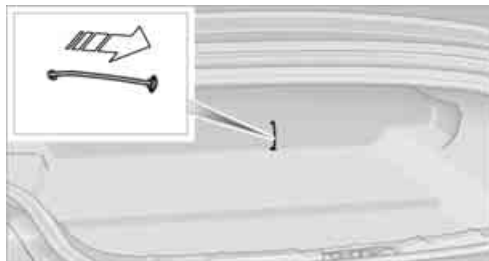

1. Pull on the cord in the rear luggage compartment panel.
The storage compartment between the seats unlocks
2. Press button; see arrow 1.

Other compartments and nets*

You will find additional storage compartments in the front doors and in the center console.

Depending on the particular version, the vehicle may also be equipped with two storage compartments behind the seats.

A net* is located on the passenger side along the center console.

Beverage holder

A beverage holder is located on either side beneath the air outlets.

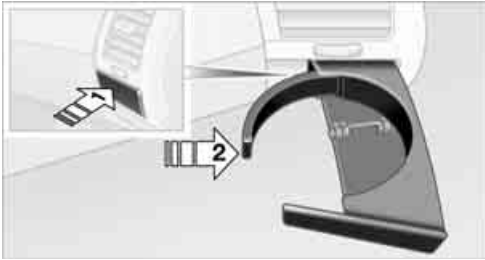

1. Press the trim piece beneath the air outlets; see arrow 1
2. Place the beverage into the holder
3. Adjust the holder to fit the size of the beverage container; see arrow 2.

⚠ Do not place glass containers into the beverage holders, as this increases the risk of injury in the event of an accident. ◀

Preparations for the cellular phone*

Hands-free system



In vehicles with telephone preparation, the cover for the hands-free microphone is located on the trim of the steering column.

For further information on the cellular phone, refer to the Owner's Manual for the telephone.

Ashtray*

To empty



1. Open cover
2. Pull out ashtray 1.

Cigarette lighter

Press in lighter 2. As soon as the lighter springs back out, it can be removed.

⚠ Hold or touch the hot cigarette lighter by the knob only. Holding or touching it in other areas could result in burns. The cigarette lighter remains operational even when the ignition key has been removed. For this reason, children should never be left in the vehicle unattended. ◀

Cigarette lighter socket

This can be used for attaching power supplies for flashlights, car vacuum cleaners and other similar appliances up to a rating of approx. 200 watts at 12 volts.

⚠ Do not damage the socket by inserting plugs of a different shape or size. ◀



Driving tips

Driving tips provides you with information you will need in certain driving situations and when using special operating modes.

Special operating instructions

Break-in procedures

To ensure that your vehicle provides maximum economy throughout a long service life, we request that you observe the following:

Engine and differential

Up to 1,200 miles / 2,000 km:
Drive at varying engine and road speeds, but do not exceed the following engine or road speed:

4,500 rpm / 4,500/min or
100 mph / 160 km/h.

Obey your local and state maximum speed limits.

Refrain from using full throttle and avoid pressing the accelerator beyond the kick-down point.

After you have driven 1,200 miles / 2,000 km, you can gradually increase the engine or road speeds.

You should also comply with these break-in procedures if the engine or differential is replaced later in the course of the vehicle's service life.

Sequential manual gearbox SMG

Up to 1,200 miles / 2,000 km:
Avoid using the acceleration assistant during the vehicle's break-in period.

Tires

Due to technical factors associated with their manufacture, tires do not achieve their full traction potential until an initial break-in period has elapsed. You should therefore drive with extra caution during the first 200 miles / 300 km.

Obey your local and state maximum speed limits.



When the vehicle is operated on wet or slushy roads, a wedge of water may form between the tire and the road

surface. This phenomenon is referred to as hydroplaning and can lead to partial or complete loss of traction, vehicle control and braking effectiveness. Reduce your speed on wet roads. ◀

Brake system

Approx. 300 miles / 500 km must elapse before the brake pads and rotors achieve their optimal surface and wear pattern.

To break in the separate parking brake drums, apply the parking brake lightly when coasting to a standstill – at a traffic signal, for instance; use caution to avoid posing a danger to other road users.

To avoid corrosion, repeat this procedure from time to time.

The brake lamps do not come on when the parking brake is set.



Vacuum for the brake system servo unit on your BMW is available only when the engine is running. When you move the car with the engine off, e.g. by towing, substantially higher levels of pedal force will be required to brake the vehicle. ◀

Clutch

The clutch will achieve its optimal functionality after approx. 300 miles / 500 km. Shift gears carefully during the break-in period.

Driving notes

Parking the vehicle

Condensation forms in the air conditioner system during operation, which then exits under the vehicle. Traces of condensed water on the ground underneath the vehicle are thus normal.

Brakes

 Do not drive with your foot resting on the brake pedal. Even light but consistent pedal pressure can lead to high temperatures, brake wear and possibly even brake failure.

Hydroplaning

 When driving on wet or slushy roads, reduce vehicle speed. If you do not, a wedge of water may form between the tires and the road surface. This phenomenon can lead to partial or complete loss of traction, vehicle control and braking effectiveness. ◀

Driving through water

 Do not drive through water on the road if it is deeper than 1 ft / 30 cm, and then only at walking speed. Otherwise, the vehicle's engine, the electrical systems and the transmission may be damaged. ◀

High temperatures

 High temperatures occur with every vehicle equipped with a catalytic converter. Heat shields are installed adjacent to some sections of the exhaust system. Never remove these shields; do not apply undercoating to their surfaces. When driving, standing at idle and parking the vehicle, take care to avoid contact between the hot exhaust system and flammable materials, e.g. hay, leaves, grass, etc. Such contact could lead to a fire, resulting in serious personal injury and property damage. ◀

Brake system

Indicator lamp



The indicator lamp lights up although the parking brake is not engaged:

Check the brake fluid level. It is very important that you follow the instructions on page 85 before driving on.

Disc brakes

Corrosion

Limited vehicle use, extended periods with the vehicle parked or in storage, and operating conditions in which braking is restricted to gentle, low-pressure applications will all increase the tendency for corrosion to form on the rotors and contamination to accumulate on the brake pads. This occurs because the minimal pressure which must be exerted by the pads to clean the rotors by brake applications is not reached.

If the brake rotors are corroded, they will tend to respond to braking with a pulsating effect which even extended application will fail to cure.

Wet roads

When driving in heavy rain and on wet roads, it is useful to apply light pressure to the brake pedal every few miles. Watch traffic conditions to ensure that this maneuver does not endanger other road users. The resulting heat dries the brake rotors and brake pads. Immediate braking control is then available if necessary.

Inclines

Extended or steep mountain descents should be driven in the gear or drive position in which only minimal periodic brake application is required. This helps avoid placing excessive loads on the brake system. Observe the maximum allowable engine speed when doing so; refer to page 48.

 Do not coast with the clutch depressed or with the transmission or selector lever in Neutral. Do not coast with the engine switched off. Otherwise the engine provides no braking effect and there is no power-assist for braking or steering when the engine is off. ◀

Brake pads



The yellow indicator lamp for the brake pads lights up: Have the condition of the brake pads inspected.

 For your own safety: use brake pads which the manufacturer has approved for your specific vehicle model. The manufacturer cannot evaluate non-approved brake pads to determine if they are suitable for use, and therefore cannot ensure the operating safety of the vehicle in the event of their use. ◀

Cargo loading

 Avoid overloading the vehicle so that the permitted load on the tires is not exceeded. Otherwise, overheating and inner damage to the tires may result. The ultimate result can assume the form of a sudden air loss. ◀

Determining the maximum load



1. Locate the following statement on your vehicle's placard*:

 The combined weight of occupants and cargo should never exceed XXX kg or YYY lbs; otherwise damage to the vehicle and unstable driving conditions could result. ◀

2. Determine the combined weight of the driver and passenger that will be riding in your vehicle
3. Subtract the combined weight of the driver and passenger from XXX kilograms or YYY pounds
4. The resulting figure equals the available amount of cargo and luggage load capacity.
For example, if the XXX amount equals 551 lbs. and there will be two 150 lbs. passengers in your vehicle, the amount of available cargo and luggage load capacity is 251 lbs.
 $551 \text{ lbs.} - 300 \text{ lbs.} = 251 \text{ lbs.}$
5. Determine the combined weight of luggage and cargo being loaded on the vehicle. That weight may not safely exceed the available cargo and luggage load capacity calculated in Step 4.

Load

The permissible load is the sum of the occupants' weights and the weight of the cargo. The greater the weight of the occupants, the less cargo can be transported.

Stowing cargo



- ▶ Load heavy cargo as far forward as possible, directly behind the luggage compartment partition, and as low as possible
- ▶ Cover sharp edges and corners.

 To avoid damaging the rear of the backrest or the rear interior trim panel, do not stow heavy cargo or cargo with sharp edges and corners behind the seats.

In addition, large and bulky cargo stowed

behind the seats may prevent the backrest from engaging properly. Ensure that the backrest is securely locked by moving the seat forward if necessary. Refer to page 28. ◀

 Always position and secure the load correctly. If you do not, it can endanger the passengers during braking or evasive maneuvers.

Do not exceed the approved gross vehicle weight or the specified maximum axle loads. Refer to page 101. Otherwise the vehicle's operating safety is no longer assured and you are in violation of the law. Do not stow heavy or hard objects in the passenger compartment without first securing them. Otherwise they would be thrown around during braking and evasive maneuvers and would endanger the occupants. ◀

Convertible top compartment

 With the convertible top closed, you can enlarge the luggage compartment, refer to page 20.

It is recommended that you always fold the convertible top compartment panel down as soon as you have removed cargo from the luggage compartment. This way, you can be sure that you can always operate the convertible top at any time.

Conversely, when the convertible top is closed, raise the convertible top compartment panel before stowing your cargo in the luggage compartment to avoid any damage to the convertible top compartment or your load. ◀

If you stow cargo behind the seats of your BMW:

- ▷ Only stow light objects such as clothing, etc.
- ▷ Do not pile objects higher than the top edge of the backrests.

Hardtop preparation*

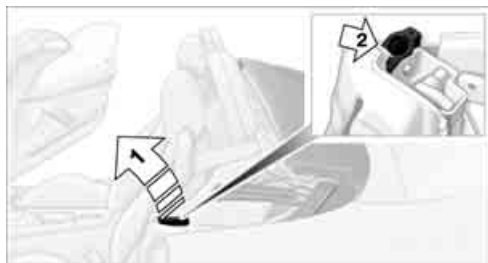

Pull covers off, see arrow 1.

The brackets for attaching the hardtop are located underneath the covers; see arrow 2.

 For instructions on how to install the hardtop, please read the accompanying assembly information. ◀

 The hardtop is available from your BMW center as a special option. ◀





Mobility

To ensure that you stay mobile, the following chapter provides you with important information on fuels and fluids, tires and wheels, maintenance procedures and steps to take in the event of a breakdown.

Refueling

Fuel filler door



1. Open fuel filler door
2. Turn the gas cap in a counter-clockwise direction
3. Place the gas cap in the bracket on the filler door.

Releasing manually

If an electrical malfunction occurs, you can unlock the fuel filler door manually:



1. Remove the covers of the tail lamps by turning the lock to the right; refer also to page 90
2. Pull the luggage compartment trim panel slightly toward the interior. The green button with the fuel pump symbol is revealed
3. Undo the adhesive strip and pull off
4. Pull the button
The fuel filler door is released.

 Pull on the button slowly and carefully as it could otherwise be torn off. ◀

Fuel gas cap

 Close the gas cap carefully after refueling until a click is heard. While closing, be sure not to squeeze the strap which is fastened to the cap. A loose or missing cap will activate the CHECK GAS CAP lamp*. ◀

Check Gas Cap*
 This indicator lamp comes on when the gas cap is loose or missing. Close the gas cap tightly as described above.

Tank capacity: approx. 14.5 gallons/
55 liters, of which approx. 2.1 gallons/
8 liters are reserve capacity.

Simple and environmentally friendly

 When handling fuels, comply with all of the applicable safety precautions posted at the service station. ◀

When refueling, insert the filler nozzle completely into the filler pipe. Lifting the nozzle during refueling

- ▷ results in premature shutoff
- ▷ and will reduce the effect of the vapor recovery system on the pump.

The fuel tank is full when the filler nozzle shuts off the first time.

 Fill the fuel tank before it is completely empty. Driving to the last drop of fuel can prevent the engine from operating properly and result in damage. ◀

Fuel specifications

The engine uses lead-free gasoline only.

Required fuel:

- ▷ Premium Unleaded Gasoline, min. 91 AKI.
AKI = Anti Knock Index

 Do not use leaded fuels. The use of leaded fuels will cause permanent damage to the system's oxygen sensor and the catalytic converter. ◀

Wheels and tires

Tire inflation pressure

Information for your safety

It is not merely the tire's service life, but also driving comfort and driving safety that largely depend on the condition of the tires and the maintenance of the specified tire pressure.

 Check tire inflation pressures regularly and correct them if necessary: at least every two weeks and before every extended journey. If this is not done, incorrect tire pressures can cause driving instability or tire damage, ultimately resulting in accidents.

Do not drive with a deflated, i.e. flat, tire unless your vehicle is equipped with Run Flat tires. A flat tire greatly impairs steering and braking response, and can lead to complete loss of control over the vehicle. ◀

Checking tire pressures

Check the tire inflation pressures only when the tires are cold. This means after a maximum driving distance of 1.25 miles/ 2 km or if the vehicle has been parked for at least 2 hours. Warm tires have higher inflation pressures.

Reinitialize the Flat Tire Monitor after correcting the tire inflation pressure. Refer to page 55.

Inflation pressures for original tires



The specified inflation pressures for tires at ambient temperature are provided on the placard on the B-pillar and are visible when the driver's door is open.

Inflation pressures for other tire sizes

The following tire inflation pressure tables show the inflation pressures for the specified tire sizes at ambient temperature.

 Reinitialize the Flat Tire Monitor after correcting the tire inflation pressure. Refer to page 55. ◀

Tire size

The inflation pressures in the table apply to BMW-approved tire sizes and brands. Your BMW center will be glad to supply this information.

Z4 2.5i

Tires

Pressure specifications in psi/kPa

Tires

All pressure specifications in the table are indicated in psi/kilopascal with cold tires, cold = ambient temperature

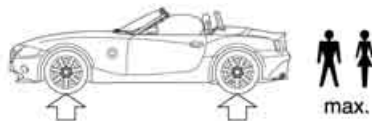

225/50 R 16 92 V	30/210	33/230
225/45 R 17 91 W		
225/40 R 18 88 W	30/210	-
245/40 R 17 91 W	-	33/230
255/35 R 18 90 W		
All winter tires	30/210	33/230

You will find more information about permissible loads and weights on page 101.

Z4 3.0i

Tires

Pressure specifications in psi/kPa

Tires

All pressure specifications in the table are indicated in psi/kilopascal with cold tires, cold = ambient temperature

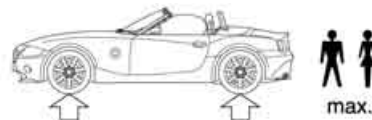

225/45 R 17 91 W	33/230	36/250
225/40 R 18 88 W	33/230	-
245/40 R 17 91 W	-	36/250
255/35 R 18 90 W		
All winter tires	33/230	36/250

You will find more information about permissible loads and weights on page 101.

Tire coding

Understanding the lettering on the tire sidewall makes it easier to identify and choose the correct tires.

Tire size

e.g. 225/50 R 16 92 V

Nominal width in mm	_____				
Cross-sectional ratio in %	_____				
Radial belt construction	_____				
Rim diameter in inches	_____				
Load index, not on ZR tires	_____				
Speed code letter, in front of the R on ZR tires	_____				

Speed code letters

Q = up to 105 mph / 160 km/h
 T = up to 118 mph / 190 km/h
 H = up to 131 mph / 210 km/h
 V = up to 150 mph / 240 km/h
 W = up to 167 mph / 270 km/h
 Y = up to 186 mph / 300 km/h

Tire Identification Number

Tires with DOT codes meet the guidelines of the U.S. Department of Transportation.

DOT code:

e.g. DOT xxxx xxx 3603

Manufacturer's code for tire brand	_____				
Tire size and tire version	_____				
Tire age	_____				

Tire age

The date on which the tire was manufactured is indicated by the code on the sidewall:

DOT ... 3603 indicates that the tire was manufactured in week 36 of the year 2003.

BMW recommends the replacement of all tires every 6 years at the latest, even if a tire usage of 10 years is possible.

Uniform Tire Quality Grading

Quality grades can be found where applicable on the tire sidewall between tread shoulder and maximum section width. For example:

Treadwear 200 Traction AA
 Temperature A

DOT quality grades

Treadwear
 Traction AA A B C
 Temperature A B C

 All passenger car tires must conform to Federal Safety Requirements in addition to these grades. ◀

Tread wear

The tread wear grade is a comparative rating based on the wear rate of the tire when tested under controlled conditions on a specified government test course. For example, a tire graded 150 would wear one and one-half, 1 1/2, times as well on the government course as a tire graded 100. The relative performance of tires depends upon the actual conditions of their use, however, and may depart significantly from the norm due to variations in driving habits, service practices and differences in road characteristics and climate.

Traction

The traction grades, from highest to lowest, are AA, A, B and C. Those grades represent the tire's ability to stop on wet pavement as measured under controlled conditions on specified government test surfaces of asphalt and concrete. A tire marked C may have poor traction performance.

 The traction grade assigned to this tire is based on straight-ahead braking traction tests, and does not include acceleration, cornering, hydroplaning, or peak traction characteristics. ◀

Temperature

The temperature grades are A, the highest, B and C, representing the tire's resistance to the generation of heat and its ability to dissipate heat when tested under controlled conditions on a specified indoor laboratory test wheel.

Sustained high temperature can cause the material of the tire to degenerate and reduce tire life, and excessive temperature can lead to sudden tire failure. The grade C corresponds to a level of performance which all passenger car tires must meet under the Federal Motor Vehicle Safety Standard No. 109. Grades B and A represent higher levels of performance on the laboratory test wheel than the minimum required by law.

 The temperature grade for this tire is established for a tire that is properly inflated and not overloaded. Excessive speed, under-inflation, or excessive loading, either separately or in combination, can cause heat buildup and possible tire failure. ◀

RSC: Run Flat tires

Run Flat tires are labeled on the sidewall with a circular symbol containing the letters RSC. Refer to page 80.

M+S

Winter and all-season tires. These have better winter performance properties than summer tires.

Tire condition

Inspect your tires frequently for tread wear, signs of damage and for foreign objects lodged in the tread. Check the tread depth.

Tire tread

Tread depth should not be allowed to go below 1/8 in/3 mm even though in Europe, for example, the legally specified minimum tread depth is only 1/16 in/1.6 mm. Below 1/8 in/3 mm tread depth, there is a very high risk of hydroplaning, even at relatively

moderate speeds and with only small amounts of water on the road.

At tread depths below approx. 1/6 in/4 mm, winter tires display a perceptible decrease in their ability to cope with winter driving conditions, and should be replaced in the interest of safety.

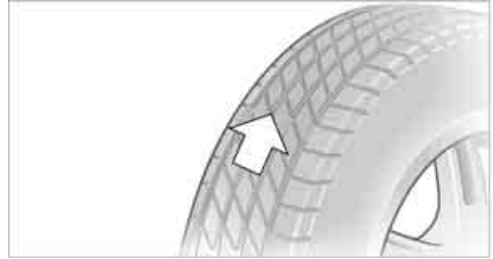

Tread wear indicators in the tread-groove base, see arrow, are distributed around the wheel circumference and are labeled on the tire sidewall as TWI, Tread Wear Indicator. At a tread depth of 1/16 in/1.6 mm, the indicators signal that the legally permissible wear limit has been reached.

Tire damage

 Unusual vibrations encountered during normal vehicle operation can indicate tire failure or some other vehicle malfunction. This type of problem can be caused by contact with curbs, etc. This is also true for irregularities in the vehicle's handling characteristics, such as a pronounced tendency to pull to the left or right. Should this occur, respond by immediately reducing your speed. Proceed carefully to the nearest BMW center or professional tire center, or have the vehicle towed there to have it and its wheels or tires inspected. Tire damage up to and including sudden and complete air loss can pose an extreme hazard for both vehicle occupants and other road users. ◀

Wheel and tire replacement

 Unprofessional attempts by laymen to service tires can lead to damage and accidents.

Have this work performed by skilled professionals only. Any BMW center has the required technical knowledge and the proper equipment and will be happy to assist you. ◀

The correct wheel and tire combination also affects various systems that would otherwise be impaired, for example ABS or DSC.

Have the wheels balanced after each tire or wheel replacement.

 BMW advises against using retreaded tires, since driving safety may be impaired. This is due to possible variations in casing structures and, in some cases, to their extreme age, factors which can lead to a decrease in their durability. ◀

The correct wheels and tires

 BMW recommends using only wheels and tires that have been tested and approved by BMW for your particular vehicle model, as otherwise body contact and serious accidents can result despite the use of the same nominal size, e.g. due to manufacturing tolerances. If non-approved wheels and tires are used, BMW cannot evaluate their suitability, and therefore cannot be held liable for driving safety. ◀

To maintain good handling and vehicle response, use only tires of a single brand and tread configuration. In the event of a flat tire, remount the previous wheel and tire combination as soon as possible.

Recommended tire sizes and brands

BMW tests certain tire brands for each tire size, classifies them as road-safe and approves them. You can best find out about these at a specialized shop, particularly your BMW center. Observe any country-specific regulations, e.g. on making a corresponding entry in the vehicle documents.

The factory-approved radial-ply tires are matched to your vehicle and have been selected to provide optimum safety and driving comfort when used properly.

Run Flat tires fitted

Use only Run Flat tires, since no spare wheel is available in the event of a flat.

Special characteristics of winter tires

BMW recommends the use of winter tires for operation under winter road conditions. While all-season tires, with M+S designation, provide better winter traction than summer tires, they generally do not achieve the full performance of winter tires.

For mounting winter tires, refer to the descriptions under Tire condition and Wheel and tire replacement, pages 78, 79.

Run Flat tires fitted

Use only winter Run Flat tires, since no spare wheel is available in the event of a flat.

Observing speed ratings

 Never exceed the maximum speed for which the winter tires are rated. Unprofessional attempts by laymen to service tires can lead to damage and accidents. Have this work performed by skilled professionals only. The technicians at your BMW center will be glad to assist you with the required professional knowledge and specialized equipment. ◀

Storage

Store tires in a cool, dry place, protecting them against light whenever possible. Protect the tires from contact with oil, grease and fuel. Do not exceed the maximum tire inflation pressures specified on the tire sidewall.

Run Flat tires



Run Flat tires are labeled on the sidewall with a circular symbol containing the letters RSC. Run Flat tires consist of self-supporting tires and special rims. The tire reinforcement ensures that driving remains possible to a restricted degree in the event of pressure drop or even if the tire is deflated.

▶ When mounting or replacing summer tires with winter tires, or vice versa, use Run Flat tires since no spare wheel is available in the event of a flat. Your BMW center knows how to work with Run Flat tires and is equipped with the necessary special tools. ◀

Driving with a damaged tire

When using Run Flat tires, you can continue driving cautiously at a maximum speed of 50 mph / 80 km/h, depending on the cargo load and the extent of tire damage.

If there is a total loss of tire inflation pressure, 0 psi/kilopascal, or obvious tire damage, you can gauge the mileage for continued driving on the basis of the following indications:

- ▶ With a light load:
 - 1 person without luggage:
approx. 150 miles/250 km
- ▶ With a medium load:
 - 1 person, luggage compartment full,
or
 - 2 persons without luggage:
approx. 90 miles/150 km

- ▶ With a full load:
 - 2 persons, luggage compartment full:
approx. 30 miles/50 km

⚠ Drive cautiously. Do not exceed a speed of 50 mph / 80 km/h. Be aware that vehicle handling will be altered when there is a loss in inflation pressure. Anticipate, e.g., reduced tracking during braking, longer braking distances and changed steering characteristics. For safety reasons, BMW recommends not to have Run Flat tires repaired if they are damaged, but to consult your BMW center in such cases. ◀

Snow chains*

Only certain types of snow chains have been tested by BMW, classified as road-safe and approved. Consult your BMW center for more information. BMW recommends using only approved fine-link snow chains. Use them in pairs on either summer or winter tires, but only on both rear wheels.

Comply with all manufacturer's safety precautions when mounting the chains. Do not exceed a speed of 30 mph / 50 km/h when using snow chains.

▶ Do not initialize the Flat Tire Monitor after snow chains have been mounted.

When driving with snow chains, it may be useful to deactivate the DSC briefly. Refer to page 53. ◀

In the engine compartment

Hood

To release the hood



Pull the lever located under the left-hand side of the instrument panel.

⚠ Do not work on your vehicle without the appropriate skills to do so. Failure to work in an informed, professional manner when servicing components and materials constitutes a safety hazard for vehicle occupants and other road users. If you are not familiar with the guidelines, BMW recommends that you have the operations performed by your BMW center. ◀

To open

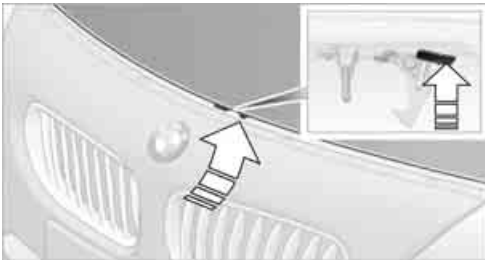

1. Reach under the engine hood
2. Push the release handle up
3. Open the hood.

To close

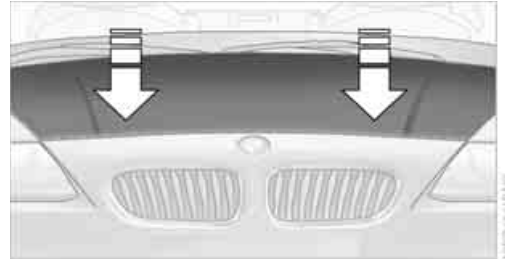

Allow the hood to fall from a low height and push on both sides so that it audibly engages.

⚠ To avoid injuries, be sure that the travel path of the hood is clear when it is closed, as with all closing procedures. If you notice while driving that the hood is not completely closed, stop immediately and close it securely. ◀

Engine compartment

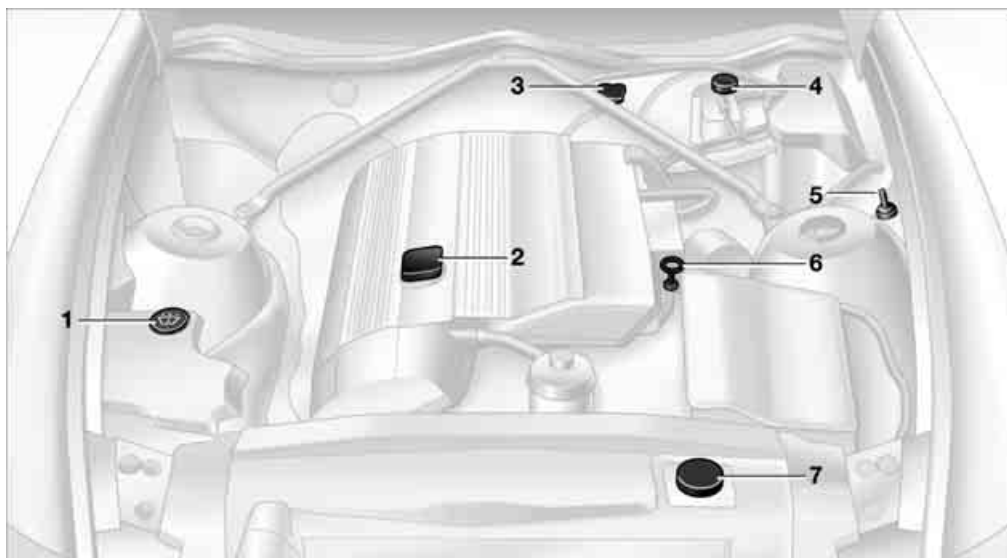

WINDCLIPMAN

- | | |
|--|-------------------------------------|
| 1 Reservoir for the headlamp and windshield washer system 83 | 4 Reservoir for brake fluid 85 |
| 2 Engine oil filler neck 84 | 5 Chassis ground, negative terminal |
| 3 Auxiliary terminal for jump-starting 94 | 6 Engine oil dipstick 83 |
| | 7 Coolant expansion tank 84 |

Washer fluids for washer systems

Headlamp* and windshield washer system



Capacity of windshield washer system: approx. 3.2 quarts/3 liters.

Capacity when equipped with headlamp washer system: approx. 5.3 quarts/5 liters.

Fill with water and, if required, with an anti-freeze agent according to the manufacturer's recommendations.

 We recommend that you mix the washer fluid before adding it to the reservoir. ◀

 Antifreeze agents for the washing systems are highly flammable. For this reason, keep them away from sources of flame and store them only in their original containers. Store them so that they are inaccessible to children. Comply with the instructions on the containers. ◀

Engine oil

Engine oil pressure

 The indicator lamp lights up in red: Stop the vehicle immediately and switch off the engine. Check the engine oil level and top off as required. If the oil level is correct, please contact the nearest BMW center.

 Do not continue driving, as the engine could sustain serious damage from inadequate lubrication. ◀

Engine oil level



The indicator lamp lights up in yellow while driving:

The oil level is at the absolute minimum; refill as soon as possible. Do not drive more than 30 miles/50 km before refilling.



The indicator lamp lights up in yellow after the engine has been switched off:

Add engine oil at the earliest opportunity, when you stop to refuel.

Engine oil sensor



The indicator lamp lights up in yellow within 20 seconds after the engine is started:

The oil level sensor is defective. Please have it checked by a BMW center.

Checking the oil level



1. Park the vehicle on a level surface
2. Switch the engine off after it has reached normal operating temperature
3. After approx. 5 minutes, pull the dipstick out and wipe it off with a clean lint-free cloth, paper towel, or similar material
4. Carefully push the dipstick all the way into the guide tube and pull it out again
5. The oil level should be between the two marks on the dipstick
6. Return the dipstick to the guide tube, inserting it as far as it will go.

As with fuel economy, oil consumption is directly influenced by your driving style and vehicle operating conditions.

The oil volume between the two marks on the dipstick corresponds to approx. 1.1 quarts/1 liter. Do not fill beyond the upper mark on the dipstick. Excess oil will damage the engine.

Adding engine oil



While you should wait until the level has dropped to just above the lower mark before adding oil, you should never allow the oil level to fall below this mark.

 BMW engines are designed to operate without oil additives; the use of additives could even lead to damage in some cases. This also applies to manual and automatic transmissions and to the differential. ◀

 Continuous exposure to used oil has caused cancer in laboratory tests. For this reason, thoroughly wash any areas of skin that come into contact with oil using soap and water.

Always store oils, grease and similar materials so that they are inaccessible to children. Comply with warning labels and the information on the containers. ◀

 Comply with the applicable environmental laws regulating the disposal of used oil. ◀

Approved engine oils

The quality of the engine oil is extremely important for the function and life of an engine. Based on extensive testing, BMW has approved certain grades of engine oil. Use approved High Performance Synthetic Oil.

If you are unable to obtain an approved High Performance Synthetic Oil, you may

use small volumes of other synthetic oils for topping up between oil changes. Use only oils with the specification API SH or higher.

 Ask your BMW center for details concerning the specific High Performance Synthetic Oil or synthetic oils that have been approved. ◀

You can also call BMW of North America toll-free at 1-800-831-1117 or visit this website: www.bmwusa.com to obtain this information.

Coolant

 The yellow coolant indicator lamp lights up:
The coolant level is too low: top up as soon as possible.

 Do not add coolant to the cooling system when the engine is hot. If you do, escaping coolant can cause burns. Antifreeze and anti-corrosion agents are hazardous to health. You should always store them in their original containers and in a location inaccessible to children. Antifreeze and anti-corrosion agents are flammable. For this reason, do not spill them on hot engine parts. They could ignite and cause burns. Comply with the instructions on the containers. ◀

Checking the coolant level

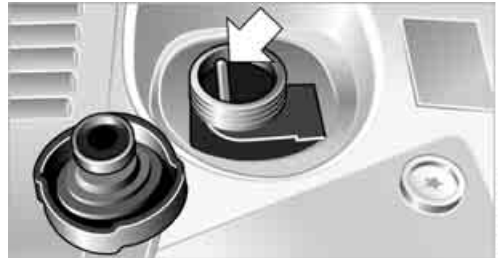

Correct coolant level when the engine is cold, approx. 68 °F/20 °C:

1. Open the cap of the expansion tank by turning it slightly counterclockwise to

allow accumulated pressure to escape, then open completely

2. The coolant level is correct when the upper end of the red float is at least even with the upper edge of the filler neck but no more than 3/4 in/2 cm above it, that is up to the second mark on the float. Refer also to the schematic diagram next to the filler neck
3. If necessary, add coolant. Slowly add coolant until the correct level is reached; do not overfill.

 Comply with the applicable environmental laws regulating the disposal of antifreeze with corrosion inhibitor. ◀

Brake fluid

Indicator lamp



 The brake warning lamp lights up red when the parking brake is not engaged: the brake fluid level is too low, refer to page 69.

 The brake warning lamp for Canadian models lights up red when the parking brake is not engaged: the brake fluid level is too low, refer to page 69.

Brake fluid, refilling

Brake fluid loss may result in extended brake pedal travel. If this occurs, also refer to the notes on page 69.

 Brake fluid is hygroscopic, that is, it absorbs moisture from the air over time.

In order to ensure the brake system's safety and reliability, have the brake fluid changed every two years by a BMW center. Refer also to page 49 and the Service Manual.

Brake fluid is toxic and damages the vehicle's paint. You should always store it in the closed original container and in a location inaccessible to children.

Do not spill the fluid and do not fill the brake fluid reservoir beyond the MAX mark. The brake fluid could ignite upon contact with hot engine parts and cause serious burns. ◀

 Comply with the applicable environmental laws regulating the disposal of brake fluid. ◀

Brake fluid level

Low brake fluid level in the reservoir combined with extended pedal travel may indicate a defect in one of the brake system's hydraulic circuits.

 BMW recommends that you proceed to the nearest BMW center. Higher brake application pressure may be necessary under these conditions, and braking distances may be significantly longer. Please remember to adapt your driving style accordingly. ◀

Maintenance

The BMW Maintenance System

The BMW Maintenance System has been designed as a reliable means of providing maximum driving and operating safety, and as cost-effectively for you as possible.

Please keep in mind that regular maintenance is not only necessary for the safety of your vehicle, but also plays a significant role in maintaining the resale value of your vehicle.

Service interval display



While conventional systems rely on distance traveled alone to determine when a service is due, the BMW Maintenance System has taken the actual conditions under which the vehicle is operated into consideration for years, because miles can be traveled in many different ways:

From a maintenance point of view, 60,000 miles/100,000 km accumulated in short-distance urban driving are not the same as 60,000 miles/100,000 km accumulated at moderate cruising speeds in long-distance highway travel.

The BMW Maintenance System includes the Engine Oil Service and Inspections I and II.

Determining the maintenance intervals based on the actual loads on the vehicle covers every kind of operating situation. Minimal use drivers, who drive fewer than about 6,200 miles/10,000 km per year, should nevertheless have the oil changed

at least every 2 years since engine oil deteriorates over time, regardless of use.

Service and Warranty Information Booklet for US models, Warranty and Service Guide Booklet for Canadian models

For additional information on required maintenance intervals and procedures, please refer to the Service and Warranty Information Booklet for US models, or the Warranty and Service Guide Booklet for Canadian models.

Depending on operating conditions, it may be advisable to have the body checked for damage from rocks or gravel as a precaution against corrosion.

 BMW recommends that you have your BMW center perform the maintenance and repair.

Be sure that all maintenance work is recorded in the Service and Warranty Information Booklet for US models, Warranty and Service Guide Booklet for Canadian models. These entries will serve as proof that the vehicle has received regular maintenance. ◀

Care

Interesting facts about the care of your vehicle are found in the Caring for your vehicle brochure.

Laws and regulations

California Proposition 65 warning

California laws require us to state the following warning:

 Engine exhaust and a wide variety of automobile components and parts, including components found in the interior furnishings in a vehicle, contain or emit chemicals known to the State of California to cause cancer and birth defects and reproductive harm. In addition, certain fluids contained in vehicles and certain products of component wear contain or emit chemicals known to the State of CA to cause cancer and birth defects or other reproductive harm. Battery posts, terminals and related accessories contain lead and lead compounds. Wash your hands after handling. Used engine oil contains chemicals that have caused cancer in laboratory animals. Always protect your skin by washing thoroughly with soap and water. ◀

OBD interface socket



The Onboard Diagnostic OBD interface socket is located on the left of the driver's side under the instrument panel and under a cover.

The cover has the letters OBD on it.

The purpose of the OBD system is to ensure proper operation of the emission control system for the vehicle's lifetime.

The system monitors emission-related components and system for deterioration and malfunction.



If the Service Engine Soon indicator lamp comes on either continuously or intermittently, this indicates a fault in the emissions-related electronic systems. Although the vehicle remains operational, you should have the systems checked by your BMW center at the earliest possible opportunity.

The illuminated indicator informs you of the need for service, not that you need to stop the vehicle. However, the systems should be checked by your BMW center at the next opportunity.

If the indicator blinks or flashes, this indicates a high level of engine misfire. Reduce speed and contact the nearest BMW center immediately. Severe engine misfiring over even a short period of time can seriously damage emission control system components, especially the catalytic converter.



Service Engine Soon warning lamp for Canadian models.



If the gas cap is not on tight enough, the OBD system can detect leaking vapor and the indicator will light up. If the gas cap is then tightened, the indicator will usually go out after a short period of time. ◀

Replacement procedures

Onboard tool kit

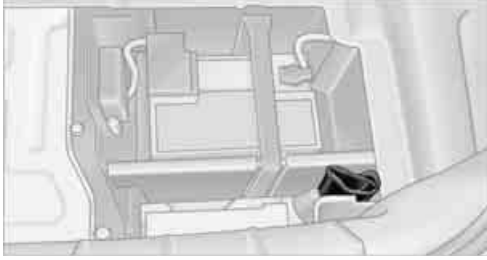

The onboard tool kit is stored in a tool pouch. It is located in the luggage compartment beneath the floor panel.

Windshield wiper blades



1. Fold the wiper arm completely out from the windshield
2. Position the wiper blade at an angle and pull the release spring, see arrow
3. Fold the wiper blade down and unhook it toward the windshield
4. Pull the wiper blade past the wiper arm toward the top
5. Insert a new wiper blade and apply pressure until you hear it engage.

Lamps and bulbs

The lamps and bulbs make essential contributions to the safety of your vehicle. Therefore, comply fully with the following instructions during bulb replacement. If you are not familiar with the procedures, BMW recommends that you have your BMW center carry out the work.

Do not touch the glass portion of a new bulb with your bare hands since even small amounts of impurities burn in to the surface and reduce the service life of the bulb. Use a clean cloth, paper napkin or a similar material, or hold the bulb by its metallic base. ◀

A replacement bulb set is available from your BMW center.

! Before working on the electrical system, switch off the electrical accessory you are working on or disconnect the cable from the negative terminal of the battery. Failure to observe this precaution could result in short circuits.

To prevent injuries and damage, always comply with any instructions provided by the bulb manufacturer. ◀

Accessing the headlamps

Protective cover in the wheel well



To gain access to the headlamp covers, turn the front wheels in the required direction.

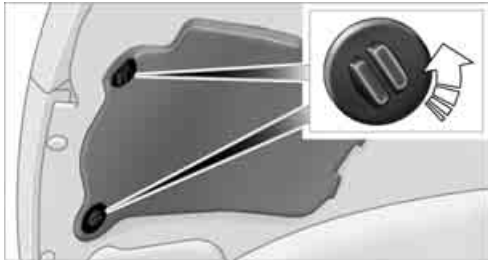

1. Open the caps with a suitable object, e.g. a coin or screwdriver
2. Fold up the protective cover in the wheel well.

Headlamp cover



1. Pull the wire clamp out straight

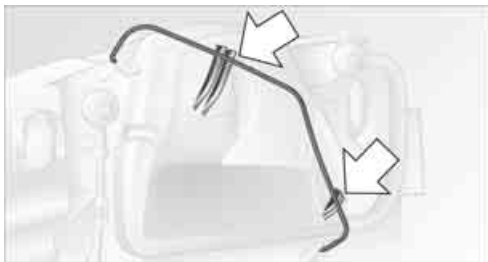

2. Pull the wire clamp past the catches, see arrows, and fold it down
3. Flip the headlamp cover open and remove.

⚠ Reinstall the headlamp cover carefully. If it is not on tight, the headlamp installation could be damaged. ◀

Reinstall the headlamp cover in reverse order.

Low beams and high beams

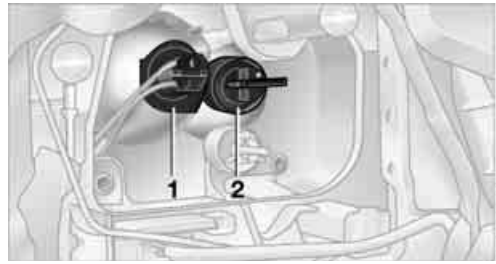

Left side of engine compartment:

- 1 Low beams
- 2 High beams

H7 bulb, 55 watts

⚠ The H7 bulb is pressurized. Therefore, wear safety glasses and protective gloves. Failure to comply with these precautions could result in physical injury if the bulb is damaged. ◀

1. Turn the bulb holder to the left and pull out
2. Remove and replace the bulb
3. Install in the reverse order.

▶ When cleaning the headlamps, please observe the instructions in the Caring for your vehicle brochure. ◀

Xenon lamps*

The service life of these bulbs is very long and the probability of a failure is very low, provided that they are not switched on and off an unusual number of times. If one of these bulbs should nevertheless fail, it is possible to continue driving with great caution using the fog lamps, provided traffic laws in your area do not prohibit this.

⚠ Because of the extremely high voltages involved, any work on the xenon lighting system, including bulb-changing, should be carried out by technically qualified personnel only. Otherwise, there is a risk of fatal injury. ◀

Front turn signal indicators

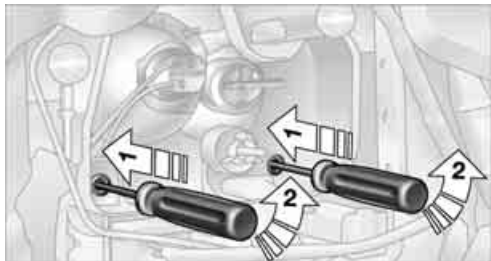

21 watt bulb

1. Insert a Phillips-head screwdriver from the onboard toolkit into the appropriate opening, arrows 1
2. Turn the screwdriver to the left, arrows 2
3. Use the Phillips-head screwdriver to pull out the entire bulb holder

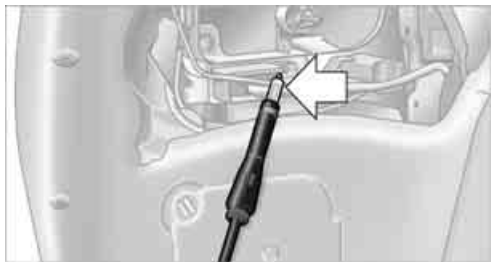

4. Replace the bulb
5. Install in the reverse order.

Side turn signal indicators

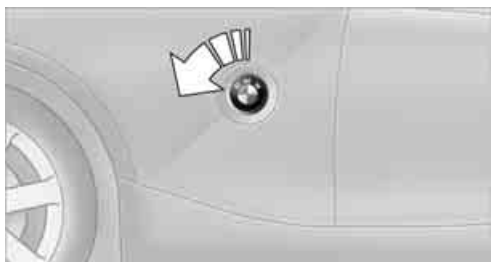

5 watt bulb

1. Turn the lamp to the left and remove
2. Apply gentle pressure to the bulb while turning it to the left to remove
3. Install in the reverse order.

Tail lamps

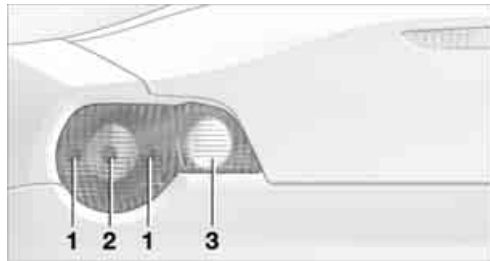

Tail lamps 1: 21/4 watt bulbs
Remaining bulbs: 21 watt

- 1 Tail lamp/brake lamp, red
- 2 Turn signal indicator, yellow
- 3 Backup lamp, white



On the right-hand side of the luggage compartment:

1. Remove the cover by turning the lock to the right; refer to the detail in the illustration
2. Applying light pressure, turn the bulb to the left. Remove and exchange the bulb
3. Reinstall the cover.

Center high-mount brake lamp



The LED strip is in the luggage compartment lid.

Please contact a BMW center in case of a malfunction.

License plate lamps

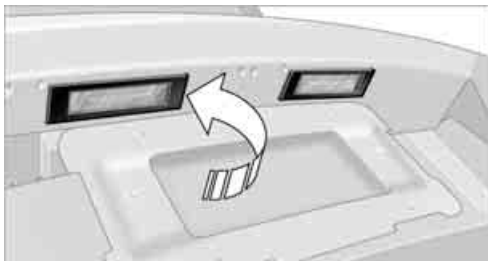

5 watt bulb

1. Push out the lamp with a suitable object and remove it
2. Replace the bulb.
Snap the lamp back into place.

Changing a wheel

Run Flat tires

Your BMW is equipped with Run Flat tires. Therefore, the wheel no longer has to be changed immediately in the event of a loss in inflation pressure.

Run Flat tires are labeled on the sidewall with a circular symbol containing the letters RSC. Refer to page 80.

BMW recommends that you consult your BMW center if you wish to replace the tires of your BMW, or change from summer to winter tires or vice versa.

Your BMW center knows how to work with Run Flat tires and is equipped with the necessary special tools.

 When mounting or replacing summer tires with winter tires, or vice versa, use only Run Flat tires since no spare wheel is available in the event of a flat. ◀

Jacking points

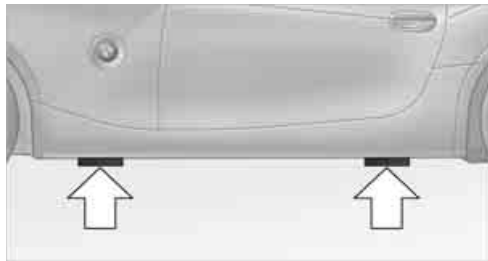

The jacking points are located at the positions indicated in the illustration.

 Your BMW center can provide you with a suitable jack. ◀

Battery

Maintenance

The battery is completely maintenance-free. This means that the original electrolyte will normally last for the service life of the battery under moderate climatic conditions.

 Please consult your BMW center whenever you have any questions concerning the battery. ◀

Indicator lamp



The indicator lamp for the battery charge current lights up:
The battery is no longer being charged. The alternator drive belt is defective or there is a malfunction in the charging circuit of the alternator. Please contact the nearest BMW center.

 If the drive belt is defective, pull over and switch off the engine immediately to prevent overheating and serious engine damage.

If the onboard supply voltage drops to a very low level, increased steering effort may also be necessary. ◀

Charging the battery

Charge the battery in the vehicle only when the engine is not running. For information on connections, refer to Jump-starting on page 94.

Battery disposal



Return used batteries to a recycling point or to your BMW center. Maintain the battery in an upright position for transport and storage. Secure the battery against tilting when transporting. ◀

Fuses

You will find the fuses and information on their respective allocation behind the glove compartment.

1. Open the glove compartment

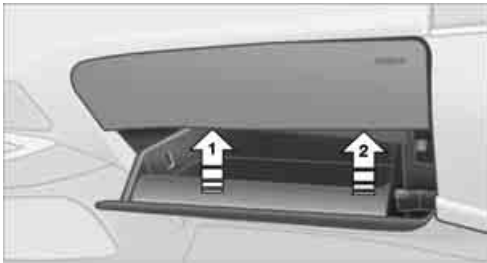

2. Press the lock on the left; see arrow 1
3. Press the lock on the right; see arrow 2
4. Swing the glove compartment down.

Spare fuses and plastic tweezers for grasping the fuses are found in the onboard tool kit; refer to page 88.



Do not attempt to repair a burned fuse or replace it with a fuse having a different color or amperage rating. To do this could cause a fire in the vehicle as a result of circuit overload. ◀

Giving and receiving assistance

Receiving assistance

The BMW Group's Mobile Service offers you 24-hour assistance in the event of a breakdown, even on weekends and holidays.

The telephone numbers of the Mobile Service control center in your country are listed in the BMW Dealer Directory.

If your vehicle has the necessary equipment, you can contact the Mobile Service or issue an emergency call using buttons in the center console, behind the parking brake under a cover.

When an emergency call is initiated, a telephone connection is established with the general emergency call center.

In vehicles with activated BMW Assist function, a telephone connection is set up to the BMW Assist emergency call center. If the current location of your vehicle can be determined, this location is transmitted to the BMW Assist emergency call center.



Fold up the cover.

- 1 Emergency call
- 2 Mobile Service

Requirements for initiating an emergency call or contacting Mobile Service:

- ▷ The car phone must be registered with a mobile network
- ▷ The emergency call system must be operational.

Initiating an emergency call*

Press button **1** for at least 2 seconds.

The indicator lamp flashes as soon as a telephone connection has been set up to the main emergency call center.

If the indicator lamp is flashing but you cannot hear the emergency call center, you may still be heard by the emergency call center.

 For technical reasons, the emergency call function cannot be guaranteed in certain unfavorable conditions. ◀

If certain requirements are met, an emergency call is automatically initiated after a serious accident. The automatic emergency call will not be hindered by pressing the button.

Mobile Service*

To establish contact with the BMW Group's Mobile Service:

Press button **2** for at least 2 seconds.

Depending on the country you are in, your vehicle's current location will also be transmitted if your vehicle is equipped with an activated BMW Assist function.

Warning triangle*



The warning triangle is stored in the rear luggage compartment panel.

Pull the ends of the rubber bands upward and out of the fasteners.

 Always observe all legal regulations requiring a warning triangle to be carried in the vehicle. ◀

First-aid kit*



The first-aid kit is located beneath the passenger seat.

To open

Pull the handle and fold the cover downward.

To close

Fold the cover up and press into the catch.

 Some of the articles in the first-aid kit have a limited period of use before expiration. For this reason, check the expiration dates of each of the items regularly, and replace any whose expiration dates have passed. You can acquire replacements in any drugstore or pharmacy. Always observe all legal regulations requir-

ing a first-aid kit to be carried in the vehicle. ◀

Jump-starting

When your battery is discharged you can use two jumper cables to start your vehicle with power from the battery in a second vehicle. You can also use the same method to help start another vehicle. Always use jumper cables with fully insulated handles on the terminal clamps.

 Do not touch components carrying current on a running engine. Contact with these components can cause fatal injury. Carefully observe the following instructions to avoid personal injury and/or damage to one or both vehicles. ◀

Preparations

1. Check whether the battery of the support vehicle has 12 volts and approximately the same capacity – measured in Ah. This information is provided on the battery
2. Stop the engine of the support vehicle
3. Switch off all electrical accessories in both vehicles

 Make absolutely certain that there is no contact between the bodywork of the two vehicles: short circuit hazard. ◀

Connecting jumper cables

 Always adhere to this sequence when connecting jumper cables; failure to observe this procedure can lead to sparks at the battery terminals and pose an injury hazard. ◀

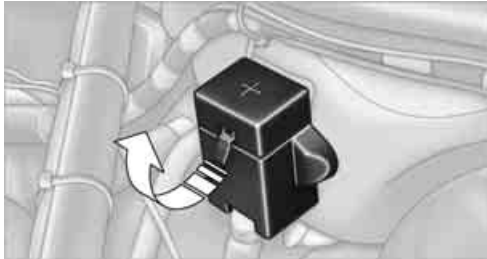

The auxiliary jump-starting terminal located in your BMW's engine compartment acts as the positive battery terminal. Refer to the engine compartment overview on page 82. The cover is marked with a +.

1. Open the cover of the BMW auxiliary jump-starting terminal. Do so by pulling the tab
2. With the + jumper cable, connect the positive terminal of the drained battery and the positive terminal of the support battery.
To do this:
Connect one terminal clamp to the positive terminal of the battery or to an auxiliary jump-starting terminal of the support vehicle.
Connect the second terminal clamp to the positive terminal of the battery or to an auxiliary jump-starting terminal of the vehicle to be jump-started.



Your BMW is equipped with a special nut, refer also to the engine compartment overview on page 82

3. With the - jumper cable, connect the negative terminals of both vehicles.
To do this:
Attach one cable clamp to the negative battery terminal or to a suitable ground on the engine or body work of the support vehicle.
Attach the second cable clamp to the negative battery terminal or to a suitable ground on the engine or body work of the vehicle to be jump-started.

Starting the engine

1. Start the engine of the support vehicle and let it run for several minutes at a slightly elevated engine idle speed
2. Start the engine of the other vehicle as usual.
If the first start attempt is not successful, wait a few minutes before another attempt in order to allow the discharged battery to recharge.
3. Allow the engines to run for several minutes
4. Then disconnect the jumper cables in reverse sequence.

Depending on the cause of the fault, have the battery checked and recharged by your BMW center.

 Never use spray starter fluids to start the engine. ◀

Towing the vehicle

 Always observe all applicable towing laws and regulations. ◀

Towing with a commercial tow truck

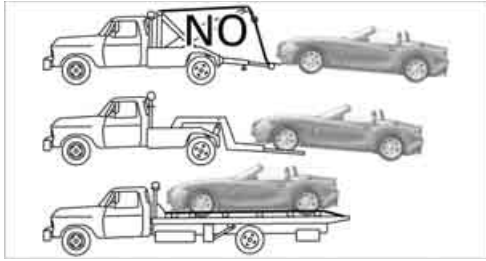

- ▷ Use a wheel lift or flatbed carrier
- ▷ Do not tow with sling-type equipment.

 Never allow passengers to ride in a towed vehicle for any reason. ◀

Towing the vehicle with the front axle raised

Vehicles with automatic transmission

- ▷ Towing speed:
Maximum 45 mph / 70 km/h
- ▷ Towing distance:
Maximum 90 miles/150 km.

Vehicles with sequential manual gearbox SMG

With the ignition on, move the selector lever to position N, then turn off the ignition.

Towing eyelet

The screw-in towing eyelet is stored in the onboard tool kit, refer to page 88; be sure that it remains in the vehicle at all times. It can be attached at the front or rear of the vehicle.

Access to towing socket

Front

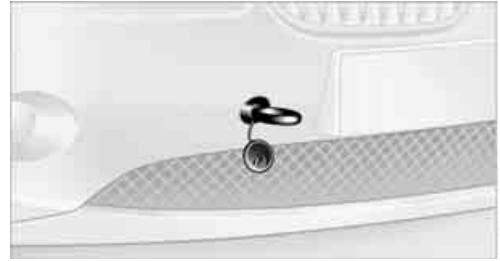

Press out the cover panel with a screwdriver inserted in the recess at the top.

Rear



Press out the cover panel with a screwdriver inserted in the recess at the top.

 Use only the towing eyelet supplied with the vehicle and screw it in firmly until it stops. Use the towing eyelet for towing on paved roads only. If you do not follow these instructions, the towing eyelet could be torn out and vehicle damage could occur.

Do not tow the vehicle by any components of the chassis or suspension, or lash them down in any way. If you do, the components could be damaged, possibly leading to accidents. ◀



Reference

This chapter will help you find the desired information as quickly as possible. It contains the Technical data section as well as the manual's index.

Technical data

Engine data

		Z4 2.5i	Z4 3.0i
Displacement	cu in/cm ³	152.1/2,494	181.7/2,979
Number of cylinders		6	6
Maximum power output at engine speed	hp/kW rpm	184/141 6,000	225/170 5,900
Maximum torque at engine speed	lb ft/Nm rpm	181/245 3,500	221/300 3,500
Compression ratio	ϵ	10.5	10.2
Stroke	in/mm	2.95/75	3.53/89.6
Bore	in/mm	3.31/84	3.31/84
Fuel-injection system	Digital electronic engine-management system DME		

Weights

		Z4 2.5i	Z4 3.0i
Curb weight			
with manual transmission	lbs/kg	2,932/1,330	2,998/1,360
with SMG	lbs/kg	2,976/1,350	3,020/1,370
with automatic transmission	lbs/kg	2,998/1,360	3,042/1,380
Approved gross vehicle weight			
with manual transmission	lbs/kg	3,483/1,580	3,549/1,610
with SMG	lbs/kg	3,527/1,600	3,571/1,620
with automatic transmission	lbs/kg	3,549/1,610	3,593/1,630
Load			
Approved front axle load	lbs/kg	1,720/780	1,742/790
Approved rear axle load	lbs/kg	1,841/835	1,863/845
Luggage compartment capacity	cu ft/l	8.5/240	8.5/240
with the convertible top compartment raised	cu ft/l	9.2/260	9.3/260
Never exceed either the approved axle loads or the approved gross vehicle weight.			

Dimensions

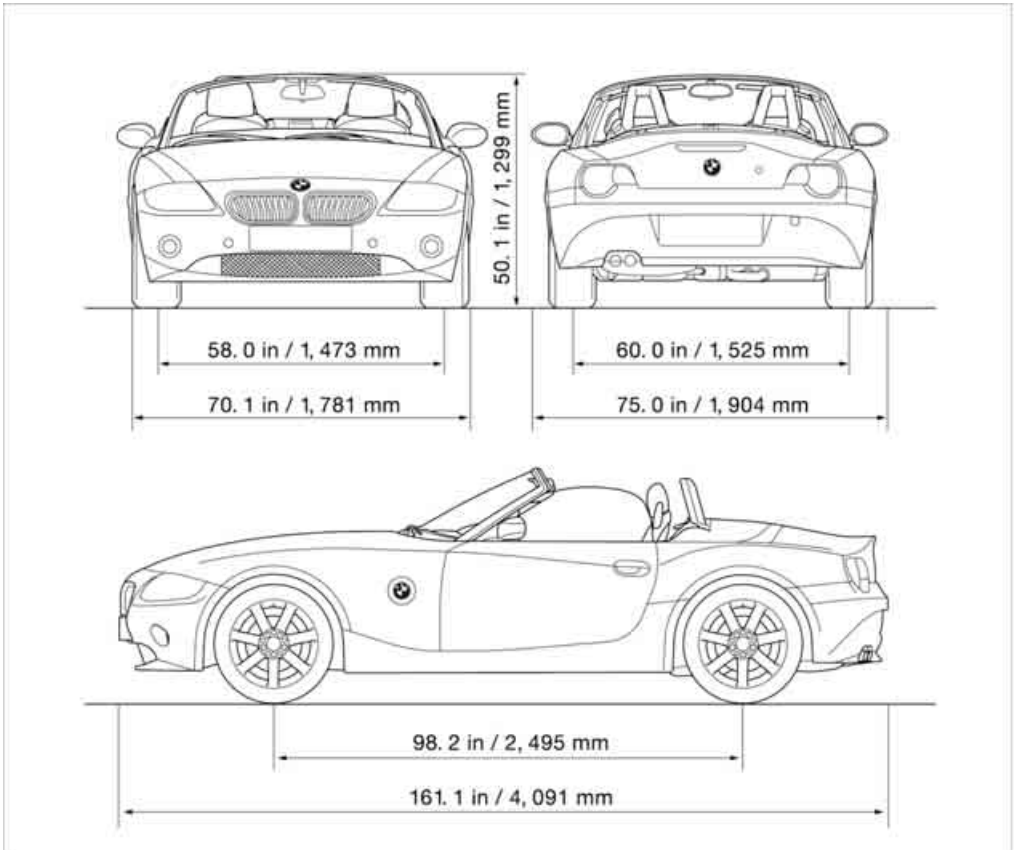

All measurements in inches/millimeters. Smallest turning circle dia. 32 ft 2 in/9.8 m.

Capacities

			Notes
Fuel tank reserve	gal./liters gal./liters	approx. 14.5/55 approx. 2.1/8	Fuel specifications: page 74
Windshield washer system/ Headlamp washer system	quarts/liters quarts/liters	approx. 3.2/3 approx. 5.3/5	For details: page 83
Cooling system including heating circuit			For details: page 84
with manual transm. or SMG	quarts/liters	8.8/8.3	
with automatic transmission	quarts/liters	9.3/8.8	
Engine with oil filter renewal	quarts/liters	6.9/6.5	For details: page 84
Manual transmission, SMG, automatic transmission and differential	quarts/liters	–	Lifetime lubricant, no oil change required

Everything from A to Z

Index

A

- ABS Antilock Brake System 54
- indicator lamp 13
- Accessories, refer to
 - For your own safety 5
 - Your individual vehicle 5
- Accident, refer to
 - Emergency call 93
- Activated-charcoal filter 63
- Adaptive Transmission Control ATC 40
- Air, drying,
 - refer to Air conditioning mode 59, 62
- Airbags 56
 - deactivation 33
 - indicator lamp 13
 - passenger airbags indicator lamp 34
 - reactivation 33
 - safe seating position 27
- Airbag switch 33
- Air conditioning 58
- Air conditioning mode
 - air conditioning 59
 - automatic climate control 62
- Air conditioning mode switching on/off manually 59, 62
- Air distribution
 - air conditioning 59
 - automatic climate control 62
- Airing out, refer to Ventilation 59, 63
- Air outlets,
 - refer to Ventilation 59, 63
- Air pressure, refer to Tire inflation pressure 75
- Air recirculation, refer to Recirculated-air mode 59, 63
- Air supply/blower
 - air conditioning 59
 - automatic climate control 62
- AKI, refer to Fuel specifications 74
- Alarm system
 - avoiding unintentional alarms 26
- Antenna, refer to the Caring for your vehicle brochure
- Antifreeze 83, 84
 - coolant 84
 - washing fluids 83
- Antilock Brake System ABS 54
 - indicator lamp 13
- Anti-theft alarm system,
 - refer to Alarm system 25
- Anti-theft protection 25
- Approved axle load, refer to Weights 101
- Approved engine oils 84
- Approved gross vehicle weight, refer to Weights 101
- Artificial leather, refer to the Caring for your vehicle brochure
- Ashtray 65
- Assistant systems, refer to Dynamic Stability Control DSC 52
- ATC Adaptive Transmission Control 40
- AUC Automatic recirculated-air control 63
- Automatic
 - air distribution 62
 - air supply/blower 62
 - cruise control 45
 - headlamp control 46
 - luggage compartment lid operation 19
- Automatic car wash, refer to the Caring for your vehicle brochure
- Automatic climate control 61
- Automatic recirculated-air control AUC 63
- Automatic transmission with Steptronic 39
 - ignition 36
 - indicator lamp 13
 - interlock 36
 - selector lever lock 39
 - shiftlock 39
- AUTO program,
 - refer to Automatic air distribution 62
- Average fuel consumption 51
 - setting units of measure 50
- Average speed 51
 - setting units of measure 50
- Axle loads, refer to Weights 101

B

- Backrest, refer to Seat adjustment 28
- Backup lamps 38
 - bulb replacement 90
- Bandages, refer to First-aid kit 94

Battery 91
– disposal 92
– indicator lamp 13, 91
– jump-starting 94
– remote control 17
Belts, refer to Safety belts 30
Belt tensioner, refer to Safety belts 30
Beverage holders 65
Blower
– air conditioning 59
– automatic climate control 62
Blower, refer to Air supply 59, 62
BMW 5
Bore, refer to Engine data 100
Bottle holders, refer to Beverage holders 65
Brake fluid 85
– filling 85
– indicator/warning lamp 13, 85
– level 85
Brake force display 53
Brake hydraulic system 85
– indicator/warning lamp 13, 69, 85
Brake lamps
– bulb replacement 90
– indicator lamp, defective lamp 13
Brake pads 70
– break-in procedures 68
– indicator lamp 70
Brake pad wear indicator
– brake pads 70
– indicator lamp 13
Brake rotors
– brake system 69
– break-in procedures 68
Brakes 69
– ABS 54
– brake fluid 85
– break-in procedures 68
– indicator/warning lamps 13, 52, 53, 54
– parking brake 38

Brake system 69
– brake fluid level 85
– brake pads 70
– break-in procedures 68
– disc brakes 69
– indicator lamp 13
Breakdown
– Flat Tire Monitor 54
Break-in procedures 68
Bulb replacement, refer to Lamps and bulbs 88
Buttons in steering wheel 11

C

California Proposition 65 warning 87
Can holders, refer to Beverage holders 65
Capacities 103
Car battery 91
Car care, refer to the Caring for your vehicle brochure
Car-care products, refer to the Caring for your vehicle brochure
Care, refer to the Caring for your vehicle brochure
Cargo loading
– vehicle 70
Car keys, refer to Keys 16
Carpet care, refer to the Caring for your vehicle brochure
Car radio, refer to Owner's Manual for Radio
Car telephone, refer to Owner's Manual for Telephone
Car wash, refer to the Caring for your vehicle brochure
Catalytic converter, refer to High temperatures 69
CD player operation, refer to Owner's Manual for Radio
Center high-mount brake lamp
– bulb replacement 90

Central locking system 16
– interior 18
Changing a wheel 91
Charge indicator lamp 13, 91
Check Gas Cap
– indicator lamp 13
Child-restraint mounting system, LATCH 35
Child-restraint systems 33
Child seat, refer to Child-restraint systems 33
Chrome parts, refer to the Caring for your vehicle brochure
Cigarette lighter 65
Cigarette lighter socket 65
Cleaning the rear window, refer to the Caring for your vehicle brochure
Cleaning the vehicle, refer to the Caring for your vehicle brochure
Cleaning the windshield 44
Clock 49, 50
– 12- or 24-hour mode 50
– refer to Owner's Manual for Radio/Onboard Computer
– setting 49
Clothes hooks 25
Clutch
– break-in procedures 68
Cockpit 10
Cold start, refer to Starting the engine 36
Compact disc operation, refer to Owner's Manual for Radio
Compartments 64
Compression ratio, refer to Engine data 100
Computer 50
– clock, 12- or 24-hour mode 50
– refer to Owner's Manual for Onboard Computer
Computer, refer to Onboard Computer 50
Condensation, refer to Air conditioning mode 59, 62

- Condensation, removing from windows
 - air conditioning 60
 - automatic climate control 62
 - Configuring settings, refer to Vehicle Memory, Key Memory 31
 - Connecting a vacuum cleaner, refer to Cigarette lighter 65
 - Consumption, refer to Average consumption 51
 - Consumption display, refer to Fuel gauge 48
 - Control elements, refer to Cockpit 10
 - Convenience operation
 - convertible top 18
 - from outside 18
 - windows 18
 - Convertible top 21, 22
 - care, refer to the Caring for your vehicle brochure
 - convenience operation 18
 - electrical fault 23
 - emergency closing 23
 - fully automatic 22
 - malfunction 23
 - manual 21
 - Convertible top compartment panel 20
 - Coolant 84
 - indicator lamp 13
 - level 84
 - temperature 48
 - Coolant water, refer to Coolant 84
 - Cooling, maximum 62
 - Cooling, refer to Air conditioning mode 59, 62
 - Cooling system, refer to Capacities 103
 - Cruise control 45
 - Cruising range 51
 - Cup holders, refer to Beverage holders 65
 - Curb weight, refer to Weights 101
 - Cylinders, refer to Engine data 100
- D**
- Data, technical 100
 - capacities 103
 - dimensions 102
 - engine data 100
 - weights 101
 - Daytime driving lamps 46
 - DBC Dynamic Brake Control 53
 - indicator lamp 13, 52
 - Defective bulb 46
 - Defrosting rear window
 - air conditioning 59
 - automatic climate control 63
 - Defrosting windows 60, 62
 - air conditioning 60
 - automatic climate control 62
 - Defrosting windows and removing condensation
 - air conditioning 60
 - automatic climate control 62
 - Defrosting windshield, refer to Defrosting windows 60, 62
 - Defrost position, refer to Defrosting windows 60, 62
 - Differential
 - break-in procedures 68
 - Digital clock 49
 - Dimensions 102
 - Dimming mirror 31
 - Dipstick, engine oil 83
 - Directional indicators, refer to Turn signal indicators 43
 - Disc brakes 69
 - Displacement, refer to Engine data 100
 - Display elements 12
 - Display lighting, refer to Instrument lighting 47
 - Displays, refer to Instrument cluster 12
- Disposal**
- oil 84
 - vehicle battery 92
- Distance remaining, refer to Range 51
- Door key 16
 - Door lock 18
 - Doors, unlocking and locking
 - from inside 18
 - from outside 17, 18
 - DOT quality grades 77
 - Draft-free ventilation 59, 63
 - Driving Dynamic Control 42
 - Driving light, refer to Parking lamps/Low beams 46
 - Driving notes 69
 - break-in procedures 68
 - driving tips 69
 - Driving stability control 52
 - Dry air, refer to Air conditioning mode 59, 62
 - DSC Dynamic Stability Control 52
 - indicator lamp 13, 52
 - DTC Dynamic Traction Control 53
 - indicator lamp 13, 52
 - Dynamic Brake Control DBC 53
 - indicator lamp 13, 52
 - Dynamic Stability Control DSC 52
 - indicator lamp 13, 52
 - Dynamic Traction Control DTC 53
 - indicator lamp 13, 52
- E**
- Electrical fault
 - automatic transmission with Steptronic 40
 - convertible top 23
 - door lock 18
 - driver's door 18
 - fuel filler door 74
 - luggage compartment lid 19
 - storage compartments 64

Electric Power Steering
EPS 43
– indicator lamp 13
Electric power windows 20
Electronic Stability
Program ESP, refer to
Dynamic Stability Control
DSC 52
Electronic transmission
control module 40
Emergency call 93
Emergency operation, refer
to Manual operation
– convertible top 23
– driver's door 18
– fuel filler door 74
– storage compartments 64
Engine 36
– break-in procedures 68
– data 100
– electronics 13
– indicator lamp 13
– speed 48
– starting 36
– switching off 37
Engine compartment 82
Engine coolant 84
Engine coolant
temperature gauge 48
Engine data 100
Engine oil 83
– alternative oils 84
– approved oils 84
– capacity 103
– indicator lamp 13
Engine oil level 83
– indicator lamp 13
Engine oil pressure 83
– indicator lamp 13
Engine oil sensor 83
– indicator lamp 13
Engine output, refer to
Engine data 100
Engine speed, refer to
Engine data 100
EPS Electric Power
Steering 43
Equipment range, see
Service and Warranty
Information Booklet for

US models, Warranty and
Service Guide Booklet for
Canadian models
ESP Electronic Stability
Program, refer to
Dynamic Stability Control
DSC 52
Exhaust system, refer to
High temperatures 69
Exterior mirrors 31
– automatic dimming
feature 31
Eyelet, towing 96

F

False alarm, stopping
alarm 26
Fasten safety belts 30
– warning lamp 13, 30
Filter, refer to
– Microfilter 59
– Microfilter/activated-
charcoal filter 63
Fine wood, refer to the
Caring for your vehicle
brochure
First aid, refer to First-aid
kit 94
First-aid kit 94
Flat tire
– Flat Tire Monitor 54
– indicator/warning
lamp 13
Flat tire, refer to Tire
condition 78
Flat Tire Monitor 54
– indicator lamp 13, 55
– initializing 55
Flooding, refer to Driving
through water 69
Floor covers, carpets, refer
to the Caring for your
vehicle brochure
Floor mats, refer to the
Caring for your vehicle
brochure
Fluid reservoir
– washing systems 83
Fog lamps 47
– indicator lamp 13

Follow me home lamps 46
Footbrake, refer to Driving
notes 69
Front airbags 56
Front turn signal indicators
– bulb replacement 90
Fuel
– average
consumption 51
– content, refer to
Capacities 103
– display 48
– preparation, refer to
Engine data 100
– quality 74
Fuel display, refer to Fuel
gauge 48
Fuel filler door 74
– unlocking in case of
electrical fault 74
Fuel gas cap 74
Fuel tank capacity, refer to
Capacities 103
Fuses 92

G

Gasoline, refer to Fuel
quality 74
Gasoline gauge, refer to
Fuel gauge 48
Gear indicator 40
Gear lever
– automatic transmission
with Steptronic 39
– manual transmission 38
Glove compartment 64
Gross weight, refer to
Weights 101

H

Handbrake, refer to Parking
brake 38
Hands-free microphone,
refer to Preparations for
the cellular phone 65
Hands-free system 65
Hardtop, refer to the
separate Owner's Manual
Hardtop preparation 71

Hazard warning flashers 10
 Headlamp cover, care, refer to the Caring for your vehicle brochure
 Headlamp flasher 43
 – indicator lamp 13
 Headlamps
 – bulb replacement 88
 – care, refer to the Caring for your vehicle brochure
 – cleaning 44
 Headlamps, automatic control 46
 Headlamp washer reservoir 83
 – content, refer to Capacities 103
 Headlamp washer system
 – cleaning the headlamps 44
 – washing fluids 83
 Head restraints 28
 Heated mirrors 31
 Heated seats 30
 Heating 58
 – exterior mirrors 31
 – rear window 59, 63
 – seats 30
 Heavy loads, refer to Stowing cargo 70
 Height, refer to Dimensions 102
 Height adjustment
 – seats 28
 – steering wheel 30
 High beams 47
 – bulb replacement 89
 – headlamp flasher 43
 – indicator lamp 13
 High Performance Synthetic Oil 84
 – alternative oils 84
 – approved oils 84
 High temperatures 69
 Holders for beverages 65
 Hood 81
 Horn 10
 Hydraulic Brake Assistant, refer to Dynamic Brake Control DBC 52

Hydraulics
 – brakes 85
 Hydroplaning 69

I

Ice warning 50
 Identification mark
 – Run Flat tires 80
 Ignition 36
 Ignition key 16
 Ignition lock 36
 Inclines 69
 Index 104
 Indicator/warning lamp
 – airbags 57
 – alarm system 26
 – brakes 13
 – coolant temperature 49
 – DSC 52
 – engine temperature 48
 – Flat Tire Monitor 55
 – fog lamps 47
 – passenger airbags 34
 – please fasten safety belts 30
 – reserve 48
 Indicator and warning lamps, overview 12
 Individual air distribution 59, 62
 Individual settings, refer to Vehicle Memory, Key Memory 31
 Inflation pressure, tires 75
 Inflation pressure monitoring, refer to Flat Tire Monitor 54
 INSPECTION 49
 Instrument cluster 12
 Instrument lighting 47
 Instrument panel, refer to Cockpit 10
 Interior lamps 47
 – remote control 17
 Interior motion sensor 26
 Interior rearview mirror 31
 – automatic dimming feature 31
 Interior temperature
 – adjusting 59, 62

Interlock, refer to Steering lock 36
 Intermittent
 – operation, wipers 44
 Interval
 – display, service 49

J

Jack 91
 Jacking points 91
 Jets, refer to Ventilation 59, 63
 Jump-starting 94

K

Key Memory 31
 Keys 16
 Key switch for passenger airbags 33
 Kickdown 39
 Knock control 74

L

Lamps 46
 Lamps and bulbs 88
 LATCH, child-restraint mounting system 35
 Leather care, refer to the Caring for your vehicle brochure
 Length, refer to Dimensions 102
 License plate lamps
 – bulb replacement 91
 Light-alloy wheels, care, refer to the Caring for your vehicle brochure
 Lighter 65
 Lighting
 – of the instruments 47
 Lighting of the instruments, refer to Instrument lighting 47
 LIGHTS ON warning 46
 Light switch 46
 Loads, refer to Cargo loading 70
 Loads, securing 70

Lock buttons on doors,
refer to Locking 19

Locking the doors

- from inside 19
- from outside 17, 18

Locking the vehicle

- from inside 18
- from outside 16

Low beams 46

- automatic 46
- bulb replacement 89
- indicator lamp, defective lamp 13

Lug bolts

- keys 88

Luggage compartment 20

- capacity 101
- increasing capacity 20
- opening/closing, refer to Luggage compartment lid 19
- opening from inside the vehicle 19
- opening from the outside 19
- opening via remote control 17

Luggage compartment lid 19

- opening from inside the vehicle 19
- opening from the outside 19
- remote control 17

M

Maintenance, refer to Service interval display 49, 86

Maintenance System 86

Making phone calls, refer to Owner's Manual for Telephone

Malfunction

- convertible top 23
- door lock 18
- fuel filler door 74
- storage compartments 64

Malfunction of electrical accessory 92

Manual convertible top 21

Manual mode, refer to Automatic transmission with Steptronic 39

Manual operation

- door lock 18
- driver's door 18
- fuel filler door 74
- luggage compartment lid 19
- power convertible top 23
- storage compartments 64

Manual transmission 38

Manufacturer 5

Master key 16

- with remote control 16

Maximum cooling 62

Maximum speed

- with winter tires 79

Measurements, refer to Dimensions 102

Mechanical seat 28

Memory, refer to Vehicle Memory, Key Memory 31

Microfilter

- air conditioning 59
- automatic climate control 63

Mirrors 31

- heated 31

Mobile Service 93

Modifications, technical, refer to For your own safety 5

M Sports seat 29

Multifunction steering wheel MFL 11

Multifunction switch

- turn signal indicators/headlamp flasher 43
- washer/wiper system 43

N

Neck supports, refer to Head restraints 28

Nets 64

O

OBD interface socket 87

Octane numbers, refer to Fuel specifications 74

Odometer 48

Oil, refer to Engine oil

- alternative oils 84
- approved oils 84
- capacity 103
- dipstick 83
- indicator lamp 13

Oil change intervals, refer to the Service and Warranty Information Booklet for US models, Warranty and Service Guide Booklet for Canadian models

Oil consumption 83

Oil filter change 103

Oil level 83

- checking 83
- indicator lamp 13

Oil pressure 83

- indicator/warning lamp 13

Oil sensor 83

- indicator lamp 13

OIL SERVICE 49

Oil types 84

Onboard computer, refer to Computer or to the Owner's Manual for Onboard Computer

Onboard monitor, refer to Computer or to the Owner's Manual for Onboard Computer

Onboard tool kit 88

Opening and closing the vehicle

- from inside 18
- from outside 16, 17
- via the door lock 18
- via the remote control 17

Operating elements 10

Outlets, refer to Ventilation 59, 63

- Outside air mode [59](#)
 - air conditioning [59](#)
 - automatic climate control [63](#)
- Outside temperature display [49](#)
 - changing units of measure [50](#)
 - in the onboard computer [50](#)
- P**
- Paintwork, refer to the Caring for your vehicle brochure
- Parking brake [38](#)
 - indicator lamp [13](#)
- Parking lamps/Low beams [46](#)
- Parking lock, refer to Transmission interlock [39](#)
- Parts and accessories, refer to Your individual vehicle [5](#)
- Passenger airbags
 - deactivation [33](#)
 - reactivation [33](#)
- Placing the vehicle in storage, refer to the Caring for your vehicle brochure
- Plastic, refer to the Caring for your vehicle brochure
- Pollen, refer to
 - Microfilter [59](#)
 - Microfilter/activated-charcoal filter [63](#)
- Power convertible top [22](#)
- Power output, refer to Engine data [100](#)
- Power seat [29](#)
- Power steering, electric [43](#)
- Preparations for the cellular phone [65](#)
- Pressure, tires [75](#)
- Pressure monitor, tires
 - Flat Tire Monitor [54](#)

- R**
- Radio, refer to the Owner's Manual for Radio
- Radio remote control key, refer to Master key with remote control [16](#)
- Rain sensor [43](#)
- Reading lamps [47](#)
- Rear turn signal indicators
 - bulb replacement [90](#)
- Rearview mirror [31](#)
- Rear window defroster
 - air conditioning [59](#)
 - automatic climate control [63](#)
- Recirculated-air mode
 - air conditioning [59](#)
 - automatic climate control [63](#)
- Recirculating the air, refer to Recirculated-air mode [59](#), [63](#)
- Refueling [74](#)
 - fuel filler door [74](#)
- Releasing
 - hood [81](#)
- Remaining distance, refer to Range [51](#)
- Remaining distance to next service [49](#)
- Remote control [16](#)
 - luggage compartment lid [17](#)
 - malfunctions [17](#)
- Replacement key [16](#)
- Replacement of tires [79](#)
 - changing a tire [79](#)
 - changing a wheel [91](#)
- Replacing lamps, refer to Lamps and bulbs [88](#)
- Reserve indicator lamp, refer to Fuel gauge [48](#)
- Restraint systems
 - for children [35](#)
 - refer to Safety belts [30](#)
- Reverse
 - automatic transmission with Steptronic [39](#)
 - manual transmission [39](#)

- Rod antenna, refer to the Caring for your vehicle brochure
- Rope, refer to Towing the vehicle [96](#)
- RSC Runflat System Component, refer to Run Flat tires [80](#)
- Rubber parts, refer to the Caring for your vehicle brochure
- Runflat System Component RSC, refer to Run Flat tires [80](#)
- Run Flat tires [80](#)
 - changing a tire [78](#), [79](#)
 - changing a wheel [91](#)
 - tire inflation pressure [75](#)

- S**
- Safe seating position [27](#)
 - with airbags [27](#)
 - with safety belts [27](#)
- Safety belts [30](#)
 - care, refer to the Caring for your vehicle brochure
 - safe seating position [27](#)
 - warning lamp [13](#), [30](#)
- Safety systems, refer to
 - Antilock Brake System ABS [54](#)
 - Dynamic Stability Control DSC [52](#)
- Screwdriver, refer to Onboard tool kit [88](#)
- Seat adjustment [28](#)
 - mechanical [28](#)
 - M Sports seat [29](#)
 - power [29](#)
- Seat heating [30](#)
- Seat memory [29](#)
- Seat position, storing [29](#)
- Seats [28](#)

Securing, locking the vehicle
– from inside 19
– from outside 17
Securing loads, refer to Cargo loading 70
Selector lever
– automatic transmission with Steptronic 39
Selector lever lock, refer to Shiftlock 39
Selector lever positions
– automatic transmission with Steptronic 39
Service, see Service and Warranty Information Booklet for US models, Warranty and Service Guide Booklet for Canadian models 86
Service and warranty 6
Service interval display 49, 86
Shifting gears
– automatic transmission with Steptronic 39
– manual transmission 38
Shiftlock 39
Side airbags 56
Side turn signal indicators
– bulb replacement 90
Signal horn, refer to Horn 10
Slipstream deflector, refer to Wind deflector 24
Smokers' package, refer to Ashtray 65
Snow chains 80
Socket, refer to Cigarette lighter 65
Socket for Onboard Diagnostics 87
SOS, refer to Emergency call 93
Spare fuses 92
Spare key 16
Special oils, refer to Specified engine oils 84
Special wash program, refer to the Caring for your vehicle brochure

Specified engine oils 84
Speed
– winter tires 79
Speedometer 12
Sport program
– automatic transmission with Steptronic 39
– Driving Dynamic Control 42
Sports seat 29
Stability control, refer to – Dynamic Stability Control DSC 52
Standing lamps 47
Starting 36
– engine 36
Starting assistance
– Dynamic Stability Control DSC 52
Starting difficulties
– jump-starting 94
– temperature 37
Status of the Owner's Manual 5
Steering lock 36
Steering wheel 10
– adjusting 30
Steptronic, refer to Manual mode 39
Storage, tires 79
Storage compartments 64
– electrical fault 64
– opening manually 64
Storage nets 64
Storage space, refer to Luggage compartment 20
Storage space, refer to Storage compartments 64
Storing seat position, refer to Seat memory 29
Stroke, refer to Engine data 100
Summer tires, refer to Wheels and tires 75
Surface ice, refer to Ice warning 50
Switches, refer to Cockpit 10
Switch for passenger airbags 33

Switching gears, refer to Automatic transmission with Steptronic 39
Switching off
– engine 37
– vehicle 38
Symbols 4

T

Tachometer 48
Tail lamps
– bulb replacement 90
– indicator lamp, defective lamp 13
Tail lamps, refer to Rear lamps 90
– bulb replacement 90
Tank capacity, refer to Fuel tank capacity 103
Tank indicator, refer to Fuel gauge 48
Technical data 100
Technical modifications, refer to For your own safety 5
Telephone, refer to the separate Owner's Manual Telephone preparation 65
Temperature
– air conditioning 59
– automatic climate control 62
– engine 48
Temperature display
– ice warning 50
– outside temperature 49, 50
– setting units of measure 50
Tempomat, refer to Cruise control 45
The BMW Maintenance System 86
Third brake lamp
– bulb replacement 90
Third brake lamp, refer to Center high-mount brake lamp 90
Three-point seat belt, refer to Safety belts 30

Tire inflation pressure
 – checking 75
 – restoring 75
 Tire pressure monitoring,
 refer to Flat Tire
 Monitor 54
 Tires
 – age 77
 – break-in procedures 68
 – changing 79
 – condition 78
 – damage 78
 – DOT quality grades 77
 – inflation pressure 75
 – replacement 79
 – Run Flat tires 80
 – size 75
 – storage 79
 – temperature 78
 – traction 77
 – tread 78
 – tread depth indicator,
 refer to Tire tread, Tire
 damage 78
 – tread wear 77
 – Uniform Tire Quality
 Grading 77
 Tool kit, refer to Onboard
 tool kit 88
 Torque, refer to Engine
 data 100
 To unlock
 – from inside 18
 – from outside 17
 Towing 96
 – eyelet 96
 Towing the vehicle 96
 – with the front axle
 raised 96
 Tow sockets for towing
 eyelet 96
 Track width, refer to
 Dimensions 102
 Transmission
 – automatic transmission
 with Steptronic 39
 – manual transmission 38
 Transmission interlock,
 refer to Changing selector
 lever positions 39

Transmission
 malfunction 40
 Transporting children
 safely 33
 Tread depth, refer to Tire
 tread 78
 Tread wear indicators in the
 tires, refer to
 Tire tread, Tire
 damage 78
 Trip distance recorder,
 refer to Trip odometer 48
 Trip meter, refer to Trip
 odometer 48
 Trip odometer 48
 Trunk, refer to Luggage
 compartment 20
 Trunk lid
 – opening via remote
 control 17
 Trunk lid, refer to Luggage
 compartment lid 19
 Trunk volume, refer to
 Luggage compartment
 capacity 101
 Turning circle, refer to
 Dimensions 102
 Turn signal indicators 43
 – indicator lamp 13
 TV function, refer to
 Owner's Manual
 for Onboard Computer

U

Undercoating, refer to the
 Caring for your vehicle
 brochure
 Unintentional alarm 26
 Units
 – average
 consumption 50
 – average
 speed 50
 – temperature 50
 Used batteries, refer to
 Battery disposal 92

V

Vehicle
 – battery 91
 – break-in procedures 68
 – care, refer to the Caring
 for your vehicle brochure
 – cargo loading 70
 – measurements, refer to
 Dimensions 102
 – storage, refer to the
 Caring for your vehicle
 brochure
 – switching off the
 engine 69
 – washing, refer to the
 Caring for your vehicle
 brochure
 – weight 101
 Vehicle Memory 31
 Vehicle vacuum cleaner,
 refer to Cigarette lighter
 socket 65
 Ventilation 59, 63
 – air conditioning 59
 – automatic climate
 control 63
 Vents, refer to
 Ventilation 59, 63
 Volume
 – fuel tank, refer to
 Capacities 103

W

Warning and indicator
 lamps 12
 Warning triangle 94
 Warranty, see Service and
 Warranty Information
 Booklet for US models,
 Warranty and Service
 Guide Booklet for
 Canadian models 86
 Warranty and service 6
 Washer/wiper system 43
 Washer fluid reservoir, refer
 to Capacities 103

Washer fluid reservoir, refer to Headlamp washer system and Windshield washer system [83](#)
Washer jets, refer to Windshield washer nozzles [44](#)
Washing fluids [83](#)
Washing systems [83](#)
Waste tray, refer to Ashtray [65](#)
Water on roads, flooding [69](#)
Weights [101](#)
Wheelbase, refer to Dimensions [102](#)
Wheel change set
– Run Flat tires [91](#)
Wheels and tires [75](#)
Wheelslip control
– Dynamic Stability Control DSC [52](#)
Width, refer to Dimensions [102](#)
Wind deflector [24](#)
Windows
– convenience operation [18](#)
Windshield wash
– reservoir [83](#)
Windshield washer nozzles [44](#)
Windshield washer reservoir [83](#)
– content, refer to Capacities [103](#)
Windshield washer system
– washer/wiper system [43](#)
– washing fluids [83](#)
Windshield wiper blades
– care, refer to the Caring for your vehicle brochure
– changing [88](#)
Windshield wipers
– changing [88](#)
Windshield wipers, refer to Washer/wiper system [43](#)
Winter tires
– changing [91](#)
– storage [79](#)

Wood decoration, refer to the Caring for your vehicle brochure
Work in the engine compartment [81](#)
Wrench, refer to Onboard tool kit [88](#)

X

Xenon lamps
– bulb replacement [89](#)

Refueling

So that you have important specifications available to you when you stop to refuel, we recommend that you fill out this table with the data that apply to your vehicle. Consult the index for individual specifications.

Fuel

Designation

Please enter your preferred fuel here.

Engine oil

Quality

The oil volume between the two marks on the oil dipstick corresponds to approx. 1.1 US quarts / 1 liter.

Tire inflation pressures

	Summer tires Front	Rear	Winter tires Front	Rear
Up to 2 persons				
2 persons plus luggage				

More about BMW

bmwusa.com



The Ultimate
Driving Machine