

brother®

USER'S GUIDE

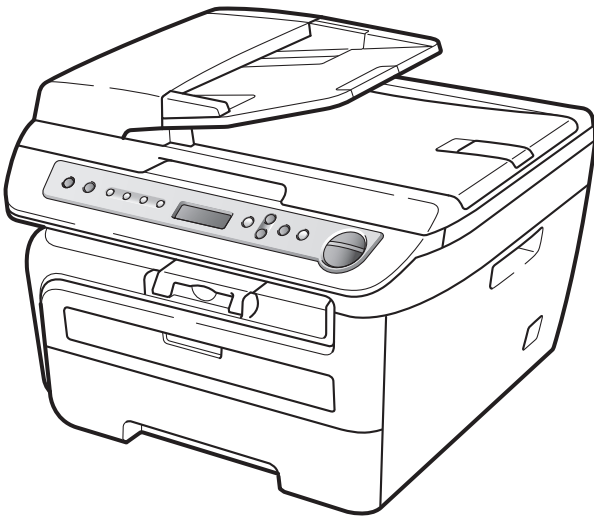

DCP-7030
DCP-7040

Not all models are available in all countries.

Version B
USA/CAN

If you need to call Customer Service

Please complete the following information for future reference:

Model Number: DCP-7030 and DCP-7040
(Circle your model number)

Serial Number: ¹ _____

Date of Purchase: _____

Place of Purchase: _____

¹ **The serial number is on the back of the unit. Retain this User's Guide with your sales receipt as a permanent record of your purchase, in the event of theft, fire or warranty service.**

Register your product on-line at

<http://www.brother.com/registration/>

By registering your product with Brother, you will be recorded as the original owner of the product. Your registration with Brother:

- may serve as confirmation of the purchase date of your product should you lose your receipt;
- may support an insurance claim by you in the event of product loss covered by insurance; and,
- will help us notify you of enhancements to your product and special offers.

The most convenient and efficient way to register your new product is online at <http://www.brother.com/registration/>

Brother numbers

IMPORTANT

For technical help, you must call the country where you bought the machine. Calls must be made **from within** that country.

Register your product

By registering your product with Brother International Corporation, you will be recorded as the original owner of the product. Your registration with Brother:

- may serve as confirmation of the purchase date of your product should you lose your receipt;
- may support an insurance claim by you in the event of product loss covered by insurance; and,
- will help us notify you of enhancements to your product and special offers.

Please complete and fax the Brother Warranty Registration And Test Sheet or, for your convenience and most efficient way to register your new product, register on-line at

<http://www.brother.com/registration/>

FAQs (frequently asked questions)

The Brother Solutions Center is our one-stop resource for all your Digital copier Center needs. You can download the latest software and utilities and read FAQs and troubleshooting tips to learn how to get the most from your Brother product.

<http://solutions.brother.com/>



Note

You can check here for Brother driver updates.

To keep your machine performance up to date, check here for the latest firmware upgrade (for Windows® only).

For Customer Service

In USA: 1-877-BROTHER (1-877-276-8437)
1-901-379-1215 (fax)

In Canada: 1-877-BROTHER
(514) 685-4898 (fax)

Service Center Locator (USA only)

For the location of a Brother authorized service center, call 1-877-BROTHER (1-877-276-8437).

Service Center Locations (Canada only)

For the location of a Brother authorized service center, call 1-877-BROTHER.

Ordering accessories and supplies

For best quality results use only genuine Brother accessories, which are available at most Brother retailers. If you cannot find the accessory you need and you have a Visa, MasterCard, Discover, or American Express credit card, you can order accessories directly from Brother. (You can visit us online for a complete selection of the Brother accessories and supplies that are available for purchase.)



Note

In Canada only Visa and MasterCard are accepted.

In USA: 1-877-552-MALL (1-877-552-6255)
1-800-947-1445 (fax)

<http://www.brothermall.com/>

In Canada: 1-877-BROTHER

<http://www.brother.ca/>

Description	Item
Toner Cartridge Standard	TN-330 (Approx. 1,500 pages) ¹
Toner Cartridge High Yield	TN-360 (Approx. 2,600 pages) ¹
Drum Unit	DR-360 (Approx. 12,000 pages) ²
User's Guide	LS1180001 (English for USA and Canada)
	LS1180002 (French for Canada)
Quick Setup Guide	LS1181001 (English for USA and Canada)
	LS1181002 (French for Canada)

¹ Approx. cartridge yield is declared in accordance with ISO/IEC 19752.

² Drum yield is approximate, and may vary by type of use.

Notice - Disclaimer of Warranties (USA and Canada)

BROTHER'S LICENSOR(S), AND THEIR DIRECTORS, OFFICERS, EMPLOYEES OR AGENTS (COLLECTIVELY BROTHER'S LICENSOR) MAKE NO WARRANTIES, EXPRESS OR IMPLIED, INCLUDING WITHOUT LIMITATION THE IMPLIED WARRANTIES OF MERCHANTABILITY AND FITNESS FOR A PARTICULAR PURPOSE, REGARDING THE SOFTWARE. BROTHER'S LICENSOR(S) DOES NOT WARRANT, GUARANTEE OR MAKE ANY REPRESENTATIONS REGARDING THE USE OR THE RESULTS OF THE USE OF THE SOFTWARE IN TERMS OF ITS CORRECTNESS, ACCURACY, RELIABILITY, CURRENTNESS OR OTHERWISE. THE ENTIRE RISK AS TO THE RESULTS AND PERFORMANCE OF THE SOFTWARE IS ASSUMED BY YOU. THE EXCLUSION OF IMPLIED WARRANTIES IS NOT PERMITTED BY SOME STATES IN THE USA AND SOME PROVINCES IN CANADA. THE ABOVE EXCLUSION MAY NOT APPLY TO YOU.

IN NO EVENT WILL BROTHER'S LICENSOR(S) BE LIABLE TO YOU FOR ANY CONSEQUENTIAL, INCIDENTAL OR INDIRECT DAMAGES (INCLUDING DAMAGES FOR LOSS OF BUSINESS PROFITS, BUSINESS INTERRUPTION, LOSS OF BUSINESS INFORMATION, AND THE LIKE) ARISING OUT OF THE USE OR INABILITY TO USE THE SOFTWARE EVEN IF BROTHER'S LICENSOR HAS BEEN ADVISED OF THE POSSIBILITY OF SUCH DAMAGES. BECAUSE SOME STATES IN THE USA AND SOME PROVINCES IN CANADA DO NOT ALLOW THE EXCLUSION OR LIMITATION OF LIABILITY FOR CONSEQUENTIAL OR INCIDENTAL DAMAGES, THE ABOVE LIMITATIONS MAY NOT APPLY TO YOU. IN ANY EVENT BROTHER'S LICENSOR'S LIABILITY TO YOU FOR ACTUAL DAMAGES FROM ANY CAUSE WHATSOEVER, AND REGARDLESS OF THE FORM OF THE ACTION (WHETHER IN CONTRACT, TORT (INCLUDING NEGLIGENCE), PRODUCT LIABILITY OR OTHERWISE), WILL BE LIMITED TO \$50.

Compilation and Publication Notice

Under the supervision of Brother Industries Ltd., this manual has been compiled and published, covering the latest product descriptions and specifications.

The contents of this manual and the specifications of this product are subject to change without notice.

Brother reserves the right to make changes without notice in the specifications and materials contained herein and shall not be responsible for any damages (including consequential) caused by reliance on the materials presented, including but not limited to typographical and other errors relating to the publication.

Brother® One-Year Limited Warranty and Replacement Service (USA Only)

Who is covered:

- This limited warranty ("warranty") is given only to the original end-use/retail purchaser (referred to in this warranty as "Original Purchaser") of the accompanying product, consumables and accessories (collectively referred to in this warranty as "this Product").
- If you purchased a product from someone other than an authorized Brother reseller in the United States or if the product was used (including but not limited to floor models or refurbished product), prior to your purchase you are not the Original Purchaser and the product that you purchased is not covered by this warranty.

What is covered:

- This Product includes a Machine and Consumable and Accessory Items. Consumable and Accessory Items include but are not limited to print heads, toner, drums, ink cartridges, print cartridges, cordless handset battery, refill ribbons, therma PLUS paper and thermal paper.
- Except as otherwise provided herein, Brother warrants that the Machine and the accompanying Consumable and Accessory Items will be free from defects in materials and workmanship, when used under normal conditions.
- This warranty applies only to products purchased and used in the United States. For products purchased in, but used outside, the United States, this warranty covers only warranty service within the United States (and does not include shipping outside the United States).

What is the length of the Warranty Periods:

- Machines: one year from the original purchase date.
- Accompanying Consumable and Accessory Items: 90 days from the original purchase date or the rated life of consumable, whichever comes first.

What is NOT covered:

This warranty does not cover:

- 1 Physical damage to this Product;
- 2 Damage caused by improper installation, improper or abnormal use, misuse, neglect or accident (including but not limited to transporting this Product without the proper preparation and/or packaging);
- 3 Damage caused by another device or software used with this Product (including but not limited to damage resulting from use of non Brother®-brand parts and Consumable and Accessory Items);

- 4 Consumable and Accessory Items that expired in accordance with a rated life;
- 5 Problems arising from other than defects in materials or workmanship; and,
- 6 Normal Periodic Maintenance Items, such as Paper Feeding Kit, Fuser and Laser Units.

This limited warranty is VOID if this Product has been altered or modified in any way (including but not limited to attempted warranty repair without authorization from Brother and/or alteration/removal of the serial number).

What to do if you think your Product is eligible for warranty service:

Report your issue to either our Customer Service Hotline at 1-877-BROTHER (1-877-276-8437) or to a Brother Authorized Service Center within the applicable warranty period. Supply Brother or the Brother Authorized Service Center with a copy of your dated bill of sale showing that this Product was purchased within the U.S. For the name of local Brother Authorized Service Center(s), call 1-877-BROTHER (1-877-276-8437) or visit www.brother-usa.com.

What Brother will ask you to do:

After contacting Brother or a Brother Authorized Service Center, you may be required to deliver (by hand if you prefer) or send the Product properly packaged, freight prepaid, to the Authorized Service Center together with a photocopy of your bill of sale.

You are responsible for the cost of shipping, packing product, and insurance (if you desire). You are also responsible for loss or damage to this Product in shipping.

What Brother will do:

If the problem reported concerning your Machine and/or accompanying Consumable and Accessory Items is covered by this warranty and if you first reported the problem to Brother or an Authorized Service Center within the applicable warranty period, Brother or its Authorized Service Center will repair or replace the Machine and/or accompanying Consumable and Accessory Items at no charge to you for parts or labor. The decision as to whether to repair or replace the Machine and/or accompanying Consumable and Accessory Items is made by Brother in its sole discretion. Brother reserves the right to supply a refurbished or remanufactured replacement Machine and/or accompanying Consumable and Accessory Items and use refurbished parts provided such replacement products conform to the manufacturer's specifications for new product/parts.

Brother® One-Year Limited Warranty and Replacement Service (USA Only)

The repaired or replacement Machine and/or accompanying Consumable and Accessory Items will be returned to you freight prepaid or made available for you to pick up at a conveniently located Authorized Service Center.

If the Machine and/or accompanying Consumable and Accessory Items are not covered by this warranty (either stage), you will be charged for shipping the Machine and/or accompanying Consumable and Accessory Items back to you and charged for any service and/or replacement parts/products at Brother's then current published rates.

The foregoing are your sole (i.e., only) and exclusive remedies under this warranty.

What happens when Brother elects to replace your Machine:

When a replacement Machine is authorized by Brother, and you have delivered the Machine to an Authorized Service Center, the Authorized Service Center will provide you with a replacement Machine after receiving one from Brother. If you are dealing directly with Brother's Express Exchange Service Brother will send to you a replacement Machine shipped for receipt within two business days, with the understanding that you will, after receipt of the replacement Machine, supply the required proof of purchase information, together with the Machine that Brother agreed to replace. You are then expected to pack the Machine that Brother agreed to replace in the package from the replacement Machine and return it to Brother using the pre-paid freight bill supplied by Brother in accordance with the instructions provided by Brother. Since you will be in possession of two machines, Brother will require that you provide a valid major credit card number. Brother will issue a hold against the credit card account number that you provide until Brother receives your original Product and determines that your original Product is entitled to warranty coverage. Your credit card will be charged up to the cost of a new Product only if: (i) you do not return your original Product to Brother within five (5) business days; (ii) the problems with your original Product are not covered by the limited warranty; (iii) the proper packaging instructions are not followed and has caused damage to the product; or (iv) the warranty period on your original Product has expired or has not been sufficiently validated with a copy of the proof of purchase (bill of sale). The

replacement Machine you receive (even if refurbished or remanufactured) will be covered by the balance of the limited warranty period remaining on the original Product, plus an additional thirty (30) days. You will keep the replacement Machine that is sent to you and your original Machine shall become the property of Brother. **Retain your original Accessory Items and a copy of the return freight bill, signed by the courier.**

Limitations:

Brother is not responsible for damage to or loss of any equipment, media, programs or data related to the use of this Product. Except for the repair or replacement as described above, Brother shall not be liable for any direct, indirect, incidental or consequential damages or specific relief. Because some states do not allow the exclusion or limitation of consequential or incidental damages, the above limitation may not apply to you.

THIS WARRANTY IS GIVEN IN LIEU OF ALL OTHER WARRANTIES, WRITTEN OR ORAL, WHETHER EXPRESSED BY AFFIRMATION, PROMISE, DESCRIPTION, DRAWING, MODEL OR SAMPLE. ANY AND ALL WARRANTIES OTHER THAN THIS ONE, WHETHER EXPRESS OR IMPLIED, INCLUDING IMPLIED WARRANTIES OF MERCHANTABILITY AND FITNESS FOR A PARTICULAR PURPOSE, ARE HEREBY DISCLAIMED.

- This Limited Warranty is the only warranty that Brother is giving for this Product. It is *the final expression and the exclusive and only statement* of Brother's obligations to you. It replaces all other agreements and understandings that you may have with Brother or its representatives.
- This warranty gives you certain rights and you may also have other rights that may vary from state to state.
- This Limited Warranty (and Brother's obligation to you) may not be changed in any way unless you and Brother sign the same piece of paper in which we (1) refer to this Product and your bill of sale date, (2) describe the change to this warranty and (3) agree to make that change.

Important: *We recommend that you keep all original packing materials, in the event that you ship this Product.*

**BROTHER MULTIFUNCTION CENTER /FAX MACHINE
LIMITED WARRANTY
(Canada only)**

Pursuant to the limited warranty of 1 year from the date of purchase for labour and parts, Brother International Corporation (Canada) Ltd. ("Brother"), or its Authorized Service Centres, will repair or replace (at Brother's sole discretion) this MFC/Fax machine free of charge if defective in material or workmanship. This warranty applies only to products purchased and used in Canada.

This limited Warranty does not include cleaning, consumables (including, without limitation, ink cartridges, print cartridges, print rolls, thermal paper rolls, toner cartridges, drum units, OPC belts, fixing units, print heads, paper feed rollers, transfer rolls, cleaning rollers, waste toner packs, oil bottles) or damage caused by accident, neglect, misuse or improper installation or operation, any damage caused from service, maintenance, modifications, or tampering by anyone other than a Brother Authorized Service Representative, or if shipped out of the country.

The use of supplies or consumable items that are non-Brother products may void your warranty. This limited warranty ceases when this machine is rented, sold, or otherwise disposed of. Operation of the MFC/Fax machine in excess of the specifications or with the Serial Number or Rating Label removed shall be deemed abuse and all repairs thereafter shall be the sole liability of the end-user/purchaser.

In order to obtain warranty service, the MFC/Fax machine must be delivered or shipped freight prepaid by the end-user/purchaser to a "Brother" Authorized Service Centre, together with your Canadian Proof of Purchase in the form of a Sales Receipt.

When shipping or transporting your MFC/Fax machine, please refer to your Operation Manual for the proper packaging procedures.

For Laser units: Failure to remove the Toner Cartridge (and Toner Drum Unit, waste toner packs or oil bottles on applicable models) during shipping or transport will cause severe damage to the Laser MFC/Fax machine and will void the Warranty.

For inkjet units: (When shipping your Inkjet MFC/Fax machine remove the ink cartridges and replace them with the original protective parts. If original protective parts are not available, leave ink cartridges installed. Please avoid shipping the unit without original protective parts or ink cartridges.) Damage to your print head resulting from packing the Inkjet MFC/Fax machine without the ink cartridges or the protective parts will void your warranty.

Improper packaging may cause severe damage to the machine during shipping and will void the warranty.

BROTHER DISCLAIMS ALL OTHER WARRANTIES EXPRESSED OR IMPLIED INCLUDING, WITHOUT LIMITATIONS, ANY IMPLIED WARRANTIES OF MERCHANTABILITY OR FITNESS FOR A PARTICULAR PURPOSE, EXCEPT TO THE EXTENT THAT ANY WARRANTIES IMPLIED BY LAW CANNOT BE VALIDLY WAIVED.

No oral or written information, advice or representation provided by Brother, its Authorized Service Centres, Distributors, Dealers, Agents or employees, shall create another warranty or modify this warranty. The warranty states Brother's entire liability and your exclusive remedy against Brother for any failure of the MFC/Fax machine to operate properly.

Neither Brother nor anyone else involved in the development, production, or delivery of this MFC/Fax machine shall be liable for any indirect, incidental, special, consequential, exemplary, or punitive damages, including lost profits, arising from the use of or inability to use the product, even if advised by the end user/purchaser of the possibility of such damages. Since some Provinces do not allow the above limitation of liability, such limitation, may not apply to you.

This Limited Warranty gives you specific legal rights and you may also have other rights which vary from Province to Province.

Warranty Service is available at Brother Authorized Service Centres throughout Canada. For Technical Assistance or for the name and location of your nearest Authorized Service Centre call 1-877-BROTHER.

At your side.
brother®

Internet support: support@brother.ca or browse Brother's Web Site www.brother.ca.

Table of Contents

Section I General

1	General information	2
	Using the documentation	2
	Symbols and conventions used in the documentation	2
	Accessing the Software User's Guide	3
	Viewing documentation	3
	Accessing Brother support (for Windows®)	5
	Control panel overview	6
2	Loading paper and documents	7
	Loading paper and print media	7
	Loading paper in the paper tray	7
	Loading paper in the manual feed slot	8
	Unprintable area	11
	Acceptable paper and other print media	12
	Recommended paper and print media	12
	Type and size of paper	12
	Handling and using special paper	14
	Loading documents	17
	Using the automatic document feeder (ADF) (DCP-7040 only)	17
	Using the scanner glass	18
3	General setup	19
	Paper settings	19
	Paper type	19
	Paper size	19
	Volume settings	19
	Beeper volume	19
	Ecology features	20
	Toner save	20
	Sleep time	20
	LCD contrast	21
	User Settings List	21

Section II Copy

4	Making copies	24
	How to copy	24
	Entering copy mode	24
	Making a single copy	24

Making multiple copies	24
Stop copying	24
Copy options (temporary settings)	25
Enlarging or reducing the image copied	25
Adjusting contrast	26
Using the Options key	27
Improving copy quality	27
Sorting copies using the ADF (DCP-7040 only)	28
Making N in 1 copies (page layout)	28
Out of memory message	29

Section III Software

5 Software features 32

How to read HTML User's Guide	32
For Windows®	32
For Macintosh®	33

Section IV Appendixes

A Safety and legal 36

Choosing a location	36
To use the machine safely	37
Important information	40
Federal Communications Commission (FCC) Declaration of Conformity (USA only)	40
Industry Canada Compliance Statement (Canada only)	41
Disconnect device	41
International ENERGY STAR® Compliance Statement	41
Laser safety	41
FDA regulations	42
Important safety instructions	42
Trademarks	45

B Troubleshooting and routine maintenance 46

Troubleshooting	46
If you are having difficulty with your machine	46
Improving the print quality	49
Error and maintenance messages	55
Document jams (DCP-7040 only)	57
Paper jams	58
Routine maintenance	62
Cleaning the outside of the machine	62
Cleaning the scanner glass	63
Cleaning the laser scanner window	64

	Cleaning the corona wire	66
	Cleaning the drum unit	68
	Replacing the consumable items	70
	Replacing a toner cartridge	70
	Replacing the drum unit	74
	Machine information	77
	Checking the serial number	77
	Checking the page counters	77
	Checking the Drum life	77
	Packing and shipping the machine	78
C	Menu and features	79
	On-screen programming	79
	Menu table	79
	Memory storage	79
	Menu keys	79
	How to access the menu mode	80
	Menu table	81
D	Specifications	83
	General	83
	Print media	85
	Copy	86
	Scan	87
	Print	88
	Interfaces	88
	Computer requirements	89
	Consumable items	90
E	Glossary	91
F	Index	92



General

General information	2
Loading paper and documents	7
General setup	19

1

General information

Using the documentation

Thank you for buying a Brother machine! Reading the documentation will help you make the most of your machine.

Symbols and conventions used in the documentation

The following symbols and conventions are used throughout the documentation.

Bold	Bold style identifies keys on the machine control panel or computer screen.
<i>Italics</i>	Italicized style emphasizes an important point or refers you to a related topic.
<code>Courier New</code>	Courier New font identifies the messages shown on the LCD of the machine.



Warnings tell you what to do to prevent possible personal injury.



Cautions specify procedures you must follow or avoid to prevent possible damage to the machine or other objects.



Electrical Hazard icons alert you to a possible electrical shock.



Hot Surface icons warn you not to touch machine parts that are hot.



Incorrect setup icons alert you to devices and operations that are not compatible with the machine.



Note icons give useful tips.



Note

Illustrations in this User's Guide are based on the DCP-7040.

Accessing the Software User's Guide

This User's Guide does not contain all the information about the machine such as how to use the advanced features of Printer and Scanner. When you are ready to learn detailed information about these operations, read the **Software User's Guide**.

Viewing documentation

Viewing documentation (Windows®)

To view the documentation, from the **Start** menu, point to **Brother, DCP-XXXX** (where XXXX is your model name) from the program group, and then click **User's Guides in HTML format**.

If you have not installed the software, you can find the documentation by following the instructions below:

- 1 Turn on your PC. Insert the Brother CD-ROM labeled Windows® into your CD-ROM drive.
- 2 If the language selection screen appears, click your language.
- 3 If the model name screen appears, click your model name. The CD-ROM main menu will appear.



If this window does not appear, use Windows® Explorer to find and run the start.exe program from the root directory of the Brother CD-ROM.

- 4 Click **Documentation**.
- 5 Click the documentation you want to read:
 - HTML document (1 manual):
Software User's Guide in HTML format.
This format is recommended for viewing on your computer.
 - PDF documents (3 manuals):
User's Guide for stand-alone operations, **Software User's Guide** and **Quick Setup Guide**.
This format is recommended for printing the manuals. Click to go to the Brother Solutions Center, where you can view or download the PDF documents. (Internet access and PDF Reader software are required.)

How to find scanning instructions

There are several ways you can scan documents. You can find the instructions as follows:

Software User's Guide:

- Scanning a document using the TWAIN driver in Chapter 2
- Scanning a document using the WIA driver (For Windows® XP/Windows Vista® only) in Chapter 2
- Using ControlCenter3 in Chapter 3

ScanSoft™ PaperPort™ 11SE with OCR How-to-Guides

- The complete ScanSoft™ PaperPort™ 11SE with OCR How-to-Guides can be viewed from the Help selection in the ScanSoft™ PaperPort™ 11SE application.

Viewing documentation (Macintosh®)

- 1 Turn on your Macintosh®. Insert the Brother CD-ROM labeled Macintosh® into your CD-ROM drive.
- 2 The following window will appear.



- 3 Double-click the **Documentation** icon.
- 4 If the language selection screen appears, double-click your language.
- 5 Double-click the top page file to view the **Software User's Guide** in HTML format.

- 6 Click the documentation you want to read.

■ Software User's Guide



Note

The documents are also available in PDF format (3 manuals):

User's Guide for stand-alone operations, **Software User's Guide** and **Quick Setup Guide**.

The PDF format is recommended for printing the manuals.

Double-click **Brother Solutions Center** icon to go to the Brother Solutions Center, where you can view or download the PDF documents. (Internet access and PDF Reader software are required.)

How to find scanning instructions

There are several ways you can scan documents. You can find the instructions as follows:

Software User's Guide:

- Scanning in Chapter 9
- Using ControlCenter2 in Chapter 10

Presto!® PageManager® User's Guide:

- The complete Presto!® PageManager® User's Guide can be viewed from the Help selection in the Presto!® PageManager® application.

Accessing Brother support (for Windows®)

You can find all the contacts you will need, such as Web support (Brother Solutions Center), Customer Service and Brother Authorized Service Centers on page i and on the Brother CD-ROM.

- Click **Brother Support** on the main menu. The following screen will appear:



- To access our web site (<http://www.brother.com/>) click **Brother Home Page**.
- To view all Brother Numbers, including Customer Service numbers for the USA and Canada, click **Support Information**.
- To access the USA Brother online shopping mall (<http://www.brothermall.com/>) for additional product and service information, click **Brother Mall.com**.
- To access Canada's Brother online shopping mall (<http://www.brother.ca/>) for additional product and service information, click **Shop Online (Canada)**.
- For the latest news and product support information (<http://solutions.brother.com/>), click **Brother Solutions Center**.

- To visit our web site for original/genuine Brother supplies (<http://www.brother.com/original/>), click **Supplies Information**.

To return to the main page, click **Back**.

Or, if you have finished, click **Exit**.

Control panel overview

DCP-7030 and DCP-7040 have the same keys.

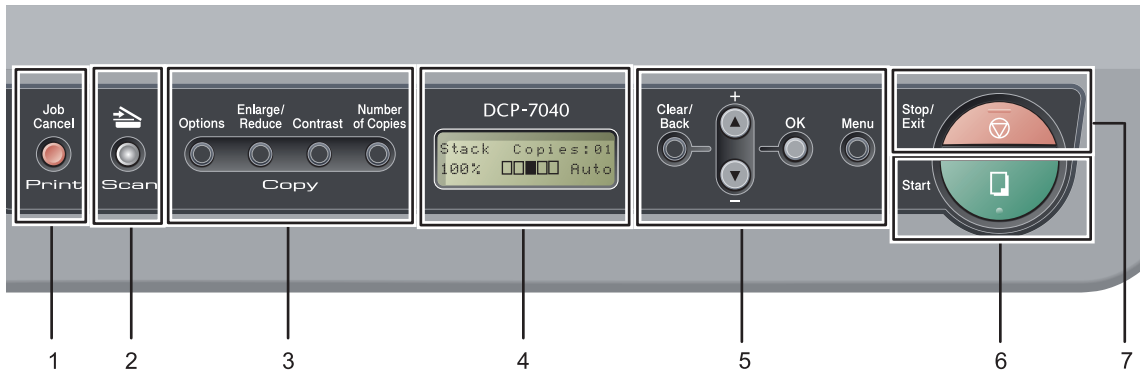

1 Print key

Job Cancel

Cancels a programmed print job and clears it from the machine's memory.

To cancel multiple print jobs, hold down this key until the LCD shows
Job Cancel (All).

2 Scan key

Puts the machine in Scan mode. (For details about scanning, see the *Software User's Guide on the CD-ROM*.)

3 Copy keys:

Options

You can choose and easily choose temporary settings for copying.

Enlarge/Reduce

Reduces or enlarges copies.

Contrast

You can increase or decrease the contrast of your copies.

Number of Copies

Use this key to make multiple copies.

4 LCD

Displays messages to help you set up and use your machine.

5 Menu keys:

Clear/Back

Deletes entered data or lets you cancel the current setting.

▲ + or ▼ -

Press to scroll through the menus and options.

OK

Lets you store your settings in the machine.

Menu

Lets you access the Menu to program your settings in this machine.

6 Start

Lets you start making copies or scanning.

7 Stop/Exit

Stops an operation or exits from a menu.

2

Loading paper and documents

Loading paper and print media

The machine can feed paper from the standard paper tray or manual feed slot.

When you put paper into the paper tray, note the following:

- If your application software supports paper size selection on the print menu, you can choose it through the software. If your application software does not support it, you can set the paper size in the printer driver or by using the control panel buttons.
- Before using paper that has holes in it, such as organizer sheets, you must 'fan' the stack to avoid paper jams and misfeeds.



Loading paper in the paper tray

2

Printing on plain paper, recycled paper or transparencies from the paper tray

- 1 Pull the paper tray completely out of the machine.

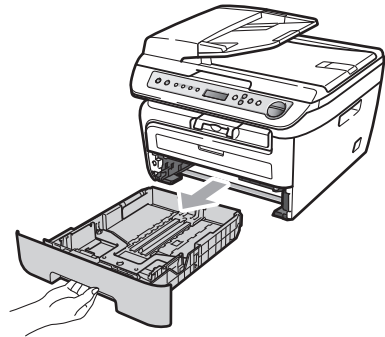

- 2 While pressing the green paper guide release lever, slide the paper guides to fit the paper size. Make sure that the guides are firmly in the slots.

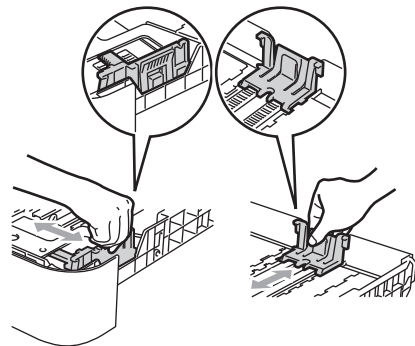

 **Note**

For Legal size paper, press in the inside latches and pull out the back of the paper tray.

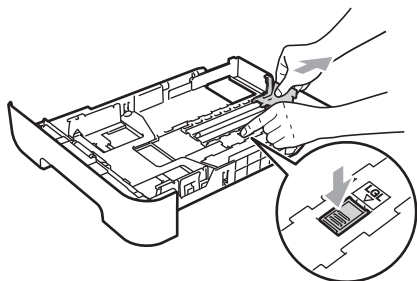

- 3 Put paper in the tray, and make sure that the paper is below the maximum paper mark (1). The side to be printed on must be face down.

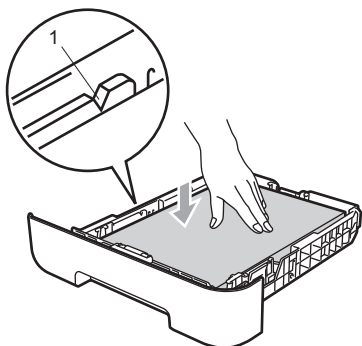

 **CAUTION**

Make sure the paper guides touch the sides of the paper so it will feed properly. If you do not do this, it may cause damage to your machine.

- 4 Put the paper tray firmly back in the machine. Make sure that it is completely inserted into the machine.

- 5 Unfold the support flap (1) to prevent paper from sliding off the face-down output tray.

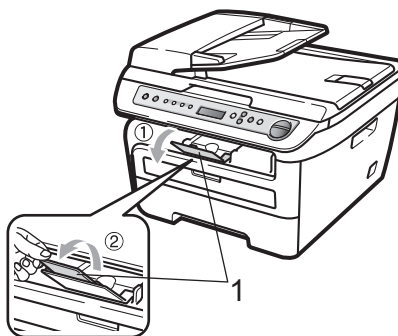

Loading paper in the manual feed slot

You can load envelopes and special print media one at a time into this slot. Use the manual feed slot to print or copy on labels, envelopes or thicker paper.

Printing on plain paper, recycled paper or transparencies from the manual feed slot

 **Note**

The machine automatically turns on the Manual Feed mode when you put paper in the manual feed slot.

- 1 Unfold the support flap (1) to prevent paper from sliding off the face-down output tray, or remove each page as soon as it comes out of the machine.

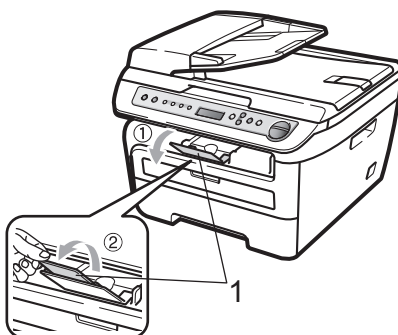

- 2 Open the manual feed slot cover.

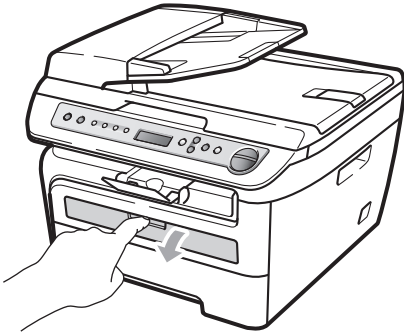

- 3 Using both hands, slide the manual feed slot paper guides to the width of the paper that you are going to use.

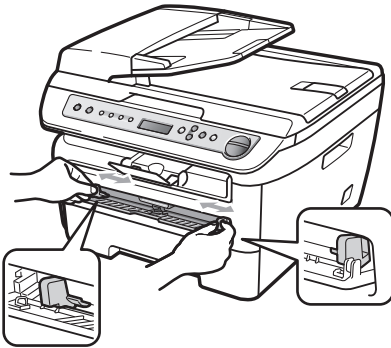

- 4 Using both hands, put one sheet of paper in the manual feed slot until the front edge of the paper or transparency touches the paper feed roller. When you feel the machine pull in the paper, let go.

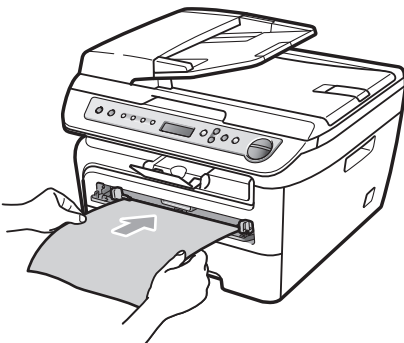

Printing on thick paper, bond paper labels and envelopes

When the back output tray is pulled down, the machine has a straight paper path from the manual feed slot through to the back of the machine. Use this paper feed and output method when you want to print on thick paper, labels or envelopes.



Note

- Remove each printed sheet or envelope immediately to prevent a paper jam.
- The machine automatically turns on the Manual Feed mode when you put paper in the manual feed slot.

- 1 Open the back cover (back output tray).

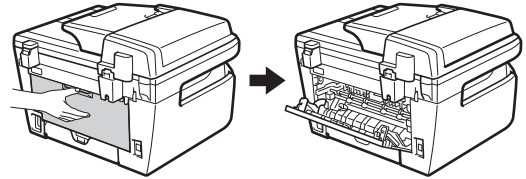

- 2 Open the manual feed slot cover.

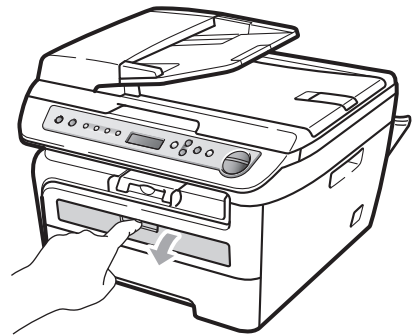

- 3 Using both hands, slide the manual feed slot paper guides to the width of the paper that you are going to use.

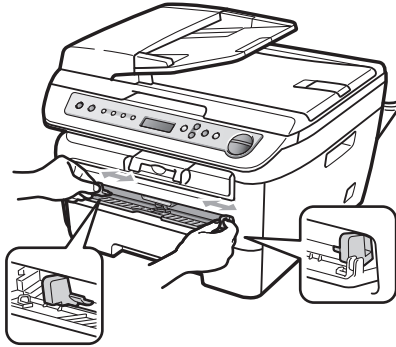

- 4 Using both hands, put one sheet of paper or one envelope in the manual feed slot until the front edge of the paper or envelope touches the paper feed roller. When you feel the machine pull in the paper, let go.

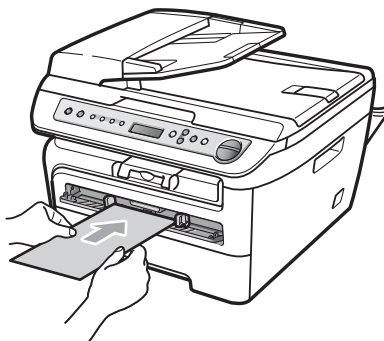
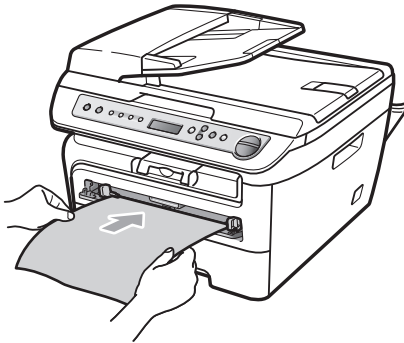

 **Note**

- Put the paper into the manual feed slot with the side to be printed face up.
- Make sure that the print media (paper, transparency and so on) is straight and in the proper position on the manual feed slot. If it is not, the paper or the transparency may not be fed properly, resulting in a skewed printout or a paper jam.
- Do not put more than one sheet of paper in the manual feed slot at any one time, as it may cause a jam.
- If you put any print media in the manual feed slot before the machine is in the Ready state, the print media may be ejected without being printed on.
- To easily remove a small printout from the output tray, lift up the scanner cover by using both hands as shown in the illustration.

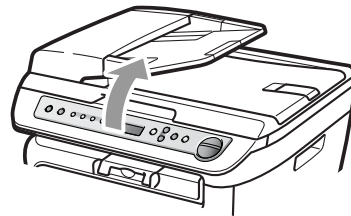

- You can still use the machine while the scanner cover is up. To close the scanner cover, push it down with both hands.

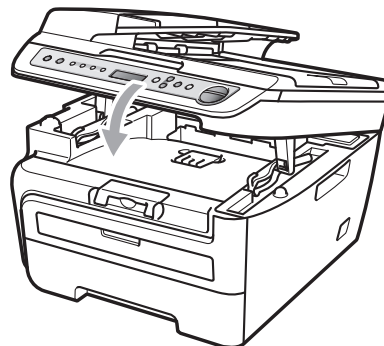

Unprintable area

Unprintable area for copies

The printable area of your machine begins at approximately 0.12 in. (3 mm) from the top and bottom and 0.16 in. (4 mm) from both sides of the paper.

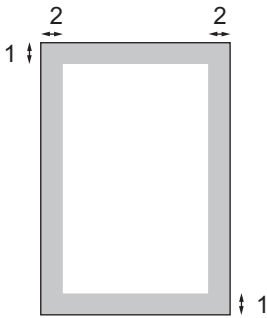

- 1 0.12 in. (3 mm)
- 2 0.16 in. (4 mm)



Note

This unprintable area shown above is for a single copy or a 1 in 1 copy using Letter size paper. The unprintable area changes with the paper size.

Unprintable area when printing from a computer

When using the default driver the printable area is smaller than the paper size, as shown below.

Portrait

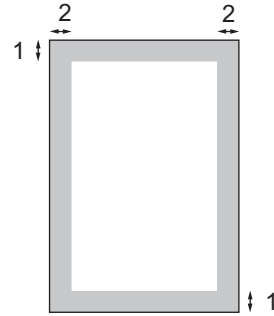

- 1 0.16 in. (4.23 mm)
- 2 0.25 in. (6.35 mm)

Landscape

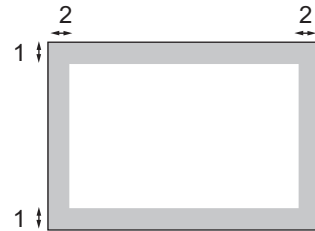

- 1 0.16 in. (4.23 mm)
- 2 0.2 in. (5.08 mm)



Note

The unprintable area shown above is for Letter size paper. The unprintable area changes with the paper size.

Acceptable paper and other print media

Print quality may vary according to the type of paper you are using.

You can use the following types of print media: plain paper, bond paper, recycled paper, transparencies, labels or envelopes.

For best results, follow the instructions below:

- Use paper made for plain paper copying.
- Use paper that is 20 to 24 lb (75 to 90 g/m²).
- Use labels and transparencies which are designed for use in laser machines.
- DO NOT put different types of paper in the paper tray at the same time because it may cause paper jams or misfeeds.
- For proper printing, you must choose the same paper size from your software application as the paper in the tray.
- Avoid touching the printed surface of the paper immediately after printing.
- When you use transparencies remove each sheet immediately to prevent smudging or paper jams.
- Use long grain paper with a neutral Ph value, and a moisture content of approx. 5%.

Recommended paper and print media

To get the best print quality, we suggest using the following paper.

Paper Type	Item
Plain Paper	Xerox 4200DP 20 lb
	Hammermill Laser Print (24 lb=90 g/m ²)
Recycled Paper	No specific brand recommended
Transparency	3M CG3300
Labels	Avery laser labels white #5160
Envelope	No specific brand recommended

Type and size of paper

The machine loads paper from the installed standard paper tray or manual feed slot.

Standard paper tray

Since the standard paper tray is a universal type, you can use any of the paper sizes (one paper type and size at a time) listed in the table in *Paper capacity of the paper trays* on page 13. The standard paper tray can hold up to 250 sheets of Letter/A4, legal or folio size paper (20 lb or 80 g/m²). Paper can be loaded up to the maximum paper mark on the sliding paper width guide.

Manual feed slot

The manual feed slot can hold a sheet with a size of 3 to 8.66 in. (76.2 to 220 mm) wide and 4.57 to 16 in. (116 to 406.4 mm) long. You can use the manual feed slot if you are using special paper, envelopes or labels.

Paper capacity of the paper trays

	Paper size	Paper types	No. of sheets
Paper Tray	A4, Letter, Legal, Executive, A5, A6, B5, B6 and Folio ¹ .	Plain paper and recycled paper	up to 250 [20 lb (80 g/m ²)]
		Transparency	up to 10
Manual Feed Slot	Width: 3 to 8.66 in. (76.2 to 220 mm) Length: 4.57 to 16 in. (116 to 406.4 mm)	Plain paper, recycled paper, bond paper, envelopes, labels and transparencies	1

¹ Folio size is 8 in. × 13 in. (215.9 mm x 330.2 mm)

Recommended paper specifications

The following paper specifications are suitable for this machine.

Basis weight	20-24 lb (75-90 g/m ²)
Thickness	80-110 µm
Roughness	Higher than 20 sec.
Stiffness	90-150 cm ³ /100
Grain direction	Long grain
Volume resistivity	10e ⁹ -10e ¹¹ ohm
Surface resistivity	10e ⁹ -10e ¹² ohm-cm
Filler	CaCO ₃ (Neutral)
Ash content	Below 23 wt %
Brightness	Higher than 80 %
Opacity	Higher than 85 %

Handling and using special paper

The machine is designed to work well with most types of xerographic and bond paper. However, some paper variables may have an effect on print quality or handling reliability. Always test samples of paper before purchasing to ensure desirable performance. Store paper in its original packaging and keep it sealed. Keep the paper flat and away from moisture, direct sunlight and heat.

Some important guidelines when selecting paper are:

- Do not use ink jet paper because it may cause a paper jam or damage your machine.
- Preprinted paper must use ink that can withstand the temperature of the machine's fusing process (200 degrees centigrade).
- If you use bond paper, paper having a rough surface or paper that is wrinkled or creased, the paper may exhibit degraded performance.

Types of paper to avoid

! CAUTION

Some types of paper may not perform well or may cause damage to your machine.

DO NOT use paper:

- that is highly textured
- that is extremely smooth or shiny
- that is curled or warped

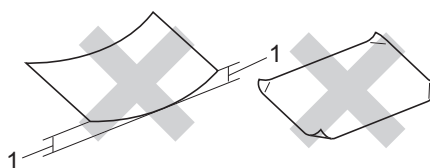

1 0.08 in. (2 mm)

- that is coated or has a chemical finish
- that is damaged, creased or folded
- that exceeds the recommended weight specification in this guide
- with tabs and staples
- with letterheads using low temperature dyes or thermography
- that is multipart or carbonless
- that is designed for inkjet printing

If you use any of the types of paper listed above, they may damage your machine. This damage is not covered under any Brother warranty or service agreement.

Envelopes

Most envelopes will be suitable for your machine. However, some envelopes may have feed and print-quality problems because of the way they have been made. A suitable envelope should have edges with straight, well-creased folds and the leading edge should not be thicker than two sheets of paper. The envelope should lie flat and not be of baggy or flimsy construction. You should buy quality envelopes from a supplier who understands that you will be using the envelopes in a laser machine.

Envelopes can be fed from manual feed slot one at a time. We recommend that you print a test envelope to make sure the print results are what you want before you print or purchase a large quantity of envelopes.

Check the following:

- Envelopes should have a lengthwise sealing flap.
- The sealing flaps should be folded crisply and correctly (irregularly cut or folded envelopes may cause paper jams).
- Envelopes should consist of two layers of paper in the area circled in figure below.

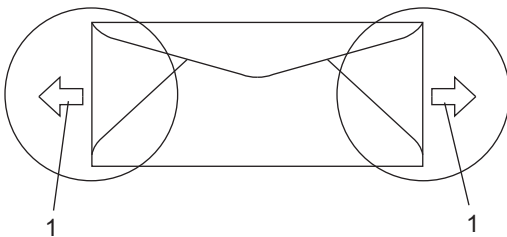

1 Feeding direction

- Envelope joints that are sealed by the manufacturer should be secure.
- We recommend that you do not print within 0.6 in. (15 mm) of the edges of envelopes.

Types of envelopes to avoid

! CAUTION

DO NOT use envelopes:

- that are damaged, curled, wrinkled or an unusual shape
- that are extremely shiny or textured
- with clasps, staples, snaps or tie strings
- with self-adhesive closures
- that are of a baggy construction
- that are not sharply creased
- that are embossed (have raised writing on them)
- that were previously printed by a laser machine
- that are pre-printed on the inside
- that cannot be arranged neatly when stacked
- that are made of paper that weighs more than the paper weight specifications for the machine
- with edges that are not straight or consistently square
- with windows, holes, cut-outs or perforations
- with glue on surface as shown in figure below

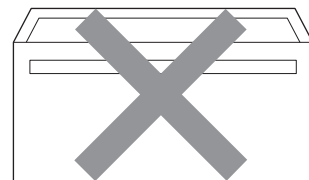

- with double flaps as shown in figure below

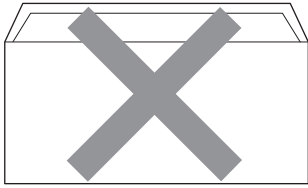

- with sealing flaps that have not been folded at purchase
- with sealing flaps as shown in figure below

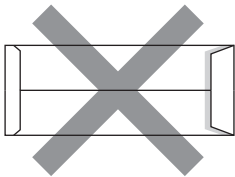

- with each side folded as shown in figure below

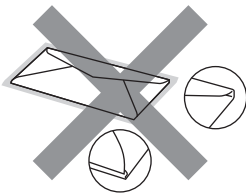

If you use any of the types of envelopes listed above, they may damage your machine. This damage is not covered under any Brother warranty or service agreement.

Occasionally you may experience paper feed problems caused by the thickness, size and flap shape of the envelopes you are using.

Labels

The machine will print on most types of labels designed for use with a laser machine. Labels should have an adhesive that is acrylic-based since this material is more stable at the high temperatures in the fuser unit. Adhesives should not come in contact with any part of the machine, because the label stock may stick to the drum unit or rollers and cause jams and print quality problems. No adhesive should be exposed between the labels. Labels should be arranged so that they cover the entire length and width of the sheet. Using labels with spaces may result in labels peeling off and causing serious jams or print problems.

All labels used in this machine must be able to withstand a temperature of 392 degrees Fahrenheit (200 degrees centigrade) for a period of 0.1 seconds.

Label sheets should not exceed the paper weight specifications described in this User's Guide. Labels exceeding this specification may not feed or print properly and may cause damage to your machine.

Labels can be fed from the manual feed slot only.

Types of labels to avoid

Do not use labels that are damaged, curled, wrinkled or an unusual shape.

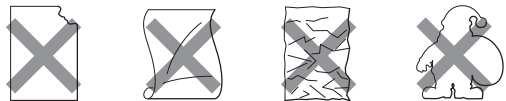

CAUTION

Avoid feeding labels with the carrier sheet exposed because your machine will be damaged.

Loading documents

Using the automatic document feeder (ADF) (DCP-7040 only)

The ADF can hold up to 35 pages and feeds each sheet individually. Use standard 20 lb (80 g/m²) paper and always fan the pages before putting them in the ADF.

Recommended environment

Temperature: 68° F to 86° F (20 to 30° C)
 Humidity: 50% - 70%
 Paper: Xerox 4200 (20 lb/Letter)

! CAUTION

DO NOT leave thick documents on the scanner glass. If you do this, the ADF may jam.

DO NOT use paper that is curled, wrinkled, folded, ripped, stapled, paper-clipped, pasted or taped.

DO NOT use cardboard, newspaper or fabric.

To avoid damaging your machine while using the ADF, DO NOT pull on the document while it is feeding.

To scan non-standard documents see *Using the scanner glass* on page 18.

- Make sure documents written with ink are completely dry.
- Documents must be from 5.8 to 8.5 in. (148 to 215.9 mm) wide and from 5.8 to 14 in. (148 to 355.6 mm) long, and of a standard weight [20 lb (80 g/m²)].

- 1 Unfold the ADF document output support flap (1) and the ADF support flap (2).

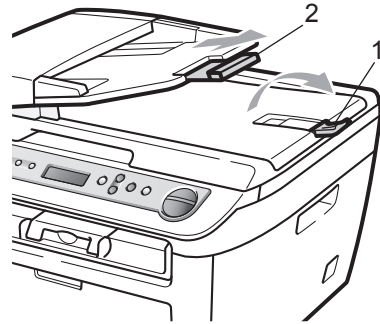

- 2 Fan the pages well.
- 3 Place your document, face up top edge first, in the ADF until you feel it touch the feed roller.
- 4 Adjust the paper guides(1) to fit the width of your document.

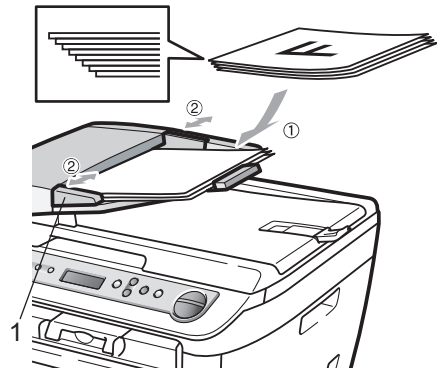

Using the scanner glass

You can use the scanner glass to copy or scan pages of a book or one page at a time. Documents can be up to 8.5 in. wide and 11.7 in. long (215.9 mm wide and 297 mm long).



Note

(DCP-7040 only) To use the scanner glass, the ADF must be empty.

! CAUTION

If the document is a book or is thick do not slam the cover or press on it.

- 1 Lift the document cover.
- 2 Using the document guidelines on the left, center the document face down on the scanner glass.

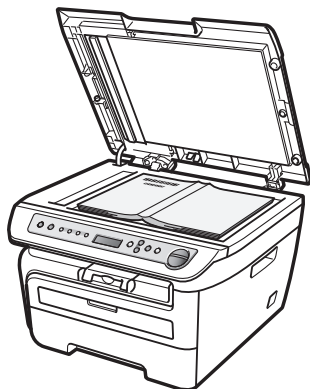
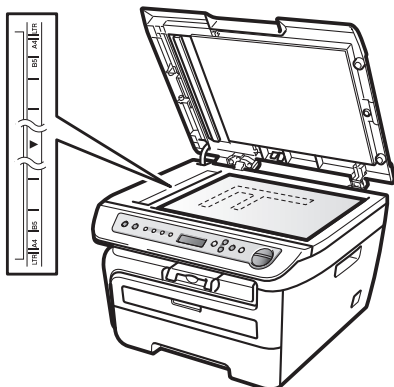

- 3 Close the document cover.

3

General setup

Paper settings

Paper type

Set up the machine for the type of paper you are using. This will give you the best print quality.

- 1 Press **Menu**.
- 2 Press **▲** or **▼** to choose 1.General Setup.
Press **OK**.
- 3 Press **▲** or **▼** to choose 1.Paper Type.

```
General Setup
1.Paper Type
```

Press **OK**.

- 4 Press **▲** or **▼** to choose Thin, Plain, Thick, Thicker, Transparency or Recycled Paper.
Press **OK**.
- 5 Press **Stop/Exit**.

Paper size

You can use nine sizes of paper for printing copies: A4, Letter, Legal, Executive, A5, A6, B5, B6 and Folio.

When you change the size of paper in the tray, you will also need to change the setting for paper size at the same time so your machine can fit the document on the page.

- 1 Press **Menu**.
- 2 Press **▲** or **▼** to choose 1.General Setup.
Press **OK**.

- 3 Press **▲** or **▼** to choose 2.Paper Size.

```
General Setup
2.Paper Size
```

Press **OK**.

- 4 Press **▲** or **▼** to choose A4, Letter, Legal, Executive, A5, A6, B5, B6 or Folio.
Press **OK**.

- 5 Press **Stop/Exit**.



Note

If you chose Transparency as the paper type you will only be able to choose Letter, Legal, Folio or A4 size paper in Step 4.

Volume settings

Beeper volume

When the beeper is on, the machine will beep when you press a key, make a mistake. You can choose a range of volume levels, from High to Off.

- 1 Press **Menu**.
- 2 Press **▲** or **▼** to choose 1.General Setup.
Press **OK**.
- 3 Press **▲** or **▼** to choose 3.Beeper.

```
General Setup
3.Beeper
```

Press **OK**.

- 4 Press **▲** or **▼** to choose Off, Low, Med or High.
Press **OK**.
- 5 Press **Stop/Exit**.

Ecology features

Toner save

You can save toner using this feature. When you set toner save to *On*, print appears lighter. The default setting is *Off*.

- 1 Press **Menu**.
- 2 Press **▲** or **▼** to choose 1.General Setup.
Press **OK**.
- 3 Press **▲** or **▼** to choose 4.Ecology.

General Setup
 4.Ecology

 Press **OK**.
- 4 Press **▲** or **▼** to choose 1.Toner Save.
Press **OK**.
- 5 Press **▲** or **▼** to choose *On* or *Off*.
Press **OK**.
- 6 Press **Stop/Exit**.



Note

We do not recommend Toner Save for printing Photo or Gray Scale images.

Sleep time

Setting the sleep time reduces power consumption by turning off the fuser while the machine is idle.

You can choose how long the machine must be idle (from 00 to 99 minutes) before it goes into sleep mode. When the machine receives computer data, or makes a copy, the timer will be reset. The default setting is 05 minutes.

While the machine is in sleep mode the LCD will display *Sleep*. When printing or copying in sleep mode, there will be a short delay while the fuser warms up.

- 1 Press **Menu**.
- 2 Press **▲** or **▼** to choose 1.General Setup.
Press **OK**.
- 3 Press **▲** or **▼** to choose 4.Ecology.

General Setup
 4.Ecology

 Press **OK**.
- 4 Press **▲** or **▼** to choose 2.Sleep Time.
Press **OK**.
- 5 Enter the length of time the machine is idle before entering sleep mode (00 to 99). Press **OK**.
- 6 Press **Stop/Exit**.



Note

To turn *off* sleep mode, press **Start** and **Options** at the same time in 5. Press **▲** or **▼** to choose *Off*. Press **OK**.

LCD contrast

You can change the contrast to make the LCD look lighter or darker.

- 1 Press **Menu**.
- 2 Press **▲** or **▼** to choose
1.General Setup.
Press **OK**.
- 3 Press **▲** or **▼** to choose
5.LCD Contrast.

General Setup
5.LCD Contrast

 Press **OK**.
- 4 Press **▲** to make the LCD darker. Or,
press **▼** to make the LCD lighter.
Press **OK**.
- 5 Press **Stop/Exit**.

User Settings List

You can print a list of the settings you programmed.

- 1 Press **Menu**.
- 2 Press **▲** or **▼** to choose
1.General Setup.
Press **OK**.
- 3 Press **▲** or **▼** to choose
6.User Settings.

General Setup
6.User Settings

 Press **OK**.
- 4 Press **Start**.
- 5 Press **Stop/Exit**.



Copy

Making copies

24

4

Making copies

How to copy

Entering copy mode

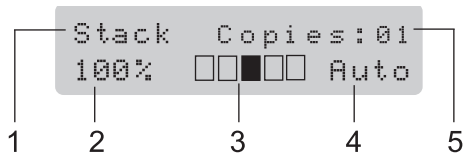

- 1 **Stack/Sort**¹
- 2 **Copy ratio and copy layout**
- 3 **Contrast**
- 4 **Quality**
- 5 **Number of copies**

¹ Sort is only available for the DCP-7040.

Making a single copy

- 1 Load your document.
- 2 Press **Start**.

Making multiple copies

- 1 Load your document.
- 2 Do one of the following:
 - Press **Number of Copies** to enter the number of copies (up to 99).
 - Press or hold ▲ or ▼ to increase or decrease the number of copies.
- 3 Press **Start**.



Note

To sort your copies, see *Sorting copies using the ADF (DCP-7040 only)* on page 28.

Stop copying

To stop copying, press **Stop/Exit**.

Copy options (temporary settings)

When you want to quickly change the copy settings temporarily for the next copy, use the temporary **Copy** keys. You can use different combinations.

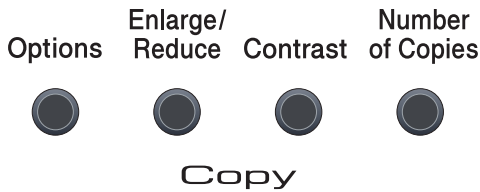

The machine returns to its default settings one minute after copying.

Enlarging or reducing the image copied

You can choose the following enlargement or reduction ratios:

Press  Enlarge/Reduce	100%*
	97% LTR→A4
	94% A4→LTR
	91% Full Page
	85% LTR→EXE
	83% LGL→A4
	78% LGL→LTR
	70% A4→A5
	50%
	Custom (25-400%)
	Auto
	200%
	141% A5→A4
	104% EXE→LTR

*The factory setting is shown in Bold with an asterisk.

(DCP-7040 only) **Auto** sets the machine to calculate the reduction ratio that best fits the size of paper. **Auto** is only available when using the ADF.

Custom (25-400%) allows you to enter a ratio from 25% to 400%.

To enlarge or reduce the next copy follow the instructions below:

- 1 Load your document.
- 2 Enter the number of copies you want.
- 3 Press **Enlarge/Reduce**.
- 4 Do one of the following:
 - Press **▲** or **▼** to choose the enlargement or reduction ratio you want.
Press **OK**.
 - Press **▲** or **▼** to choose **Custom (25-400%)**.
Press **OK**.
Press **▲** or **▼** to enter an enlargement or reduction ratio from 25% to 400%.
Press **OK**.
- 5 Press **Start**.



Note

Page Layout Options 2 in 1(P), 2 in 1(L), 4 in 1(P) or 4 in 1(L) are *not* available with Enlarge/Reduce.

Adjusting contrast

Contrast

Adjust the contrast to help an image look sharper and more vivid.

To *temporarily* change the contrast setting, follow the steps below:

- 1 Load your document.
- 2 Enter the number of copies you want.
- 3 Press **Contrast**.
- 4 Press ▲ or ▼ to increase or decrease the contrast.
Press **OK**.
- 5 Press **Start**.

To change the *default* setting follow the steps below:

- 1 Press **Menu**.
- 2 Press ▲ or ▼ to choose 2.Copy.
Press **OK**.
- 3 Press ▲ or ▼ to choose 2.Contrast.

```
Copy
2.Contrast
```

Press **OK**.

- 4 Press ▲ or ▼ to increase or decrease the contrast.
Press **OK**.
- 5 Press **Stop/Exit**.

Using the Options key

Use the **Options** key to quickly set the following copy settings temporarily for the next copy.

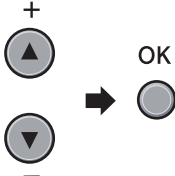
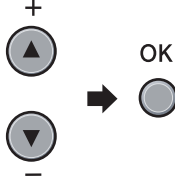
Press	Menu selections	Options	Page
Press 	Press ▲ or ▼, then press OK 	Press ▲ or ▼, then press OK 	
	Quality	Auto* Photo Text	27
	(DCP-7040 only) Stack/Sort (appears when the document is in the ADF)	Stack* Sort	28
	Page Layout	Off (1 in 1) * 2 in 1 (P) 2 in 1 (L) 4 in 1 (P) 4 in 1 (L)	28

 The factory settings are shown in Bold with an asterisk.

Improving copy quality

You can choose from a range of quality settings. The default setting is *Auto*.

■ **Auto**

Auto is the recommended mode for ordinary printouts. Suitable for documents that contain both text and photographs.

■ **Text**

Suitable for documents containing only text.

■ **Photo**

Suitable for copying photographs.

To *temporarily* change the quality setting, follow the steps below:

- 1 Load your document.
- 2 Enter the number of copies you want.
- 3 Press **Options**.
Press ▲ or ▼ to choose *Quality*.
Press **OK**.
- 4 Press ▲ or ▼ to choose *Auto*, *Photo* or *Text*.
Press **OK**.
- 5 Press **Start**.

To change the *default* setting, follow the steps below:

- 1 Press **Menu**.
- 2 Press **▲** or **▼** to choose 2.Copy.
Press **OK**.
- 3 Press **▲** or **▼** to choose 1.Quality.

Copy
1.Quality

 Press **OK**.
- 4 Press **▲** or **▼** to choose the copy quality.
Press **OK**.
- 5 Press **Stop/Exit**.

Sorting copies using the ADF (DCP-7040 only)

You can sort multiple copies. Pages will be stacked in the order 1 2 3, 1 2 3, 1 2 3, and so on.

- 1 Load your document in the ADF.
- 2 Enter the number of copies you want.
- 3 Press **Options** and **▲** or **▼** to choose Stack/Sort.
Press **OK**.
- 4 Press **▲** or **▼** to choose Sort.
Press **OK**.
- 5 Press **Start**.

Making N in 1 copies (page layout)

You can reduce the amount of paper used when copying by using the N in 1 copy feature. This allows you to copy two or four pages onto one page, which lets you save paper.

Important

- Please make sure the paper size is set to Letter, A4, Legal or Folio.
- (P) means Portrait and (L) means Landscape.
- You cannot use the Enlarge/Reduce setting with the N in 1 feature.

- 1 Load your document.
- 2 Enter the number of copies you want.
- 3 Press **Options**.
- 4 Press **▲** or **▼** to choose Page Layout.
Press **OK**.
- 5 Press **▲** or **▼** to choose 2 in 1 (P), 2 in 1 (L), 4 in 1 (P), 4 in 1 (L) or Off(1 in 1).
Press **OK**.
- 6 Press **Start** to scan the page. (DCP-7040 only) If you placed the document in the ADF, the machine scans the pages and starts printing. **If you are using the scanner glass, go to 7.**
- 7 After the machine scans the page, press **▲** to scan the next page.

Next Page?
▲ Yes ▼ No
- 8 Place the next page on the scanner glass.
Press **OK**.
Repeat 7 and 8 for each page of the layout.

- 9 After all the pages have been scanned, press **▼** in **8** to finish.

(DCP-7040 only) If you are copying from the ADF:

Insert your document face up in the direction shown below:

■ 2 in 1 (P)



■ 2 in 1 (L)

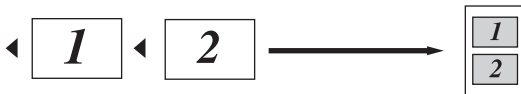

■ 4 in 1 (P)



■ 4 in 1 (L)



If you are copying from the scanner glass:

Insert your document face down in the direction shown below:

■ 2 in 1 (P)



■ 2 in 1 (L)

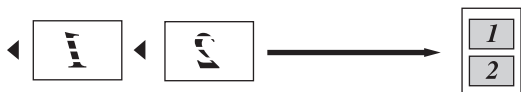

■ 4 in 1 (P)



■ 4 in 1 (L)



Out of memory message

If the memory becomes full while you are making copies, the LCD message will guide you through the next step.

(DCP-7030 only) If you get an *Out of Memory* message, press **Stop/Exit** to cancel the operation.

(DCP-7040 only) If you get an *Out of Memory* message while scanning a subsequent page, you will have the option to press **Start** to copy the pages scanned so far, or to press **Stop/Exit** to cancel the operation.



Software

Software features

32

5

Software features

The User's Guide on the CD-ROM includes the **Software User's Guide** for features available when connected to a computer (for example, printing and scanning). This guide has easy to use links that, when clicked, will take you directly to a particular section.

You can find information on these features:

- Printing
- Scanning
- ControlCenter3 (for Windows®)
- ControlCenter2 (for Macintosh®)



Note

See *Accessing the Software User's Guide* on page 3.

How to read HTML User's Guide

This is a quick reference for using the HTML User's Guide.

For Windows®



Note

If you have not installed the software, see *Chapter 1*.

- 1 From the **Start** menu, point to **Brother**, **DCP-XXXX** from the programs group, then click **User's Guides in HTML format**.
- 2 Click on **SOFTWARE USER'S GUIDE** from the top menu.

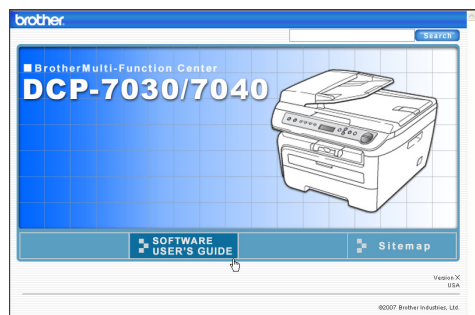

- 3 Click the heading you would like to view from the list at the left of the window.



For Macintosh®

- 1 Make sure your Macintosh® is turned on. Insert the Brother CD-ROM into your CD-ROM drive.
- 2 Double-click the **Documentation** icon.
- 3 Double-click your language folder, and then double-click the top page file.
- 4 Click on **SOFTWARE USER'S GUIDE** in the top menu, and then click the heading you would like to read from the list at the left of the window.





Appendixes

Safety and legal	36
Troubleshooting and routine maintenance	46
Menu and features	79
Specifications	83
Glossary	91

A

Safety and legal

Choosing a location

Place your machine on a flat, stable surface that is free of vibration and shocks. Put the machine near a standard, grounded AC power outlet. Choose a location where the temperature remains between 50° F and 90.5° F (10° C and 32.5° C) and the humidity is between 20% to 80% (without condensation).

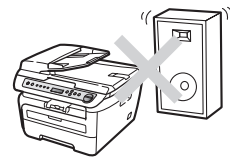
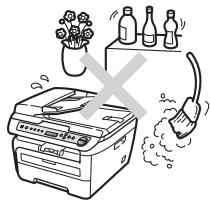
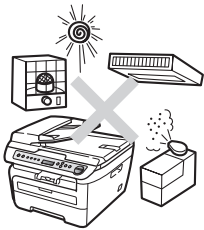

! CAUTION

Avoid placing your machine in a high-traffic area.

DO NOT place the machine near heaters, air conditioners, refrigerators, water, chemicals or devices that contain magnets or generate magnetic fields.

DO NOT expose the machine to direct sunlight, excessive heat, open flames, salty or corrosive gasses, moisture, or dust.

DO NOT connect your machine to an AC power outlet controlled by wall switches or automatic timers.

Disruption of power can wipe out information in the machine's memory.

DO NOT connect your machine to an AC power outlet on the same circuit as large appliances or other equipment that might disrupt the power supply.

DO NOT put objects on top of the machine.

To use the machine safely

Please keep these instructions for later reference and read them before attempting any maintenance. If you do not follow these safety instructions, there is a possibility of a fire, electrical shock, burn or suffocation.



WARNING



There are high voltage electrodes inside the machine. Before you clean the inside of the machine, make sure you have unplugged the power cord from the AC power outlet (See *Routine maintenance* on page 62.)

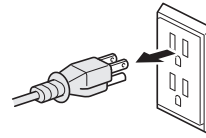

DO NOT use flammable substances, any type of spray, or an organic solvent/liquid that contains alcohol or ammonia to clean the inside or outside of the machine. Refer to *Routine maintenance* on page 62 for how to clean the machine.



DO NOT handle the plug with wet hands. Doing this might cause an electrical shock.

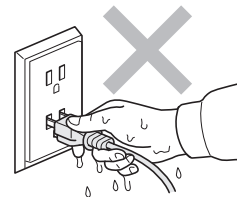

Always make sure the plug is fully inserted.



After you have just used the machine, some internal parts of the machine will be extremely hot. When you open the front or back cover of the machine, DO NOT touch the shaded parts shown in the illustration.

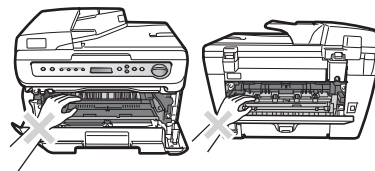



To prevent injuries, be careful not to put your hands on the edge of the machine under the document cover or scanner cover.

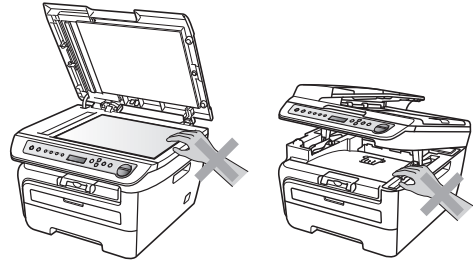

(DCP-7040 only) To prevent injuries, be careful not to put your fingers in the area shown in the illustration.

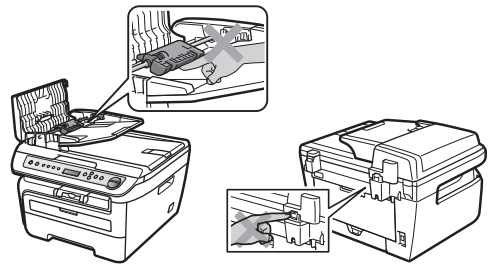

DO NOT use a vacuum cleaner to clean up scattered toner. Doing this might cause the toner dust to ignite inside the vacuum cleaner, potentially starting a fire. Please carefully clean the toner dust with a dry, lint-free cloth and dispose of it according to local regulations.



When you move the machine, grasp the side hand holds that are under the scanner.



This product must be installed near an AC power outlet that is easily accessible. In case of an emergency, you must disconnect the power cord from the AC power outlet to shut off the power completely.



Plastic bags are used in the packaging of your machine and drum unit. To avoid the danger of suffocation, keep these bags away from babies and children.

! CAUTION

Lightning and power surges can damage this product! We recommend that you use a quality surge protection device on the AC power line or unplug the cords during a lightning storm.

**Note**

The fuser unit is marked with a Caution label. Please DO NOT remove or damage the label.

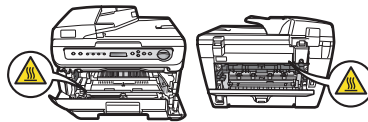
**! WARNING****IMPORTANT SAFETY INSTRUCTIONS**

When using your equipment, basic safety precautions should always be followed to reduce the risk of fire, electric shock and injury to people, including the following:

- 1 DO NOT use this product near water, for example, near a bath tub, wash bowl, kitchen sink, washing machine, or in a wet basement or near a swimming pool.
- 2 Avoid using this product during an electrical storm. There may be a remote risk of electric shock from lightning.
- 3 DO NOT use this product to report a gas leak in the vicinity of the leak.
- 4 Use only the power cord provided with the machine.

SAVE THESE INSTRUCTIONS

Important information

Federal Communications Commission (FCC) Declaration of Conformity (USA only)

Responsible Party: Brother International Corporation
100 Somerset Corporate Boulevard
Bridgewater, NJ 08807-0911 USA
TEL: (908) 704-1700

declares, that the products

Product Name: DCP-7030 and DCP-7040

comply with Part 15 of the FCC Rules. Operation is subject to the following two conditions: (1) This device may not cause harmful interference, and (2) this device must accept any interference received, including interference that may cause undesired operation.

This equipment has been tested and found to comply with the limits for a Class B digital device, pursuant to Part 15 of the FCC Rules. These limits are designed to provide reasonable protection against harmful interference in a residential installation. This equipment generates, uses, and can radiate radio frequency

and, if not installed and used in accordance with the instructions, may cause harmful interference to radio communications. However, there is no guarantee that interference will not occur in a particular installation. If this equipment does cause harmful interference to radio or television reception, which can be determined by turning the equipment off and on, the user is encouraged to try to correct the interference by one or more of the following measures:

- Reorient or relocate the receiving antenna.
- Increase the separation between the equipment and receiver.
- Connect the equipment into an outlet on a circuit different from that to which the receiver is connected.
- Call the dealer or an experienced radio/TV technician for help.

Important

Changes or modifications not expressly approved by Brother Industries, Ltd. could void the user's authority to operate the equipment.

Important—about the interface cable

A shielded interface cable should be used to ensure compliance with the limits for a Class B digital device.

Industry Canada Compliance Statement (Canada only)

This Class B digital apparatus complies with Canadian ICES-003.

Cet appareil numérique de la classe B est conforme à la norme NMB-003 du Canada.

Disconnect device

This product must be installed near an AC power outlet that is easily accessible. In case of emergencies, you must disconnect the power cord from the AC power outlet to shut off power completely.

International ENERGY STAR® Compliance Statement

The purpose of the International ENERGY STAR® Program is to promote the development and popularization of energy-efficient office equipment.

As an ENERGY STAR® Partner, Brother Industries, Ltd. has determined that this product meets the ENERGY STAR® guidelines for energy efficiency.



Laser safety

This equipment is certified as a Class 1 laser product as defined in IEC 60825-1+A2: 2001 under the U.S. Department of Health and Human Services (DHHS) Radiation Performance Standard according to the Radiation Control for Health and Safety Act of 1968. This means that the equipment does not produce hazardous laser radiation.

Since radiation emitted inside the equipment is completely confined within protective housings and external covers, the laser beam cannot escape from the machine during any phase of user operation.

FDA regulations

U.S. Food and Drug Administration (FDA) has implemented regulations for laser products manufactured on and after August 2, 1976. Compliance is mandatory for products marketed in the United States. One of the following labels on the back of the machine indicates compliance with the FDA regulations and must be attached to laser products marketed in the United States.

Manufactured:

Brother Industries (Vietnam) Ltd.

Phuc Dien Industrial Zone Cam Phuc Commune, Cam giang Dist Hai Duong Province, Vietnam.

This product complies with FDA performance standards for laser products except for deviations pursuant to Laser Notice No. 50, dated June 24, 2007.

Manufactured:

BROTHER TECHNOLOGY (SHENZHEN) LTD.

NO6 Gold Garden Ind., Nanling Buji, Longgang, Shenzhen, China

This product complies with FDA performance standards for laser products except for deviations pursuant to Laser Notice No. 50, dated June 24, 2007.



WARNING

Use of controls, adjustments or performance of procedures other than those specified in this manual may result in hazardous invisible radiation exposure.

Internal laser radiation

Max. Radiation Power: 10 mW

Wave Length: 780 – 800 nm

Laser Class: Class 3B

Important safety instructions

- 1 Read all of these instructions.
- 2 Save them for later reference.
- 3 Follow all warnings and instructions marked on the product.
- 4 Unplug this product from the wall outlet before cleaning inside of the machine. DO NOT use liquid or aerosol cleaners. Use a damp cloth for cleaning.
- 5 DO NOT place this product on an unstable cart, stand, or table. The product may fall, causing serious damage to the product.
- 6 Slots and openings in the cabinet at the back or bottom are provided for ventilation. To ensure reliable operation of the product and to protect it from overheating, these openings must not be blocked or covered. The openings should never be blocked by placing the product on a bed, sofa, rug, or other similar surface. This product should never be placed near or over a radiator or heater. This product should never be placed in a built-in installation unless proper ventilation is provided.
- 7 This product should be connected to an AC power source within the range indicated on the rating label. DO NOT connect it to a DC power source or inverter. If you are not sure, contact a qualified electrician.

- 8 This product is equipped with a 3-wire grounded plug. This plug will only fit into a grounded power outlet. This is a safety feature. If you are unable to insert the plug into the outlet, call your electrician to replace your obsolete outlet. DO NOT defeat the purpose of the grounded plug.
- 9 Use only the power cord supplied with this machine.
- 10 DO NOT allow anything to rest on the power cord. DO NOT place this product where people can walk on the cord.
- 11 If an extension cord is used with this product, make sure that the total ampere ratings on the products plugged into the extension cord DO NOT exceed the extension cord ampere rating. Also, make sure that the total of all products plugged into the AC power outlet does not exceed 15 amperes (US only).
- 12 The power cord, including extensions, should be no longer than 16.5 feet (5 meters).
DO NOT share the same power circuit with other high powered appliances such as an air conditioner, copier, shredder, and so on. If you cannot avoid using the printer with these appliances, we recommend that you use a voltage transformer or a high-frequency noise filter.
Use a voltage regulator if the power source is not stable.
- 13 DO NOT place anything in front of the machine that will block printed pages. DO NOT place anything in the path of printed pages.
- 14 Wait until pages have exited the machine before picking them up.
- 15 Never push objects of any kind into this product through cabinet slots, since they may touch dangerous voltage points or short out parts resulting in the risk of fire or electric shock. Never spill liquid of any kind on the product. DO NOT attempt to service this product yourself because opening or removing covers may expose you to dangerous voltage points and other risks and may void your warranty. Refer all servicing to a Brother Authorized Service Center. For the location of your nearest Brother Authorized Service Center, please call:
In USA: 1-877-BROTHER (1-877-276-8437)
In Canada: 1-877-BROTHER
- 16 Unplug this product from the AC power outlet and refer all servicing to Brother Authorized Service Personnel under the following conditions:
 - When the power cord is damaged or frayed.
 - If liquid has been spilled into the product.
 - If the product has been exposed to rain or water.
 - If the product does not operate normally when the operating instructions are followed. Adjust only those controls that are covered by the operating instructions. Improper adjustment of other controls may result in damage and will often require extensive work by a qualified technician to restore the product to normal operation.
 - If the product has been dropped or the cabinet has been damaged.
 - If the product exhibits a distinct change in performance, indicating a need for service.
- 17 To protect your product against power surges, we recommend the use of a power protection device (Surge Protector).

18 To reduce the risk of fire, electric shock and injury to people, note the following:

- DO NOT use this product near appliances that use water, a swimming pool or in a wet basement.
- DO NOT use the machine during an electrical storm (there is the remote possibility of an electrical shock).

Trademarks

The Brother logo is a registered trademark of Brother Industries, Ltd.

Brother is a registered trademark of Brother Industries, Ltd.

Multi-Function Link is a registered trademark of Brother International Corporation.

Windows Vista is either a registered trademark or a trademark of Microsoft Corporation in the United States and other countries.

Microsoft, Windows and Windows Server are registered trademarks of Microsoft Corporation in the United States and/or other countries.

Macintosh and TrueType are registered trademarks of Apple Inc.

Nuance, the Nuance logo, PaperPort and ScanSoft are trademarks or registered trademarks of Nuance Communications, Inc. or its affiliates in the United States and/or other countries.

Presto! PageManager is a registered trademark of NewSoft Technology Corporation.

Java and all Java-based trademarks and logos are trademarks or registered trademarks of Sun Microsystems, Inc. in the United States and other countries.

Each company whose software title is mentioned in this manual has a Software License Agreement specific to its proprietary programs.

All other brand and product names mentioned in this User's Guide are registered trademarks of their respective companies.

B

Troubleshooting and routine maintenance

Troubleshooting

IMPORTANT

For technical help, you must call the country where you bought the machine. Calls must be made **from within** that country.

If you are having difficulty with your machine

If you think there is a problem, check the chart below and follow the troubleshooting tips. You can solve most problems by yourself.

If you need additional help, the Brother Solutions Center offers the latest FAQs and troubleshooting tips.

Visit us at <http://solutions.brother.com/>.

Copy quality difficulties

Difficulties	Suggestions
Vertical black line appears in copies.	Black vertical lines on copies are typically caused by dirt or correction fluid on the glass strip (DCP-7040 only) , or the corona wire for printing is dirty. (See <i>Cleaning the scanner glass</i> on page 63 and <i>Cleaning the corona wire</i> on page 66.)

Printing difficulties

Difficulties	Suggestions
No printout.	<ul style="list-style-type: none"> ■ Check that the machine is plugged in and the power switch is turned on. ■ Check that the toner cartridge and drum unit are installed properly. (See <i>Replacing the drum unit</i> on page 74.) ■ Check the interface cable connection on both the machine and your computer. (See <i>the Quick Setup Guide</i>.) ■ Check that the correct printer driver has been installed and chosen. ■ Check to see if the LCD is showing an error message. (See <i>Error and maintenance messages</i> on page 55.) ■ Check that machine is online: (For Windows Vista®) Click the Start button, Control Panel, Hardware and Sound, and then Printers. Right-click Brother DCP-XXXX Printer. Make sure that Use Printer Offline is unchecked. (For Windows® XP and Windows Server® 2003) Click the Start button and choose Printers. Right-click Brother DCP-XXXX Printer. Make sure that Use Printer Offline is unchecked. (For Windows® 2000) Click the Start button and choose Settings and then Printers. Right-click Brother DCP-XXXX Printer. Make sure that Use Printer Offline is unchecked.
The machine prints unexpectedly or it prints garbage.	<ul style="list-style-type: none"> ■ Pull out the paper tray and wait until the machine stops printing. Then turn off the machine's power switch and disconnect from the power for several minutes. ■ Check the settings in your application to make sure it is set up to work with your machine.
The machine prints the first couple of pages correctly, then some pages have text missing.	<ul style="list-style-type: none"> ■ Check the settings in your application to make sure that it is set up to work with your machine. ■ Your computer is not recognizing the machine's input buffer's full signal. Make sure that you connected the interface cable correctly. (See <i>the Quick Setup Guide</i>.)
The headers or footers appear when the document displays on the screen but they do not show up when it is printed.	There is an unprintable area on the top and bottom of the page. Adjust the top and bottom margins in your document to allow for this.

Scanning difficulties

Difficulties	Suggestions
TWAIN errors appear while scanning.	Make sure that the Brother TWAIN driver is chosen as the primary source. In PaperPort™ 11SE, click File, Scan or Get Photo and choose the Brother TWAIN driver .
OCR does not work	Try increasing the scanning resolution.

Software difficulties

Difficulties	Suggestions
Cannot install software or print.	Run the Repair MFL-Pro Suite program on the CD-ROM. This program will repair and reinstall the software.
Cannot perform '2 in 1' or '4 in 1' printing.	Check that the paper size setting in the application and in the printer driver are the same.
The machine does not print from Adobe Illustrator.	Try to reduce the print resolution. (See <i>Advanced tab in the Software User's Guide on the CD-ROM.</i>)





Paper handling difficulties

Difficulties	Suggestions
The machine does not load paper. The LCD shows No Paper or a Paper Jam message.	<ul style="list-style-type: none"> ■ If there is no paper, load a new stack of paper into the paper tray. ■ If there is paper in the paper tray, make sure it is straight. If the paper is curled, you should straighten it. Sometimes it is helpful to remove the paper, turn the stack over and put it back into the paper tray. ■ Reduce the amount of paper in the paper tray, and then try again. ■ If the LCD shows Paper Jam message and you still have a problem, see <i>Paper jams</i> on page 58.
How do I print on envelopes?	You can load envelopes from the manual feed slot. Your application must be set up to print the envelope size you are using. This is usually done in the Page Setup or Document Setup menu of your application. (See your application's manual for more information.)
Which paper can I use?	You can use plain paper, recycled paper, transparency and labels that are made for laser machines. (For details, see <i>Acceptable paper and other print media</i> on page 12.)
There is a paper jam.	(See <i>Paper jams</i> on page 58.)

Print quality difficulties

Difficulties	Suggestions
Printed pages are curled.	<ul style="list-style-type: none"> ■ Low quality thin or thick paper or not printing on the recommended side of the paper could cause this problem. Try turning over the stack of paper in the paper tray. ■ Make sure that you choose the Paper Type that suits the print media type you are using. (See <i>Acceptable paper and other print media</i> on page 12.)
Printed pages are smeared.	The Paper Type setting may be incorrect for the type of print media you are using, or the print media may be too thick or have a rough surface. (See <i>Acceptable paper and other print media</i> on page 12 and <i>Basic tab in the Software User's Guide on the CD-ROM.</i>)
Printouts are too light.	<ul style="list-style-type: none"> ■ If this problem occurs when making copies or printing, turn Toner Save mode to off in the machine menu settings. (See <i>Toner save</i> on page 20.) ■ Set Toner Save mode to off in the Advanced tab in the printer driver. (See <i>Advanced tab in the Software User's Guide on the CD-ROM.</i>)

Improving the print quality

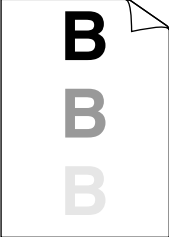
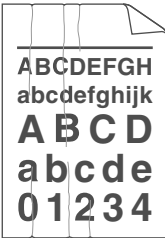
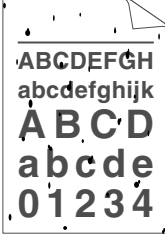

Examples of poor print quality	Recommendation
 <p>White lines across the page</p>	<ul style="list-style-type: none"> ■ Make sure that you use paper that meets our specifications. A rough surfaced paper or thick print media can cause the problem. (See <i>Acceptable paper and other print media</i> on page 12.) ■ Make sure that you choose the appropriate media type in the printer driver or in the machine's Paper Type menu setting. (See <i>Acceptable paper and other print media</i> on page 12 and <i>Basic tab in the Software User's Guide on the CD-ROM</i>.) ■ The problem may disappear by itself. Print multiple pages to clear this problem, especially if the machine has not been used for a long time. ■ The drum unit may be damaged. Put in a new drum unit. (See <i>Replacing the drum unit</i> on page 74.)
 <p>White lines down the page</p>	<ul style="list-style-type: none"> ■ Wipe the laser scanner windows with a soft cloth. (See <i>Cleaning the laser scanner window</i> on page 64.) ■ Make sure that a torn sheet of paper is not inside the machine covering the scanner window. ■ The toner cartridge may be damaged. Put in a new toner cartridge. (See <i>Replacing a toner cartridge</i> on page 70.) ■ The drum unit may be damaged. Put in a new drum unit. (See <i>Replacing the drum unit</i> on page 74.)
 <p>Hollow print</p>	<ul style="list-style-type: none"> ■ Make sure that you use paper that meets our specifications. (See <i>Acceptable paper and other print media</i> on page 12.) ■ Choose Thick paper mode in the printer driver, choose Thick in the machine's Paper Type menu setting or use thinner paper than you are currently using. (See <i>Paper type</i> on page 19 and <i>Basic tab in the Software User's Guide on the CD-ROM</i>.) ■ Check the machine's environment. Conditions such as high humidity can cause hollow print. (See <i>Choosing a location</i> on page 36.) ■ The drum unit may be damaged. Put in a new drum unit. (See <i>Replacing the drum unit</i> on page 74.)
 <p>Gray background</p>	<ul style="list-style-type: none"> ■ Make sure that you use paper that meets our specifications. (See <i>Acceptable paper and other print media</i> on page 12.) ■ Check the machine's environment. Conditions such as high temperatures and high humidity can increase the amount of background shading. (See <i>Choosing a location</i> on page 36.) ■ The toner cartridge may be damaged. Put in a new toner cartridge. (See <i>Replacing a toner cartridge</i> on page 70.) ■ The drum unit may be damaged. Put in a new drum unit. (See <i>Replacing the drum unit</i> on page 74.)

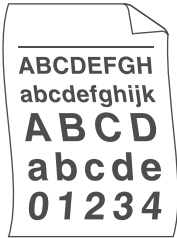
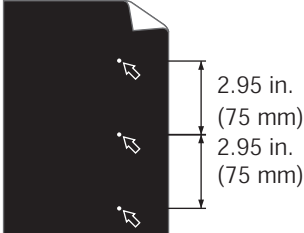
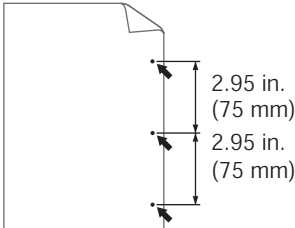
Examples of poor print quality	Recommendation
 <p data-bbox="203 585 353 610">Page skewed</p>	<ul style="list-style-type: none"> <li data-bbox="477 295 1221 378">■ Make sure that the paper or other print media is loaded properly in the paper tray and that the guides are not too tight or too loose against the paper stack. <li data-bbox="477 394 1221 450">■ Set the paper guides correctly. (See <i>Loading paper in the paper tray</i> on page 7.) <li data-bbox="477 465 827 490">■ The paper tray may be too full. <li data-bbox="477 506 1167 562">■ If you are using the manual feed slot, see <i>Loading paper in the manual feed slot</i> on page 8. <li data-bbox="477 577 1221 633">■ Check the paper type and quality. (See <i>Acceptable paper and other print media</i> on page 12.)
 <p data-bbox="244 948 316 973">Ghost</p>	<ul style="list-style-type: none"> <li data-bbox="477 649 1221 736">■ Make sure that you use paper that meets our specifications. Rough-surfaced paper or thick paper may cause the problem. (See <i>Acceptable paper and other print media</i> on page 12.) <li data-bbox="477 751 1221 861">■ Make sure that you choose the proper media type in the printer driver or in the machine's Paper Type menu setting. (See <i>Acceptable paper and other print media</i> on page 12 and <i>Basic tab in the Software User's Guide on the CD-ROM</i>.) <li data-bbox="477 877 1157 933">■ The drum unit may be damaged. Put in a new drum unit. (See <i>Replacing the drum unit</i> on page 74.) <li data-bbox="477 948 1221 973">■ The fuser unit may be contaminated. Call Brother Customer Service.
 <p data-bbox="166 1286 391 1311">Wrinkles or creases</p>	<ul style="list-style-type: none"> <li data-bbox="477 991 1221 1047">■ Check the paper type and quality. (See <i>Acceptable paper and other print media</i> on page 12.) <li data-bbox="477 1062 1215 1118">■ Make sure that paper is loaded properly. (See <i>Loading paper in the paper tray</i> on page 7.) <li data-bbox="477 1134 1221 1190">■ Turn over the stack of paper in the tray or rotate the paper 180° in the input tray.
 <p data-bbox="216 1619 343 1644">Poor fixing</p>	<ul style="list-style-type: none"> <li data-bbox="477 1325 1221 1416">■ Choose Improve Toner Fixing mode in the printer driver. (See <i>Device Options (For Windows®)</i> or <i>Print Settings (For Macintosh®)</i> in the software <i>User's Guide on the CD-ROM</i>.) <p data-bbox="502 1431 1177 1487">If you print only a few pages, change the printer driver setting in Media Type to a thin setting.</p>

Examples of poor print quality	Recommendation
 <p data-bbox="220 581 395 610">Curled or wavy</p>	<ul style="list-style-type: none"> ■ Check the paper type and quality. High temperatures and high humidity will cause paper to curl. ■ If you do not use the machine often, the paper may have been in the paper tray too long. Turn over the stack of paper in the paper tray. Also, fan the paper stack and then rotate the paper 180° in the paper tray.
 <p data-bbox="161 917 452 1000">White Spots on black text and graphics at 2.95 in. (75 mm) intervals</p>  <p data-bbox="182 1304 433 1358">Black Spots at 2.95 in. (75 mm) intervals</p>	<ul style="list-style-type: none"> ■ Make ten copies of a blank, white sheet of paper. (See <i>Making multiple copies</i> on page 24.) If the problem is not solved, the drum unit may have glue from a label stuck on the OPC drum surface. Clean the drum unit. (See <i>Cleaning the drum unit</i> on page 68.) ■ The drum unit may be damaged. Put in a new drum. (See <i>Replacing the drum unit</i> on page 74.)

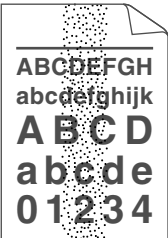
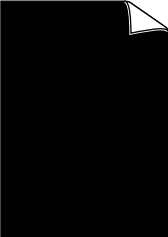
B

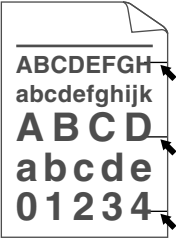
Examples of poor print quality	Recommendation
 <p>ABCDEF GH abcde fghijk A B C D a b c d e 0 1 2 3 4</p> <p>Faint</p>	<ul style="list-style-type: none"> ■ Check the machine's environment. Conditions such as humidity, high temperatures, and so on, may cause this print fault. (See <i>Choosing a location</i> on page 36.) ■ If the whole page is too light, Toner Save mode may be on. Turn off Toner Save mode in the machine menu settings or Toner Save mode in the printer Properties of the driver. (See <i>Toner save</i> on page 20 or <i>Advanced tab in the Software User's Guide on the CD-ROM</i>.) ■ Clean the scanner window and the primary corona wire of the drum unit. (See <i>Cleaning the laser scanner window</i> on page 64 and <i>Cleaning the corona wire</i> on page 66.) ■ The toner cartridge may be damaged. Put in a new toner cartridge. (See <i>Replacing a toner cartridge</i> on page 70.) ■ The drum unit may be damaged. Put in a new drum unit. (See <i>Replacing the drum unit</i> on page 74.)
 <p>ABCDEF GH abcde fghijk A B C D a b c d e 0 1 2 3 4</p> <p>Toner specks</p>	<ul style="list-style-type: none"> ■ Make sure that you use paper that meets our specifications. Rough-surfaced paper may cause the problem. (See <i>Acceptable paper and other print media</i> on page 12.) ■ Clean the primary corona wire and the drum unit. (See <i>Cleaning the corona wire</i> on page 66 and <i>Cleaning the drum unit</i> on page 68.) ■ The drum unit may be damaged. Put in a new drum unit. (See <i>Replacing the drum unit</i> on page 74.) ■ The fuser unit may be contaminated. Call Brother Customer Service.
 <p>All black</p>	<ul style="list-style-type: none"> ■ Clean the primary corona wire inside the drum unit by sliding the green tab. Be sure to return the green tab to the home position (▲). (See <i>Cleaning the corona wire</i> on page 66.) ■ The drum unit may be damaged. Put in a new drum unit. (See <i>Replacing the drum unit</i> on page 74.) ■ The fuser unit may be contaminated. Call Brother Customer Service.

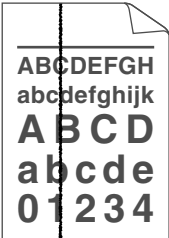
Examples of poor print quality	Recommendation
 <p>Black toner marks across the page</p>	<ul style="list-style-type: none"> ■ Make sure that you use paper that meets our specifications. (See <i>Acceptable paper and other print media</i> on page 12.) ■ If you use label sheets for laser machines, the glue from the sheets may sometimes stick to the OPC drum surface. Clean the drum unit. (See <i>Cleaning the drum unit</i> on page 68.) ■ Do not use paper that has clips or staples because they will scratch the surface of the drum. ■ If the unpacked drum unit is in direct sunlight or room light, the unit may be damaged. ■ The toner cartridge may be damaged. Put in a new toner cartridge. (See <i>Replacing a toner cartridge</i> on page 70.) ■ The drum unit may be damaged. Put in a new drum unit. (See <i>Replacing the drum unit</i> on page 74.)
 <p>Line across the page</p>	<ul style="list-style-type: none"> ■ Clean the laser scanner window and the primary corona wire inside the drum unit. (See <i>Cleaning the laser scanner window</i> on page 64 and <i>Cleaning the corona wire</i> on page 66.) ■ The drum unit may be damaged. Put in a new drum unit. (See <i>Replacing the drum unit</i> on page 74.)
 <p>Black lines down the page Printed pages have toner stains down the page</p>	<ul style="list-style-type: none"> ■ Clean the primary corona wire inside the drum unit by sliding the green tab. Be sure to return the green tab to the home position (▲). (See <i>Cleaning the corona wire</i> on page 66.) ■ The toner cartridge may be damaged. Put in a new toner cartridge. (See <i>Replacing a toner cartridge</i> on page 70.) ■ The drum unit may be damaged. Put in a new drum unit. (See <i>Replacing the drum unit</i> on page 74.) ■ The fuser unit may be smudged. Call Brother Customer Service at 1-877-BROTHER (1-877-276-8437) (in USA) or 1-877-BROTHER (in Canada).

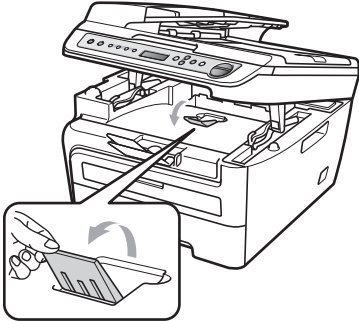
Examples of poor print quality	Recommendation
 <p data-bbox="241 595 319 620">Curled</p>	<ul style="list-style-type: none"> <li data-bbox="477 291 1218 413">■ Choose Reduce Paper Curl mode in the printer driver when you do not use our recommended paper. (See <i>Device Options (For Windows®)</i> or <i>Print Settings (For Macintosh®)</i> in the <i>Software User's Guide on the CD-ROM.</i>) <li data-bbox="477 430 1188 484">■ Turn the paper over in the paper tray, and print again. (Excluding Letterhead paper) <li data-bbox="477 500 865 527">■ Lift up the output tray support flap.  <ul style="list-style-type: none"> <li data-bbox="477 919 1218 973">■ Replace the paper in the paper tray with paper from a freshly opened ream. <li data-bbox="477 991 1222 1045">■ Make sure you are using paper that is recommended for your machine. (See <i>Acceptable paper and other print media</i> on page 12.)

Error and maintenance messages

As with any sophisticated office product, errors may occur and consumable items may need to be replaced. If this happens, your machine identifies the error or required routine maintenance and shows the appropriate message. The most common error and maintenance messages are shown below.

You can correct most errors and routine maintenance by yourself. If you need more help, the Brother Solutions Center offers the latest FAQs and troubleshooting tips.

Visit us at <http://solutions.brother.com/>.

Error Message	Cause	Action
Cartridge Error	The toner cartridge is not installed properly.	Pull out the drum unit, take out the toner cartridge that is indicated on the LCD, and put it back into the drum unit again.
Drum End Soon	The drum unit is near the end of its life.	Use the drum unit until you have a print quality problem; then replace the drum unit with a new one. <i>(See Replacing the drum unit on page 74.)</i>
Cooling Down Wait for a while	The temperature of the drum unit or toner cartridge is too hot. The machine will pause its current print job and go into cooling down mode. During the cooling down mode, you will hear the cooling fan running while the LCD shows <i>Cooling Down, and Wait for a while.</i>	Make sure that you can hear the fan in the machine spinning and that the exhaust outlet is not blocked by something. If the fan is spinning, remove any obstacles that surround the exhaust outlet, and then leave the machine turned on but do not use it for several minutes. If the fan is not spinning do the following: Disconnect the machine from the power for several minutes and then reconnect it.
Cover is Open	The front cover is not closed completely.	Close the front cover of the machine.
Cover is Open	The fuser cover is not closed completely.	Close the fuser cover of the machine.
Cover is Open	The fuser cover is not closed completely or paper was jammed in the back of the machine when you turned on the power.	Make sure paper is not jammed inside the back of the machine, and then close the fuser cover and press Start .
Document Jam (DCP-7040 only)	The document was not inserted or fed properly, or the document scanned from the ADF was too long.	See <i>Document jams (DCP-7040 only)</i> on page 57 or <i>Using the automatic document feeder (ADF) (DCP-7040 only)</i> on page 17.
Drum Error	The corona wire on the drum unit needs to be cleaned.	Clean the corona wire on the drum unit. (See <i>Cleaning the corona wire</i> on page 66.)
	The drum unit has reached the end of its life.	Replace the drum unit. (See <i>Replacing the drum unit</i> on page 74.)

Error Message	Cause	Action
Fuser Error	The temperature of fuser unit does not rise at a specified temperature within specified time.	Turn the power switch off, wait a few seconds, and then turn it on again. Leave the machine for 15 minutes with the power on.
	The fuser unit is too hot.	
Init Unable XX	The machine has a mechanical problem.	Disconnect the machine from the power for several minutes and then reconnect it.
Jam Rear	The paper is jammed in the back of the machine.	(See <i>Paper jams</i> on page 58.)
Jam Inside	The paper is jammed inside the machine.	(See <i>Paper jams</i> on page 58.)
Jam Tray	The paper is jammed in the paper tray of the machine.	(See <i>Paper jams</i> on page 58.)
No Paper	The machine is out of paper or paper is not properly loaded in the paper tray.	Do one of the following: <ul style="list-style-type: none"> ■ Refill the paper in the paper tray, and then press Start. ■ Remove the paper and load it again, and then press Start.
Out of Memory	The machine's memory is full.	<p>Copy operation in progress</p> <p>Do one of the following:</p> <ul style="list-style-type: none"> ■ Press Start to copy the scanned pages. ■ Press Stop/Exit and wait until the other operations in progress finish, and then try again. ■ Clear the data from the memory. (See <i>Out of memory message</i> on page 29.) <p>Print operation in process</p> <p>Reduce print resolution. (See <i>Advanced tab in the Software User's Guide on the CD-ROM</i>.)</p>
Print Unable XX	The machine has a mechanical problem.	Disconnect the machine from the power for several minutes and then reconnect it.
Scan Unable XX	The machine has a mechanical problem.	Disconnect the machine from the power for several minutes and then reconnect it.
Toner Life End	The drum unit and toner cartridge assembly may have been installed improperly, or the toner cartridge is used up and printing is not possible.	Do one of the following: <ul style="list-style-type: none"> ■ Re-install the toner cartridge and drum unit assembly. ■ Replace the empty toner cartridge with a new one. (See <i>Replacing a toner cartridge</i> on page 70.)
Toner Low	If the LCD shows Toner Low , you can still print; however, the machine is telling you that the toner cartridge is near the end of its life and the toner will soon run out.	Order a new toner cartridge now.

Document jams (DCP-7040 only)

If the document is jammed, follow the steps below.



Note

After removing a jammed document, check that no paper scraps are left in the machine that could cause another jam.

Document is jammed in the top of the ADF unit

- 1 Take out any paper from the ADF that is not jammed.
- 2 Open the ADF cover.
- 3 Pull the jammed document out to the left.

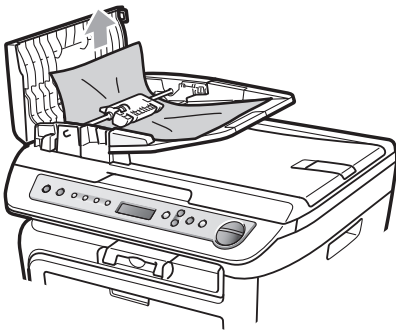

- 4 Close the ADF cover.
- 5 Press **Stop/Exit**.

Document is jammed under the document cover

- 1 Take out any paper from the ADF that is not jammed.
- 2 Lift the document cover.

- 3 Pull the jammed document out to the right.

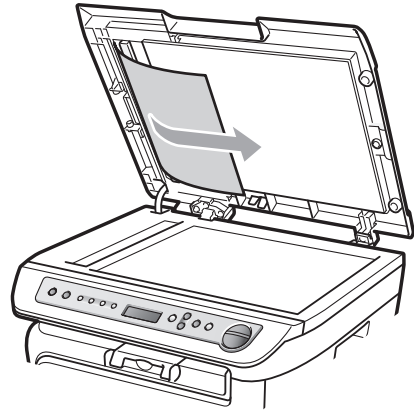

- 4 Close the document cover.
- 5 Press **Stop/Exit**.

Document is jammed at the output tray

- 1 Pull the jammed document out to the right.

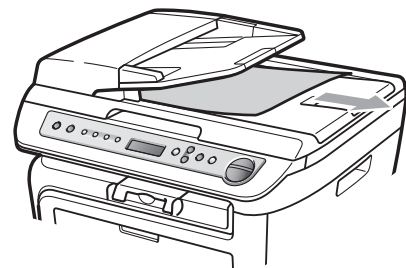

- 2 Press **Stop/Exit**.

Paper jams

To clear paper jams, please follow the steps in this section.

Note

- Please confirm that you have installed both a toner cartridge and a drum unit in the machine. If you have not installed a drum unit or have installed the drum unit improperly, then this may cause a paper jam in your Brother machine.
- If the error message remains, open and close the front cover and fuser cover firmly to reset the machine.

WARNING

HOT SURFACE

After you have just used the machine, some internal parts of the machine will be extremely hot. When you open the front or back cover (back output tray) of the machine, DO NOT touch the shaded parts shown in the illustration. If you do this, you may get burned.

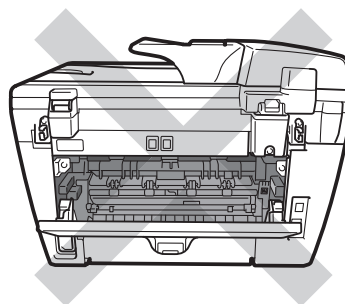
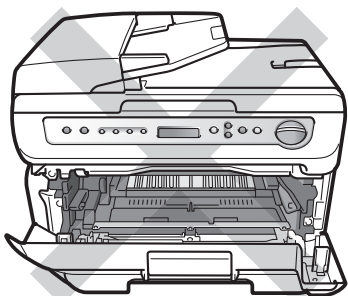

CAUTION

To prevent damage to the machine caused by static electricity, DO NOT touch the electrodes shown in the illustration.

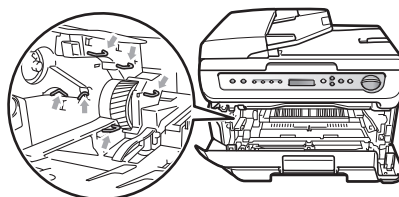

Paper is jammed inside the machine

- 1 Open the front cover.

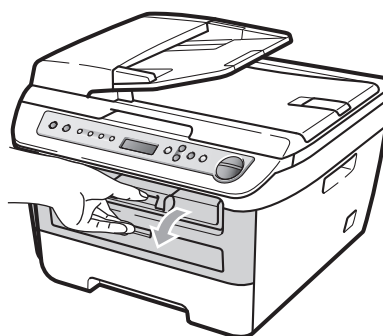

- 2 Slowly take out the drum unit and toner cartridge assembly. The jammed paper will be pulled out with the toner cartridge and drum unit assembly.

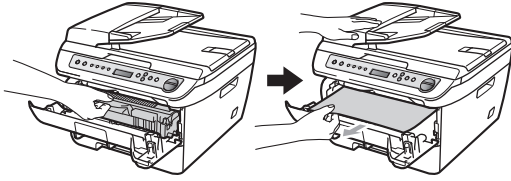

! CAUTION

We recommend that you place the drum unit and toner cartridge assembly on a clean, flat surface with a piece of disposable paper or cloth underneath it in case you accidentally spill or scatter toner.

- 3 Do one of the following:
- If you were able to remove the drum unit and toner cartridge assembly and the jammed paper, then go to step 7.
 - If you can not remove the drum unit and toner cartridge assembly easily, do not use extra force. Instead, lift the scanner cover.

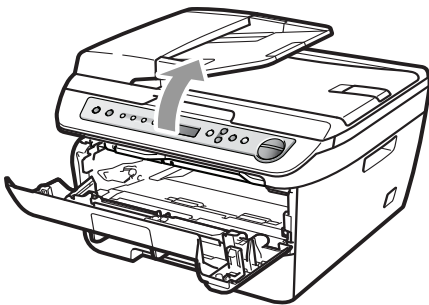

Use both hands to carefully pull the jammed paper up and out of the output tray opening.

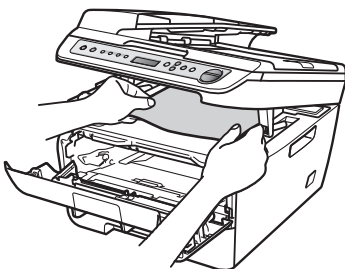

- 4 Close the scanner cover.
- 5 If you could not pull the jammed paper out of the output tray opening as shown in step 3, take the paper tray completely out of the machine.

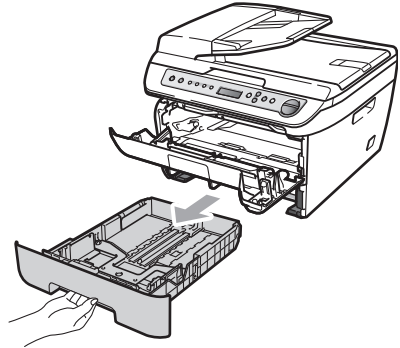

- 6 Pull the jammed paper out of the paper tray opening.

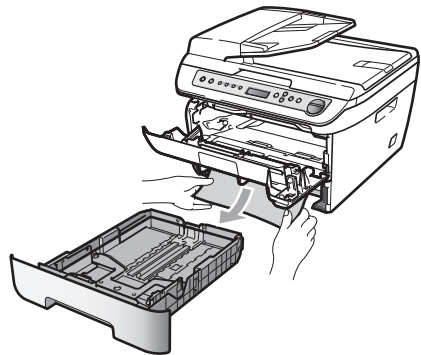

- 7 Put the drum unit and toner cartridge assembly back in the machine.

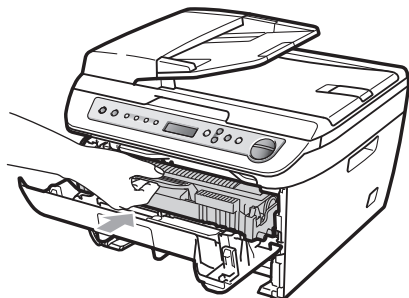

- 8 Put the paper tray back in the machine.
- 9 Close the front cover.

Paper is jammed at the back of the machine

- 1 Open the front cover.

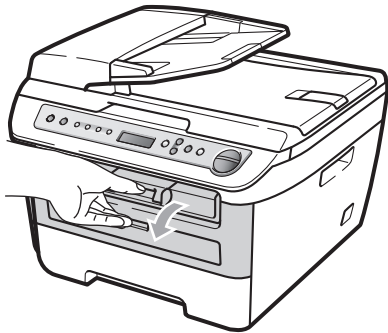

- 2 Slowly take out the drum unit and toner cartridge assembly.

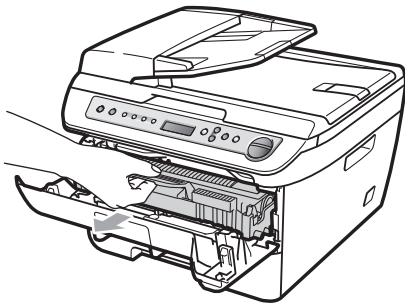

! CAUTION

We recommend that you place the drum unit and toner cartridge assembly on a clean, flat surface with a piece of disposable paper or cloth underneath it in case you accidentally spill or scatter toner.

- 3 Open the back cover (back output tray).

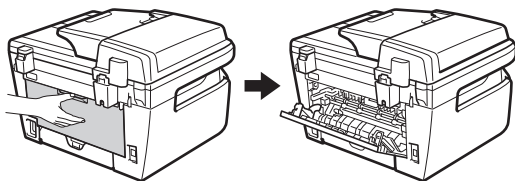

- 4 Pull the tabs (1) toward you to open the fuser cover (2).

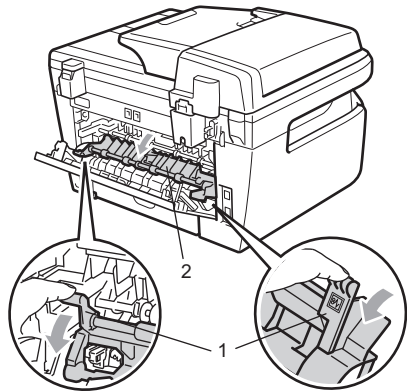

- 5 Pull the jammed paper out of the fuser unit.

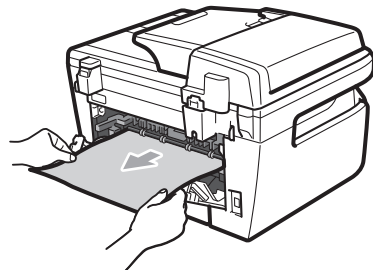

- 6 Close the back cover (back output tray).

- 7 Put the drum unit and toner cartridge assembly back in the machine.

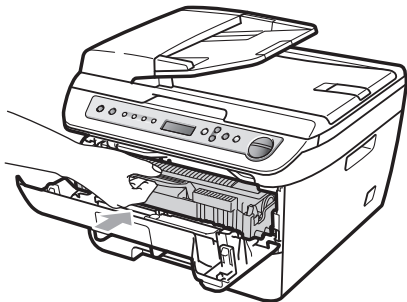

- 8 Close the front cover.

Paper is jammed inside the drum unit and toner cartridge assembly

- 1 Open the front cover.

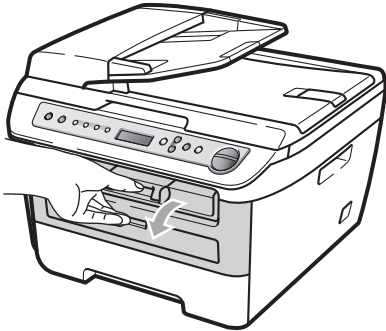

- 2 Slowly take out the drum unit and toner cartridge assembly.

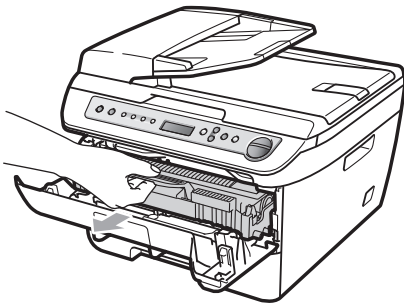

! CAUTION

We recommend that you place the drum unit and toner cartridge assembly on a clean, flat surface with a piece of disposable paper or cloth underneath it in case you accidentally spill or scatter toner.

- 3 Push down the green lock lever and take the toner cartridge out of the drum unit.

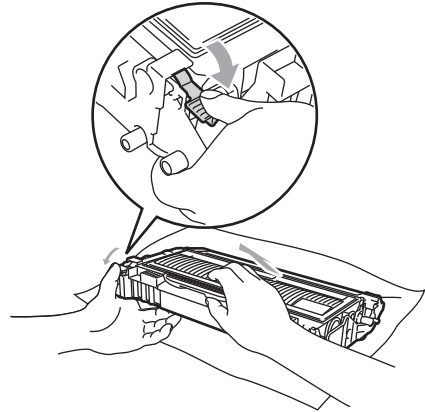

! CAUTION

Handle the toner cartridge carefully. If toner scatters on your hands or clothes, wipe or wash it off with cold water at once.

To avoid print quality problems, DO NOT touch the shaded parts shown in the illustrations below.

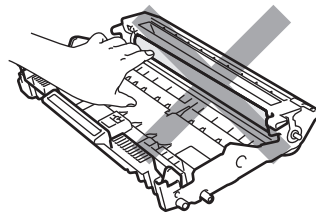
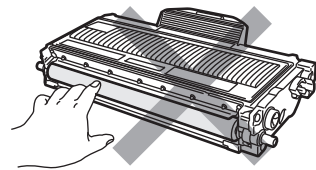

- 4 Clear the jammed paper if there is any inside the drum unit.

- Put the toner cartridge back into the drum unit until you hear it lock into place. If you put it in properly, the green lock lever will lift automatically.

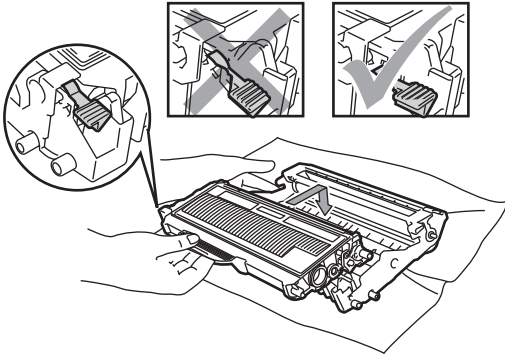

- Put the drum unit and toner cartridge assembly back in the machine.

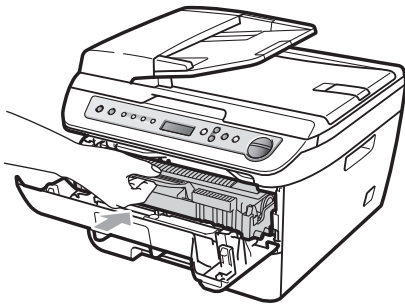

- Close the front cover.

Routine maintenance

WARNING

Use neutral detergents.

DO NOT use cleaning materials that contain ammonia, alcohol, any type of spray, or any type of flammable substance to clean the outside or inside of the machine. Doing this may cause a fire or electrical shock. For more information see *Important safety instructions* on page 42.

CAUTION

The drum unit contains toner, so handle it carefully. If toner scatters on your hands or clothes, wipe or wash it off with cold water at once.

Cleaning the outside of the machine

Clean the outside of the machine as follows:

- Turn off the machine's power switch. Disconnect all cables, and then unplug the power cord from the AC power outlet.

- 2 Pull the paper tray completely out of the machine.

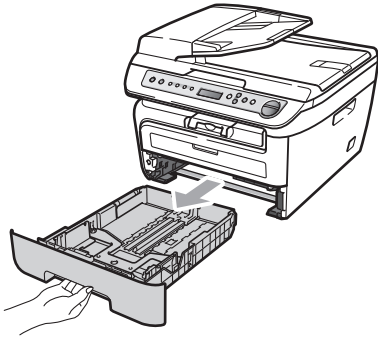

- 3 Wipe the outside of the machine with a soft cloth to remove dust.

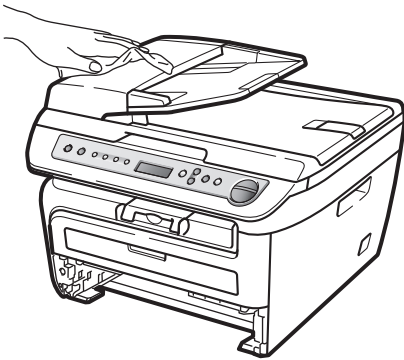

- 4 Remove anything that is stuck inside the paper tray.

- 5 Wipe the inside and the outside of the paper tray with a soft cloth to remove dust.

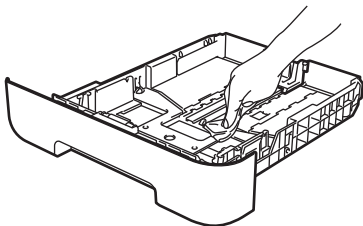

- 6 Re-load the paper and put the paper tray firmly back in the machine.

- 7 Plug the machine's power cord back into the AC power outlet first, and then reconnect all cables. Turn on the machine's power switch.

Cleaning the scanner glass

- 1 Turn off the machine's power switch. Disconnect all cables and then unplug the power cord from the AC power outlet.
- 2 Lift the document cover (1). Clean the white plastic surface (2) and scanner glass (3) underneath it with a soft lint-free cloth moistened with water.

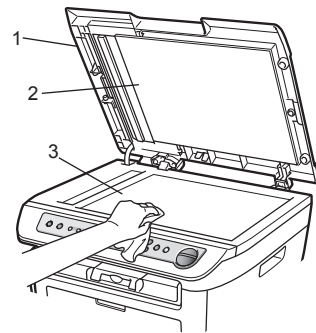

- 3 (DCP-7040 only) In the ADF unit, clean the white bar (1) and the scanner glass strip (2) underneath it with a soft lint-free cloth moistened with water.

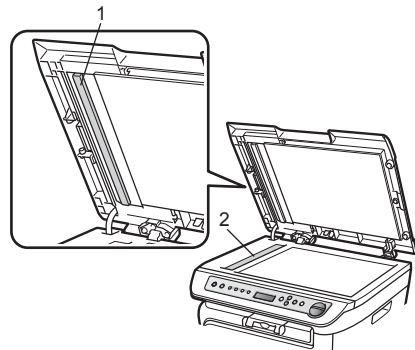

- 4 Plug the machine's power cord back into the AC power outlet first, and then reconnect all cables. Turn on the machine's power switch.

 **Note**

In addition to cleaning the scanner glass and glass strip with a soft lint-free cloth moistened with water, run your finger tip over the glass to see if you can feel anything on it. If you feel dirt or debris, clean the glass again concentrating on that area. You may need to repeat the cleaning process three or four times. To test, make a copy after each cleaning.

Cleaning the laser scanner window

 **WARNING**

DO NOT use isopropyl alcohol to clean the laser scanner window.

 **CAUTION**

DO NOT touch the laser scanner window with your fingers.

- 1 Before you clean the inside of the machine, turn off the machine's power switch. Unplug the power cord from the AC power outlet.
- 2 Open the front cover and slowly take out the drum unit and toner cartridge assembly.

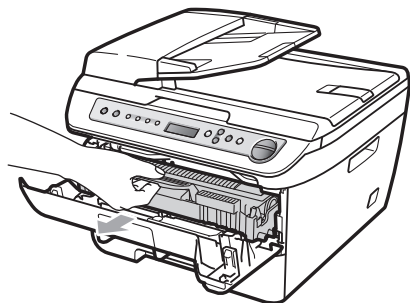
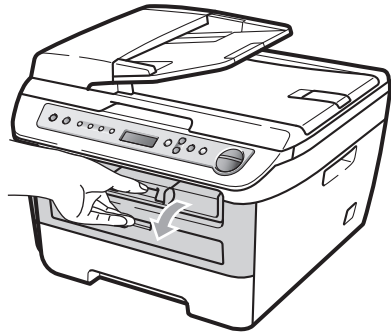

! WARNING

! HOT SURFACE

After you have just used the machine, some internal parts of the machine will be extremely hot. When you open the front or back cover (back output tray) of the machine, DO NOT touch the shaded parts shown in the illustration. If you do this, you may get burned.

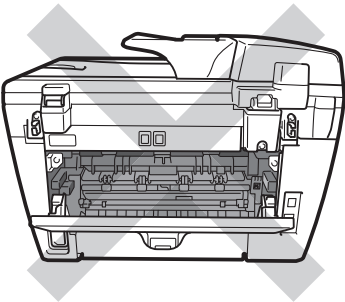
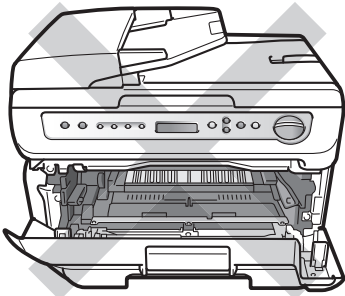

! CAUTION

To prevent damage to the machine caused by static electricity, DO NOT touch the electrodes shown in the illustration.

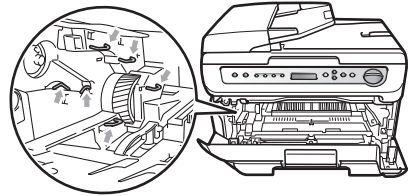

We recommend that you place the drum unit on a clean, flat surface with a piece of disposable paper or cloth underneath it in case you accidentally spill or scatter toner.

B

- 3 Wipe the laser scanner window by wiping it with a clean soft, dry lint-free cloth.

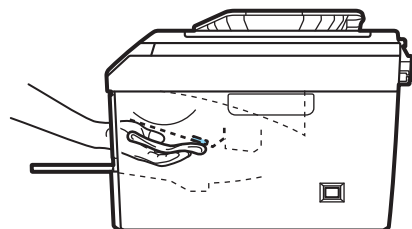
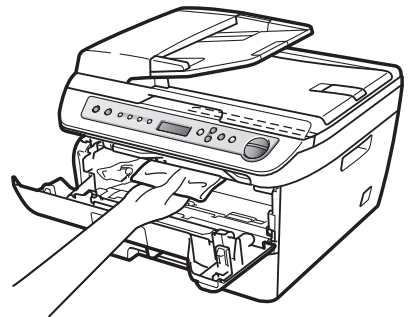

- Put the drum unit and toner cartridge assembly back in the machine.

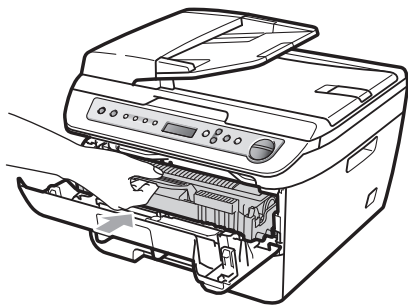

- Close the front cover.
- Plug the machine's power cord back into the AC power outlet. Turn on the machine's power switch.

Cleaning the corona wire

If you have print quality problems, clean the corona wire as follows:

- Turn off the machine's power switch. Disconnect all cables, and then unplug the power cord from the AC power outlet.
- Open the front cover.

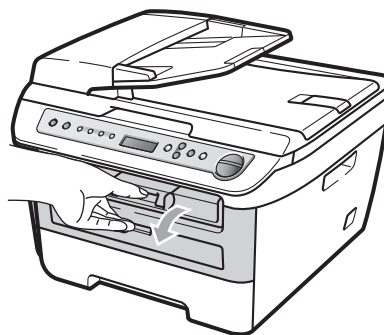

- Slowly take out the drum unit and toner cartridge assembly.

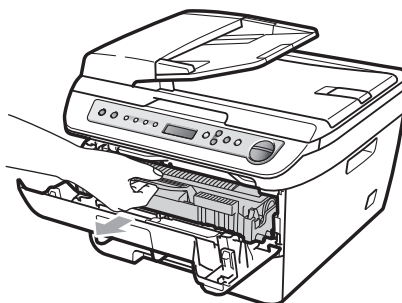

! CAUTION

We recommend that you place the drum unit and toner cartridge assembly on a clean, flat surface with a piece of disposable paper or cloth underneath it in case you accidentally spill or scatter toner.

Handle the toner cartridge carefully. If toner scatters on your hands or clothes, wipe or wash it off with cold water at once.

To prevent damage to the machine caused by static electricity, **DO NOT** touch the electrodes shown in the illustration.

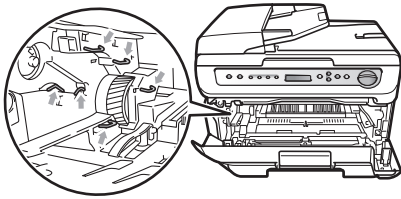

- 4 Clean the primary corona wire inside the drum unit by gently sliding the green tab from right to left and left to right several times.

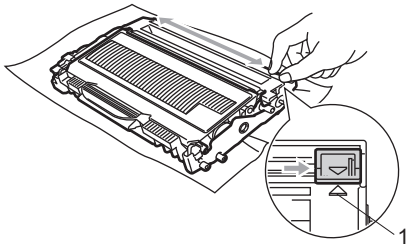

! CAUTION

Be sure to return the green tab to the home position (▲) (1). If you do not, printed pages may have a vertical stripe.

- 5 Put the drum unit and toner cartridge assembly back in the machine.
- 6 Close the front cover.

- 7 Plug the machine's power cord back into the AC power outlet first, and then reconnect all cables. Turn on the machine's power switch.

! CAUTION

To avoid print quality problems, **DO NOT** touch the shaded parts shown in the illustrations below.

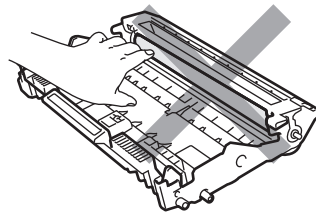
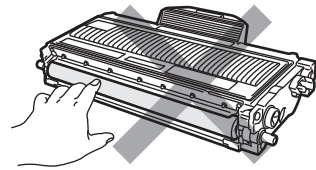

Cleaning the drum unit

If you have print quality problems, clean the drum unit as follows.

- 1 Turn off the machine's power switch. Unplug the power cord from the AC power outlet.
- 2 Open the front cover.

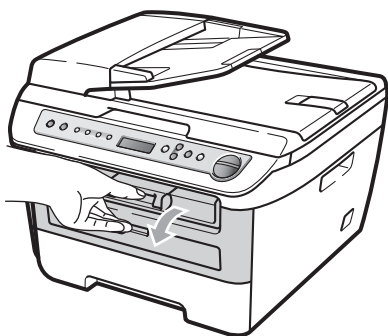

- 3 Slowly take out the drum unit and toner cartridge assembly.

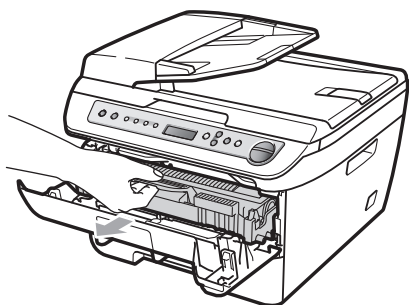

! CAUTION

We recommend that you put the drum unit and toner cartridge assembly on a clean, flat surface with a piece of disposable paper or cloth underneath it in case you accidentally spill or scatter toner.

To prevent damage to the machine caused by static electricity, DO NOT touch the electrodes shown in the illustration.

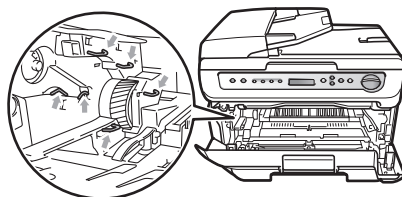

- 4 Push down the green lock lever and take the toner cartridge out of the drum unit.

! CAUTION

Handle the toner cartridge carefully. If toner scatters on your hands or clothes, wipe or wash it off with cold water at once.

To avoid print quality problems, DO NOT touch the shaded parts shown in the illustrations below.

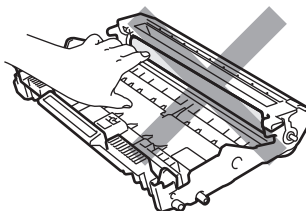
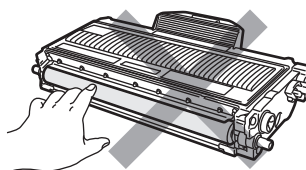

- Put the print sample in front of the drum unit, and find the exact position of the poor print.

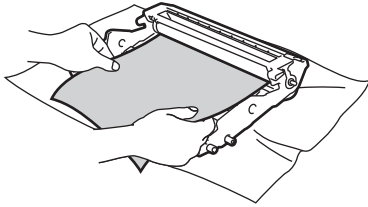

- Turn the drum unit gear by hand while looking at the surface of the OPC drum (1).

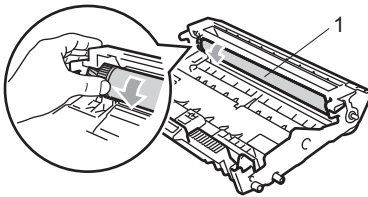

- When you have found the mark on the drum that matches the print sample, wipe the surface of the OPC drum with a dry cotton swab until the dust or glue on the surface comes off.

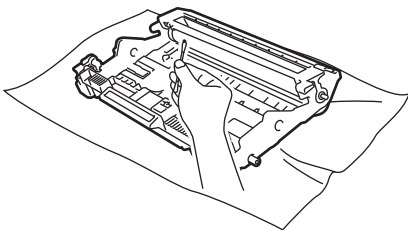

! CAUTION

The drum is photosensitive so **DO NOT** touch it with your fingers.

DO NOT clean the surface of the photosensitive drum with a sharp object.

DO NOT use a scrubbing or wiping motion because this might damage the drum.

- Put the toner cartridge back into the drum unit until you hear it lock into place. If you put the cartridge in properly, the green lock lever will lift automatically.

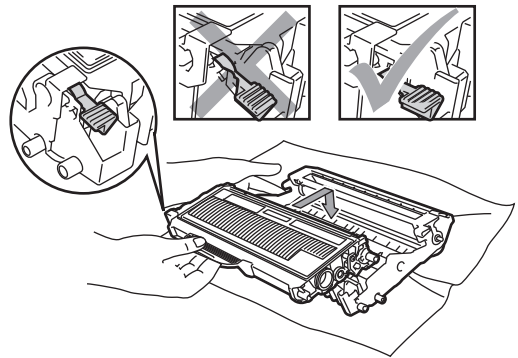

- Put the drum unit and toner cartridge assembly back in the machine.

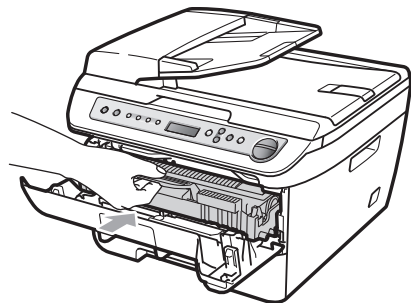

- Close the front cover.
- Plug the machine's power cord back into the AC power outlet first, and then reconnect all cables. Turn on the machine's power switch.

Replacing the consumable items

You will need to replace the consumable items when the machine indicates that the life of the consumable is over.

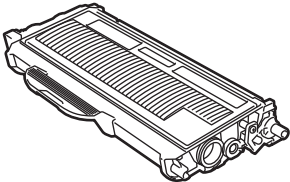
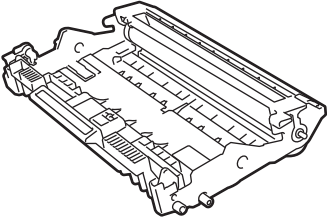
Toner cartridge	Drum unit
	
Order No. TN-330, TN-360	Order No. DR-360

Note

- Go to <http://www.brother.com/original/index.html> for instructions on how to return your used consumable items to the Brother collection program. If you choose not to return your used consumable, please discard the used consumable according to local regulations, keeping it separate from domestic waste. If you have questions, call your local waste disposal office. Be sure to reseal the consumable items tightly so that the material inside does not spill.
- We recommend placing used consumable items on a piece of paper to prevent accidentally spilling or scattering the material inside.
- If you use paper that is not a direct equivalent for the recommended paper, the life of consumable items and machine parts may be reduced.

Replacing a toner cartridge

The High Yield toner cartridges can print approximately 2,600 pages¹ and the Standard toner cartridges can print approximately 1,500 pages¹. Actual page count will vary depending on your average type of document (i.e., standard letter, detailed graphics).

The machine is supplied with the Starter toner cartridge that will need to be replaced after approximately 1,000 pages¹. When a toner cartridge is running low, the LCD shows **Toner Low**.

¹ Approx. cartridge yield is declared in accordance with ISO/IEC 19752.

Note

It is a good idea to keep a new toner cartridge ready for use when you see the **Toner Low** warning.

! WARNING

! HOT SURFACE

After you have just used the machine, some internal parts of the machine will be extremely hot. When you open the front or back cover (back output tray) of the machine, DO NOT touch the shaded parts shown in the illustration. If you do this, you may get burned.

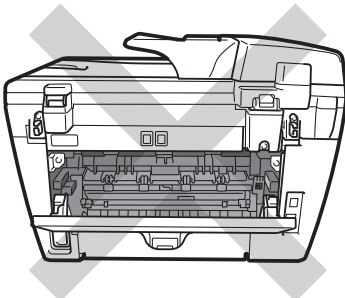
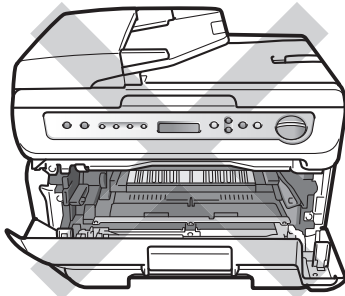

- 1 Open the front cover.

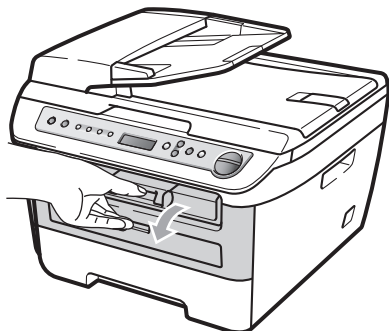

- 2 Slowly take out the drum unit and toner cartridge assembly.

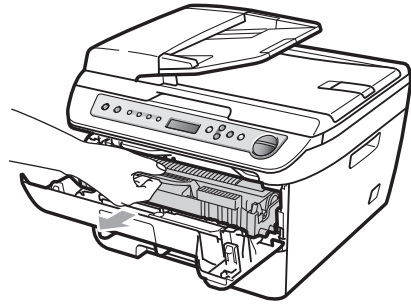

! CAUTION

We recommend that you put the drum unit and toner cartridge assembly on a clean, flat surface with a piece of disposable paper or cloth underneath it in case you accidentally spill or scatter toner.

To prevent damage to the machine caused by static electricity, DO NOT touch the electrodes shown in the illustration.

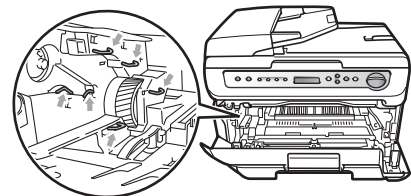

- 3 Push down the green lock lever and take the used toner cartridge out of the drum unit.

! WARNING

DO NOT put a toner cartridge into a fire. It could explode, resulting in injuries.

B

! CAUTION

Handle the toner cartridge carefully. If toner scatters on your hands or clothes, wipe or wash it off with cold water at once.

To avoid print quality problems, DO NOT touch the shaded parts shown in the illustrations.

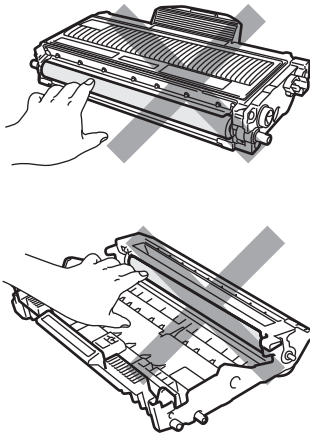

Brother strongly recommends that you DO NOT refill the toner cartridge provided with your machine. We also strongly recommend that you continue to use only Genuine Brother Brand replacement toner cartridge. Use or attempted use of potentially incompatible toner and/or cartridge in the Brother machine may cause damage to the machine and/or may result in unsatisfactory print quality. Our warranty coverage does not apply to any problem that is caused by the use of unauthorized third party toner and/or cartridge. To protect your investment and obtain premium performance from the Brother machine, we strongly recommend the use of Genuine Brother Supplies.

Wait to unpack the new toner cartridge until immediately before you put it in the machine. If a toner cartridge is left unpacked for a long time, the toner life will be shortened.

✎ Note

Be sure to seal up the used toner cartridge tightly in a suitable bag so that toner powder does not spill out of the cartridge.

4. Unpack the new toner cartridge. Hold the cartridge level with both hands and gently rock it from side to side five or six times to spread the toner evenly inside the cartridge.

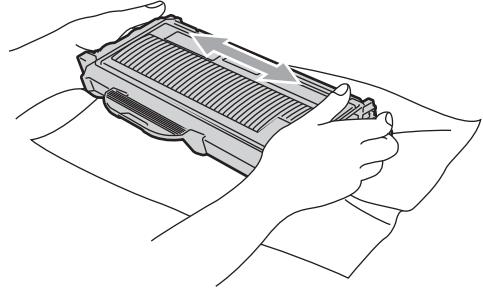

5. Pull off the protective cover.

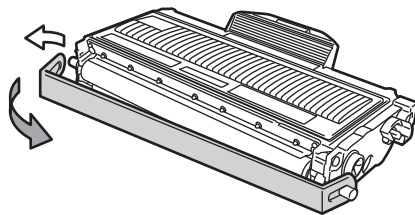

- 6 Put the new toner cartridge firmly into the drum unit until you hear it lock into place. If you put it in properly, the lock lever will lift automatically.

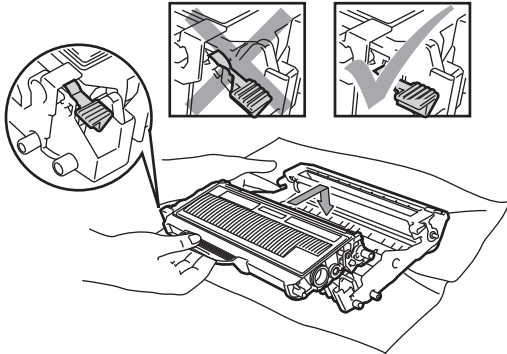

! CAUTION

Make sure that you put in the toner cartridge properly or it may separate from the drum unit.

- 7 Clean the primary corona wire of the drum unit by gently sliding the green tab from right to left and left to right several times.

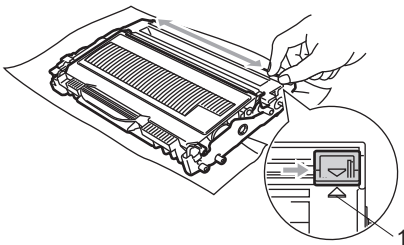

! CAUTION

Be sure to return the green tab to the home position (▲) (1). If you do not, printed pages may have a vertical stripe.

- 8 Put the drum unit and toner cartridge assembly back in the machine.

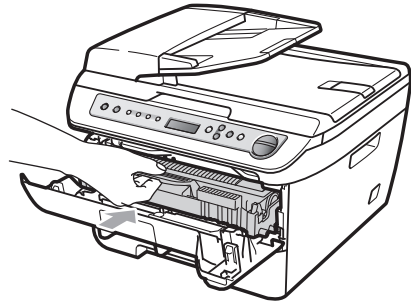

- 9 Close the front cover.

! CAUTION

DO NOT turn off the machine's power switch or open the front cover until the LCD returns to the standby state.

B

Replacing the drum unit

The machine uses a drum unit to create print images on paper. If the LCD shows *Drum End Soon*, the drum unit is near the end of its life and it is time to buy a new one. Even if the LCD shows *Drum End Soon*, you may be able to continue printing without having to replace the drum unit for a while. However, if there is a noticeable deterioration in the output print quality (even before *Drum End Soon* appears), then the drum unit should be replaced. You should clean the machine when you replace the drum unit. (See *Cleaning the laser scanner window* on page 64.)

CAUTION

While removing the drum unit, handle it carefully because it may contain toner. If toner scatters on your hands or clothes, wipe or wash it off with cold water at once.

Note

The drum unit is a consumable item, and it is necessary to replace it periodically. There are many factors that determine the actual drum life, such as temperature, humidity, type of paper and how much toner you use for the number of pages per print job. The estimated drum life is approximately 12,000 pages¹. The actual number of pages your drum will print may be significantly less than this estimate. Because we have no control over the many factors that determine the actual drum life, we cannot guarantee a minimum number of pages that will be printed by your drum.

¹ Drum yield is approximate, and may vary by type of use.

WARNING

HOT SURFACE

After you have just used the machine, some internal parts of the machine will be extremely hot. When you open the front or back cover (back output tray) of the machine, DO NOT touch the shaded parts shown in the illustration. If you do this, you may get burned.

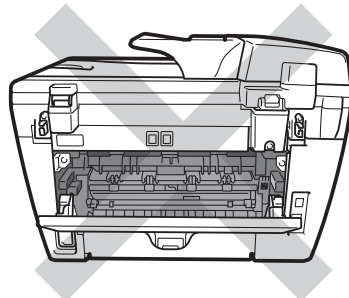
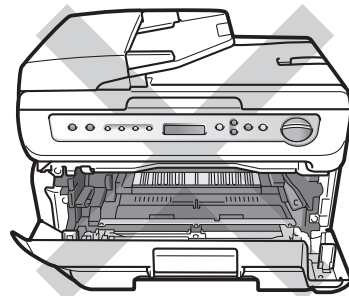

- 1 Open the front cover.

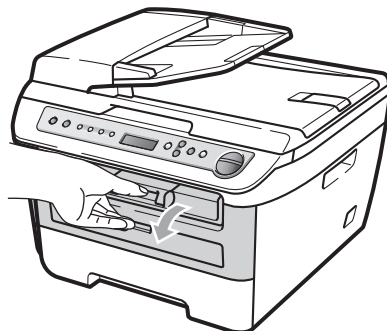

- 2 Slowly take out the drum unit and toner cartridge assembly.

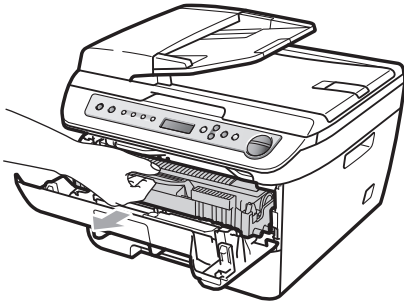

! CAUTION

We recommend that you put the drum unit and toner cartridge assembly on a clean, flat surface with a piece of disposable paper or cloth underneath it in case you accidentally spill or scatter toner.

To prevent damage to the machine caused by static electricity, DO NOT touch the electrodes shown in the illustration.

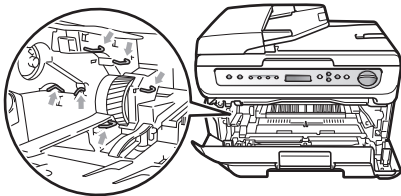

- 3 Push down the green lock lever and take the toner cartridge out of the drum unit.

! CAUTION

To avoid print quality problems, DO NOT touch the shaded parts shown in the illustrations.

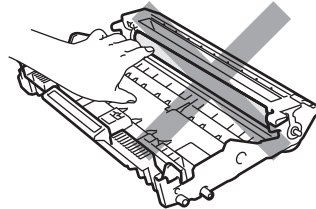
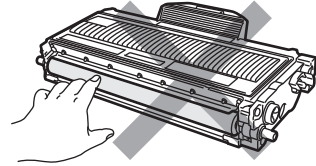

Wait to unpack a new drum unit until immediately before you put it in the machine. Exposure to direct sunlight or room light may damage the drum unit.

Note

Be sure to seal up the used drum unit tightly in a bag so that toner powder does not spill out of the unit.

- 4 Unpack the new drum unit.

- 5 Put the toner cartridge firmly into the new drum unit until you hear it lock into place. If you put the cartridge in properly, the green lock lever will lift automatically.

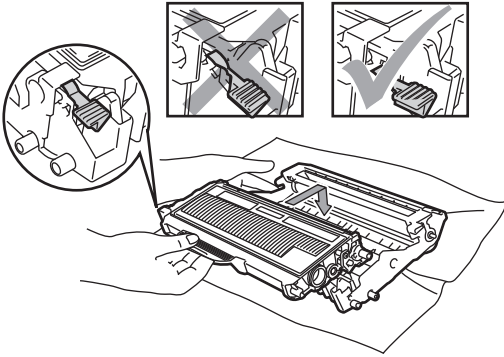

! CAUTION

Make sure that you put in the toner cartridge properly or it may separate from the drum unit.

- 6 Clean the primary corona wire inside the drum unit by gently sliding the green tab from right to left and left to right several times.

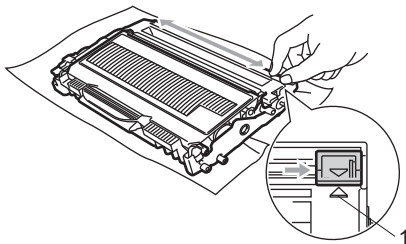

! CAUTION

Be sure to return the green tab to the home position (▲) (1). If you do not, printed pages may have a vertical stripe.

- 7 Put the new drum unit and toner cartridge assembly in the machine.

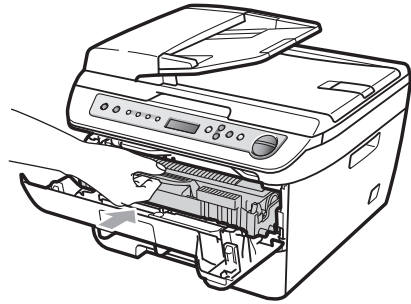

- 8 Press **Clear/Back**.
To confirm you are installing a new drum, press ▲.
- 9 When the LCD shows *Accepted*, close the front cover.

Machine information

Checking the serial number

You can see the machine's serial number on the LCD.

- 1 Press **Menu**.
- 2 Press **▲** or **▼** to choose 3.Machine Info.
Press **OK**.
- 3 Press **▲** or **▼** to choose 1.Serial No.
Press **OK**.
- 4 Press **Stop/Exit**.

Checking the page counters

You can see the machine's page counters for copies, printed pages, reports and lists or a summary total.

- 1 Press **Menu**.
- 2 Press **▲** or **▼** to choose 3.Machine Info.
Press **OK**.
- 3 Press **▲** or **▼** to choose 2.Page Counter.
Press **OK**.
- 4 Press **▲** or **▼** to choose Total, List, Copy or Print.
You can see the machine's page count.
- 5 Press **Stop/Exit**.

Checking the Drum life

You can see the machine's drum life on the LCD.

- 1 Press **Menu**.
- 2 Press **▲** or **▼** to choose 3.Machine Info.
Press **OK**.
- 3 Press **▲** or **▼** to choose 3.Drum Life.
Press **OK**.
You can see the remaining percentage of drum life.
- 4 Press **Stop/Exit**.



Note

The drum life check will be accurate only if you have reset the drum counter when you installed a *new* drum unit. It will not be accurate if you have reset the drum counter during the life of a *used* drum.

Packing and shipping the machine

! CAUTION

If you pack the machine soon after turning off the power make sure the machine has cooled down completely.

When you transport the machine, use the packing materials that came with your machine. If you do not pack the machine properly, you could void your warranty. The machine should be adequately insured with the carrier.

- 1 Turn off the machine's power switch.
- 2 Unplug all the cables and AC power cord from the machine.
- 3 Open the front cover.
- 4 Remove the drum unit and toner cartridge assembly. Leave the toner cartridge installed in the drum unit.
- 5 Place the drum unit and toner cartridge assembly into the plastic bag and seal the bag.
- 6 Close the front cover.
- 7 Wrap the machine in the plastic bag and place it in the original carton with the original packing material.

- 8 Pack the drum unit and toner cartridge assembly, AC cord and printed materials in the original carton as shown below:

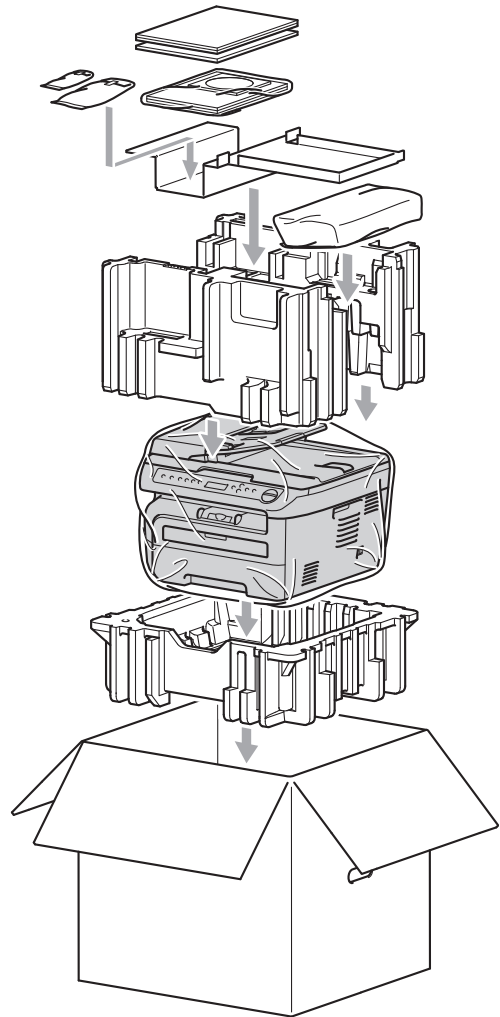

Note

If you are returning your machine to Brother as part of the Exchange Service, pack only the machine. Keep all separate parts and printed materials to use with your "Exchange" machine.

- 9 Close the carton and tape it shut.

On-screen programming

Your machine has been designed to be easy to use. The LCD provides on-screen programming using the menu keys.

We have created step by step on-screen instructions to help you program your machine. Simply follow the steps as they guide you through the menu selections and programming options.

Menu table

You can program your machine by using the *Menu table* on page 81. These pages list the menu selections and options.

Press **Menu** followed by the menu numbers to program your machine.

For example, to set *Beeper* volume to *Low*:

- 1 Press **Menu**.
- 2 Press ▲ or ▼ to choose 1. *General Setup*. Press **OK**.
- 3 Press ▲ or ▼ to choose 3. *Beeper*.

```
General Setup
3. Beeper
```











Press **OK**.

- 4 Press ▲ or ▼ to choose *Low*. Press **OK**.
- 5 Press **Stop/Exit**.

Memory storage

Your menu settings are stored permanently, and in the event of a power failure will *not* be lost. Temporary settings (for example, Contrast) *will* be lost.

Menu keys

Clear/ Back 	+   -	OK 	Menu 
Menu 	Access the menu.		
OK 	Go to the next menu level. Accept an option.		
Clear/ Back 	Exit the menu by pressing repeatedly. Go back to the previous menu level.		
+   -	Scroll through the current menu level.		
Stop/ Exit 	Exit the menu.		

How to access the menu mode

- 1 Press **Menu**.
- 2 Scroll through each menu level by pressing ▲ or ▼ for the direction you want.
- 3 Press **OK** when the option you want appears on the LCD.
The LCD will then show the next menu level.
- 4 Press ▲ or ▼ to scroll to your next menu selection.
- 5 Press **OK**.
When you have finished setting an option, the LCD will show *Accepted*.
- 6 Press **Stop/Exit** to exit Menu mode.

Menu table

The factory settings are shown in Bold with an asterisk.

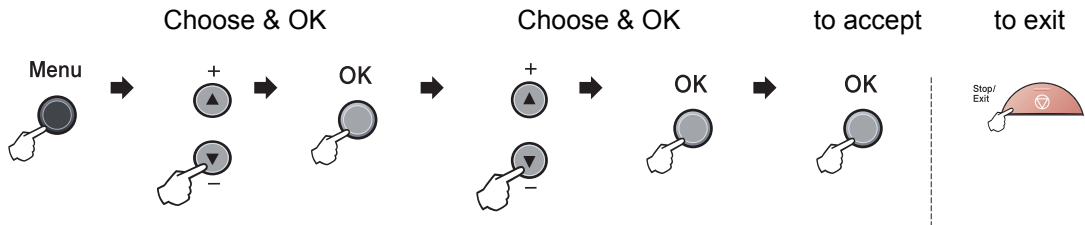

Main Menu	Submenu	Menu Selections	Options	Descriptions	Page
1. General Setup	1. Paper Type	—	Thin Plain* Thick Thicker Transparency Recycled Paper	Sets the type of paper in the paper tray.	19
	2. Paper Size	—	A4 Letter* Legal Executive A5 A6 B5 B6 Folio	Sets the size of the paper in the paper tray.	19
	3. Beeper	—	Off Low Med* High	Adjusts the volume level of the beeper.	19
	4. Ecology	1. Toner Save	—	On Off*	Increases the page yield of the toner cartridge.
2. Sleep Time		—	(00-99) 05Min*	Conserves power.	20

 The factory settings are shown in Bold with an asterisk.

Main Menu	Submenu	Menu Selections	Options	Descriptions	Page
1. General Setup (continued)	5. LCD Contrast	—	▼ -□□□■+ ▲ ▼ -□□■□+ ▲ ▼ -□□□□+ ▲* ▼ -□■□□+ ▲ ▼ -■□□□+ ▲	Adjusts the contrast of the LCD.	21
	6. User Settings	—	—	Lists your current settings.	21
	0. Local Language	—	(in USA) English* Spanish (in Canada) English* French	Allows you to change the LCD language for your country.	See <i>Quick Setup Guide</i> .
2. Copy	1. Quality	—	Auto* Text Photo	You can choose the Copy resolution for your type of document.	27
	2. Contrast	—	▼ -□□□■+ ▲ ▼ -□□■□+ ▲ ▼ -□□□□+ ▲* ▼ -□■□□+ ▲ ▼ -■□□□+ ▲	Adjusts the contrast for copies.	26
3. Machine Info.	1. Serial No.	—	—	You can check the serial number of your machine.	77
	2. Page Counter	—	Total List Copy Print	You can check the number of total pages the machine has printed during its life.	77
	3. Drum Life	—	—	You can check the percentage of a Drum life that remains available.	77
 The factory settings are shown in Bold with an asterisk.					

D

Specifications

General

Printer Type	Laser
Print Method	Electrophotography by semiconductor laser beam scanning
Memory Capacity	16 MB
LCD (liquid crystal display)	16 characters × 2 lines
Power Source	110-120 V AC 50/60 Hz
Power Consumption	Peak: 1056 W
	Copying: Average 320 W ¹
	Sleep: (DCP-7030) Average 8 W
	(DCP-7040) Average 9 W
	Standby: Average 75 W

¹ When making a copy from one sheet

Dimensions

DCP-7030

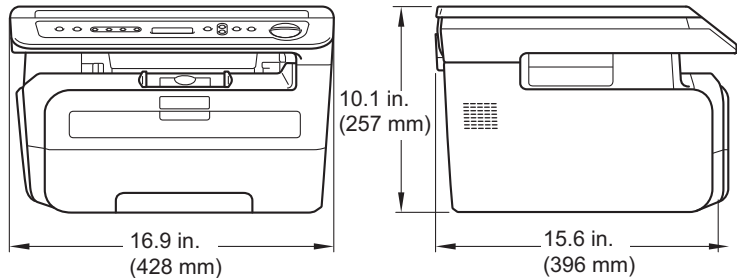

DCP-7040

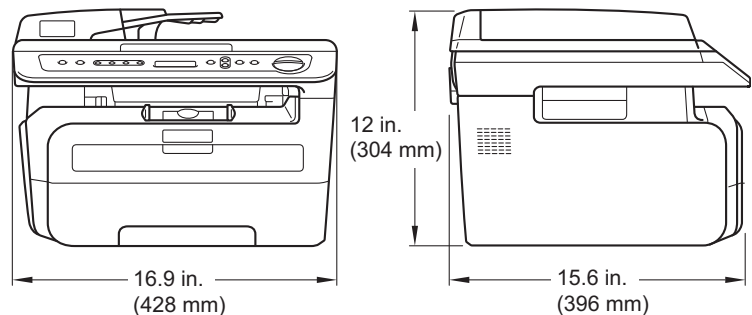

Weight

Without Drum/Toner Unit:
 (DCP-7030) 19.2 lb (8.7 kg)
 (DCP-7040) 22 lb (10 kg)

Noise level

Sound power

Operating (Copying): LWAd = 6.2 Bell

Standby: LWAd = 4.4 Bell

Sound pressure

Operating (Copying): LpAm = 53 dBA

Standby: LpAm = 32 dBA

Temperature

Operating: 50° F to 90.5° F (10 to 32.5° C)

Storage: 41° F to 95° F (5 to 35° C)

Humidity

Operating: 20 to 80% (without condensation)

Storage: 10 to 90% (without condensation)

ADF (automatic document feeder)

(DCP-7040 only)

Up to 35 pages (Staggered) 20 lb (80 g/m²)

Recommended Environment for Best Results:

Temperature: 68° F to 86° F (20 to 30° C)

Humidity: 50% - 70%

Paper: Xerox 4200 (20 lb/Letter)

Paper Tray250 Sheets 20 lb (80 g/m²)

Print media

Paper Input	Paper Tray	
	<ul style="list-style-type: none"> ■ Paper Type: Plain Paper, Transparencies ¹ or Recycled Paper ■ Paper Size: Letter, A4, B5(ISO), A5, B6, A6, Executive, Legal and Folio ■ Paper Weight: 16 to 28 lb (60 to 105 g/m²) ■ Maximum Paper Tray Capacity: Up to 250 sheets of 20 lb (80 g/m²) Plain Paper 	
	Manual Feed Slot	
	<ul style="list-style-type: none"> ■ Paper Type: Plain Paper, Transparencies, Recycled Paper, Bond Paper, Envelopes or Labels ¹ ■ Paper Size: Width: 3.0 to 8.66 in. (76.2 to 220 mm) Length: 4.57 to 16 in. (116.0 to 406.4 mm) ■ Paper Weight: 16 to 43 lb (60 to 163 g/m²) ■ Maximum Manual Feed Slot Capacity: One sheet at a time 	

¹ For transparencies and labels, we recommend removing printed pages from the output paper tray immediately after they exit the machine to avoid the possibility of smudging.

Paper Output Up to 100 sheets (face down print delivery to the output paper tray)

Copy

Copy Speed	Up to 23 pages/minute (Letter size) ¹
Color/Monochrome	Monochrome
Document Size	ADF Width: 5.8 to 8.5 in. (148 to 215.9 mm) (DCP-7040 only) ADF Length: 5.8 to 14 in. (148 to 355.6 mm) (DCP-7040 only) Scanner Glass Width: Max. 8.5 in. (215.9 mm) Scanner Glass Length: Max. 11.7 in. (297 mm) Copy Width: Max. 8.26 in. (210 mm)
Multiple Copies	Stacks up to 99 pages Sorts up to 99 pages (DCP-7040 only)
Reduce/Enlarge	25% to 400% (in increments of 1%)
Resolution	Up to 600 × 600 dpi
First Copy Out Time	Less than 15 seconds (from Ready state) ²

¹ The copy speed may change depending on the type of document you copy.

² The first copy out time may vary depending on scanner lamp warm up time.

Scan

Color/Monochrome	Yes
TWAIN Compliant	Yes (Windows® 2000 Professional/XP/ XP Professional x64 Edition/Windows Vista®) Mac OS® X 10.2.4 or greater
WIA Compliant	Yes (Windows® XP/Windows Vista®)
Color Depth	24 bit color
Resolution	Up to 19200 × 19200 dpi (interpolated) ¹ Up to 600 × 2400 dpi (optical) (From Scanner Glass) (DCP-7040 only) Up to 600 × 600 dpi (optical) (From ADF)
Document Size	ADF Width: 5.8 to 8.5 in. (148.0 to 215.9 mm) (DCP-7040 only) ADF Length: 5.8 to 14 in. (148.0 to 355.6 mm) (DCP-7040 only) Scanner Glass Width: Max. 8.5 in. (215.9 mm) Scanner Glass Length: Max. 11.7 in. (297 mm)
Scanning Width	Max. 8.26 in. (210 mm)
Gray Scale	256 levels

¹ Maximum 1200 × 1200 dpi scanning with the WIA driver in Windows® XP/Windows Vista® (resolution up to 19200 × 19200 dpi can be chosen by using the Brother scanner utility)

Print

Printer Driver	Host-Based Driver for Windows® 2000 Professional/ XP/XP Professional x64 Edition/Windows Vista® Macintosh® Printer Driver for Mac OS® X 10.2.4 or greater
Resolution	HQ1200 (2400 × 600 dpi), 600, 300 dpi
Print Speed	Up to 23 pages/minute (Letter size) ¹
First Print Out Time	Less than 10 seconds (from the Ready state and the standard tray)

¹ The print speed may change depending on the type of document you print.

Interfaces

USB Use a USB 2.0 interface cable that is no longer than 6 feet (2.0 m). ¹ ²

¹ Your machine has a USB interface that is compatible with the USB 2.0 specification. This interface is also compatible with High-Speed USB 2.0; however, the maximum data transfer rate will be 12 Mbits/s. The machine can also be connected to a computer that has a USB 1.1 interface.

² Third party USB ports are not supported for Macintosh®.

Computer requirements

Minimum System Requirements and Supported PC Software Functions								
Computer Platform & Operating System Version		Supported PC Software Functions	PC Interface	Processor Minimum Speed	Minimum RAM	Recommended RAM	Available Hard Disk Space	
							For Drivers	For Applications
Windows® Operating System ¹	Windows® 2000 Professional ⁴	Printing, Scanning	USB	Intel® Pentium® II or AMD equivalent	64 MB	256 MB	150 MB	310 MB
	Windows® XP Home ^{2 4} Windows® XP Professional ^{2 4}				128 MB			
	Windows® XP Professional x64 Edition ²			64-bit (Intel® 64 or AMD64) supported CPU	256 MB	512 MB		
	Windows Vista® ²			Intel® Pentium® 4 or equivalent 64-bit (Intel® 64 or AMD64) supported CPU	512 MB	1 GB		
Macintosh® Operating System	Mac OS® X 10.2.4 - 10.4.3	Printing, Scanning	USB ³	PowerPC G4/G5, PowerPC G3 350MHz	128 MB	256 MB	80 MB	400 MB
	Mac OS® X 10.4.4 or greater			PowerPC G4/G5, Intel® Core™ Processor	512 MB			

¹ Microsoft® Internet Explorer 5.5 or greater

² For WIA, 1200x1200 resolution. Brother Scanner Utility enables to enhance up to 19200 x 19200 dpi.

³ Third party USB ports are not supported.

⁴ PaperPort™ 11SE supports Microsoft® SP4 or higher for Windows® 2000 and SP2 or higher for XP.

Consumable items

Toner Cartridge Life	Starter Toner Cartridge:	Approx. 1,000 pages ¹
	Standard Toner Cartridge: TN-330:	Approx. 1,500 pages (Letter) ¹
	High-Yield Toner Cartridge: TN-360:	Approx. 2,600 pages (Letter) ¹
Drum Unit	DR-360:	Approx. 12,000 pages (Letter) ²

¹ Approx. cartridge yield is declared in accordance with ISO/IEC 19752.

² Drum yield is approximate, and may vary by type of use.

E

Glossary

ADF (automatic document feeder)

(DCP-7040 only) The document can be placed in the ADF and scanned one page at a time automatically.

Beeper Volume

Volume setting for the beep when you press a key or make an error.

Cancel Job

Cancels a programmed print job and clears the machine's memory.

Contrast

Setting to compensate for dark or light documents, by making copies of dark documents lighter and light documents darker.

Gray scale

The shades of gray available for copying photographs.

LCD (liquid crystal display)

The display screen on the machine that shows interactive messages during On-Screen Programming and shows the date and time when the machine is idle.

Menu mode

Programming mode for changing your machine's settings.

OCR (optical character recognition)

The bundled ScanSoft™ PaperPort™ 11SE with OCR or Presto!® PageManager® software application converts an image of text to text you can edit.

Resolution

The number of vertical and horizontal lines per inch.

Scanning

The process of sending an electronic image of a paper document into your computer.

Temporary settings

You can choose certain options for each copy without changing the default settings.

User Settings List

A printed report that shows the current settings of the machine.

F

Index

A	
<hr/>	
Accessories and supplies	ii
ADF (automatic document feeder)	
using	17
Apple® Macintosh®	
See Software User's Guide on the CD-ROM.	
B	
<hr/>	
Brother	
accessories and supplies	ii
Brother numbers	i
Customer Service	i
FAQs (frequently asked questions)	i
product support	i
service centers	i
warranties	iii, iv, vi
C	
<hr/>	
Canceling	
print jobs	6
Cleaning	
corona wire	66
drum unit	68
laser scanner window	64
scanner glass	63
Consumable items	70
Control panel overview	6
ControlCenter2 (for Macintosh®)	
See Software User's Guide on the CD-ROM.	
ControlCenter3 (for Windows®)	
See Software User's Guide on the CD-ROM.	
Copy	
contrast	24, 26
Enlarge/Reduce key	25
keys	6, 25
multiple	24
N in 1 (page layout)	28
out of memory	29
quality	27
single	24
sort (ADF only)	28
temporary settings	25
using ADF	28, 29
using scanner glass	28, 29
D	
<hr/>	
Document	
how to load	17, 18
Drum unit	
checking (remaining life)	77
cleaning	66, 68
replacing	74
E	
<hr/>	
Enlarge/Reduce key	25
Envelopes	9, 12, 13, 15, 16, 48
how to load	9
Error messages on LCD	55
Init Unable XX	56
No Paper	56
Out of Memory	56
Print Unable XX	56
Scan Unable XX	56
F	
<hr/>	
Folio	13
G	
<hr/>	
Gray scale	87
H	
<hr/>	
HELP	
LCD messages	79
Menu Table	79, 81
using menu keys	79
J	
<hr/>	
Jams	
paper	58
Job Cancel key	6

L

- Labels 8, 9, 12, 13, 16, 48, 85
- LCD (liquid crystal display) 6, 79
- contrast 21

M

- Machine information
 - checking remaining life of drum unit 77
 - page counts 77
- Macintosh®
 - See Software User's Guide on the CD-ROM.
- Maintenance, routine 62
 - checking the remaining life of drum unit 77
 - replacing
 - drum unit 74
 - toner cartridge 70
- Memory
 - storage 79
- Menu Table 79, 81
 - using menu keys 79

N

- N in 1 (page layout) 28

O

- Out of Memory message 29, 56

P

- Packing and shipping the machine 78
- Page layout (N in 1) 28
- Paper 12, 85
 - how to load 7
 - jam 58
 - recommended 12, 13
 - size 12, 19
 - size of document 86, 87
 - tray capacity 13
 - type 12, 19
- PaperPort™ 11SE with OCR
 - See Software User's Guide on the CD-ROM and Help in the PaperPort™ 11SE application to access How-to-Guides.
- Power failure 79

Print

- difficulties 47
- drivers 88
- Job Cancel key 6
- paper jams 58
- quality 48, 49
- resolution 88
- specifications 88
- Printing
 - See Software User's Guide on the CD-ROM.
- Programming your machine 79

Q

- Quality
 - copying 27
 - printing 48, 49

R

- Reducing
 - copies 25
- Replacing
 - drum unit 74
 - toner cartridge 70
- Resolution
 - copy 86
 - print 88
 - scan 87

S

- Safety instructions 42
- Scanner glass
 - using 18
- Scanning
 - See Software User's Guide on the CD-ROM.
- Serial number
 - how to find See inside front cover
- Service centers i
- Shipping the machine 78
- Sleep time 20
- Sort 28

F

T

Temporary copy settings	25
Toner cartridge, replacing	70
Toner save	20
Transparency	7, 8, 12, 13, 48, 85
Troubleshooting	46
document jam	57
error messages on LCD	55
if you are having difficulty	
copy quality	46
paper handling	48
print quality	48, 49
printing	47
scanning	47
software	48
maintenance messages on LCD	55
paper jam	58

V

Volume, setting	
beeper	19

W

Warranties	
Canada	vi
Notice-Disclaimer	iii
USA	iv
Windows®	
See Software User's Guide on the CD-ROM.	
World Wide Web	i

EQUIPMENT ATTACHMENT LIMITATIONS (Canada only)

NOTICE

This product meets the applicable Industry Canada technical specifications.

Brother International Corporation
100 Somerset Corporate Boulevard
P.O. Box 6911
Bridgewater, NJ 08807-0911 USA

Brother International Corporation (Canada) Ltd.
1 rue Hôtel de Ville,
Dollard-des-Ormeaux, QC, Canada H9B 3H6

brother®

Visit us on the World Wide Web
<http://www.brother.com/>

These machines are made for use in the USA and Canada only. We cannot recommend using them overseas because the power requirement of your Digital Copier/Printer may not be compatible with the power available in foreign countries. **Using USA or Canada models overseas is at your own risk and may void your warranty.**