

OWNER'S MANUAL

Personal

FAX-170
FAX-190

CONTENTS

- Chapter 1 INTRODUCTION
- Chapter 2 INSTALLATION
- Chapter 3 FAX SETTINGS
- Chapter 4 ON-SCREEN PROGRAMMING
- Chapter 5 BASIC FAX OPERATION
- Chapter 6 TELEPHONE (VOICE) OPERATION
- Chapter 7 ADVANCED FAX OPERATION
- Chapter 8 PRINTING REPORTS AND LISTS
- Chapter 9 IMPORTANT INFORMATION
- Chapter 10 MAINTENANCE
AND TROUBLESHOOTING
- INDEX
- SPECIFICATIONS

brother®

Table of Contents

<p>1 Introduction</p> <p>2 Installation</p> <p>3 Fax Settings</p>	<p>Using This Manual 1</p> <p> Finding Information 1</p> <p> Test Sheet Procedures 1</p> <p> About Fax Machines 2</p> <p> Fax Tones and Handshake 2</p> <p>Control Panel Overview 3</p> <p>Caution 5</p> <p>Packing List 6</p> <p>Choosing a Location 7</p> <p>Assembly 7</p> <p> Load the recording paper 7</p> <p> Connect the handset 8</p> <p> Connect the power cord 8</p> <p> Connect the telephone line 9</p> <p> Attach the document support 9</p> <p> Special Line Considerations 9</p> <p> Roll Over Phone Lines 9</p> <p> Two-Line Phone System 10</p> <p> Converting Telephone Wall Outlets 10</p> <p> Installing Fax Machine, Two-Line TAD, and Two-Line Telephone 10</p> <p> Multi-Line Connections (PBX) 11</p> <p> If you are installing the machine to work with a PBX: 12</p> <p> Custom Features on Your Phone Line 12</p> <p> Connecting a Telephone Answering Device (TAD) 12</p> <p> Sequence 12</p> <p> Connections 13</p> <p> Outgoing Message (OGM) 14</p> <p> Connecting an External Telephone 14</p> <p>Fax Settings 15</p> <p> Setting Dialing Mode (Tone/Pulse) 15</p> <p> Setting Date and Time 15</p> <p> Setting Station ID 16</p>
-------------------------------------------------------------------------------------------------------------------------	--------------------------------------------------------------------------------------------------------------------------------------------------------------------------------------------------------------------------------------------------------------------------------------------------------------------------------------------------------------------------------------------------------------------------------------------------------------------------------------------------------------------------------------------------------------------------------------------------------------------------------------------------------------------------------------------------------------------------------------------------------------------------------------------------------------------------------------------------------------------------------------------------------------------------------------------------------------------------------------------------------------------------------------------------------------------------------------------------------------------------------------------------------------------------------------------------------------------------------------------------------------------------------------------------------------------------------------------------------------------------------------------------------------------------------------------------------------------------------------------------------------------------------

**On-Screen
Programming****Basic Fax
Operation****Telephone
(Voice)
Operation**

Entering Text	16
Inserting spaces	17
Making corrections	17
Repeating letters	17
Special characters and symbols	17
Storing One Touch Dial Numbers	18
One Touch Dialing	20
Storing Speed Dial Numbers	20
Speed Dialing	21
Changing One Touch and Speed Dial Numbers	21
Setting Beeper Level	22
Temporary Memory Backup Storage	22
User-Friendly Programming	23
Function Mode	23
Alternating Displays	24
Function Selection Table	24
Sending Faxes	27
Before you begin:	27
Contrast Setting	28
Manual Transmission	28
Automatic Transmission	29
Manual and Automatic Fax Redial	29
Receiving Faxes	29
Select Answer Mode	29
Easy Receive	30
To select or change your Answer Mode	31
Setting Ring Delay	31
Setting F/T Ring Time	31
Speaker Volume	32
Ring Volume	32
Smoothing	32
Making Voice Calls	33
Manual Dialing	33
One Touch Dialing	33
Speed Dialing	34
Hold	34
Pause	34
Tone/Pulse	34
Searching Telephone Index	34

**Advanced
Fax Operation**

Sending Faxes 35

Daily Timer 35

Delayed Transmission 35

Interrupting Timer and Poll Waiting 36

Canceling a Delayed Fax 36

Overseas Mode 36

Gray Scale 37

Sending Electronic Cover Page 37

Always Send Cover Page 37

Temporary Page 38

Printing a Cover Page 38

Call Reservation 39

Print Call Back Message 39

Next-Fax Reservation (FAX 190 only) 40

Receiving Faxes 41

Remote Operation 41

 For F/T Mode Only 41

 Changing Remote Codes 41

 To change Remote Codes 42

Distinctive Ringing 42

 Registering the distinctive ringing phone number 43

Caller ID 43

Polling 44

 Setup to Poll Another Fax 44

 Setup to Be Polled (Poll Waiting) 45

 Delayed Polling 45

Copy Functions 46

**Printing
Reports
and Lists**

Fax Machine Activity 47

 To print a report 48

 Activity Report Interval 48

 Transmission Verification (Xmit) Report 48

**Important
Information**

Standard Telephone and FCC Notices 49

 These notices are in effect on models sold and used in the United States 49

 WARNING 51

 Important Safety Instructions 52

**Maintenance and
Troubleshooting**

Fax-Back SM System	55
Brother Home Page	55
Brother Bulletin Board	55
Other Problems	59
Condensed Print and Horizontal Streaks; Top and Bottom of Sentences Cut Off	59
Copies and Received Faxes are Blank Pages	59
Cover Page Comment Always Prints "Please Call" When Printing Report	59
Dialing Does Not Work	60
Enabling/Disabling Anti-Curl Check Sheet (ACS)	60
Fax Machine Does Not Answer When Called	60
No Dial Tone on the Handset	60
Poor Transmitting Quality	60
Vertical Black Lines When Receiving	60
Vertical Black Lines When Sending	61
Ring Change in F/T Mode	61
Transmission Verification Report Prints "Result: NG"	61
Sending a Call to the Fax Machine	61
Fax Machine Doesn't Have Dial Tone	61
Fax "Hears" Voice as CNG Tone	61
For Customer Service	62
Index	63
Specifications	65

CHAPTER ONE

Introduction

Using This Manual

Thank you for purchasing a Brother fax machine. This fax machine has been designed to be simple to use, with LCD screen prompts to guide you through functions. However, you can use your fax machine to its fullest potential by taking a few minutes to read this manual.



Additionally, your fax machine has a Help Key. Press **Help** to print a list of basic operational steps and functions.

Finding Information

All chapter headings and subheadings are listed in the Table of Contents. You will be able to find information about a specific feature or function by checking the Index at the back of this manual. Also, throughout this manual, you'll see special symbols alerting you to important information, cross-references, and warnings. Illustrations of some screen displays also help you choose the correct key-presses.

Test Sheet Procedures

After programming your Station ID, please fill out the TEST SHEET included with your fax machine and fax it to Brother's Automated Fax Response System as your first transmission. This will verify that your fax machine is properly installed.

When this document is received a confirmation sheet will be sent back to your machine. Be sure to set up your Station ID.

USA Fax 1-908-469-4547

Canada Fax 1-514-685-0702

*See
Station ID
p. 16*

About Fax Machines

If you're a first-time fax machine user, fax operation might seem a little mysterious. You'll soon get used to the unusual fax tones on your phone line, and be able to send and receive faxes easily.

Fax Tones and Handshake

When someone is sending a fax, the fax machine sends fax calling tones, (CNG tones) — soft, intermittent beeps at 4-second intervals. You'll hear them when you dial and press **Start**, and they continue for 30 seconds after dialing. During that time, the sending machine must begin the "handshake" with the receiving machine. Each time you use automatic procedures to send a fax, you are sending CNG tones over the phone line. You'll soon learn to listen for these soft beeps each time you answer a phone on your fax line, so you can know if you are receiving a fax message.

The receiving fax responds with fax receiving tones — loud, chirping sounds. A receiving fax chirps for 40 seconds over the phone line, and the screen displays "RECEIVE." If your machine is set to the FAX ONLY Mode, it will answer every call automatically with fax receiving tones. Even if the other party hangs up, your fax machine continues to send the "chirps" for 40 seconds, and the screen continues to display "RECEIVE." To cancel the receiving mode, press **Stop**.

When your fax machine is in FAX/TEL (F/T), it answers with a short beep. After this beep, the fax machine listens for CNG tones, and then responds with receiving tones.

The fax "handshake" is the time in which the sending machine's CNG tones and the receiving machines "chirps" overlap. This must be for at least two to four seconds, so the fax machines can understand how each is sending and receiving the fax. The handshake cannot begin until the call is answered, and the CNG tones only last for 30 seconds after the number is dialed. Therefore, it's important for the receiving machine to answer the call in as few rings as possible.



When you have a telephone answering device (TAD) on your fax line, your TAD will determine the number of rings before the call is answered. Pay special attention to the directions in the Installation chapter for connecting a TAD to your fax machine.

Control Panel Overview

Section of Control Panel Detailed on this Page

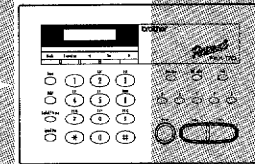

Liquid Crystal Display
LCD displays messages to help you set up and operate your fax machine.

◀ (Left Arrow)
▶ (Right Arrow)
Moves the LCD cursor to the left or right.

Resolution
Sets the resolution when sending a fax.

Mode
Specifies how the fax machine will handle incoming calls.

Hook
Lets you dial telephone and fax numbers without lifting the handset.

Hold
Lets you put calls on hold.

Redial / Pause
Re-dials the last number called. Also inserts a pause in autodial numbers.

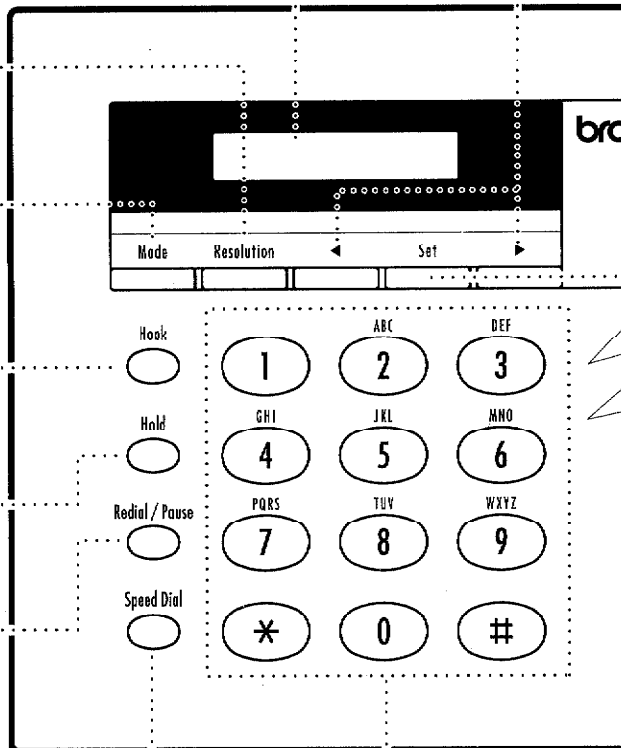

Set
Stores a function setting into the fax machine.

Speed Dial
Lets you dial stored phone numbers by pressing a two-digit number.

Number Keys
Dials phone and fax numbers, and can be used as a keyboard for entering information into the fax machine.

Control Panel Overview

Section of Control Panel Detailed on this Page

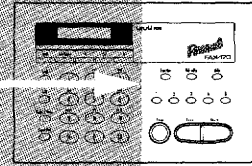

Tel-index

Lets you look up numbers stored in the dialing memory.

Function

Lets you access the function and programming mode.

Stop

Stops a fax, cancels an operation, or exits from function mode.

Help

Prints a quick reference Help List.

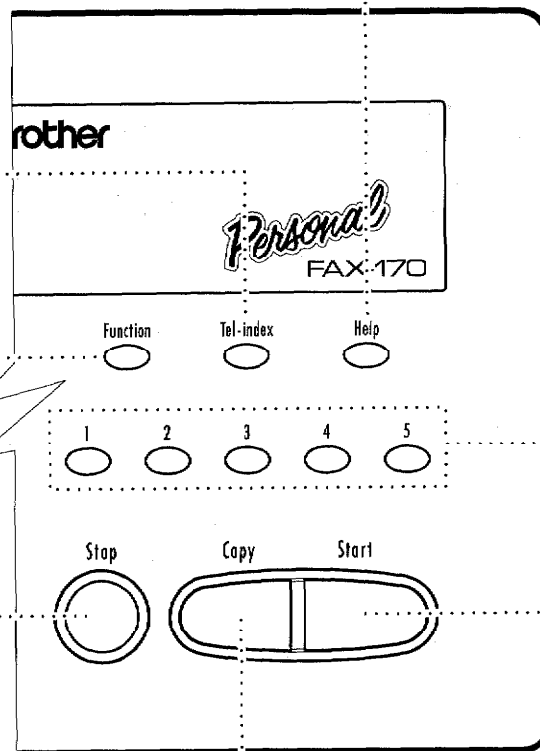

One Touch Dial Keys

These five keys give you instant access to previously stored phone numbers.

Start

Starts an operation, such as sending a fax.

Copy

Makes a copy.

CHAPTER TWO

Installation

Caution

- 1 Never install telephone wiring during a lightning storm.
- 2 Never install a telephone jack in a wet location unless the jack is specifically designed for a wet location.
- 3 Never touch telephone wires or terminals that are not insulated unless the telephone line has been disconnected at the network interface.
- 4 Use caution when installing or modifying telephone lines.
- 5 Avoid using a telephone (other than a cordless type) during an electrical storm. There may be a remote risk of electric shock from lightning.
- 6 Do not use the telephone to report a gas leak in the vicinity of the leak.
- 7 For PLUGGABLE EQUIPMENT, the socket-outlet should be installed near the equipment and should be easily accessible.

Packing List

Make sure you have the following items:

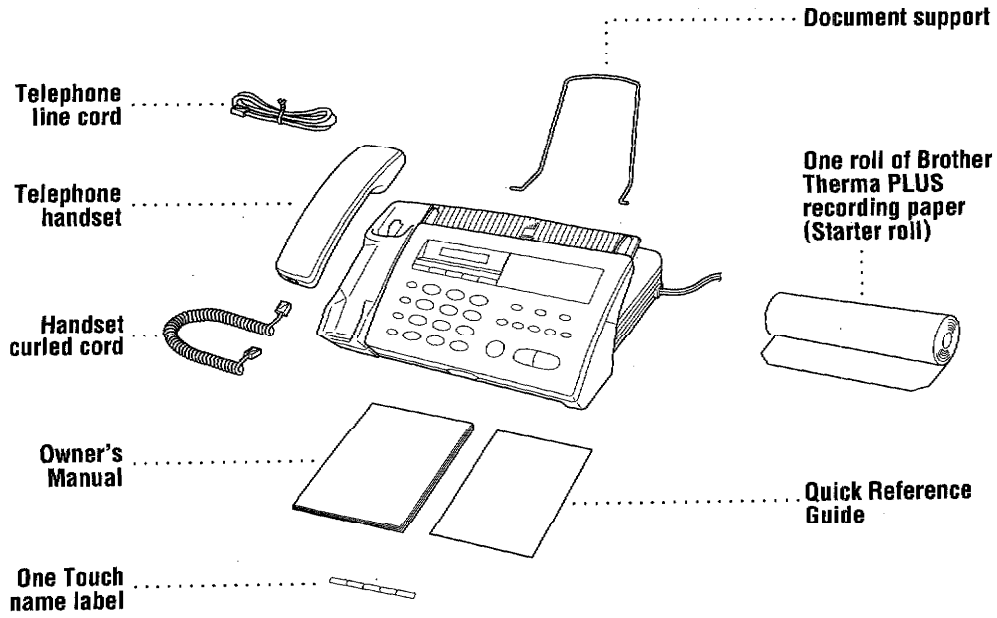

Choosing a Location

Place your fax machine on a flat, stable surface, such as a desk. Select a place that is free of vibration and shocks. Locate the fax machine near a telephone jack and a standard, grounded power outlet.



Avoid placing your fax machine in a high-traffic area. Do not place near heaters, air conditioners, water, chemicals, or refrigerators. Do not expose the fax machine to direct sunlight, excessive heat, moisture, or dust. Do not connect your fax machine to electrical outlets controlled by wall switches or automatic timers. Disruption of power can wipe out information in the unit's memory. Do not connect your fax machine to electrical outlets on the same circuit as large appliances or other equipment that might disrupt the power supply. Avoid interference sources, such as speakers or the base units of cordless phones.

Assembly

Load the recording paper

- 1 Lift up the cover by placing your finger in the groove under the arrow in the front center of the cover, and lift up.
- 2 Pull the release lever (blue) on the print head unit so that you can lift it up and remove the recording paper.
- 3 Remove the three pieces of protective paper.
- 4 Take the new roll of recording paper out of its wrapper. If you are replacing a roll, you must remove any paper remaining in the machine.
- 5 Insert the new recording paper into the paper bin, with the paper feeding from the bottom of the roll.
- 6 Insert the edge of the paper into the slot between the roller and the plate. Feed the paper through until you can see it come out the front of the machine. Keep the paper stretched tightly.
- 7 Push the release lever (blue) down, then close the cover.

*See
Instructions
printed
inside
paper bin*

Connect the handset

Connect the curled handset cord to the bottom of the handset and the side of the fax machine.

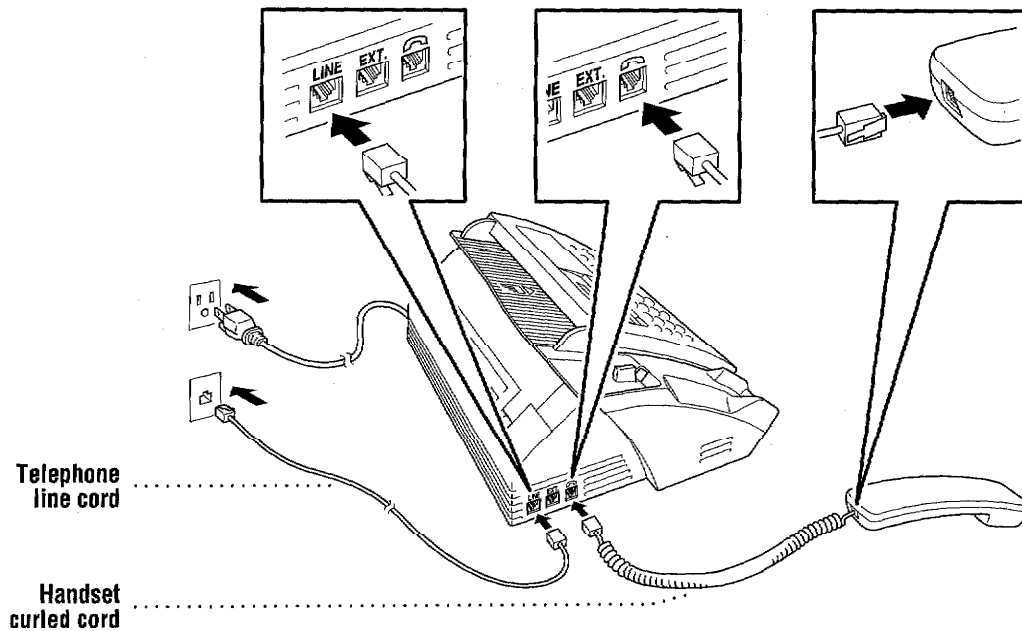

Connect the power cord

When you connect the power, your fax machine cuts the fax paper automatically, and the screen displays 01/01 00:00.

NOTICE: 1) This fax must be grounded using a 3-prong plug. **2)** Since the machine is grounded through the power outlet, you can protect yourself from potentially hazardous electrical conditions on the telephone network by keeping the power to your fax machine on when you connect it to a telephone line. Similarly, you can protect yourself when you want to move your machine, by disconnecting the telephone line first, and then the power cord. **3)** Lightning and power surges can damage this product! We recommend that you use a quality surge protection device on the AC power line as well as on the telephone line, or unplug the lines during a lightning storm.

Connect the telephone line

Connect one end of the telephone line cord to the jack labeled **LINE** on the back of the fax machine. Connect the other end to a modular wall jack.

Attach the document support

Attach the document support as shown in the illustration below.

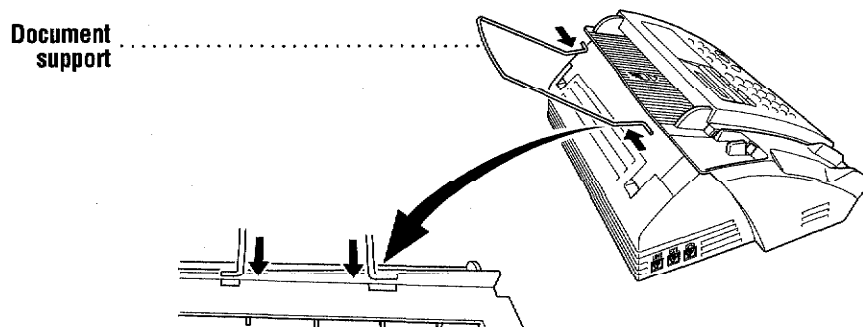

Special Line Considerations

Roll Over Phone Lines

A roll over phone system is a group of two or more separate telephone lines that pass incoming calls to each other if they are busy. The calls are usually passed down or "rolled over" to the next available phone line in a preset order.

Your fax machine can work in a roll over system as long as it is the last number in the sequence, so the call cannot roll away. Do not put the fax machine on any of the other numbers; when the other lines are busy and a second fax call is received, the fax call is transferred to a line that does not have a fax machine. Your fax machine will work best on a dedicated line.

Two-Line Phone System

A two-line phone system is nothing more than two separate phone numbers on the same wall outlet. The two phone numbers can be on separate jacks (RJ11) or combined into one jack (RJ14). Your fax machine must be plugged into an RJ11 jack. RJ11 and RJ14 jacks may be equal in size and appearance and both may contain 4 wires (black, red, green, yellow). To test the type of jack, plug in a two-line phone and see if it can access both lines. If it can, you must separate the line for your fax machine.

Converting Telephone Wall Outlets

There are three ways to convert to an RJ11 receptacle. The first two ways may require assistance from the telephone company. You can change the wall outlets from one RJ14 jack to two RJ11 jacks. Or, you can have an RJ11 wall outlet installed and slave or jump one of the phone numbers to it.

The third way is the easiest: Buy a triplex adapter. You can plug a triplex adapter into an RJ14 outlet. It separates the wires into two separate RJ11 jacks (Line 1, Line 2) and a third RJ14 jack (Lines 1 and 2). Plug the fax machine into Line 2 of the triplex adapter.

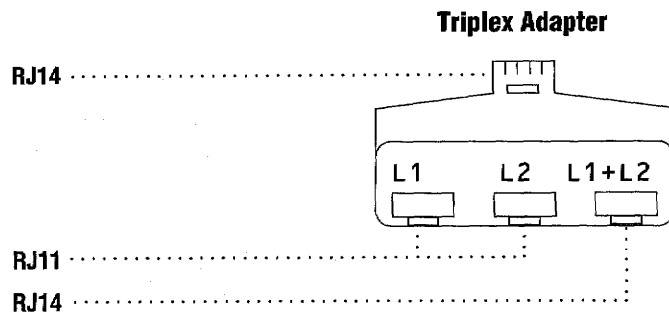

Installing Fax Machine, Two-Line TAD, and Two-Line Telephone

When you are installing a two-line telephone answering device (TAD) and a two-line telephone, your fax machine must be isolated on one line at both the wall jack and at the TAD. The most common connection is to put the fax machine on Line 2. The back of the two-line TAD must have two telephone jacks: one labeled L1 or L1/L2, and the other labeled L2. You will need at least three telephone line cords, the one that came with your fax machine and two for your two-line TAD. You will need a fourth line cord if you add a two-line telephone.

- 1 Place the two-line TAD and the two-line telephone next to your fax machine.
- 2 Plug one end of the telephone line cord for your fax machine into the L2 jack of the triplex adapter. Plug the other end into the **LINE** jack on the left side of the fax machine.
- 3 Plug one end of the first telephone line cord for your TAD into the L1 jack of the triplex adapter. Plug the other end into the L1 or L1/L2 jack of the two-line TAD.
- 4 Plug one end of the second telephone line cord for your TAD into the L2 jack of the two-line TAD. Plug the other end into the **EXT.** jack on the left side of the fax machine.

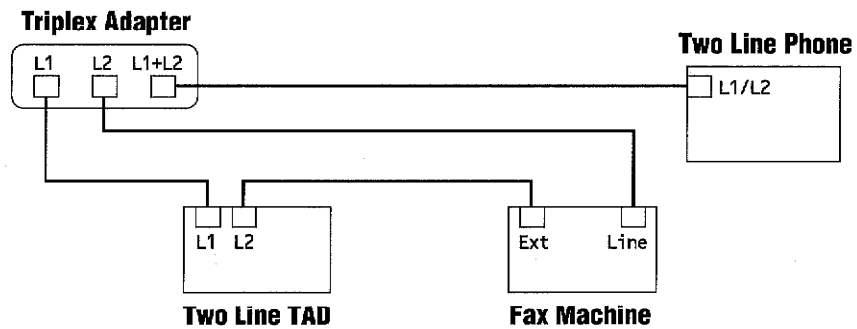

You can keep two-line telephones on other wall outlets as always. There are two ways to add a two-line telephone to the fax machine's wall outlet. You can plug the telephone line cord from the two-line telephone into the L1+L2 jack of the triplex adapter. Or, you can plug the two-line telephone into the TEL jack of the two-line TAD.

Multi-Line Connections (PBX)

Most offices use a central telephone system. While it is often relatively simple to connect the machine to a key system or a PBX (Private Branch Exchange), we suggest that you contact the company that installed your telephone system and ask them to connect the fax machine for you. It is advisable to have a separate line for the fax machine. You can then leave the machine in FAX ONLY Mode to receive faxes any time of day or night.

*See
Fax Only
Mode
p. 29*

If the fax machine is to be connected to a multi-line system, ask your installer to connect the unit to the last line on the system. This prevents the unit from being activated each time a telephone call is received.



As with all fax units, this machine must be connected to a two wire system. If your line has more than two wires, proper connection of the fax machine cannot be made.

If you are installing the machine to work with a PBX:

- 1 It is not guaranteed that the unit will operate correctly under all circumstances with a PBX. Any cases of difficulty should be reported first to the company that handles your PBX.
- 2 If all incoming calls will be answered by a switchboard operator, it is recommended that the Answer Mode be set to MANUAL. All incoming calls should initially be regarded as telephone calls.
- 3 The unit may be used with either pulse or tone dialing telephone service.

*See
Fax Only
Mode
p. 29*

Custom Features on Your Phone Line

If you have Call Waiting, Ring Master, Voice Mail, an answering service, alarm system or any other custom feature on your telephone line, it may create a problem in the operation of your fax machine.

Connecting a Telephone Answering Device (TAD)

Sequence

When you have a TAD on the same telephone line as the fax machine, the TAD answers all calls. The fax machine “listens” for fax calling (CNG) tones. If it hears them, the fax machine takes over the call and receives the fax. If it doesn’t hear CNG tones, the fax machine lets the TAD continue playing your outgoing message so your caller can leave you a voice message.

*See Fax
Handshake
p. 2*

The TAD must answer within 4 rings (the recommended setting is 2 rings). The fax machine cannot hear CNG tones until the TAD has answered the call, and with 4 rings there are only 8-10 seconds of CNG tones left for the fax “handshake.” Make sure you carefully follow instructions in this manual for recording your outgoing message. Do not use a “toll-saver” ring setting on the TAD.

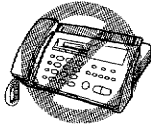

Do not connect a TAD elsewhere on the same phone line — your fax machine and TAD will both try to control the line.

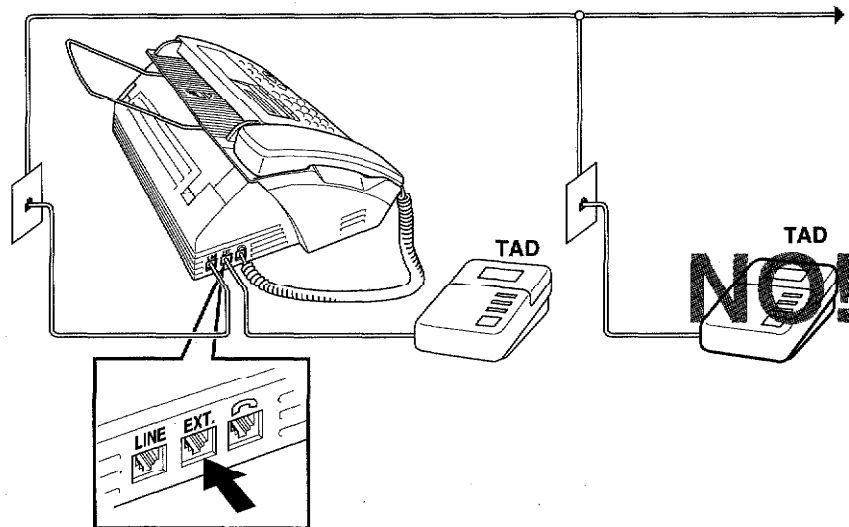

Connections

The TAD must be plugged into the left side of the fax machine, into the jack labeled EXT. Your fax machine cannot work properly if you plug the TAD into a wall jack.

- 1 Plug the telephone line cord from the wall jack into the left side of the fax machine, in the jack labeled LINE.
- 2 Plug the telephone line cord from your TAD into the left side of the fax machine, in the jack labeled EXT. (Make sure this cord is connected to the TAD at the TAD's telephone line jack, and not its telephone set jack.)
- 3 Press **Mode** until the screen displays **TAD: ANSWER MACH.**
- 4 Set your TAD to 4 rings or less. (The fax machine's Ring Delay setting does not apply).
- 5 Set the TAD to answer calls.
- 6 Record the outgoing message (see below).

Outgoing Message (OGM)

Timing is important in recording this message. The message sets up the ways to handle both manual and automatic fax reception.

- 1 Record 5 seconds of silence at the beginning of your message. (This allows your fax machine time to listen for the fax CNG tones of automatic transmissions before they stop.)
- 2 Limit your speaking to 20 seconds.
- 3 End your 20-second message by giving your Remote Activation Code for people sending manual faxes. For example:
“After the beep, leave a message or send a fax by pressing * 5 1.”

*See
Easy Receive
p. 30*

Connecting an External Telephone

Your fax machine is equipped with a handset that you can use as a regular phone. However, you can also connect a separate telephone (or telephone answering device) directly to your fax machine.

Connect the modular plug on the telephone's line cord to the jack labeled **EXT.** on the left side of the fax machine.

Whenever this phone (or TAD) is in use, the screen displays “EXT. TEL IN USE,” and, if the fax handset is lifted, an alarm sounds. To disconnect the call on the external phone and switch to the fax, press **[Hook]**.

CHAPTER THREE

Fax Settings

Fax Settings

Setting Dialing Mode (Tone/Pulse)

Your fax machine comes set to accommodate tone (multi-frequency) dialing service. If you have pulse (rotary) dialing service, you need to change the dialing mode.

- 1 Press **[Function]**, **[6]**, **[1]**. The screen prompts you to select TONE or PULSE.

DIALING: TONE

DIALING: PULSE

- 2 Use **[◀]** or **[▶]** to select dialing mode.
- 3 Press **[Set]** when the screen displays the dialing mode you want.
- 4 Press **[Stop]**.

Setting Date and Time

Your fax machine displays the date and time, and prints it on every fax you send.

In the event of a power failure, the fax machine maintains date and time information for about one hour. All other settings remain unaffected.

- 1 Press **[Function]**, **[7]**, **[1]**. The screen prompts you to enter the year.

ENTER YEAR: XX

- 2 Enter the last two digits of the year. The screen displays your entry, then prompts you to enter the month.

ENTER MONTH: XX

- 3 Enter two digits for the month (for example, enter 09 for September, or 10 for October). The screen displays your entry, then prompts you to enter the day.

ENTER DAY: XX

- 4 Enter two digits for the day (for example, 06). The screen displays your entry, then prompts you to set the time.

ENTER TIME: XX:XX

- 5 Enter the time in 24-hour format (for example, enter 15:25 for 3:25 PM).
- 6 Wait two seconds.
- 7 Press **Stop**. The screen now displays the date and time you set, and displays it whenever the fax machine is standing by.

Setting Station ID

*See
Cover Page
p. 37*

You can store your name, fax number, and telephone number to be printed on the fax Cover Page, and on all fax pages.

- 1 Press **Function**, **7**, **4**. The screen prompts you to enter your fax number.

FAX:

- 2 Enter your fax number (up to 20 digits). The screen displays your entry.

- 3 Press **Set**. The screen prompts you to enter your telephone number.

TEL:

- 4 Enter your telephone number (up to 20 digits). If your telephone number and fax number are the same, enter the same number again.

- 5 Press **Set**. The screen prompts you to enter your name or your company name.

NAME:

- 6 Use the keypad to enter your name. (You can use the chart on page 17 to help you enter letters.)

- 7 Press **Set** to confirm.

- 8 Press **Stop**. The screen returns to the date and time.

Entering Text

When you are setting certain functions, such as the Station ID, you may need to enter text into the fax machine. Most number keys have two or three letters printed above them. The keys for 0, #, and * don't have printed letters because they are used for special characters.

By pressing the appropriate number key the correct number of times, you can access the character you want.

Press Key	one time	two times	three times	four times
2	A	B	C	
3	D	E	F	
4	G	H	I	
5	J	K	L	
6	M	N	O	
7	P	Q	R	S
8	T	U	V	
9	W	X	Y	Z

Inserting spaces

If you want to enter a blank space, press  twice.

Making corrections

If you entered a letter incorrectly and want to change it, press  to move the cursor back. When you reach the letter you want to change, enter a new one in its place.

Repeating letters

If you need to enter a character assigned to the same key as the previous character, press  to move the cursor to the right.

Special characters and symbols

Press * for (space) ! " # \$ % & ' () * + , - . /

Press # for ; : < = > ? @ [] ^ _

Press Ø for Ä Ë Ö Ü à ç è é 1

NOTICE: The Telephone Consumer Protection Act of 1991 makes it unlawful for any person to use a computer or electronic device to send any message via a telephone fax machine unless such messages clearly contain, in a margin at the top or bottom of each transmitted page, or on the first page of the transmission, the date and time it is sent and an identification of the business or other entity or other individual sending the message and the telephone number of the sending machines or such business, other entity, or individual.



- The telephone number you enter is used only for Call Back Message and Cover Page features.
- If you do not enter a fax number, no additional information can be entered.
- To enter a space, press **[▶]**.
- If your Station ID has already been programmed, the screen prompts “1” to make a change, or “2” to exit without changing.

Storing One Touch Dial Numbers

You can store 5 fax/phone numbers that you can dial by pressing one key. You can also store names with these numbers. When you press a One Touch dial location, the screen displays the name or number as the call is dialed.

One Touch keys are not the dial pad keys. They are the 5 keys (number 1-5) located to the right of the dial pad.

- 1 Press **[Function]**, **[4]**, **[1]**.
- 2 Press the One Touch key where you want to store a number. (Key **[1]** is pre-programmed for Brother Fax-BackSM System. You can override it if you wish.) The screen displays the location you selected.
- 3 Enter a number (up to 20 digits). If you want to enter a pause in the dialing sequence (to wait for an “outside line,” for example), press **[Redial/Pause]** as you’re entering digits. You can enter only one pause in each AUTO DIAL number. Pressing **[Redial/Pause]** enters a 3.5-second pause when the number is dialed, and a dash appears on the screen.
- 4 Press **[Set]**. The screen prompts you to enter a name for this number.

NAME: _____

- 5 Use the keypad to enter the name (up to 15 characters). You can use the chart on page xx to help you enter letters — **OR** — Press **[Set]** and go to Step 7 to store the number without a name.

- 6 Press **Set**. The screen prompts you to select the type of number this is. Use **◀** or **▶** to select the type you want.
- FAX** a fax only number
 - TEL** a telephone (voice) number
 - F/T** both a fax and voice number
 - CHAIN** a number (usually an access code) for chain dialing.
- 7 Press **Set**.
- 8 Return to Step 2 to store another One-Touch number — **OR** — Press **Stop** to exit.

When you dial an AUTO DIAL number, the screen displays the name you've stored, or, if you haven't stored a name, the number you've stored.



If you need to store a pause longer than 3.5 seconds, please call Brother Customer Service at 1-800-284-4329 in the USA, or 1-800-853-6660 from within Canada.

You can use chain dialing to store long dialing sequences. For example, to store **9 1 201 555 1234 987 65 4321**, divide the number into 2 parts. Store the first part as a Chain type number (this tells the system that the dialing sequence is not complete).

CHAIN — 9 1 201 555 1234

The last part must be stored as any of the other 3 types.

FAX or F/T or TEL — 987 65 4321

Now, when you dial, just press the two keys (one after the other, in order) where you've stored the two parts of the number.



If you are using Chain Dialing with a credit card number, do not send an electronic cover page. The credit card number will appear on it.

One Touch Dialing

- 1 Pick up the handset — **OR** — Press **[Hook]**.
- 2 When you hear a dial tone, press the One Touch key of the location you want to call.
- 3 If you pressed **[Hook]** to dial the call, pick up the handset when the other party answers. (The speaker works only one way; the other party won't be able to hear you unless you pick up the handset.)



If you try to use a One Touch location with no number stored in it, you hear a warning sound, and the screen displays "NOT REGISTERED." The display returns to normal after 2 seconds.

Storing Speed Dial Numbers

You can store 15 (Fax 170) or 20 (Fax 190) Speed Dial numbers, which you dial by pressing only three keys. Even if you lose electrical power, numbers stored in memory will not be lost.

- 1 Press **[Function]**, **[4]**, **[2]**. The screen prompts you to enter a location.

SPEED-DIAL? #_

- 2 Use the keypad to enter a 2-digit location (01 - 15 for Fax 170; 01 - 20 for Fax 190). The screen displays your entry, then prompts you to enter the number you're storing.

#*05
ENTER & SET

- 3 Enter the number (up to 20 digits).
- 4 Press **[Set]**. The screen now prompts you to store a name with this number.

NAME:

- 5 Use the keypad to enter the name. You can use the chart on page 17 to help you enter letters — **OR** — Press **[Set]** and go to Step 7 to store the number without a name.
- 6 Press **[Set]**.

- 7 The screen prompts you to select the type of number this is. Use **◀** or **▶** to select the type you want.

FAX a fax number

TEL a telephone (voice) number

F/T both a fax and telephone number

CHAIN a number (usually an access code) for chain dialing.

- 8 Press **Set**.
- 9 Return to Step 2 to store another Speed Dial number — **OR** — Press **Stop** to exit.

Speed Dialing

- 1 Pick up the handset — **OR** — Press **Hook**.
- 2 When you hear a dial tone, press **Speed Dial**, then press the two-digit Speed Dial number.
- 3 If you pressed **Hook** to dial the call, pick up the handset when the other party answers. (The speaker works only one way; the other party won't be able to hear you unless you pick up the handset.)

Changing One Touch and Speed Dial Numbers

If you try to store a One Touch or Speed Dial number in a location where a number is already stored, the screen displays the current name stored there, then prompts you to either

1. CHANGE — OR — 2. EXIT.

- 1 Press **1** to change the number stored, or press **2** to exit without making a change.
- 2 If you want to erase the number, press **Stop** when the cursor is to the far left of the digits.
- 3 If you want to change a digit, use **◀** or **▶** to position the cursor under the digits you want to change, then press **Stop**.
- 4 Enter a new number, and press **Set**.
- 5 Follow the directions from Step 5 in Storing One Touch Numbers or Storing Speed Dial Numbers.

Setting Beeper Level

You can set the beeper to LOW, HIGH or OFF. The machine comes set to LOW. When the beeper is set to LOW or HIGH, the fax machine beeps every time you press a key or make an error, and at the end of fax sending or receiving.

- 1 Press **Function**, **5**, **2**.
- 2 Press **◀** or **▶** to select your setting.
- 3 When the screen displays the setting you want, press **Set**.
- 4 Press **Stop** to exit.

Temporary Memory Backup Storage

All settings in the SET AUTO DIAL, USER OPTIONS, TEL OPTIONS, and SETUP SYSTEM functions are stored permanently and will be retained even in the event of a power failure.

CHAPTER FOUR

On-Screen Programming

User-Friendly Programming

*See
Using This
Manual p. 1*

We have designed your fax machine with on-screen programming and a Help key. User-friendly programming helps you take full advantage of all the functions your fax machine has to offer.

Since your fax programming is done on the LCD, we created step-by-step on-screen prompts to help you program your fax machine. All you need to do is follow the prompts as they guide you through the function menu selections and programming options and settings.

Function Mode

You can access the function mode by pressing **[Function]**. When you enter the function mode, your fax machine displays a list of Level One Functions from which you can choose. These function options appear one after the other on the display. Select an option by pressing **[Set]** when the option appears on the LCD.

You can “scroll” more quickly through options by pressing **[▶]**. When the screen displays your selection, press **[Set]**.



If you want to exit the Function Mode, press **[Stop]**.

Alternating Displays

When you see alternating displays, the LCD sometimes alternates between the currently selected option, and a help message giving brief instructions about how to proceed. The display you'll probably see most often is shown below, showing you, when you place a document in the feeder, that you can dial a number and send a fax, or you can make a copy.



Function Selection Table

If you have a basic understanding of how to program a fax machine, you can perform most of the programming settings without the Owner's Manual. To help you understand the function selections, options, and settings that are found in your fax programs, use the Function Selection Table below.

1. TEMP. SETTINGS

Function	Description	Factory Set	More Info
1. TIMER	Send documents later.	--	p. 35
2. POLLING	Retrieve faxes from another machine.	STANDARD	p. 44
3. CALL RESERVE	You can send a fax, then speak.	OFF	p. 39
4. CONTRAST	Change lightness or darkness of fax you're sending.	AUTO	p. 28
5. RESOLUTION	Allows you to change resolution page by page.	STANDARD	p. 28
6. OVERSEAS MODE	Adjusts for sometimes difficult overseas transmissions.	OFF	p. 36
7. COVERPAGE	Automatically sends coverpage you program.	OFF	p. 37

6. TEL OPTIONS 5. USER OPTIONS 4. SET AUTO DIAL 3. PRINT REPORTS 2. CANCEL JOB

Function	Description	Factory Set	More Info
	Cancel a timed or polled job.		p. 36
1. ACT. REPORT 2. ALL DIAL 3. TEL. INDEX 4. COVER PAGE 5. CALL BACK MSG 6. USER OPTIONS 7. XMIT REPORT	Print lists and reports of activity. (Details in Chapter 8)	OFF	p. 48 p. 47 p. 47 p. 47 p. 47 p. 47 p. 48
1. ONE-TOUCH DIAL 2. SPEED-DIAL	Dial numbers stored in memory by pressing only one key. Dial numbers stored in memory pressing only 3 keys.	USER DEFINED	p. 18 p. 20
1. SMOOTHING 2. BEEPER 3. COVERPG ON/OFF 4. GRAY SCALE	Enhance the appearance of incoming faxes. Adjust volume level of beeper. Send automatic coverpage with comment. Select a gray scale level.	ON LOW OFF 32	p. 32 p. 22 p. 37 p. 37
1. TONE/PULSE 2. RING DELAY 3. SPEAKER VOLUME 4. F/T RING TIME 5. RING VOLUME 6. DISTINCTIVE	Select dialing mode. Number of rings before machine answers in F/T or FAX ONLY mode. Adjust speaker volume. Sets the time for "double-ring" in F/T mode. Adjust volume of ringer. Use with phone company distinctive ringing service to register ring pattern with fax machine.	TONE 2 LOW 20 MED OFF	p. 34 p. 31 p. 32 p. 31 p. 32 p. 42

7. SETUP SYSTEM

Function	Description	Factory Set	More Info
1. DATE/TIME	Enter date and time for LCD display and to print on transmissions.	01/01 00:00	p. 15
2. DAILY TIMER	Send delayed jobs at the same time every day.	00:00	p. 35
3. INTERVAL	Select the interval of time between activity reports.	OFF	p. 48
4. STATION ID	Program name, fax number, and telephone number to appear on each transmitted page.	--	p. 16
5. REMOTE CODE	Enter code to activate or deactivate machine from a remote location.	ON	p. 41
6. EASY RECEIVE	Receive fax messages without pressing Start key.	OFF	p. 30

CHAPTER FIVE

Basic Fax Operation

Sending Faxes

Before you begin:

- Documents must be between 5.8 and 8.5 inches wide, and 5.9 and 23.7 inches long. Your fax machine can only scan an image 8.2 inches wide, regardless of how wide the paper is.
- Make sure you insert documents **face down, top edge first**.
- Adjust the paper guides to fit the width of your document.

Paper guides

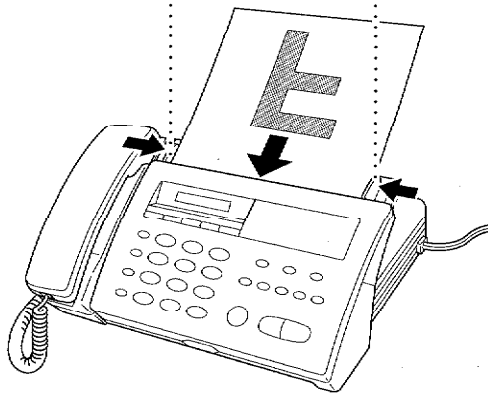

- The automatic document feeder (ADF) can hold up to 10 pages, feeding each one individually through the fax machine. Use standard (20 lb.) paper when using the ADF; if you're using heavier paper, feed each sheet individually to prevent paper jams.

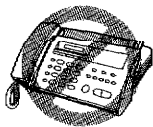

- Press **Resolution** (before you send the fax) to select the resolution for the document you're sending.

Standard — suitable for most typed documents.

Fine — good for small print; transmits a little slower than standard resolution.

Super Fine — good for small print or artwork; transmits slower than fine resolution.

Photo — use when document has varying shades of gray; slowest transmission time.

- **DO NOT** use curled, wrinkled, folded, or ripped paper, or paper with staples, paper clips, paste or tape attached. **DO NOT** use cardboard, newspaper, or fabric.
- Make sure documents written with ink are completely dry.

Contrast Setting

If your document is very light or very dark, you might want to set the contrast accordingly.

- 1 Insert the document, face down, in the feeder.
- 2 Press **Function**, **1**, **4**.
- 3 Use **◀** or **▶** to select **AUTO**, **S.LIGHT**, or **S.DARK**.
- 4 When the screen displays your selection, press **Set**.
- 5 Press **Stop** to exit.
- 6 Press **Start** to send a fax — **OR** — Press **Copy** to make a copy.

Manual Transmission

Manual transmission lets you hear the dial tone, ringing, and fax chirps before sending the fax. Don't wait too long to press **Start** after you hear the chirp, or your fax machine will go into receiving mode.

- 1 Insert the document face down in the feeder.
- 2 Pick up the handset and listen for a dial tone — **OR** — Press **Hook** and listen for a dial tone.
- 3 Enter the fax number you want to call (you can enter the digits using the keypad, or you can enter a One Touch or Speed Dial number or you can call from the Tel-Index).

See
One-Touch
p. 18

*See
Speed Dial
p. 20*

- 4 When you hear the fax tone, press **Start**.
- 5 If you're using the handset, hang up.

Automatic Transmission

This is the easiest way to send a fax. Do not pick up the handset or press **Hook**. You won't hear any tones, but the fax machine is sending them over the phone line.

- 1 Insert the document face down in the feeder.
- 2 Enter the fax number from One Touch or Speed Dial or Tel-Index.
- 3 Press **Start**.

Manual and Automatic Fax Redial

If you're sending a fax manually and the line is busy, press **Redial/Pause** to retry the number.

If you're sending a fax automatically, the machine will detect if the line is busy and will automatically redial up to three times.

Receiving Faxes

*See
Distinctive
Ringing
p. 42*

Select Answer Mode

Manual — You must answer all calls yourself. You can use this mode with Distinctive Ringing.

Fax Only — The fax machine automatically answers every call as a fax call. You cannot receive a voice call, but you can dial out and make a voice call.

F/T — The fax machine automatically answers every call. If the call is a fax, it prints the fax. If the call is not a fax, it signals you with a double ring (ring-ring), different from the phone company ringing, to alert you to pick up the call. If you select this setting, you'll need to set the Ring Delay and F/T Ring Time features (on the following pages). If you have extension phones on the same line as the fax machine, set Ring Delay to 4.

TAD — This is the only setting in which you can use an answering machine. Your telephone answering device is connected to your fax machine, and answers every call. Once the TAD answers, the fax machine listens for fax tones. If it detects fax tones, it prints the fax.

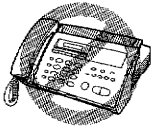

The TAD setting works only with an external telephone answering device (TAD); it does not work with telephone company voice mail. Ring Delay and F/T Ring Time do not work in this setting.

Current
Answer Mode

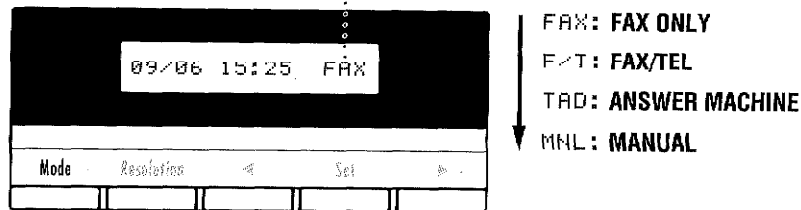

Easy Receive

When you use this feature, you don't have to press **Start** when you answer a fax call and hear calling beeps. Just hold the handset and wait a few seconds. When you see "Receive" on the fax screen or when you hear "chirps" through the handset of an extension phone connected to another wall jack, just replace the handset, and the fax machine does the rest. Selecting "ON" allows the machine to receive fax calls automatically, even if you lift the handset of an extension phone. Selecting "SEMI" lets the fax machine receive the call only if you've answered it at the fax machine or on a phone or TAD connected to the fax machine. Selecting "OFF" means you'll have to activate the fax machine yourself, by pressing **Start** or by pressing ***51** if you are not at the fax machine.

In case Easy Receive does not work, because of a poor phone line connection, just press **Start** or press the Activation Code ***51**.

- 1 Press **Function**, **7**, **6**.
- 2 Use **◀** or **▶** to select ON, SEMI, or OFF.
- 3 Press **Set** when screen displays your selection.
- 4 Press **Stop** to exit.

See Remote
Operation
p. 41

If you've set the feature to ON, but your fax machine doesn't automatically connect a fax call when you lift the extension phone handset, press **[*] [5] [1]**. At the fax machine, lift the handset and press **[Start]**.

To select or change your Answer Mode

1 Press **[Mode]**. The screen displays your current selection.

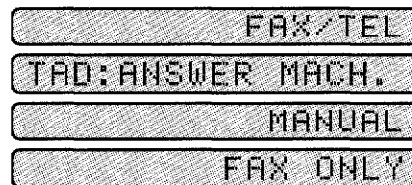

2 Continue to press **[Mode]** until your new selection appears. After 2 seconds, the screen returns to the date and time display, along with your new Answer Mode setting.

If you're changing Answer Mode while in another operation, the screen returns to the current operation display.



Setting Ring Delay

The Ring Delay setting determines the number of times the fax machine rings before it answers. If you have extension phones on the same line as the fax machine, set the Ring Delay to 4.

1 Press **[Function], [6], [2]**.

2 Press **[◀]** or **[▶]** to select how many times the line rings before the fax machine answers (00 – 04). If you select 00, the line doesn't ring at all.

3 Press **[Set]** when the screen displays your selection.

4 Press **[Stop]** to exit.

Setting F/T Ring Time

You need to determine how long the fax machine will send you its special double ring when you have a voice call. This ringing happens *after* the initial ringing from the phone company. Only the fax machine rings, for 10, 20, 30, or 60 seconds; no other phones on the same line ring the special double ring. However, you can answer the call on any phone on the same line as the fax machine.

1 Press **[Function], [6], [4]**.

2 Press **[◀]** or **[▶]** to select how long the fax machine will ring to alert you that you have a voice call.

3 Press **[Set]** when the screen displays your selection.

See Remote Codes p. 41



RING TIME:XX SEC

- 4 Press **Stop** to exit.

Now, when a call comes in and the machine is set to F/T Mode, all phones on this line will ring the number of times you selected in Ring Delay.

You can let the fax machine pick up and detect if it's a fax or voice call. If it's a fax call, the machine prints the fax. If it's a voice call, the machine signals you with a double ring for the length of time you selected in F/T Ring Time.

Even if the caller hangs up during the double ringing, the fax machine continues for the set time. If you don't pick up during the ring time, the fax machine begins sending a fax tone, even if the caller is still on the line.

Speaker Volume

You can set the volume of the fax machine speaker.

- 1 Press **Function**, **6**, **3**.
- 2 Press **Left** or **Right** to select your volume setting (OFF, LOW, MEDIUM, or HIGH).
- 3 Press **Set** when the screen displays your selection.
- 4 Press **Stop** to exit.

Even if you select OFF, the sounds you hear after pressing **Hook** remain on LOW.



Ring Volume

You can select how loudly, or if, the fax machine rings.

- 1 Press **Function**, **6**, **5**.
- 2 Press **Left** or **Right** to select OFF, LOW, MEDIUM, or HIGH.
- 3 Press **Set** when the screen displays your selection.
- 4 Press **Stop** to exit.

Even if you select OFF, the ring volume will remain on LOW in F/T mode, and on LOW in Call Reservation and Distinctive Ringing (if they're set to ON).



Smoothing

When activated, this feature enhances the appearance of incoming faxes by "smoothing" lines. It takes no longer to receive faxes in this setting, which comes set to ON.

You cannot use "smoothing" for outgoing faxes, or for printing lists and reports.

- 1 Press **Function**, **5**, **1**.
- 2 Press **Left** or **Right** to choose ON or OFF.
- 3 Press **Set**.
- 4 Press **Stop** to exit.

CHAPTER SIX

Telephone (Voice) Operation

Making Voice Calls

You can use your fax machine to make voice telephone calls, by dialing manually or by using One Touch or Speed Dial memory.

Manual Dialing

Manual dialing is simply pressing all of the digits of the phone number.

- ➊ Pick up the handset — **OR** — Press **[Hook]**.
- ➋ When you hear a dial tone, dial the call, using the keypad.
- ➌ If you pressed **[Hook]** to dial the call, pick up the handset when the other party answers. (The speaker works only one way; the other party won't be able to hear you unless you pick up the handset.)

One Touch Dialing

- ➊ Pick up the handset — **OR** — Press **[Hook]**.
- ➋ When you hear a dial tone, press the One Touch key of the location you want to call.
- ➌ If you pressed **[Hook]** to dial the call, pick up the handset when the other party answers. (The speaker works only one way; the other party won't be able to hear you unless you pick up the handset.)

*See
One Touch
p. 18*



If you try to use a One Touch location with no number stored in it, you hear a warning sound, and screen displays "NOT REGISTERED." The display returns to normal after 2 seconds.

*See
Speed Dial
p. 20*

Speed Dialing

- 1 Pick up the handset — **OR** — Press **[Hook]**.
- 2 When you hear a dial tone, press **[Speed Dial]**, then press the two-digit Speed Dial number.
- 3 If you pressed **[Hook]** to dial the call, pick up the handset when the other party answers. (The speaker works only one way; the other party won't be able to hear you unless you pick up the handset.)

Hold

- 1 Press **[Hold]** to put a call on Hold.
- 2 You can put down the handset without disconnecting the call.
- 3 Pick up the fax machine handset to release the call from Hold. Picking up an extension handset will not release the call from Hold.

Pause

Press **[Redial/Pause]** to insert a 3.5 second pause between numbers.

Tone/Pulse

If you have pulse dialing service, but need to send tone signals (for telephone banking, for example), follow the directions below. If you have touch tone service, you do not need this feature to send tone signals.

- 1 Lift the handset.
- 2 Press **[#]**. Any digits dialed after this send tone signals.
- 3 When you hang up, the fax machine returns to pulse dialing service.

Searching Telephone Index

*See
One-Touch
and
Speed Dial
p. 20*

You can search for names you have stored in One Touch and Speed Dial memories. Names are stored alphabetically.

- 1 Press **[Tel-index]**, then enter the first letter of the name you're looking for.
- 2 Press **[◀]** or **[▶]** to search the memory.
- 3 When the screen displays the name you want to call, pick up the handset or press **[Hook]**.
- 4 Press **[Start]** to begin dialing.
- 5 When the call is over, hang up, or press **[Hook]** to cancel the call.

CHAPTER SEVEN

Advanced Fax Operation

Sending Faxes

Daily Timer

You can use this function to send a fax at a set time every day. The setting stays the same until you change it.

- 1 Press **Function**, **7**, **2**.
- 2 Use the keypad to enter the time in 24-hour format (for example, enter 19:45 for 7:45 PM).
- 3 Wait 2 seconds, then press **Stop** to exit.

Delayed Transmission

You can use this function to send a fax up to 24 hours later.

- 1 Insert the document in the feeder.
- 2 Press **Function**, **1**, **1**.
- 3 Enter the time you want the fax to be sent, in 24-hour format (for example, enter 19:45 for 7:45 PM).
- 4 Wait two seconds (the screen will display "1. TIMER"), then press **Stop**. The screen prompts you to enter the fax number and press the **Start** key.



- 5 Enter the fax number, and press **Start**. The fax machine will wait until the time you have entered to send the fax.

Interrupting Timer and Poll Waiting

You can send a fax now, even if you have the machine set to send a fax later, or if you have it set for Poll Waiting. However, you cannot use automatic redial or the function mode.

- 1 Press **[Function]**, **[0]**.
- 2 Wait 2 seconds, then remove the documents that are waiting in the feeder.

INSERT DOCUMENT

- 3 Place the document you want to send now in the feeder.
- 4 Enter the number for the fax you want to send now.
- 5 Press **[Start]**.
- 6 After the transmission is finished, return the first document to the feeder.
- 7 Press **[Function]**, **[0]** to restore the timer.

Canceling a Delayed Fax

You can cancel tasks you've scheduled using the timer.

- 1 Press **[Function]**, **[2]**. Any waiting jobs appear on the display. If nothing is waiting, the screen displays NO JOB WAITING.

2. CANCEL JOB

- 2 Press **[Set]** when the screen displays the job you want to cancel.
- 3 Press **[1]** to cancel — **OR** — Press **[2]** to exit without canceling.

Overseas Mode

After you send a fax using this feature, the feature turns itself off.

- 1 Insert document.
- 2 Press **[Function]**, **[1]**, **[6]**.

6. OVERSEAS MODE

- 3 Press **[◀]** or **[▶]** to select this mode.
- 4 Press **[Set]** when the screen displays your selection.
- 5 Press **[Stop]** to exit.
- 6 Follow basic procedures to send fax.

*See
Sending
Faxes
p. 27*

Gray Scale

This fax machine is preset to a gray scale level of 32, which is effective for sending photographs. However, if the machine to which you are sending the fax cannot receive a 32 gray scale level, your machine will automatically adjust to a 16 gray scale level. So, if you frequently send to a fax machine that can only receive at 16, you might want to set your machine to 16.

- 1 Press **Function**, **5**, **4**.
- 2 Press **◀** or **▶** to select the gray scale level.
- 3 Press **Set** when the screen displays your selection.
- 4 Press **Stop** to exit.

Sending Electronic Cover Page

- 1 Your cover page includes the name/number stored in the One Touch or Speed Dial memory. If you're dialing manually, the name is left blank.
- 2 The cover page indicates the fax is from your Station ID, and the number of pages you're sending. If you're sending from automatic settings, the number of pages remains blank.
- 3 You can select comments to include on your cover page.

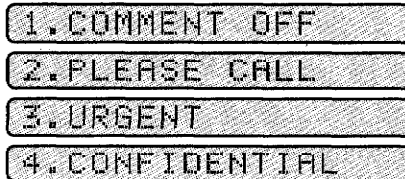

Always Send Cover Page

You can set the machine to print a cover page whenever you send a fax. The number of pages in your fax is not included when you use this setting.

- 1 Press **Function**, **5**, **3**.
- 2 Press **◀** or **▶** to select.

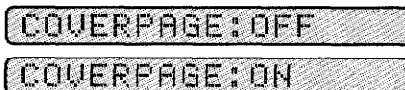

- 3 Press **Set** when the screen displays your selection. (If you select ON, a coverpage is always sent when you send a fax.)
- 4 If you selected ON, you must select a comment. Use **◀** or **▶** to view possible selections.

*See
One-Touch
and
Speed Dial
p. 20*

*See
Station ID
p. 16*

1. COMMENT OFF

2. PLEASE CALL

3. URGENT

4. CONFIDENTIAL

- 5 Press **[Set]** when the screen displays your selection.
- 6 Press **[Stop]** to exit. Now, whenever you insert a document in the feeder, the screen displays COVERPAGE ON before prompting you to dial.

Temporary Page

You can set the fax to send a cover page with a particular document. This cover page will include the number of pages in your document.

- 1 Insert the document in the feeder.
- 2 Press **[Function]**, **[1]**, **[7]**.
- 3 Press **[Left]** or **[Right]** to select ON or OFF.
- 4 Press **[Set]** when the screen displays your selection.
- 5 Press **[Left]** or **[Right]** to view comment selections.

1. COMMENT OFF

2. PLEASE CALL

3. URGENT

4. CONFIDENTIAL

- 6 Press **[Set]** when the screen displays your selection.
- 7 Enter the number of pages you are sending.
(Enter **[0]** to leave number of pages blank).
- 8 Wait 2 seconds, then press **[Stop]**.
- 9 Enter the fax number you're calling.
- 10 Press **[Start]**.

Printing a Cover Page

- 1 Press **[Function]**, **[3]**, **[4]**.
- 2 Press **[Start]**. Your fax machine prints a copy of your cover page for you.

Call Reservation

You can send a fax and let the other party know that you want to speak to him after the fax transmission is complete. The other fax machine will ring as if it were receiving a telephone call; if the other party picks up the handset, your fax machine will ring. Lift the handset to have a conversation.

If you set Call Reservation and Call Back message to ON, your fax machine leaves a message if the other party does not answer.

- 1 Insert the document in the feeder.
- 2 Press **Function**, **1**, **3**. The screen displays the current setting for Call Reservation.

CALL RESERVE: ON
CALL RESERVE: OFF

- 3 Press **◀** or **▶** to select ON or OFF.
- 4 Press **Set** when the screen displays your selection. The screen displays the current setting for Call Back Message.

CALL BACK: OFF
CALL BACK: ON

- 5 Press **◀** or **▶** to select ON or OFF.
- 6 Press **Set** when the screen displays your selection.
- 7 Press **Stop**. The screen prompts you to enter the fax number you want to call.
- 8 Enter the fax number, and press **Start**.
- 9 If you've set Call Reservation to ON, pick up your handset if the fax machine rings.

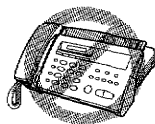

You cannot use auto redial with Call Reservation. You cannot use Call Reservation with Delayed Transmission or with Polling. You must register your Station ID number to set Call Back Message to on.

Print Call Back Message

- 1 Press **Function**, **3**, **5**.
- 2 Press **Start**.

Next-Fax Reservation (FAX 190 only)

Even if your fax is receiving another fax, you can set your machine to send your fax next. This way, you don't have to wait for it to finish sending or receiving the other fax. You can dial this fax call manually, or by using Redial, One Touch, Speed Dial, or Chain dialing. (When you use One Touch and Speed Dial, only the memory location — not the name of the person you're calling — is displayed.)

- 1 Insert the documents in the feeder. If necessary, press **Resolution** to adjust resolution.
- 2 Enter the fax number.
- 3 Press **Start**.
- 4 Press **Set**. The screen displays

NEXT-FAX RESERVD

- 5 To cancel the reservation, remove the documents and press **Stop**.



You can't use this feature if there is a document waiting in the feeder (possibly for Delayed Transmission or Poll Waiting), or when the timer has been interrupted.

Receiving Faxes

Remote Operation

If you answer a fax call on an extension phone, you can make your fax machine take over by using the Activation Code. When you press the Activation Code *** 5 1**, the fax machine starts to receive a fax.

If the fax machine answers a voice call and double-rings for you to take over, use the Deactivation Code to take the call at an extension phone.

If you answer a call, and no one is on the line, assume you're receiving a fax. At the fax machine phone, press **Start**, then hang up. At an extension phone, press *** 5 1**, wait for fax receiving tones (chirps), then hang up. (Your caller will have to press **Start** to send the fax.)

*See
Easy Receive
p. 30*

For F/T Mode Only

When the machine is in F/T mode, it will use the F/T Ring Time (double ringing) to alert you to a voice call. If you're at the fax machine you can lift the handset to answer.

If you're at an extension phone, you'll need to lift the handset during the F/T Ring Time and press **## 5 1** between the double rings. If no one is on the line, or if someone wants to send you a fax, send the call back to the fax machine by pressing *** 5 1**.

*See
F/T Ring
Time
p. 31*

Changing Remote Codes

Remote Codes might not work with some telephone systems. The preset Activation Code is *** 5 1**. The preset Deactivation Code is **## 5 1**.

If you are always disconnected when accessing your TAD remotely, try changing the Activation Code from *** 5 1** to **## ## ##** and the Deactivation Code from **## 5 1** to **9 9 9**.



To change Remote Codes

1 Press **[Function]**, **[7]**, **[5]**.

2 Press **[◀]** or **[▶]** to select **ON** or **OFF**.

REMOTE ACT.: ON

3 Press **[Set]** when the screen displays the setting you want.

4 If you want to, enter a new Remote Activation Code, then wait 2 seconds.

ACT. CODE: *51

5 If you want to, enter a new Remote Deactivation Code, then wait 2 seconds.

DEACT. CODE: #51

6 Press **[Stop]** to exit.

Distinctive Ringing

Distinctive Ringing is a subscriber service offered by some telephone companies, and allows you to have several telephone numbers on one phone line. Each phone number has its own distinctive ringing pattern, so you know which phone number is ringing. This is one way you can have a separate phone number for your fax machine.

Your fax machine has a distinctive ringing function, allowing you to dedicate one phone number just for receiving faxes. You'll need to follow the directions below to "register" the distinctive ringing pattern, so your fax machine can recognize its incoming calls. You will need another person standing by on another line to help you with Step 6 of this registration.

You can change or cancel the distinctive ringing pattern at any time. You can switch it off temporarily, then turn it back on. When you get a new fax number, make sure you reset this function.

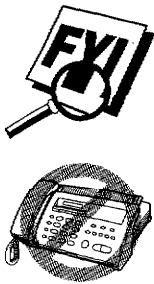

You can register only one distinctive ringing pattern with the fax machine. Some ringing patterns cannot be registered.

- The fax machine will answer only calls to its registered number.
- To have your TAD answer only the main number, the fax machine must be in Manual Mode.
- In F/T Mode or FAX ONLY, the fax machine will answer all numbers on the phone line.

Registering the distinctive ringing phone number

- 1 Disconnect the fax machine from any TAD or telephone company voice mail. Set the fax machine to MANUAL mode.
- 2 Have someone ready to call the distinctive ringing number you're assigning the fax machine.
- 3 Press **Function**, **6**, **6**.
- 4 Press **◀** or **▶** to select the SET Mode.
- 5 Press **Set**.
- 6 Press **Stop**. The screen displays

D/R SET MODE

Now, another person must call the fax number.

- 7 When the fax machine rings, listen for the ring pattern, and make sure it's the one you want for the fax machine.

If it is, wait for at least 2 complete rings. The screen displays

PICK UP TO SET

- 8 Lift the fax machine handset and press **Start**. The screen displays REGISTERED. (If the incorrect distinctive ringing number was called, press **Stop** to cancel.)
- 9 Hang up.

Once you've registered the distinctive ringing number in your fax machine, you can turn this feature ON or OFF. To change the setting, follow steps 1 to 4 above, selecting ON or OFF.

Caller ID



Caller ID is a telephone company subscriber service that allows you to see the name or telephone number of your caller as the line rings.

As your phone rings, the screen displays the telephone number of your caller (or name, if available). Once you pick up the handset, the Caller ID information disappears.

- You will see the first 16 characters of the number or name.
- OUT-OF-AREA display means call originates outside your Caller ID service area.
- PRIVATE CALL display means the caller has intentionally blocked transmission of information.
- CALL PICKUP display remains on screen when no Caller ID information was transmitted.

If both the name and number are received, the screen displays only the name. Caller ID service varies with different carriers. Call your local phone company to determine what kind of service is available in your area.

Polling

Polling is the process of retrieving faxes from another fax machine. You can use your fax machine to “poll” other machines, or you can have someone poll your machine.

All parties involved in polling need to set up their fax machines to accommodate polling. When someone polls your machine to receive a fax, they pay for the call; if you poll someone’s fax machine to receive a fax, you pay for the call.

Some fax machines do not respond to the polling function.



Setup to Poll Another Fax

- 1 Make sure no document is in the feeder.
- 2 Press **Function**, **1**, **2**.
- 3 Wait 2 seconds.
- 4 The screen displays

POLLING: OFF

- 5 Press **◀** or **▶** to choose ON.
- 6 Press **Set**.
- 7 Press **Stop**.

The screen prompts you to enter the fax number you want to poll, and then

- 8 Press **Start**.

ENTER FAX NO.

PRESS START KEY

- 9 Enter the fax number you are polling.
- 10 Press **Start**.

Setup to Be Polled (Poll Waiting)

- 1 Place document in feeder.
- 2 Press **Function**, **1**, **2**.
- 3 Wait 2 seconds.
- 4 The screen displays

POLLING: OFF
- 5 Press **◀** or **▶** to choose ON.
- 6 Press **Set**.
- 7 Press **Stop**. The screen prompts you to press **Start**.
- 8 Press **Start** and wait for the fax to be polled.

Delayed Polling

You can set your fax machine to begin polling at a later time. Once you set this feature, you will need to use the Interrupting Timer to send a fax.

- 1 Make sure no document is in the feeder.
- 2 Press **Function**, **1**, **2**.
- 3 Wait 2 seconds.
The screen displays

POLLING: OFF
- 4 Press **◀** or **▶** to choose ON.
- 5 Press **Set**.
- 6 Press **1**. The screen prompts you to enter the time you want to begin polling.

SET TIME=00:00
- 7 Enter the time (in 24-hour format) you want to begin polling. For example, enter 21:45 for 9:45 PM.
- 8 Wait 2 seconds, then press **Stop**. The screen prompts you to enter the fax number you are polling.

FAX: ENTER FAX NO.
- 9 Enter the fax number (you can use One Touch or Speed Dial, or dial manually).
- 10 Press **Start**. The fax machine makes the polling call at the time you entered.

*See
Interrupting
Timer and
Poll Waiting
p. 36*

*See
Resolution
p. 28*



Copy Functions

Your fax machine cannot scan anything closer than one-eighth inch from the edge of the paper. Set the resolution to **S.FINE** or **PHOTO**.

- 1 Place document face down in the feeder.
- 2 Press **Copy**. (You can press **Copy** again for faster response — otherwise, copying begins in about 5 seconds.)

Do not pull on the paper while copying is in progress.

CHAPTER EIGHT

Printing Reports and Lists

Fax Machine Activity

You can print the following lists and reports:

1. ACT. REPORT

Activity Report lists information about the last 30 incoming and outgoing faxes.

2. ALL DIAL

Lists names and numbers stored in One Touch and Speed Dial memory, in numerical order.

3. TEL INDEX

ALL DIAL list (above), in alphabetical order.

4. COVERPAGE

Lets you check cover page format.

5. CALL BACK MSG

Lets you check Call Back Message format.

6. USER OPTIONS

Lists your settings for USER OPTIONS, TEL OPTIONS, SETUP SYSTEM.

7. XMIT REPORT

You can choose if the Transmission Verification Report will be printed after all faxes you send.

To print a report

- 1 Press **[Function]**, **[3]**.
- 2 Enter the number (see list above) of the report you want to print. For example, press **[3]** to print the TEL-INDEX.
- 3 Press **[Start]**.

Activity Report Interval

You can set the fax machine to print activity reports at specific intervals (6, 12, 24 hours, 2, 4, or 7 days). If you set the interval to OFF, you can print the report by following the steps in the previous section.

- 1 Press **[Function]**, **[7]**, **[3]**. The screen displays the current interval setting.

ACT. RPT. : OFF

- 2 Press **[◀]** or **[▶]** to choose your setting. If you choose 7 days, the screen prompts you to choose a day at which to begin the 7-day countdown.
- 3 When the screen displays the setting you want, press **[Set]**.
- 4 Enter the time to begin printing, in 24-hour format. (For example, enter 19:45 for 7:45 PM).
- 5 Wait 2 seconds.
- 6 Press **[Stop]** to exit.

Transmission Verification (Xmit) Report

You can use the Xmit Report as proof that you sent a fax. This report lists the name or fax number of the receiving party, the time and date of transmission, and if the transmission was successful.

When the feature is OFF, the report is printed automatically only if there's an error during transmission. If the report indicates NG, send the document again. If the report indicates you should check the readability of certain pages, resend those pages.

When the feature is ON, the report is printed with every fax you send.

- 1 Press **[Function]**, **[3]**, **[7]**.
- 2 Press **[◀]** or **[▶]** to select ON or OFF.
- 3 Press **[Set]**.
- 4 Press **[Stop]** to exit.

CHAPTER NINE



Important Information

Standard Telephone and FCC Notices

These notices are in effect on models sold and used in the United States.

This equipment is hearing aid compatible.

When programming emergency numbers and/or making test calls to emergency numbers:

- Remain on the line and briefly explain to the dispatcher the reason for the call before hanging up.
- Perform such activities in the off-peak hours, such as early morning or late evening.

This equipment complies with Part 68 of FCC Rules. On the rear panel of this equipment is a label that contains, among other information, the FCC Registration Number and Ringer Equivalence Number (REN) for this equipment. You must, upon request, provide this information to your telephone company.

You may safely connect this equipment to the telephone network by means of a standard modular jack, USOC RJ11C.

An FCC compliant telephone cord with a modular plug is provided with this equipment. This equipment is designed to be connected to the telephone network or premises wiring using a compatible modular jack that is Part 68 compliant. See the Installation section of this manual for details.

The REN is useful to determine the quantity of devices you may connect to your telephone line and still have those devices ring when your telephone number is called. In most, but not all areas, the sum of the RENs of all devices connected to one line should not exceed five (5). To be certain of the number of devices you may connect to your line, as determined by the REN, you should contact your local telephone company to determine the maximum REN for your calling area. If your fax damages the telephone network, the telephone company may discontinue your service temporarily. If possible, they will notify you in advance. But if advanced notice is not practical, you will be notified as soon as possible. You will be informed of your right to file a complaint with the FCC.

Your telephone company may make changes to its facilities, equipment, operations or procedures that could affect the proper functioning of your equipment. If they do, you will be notified in advance to give you an opportunity to maintain uninterrupted telephone service.

If you experience trouble with this fax, please contact the manufacturer's authorized service agency for information on obtaining service or repair. The telephone company may ask that you disconnect this equipment from the network until the problem has been corrected or until you are sure that the equipment is not malfunctioning.

If you are not able to solve a problem with your fax machine, contact Brother at 1-800-284-4 FAX (voice) or 1-908-271-1937 (fax) in the USA only.



WARNING

For protection against the risk of electrical shock, always disconnect all cables from the wall outlet before servicing, modifying or installing the equipment.

This equipment may not be used on coin service lines provided by the telephone company or connected to party lines.

This equipment has been tested and found to comply with the limits for a Class B digital device, pursuant to Part 15 of the FCC Rules. These limits are designed to provide reasonable protection against harmful interference in a residential installation. This equipment generates, uses, and can radiate radio frequency energy and, if not installed and used in accordance with the instructions, may cause harmful interference to radio communications. However, there is no guarantee that interference will not occur in a particular installation. If this equipment does cause harmful interference to radio or television reception, which can be determined by turning the equipment off and on, the user is encouraged to try to correct the interference by one or more of the following measures:

- Reorient or relocate the receiving antenna.
- Increase the separation between the fax equipment and the receiver.
- Connect the fax equipment on a separate circuit.
- Consult with the dealer or an experienced radio/TV technician for help.

Brother cannot accept any financial or other responsibilities that may be the result of your use of this information, including direct, special or consequential damages. There are no warranties extended or granted by this document.

The serial number may be found on the label affixed to the back of the unit. For your convenience, note the number below and retain this Owner's Manual to serve as a permanent record of your purchase, in the event of a theft or fire, or for future reference.

MODEL NO. FAX 170/190

SERIAL NUMBER _____

NAME OF DEALER _____

DATE OF PURCHASE _____

Important Safety Instructions

- 1** Read all of these instructions.
- 2** Save them for later reference.
- 3** Follow all warnings and instructions marked on the product.
- 4** Unplug this product from the wall outlet before cleaning. Do not use liquid or aerosol cleaners. Use a damp cloth for cleaning.
- 5** Do not use this product near water.
- 6** Do not place this product on an unstable cart, stand, or table. The product may fall, causing serious damage to the product.
- 7** Slots and openings in the cabinet and the back or bottom are provided for ventilation; to ensure reliable operation of the product and to protect it from overheating, these openings must not be blocked or covered. The openings should never be blocked by placing the product on a bed, sofa, rug, or other similar surface. This product should never be placed near or over a radiator or heater. This product should never be placed in a built-in installation unless proper ventilation is provided.
- 8** This product should be operated from the type of power source indicated on the label. If you are not sure of the type of power available, consult with your dealer or local power company.
- 9** This product is equipped with a 3-wire grounding type plug, a plug having a third (grounding) pin. This plug will fit into only a grounding-type power outlet. This is a safety feature. If you are unable to insert the plug into the outlet, contact your electrician to replace your obsolete outlet. Do not defeat the purpose of the grounding-type plug.
- 10** Do not allow anything to rest on the power cord. Do not place this product where people can walk on the cord.
- 11** If an extension cord is used with this product, make sure that the total ampere ratings on the products plugged into the extension cord do not exceed the extension cord ampere rating. Also, make sure that the total of all products plugged into the wall outlet does not exceed 15 amperes (USA only).
- 12** Do not place anything in front of the machine that will block received faxes. Do not place anything in the path of received faxes.
- 13** Do not touch a document during printing.

- 14** Never push objects of any kind into this product through cabinet slots, since they may touch dangerous voltage points or short out parts resulting in a risk of fire or electric shock. Never spill liquid of any kind on the product.
- 15** Do not attempt to service this product yourself, as opening or removing covers may expose you to dangerous voltage points and/or other risks, and may void your warranty. Refer all servicing to Authorized Service Personnel. A list of Authorized Service Centers has been included for your convenience, or you may contact the following Customer Service Numbers for your nearest Authorized Service Center:
- USA** *1-800-284-4FAX* (voice)
 1-908-271-1937 (fax)
 1-800-521-2846 (Fax-BackSMSystem)
- Canada** *1-800-853-6660* (calling within Canada 8 AM-8 PM EST).
- 16** Unplug this product from the wall outlet and refer servicing to Authorized Service Personnel under the following conditions:
- A** When the power cord is damaged or frayed.
 - B** If liquid has been spilled into the product.
 - C** If the product has been exposed to rain or water.
 - D** If the product does not operate normally when the operating instructions are followed. Adjust only those controls that are covered by the operating instructions. Improper adjustment of other controls may result in damage and will often require extensive work by a qualified technician to restore the product to normal operation.
 - E** If the product has been dropped or the cabinet has been damaged.
 - F** If the product exhibits a distinct change in performance, indicating a need for service.
- 17** To protect your product against power surges, we recommend the use of a power protection device (Surge Protector).

CHAPTER TEN

Maintenance and Troubleshooting

Fax-BackSM System

Brother Customer Service has installed an easy-to-use Fax-BackTM System, so you can get instant answers to common technical questions and product information for all Brother products. This system is available 24 hours a day, 7 days a week. You can use the system to send faxes to any fax machine, not just the one from which you are calling.

If you can't resolve difficulty with your fax machine using this manual, call **1-800-521-2846**, and follow the voice prompts to receive faxed instructions about using the system, and an index of Fax-Back subjects.

Brother Home Page

Visit the Internet Brother Home Page on the World Wide Web at <http://www.brother.com>.

Brother Bulletin Board

Brother's Bulletin Board Number is **1-714-859-2610**.

You may occasionally encounter a problem with your fax machine or telephone line. If this happens, your fax machine often identifies the problem and displays an error message. The list below explains the most common error messages. If you need additional help, call the Brother Fax-BackSM System at **1-800-521-2846**.

CLEAN UP SCANNER

The scanner is dirty; clean the white bar and the glass under the bar.

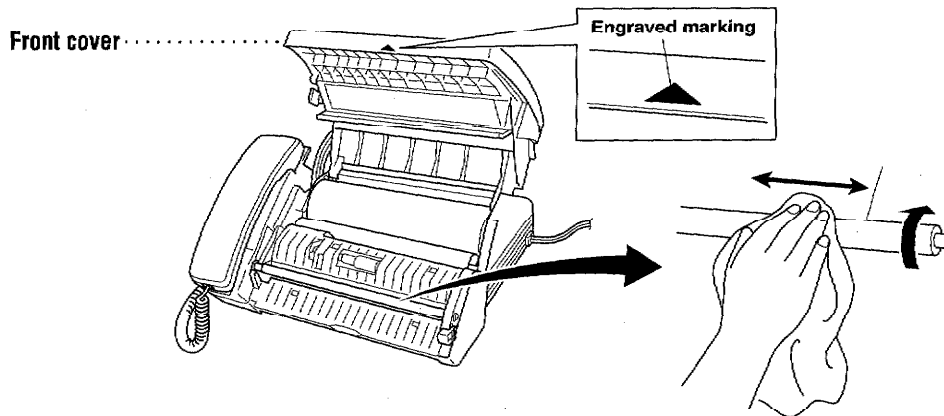
**COMM. ERROR**

A poor quality phone line resulted in a communications error. Try the call again.

CONNECTION FAIL

You have requested a polling call from another party, but the other fax machine is not in Poll Waiting mode.

COVER OPEN

The cover is not completely closed.

CUTTER JAM

The fax paper is jammed in the cutter.

- ➊ Unplug the power cord.
- ➋ Open the cover.
- ➌ Pull the blue release lever on the print head unit and raise it.

- 4 Use scissors to cut off the wrinkled portion of the paper.

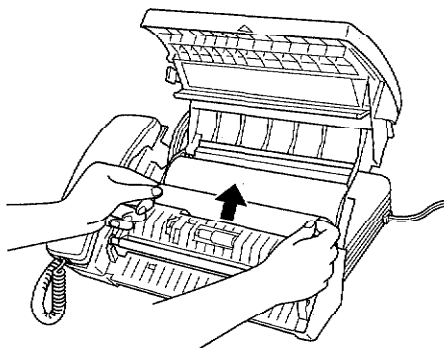

- 5 Pull the wrinkled paper out from the front or rear side.
- 6 Plug in the power cord.
- 7 Load the fax paper again, and push the blue release lever down. Close the cover.

DISCONNECTED

The other party has disconnected during a call or fax. Try calling the other party.

DOCUMENT JAM

The documents were not inserted or fed properly, or were too long.

- 1 Open the cover.
- 2 Pull the documents toward the front of the fax machine, in the same direction they were feeding.
- 3 Close the cover.

Front cover

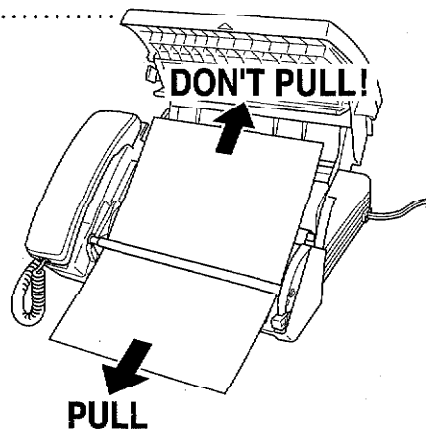

MACHINE ERROR XX

and

PRESS STOP KEY

Contact Brother Customer Service at **1-800-284-4FAX (4329)**.

NO RESPONSE/BUSY

The number you called does not answer or is busy. You may also have reached a number not connected to a fax. Check the number and call again.

NOT REGISTERED

You've tried accessing a One Touch or Speed Dial location with no number assigned to it. See page 18 for information about storing One Touch or Speed Dial numbers.

PAPER ROLL EMPTY

The paper roll is empty; follow the instructions in Installation to replace the paper roll.

PRINTER FAULT

The recording head has overheated. Unplug the machine and wait 30 minutes for it to cool.

PRINTER JAM

The fax paper is jammed in the printer.

- 1** Unplug the power cord.
- 2** Open the cover by lifting it at the grooves.
- 3** Pull the blue release lever on the print head unit and raise it.
- 4** Use scissors to cut off the wrinkled portion of the paper.
- 5** Pull the wrinkled paper out from the front or rear side.
- 6** Plug in the power cord.
- 7** Load the fax paper again, and push the blue release lever down. Close the cover.

SCANNER ERROR

Try cleaning the white bar and the glass under the bar. If you still get a scanner error, contact Brother Customer Service at **1-800 284-4FAX (4329)**.

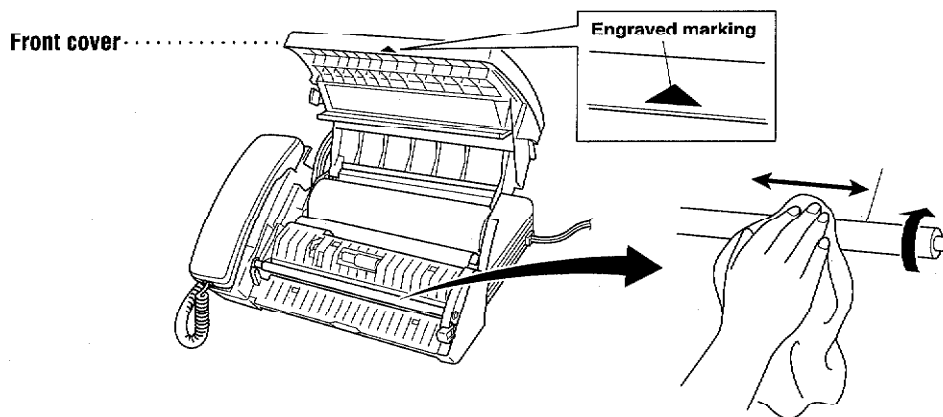

Other Problems

Condensed Print and Horizontal Streaks; Top and Bottom of Sentences Cut Off

You probably had a bad connection, with static or interference on the phone line. Use your fax machine to make a copy. If the copy is okay, then the problem was with the phone line.

Copies and Received Faxes are Blank Pages

The roll of recording paper is upside down, or you are not using thermal fax paper. Scratch both sides of the thermal fax paper; one side should result in a black or gray line where you scratched. Place this side down in the fax machine.

Cover Page Comment Always Prints "Please Call" When Printing Report

The report is only a sample of the format, and always prints "Please Call." The comment you programmed appears at the receiving fax machine.

Dialing Does Not Work

Check for a dial tone.

Change TONE/PULSE setting (see “Fax Settings”).

Check all line cord connections, and make sure the curled handset cord is not in the **EXT** jack.

Check power cord connection.

Send a manual fax (press **Hook** or lift handset), and wait to hear fax receiving tones before pressing **Start**.

Enabling/Disabling Anti-Curl Check Sheet (ACS)

Although the factory setting of Anti-Curl Check Sheet feature is OFF, you can check the status of your fax machine’s Anti-Curl (ACS) feature by printing an Anti-Curl Check Sheet.

Press **1** and **5** at the same time to print an ACS Check Sheet.

Press **1** and **5** at the same time to discontinue printing ACS Check Sheet.

Fax Machine Does Not Answer When Called

Make sure the fax machine is not in MANUAL mode.

Make sure it is in the correct receiving mode for your setup (either FAX ONLY, F/T or TAD). Check for dial tone. If possible, call your fax machine to hear if it chirps.

No Dial Tone on the Handset

Press **Hook**. If you hear no dial tone, check telephone line cord connections at the fax machine and wall jack.

Poor Transmitting Quality

Try changing your resolution to FINE or SUPERFINE (see “Sending Faxes”).

Try cleaning the white pressure bar of the scanner and the glass under the bar (see p. 56).

Vertical Black Lines When Receiving

The sender’s scanner may be dirty. Ask the sender to make a copy to see if the problem is with the sending machine.

Vertical Black Lines When Sending

Use your fax machine to make a copy. If the copy shows the same problem, the scanner area is dirty. Lift the front cover and check the document path. Clean the scanner's white pressure bar and the glass under the bar using isopropyl alcohol and a lint-free cloth.

Ring Change in F/T Mode

If the fax machine double-rings (short-short) after the normal rings from the telephone company, and you have the fax machine set to F/T Mode, your fax machine is signaling you to take over a call. Pick up the fax machine handset and speak, or from an extension phone, press #51 to take the call.

*See
For F/T Mode
Only
p. 41*

Transmission Verification Report Prints "Result: NG"

Usually this means there is temporary noise or static on the phone line. Try sending the fax again. You might want to try sending the fax to another fax machine to see if the problem is with your machine or the machine receiving your fax.

Sending a Call to the Fax Machine

If you have answered the fax handset, press **Start**, and hang up immediately.

If you are on another phone, press your three-digit Remote Activation Code (the factory setting is *51. Wait to hear your fax machine chirp (about 3 seconds), then hang up.

Fax Machine Doesn't Have Dial Tone

Make sure that all line and power cord connections are in place. Check the back of the set, as well as wall outlets and jacks.

Make sure the telephone line cord for the fax machine is plugged into the **LINE** jack, and not into the **EXT** jack.

Check your phone line. Plug another telephone into the jack you're using for the fax machine. If the other phone doesn't work, the problem is with your telephone line. Contact your local phone company to report the problem.

Fax "Hears" Voice as CNG Tone

If your fax machine is set to Easy Receive On, and it answers voice calls by trying to receive a fax, try turning Easy Receive Off.

For Customer Service**USA** 1-908-271-1937 (fax)

1-800-284-4FAX/4329 (voice)

Canada 1-514-685-0702 (fax)

1-800-853-6660 (voice)—calling within Canada 8 AM-8 PM EST.

Index



A

ACS Check Sheet 60
 Activity Report 26, 47, 48
 ADF 27
 ALL DIAL List 47
 Answer Mode 12, 29, 31
 Assembly 7

B

Beeper 22, 25
 Brother Bulletin Board 55
 Brother Home Page 55

C

Call Back Message 18, 39, 47
 Call Reservation 32, 39
 Call Reserve 24
 Caller ID 43, 44
 Canceling 36
 Catch tray 65
 Chain Dialing 19, 21, 40
 Cleaning 52, 60
 Connecting 2, 8, 12, 14
 Contrast 24, 28
 Control Panel 3, 4
 Copy 24, 28, 38, 46, 59, 61
 Cover Page 16, 18, 19, 24, 25, 37, 38, 47, 59

D

Daily Timer 26, 35
 Date and Time 15, 16, 18, 26, 31
 Delayed Polling 45
 Delayed Transmission 35, 39, 40
 Distinctive Ringing 25, 29, 32, 42, 43
 Document 27, 28

E

Easy Receive 26
 Error Messages 56
 Extension Cord 52
 Extension Telephone 29, 30, 31, 41, 61
 External Telephone 14, 30

F

Fax-BackSM System 55
 F/T Mode 25, 32, 41, 42, 61
 F/T Ring Time 25, 29, 30, 31, 32, 41
 Fine 28, 60
 Function 16, 23

G

Gray Scale 25, 37
 Group 9

H

HELP 1, 23, 24, 56
 Hold 27, 30, 34
 Hook 3, 28

I

Interrupting 36, 45
Interval 2, 26, 48

J

Jacks 10, 61
Jam 27, 56, 58

L

Loading Paper 7, 57, 58

M

Maintenance 55
Manual Dial 33
Manual Mode 42, 43, 60
Memory 7, 20, 34
 Temporary Memory Backup Storage 22

N

Next-Fax Reservation 40

O

On-Screen Programming 23
One Touch 47
One Touch Dial 18, 19, 20, 21, 25, 28, 29,
 33, 34, 37, 40, 45, 58
Overseas Mode 24, 36

P

Packing List 6
Pause 18, 19, 34
PBXs 11, 12
Photo 28, 46
Polling 24, 39, 44
Power 7, 8, 15, 20, 22, 52, 53
Printing 32, 38, 48, 52, 59, 60

R

Redial 29, 36, 39, 40
Remote Activation 14, 42, 61
Remote Codes 26, 41, 42
Remote Deactivation 42
Reports 25, 32, 47
Resolution 24, 28, 40, 46, 60
Ring Delay 13, 25, 29, 30, 31, 32
Ring Volume 25, 32

S

Setting Up 5
Smoothing 25, 32
Speaker Volume 25, 32
Specifications 65
Speed Dial 20, 21
Standard Mode 28
Station ID 1, 16, 18, 26, 37, 39
Super Fine Mode 28

T

Telephone Answering Device (TAD) 12, 13, 14
Telephone Index 34
Test Sheet Procedures 1
Timer 24
Tone/Pulse 15, 25, 60
Transmission Verification Report 61
Troubleshooting 55

Specifications

Type	Desktop facsimile transceiver
Compatibility	ITU-TS Group 3
Coding system	Modified Huffman (MH)
Modem speed	9600/7200/4800/2400; Automatic Fallback
Document input width	148 mm to 216 mm (5.8 inches to 8.5 inches)
Scanning/Printing width	208 mm (8.2 inches)
Paper roll size: width	216 mm (8.5 inches)
length	30 m (98 feet) with standard thermal paper 30 m (98 feet) with Therma PLUS paper
Printer type	Line thermal
Gray scale	32 levels
Paper cutter	Automatic
Display	LCD, 16 characters
Polling types	Standard, Delay
Contrast control	Automatic/Super Light/Super Dark (manual setting)
Resolution	<ul style="list-style-type: none"> • Horizontal 8 dot/mm (203 dot/inch) • Vertical Standard 3.85 line/mm (98 line/inch) Fine, Photo 7.7 line/mm (196 line/inch) Superfine, Photo (copy) 15.4 line/mm (392 line/inch)
One touch dial	5 stations
Speed-dial	15 stations (FAX 170)/20 stations (FAX 190)
Automatic redial	3 times at 5 minute intervals
Speaker type	Monitor
Auto answer	0, 1, 2, 3 or 4 rings
Communication source	Public switched telephone network
Operating environment	41 - 95° F
Power source	120V AC 50/60Hz (U.S.A., Canadian Version Only)
Power consumption	Standby: under 10 watts Peak: under 110 watts
Dimensions	299 x 240 x 135 (mm) / 11.8 x 9.4 x 5.3 (inches)
Weight	2.8 kg / 5.98 lb

* "Pages" refers to the "Brother Standard chart no. 1" (a typical A4 business letter, Standard resolution). Specifications are subject to change for improvement without prior notice.

An optional paper Catch Tray is available (call 1-800-284-4357).

brother®

Brother International Corporation
200 Cottontail Lane,
Somerset, NJ 08875-6714, U.S.A.

Brother International Corporation (Canada) Ltd.
1 rue Hôtel de Ville,
Dollard-des-Ormeaux, QC, CANADA H9B 3H6

These machines are made for use in the USA or CANADA only. We can not recommend using them overseas because it may violate the Telecommunications Regulations of that country and the power requirements of your fax machine may not be compatible with the power available in foreign countries. **Using USA or CANADA models overseas is at your own risk and will void your warranty.**

* Manufactured by Brother Industries Ltd. whose quality system is registered by BSI and JQA.

BSI Certificate of registration No. FM27391
JQA Certificate of registration No. JQA-0340

UF6861001
Printed in Japan