

OWNER'S MANUAL

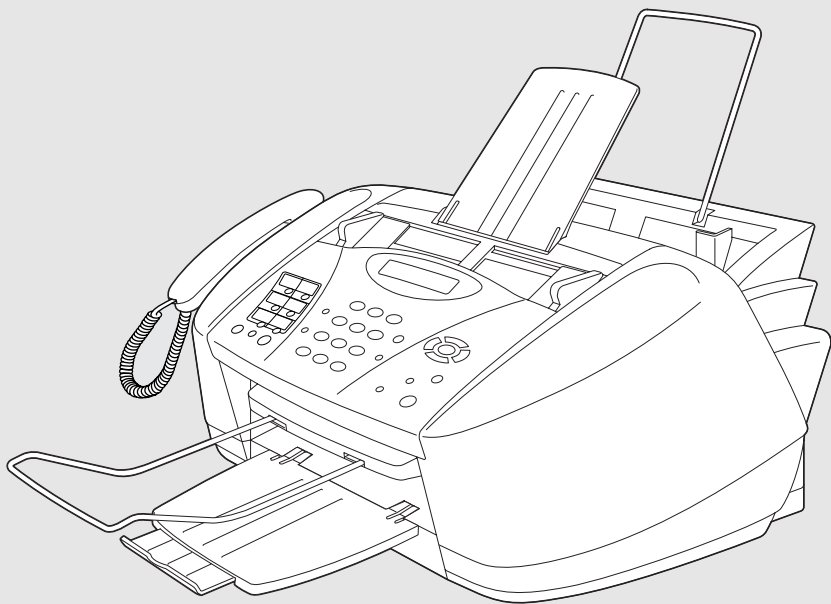

FAX-1800C

brother.

If You Need to Call Customer Service

Please complete the following information for future reference:

Model Number: FAX-1800C

Serial Number:* _____

Date of Purchase: _____

Place of Purchase: _____

*** The serial number is on the back of the unit. Retain this Owner's Manual with your sales receipt as a permanent record of your purchase, in the event of a theft, fire or warranty service.**

Brother Numbers

IMPORTANT

For technical and operational assistance, you must call the country where you purchased the fax machine. Calls must be made *from within* that country.

Brother fax-back system

Brother Customer Service has installed an easy-to-use fax-back system, so you can get instant answers to common technical questions and product information for all Brother products. This system is available 24 hours a day, 7 days a week. You can use the system to send faxes to any fax machine, not just the one from which you are calling.

If you can't resolve a difficulty with your fax machine using this manual, call our fax-back system and follow the voice prompts to receive faxed instructions about using the system and an index of fax-back subjects.

In USA: 1-800-521-2846

In Canada: 1-800-681-9838
1-514-685-5381 **In Montreal**

(For USA only) The Brother fax-back system number has been preprogrammed on One Touch key **1**.

Frequently Asked Questions (FAQs)

The Brother Solutions Center is our one-stop resource for all your Fax Machine/Multi-Function Center needs. You can download the latest software and utilities, read FAQs and troubleshooting tips, and go to the "Solutions" section to learn how to get the most from your Brother product. Visit us at:

<http://solutions.brother.com>



You can check here for Brother Printer Driver updates.

For Customer Service

In USA: 1-800-284-4329 (voice)
1-908-575-8790 (fax)
1-800-284-3238 (TTY service for the hearing-impaired)

In Canada: 1-800-853-6660 (voice)
1-514-685-4898 (fax)
1-514-685-6464 (voice) **In Montreal**

Dealers/Service Centers (For USA Only)

For the name of a Brother authorized dealer or service center, call 1-800-284-4357.

Service Centers (For Canada Only)

For service center addresses in Canada, call 1-800-853-6660.

Ordering Accessories and Supplies

IMPORTANT

For technical and operational assistance, you must call the country where you purchased the fax machine. Calls must be made *from within* that country.

For best quality results use only genuine Brother accessories, available at most Brother retailers. If you cannot find the accessory you need and you have a Visa, MasterCard, Discover, or American Express credit card, you can order accessories directly from Brother. (In the USA, you can visit us online for a complete selection of Brother accessories and supplies available for purchase.)

In USA: 1-888-879-3232 (voice)
1-800-947-1445 (fax)
<http://www.brothermall.com>

In Canada: 1-800-668-2768 (voice)

Description	Item
Ink Cartridge <black>	LC21BK
Ink Cartridge <cyan>(blue)	LC21C
Ink Cartridge <magenta>(red)	LC21M
Ink Cartridge <yellow>	LC21Y
Power Protector for A/C Power and Phone Line	QPD120
Telephone Line Cord	LG3077001
Telephone Handset	LE0446011
Handset Curled Cord	LE6681001
Paper Wire Extension	UU1309001
Document Wire Extension	LE3305001
Document Support	UU2080008
Paper Tray	UU2069008
Card Stock Support	LE6486002
Owner's Manual	LE6598001

Notice – Disclaimer of Warranties (For USA and Canada)

BROTHER'S LICENSOR(S), AND THEIR DIRECTORS, OFFICERS, EMPLOYEES OR AGENTS (COLLECTIVELY BROTHER'S LICENSOR) MAKE NO WARRANTIES, EXPRESS OR IMPLIED, INCLUDING WITHOUT LIMITATION THE IMPLIED WARRANTIES OF MERCHANTABILITY AND FITNESS FOR A PARTICULAR PURPOSE, REGARDING THE SOFTWARE. BROTHER'S LICENSOR(S) DOES NOT WARRANT, GUARANTEE OR MAKE ANY REPRESENTATIONS REGARDING THE USE OR THE RESULTS OF THE USE OF THE SOFTWARE IN TERMS OF ITS CORRECTNESS, ACCURACY, RELIABILITY, CURRENTNESS OR OTHERWISE. THE ENTIRE RISK AS TO THE RESULTS AND PERFORMANCE OF THE SOFTWARE IS ASSUMED BY YOU. THE EXCLUSION OF IMPLIED WARRANTIES IS NOT PERMITTED BY SOME STATES IN THE USA AND SOME PROVINCES IN CANADA. THE ABOVE EXCLUSION MAY NOT APPLY TO YOU.

IN NO EVENT WILL BROTHER'S LICENSOR(S) BE LIABLE TO YOU FOR ANY CONSEQUENTIAL, INCIDENTAL OR INDIRECT DAMAGES (INCLUDING DAMAGES FOR LOSS OF BUSINESS PROFITS, BUSINESS INTERRUPTION, LOSS OF BUSINESS INFORMATION, AND THE LIKE) ARISING OUT OF THE USE OR INABILITY TO USE THE SOFTWARE EVEN IF BROTHER'S LICENSOR HAS BEEN ADVISED OF THE POSSIBILITY OF SUCH DAMAGES. BECAUSE SOME STATES IN THE USA AND SOME PROVINCES IN CANADA DO NOT ALLOW THE EXCLUSION OR LIMITATION OF LIABILITY FOR CONSEQUENTIAL OR INCIDENTAL DAMAGES, THE ABOVE LIMITATIONS MAY NOT APPLY TO YOU. IN ANY EVENT BROTHER'S LICENSOR'S LIABILITY TO YOU FOR ACTUAL DAMAGES FROM ANY CAUSE WHATSOEVER, AND REGARDLESS OF THE FORM OF THE ACTION (WHETHER IN CONTRACT, TORT (INCLUDING NEGLIGENCE), PRODUCT LIABILITY OR OTHERWISE), WILL BE LIMITED TO \$50.

Compilation and Publication Notice

Under the supervision of Brother Industries Ltd., this manual has been compiled and published, covering the latest product descriptions and specifications.

The contents of this manual and the specifications of this product are subject to change without notice.

Brother reserves the right to make changes without notice in the specifications and materials contained herein and shall not be responsible for any damages (including consequential) caused by reliance on the materials presented, including but not limited to typographical and other errors relating to the publication.

BROTHER ONE YEAR LIMITED WARRANTY and EXCHANGE SERVICE (For USA Only)

This warranty gives you certain rights and you may also have other rights that may vary from state to state.

This warranty is given only to the first end-use purchaser of the accompanying product (referred to in this warranty as "this Product").

What is covered: Brother warrants to you for the Warranty Period that there are no defects in the materials, workmanship or Year 2000 compliance of this Product. The "Warranty Period" is 1 year from the date you purchased this product. The "Warranty Period" for consumable items, such as Print Heads, Toner, Drums, Ink Cartridges, Print Cartridges, Refill Ribbons, Therma PLUS Paper and Thermal Paper, etc. is 90 days from the date of purchase, or the rated life of the Consumable item, whichever is shorter.

What is NOT covered: This warranty is VOID -- that is, this Product has no warranty -- if: (1) you did not purchase this Product from an authorized Brother reseller within the United States, (2) this Product has been serviced, modified or tampered with by anyone other than an Authorized Service Representative of Brother, (3) the serial number has been modified, defaced or removed from this Product, (4) this Product has been abused or damaged, or the recommended monthly volume has been exceeded, (5) non Brother[®]-brand or non Brother approved parts, supplies, power supplies or other accessories have been used with this Product, or (6) this Product has been transported without the proper preparation and packaging.

What to do if you think your Product is defective:

Call our Customer Service Hotline at 1-800-284-4329, or if you suspect a defect in materials or workmanship in this Product, you can report it to a Brother Authorized Service Center. During the Warranty Period, supply Brother's representative with a copy of your dated bill of sale showing that this Product was purchased within the United States. For the name of your Brother Authorized Service Center, call 1-800-521-2846. After contacting the Brother Authorized Service Center, you may be required to

deliver or send the Product properly packaged, freight prepaid, to the Authorized Service Center together with a photocopy of your bill of sale.

What Brother will do: Brother (or its Authorized Service Center) will evaluate your report of a possible defect to determine whether a defect exists, and if it does exist, Brother (or its Authorized Service Center) will repair or (at Brother's option) replace the Product with a product that performs the same functions and performs as well as the original Product. Brother reserves the right to supply refurbished or remanufactured replacement parts provided that the replacement parts conform to the manufacturer's specifications for new products. The repaired or replacement product will be returned to you at no cost.

Exchange Service:

When an exchange is authorized, Brother will exchange your non-working product with a refurbished or remanufactured product that conforms to the manufacturer's specifications for new products. The refurbished or remanufactured Product you receive will be covered by the balance of the limited warranty period remaining on the original Product, plus an additional thirty (30) days. You will keep the replacement Product that is sent to you and must return (or be billed up to the cost of a new product) your original non-working product, which shall become the property of Brother. You must call Brother Customer Service and if the representative cannot correct the product's malfunction over the telephone and you elect the exchange service, you must provide information pertaining to this Product and you must also provide a valid major credit card number. Your credit card will be charged up to the cost of a new Product if: (i) you do not return your original Product to Brother within five (5) business days; (ii) the malfunctions of your original Product are not covered by the limited warranty; (iii) the proper packaging instructions are not followed and has caused damage to the product;

BROTHER ONE YEAR LIMITED WARRANTY and EXCHANGE SERVICE (For USA Only)

or (iv) the warranty period on your original Product has expired or has not been sufficiently validated with a copy of the proof of purchase (bill of sale). The Brother Customer Service Representative will ship the exchange Product via next business day delivery courier service, with return instructions and prepaid return air bill. Follow the return instructions. You must return the original Product in the same shipping carton in which the exchanged Product was received and include a copy of proof of purchase (bill of sale). Retain your original accessory items and a copy of the return air bill, signed by the courier.

Limitations:

Repair or replacement as described above is your sole and exclusive (that is, your only) remedy if this Product is defective. Brother is not responsible for damage to or loss of any equipment, media, programs or data related to the use of this Product. Except for that repair or replacement, *Brother shall not be liable for any direct, indirect, incidental or consequential damages or specific relief. Because some states do not allow the exclusion or limitation of consequential or incidental damages, the above limitation may not apply to you.*

THIS WARRANTY IS GIVEN IN LIEU OF ALL OTHER WARRANTIES, WRITTEN OR ORAL, WHETHER EXPRESSED BY AFFIRMATION, PROMISE, DESCRIPTION, DRAWING, MODEL OR SAMPLE. ANY AND ALL WARRANTIES OTHER THAN THIS ONE, WHETHER EXPRESS OR IMPLIED, INCLUDING IMPLIED WARRANTIES OF MERCHANTABILITY AND FITNESS FOR A PARTICULAR PURPOSE, ARE HEREBY DISCLAIMED.

This Limited Warranty is the only warranty that Brother is giving for this Product. *It is the final expression and the exclusive and only statement of Brother's obligations to you.* It replaces all other agreements and understandings that you may have with Brother or its representatives.

This Limited Warranty (and Brother's obligation to you) may not be changed in any way unless you and Brother sign the same piece of paper in which we (1) refer to this Product and your bill of sale date, (2) describe the change to this warranty and (3) agree to make that change.

Product Support: Toll-free customer service and technical support is available for hardware operational assistance at 1-800-284-4329. At any time, free technical support in the form of Frequently Asked Questions, troubleshooting tips and service center locator is available through our fax-back system at 1-800-521-2846 or Brother's Internet Web Site (www.brother.com). Now you can visit us on-line (www.brothermall.com), your complete source for genuine Brother Accessories and Supplies.

**BROTHER INTERNATIONAL CORPORATION
100 SOMERSET CORPORATE BLVD.
BRIDGEWATER, NEW JERSEY 08807-0911**

Please record your model and serial numbers and your date and location of Purchase below for your records. Keep this information with your proof of purchase (bill of sale) in case your Product is lost, stolen or requires service.

Model # _____

Serial # _____

Date of purchase: _____

Store where purchased: _____

Location of store: _____

Important: We recommend that you keep all original packing materials, in the event that you ship this product.

**BROTHER FACSIMILE MACHINE
LIMITED WARRANTY
(For Canada Only)**

Pursuant to this limited warranty of 1 year from the date of purchase for labour and parts, Brother International Corporation (Canada) Ltd. ("Brother"), or its Authorized Service Centers, will repair this Facsimile machine free of charge if defective in material or workmanship. This Limited Warranty does not include cleaning, consumables (including, without limitation, print cartridges, print head, toner and drum) or damage caused by accident, neglect, misuse or improper installation or operation, any damage caused from service, maintenance, modifications, or tampering by anyone other than a Brother Authorized Service Representative, or from the use of supplies or consumable items that are non-Brother products. Operation of the Facsimile machine in excess of the specifications or with the Serial Number or Rating Label removed shall be deemed abuse and all repairs thereafter shall be the sole liability of the end-user/purchaser. In order to obtain warranty service, the Facsimile machine must be delivered or shipped freight prepaid by the end user/purchaser to a "Brother" Authorized Service Center, together with your Proof of Purchase in the form of a Sales Receipt.

For laser products: Failure to remove the Toner Cartridge (and Toner Drum Unit on applicable models) during shipping will cause severe damage to the Facsimile and will VOID the Warranty. (Refer to your Operation Manual for proper packaging.)

For ink-jet products: Do not remove the ink cartridges during shipping. Damage to your print head resulting from packing without the ink cartridges will VOID your warranty. (Refer to your Operation Manual for proper packaging.)

BROTHER DISCLAIMS ALL OTHER WARRANTIES EXPRESSED OR IMPLIED INCLUDING, WITHOUT LIMITATION, ANY IMPLIED WARRANTIES OF MERCHANTABILITY OR FITNESS FOR A PARTICULAR PURPOSE, EXCEPT TO THE EXTENT THAT ANY WARRANTIES IMPLIED BY LAW CANNOT BE VALIDLY WAIVED.

No oral or written information, advice or representation provided by Brother, its Authorized Service Centers, Distributors, Dealers, Agents or employees, shall create another warranty or modify this warranty. This warranty states Brother's entire liability and your exclusive remedy against Brother for any failure of the Facsimile machine to operate properly.

Neither Brother nor anyone else involved in the development, production, or delivery of this Facsimile machine shall be liable for any indirect, incidental, special, consequential, exemplary, or punitive damages, including lost profits, arising from the use of or inability to use the product, even if advised by the end user/purchaser of the possibility of such damages. Since some Provinces do not allow the above limitation of liability, such limitation may not apply to you.

This Limited Warranty gives you specific legal rights and you may also have other rights which vary from Province to Province.

Warranty Service is available at Brother Authorized Service Centers throughout Canada. For Technical Support or for the name and location of your nearest Authorized Service Center call 1-800-853-6660. Within Montreal, please call 685-6464. Internet support: support@brother.ca or browse Brother's Web Site: www.brother.com

Brother International Corporation (Canada) Ltd.
1 Rue Hôtel de Ville
Dollard-Des-Ormeaux, QC H9B 3H6

At your side.
brother®





Quick Reference Guide

Sending Black & White Faxes

Automatic Transmission



- 1 Place the original face down in the ADF.
- 2 Enter the fax number using One Touch, Speed Dial, Search or the dial pad.
- 3 Press **Black Fax Start**.

Sending a Cover Page

- 1 Place the original face down in the ADF.
- 2 Press **Menu/Set, 2, 2, 7**.
- 3 When **NEXT FAX ONLY?** appears, press **Menu/Set**.
- 4 Press  to select **ON**, and then press **Menu/Set**.
- 5 Press  to select a comment, and then press **Menu/Set**.
- 6 Enter two digits to indicate the number of pages being sent, and then press **Menu/Set**.
- 7 Press **1** to select additional settings—**OR**—Press **2** if you are ready to fax.
- 8 Enter the fax number.
- 9 Press **Black Fax Start**.

Real Time Transmission

You can send faxes in real time.

- 1 Place the original face down in the ADF.
- 2 Press **Menu/Set, 2, 2, 5**.
- 3 Press  to select **ON**, and then press **Menu/Set**—**OR**—For the next transmission only, press  to select **NEXT FAX ONLY**, and then press **Menu/Set**.
- 4 For the next fax only, press  to select **ON**, and then press **Menu/Set**.
- 5 Press **1** to select additional settings—**OR**—Press **2** to fax.
- 6 Enter the fax number.
- 7 Press **Black Fax Start**.

Receiving Faxes

Select Receive Mode

Press **Receive Mode** to select **FAX ONLY, FAX/TEL, TAD:ANSWER MACH.** or **MANUAL**. If you select **FAX/TEL**, make sure to set Ring Delay and F/T Ring Time.

Manual Reception

- 1 Pick up the handset.
- 2 Press **Black Fax Start** if you hear fax tones (beeps).
- 3 When the LCD shows **RECEIVING**, replace the handset.

Storing Numbers

Storing One Touch Dial Numbers

- 1 Press **Menu/Set, 2, 3, 1**.
- 2 Press the One Touch key where you want to store the number.
- 3 Enter a number (up to 20 digits), and then press **Menu/Set**.
- 4 Enter a name (or leave it blank), and then press **Menu/Set**.
- 5 Press **Stop/Exit**.

Storing Speed Dial Numbers



- 1 Press **Menu/Set, 2, 3, 2**.
- 2 Enter a two-digit Speed Dial number, and then press **Menu/Set**.
- 3 Enter a number (up to 20 digits), and then press **Menu/Set**.
- 4 Enter a name (or leave it blank), and then press **Menu/Set**.
- 5 Press **Stop/Exit**.

Telephone Operation

One Touch Dialing / Speed Dialing

- 1 Pick up the handset—**OR**—Press **Hook/Hold** and listen for a dial tone.
- 2 When you hear the dial tone, press the One Touch key of the location you want to call—**OR**—Press **Search/Speed Dial**, press **#**, then press the two-digit Speed Dial number. (If you pressed **Hook/Hold** to dial, pick up the handset when the other party answers.)
- 3 To hang up, replace the handset.

Search/Speed Dial

- 1 Press **Search/Speed Dial**, then enter the first letter of the name you're looking for.
- 2 Press  or  to search the memory.
- 3 When the name is displayed, lift the handset—**OR**—Press **Hook/Hold**.
- 4 Press **Black Fax Start** to dial. (If you pressed **Hook/Hold** to dial, pick up the handset when the other party answers.)
- 5 To hang up, replace the handset.

Making Copies

Making a Single Copy

- 1 Place the original face down in the ADF.
- 2 Press **Black Copy** or **Color Copy**.

Making Multiple Copies

- 1 Place the original face down in the ADF.
- 2 Use the dial pad to enter the number of copies you want (up to 99).
- 3 Press **Black Copy** or **Color Copy**.

Brother fax-back system:

In USA: 1-800-521-2846
In Canada: 1-800-681-9838
1-514-685-5381
(In Montreal)

Brother Global Web Site:

<http://www.brother.com>

Frequently Asked Questions (FAQs) and Product Support:

<http://solutions.brother.com>

Brother Accessories & Supplies:

In USA: 1-888-879-3232 (voice)
1-800-947-1445 (fax)

<http://www.brothermall.com>

In Canada: 1-800-668-2768 (voice)

Table of Contents

1

Introduction.....	1-1
Using This Manual	1-1
Finding Information.....	1-1
Conventions Used in this Manual.....	1-1
Test Sheet Procedure and Product Registration (For USA Only)	1-2
FAX-1800C Control Panel Overview	1-3
About Fax Machines	1-5
Custom Features	1-5
Do You Have Voice Mail on the Phone Line?	1-5
Why Should There Be Trouble?	1-5
How Can You Avoid Possible Problems?	1-5
Fax Tones and Handshake.....	1-5
ECM (Error Correction Mode).....	1-6

2

Assembly and Connections	2-1
Packing List.....	2-1
Choosing a Location.....	2-2
Assembly.....	2-3
Removing the Protective Yellow Bar.....	2-3
Setting Up the Fax Machine.....	2-4
Loading Paper in the Multi-Purpose Sheet Feeder (Paper Cassette)	2-8
Installing the Ink Cartridges	2-9
Important.....	2-11
Connecting the Fax Machine.....	2-13
Connecting an External Telephone	2-13
Connecting an External Telephone Answering Device (TAD).....	2-13
Sequence	2-13
Connections.....	2-14
Recording Outgoing Message (OGM).....	2-15
Special Line Considerations.....	2-15
Roll Over Phone Lines.....	2-15
Two-Line Phone System.....	2-15
Converting Telephone Wall Outlets	2-16
Installing fax machine, External Two-Line TAD and Two-Line Telephone	2-16

Multi-Line Connections (PBX)	2-17
If You are Installing the Fax Machine to	
Work with a PBX:	2-17
Custom Features on Your Phone Line.....	2-18

3

Paper	3-1
About Paper.....	3-1
Handling and Using Special Paper	3-1
Recommended Paper for the FAX-1800C	3-1
Paper Capacity of Multi-purpose Sheet Feeder.....	3-2
Paper Specifications for Multi-purpose Sheet Feeder	3-2
Print Area.....	3-3

4

On-Screen Programming.....	4-1
User-Friendly Programming.....	4-1
Menu Selection Table.....	4-1
Alternating Displays	4-1
Navigation Keys	4-2
Key Operations Table.....	4-8

5

Initial Setup.....	5-1
Getting Started.....	5-1
Setting Paper Type	5-1
Setting Paper Size	5-1
Setting Date and Time	5-2
Setting Station ID	5-2
Entering Text.....	5-3
Inserting Spaces	5-3
Making Corrections.....	5-3
Repeating Letters	5-3
Special Characters and Symbols	5-3
Setting the Ring Volume	5-4
Setting the Beeper Volume.....	5-4
Setting the Speaker Volume	5-5
Setting the Handset Volume	5-5
Choosing the Handset Volume (For Volume Amplify)	5-6
Setting Volume Amplify	5-6
Turning On Automatic Daylight Savings Time	5-7
Setting Tone/Pulse Dialing Mode	5-7

Memory Storage	5-7
----------------------	-----

6

Setup Receive.....6-1

Basic Receiving Operations	6-1
Choosing the Receive Mode.....	6-1
To Select or Change Your Receive Mode	6-2
Setting Ring Delay	6-2
Setting the F/T Ring Time (For FAX/TEL Mode Only).....	6-3
Easy Receive	6-3
Printing a Reduced Incoming Fax (Auto Reduction)	6-4
Advanced Receiving Operations.....	6-5
Operation from Extension Telephones	6-5
For FAX/TEL Mode Only.....	6-5
Using a Cordless External Handset.....	6-5
Changing the Remote Codes	6-5
Printing a Fax in Memory.....	6-6
Polling.....	6-6
Setting Up Polling Receive	6-6
Setting Up Sequential Polling Receive	6-7
Canceling a Scheduled Job	6-7

7

Setup Send7-1

Before You Begin.....	7-1
Using the ADF (Automatic Document Feeder).....	7-1
Sending Faxes with Multiple Settings	7-2
Basic Sending Operations	7-2
Contrast.....	7-2
Fax Resolution.....	7-3
Manual Transmission	7-3
Automatic Transmission.....	7-3
Color Fax Transmission	7-4
Manual and Automatic Fax Redial.....	7-4
Dual Access (Not Available for Color Faxes).....	7-4
Real Time Transmission.....	7-5
Checking Job Status	7-5
Canceling a Job in Memory.....	7-6
Advanced Sending Operations	7-7
Composing Electronic Cover Page.....	7-7
Composing Your Own Comments.....	7-7
Cover Page for the Next Fax Only.....	7-8

Always Send a Cover Page	7-8
Using a Printed Cover Page	7-9
Overseas Mode	7-9
Delayed FAX (Not Available for Color Faxes).....	7-10
Delayed Batch Transmission (Not Available for Color Faxes)	7-10
Setting Up Polled Transmit (Not Available for Color Faxes)	7-11

8

Auto Dial Numbers and Dialing Options 8-1

Storing Numbers for Easy Dialing	8-1
Storing One Touch Dial Numbers	8-1
Storing Speed Dial Numbers	8-2
Changing One Touch and Speed Dial Numbers.....	8-2
Setting Up Groups for Broadcasting	8-3
Dialing Options	8-4
Manual Dialing	8-4
Search	8-4
One Touch Dialing	8-5
Speed Dialing	8-5
Access Codes and Credit Card Numbers.....	8-6
Broadcasting (Not Available for Color Faxes).....	8-6
Pause	8-7
Hold	8-7
Fax Redial.....	8-7
Tone/Pulse	8-8

9

Telephone Services 9-1

Custom Features	9-1
Distinctive Ring.....	9-1
What Does Your Telephone Company's "Distinctive Ring" Do?.....	9-1
What Does Brother's "Distinctive Ring" Do?	9-1
Do You Have Voice Mail?.....	9-2
Before You Choose the Ring Pattern to Register	9-2
VERY IMPORTANT	9-3
Registering the Distinctive Ring Pattern.....	9-3
Caller ID	9-3
Viewing Caller ID List.....	9-4
Printing Caller ID List.....	9-4

Remote Fax Options

(Not Available for Color Faxes).....	10-1
Fax Forwarding/Paging	10-1
Programming a Fax Forwarding Number.....	10-1
Programming Your Pager Number.....	10-1
Setting Fax Storage	10-2
Backup Print	10-2
Changing Remote Retrieval Access Code	10-3
Remote Retrieval.....	10-3
Using Remote Retrieval Access Code.....	10-3
Remote Commands	10-4
Retrieving Fax Messages.....	10-5
Changing Fax Forwarding Number.....	10-5

Printing Reports.....11-1

FAX Settings and Activity	11-1
Customizing the Transmission Verification Report.....	11-1
Setting the Fax Activity Report Interval	11-1
Using the Reports Key.....	11-2
To Print a Report.....	11-2

Making Copies.....12-1

Basic Copy Operations.....	12-1
Making a Single Copy	12-1
Making Multiple Copies.....	12-1
Out of Memory Message	12-2
Temporary Copy Settings.....	12-2
Copying Using Multiple Settings	12-2
Using the Options Key	12-3
Paper Type	12-3
Paper Size.....	12-4
Copy Quality.....	12-4
Copy Brightness.....	12-4
Reducing and Enlarging Copies.....	12-5
Selecting Fixed Reduction Ratios:.....	12-5
Special Copy Option	12-6
2 in 1	12-6

Changing Default Copy Settings.....	12-7
Copy Quality	12-8
Color Adjustment	12-8
Copy Contrast.....	12-8
Legal Limitations	12-9

13

Using FAX-1800C as a Printer 13-1

Download the Printer Driver from the Brother Web Site	13-1
---	------

14

Important Information 14-1

Standard Telephone and FCC Notices	14-1
Federal Communications Commission (FCC)	
Declaration of Conformity (For USA Only).....	14-2
Important.....	14-3
Industry Canada Compliance Statement (For Canada Only).....	14-3
International ENERGY STAR® Compliance Statement.....	14-3
Important Safety Instructions	14-4
Trademarks	14-5

15

Troubleshooting and Routine Maintenance..... 15-1

Troubleshooting.....	15-1
Error Messages	15-1
Original Jam	15-3
Printer Jam or Paper Jam	15-4
If You Are Having Difficulty with Your Fax Machine....	15-7
How to Improve Print Quality.....	15-9
Cleaning the Print Head.....	15-9
Print Quality Check	15-9
STEP A: Color Block Quality Check	15-9
STEP B: Alignment Check	15-10
Packing and Shipping the Fax Machine	15-12
Routine Maintenance.....	15-15
Cleaning the Scanner	15-15
Cleaning the Fax Machine Printer Platen.....	15-15
Replacing the Ink Cartridges	15-16

Specifications	S-1
Fax	S-1
Printer	S-2
Controller.....	S-2
Print Media	S-3
Consumable Items	S-3
Glossary	G-1
Index.....	I-1
Remote Retrieval Access Card	R-1

1 Introduction

Using This Manual

Thank you for purchasing a Brother Color Ink Jet fax machine. This model was designed to be simple to use, with LCD screen prompts to guide you through programming the settings. However, you can use your fax machine to its fullest potential by taking a few minutes to read this manual.



Additionally, your fax machine has a **Reports** key. Press **Reports** while holding down **Shift**, and then press **1** to print a list of basic operational steps.

Finding Information

All chapter headings and subheadings are listed in the Table of Contents. You will be able to find information about a specific feature or operation by checking the Index in the back of this manual.

Conventions Used in this Manual

Throughout this manual you'll see special symbols alerting you to important information, warnings, and actions to perform. For clarification, and to help you choose the correct key presses, we've added illustrations of some of the LCD messages.

boldface Bold typeface identifies a specific key on the fax machine control panel.

italics Italics typeface emphasize an important point, or refer you to related topic.

`bubble dot` Bubble Dot typeface identifies the messages on the LCD of the fax machine.



Warnings detail precautions you must take to avoid possible personal injury.



Cautions specify procedures you must follow or avoid to prevent possible damage to the fax machine.



Notes tell you the proper response for a situation that may occur.



FYI tips provide details about how the current operation interacts with other features.



Improper Setup alerts you to devices and procedures that are not compatible with the fax machine.

Test Sheet Procedure and Product Registration (For USA Only)

After programming your Station ID, please fill out the TEST SHEET included with your fax machine and then fax it to Brother's Automated Fax Response System as your first transmission. This will verify that your fax machine is properly installed.

To receive a response, be sure to set up your Station ID.
(*Setting Station ID*, page 5-2.)

In USA: 1-877-268-9575

When your TEST SHEET is received, a Confirmation Sheet and Product Registration form will be sent back to your machine. Please fill out the form and return it to complete your registration.

FAX-1800C Control Panel Overview

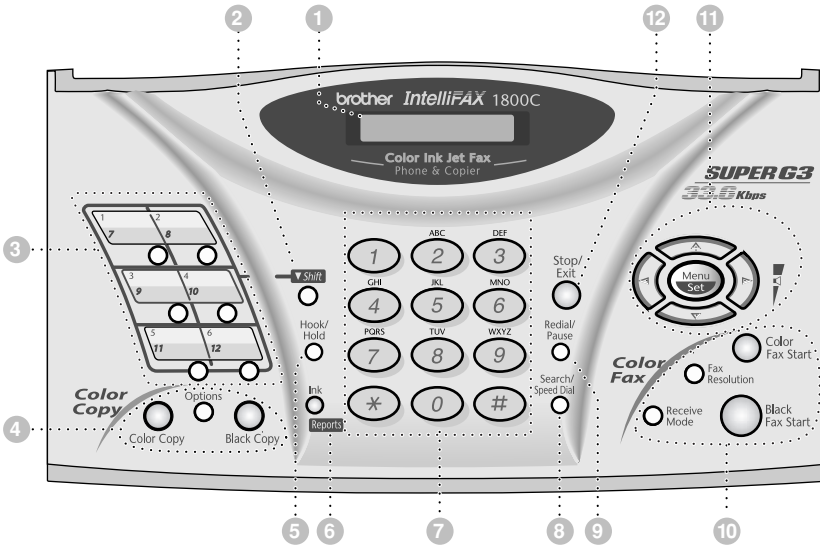

1 Liquid Crystal Display (LCD)

The LCD displays messages to help you set up and operate your fax machine.

2 Shift

Accesses the second number stored on each One Touch key (7-12).

3 One Touch Keys:

These 6 keys give you instant access to 12 previously stored auto dial numbers.

4 Copy Keys: (For the Next Copy Only)

Options

You can quickly and easily select temporary settings (for the next copy only).

Color Copy

Makes a full-color copy.

Black Copy

Makes a black-and-white copy.

5 Hook/Hold

Lets you dial telephone and fax numbers without lifting the handset.

—OR—

Lets you place telephone calls on hold.

6 Ink/Reports

Cleans the ink print heads and replaces an ink cartridge.

Also, accesses the Reports menu when you press this key while holding down **Shift**.

You can select a report to print: Help List, Auto Dial, Fax Activity, Transmission Verification, User Settings.

7 Dial Pad

Use to dial phone and fax numbers and as a keyboard for entering information into the fax machine.

The **#** key lets you switch the dialing type during a telephone call from **PULSE** to **TONE**.

8 Search/Speed Dial

Lets you look up numbers stored in the dialing memory.

Also lets you dial stored phone numbers by pressing # and a two-digit number.

9 Redial/Pause

Redials the last number called.

Also inserts a pause in auto dial numbers.

10 Fax Keys:

Color Fax Start

Starts sending a color fax.

Black Fax Start

Starts sending a black and white fax.

Fax Resolution

Sets the resolution when you send a fax.

Receive Mode

Use to select how the fax machine will handle incoming calls.

11 Navigation Keys:

Menu/Set

Lets you access the Menu and Programming mode, and stores your settings in the fax machine.



Press to scroll forward or backward while setting a menu selection.

Also, you can use these keys to do an alphabetical search for the names of stored numbers.



Volume

Press to scroll through the menus and options.

When using the speaker, ring or handset, you can press these keys to adjust the volume.

12 Stop/Exit

Stops a fax, cancels an operation, or exits from the Menu. Also, lets you clear data remaining in the printer memory.

About Fax Machines

If you're a first-time fax machine user, fax operation might seem a little mysterious. Soon, you'll recognize the unusual fax tones on your phone line, and be able to send and receive faxes easily.

Custom Features

Do You Have Voice Mail on the Phone Line?

If you have Voice Mail on the phone line on which you will install your new fax machine, *there is a strong possibility that Voice Mail and the fax machine will conflict with each other while receiving incoming calls.*

Why Should There Be Trouble?

Since both fax machines and Voice Mail pick up the line at the number of rings you have set, each of them has the ability to keep the other from receiving calls. For example, if your Voice Mail is set to answer after two rings and your fax machine is set to answer after four, your Voice Mail will keep your fax machine from receiving faxes. If you set Voice Mail and the Brother machine to answer at the same number of rings, there is no way of knowing which one will answer first. It is important to remember that neither Voice Mail nor the fax machine can pass the call back to the other after the call has been answered.

How Can You Avoid Possible Problems?

A very good way to avoid problems like the one mentioned previously is *to get a second phone number on your present phone line.* Many people with Voice Mail opt for this choice, which is called "Distinctive Ring", and they are very satisfied with it. *For details about this type of custom service, please see Distinctive Ring, page 9-1*

Another way to avoid possible problem is to replace your Voice Mail with an answering machine. Your Brother fax machine is designed to work in tandem with an answering machine or TAD (telephone answering device). (See *Connecting an External Telephone Answering Device (TAD)*, page 2-13.)

Fax Tones and Handshake

When someone is sending a fax, the fax machine sends fax calling tones (CNG tones) — soft, intermittent beeps at 4-second intervals. You'll hear them after you dial and press **Black Fax Start**; they continue for about 60 seconds after dialing. During that time, the sending machine must begin the "handshake" with the receiving machine. Each time you use automatic procedures to send a fax, you are sending CNG tones over the phone line. You'll soon learn to listen for these soft beeps each time you answer a phone on your fax line, so you can know if you are receiving a fax message.

The receiving fax responds with fax receiving tones—loud, chirping sounds. A receiving fax chirps for about 40 seconds over the phone line, and the LCD shows **RECEIVING**. If your fax machine is set to the FAX mode, it will answer every call automatically with fax receiving tones. Even if the other party hangs up, your fax machine continues to send the “chirps” for about 40 seconds, and the LCD continues to display **RECEIVING**. To cancel the receiving mode, press **Stop/Exit**.

When your fax machine answers in FAX/TEL mode, it listens for CNG tones and then responds with receiving tones.

The fax “handshake” is the time in which the sending machine’s CNG tones and the receiving machines “chirps” overlap. This must be for at least 2 to 4 seconds, so the machines can understand how each is sending and receiving the fax. The handshake cannot begin until the call is answered, and the CNG tones only last for about 60 seconds after the number is dialed. Therefore, it’s important for the receiving machine to answer the call in as few rings as possible.



When you have an external telephone answering device (TAD) on your fax line, your TAD will determine the number of rings before the call is answered. Pay special attention to the directions chapter for connecting a TAD to your fax machine in Chapter 2, *Assembly and Connections*.

ECM (Error Correction Mode)

The Error Correction Mode (ECM) is a way for the fax machine to check the integrity of a fax transmission while it is in progress. ECM transmissions are possible only between machines that both have the ECM feature. If they do, you may send and receive fax messages that are continuously checked for their integrity.

Sufficient memory must be available in your fax machine for this feature to work.

2

Assembly and Connections

Packing List

Make sure you have the following items:

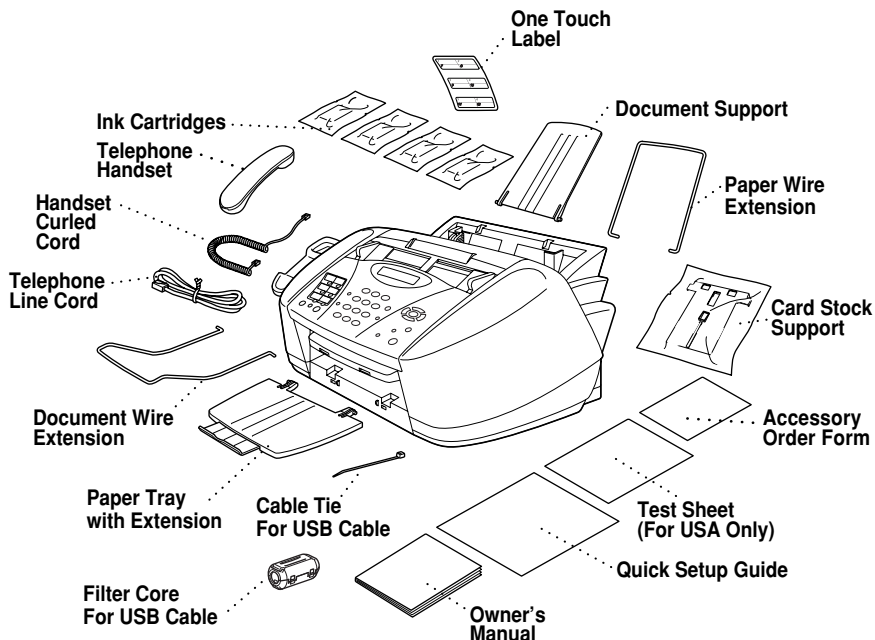

! Caution

Do NOT throw away the filter core and cable tie by accident. You will need them to meet FCC Emission Requirements when you connect the machine to your computer using a USB cable.



If an item is missing, call Brother Customer Service at 1-800-284-4329 (in USA), 1-800-853-6660 (in Canada) or 1-514-685-6464 (in Montreal). See *Ordering Accessories and Supplies* on page ii for the correct item numbers.



Whenever you transport the fax machine, use the packing materials that came with your machine. If you do not pack the fax machine correctly, you may void your warranty.

Choosing a Location

Place your fax machine on a flat, stable surface, such as a desk. Select a place that is free of vibration and shocks. Locate the fax machine near a telephone jack and a standard, grounded power outlet. Choose a location where the temperature remains between 50°F and 95°F (10°–35°C).

- ⊘ Avoid placing your fax machine in a high-traffic area. Do not place near heaters, air conditioners, water, chemicals, or refrigerators. Do not expose the fax machine to direct sunlight, excessive heat, moisture, or dust. Do not connect your fax machine to electrical outlets controlled by wall switches or automatic timers. Disruption of power can wipe out information in the fax machine's memory. Do not connect your fax machine to electrical outlets on the same circuit as large appliances or other equipment that might disrupt the power supply. Avoid interference sources, such as speakers or the base units of cordless phones.

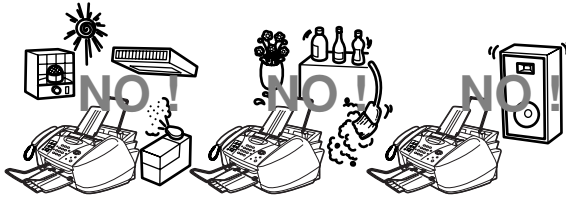

⚠ WARNING

- Never install telephone wiring during a lightning storm.
- We recommend that this product be used with a surge protection device to protect the product against lightning storms.
- Never install a telephone jack in a wet location unless the jack is specifically designed for a wet location.
- Never touch telephone wires or terminals that are not insulated unless the telephone line has been disconnected at the network interface.
- Use caution when installing or modifying telephone lines.
- Avoid using a telephone (other than a cordless type) during an electrical storm. There may be a remote risk of electric shock from lightning.
- Do not use the telephone to report a gas leak in the vicinity of the leak.
- For PLUG CABLE EQUIPMENT, the socket-outlet should be installed near the equipment and should be easily accessible.
- To reduce the risk of shock or fire, use only a No. 26 AWG or larger telecommunications line cord.

Assembly

Removing the Protective Yellow Bar

- 1 Open the control panel cover by pulling it toward you (①), and then lift the top cover toward the back (②).

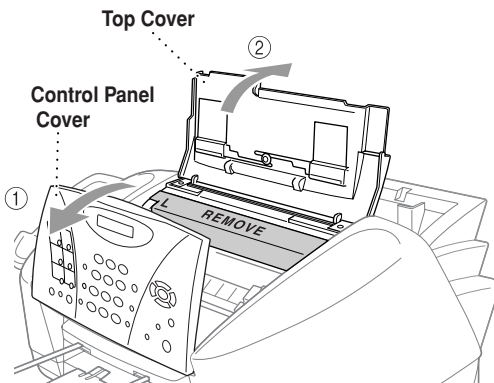

- 2 Pull the protective yellow bar out of the machine.

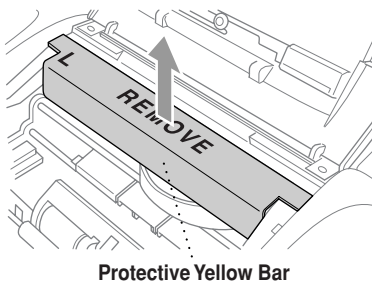

Caution

Do not throw away the protective yellow bar. You will need it for future transportation.

- 3 Close the top cover, and then close the control panel cover.

Setting Up the Fax Machine

1 Connect the handset.

Connect the curled handset cord to the fax machine and the other end to the handset.

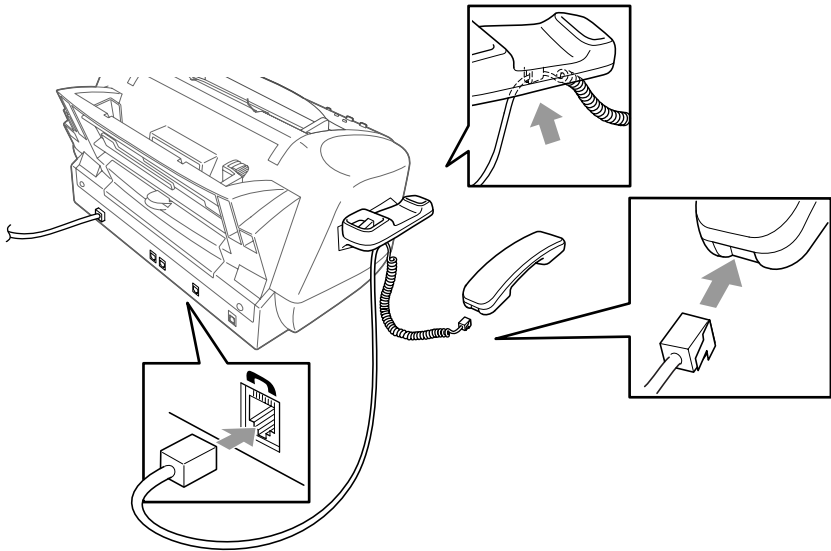

2 Connect the power cord.

There is no ON/OFF switch. When you plug in the power cord, the power goes on and the LCD shows:

CHECK CARTRIDGE

! WARNING

- The fax machine must be grounded using a 3-prong plug.
- Since the fax machine is grounded through the power outlet, you can protect yourself from potentially hazardous electrical conditions on the telephone network by keeping the power to your fax machine on when you connect it to a telephone line. Similarly, you can protect yourself when you want to move your fax machine by disconnecting first the telephone line and then the power cord.
- Lightning and power surges can damage this product! We recommend that you use a quality surge protection device on the AC power line as well as on the telephone line, or unplug the lines during a lightning storm.

3 Connect the telephone line cord.

Connect one end of the telephone line cord to the jack on the fax machine and the other end to a modular wall jack.

Caution

Operating the fax machine before you install the ink cartridges will permanently damage the print head.

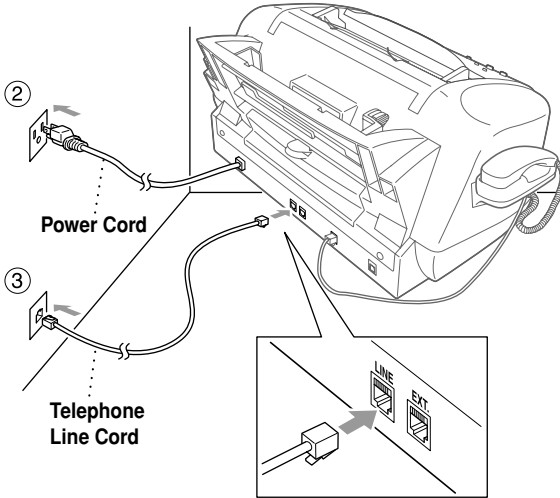

4 Attach the paper wire extension to the multi-purpose sheet feeder.

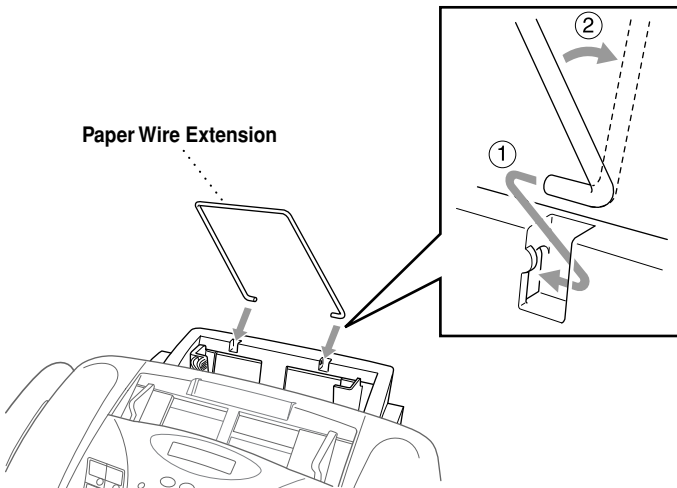

5 Attach the plastic document support.

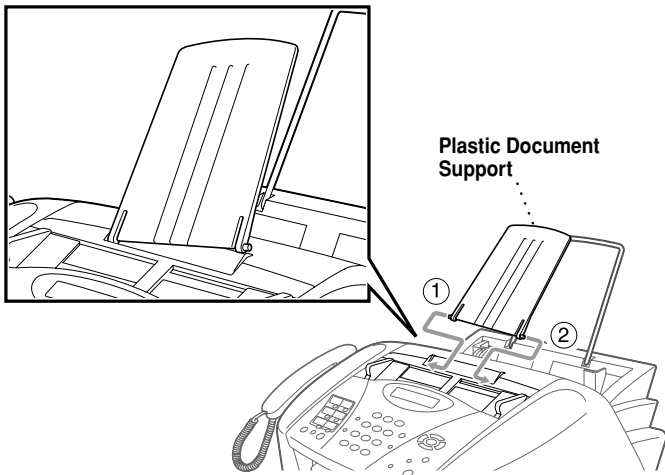

6 Attach the plastic paper tray, and then pull out the extension.

! Caution

Please attach the paper tray to prevent paper jams and maintain print quality.

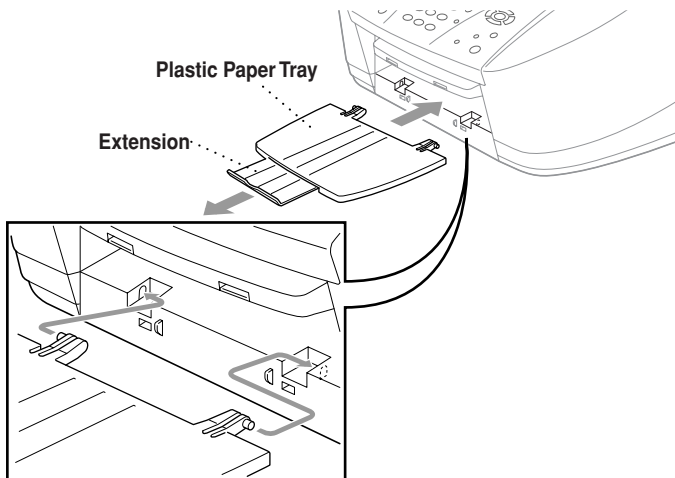

7 Attach the document wire extension.

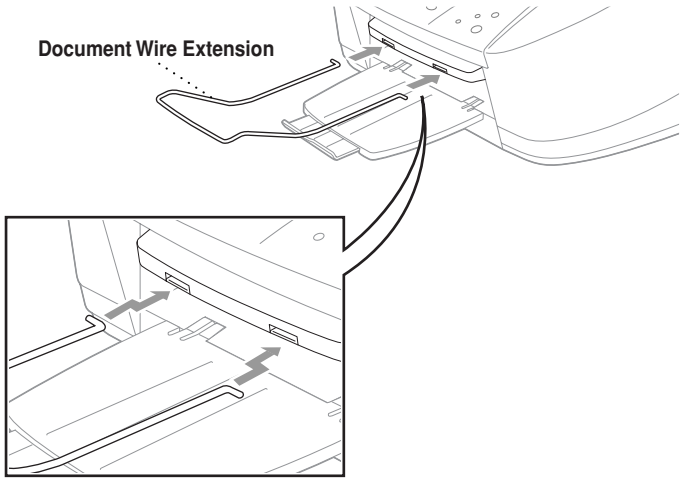

Loading Paper in the Multi-Purpose Sheet Feeder (Paper Cassette)

You can load up to 100 sheets of 20 lb (75 g/m²) paper if you use the plain paper. (See *Paper Capacity of Multi-purpose Sheet Feeder*, page 3-2.)

- 1 Fan the paper well.
Gently insert the paper.
Make sure the print side is toward you and the paper level is stacked below the paper guide line.

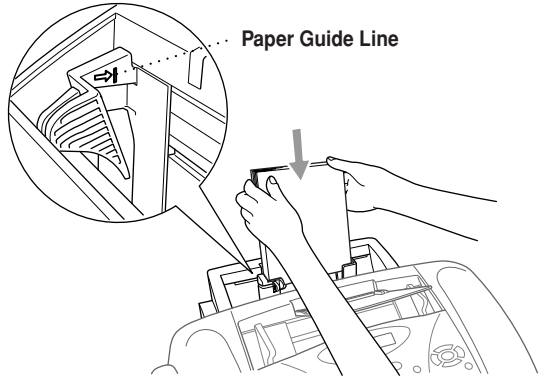

- 2 Press and slide the guide to fit the paper width.

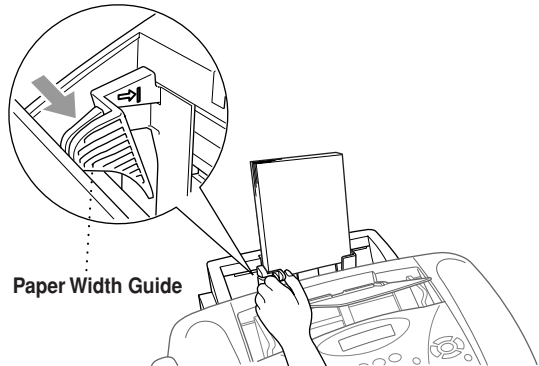

Installing the Ink Cartridges

- 1 Check that you turned on the power (by plugging in the power cord). The LCD shows:

CHECK CARTRIDGE

- 2 Open the control panel cover by pulling it toward you (①), and then lift the top cover toward the back (②). After a few seconds, the print head will move left to its replacement position.

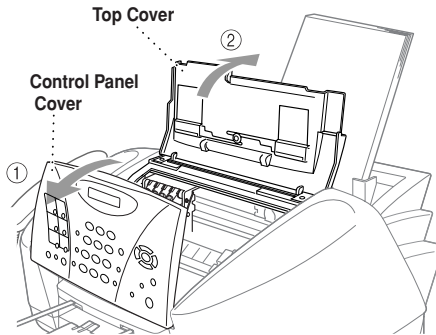

- 3 Remove the protective blue tape from the colored ink cartridge covers.

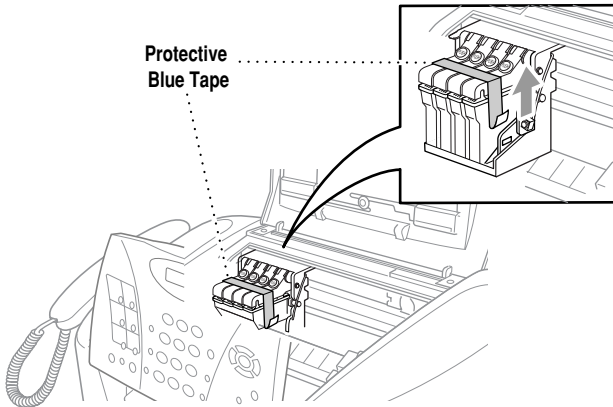

- 4 Push the four colored ink cartridge covers one at a time so they pop up. Then remove the white shipping cover by pulling it toward you and lifting it up and out.

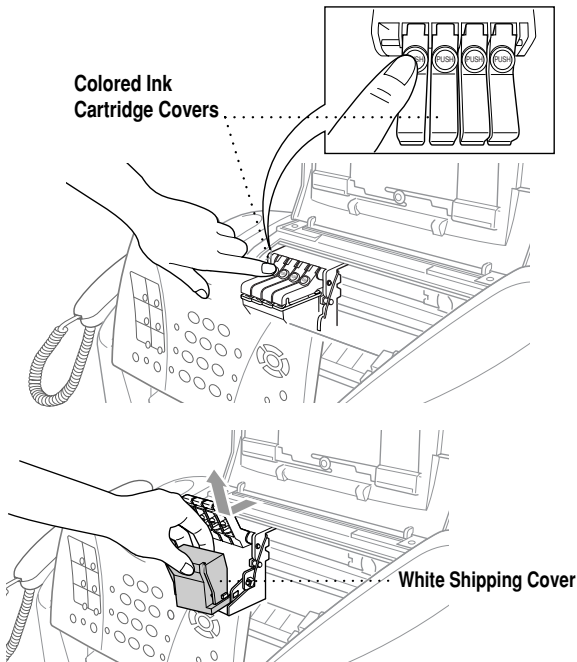

⚠ WARNING

If ink gets in your eyes irrigate them with water immediately; and if irritation occurs consult a doctor.

⚠ Caution

- The bottom of the white shipping cover is wet with ink that will cause stains, so wipe it clean before you place it down.
- Do not throw away the white shipping cover. You will need it for future transportation.

We recommend that you install the ink cartridges from left to right in this order: Black, Cyan, Yellow, Magenta.

- 5 Open the Black ink cartridge bag and take out the ink cartridge.
- 6 Carefully remove the sealing tape from the bottom of the ink cartridge. Be sure to peel the tape in the direction *away* from you.

Important

To prevent spilling ink and staining your hands and clothing, peel the sealing tape gently and slowly. Do not touch the ink opening on the cartridge or the removed tape.



- 7 Each color has its own correct position. Match the colors of the ink cartridge covers. First, gently insert the Black ink cartridge, and then press the cover down until it clicks.

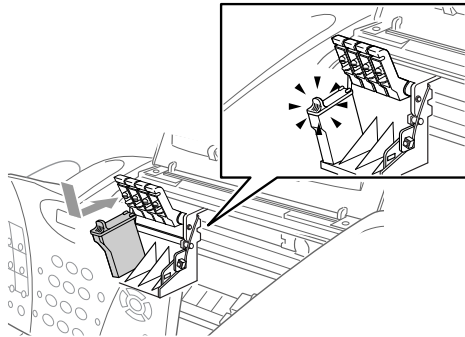

- 8 Repeat Steps 4 to 6 to install each color ink cartridge.
- 9 After installing all ink cartridges, close the top cover and control panel cover until they click into place. Your fax machine will enter a “head cleaning” cycle for approximately four minutes.

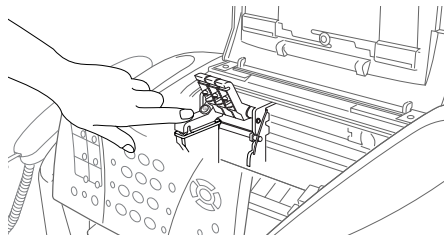

! Caution

Make sure the paper is loaded in the multi-purpose sheet feeder. The LCD shows **CLEANING**. After the cleaning cycle is finished, the LCD shows **PRESS FAX START**.

- 10 Press **Black Fax Start**. The fax machine starts printing the Print Quality Check Sheet (only during initial ink cartridge installation).

The LCD shows:

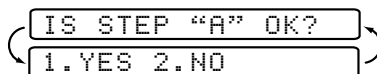

- 11 Follow the instructions printed on the sheet.

! Caution

- DO NOT remove ink cartridges if you do not need to replace them. If you do so, it may reduce the ink quantity and the fax machine will not know the quantity of ink left in the cartridge.
- DO NOT shake the ink cartridges. If you do so, the ink may spill when you take off the sealing tape. If ink stains your body or clothing, wash with soap or detergent immediately.
- If you mix the colors by installing an ink cartridge in the wrong color position, you must clean the print head several times after correcting the cartridge installation and before you start printing.
- Once you open an ink cartridge, install it in the fax machine and use it up within six months of installation. Use unopened ink cartridges by the expiration date written on the cartridge package.
- DO NOT refill the ink cartridges. Attempting to use refilled cartridges and using incompatible inks may cause damage to the print head in this machine and such damage will not be covered by warranty. Warranty coverage does not apply to problems caused by the use of 3rd party ink or 3rd party ink cartridges. Use only genuine Brother ink cartridges.



If **INK EMPTY** shows on the LCD after you install the ink cartridges, check to make sure the ink cartridges are installed correctly.

Connecting the Fax Machine

Connecting an External Telephone

Although your fax machine has a handset, you can connect a separate telephone (or telephone answering device) directly to your fax machine.

Connect the modular plug on the telephone's line cord to the jack labeled EXT. on the back side of the fax machine.

Whenever this phone (or TAD) is in use, the LCD displays **EXT. TEL IN USE**, and, if the fax handset is lifted, an alarm sounds. To disconnect the call on the external phone and switch to the fax, press **Hook/Hold**.



The external telephone can be cordless. Set the Receive Mode to **FAX/TEL**. (See *Using a Cordless External Handset*, page 6-5.)

Connecting an External Telephone Answering Device (TAD)

Sequence

You may choose to connect an answering system. However, when you have an **external** TAD on the same telephone line as the fax machine, the TAD answers all calls. The fax machine "listens" for fax calling (CNG) tones. If it hears them, the fax machine takes over the call and receives the fax. If it doesn't hear CNG tones, the fax machine lets the TAD continue playing your outgoing message so your caller can leave you a voice message.

The TAD must answer within five rings (the recommended setting is two rings). The fax machine cannot hear CNG tones until the TAD has answered the call, and with five rings there are only 8–10 seconds of CNG tones left for the fax "handshake." Make sure you carefully follow instructions in this manual for recording your outgoing message. We do not recommend using the toll saver feature on your external answering machine if it exceeds five rings.



If you do not receive all your faxes, you must reset the setting on your external TAD to four rings.



The external TAD can be cordless. Set the Receive Mode to **TAD:ANSWER MACH.**



If You Subscribe to your Telephone Company's Distinctive Ring Service:

You may connect an external TAD to a separate wall jack *only* if you subscribe to your telephone company's Distinctive Ring service, have registered the distinctive ring pattern on your fax machine, use that number as a fax number, and have set your machine's Receive mode to **MANUAL**. The recommended setting is three or four rings on the external TAD when you have the telephone company's Distinctive Ring Service.



If You Do Not Subscribe to Distinctive Ring Service:

You *must* plug your TAD into the EXT. jack of your fax machine. If your TAD is plugged into a wall jack, both your machine and the TAD will try to control the phone line. (See illustration on page 2-14.)



Do not connect a TAD elsewhere on the same phone line (unless you have the Distinctive Ring service).

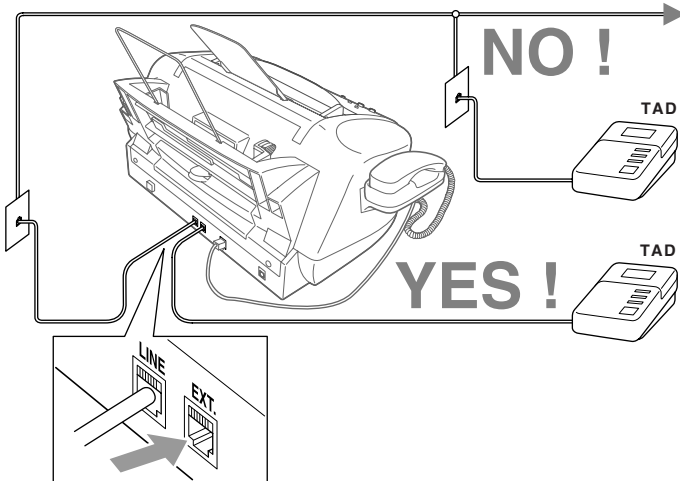

Connections

The external TAD **must** be plugged into the back side of the fax machine, in the jack labeled EXT. Your fax machine cannot work properly if you plug the TAD into a wall jack (unless you are using Distinctive Ring).

- 1 Plug the telephone line cord from the wall jack into the back side of the fax machine, in the jack labeled LINE.
- 2 Plug the telephone line cord from your external TAD into the back side of the fax machine, in the jack labeled EXT. (Make sure this cord is connected to the TAD at the TAD's telephone line jack, and not its telephone set jack.)
- 3 Set your external TAD to four rings or less. (The fax machine's Ring Delay setting does not apply.)
- 4 Record the outgoing message on your external TAD (see page 2-15).
- 5 Set the TAD to answer calls.
- 6 Set the Receive Mode to **TAD:ANSWER MACH.**
(See *Choosing the Receive Mode*, page 6-1.)

Recording Outgoing Message (OGM)

Timing is important in recording this message. The message sets up the ways to handle both manual and automatic fax reception.

- 1 Record 5 seconds of silence at the beginning of your message. (This allows your fax machine time to listen for the fax CNG tones of automatic transmissions before they stop.)
- 2 Limit your speaking to 20 seconds.
- 3 End your 20-second message by giving your Fax Receive Code for people sending manual faxes. For example:
“After the beep, leave a message or send a fax by pressing * 51 and Start.”



We recommend beginning your OGM with an initial 5-second silence because the fax machine cannot hear fax tones over a resonant or loud voice. You may try omitting this pause, but if your fax machine has trouble receiving, then you must rerecord the OGM to include it.

Special Line Considerations

Roll Over Phone Lines

A roll over phone system is a group of two or more separate telephone lines that pass incoming calls each other if they are busy. The calls are usually passed down or “rolled over” to the next available phone line in a preset order.

Your fax machine can work in a roll over system as long as it is the last number in the sequence, so the call cannot roll away. Do not put the fax machine on any of the other numbers; when the other lines are busy and a second fax call would be received, the fax call is transferred to a line that does not have a fax machine.

Your fax machine will work best on a dedicated line.

Two-Line Phone System

A two-line phone system is nothing more than two separate phone numbers on the same wall outlet. The two phone numbers can be on separate jacks (RJ11) or combined into one jack (RJ14). Your fax machine must be plugged into an RJ11 jack. RJ11 and RJ14 jacks may be equal in size and appearance and both may contain four wires (black, red, green, yellow). To test the type of jack, plug in a two-line phone and see if it can access both lines. If it can, you must separate the line for your fax machine. (See *Easy Receive*, page 6-3.)

Converting Telephone Wall Outlets

There are three ways to convert to an RJ11 jack. The first two ways may require assistance from the telephone company. You can change the wall outlets from one RJ14 jack to two RJ11 jacks. Or, you can have an RJ11 wall outlet installed and slave or jump one of the phone numbers to it.

The third way is the easiest: Buy a triplex adapter. You can plug a triplex adapter into an RJ14 outlet. It separates the wires into two separate RJ11 jacks (Line 1, Line 2) and a third RJ14 jack (Lines 1 and 2). If your fax machine is on Line 1, plug the fax machine into L1 of the triplex adapter. If your fax machine is on Line 2, plug it into L2 of the triplex adapter.

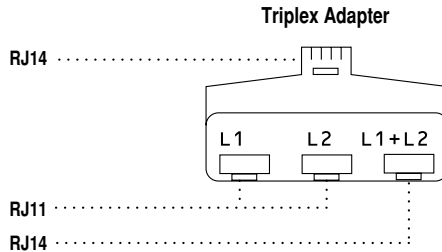

Installing fax machine, External Two-Line TAD and Two-Line Telephone

When you are installing an **external** two-line telephone answering device (TAD) and a two-line telephone, your fax machine must be isolated on one line at both the wall jack and at the TAD. *The most common connection is to put the fax machine on Line 2.* The two-line TAD must have two telephone jacks: one labeled L1 or L1/L2, and the other labeled L2, which is explained in the following Steps. You will need at least three telephone line cords, the one that came with your fax machine and two for your external two-line TAD. You will need a fourth line cord if you add a two-line telephone.

- 1 Place the two-line TAD and the two-line telephone next to your fax machine.
- 2 Plug one end of the telephone line cord for your fax machine into the L2 jack of the triplex adapter. Plug the other end into the LINE jack on the left side of the fax machine.
- 3 Plug one end of the first telephone line cord for your TAD into the L1 jack of the triplex adapter. Plug the other end into the L1 or L1/L2 jack of the two-line TAD.

- 4 Plug one end of the second telephone line cord for your TAD into the L2 jack of the two-line TAD. Plug the other end into the EXT. jack on the left side of the fax machine.

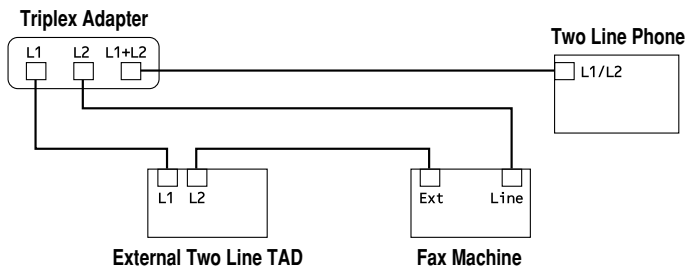

You can keep two-line telephones on other wall outlets as always. There are two ways to add a two-line telephone to the fax machine's wall outlet. You can plug the telephone line cord from the two-line telephone into the L1+L2 jack of the triplex adapter. Or, you can plug the two-line telephone into the TEL jack of the two-line TAD.

Multi-Line Connections (PBX)

Most offices use a central telephone system. While it is often relatively simple to connect the machine to a key system or a PBX (Private Branch Exchange), we suggest that you contact the company that installed your telephone system and ask them to connect the fax machine for you. It is advisable to have a separate line for the fax machine. You can then leave the fax machine in **FAX ONLY** mode to receive faxes any time of day or night.

If the fax machine is to be connected to a multi-line system, ask your installer to connect the unit to the last line on the system. This prevents the unit from being activated each time a telephone call is received.

- ⊘ As with all fax units, this machine must be connected to a two wire system. If your line has more than two wires, proper connection of the fax machine cannot be made.

If You are Installing the Fax Machine to Work with a PBX:

- 1 It is not guaranteed that the unit will operate correctly under all circumstances with a PBX. Any cases of difficulty should be reported first to the company that handles your PBX.
- 2 If all incoming calls will be answered by a switchboard operator, it is recommended that the Receive Mode be set to **MANUAL**. All incoming calls should initially be regarded as telephone calls.
- 3 The fax machine may be used with either pulse or tone dialing telephone service.

Custom Features on Your Phone Line

If you have Voice Mail, Call Waiting, Call Waiting/Caller ID, RingMaster, an answering service, an alarm system or other custom feature on one phone line, it may create a problem with the operation of your fax machine. (See *Custom Features on a Single Line*, page 15-8.)

3 Paper

About Paper

The quality of your document can be affected by the kind of paper you use in the fax machine. You can use plain paper, inkjet paper (coated paper), glossy paper, transparencies and envelopes. We recommend testing various papers before purchasing large quantities. For best results, use the recommended paper.

To ensure the best print quality for the settings you've chosen, always set the Paper Type to match the type of paper you load.



When using inkjet paper, glossy paper or transparencies, avoid stacking by removing each page after copying or receiving faxes.

Handling and Using Special Paper

- Store paper in the original bag, and keep it sealed. Keep the paper flat and away from moisture, direct sunlight and heat.
- The coated side of glossy paper is shiny. Do not touch the shiny (coated) side. Load glossy paper with the shiny side facing up toward you.
- Do not touch either side of transparencies, because they absorb water and perspiration easily and may cause decreased output quality. Transparencies designed for laser printers/copiers may stain your next document. Use only recommended transparencies.

Recommended Paper for the FAX-1800C

Plain Paper:	Xerox 4200
Inkjet Paper:	KODAK® Premium Inkjet Paper (Matte)
Glossy Paper:	JETPRINT PHOTO® Graphic image paper — Gloss Finish
Transparencies:	3M Transparency Film (CG3410)



The output quality depends on the paper type and paper brand. Visit us at <http://solutions.brother.com> and check the latest recommendations for paper that can be used with the FAX-1800C.

Paper Capacity of Multi-purpose Sheet Feeder

Paper Type	Paper Size	Capacity
Plain Paper (Cut Sheet)	Letter, Executive	100 Sheets of 20 lb (75 g/m ²)
	Legal	100 Sheets of 20 lb (75 g/m ²)
Inkjet Paper	Letter	20 Sheets
Glossy Paper*	Letter	20
Transparencies	Letter	10
Envelopes*	DL, COM-10, C5, Monarch	10
Postcard*	4" × 6"	30
Index Card*	5" × 8"	30

*If you want to load thick paper such as postcards, index cards, envelopes and glossy paper in the multi-purpose sheet feeder, you must first install the Card Stock Support in the feeder.

Paper Specifications for Multi-purpose Sheet Feeder

Cut Sheet Paper Weight	Plain Paper: 17 to 32 lb (64 to 120 g/m ²) Inkjet Paper: Up to 32 lb (120 g/m ²) Glossy Paper: Up to 40 lb (150 g/m ²) Postcard: Up to 45 lb (170 g/m ²) Index card: Up to 32 lb (120 g/m ²)
Thickness	Plain Paper: 0.003 to 0.006 inches (0.08 to 0.15 mm) Inkjet Paper: Up to 0.006 inches (0.15 mm) Glossy Paper: Up to 0.007 inches (0.18 mm) Envelopes: Up to 0.02 inches (0.52 mm) Postcard: Up to 0.009 inches (0.23 mm) Index card: Up to 0.006 inches (0.15 mm)
Sheet Feeder	Up to 0.39 inches (10 mm) Approximately 100 sheets of 20 lb (75 g/m ²)
Output Stacker	Approximately 50 sheets of 20 lb (75 g/m ²) (Transparencies and glossy paper must be picked up from the paper tray one page at a time.)



Do not use the following types of paper and envelopes:

- Damaged, curled, wrinkled, or irregularly shaped paper and envelopes
- Extremely shiny or highly textured paper and envelopes
- Paper and envelopes already printed with a laser printer
- Paper and envelopes that cannot be arranged uniformly when stacked

Print Area

The print area depends on the settings in the application you are using. The figures below show the unprintable areas on cut sheet paper and envelopes.

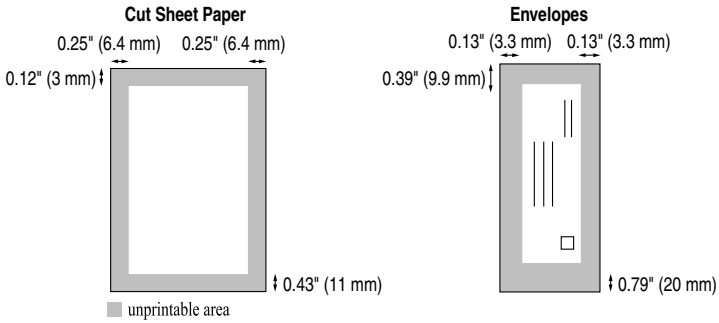

4 On-Screen Programming

User-Friendly Programming

We have designed your fax machine with on-screen programming using navigation keys. User-friendly programming helps you take full advantage of all the menu selections your fax machine has to offer.

Since your programming is done on the LCD, we created step-by-step on-screen prompts to help you program your fax machine. All you need to do is follow the prompts as they guide you through the menu selections and programming options. Additionally, you can program settings more quickly by pressing **Menu/Set** and the menu number using the dial pad.

Menu Selection Table

You can probably perform most of these programming operations without the Owner's Manual. To help you understand the menu selections, and options that are found in the fax machine programs, use the Menu Selection Table on page 4-3.



You can program your fax machine by pressing **Menu/Set** followed by the menu numbers. For example: to set **FAX RESOLUTION** to **FINE**,

press **Menu/Set**, **2, 2, 2** and  to select **FINE**, and then press **Menu/Set**.

Alternating Displays

Sometimes, the LCD alternates between the active setting, and a help message giving brief instructions about how to proceed. The LCD message you'll probably see most often is shown below. When you place an original in the ADF, it appears to tell you that you can dial a number to send a fax or you can make a copy.

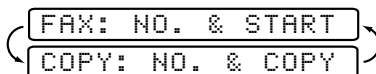

Navigation Keys

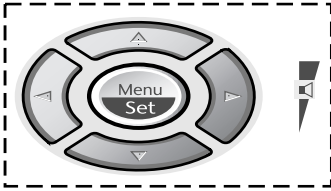

- * Access the Menu
- * Go to next menu level
- * Accept an option



- * Scroll through the current menu level



- * Back to previous menu level



- * Forward to next menu level



- * Exit the Menu

You can access the menu mode by pressing **Menu/Set**. When you enter the Menu, the LCD scrolls;

Then press **1** for General Setup Menu—**OR**—

Press **2** for Fax Menu—**OR**—

Press **3** for Copy Menu—**OR**—

Press **4** for Test Print

SELECT ↑ ↓ & SET

1. GENERAL SETUP

2. FAX

3. COPY

4. TEST PRINT

—**OR**—

You can scroll more quickly through the each menu level by pressing , and then set an option by pressing **Menu/Set** when that option appears on the LCD.

Then the LCD shows next menu level. Press  to scroll to your next menu selection, and then press **Menu/Set**.

When you finish setting an option, the LCD shows **ACCEPTED**.



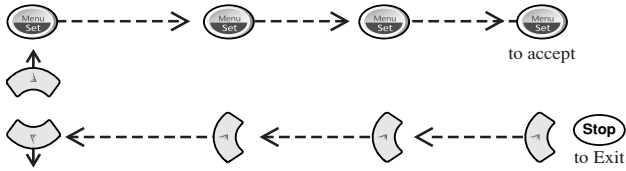

Use  to scroll backward if you passed your choices or to save keystrokes.

To access the menu, press  **Menu/Set**.



Main Menu	Submenu	Menu Selections	Options	Descriptions	Page	
1. GENERAL SETUP	1. PAPER TYPE	—	PLAIN INKJET GLOSSY (4-COLOR/3-COLOR) TRANSPARENCY	Identifies the type of paper in the multi-purpose sheet feeder.	5-1	
	2. PAPER SIZE	—	LETTER LEGAL A4	Selects the size of paper.	5-1	
	3. DATE/TIME	—	—	Enter date and time for the LCD display and heading on fax transmissions.	5-2	
	4. STATION ID	—	—	Program your name and fax number to appear on each transmitted page.	5-2	
	5. VOLUME		1. RING	HIGH LOW OFF	Adjusts ring volume.	5-4
			2. BEEPER	HIGH LOW OFF	Adjusts volume level of beeper.	5-4
			3. SPEAKER	HIGH MED LOW OFF	Adjusts speaker volume.	5-5
			4. HANDSET	HIGH LOW	Adjusts handset volume.	5-5
			5. VOLUME AMPLIFY	ON (PERMANENT/ TEMPORARY) OFF	For the hearing-impaired, you can set the volume to the VOL AMPLIFY:ON setting on a permanent or temporary basis.	5-6

 The factory setting (option) is shown in bold.

To access the menu, press  **Menu/Set**.

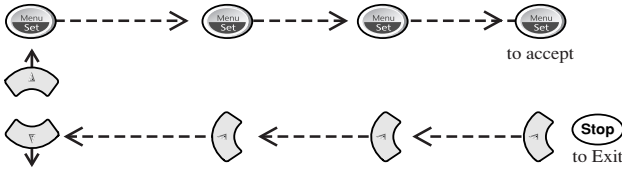

Main Menu	Submenu	Menu Selections	Options	Descriptions	Page
	6. AUTO DAYLIGHT	—	ON OFF	Changes for Daylight Savings Time automatically.	5-7
	7. TONE/PULSE	—	TONE PULSE	Selects dialing mode	5-7
	8. LOCAL LANGUAGE (Canada Only)	—	ENGLISH FRENCH	Allows you to change the LCD Language to French.	See French Manual
2. FAX	1. SETUP RECEIVE	1. RING DELAY	04 03 02 01 00	Sets number of rings before fax machine answers in FAX ONLY or FAX/TEL mode.	6-2
		2. F/T RING TIME	70 40 30 20	Sets the length of time for “double-ring” in FAX/TEL mode.	6-3
		3. EASY RECEIVE	ON SEMI OFF	Receive fax messages without pressing the Start key.	6-3
		4. REMOTE CODE	ON (* 51, #51) OFF	Activate or deactivate the fax machine from a remote location. You can also personalize these codes.	6-5
		5. AUTO REDUCTION	ON OFF	Reduces the size of incoming fax images to fit on your paper.	6-4
		6. POLLING RX	ON OFF	Sets up your fax machine to poll another fax machine.	6-6

 The factory setting (option) is shown in bold.

To access the menu, press  **Menu/Set**.

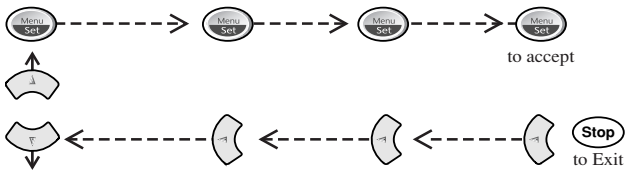







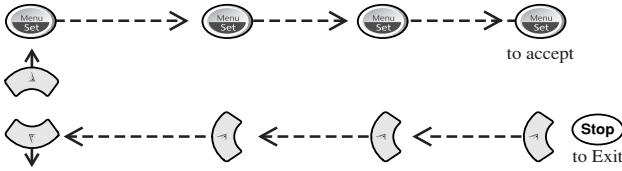





















Main Menu	Submenu	Menu Selections	Options	Descriptions	Page
2. FAX	2. SETUP SEND	1. CONTRAST ↑	AUTO ↑ S.LIGHT ↕ S.DARK ↓	Changes the lightness or darkness of a fax you are sending.	7-2
		2. FAX RESOLUTION	STANDARD ↑ FINE ↕ S. FINE ↕ PHOTO ↓	Changes the default setting of fax resolution.	7-3
		3. DELAYED FAX	—	Sends documents later.	7-10
		4. BATCH TX	ON ↑ OFF ↕ ↓	Sends all delayed faxes that are to the same fax number and at the same time as one transmission.	7-10
		5. REAL TIME TX ↕	OFF ↑ ON ↕ NEXT FAX ONLY ↕	You can send a fax without using memory.	7-5
		6. POLLED TX	ON ↑ OFF ↕ ↓	Sets up your fax machine with a document to be retrieved by another fax machine.	7-11
		7. COVERPG SETUP	NEXT FAX ONLY ↑ ON ↕ OFF ↕ PRINT SAMPLE ↓	Automatically sends a cover page you program.	7-8
		8. COVERPAGE MSG	—	Programs customized message for fax cover page.	7-7
		9. OVERSEAS MODE	ON ↑ OFF ↕	Ajusts for sometimes difficult overseas transmissions.	7-9

 The factory setting (option) is shown in bold.

To access the menu, press  **Menu/Set**.









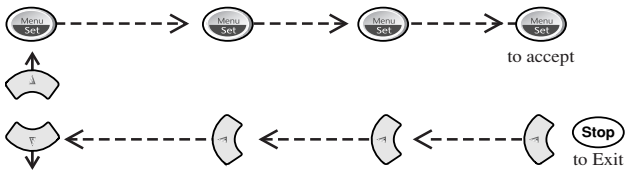















Main Menu	Submenu	Menu Selections	Options	Descriptions	Page
2. FAX (Continued)	3. SET AUTO DIAL	1. ONE-TOUCH DIAL 	—	Store One-Touch Dial so you can dial by pressing only one key.	8-2
		2. SPEED-DIAL  	—	Store Speed Dial numbers so you can dial by pressing only four keys.	8-1
		3. SETUP GROUPS 	—	Sets up a Group number for Broadcasting.	8-3
	4. SETUP REPORTS  	1. TRANSMISSION  	ON ON+IMAGE 	Initial setup for Transmission Verification Report and Fax Activity Report.	11-1
			OFF OFF+IMAGE 		
	2. ACT. INTERVAL  	OFF  	7/4/2 Days 	11-1	
			24/12/6 Hours 		
	5. REMOTE FAX OPT 	1. FAX FWD/PAGING  	OFF 	Sets fax machine to forward fax messages— OR —to call your pager.	10-1
			FAX FORWARD PAGING 		
		2. FAX STORAGE  	ON 	Stores incoming faxes in memory for Remote Retrieval.	10-2
			OFF 		
	3. REMOTE ACCESS 	159 ✖	Personalizes code for retrieving faxes.	10-3	
4. PRINT FAX 	—	Prints incoming faxes stored in the memory.	6-6		

 The factory setting (option) is shown in bold.

To access the menu, press  **Menu/Set**.



Main Menu	Submenu	Menu Selections	Options	Descriptions	Page	
2. FAX (Continued)	6. REMAINING JOBS	—	—	Check which jobs are in memory or cancel a Delayed Fax or Polling job.	6-7, 7-6	
	0. TEL SERVICE	1. DISTINCTIVE	ON	                      	Uses the phone company Distinctive Ring subscriber service to register the ring pattern with the fax machine.	9-3
		2. CALLER ID	DISPLAY #		PRINT REPORT	View or print a list of the last 30 Caller IDs stored in memory.
	1. QUALITY	—	NORMAL		FAST	BEST
3. COPY	2. COLOR ADJUST	1. RED	R:- ■■■■ + R:- ■■■■ □ + R:- ■■■■ □ □ + R:- ■■■■ □ □ □ + R:- ■■■■ □ □ □ □ +	Adjust the amount of Red in copies.	12-8	
		2. GREEN	G:- ■■■■ + G:- ■■■■ □ + G:- ■■■■ □ □ + G:- ■■■■ □ □ □ + G:- ■■■■ □ □ □ □ +	Adjust the amount of Green in copies.	12-8	
		3. BLUE	B:- ■■■■ + B:- ■■■■ □ + B:- ■■■■ □ □ + B:- ■■■■ □ □ □ + B:- ■■■■ □ □ □ □ +	Adjust the amount of Blue in copies.	12-8	
	3. CONTRAST	—	- ■■■■ + - ■■■■ □ + - ■■■■ □ □ + - ■■■■ □ □ □ + - ■■■■ □ □ □ □ +	Adjust the contrast.	12-8	
4. TEST PRINT	—	—	—	You can print a test sample page to check print quality and adjust the Vertical Alignment.	15-9	

 The factory setting (option) is shown in bold.

Key Operations Table

You can use the temporary keys on the control panel to conveniently choose temporary copy and fax settings. The Key Operations Table below shows the options they provide.

Press the temporary key repeatedly until you see the option you want; some keys require pressing **Menu/Set** to select it. For the **Options** key, press  to scroll through the next level of options, and then select the one you want by pressing **Menu/Set** again.

Keys	Options		Descriptions	Page
Options	OPT:#OF COPIES 01	NO.OF COPIES:01	Enter the number of copies.	12-3
	OPT:PAPER TYPE	PLAIN/INK JET/ GLOSSY(4-COLOR or 3-COLOR)/ TRANSPARENCY	Identify the type of paper in the multi-purpose sheet feeder.	12-3
	OPT:PAPER SIZE	LETTER/LEGAL/A4/ POST CARD: 4"X6"	Specify the size of paper.	12-4
	OPT:QUALITY	NORMAL/BEST/FAST	Select the Quality.	12-4
	OPT:BRIGHTNESS	- ■■■□□ +	Select the degree of Brightness.	12-4
	OPT:ELG/RDC	50%, 78% LGL>LTR, 94% A4>LTR, 100% , 104% EXE>LTR, 150%, 200%, ZOOM	Select one a fixed reduction or enlargement ratio, or enter a percentage between 25% and 400%.	12-5
	OPT:SPECIAL	2 IN 1 OFF(1 IN 1)	You can change the layout of copies on the print media.	12-6
Ink	1.CLEANING	BLACK/CYAN YELLOW/MAGENTA ALL	These two colors are cleaned together. These two colors are cleaned together. All four colors are cleaned.	15-9
	2.REPLACE INK	—	—	15-16
Color Copy	—		Make a color copy.	12-1
Black Copy	—		Make a black & white copy.	12-1
Reports (Shift + Ink)	1.HELP LIST 2.AUTO DIAL 3.FAX ACTIVITY 4.TRANSMISSION 5.USER SETTINGS		Press Shift and Ink together to access the Reports menu.	11-2

Keys	Options	Descriptions	Page
Receive Mode	FAX ONLY FAX/TEL TAD:ANSWER MACH. MANUAL	Select the machine's Receive Mode.	6-1
Fax Resolution	STANDARD FINE S.FINE PHOTO	Black & white / color Black & white / color Black & white only Black & white only	7-3
Color Fax Start	—	Send the fax in color (if receiving machine has this feature).	7-4
Black Fax Start	—	Send the fax in black & white.	7-3
Shift + Hook (Secure Feed)	—	After loading paper in the cassette, press Shift and Hook together to turn ON; repeat to turn OFF.	15-4



The factory setting (option) is shown in bold.

5 Initial Setup

Getting Started



Setting Paper Type

You can choose the Paper Type you use.

- 1 Press **Menu/Set, 1, 1.**

1.PAPER TYPE

- 2 Press  **OR**  to select **PLAIN, INK JET, GLOSSY** or **TRNSPRNCY (TRANSPARENCY)**, and then press **Menu/Set**.

- 3 If you selected **GLOSSY**, press  **OR**  to select **GLOSSY:4-COLOR** or **GLOSSY:3-COLOR**, and then press **Menu/Set**.

 **Note** The print quality of black ink varies depending on the kind of glossy paper you are using. Black ink is used when you select **GLOSSY:4-COLOR**. If the glossy paper you are using repels the black ink, select **GLOSSY:3-COLOR**, which simulates black ink by combining the three ink colors.

- 4 Press **Stop/Exit**.



 **Note** The fax machine ejects paper with printed surfaces face up onto the paper tray in the front of the fax machine. When you use transparencies, remove each sheet immediately, to prevent a paper jam or curled.

Setting Paper Size

You can use three sizes of paper for printing your faxes and copies — letter, legal and A4. When you change the kind of paper you have loaded in the fax machine, you will need to change the setting for Paper Size so your fax machine can fit the incoming fax on the page.





- 1 Press **Menu/Set, 1, 2.**

2.PAPER SIZE

- 2 Press  **OR**  to select **LETTER, LEGAL** or **A4**, and then press **Menu/Set**.
- 3 Press **Stop/Exit**.



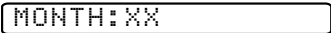

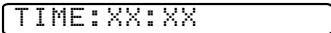
Setting Date and Time

Your fax machine displays the date and time, and prints it on every fax you send. In the event of a power failure, you may have to reset the date and time. All other settings remain unaffected.

- 1 Press **Menu/Set**, **1**, **3**.

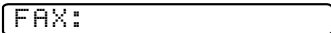
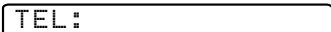
- 2 Enter the last two digits of the year, and then press **Menu/Set**.

- 3 Enter two digits for the month (for example, enter 09 for September, or 10 for October), and then press **Menu/Set**.

- 4 Enter two digits for the day (for example, 06), and then press **Menu/Set**.

- 5 Enter the time in 24-hour format (for example, enter 15:25 for 3:25 P.M.), and then press **Menu/Set**.

- 6 Press **Stop/Exit**.
The LCD now displays the date and time you set whenever the fax machine is in Standby mode.

Setting Station ID

You can store your name, fax number and telephone number in this setting. The name and fax number will be printed on the fax cover pages and all fax pages that you send.

- 1 Press **Menu/Set**, **1**, **4**.

 - 2 Enter your fax number (up to 20 digits), and then press **Menu/Set**.
You must enter a fax number to proceed.

 - 3 Enter your telephone number (up to 20 digits) and press **Menu/Set**. If your telephone number and fax number are the same, enter the same number again.

-  The telephone number you enter is used only for Cover Page features. (See *Composing Electronic Cover Page*, page 7-7.)
- 4 Use the dial pad to enter your name (up to 20 characters), and then press **Menu/Set**. (See *Entering Text*, page 5-3.)

 - 5 Press **Stop/Exit**.
The LCD returns to the date and time.
-  If your Station ID has already been programmed, the LCD prompts **1** to make a change, or **2** to exit without changing.

Entering Text

When you are setting certain functions, such as the Station ID, you may need to type text into the fax machine. Most number keys have three or four letters printed above them. The keys for 0, #, and ✖ do not have printed letters because they are used for special characters.

By pressing the appropriate number key repeatedly, you can access the character you want.

Press Key	one time	two times	three times	four times
2	A	B	C	2
3	D	E	F	3
4	G	H	I	4
5	J	K	L	5
6	M	N	O	6
7	P	Q	R	S
8	T	U	V	8
9	W	X	Y	Z

Inserting Spaces

To enter a space, press  once between numbers and twice between characters.



Making Corrections

If you entered a letter incorrectly and want to change it, press  to move the cursor after the last correct letter. Then press **Stop/Exit**; all letters above and to the right of the cursor will be deleted. Re-enter the correct characters. You can also back up and type over incorrect letters.

Repeating Letters

If you need to enter a character that is assigned to the same key as the previous character, press  to move the cursor to the right.

Special Characters and Symbols

Press ✖, # or 0, and then press  or  to move the cursor under the special character or symbol you want. Then press **Menu/Set** to select it.

Press ✖ for (space) ! “ # \$ % & ’ () * + , - . /

Press # for ; : < = > ? @ [] ^ _

Press 0 for É À È Ê Î Ç Ë Ö 0

NOTICE

The Telephone Consumer Protection Act of 1991 makes it unlawful for any person to use a computer or electronic device to send any message via a telephone fax machine unless such messages clearly contain, in a margin at the top or bottom of each transmitted page, or on the first page of the transmission, the date and time it is sent and an identification of the business or other entity or other individual sending the message and the telephone number of the sending machines or such business, other entity or individual.

In order to program this information into your fax machine, complete the steps described on page 5-2.



If you do not enter a fax number, no additional information can be entered.

Setting the Ring Volume

- 1 Press **Menu/Set**, **1**, **5**, **1**.

1. RING

- 2 Press  **OR** select (**OFF**, **LOW** or **HIGH**), and then press **Menu/Set**.

- 3 Press **Stop/Exit**.

—OR—

You can adjust the ring volume when your fax machine is idle. You can turn the ring **OFF** or you can select a ring volume level.

Press  to adjust the volume level. With each key press, the fax machine rings so you can hear the active setting as the LCD shows it. Each key press changes the volume. The new setting will remain until you change it again.

Setting the Beeper Volume

You can set the beeper to **LOW**, **HIGH** or **OFF**. The default setting is **LOW**. When the beeper is set to **LOW** or **HIGH**, the fax machine beeps every time you press a key or make an error and when fax sending or receiving is finished.

- 1 Press **Menu/Set**, **1**, **5**, **2**.

2. BEEPER

- 2 Press  **OR** to select your option.

- 3 When the LCD shows the option you want, press **Menu/Set**.

Press **Stop/Exit**.

Setting the Speaker Volume

- 1 Press **Menu/Set, 1, 5, 3.**

3. SPEAKER

- 2 Press  to select **LOW, MED, HIGH** or **OFF**, and then press **Menu/Set**.

- 3 Press **Stop/Exit**.

—OR—

If you are using **Hook/Hold**, you can adjust the speaker volume while dialing. You can turn the speaker off or you can select a speaker volume level. The default setting is the lowest volume.

Press  to adjust the volume level. With each key press, the volume changes as the LCD shows the active setting. The new setting will remain until you change it again.

Setting the Handset Volume

- 1 Press **Menu/Set, 1, 5, 4.**

4. HANDSET

- 2 Press  to select **HIGH** (or **LOW**), and then press **Menu/Set**.

- 3 Press **Stop/Exit**.

—OR—

You can adjust the handset volume any time you are talking on the telephone. There are two handset volume levels, **LOW** and **HIGH**. The default setting is **LOW**.

Press  to adjust the volume level. The LCD shows the setting you are choosing. The new setting will remain until you change it again.

Choosing the Handset Volume (For Volume Amplify)

Before you begin to use the machine, you must decide if you need to set the handset volume to **VOL AMPLIFY: ON** for a user who is hearing-impaired. The **AMPLIFY** volume level complies with FCC standards.

VOLUME AMPLIFY: OFF

This default setting is appropriate if *none* of the users are hearing-impaired.

During a conversation, users can press Volume  on the control panel to adjust the volume to **LOW** or **HIGH**. When the handset is replaced, the handset volume will remain until you change it again.

VOLUME AMPLIFY: ON—TEMPORARY

This setting is appropriate if *some* of the users are hearing-impaired. During a conversation, users can press Volume  on the control panel to adjust the volume to **LOW**, **HIGH** or **AMPLIFY**. When the handset is replaced, the handset volume returns to the default setting of **LOW**.

VOLUME AMPLIFY: ON—PERMANENT

Choose **VOL AMPLIFY: ON—PERMANENT** if *all* of the users are hearing-impaired. During a conversation, users can press Volume  on the control panel to adjust the volume to **LOW**, **HIGH** or **AMPLIFY**. When the handset is replaced, the handset volume returns to the default setting of **AMPLIFY**.



When you press Volume  on the control panel to adjust the volume, the LCD shows the setting you are choosing. Each key press changes the volume to the next setting.



WARNING





It is important that you do NOT choose PERMANENT unless ALL the users are hearing-impaired. Otherwise, the default setting of **AMPLIFY** may damage the hearing of some users.

Setting Volume Amplify

Please carefully read *Choosing the Handset Volume* on page 5-6 before you do the following steps:



- 1 Press **Menu/Set, 1, 5, 5.**

5.VOLUME AMPLIFY

- 2 If *none* of the users are hearing-impaired, VOL AMPLIFY:ON?
- press  **OF**  to select **VOL AMPLIFY:OFF?**, and then press **Menu/Set** and go to Step 4—**OR**—
- If *some* or *all* of the users are hearing-impaired, select **VOL AMPLIFY:ON?**, and then press **Menu/Set**.
- 3 If all the users are hearing-impaired, PERMANENT?
- press  **OF**  to select **PERMANENT?**, TEMPORARY?
- and then press **Menu/Set**—**OR**—
- If only *some* of the users are hearing-impaired, select **TEMPORARY?**, and then press **Menu/Set**.
- 4 Press **Stop/Exit**.



Turning On Automatic Daylight Savings Time

You can set the machine to change automatically for Daylight Savings Time. It will reset itself forward one hour in the Spring and backward one hour in the Fall.

- 1 Press **Menu/Set, 1, 6**. 6. AUTO DAYLIGHT
- 2 Press  **OF**  to select **ON** (or **OFF**), and then press **Menu/Set**.
- 3 Press **Stop/Exit**.

Setting Tone/Pulse Dialing Mode

Your fax machine comes set to accommodate tone dialing service (multi-frequency). If you have pulse dialing service (rotary), you need to change the dialing mode.

- 1 Press **Menu/Set, 1, 7**. 7. TONE/PULSE
- 2 Press  **OF**  to select **PULSE** (or **TONE**), and then press **Menu/Set**.
- 3 Press **Stop/Exit**.

Memory Storage

In the event of a power failure, all settings in the **GENERAL SETUP, SETUP RECEIVE, SET AUTO DIAL, SETUP REPORTS, REMOTE FAX OPT, COPY**, plus the **COVERPG SETUP** and **COVERPAGE MSG** settings (from **SETUP SEND**) are stored permanently. You may have to reset the date and time.

6 Setup Receive

Basic Receiving Operations

Choosing the Receive Mode

There are three different receive modes for your fax machine. You may choose the mode that best suits your needs by pressing **Receive Mode** repeatedly until the LCD shows the setting you want to use.

LCD	How it works	When to use it
FAX ONLY (automatic receive)	The fax machine automatically answers every call as a fax.	For dedicated fax lines. You cannot receive a voice call but you can call out.
FAX/TEL* (fax/telephone)	The fax machine controls the line and automatically answers every call. If the call is a fax it will receive the fax. If the call is not a fax it will ring (double-ring) for you to pick up the call.	You cannot have an answering machine on the same line, even if it is on a separate wall jack on the same line. You cannot use the telephone company's Voice Mail in this mode.
TAD:ANSWER MACH. (external telephone answering device)	The external TAD automatically answers every call. Voice messages are stored on the external TAD. Fax messages are printed.	Use this mode if you have an external answering machine on your phone line.
MANUAL (manual receive)	You control the phone line and must answer every call yourself.	Use this mode when you are using a computer modem on the same line or if you receive very few fax messages. You can also use this mode with Distinctive Ring.

*In FAX/TEL mode you must set the Ring Delay and F/T Ring Time. If you have extension phones on the line, keep the Ring Delay set to 4 rings.

To Select or Change Your Receive Mode

- 1 Press **Receive Mode**. The LCD shows your current selection.

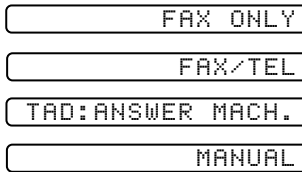

- 2 Continue to press **Receive Mode** until your new selection appears. After two seconds the LCD returns to the date and time display, along with your new Receive Mode setting.



If you are changing the Receive Mode while in another operation, the LCD returns to that operation.

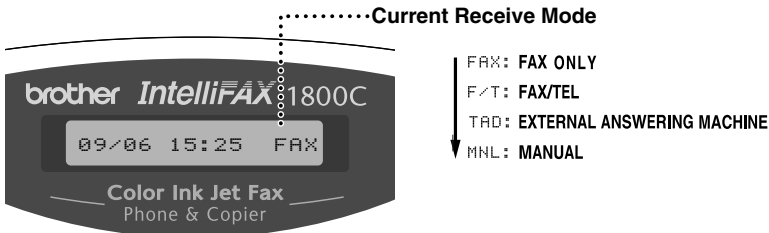

Setting Ring Delay

The Ring Delay setting determines the number of times the fax machine rings before it answers. If you have extension phones on the same line as the fax machine, or subscribe to the telephone company's Distinctive Ring service, keep the Ring Delay default setting of 4. (See *Easy Receive*, page 6-3 and *Operation from Extension Telephones*, page 6-5.)

- 1 Press **Menu/Set, 2, 1, 1**.



- 2 Press  to select how many times the line rings before the fax machine answers (00–04), and then press **Menu/Set**. If you select 00, the line doesn't ring at all.
- 3 Press **Stop/Exit**.

Setting the F/T Ring Time (For FAX/TEL Mode Only)

If you set the receive mode to FAX/TEL, you'll need to determine how long the fax machine will send you its special double-ring when you have a voice call. This ringing happens *after* the initial ringing from the phone company. Only the fax machine rings, for 20, 30, 40 or 70 seconds; no other phones on the same line ring the special double-ring. However, you can answer the call on any extension phone (in a separate wall jack) on the same line as the fax machine. (See *Operation from Extension Telephone*, page 6-5.)

- 1 Press **Menu/Set**, **2**, **1**, **2**.

2.F/T RING TIME

- 2 Press  to select how long the fax machine will ring to alert you that you have a voice call, and then press **Menu/Set**.

RING TIME: 20 SEC

- 3 Press **Stop/Exit**.

Now, when a call comes in and the fax machine is set to FAX/TEL mode, all phones on this line will ring the number of times you selected in Ring Delay.

You can let the fax machine answer and detect if it's a fax or voice call. If it's a fax call, the fax machine prints the fax. If it's a voice call, the fax machine signals you with a double-ring for the length of time you selected in F/T Ring Time.



Even if the caller hangs up during the double-ringing, the fax machine continues for the set time.

Easy Receive

When you use this feature, you don't have to press **Black Fax Start** when you answer a fax call and hear calling beeps. Just hold the handset and wait a few seconds. When you see **RECEIVING** on the LCD or when you hear "chirps" through the handset of an extension phone connected to another wall jack, just replace the handset. Your fax machine does the rest. Selecting **ON** allows the fax machine to receive fax calls automatically, even if you lift the handset of an extension or external phone. Selecting **SEMI** lets the fax machine receive the call only if you've answered it at the fax machine. Selecting **OFF** means you'll have to activate the fax machine yourself, by pressing **Black Fax Start** or by pressing *** 5 1** if you are not at your fax machine.

(See *Operation from Extension Telephones*, page 6-5 and *For FAX/TEL Mode Only*, page 6-5.)



If you've set the feature to **ON**, but your fax machine doesn't automatically connect a fax call when you lift an external or extension phone handset, press the Fax Receive code *** 5 1**. At the fax machine, lift the handset and then press **Black Fax Start**.



If you send faxes from a computer on the same phone line and the fax machine intercepts them, set Easy Receive to **OFF**.

1 Press **Menu/Set, 2, 1, 3.**

3.EASY RECEIVE

2 Use  to select **ON, SEMI, or OFF,**
and then press **Menu/Set.**

3 Press **Stop/Exit.**

Printing a Reduced Incoming Fax (Auto Reduction)

You can always reduce the size of an incoming fax to a fixed percentage, regardless of the size of the paper in your fax machine. **ON** lets your fax machine choose the level of reduction for you.

1 Press **Menu/Set, 2, 1, 5.**

5.AUTO REDUCTION

2 Use  to select **ON (or OFF),**
and then press **Menu/Set.**

3 Press **Stop/Exit.**



If incoming faxes show that information in the left and right margins has been cut off, make sure this Auto Reduction feature is turned on.

FOR YOUR INFORMATION

If one or more ink cartridges are empty, the fax machine will stop printing to protect the print heads; black & white faxes will be received into memory. The FAX-1800C's "handshake" will request that color faxes be sent as black & white. If the sending machine has the feature to send color faxes in black & white, they can be received into memory also.

Replace the empty ink cartridges to print the faxes from memory.

If the fax machine runs out of paper, it stops printing and receives faxes into memory. Add paper, and then press **Black Fax Start** to print the faxes.

Advanced Receiving Operations

Operation from Extension Telephones

If you answer a fax call on an extension phone or on an external phone in the EXT. jack, you can make your fax machine take over by using the Fax Receive Code. When you press the Fax Receive Code ✕ **5 1**, the fax machine starts to receive a fax. (See *Easy Receive*, page 6-3.)

If the fax machine answers a voice call and double-rings for you to take over, use the Telephone Answer Code **# 5 1** to take the call at an extension phone. (See *Setting F/T Ring Time*, page 6-3.)

If you answer a call, and no one is on the line, assume you're receiving a fax. At the fax machine phone press **Black Fax Start**, and then hang up. At an extension phone, press ✕ **5 1**, wait for fax receiving tones (chirps), and then hang up. At an external phone, press ✕ **5 1** and wait for the phone to be disconnected before you hang up (the LCD shows **RECEIVING**). (Your caller will have to press **Black Fax Start** to send the fax.)

For FAX/TEL Mode Only

When the fax machine is in FAX/TEL mode, it will use the F/T Ring Time (double-ringing) to alert you to a voice call. If you're at the fax machine, you can lift the handset to answer.

If you're at an extension phone, you'll need to lift the handset during the F/T Ring Time, and then press **# 5 1** between the double-rings. If no one is on the line or if someone wants to send you a fax, send the call back to the fax machine by pressing ✕ **5 1**.

Using a Cordless External Handset

If your cordless telephone is connected to the EXT. jack of the fax machine and you typically carry the cordless handset elsewhere, it is easier to answer calls during the Ring Delay. If you let the fax machine answer first, you will have to answer using the cordless and then go to the fax machine so you can press **Hook/Hold** to transfer the call to the cordless handset.



Changing the Remote Codes

Remote Codes might not work with some telephone systems. The preset Fax Receive Code is ✕ **5 1**. The preset Telephone Answer Code is **# 5 1**.



If you are always disconnected when accessing your external TAD remotely, try changing the Fax Receive Code from ✕ **5 1** to **###** and the Telephone Answer Code from **# 5 1** to **999**.

1 Press **Menu/Set, 2, 1, 4.**

2 Press  **OR**  to select **ON** (or **OFF**), and then press **Menu/Set.**

4.REMOTE CODE

REMOTE ACT.:ON?

3 If you want to, enter a new Fax Receive Code, and then press **Menu/Set.**

FAX RECEIVE:*51

4 If you want to, enter a new Telephone Answer Code, and then press **Menu/Set.**

TEL ANSWER:#51

5 Press **Stop/Exit.**

Printing a Fax in Memory

If you set Fax Storage to **ON** for remote retrieval, you can still print a fax from the memory when you are at your fax machine. (See *Setting Fax Storage*, page 10-2.)

1 Press **Menu/Set, 2, 5, 4.**

4.PRINT FAX

2 Press **Black Fax Start.**

3 After printing is finished, press **Stop/Exit.**

Polling

Polling is the process of retrieving faxes from another fax machine. You can use your fax machine to “poll” other machines, or you can have someone poll your fax machine.

All parties involved in polling need to set up their fax machines to accommodate polling. When someone polls your fax machine to receive a fax, they pay for the call; if you poll someone’s fax machine to receive a fax, you pay for the call.





Some fax machines do not respond to the Polling feature.

Setting Up Polling Receive

Polling Receive is when you call another fax machine to receive a fax from it.

1 Press **Menu/Set, 2, 1, 6.**

6.POLLING RX



2 Press  **OR**  to select **POLLING RX: ON**, and then press **Menu/Set.**

3 Enter the fax number you are polling.

4 Press **Black Fax Start.**
The LCD shows **DIALING.**



Setting Up Sequential Polling Receive

Your fax machine can request documents from several fax units in a single operation. Afterward, a Sequential Polling Report will be printed.

- 1 Press **Menu/Set, 2, 1, 6.** 
- 2 Press  to select **POLLING RX: ON**, and then press **Menu/Set**.
- 3 Specify the destination fax machines you wish to poll using One Touch, Speed Dial, a Group or the dial pad. You must press **Menu/Set** between each location.
- 4 Press **Black Fax Start**. Your fax machine will poll each number or group number in turn for a document.

Canceling a Scheduled Job

You can cancel tasks you've scheduled, such as Delayed Fax or Polling Transmit. (See *Checking Job Status*, page 7-5.)

- 1 Press **Menu/Set, 2, 6.** Any waiting jobs appear on the LCD. If no job is waiting, the LCD shows **NO JOB WAITING**. 
- 2 If you have more than two jobs waiting, press  to select the job you want to cancel, and then press **Menu/Set**.
—OR—
If you have only one job waiting, go to Step 3.
- 3 Press **1** to cancel—OR—Press **2** to exit without canceling. To cancel another job, return to Step 2.
- 4 Press **Stop/Exit**.

7 Setup Send

Before You Begin

Before you begin sending faxes, please be sure to read all the instructions and cautions listed below for placing originals in the automatic document feeder.

Using the ADF (Automatic Document Feeder)

- Documents must be between 3.5 and 8.5 inches wide and 5 and 14 inches long.
- Make sure you place originals **face down, top edge first**.
- Adjust the paper guides to fit the width of your document.

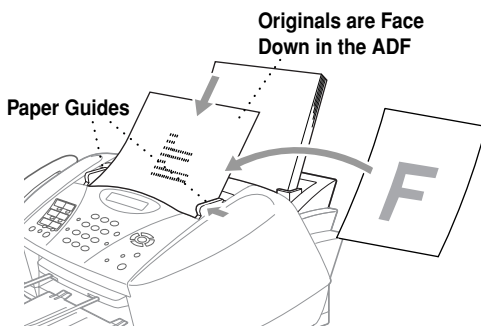

- The automatic document feeder (ADF) can hold up to 20 pages, feeding each one individually through the fax machine. Use standard (20 lb/75g/m²) paper when using the ADF.

Fan the paper, and then stagger the pages in the ADF as shown:

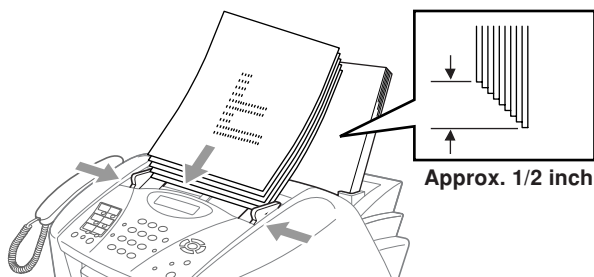

- ⊘ **DO NOT** use curled, wrinkled, folded, or ripped paper, or paper with staples, paper clips, paste or tape attached. **DO NOT** use cardboard, newspaper or fabric.

Make sure documents written with ink are completely dry.

Sending Faxes with Multiple Settings

When you send a fax you can choose any combination of these settings: set the contrast or resolution; send using overseas mode, delayed fax, polling transmission or real time transmission.

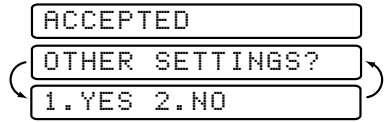

After each menu selection is accepted, the LCD will ask if you want to enter other settings:

- Press **1** if you want to select additional settings. The LCD returns to the **SETUP SEND** menu

—OR—

Press **2** if you are finished choosing settings, and then go to the next step.

Basic Sending Operations

Contrast

If your document is very light or very dark, you might want to set the contrast. Use **S.LIGHT** to send a very light document. Use **S.DARK** to send a very dark document.

1 Place the original face down in the ADF.

2 Press **Menu/Set, 2, 2, 1**.

1. CONTRAST

3 Press  to select **AUTO, S.LIGHT** or **S.DARK**, and then press **Menu/Set**.

4 Press **1** if you want to select additional settings. The LCD returns to the **SETUP SEND** menu—OR—Press **2** if you are finished choosing settings, and then go to Step 5.

5 Enter a fax number.

6 Press **Black Fax Start** to send a fax.

Fax Resolution



When you have a document in the ADF, you can use the **FAX Resolution** key to temporarily change the setting. Press **FAX Resolution** repeatedly until the LCD shows the setting you want.

—OR—

You can change the default setting.

- 1 Press **Menu/Set, 2, 2, 2.**

2.FAX RESOLUTION

- 2 Press  **OR**  to select the resolution you want, and then press **Menu/Set.**

- 3 Press **Stop/Exit.**

STANDARD—Suitable for most typed documents.

FINE—Good for small print; transmits a little slower than Standard resolution.

S. FINE—Good for small print or artwork; transmits slower than Fine resolution (black and white only).

PHOTO—Use when original has varying shades of gray; this is the slowest transmission time (black and white only).

Manual Transmission

Manual transmission lets you hear the dial tone, ringing and fax receiving tones while sending a fax.

- 1 Place the original face down in the ADF.
- 2 Pick up the handset and listen for a dial tone—**OR**—press **Hook/Hold** and listen for a dial tone.
- 3 Enter the fax number you want to call. You can enter the digits using the dial pad, or you can enter a One Touch or Speed Dial number or you can call using Search. (See *One Touch Dialing*, page 8-5.)
- 4 When you hear the fax tone, press **Black Fax Start.**
- 5 Replace the handset.

Automatic Transmission

This is the easiest way to send a fax. **IMPORTANT:** Do **not** pick up the handset, or press **Hook/Hold** to listen for a dial tone.

- 1 Place the original face down in the ADF.
- 2 Enter the fax number using the dial pad, One Touch, Speed Dial or Search. (See *Speed Dialing*, page 8-5.)
- 3 Press **Black Fax Start.**

Color Fax Transmission

Your fax machine allows you to transmit a color fax.

- 1 Place the original face down in the ADF.
- 2 Enter the fax number using the dial pad, Speed Dial or Search.
- 3 Press **Color Fax Start**.



When you are sending a color fax, the fax machine starts sending the fax without scanning the original into memory.

Manual and Automatic Fax Redial

If you're sending a fax manually and the line is busy, press **Redial/Pause** to try again. Anytime you want to make a second call to the last number dialed, press **Redial/Pause** to save time.

If you're sending a fax automatically and the line is busy, the fax machine will automatically redial (up to three times at 5 minute intervals).

Dual Access (Not Available for Color Faxes)

You can scan *up to* 50 documents into the fax memory, even while the machine is receiving or sending another fax (from memory). You can set temporary settings for each fax you're scanning, except Polling.

If you try to scan and store a 51st fax, the fax machine will send it immediately, without storing it in memory.



If you get a **OUT OF MEMORY** message while scanning the first page of a fax, press **Stop/Exit** to cancel scanning. If you get a **OUT OF MEMORY** message while scanning a subsequent page, you can press **Black Fax Start** to transmit the pages scanned so far, or press **Stop/Exit** to cancel the operation.

- 1 Place the original face down in the ADF.
- 2 Enter the fax number.
- 3 Press **Black Fax Start**. The fax machine scans the original and the LCD shows the job number (#XXX) of the fax and how much memory is available. Then the fax machine starts dialing. You can immediately repeat Steps 1 to 3 for the next fax.



Your machine normally operates in Dual Access mode. However, to send a color fax, you must override Dual Access and use Real Time Transmission.



The number of pages you can scan into memory varies with the data they contain.

Real Time Transmission



When you are sending a fax, the fax machine will scan originals into memory before sending. Then, as soon as the phone line is free, the fax machine will start dialing and sending the fax. If memory becomes full, the fax machine will send the document in real time (even if **REAL TIME TX** is set to **OFF**).

Sometimes you may want to send an important document immediately, without waiting for memory transmission. You can set **REAL TIME TX** to **ON**.

1 Place the original face down in the ADF.

2 Press **Menu/Set, 2, 2, 5**.

5. REAL TIME TX

3 To change the default setting, press  **OR**  to select **ON** (or **OFF**), and then press **Menu/Set**.

Go to Step 5—**OR**—For the next fax transmission only, press  to select **NEXT FAX ONLY**, and then press **Menu/Set**.

4 For the next fax only, press  to select **ON** (or **OFF**), and then press **Menu/Set**.

5 Press **1** if you want to select additional settings. The LCD returns to the **SETUP SEND** menu—**OR**—Press **2** if you are finished choosing settings, and then go to Step 6.

6 Enter fax number, and then press **Black Fax Start**.





If you are sending a color Fax, the fax machine will send it in real time even if **REAL TIME TX** is set to **OFF**.

Checking Job Status

Check which jobs are still waiting in memory to be sent. (If no jobs are waiting, the LCD shows **NO JOB WAITING**.) (See *Canceling a Job in Memory*, page 7-6.)



1 Press **Menu/Set, 2, 6**.

2 If you have multiple jobs waiting, press  **OR**  to scroll through the list.

3 Press **Stop/Exit**.

Canceling a Job in Memory

You can cancel tasks you've scheduled, such as Polling Transmit, or faxes waiting in Memory to be sent. (See *Checking Job Status*, page 7-5.)

- 1 Press **Menu/Set, 2, 6**.
Any waiting jobs appear on the LCD.
If no jobs are waiting, the LCD shows
NO JOB WAITING.

- 2 If you have more than two jobs waiting, press  to select the job you want to cancel, and then press **Menu/Set**.
—OR—
If you have only one job waiting, go to Step 3.
- 3 Press **1** to cancel—OR—Press **2** to exit without canceling.
To cancel another job, return to Step 2.
- 4 Press **Stop/Exit**.

Advanced Sending Operations

Composing Electronic Cover Page

The cover page is generated at the receiving party's machine. Your cover page includes the name stored in the One Touch or Speed Dial memory. If you're dialing manually, the name is left blank.

The cover page indicates your Station ID and the number of pages you're sending. If you have Cover page Setup set to ON, the number of pages remains blank. (**Menu/Set, 2, 2, 7**) (See *Setting Station ID*, page 5-2.)

You can select a comment to include on your cover page.

- 1. COMMENT OFF
- 2. PLEASE CALL
- 3. URGENT
- 4. CONFIDENTIAL

Instead of using one of the comments above, you can enter up to two customized messages, each 27 characters long. Use the chart on page 5-3 to help enter characters. (See *Composing Your Own Comments* below.)

- 5. (USER DEFINED)
- 6. (USER DEFINED)

Most of the **SETUP SEND** menu selections are temporary settings that allow you to make adjustments for each document you send. However, so you can set up your cover page and cover page comments in advance, the Cover Page Setup and Cover Page Message features will change the default settings.

Composing Your Own Comments





You can set up two custom comments.

- 1 Press **Menu/Set, 2, 2, 8**. 8. COVERPAGE MSG
- 2 Press  to choose position 5 or 6 for your customized comment, and then press **Menu/Set**.
- 3 Use the dial pad to enter your customized comment, and then press **Menu/Set**. (See *Entering Text*, page 5-3.)
- 4 Press **1** if you want to select additional settings. The LCD returns to the **SETUP SEND** menu—**OR**—Press **2** to exit.

Cover Page for the Next Fax Only

Make sure the Station ID is set up (see page 5-2). This feature does not work without the Station ID.





You can set the fax to send a cover page with a particular document. This cover page will include the number of pages in your document.

- 1 Place the original face down in the ADF.
- 2 Press **Menu/Set, 2, 2, 7.** 7. COVERPG SETUP
- 3 When LCD shows **NEXT FAX ONLY?**, and then press **Menu/Set**.
- 4 Press  **OR**  to select **ON** (or **OFF**), and then press **Menu/Set**.
- 5 Press  **OR**  to select one of the standard or custom comments, and then press **Menu/Set**.
- 6 Enter two digits to indicate the number of pages you are sending, and then press **Menu/Set**. (For example, press **0, 2** for 2.)
(Enter **0 0** to leave the number of pages blank. If you make a mistake, press  to back up and re-enter the number of pages.)
- 7 Press **1** if you want to select additional settings. The LCD returns to the **SETUP SEND** menu—**OR**—Press **2** if you are finished choosing settings.
- 8 Enter the fax number you're calling.
- 9 Press **Black Fax Start**.

Always Send a Cover Page

Make sure the Station ID is set up (see page 5-2). This feature does not work without the Station ID.

You can set the fax machine to send a cover page whenever you send a fax. The number of pages in your fax is not included when you use this setting.

- 1 Press **Menu/Set, 2, 2, 7.** 7. COVERPG SETUP
- 2 Press  **OR**  to select **COVERPAGE:ON?**, and then press **Menu/Set**.
- 3 If you selected **ON**, press  **OR**  to select one of the standard or custom comments, and then press **Menu/Set**.
- 4 Press **1** if you want to select additional settings. The LCD returns to the **SETUP SEND** menu—**OR**—Press **2** to exit if you are finished choosing settings.

Using a Printed Cover Page

If you prefer using a printed cover page that you can write on, you can print the sample page and attach it to your fax.

- 1 Press **Menu/Set**, **2**, **2**, **7**.

7.COVERPG SETUP

- 2 Press  to select **PRINT SAMPLE?**, and then press **Menu/Set**.

- 3 Press **Black Fax Start**. Your fax machine prints a copy of your cover page.

- 4 Press **Stop/Exit**.

=== COVER PAGE ===

TO: _____

FROM: _____

FAX: _____

TEL: _____

PAGE[S] TO FOLLOW

COMMENT:

Overseas Mode

After you send a fax using this feature, the feature turns itself off.

- 1 Place the original face down in the ADF.

- 2 Press **Menu/Set**, **2**, **2**, **9**.

9.OVERSEAS MODE

- 3 Press  to select **ON** (or **OFF**), and then press **Menu/Set**.



- 4 Press **1** if you want to select additional settings. The LCD returns to the **SETUP SEND** menu—**OR**—Press **2** if you are finished choosing settings, and then go to Step 5.

- 5 Enter the fax number you're calling.

- 6 Press **Black Fax Start**.

Delayed FAX (Not Available for Color Faxes)

During the day you can store *up to* 50 documents in memory for delayed sending. Transmission of these documents will begin at the time of day you enter in Step 3, which shows the time you entered last. Press **Menu/Set** to accept it, or enter another time for this fax.



- 1 Place the original face down in the ADF.
- 2 Press **Menu/Set, 2, 2, 3**.

- 3 Enter the time you want the fax to be sent (in 24-hour format), and then press **Menu/Set**. (For example, enter 19:45 for 7:45 PM.)
- 4 Press **1** to leave the originals waiting in the ADF—**OR**—Press **2** to scan the original into memory.

- 5 Press **1** if you want to select additional settings. The LCD returns to the **SETUP SEND** menu—**OR**—Press **2** if you are finished choosing settings, and then go to Step 6.
- 6 Enter the fax number.
- 7 Press **Black Fax Start**. The fax machine will wait to send the fax at the time you set.



The number of documents you can scan into memory varies with the data they contain.



Delayed Batch Transmission (Not Available for Color Faxes)

Before sending the delayed faxes, your Brother machine will economize by sorting all the documents in memory by destination and scheduled time. All delayed faxes scheduled at the same time to the same fax number will be sent as one transmission.

- 1 Press **Menu/Set, 2, 2, 4**.

- 2 Press  to select **ON** (or **OFF**), and then press **Menu/Set**.
- 3 Press **Stop/Exit**.

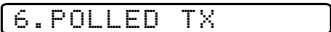
Setting Up Polled Transmit (Not Available for Color Faxes)

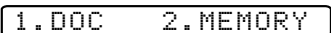
Polled Transmit is when you set up your fax machine to wait with a document so another fax machine can retrieve it.

- 1 Place the original to be retrieved face down in the ADF.
- 2 Press **Menu/Set, 2, 2, 6.** 
- 3 Press  to choose **ON** (or **OFF**), and then press **Menu/Set**.
- 4 Press **1** to leave the originals waiting in the ADF—**OR**—Press **2** to scan the original into memory. 
- 5 Press **1** if you want to select additional settings. The LCD returns to the **SETUP SEND** menu—**OR**—Press **2** if you are finished choosing settings, and then go to step 6.
- 6 Press **Black Fax Start**.



If you pressed **1** in Step 4, the original remains in the ADF until your fax machine is polled. If you must use your fax machine before the polled transmit occurs, you must first cancel this job.

8

Auto Dial Numbers and Dialing Options

Storing Numbers for Easy Dialing

You can set up your fax machine to do three types of easy dialing: One Touch, Speed Dial and Groups for Broadcasting faxes.



If you loose electrical power, auto dial numbers in memory will not be lost.

Storing One Touch Dial Numbers

You can store 12 fax/telephone numbers that you can dial by pressing one key (and **Black Fax Start**). To access numbers 7 to 12, hold down **Shift**. When you press a One Touch dial location, the LCD shows the name or number as the call is dialed. (See *One Touch Dialing*, page 8-5.)

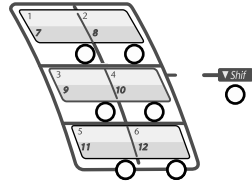

One Touch keys are the 6 keys (numbers 7 to 12) located to the left of the dial pad.



(For USA only) For your convenience, One Touch key **1** is pre-programmed for the Brother fax-back system. One Touch key **2** has been programmed with a telephone number associated with a feature that is no longer available. You can overwrite these numbers by storing your own auto dial numbers in their place. (Please see *Changing One Touch and Speed Dial Numbers*, page 8-2.)

- 1 Press **Menu/Set**, **2**, **3**, **1**.

1. ONE-TOUCH DIAL

- 2 Press the One Touch key where you want to store a number. The LCD shows the location you selected.
- 3 Enter a number (up to 20 digits), and then press **Menu/Set**. If you want to enter a pause in the dialing sequence (for example, to wait for an “outside line”), press **Redial/Pause** as you’re entering digits. A dash appears on the LCD. Pressing **Redial/Pause** enters a 3.5 second pause when the number is dialed.
- 4 Use the dial pad to then enter the name (up to 15 characters), and then press **Menu/Set**. You can use the chart on page 5-3 to help you enter letters—**OR**—To store the number without a name, press **Menu/Set**.
- 5 Return to Step 2 to store another One Touch number—**OR**—Press **Stop/Exit**.

NAME:

When you dial an auto dial number, the LCD shows the name you’ve stored, or, if you haven’t stored a name, the number you’ve stored.



If you need to store a pause longer than 3.5 seconds, press **Redial/Pause** two or more times.



You can store Groups (for Broadcasting) on the One Touch keys.

Storing Speed Dial Numbers



You can store Speed Dial numbers, so when you dial you will have to press only five keys (Search/Speed Dial, #, the two-digit location, and Black Fax Start). The fax machine has 100 Speed Dial locations.

- 1 Press **Menu/Set, 2, 3, 2.** 2. SPEED-DIAL
- 2 Use the dial pad to enter a two-digit location (00-99), and then press **Menu/Set.** SPEED-DIAL? #
- 3 Enter the number (up to 20 digits), and then press **Menu/Set.** #05:
- 4 Use the dial pad to enter the name (up to 15 characters), and then press **Menu/Set.** You can use the chart on page 5-3 to help you enter letters—**OR**—Press **Menu/Set,** and then go to Step 5 to store the number without a name. NAME:
- 5 Return to Step 2 to store another Speed Dial number—**OR**—Press **Stop/Exit .**

Changing One Touch and Speed Dial Numbers

If you try to store a One Touch or Speed Dial number in a location where a number is already stored, the LCD shows the current name stored there, and then prompts you to either:

1. CHANGE 2. EXIT

- 1 Press **1** to change the stored number—**OR**— Press **2** to exit without making a change.
- 2 Enter a new number, and then press **Menu/Set.**
 - If you want to erase the whole number, press **Stop/Exit** when the cursor is to the left of the digits. The letters above and to the right of the cursor will be deleted.
 - If you want to change a digit, use  or  to position the cursor under the digit you want to change, and then type over it.
- 3 Follow the directions beginning at Step 4 in *Storing One Touch Numbers* and *Storing Speed Dial Numbers.*



Please note that a telephone number associated with a feature that is no longer offered has been stored in One Touch Key **2.** Please follow the steps above to store your own auto dial number in its place.

Setting Up Groups for Broadcasting

Groups, which can be stored on a One Touch key or a Speed Dial location, allow you to send the same fax message to many fax numbers by pressing only a One Touch key and **Black Fax Start** or **Search/Speed Dial**, #, the two-digit location and **Black Fax Start**. **First**, you'll need to store each fax number as a One Touch or Speed Dial number. **Then**, you can combine them into a Group. *Each Group uses up a One Touch key or a Speed Dial location.* Finally, you can have up to six small Groups, or you can assign up to 111 numbers to one large Group.

(See *Storing One Touch Dial Numbers*, page 8-1 and *Storing Speed Dial Numbers*, page 8-2.)

- 1 Press **Menu/Set**, 2, 3, 3.

3.SETUP GROUPS

- 2 Decide where you wish to store the Group
—AND—

PRESS SPEED DIAL
OR ONE-TOUCH KEY

Press a One Touch Key

—OR—

Press **Search/Speed Dial** and enter the two-digit location, and then press **Menu/Set**.

(For example, press One Touch key 2 for Group 1.)

- 3 Use the dial pad to enter the Group number, and then press **Menu/Set**.
(For example, press **1** for Group 1.)

SETUP GROUP:G0

- 4 To include One Touch or Speed Dial numbers in the Group, enter them as if you were dialing.

G01:
ENTER & SET KEY

For example, for One Touch key **5**, and then press One Touch key **5**. For Speed Dial location 09, press **Search/Speed Dial**, then press **0, 9** on the dial pad. The LCD shows ✖05, #09.

G01:*05#09_

- 5 Press **Menu/Set** to accept the numbers for this Group.
- 6 Use the dial pad and the chart on page 5-3 to enter a name for the Group, and then press **Menu/Set**.
(For example, NEW CLIENTS).
- 7 Press **Stop/Exit**.

NAME:



You can print a list of all One Touch and Speed Dial numbers. (See Chapter 11, *Printing Reports*.)

Dialing Options

You can use your fax machine to make telephone calls by dialing manually or by using Search, One Touch or Speed Dial memory. When you dial an auto dial number, the LCD shows the name you've stored, or, if you haven't stored a name, the fax number you've stored.



Manual Dialing

Manual dialing is simply pressing all of the digits of the phone number.

- 1 Pick up the handset—**OR**— press **Hook/Hold**.
- 2 When you hear a dial tone, dial the call using the dial pad.
- 3 If you pressed **Hook/Hold** to dial the call, pick up the handset when the other party answers. (The speaker works only one way; the other party won't be able to hear you unless you pick up the handset.)
- 4 To hang up, replace the handset.

Search

You can search for names you have stored in One Touch and Speed Dial memories. (See *Storing One Touch Dial Numbers*, page 8-1 and *Storing Speed Dial Numbers*, page 8-2.)

- 1 Press **Search/Speed Dial**.
- 2 To search for numbers alphabetically by name, enter the first letter of the name, and then press  or .
- OR**—
To search for numbers numerically by One Touch and Speed-Dial numbers, press .
- 3 When the LCD shows the name you want to call, press **Black Fax Start**.
- 4 If you pressed **Hook/Hold** to dial the call, pick up the handset when the other party answers. (The speaker works only one way; the other party won't be able to hear you unless you pick up the handset.)
- 5 When the call is over, hang up.

One Touch Dialing

- 1 Pick up the handset—**OR**—Press **Hook/Hold**.
- 2 When you hear a dial tone, press the One Touch key of the location you want to call. (See *Storing One Touch Dial Numbers*, page 8-1.)



To dial One Touch numbers 6 to 12, hold down **Shift** as you press the One Touch key.

- 3 If you pressed **Hook/Hold** to dial the call, pick up the handset when the other party answers. (The speaker works only one way; the other party won't be able to hear you unless you pickup the handset.)
- 4 To hang up, replace the handset.



If you try to use a One Touch location with no number stored in it, you'll hear a warning sound, and screen will display **NOT REGISTERED**. The display will return to normal after 2 seconds.



If you are sending a fax, press **Black Fax Start** after pressing the One Touch key. If you picked up the handset, press **Black Fax Start** when the receiving fax machine answers with fax tones.

Speed Dialing

- 1 Pick up the handset—**OR**—Press **Hook/Hold**.
(See *Storing Speed Dial Numbers*, page 8-2.)
- 2 When you hear a dial tone, press **Search/Speed Dial**, and then press # then the two-digit Speed Dial number.
- 3 If you pressed **Hook/Hold** to dial the call, pick up the handset when the other party answers. (The speaker works only one way; the other party won't be able to hear you unless you pickup the handset.)
- 4 To hang up, replace the handset.



If you are sending a fax, press **Black Fax Start** after pressing the Speed Dial number. If you picked up the handset, press **Black Fax Start** when the receiving fax machine answers with fax tones.

Access Codes and Credit Card Numbers

Sometimes you may want to choose from among several long distance carriers when you make a call. Rates may vary depending upon the time and destination. To take advantage of low rates, you can store the access codes or long-distance carriers as One Touch and Speed Dial numbers. You can store these long dialing sequences by dividing them and setting them up separately in any combination. You can even include manual dialing using the dial pad. The combined number will be dialed in the order you entered it, as soon as you press **Black Fax Start**. (See *Storing One Touch Dial Numbers*, page 8-1.)

You store “555” on One Touch key **3** and “7000” on One Touch key **4**. If you press One Touch **3, 4** and **Black Fax Start** you can dial “555-7000”. To temporarily change a number, you can substitute part of the number with manual dialing using the dial pad. For example, to change the number to 555-7001 you could press One Touch **3** and then press **7, 0, 0, 1** using the dialing pad.



If you must wait for another dial tone at any point in the dialing sequence, store a pause at that point in the number by pressing **Redial/Pause**. Each key press adds a 3.5 second delay.

Broadcasting (Not Available for Color Faxes)

Broadcasting is automatically sending the same fax message to multiple fax numbers. Using the **Menu/Set** key, you can include Groups, One Touch locations, Speed Dial locations plus up to 50 manually dialed numbers. If you did not use up any locations for Groups, access codes or credit card numbers, you can "broadcast" faxes automatically to up to 162 different locations from the fax machine. However, available memory will vary with all types of jobs in memory and numbers of locations used for broadcasting. If you broadcast to more than the maximum locations available, you will not be able to set up transmissions using dual access and the timer.

The easiest way to broadcast is to press Group keys. You can include One Touch, Speed Dial, and manually dialed numbers in the same broadcast. (See *Setting Up Groups for Broadcasting*, page 8-3.)

You must press **Menu/Set** between each of these locations.

Use the **Search/Speed Dial** to help you choose the numbers easily.

After the broadcast is finished, a Broadcast Report will be printed automatically to let you know the results.

- To stop the broadcast in progress, press **Stop/Exit**. The LCD asks if you want to cancel the location that is being sent.
- Enter the long dialing sequence numbers as you normally would, but keep in mind that each key counts as one location, so the number of locations you can call becomes limited.
- If the line is busy or for other reasons a connection could not be made while broadcasting, the fax machine will redial the number automatically.

- If the memory is full, press **Stop/Exit** to abort the job or if more than one page has been scanned, press **Black Fax Start** to send the portion that is in the memory.
- 1 Place the original face down in the ADF.
- 2 Enter a number using One Touch, Speed Dial, a Group number, Search or the dial pad.
Example: Group number
- 3 Press **Menu/Set**. You will be prompted to press the next number.
- 4 Enter the next number.
Example: Speed Dial
- 5 Press **Menu/Set**.
- 6 Enter the fax number.
Example: Manual dialing using the dial pad.
- 7 Press **Black Fax Start**.
Your fax machine will read the original into memory and then start sending faxes to the numbers you entered.

Pause

Press **Redial/Pause** to insert a 3.5 second pause between numbers. If you are dialing overseas, you can press **Redial/Pause** as many times as needed to increase the length of the pause.

Hold

- 1 Press **Hook/Hold** to place a call on Hold.
- 2 You can replace the handset without disconnecting the call.
- 3 Pick up the fax machine handset. (Picking up an extension handset will not release the call from Hold.)

Fax Redial

If you're sending a fax manually and the line is busy, press **Redial/Pause** to try again. Anytime you want to make a second call to the last number dialed, press **Redial/Pause** to save time.

If you're sending a fax automatically and the line is busy, the fax machine will redial automatically up to three times at 5 minute intervals.

Tone/Pulse

If you have pulse dialing service, but need to send tone signals (for example, for telephone banking), follow the directions below. If you have touch tone service, you do not need this feature to send tone signals.

- 1** Lift the handset.
- 2** Press **#**. Any digits dialed after this send tone signals.
- 3** When you hang up, the fax machine returns to pulse dialing service.

9 Telephone Services

Custom Features

Your fax machine supports the Distinctive Ring and Caller ID telephone services offered by some telephone companies.



If you have Voice Mail, Call Waiting, Call Waiting/Caller ID, RingMaster, an answering service, or an alarm system or other custom feature on your telephone line, it may create a problem in the operation of your fax machine.

(See *Custom Features on a Single Line*, page 15-8.)

If you have Voice Mail on your phone line, please read the following carefully.

Distinctive Ring

The term “Distinctive Ring” is used by Brother to identify a phone company service that is given *many names, depending on the telephone company you are using*. For example, this service may be called SmartRing, RingMaster, Teen-Ring, Ident-a-Call or Ident-a-Ring.

What Does Your Telephone Company’s “Distinctive Ring” Do?

Your telephone company’s Distinctive Ring service allows more than one number on the same phone line. **If you need more than one phone number, it is an inexpensive alternative to paying for an additional line.** Each phone number has its own distinctive ring pattern, so you will know which phone number is ringing. This is one way you can have a separate phone number for your fax machine.



Please consult your telephone company for availability and rates.

What Does Brother’s “Distinctive Ring” Do?

The Brother machine has a Distinctive Ring feature that allows you to use your fax machine to take full advantage of the telephone company’s Distinctive Ring service. You can dedicate the new phone number on your line to receiving only faxes.



You must purchase your telephone company’s Distinctive Ring service *before* you program the fax machine to work with it.

Do You Have Voice Mail?

If you have Voice Mail on the phone line on which you will install your new fax machine, *there is a strong possibility that Voice Mail and the fax machine will conflict with each other while receiving incoming calls.* **However, this Distinctive Ring feature allows the use of more than one number on your line, so both Voice Mail and the fax machine can coexist peacefully.** If each one has a separate phone number, neither will interfere with the other's work.

If you decide to get the Distinctive Ring Service from the telephone company, you will need to follow the directions below to "register" the new Distinctive Ring pattern they provided, so your fax machine can recognize its incoming calls.



You can change or cancel the Distinctive Ring pattern at any time. You can switch it off temporarily and later turn it back on. When you get a new fax number, make sure you reset this feature.

Before You Choose the Ring Pattern to Register

You can register only one Distinctive Ring pattern with the fax machine. Some ring patterns cannot be registered. Please refer to some popular ring pattern examples that will be provided from the phone company in the USA and Canada that are shown in the Brother compatibility table below.

Ring Pattern	Rings	
1	long - long	
2	short - long - short	
3	short - short - long	
4	very long (normal pattern)	







If the ring pattern the phone company provided cannot be registered by the fax, **please check for other available ring pattern choices from the phone company.**

- The fax machine will answer only calls to its registered number.
- The first two rings are silent on the fax machine. This is because the fax must «listen» to the ring pattern (compare it to the pattern that was "registered").
- If you program the fax machine correctly, it will recognize the registered ring pattern of the "fax number" within two ring patterns and then automatically answer with a fax tone. When the "voice number" is called, the fax machine will not interrupt the call.

VERY IMPORTANT

If you have Voice Mail or a TAD (Telephone Answering Device) and want to keep one of your phone numbers dedicated only to fax calls, you must leave the fax machine in **MANUAL** mode at all times while using the Distinctive Ring Feature. Here's why: **MANUAL** mode will never pick up a call by itself, since it is «Neutral». When the fax machine is in this «neutral» mode, the Distinctive Ring Feature can be activated. The Distinctive Ring feature is actually an answering mode. So, do not activate **FAX ONLY** mode or **FAX/TEL** mode while using Distinctive Ring; otherwise, the fax machine will answer calls for *all* the numbers.

Registering the Distinctive Ring Pattern

- 1 Set the fax machine to **MANUAL** mode.
- 2 Press **Menu/Set, 2, 0, 1**. 1. DISTINCTIVE
- 3 Press  **OR**  to select **DISTINCTIVE:SET?**, and then press **Menu/Set**.
- 4 Press  **OR**  to select the prestored ring pattern you want to assign, and then press **Menu/Set**. (You will hear each pattern as you scroll through the four patterns.) Be sure to choose the pattern assigned by the telephone company.
- 5 Press **Stop/Exit**.

Caller ID



The Caller ID feature lets you use the Caller ID subscriber service offered by many local telephone companies. This service provides you, by means of the LCD, the name or telephone number of your caller as the line rings.

After a few rings, the LCD shows the telephone number of your caller (or name, if available). Once you pick up the handset, the Caller ID information disappears from the LCD, but the call information remains stored in the Caller ID memory.

- You will see the first 16 characters of the number (or name).
- **OUT OF AREA** display means call originates outside your Caller ID service area.
- **PRIVATE CALL** display means the caller has intentionally blocked transmission of information.
- **CALL PICKUP** display remains on the LCD when no Caller ID information was transmitted.

If both the name and number are received, the LCD shows only the name. You can print a list of Caller ID information received by your fax machine. (See *Printing Caller ID List*, page 9-4.)

Caller ID service varies with different carriers. Call your local telephone company to determine the kind of service available in your area.

Viewing Caller ID List

Caller ID memory stores information for up to thirty calls; when the thirty-first call comes in, information about the first call is erased. You can scroll through Caller ID information to review those calls made to your fax machine.

- 1 Press **Menu/Set, 2, 0, 2.**

2. CALLER ID

- 2 Press  to select **DISPLAY #?**, and then press **Menu/Set.**

If the name was not received, it will not be displayed.

- 3 Press  to scroll through the Caller ID memory to select the Caller ID you want to view, and then press **Menu/Set.** The LCD shows the caller's name and number and the date and time of the call.

- 4 Press  to return to the Caller ID listing—**OR**—Press **Stop/Exit.**

Printing Caller ID List

- 1 Press **Menu/Set, 2, 0, 2.**

2. CALLER ID

- 2 Press  to select **PRINT REPORT ?**, and then press **Menu/Set.**

- 3 Press **Black Fax Start.**

10 Remote Fax Options

(Not Available for Color Faxes)

Fax Forwarding/Paging



You cannot use Paging and Fax Forwarding at the same time.
You cannot use Paging and Fax Forwarding when Fax Storage is set to **OFF**.

Programming a Fax Forwarding Number

When Fax Forwarding is set to **ON**, your fax machine stores the received fax in memory. Then it dials the fax number you've programmed and forwards the fax message.

- 1 Press **Menu/Set**, **2**, **5**, **1**.

1.FAX FWD/PAGING

- 2 Press  until the LCD shows **FAX FORWARD?**, and then press **Menu/Set**.

- 3 The LCD prompts you to enter the fax number where faxes will be forwarded. Enter the forwarding number (up to 20 digits), and then press **Menu/Set**.

FWD#:

- 4 Press **Stop/Exit**.

Programming Your Pager Number

When Paging is selected, your fax machine dials the pager number you've programmed, and then dials your Personal Identification Number (PIN); this activates your pager so you will know that you have a fax message in the memory.

- 1 Press **Menu/Set**, **2**, **5**, **1**.

1.FAX FWD/PAGING

- 2 Press  until the LCD shows **PAGING?**, and then press **Menu/Set**.

- 3 Enter your pager phone number (up to 20 digits) followed by **# #**, and then press **Menu/Set**. Do not include the area code if it is the same as that of your fax machine.
For example, 1 8 0 0 5 5 1 2 3 4 # #.

PAG#:

4 If your pager requires a PIN, enter the PIN, press **#**, press **Redial/Pause**, enter your fax machine telephone number followed by **##**, and then press **Menu/Set**.
For example, **1 2 3 4 5 # Redial/Pause 1 8 0 0 5 2 1 2 8 4 6 # #**
—OR—

If you do not need a PIN, press **Redial/Pause**, enter the fax number of your fax machine followed by **##**, and then press **Menu/Set**.
For example, **Redial/Pause 1 8 0 0 5 2 1 2 8 4 6 # #**

5 Press **Stop/Exit**.



You cannot change a Paging number or PIN remotely.





Press **Redial/Pause** for each 3.5 second delay, as needed.

Setting Fax Storage

If you set Fax Storage to **ON**, you will be able to retrieve fax messages from another location using Fax Forwarding, Paging, or Remote Retrieval functions. The LCD will indicate when you have a fax stored in memory.

1 Press **Menu/Set, 2, 5, 2**. The LCD prompts you to choose a fax setting.

2 Press  or  to select **ON** (or **OFF**), and then press **Menu/Set**.

3 Press **Stop/Exit**.



If there are faxes in memory when you turn the Fax Storage **OFF**, the LCD prompts you to erase any faxes in memory.

If you press **1**, all fax data is erased and Fax Storage is turned off. If you press **2**, data is not erased and Fax Storage remains on.
(See *Printing a Fax in Memory*, page 6-6.)

Backup Print

If you've set **FAX STORAGE** to **ON**, your fax machine *automatically prints* faxes as they are received into memory. This is a safety feature in case the power goes out so you won't lose your messages.

Changing Remote Retrieval Access Code

Enter your Remote Access Code when the fax machine picks up your call, so you can access features remotely. The access code is preset to 1 5 9 ✳, but you can change this. (See *Operation from Extension Telephones*, page 6-5.)

- 1 Press **Menu/Set**, **2**, **5**, **3**. 
- 2 Enter a three-digit number from 000 to 999, and then press **Menu/Set**. The “✳” cannot be changed. (Do not use the same digits that appear in your Fax Receive Code or Telephone Answer Code.)
- 3 Press **Stop/Exit**.

Remote Retrieval

You can call your fax machine from any fax machine using touch tone, then use the Remote Retrieval Access Code and other button presses to retrieve fax messages. *Cut out the Remote Retrieval Access Card on the last page and keep it in your wallet as an aid.*

Using Remote Retrieval Access Code

- 1 Dial your fax number from a fax machine using touch tone.
- 2 When your fax machine answers, immediately enter your Remote Retrieval Access Code (1 5 9 ✳).
- 3 The fax machine signals the kinds of messages received:
1 long beep — Fax message(s)
No beeps — No messages
- 4 The fax machine prompts you with two short beeps to enter a command. If you wait longer than 30 seconds to enter a command, the fax machine hangs up. If you enter an invalid command, the fax machine beeps three times.
- 5 Press **9 0** to reset the fax machine when you're finished.
- 6 Hang up.



If your fax machine is set to **MANUAL** mode, you can access it by waiting about 2 minutes, and then entering the Remote Retrieval Access Code within 30 seconds.

Remote Commands

Follow the commands below to access features remotely. When you call the fax machine and enter your Remote Retrieval Access Code (1 5 9 ✳), the system will signal you with two short beeps to enter a remote command.

Remote Commands		Operation Details
95	Change Fax Forwarding /Paging setting	
	1 OFF	If you hear one long beep, the change is accepted. If you hear three short beeps, you cannot change it because the conditions have not been met (Example: registering paging number). You can register your fax forwarding number by using 4. FAX FWD NO. (see page 10-5). Once you have registered the number, the fax machine will change automatically to FAX FWD:ON mode.
	2 Fax Forwarding	
	3 Paging	
	4 FAX FWD No.	
	6 Fax Storage ON	You can turn FAX STORAGE to ON or OFF.
	7 Fax Storage OFF	
96	Retrieve a fax	
	2 Retrieve all faxes	Enter the number of a remote fax machine to receive stored fax message(s). (See page 10-5.)
	3 Erase fax from the memory	If you hear one long beep, you can erase fax message(s) from the memory.
97	Check the Receiving Status	
	1 FAX	You can check whether your fax machine has received any faxes. If yes, you will hear one long beep. If no, you will hear three short beeps.
98	Change Receive Mode	
	1 TAD: ANSWER MACH.	If you hear one long beep, you can change the Receive Mode. If you hear three short beeps, you cannot change it.
	2 FAX/TEL	
	3 FAX ONLY	
90	Exit	After a long beep, you can exit remote retrieval.

Retrieving Fax Messages

- 1 Dial your fax number.
- 2 When you hear the beep, immediately enter your Remote Retrieval Access Code (1 5 9 *).
- 3 As soon as you hear two short beeps, use the dial pad to press **9 6 2**.
- 4 Using the dial pad, enter the number of the remote fax machine where you want your fax messages forwarded (up to 20 digits) followed by **# #**.



You cannot use * and # as dial numbers. However, if you want to store a pause, press #.

- 5 After you hear your fax machine beep, hang up and wait. Your fax machine calls the remote fax machine. The remote fax machine prints your fax messages.

Changing Fax Forwarding Number

You can change the default setting of your fax forwarding number from a remote fax machine.

- 1 Dial your fax number.
- 2 When you hear the beep, immediately enter your Remote Retrieval Access Code (1 5 9 *).
- 3 When you hear two short beeps, use the dial pad to press **9 5 4**.
- 4 Enter the new number of the remote fax machine where you want your fax messages forwarded (up to 20 digits) followed by **# #**.



You cannot use * and # as dial numbers. However, if you want to store a pause, press #.

- 5 After you hear your fax machine beep, hang up.

11 Printing Reports

FAX Settings and Activity

Two reports require initial setup in the Menu table: Transmission Verification Report and Fax Activity Report. For initial setup:

Press **Menu/Set, 2, 4, 1.**

1. TRANSMISSION

—OR—

Press **Menu/Set, 2, 4, 2.**

2. ACT. INTERVAL

Customizing the Transmission Verification Report

You can use the Transmission Verification Report as proof that you sent a fax. This report lists the time and date of transmission and whether the transmission was successful (OK). If you select **ON** or **ON+IMAGE**, the report will print for every fax you send.

Note When the feature is **OFF**, the report prints only when a transmission error prevented delivery (NG).

If you typically send multiple faxes to the same destinations, you may need more than the job numbers to know which faxes you must send again. Selecting **OFF+IMAGE** will print a portion of the fax's first page on the report to help you remember.

1 Press **Menu/Set, 2, 4, 1.**

1. TRANSMISSION

2 Press  to select **OFF**, **OFF+IMAGE**, **ON** or **ON+IMAGE**, and then press **Menu/Set**.

3 Press **Stop/Exit**.

Setting the Fax Activity Report Interval

You can set the machine to print activity reports at specific intervals (6, 12, 24 hours, 2, 4, or 7 days). If you set the interval to **OFF**, you can print the report by following the Steps in the previous section.

1 Press **Menu/Set, 2, 4, 2.**

2. ACT. INTERVAL

- 2 Press  to choose an interval, and then press **Menu/Set**.

INTERVAL:OFF

(If you choose 7 days, the LCD prompts you to choose the day at which to begin the 7-day countdown.)

- 3 Enter the time to begin printing in 24-hour format, and then press **Menu/Set**. (For example: enter 19:45 for 7:45 PM.)
- 4 Press **Stop/Exit**.

Using the Reports Key



Five reports are available:

1.HELP LIST

Prints the Help List so you can see at-a-glance how to quickly program every menu selection.

2.AUTO DIAL

Lists names and numbers stored in One Touch and Speed Dial memory, in numerical order.

3.FAX ACTIVITY

Lists information about the last 200 incoming and outgoing faxes. TX means Transmit; RX means Receive.

4.TRANSMISSION

Prints a Transmission Verification Report for your last transmission.

5.USER SETTINGS

Lists settings for **GENERAL SETUP**, **SETUP RECEIVE**, **SETUP SEND**, **SETUP REPORTS**, and **TEL SERVICE**. The settings for **REMOTE FAX OPT** are included.

To Print a Report

- 1 Press **Reports** while holding down **Shift**.
- 2 Press  to select the report you want, and then press **Menu/Set**.

—OR—

Enter the number of the report you want to print. For example, press **1** to print the Help List.

12 Making Copies

Basic Copy Operations

Your fax machine allows you to make high-quality photocopies and transparencies. Copies can be in black and white or full color. Always make sure you have paper in the cassette before making copies. Do not pull on the paper while copying is in progress.



 Incoming faxes cannot be received on paper or into memory while the fax machine is copying.

Making a Single Copy

- 1 Place the original face down in the ADF.
- 2 Press **Black Copy** or **Color Copy**.
(Do **NOT** pull on the paper while copying is in progress.)

COPYING P.01

 To stop the copy process and release the original, press **Stop/Exit**.

Making Multiple Copies

You can make multiple copies.

- 1 Place the original face down in the ADF.
- 2 Using the dial pad, enter the number of copies you want (up to 99).
For example, press **3 8** for 38 copies.
- 3 Press **Black Copy** or **Color Copy**.

Out of Memory Message

If the memory becomes full while you are making copies, the LCD shows a message:

A rectangular LCD display with a thin border, showing the text "OUT OF MEMORY" in a simple, pixelated font.

If the **OUT OF MEMORY** message appears while you are scanning the *first* page of your original, press **Stop/Exit** to cancel. Clear some jobs from memory so you can continue. If you were scanning *subsequent* page(s), press **Black Copy** or **Color Copy** to print the scanned pages—**OR**—Press **Stop/Exit** to cancel.



To gain extra memory, you can turn off Fax Storage (see page 10-2).
—**OR**—Print the faxes in memory (see page 6-6).

Temporary Copy Settings

You can improve your copies by using the **Options** key. These settings are *temporary*, and the fax machine returns to its default settings when you finish copying.

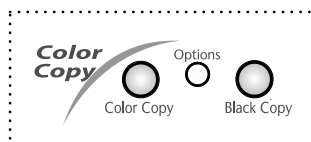

Copying Using Multiple Settings

You can try different combinations of settings for the best results. After you finish your settings using the **Options** key, the LCD shows:



- Press  if you want to select additional settings.

—**OR**—

Press **Black Copy** or **Color Copy** if you are finished choosing settings.



Using the Options Key

Use the **Options** key to set number of copies, paper type, paper size, brightness, enlargement/reduction ratio and special copy options **for the next copy only**.

Press Options	Menu Selections	Options	Factory Setting
 Options	OPT:#OF COPIES01	NO. OF COPIES:XX	01
	OPT:PAPER TYPE	PLAIN/INK JET/GLOSSY (4-COLOR or 3-COLOR)/ TRANSPARENCY	PLAIN
	OPT:PAPER SIZE	LETTER/LEGAL/A4/ POST CARD: 4" × 6"	LETTER
	OPT:QUALITY	NORMAL/BEST/FAST	NORMAL
	OPT:BRIGHTNESS	-■■■■■+	-■■■□□+
	OPT:ELG/RDC	50%/78% LGL>LTR/ 94% A4>LTR/100%/ 104% EXE>LTR/150%/ 200%/ZOOM	100%
	OPT:SPECIAL	OFF (1 IN 1)	OFF (1 IN 1)

Paper Type

You can change the paper type setting for the next copy only.



- 1 Place the original face down in the ADF.
- 2 Use the dial pad to enter the number of copies you want (up to 99).
- 3 Press **Options** and press  to select **OPT:PAPER TYPE**, and then press **Menu/Set**.
- 4 Press  to select the type of paper you are using (**PLAIN**, **INKJET**, **GLOSSY** or **TRANSPARENCY**), and then press **Menu/Set**.
- 5 If you selected **GLOSSY**, press  to select **4-COLOR** or **3-COLOR**, and then press **Menu/Set**.

 **Note:** The print quality of black ink varies depending on the kind of glossy paper you are using. Black ink is used when you select **4-COLOR**. If the glossy paper you are using repels the black ink, select **3-COLOR**, which simulates black ink by combining the three ink colors.

- 6 Press **Black Copy** or **Color Copy**—OR—Press  for additional settings.

Paper Size



You can change the paper size setting for the next copy only.

- 1 Place the original face down in the ADF.
- 2 Use the dial pad to enter the number of copies you want (up to 99).
- 3 Press **Options** and select **OPT:PAPER SIZE**, and then press **Menu/Set**.
- 4 Press  to select the size of paper you are using (**LETTER**, **LEGAL**, **A4** or **POST CARD: 4" × 6"**), and then press **Menu/Set**.
- 5 Press **Black Copy** or **Color Copy**—OR—Press  for additional settings.





Copy Quality

You can change the copy quality setting (**NORMAL**, **BEST** or **FAST**).

FAST:	Fast copy speed and lowest ink consumption. Use FAST to save time (documents to be proof-read, large documents or many copies).
NORMAL:	Recommended mode for ordinary printouts. Good copy quality with adequate copy speed.
BEST:	Use this mode to copy precise images such as photographs. BEST uses the highest resolution and slowest speed.

- 1 Place the original face down in the ADF.
- 2 Use the dial pad to enter the number of copies you want (up to 99).
- 3 Press **Options** and select **OPT:QUALITY**, and then press **Menu/Set**.
- 4 Press  to select the copy quality (resolution), and then press **Menu/Set**.
- 5 Press **Black Copy** or **Color Copy**—OR—Press  for additional settings.

Copy Brightness

- 1 Place the original face down in the ADF.
- 2 Use the dial pad to enter the number of copies you want (up to 99).
- 3 Press **Options** and press  to select **OPT:BRIGHTNESS**, and then press **Menu/Set**.

- 4 Press  to make a lighter copy—OR—press  to make a darker copy, and then press **Set**.

- 5 Press **Black Copy** or **Color Copy**—OR—Press  for additional settings.

Reducing and Enlarging Copies

- 1 Place the original face down in the ADF.
- 2 Use the dial pad to enter the number of copies you want (up to 99).
- 3 Press **Options** and press  to select **OPT:ELG/RDC**, and then press **Menu/Set**.

- 4 Press  to choose an enlargement or reduction ratio, and then press **Menu/Set**.

You can reduce to **50%**, **78% LGL>LTR** or **94% A4>LTR** of the original size.
—OR—

You can enlarge to **104% EXE>LTR**, **150%** or **200%**.
—OR—

For more choices select **ZOOM**, and then press **Menu/Set**. Use the dial pad to enter any percentage between **25%** and **400%**, and then press **Menu/Set**. For example, press **5 3** to enter 53%.

- 5 Press **Black Copy** or **Color Copy**—OR—Press  for additional settings.

Selecting Fixed Reduction Ratios:

When selecting a reduction ratio, you will need to know the size of paper you registered in Menu 1-2 if you don't change the paper size setting using **Options**.





If you want to make a copy the same size as the original, you should choose a reduction of 93%. (For example, if you want to copy from letter to letter, you should choose a reduction of 93%.)

Original size is...	Paper size is...	Recommended reduction ratio is...
LETTER DOCUMENT	LETTER	93%
	LEGAL	100%
A4 DOCUMENT	LETTER	94%
LEGAL DOCUMENT	LETTER	78%
	LEGAL	93%

Special Copy Option

You can save paper by copying two pages onto one page.

- 1 Place the original face down in the ADF.
- 2 Press **Options** and  to select **OPT: SPECIAL**, and then press **Menu/Set**.
- 3 Press  to select **2 IN 1** or **OFF (1 IN 1)**, and then press **Menu/Set**.
- 4 Press **Black Copy** or **Color Copy**—**OR**—Press  for additional settings.

2 in 1



 2 in 1 copies are not available with:

- Multiple Copies
- Enlarge/Reduce
- GLOSSY Paper Type setting

 If 2 in 1 Copies are in color, you must use letter or A4 paper.

Changing Default Copy Settings

Press **Menu/Set** and **3** to change default Copy mode settings. They will remain until you change them again by pressing **Menu/Set**.

By pressing a number, you can adjust the Quality, Color and Contrast copy settings shown in the following chart. Press  to scroll through the options for each setting, and then press **Menu/Set** to save your selection.

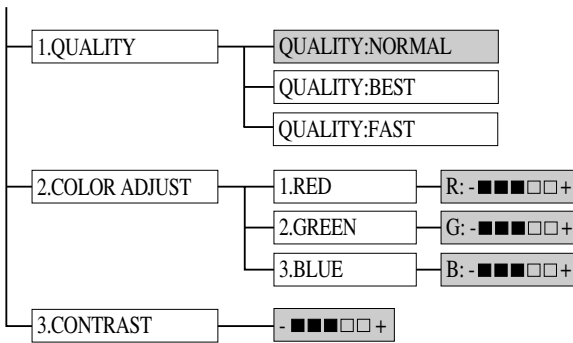

Press **Stop/Exit**—OR—Press  to select the next setting you want to change.

Press **Menu/Set** and **3**.







 is default

Copy Quality

- 1 Press **Menu/Set, 3, 1.**
- 2 Press  **OF**  to select the copy quality, and then press **Menu/Set.**
- 3 Press **Stop/Exit.**



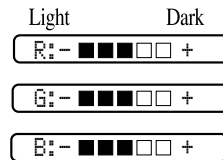

Color Adjustment

- 1 Press **Menu/Set, 3, 2.**
- 2 Press  **OF**  to select **RED, GREEN** or **BLUE**, and then press **Menu/Set.**
- 3 Press  to make a darker copy, or press  to make a lighter copy, and then press **Menu/Set.**
- 4 Return to Step 2 to select the next color
—OR—
Press **Stop/Exit.**



Copy Contrast

You can change the contrast to help an image look sharper and more vivid.

- 1 Press **Menu/Set, 3, 3.**
- 2 Press  to increase the contrast, or press  to decrease the contrast, and then press **Menu/Set.**
- 3 Press **Stop/Exit.**



Legal Limitations

Color reproductions of certain documents are illegal and may result in either criminal or civil liability. This memorandum is intended to be a guide rather than a complete listing of every possible prohibition. In case of doubt, we suggest that you check with counsel as to any particular questionable documents.

The following documents issued by the United States/Canadian Government or any of its Agencies may not be copied:

- Paper money
- Bonds or other certificates of indebtedness
- Certificates of Deposit
- Internal Revenue Stamps (canceled or uncanceled)
- Selective Service or draft papers
- Passports
- United States/Canadian Postage Stamps (canceled or uncanceled)
- Food Stamps
- Immigration Papers
- Checks or drafts drawn by Governmental agencies
- Identifying badges or insignias

Copyrighted works cannot be copied; however, sections of a copyrighted work can be copied for “fair use.” Multiple copies would indicate improper use.

Works of art should be considered the equivalent of copyrighted works.

Licenses and Certificates of Title to motor vehicles may not be copied under certain state/provincial laws.

13 Using FAX-1800C as a Printer

Download the Printer Driver from the Brother Web Site

You can download the Brother Printer Driver from the Brother Solutions Center to use the FAX-1800C as a printer.

Printer Specifications

Print Method	Piezo technology
Resolution	up to 2400 × 1200 dpi (Color) up to 1200 × 1200 dpi (Mono)
Print Speed	up to 8 ppm (Color) up to 10 ppm (Mono)

At the same time, you can download the manual for setting up and using the Brother Printer Driver and get the additional Brother PC-Fax software.

Visit us at:

<http://solutions.brother.com>

The Brother Solutions Center provides access to a variety of information, such as Frequently Asked Questions (FAQs), Technical Questions, Product Support and Driver Updates.

Caution

You must download the Printer Driver before connecting the machine to your computer with the USB cable.

14 Important Information

Standard Telephone and FCC Notices

These notices are in effect on models sold and used in the United States only.

This equipment is hearing aid compatible.

When programming emergency numbers and/or making test calls to emergency numbers:

- Remain on the line and briefly explain to the dispatcher the reason for the call before hanging up.
- Perform these activities in the off-peak hours, such as early morning or late evening.

This equipment complies with Part 68 of FCC Rules. On the rear panel of this equipment is a label that contains, among other information, the FCC Registration Number and Ringer Equivalence Number (REN) for this equipment. You must, upon request, provide this information to your telephone company.

You may safely connect this equipment to the telephone line by means of a standard modular jack, USOC RJ11C.

An FCC compliant telephone cord with a modular plug is provided with this equipment. This equipment is designed to be connected to the telephone line or premises wiring using a compatible modular jack that is Part 68 compliant. See the Installation section of this manual for details.

The REN is useful to determine the quantity of devices you may connect to your telephone line and still have those devices ring when your telephone number is called. In most, but not all areas, the sum of the RENs of all devices connected to one line should not exceed five (5). To be certain of the number of devices you may connect to your line, as determined by the REN, you should contact your local telephone company to determine the maximum REN for your calling area. If your FAX-1800C damages the telephone line, the telephone company may discontinue your service temporarily. If possible, they will notify you in advance. But if advanced notice is not practical, you will be notified as soon as possible. You will be informed of your right to file a complaint with the FCC.

Your telephone company may make changes to its facilities, equipment, operations or procedures that could affect the proper functioning of your equipment. If they do, you will be notified in advance to give you an opportunity to maintain uninterrupted telephone service.

If you experience trouble with your FAX-1800C, please contact a Brother Authorized Service Center for information on obtaining service or repair. The telephone company may ask that you disconnect this equipment from the line until the problem has been corrected or until you are sure that the equipment is not malfunctioning.

If you are not able to solve a problem with your fax machine, contact Brother Customer Service. (See *Brother Numbers*, page i.)



WARNING

For protection against the risk of electrical shock, always disconnect all cables from the wall outlet before servicing, modifying or installing the equipment.

This equipment may not be used on coin service lines provided by the telephone company or connected to party lines.

Brother cannot accept any financial or other responsibilities that may be the result of your use of this information, including direct, special or consequential damages. There are no warranties extended or granted by this document.

Federal Communications Commission (FCC) Declaration of Conformity (For USA Only)

Responsible Party:	Brother International Corporation 100 Somerset Corporate Boulevard Bridgewater, NJ 08807-0911 USA TEL: (908) 704-1700
--------------------	--

declares, that the products

Product Name: FAX-1800C

comply with Part 15 of the FCC Rules. Operation is subject to the following two conditions: (1) This device may not cause harmful interference, and (2) this device must accept any interference received, including interference that may cause undesired operation.

This equipment has been tested and found to comply with the limits for a Class B digital device, pursuant to Part 15 of the FCC Rules. These limits are designed to provide reasonable protection against harmful interference in a residential installation. This equipment generates, uses, and can radiate radio frequency energy and, if not installed and used in accordance with the instructions, may cause harmful interference to radio communications. However, there is no guarantee that interference will not occur in a particular installation. If this equipment does cause harmful interference to radio or television reception, which can be determined by turning the equipment off and on, the user is encouraged to try to correct the interference by one or more of the following measures:

- Reorient or relocate the receiving antenna.
- Increase the separation between the equipment and receiver.
- Connect the equipment into an outlet on a circuit different from that to which the receiver is connected.
- Consult the dealer or an experienced radio/TV technician for help.

Important

Changes or modifications not expressly approved by Brother Industries, Ltd. could void the user's authority to operate the equipment.

Industry Canada Compliance Statement (For Canada Only)

This Class B digital apparatus complies with Canadian ICES-003.

Cet appareil numérique de la classe B est conforme à la norme NMB-003 du Canada.

International ENERGY STAR® Compliance Statement

As an ENERGY STAR® Partner, Brother Industries, Ltd. has determined that product meets the ENERGY STAR® guidelines for energy efficiency.



Important Safety Instructions

- 1 Read all of these instructions.
- 2 Save them for later reference.
- 3 Follow all warnings and instructions marked on the product.
- 4 Unplug this product from the wall outlet before cleaning. Do not use liquid or aerosol cleaners. Use a damp cloth for cleaning.
- 5 Do not use this product near water.
- 6 Do not place this product on an unstable cart, stand, or table. The product may fall, causing serious damage to the product.
- 7 Slots and openings in the cabinet and the back or bottom are provided for ventilation; to ensure reliable operation of the product and to protect it from overheating, these openings must not be blocked or covered. The openings should never be blocked by placing the product on a bed, sofa, rug, or other similar surface. This product should never be placed near or over a radiator or heater. This product should never be placed in a built-in installation unless proper ventilation is provided.
- 8 This product should be operated from the type of power source indicated on the label. If you are not sure of the type of power available, consult your dealer or local power company.
- 9 This product is equipped with a 3-wire grounding type plug, a plug having a third (grounding) pin. This plug will fit into only a grounding-type power outlet. This is a safety feature. If you are unable to insert the plug into the outlet, contact your electrician to replace your obsolete outlet. Do not defeat the purpose of the grounding-type plug.
- 10 Do not allow anything to rest on the power cord. Do not place this product where people can walk on the cord.
- 11 If an extension cord is used with this product, make sure that the total ampere ratings on the products plugged into the extension cord do not exceed the extension cord ampere rating. Also, make sure that the total of all products plugged into the wall outlet does not exceed 15 amperes (USA only).
- 12 Do not place anything in front of the machine that will block received faxes. Do not place anything in the path of received faxes.
- 13 Wait until pages have exited the machine before picking them up.
- 14 Never push objects of any kind into this product through cabinet slots, since they may touch dangerous voltage points or short out parts resulting in the risk of fire or electric shock. Never spill liquid of any kind on the product.
- 15 Do not attempt to service this product yourself, as opening or removing covers may expose you to dangerous voltage points and/or other risks, and may void your warranty. Refer all servicing to Authorized Service Personnel. A list of Authorized Service Centers has been included for your convenience, or you may contact Customer Service for your nearest Brother Authorized Service Center. (See *Brother Numbers*, page i.)
- 16 This product does not have an ON/OFF switch. Therefore, it is very important that you have easy access to the main plug and the main socket to which the plug is connected, in case the main power to the fax machine must be disconnected quickly.
- 17 Unplug this product from the wall outlet and refer servicing to Authorized Service Personnel under the following conditions:
 - A When the power cord is damaged or frayed.
 - B If liquid has been spilled into the product.
 - C If the product has been exposed to rain or water.
 - D If the product does not operate normally when the operating instructions are followed. Adjust only those controls that are covered by the operating instructions. Improper adjustment of other controls may result in damage and will often require extensive work by a qualified technician to restore the product to normal operation.
 - E If the product has been dropped or the cabinet has been damaged.
 - F If the product exhibits a distinct change in performance, indicating a need for service.
- 18 To protect your product against power surges, we recommend the use of a power protection device (Surge Protector).

Trademarks

The brother logo is a registered trademark of Brother Industries, Ltd.

Brother is a registered trademark of Brother Industries, Ltd.

© Copyright 2000 Brother Industries, Ltd. All rights reserved.

IBM, IBM PC and Proprinter are registered trademarks of International Business Machines Corporation.

Hammermill and JetPrint PHOTO are a registered trademark of International Paper.

All other brand and product names mentioned in this manual are registered trademarks of their respective companies.

15 Troubleshooting and Routine Maintenance

Troubleshooting

IMPORTANT

For technical and operational assistance, you must call the country where you purchased the fax machine. Calls must be made *from within* that country.

Error Messages

As with any sophisticated office product, errors may sometimes occur. If this happens, your fax machine often identifies the problem and displays an error message. The table below explains the most common error messages.

You can correct most problems by yourself. If you need additional help, call the Brother fax-back system.

In USA: 1-800-521-2846

In Canada: 1-800-681-9838

1-514-685-5381 **In Montreal**

Or, visit us at: <http://solutions.brother.com>

ERROR MESSAGES

ERROR MESSAGE	CAUSE	ACTION
CHECK CARTRIDGE	An ink cartridge is not installed properly.	Re-install the ink, seating it properly. See page 15-16.
CHECK ORIGINAL	Original was not inserted or fed properly, or document was longer than about 40" inches (90cm).	See page 15-3.
CHECK PAPER SIZE	Your paper is not the correct size.	Reload the correct size of paper, and then press Black Fax Start .
CHECK PAPER	Fax machine is out of paper.	Add paper, and then press Black Fax Start .
COMM. ERROR	Poor phone line quality caused a communication error.	Try the call again. If problem continues, call the telephone company to check your phone line.
CONNECTION FAIL	You tried to poll a fax machine that is not in Polled Waiting mode.	Verify the other party's polling setup.
HIGH TEMPERATURE	The print head detects high temperature.	Use the fax machine in a cool room or lower the temperature.
COVER OPEN	Control panel cover or top cover is not closed completely.	Open and close the covers.
DISCONNECTED	The other party or other party's fax machine terminated the call.	Try to transmit or receive again.

ERROR MESSAGES

ERROR MESSAGE	CAUSE	ACTION
INK EMPTY	<p>One or more of the ink cartridges are empty. The fax machine will stop all print operations (such as printing copies, faxes and jobs from the PC). While memory is available, black and white faxes will be received into memory. If a sending machine has a color fax, the fax machine's "handshake" will request that the fax be sent as black and white; if the sending machine has the feature to convert it, the color fax will be received into memory as a black and white fax. fax machines connected with a USB cable will be able to perform scan operations; fax machines connected with a parallel cable, will not scan.</p> <p>To preserve good quality, the fax machine periodically cleans the print head. Also, you can press Ink to start the cleaning when needed. This cleaning process uses up ink and can cause the ink to run out.</p>	Replace the ink cartridges. See page 15-16.
INK EMPTY & FAX IN MEMORY	Fax machine can not print fax messages because one or more of the ink cartridges are empty.	Replace the empty ink cartridges. See page 15-16.
LOW TEMPERATURE	The print head detects low temperature.	Use the fax machine in a warm room or raise the temperature.
MACHINE ERROR XX	Fax machine has a mechanical problem.	Call Brother Customer Service. In USA: 1-800-284-4329 In Canada: 1-800-853-6660 In Montreal: 1-514-685-6464
NEAR EMPTY	One or more of the ink cartridges are running out of ink. The fax machine will stop receiving color faxes. The fax machine's "handshake" will request that it be sent in black and white; if the sending machine has the feature to convert it, the color fax will be received into memory as a black and white fax.	Order a new ink cartridge. See page ii.
NO RESPONSE/ BUSY	The number you dialed does not answer or is busy.	Verify the number and try again.
NOT REGISTERED	You tried to access a Speed Dial number that is not programmed.	Set up the Speed Dial number. See page 8-1.
OUT OF MEMORY	The data is too large for the fax machine's memory.	See page 12-2.
PAPER JAM	The paper is jammed in the fax machine.	See page 15-4.

Original Jam

If the original is jammed, follow the steps below.

Original is jammed inside front of control panel.

- 1 Remove any paper from the ADF that is not jammed.
- 2 Pull the jammed original toward the front of the fax machine.
- 3 Press **Stop/Exit**.



Original is jammed inside back of control panel.

- 1 Remove any paper from the ADF that is not jammed.
- 2 Open the control panel cover.
- 3 Pull the jammed original out toward the back of the fax machine.
- 4 Close the control panel cover.

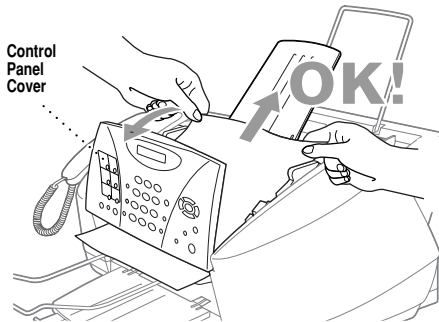

Printer Jam or Paper Jam

Remove the jammed paper depending on where it is jammed in the fax machine.

Paper is jammed in the multi-purpose sheet feeder.

- 1 Remove any paper from the multi-purpose sheet feeder that is not jammed.
- 2 Pull up the jammed paper to remove it.

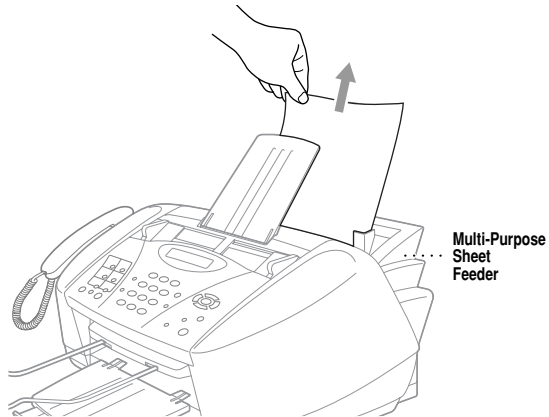

Note If it is difficult to pull the jammed paper, try to pull it while holding down the Paper Release Lever.

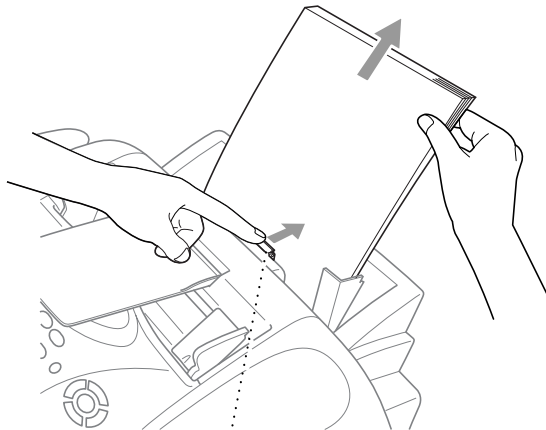

Paper Release Lever

Note To improve the reliability of paper feeding, turn on Secure Feed mode by pressing the **Shift** and **Hook/Hold** keys simultaneously. The fax machine will then feed paper more securely, but paper feeding will take a longer time. To turn off the Secure Feed mode, simultaneously press **Shift** and **Hook/Hold** again.

Paper is jammed inside the fax machine.

- 1 Open the control panel cover by lifting it toward you, and then lift the top cover toward the back.
- 2 Remove the jammed paper.



If the jammed paper is under the Print Head, unplug the fax machine, and then you can move the Print Head to remove the paper.

- 3 Close the control panel cover and top cover.

Paper is jammed inside the front of the fax machine.

- 1 Pull the paper toward you.

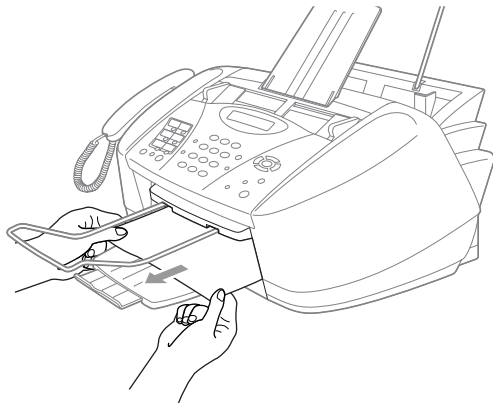

Paper is jammed inside the back of the fax machine.

If the paper rips, the pieces of paper may get stuck inside the back of the machine.

- 1 Remove any paper from the multi-purpose sheet feeder that is not jammed.
- 2 Open the Paper Jam Cover.
- 3 To loosen the paper, slide the Paper Width Guide to the widest position.
- 4 Use tweezers to pull out the ripped pieces of paper.
- 5 Close the Paper Jam Cover.

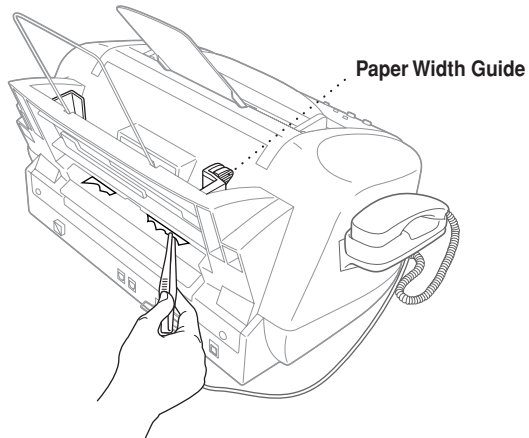

Note If **PAPER JAM** occurs frequently, install the Card Stock Support in the feeder and reload the paper. Or, try reloading the paper upside down.

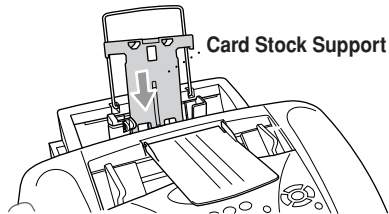

If You Are Having Difficulty with Your Fax Machine

If you think there is a problem with your fax machine, *make a copy first*. If the copy looks good, the problem is probably not your fax machine. Check the chart below and follow the troubleshooting tips.

If you have any other problems, visit us at: <http://solutions.brother.com>

DIFFICULTY	SUGGESTIONS
Printing or Receiving Faxes	
Condensed Print and Horizontal Streaks / Top and Bottom of Sentences Are Cut Off	If your copy looks good, you probably had a bad connection, with static or interference on the phone line. If the copy looks bad, call Brother Customer Service at 1-800-284-4329 (in USA), 1-800-853-6660 (in Canada) or 1-514-685-6464 (in Montreal).
Poor Quality Print	If you are using plain paper, try using recommended special paper (See Chapter 3). Don't handle the paper until the ink is dry. Adjust the Vertical Alignment (See page 15-10).
Print Too Dark or Too Light	Make sure your ink cartridges are fresh. Cartridges are good up to two years; after that the ink may become clogged. Cartridge expiration dates are printed on the package. Try using recommended special paper (See Chapter 3). The recommended environment for your fax machine is between 68°F to 91°F.
Print Appears Dirty or Ink Seems to Run	Make sure you are using the recommended paper (See Chapter 3). Don't handle the paper until the ink is dry. The recommended environment for your fax machine is between 68°F to 91°F.
White Lines in Text or Graphics	Clean the print head (See <i>Cleaning the Print Head</i> , page 15-9.).
Stains Appear on the Reverse Side or at the Bottom of the Page	Make sure the Printer Platen and Pick Up Roller are not dirty with ink mist. (See page 15-15).
Vertical Black Lines When Receiving	The sender's scanner may be dirty. Ask the sender to make a copy to see if the problem is with the sending machine. Try receiving from another fax machine. If the problem continues, call Brother Customer Service at 1-800-284-4329 (in USA), 1-800-853-6660 (in Canada) or 1-514-685-6464 (in Montreal).
Received color fax prints only in B & W.	Replace the color ink cartridges that are empty or nearly empty, and then ask the other party to send the color fax again. (See <i>Replacing the Ink Cartridges</i> , page 15-16.)
Left and right margins are cut off.	Turn on Auto Reduction. (See <i>Printing a Reduced Incoming Fax (Auto Reduction)</i> , Page 6-4.)
Horizontal lines appear in Text or Graphics.	Clean the print head (See <i>Cleaning the Print Head</i> , page 15-9.). If you clean the print heads five times and the print has not improved, call Brother Customer Service at 1-800-284-4329 (in USA), 1-800-853-6660 (in Canada) or 1-514-685-6464 (in Montreal).
Phone Line or Connections	
Dialing does not work.	Check for a dial tone. Change TONE/PULSE setting (See <i>Setting Tone/Pulse Dialing Mode</i> , page 5-7). Check all line cord connections, and make sure the curled handset cord is not in the EXT jack. Check power cord connection. Send a manual fax by pressing Hook/Hold—OR— by lifting the handset, and dialing the number. Wait to hear the fax receiving tones before pressing Black Fax Start .

DIFFICULTY	SUGGESTIONS
Fax Machine Does Not Answer When Called	Make sure the fax machine is in the correct receiving mode for your setup (either FAX ONLY , FAX/TEL or TAD: ANSWER MACH). Check for dial tone. If possible, call your fax machine to hear it answer. If there is still no answer, check the telephone line cord connection. If there is no ringing when you call your fax machine, call your telephone company to check the line.
There is no dial tone on the handset.	Press Hook/Hold—OR—Lift the handset. If you hear no dial tone, check telephone line cord connections at the fax machine and wall jack. Check that the handset curled cord is connected to the fax machine's handset jack. Test the jack with another single line telephone. If no dial tone on the wall outlet, call your telephone company.
Sending Faxes	
Poor Transmission Quality	Try changing your resolution to FINE or S.FINE . Make a copy to verify your fax machine's scanner operation.
Transmission Verification Report says "Result:NG"	There is probably temporary noise or static on the line. Try sending the fax again. If the problem continues, call the telephone company to check your phone line.
Vertical Black Lines When Sending	If the copy you made shows the same problem, your scanner is dirty (See <i>Cleaning the Scanner</i> , page 15-15.).
Handling Incoming Calls	
Fax Machine "Hears" Voice as CNG Tone	If your fax machine is set to Easy Receive ON, it is more sensitive to sounds. Your fax machine may mistakenly interpret certain voices or music on the line as a calling fax machine and respond with fax receiving tones. Deactivate the fax by pressing Stop/Exit . Try avoiding this problem by turning Easy Receive to OFF. (See <i>Easy Receive</i> , page 6-3.)
Transferring a Fax Call to the Fax Machine	If you answered at the fax machine, press Black Fax Start and hang up immediately. If you answered at an extension phone, press your Fax Receive Code (default setting is *51). When your fax machine answers, hang up.
Custom Features on a Single Line	If you have Call Waiting, Call Waiting/Caller ID, Ring Master, Voice Mail, an alarm system or any other custom feature on a single phone line with your fax machine, it may create a problem sending or receiving fax data. For example: If you are sending or receiving a fax message while a custom feature signal comes through on the line, the signal can temporarily interrupt or disrupt the fax data. Brother's ECM feature should help overcome this problem. This condition is related to the telephone system industry and is common to all devices that send and receive information on a single, shared line with custom features. If avoiding a slight interruption is crucial to your business, a separate line with no custom features is recommended.

How to Improve Print Quality

Cleaning the Print Head

Clean the print head if you get a horizontal line in the text or graphics on your printed pages. There are two print heads; each contains two print cartridges. You can clean either black and cyan, yellow and magenta, or all four colors by using **Ink**.

! Caution

Do NOT clean the print head by touching it with your hand or a cloth.

- 1 Press **Ink**.
- 2 Press **1** to choose **1.CLEANING**.
- 3 Press  to choose the color you want to clean, and then press **Menu/Set**.

The fax machine will clean the print head automatically. When cleaning is finished, the fax machine will go back online automatically.



If you clean the print head at least five times and the print has not improved, call Brother Customer Service for assistance at 1-800-284-4329 (**in USA**), 1-800-853-6660 (**in Canada**), or 1-514-685-6464 (**in Montreal**).

Print Quality Check

If the print quality is not satisfactory, you can print a Print Quality Check Sheet to help you identify settings you may need to change.

- 1 Press **Menu/Set, 4**.
- 2 Press **Black Fax Start**.
The fax machine begins printing the Print Quality Check Sheet.
The LCD shows:

4. TEST PRINT

IS STEP "A" OK?
1. YES 2. NO

- 3 Check the sheet to see if the quality and alignment are OK by following STEPs A and B.

STEP A: Color Block Quality Check

The LCD shows:

IS STEP "A" OK?
1. YES 2. NO

Check the quality of the four color blocks in the sheet. (BLACK/CYAN/YELLOW/MAGENTA).

If the quality is OK for all colors, press **1 (YES)** to go to **STEP B—OR—**
 If white horizontal lines appear in some color blocks below, press **2 (NO)**.

OK



Poor



The LCD will ask you if the print quality is OK for each color.

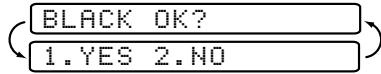

Press **2 (NO)** for any color with a problem.

The LCD shows:

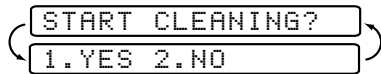

Press **1 (YES)**, the fax machine will start cleaning the colors.

After cleaning is finished, press **Black Fax Start**. The fax machine will start printing the Print Quality Check Sheet again and then return to **STEP A**. If **STEP A** is OK, press **1** to proceed to **STEP B**.

STEP B: Alignment Check

The LCD shows:

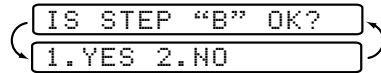

Check the 600 DPI and 1200 DPI test prints to see if number 5 most closely matches number 0. If the number 5 sample of both the 600 DPI and 1200 DPI are the best matches, press **1 (YES)** to finish **STEP B—OR—**

If another test print number is a better match for either 600 DPI or 1200 DPI, press **2 (NO)** to select it.

OK sample

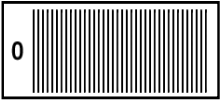

Do NOT select

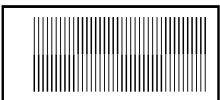

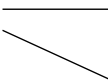

PRINT QUALITY CHECK SHEET

STEP A: Color Block Quality Check
 1. Check the quality of the four color blocks (BLACK/CYAN/YELLOW/MAGENTA).
 2. If the quality is OK for all colors, press 1 (YES) to go to STEP B. OR—
 If white horizontal lines appear in some color blocks, press 2 (NO) to begin the color cleaning process and follow the prompts on the LCD.

STEP B: Alignment Check
 1. Check the alignment with 000000 test print to use as #0. It most closely matches the #4 sample.
 2. Check the alignment with 111111 test print to use as #1.
 3. Check the alignment with 222222 test print to use as #2.
 4. Check the alignment with 333333 test print to use as #3.
 5. Check the alignment with 444444 test print to use as #4.
 6. Check the alignment with 555555 test print to use as #5.
 7. Check the alignment with 666666 test print to use as #6.
 8. Check the alignment with 777777 test print to use as #7.
 9. Check the alignment with 888888 test print to use as #8.
 10. Check the alignment with 999999 test print to use as #9.
 11. Check the alignment with 000000 test print to use as #0.
 12. Check the alignment with 111111 test print to use as #1.
 13. Check the alignment with 222222 test print to use as #2.
 14. Check the alignment with 333333 test print to use as #3.
 15. Check the alignment with 444444 test print to use as #4.
 16. Check the alignment with 555555 test print to use as #5.
 17. Check the alignment with 666666 test print to use as #6.
 18. Check the alignment with 777777 test print to use as #7.
 19. Check the alignment with 888888 test print to use as #8.
 20. Check the alignment with 999999 test print to use as #9.
 21. Check the alignment with 000000 test print to use as #0.
 22. Check the alignment with 111111 test print to use as #1.
 23. Check the alignment with 222222 test print to use as #2.
 24. Check the alignment with 333333 test print to use as #3.
 25. Check the alignment with 444444 test print to use as #4.
 26. Check the alignment with 555555 test print to use as #5.
 27. Check the alignment with 666666 test print to use as #6.
 28. Check the alignment with 777777 test print to use as #7.
 29. Check the alignment with 888888 test print to use as #8.
 30. Check the alignment with 999999 test print to use as #9.
 31. Check the alignment with 000000 test print to use as #0.
 32. Check the alignment with 111111 test print to use as #1.
 33. Check the alignment with 222222 test print to use as #2.
 34. Check the alignment with 333333 test print to use as #3.
 35. Check the alignment with 444444 test print to use as #4.
 36. Check the alignment with 555555 test print to use as #5.
 37. Check the alignment with 666666 test print to use as #6.
 38. Check the alignment with 777777 test print to use as #7.
 39. Check the alignment with 888888 test print to use as #8.
 40. Check the alignment with 999999 test print to use as #9.



600 DPI

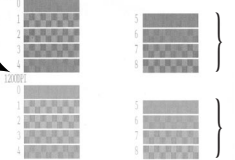

1200 DPI

For 600 DPI, press the number of the test print that most closely matches the number 0 sample (1-8).

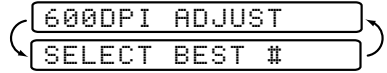

For 1200 DPI, press the number of the test print that most closely matches the number 0 sample (1-8).



- 4 Repeat Steps 1 and 2 (in *Print Quality Check*) to print another sample Print Quality Check Sheet, and then check it.
- 5 Press **Stop/Exit**.



When an ink head nozzle is clogged the printed sample looks like this.



After the ink head nozzle is cleaned, the horizontal lines are gone.

If you still see missing ink in this Print Quality Check Sheet, repeat the cleaning and test print procedures at least five times. If ink is still missing after the fifth cleaning and test print, replace the ink cartridge for the clogged color. (Perhaps the ink cartridge was in your fax machine over six months or the expiration date written on the cartridge package has passed. Or, the ink may not have been stored properly before use.)

After replacing the ink cartridge, check it by printing another Print Quality Check Sheet. If the problem still exists, repeat the cleaning and test print procedures at least five times for the new ink cartridge. If ink is still missing, call Customer Service at 1-800-284-4329 (**in USA**), 1-800-853-6660 (**in Canada**) or 1-514-685-6464 (**in Montreal**).



Caution

Do NOT touch the print head. Touching the print head may cause permanent damage and may void the print head's warranty.

Packing and Shipping the Fax Machine

Whenever you transport the fax machine, use the packing materials that came with your fax machine. If you do not pack the fax machine correctly, you could void your warranty.

- 1 First, remove all the ink cartridges and attach the white shipping cover. (See *Replacing the Ink Cartridges*, page 15-16.) After attaching the white shipping cover, press the all ink cartridge covers down.

To attach the white shipping cover

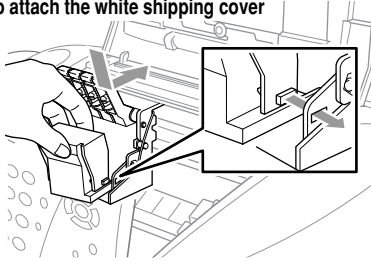

! Caution

Damage to your print head resulting from packing without the shipping cover will void your warranty.

- 2 Attach the protective yellow bar, and then close the top cover and control panel cover until they click into place.

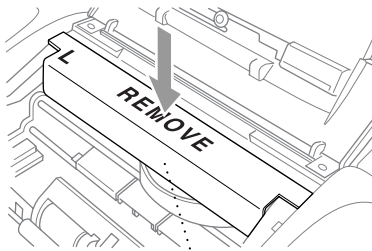

Protective Yellow Bar

- 3 Unplug the fax machine from the telephone wall jack and remove the telephone line cord from machine.

! Caution

Do not unplug the fax machine after a print job until you hear the final click.

- 4 Unplug the fax machine from the AC outlet.
- 5 Unplug the USB cable from the fax machine, if it is connected.
- 6 Remove the paper wire extension, paper tray, document support, document wire extension, handset and handset curled cord.



If you are packing the machine for the Brother Exchange Service, keep these items and return only the machine.

- 7 Wrap the fax machine in the plastic bag and place it in the original carton with the original packing material.

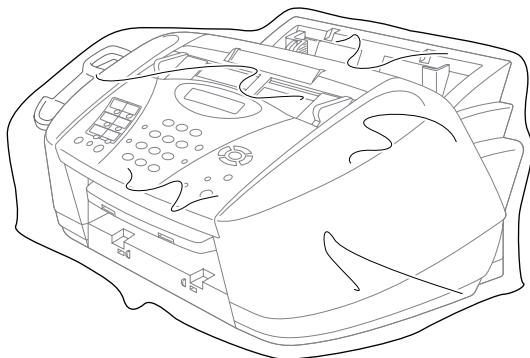

- 8 Pack the printed materials in the original carton as shown below. Do not pack the used ink cartridges in the carton.

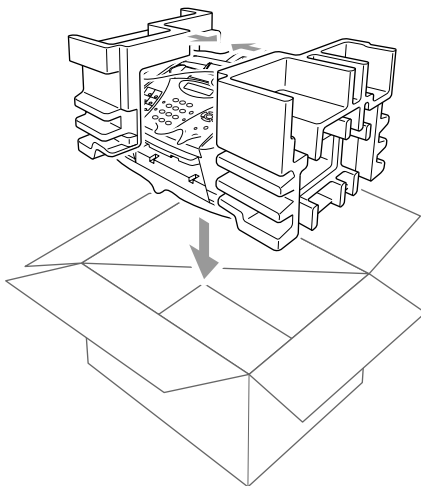

Note If you are returning your machine to Brother as part of the Exchange Service, pack *only* the fax machine. Keep all separate parts and printed materials to use with your “Exchange” machine.

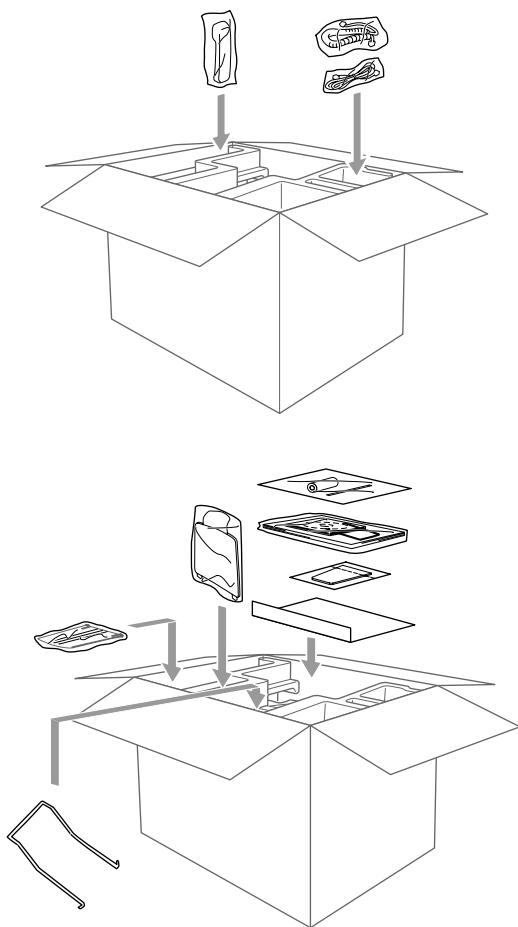

9 Close the carton.

Routine Maintenance

Cleaning the Scanner

Unplug the fax machine, and then open the control panel cover. Clean the flat white pressure bar and the glass strip under the bar with isopropyl alcohol on a lint-free cloth.

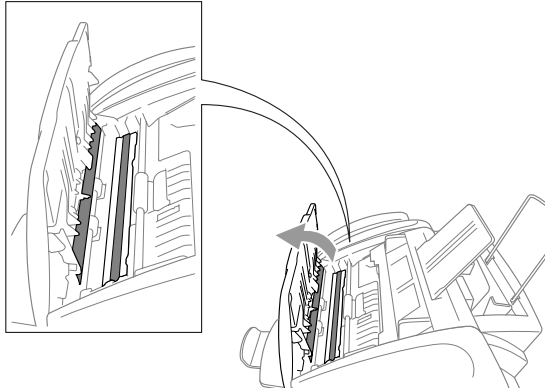

Cleaning the Fax Machine Printer Platen

WARNING

- Be sure to unplug the fax machine from the AC power outlet before cleaning the printer platen.
- Be careful not to touch the paper feed star wheels, flat cable and encode film.

When you want to clean your fax machine printer platen, wipe it with a lint free cloth that is *dry*.

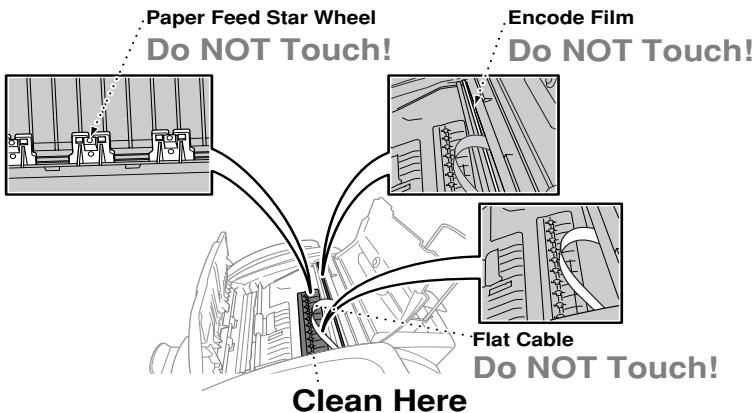

Replacing the Ink Cartridges

Your fax machine is equipped with an ink dot counter that automatically monitors the ink level in each color cartridge. When the counter detects an ink cartridge is running out of ink, the fax machine will notify you with a message on the LCD.

The LCD shows you which color cartridges are low or empty. Be sure to follow the LCD prompts so you replace the color cartridges in the appropriate order.

When the ink cartridges are running low, you must use the **Ink key to begin the cartridge replacement (Steps 1 to 3). If the ink is empty, skip to Step 4.**

- 1 Press **Ink**.
- 2 Press **2** to choose **2. REPLACE INK**.
If one or more ink cartridges are empty, for example Black, the LCD shows **INK EMPTY BLACK** and **PLS OPEN COVER**
- 3 Open the control panel cover, and then lift the top cover.
- 4 Push the appropriate colored ink cartridge covers and remove the ink cartridge.

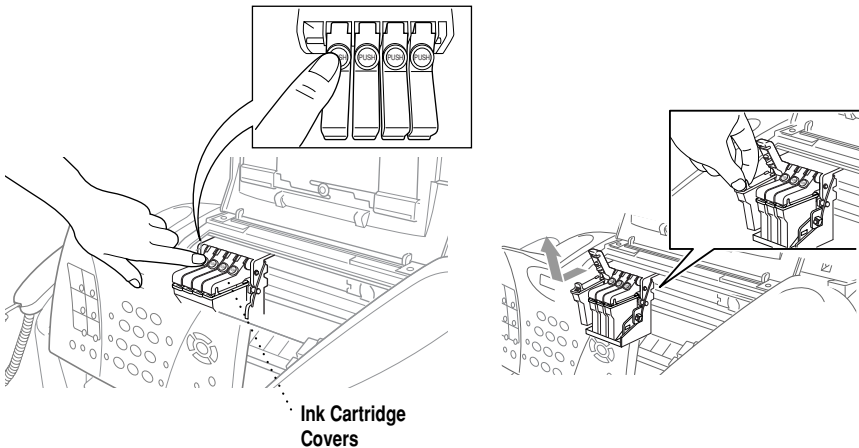

- 5 Open the new ink cartridge bag for the color shown on the LCD, and then take out the ink cartridge.

- 6 Hold the new ink cartridge as shown in the illustration, and then peel the sealing tape from the side of the ink cartridge. Carefully peel the tape in the direction away from you.



Note To prevent spilling ink and staining your hands and clothing, remove the sealing tape gently.

- 7 Each color has its own correct position. Insert each new ink cartridge into the carriage.
- 8 After installing the ink cartridges, close the top cover and control panel cover. Your fax machine prepares for a “head cleaning” and goes online. The LCD prompts you to verify a new ink cartridge was inserted for each color you removed. Example: **DID YOU CHANGE BLCK? 1. YES 2. NO.** If the ink cartridge you installed is not a brand new one, please make sure to select 2.
- 9 For each new cartridge, press **1** on the dial pad to reset the ink dot counter for that color automatically. (The ink dot counter enables the fax machine to notify you when a color is running low.) The fax machine will enter a cleaning cycle for approximately 3 minutes for each replaced cartridge. The LCD alternately shows **CLEANING** and **PLEASE WAIT**.

When the fax machine completes the cleaning cycle, the LCD returns to Standby mode (date and time).



WARNING

If ink gets in your eyes, irrigate them with water immediately and consult a doctor if you are concerned.

Caution

- DO NOT remove ink cartridges if you do not need to replace them. If you do so, it may reduce the ink quantity and the printer will not know the quantity of ink left in the cartridge.
- DO NOT shake the ink cartridges, because the ink may spill when you take off the sealing tape.
- If ink stains your body or clothing, wash with soap or detergent immediately.
- If you install an ink cartridge in the wrong color position, you must clean the print head several times before you start printing (after correcting the cartridge installation) because the colors were mixed.
- Once you open an ink cartridge, install it in the fax machine and use it up within six months of installation. Use unopened ink cartridges by the expiration date written on the cartridge package.
- DO NOT refill the ink cartridges. Attempting to use refilled cartridges and using incompatible inks may cause damage to the print head in this machine and such damage will not be covered by warranty. Warranty coverage does not apply to problems caused by the use of 3rd party ink or 3rd party ink cartridges. Use only genuine Brother ink cartridges.



If the **INK EMPTY** message is on the display after you have installed ink cartridges, check that the ink cartridges are installed correctly.

If you still cannot solve a problem with your fax machine, call Brother Customer Service (See *Brother Numbers*, page i).

S Specifications

Fax

Compatibility	ITU-T Group 3
Coding System	MH/MR/MMR/JPEG
Modem Speed	33600-2400 bps Automatic Fallback
Cut Sheet Size	Min. 3.5" (W) × 5.0" (L) Max. 8.5" (W) × 14.0" (L)
Scanning Width	8.2 inches (208 mm)
Printing Width	8 inches (203.2 mm)
Automatic Document Feeder (ADF)	up to 20 sheets (20 lbs.), staggered
Multi-purpose Sheet Feeder	100 Sheets (20 lbs.)
Printer Type	Ink Jet
Gray Scale	256 levels (Error Diffusion)
LCD	1 line, 16 characters
Polling Types	Standard, Sequential
Contrast Control	Automatic/Super Light/Super Dark (manual setting)
Resolution	<ul style="list-style-type: none">• Horizontal 203 dot/inch (8 dot/mm) (B&W/Color)• Vertical Standard — 98 line/inch (B&W only) (3.85 line/mm) — 196 line/inch (Color) (7.7 line/mm) Fine — 196 line/inch (B&W/Color) (7.7 line/mm) Photo — 196 line/inch (B&W only) (7.7 line/mm) Superfine — 392 line/inch (B&W only) (15.4 line/mm)
Memory Capacity	8 MB (up to 480 pages)*

- * “Pages” refers to the “Brother Standard Chart No.1” (a typical business letter, Standard resolution, MMR code). Specifications and printed materials are subject to change without prior notice.

One Touch Dial	12 stations
Speed Dial	100 stations
Automatic Redial	3 times at 5 minute intervals
Auto Answer	0, 1, 2, 3 or 4 rings
Communication Source	Public switched telephone network
Operating Environment	50–95° F (10–35° C)
Best Print Quality	68–91° F (20–33° C)
Power Source	120V AC 50/60Hz (USA, Canadian Version Only)
Power Consumption	Standby: under 7 watts Peak: under 35 watts
Dimensions	19.1 × 13.5 × 8.5 (inch) 486 × 342 × 217 (mm)
Weight	14.3 lb/6.5 kg

Printer

Print Method	Piezo with 75 × 4 nozzles
Resolution	2400 × 1200 dots per inch (DPI) 1200 × 1200 dots per inch (DPI) 600 × 600 dots per inch (DPI) 600 × 300 dots per inch (DPI) 600 × 150 dots per inch (DPI)
Print Speed	up to 10 pages/minute (Mono) up to 8 pages/minute (Color)

Controller

USB Interface	A Standard Universal Serial Bus cable that is no longer than 6 feet (1.8 m) (not included)
----------------------	---



To meet FCC emission requirements for the fax machine, you must attach the included filter core and cable tie to a USB cable (USB cable not included).

Print Media

Paper Input

Automatic loading from the Multi-Purpose Sheet Feeder

■ Paper type:
Plain paper, inkjet paper (coated paper), glossy paper, transparencies and envelopes

■ Paper size:
A4, Letter, Legal

Width 3.5–8.5" (89–216 mm)

Length 5–14" (127–356 mm)

Weight 17–32 lb (64–120 g/m²)

Thickness 0.003-0.006" (0.08-0.15 mm)
envelopes: up to 0.02" (0.52 mm)
postcard: up to 0.009" (0.23 mm)
glossy paper: up to 0.007" (0.18 mm)

■ Maximum feeder capacity: Approx. 100 sheets of 20 lb (75 g/m²) plain paper.

Paper Output

Approximately 50 sheets of plain paper (Face up print delivery to the paper output tray)
We recommend that you remove printed sheets from the paper output tray immediately after printing.

Consumable Items

Ink

Black and 3 individual color ink cartridges separate from the two print heads.

Glossary

ADF (Automatic Document Feeder) Refers to the number of pages that can be placed in the document feeder and fed one at a time automatically.

Auto Dial List A listing of names and numbers stored in Speed Dial memory, in numerical order.

automatic fax transmission Sending a fax without picking up the handset of an external phone.

Automatic Redial A feature that enables your fax machine to redial the last fax number if the original fax did not go through because the line was busy or there was no answer.

Backup Print Your fax machine prints a copy of every fax that is received and stored in memory. This is a safety feature so you will not lose messages during a power failure.

Batch Transmission As a cost savings feature, all delayed faxes to the same fax number will be sent as one transmission.

beeper The sound the keys make when they are pressed, an error occurs or a document has been received or transmitted.

beeper volume Volume setting for the beep when you press a key or make an error.

Brightness Changing the Brightness makes the whole image lighter or darker.

Broadcasting (Not Available for Color Faxes) The ability to send the same fax message to more than one location.

Caller ID A service purchased from the telephone company that lets you see the number (or name) of the party calling you.

cancel job You can cancel a programmed job, like Delayed Fax or Polling.

CNG tones The special tones (beeps) sent by fax machines during automatic transmission to tell the receiving machine that they are a from fax machine.

communication error (or Comm. Error) An error during fax sending or receiving, usually caused by line noise or static.

Coding Method Method of coding the information contained in a document. All fax machines must use a minimum standard of Modified Huffman (MH). Your fax machine is capable of greater compression methods, Modified Read (MR) and Modified Modified Read (MMR), if the receiving machine has the same capability.

Compatibility Group The ability of one fax unit to communicate with another. Compatibility is assured between ITU-T Groups.

Contrast Setting to compensate for dark or light documents, by lightening dark originals or darkening light originals.

Cover Page Prints a page at the other party's fax machine that contains the sender and recipient's name and fax number, number of pages and comment. You can generate an electronic cover page at the other end with pre-programmed information from memory or you can print a sample cover page to fax with your original.

Cover Page Message The comment that is on the Cover Page. This is a programmable feature.

Delayed Fax (Not Available for Color Faxes) Sends your faxes at a later time that day.

- Distinctive Ring** A service purchased from the Telephone Company that provides another phone number on an existing phone line. The Brother fax machine uses the new number to simulate a dedicated fax line.
- Dual Access** (Not Available for Color Faxes) Your fax machine can scan outgoing faxes or scheduled jobs into memory at the same time it is sending a fax or receiving or printing an incoming fax.
- Easy Receive** Enables your fax machine to respond to CNG tones if you interrupt a fax call by answering it.
- ECM (Error Correction Mode)** Detects errors during fax transmission and resends the page(s) of the document that had an error.
- Electronic Cover Page** A preprogrammed cover page that is transmitted from the fax machine's memory, eliminating the need for creating cover pages manually.
- extension phone** A telephone on the fax number that is plugged into a separate wall jack.
- external phone** A TAD (telephone answering device) or telephone that is plugged into the EXT jack of your fax machine.
- Fax Activity Report** Lists information about the last 200 incoming and outgoing faxes. TX means Transmit. RX means Receive.
- Fax Forwarding** (Not Available for Color Faxes) Sends a fax received in memory to another preprogrammed fax number.
- Fax Storage** (Not Available for Color Faxes) You can print stored faxes later, or retrieve them from another location using Fax Forwarding, Paging, or Remote Retrieval operations.
- fax tones** The signals sent by sending and receiving fax machines while communicating information.
- Fine resolution** 196 × 203 dpi. It is used for small print and graphs.
- gray scale** The shades of gray available for copying and faxing photographs.
- Group number** A combination of One Touch and Speed Dial numbers that are stored on a One Touch key or Speed Dial location for Broadcasting.
- Ink button** Cleans the print head and/or resets the ink dot counter after replacing an ink cartridge.
- Interval** The preprogrammed time period between automatically printed Activity Reports. You can print Activity Reports on demand without interrupting this cycle.
- LCD (liquid crystal display)** The display screen on the fax machine that shows interactive messages during On-Screen Programming. The LCD shows the date and time while the machine is idle.
- manual fax** When you lift the handset of your external telephone so you can hear the receiving fax machine answer before you press Start to begin transmission.
- Menu Mode** The programming mode for changing the settings for your fax machine.
- Next Fax Reservation** Dual Access accepts the next original in the ADF for real-time transmission while the Memory is full.
- One Touch** Keys on the fax machine control panel where you can store numbers for easy dialing.
- Out of Paper Reception** Receives faxes into the fax machine's memory when the machine is out of paper.

Overseas mode Makes temporary changes to the fax tones to accommodate noise and static on overseas phone lines.

Paging Feature enables your fax machine to call your pager when a fax is received into its memory.

Pause Allows you to place one or more 3.5 second delays in the dialing sequence of stored One Touch and Speed Dial numbers.

Photo resolution (Not Available for Color Faxes) Varying shades of gray provide the best representation of photographs.

Polling The process of a fax machine calling another fax machine to retrieve waiting fax messages.

printer alarm Audible alarm when the printer is not able to print.

Pulse (For Canada only) A form of rotary dialing on a telephone line.

Real Time Transmission When memory is full, you can send documents in real time.

Reduction reduces the size of incoming faxes.

remaining jobs You can check which jobs are waiting in memory and cancel jobs individually.

Remote Activation allows you to transfer a fax call, answered at an extension phone, to the fax machine.

Remote Retrieval Access Code The four-digit code (159✳) that allows you to call and access your fax machine from a remote location.

Resolution The number of vertical and horizontal lines per inch. See: Standard, Fine, Super Fine and Photo.

Ring Delay The number of rings before the fax machine answers in FAX ONLY and FAX/TEL modes.

Ring Volume Volume setting for the fax machine's ring.

Speaker Volume You can set the volume when your fax machine is on **Hook/Hold**.

Speed Dial A preprogrammed number for easy dialing. You must press the **Search/Speed Dial** button and then #, two digit code to start the dialing process.

Standard resolution 98 × 203 dpi. Use it for regular size text and quickest transmission.

Station ID The stored information that appears on the top of faxed pages. It includes the sender's name and fax number.

Super Fine resolution (Not Available for Color Faxes) 392 × 203 dpi. It is best for very small print and line art.

TAD (telephone answering device) You can connect an *external* TAD to the EXT. jack of the fax machine for TAD: ANSWER MACH. mode.

temporary settings You can select certain options for the next fax transmission or copy you make without changing the default settings.

Tone The telephone line mode that is used for dialing with Touch Tone telephones.

transmission The process of sending documents over the phone lines from your fax machine to the receiving fax machine.

Transmission Verification Report A listing of each transmission that shows its date, time, and number of pages. OK means delivered; NG means failed.

User Settings List A printed report that shows the current settings of your fax machine.

Index

A

- access codes, storing and dialing 8-6
- accessories and supplies ii
- ADF (Automatic Document Feeder) 7-1
- alternating displays 4-1
- assembly 2-3
 - document wire extension 2-7
 - grounded 3-prong plug 2-4
 - loading paper 2-8
 - paper wire extension 2-5
 - plastic document support 2-6
 - plastic paper tray 2-6
- automatic
 - dialing 8-4, 8-5
 - fax receive 6-1
 - fax redial 7-4
 - transmission 7-3

B

- Backup Print 10-2
- Brightness 1-4
- Broadcasting 8-6
 - setting up Groups for 8-3
- Brother
 - accessories and supplies ii
 - Brother numbers i
 - Customer Service i
 - fax-back system i
 - Frequently Asked Questions (FAQs) i
 - test sheet, sending 1-2

C

- CALL PICKUP 9-3
- Caller ID 9-3, 9-4
- canceling
 - Fax Forwarding 10-4
 - fax jobs in memory 6-7
 - jobs awaiting redial 7-6
 - Paging 10-4
 - scheduled jobs 6-7
- cleaning
 - cycle 2-12
 - print head 15-9
 - printer platen 15-15
 - scanner 15-15
- CNG tones 1-5
- connecting 2-1
- control panel, overview 1-3
- copy
 - brightness 12-4
 - color adjustment 12-8
 - contrast 12-8
 - default settings 12-7
 - enlarging 12-5
 - multiple 12-1
 - quality 12-8
 - reducing 12-5
 - single 12-1
 - temporary settings 12-2
- cordless 2-13
- cover page 5-2, 7-7, 7-8, 7-9
 - custom comments 7-7
 - for all faxes 7-8
 - for next fax only 7-8
 - printed form 7-9
- credit card numbers 8-6
- custom telephone features 2-18, 15-8
- Customer Service i

D

- date and time 5-2
- Delayed Batch Transmission 7-10
- Delayed Fax 7-10
- dialing
 - automatic fax redial 7-4
 - Groups 8-6
 - One Touch numbers 8-5
 - Search 8-4
 - Speed Dial numbers 8-5
- document
 - jam 15-3
 - size and resolution 7-1
- Dual Access 7-4

E

- Easy Receive 6-3
- ECM (Error Correction Mode) 1-6
- envelopes 3-2, 3-3
- error messages on LCD 15-1
 - CHECK PAPER 15-1
 - COMM. ERROR 15-1
 - INK EMPTY 2-12
 - NOT REGISTERED 15-2
 - OUT OF MEMORY 15-2
 - while scanning a document 7-4, 12-2
- extension telephone, using 6-5
- external telephone 2-13
 - cordless 2-13, 6-5
- external two-line TAD 2-16

F

- fax
 - codes
 - Fax Receive Code 6-3, 6-5
 - Remote Retrieval Access Code 10-3
 - Telephone Answer Code 6-5
 - troubleshooting 6-5

- receiving 6-1
 - difficulties 15-7
 - erasing from the memory 10-4
 - forwarding 10-1, 10-4
 - Polling 6-6
 - reducing to fit on paper 6-4
 - retrieving from a remote site 10-5
 - Ring Delay, setting 6-2
- sending
 - automatic fax redial 7-4
 - automatic transmission 7-3
 - canceling from memory 7-6
 - color fax 7-4
 - contrast 7-2
 - cover page 7-7
 - delayed 7-10
 - from memory (dual access) 7-4
 - manual transmission 7-3
 - overseas 7-9
 - Polled Transmit 7-11
 - Real Time Transmission 7-5
 - resolution 7-3
- Fax Forwarding 10-1
 - changing remotely 10-4, 10-5
 - programming a number 10-1
- Fax Storage 10-2
 - printing from 6-6
 - setting 10-2
- FAX/TEL receive mode 6-3
 - answering voice calls 6-5
 - double-ringing (voice calls) 6-3
 - receiving faxes 6-3
- FCC notices 14-1

G

- gray scale S-1
- Groups (for Broadcasting) 8-3

H

- Hearing aid compatible 5-6, 14-1
- HELP 4-1, 11-2

I

- ink cartridges 2-1, 2-10, 2-11, 2-12
 - installing 2-9
 - replacing 15-16
- Ink Dot Counter 15-16
- ink management 1-3, 15-9

J

- jack 2-15, 2-16
 - convert to RJ11 wall jack 2-16
 - EXT. jack
 - external telephone 2-13
 - cordless phone 2-13
 - TAD (answering machine) 2-13
 - two-line telephone or TAD 2-16
 - triplex adapter 2-16

L

- LCD (Liquid Crystal Display) 1-3, 4-1

M

- maintenance, routine 15-15
- manual
 - dialing 8-4
 - fax receive 6-1
 - transmission 7-3
- Menu mode 4-1
 - programming at-a-glance 4-1
- multi-line connections (PBX) 2-17
- multi-purpose sheet feeder 2-5
 - loading paper 2-8

O

- One Touch numbers
 - accessing with Shift key 8-1
 - changing 8-2
 - dialing 8-5
 - storing 8-1
- Options key (copying) 12-2, 12-3
- OUT OF AREA 9-3

P

- packing list 2-1
- Paging 10-1, 10-2
 - programming your pager number 10-1
- paper
 - capacity 3-2
 - jam 15-4
 - size 5-1
 - specification 3-2
- PBX 2-17
- phone line difficulties 15-7
- Polled Transmit 7-11
- Polling 6-6
- power failure 5-7
 - memory storage 5-7
- print 7-9
 - area 3-3
 - difficulties 15-7
 - fax from memory 6-6
 - improving print quality 15-9
 - jam 15-4
 - resolution S-2

R

- Receive mode
 - FAX ONLY 6-1
 - FAX/TEL 6-1
 - MANUAL 6-1
 - TAD:ANSWER MACH. 6-1
- Redial/Pause 7-4, 8-7
- remote codes for extension phones 6-5
- Remote Fax Options 10-1
- Reports 11-1
- resolution
 - fax (Standard, Fine, SuperFine, Photo) S-1
 - setting for the next fax 7-3
- Ring Delay, setting 6-2

S

- safety instructions 14-4
- Search for stored numbers 8-4
- Secure Feed 15-4
- Setup
 - date and time 5-2
 - Station ID (fax header) 5-2
- shipping the machine 15-12
- special characters 5-3
- Speed Dial
 - changing 8-2
 - dialing 8-5
 - storing 8-2

T

- TAD (telephone answering device)
 - connecting 2-13, 2-14
 - Receive Mode 6-1
 - recording outgoing message 2-15
 - two-line TAD 2-16
- text, entering 5-3, 5-4
- Tone signals on Pulse line 8-8
- Transmission Verification Report 11-2
- troubleshooting 15-1
 - error messages on LCD 15-1
 - if you are having difficulty with 15-7
 - incoming calls 15-8
 - phone line 15-7
 - printing or receiving faxes 15-7
 - sending faxes 15-8
- two-line phone system 2-15, 2-16, 2-17

U

- Using the Options Key 12-3

V

- voice calls
 - FAX/TEL (double-ring) 6-3
- volume, setting
 - beeper 5-4
 - handset 5-6
 - amplify (for hearing-impaired) 5-6
 - ring 5-4
 - speaker 5-5

W

- Warranties iii
 - Canada vi
 - Notice – Disclaimer iii
 - USA iv
- World Wide Web i

Remote Retrieval Access Card

If you plan to receive fax messages while away from your machine, carrying the Remote Retrieval Access Card printed below will serve as a convenient reminder of the retrieval procedures. Simply cut out the card and fold it to fit your wallet or organizer. Keeping it handy will help you derive the full benefit of your machine's forwarding, paging and remote retrieval features.

REMOTE RETRIEVAL ACCESS CARD

CHECK RECEIVING STATUS
Press **9 7 1**
1 long beep — Fax message(s)
3 short beeps — No messages

CHANGE ANSWER MODE
Press **9 8**
then for TAD, press **1**.
FAX/TEL, press **2**.
FAX, press **3**.

EXIT REMOTE OPERATION
Press **9 0**.

Using Remote Retrieval Access Code

- 1 Dial your fax number from a fax machine using touch tone.
- 2 When your fax machine answers, immediately enter your Remote Retrieval Access Code (159✳).
- 3 Your fax machine signals the kinds of messages received:
1 long beep — Fax message(s)
No beeps — No messages.
- 4 After 2 short beeps, enter a command.
- 5 Press **9 0** to reset your fax machine when you finish.
- 6 Hang up.

1

4

Fold →

← Fold

Changing Remote Retrieval Access Code

- 1 Press **Menu/Set 2, 5, 3**
- 2 Enter a three-digit number from 000 to 999.
The * cannot be changed.
- 3 Press **Menu/Set**
- 4 Press **Stop/Exit**.

Remote Commands

CHANGE PAGING/FAX FORWARDING SETTING

- Press **9 5**.
- then to*
- Turn Feature off, press **1**.
 - Select Fax Forwarding, press **2**.
 - Select Paging, press **3**.

Program Fax Forwarding Number, press 4 Enter the new fax number where you want your fax messages forwarded followed by **##**.

- Turn Fax Storage on, press 6.**
- Turn Fax Storage off, press 7.**

RETRIEVE A FAX

- Press **9 6**
- then to*
- Retrieve all faxes, press 2.**
 - After the beep, hang up and wait.
 - Erase all fax messages, press 3.**

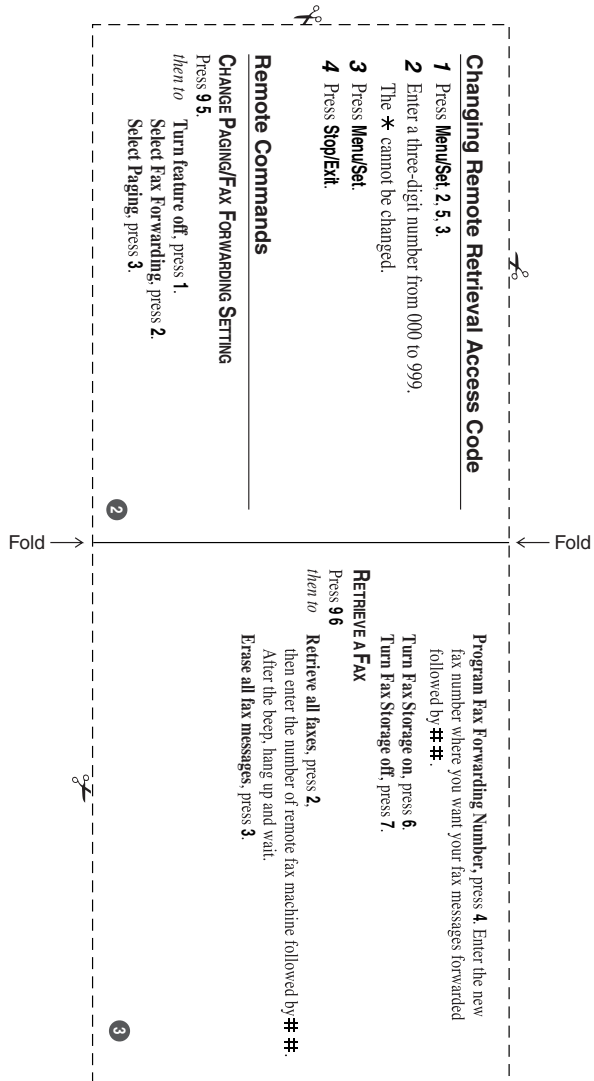

EQUIPMENT ATTACHMENT LIMITATIONS (For Canada Only)

NOTICE:

The industry Canada label identifies certified equipment. This certification means that the equipment meets telecommunications network protective, operational and safety requirements as prescribed in the appropriate Terminal Equipment Technical Requirements document(s). The Department does not guarantee the equipment will operate to the user's satisfaction.

Before installing this equipment, users should ensure that it is permissible to be connected to the facilities of the local telecommunications company. The equipment must also be installed using an acceptable method of connection. The customer should be aware that compliance with the above conditions may not prevent degradation of service in some situations.

Repairs to certified equipment should be coordinated by a representative designated by the supplier. Any repairs or alterations made by the user to this equipment, or equipment malfunctions, may give the telecommunications company cause to request the user to disconnect the equipment.

Users should ensure for their own protection that the electrical ground connections of the power utility, telephone lines and internal metallic water pipe system, if present, are connected together. This precaution may be particularly important in rural areas.

Caution:

Users should not attempt to make such connections themselves, but should contact the appropriate electric inspection authority, or electrician, as appropriate.

NOTICE:

The Ringer Equivalence Number (REN) assigned to each terminal device provides an indication of the maximum number of terminals allowed to be connected to a telephone interface. The termination on an interface may consist of any combination of devices subject only to the requirement that the sum of the Ringer Equivalence Numbers of all the devices does not exceed 5 REN=0.3



Brother International Corporation
100 Somerset Corporate Boulevard
P.O. Box 6911
Bridgewater, NJ 08807-0911 USA

Brother International Corporation (Canada) Ltd.
1 rue Hôtel de Ville,
Dollard-des-Ormeaux, QC, CANADA H9B 3H6

**Visit us on the World Wide Web
<http://www.brother.com>**

These fax machines are made for use in the USA and CANADA only. We cannot recommend using them overseas because it may violate the Telecommunications Regulations of that country and the power requirements of your multi-function center may not be compatible with the power available in foreign countries. **Using USA or CANADA models overseas is at your own risk and will void your warranty.**