



**FACSIMILE EQUIPMENT  
SERVICE MANUAL**

**MODELS: MFC845CW/665CW  
MFC660CN/440CN/240C  
FAX2580C/2480C**

*Confidential*

## How this manual is organized

This manual is made up of nine chapters and appendices.

### **CHAPTER 1 PARTS NAMES AND FUNCTIONS**

Contains external views and names of components and describes their functions. Information about the keys on the control panel is included to help you check operation or make adjustments.

### **CHAPTER 2 SPECIFICATIONS**

Lists the specifications of each model, which enables you to make a comparison of different models.

### **CHAPTER 3 THEORY OF OPERATION**

Gives an overview of the scanning and printing mechanisms as well as the sensors, actuators, and control electronics. It aids in understanding the basic principles of operation as well as locating defects for troubleshooting.

### **CHAPTER 4 ERROR INDICATION AND TROUBLESHOOTING**

Details error messages and codes that the incorporated self-diagnostic functions display if any error or malfunction occurs. If any error message appears, refer to this chapter to find which components should be checked or replaced.

The latter half of this chapter provides sample problems that could occur in the main sections of the machine and related troubleshooting procedures. This will help service personnel pinpoint and repair defective components.

### **CHAPTER 5 TRANSFER OF DATA LEFT IN THE MACHINE TO BE SENT FOR REPAIR**

Describes how to transfer data left in the machine to be sent for repair. The service personnel should instruct end users to follow the transfer procedure given in this chapter if the machine at the user site cannot print received data due to the printing mechanism defective. End users can transfer received data to another machine to prevent data loss.

### **CHAPTER 6 DISASSEMBLY/REASSEMBLY AND LUBRICATION**

Details procedures for disassembling and reassembling the machine together with related notes. The disassembly order flow provided enables you to see at a glance the quickest way to get to component(s) involved.

At the start of a disassembly job, you check the disassembly order flow that guides you through a shortcut to the target components.

This chapter also covers screw tightening torques and lubrication points to which the specified lubricants should be applied during reassembly jobs.

### **CHAPTER 7 ADJUSTMENTS AND UPDATING OF SETTINGS, REQUIRED AFTER PARTS REPLACEMENT**

Details adjustments and updating of settings, which are required if the head/carriage unit, main PCB and some other parts have been replaced.

### **CHAPTER 8 CLEANING**

Provides cleaning procedures not covered by the User's Guide. Before starting any repair work, clean the machine as it may solve the problem concerned.

## CHAPTER 9 MAINTENANCE MODE

Describes the maintenance mode which is exclusively designed for the purpose of checks, settings and adjustments of the machine using the keys on the control panel.

In the maintenance mode, you can update memory (EEPROM: electrically erasable programmable read-only memory) contents for optimizing the drive conditions of the head/carriage unit or the paper feed roller and paper ejection roller in the engine unit, if those units have been replaced, or for setting the CIS scanner area, for example. You can also customize the EEPROM according to the shipment destination of the machine concerned. In addition, you can perform operational checks of the LCD, control panel PCB or sensors, perform a print test, display the log information or error codes, and modify firmware switches (WSW).

For models with a cordless handset, the maintenance functions dedicated to cordless handsets are provided.

### Appendix 1 Reading Labels

Shows the location of labels put on some parts and describes the coding information for serial number, property data, and manufacturing information.

### Appendix 2 Firmware Installation

Provides instructions on how to change firmware stored in the flash ROM on the main PCB or load firmware to a new main PCB from the host PC.

### Appendix 3 EEPROM Customizing Codes

Provides instructions on how to set up the EEPROM customizing codes for the various preferences exclusively designed for each destination. The specified customizing code is stored in the EEPROM mounted on the main PCB. If the main PCB is replaced, therefore, you need to set up the proper customizing code with the machine in the maintenance mode.

Customizing codes customize firmware for individual models, enabling the common firmware to be used for various models.

### Appendix 4 Firmware Switches (WSW)

Describes the functions of the firmware switches, which can be divided into two groups: one is for customizing preferences designed for the shipping destination (as described in [Appendix 3](#)) and the other is for modifying preferences that match the machine to the environmental conditions. Use the latter group if the machine malfunctions due to mismatching.

### Appendix 5 Wiring Diagrams

Provides the wiring diagrams that help you understand the connections between PCBs.

### Appendix 6 Circuit Diagrams

Provides the circuit diagrams of the MJ PCB and power supply PCB.

### Appendix 7 Deletion of Personal Information







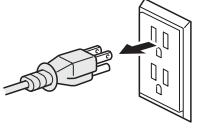

Provides instructions on how to delete personal information recorded in the machine and cordless handset(s).

## SAFETY PRECAUTIONS

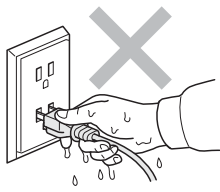
### To use the machine safely

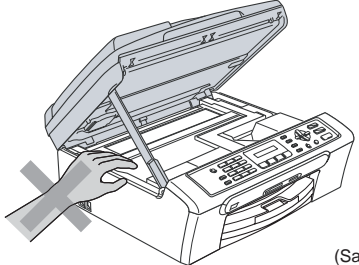
Please refer to these instructions for later reference and before attempting any maintenance.

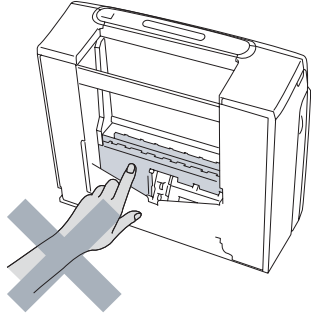
### **WARNING**

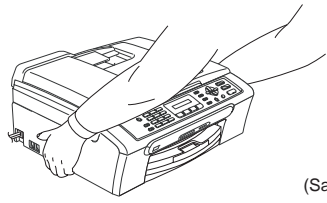
	<p>There are high voltage electrodes inside the machine. Before you clean the machine, make sure you have unplugged the telephone line cord first and then the power cord from the AC power outlet.</p> <div style="text-align: center;">  <p>(Safety_1)</p> </div>		<p>Do not handle the plug with wet hands. Doing this might cause an electrical shock.</p> <div style="text-align: center;">  <p>(Safety_2)</p> </div>
	<p>To prevent injuries, be careful not to put your hands on the edge of the machine under the scanner cover.</p> <div style="text-align: center;">  <p>(Safety_3_MFC)</p> </div>		<p>To prevent injuries, be careful not to touch the area shaded in the illustration.</p> <div style="text-align: center;">  <p>(Safety_4)</p> </div>
	<p>When moving the machine you must lift it from the base, by placing a hand at each side of the unit as shown in the illustration. Do NOT carry the machine by holding the scanner cover.</p> <div style="text-align: right; margin-top: 20px;">  <p>(Safety_5_MFC)</p> </div>		

**⚠ WARNING**

- Use caution when installing or modifying telephone lines. Never touch telephone wires or terminals that are not insulated unless the telephone line has been disconnected at the wall jack. Never install telephone wiring during a lightning storm. Never install a telephone wall jack in a wet location.
- This product must be installed near an AC power outlet that is easily accessible. In case of emergencies, you must disconnect the power cord from the AC power outlet in order to shut off power completely.
- To reduce the risk of shock or fire, use only a No. 26 AWG or larger telecommunication line cord.

**! Caution**

- Lightning and power surges can damage this product! We recommend that you use a quality surge protection device on the AC power line and on the telephone line, or unplug the cords during a lightning storm.
- When lifting up the machine, hold it from the base. Do not hold the scanner cover (scanner unit); doing so causes the machine body to be inclined, which may disengage the scanner cover from the machine body and lead to falling of the machine body.

<b>⚠</b>	<b>IMPORTANT SAFETY INSTRUCTIONS</b>
	<p>When using the machine, basic safety precautions should always be followed to reduce the risk of fire, electric shock and injury to persons, including the following:</p> <ol style="list-style-type: none"><li>1. Do not use this product near water, for example, near a bath tub, wash bowl, kitchen sink or washing machine, in a wet basement or near a swimming pool.</li><li>2. Avoid using this product during a lightning storm. There may be a remote risk of electric shock from lightning.</li><li>3. Do not use this product to report a gas leak in the vicinity of the leak.</li><li>4. Use only the power cord provided with the machine.</li></ol> <p>SAVE THESE INSTRUCTIONS</p>

## Choosing a location

Place the machine on a flat, stable surface that is free of vibration and shocks, such as a desk. Put the machine near a telephone wall jack and a standard, grounded AC power outlet. Choose a location where the temperature remains between 50°F and 95°F (10°C and 35°C).

### ! Caution

- Avoid placing the machine in a high-traffic area.
- Avoid placing the machine on the carpet.
- Do not place the machine near heaters, air conditioners, water, chemicals, or refrigerators.
- Do not expose the machine to direct sunlight, excessive heat, moisture, or dust.
- Do not connect the machine to electrical outlets controlled by wall switches or automatic timers.
- Disruption of power can wipe out information in the machine's memory.
- Do not connect the machine to electrical outlets on the same circuit as large appliances or other equipment that might disrupt the power supply.
- Avoid interference sources, such as speakers or the base units of cordless phones.

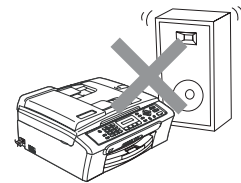
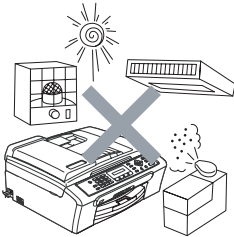

(Location\_MFC)

### Legal limitations for copying

Color reproductions of certain documents are illegal and may result in either criminal or civil liability. This memorandum is intended to be a guide rather than a complete listing of every possible prohibition. In case of doubt, we suggest that you check with relevant authorities as to any particular questionable documents.

The following are examples of documents which should not be copied:

- Money
- Bonds or other certificates of indebtedness
- Certificates of Deposit
- Armed Forces Service or Draft papers.
- Passports
- Postage Stamps (cancelled or uncanceled)
- Immigration Papers
- Welfare documents
- Cheques or Drafts drawn by Governmental Agencies
- Identification Documents, badges or insignias
- Licences and Certificates of Title to motor vehicles

Copyrighted works cannot be copied. Sections of a copyrighted work can be copied for 'fair use'. Multiple copies would indicate improper use.

Works of art should be considered the equivalent of copyrighted works.

Licenses and Certificates of Title to motor vehicles may not be copied under certain state/provincial laws.

# CHAPTER 1

## PARTS NAMES AND FUNCTIONS

**SAMPLE PAGE ONLY**  
 ServiceManual-Ebook.com

*Confidential*

**SAMPLE PAGE ONLY**  
 ServiceManual-Ebook.com



## CHAPTER 1 PARTS NAMES AND FUNCTIONS

This chapter contains external views and names of components and describes their functions. Information about the keys on the control panel is included to help you check operation or make adjustments.

### CONTENTS

1.1	OUTLINE .....	1-1
1.2	CONTROL PANEL.....	1-4
1.3	COMPONENTS .....	1-17

# 1.1 OUTLINE

## ■ Fax machine

### Front view

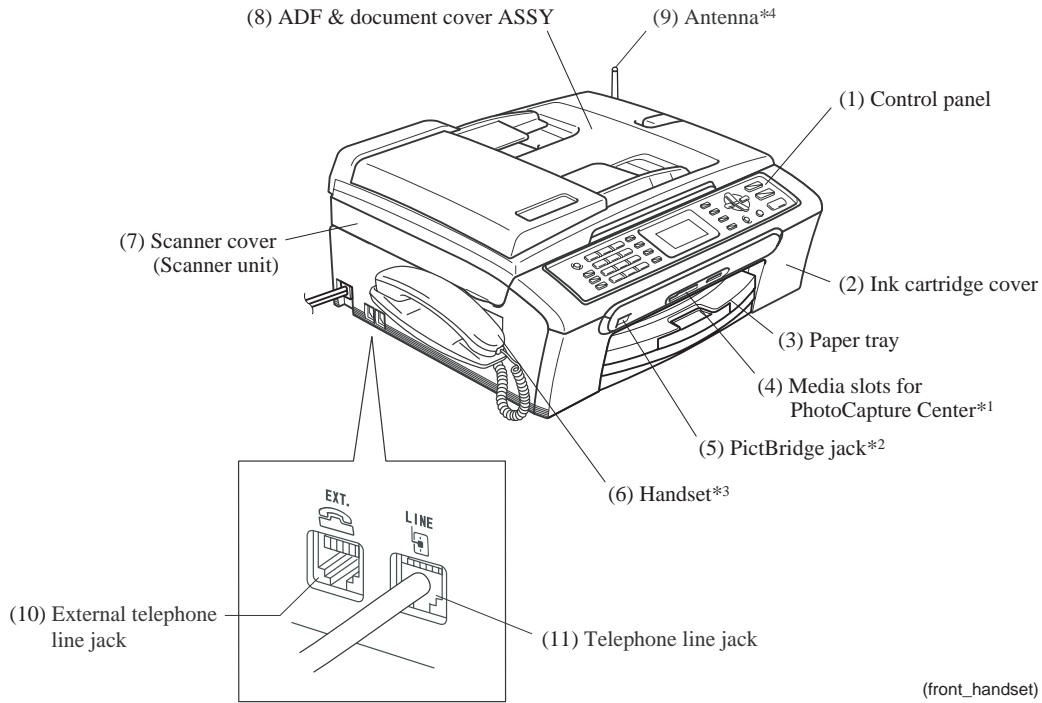

### Back view

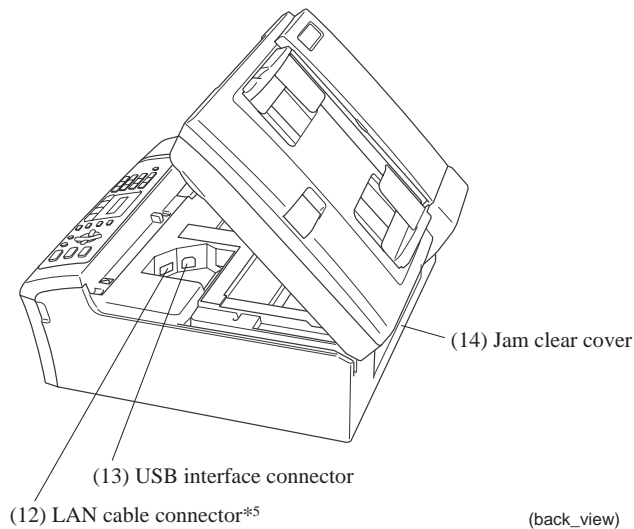

\*1 For models with PhotoCapture Center

\*2 For PictBridge-enabled models

\*3 For models with handset

\*4 For models with cordless handset

\*5 For wired LAN-enabled models



## FACSIMILE EQUIPMENT PARTS REFERENCE LIST

**MODEL: DCP130C / DCP330C  
DCP540CN / DCP750CW  
FAX2480C / FAX2580C  
MFC240C / MFC440CN  
MFC660CN / MFC665CW  
MFC845CW**

© Copyright Brother 2006

All rights reserved

No part of this publication may be reproduced in any form  
or by any means without permission in writing from the  
publisher.

Specifications are subject to change without prior notice.

SAMPLE PAGE ONLY

ServiceManual-Ebook.com

# CONTENTS

1.	<u>ADF</u> .....	1
2.	<u>SCANNER</u> .....	3
3.	<u>ENGINE</u> .....	5
4.	<u>CARTRIDGE CASE</u> .....	7
5.	<u>HEAD</u> .....	9
6.	<u>PAPER TRAY</u> .....	11
7.	<u>COVER</u> .....	13
8.	<u>PANEL1</u> .....	15
	<u>PANEL2</u> .....	16
	<u>PANEL3</u> .....	17
9.	<u>PCB</u> .....	24
10.	<u>ACCESSORIES</u> .....	26
11.	<u>PRINTED MATERIALS</u> .....	30
12.	<u>PACKAGING</u> .....	34
13.	<u>OTHERS</u> .....	40

1 ADF

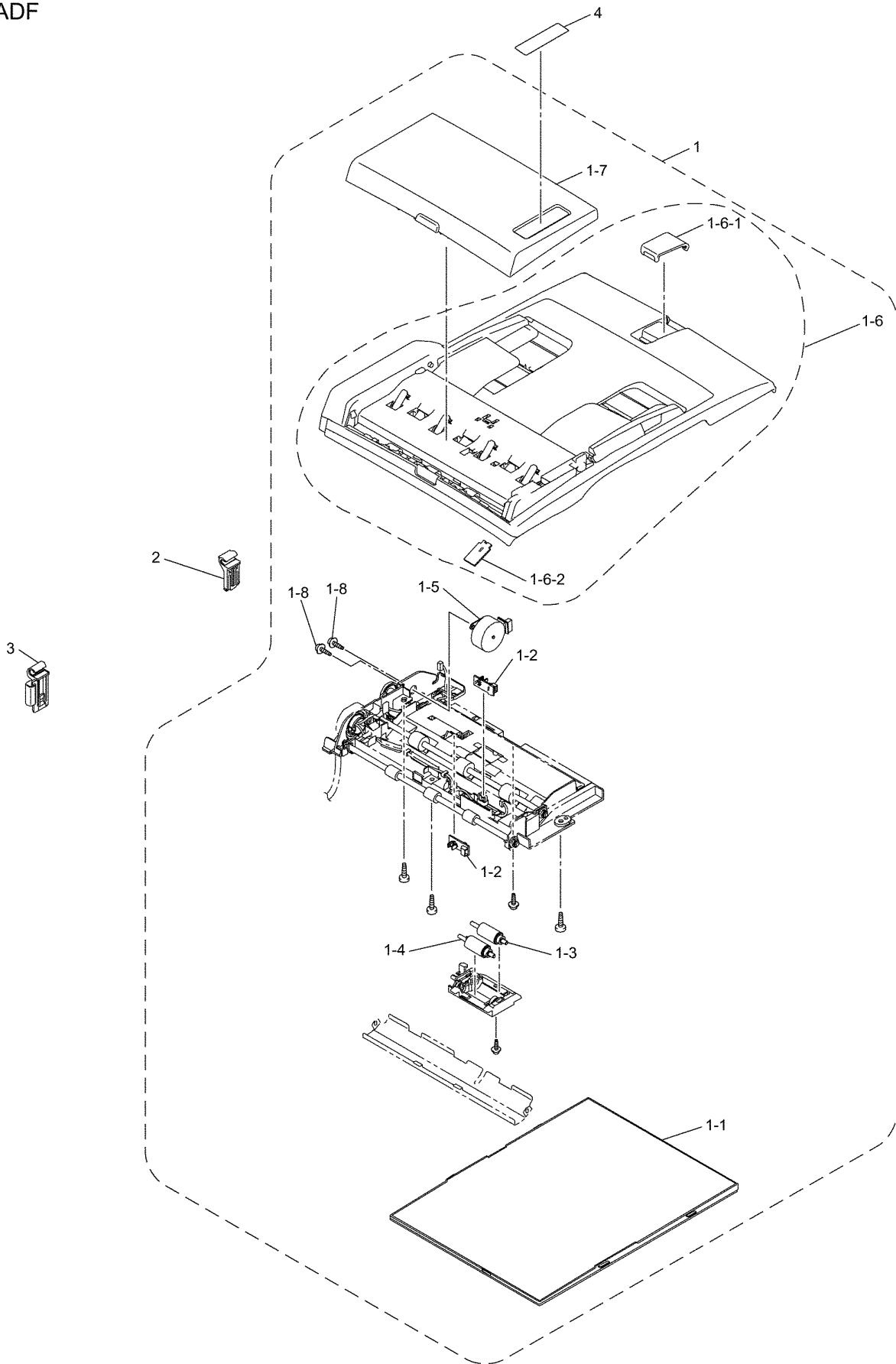



**FACSIMILE EQUIPMENT  
PARTS REFERENCE LIST**

**MODEL: DCP130C / DCP330C  
DCP540CN / DCP750CW  
FAX2480C / FAX2580C  
MFC230C / MFC240C  
MFC240CE / MFC440CN  
MFC660CN / MFC665CW  
MFC665CWE / MFC845CW**

© Copyright Brother 2006

All rights reserved

No part of this publication may be reproduced in any form  
or by any means without permission in writing from the  
publisher.

**SAMPLE PAGE ONLY**

 ServiceManual-Ebook.com

# CONTENTS

1.	<u>ADF</u> .....	1
2.	<u>SCANNER</u> .....	3
3.	<u>ENGINE</u> .....	5
4.	<u>CARTRIDGE CASE</u> .....	7
5.	<u>HEAD</u> .....	9
6.	<u>PAPER TRAY</u> .....	11
7.	<u>COVER</u> .....	13
8.	<u>PANEL1</u> .....	16
	<u>PANEL2</u> .....	17
	<u>PANEL3</u> .....	18
9.	<u>PCB</u> .....	25
10.	<u>ACCESSORIES</u> .....	27
11.	<u>PRINTED MATERIALS</u> .....	31
12.	<u>PACKAGING</u> .....	35
13.	<u>OTHERS</u> .....	41

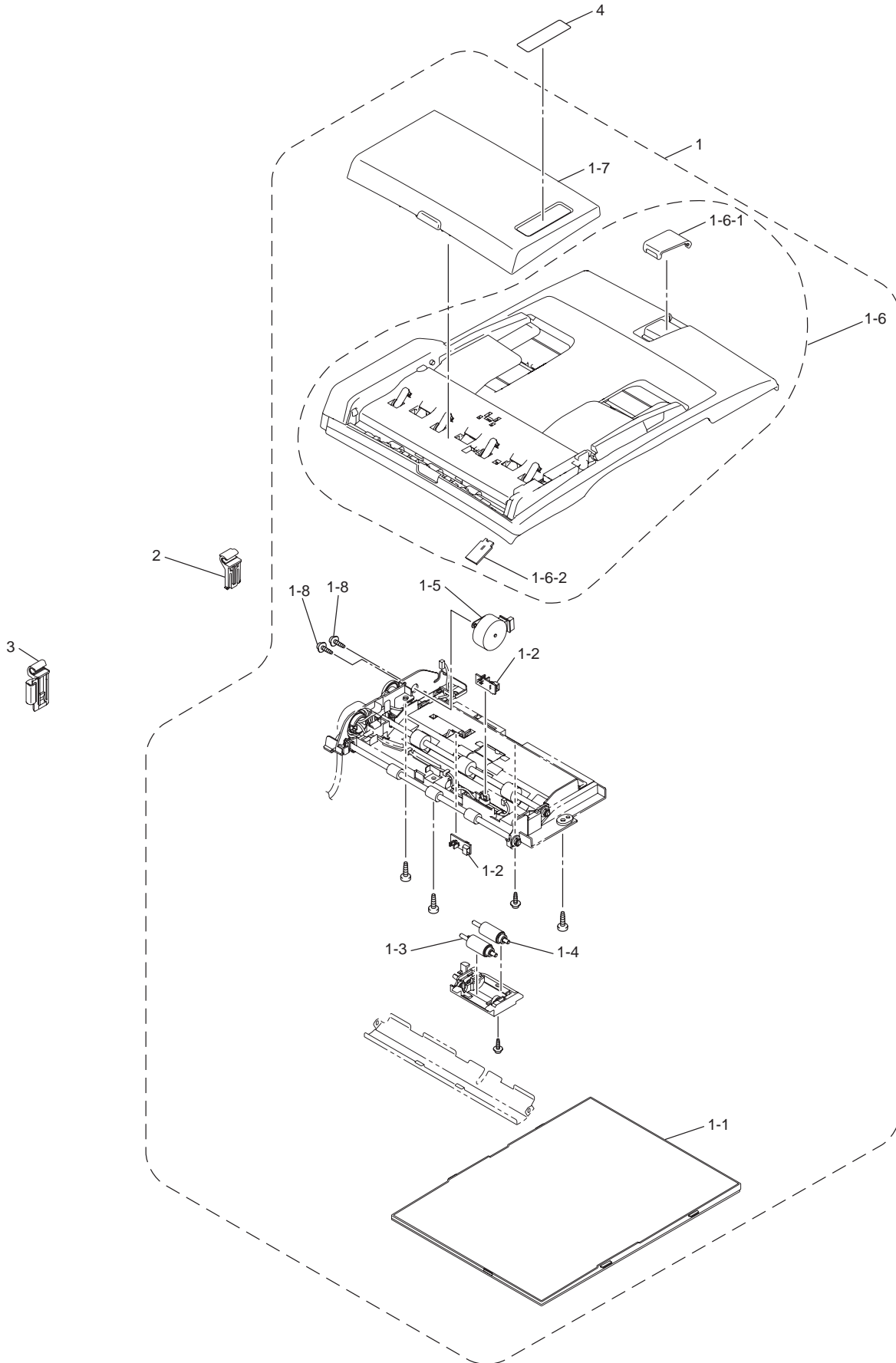





# SERVICE MANUAL E-BOOK

<http://www.servicemanual-ebook.com>

- EN - Thank you for downloading these sample pages.  
To obtain the complete manual please click below:  
[Brother FAX-2580C 2480C MFC- 240C 440CN 660CN 845CW 665CW Service Manual](#)
- DE - Dankeschön für das Herunterladen dieser Musterseiten.  
Zum Download der kompletten Anleitung klicken Sie bitte unten:  
[Brother FAX-2580C 2480C MFC- 240C 440CN 660CN 845CW 665CW Service Manual](#)
- ES - Gracias por descargar estas páginas de muestra.  
Para descargar el manual completo, por favor haga clic a continuación:  
[Brother FAX-2580C 2480C MFC- 240C 440CN 660CN 845CW 665CW Service Manual](#)
- FR - Merci d'avoir téléchargé ces pages échantillon.  
Pour télécharger le manuel complet s'il vous plaît cliquez ci-dessous:  
[Brother FAX-2580C 2480C MFC- 240C 440CN 660CN 845CW 665CW Service Manual](#)
- IT - Grazie per aver scaricato queste pagine di esempio.  
Per scaricare il manuale completo clicca qui sotto:  
[Brother FAX-2580C 2480C MFC- 240C 440CN 660CN 845CW 665CW Service Manual](#)
- NL - Bedankt voor het downloaden van deze sample pagina's.  
Voor het downloaden van de volledige handleiding kunt u hieronder klikken:  
[Brother FAX-2580C 2480C MFC- 240C 440CN 660CN 845CW 665CW Service Manual](#)
- PL - Dziękujemy za pobranie tych przykładowych stron.  
Aby pobrać kompletny podręcznik proszę kliknąć poniżej:  
[Brother FAX-2580C 2480C MFC- 240C 440CN 660CN 845CW 665CW Service Manual](#)
- PT - Obrigado por carregar essas páginas de amostra.  
Para obter o manual completo clique abaixo:  
[Brother FAX-2580C 2480C MFC- 240C 440CN 660CN 845CW 665CW Service Manual](#)
- RU - Благодарим Вас за загрузку этих образцов страниц.  
Чтобы получить полное руководство, пожалуйста, нажмите ниже:  
[Brother FAX-2580C 2480C MFC- 240C 440CN 660CN 845CW 665CW Service Manual](#)

