

Before you can use the machine, read this Quick Setup Guide for the correct setup and installation.

! WARNING

Warnings tell you what to do to prevent possible personal injury.

Important

DO NOT connect the USB cable yet (if you are using a USB cable).



1

Unpack the machine and check the components

		<p>Black Yellow Cyan Magenta</p> <p>Starter Ink Cartridges [x4]</p>	<p>Quick Setup Guide</p>
<p>User's Guide</p>	<p>CD-ROM</p>	<p>Accessory Order Form</p>	<p>Test Sheet (USA only)</p>
		<p>Telephone Line Cord</p>	

! WARNING

Plastic bags are used in the packaging of your machine. To avoid danger of suffocation, please keep these bags away from babies and children.

- a** Remove the protective tape and film covering the scanner glass.
- b** Remove the green protective packing **1** by lifting the front of the machine and then pulling down on the packing part.
- c** Remove the plastic bag **2** containing the ink cartridges from on top of the paper tray.
- d** Make sure you have all components.

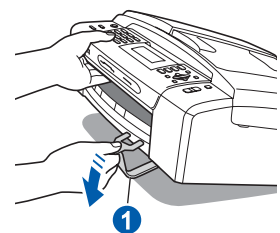

Note

- The components included in the box may differ depending on your country.
- Save all packing materials and the box in case for any reason you must ship your machine.
- You need to purchase the correct interface cable for the interface you want to use (for USB or network connection).

USB cable

Please make sure you use a USB 2.0 cable (Type A/B) that is no more than 6 feet (2 meters) long.

Network cable

Use a straight-through Category5 (or greater) twisted-pair cable for 10BASE-T or 100BASE-TX Fast Ethernet Network.

2 Load plain Letter/A4 paper

- a** Pull the paper tray **1** completely out of the machine.

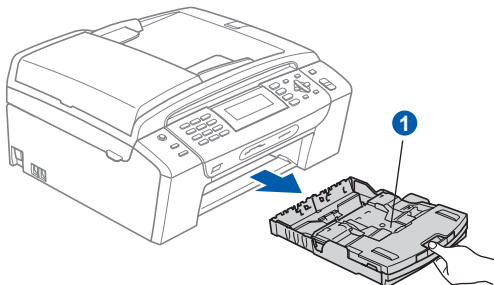

- b** Open the paper tray cover **1**.

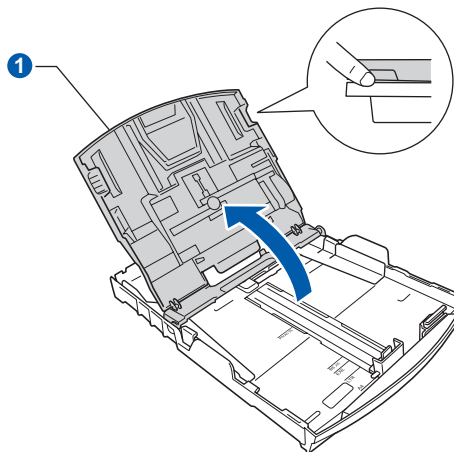

- c** With both hands, gently press and slide the paper side guides **1** and then the paper length guide **2** to fit the paper size.

Make sure that the triangular marks **3** on the paper side guides **1** and paper length guide **2** line up with the mark for the paper size you are using.

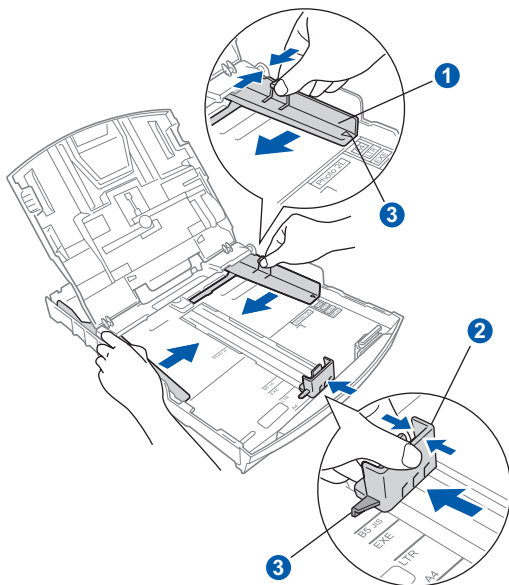

- d** Fan the stack of paper well to avoid paper jams and misfeeds.

- e** Gently put the paper into the paper tray print side down and top edge first. Check that the paper is flat in the tray.

Important

Do not push the paper in too far.

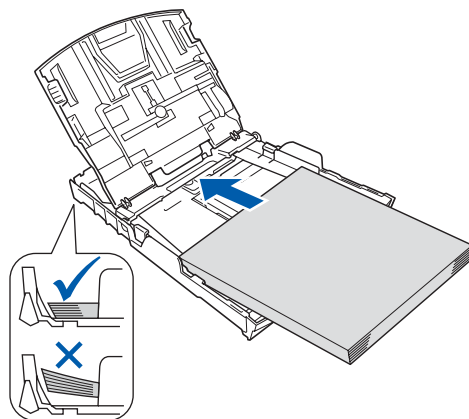

Note

When you use Legal size paper, press and hold the universal guide release button **1** as you slide out the front of the paper tray.

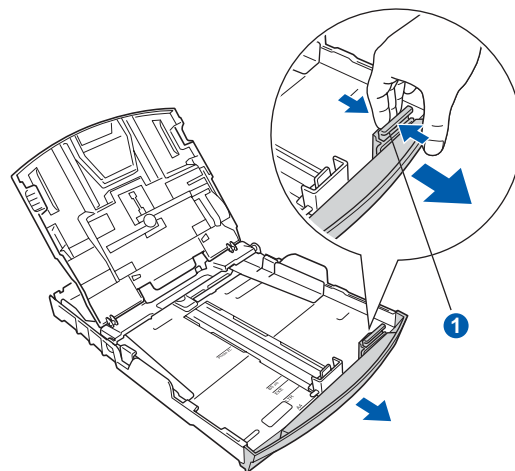

- f** Gently adjust the paper side guides to the paper with both hands. Make sure that the paper side guides touch the edges of the paper.

g Close the paper tray cover ①.

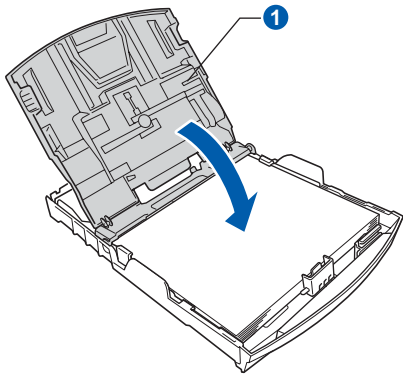

h Slowly push the paper tray completely into the machine.

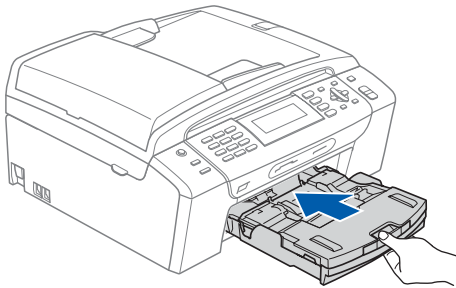

i While holding the paper tray in place, pull out the paper support ① until it clicks, and then unfold the paper support flap ②.

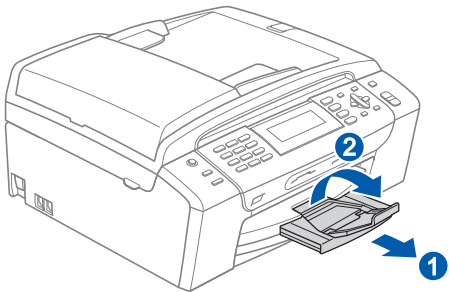

3

Connect the power cord and telephone line

Important

DO NOT connect the USB cable yet (if you are using a USB cable).

- a** Connect the power cord.

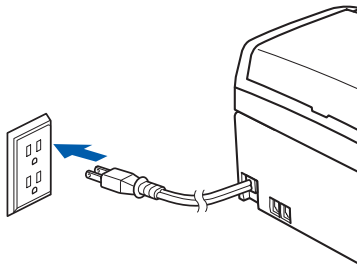

- b** Connect the telephone line cord. Connect one end of the telephone line cord to the jack on the machine marked **LINE** and the other end to a modular wall jack.

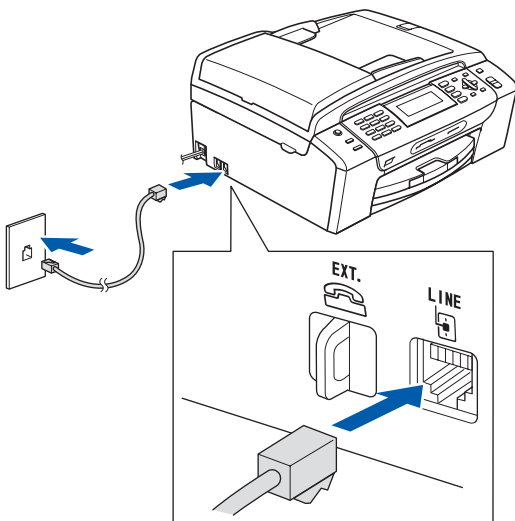

Important

The telephone line cord **MUST** be connected to the jack on the machine marked **LINE**.

Note

If you are sharing one telephone line with an external telephone, connect it as shown below. Before you connect the external telephone, remove the protective cap 1 from the **EXT.** jack on the machine.

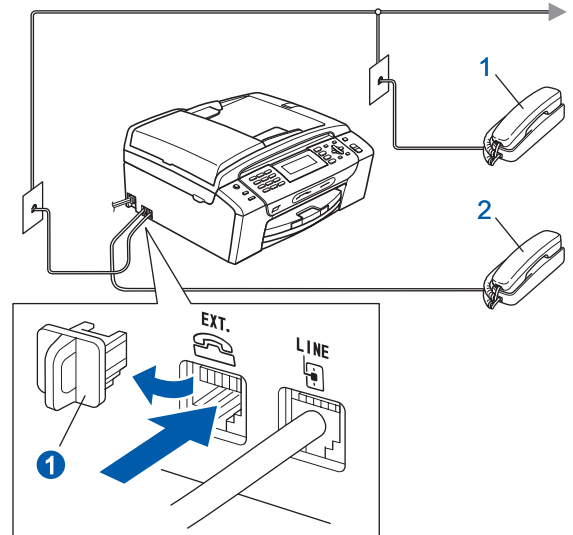

- 1 Extension telephone
- 2 External telephone

Note

If you are sharing one telephone line with an external telephone answering machine, connect it as shown below. Before you connect the external telephone answering machine, remove the protective cap 1 from the **EXT.** jack on the machine.

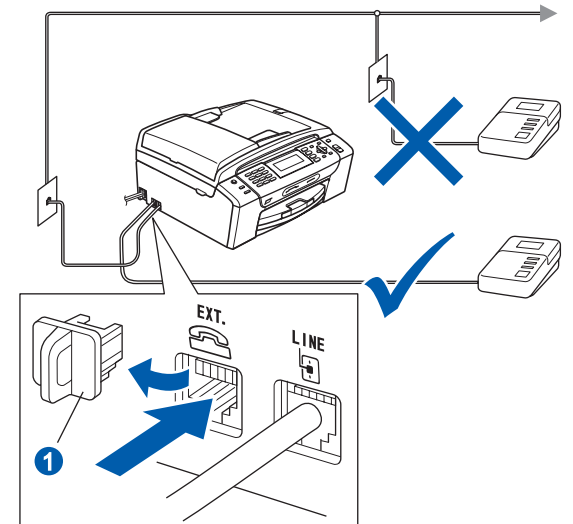

Set the receive mode to *External TAD* if you have an external answering machine. See *Choose the correct Receive Mode* on page 8. For additional details, see *Connecting an external TAD (telephone answering device)* in Chapter 7 of the User's Guide.

4 Install the ink cartridges

! WARNING

If ink gets in your eyes, wash them out with water at once, and if irritation occurs consult a doctor.

- a** Make sure that the power is turned on. The LCD shows:

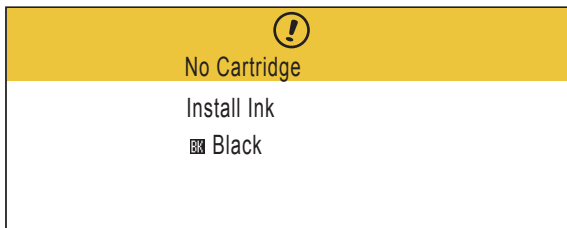

- b** Open the ink cartridge cover 1.

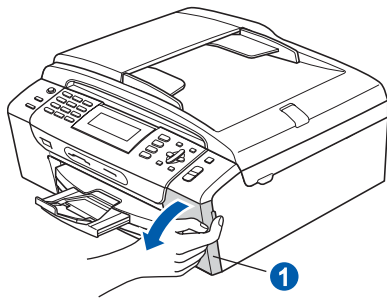

- c** Remove the green protective part 1.

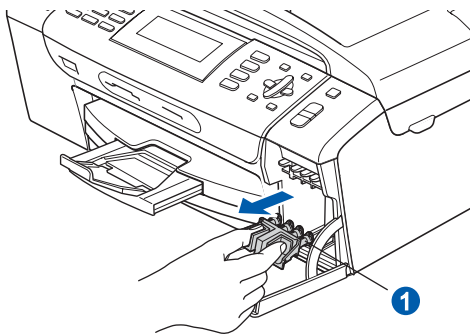

Note

Do not throw away the green protective part. You will need it if you transport the machine.

- d** Unpack the ink cartridge.

- e** Turn the green knob on the protective yellow cap clockwise until it clicks to release the vacuum seal, then remove the cap 1.

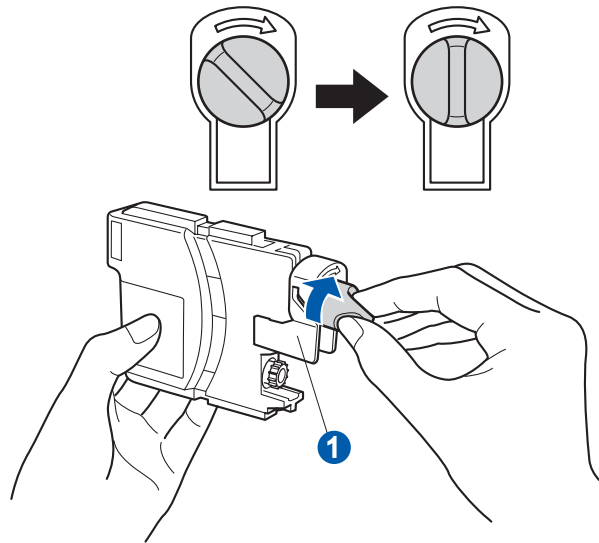

- f** Take care to match the color of the lever 1 with the cartridge color 2, as shown in the diagram below.

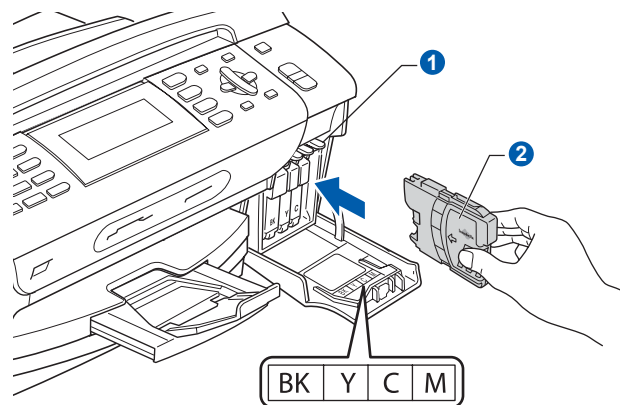

- g** Install each ink cartridge in the direction of the arrow on the label.

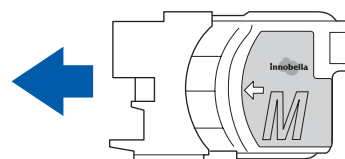

- h** Gently push the ink cartridge until it clicks. After all the ink cartridges are installed close the ink cartridge cover.

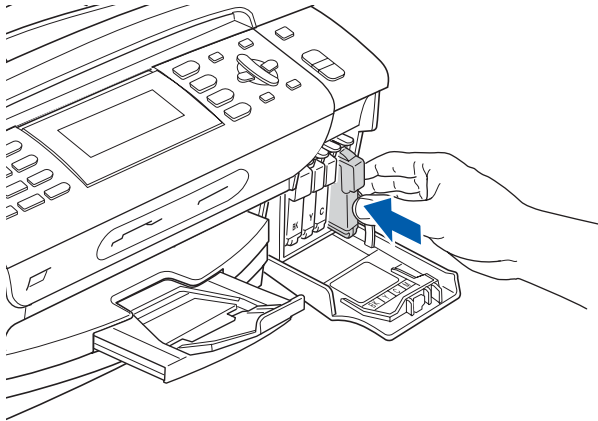

 **Note**

The machine will prepare the ink tube system for printing. This process will take approximately four minutes. Do not turn off the machine.

Important

- **DO NOT** take out ink cartridges if you do not need to replace them. If you do so, it may reduce the ink quantity and the machine will not know the quantity of ink left in the cartridge.
- **DO NOT** shake the ink cartridges. If ink stains your skin or clothing, wash with soap or detergent at once.
- **DO NOT** repeatedly insert and remove the cartridges. If you do so, ink may seep out of the cartridge.
- If you mix the colors by installing an ink cartridge in the wrong position, clean the print head several times after correcting the cartridge installation. (See *Cleaning the print head in Appendix B of the User's Guide.*)
- Once you open an ink cartridge, install it in the machine and use it up within six months of installation. Use unopened ink cartridges by the expiration date written on the cartridge package.
- **DO NOT** dismantle or tamper with the ink cartridge, this can cause the ink to leak out of the cartridge.
- Brother strongly recommends that you do not refill the ink cartridges provided with your machine. We also strongly recommend that you continue to use only Genuine Brother Brand replacement ink cartridges. Using or attempting to use potentially incompatible inks and/or cartridges in your machine may cause damage to the machine itself and/or it may result in unsatisfactory print quality. Our warranty coverage does not apply to any problem that was caused by the use of unauthorized third party ink and/or cartridges. To protect your investment and guarantee your print quality please continue to replace consumed ink cartridges with only Genuine Brother Branded Supplies.

5 Check the print quality

- a** When the preparation process has finished, the LCD shows this message

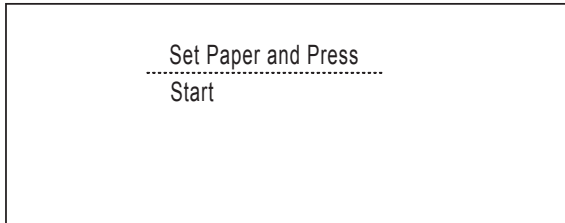

Press **Color Start**.

- b** Check the quality of the four color blocks **1** on the sheet. (black/yellow/cyan/magenta)

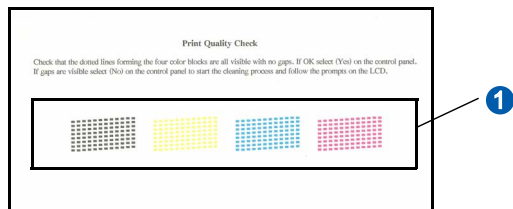

- c** If all lines are clear and visible, press **1** (Yes) on the dial pad to finish the quality check.

OK

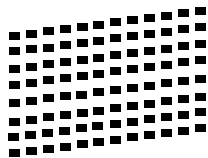

If you can see missing short lines, press **2** (No) on the dial pad and go to **d**.

Poor

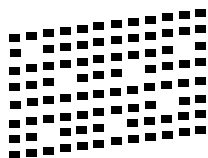

- d** The LCD asks you if the print quality is OK for black and color. Press **1** (Yes) or **2** (No) on the dial pad.

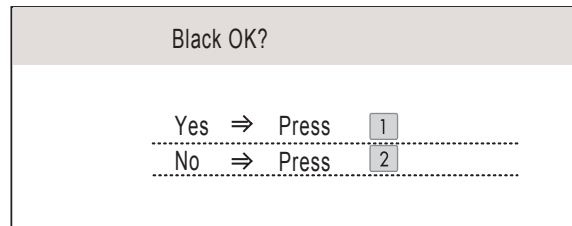

After pressing **1** (Yes) or **2** (No) for both black and color, the LCD shows:

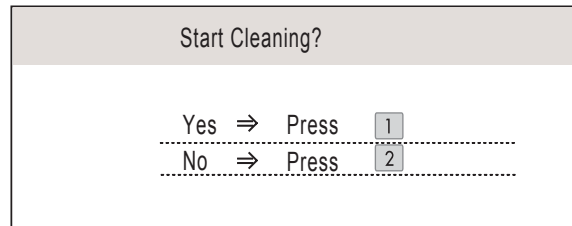

- e** Press **1** (Yes), the machine will then start cleaning the colors.

- f** After cleaning is finished, press **Color Start**. The machine starts printing the Print Quality Check Sheet again. Go back to **b**.

6 Choose your language (If needed)

- a** Press **Menu**.

- b** Press **▲** or **▼** to choose **Initial Setup**. Press **OK**.

- c** Press **▲** or **▼** to choose **Local Language**. Press **OK**.

- d** Press **▲** or **▼** to choose your language. Press **OK**.

- e** Press **Stop/Exit**.

7

Choose the correct Receive Mode

The correct Receive Mode is determined by the external devices and telephone subscriber services (Voice Mail, Distinctive Ring, etc.) you have (or will be using) on the same line as the Brother machine.

Will you be using a Distinctive Ring number for receiving faxes?

Brother uses the term "Distinctive Ring" but telephone companies may have other names for this service such as Custom Ringing, RingMaster, Personalized Ring, Teen Ring, Ident-A-Call, and Smart Ring. See Distinctive Ring in Chapter 7 of the User's Guide for instruction on setting up your machine using this feature.

Will you be using Voicemail on the same telephone line as your Brother machine?

If you have Voice Mail on the same telephone line as your Brother machine, there is a strong possibility that Voice Mail and the Brother machine will conflict with each other when receiving incoming calls. See Voice Mail in Chapter 7 of the User's Guide for instructions on setting up your machine using this service.

Will you be using a Telephone Answering Device on the same telephone line as your Brother machine?

Your external telephone answering device (TAD) will automatically answer every call. Voice messages are stored on the external TAD and fax messages are printed. Choose `External TAD` as your receive mode. See the instructions below.

Will you be using your Brother machine on a dedicated fax line?

Your machine automatically answers every call as a fax. Choose `Fax Only` as your receive mode. See the instructions below.

Will you be using your Brother machine on the same line as your telephone?

Do you want to receive voice calls and faxes automatically?

The `Fax/Tel` receive mode is used when sharing the Brother machine and your telephone on the same line. Choose `Fax/Tel` as your receive mode. See the instructions below.

Important Note: You cannot receive voice messages on either Voice Mail or an answering machine when choosing the `Fax/Tel` mode.

Do you expect to receive very few faxes?

Choose `Manual` as your receive mode. You control the phone line and must answer every call yourself. See the instructions below.



For details, see Using receive modes in Chapter 6 of the User's Guide.

- a** Press **Menu**.
- b** Press **▲** or **▼** to choose `Initial Setup`. Press **OK**.
- c** Press **▲** or **▼** to choose `Receive Mode`.
- d** Press **◀** or **▶** to choose the receive mode. Press **OK**.
- e** Press **Stop/Exit**.

8

Set the LCD contrast (If needed)

If you are having difficulty reading the LCD, try changing the contrast setting.

- a** Press **Menu**.
- b** Press **▲** or **▼** to choose **General Setup**. Press **OK**.
- c** Press **▲** or **▼** to choose **LCD Settings**. Press **OK**.
- d** Press **▲** or **▼** to choose **LCD Contrast**.
- e** Press **◀** or **▶** to choose **Light, Med** or **Dark**. Press **OK**.
- f** Press **Stop/Exit**.



Note

You can also adjust the angle of the display by lifting it.

9

Set the date and time

The machine displays the time, and if you set up the station ID the date and time will be added to each fax you send.

- a** Press **Menu**.
- b** Press **▲** or **▼** to choose **Initial Setup**. Press **OK**.
- c** Press **▲** or **▼** to choose **Date&Time**. Press **OK**.

- d** Enter the last two digits of the year on the dial pad, and then press **OK**.

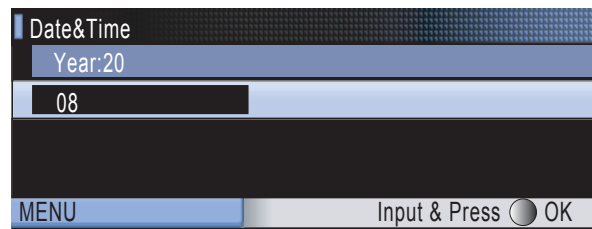

(e.g. Enter **08** for 2008.)

- e** Enter the two digits for the month on the dial pad, and then press **OK**.

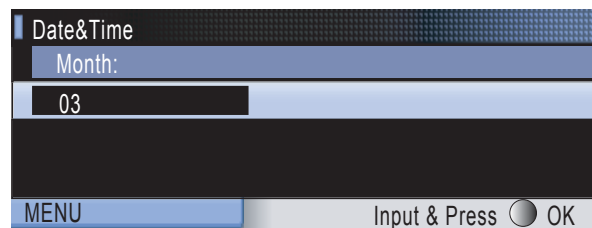

(e.g. Enter **03** for March.)

- f** Enter the two digits for the day on the dial pad, and then press **OK**.

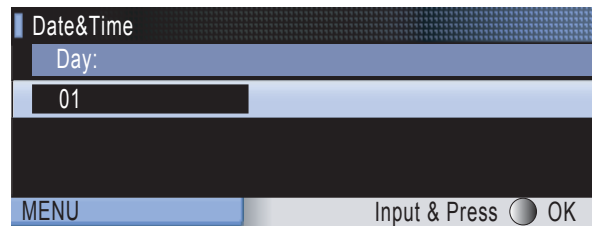

(e.g. Enter **01** for the first day of the month.)

- g** Enter the time in 24-hour format on the dial pad, and then press **OK**.

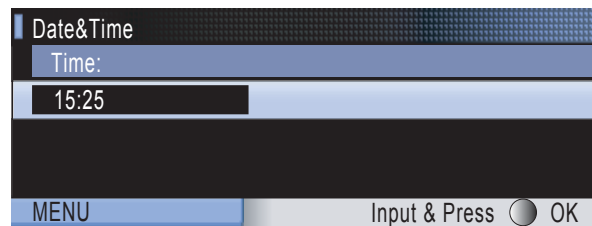

(e.g. Enter **15, 25** for 3:25 P.M.)

- h** Press **Stop/Exit**.



To confirm the current date and time, print out the **User Settings report**. (See **Printing Reports** in Chapter 9 of the *User's Guide*.)

10 Set your station ID

You should store your name and fax number to be printed on all fax pages that you send.

- a** Press **Menu**.
- b** Press **▲** or **▼** to choose **Initial Setup**. Press **OK**.
- c** Press **▲** or **▼** to choose **Station ID**. Press **OK**.
- d** Enter your fax number (up to 20 digits) on the dial pad, and then press **OK**.
- e** Enter your name (up to 20 characters) using the dial pad, and then press **OK**.



Note

- See the following chart for entering your name.
- If you need to enter a character that is on the same key as the last character, press **▶** to move the cursor to the right.
- If you entered a letter incorrectly and want to change it, press **◀** or **▶** to move the cursor to the incorrect character, press **Clear/Back**.

Press key	One time	Two times	Three times	Four times
2	A	B	C	2
3	D	E	F	3
4	G	H	I	4
5	J	K	L	5
6	M	N	O	6
7	P	Q	R	S
8	T	U	V	8
9	W	X	Y	Z



Press **Stop/Exit**.



Note

If you make a mistake and want to start again, press **Stop/Exit** and go back to **a**.



For details, see *Entering Text* in Appendix C of the User's Guide.



Note

(USA only)

The Telephone Consumer Protection Act of 1991 makes it unlawful for any person to use a computer or electronic device to send any message via a telephone fax machine unless such messages clearly contain, in a margin at the top or bottom of each transmitted page, or on the first page of the transmission, the date and time it is sent and an identification of the business or other entity or other individual sending the message and the telephone number of the sending machines or such business, other entity or individual.

11

Set tone or pulse dialing mode

Your machine comes set for Tone dialing service. If you have Pulse dialing service (rotary), you need to change the dialing mode.

- a** Press **Menu**.
- b** Press **▲** or **▼** to choose `Initial Setup`. Press **OK**.
- c** Press **▲** or **▼** to choose `Tone/Pulse`.
- d** Press **◀** or **▶** to choose `Pulse (or Tone)`. Press **OK**.
- e** Press **Stop/Exit**.

12

Automatic Daylight Savings Time

You can set the machine to change automatically for daylight savings time. It will reset itself forward one hour in the Spring and backward one hour in the Fall.

- a** Press **Menu**.
- b** Press **▲** or **▼** to choose `General Setup`. Press **OK**.
- c** Press **▲** or **▼** to choose `Auto Daylight`.
- d** Press **◀** or **▶** to choose `On (or Off)`. Press **OK**.
- e** Press **Stop/Exit**.

13 Send in the Product Registration and Test Sheet (USA only)

You can also register your product online using the On-Line Registration link from the installation CD-ROM or visit <http://www.brother.com/registration/>.

a Fill out the Product Registration and Test Sheet.

b Put the sheet face down in the ADF (Automatic Document Feeder) or face down on the scanner glass.

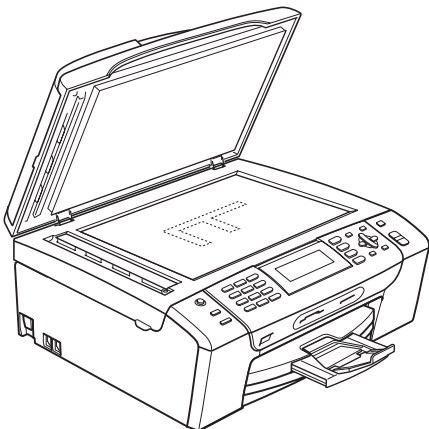
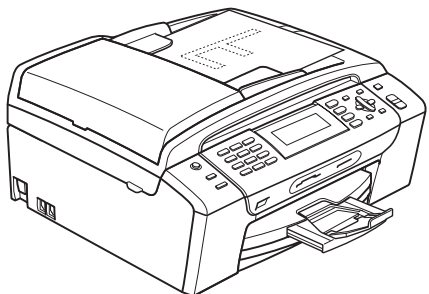

c Make sure  (**Fax**) is illuminated in Blue.

d Enter the toll-free fax number: 1-877-268-9575.

e Press **Black Start**.

 **Note**

You will receive a confirmation fax of your Product Registration.

14

Choose your connection type

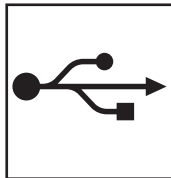
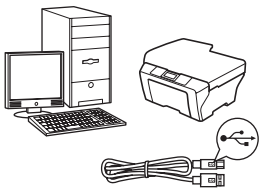

For USB interface cable

Windows[®], go to page 14
Macintosh[®], go to page 18

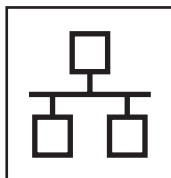
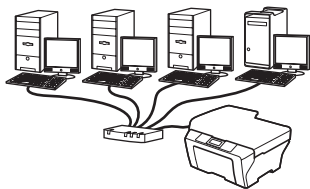

For Wired Network

Windows[®], go to page 21
Macintosh[®], go to page 26

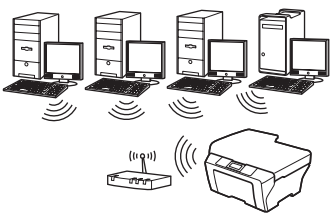

For Wireless Network

Windows[®] and Macintosh[®],
go to page 29

Windows[®]
USB

Macintosh[®]

Windows[®]
Wired Network

Macintosh[®]

Wireless Network



For USB Interface Users (For Windows® 2000 Professional/XP/ XP Professional x64 Edition/ Windows Vista®)

15 Before you install

a Make sure that your computer is ON and you are logged on with Administrator rights.

Important

- **DO NOT connect the USB cable yet.**
- **If there are any programs running, close them.**
- **Make sure there are no memory cards or a USB Flash memory drive inserted.**
- **The screen may differ depending on the operating system.**
- **The supplied CD-ROM includes ScanSoft™ PaperPort™ 11SE. This software supports Windows® 2000 (SP4 or greater), XP (SP2 or greater), XP Professional x64 Edition and Windows Vista®. Update to the latest Windows® Service Pack before installing MFL-Pro Suite.**

b Unplug the machine from the AC outlet and from your computer, if you already connected an interface cable.

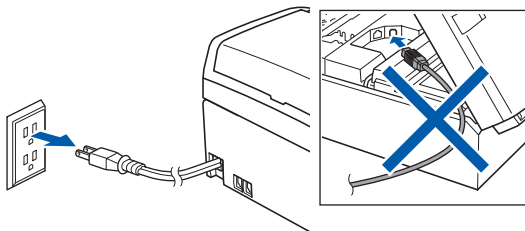

16 Install MFL-Pro Suite

a Put the supplied CD-ROM into your CD-ROM drive. If the model name screen appears, choose your machine. If the language screen appears, choose your language.

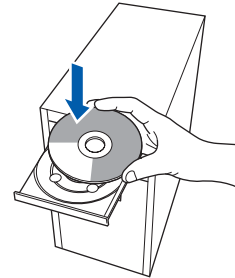

Note

*If the Brother screen does not appear automatically, go to **My Computer (Computer)**, double-click the CD-ROM icon, and then double-click **start.exe**.*

b The CD-ROM main menu will appear. Click **Install MFL-Pro Suite**.

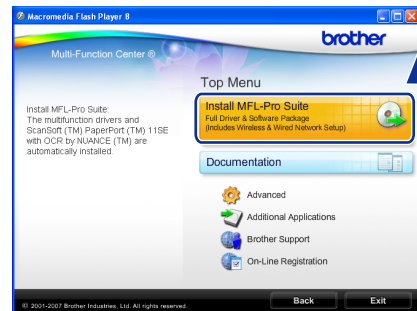



Note

- If this screen appears, click **OK** and restart your computer.

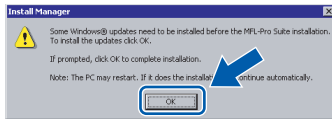

- If the installation does not continue automatically, open the main menu again by ejecting and then reinserting the CD-ROM or double-click the **start.exe** program from the root folder, and continue from **b** to install MFL-Pro Suite.
- For Windows Vista®, when the **User Account Control** screen appears, click **Allow**.

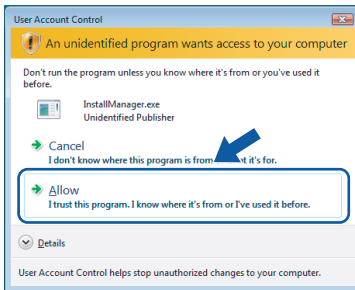

- When the ScanSoft™ PaperPort™ 11SE **License Agreement** window appears, click **Yes** if you agree to the Software **License Agreement**.

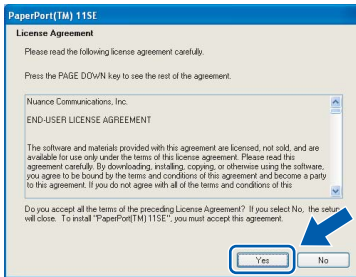

- The installation of ScanSoft™ PaperPort™ 11SE will automatically start and is followed by the installation of MFL-Pro Suite.

- When the Brother MFL-Pro Suite Software **License Agreement** window appears, click **Yes** if you agree to the Software **License Agreement**.

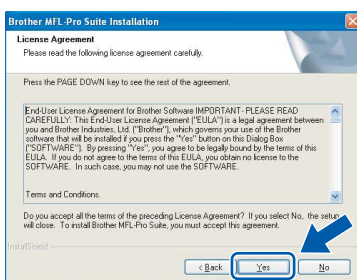

f

Choose **Local Connection**, and then click **Next**. The installation continues.

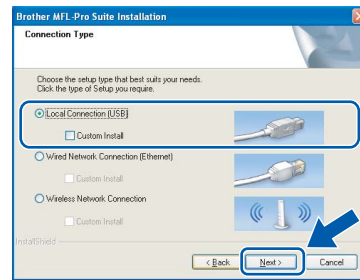

g

When this screen appears, go to the next step.

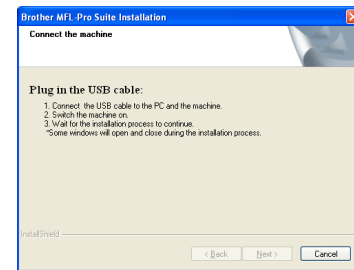





17 Connect the USB cable

Important

- **DO NOT** connect the machine to a USB port on a keyboard or a non-powered USB hub.
- **Connect the machine directly to your computer.**

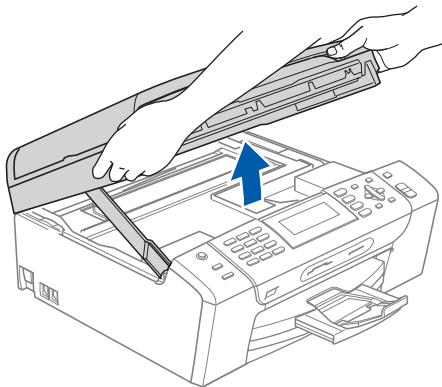
a Using both hands, use the plastic tabs on both sides of the machine to lift the scanner cover until it locks securely into the open position.



b Connect the USB cable to the USB socket marked with a  symbol. You will find the USB socket inside the machine on the right as shown below.

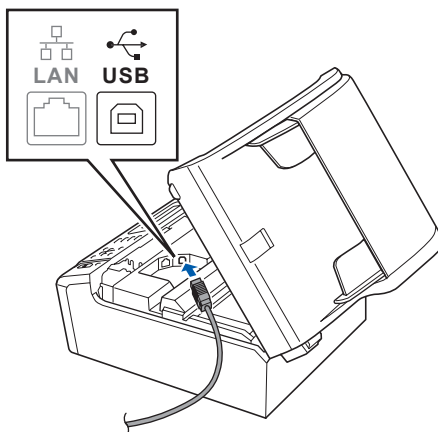

c Carefully route the USB cable through the trench and out the back of the machine as shown below and connect the cable to your computer.

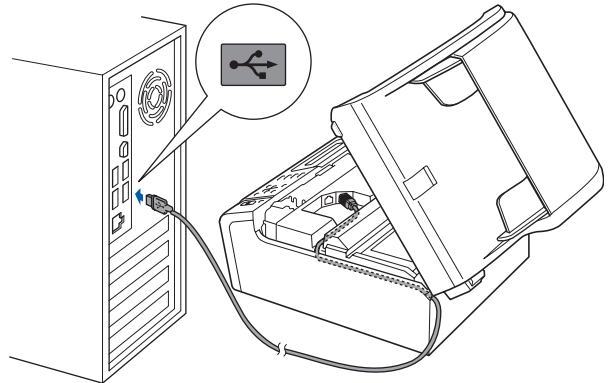

Important

Make sure that the cable does not restrict the cover from closing, or an error may occur.

d Lift the scanner cover to release the lock **1**. Gently push the scanner cover support down **2** and close the scanner cover **3**.

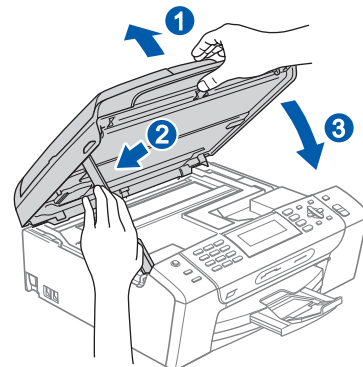



18 Connect the power cord

- a Connect the power cord. The installation will continue automatically. The installation screens appear one after another.

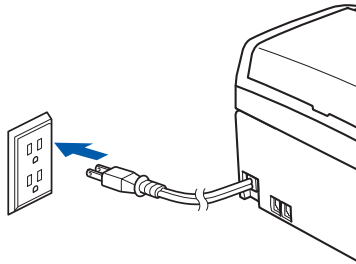

Important
DO NOT cancel any of the screens during the installation. It may take a few seconds for all screens to appear.

Note
For Windows Vista®, when this screen appears, click the check box and click **Install** to complete the installation correctly.

- b When the **On-Line Registration** screen is displayed, make your selection and follow the on-screen instructions. Once you have completed the registration process, close your web browser to return to this window. Then click **Next**.

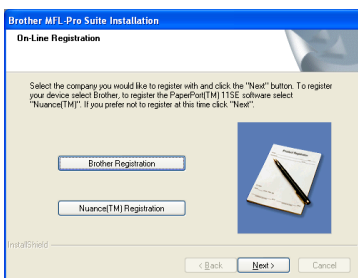

19 Finish and restart

- a Click **Finish** to restart your computer. After restarting the computer, you must be logged on with Administrator rights.

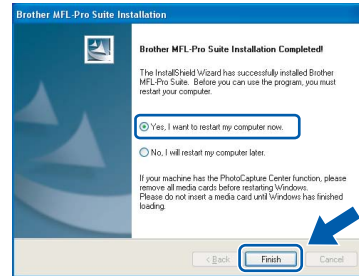

Note
If an error message appears during the software installation, run the **Installation Diagnostics** located in **Start/All Programs/Brother/MFC-XXXX** (where MFC-XXXX is your model name).

Finish The installation is now complete.

Now go to
Proceed to **Install Optional Applications** on page 42.



For USB Interface Users (For Mac OS® X 10.2.4 or greater)

15 Before you install

a Make sure your machine is connected to the power and your Macintosh® is ON. You must be logged on with Administrator rights.

Important

- For Mac OS® X 10.2.0 to 10.2.3 users, upgrade to Mac OS® X 10.2.4 or greater. (For the latest information for Mac OS® X, visit <http://solutions.brother.com/>)
- Make sure there are no memory cards or a USB Flash memory drive inserted.

16 Connect the USB cable

Important

- DO NOT connect the machine to a USB port on a keyboard or a non-powered USB hub.
- Connect the machine directly to your Macintosh®.

a Using both hands, use the plastic tabs on both sides of the machine to lift the scanner cover until it locks securely into the open position.

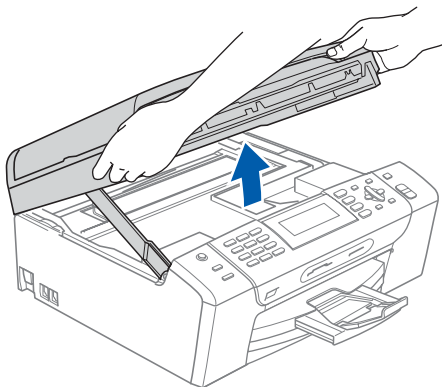

b Connect the USB cable to the USB socket marked with a  symbol. You will find the USB socket inside the machine on the right as shown below.

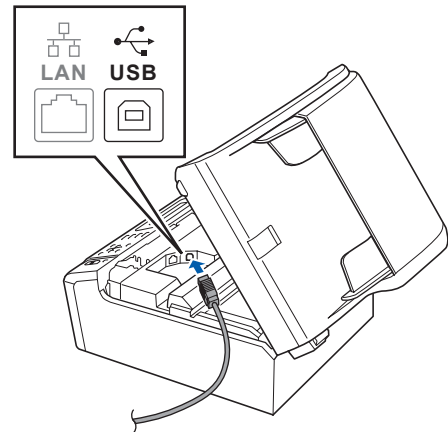

c Carefully route the USB cable through the trench and out the back of the machine as shown below and connect the cable to your Macintosh®.

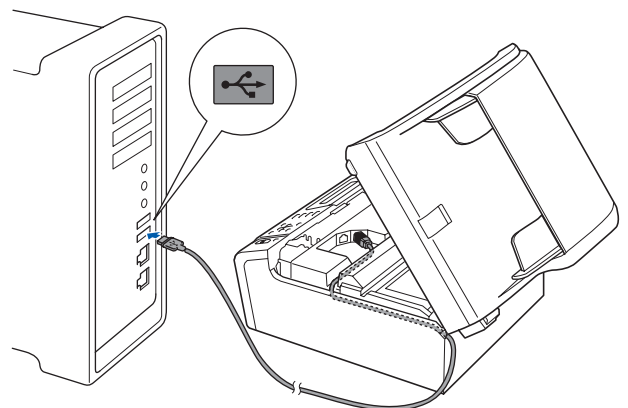

Important

Make sure that the cable does not restrict the cover from closing, or an error may occur.

d Lift the scanner cover to release the lock **1**. Gently push the scanner cover support down **2** and close the scanner cover **3**.

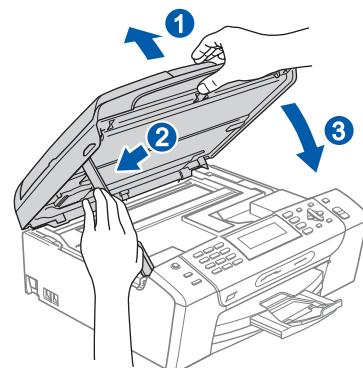



17 Install MFL-Pro Suite

a Put the supplied CD-ROM into your CD-ROM drive.

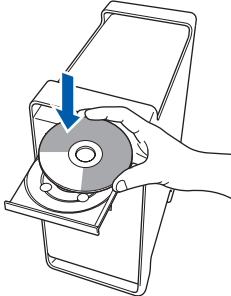

b Double-click the **Start Here OSX** icon to install.

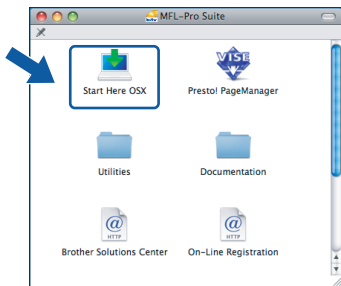

c Choose **Local Connection**, and then click **Next**. Follow the on-screen instructions.

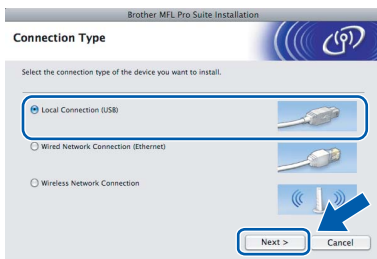

Note

*Please wait, it will take a few seconds for the software to install. After the installation, click **Restart** to finish installing the software.*

d The Brother software will search for the Brother device. During this time the following screen will appear.

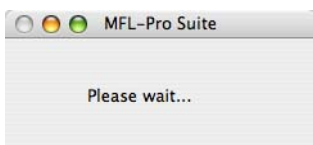

e When this screen appears, click **OK**.

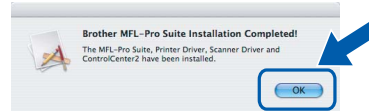

OK! For Mac OS® X 10.3.x or greater, the installation of MFL-Pro Suite is now complete. Go to step **18** on page 20.

f For Mac OS® X 10.2.4 to 10.2.8 users, click **Add**.

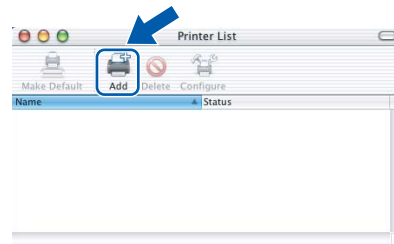

g Choose **USB**.

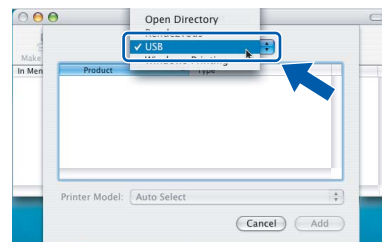

h Choose **XXX-XXXX** (where XXX-XXXX is your model name), and then click **Add**.

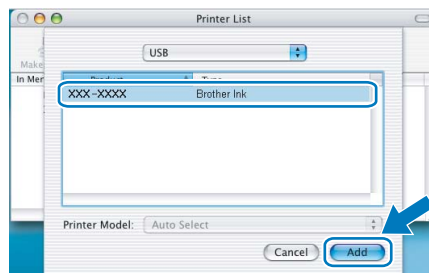

i Click **Print Center**, then **Quit Print Center**.

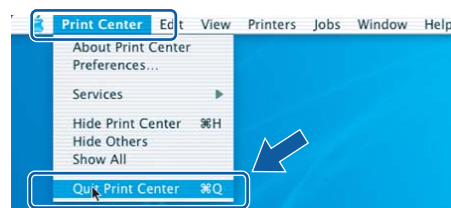
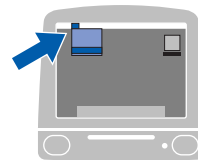

OK! The installation of MFL-Pro Suite is now complete. Go to step **18** on page 20.



18 Install Presto!® PageManager®

When Presto!® PageManager® is installed OCR capability is added to Brother ControlCenter2. You can easily scan, share and organize photos and documents using Presto!® PageManager®.

- a** Double-click the **Presto! PageManager** icon and follow the on-screen instructions.



For Mac OS® X 10.2.4 to 10.3.8 users, when this screen appears, click **Go** to download the software from the Brother Solutions Center website.



Finish The installation is now complete.



For Wired Network Interface Users (For Windows® 2000 Professional/XP/ XP Professional x64 Edition/ Windows Vista®)

15 Before you install

- a** Make sure that your computer is ON and you are logged on with Administrator rights.

Important

- If there are any programs running, close them.
- Make sure there are no memory cards or a USB Flash memory drive inserted.
- The screens may differ depending on the operating system.
- The supplied CD-ROM includes ScanSoft™ PaperPort™ 11SE. This software supports Windows® 2000 (SP4 or greater), XP (SP2 or greater), XP Professional x64 Edition and Windows Vista®. Update to the latest Windows® Service Pack before installing MFL-Pro Suite.

Important

Before installation, if you are using personal firewall software (other than Windows® Firewall), anti-spyware or antivirus applications, temporarily disable them.

- b** Unplug the machine from the AC outlet.

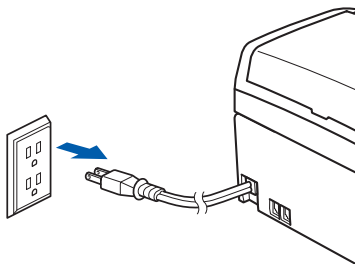

16 Connect the network cable

- a** Using both hands, use the plastic tabs on both sides of the machine to lift the scanner cover until it locks securely into the open position.

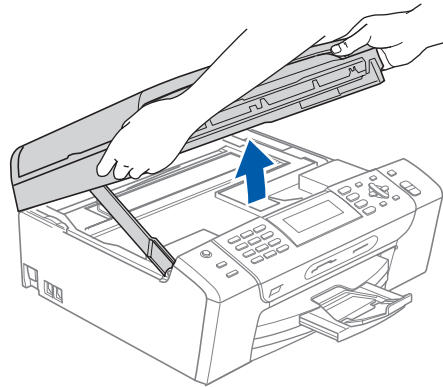

- b** Connect the network cable to the LAN socket marked with a  symbol. You will find the LAN socket inside the machine on the left as shown below.

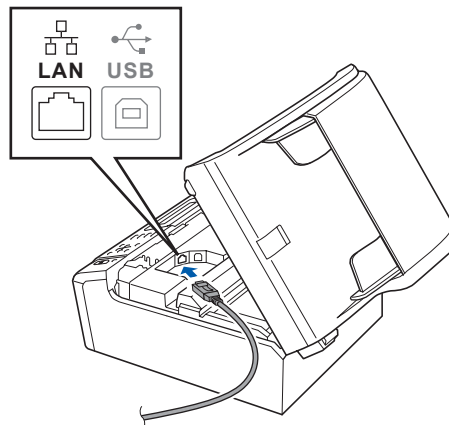

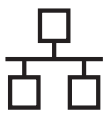

- c** Carefully route the network cable through the trench and out the back of the machine. Then, connect the cable to your network.

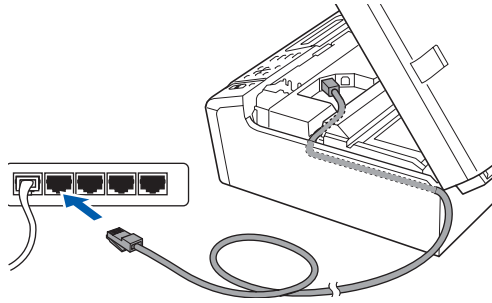

Note

If both USB and LAN cables are being used, guide both cables through the trench with one on top of the other.

Important

Make sure that the cable does not restrict the cover from closing, or an error may occur.

- d** Lift the scanner cover to release the lock **1**. Gently push the scanner cover support down **2** and close the scanner cover **3**.

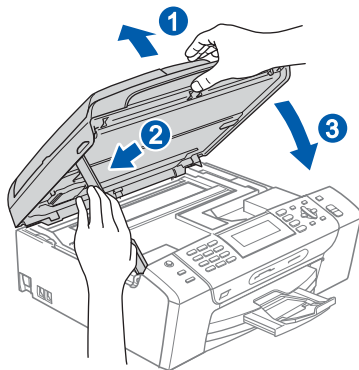

17 Connect the power cord

- a** Connect the power cord.

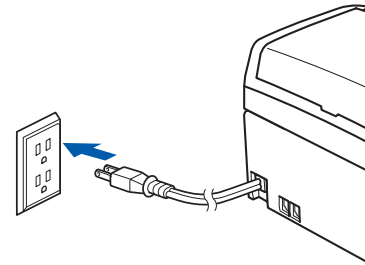

Important

If you have previously set up your machine for a wireless network and then want to set it up on a wired network, you should check that the machine's Network I/F is set to Wired LAN. The wireless network interface will become inactive with this setting.

On your machine, press Menu.

Press ▲ or ▼ to choose Network and press OK.

Press ▲ or ▼ to choose Network I/F and press OK.

Press ▲ or ▼ to choose Wired LAN and press OK.

Press Stop/Exit.



18 Install MFL-Pro Suite

a Put the supplied CD-ROM into your CD-ROM drive. If the model name screen appears, choose your machine. If the language screen appears, choose your language.

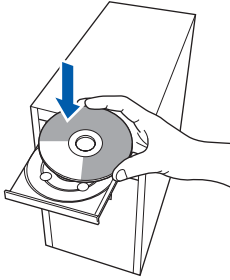

Note

If the Brother screen does not appear automatically, go to **My Computer (Computer)**, double-click the CD-ROM icon, and then double-click **start.exe**.

b The CD-ROM main menu will appear. Click **Install MFL-Pro Suite**.

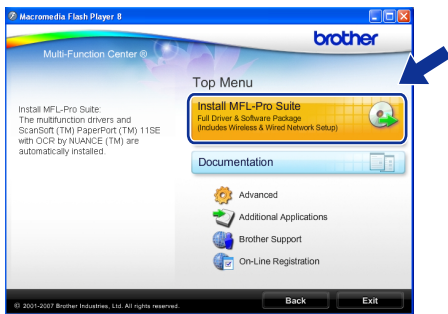

Note

If this screen appears, click **OK** and restart your computer.

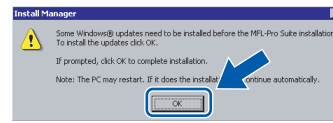

If the installation does not continue automatically, open the main menu again by ejecting and then reinserting the CD-ROM or double-click the **start.exe** program from the root folder, and continue from **b** to install MFL-Pro Suite.

For Windows Vista®, when the **User Account Control** screen appears, click **Allow**.

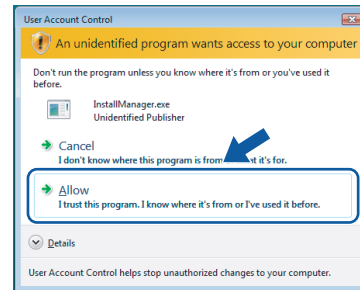

c When the ScanSoft™ PaperPort™ 11SE License Agreement window appears, click **Yes** if you agree to the Software License Agreement.

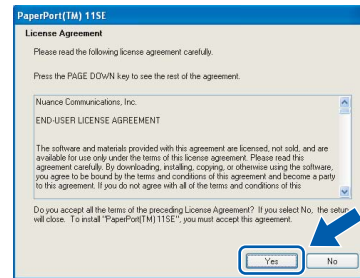

The installation of ScanSoft™ PaperPort™ 11SE will automatically start and is followed by the installation of MFL-Pro Suite.

e When the Brother MFL-Pro Suite Software License Agreement window appears, click **Yes** if you agree to the Software License Agreement.

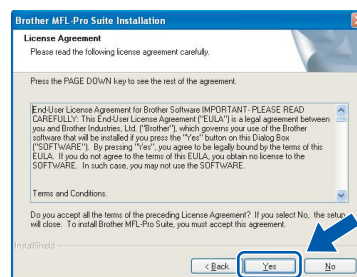



- f** Choose **Wired Network Connection**, and then click **Next**.

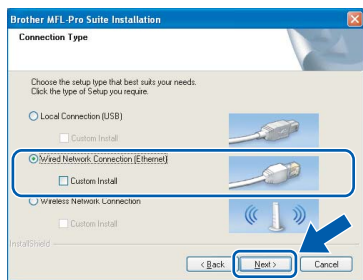

- g** For Windows® XP SP2/Windows Vista® users, when this screen appears, choose **Change the Firewall port settings to enable network connection and continue with the installation. (Recommended)** and click **Next**.

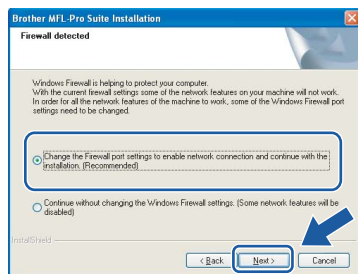

If you are using a firewall other than Windows® Firewall or Windows® Firewall is off, this screen may appear.

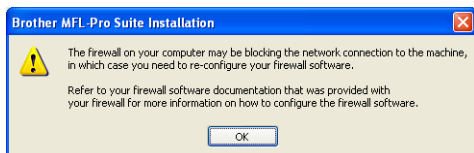

See the instructions provided with your firewall software for information on how to add the following network ports.

- For network scanning, add UDP port 54925.
- For network PC-Fax receiving, add UDP port 54926.
- If you still have trouble with your network connection, add UDP port 137.

Note

- If the machine is configured for your network, choose the machine from the list, and then click **Next**.
This window will not appear if there is only one machine connected on the network, it will be chosen automatically.

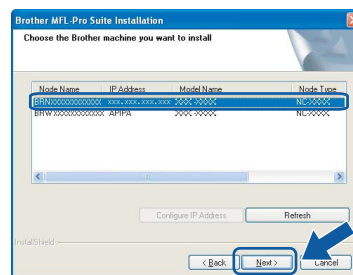

If your machine shows **APIPA** in the **IP Address** field, click **Configure IP Address** and enter an IP address for your machine that is suitable for your network.

- If the machine is not yet configured for use on your network, the following screen appears.



Click **OK**.
The **Configure IP Address** window will appear. Enter an IP address for your machine that is suitable for your network by following the on-screen instructions.

- h** The installation of the Brother drivers will automatically start. The installation screens appear one after another.

Important

DO NOT cancel any of the screens during the installation. It may take a few seconds for all screens to appear.

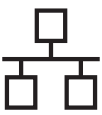

Note

For Windows Vista®, when this screen appears, click the check box and click **Install** to complete the installation correctly.

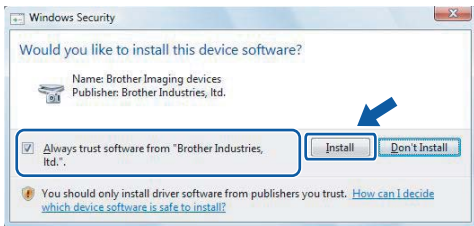

i When the **On-Line Registration** screen is displayed, make your selection and follow the on-screen instructions. Once you have completed the registration process, close your web browser to return to this window. Then click **Next**.

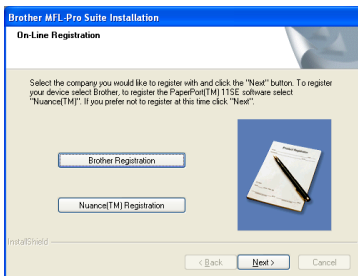

19 Finish and restart

a Click **Finish** to restart your computer. After restarting the computer, you must be logged on with Administrator rights.



Note

If an error message appears during the software installation, run the **Installation Diagnostics** located in **Start/All Programs/Brother/MFC-XXXX** (where MFC-XXXX is your model name).

20 Install MFL-Pro Suite on additional computers (If needed)

If you want to use your machine with multiple computers on the network, install MFL-Pro Suite on each computer. Go to step **18** on page 23. Also see step **15-a** on page 21 before you install.

Note

The MFL-Pro Suite Software License permits installation on up to 2 network computers. If you want to install MFL-Pro Suite on additional computers, you can purchase additional NL-5 (five user) license agreements from your authorized Brother dealer or contact Brother customer service.

Finish

The installation is now complete.

Now go to

Proceed to Install Optional Applications on page 42.



For Wired Network Interface Users (For Mac OS® X 10.2.4 or greater)

15 Before you install

- a** Make sure your machine is connected to the power and your Macintosh® is ON. You must be logged on with Administrator rights.

Important

- For Mac OS® X 10.2.0 to 10.2.3 users, upgrade to Mac OS® X 10.2.4 or greater. (For the latest information for Mac OS® X, visit <http://solutions.brother.com/>)
- Make sure there are no memory cards or a USB Flash memory drive inserted.
- If you have previously set up your machine for a wireless network and then want to set it up on a wired network, you should check that the machine's Network I/F is set to Wired LAN. The wireless network interface will be inactive with this setting. On your machine, press Menu. Press ▲ or ▼ to choose Network and press OK. Press ▲ or ▼ to choose Network I/F and press OK. Press ▲ or ▼ to choose Wired LAN and press OK. Press Stop/Exit.

16 Connect the network cable

- a** Using both hands, use the plastic tabs on both sides of the machine to lift the scanner cover until it locks securely into the open position.

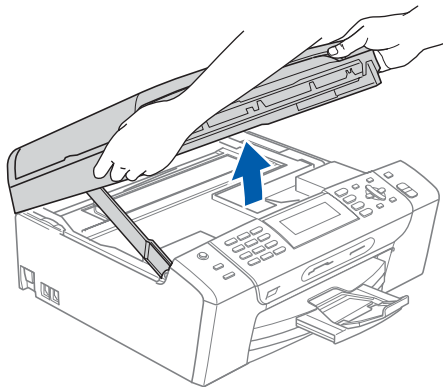

- b** Connect the network cable to the LAN socket marked with a  symbol. You will find the LAN socket inside the machine on the left as shown below.

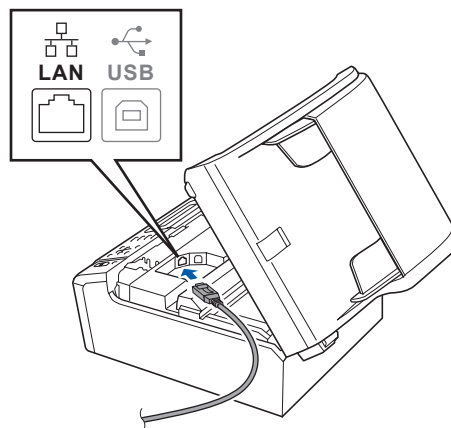

- c** Carefully route the network cable through the trench and out the back of the machine. Then, connect the cable to your network.

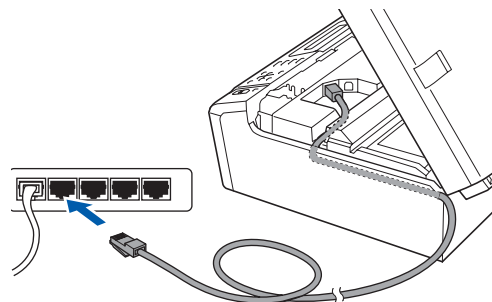

Important

Make sure that the cable does not restrict the cover from closing, or an error may occur.

Note

If both USB and LAN cables are being used, guide both cables through the trench with one on top of the other.

- d** Lift the scanner cover to release the lock ①. Gently push the scanner cover support down ② and close the scanner cover ③.

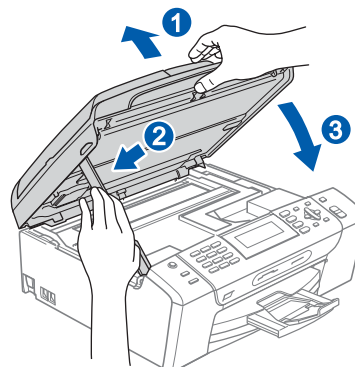



17 Install MFL-Pro Suite

- a Put the supplied CD-ROM into your CD-ROM drive.

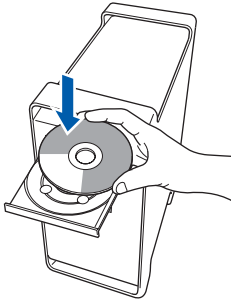

- b Double-click the **Start Here OSX** icon to install.

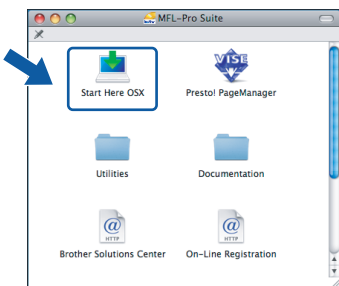

- c Choose **Wired Network Connection**, and then click **Next**. Follow the on-screen instructions.



Note

Please wait, it will take a few seconds for the software to install. After the installation, click **Restart** to finish installing the software.

- d The Brother software will search for the Brother device. During this time the following screen will appear.

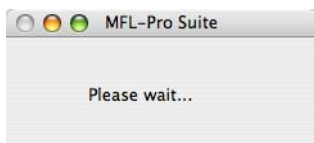

Note

- If the machine is configured for your network, choose the machine from the list, and then click **OK**. This window will not appear if there is only one machine connected on the network, it will be chosen automatically. Go to e.

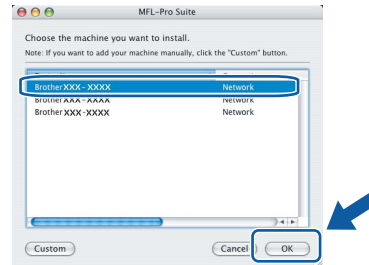

- If this screen appears click **OK**.



Enter a name for your Macintosh® in **Display Name** up to 15 characters long and click **OK**. Go to e.

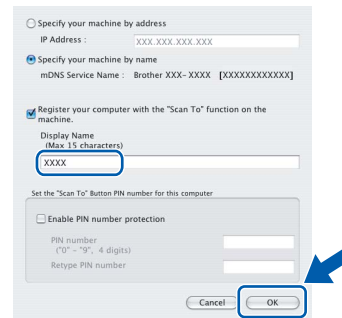

- If you want to use the machine's **Scan** key to scan over the network you must check the **Register your computer with the "Scan To" function on the machine box**.
- The name you enter will appear on the machine's LCD when you press the **Scan** key and choose a scan option. (For more information, see *Network Scanning* in the *Software User's Guide* on the CD-ROM.)

- e When this screen appears, click **OK**.



- OK!** For Mac OS® X 10.3.x or greater, the installation of MFL-Pro Suite is now complete. Go to step **18** on page 28.

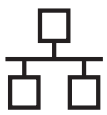

f For Mac OS® X 10.2.4 to 10.2.8 users, click **Add**.

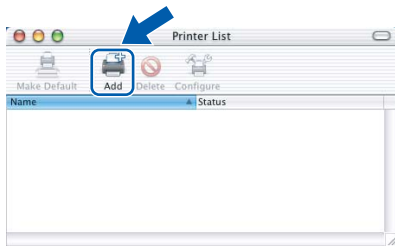

g Make the selection shown below.

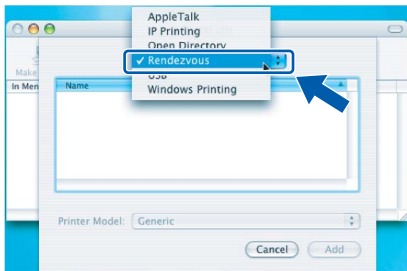

h Choose **XXX-XXXX** (where XXX-XXXX is your model name), and then click **Add**.

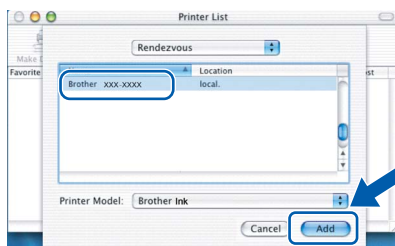

i Click **Print Center**, then **Quit Print Center**.

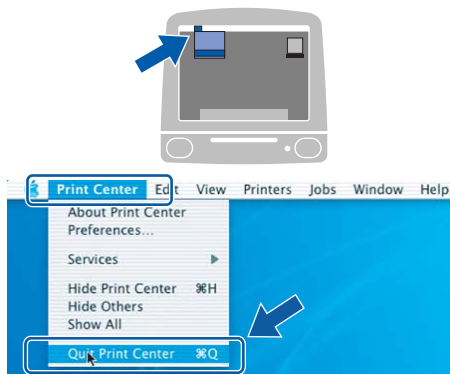

OK! The installation of MFL-Pro Suite is now complete.
Go to step **18** on page 28.

18 Install Presto!® PageManager®

When Presto!® PageManager® is installed OCR capability is added to Brother ControlCenter2. You can easily scan, share and organize photos and documents using Presto!® PageManager®.

a Double-click the **Presto! PageManager** icon and follow the on-screen instructions.



For Mac OS® X 10.2.4 to 10.3.8 users, when this screen appears, click **Go** to download the software from the Brother Solutions Center website.



19 Install MFL-Pro Suite on additional computers (If needed)

If you want to use your machine with multiple computers on the network, install MFL-Pro Suite on each computer. Go to step **17** on page 27. Also see step **15-a** on page 26 before you install.

Finish The installation is now complete.



For Wireless Network Interface Users

15 Before you begin

First you must configure the wireless network settings of your machine to communicate with your network access point (router). After the machine is configured to communicate with your access point (router) computers on your network will have access to the machine. To use the machine from these computers, you will need to install the drivers and software. The following steps will guide you through the configuration and installation process.

To achieve optimum results with normal everyday document printing, place the Brother machine as close to the network access point (router) as possible with minimal obstructions. Large objects and walls between the two devices as well as interference from other electronic devices can affect the data transfer speed of your documents.

Due to these factors, wireless may not be the best method of connection for all types of documents and applications. If you are printing large files, such as multi-page documents with mixed text and large graphics, you may want to consider choosing wired Ethernet for a faster data transfer or USB for the fastest throughput speed.

Although the Brother MFC-490CW can be used in a both wired and wireless network, only one of the connection methods can be used at a time.

Important

If you have previously configured the wireless settings of the machine you must reset the network (LAN) settings before you can configure the wireless settings again.

On your machine, press Menu. Press ▲ or ▼ to choose Network and press OK.

Press ▲ or ▼ to choose Factory Reset, and then press OK.

Press 1 twice for Yes to accept the change.

Note

The following instructions are for infrastructure mode.

To set up your machine in any other wireless environment you can find instructions in the Network User's Guide on the CD-ROM.

You can view the Network User's Guide by following the instructions below.

1 Turn on your computer/Macintosh®. Insert the Brother CD-ROM into your CD-ROM drive.

For Windows®:

2 Choose your model and the language. The CD-ROM main menu will appear.

3 Click **Documentation, and then click **HTML documents**.**

For Macintosh®:

2 Double-click **Documentation, and then double-click your language folder.**

3 Double-click **top.html.**

Infrastructure Mode

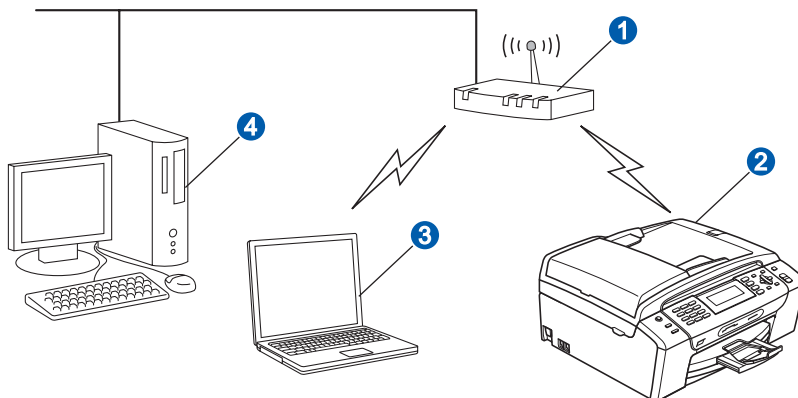

- ① Access Point (router)
- ② Wireless Network machine (your machine)
- ③ Wireless capable computer connected to the access point
- ④ Wired computer connected to the access point



16 Confirm your network environment (Infrastructure Mode)

The following instructions will offer two methods for installing your Brother machine in a wireless network environment. Both methods are for infrastructure mode, using a wireless router or access point that uses DHCP to assign IP addresses. Choose a configuration method and proceed to the page indicated.

- a** If your wireless router/access point does not support SecureEasySetup™, Wi-Fi Protected Setup™ or AOSS™, write down the wireless network settings of your access point or wireless router.

Important

If you do not know this information (Network Name, WEP key or WPA2-PSK (Pre-Shared Key)), you cannot continue the wireless setup. You should see the documentation provided with your access point or wireless router, consult the router manufacturer, or your system administrator.

SSID (Service Set ID or Network name)

Authentication (Open System or Shared Key)/Encryption Type (None or WEP)

WEP Key (if needed) ¹

WPA/WPA2-PSK Encryption type (TKIP or AES) (if needed) ²

WPA/WPA2-PSK (Pre-Shared Key) (if needed) ²

- ¹ The WEP key is for 64-bit encrypted networks or 128-bit encrypted networks and can contain both numbers and letters. If you do not know this information you should see the documentation provided with your access point or wireless router. This key is a 64-bit or 128-bit value that must be entered in an ASCII or HEXADECIMAL format.

For example:

64-bit ASCII: Uses 5 text characters e.g. "Hello" (this is case sensitive)

64-bit Hexadecimal: Uses 10 digits of hexadecimal data e.g. "71f2234aba"

128-bit ASCII: Uses 13 text characters e.g. "Wirelesscomms" (this is case sensitive)

128-bit Hexadecimal: Uses 26 digits of hexadecimal data e.g.

"71f2234ab56cd709e5412aa3ba"

- ² WPA/WPA2-PSK is a Wi-Fi® Protected Access Pre-Shared Key, which lets the Brother wireless machine associate with access points using TKIP or AES encryption (WPA-Personal). WPA/WPA2-PSK (TKIP or AES) uses a Pre-Shared Key (PSK) that is 8 or more characters in length, up to a maximum of 63 characters.

Now go to

page 31

- b** If your wireless router/access point supports automatic wireless (one-push) setup (SecureEasySetup™, Wi-Fi Protected Setup™ or AOSS™)

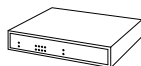
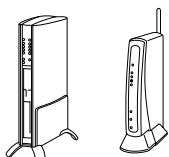

Now go to

page 33



Connecting the Brother machine to the wireless network

17 Configure the wireless settings (Typical Wireless Setup in infrastructure mode)

- a** On your machine, press **Menu**.
Press **▲** or **▼** to choose **Network** and press **OK**.
Press **▲** or **▼** to choose **WLAN** and press **OK**.
Press **▲** or **▼** to choose **Setup Wizard** and press **OK**.

When **Network I/F switched to Wireless** is displayed, press **OK** to accept.
This will start the wireless setup wizard.
To cancel, press **Clear/Back**.

- b** The machine will search for available SSIDs. If a list of SSIDs is displayed, use the **▲** or **▼** keys to choose the SSID you wrote down in step **16** on page 30, then press **OK**. Go to **f**.

Note

It will take several seconds to display a list of available SSIDs.

If your access point is set to not broadcast the SSID you will have to manually add the SSID name. Go to **c**.

- c** Press **▲** or **▼** to choose **<New SSID>** and press **OK**. Go to **d**.

- d** Enter the SSID you wrote down in step **16** on page 30 using the dial pad to choose each letter or number.

You can use the **◀** and **▶** keys to move the cursor left and right. For example, to enter the letter **a**, press the **2** key on the dial pad once. To enter the number **3**, press the **3** key on the dial pad seven times.

The letters appear in this order: lower case, upper case and then numbers.
(For more information, see *Entering Text for Wireless Settings* on page 46.)

Press **OK** when you have entered all the characters.

- e** Press **▲** or **▼** to choose **Infrastructure**, then press **OK**.

- f** Use the **▲**, **▼** and **OK** keys to choose one of the options below: If your network is configured for Authentication and Encryption you must match the settings used for your network.

- **No Authentication or Encryption:**
Choose **Open System**, press **OK** then choose **None** for **Encryption Type?** and press **OK**. Then press **1** for **Yes** to apply your settings. Go to **i**.
- **No Authentication with WEP Encryption:**
Choose **Open System**, press **OK** then use the **▲** or **▼** to choose **WEP** for the **Encryption Type?** and press **OK**.
Go to **g**.
- **Authentication with WEP Encryption:**
Choose **Shared Key** and press **OK**.
Go to **g**.
- **Authentication with WPA/WPA2-PSK (TKIP or AES) Encryption:**
Choose **WPA/WPA2-PSK** and press **OK**.
Go to **h**.

- g** Choose the appropriate key number and press **OK**. Enter the WEP key you wrote down in step **16** on page 30 using the dial pad to choose each letter or number.

You can use the **◀** and **▶** keys to move the cursor left and right. For example, to enter the letter **a**, press the **2** key on the dial pad once. To enter the number **3**, press the **3** key on the dial pad seven times.

The letters appear in this order: lower case, upper case and then numbers.
(For more information, see *Entering Text for Wireless Settings* on page 46.)

Press **OK** when you have entered all the characters, then press **1** for **Yes** to apply your settings. Go to **i**.

- h** Press **▲** or **▼** to choose **TKIP** or **AES** for **Encryption Type?** and press **OK**. Enter the WPA/WPA2-PSK password you wrote down in step **16** on page 30 using the dial pad to choose each letter or number.



You can use the ◀ and ▶ keys to move the cursor left and right. For example, to enter the letter a, press the 2 key on the dial pad once. To enter the number 3, press the 3 key on the dial pad seven times.

The letters appear in this order: lower case, upper case and then numbers.
(For more information, see *Entering Text for Wireless Settings* on page 46.)

Press **OK** when you have entered all the characters, then press **1** for **Yes** to apply your settings. Go to **i**.



Your machine will now try to connect to your wireless network using the information you have entered. If successful, **Connected** will appear briefly on the LCD.

*If your machine does not successfully connect to your network, verify your network settings collected in step **16** on page 30, then repeat **a** to **h** to make sure you have entered the correct information.*

*If your access point does not have DHCP enabled you will need to manually configure the IP address, subnet mask and gateway of the machine to suit your network. See the *Network User's Guide* for details.*



Wireless setup is now complete. A four level indicator at the top of your machine's LCD will show the wireless signal strength of your access point or router.

To install MFL-Pro Suite, continue to step **18.**

For Windows® Users:

Now go to

Page 35

For Mac OS® Users:

Now go to

Page 39



17 Configure the wireless settings using the automatic wireless (one-push) method

- a** Confirm your wireless router or access point has the SecureEasySetup™, Wi-Fi Protected Setup™ or AOSS™ symbol as shown below.



- b** Place the Brother machine within range of a SecureEasySetup™, Wi-Fi Protected Setup™ or AOSS™ access point/router. The range may differ depending on your environment. Refer to the instructions provided with your access point/router.

- c** Push the SecureEasySetup™, Wi-Fi Protected Setup™ or AOSS™ button on your wireless router or access point. See the user's guide for your wireless router or access point for instructions.

- d** On your machine, press **Menu**. Press **▲** or **▼** to choose **Network** and press **OK**. Press **▲** or **▼** to choose **WLAN** and press **OK**. Press **▲** or **▼** to choose **SES/WPS/AOSS** and press **OK**.

When **Network I/F switched to Wireless** is displayed, press **OK** to accept. This will start the wireless setup wizard. To cancel, press **Clear/Back**.

This feature will automatically detect which mode (SecureEasySetup™, Wi-Fi Protected Setup™ or AOSS™) your access point uses to configure your machine.

Note

If your wireless access point supports **Wi-Fi Protected Setup™ (PIN Method)** and you want to configure your machine using the **PIN (Personal Identification Number) Method**, see **Using the PIN Method of Wi-Fi Protected Setup™ in the Network User's Guide on the CD-ROM**.

- e** If the LCD shows **Connected**, the machine has successfully connected to your router or access point. You can now use your machine in a wireless network.

If the LCD shows **Setting WLAN**, **Connecting SES (Connecting WPS or Connecting AOSS)**, then **Connection Failed**, the machine has not successfully connected to your router or access point. Try starting from **c** again. If the same message is indicated again, reset the machine back to the default factory settings and try again. For resetting, see *Restore the network settings to factory default* on page 46.

If the LCD shows **Setting WLAN**, then **Connection Failed** or **Incorrect Mode**, a session overlap or connection failure was detected. (see the table below), the machine has detected 2 or more routers or access points on your network that have the SecureEasySetup™, Wi-Fi Protected Setup™ mode or AOSS™ mode enabled. Make sure that only one router or access point has the SecureEasySetup™, Wi-Fi Protected Setup™ mode or AOSS™ mode enabled and try starting from **c** again.

LCD messages when using the SES/WPS/AOSS control panel menu	
<i>Setting WLAN</i>	<i>Searching or accessing the access point and downloading settings from the access point.</i>
<i>Connecting SES/WPS/AOSS</i>	<i>Connecting to the access point.</i>
<i>Connection Failed</i>	<i>Connection failed. If this is shown after the LCD shows Connecting SES/WPS/AOSS, a session overlap was detected.</i>
<i>Incorrect Mode</i>	<i>A session overlap was detected.</i>
<i>Connected</i>	<i>The machine has successfully connected.</i>

Note

If you encounter a problem during setup, temporarily place your machine closer to the wireless access point, and go back to **c**.



Wireless setup is now complete.



Wireless setup is now complete. To install MFL-Pro Suite, continue to step **18**.

For Windows® Users:

Now go to

Page 35

For Mac OS® Users:

Now go to

Page 39



Install the Drivers & Software

(For Windows® 2000 Professional/XP/XP Professional x64 Edition/
Windows Vista®)

18 Before you install MFL-Pro Suite

- a Make sure that your computer is ON and you are logged on with Administrator rights.

Important

- If there are any programs running, close them.
- Make sure there are no memory cards or a USB Flash memory drive inserted.
- The screens may differ depending on the operating system.
- The supplied CD-ROM includes ScanSoft™ PaperPort™ 11SE. This software supports Windows® 2000 (SP4 or greater), XP (SP2 or greater), XP Professional x64 Edition and Windows Vista®. Update to the latest Windows® Service Pack before installing MFL-Pro Suite.

Important

Before installation, if you are using personal firewall software (other than Windows® Firewall), anti-spyware or antivirus applications, temporarily disable them.

19 Install MFL-Pro Suite

- a Put the supplied CD-ROM into your CD-ROM drive. If the model name screen appears, choose your machine. If the language screen appears, choose your language.

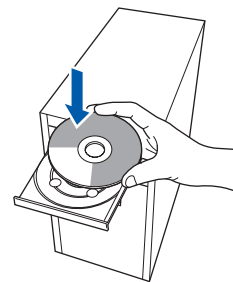

Note

If the Brother screen does not appear automatically, go to **My Computer (Computer)**, double-click the CD-ROM icon, and then double-click **start.exe**.

- b The CD-ROM main menu will appear. Click **Install MFL-Pro Suite**.





Note

- If this screen appears, click **OK** and restart your computer.

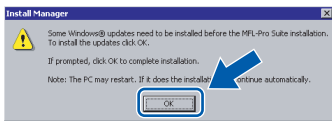

- If the installation does not continue automatically, open the main menu again by ejecting and then reinserting the CD-ROM or double-click the **start.exe** program from the root folder, and continue from **b** to install MFL-Pro Suite.
- For Windows Vista®, when the **User Account Control** screen appears, click **Allow**.

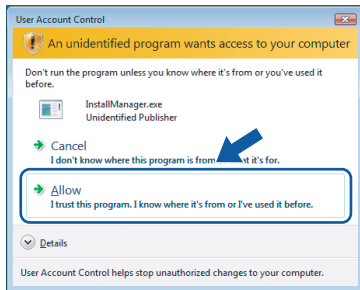

- When the ScanSoft™ PaperPort™ 11SE License Agreement window appears, click **Yes** if you agree to the Software License Agreement.

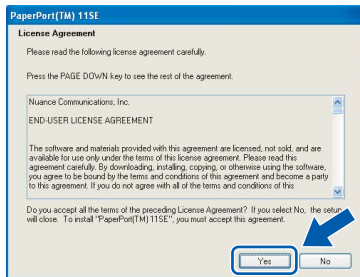

- The installation of ScanSoft™ PaperPort™ 11SE will automatically start and is followed by the installation of MFL-Pro Suite.

- When the Brother MFL-Pro Suite Software License Agreement window appears, click **Yes** if you agree to the Software License Agreement.

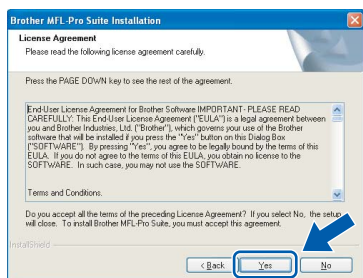

f

Choose **Wireless Network Connection**, and then click **Next**.

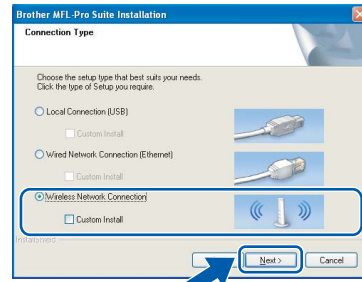

g

Click on **Checked and confirmed** check box, and then click **Next**.

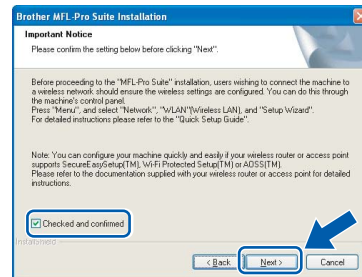

h

For Windows® XP SP2/Windows Vista® users, when this screen appears, choose **Change the Firewall port settings to enable network connection and continue with the installation. (Recommended)** and click **Next**.

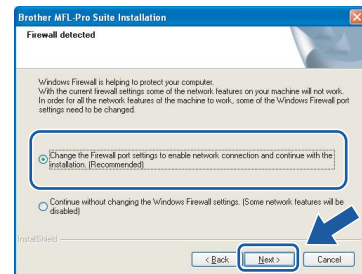

If you are using a firewall other than Windows® Firewall or Windows® Firewall is off, this screen may appear.

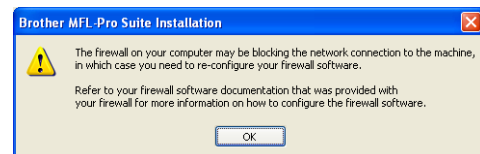

See the instructions provided with your firewall software for information on how to add the following network ports.

- For network scanning, add UDP port 54925.
- For network PC-Fax receiving, add UDP port 54926.
- If you still have trouble with your network connection, add UDP port 137.



Note

- If the machine is configured for your network, choose the machine from the list, and then click **Next**.

This window will not appear if there is only one machine connected on the network, it will be chosen automatically.

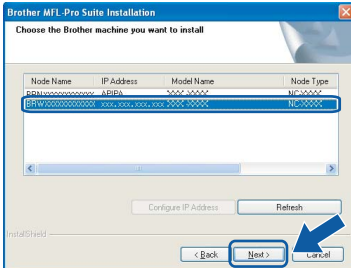

If your machine shows **APIPA** in the **IP Address** field, click **Configure IP Address** and enter an IP address for your machine that is suitable for your network.



- If your wireless settings fail, an error message will appear during the installation of MFL-Pro Suite and the installation will be terminated. If you encounter this failure, go to step 16 on page 30 and setup the wireless connection again.
- If you are using WEP and the LCD displayed 'Connected' but your machine is not found, make sure you entered the WEP key correctly. The WEP key is case sensitive.
- If the machine is not yet configured for use on your network, the following screen appears.



Click **OK**. The **Configure IP Address** window will appear. Enter an IP address for your machine that is suitable for your network by following the on-screen instructions.

i

The installation of the Brother drivers will automatically start. The installation screens appear one after another.

Important

DO NOT cancel any of the screens during the installation. It may take a few seconds for all screens to appear.

Note

For Windows Vista®, when this screen appears, click the check box and click **Install** to complete the installation correctly.

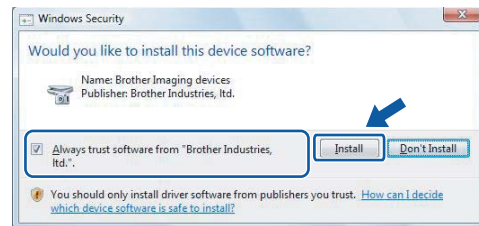

j

When the **On-Line Registration** screen is displayed, make your selection and follow the on-screen instructions. Once you have completed the registration process, close your web browser to return to this window. Then click **Next**.

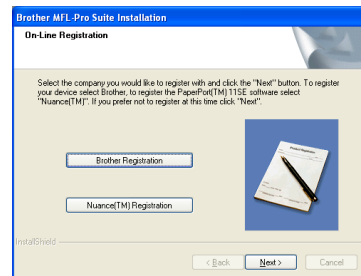



20 Finish and restart

- a** Click **Finish** to restart your computer. After restarting the computer, you must be logged on with Administrator rights.

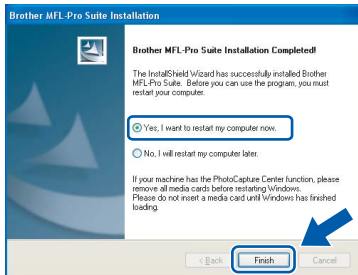

Note

If an error message appears during the software installation, run the **Installation Diagnostics** located in **Start/All Programs/Brother/MFC-XXXX** (where MFC-XXXX is your model name).

21 Install MFL-Pro Suite on additional computers (If needed)

If you want to use your machine with multiple computers on the network, install MFL-Pro Suite on each computer. Go to step **18** on page 35.

Note

The MFL-Pro Suite Software License permits installation on up to 2 network computers. If you want to install MFL-Pro Suite on additional computers, you can purchase additional NL-5 (five user) license agreements from your authorized Brother dealer or contact Brother customer service.

Finish

The installation is now complete.

Now go to

Proceed to Install Optional Applications on page 42.



Install the Drivers & Software (For Mac OS® X 10.2.4 or greater)

18 Before you install MFL-Pro Suite

- a Make sure your machine is connected to the power and your Macintosh® is ON. You must be logged on with Administrator rights.

Important

- For Mac OS® X 10.2.0 to 10.2.3 users, upgrade to Mac OS® X 10.2.4 or greater. (For the latest information for Mac OS® X, visit <http://solutions.brother.com/>)
- Make sure there are no memory cards or a USB Flash memory drive inserted.

19 Install MFL-Pro Suite

- a Put the supplied CD-ROM into your CD-ROM drive.

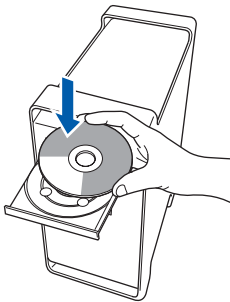

- b Double-click the **Start Here OSX** icon to install.

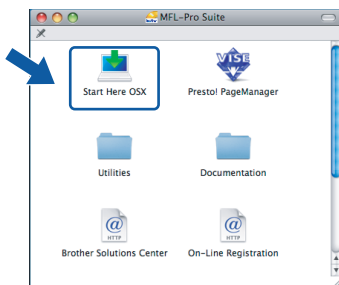

- c Choose **Wireless Network Connection**, and then click **Next**.

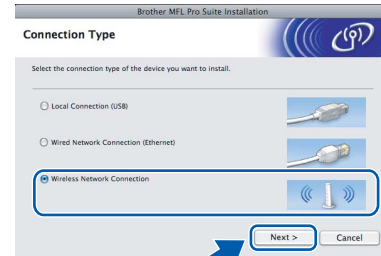

- d Click on the **Checked and confirmed** check box, and then click **Next**. Follow the on-screen instructions.

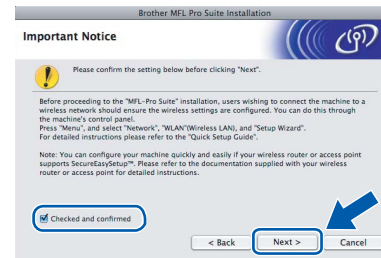

Note

*Please wait, it will take a few seconds for the software to install. After the installation, click **Restart** to finish installing the software.*

- e The Brother software will search for the Brother device. During this time the following screen will appear.

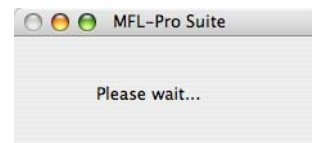



Note

- If the machine is configured for your network, choose the machine from the list, and then click **OK**.
This window will not appear if there is only one machine connected on the network, it will be chosen automatically. Go to **f**.

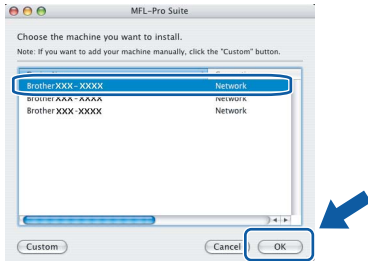

- If your machine is not detected, go to step **16** on page 30 and setup the wireless connection again.
- If you are using WEP and the LCD displayed 'Connected' but your machine is not found, make sure you entered the WEP key correctly. The WEP key is case sensitive.
- If this screen appears click **OK**.



Enter a name for your Macintosh® in **Display Name** up to 15 characters long and click **OK**. Go to **f**.

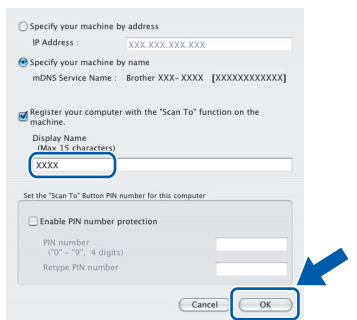

- If you want to use the machine's **Scan** key to scan over the network you must check the **Register your computer with the "Scan To" function on the machine box**.
- The name you enter will appear on the machine's LCD when you press the **Scan** key and choose a scan option. (For more information, see *Network Scanning in the Software User's Guide on the CD-ROM*.)

f

When this screen appears, click **OK**.



OK!

For Mac OS® X 10.3.x or greater, the installation of MFL-Pro Suite is now complete.
Go to step **20** on page 41.

g

For Mac OS® X 10.2.4 to 10.2.8 users, click **Add**.

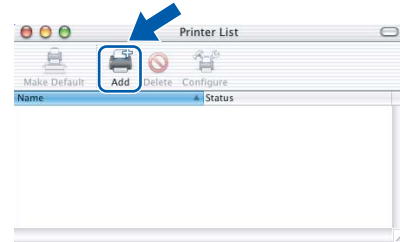

h

Make the selection shown below.

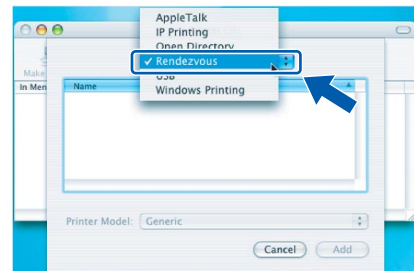

i

Choose **XXX-XXXX** (where XXX-XXXX is your model name), and then click **Add**.

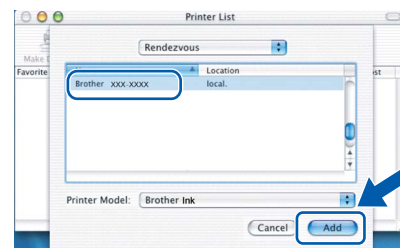

j

Click **Print Center**, then **Quit Print Center**.

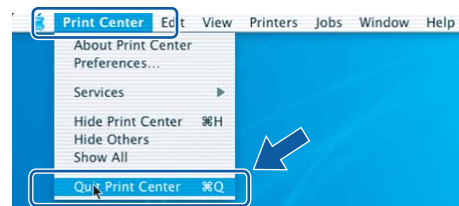
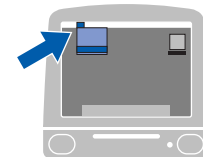

OK!

The installation of MFL-Pro Suite is now complete.
Go to step **20** on page 41.



20 Install Presto!® PageManager®

When Presto!® PageManager® is installed OCR capability is added to Brother ControlCenter2. You can easily scan, share and organize photos and documents using Presto!® PageManager®.

- a** Double-click the **Presto! PageManager** icon and follow the on-screen instructions.



For Mac OS® X 10.2.4 to 10.3.8 users, when this screen appears, click **Go** to download the software from the Brother Solutions Center website.



21 Install MFL-Pro Suite on additional computers (If needed)

If you want to use your machine with multiple computers on the network, install MFL-Pro Suite on each computer. Go to step **18** on page 39.

Finish

The installation is now complete.

1 Install FaceFilter Studio supported by Reallusion, Inc

FaceFilter Studio is an easy-to-use borderless photo printing application. FaceFilter Studio also lets you edit your photo data and add photo effects such as red eye reduction or skin tone enhancement.

Important

- The machine must be ON and connected to the computer.
- The computer must be connected to the Internet.

- a Open the main menu again by ejecting and then reinserting the CD-ROM or by double-clicking the **start.exe** program from the root folder.
- b The CD-ROM main menu will appear. Choose your language and then click **Additional Applications**.



- c Click the **FaceFilter Studio** button to install.



2 Install FaceFilter Studio Help

To get instructions on how to use FaceFilter Studio, download and install FaceFilter Studio Help.

- a To run FaceFilter Studio, go to **Start/All Programs/Reallusion/FaceFilter Studio** on your computer.
- b Click the  button on the upper right corner of the screen.
- c Click **Check for updates** to go to the Reallusion update web page.



- d Click the **Download** button and choose a folder to save the file in.
- e Close FaceFilter Studio before you start the installer for FaceFilter Studio Help. Double-click the downloaded file from the folder you specified and follow the on-screen instructions for installation.

Note

To view the complete FaceFilter Studio Help, choose **Start/All Programs/Reallusion/FaceFilter Studio/FaceFilter Studio Help** on your computer.

3 Install BookScan&Whiteboard Suite supported by Reallusion, Inc

You can install **BookScan&Whiteboard Suite**.
The **BookScan Enhancer** software can correct your scanned book images automatically.
The **Whiteboard Enhancer** software cleans up and enhances text and images from photos taken of your whiteboard. (Internet access required.)

Important

- The machine must be ON and connected to the computer.
- The computer must be connected to the Internet.

- Open the main menu again by ejecting and then reinserting the CD-ROM or by double-clicking the **start.exe** program from the root folder.
- The CD-ROM main menu will appear. Choose your language and then click **Additional Applications**.



- Click the **BookScan&Whiteboard Suite** button to install.

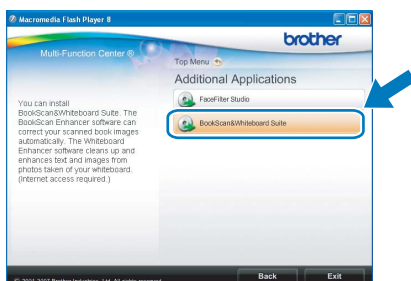

BRAdmin Light utility (For Windows® users)

BRAdmin Light is a utility for initial setup of Brother network connected devices. It also can search for Brother products on your network, view the status and configure basic network settings, such as IP address. For more information on BRAdmin Light, visit us at <http://solutions.brother.com/>.

Note

If you require more advanced printer management, use the latest Brother BRAdmin Professional utility version that is available as a download from <http://solutions.brother.com/>.

Install the BRAdmin Light configuration utility

- a** Click **Advanced** and then **Network Utilities** on the menu screen.



- b** Click **BRAdmin Light** and follow the on-screen instructions.



Set your IP address, Subnet Mask and Gateway using BRAdmin Light

Note

If you have a DHCP/BOOTP/RARP server in your network, you don't have to do the following operation. The machine will automatically obtain its own IP address.

- a** Start BRAdmin Light. It will search for new devices automatically.

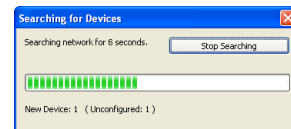

- b** Double-click the unconfigured device.

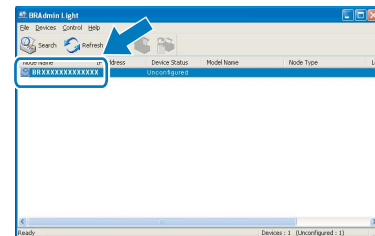

- c** Choose **STATIC** for the **Boot Method**. Enter the **IP Address**, **Subnet Mask** and **Gateway**, and then click **OK**.

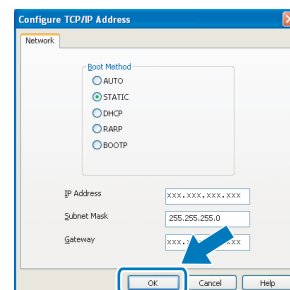

- d** The address information will be saved to the machine.

BRAdmin Light utility (For Mac OS® X users)

BRAdmin Light is a utility for initial setup of Brother network connected devices. It also can search for Brother products on your network, view the status and configure basic network settings, such as IP address from a computer running Mac OS® X 10.2.4 or greater.

The BRAdmin Light software will be installed automatically when you install the printer driver. If you have already installed the printer driver, you don't have to install BRAdmin Light again. For more information on BRAdmin Light, visit us at <http://solutions.brother.com/>.

Set your IP address, Subnet Mask and Gateway using BRAdmin Light

Note

- If you have a DHCP/BOOTP/RARP server in your network, you don't have to do the following operation. The machine will automatically obtain its own IP address.
- Make sure that version 1.4.1_07 or later of Java™ client software is installed on your computer.

- a** Double-click the **Macintosh HD** icon on your desktop.

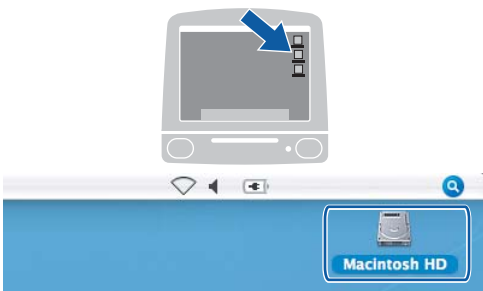

- b** Choose **Library**, **Printers**, **Brother** and then **Utilities**.

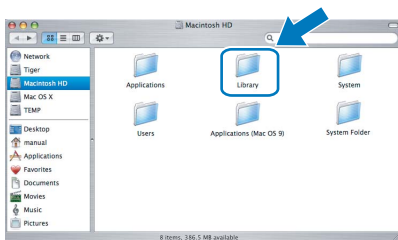

- c** Double-click the file **BRAdmin Light.jar** and run the software. BRAdmin Light will then search for new devices automatically.

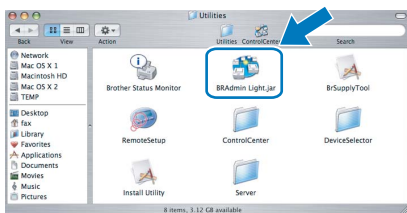

- d** Double-click the unconfigured device.

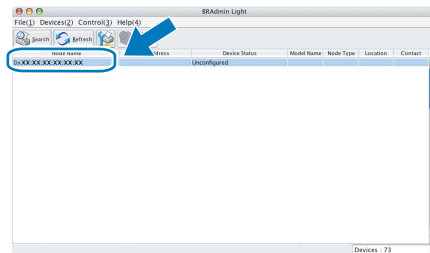

- e** Choose **STATIC** for the **Boot Method**. Enter the **IP Address**, **Subnet Mask** and **Gateway**, and then click **OK**.

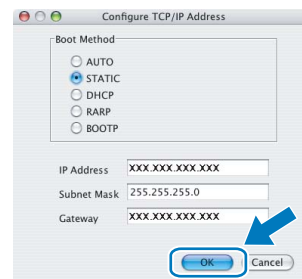

- f** The address information will be saved to the machine.

Restore the network settings to factory default

To restore all network settings of the internal Print/Scan server to factory default, please follow the steps below.

- a** Make sure the machine is not operating, then disconnect all the cables from the machine (except the power cord).
- b** Press **Menu**.
- c** Press **▲** or **▼** to choose **Network**. Press **OK**.
- d** Press **▲** or **▼** to choose **Factory Reset**. Press **OK**.
- e** Press **1** to choose **Yes**.
- f** Press **1** to choose **Yes**.
- g** The machine will restart, re-connect cables once this is complete.

Entering Text for Wireless Settings

Most number keys have three or four letters printed on them. The keys for **0**, **#** and ***** do not have printed letters because they are used for special characters.

By pressing the proper number key repeatedly, you can access the character you want.

For configuring wireless network settings

Press Key	One time	Two times	Three times	Four times	Five times	Six times	Seven times	Eight times
2	a	b	c	A	B	C	2	a
3	d	e	f	D	E	F	3	d
4	g	h	i	G	H	I	4	g
5	j	k	l	J	K	L	5	j
6	m	n	o	M	N	O	6	m
7	p	q	r	s	P	Q	R	S
8	t	u	v	T	U	V	8	t
9	w	x	y	z	W	X	Y	Z

Putting spaces

To enter a space in a name, press **▶** twice between characters.

Making corrections

If you entered a letter incorrectly and want to change it, press **◀** or **▶** to move the cursor under the incorrect character, press **Clear/Back**. Re-enter the correct character. You can also back up and insert letters.

Repeating letters

If you need to enter a letter that is on the same key as the letter before, press **▶** to move the cursor right before you press the key again.

Special characters and symbols

Press *****, **#** or **0** repeatedly until you see the special character or symbol you want. Press **OK** to select it.

Press ***** for (space)! " # \$ % & ' () * + , - . /

Press **#** for ; < = > ? @ [] ^ _

Press **0** for 0 \ { | } ~

Replacement consumables

When the time comes to replace ink cartridges, an error message will be indicated on the LCD. For more information about the ink cartridges for your machine, visit <http://www.brother.com/original/> or contact your local Brother re-seller.

Ink cartridge

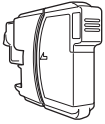
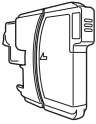
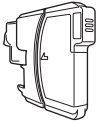
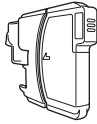
Black	Yellow	Cyan	Magenta
LC61BK	LC61Y	LC61C	LC61M
			

What is Innobella™?

Innobella™ is a range of genuine consumables offered by Brother. The name "Innobella™" derives from the words "Innovation" and "Bella" (meaning "Beautiful" in Italian) and is a representation of the "innovative" technology providing you with beautiful and long lasting print results.



Trademarks

The Brother logo is a registered trademark of Brother Industries, Ltd.
Brother is a registered trademark of Brother Industries, Ltd.
Multi-Function Link is a registered trademark of Brother International Corporation.
Windows Vista is either a registered trademark or a trademark of Microsoft Corporation in the United States and other countries.
Microsoft, Windows and Windows Server are registered trademarks of Microsoft Corporation in the United States and/or other countries.
Macintosh and TrueType are registered trademarks of Apple Inc.
Nuance, the Nuance logo, PaperPort and ScanSoft are trademarks or registered trademarks of Nuance Communications, Inc. or its affiliates in the United States and/or other countries.
Presto! PageManager is a registered trademark of NewSoft Technology Corporation.
PictBridge is a trademark.
FaceFilter Studio is a trademark of Reallusion, Inc.
BROADCOM, SecureEasySetup and the SecureEasySetup logo are trademarks or registered trademarks of Broadcom Corporation in the United States and/or other countries.
AOSS is a trademark of Buffalo Inc.
Wi-Fi, WPA and WPA2 are registered trademarks and Wi-Fi Protected Setup is a trademark of Wi-Fi Alliance.
Each company whose software title is mentioned in this manual has a Software License Agreement specific to its proprietary programs.

All other brand and product names mentioned in this manual are trademarks or registered trademarks of their respective companies.

Compilation and Publication

Under the supervision of Brother Industries, Ltd., this manual has been compiled and published, covering the latest product descriptions and specifications.

The contents of this manual and the specifications of this product are subject to change without notice.

Brother reserves the right to make changes without notice in the specifications and materials contained herein and shall not be responsible for any damages (including consequential) caused by reliance on the materials presented, including but not limited to typographical and other errors relating to the publication.

Copyright and License

©2008 Brother Industries, Ltd.

This product includes software developed by the following vendors:

©1983-1998 PACIFIC SOFTWARE WORKS, INC.

This product includes the "KASAGO TCP/IP" software developed by ELMIC WESCOM, Inc.

©2008 Devicescape Software, Inc.