

brother®

USER'S GUIDE

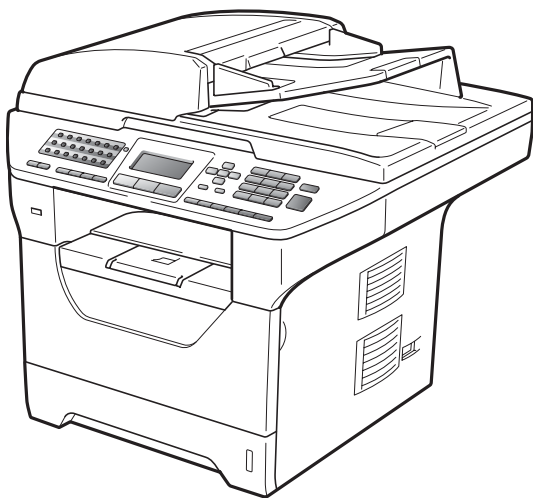

MFC-8480DN
MFC-8680DN
MFC-8690DW
MFC-8890DW

Note: Not all models are available in all countries.

Version 0

USA/CAN

If you need to call Customer Service

Please complete the following information for future reference:

**Model Number: MFC-8480DN, MFC-8680DN,
MFC-8690DW and MFC-8890DW**
(Circle your model number)

Serial Number: ¹ _____

Date of Purchase: _____

Place of Purchase: _____

¹ The serial number is on the back of the unit. Retain this User's Guide with your sales receipt as a permanent record of your purchase, in the event of theft, fire or warranty service.

Register your product on-line at

<http://www.brother.com/registration/>

By registering your product with Brother, you will be recorded as the original owner of the product. Your registration with Brother:

- may serve as confirmation of the purchase date of your product should you lose your receipt;
- may support an insurance claim by you in the event of product loss covered by insurance; and,
- will help us notify you of enhancements to your product and special offers.

The most convenient and efficient way to register your new product is online at <http://www.brother.com/registration/>

Brother numbers

! IMPORTANT

For technical help, you must call the country where you bought the machine. Calls must be made *from within* that country.

Register your product

By registering your product with Brother International Corporation, you will be recorded as the original owner of the product. Your registration with Brother:

- may serve as confirmation of the purchase date of your product should you lose your receipt;
- may support an insurance claim by you in the event of product loss covered by insurance; and,
- will help us notify you of enhancements to your product and special offers.

Please complete and fax the Brother Warranty Registration And Test Sheet or, for your convenience and most efficient way to register your new product, register on-line at

<http://www.brother.com/registration/>

FAQs (frequently asked questions)

The Brother Solutions Center is our one-stop resource for all your Fax Machine/Multi-Function Center needs. You can download the latest software and utilities and read FAQs and troubleshooting tips to learn how to get the most from your Brother product.

<http://solutions.brother.com/>



Note

You can check here for Brother driver updates.

To keep your machine performance up to date, check here for the latest firmware upgrade (Windows®).

For Customer Service

In USA: 1-877-BROTHER (1-877-276-8437)

1-901-379-1215 (fax)

In Canada: 1-877-BROTHER

(514) 685-4898 (fax)

Service Center Locator (USA only)

For the location of a Brother authorized service center, call 1-877-BROTHER (1-877-276-8437).

Service Center Locations (Canada only)

For the location of a Brother authorized service center, call 1-877-BROTHER.

Ordering accessories and supplies

For best quality results use only genuine Brother accessories, which are available at most Brother retailers. If you cannot find the accessory you need and you have a Visa, MasterCard, Discover, or American Express credit card, you can order accessories directly from Brother. (You can visit us online for a complete selection of the Brother accessories and supplies that are available for purchase.)



Note

In Canada, only Visa and MasterCard are accepted.

In USA: 1-877-552-MALL (1-877-552-6255)
1-800-947-1445 (fax)

<http://www.brothermall.com/>

In Canada: 1-877-BROTHER

<http://www.brother.ca/>

Description	Item
Toner Cartridge Standard	TN-620 (Approx. 3,000 pages) ¹
Toner Cartridge High Yield	TN-650 (Approx. 8,000 pages) ¹
Drum Unit	DR-620 (Approx. 25,000 pages) ²
Telephone Line Cord	LG3077001
User's Guide	LX2704001 (English for USA and Canada)
	LS7438002 (French for Canada)
Quick Setup Guide	(MFC-8480DN, MFC-8680DN) LX2021001 (English for USA and Canada)
	(MFC-8690DW, MFC-8890DW) LX2702001 (English for USA and Canada)
	(MFC-8480DN) LS7493002 (French for Canada)
	(MFC-8890DW) LS7450002 (French for Canada)

¹ Approx. cartridge yield is declared in accordance with ISO/IEC 19752.

² Drum yield is approximate, and may vary by type of use.

Notice - Disclaimer of Warranties (USA and Canada)

BROTHER'S LICENSOR(S), AND THEIR DIRECTORS, OFFICERS, EMPLOYEES OR AGENTS (COLLECTIVELY BROTHER'S LICENSOR) MAKE NO WARRANTIES, EXPRESS OR IMPLIED, INCLUDING WITHOUT LIMITATION THE IMPLIED WARRANTIES OF MERCHANTABILITY AND FITNESS FOR A PARTICULAR PURPOSE, REGARDING THE SOFTWARE. BROTHER'S LICENSOR(S) DOES NOT WARRANT, GUARANTEE OR MAKE ANY REPRESENTATIONS REGARDING THE USE OR THE RESULTS OF THE USE OF THE SOFTWARE IN TERMS OF ITS CORRECTNESS, ACCURACY, RELIABILITY, CURRENTNESS OR OTHERWISE. THE ENTIRE RISK AS TO THE RESULTS AND PERFORMANCE OF THE SOFTWARE IS ASSUMED BY YOU. THE EXCLUSION OF IMPLIED WARRANTIES IS NOT PERMITTED BY SOME STATES IN THE USA AND SOME PROVINCES IN CANADA. THE ABOVE EXCLUSION MAY NOT APPLY TO YOU.

IN NO EVENT WILL BROTHER'S LICENSOR(S) BE LIABLE TO YOU FOR ANY CONSEQUENTIAL, INCIDENTAL OR INDIRECT DAMAGES (INCLUDING DAMAGES FOR LOSS OF BUSINESS PROFITS, BUSINESS INTERRUPTION, LOSS OF BUSINESS INFORMATION, AND THE LIKE) ARISING OUT OF THE USE OR INABILITY TO USE THE SOFTWARE EVEN IF BROTHER'S LICENSOR HAS BEEN ADVISED OF THE POSSIBILITY OF SUCH DAMAGES. BECAUSE SOME STATES IN THE USA AND SOME PROVINCES IN CANADA DO NOT ALLOW THE EXCLUSION OR LIMITATION OF LIABILITY FOR CONSEQUENTIAL OR INCIDENTAL DAMAGES, THE ABOVE LIMITATIONS MAY NOT APPLY TO YOU. IN ANY EVENT BROTHER'S LICENSOR'S LIABILITY TO YOU FOR ACTUAL DAMAGES FROM ANY CAUSE WHATSOEVER, AND REGARDLESS OF THE FORM OF THE ACTION (WHETHER IN CONTRACT, TORT (INCLUDING NEGLIGENCE), PRODUCT LIABILITY OR OTHERWISE), WILL BE LIMITED TO \$50.

Compilation and Publication Notice

Under the supervision of Brother Industries Ltd., this manual has been compiled and published, covering the latest product descriptions and specifications.

The contents of this manual and the specifications of this product are subject to change without notice.

Brother reserves the right to make changes without notice in the specifications and materials contained herein and shall not be responsible for any damages (including consequential) caused by reliance on the materials presented, including but not limited to typographical and other errors relating to the publication.

Brother™ One-Year Limited Warranty and Replacement Service (USA Only)

Who is covered:

- This limited warranty (“warranty”) is given only to the original end-user/retail purchaser (referred to in this warranty as “Original Purchaser”) of the accompanying product, consumables and accessories (collectively referred to in this warranty as “this Product”).
- If you purchased a product from someone other than an authorized Brother reseller in the United States or if the product was used (including but not limited to floor models or refurbished product by someone other than Brother), prior to your purchase you are not the Original Purchaser and the product that you purchased is not covered by this warranty.

What is covered:

- This Product includes a Machine and Consumable and Accessory Items. Consumable and Accessory Items include but are not limited to print heads, toner, drums, ink cartridges, print cartridges, cordless handset battery, refill ribbons, thermal PLUS paper and thermal paper.
- Except as otherwise provided herein, Brother warrants that the Machine and the accompanying Consumable and Accessory Items will be free from defects in materials and workmanship, when used under normal conditions.
- This warranty applies only to products purchased and used in the United States. For products purchased in, but used outside, the United States, this warranty covers only warranty service within the United States (and does not include shipping outside the United States).

What is the length of the Warranty Periods:

- Machines: one year from the original purchase date.
- Accompanying Consumable and Accessory Items: 90 days from the original purchase date or the rated life of consumable, whichever comes first.

What is NOT covered:

This warranty does not cover:

- 1 Physical damage to this Product;
- 2 Damage caused by improper installation, improper or abnormal use, misuse, neglect or accident (including but not limited to transporting this Product without the proper preparation and/or packaging);

- 3 Damage caused by another device or software used with this Product (including but not limited to damage resulting from use of non Brother™-brand parts and Consumable and Accessory Items);
- 4 Consumable and Accessory Items that expired in accordance with a rated life;
- 5 Problems arising from other than defects in materials or workmanship; and,
- 6 Normal Periodic Maintenance Items, such as Waste Ink Absorber, Paper Feeding Kit, Fuser and Laser Units.

This limited warranty is VOID if this Product has been altered or modified in any way (including but not limited to attempted warranty repair without authorization from Brother and/or alteration/removal of the serial number).

What to do if you think your Product is eligible for warranty service:

Report your issue to either our Customer Service Hotline at 1-877-BROTHER (1-877-276-8437) or to a Brother Authorized Service Center within the applicable warranty period. Supply Brother or the Brother Authorized Service Center with a copy of your dated bill of sale showing that this Product was purchased within the U.S. For the name of local Brother Authorized Service Center(s), call 1-877-BROTHER (1-877-276-8437) or visit www.brother-usa.com.

What Brother will ask you to do:

After contacting Brother or a Brother Authorized Service Center, you may be required to deliver (by hand if you prefer) or send the Product properly packaged, freight prepaid, to the Authorized Service Center together with a photocopy of your bill of sale. **You are responsible for the cost of shipping, packing product, and insurance (if you desire). You are also responsible for loss or damage to this Product in shipping.**

What Brother will do:

If the problem reported concerning your Machine and/or accompanying Consumable and Accessory Items is covered by this warranty and if you first reported the problem to Brother or an Authorized Service Center within the applicable warranty period, Brother or its Authorized Service Center will repair or replace the Machine and/or accompanying Consumable and Accessory Items at no charge to you for parts or labor. The decision as to whether to repair or replace the Machine and/or accompanying Consumable and Accessory Items is made by Brother in its sole discretion. Brother reserves the right to supply

Brother™ One-Year Limited Warranty and Replacement Service (USA Only)

a refurbished or remanufactured replacement Machine and/or accompanying Consumable and Accessory Items and use refurbished parts provided such replacement products conform to the manufacturer's specifications for new product/parts. The repaired or replacement Machine and/or accompanying Consumable and Accessory Items will be returned to you freight prepaid or made available for you to pick up at a conveniently located Authorized Service Center.

If the Machine and/or accompanying Consumable and Accessory Items are not covered by this warranty (either stage), you will be charged for shipping the Machine and/or accompanying Consumable and Accessory Items back to you and charged for any service and/or replacement parts/products at Brother's then current published rates.

The foregoing are your sole (i.e., only) and exclusive remedies under this warranty.

What happens when Brother elects to replace your Machine:

When a replacement Machine is authorized by Brother, and you have delivered the Machine to an Authorized Service Center, the Authorized Service Center will provide you with a replacement Machine after receiving one from Brother. If you are dealing directly with Brother's Express Exchange Service Brother will send to you a replacement Machine shipped for receipt within two business days, with the understanding that you will, after receipt of the replacement Machine, supply the required proof of purchase information, together with the Machine that Brother agreed to replace. You are then expected to pack the Machine that Brother agreed to replace in the package from the replacement Machine and return it to Brother using the pre-paid freight bill supplied by Brother in accordance with the instructions provided by Brother. Since you will be in possession of two machines, Brother will require that you provide a valid major credit card number. Brother will issue a hold against the credit card account number that you provide until Brother receives your original Product and determines that your original Product is entitled to warranty coverage. Your credit card will be charged up to the cost of a new Product only if: (i) you do not return your original Product to Brother within five (5) business days; (ii) the problems with your original Product are not covered by the limited warranty; (iii) the proper packaging instructions are not followed and has caused

damage to the product; or (iv) the warranty period on your original Product has expired or has not been sufficiently validated with a copy of the proof of purchase (bill of sale). The replacement Machine you receive (even if refurbished or remanufactured) will be covered by the balance of the limited warranty period remaining on the original Product, plus an additional thirty (30) days. You will keep the replacement Machine that is sent to you and your original Machine shall become the property of Brother. **Retain your original Accessory Items and a copy of the return freight bill, signed by the courier.**

Limitations:

Brother is not responsible for damage to or loss of any equipment, media, programs or data related to the use of this Product. Except for the repair or replacement as described above, Brother shall not be liable for any direct, indirect, incidental or consequential damages or specific relief. Because some states do not allow the exclusion or limitation of consequential or incidental damages, the above limitation may not apply to you.

THIS WARRANTY IS GIVEN IN LIEU OF ALL OTHER WARRANTIES, WRITTEN OR ORAL, WHETHER EXPRESSED BY AFFIRMATION, PROMISE, DESCRIPTION, DRAWING, MODEL OR SAMPLE. ANY AND ALL WARRANTIES OTHER THAN THIS ONE, WHETHER EXPRESS OR IMPLIED, INCLUDING IMPLIED WARRANTIES OF MERCHANTABILITY AND FITNESS FOR A PARTICULAR PURPOSE, ARE HEREBY DISCLAIMED.

- This Limited Warranty is the only warranty that Brother is giving for this Product. It is *the final expression and the exclusive and only statement* of Brother's obligations to you. It replaces all other agreements and understandings that you may have with Brother or its representatives.
- This warranty gives you certain rights and you may also have other rights that may vary from state to state.
- This Limited Warranty (and Brother's obligation to you) may not be changed in any way unless you and Brother sign the same piece of paper in which we (1) refer to this Product and your bill of sale date, (2) describe the change to this warranty and (3) agree to make that change.

Important: *We recommend that you keep all original packing materials, in the event that you ship this Product.*

**BROTHER MULTIFUNCTION CENTER / FAX MACHINE
LIMITED WARRANTY
(Canada only)**

Pursuant to the limited warranty of 1 year from the date of purchase for labour and parts, Brother International Corporation (Canada) Ltd. ("Brother"), or its Authorized Service Centres, will repair or replace (at Brother's sole discretion) this MFC/Fax machine free of charge if defective in material or workmanship. This warranty applies only to products purchased and used in Canada.

This limited Warranty does not include cleaning, consumables (including, without limitation, ink cartridges, print cartridges, print rolls, thermal paper rolls, toner cartridges, drum units, OPC belts, fixing units, print heads, paper feed rollers, transfer rolls, cleaning rollers, waste toner packs, oil bottles) or damage caused by accident, neglect, misuse or improper installation or operation, any damage caused from service, maintenance, modifications, or tampering by anyone other than a Brother Authorized Service Representative, or if shipped out of the country.

The use of supplies or consumable items that are non-Brother products may void your warranty. This limited warranty ceases when this machine is rented, sold, or otherwise disposed of. Operation of the MFC/Fax machine in excess of the specifications or with the Serial Number or Rating Label removed shall be deemed abuse and all repairs thereafter shall be the sole liability of the end-user/purchaser.

In order to obtain warranty service, the MFC/Fax machine must be delivered or shipped freight prepaid by the end-user/purchaser to a "Brother" Authorized Service Centre, together with your Canadian Proof of Purchase in the form of a Sales Receipt.

When shipping or transporting your MFC/Fax machine, please refer to your Operation Manual for the proper packaging procedures.

For Laser units: Failure to remove the Toner Cartridge (and Toner Drum Unit, waste toner packs or oil bottles on applicable models) during shipping or transport will cause severe damage to the Laser MFC/Fax machine and will void the Warranty.

For inkjet units: (When shipping your Inkjet MFC/Fax machine remove the ink cartridges and replace them with the original protective parts. If original protective parts are not available, leave ink cartridges installed. Please avoid shipping the unit without original protective parts or ink cartridges.) Damage to your print head resulting from packing the Inkjet MFC/Fax machine without the ink cartridges or the protective parts will void your warranty.

Improper packaging may cause severe damage to the machine during shipping and will void the warranty.

BROTHER DISCLAIMS ALL OTHER WARRANTIES EXPRESSED OR IMPLIED INCLUDING, WITHOUT LIMITATIONS, ANY IMPLIED WARRANTIES OF MERCHANTABILITY OR FITNESS FOR A PARTICULAR PURPOSE, EXCEPT TO THE EXTENT THAT ANY WARRANTIES IMPLIED BY LAW CANNOT BE VALIDLY WAIVED.

No oral or written information, advice or representation provided by Brother, its Authorized Service Centres, Distributors, Dealers, Agents or employees, shall create another warranty or modify this warranty. The warranty states Brother's entire liability and your exclusive remedy against Brother for any failure of the MFC/Fax machine to operate properly.

Neither Brother nor anyone else involved in the development, production, or delivery of this MFC/Fax machine shall be liable for any indirect, incidental, special, consequential, exemplary, or punitive damages, including lost profits, arising from the use of or inability to use the product, even if advised by the end user/purchaser of the possibility of such damages. Since some Provinces do not allow the above limitation of liability, such limitation, may not apply to you.

This Limited Warranty gives you specific legal rights and you may also have other rights which vary from Province to Province.

Warranty Service is available at Brother Authorized Service Centres throughout Canada. For Technical Assistance or for the name and location of your nearest Authorized Service Centre call 1-877-BROTHER.

brother®

Internet support: support@brother.ca or browse Brother's Web Site www.brother.ca.

Table of Contents

Section I General

1	General information	2
	Using the documentation.....	2
	Symbols and conventions used in the documentation	2
	Accessing the Software User's Guide and Network User's Guide	3
	Viewing documentation	3
	Accessing Brother support (Windows®)	5
	Control panel overview	6
	Status LED indications	9
2	Loading paper and documents	10
	Loading paper and print media.....	10
	Loading paper in the standard paper tray.....	10
	Loading paper in the multi-purpose tray (MP tray)	12
	Unprintable area	13
	Acceptable paper and other print media.....	14
	Recommended paper and print media	14
	Type and size of paper	15
	Handling and using special paper	16
	Loading documents	20
	Using the automatic document feeder (ADF)	20
	Using the scanner glass	21
3	General Setup	22
	Mode Timer.....	22
	Paper settings.....	22
	Paper Type	22
	Paper Size	23
	Tray Use in copy mode.....	23
	Tray Use in fax mode	24
	Tray Use in print mode	25
	Volume settings	25
	Ring volume.....	25
	Beeper volume	25
	Speaker volume.....	26
	Automatic daylight savings time	26
	Ecology features.....	27
	Toner Save	27
	Sleep Time	27
	Turning off the scanner lamp.....	28
	LCD Contrast.....	28
	Dial Prefix	29
	Setting up the prefix number	29
	Changing the prefix number	29

4 Security features 30

Secure Function Lock 2.0	30
Setting the password for the administrator	30
Changing the password for the administrator	31
Setting up the public user mode	31
Setting up restricted users	32
Turning Secure Function Lock on/off	33
Switching Users	33
Setting Lock	34
Setting up the password	34
Changing your Setting Lock password	35
Turning Setting Lock on/off	35
Restricting dialing	36
Dial pad restriction	36
One Touch restriction	36
Speed Dial restriction	36
LDAP server restriction (MFC-8690DW and MFC-8890DW)	36

Section II Fax

5 Sending a fax 38

How to fax	38
Entering fax mode	38
Sending a single-sided fax from the ADF	38
Sending a 2-sided fax from the ADF (MFC-8680DN, MFC-8690DW and MFC-8890DW)	38
Sending a fax from the scanner glass	39
Faxing A4/Legal/Folio size documents from the scanner glass	40
Canceling a fax in progress	40
Broadcasting	41
Canceling a Broadcast in progress	41
Additional sending operations	42
Sending faxes using multiple settings	42
Electronic cover page	42
Contrast	44
Changing Fax Resolution	44
Dual access	45
Real Time Transmission	45
Overseas Mode	46
Delayed Fax	46
Delayed batch transmission	46
Checking and canceling waiting jobs	47
Sending a fax manually	47
Sending a fax at the end of a conversation	47
Out of memory message	47

6	Receiving a fax	48
	Choose the correct Receive Mode	48
	Using receive modes	49
	Fax Only	49
	Fax/Tel.....	49
	Manual.....	49
	External TAD	49
	Receive Mode settings	50
	Ring Delay	50
	F/T Ring Time (Fax/Tel mode only).....	50
	Easy Receive.....	51
	Setting the Print Density	51
	Additional receiving operations.....	52
	Printing a reduced incoming fax	52
	Duplex (2-sided) printing for Fax mode	52
	Setting the Fax Receive Stamp	53
	Receiving a fax at the end of a conversation.....	53
	Printing a fax from the memory	53
	Receiving faxes into memory when the paper tray is empty	53
7	Telephone services and external devices	54
	Telephone line services.....	54
	Voice Mail.....	54
	Distinctive Ring.....	54
	Connecting an external TAD (telephone answering device).....	57
	Connections.....	58
	Recording an outgoing message (OGM).....	58
	Special line considerations	58
	Multi-line connections (PBX)	60
	External and extension telephones.....	60
	Using external and extension telephones.....	60
	For Fax/Tel mode only.....	61
	Connecting an external or extension telephone	61
	Using a non-Brother cordless external handset	61
	Using Remote Codes	61
8	Dialing and storing numbers	63
	How to dial.....	63
	Manual dialing	63
	One touch dialing.....	63
	Speed dialing.....	63
	Search	64
	LDAP search (MFC-8690DW and MFC-8890DW).....	64
	Fax redial.....	64

Storing numbers	65
Storing a pause	65
Storing One Touch Dial numbers	65
Storing Speed Dial numbers	67
Changing One Touch and Speed Dial numbers	68
Setting up Groups for Broadcasting	69
Dialing access codes and credit card numbers	70
Pause	70
Tone or Pulse (Canada only)	70

9 Remote Fax Options 71

Fax Forwarding	71
Paging	72
Fax Storage	72
PC Fax Receive	73
Changing Remote Fax Options	74
Turning off Remote Fax Options	74
Remote retrieval	75
Setting a Remote Access Code	75
Using your Remote Access Code	75
Retrieving fax messages	76
Changing the Fax Forwarding number	76
Remote fax commands	77

10 Polling 78

Polling receive	78
Sequential polling	78
Polled transmit	79
Setup for polled transmit	79

11 Printing reports 80

Fax reports	80
Transmission verification report	80
Fax Journal	81
Reports	81
How to print a report	81

Section III Copy

12	Making copies	84
	How to copy.....	84
	Entering copy mode.....	84
	Making a single copy.....	84
	Making multiple copies.....	84
	Stop copying.....	84
	Copy options (temporary settings).....	85
	Enlarging or reducing the image copied.....	85
	Improving copy quality.....	86
	Sorting copies using the ADF.....	86
	Changing text copy resolution.....	86
	Adjusting Contrast and Brightness.....	87
	Making N in 1 copies (page layout).....	88
	Duplex (2-sided) copying.....	89
	Duplex Copy (long edge flip).....	89
	Advanced Duplex Copy (short edge flip).....	90
	Tray selection.....	92
	Out of memory message.....	92

Section IV Direct printing

13	Printing data from a USB Flash memory drive or a digital camera supporting mass storage	94
	Supported file formats.....	94
	Creating a PRN or PostScript® 3™ file for direct printing.....	94
	Printing data directly from the USB Flash memory drive or digital camera supporting mass storage.....	95
	Understanding the error messages.....	97

Section V Software

14	Software and Network features	100
	How to read the HTML User's Guide.....	100
	Windows®.....	100
	Macintosh.....	101

Section VI Appendixes

A	Safety and legal	104
	Choosing a location	104
	To use the machine safely	106
	Important safety instructions	110
	Standard telephone and FCC notices	112
	Industry Canada Compliance Statement (Canada only)	114
	Laser safety (For 110-120V Models only)	114
	FDA regulations (For 110-120V Models only)	115
	Disconnect device	115
	LAN connection	116
	International ENERGY STAR [®] Qualification Statement.....	116
	Libtiff Copyright and License	117
	Trademarks.....	118
B	Options	119
	Options	119
	Optional paper tray (LT-5300)	120
	Memory board.....	120
	Installing extra memory	121
C	Troubleshooting and routine maintenance	122
	Troubleshooting	122
	If you are having difficulty with your machine	122
	Improving the print quality	131
	Setting Dial Tone detection	138
	Telephone line interference	138
	Error and maintenance messages.....	139
	Transferring your faxes or Fax Journal report	144
	Document jams.....	145
	Paper jams	147
	Routine maintenance.....	154
	Cleaning the outside of the machine	154
	Cleaning the scanner.....	155
	Cleaning the laser scanner window	155
	Cleaning the corona wire	157
	Cleaning the drum unit	158
	Replacing the consumable items	160
	Replacing a toner cartridge	161
	Replacing the drum unit.....	164
	Replacing periodic maintenance parts.....	166

Machine Information	166
Checking the Serial Number.....	166
Checking the Page Counters.....	166
Checking the remaining life of parts	167
Reset	167
How to reset	168
Packing and shipping the machine	168
D Menu and features	170
On-screen programming.....	170
Menu table.....	170
Memory storage.....	170
Menu keys	170
How to access the menu mode	171
Menu table	172
Entering text	193
E Specifications	195
General.....	195
Print media.....	197
Fax.....	199
Copy	200
Scan	201
Print	202
Interfaces.....	203
Direct Print feature.....	204
Computer requirements.....	205
Consumable items	207
Ethernet wired network.....	208
Ethernet wireless network (MFC-8690DW and MFC-8890DW)	210
Authentication and encryption for wireless users only.....	212
Wireless one-push configuration	214
F Glossary	215
G Index	219





General

General information	2
Loading paper and documents	10
General Setup	22
Security features	30

Using the documentation

Thank you for buying a Brother machine! Reading the documentation will help you make the most of your machine.

Symbols and conventions used in the documentation

The following symbols and conventions are used throughout the documentation.

Bold	Bold style identifies keys on the machine control panel or computer screen.
<i>Italics</i>	Italicized style emphasizes an important point or refers you to a related topic.
Courier New	Courier New font identifies the messages shown on the LCD of the machine.

WARNING

Warnings tell you what to do to prevent possible personal injury.

CAUTION

Cautions specify procedures you must follow or avoid to prevent possible minor injuries.

IMPORTANT

IMPORTANT describes procedures you must follow or avoid to prevent possible machine problems or damage to other objects.



Electrical Hazard icons alert you to a possible electrical shock.



Hot Surface icons warn you not to touch machine parts that are hot.



Notes tell you how you should respond to a situation that may arise or give tips about how the current operation works with other features.

Accessing the Software User's Guide and Network User's Guide

This User's Guide does not contain all the information about the machine such as how to use the advanced features of Fax, Printer, Scanner, PC Fax and Network. When you are ready to learn detailed information about these operations, read the **Software User's Guide** and **Network User's Guide**.

Viewing documentation

Viewing documentation (Windows®)

To view the documentation, from the **Start** menu, point to **Brother, MFC-XXXX** (where XXXX is your model name) from the program group, and then click **User's Guides in HTML format**.

If you have not installed the software, you can find the documentation by following the instructions below:

- 1 Turn on your PC. Insert the Brother CD-ROM into your CD-ROM drive.
- 2 If the language selection screen appears, click your language.

- 3 If the model name screen appears, click your model name. The CD-ROM main menu will appear.



If this window does not appear, use Windows® Explorer to find and run the start.exe program from the root directory of the Brother CD-ROM.

- 4 Click **Documentation**.
- 5 Click the documentation you want to read:
 - HTML documents (2 manuals): **Software User's Guide** and **Network User's Guide** in HTML format.

This format is recommended for viewing on your computer.
 - PDF documents (4 manuals): **User's Guide** for stand-alone operations, **Software User's Guide**, **Network User's Guide** and **Quick Setup Guide**.

This format is recommended for printing the manuals. Click to go to the Brother Solutions Center, where you can view or download the PDF documents. (Internet access and PDF Reader software are required.)

How to find scanning instructions

There are several ways you can scan documents. You can find the instructions as follows:

Software User's Guide:

- Scanning a document using the TWAIN driver in Chapter 2
- Scanning a document using the WIA driver (Windows® XP/Windows Vista®) in Chapter 2
- Using ControlCenter3 in Chapter 3
- Network Scanning in Chapter 4

ScanSoft™ PaperPort™ 11SE with OCR How-to-Guides:

- The complete ScanSoft™ PaperPort™ 11SE with OCR How-to-Guides can be viewed from the Help selection in the ScanSoft™ PaperPort™ 11SE application.

How to find Network setup instructions (MFC-8690DW and MFC-8890DW)

Your machine can be connected to a wireless or wired network. You can find basic setup instructions in the Quick Setup Guide. If your wireless access point supports SecureEasySetup™, Wi-Fi Protected Setup or AOSS™, follow the steps in the Quick Setup Guide. For more information about network setup please see the Network User's Guide.

Viewing documentation (Macintosh)

- 1 Turn on your Macintosh. Insert the Brother CD-ROM into your CD-ROM drive.
- 2 The following window will appear.



- 3 Double-click the **Documentation** icon.
- 4 If the language selection screen appears, double-click your language.
- 5 Double-click the top page file to view the **Software User's Guide** and **Network User's Guide** in HTML format.
- 6 Click the documentation you want to read.
 - **Software User's Guide**
 - **Network User's Guide**



Note

The documents are also available in PDF format (4 manuals): **User's Guide** for stand-alone operations, **Software User's Guide**, **Network User's Guide** and **Quick Setup Guide**. The PDF format is recommended for printing the manuals.

Double-click **Brother Solutions Center** icon to go to the Brother Solutions Center, where you can view or download the PDF documents. (Internet access and PDF Reader software are required.)

How to find scanning instructions

There are several ways you can scan documents. You can find the instructions as follows:

Software User's Guide:

- Scanning in Chapter 9
- Using ControlCenter2 in Chapter 10
- Network Scanning in Chapter 11

Presto! PageManager User's Guide:

- The complete Presto! PageManager User's Guide can be viewed from the Help selection in the Presto! PageManager application.

How to find Network setup instructions (MFC-8690DW and MFC-8890DW)

Your machine can be connected to a wireless or wired network. You can find basic setup instructions in the Quick Setup Guide. If your wireless access point supports SecureEasySetup™, Wi-Fi Protected Setup or AOSS™, follow the steps in the Quick Setup Guide. For more information about network setup please see the Network User's Guide.

Accessing Brother support (Windows®)

You can find all the contacts you will need, such as Web support (Brother Solutions Center), Customer Service and Brother Authorized Service Centers in *Brother numbers* on page i and on the Brother CD-ROM.

- Click **Brother Support** on the main menu. The following screen will appear:



- To access our web site (<http://www.brother.com/>) click **Brother Home Page**.
- To view all Brother Numbers, including Customer Service numbers for the USA and Canada, click **Support Information**.
- To access the USA Brother online shopping mall (<http://www.brothermall.com/>) for additional product and services information, click **Brother Mall.com**.
- To access Canada's Brother online shopping mall (<http://www.brother.ca/>) for additional product and services information, click **Shop Online (Canada)**.
- For the latest news and product support information (<http://solutions.brother.com/>), click **Brother Solutions Center**.
- To visit our web site for original/genuine Brother supplies (<http://www.brother.com/original/>), click **Supplies Information**.
- To return to the main page, click **Back** or, if you have finished, click **Exit**.

Control panel overview

MFC-8480DN, MFC-8680DN, MFC-8690DW and MFC-8890DW have the same keys.

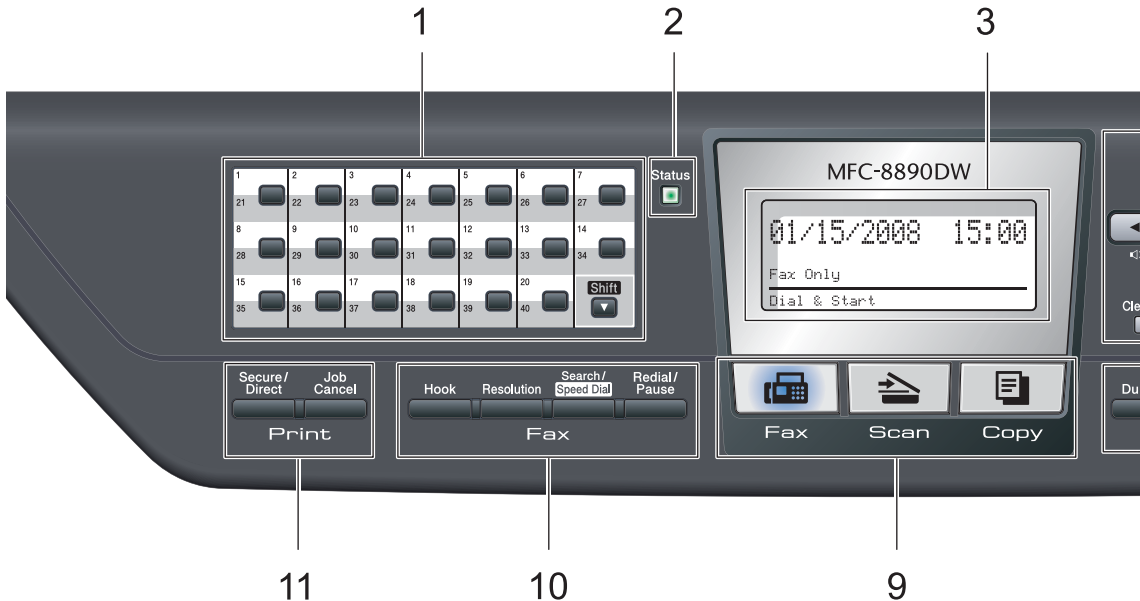

1 One Touch keys

These 20 keys give you instant access to 40 previously stored numbers.

Shift

Lets you access One Touch numbers 21 to 40 when held down.

2 Status LED

The LED will flash and change color depending on the machine status.

3 LCD

Displays messages to help you set up and use your machine.

(MFC-8690DW and MFC-8890DW) A four level indicator shows the current wireless signal strength if you are using a wireless connection.



4 Menu keys:

Menu

Lets you access the Menu to program your settings in this machine.

Clear/Back

Deletes entered data or lets you cancel the current setting.

OK

Lets you store your settings in the machine.

Volume keys

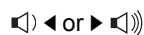

Press to scroll backwards or forwards through menu selections. Press to change the volume when in fax or standby mode.



Press to scroll through the menus and options.

5 Dial pad

Use these keys to dial telephone and fax numbers and as a keyboard for entering information into the machine.

(Canada only) The # key temporarily switches the dialing mode from Pulse to Tone during a telephone call.

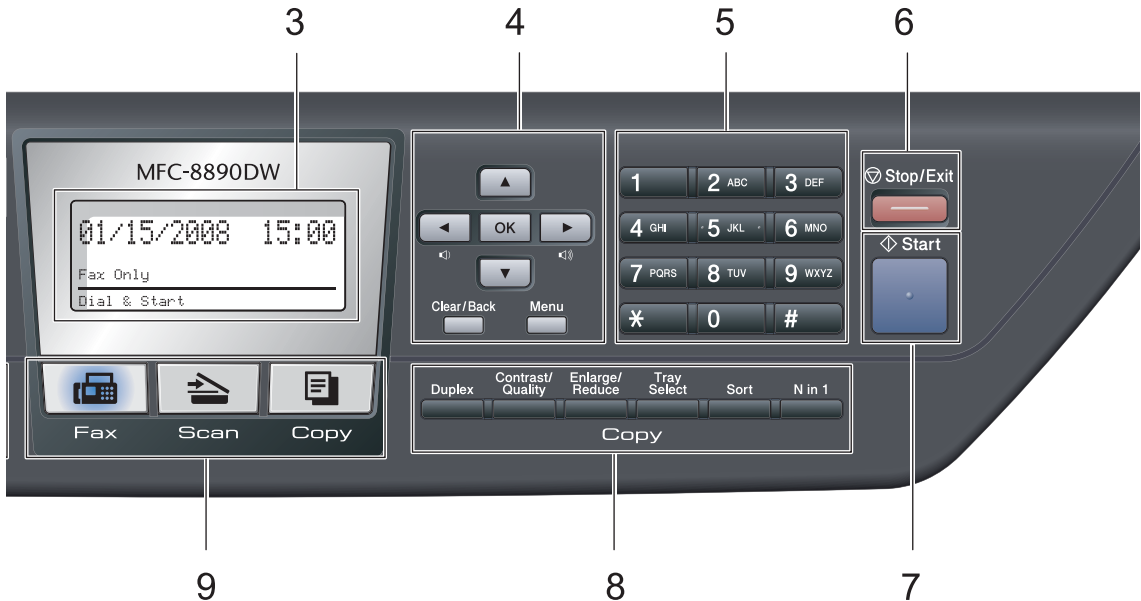
**6 Stop/Exit**

Stops an operation or exits from a menu.

7 Start

Lets you start sending faxes, making copies or scanning.

8 Copy keys:**Duplex**

You can choose Duplex to copy on both sides of the paper.

Contrast/Quality

Lets you change the quality or contrast for the next copy.

Enlarge/Reduce

Reduces or enlarges copies.

Tray Select

Lets you change which tray will be used for the next copy.

Sort

Sorts multiple copies using the ADF.

N in 1

You can choose N in 1 to copy 2 or 4 pages onto one page.

9 Mode keys:

Fax

Puts the machine in Fax mode.



Scan

Puts the machine in Scan mode.

(For details about scanning, see the *Software User's Guide* on the CD-ROM.)



Copy

Puts the machine in Copy mode.

10 Fax and telephone keys:

Hook

Press before dialing if you want to make sure a fax machine will answer, and then press **Start**. Also, press this key after you pick up the handset of an external telephone during the F/T ring (fast double-rings).

Resolution

Sets the resolution when sending a fax.

Search/Speed Dial

Lets you look up numbers stored in memory. It also lets you access speed dial numbers directly if you hold down the **Shift** key and press Search/Speed Dial, and then enter a three digit number.

Redial/Pause

Redials the last number called. It also inserts a pause when programming quick dial numbers or when dialing a number manually.

11 Print Keys:

Secure/Direct

This key has two functions.

■ Secure

You can print data saved in the memory when you enter your four-digit password. (For details about using the Secure key, see the *Software User's Guide* on the CD-ROM.)

When using Secure Function Lock, you can switch restricted users by holding down **Shift** as you press **Secure**. (See *Secure Function Lock 2.0* on page 30.)

■ Direct

Lets you print data from a USB Flash memory drive that you can connect directly to the machine. The Direct key will be active when a USB Flash memory drive is connected to the machine's USB direct interface.

(See *Printing data directly from the USB Flash memory drive or digital camera supporting mass storage* on page 95.)

Job Cancel





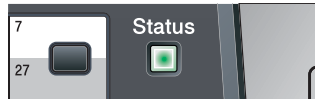

Cancels a programmed print job and clears it from the machine's memory.

To cancel multiple print jobs, hold down this key until the LCD shows
Job Cancel (All).

Status LED indications

The **Status** LED (light emitting diode) will flash and change color depending on the machine's status.

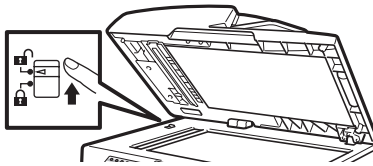

LED	Machine Status	Description
	Sleep Mode	The power switch is off or the machine is in Sleep mode.
 Green (blinking)	Warming Up	The machine is warming up for printing.
 Green	Ready	The machine is ready to print.
 Yellow (blinking)	Receiving Data	The machine is either receiving data from the computer, processing data in memory, or printing data.
 Yellow	Data Remaining in Memory	Print data remains in the machine memory.
 Red (blinking)	Service error	Follow the steps below. 1. Turn off the power switch. 2. Wait a few seconds, and then turn it back on and try to print again. If you cannot clear the error and you see the same service call indication after turning the machine back on, please call Brother Customer Service. (See <i>Brother numbers</i> on page i.)
 Red	Cover open	The front cover or fuser cover is open. Close the cover.
	Toner Life End	Replace the toner cartridge with a new one.
	Paper error	Put paper in the tray or clear the paper jam. Check the LCD message.
	Scan lock	Check that the scanner lock lever is released. 
	Others	Check the LCD message.



Note

When the power switch is off or the machine is in Sleep mode, the LED is off.

2

Loading paper and documents

Loading paper and print media

The machine can feed paper from the standard paper tray, optional lower tray or multi-purpose tray.

When you put paper into the paper tray, note the following:

- If your application software supports paper size selection on the print menu, you can select it through the software. If your application software does not support it, you can set the paper size in the printer driver or by using the control panel buttons.

Loading paper in the standard paper tray

Printing on plain paper, thin paper, recycled paper or transparencies from the paper tray

- 1 Pull the paper tray completely out of the machine.

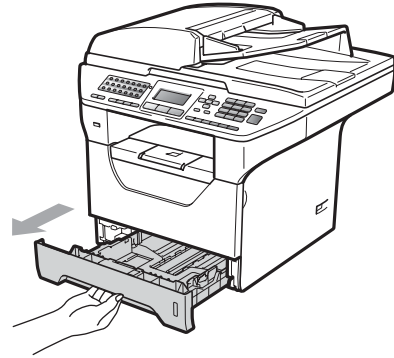

- 2 While pressing the blue paper-guide release lever (1), slide the paper guides to fit the paper size you are loading in the tray. Make sure that the guides are firmly in the slots.

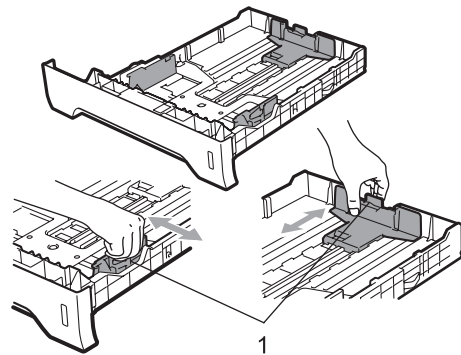

**Note**

For Legal and Folio size paper, press the release button (1) in the bottom of the paper tray and then pull out the back of the paper tray. (Legal or Folio size paper are not available in some regions.)

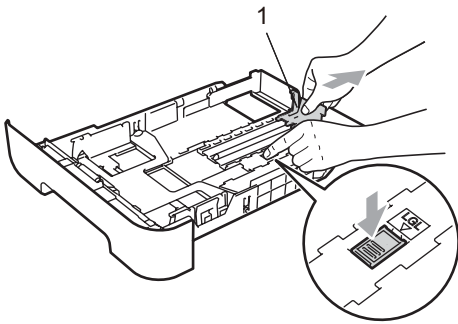

- 3 Fan the stack of paper well to avoid paper jams and misfeeds.

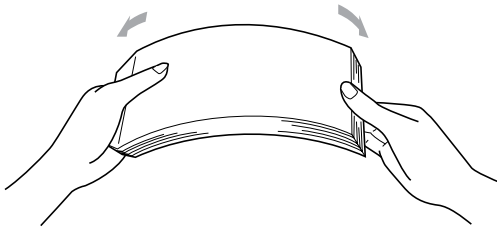

- 4 Put paper in the tray, and make sure that the paper is below the maximum paper mark (1). The side to be printed on must be face down.

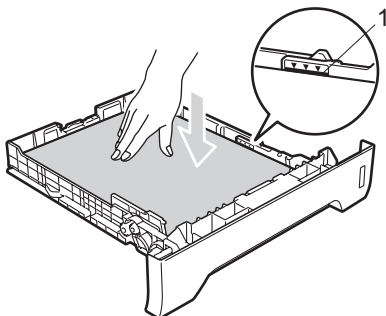
**! IMPORTANT**

Make sure the paper guides touch the sides of the paper so it will feed properly.

- 5 Put the paper tray firmly back in the machine. Make sure that it is completely inserted into the machine.
- 6 Unfold the support flap (1) to prevent paper from sliding off the face-down output tray.

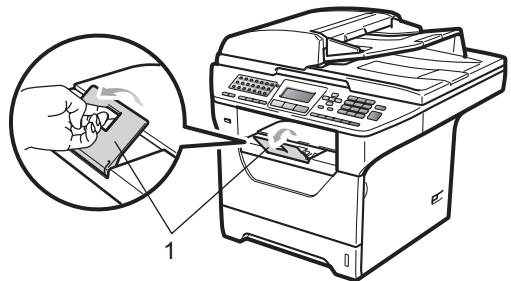

Loading paper in the multi-purpose tray (MP tray)

You can load up to 3 envelopes or special print media in the MP tray or up to 50 sheets of plain paper. Use this tray to print or copy on thick paper, bond paper, envelopes, labels or transparencies.

Printing on thick paper, bond paper, envelopes, labels and transparencies

Before loading, press the corners and sides of the envelopes to make them as flat as possible.

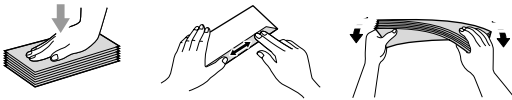

When the back output tray is pulled down, the machine has a straight paper path from the MP tray through to the back of the machine. Use this paper feed and output method when you want to print on thick paper, bond paper, envelopes, labels or transparencies.

! IMPORTANT

Remove each printed sheet or envelope immediately to prevent a paper jam.

- 1 Open the back cover (back output tray).

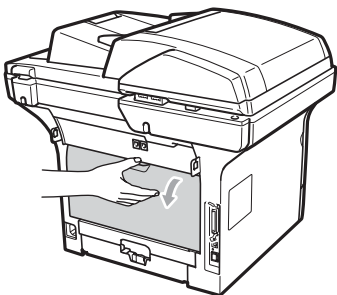

- 2 Open the MP tray and lower it gently.

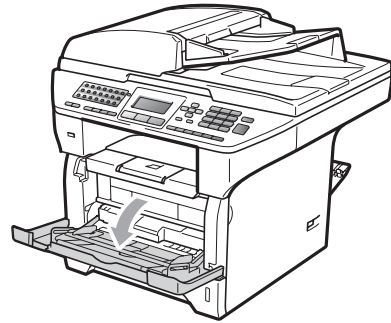

- 3 Pull out the MP tray support (1) and unfold the flap (2).

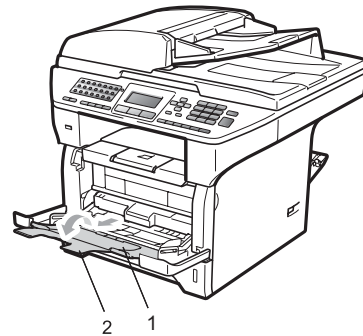

- 4 While pressing the paper side guide release lever, slide the paper guides to fit the width of the paper that you are going to use.

! IMPORTANT

Make sure the paper guides touch the sides of the paper so it will feed properly.

- 5 Put the envelopes (up to 3), thick paper, labels or transparencies in the MP tray with the top edge first and the print side face up. Make sure that the paper stays under the maximum paper mark (▼).

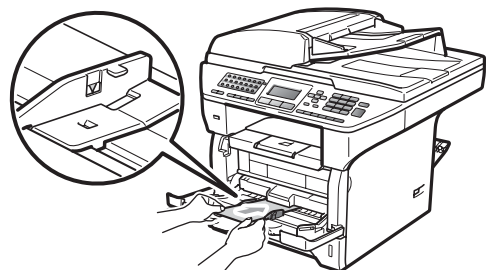

Unprintable area

Unprintable area for faxes and copies

The figures below show unprintable areas.

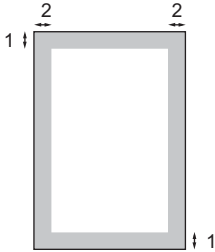

Usage	Document Size	Top (1)	Left (2)
		Bottom (1)	Right(2)
Fax	Letter	0.12 in.(3 mm)	0.16 in.(4 mm)
	A4	0.12 in.(3 mm)	0.16 in.(4 mm)
Copy	Letter	0.12 in.(3 mm)	0.16 in.(4 mm)
	A4	0.12 in.(3 mm)	0.08 in.(2mm)



Note

This unprintable area shown above is for a single copy or a 1 in 1 copy using Letter size paper. The unprintable area changes with the paper size.

Unprintable area when printing from a computer

When using the driver the printable area is smaller than the paper size, as shown below.

Portrait

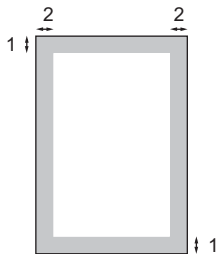

Landscape

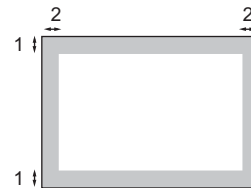

		Windows® printer driver and Macintosh printer driver	BRScript Driver for Windows® and Macintosh
Portrait	1	0.16 in. (4.23 mm)	0.16 in. (4.23 mm)
	2	0.25 in. (6.35 mm)	0.16 in. (4.23 mm)
Landscape	1	0.16 in. (4.23 mm)	0.16 in. (4.23 mm)
	2	0.2 in. (5.08 mm)	0.16 in. (4.23 mm)



Note

The unprintable area shown above is for Letter size paper. The unprintable area changes with the paper size.

Acceptable paper and other print media

Print quality may vary according to the type of paper you are using.

You can use the following types of print media: thin paper, plain paper, thick paper, bond paper, recycled paper, transparencies, labels or envelopes.

For best results, follow the instructions below:

- Use paper made for plain paper copying.
- Use paper that is 16 to 28 lb (60 to 105 g/m²).
- Use labels and transparencies which are designed for use in laser machines.
- DO NOT put different types of paper in the paper tray at the same time because it may cause paper jams or misfeeds.
- For proper printing, you must choose the same paper size from your software application as the paper in the tray.
- Avoid touching the printed surface of the paper immediately after printing.
- When you use transparencies remove each sheet immediately to prevent smudging or paper jams.
- Use long grain paper with a neutral Ph value, and a moisture content of approx. 5%.

Recommended paper and print media

To get the best print quality, we suggest using the following paper.

Paper Type	Item
Plain Paper	Xerox 4200DP 20 lb
	Hammermill Laser Print (24 lb=90 g/m ²)
Recycled Paper	No specific brand recommended
Transparency	3M CG3300
Labels	Avery laser labels white #5160
Envelope	No specific brand recommended

Type and size of paper

The machine loads paper from the installed standard paper tray, optional lower tray or multi-purpose tray.

Standard paper tray

Since the standard paper tray is a universal type, you can use any of the paper sizes (one paper type and size at a time) listed in the table in *Paper capacity of the paper trays* on page 15. The standard paper tray can hold up to 250 sheets of Letter/A4, Legal or Folio size paper (20 lb or 80 g/m²). Paper can be loaded up to the maximum paper mark on the sliding paper width guide.

Multi-purpose tray (MP tray)

The MP tray can hold up to 50 sheets of plain paper (20 lb or 80 g/m²) or up to 3 envelopes. Paper can be loaded up to the maximum paper mark on the sliding paper width guide.

Paper capacity of the paper trays

	Paper size	Paper types	No. of sheets
Paper Tray (Tray #1)	A4, Letter, Legal, Executive, A5, A5 (Long Edge), A6, B5, B6 and Folio ¹ .	Plain paper, Thin paper, Bond paper and Recycled paper	up to 250 20 lb (80 g/m ²)
		Transparency	up to 10
Multi-purpose tray (MP tray)	Width: 2.75 to 8.5 in. (69.8 to 216 mm) Length: 4.57 to 16 in. (116 to 406.4 mm)	Plain paper, Thin paper, Thick paper, Bond paper, Recycled paper, Envelopes and Labels.	up to 50 20 lb (80 g/m ²) up to 3 (envelopes)
		Transparency	up to 10
Paper Tray (Tray #2)	A4, Letter, Legal, Executive, A5, B5, B6 and Folio ¹ .	Thin paper, Plain paper, Bond paper and Recycled paper	up to 250 20 lb (80 g/m ²)

¹ Folio size is 8.5 in. × 13 in. (215.9 mm × 330.2 mm)

Optional lower tray (LT-5300)

The optional lower tray can hold up to 250 sheets of Letter/A4, Legal and Folio size paper (20 lb or 80 g/m²). Paper can be loaded up to the top line of the maximum paper mark on the sliding paper width guide.

The name for the paper trays in the printer driver in this Guide are as follows:

Tray and optional unit	Name
Standard paper tray	Tray 1
Optional lower tray	Tray 2
Multi-purpose tray	MP tray

Recommended paper specifications

The following paper specifications are suitable for this machine.

Basis weight	20-24 lb (75-90 g/m ²)
Thickness	80-110 μm
Roughness	Higher than 20 sec.
Stiffness	90-150 cm ³ /100
Grain direction	Long grain
Volume resistivity	10e ⁹ -10e ¹¹ ohm
Surface resistivity	10e ⁹ -10e ¹² ohm-cm
Filler	CaCO ₃ (Neutral)
Ash content	Below 23 wt%
Brightness	Higher than 80%
Opacity	Higher than 85%

Handling and using special paper

The machine is designed to work well with most types of xerographic and bond paper. However, some paper variables may have an effect on print quality or handling reliability. Always test samples of paper before purchasing to ensure desirable performance. Store paper in its original packaging and keep it sealed. Keep the paper flat and away from moisture, direct sunlight and heat.

Some important guidelines when selecting paper are:

- Do not use inkjet paper because it may cause a paper jam or damage your machine.
- Preprinted paper must use ink that can withstand the temperature of the machine's fusing process (200 degrees centigrade).
- If you use bond paper, paper having a rough surface or paper that is wrinkled or creased, the paper may exhibit degraded performance.

Types of paper to avoid

! IMPORTANT

Some types of paper may not perform well or may cause damage to your machine.

DO NOT use paper:

- that is highly textured
- that is extremely smooth or shiny
- that is curled or warped

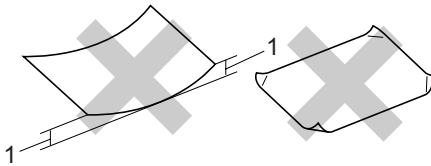

1 0.08 in. (2mm) or greater curl may cause jams to occur.

- that is coated or has a chemical finish
- that is damaged, creased or folded
- that exceeds the recommended weight specification in this guide
- with tabs and staples
- with letterheads using low temperature dyes or thermography
- that is multipart or carbonless
- that is designed for inkjet printing

If you use any of the types of paper listed above, they may damage your machine. This damage is not covered under any Brother warranty or service agreement.

Envelopes

Most envelopes will be suitable for your machine. However, some envelopes may have feed and print-quality problems because of the way they have been made. A suitable envelope should have edges with straight, well-creased folds and the leading edge should not be thicker than two sheets of paper. The envelope should lie flat and not be of baggy or flimsy construction. You should buy quality envelopes from a supplier who understands that you will be using the envelopes in a laser machine.

Envelopes can only be fed from the MP tray. Do not print envelopes using duplex printing. We recommend that you print a test envelope to make sure the print results are what you want before you print or purchase a large quantity of envelopes.

Check the following:

- Envelopes should have a lengthwise sealing flap.
- The sealing flaps should be folded crisply and correctly (irregularly cut or folded envelopes may cause paper jams).
- Envelopes should consist of two layers of paper in the area circled in figure below.

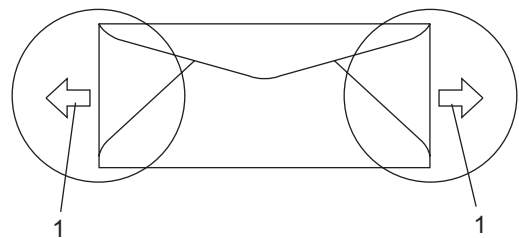

1 Feeding direction

- Envelope joints that are sealed by the manufacturer should be secure.
- We recommend that you do not print within 0.6 in. (15 mm) of the edges of envelopes.

Types of envelopes to avoid

! IMPORTANT

DO NOT use envelopes:

- that are damaged, curled, wrinkled or an unusual shape
- that are extremely shiny or textured
- with clasps, staples, snaps or tie strings
- with self-adhesive closures
- that are of a baggy construction
- that are not sharply creased
- that are embossed (have raised writing on them)
- that were previously printed by a laser machine
- that are pre-printed on the inside
- that cannot be arranged neatly when stacked
- that are made of paper that weighs more than the paper weight specifications for the machine
- with edges that are not straight or consistently square
- with windows, holes, cut-outs or perforations
- with glue on surface as shown in figure below

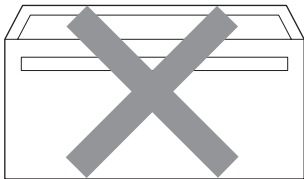

- with double flaps as shown in figure below

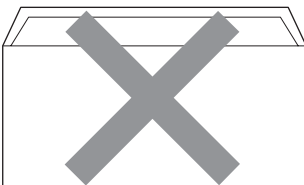

- with sealing flaps that have not been folded at purchase
- with sealing flaps as shown in figure below

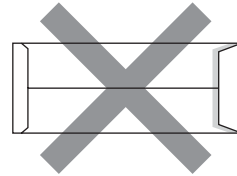

- with each side folded as shown in figure below

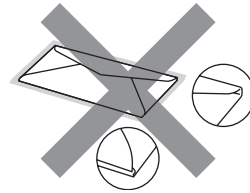

If you use any of the types of envelopes listed above, they may damage your machine. This damage is not covered under any Brother warranty or service agreement.

Occasionally you may experience paper feed problems caused by the thickness, size and flap shape of the envelopes you are using.

Labels

The machine will print on most types of labels designed for use with a laser machine. Labels should have an adhesive that is acrylic-based since this material is more stable at the high temperatures in the fuser unit. Adhesives should not come in contact with any part of the machine, because the label stock may stick to the drum unit or rollers and cause jams and print quality problems. No adhesive should be exposed between the labels. Labels should be arranged so that they cover the entire length and width of the sheet. Using labels with spaces may result in labels peeling off and causing serious jams or print problems.

All labels used in this machine must be able to withstand a temperature of 392 degrees Fahrenheit (200 degrees centigrade) for a period of 0.1 seconds.

Label sheets should not exceed the paper weight specifications described in this User's Guide. Labels exceeding this specification may not feed or print properly and may cause damage to your machine.

Labels can be fed from the MP Tray.

Types of labels to avoid

Do not use labels that are damaged, curled, wrinkled or an unusual shape.

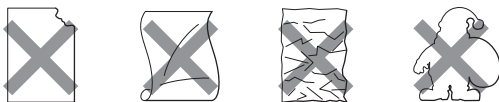

! IMPORTANT

Avoid feeding labels with the carrier sheet exposed because your machine will be damaged.

Loading documents

Using the automatic document feeder (ADF)

The ADF can hold up to 50 pages and feeds each sheet individually. Use standard 20 lb (80 g/m²) paper and always fan the pages before putting them in the ADF.

Recommended environment

Temperature: 68° F to 86° F (20 to 30° C)

Humidity: 50% - 70%

Paper: Xerox 4200 (20 lb/Letter)

! IMPORTANT

- DO NOT leave thick documents on the scanner glass. If you do this, the ADF may jam.
- DO NOT use paper that is curled, wrinkled, folded, ripped, stapled, paper-clipped, pasted or taped.
- DO NOT use cardboard, newspaper or fabric.
- To avoid damaging your machine while using the ADF, DO NOT pull on the document while it is feeding.



Note

To scan non-standard documents see *Using the scanner glass* on page 21.

- Make sure documents written with ink are completely dry.
- Documents to be faxed must be from 5.8 to 8.5 in. (148 to 215.9 mm) wide and from 5.8 to 14 in. (148 to 355.6 mm) long, and of a standard weight [20 lb (80 g/m²)].

- 1 Unfold the ADF document output support flap (1) and the ADF support flap (2).

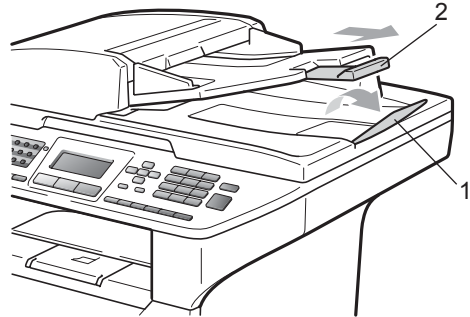

- 2 Fan the pages well.
- 3 Place your document **face up, top edge first** in the ADF until you feel it touch the feed roller.
- 4 Adjust the paper guides (1) to fit the width of your document.

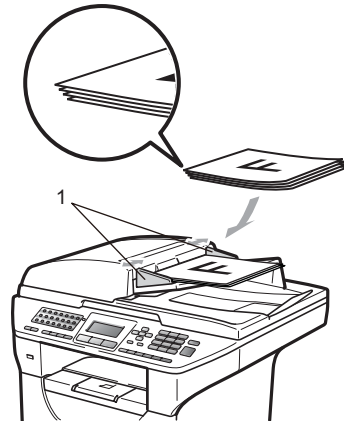

Using the scanner glass

You can use the scanner glass to fax, copy or scan pages of a book or one page at a time.

Documents can be up to 8.5 in. wide and 14 in. long (215.9 mm wide and 355.6 mm long).



Note

To use the scanner glass, the ADF must be empty.

- 1 Lift the document cover.
- 2 Using the document guidelines on the left, center the document face down on the scanner glass.

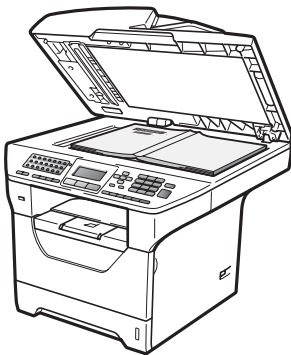
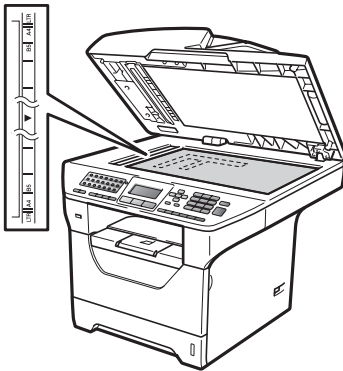

- 3 Close the document cover.

! IMPORTANT

If the document is a book or is thick do not slam the cover or press on it.

3

General Setup

Mode Timer

The machine has three mode keys on the control panel: **Fax**, **Scan**, and **Copy**.

You can set how much time the machine takes after the last Copy or Scan operation to return to Fax mode. If you choose **OFF**, the machine will stay in the mode you used last.

This setting also sets the time the machine will change from individual user to the Public user when using Secure Function Lock. (See *Switching Users* on page 33.)



- 1 Press **Menu**, **1**, **1**.

```
11.Mode Timer
▲ 2 Mins
  5 Mins
▼ Off
Select ▲▼ or OK
```

- 2 Press **▲** or **▼** to choose 0 Sec, 30 Secs, 1 Min, 2 Mins, 5 Mins OR Off. Press **OK**.
- 3 Press **Stop/Exit**.

Paper settings

Paper Type

Set up the machine for the type of paper you are using. This will give you the best print quality.

- 1 Do one of the following:
 - To set the paper type for the MP Tray press **Menu**, **1**, **2**, **1**, **1**.
 - To set the paper type for Tray#1 press **Menu**, **1**, **2**, **1**, **2**.
 - To set the paper type for Tray#2¹ press **Menu**, **1**, **2**, **1**, **3** if you installed the optional tray.

¹ Tray#2 Only or T2 appears only if the optional tray is installed.

```
21.Paper Type
 1.MP Tray
▲ Plain
▼ Thick
Select ▲▼ or OK
```

- 2 Press **▲** or **▼** to choose Thin, Plain, Thick, Thicker, Transparency OR Recycled Paper. Press **OK**.
- 3 Press **Stop/Exit**.



Note

You can choose Transparency for Tray #1 and the MP Tray.

Paper Size

You can use ten sizes of paper for printing copies: Letter, Legal, Executive, A5, A5 L, A6, B5, B6, Folio and A4 and four sizes for printing faxes: A4, Letter, Legal or Folio (8.5"×13").

When you change the size of paper in the tray, you will also need to change the setting for paper size at the same time so your machine can fit the document or an incoming fax on the page.

- 1 Do one of the following:
 - To set the paper size for the MP Tray press **Menu, 1, 2, 2, 1**.
 - To set the paper size for Tray#1 press **Menu, 1, 2, 2, 2**.
 - To set the paper size for Tray#2¹ press **Menu, 1, 2, 2, 3** if you installed the optional tray.

¹ Tray#2 Only or T2 appears only if the optional tray is installed.

```

22.Paper Size
  1.MP Tray
  ▲ Letter
  ▼ Legal
Select ▲▼ or OK
  
```

- 2 Press **▲** or **▼** to choose , Letter, Legal, Executive, A5, A5 L, A6, B5, B6, Folio, A4 or Any. Press **OK**.
- 3 Press **Stop/Exit**.

Note

- Any size appears only when you choose the MP tray.
- If you choose Any for the MP Tray Paper Size: You must choose MP Only for the Tray Use setting. You cannot use the Any Paper Size selection for the MP tray when making N in 1 copies. You must choose one of the other available Paper Size selections for the MP tray.
- A5 L and A6 size are not available for the optional Tray #2.
- If you chose Transparency for the Paper Type you will only be able to choose Letter, Legal, Folio or A4 size paper in step 2.

Tray Use in copy mode

You can change the priority tray that the machine will use for printing copies.

When you choose Tray#1 Only, MP Only or Tray#2 Only¹, the machine pulls the paper only from that tray. If the selected tray is out of paper, No Paper will appear on the LCD. Insert the paper in the empty tray.

To change the tray setting follow the instructions below:

- 1 Press **Menu, 1, 6, 1**.

```

16.Tray Use
  1.Copy
  ▲ MP>T1
  ▼ T1>MP
Select ▲▼ or OK
  
```

- 2 Press **▲** or **▼** to choose Tray#1 Only, Tray#2 Only¹, MP Only, MP>T1>T2¹ or T1>T2¹>MP. Press **OK**.

¹ Tray#2 Only or T2 appears only if the optional tray is installed.

- 3 Press **Stop/Exit**.

 **Note**

- When loading the documents in the ADF and MP>T1>T2 or T1>T2>MP is selected, the machine looks for the tray with the most suitable paper and pulls paper from that tray. If no tray has suitable paper, the machine pulls paper from the higher priority tray.
- When using the scanner glass, your document is copied from the higher priority tray even if more suitable paper is in another paper tray.

Tray Use in fax mode

You can change the default tray that the machine will use for printing received faxes.

When you choose Tray#1 Only, MP Only or Tray#2 Only¹, the machine pulls the paper only from that tray. If the selected tray is out of paper, No Paper will appear on the LCD. Insert the paper in the empty tray.

When you choose T1>T2¹>MP, the machine pulls paper from Tray #1 until it is empty, then from Tray #2, and then from the MP tray.

When you choose MP>T1>T2¹, the machine pulls paper from the MP tray until it is empty, then from Tray #1, and then from Tray #2.

 **Note**

- You can use four sizes of paper for printing faxes: A4, Letter, Legal or Folio. When a suitable size is not in any of the trays received faxes will be stored in the machine's memory and Size Mismatch will appear on the LCD. (For details, see *Error and maintenance messages* on page 139.)
- If the tray is out of paper and received faxes are in the machine's memory, No Paper will appear on the LCD. Insert paper in the empty tray.

- 1 Press **Menu, 1, 6, 2**.

```

16.Tray Use
 2.Fax
▲  MP>T1
▼  T1>MP
-----
Select ▲▼ or OK

```

- 2 Press **▲** or **▼** to choose Tray#1 Only, Tray#2 Only¹, MP Only, MP>T1>T2¹ or T1>T2¹>MP. Press **OK**.

¹ Tray#2 Only or T2 appears only if the optional tray is installed.

- 3 Press **Stop/Exit**.

Tray Use in print mode

You can change the default tray the machine will use for printing from your computer.

- 1 Press **Menu, 1, 6, 3.**

```
16.Tray Use
 3.Print
  ▲ MP>T1
  ▼ T1>MP
Select ▲▼ or OK
```

- 2 Press **▲** or **▼** to choose Tray#1 Only, Tray#2 Only¹, MP Only, MP>T1>T2¹ or T1>T2¹>MP. Press **OK**.

¹ Tray#2 Only or T2 appears only if the optional tray is installed.

- 3 Press **Stop/Exit**.



Note

- The setting in the printer driver will take priority over the setting made on the control panel.
- If the control panel is set to Tray#1 Only, MP Only or Tray#2 Only¹ and you choose **Auto Select** in the printer driver, the machine pulls the paper from that tray.

¹ Tray#2 Only appears only if the optional tray is installed.

Volume settings

Ring volume

You can choose a ring volume level from a range of settings, from High to Off.

While in Fax mode press **◀** or **▶** to adjust the volume level. The LCD will show the current setting, and each key press will change the volume to the next level. The machine will keep the new setting until you change it.

You can also change the ring volume through the menu:

- 1 Press **Menu, 1, 3, 1.**

```
13.Volume
 1.Ring
  ▲ Med
  ▼ High
Select ▲▼ or OK
```

- 2 Press **▲** or **▼** to choose Off, Low, Med or High. Press **OK**.

- 3 Press **Stop/Exit**.

Beeper volume

When the beeper is on, the machine will beep when you press a key, make a mistake, or after you send or receive a fax. You can choose a range of volume levels, from High to Off.

- 1 Press **Menu, 1, 3, 2.**

```
13.Volume
 2.Beeper
  ▲ Med
  ▼ High
Select ▲▼ or OK
```

- 2 Press **▲** or **▼** to choose Off, Low, Med or High. Press **OK**.

- 3 Press **Stop/Exit**.

Speaker volume

You can choose a range of speaker volume levels, from **High** to **Off**.



- 1 Press **Menu**, **1**, **3**, **3**.

```
13. Volume
   3. Speaker
   ▲ Med
   ▼ High
Select ▲▼ or OK
```

- 2 Press **▲** or **▼** to choose **Off**, **Low**, **Med** or **High**.
Press **OK**.

- 3 Press **Stop/Exit**.

You can also adjust the speaker volume with the control panel keys.

- 1 Press  (**Fax**).
 - 2 Press **Hook**.
 - 3 Press  or .
- This setting will stay until you change it again.
- 4 Press **Hook**.

Automatic daylight savings time

You can set the machine to change automatically for Daylight Savings Time. It will set itself forward one hour in the Spring, and back one hour in the Fall.

- 1 Press **Menu** **1**, **4**.

```
14. Auto Daylight
   ▲ On
   ▼ Off
Select ▲▼ or OK
```

- 2 Press **▲** or **▼** to choose **On** or **Off**.
Press **OK**.
- 3 Press **Stop/Exit**.

Ecology features

Toner Save

You can save toner using this feature. When you set Toner Save to *On*, print appears lighter. The default setting is *Off*.

- 1 Press **Menu, 1, 5, 1**.

```

15.Ecology
  1.Toner Save
▲      On
▼      Off
Select ▲▼ or OK
  
```

- 2 Press ▲ or ▼ to choose *On* or *Off*. Press **OK**.
- 3 Press **Stop/Exit**.



Note

We do not recommend Toner Save for printing Photo or Gray Scale images.

Sleep Time

The Sleep Time setting can reduce power consumption by turning off the fuser while the machine is idle.

You can choose how long the machine must be idle before it goes into sleep mode. When the machine receives a fax, computer data, or makes a copy, the timer will be reset. The default setting is 05 minutes.

While the machine is in sleep mode the LCD will display *Sleep*. When printing or copying in sleep mode, there will be a short delay while the fuser warms up.

- 1 Press **Menu 1, 5, 2**.

```

15.Ecology
  2.Sleep Time

  005Min
Enter & OK Key
  
```

- 2 Enter the length of time the machine is idle before entering sleep mode. Press **OK**.
- 3 Press **Stop/Exit**.

Turning off the scanner lamp

The scanner lamp stays on for 16 hours before automatically switching off to preserve the life of the lamp and reduce power consumption.

To turn the scanner lamp off manually press the ◀ and ▶ keys simultaneously. The scanner lamp will remain turned off until the next time you use the scanning feature.



Note

Turning the lamp off regularly will reduce the lamp's life.

LCD Contrast

You can change the contrast to make the LCD look lighter or darker.

- 1 Press **Menu**, **1**, **7**.

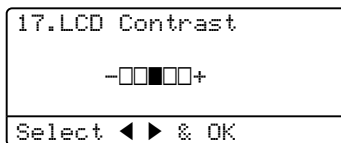

- 2 Press ◀ to make the LCD lighter. Or, press ▶ to make the LCD darker. Press **OK**.
- 3 Press **Stop/Exit**.

Dial Prefix

The Dial Prefix setting will automatically dial a predefined number before every fax number you dial. For example: If your telephone system requires a 9 to dial an outside number use this setting to automatically dial 9 for every fax you send.

Setting up the prefix number

- 1 (USA) Press **Menu, 0, 5**.
(Canada) Press **Menu, 0, 6**.
- 2 Enter the prefix number (up to 5 digits) on the dial pad.
Press **OK**.



Note

- You can use the numbers 0 to 9, #, * and !. (Press **Hook** to display "!".)

You cannot use ! with any other numbers or characters.

If your telephone system requires a timed break recall (hookflash), press **Hook** to enter the break.

- (Canada only) If the pulse dialing mode is on, # and * are not available to use.

- 3 Press **Stop/Exit**.

Changing the prefix number

- 1 (USA) Press **Menu, 0, 5**.
(Canada) Press **Menu, 0, 6**.
- 2 Do one of the following:
 - To change the prefix number, press **1**.
 - To exit without making a change, press **2** and go to 4.
- 3 Enter a new prefix number using the dial pad (up to 5 digits), press **OK**.
- 4 Press **Stop/Exit**.

4

Security features

Secure Function Lock 2.0

Secure Function Lock lets you restrict Public access to the following machine functions:

- PC Print
- USB Direct Print
- Copy
- Fax Tx
- Fax Rx
- Scan

This feature also prevents users from changing the Default settings of the machine by limiting access to the Menu settings.

Before using the security features you must first enter an administrator password.

Access to restricted operations can be enabled by creating a restricted user. Restricted users must enter a user password to use the machine.

Make a careful note of your password. If you forget it, you will have to reset the password stored in the machine. For information about how to reset the password call Brother Customer Service.

Note

- Secure Function Lock can be set manually at the control panel or by using Web Based Management. We recommend using Web Based Management to configure this feature. For more information, see the *Network User's Guide* on the CD-ROM.
- Only administrators can set limitations and make changes for each user.

- When Secure Function Lock is on, you can only use 1. Contrast and 7. Coverpg Setup in the Fax menu.

If Fax Tx is disabled, you cannot use any function in the Fax menu.

- Polling Receive is enabled only when both Fax Tx and Fax Rx are enabled.

Setting the password for the administrator

The password you set in these steps is for the administrator. This password is used to set up users and to turn Secure Function Lock on or off. (See *Setting up restricted users* on page 32 and *Turning Secure Function Lock on/off* on page 33.)

- 1 Press **Menu, 1, 8, 1**.

```
18.Security
 1.Function Lock

New Passwd:XXXX
Enter & OK Key
```

- 2 Enter a four-digit number for the password using numbers 0-9. Press **OK**.
- 3 Re-enter the password when the LCD shows *Verify:*. Press **OK**.
- 4 Press **Stop/Exit**.

Changing the password for the administrator

- 1 Press **Menu, 1, 8, 1**.

```

18.Security
  1.Function Lock
  ▲ Lock Off-On
  ▼ Set Password
Select ▲▼ or OK
  
```

- 2 Press **▲** or **▼** to choose **Set Password**. Press **OK**.
- 3 Enter the registered four-digit password. Press **OK**.
- 4 Enter a four-digit number for the new password. Press **OK**.
- 5 If the LCD shows **Verify**: re-enter the new password. Press **OK**.
- 6 Press **Stop/Exit**.

Setting up the public user mode

Public user mode restricts the functions that are available for Public users. Public users do not need to enter a password to access the features made available through this setting. You can set up one Public user.

- 1 Press **Menu, 1, 8, 1**.

```

18.Security
  1.Function Lock
  ▲ Lock Off-On
  ▼ Set Password
Select ▲▼ or OK
  
```

- 2 Press **▲** or **▼** to choose **Setup ID**. Press **OK**.
- 3 Enter the administrator password. Press **OK**.
- 4 Press **▲** or **▼** to choose **Public**. Press **OK**.
- 5 Press **▲** or **▼** to choose **Enable** or **Disable** for **Fax Tx**. Press **OK**.
After you have set **Fax Tx**, repeat this step for **Fax Rx**, **Copy**, **Scan**, **USB Direct** and **PC Print**.
When you have finished changing settings press **◀** or **▶** to choose **Exit** and press **OK**.
- 6 Press **Stop/Exit**.

Setting up restricted users

You can set up users with restrictions and a password for functions that are available to them. You can set up more advanced restrictions, such as by page count or PC user login name, through Web Based Management. (For more information, see the *Network User's Guide* on the CD-ROM.) You can set up to 25 restricted users with restrictions and a password.

- 1 Press **Menu, 1, 8, 1**.

```

18.Security
 1.Function Lock
▲ Lock Off-On
▼ Set Password
Select ▲▼ or OK

```

- 2 Press ▲ or ▼ to choose `Setup ID`. Press **OK**.
- 3 Enter the administrator password. Press **OK**.
- 4 Press ▲ or ▼ to choose `User01`. Press **OK**.
- 5 Use the numeric keys to enter the user name. (See *Entering text* on page 193.) Press **OK**.
- 6 Enter a four-digit password for the user. Press **OK**.
- 7 Press ▲ or ▼ to choose `Enable` or `Disable` for `Fax Tx`. Press **OK**.
After you have set `Fax Tx`, repeat this step for `Fax Rx`, `Copy`, `Scan`, `USB Direct` and `PC Print`.
When you have finished changing settings press ◀ or ▶ to choose `Exit` and press **OK**.
- 8 Repeat steps 4 to 7 for entering each additional user and password.

- 9 Press **Stop/Exit**.



Note

You cannot use the same name as another user's name.

Turning Secure Function Lock on/off

If you enter the wrong password, the LCD will show `Wrong Password`. Re-enter the correct password.

Turning Secure Function Lock on

- 1 Press **Menu, 1, 8, 1**.

```
18.Security
 1.Function Lock
▲ Lock Off-On
▼ Set Password
Select ▲▼ or OK
```

- 2 Press **▲** or **▼** to choose `Lock Off-On`. Press **OK**.
- 3 Enter your four-digit administrator password. Press **OK**.

Turning Secure Function Lock off

- 1 Press **Menu, 1, 8, 1**.

```
18.Security
 1.Function Lock
▲ Lock On-Off
▼ Change ID
Select ▲▼ or OK
```

- 2 Press **▲** or **▼** to choose `Lock On-Off`. Press **OK**.
- 3 Enter your four-digit administrator password. Press **OK**.

Switching Users

This setting allows you to switch between registered restricted users or Public mode when Secure Function Lock is turned on.

Changing to the restricted user Mode

- 1 Hold down **Shift** as you press **Secure/Direct**.

```
Function Lock
Change ID
▲ Brother
▼ ABC
Select ▲▼ or OK
```

- 2 Press **▲** or **▼** to choose your name. Press **OK**.
- 3 Enter your four-digit password. Press **OK**.

Note

If you press a Mode key that is restricted, `Access Denied` will appear on the LCD and then the machine will ask your name. If you are a restricted user with access to this Mode, press **▲** or **▼** to choose your name and enter your four-digit password.

Changing to the Public Mode

After a restricted user has finished using the machine, it will return to the Public setting within the same time as the Mode Timer setting (**Menu, 1, 1**). (See *Mode Timer* on page 22.) You can also exit from the restricted user mode by pressing the current Mode key you are in. Then the LCD will ask you `Go to Public?`

Press **▲** or **▼** to choose `1. Yes`.

Press **OK**.

Setting Lock

Setting Lock lets you set a password to stop other people from accidentally changing your machine settings.

Make a careful note of your password. If you forget it, you will have to reset the passwords stored in the machine. Please call your administrator or Brother Customer Service.

While Setting Lock is **On**, you cannot change the following settings without a password:

- Date/Time
- Station ID
- Quick Dial settings
- Mode Timer
- Paper Type
- Paper Size
- Volume
- Auto Daylight
- Ecology
- Tray Use
- LCD Contrast
- Document Scan
- Setting Lock
- Secure Function Lock
- Dial Restriction

Setting up the password

- 1 Press **Menu**, **1**, **8**, **2**.

```
18.Security
 2.Setting Lock

New Passwd:XXXX
Enter & OK Key
```

- 2 Enter a four-digit number for the password using numbers 0-9. Press **OK**.
- 3 Re-enter your password when the LCD shows *Verify:*. Press **OK**.
- 4 Press **Stop/Exit**.

Changing your Setting Lock password

- 1 Press **Menu, 1, 8, 2**.

```

18.Security
  2.Setting Lock
  ▲      On
  ▼      Set Password
Select ▲▼ or OK
  
```

- 2 Press **▲** or **▼** to choose **Set Password**. Press **OK**.
- 3 Enter your four-digit password. Press **OK**.
- 4 Enter a four-digit number for the new password. Press **OK**.
- 5 Re-enter your new password when the LCD shows **Verify:.** Press **OK**.
- 6 Press **Stop/Exit**.

Turning Setting Lock on/off

If you enter the wrong password when following the instructions below, the LCD will show **Wrong Password**. Re-enter the correct password.

Turning Setting Lock on

- 1 Press **Menu, 1, 8, 2**.

```

18.Security
  2.Setting Lock
  ▲      On
  ▼      Set Password
Select ▲▼ or OK
  
```

- 2 Press **▲** or **▼** to choose **On**. Press **OK**.
- 3 Enter your four-digit password. Press **OK**.
- 4 Press **Stop/Exit**.

Turning Setting Lock off

- 1 Press **Menu, 1, 8, 2**.

```

18.Security
  2.Setting Lock

Password:XXXX
Enter & OK Key
  
```

- 2 Enter your four-digit password. Press **OK** twice.
- 3 Press **Stop/Exit**.

Restricting dialing

This feature is to prevent users from sending a fax or call to a wrong number by mistake. You can set the machine to restrict dialing by using the dial pad, One Touch, Speed Dial or LDAP search ¹.

If you choose **Off**, the machine does not restrict any dialing method.

If you choose **Enter # twice**, the machine will prompt you to re-enter the number, and then if you re-enter the same number correctly, the machine will start dialing. If you re-enter the wrong number, the LCD will show an error message.

If you choose **On**, the machine will restrict all fax sending and outbound calls.

¹ LDAP search is not available for MFC-8480DN and MFC-8680DN.

Dial pad restriction

- 1 Press **Menu, 2, 6, 1**.

```
26.Dial Restrict.
 1.Dial Pad
▲ Off
▼ Enter # twice
Select ▲▼ or OK
```

- 2 Press **▲** or **▼** to choose **Off**, **Enter # twice** or **On**. Press **OK**.

- 3 Press **Stop/Exit**.

One Touch restriction

- 1 Press **Menu, 2, 6, 2**.

```
26.Dial Restrict.
 2.One Touch Dial
▲ Off
▼ Enter # twice
Select ▲▼ or OK
```

- 2 Press **▲** or **▼** to choose **Off**, **Enter # twice** or **On**. Press **OK**.

- 3 Press **Stop/Exit**.

Speed Dial restriction

- 1 Press **Menu, 2, 6, 3**.

```
26.Dial Restrict.
 3.Speed Dial
▲ Off
▼ Enter # twice
Select ▲▼ or OK
```

- 2 Press **▲** or **▼** to choose **Off**, **Enter # twice** or **On**. Press **OK**.

- 3 Press **Stop/Exit**.

LDAP server restriction (MFC-8690DW and MFC-8890DW)

- 1 Press **Menu, 2, 6, 4**.

```
26.Dial Restrict.
 4.LDAP server
▲ Off
▼ Enter # twice
Select ▲▼ or OK
```

- 2 Press **▲** or **▼** to choose **Off**, **Enter # twice** or **On**. Press **OK**.

- 3 Press **Stop/Exit**.



Note

- The **Enter # twice** setting will not work if you use an external phone or press **Hook** before entering the number. You will not be asked to re-enter the number.
- You can not restrict dialing when you use **Redial/Pause**.
- If you chose **On** or **Enter # twice**, you can not use the Broadcasting feature and can not combine quick dial numbers when dialing.



Fax

Sending a fax	38
Receiving a fax	48
Telephone services and external devices	54
Dialing and storing numbers	63
Remote Fax Options	71
Polling	78
Printing reports	80

5

Sending a fax

How to fax

Entering fax mode

To enter fax mode press  (Fax), and the key will glow blue.

Sending a single-sided fax from the ADF

Using the ADF to send your faxes is the easiest way. To cancel a fax in progress press **Stop/Exit**.

- 1 Make sure you are in Fax mode .
- 2 Place your document *face up* in the ADF.
- 3 Dial the fax number. (See *How to dial* on page 63.)
- 4 Press **Start**.
The machine scans the pages into memory and then sends the document.



Note

If the *Out of Memory* message appears while scanning a document into memory, press **Stop/Exit** to cancel or **Start** to send the scanned pages.

Sending a 2-sided fax from the ADF (MFC-8680DN, MFC-8690DW and MFC-8890DW)

You can send a 2-sided document from the ADF. To cancel a fax in progress press **Stop/Exit**.

- 1 Make sure you are in Fax mode .
- 2 Place your document in the ADF.
- 3 Press **Duplex**.
- 4 Dial the fax number. (See *How to dial* on page 63.)
- 5 Press **Start**.

The machine will now scan and send your document.



Note

- Legal size 2-sided documents cannot be faxed from the ADF.
 - When the machine is ready to scan a 2-sided document the LCD shows  for Duplex in the lower right corner.
-

Changing a 2-sided fax layout

You need to choose the duplex scanning format before you send a fax. The format you choose will depend on the layout of your 2-sided document.

- 1 Press **Menu, 1, 9, 3**.

```

19.Document Scan
 3.Duplex Scan
▲ Long edge
▼ Short edge
Select ▲▼ or OK
  
```

- 2 Do one of the following:

- If your document is flipped on the Long edge, press ▲ or ▼ to choose Long edge.

Press **OK**.

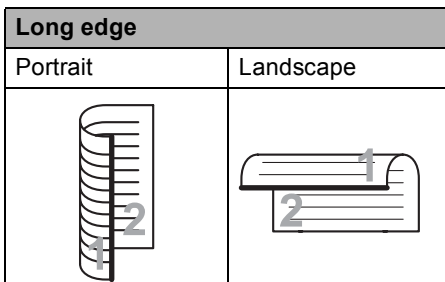

- If your document is flipped on the Short edge, press ▲ or ▼ to choose Short edge.

Press **OK**.

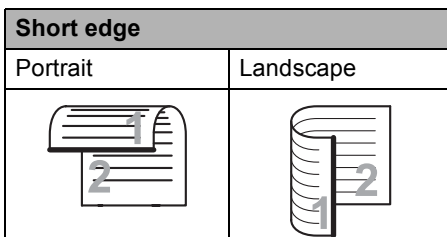

- 3 Press **Stop/Exit**.

Sending a fax from the scanner glass

You can use the scanner glass to fax the pages of a book, or a single page at a time. The documents can be up to Letter, A4, Legal or Folio size. Press **Stop/Exit** to cancel a fax in progress.

- 1 Make sure you are in Fax mode .

- 2 Place your document *face down* on the scanner glass.

- 3 Dial the fax number. (See *How to dial* on page 63.)

- 4 Press **Start**.

The machine starts scanning the first page.

- 5 After the machine scans the page, the LCD will prompt you to choose one of the options below:

```

Flatbed Fax:
Next Page?
▲ 1.Yes
▼ 2.No (Send)
Select ▲▼ or OK
  
```

- Press **1** to send another page. Go to step 6.

- Press **2** or **Start** to send the document. Go to step 7.

- 6 Place the next page on the scanner glass, press **OK**. Repeat steps 5 and 6 for each additional page.

```

Flatbed Fax:

Set Next Page
Then Press OK
  
```

- 7 Your machine will automatically send the fax.

**Note**

When faxing multiple pages from the scanner glass, real time transmission should be set to **Off**. (See *Real Time Transmission* on page 45.)

Faxing A4/Legal/Folio size documents from the scanner glass

When faxing A4/Legal/Folio size documents, you need to set the scan glass size to **A4** or **Legal/Folio** otherwise a portion of your faxes will be missing.

- 1 Make sure you are in Fax mode .
- 2 Press **Menu, 1, 9, 1**.

```

19.Document Scan
   1.Glass ScanSize
   ▲ Letter
   ▼ Legal/Folio
Select ▲▼ or OK

```

- 3 Press **▲** or **▼** to choose **A4** or **Legal/Folio**. Press **OK**.
- 4 Press **Stop/Exit**.

Canceling a fax in progress

Press **Stop/Exit** to cancel the fax. If you press **Stop/Exit** while the machine is dialing or sending, the LCD will show as below:

```

Clear Fax?
   ▲ 1.Yes
   ▼ 2.No
Select ▲▼ or OK

```

Press **1** to cancel the fax.

Broadcasting

Broadcasting lets you send the same fax message to more than one fax number. You can include Groups, One Touch, Speed Dial numbers and up to 50 manually dialed numbers in the same broadcast.

You can broadcast up to 390 different numbers. This will depend on how many groups, access codes or credit card numbers you have stored, and on how many delayed or stored faxes in memory.



Note

Use **Search/Speed Dial** to help you choose numbers easily.

- 1 Make sure you are in Fax mode .
- 2 Load your document.
- 3 Enter a number.
Press **OK**.
You can use either a One Touch, Speed Dial, a Group number, or a number manually entered using the dial pad. (See *How to dial* on page 63.)
- 4 Repeat step 3 until you have entered all the fax numbers you want to broadcast to.
- 5 Press **Start**.

After the broadcast is finished the machine will print a broadcast report to let you know the results.



Note

- The scan profile of the One-Touch, Speed-Dial or Group number you chose first will be applied to the broadcast.
- (MFC-8690DW and MFC-8890DW) If the Fax Resolution setting of the fax number you chose first is *S.Fine* and you enter a stored I-Fax number, *Select Std/Fine* will appear on the LCD. Press **Stop/Exit**. Press **Resolution** and choose *Standard, Fine* or *Photo* then re-enter the I-Fax number. If you want to enter another number, go back to step 3.

5

Canceling a Broadcast in progress

While broadcasting you can cancel the fax currently being sent or the whole broadcast job.

- 1 Press **Menu, 2, 7**.
The LCD will display the Broadcast job number followed by the fax number being dialed (for example, #001 0123456789) and the broadcast job number (for example, Broadcast#001).

```

27.Remaining Jobs
▲ #001 0123456789
▼ Broadcast#001
-----
Select ▲▼ or OK
  
```

- 2 Press **▲** or **▼** to choose the job number you want to cancel.
Press **OK**.
- 3 Press **1** to clear the job number or **2** to exit.
If you chose to only cancel the fax currently being sent in step 2, the machine will ask you if you want to cancel the broadcast. Press **1** to clear the whole broadcast job or **2** to exit.
- 4 Press **Stop/Exit**.

Additional sending operations

Sending faxes using multiple settings

Before you send a fax, you can change any combination of these settings: contrast, resolution, overseas mode, delayed fax timer, polling transmission, real time transmission or cover page settings.

- 1 Make sure you are in Fax mode . After each setting is accepted, the LCD asks if you want to enter more settings:

```

22.Setup Send
  Other Settings?
▲ 1.Yes
▼ 2.No
Select ▲▼ or OK
  
```

- 2 Do one of the following:
 - To choose more settings, press **1**. The LCD returns to the `Setup Send` menu so you can choose another setting.
 - If you have finished choosing settings, press **2** and go to the next step for sending your fax.

Electronic cover page

This feature will *not* work unless you have already programmed your Station ID. (See the *Quick Setup Guide*.)

You can automatically send a cover page with every fax. Your cover page includes your Station ID, a comment, and the name (or number) stored in the One Touch or Speed Dial memory.

By choosing `Next Fax:On` you can also display the number of pages on the cover page.

You can choose one of the following preset comments.

- 1.Comment Off
- 2.Please Call
- 3.Urgent
- 4.Confidential

Instead of using one of the preset comments, you can enter two personal messages of your own, up to 27 characters long. Use the chart on page 193 for help entering characters.

(See *Composing your own comments* on page 43.)

- 5.(User Defined)
- 6.(User Defined)

Composing your own comments

You can set up two comments of your own.

- 1 Make sure you are in Fax mode .
- 2 Press **Menu, 2, 2, 8**.

```
22.Setup Send
 8.Coverpage Msg
▲      5.
▼      6.
Select ▲▼ or OK
```

- 3 Press **▲** or **▼** to choose 5. or 6. to store your own comment. Press **OK**.
- 4 Enter your own comment using the dial pad. Press **OK**.

Use the chart on page 193 for help entering characters.

Send a cover page for the next fax

If you want to send a cover page only for the next fax, your machine will ask you to enter the number of pages you are sending so it can be printed on the cover page.

- 1 Make sure you are in Fax mode .
- 2 Load your document.
- 3 Press **Menu, 2, 2, 7**.

```
22.Setup Send
 7.Coverpg Setup
▲      Next Fax:On
▼      Next Fax:Off
Select ▲▼ or OK
```

- 4 Press **▲** or **▼** to choose Next Fax:On (or Next Fax:Off). Press **OK**.
- 5 Press **▲** or **▼** to choose a comment. Press **OK**.
- 6 Enter two digits to show the number of pages you are sending. Press **OK**.

For example, enter **0, 2** for 2 pages or **0, 0** to leave the number of pages blank. If you make a mistake, press **◀** or **Clear/Back** to back up and re-enter the number of pages.

Send a cover page for all faxes

You can set the machine to send a cover page whenever you send a fax.

- 1 Make sure you are in Fax mode .
- 2 Press **Menu, 2, 2, 7**.

```
22.Setup Send
 7.Coverpg Setup
▲      Next Fax:On
▼      Next Fax:Off
Select ▲▼ or OK
```

- 3 Press **▲** or **▼** to choose On (or Off). Press **OK**.
- 4 Press **▲** or **▼** to choose a comment. Press **OK**.

Using a printed cover page

If you want to use a printed cover page that you can write on, you can print the sample page and attach it to your fax.

- 1 Make sure you are in Fax mode .
- 2 Press **Menu, 2, 2, 7**.

```
22.Setup Send
 7.Coverpg Setup
▲      Next Fax:On
▼      Next Fax:Off
Select ▲▼ or OK
```

- 3 Press **▲** or **▼** to choose Print Sample. Press **OK**.
- 4 Press **Start**.
- 5 After the machine print a copy of your cover page, press **Stop/Exit**.

Contrast

For most documents the default setting of **Auto** will give the best results. It automatically chooses the suitable contrast for your document.

If your document is very light or dark, changing the contrast may improve the quality of the fax.

Use **Dark** to make the faxed document lighter.

Use **Light** to make the faxed document darker.

- 1 Make sure you are in Fax mode .
- 2 Load your document.
- 3 Press **Menu, 2, 2, 1**.

```

22.Setup Send
 1.Contrast
▲   Auto
▼   Light
Select ▲▼ or OK

```

- 4 Press **▲** or **▼** to choose **Auto**, **Light** or **Dark**. Press **OK**.



Note

Even if you choose **Light** or **Dark**, the machine will send the fax using the **Auto** setting if you choose **Photo** as the Fax Resolution.

Changing Fax Resolution

The quality of a fax can be improved by changing the Fax Resolution. Resolution can be changed for the next fax or for all faxes.

To change the Fax Resolution setting for the *next* fax

- 1 Make sure you are in Fax mode .
- 2 Load your document.
- 3 Press **Resolution**, then **▲** or **▼** to choose the resolution. Press **OK**.

To change the default Fax Resolution setting

- 1 Make sure you are in Fax mode .
- 2 Press **Menu, 2, 2, 2**.

```

22.Setup Send
 2.Fax Resolution
▲   Standard
▼   Fine
Select ▲▼ or OK

```

- 3 Press **▲** or **▼** to choose the resolution you want. Press **OK**.



Note

You can choose four different resolution settings.

Standard Suitable for most typed documents.

Fine Good for small print and transmits a little slower than **Standard** resolution.

S.Fine Good for small print or artwork and transmits slower than **Fine** resolution.

Photo Use when the document has varying shades of gray or is a photograph. This has the slowest transmission time.

Dual access

You can dial a number, and start scanning the fax into memory—even when the machine is sending from memory, receiving faxes or printing PC data. The LCD will show the new job number.

The number of pages you can scan into the memory will vary depending on the data that is printed on them.



Note

If you get an **Out of Memory** message while scanning the first page of a fax, press **Stop/Exit** to cancel scanning. If you get an **Out of Memory** message while scanning a subsequent page, you can press **Start** to send the pages scanned so far, or press **Stop/Exit** to cancel the operation.

Real Time Transmission

When you are sending a fax, the machine will scan the documents into the memory before sending. Then, as soon as the telephone line is free, the machine will start dialing and sending.

If the memory is full, the machine will send the document in real time (even if **Real Time TX** is set to **Off**).

Sometimes, you may want to send an important document immediately, without waiting for memory transmission. You can set **Real Time TX** to **On** for all documents or **Next Fax:On** for the next fax only.



Note

In **Real Time Transmission**, the automatic redial feature does not work when using the scanner glass.

Sending in real time for all faxes

1 Make sure you are in Fax mode .

2 Press **Menu**, **2**, **2**, **5**.

```
22.Setup Send
 5.Real Time TX
▲      On
▼      Off
Select ▲▼ or OK
```

3 Press **▲** or **▼** to choose **On**. Press **OK**.

Sending in real time for the next fax only

1 Make sure you are in Fax mode .

2 Press **Menu**, **2**, **2**, **5**.

```
22.Setup Send
 5.Real Time TX
▲      On
▼      Off
Select ▲▼ or OK
```

3 Press **▲** or **▼** to choose **Next Fax:On**. Press **OK**.

Overseas Mode

If you are having difficulty sending a fax overseas due to a bad connection, then turning on Overseas Mode may help.

This is a temporary setting, and will only be active for your next fax.

- 1 Make sure you are in Fax mode .

- 2 Load your document.

- 3 Press **Menu, 2, 2, 9**.

```

22.Setup Send
 9.Overseas Mode
▲   On
▼   Off
Select ▲▼ or OK

```

- 4 Press ▲ or ▼ to choose On or Off.
Press **OK**.

Delayed Fax

You can store up to 50 faxes in the memory to be sent within a twenty four hour period.

- 1 Make sure you are in Fax mode .

- 2 Load your document.

- 3 Press **Menu, 2, 2, 3**.

```

22.Setup Send
 3.Delayed Fax

Set Time=00:00
Enter & OK Key

```

- 4 Enter the time you want the fax to be sent (in 24-hour format).
(For example, enter 19:45 for 7:45 PM)
Press **OK**.



Note

The number of pages you can scan into the memory depends on the amount of data printed on each page.

Delayed batch transmission

Before sending the delayed faxes, your machine will help you economize by sorting all the faxes in the memory by destination and scheduled time.

All delayed faxes that are scheduled to be sent at the same time to the same fax number will be sent as one fax to save transmission time.

- 1 Make sure you are in Fax mode .

- 2 Press **Menu, 2, 2, 4**.

```

22.Setup Send
 4.Batch TX
▲   On
▼   Off
Select ▲▼ or OK

```

- 3 Press ▲ or ▼ to choose On or Off.
Press **OK**.

- 4 Press **Stop/Exit**.

Checking and canceling waiting jobs

Check which jobs are still waiting in the memory to be sent. If there are no jobs, the LCD will show **No Jobs Waiting**. You can cancel a fax job that is stored and waiting in the memory.

- 1 Press **Menu**, **2**, **7**.
The number of jobs still to be sent will be displayed.
- 2 Do one of the following:
 - Press **▲** or **▼** to scroll through the waiting jobs, press **OK** to choose a job, and then press **1** to cancel it.
 - Press **2** to exit without canceling.
- 3 When you have finished, press **Stop/Exit**.

Sending a fax manually

Manual transmission

Manual transmission lets you hear the dialing, ringing and fax-receiving tones while sending a fax.

- 1 Make sure you are in Fax mode .
- 2 Load your document.
- 3 Press **Hook** and listen for a dial tone. Or pick up the handset of the external telephone and listen for a dial tone.
- 4 Dial the fax number you want to call.
- 5 When you hear the fax tone, press **Start**.
 - If you are using the scanner glass, press **1** to send a fax.
- 6 If you picked up the handset of an external telephone, replace it.

Sending a fax at the end of a conversation

At the end of a conversation you can send a fax to the other party before you both hang up.

- 1 Ask the other party to wait for fax tones (beeps) and then to press the **Start** or **Send** key before hanging up.
- 2 Make sure you are in Fax mode .
- 3 Load your document.
- 4 Press **Start**.
 - If you are using the scanner glass, press **1** to send a fax.
- 5 Replace the handset of an external telephone.

Out of memory message

If you get an **Out of Memory** message while scanning the first page of a fax, press **Stop/Exit** to cancel the fax.

If you get an **Out of Memory** message while scanning a subsequent page, you will have the option to press **Start** to send the pages scanned so far, or to press **Stop/Exit** to cancel the operation.



Note

If you get an **Out of Memory** message while faxing and you do not want to delete your stored faxes to clear the memory, you can send the fax in real time. (See *Real Time Transmission* on page 45.)

6

Receiving a fax

Choose the correct Receive Mode

The correct Receive mode is determined by the external devices and telephone subscriber services (Voice Mail, Distinctive Ring, etc.) you have (or will be using) on the same line as the Brother machine.

Will you be using a Distinctive Ring number for receiving faxes?

Brother uses the term "Distinctive Ring" but different telephone companies may have other names for this service such as Custom Ringing, RingMaster, Personalized Ring, Teen Ring, Ident-A-Ring, Ident-A-Call, Date Ident-A-Call, Smart Ring and SimpleBiz Fax & Alternate Number Ringing. (See *Distinctive Ring* on page 54 for instructions on setting up your machine using this feature.)

Will you be using Voice Mail on the same telephone line as your Brother machine?

If you have Voice Mail on the same telephone line as your Brother machine, there is a strong possibility that Voice Mail and the Brother machine will conflict with each other when receiving incoming calls. (See *Voice Mail* on page 54 for instructions on setting up your machine using this service.)

Will you be using a Telephone Answering Device on the same telephone line as your Brother machine?

Your external telephone answering device (TAD) will automatically answer every call. Voice messages are stored on the external TAD and fax messages are printed. Choose `External TAD` as your receive mode. (See *Connecting an external TAD (telephone answering device)* on page 57.)

Will you be using your Brother machine on a dedicated fax line?

Your machine automatically answers every call as a fax. Choose `Fax Only` as your receive mode. (See *Fax Only* on page 49.)

Will you be using your Brother machine on the same line as your telephone?

Do you want to receive voice calls and faxes automatically?

The `Fax/Tel` receive mode is used when sharing the Brother machine and your telephone on the same line. Choose `Fax/Tel` as your receive mode. (See *Fax/Tel* on page 49.)

Important Note: You can not receive voice messages on either Voice Mail or an answering machine when choosing the `Fax/Tel` mode.

Do you expect to receive very few faxes?

Choose `Manual` as your receive mode. You control the telephone line and must answer every call yourself. (See *Manual* on page 49.)

To set the receive mode follow the instructions below:

- 1 Press **Menu**, **0**, **1**.
- 2 Press **▲** or **▼** to choose the receive mode. Press **OK**.
- 3 Press **Stop/Exit**.

The LCD will display the current receive mode.

```
01.Receive Mode
▲ Fax Only
Fax/Tel
▼ External TAD
Select ▲▼ or OK
```

Using receive modes

Some receive modes answer automatically (Fax Only and Fax/Tel). You may want to change the Ring Delay before using these modes. (See *Ring Delay* on page 50.)

Fax Only

Fax Only mode will automatically answer every call as a fax.

Fax/Tel

Fax/Tel mode helps you automatically manage incoming calls, by recognizing whether they are fax or voice calls and handling them in one of the following ways:

- Faxes will be automatically received.
- Voice calls will start the F/T ring to tell you to pick up the line. The F/T ring is a fast double ring made by your machine.

(Also see *F/T Ring Time (Fax/Tel mode only)* on page 50 and *Ring Delay* on page 50.)

Manual

Manual mode turns off all automatic answering functions unless you are using the Distinctive Ring Receive feature.

To receive a fax in Manual mode lift the handset of the external telephone or press **Hook**. When you hear fax tones (short repeating beeps), press **Start**, and then press **2** to receive a fax. You can also use the Easy Receive feature to receive faxes by lifting a handset on the same line as the machine.

(Also see *Easy Receive* on page 51.)

External TAD

External TAD mode lets an external answering device manage your incoming calls. Incoming calls will be handled in the following ways:

- Faxes will be automatically received.
- Voice callers can record a message on the external TAD.

(For more information see *Connecting an external TAD (telephone answering device)* on page 57.)

Receive Mode settings

Ring Delay

The Ring Delay setting sets the number of times the machine rings before it answers in Fax Only and Fax/Tel modes.

If you have external or extension telephones on the same line as the machine, keep the Ring Delay setting of 4. (See *Using external and extension telephones* on page 60 and *Easy Receive* on page 51.)

1 Make sure you are in Fax mode .

2 Press **Menu, 2, 1, 1**.

```
21.Setup Receive
 1.Ring Delay
▲   03
▼   04
Select ▲▼ or OK
```

3 Press ▲ or ▼ to choose 00, 01, 02, 03 or 04 for how many times the line rings before the machine answers. Press **OK**.

4 Press **Stop/Exit**.



Note

Choose 00 in step 3 to have the machine answer immediately.

F/T Ring Time (Fax/Tel mode only)

When somebody calls your machine, you and your caller will hear the normal telephone ring sound. The number of rings is set by the Ring Delay setting.

If the call is a fax, then your machine will receive it; however, if it is a voice call the machine will sound the F/T ring (a fast double-ring) for the time you have set in the F/T Ring Time setting. If you hear the F/T ring it means that you have a voice caller on the line.

Because the F/T ring is made by the machine, extension and external telephones will *not* ring; however, you can still answer the call on any telephone. (For more information see *Using Remote Codes* on page 61.)

1 Make sure you are in Fax mode .

2 Press **Menu, 2, 1, 2**.

```
21.Setup Receive
 2.F/T Ring Time
▲   20 Secs
▼   30 Secs
Select ▲▼ or OK
```

3 Press ▲ or ▼ to choose how long the machine will ring to alert you that you have a voice call (20, 30, 40 or 70 seconds). Press **OK**.

4 Press **Stop/Exit**.

Easy Receive

If Easy Receive is On:

The machine can receive a fax automatically, even if you answer the call. When you see *Receiving* on the LCD or hear a click on the phone line through the handset you are using, just replace the handset. Your machine will do the rest.

If Easy Receive is Off:

If you are at the machine and answer a fax call first by lifting an external handset, then press **Start**, and then press **2** to receive.

If you answered at an extension telephone press ***51**. (See *Using external and extension telephones* on page 60.)



Note

- If this feature is set to **On**, but your machine does not connect a fax call when you lift an extension telephone handset, press the fax receive code ***51**.
- If you send faxes from a computer on the same telephone line and the machine intercepts them, set Easy Receive to **Off**.

1 Make sure you are in Fax mode .

2 Press **Menu, 2, 1, 3**.

```

21.Setup Receive
 3.Easy Receive
▲      On
▼      Off
Select ▲▼ or OK
  
```

3 Press **▲** or **▼** to choose **On** or **Off**. Press **OK**.

4 Press **Stop/Exit**.

Setting the Print Density

You can adjust the Print Density setting to make your printed pages darker or lighter.

1 Make sure you are in Fax mode .

2 Press **Menu, 2, 1, 6**.

```

21.Setup Receive
 6.Print Density
  -□□□□+
Select ◀ ▶ & OK
  
```

3 Press **◀** to make the print darker. Or, press **▶** to make the print lighter. Press **OK**.

4 Press **Stop/Exit**.

Additional receiving operations

Printing a reduced incoming fax

If you choose **On**, the machine automatically reduces each page of an incoming fax to fit on one page of A4, Letter, Legal or Folio size paper.

The machine calculates the reduction ratio by using the page size of the fax and your Paper Size setting (**Menu, 1, 2, 2**).

- 1 Make sure you are in Fax mode .
- 2 Press **Menu, 2, 1, 5**.

```

21.Setup Receive
 5.Auto Reduction
▲      On
▼      Off
Select ▲▼ or OK
  
```

- 3 Press **▲** or **▼** to choose **On** or **Off**. Press **OK**.
- 4 Press **Stop/Exit**.

Duplex (2-sided) printing for Fax mode

Your machine can automatically print received faxes onto both sides of the paper when Duplex is set to **On**.

You can use Letter, Legal, A4 or Folio (8.5"×13") size paper for this function (16 to 28 lb/60 to 105 g/m²).

- 1 Make sure you are in Fax mode .
- 2 Press **Menu, 2, 1, 9**.

```

21.Setup Receive
 9.Duplex
▲      On
▼      Off
Select ▲▼ or OK
  
```

- 3 Press **▲** or **▼** to choose **On** (or **Off**). Press **OK**.
- 4 Press **Stop/Exit**.



Note

When you turn on Duplex the Auto Reduction feature is also turned on.

Setting the Fax Receive Stamp

You can set the machine to print the received date and time in the top center of each received fax page.

1 Make sure you are in Fax mode .

2 Press **Menu, 2, 1, 8**.

```
21.Setup Receive
 8.Fax Rx Stamp
▲   On
▼   Off
Select ▲▼ or OK
```

3 Press **▲** or **▼** to choose On or Off. Press **OK**.

4 Press **Stop/Exit**.



Note

- The received time and date will not appear when using Internet Fax.
- Make sure you have set the current date and time in the machine.

Receiving a fax at the end of a conversation

At the end of a conversation you can ask the other party to send you a fax before you both hang up.

1 Ask the other party to place the document in their machine and to press the Start or Send key.

2 When you hear the CNG tones (slowly repeating beeps), press **Start**.

3 Press **2** to receive a fax.

4 Replace the external handset.

Printing a fax from the memory

If you are using the Fax Storage feature (**Menu, 2, 5, 1**), you can still print a fax from the memory when you are at your machine. (See *Fax Storage* on page 72.)

1 Press **Menu, 2, 5, 3**.

```
25.Remote Fax Opt
 3.Print Fax
Press Start
```

2 Press **Start**.

3 Press **Stop/Exit**.

Receiving faxes into memory when the paper tray is empty

As soon as the paper tray becomes empty during fax reception, the LCD shows **No Paper** and begins receiving faxes into the machine's memory. Put some paper in the paper tray. (See *Loading paper and print media* on page 10.)

The machine will carry on receiving the fax, with the remaining pages being stored in memory, if enough memory is available.

Further incoming faxes will also be stored into memory until the memory is full. When the memory is full the machine will stop automatically answering calls. To print the faxes, put fresh paper in the tray.

Telephone line services

Voice Mail

If you have Voice Mail on the same telephone line as your Brother machine, Voice Mail and the Brother machine will conflict with each other when receiving incoming calls.

For example, if your Voice Mail is set to answer after 4 rings and your Brother machine is set to answer after 2 rings, then your Brother machine will answer first. This will prevent callers from being able to leave a message in your Voice Mail.

Similarly, if your Brother machine is set to answer after 4 rings and your Voice Mail is set to answer after 2 rings, then your Voice Mail will answer first. This will prevent your Brother machine from being able to receive an incoming fax, since Voice Mail cannot transfer the incoming fax back to the Brother machine.

To avoid conflicts between your Brother machine and your Voice Mail service, do one of the following:

Get the Distinctive Ring service from your telephone company. Distinctive Ring is a feature of your Brother machine that allows a person with one line to receive fax and voice calls through two different telephone numbers on that one line. Brother uses the term 'Distinctive Ring,' but telephone companies market the service under a variety of names, such as Custom Ringing, Personalized Ring, Smart Ring, RingMaster, Ident-A-Ring, Ident-A-Call, Data Ident-A-Call, Teen Ring, and SimpleBiz Fax & Alternate Number Ringing. This service establishes a second telephone number on the same line as your existing telephone number, and each number has its own ring pattern.

Typically, the original number rings with the standard ring pattern and is used for receiving voice calls, and the second number rings with a different ring pattern and is used for receiving faxes. (See *Distinctive Ring* on page 54.)

OR

Set your Brother machine's Receive Mode to "Manual". Manual Mode requires that you answer every incoming call if you want to be able to receive a fax. If the incoming call is a telephone call, then complete the call as you normally would. If you hear fax sending tones you must transfer the call to the Brother machine. (See *Using external and extension telephones* on page 60.) Unanswered fax and voice calls will go to your Voice Mail. (To set the machine in **MANUAL** Mode, see *Choose the correct Receive Mode* on page 48.)

Distinctive Ring

Distinctive Ring is a function of your Brother machine that allows a person with one line to receive fax and voice calls through two different phone numbers on that one line. Brother uses the term "Distinctive Ring," but telephone companies market the service under a variety of names, such as Smart Ring, Ring Master or Ident-a-Ring. This service establishes a second telephone number on the same line as your existing telephone number, and each number has its own ring pattern. Typically, the original number rings with the standard ring pattern and is used for receiving voice calls, and the second number rings with a different ring pattern and is used for receiving faxes.

**Note**

- You must pay for your telephone company's Distinctive Ring service before you program the machine to work with it.
- Please call your telephone company for availability and rates.

What does your telephone company's 'Distinctive Ring' do?

Your telephone company's Distinctive Ring service allows you to have more than one number on the same telephone line. **If you need more than one telephone number, it is cheaper than paying for an extra line.** Each telephone number has its own distinctive ring pattern, so you will know which telephone number is ringing. This is one way you can have a separate telephone number for your machine.

**Note**

Please call your telephone company for availability and rates.

What does Brother's 'distinctive ring' do?

The Brother machine has a Distinctive Ring feature that allows you to use your machine to take full advantage of the telephone company's Distinctive Ring service. The new telephone number on your line can just receive faxes.

**Note**

You must pay for your telephone company's Distinctive Ring service before you program the machine to work with it.

Do you have Voice Mail?

If you have Voice Mail on the telephone line that you will install your new machine on, *there is a strong possibility that Voice Mail and the machine will conflict with each other while receiving incoming calls.* **However, the Distinctive Ring feature allows you to use more than one number on your line, so both Voice Mail and the machine can work together without any problems.** If each one has a separate telephone number, neither will interfere with the other's operations.





If you decide to get the Distinctive Ring service from the telephone company, you will need to follow the directions below to 'register' the new Distinctive Ring pattern they give you. This is so your machine can recognize its incoming calls.

**Note**

You can change or cancel the Distinctive Ring pattern at any time. You can switch it off temporarily, and turn it back on later. When you get a new fax number, make sure you reset this feature.

Before you choose the ring pattern to register

You can only register one Distinctive Ring pattern with the machine. Some ring patterns cannot be registered. The ring patterns below are supported by your Brother machine. Register the one your telephone company gives you.

Ring Pattern	Rings	
1	long-long	
2	short-long-short	
3	short-short-long	
4	very long (normal pattern)	



Note

- Ring Pattern #1 is often called Short-Short and is the most commonly used.
 - If the ring pattern you received is not on this chart, **please call your telephone company and ask for one that is shown.**
-
- The machine will only answer calls to its registered number.
 - The first two rings are silent on the machine. This is because the fax must <<listen>> to the ring pattern (to compare it to the pattern that was 'registered'). (Other telephones on the same line will ring.)
 - If you program the machine properly, it will recognize the registered ring pattern of the 'fax number' within 2 ring patterns and then answer with a fax tone. When the 'voice number' is called, the machine will not answer.

Registering the distinctive ring pattern Very important!

After you have set the Distinctive Ring feature to On, your Distinctive Ring number will receive faxes automatically. The receive mode is automatically set to Manual and you cannot change it to another receive mode while Distinctive Ring is set to On. This ensures the Brother machine will only answer the Distinctive Ring number and not interfere when your main telephone number is called.

- 1 Press **Menu, 2, 0, 2.**

```

20.Miscellaneous
 2.Distinctive
▲   Off
▼   Set
Select ▲▼ or OK
  
```

- 2 Press **▲** or **▼** to choose **Set**.
- 3 Press **OK**.
- 4 Press **▲** or **▼** to choose the prestored ring pattern you want to use. Press **OK**. (You will hear each pattern as you scroll through the four patterns. Make sure you choose the pattern that the telephone company gave you.)
- 5 Press **Stop/Exit**. Distinctive Ring is now set to On.

Turning off distinctive ring

- 1 Press **Menu, 2, 0, 2**.

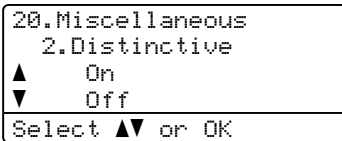

- 2 Press ▲ or ▼ to choose **Off**. Press **OK**.

- 3 Press **Stop/Exit**.



Note

If you do not want to receive faxes on your Distinctive Ring number, you can turn off Distinctive Ring. The machine will stay in *Manual* receive mode so you will need to set the Receive Mode again. (See *Choose the correct Receive Mode* on page 48.)

Connecting an external TAD (telephone answering device)

You can connect an external Telephone Answering Device (TAD) to the same line as your machine. When the TAD answers a call, your machine will “listen” for the CNG (fax calling) tones sent by a sending fax machine. If it hears them it will take over the call and receive the fax. If it does not hear them, it will let your TAD take a voice message and the display will show *Telephone*.

The external TAD must answer within four rings (we recommend you set it to two rings). This is because your machine cannot hear the CNG tones until the external TAD has picked up the call. The sending machine will send CNG tones for only eight to ten seconds longer. We do not recommend using the toll saver feature on your external TAD if it needs more than four rings to activate it.

Unless you are using Distinctive Ring, the TAD must be connected to the **EXT.** jack of the machine.

Before you connect an external TAD (telephone answering device), remove the protective cap (2) from the **EXT.** jack on the machine.

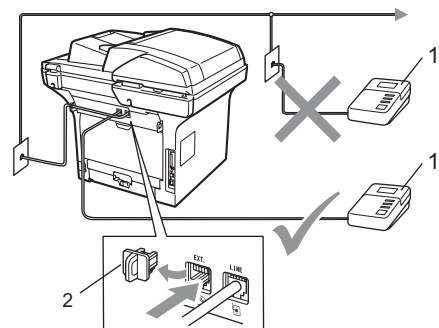

- 1 TAD
- 2 Protective Cap

**Note**

If you have problems receiving faxes, reduce the ring delay setting on your external TAD.

Connections

The external TAD must be plugged into the back of the machine, into the jack labeled EXT. Your machine cannot work properly if you plug the TAD into a wall jack (unless you are using Distinctive Ring).

- 1 Plug the telephone line cord from the telephone wall jack into the back of the machine, in the jack labeled LINE.
- 2 Plug the telephone line cord from your external TAD into the back of the machine, in the jack labeled EXT. (Make sure this cord is connected to the TAD at the TAD's telephone line jack, and not its handset jack.)
- 3 Set your external TAD to four rings or less. (The machine's Ring Delay setting does not apply.)
- 4 Record the outgoing message on your external TAD.
- 5 Set the TAD to answer calls.
- 6 Set the Receive Mode to *External TAD*. (See *Choose the correct Receive Mode* on page 48.)

Recording an outgoing message (OGM)

- 1 Record 5 seconds of silence at the beginning of your message. This allows your machine time to listen for fax tones.
- 2 Limit your speaking to 20 seconds.
- 3 End your 20-second message by giving your Fax Receive Code for people sending manual faxes. For example: "After the beep, leave a message or send a fax by pressing *51 and **Start**."

**Note**

We recommend beginning your OGM with an initial 5 second silence because the machine cannot hear fax tones over a loud voice. You may try leaving out this pause, but if your machine has trouble receiving, then you should re-record the OGM to include it.

Special line considerations

Roll over telephone lines

A roll over telephone system is a group of two or more separate telephone lines that pass incoming calls to each other if they are busy. The calls are usually passed down or "rolled over" to the next available telephone line in a preset order.

Your machine can work in a roll over system as long as it is the last number in the sequence, so the call cannot roll away. Do not put the machine on any of the other numbers; when the other lines are busy and a second fax call is received, the fax call would be transferred to a line that does not have a fax machine. **Your machine will work best on a dedicated line.**

Two-line telephone system

A two-line telephone system is nothing more than two separate telephone numbers on the same wall outlet. The two telephone numbers can be on separate jacks (RJ11) or combined into one jack (RJ14). Your machine must be plugged into an RJ11 jack. RJ11 and RJ14 jacks may be equal in size and appearance and both may contain four wires (black, red, green, yellow). To test the type of jack, plug in a two-line telephone and see if it can access both lines. If it can, you must separate the line for your machine. (See *Easy Receive* on page 51.)

Converting telephone wall outlets

There are three ways to convert to an RJ11 jack. The first two ways may require assistance from the telephone company. You can change the wall outlets from one RJ14 jack to two RJ11 jacks. Or, you can have an RJ11 wall outlet installed and slave or jump one of the telephone numbers to it.

The third way is the easiest: Buy a triplex adapter. You can plug a triplex adapter into an RJ14 outlet. It separates the wires into two separate RJ11 jacks (Line 1, Line 2) and a third RJ14 jack (Lines 1 and 2). If your machine is on Line 1, plug the machine into L1 of the triplex adapter. If your machine is on Line 2, plug it into L2 of the triplex adapter.

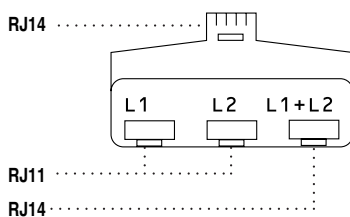

Installing machine, external two-line TAD and two-line telephone

When you are installing an external two-line telephone answering device (TAD) and a two-line telephone, your machine must be isolated on one line at both the wall jack and at the TAD. The most common connection is to put the machine on Line 2, which is explained in the following steps. The back of the two-line TAD must have two telephone jacks: one labeled L1 or L1/L2, and the other labeled L2. You will need at least three telephone line cords, the one that came with your machine and two for your external two-line TAD. You will need a fourth line cord if you add a two-line telephone.

Place the two-line TAD and the two-line telephone next to your machine.

Plug one end of the telephone line cord for your machine into the L2 jack of the triplex adapter. Plug the other end into the LINE jack on the back of the machine.

Plug one end of the first telephone line cord for your TAD into the L1 jack of the triplex adapter. Plug the other end into the L1 or L1/L2 jack of the two-line TAD.

Plug one end of the second telephone line cord for your TAD into the L2 jack of the two-line TAD. Plug the other end into the EXT. jack on the left side of the machine.

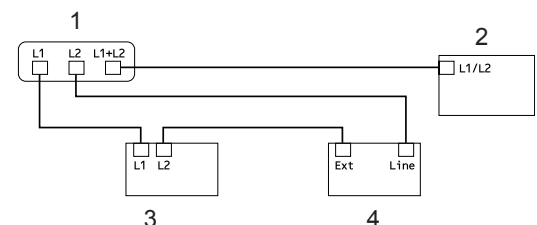

- 1 Triplex Adapter
- 2 Two Line Telephone
- 3 External Two Line TAD
- 4 Machine

You can keep two-line telephones on other wall outlets as always. There are two ways to add a two-line telephone to the machine's wall outlet. You can plug the telephone line cord from the two-line telephone into the L1+L2 jack of the triplex adapter. Or, you can plug the two-line telephone into the TEL jack of the two-line TAD.

Multi-line connections (PBX)

We suggest you ask the company who installed your PBX to connect your machine. If you have a multi line system we suggest you ask the installer to connect the unit to the last line on the system. This prevents the machine being activated each time the system receives telephone calls. If all incoming calls will be answered by a switchboard operator we recommend that you set the Receive Mode to *Manual*.

We cannot guarantee that your machine will operate properly under all circumstances when connected to a PBX. Any difficulties with sending or receiving faxes should be reported first to the company who handles your PBX.

External and extension telephones

Using external and extension telephones

Using extension telephones

If you answer a fax call at an extension telephone, you can make your machine receive the fax by pressing the Fax Receive Code ***51**.

If the machine answers a voice call and pseudo/double-rings for you to take over, you can take the call at an extension telephone by pressing the Telephone Answer Code **#51**.

(See *F/T Ring Time (Fax/Tel mode only)* on page 50.)

Using an external telephone(Connected to the EXT. jack of the machine)

If you answer a fax call at the external telephone, you can make the machine receive the fax by pressing **Start**.

If the machine answers a voice call and pseudo/double-rings for you to take over, you can take the call at the external telephone by pressing **Hook**.

If you answer a call and no one is on the line:

You should assume that you're receiving a manual fax.

Press ***51** and wait for the chirp or until the LCD shows *Receiving*, and then hang up.



Note

You can also use the Easy Receive feature to make your machine automatically take the call. (See *Easy Receive* on page 51.)

For Fax/Tel mode only

When the machine is in Fax/Tel mode, it will use the F/T Ring Time (pseudo/double-ringing) to alert you to pick up a voice call.

Lift the external telephone's handset, and then press **Hook** to answer.

If you are at an extension telephone, you will need to lift the handset during the F/T Ring Time and then press **#51** between the pseudo/double rings. If no one is on the line, or if someone wants to send you a fax, send the call back to the machine by pressing ***51**.

Connecting an external or extension telephone

You can connect a separate telephone directly to your machine as shown in the diagram below.

Connect the telephone line cord to the jack labeled EXT.

Before you connect the external telephone, remove the protective cap (3) from the EXT. jack on the machine.

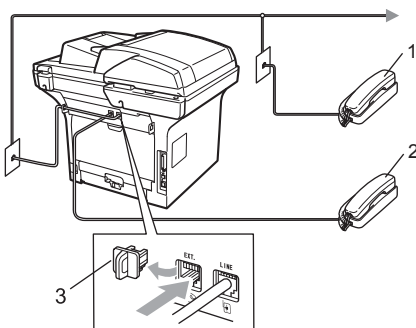

- 1 Extension telephone
- 2 External telephone
- 3 Protective Cap

When you are using the external telephone, the LCD shows *Telephone*.

Using a non-Brother cordless external handset

If your non-Brother cordless telephone is connected to the EXT. jack of the machine (see page 61) and you typically carry the cordless handset elsewhere, it is easier to answer calls during the Ring Delay.

If you let the machine answer first, you will have to go to the machine so you can press **Hook** to transfer the call to the cordless handset.

Using Remote Codes

Fax Receive Code

If you answer a fax call on an extension telephone, you can tell your machine to receive it by pressing the Fax Receive Code ***51**. Wait for the chirping sounds then replace the handset. (See *Easy Receive* on page 51.)

If you answer a fax call at the external telephone, you can make the machine receive the fax by pressing **Start** and choosing *Receive*.

Telephone Answer Code

If you receive a voice call and the machine is in F/T mode, it will start to sound the F/T (double-ring) after the initial ring delay. If you pick up the call on an extension telephone you can turn the F/T ring off by pressing **#51** (make sure you press this *between* the rings).

If the machine answers a voice call and pseudo/double-rings for you to take over, you can take the call at the external telephone connected to the EXT jack of the machine by pressing **Hook**.

Changing the Remote Codes

The preset Fax Receive Code is *51. The preset Telephone Answer Code is #51. If you are always disconnected when accessing your External TAD, try changing the three-digit remote codes, for example ### and 999.

1 Make sure you are in Fax mode .

2 Press **Menu 2, 1, 4**.

```
21.Setup Receive
 4.Remote Codes
▲   On
▼   Off
-----
Select ▲▼ or OK
```

3 Press ▲ or ▼ to choose On (or Off).
Press **OK**.

4 If you chose On in step 3, enter the new Fax Receive Code.
Press **OK**.

5 Enter the new Telephone Answer Code.
Press **OK**.

6 Press **Stop/Exit**.

8

Dialing and storing numbers

How to dial

You can dial in any of the following ways.

Manual dialing

Use the dial pad to enter all the digits of the telephone or fax number.



One touch dialing

Press the One Touch key that stores the number you want to call. (See *Storing One Touch Dial numbers* on page 65.)

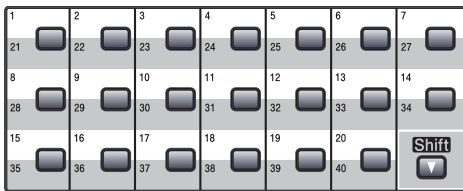

To dial One Touch numbers 21 to 40, hold down **Shift** as you press the One Touch key.

Speed dialing

Press **Search/Speed Dial** and **Shift** simultaneously and then the three digit Speed Dial number. (See *Storing Speed Dial numbers* on page 67.)

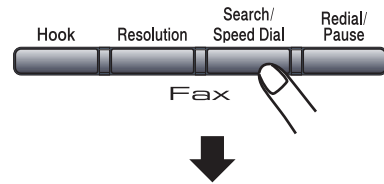
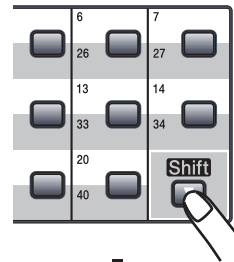

Three-digit number



Note

If the LCD shows *Register Now?* when you enter a One Touch or Speed Dial number, it means that a number is not stored there.

Search

You can search alphabetically for names you have stored in the One Touch and Speed Dial memories. (See *Storing One Touch Dial numbers* on page 65 and *Storing Speed Dial numbers* on page 67.)

- 1 Press **Search/Speed Dial**.
- 2 Press the dial pad keys for the first few letters of the name. (Use the chart on *Entering text* on page 193 to help you enter letters.)
Press **OK**.
- 3 Press **▲** or **▼** to scroll until you find the name you are looking for.
Press **OK**.



Note

- (MFC-8690DW and MFC-8890DW) If you are using LDAP names that are stored in the LDAP address book, a **▶** will appear next to the names on the LCD.
- You can press **Resolution** to change the fax resolution.

- 4 Press **Start**.



Note

- If you do not enter a letter and press **OK** in step 2, all registered names will appear. Press **▲** or **▼** to scroll until you find the name you are looking for. If you are using LDAP you must enter the letters of your search in step 2.
- If the LCD shows **No Contact Found** when you enter the first few letters of the name, it means that a name for the letter is not stored.

LDAP search (MFC-8690DW and MFC-8890DW)

If the machine is connected to your LDAP server, you can search for information such as fax numbers and E-mail addresses from your server. (For details about how to set up LDAP see the *Network User's Guide* on the CD-ROM.)

Fax redial

If you are sending a fax manually and the line is busy, press **Redial/Pause**, wait for the other fax machine to answer, and then press **Start** to try again. If you want to make a second call to the last number dialed, you can save time by pressing **Redial/Pause** and **Start**.

Redial/Pause only works if you dialed from the control panel.

If you are sending a fax automatically and the line is busy, the machine will automatically redial one time after five minutes.

Storing numbers

You can set up your machine to do the following types of easy dialing: One Touch, Speed Dial and Groups for Broadcasting faxes. You can also specify the default resolution for each One Touch and Speed Dial number. When you dial a quick dial number, the LCD shows the name, if you stored it, or the number. A scan profile can also be stored along with the fax number.

If you lose electrical power, the quick dial numbers stored in the memory will not be lost.

A scan profile is the resolution and other scan settings that you choose when you store a number. For example, you will be asked to select Standard, Fine, S.Fine or Photo if you have selected the Fax/Tel option. Or, you will be asked to select B&W 200 dpi, B&W 200x100 dpi, Gray 100dpi, Gray 200dpi, Gray 300 dpi, Color 100 dpi, Color 200 dpi, Color 300 dpi or Color 600 dpi if you selected the E-Mail option.

Storing a pause

Press **Redial/Pause** to insert a 3.5-second pause between numbers. You can press **Redial/Pause** as many times as needed to increase the length of the pause.

Storing One Touch Dial numbers

Your machine has 20 One Touch keys where you can store 40 fax or telephone numbers for automatic dialing. To access numbers 21 to 40, hold down **Shift** as you press the One Touch key.

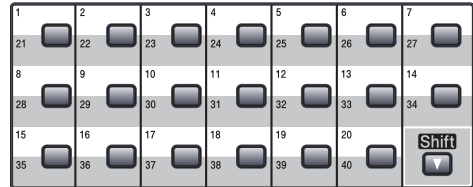

MFC-8480DN and MFC-8680DN:

- 1 Press the One Touch key where you want to store the number. If a number is not stored there, the LCD shows *Register Now?*. Press **1** to choose *Yes*.
- 2 Enter the phone or fax number (up to 20 characters). Press **OK**.
- 3 Choose one of the options below:
 - Enter the name using the dial pad (up to 15 characters). Use the chart on *Entering text* on page 193 to help you enter letters.
Press **OK**.
 - Press **OK** to store the number without a name.
- 4 If you want to save a fax resolution along with the number, choose one of the options below:
 - To store the fax resolution, press **▲** or **▼** to select *Std*, *Fine*, *S.Fine* or *Photo*.
Press **OK**.
 - Press **OK** if you don't want to change the default resolution.

MFC-8690DW and MFC-8890DW:

- 1 Press the One Touch key where you want to store the number.
If a number is not stored there, the LCD shows *Register Now?*
Press **1** to choose *Yes*.
- 2 Press **▲** or **▼** to select *Fax/Tel*, *E-Mail* or *IFAX*.
Press **OK**.
- 3 Choose one of the options below:
 - Enter the number (up to 20 characters) if you selected *Fax/Tel*.
Press **OK**.
 - Enter the E-mail address (up to 60 characters) if you selected *E-Mail* or *IFAX*. Use the chart on *Entering text* on page 193 to help you enter letters.
Press **OK**.

**Note**

If you selected *E-Mail* and save the E-mail address, you can only use the E-mail address when you are in Scan mode. If you selected *IFAX* and save the E-mail address, you can only use the E-mail address when you are in Fax mode.

- 4 Choose one of the options below:
 - Enter the name using the dial pad (up to 15 characters).
Press **OK**.
 - Press **OK** to store the number or E-mail address without a name.
- 5 If you want to save a fax/scan resolution along with the number, choose one of the options below:
 - If you selected *Fax/Tel* in step 2, press **▲** or **▼** to select *Std*, *Fine*, *S. Fine* or *Photo*.
Press **OK**.

- If you selected *E-Mail* in step 2, press **▲** or **▼** to select *Color100dpi*, *Color200dpi*, *Color300dpi*, *Color600dpi*, *Gray100dpi*, *Gray200dpi*, *Gray300dpi*, *B&W200dpi* or *B&W200x100*.

Press **OK** and then go to step 6.

- If you selected *IFAX* in step 2, press **▲** or **▼** to select *Std*, *Fine* or *Photo*.

Press **OK**.

- Press **OK** if you don't want to change the default resolution.

- 6 Choose one of the options below:
If you selected *Black & White* in step 5, select the file format (*TIFF*, *PDF* or *Secure PDF*) that will be used to send to your PC. If you selected *Gray* or *Color* in step 5, select the file format (*PDF*, *Secure PDF*, *JPEG*, or *XPS*) that will be used to send your PC.
Press **OK**.

**Note**

- When you do a broadcast and you have saved a scan profile along with the number or E-mail address, the scan profile of the One-Touch, Speed-Dial or Group number you chose first will be applied to the broadcast.
- You can also store the number by pressing **Menu, 2, 3, 1**.

Storing Speed Dial numbers

You can store your frequently used numbers as Speed Dial numbers, so that when you dial you will only have to press a few keys (Hold down **Shift** as you press **Search/Speed Dial**, the three-digit number and **Start**). The machine can store 300 Speed Dial numbers (001 - 300).

MFC-8480DN and MFC-8680DN:

- 1 Hold down **Shift** as you press **Search/Speed Dial** and enter a three-digit Speed Dial location number (001-300).
If a number is not stored there, the LCD shows *Register Now?*
Press **1** to choose *Yes*.
- 2 Enter the phone or fax number (up to 20 characters).
Press **OK**.
- 3 Choose one of the options below:
 - Enter the name using the dial pad (up to 15 characters). Use the chart on *Entering text* on page 193 to help you enter letters.
Press **OK**.
 - Press **OK** to store the number without a name.
- 4 If you want to save a fax resolution along with the number, choose one of the options below:
 - To store the fax resolution, press **▲** or **▼** to select *Std*, *Fine*, *S.Fine* or *Photo*.
Press **OK**.
 - Press **OK** if you don't want to change the default resolution.

MFC-8690DW and MFC-8890DW

- 1 Hold down **Shift** as you press **Search/Speed Dial** and enter a three-digit Speed Dial location number (001-300).
If a number is not stored there, the LCD shows *Register Now?*
Press **1** to choose *Yes*.
- 2 Press **▲** or **▼** to select *Fax/Tel*, *E-Mail* or *IFAX*.
Press **OK**.
- 3 Choose one of the options below:
 - Enter the number (up to 20 characters) when you select *Fax/Tel*.
Press **OK**.
 - Enter the E-mail address (up to 60 characters) if you selected *E-Mail* or *IFAX*. Use the chart on *Entering text* on page 193 to help you enter letters.
Press **OK**.



Note

If you selected *E-Mail* and save the E-mail address, you can only use the E-mail address when you are in Scan mode. If you selected *IFAX* and save the E-mail address, you can only use the E-mail address when you are in Fax mode.

- 4 Choose one of the options below:
 - Enter the name using the dial pad (up to 15 characters).
Press **OK**.
 - Press **OK** to store the number or E-mail address without a name.

- 5 If you want to save a fax/scan resolution along with the number, choose one of the options below:
- If you selected Fax/Tel in step 2, press ▲ or ▼ to select Std, Fine, S. Fine or Photo.
Press **OK**.
 - If you selected E-Mail in step 2, press ▲ or ▼ to select Color100dpi, Color200dpi, Color300dpi, Color600dpi, Gray100dpi, Gray200dpi, Gray300dpi, B&W200dpi or B&W200x100.
Press **OK** and then go to step 6.
 - If you selected IFAX in step 2, press ▲ or ▼ to select Std, Fine or Photo.
Press **OK**.
 - Press **OK** if you don't want to change the default resolution.

- 6 If you selected Black & White in step 5, select the file format (TIFF, PDF or Secure PDF) that will be used to send to your PC. If you selected Gray or Color in step 5, select the file format (PDF, Secure PDF, JPEG or XPS) that will be used to send your PC.
Press **OK**.



Note

- When you do a broadcast and you have saved a scan profile along with the number or E-mail address, the scan profile of the One-Touch, Speed-Dial or Group number you chose first will be applied to the broadcast.
- You can also store the number by pressing **Menu, 2, 3, 2**.

Changing One Touch and Speed Dial numbers

If you try to store a One Touch or Speed Dial number over an existing number, the LCD will show the name or number already stored there. If your machine has a scheduled job or you have set a fax forwarding number, the LCD will ask you if you want to change the number.

- 1 Do one of the following:
- To change a stored One Touch number, press **Menu, 2, 3, 1**.
Choose the One Touch number you want to change.
 - To change a stored Speed Dial number, press **Menu, 2, 3, 2**.
Choose the Speed Dial number you want to change, then press **OK**.
- 2 Do one of the following:
- To change the stored number, press **1**.
 - To exit without making a change, press **2**.

23.Address Book
#005:MIKE
▲ 1.Change
▼ 2.Exit
Select ▲▼ or OK

MFC-8480DN and MFC-8680DN, go to step 4.
MFC-8690DW and MFC-8890DW, go to step 3.

- 3 (MFC-8690DW and MFC-8890DW)
Press ▲ or ▼ to select Fax/Tel, E-Mail or IFAX.
Press **OK**.
- 4 Enter a new number or character.
Press **OK**.

- 5 Press ◀ or ▶ to position the cursor under the character you want to change, and then press **Clear/Back** to delete it. Repeat for each character you want to delete.
- 6 Follow the directions beginning in step 4 in Storing One-Touch dial numbers and Storing Speed-Dial numbers. (See *Storing One Touch Dial numbers* on page 65 and *Storing Speed Dial numbers* on page 67.)

Setting up Groups for Broadcasting

If you often want to send the same fax message to many fax numbers you can set up a group.

Groups are stored on a One Touch key or a Speed Dial number. Each group uses up a One Touch key or a Speed Dial location. You can then send the fax message to all the numbers stored in a group just by pressing a One Touch key or entering a Speed Dial number, and then pressing **Start**.

Before you can add numbers to a group, you need to store them as One Touch or Speed Dial numbers. You can have up to 20 small groups, or you can assign up to 339 numbers to one large group.

- 1 Press **Menu, 2, 3, 3**.

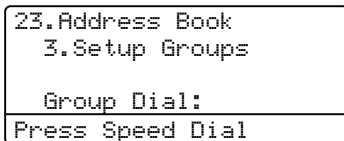

- 2 Choose an empty location where you want to store the group in one of the following ways:
 - Press a One Touch key.
 - Hold down **Shift** as you press **Search/Speed Dial** and then enter the three-digit Speed Dial location. Press **OK**.

- 3 Use the dial pad to enter a group number (01 to 20). Press **OK**. (MFC-8480DN and MFC-8680DN) Go to step 5. (MFC-8690DW and MFC-8890DW) Go to step 4.
- 4 (MFC-8690DW and MFC-8890DW) Press ▲ or ▼ to select Fax/IFAX or E-Mail. Press **OK**.

- 5 To add One Touch or Speed Dial numbers follow the instructions below:
 - For One Touch numbers, press the One Touch keys one after the other.
 - For Speed Dial numbers, hold down **Shift** as you press **Search/Speed Dial**, and then enter the three-digit Speed Dial location.

The LCD will display your chosen One Touch numbers with a * and Speed Dial numbers with a # (for example *006, #009).

- 6 Press **OK** when you have finished adding numbers.
- 7 Do one of the following:
 - Enter the name using the dial pad (up to 15 characters). Use the chart on *Entering text* on page 193 to help you enter letters. Press **OK**.
 - Press **OK** to store the group without a name. Go to step 8 or 9.
- 8 (MFC-8480DN and MFC-8680DN) If you want to save a fax resolution along with the number, choose one of the options below:
 - To store the fax resolution, press ▲ or ▼ to select Std, Fine, S.Fine or Photo. Press **OK**.

- Press **OK** if you don't want to change the default resolution.

9 (MFC-8690DW and MFC-8890DW)
You can save a fax/scan resolution along with the number. Do one of the following:

- If you selected **Fax/IFAX** in step **4**, press **▲** or **▼** to select **Std**, **Fine**, **S. Fine** or **Photo**.

Press **OK**.

- If you selected **E-mail** in step **4**, press **▲** or **▼** to select **Color100dpi**, **Color200dpi**, **Color300dpi**, **Color600dpi**, **Gray100dpi**, **Gray200dpi**, **Gray300dpi**, **B&W200dpi** or **B&W200x100**.

Press **OK**.

- Press **OK** if you don't want to change the default resolution.



Note

If you have selected **Fax/IFAX** in step **4** and added One-Touch or Speed-Dial numbers that are stored as 'I-Fax', you cannot select **S. Fine**.

10 (MFC-8690DW and MFC-8890DW)
If you selected **Black & White** in step **5**, select the file format (**TIFF**, **PDF** or **Secure PDF**) that will be used to send to your PC. If you selected **Gray** or **Color** in step **5**, select the file format (**PDF**, **Secure PDF**, **JPEG** or **XPS**) that will be used to send your PC.
Press **OK**.

Dialing access codes and credit card numbers

You can combine more than one Quick Dial number when you dial. This feature may be useful if you need to dial an access code for a cheaper rate from another long distance carrier.

For example, you might have stored '555' on Speed Dial #003 and '7000' on Speed Dial #002. You can use them both to dial '555-7000' if you press the following keys:

Hold down **Shift** as you press **Search/Speed Dial, 003**.

Hold down **Shift** as you press **Search/Speed Dial, 002** and **Start**.

Numbers can be added manually by entering them on the dial pad:

Hold down **Shift** as you press **Search/Speed Dial, 003, 7001** (on the dial pad), and **Start**.

This would dial '555-7001'. You can also add a pause by pressing **Redial/Pause**.

Pause

Press **Redial/Pause** to insert a 3.5-second pause between numbers. You can press **Redial/Pause** as many times as needed to increase the length of the pause.

Tone or Pulse (Canada only)

If you have a Pulse dialing service, but need to send Tone signals (for example, for telephone banking), follow the instructions below. If you have Touch Tone service, you will not need this feature to send tone signals.

1 Press **Hook**.

2 Press **#** on the machine's control panel. Any digits dialed after this will send tone signals.
When you hang up, the machine will return to the Pulse dialing service.

9

Remote Fax Options

Remote Fax Options let you receive faxes while you are away from the machine.

You can use *only one* Remote Fax Option at a time.

Fax Forwarding

The Fax Forwarding feature lets you automatically forward your received faxes to another machine.

- 1 Press **Menu**, **2**, **5**, **1**.

```
25.Remote Fax Opt
 1.Fwd/Page/Store
▲   Off
▼   Fax Forward
Select ▲▼ or OK
```

- 2 Press **▲** or **▼** to choose **Fax Forward**. Press **OK**.

The LCD will ask you to enter the fax number you want your faxes to be forwarded to.

- 3 Enter the forwarding number using the dial pad (up to 20 digits), using a One Touch key or holding down **Shift** as you press **Search/Speed Dial** and the three-digit location. Press **OK**.



Note

- If you store a group on a One Touch key or a Speed Dial location, the faxes will be forwarded to several fax numbers.
- You can also enter an E-mail address if your machine has been configured for the Internet Fax feature. (For details about Internet Fax, see the *Network User's Guide* on the CD-ROM. For information about Fax Forward to E-mail, see the Brother Solutions Center at <http://solutions.brother.com/>)

- 4 Press **▲** or **▼** to choose **On** or **Off**. Press **OK**.

```
25.Remote Fax Opt
 Backup Print
▲   Off
▼   On
Select ▲▼ or OK
```

- 5 Press **Stop/Exit**.

! IMPORTANT

If you choose Backup Print On, the machine will also print the fax at your machine so you will have a copy. This is a safety feature in case if there is a power failure before the fax is forwarded or a problem at the receiving machine. The machine can store faxes for approximately 60 hours if there is a power failure.

Paging

When Paging is chosen, the machine dials the cell phone or pager number you programmed. This activates your cell phone or pager so you will know that you have a fax message in the machine's memory.

- 1 Press **Menu, 2, 5, 1**.

```

25.Remote Fax Opt
 1.Fwd/Page/Store
▲   Off
▼   Fax Forward
-----
Select ▲▼ or OK
  
```

- 2 Press **▲** or **▼** to choose Paging. Press **OK**.
- 3 Enter your cell phone or pager number followed by **# #** (up to 20 digits). Press **OK**.
Do not include the area code if it is the same as that of your machine.
For example, press
1 8 0 0 5 5 5 1 2 3 4 # #
- 4 Do one of the following:
 - If your pager needs a PIN, enter the PIN, press **#**, press **Redial/Pause**, enter your fax number followed by **# #**.
Press **OK**
(For example, press: **1 2 3 4 5 # Redial/Pause 1 8 0 0 5 5 5 6 7 8 9 # #**)
 - If you do not need a PIN, press **OK**.
 - If you are programming a cell phone number, press **OK**.

- 5 Press **Stop/Exit**.



Note

- If you have set Paging, a backup copy will automatically be printed at the machine.
- You cannot change a Paging or PIN number remotely.

Fax Storage

The Fax Storage feature lets you store your received faxes in the machine's memory. You can retrieve stored fax messages from a fax machine at another location using the remote retrieval commands. (See *Retrieving fax messages* on page 76.) Your machine will automatically print a copy of the stored fax.

- 1 Press **Menu, 2, 5, 1**.

```

25.Remote Fax Opt
 1.Fwd/Page/Store
▲   Off
▼   Fax Forward
-----
Select ▲▼ or OK
  
```

- 2 Press **▲** or **▼** to choose Fax Storage. Press **OK**.
- 3 Press **Stop/Exit**.

PC Fax Receive

If you turn on the PC Fax Receive feature your machine will store received faxes in memory and send them to your PC automatically. You can then use your PC to view and store these faxes.

Even if you have turned off your PC (at night or on the weekend, for example), your machine will receive and store your faxes in its memory. The LCD will show the number of stored faxes received, for example:

```
PC Fax Msg:001
```

When you start your PC and the PC Fax Receiving software runs, your machine transfers your faxes to your PC automatically.

For PC Fax Receive to work you must have the PC-FAX Receive software running on your PC. (For details, see *PC-FAX Receiving* in the *Software User's Guide* on the CD-ROM.)

If you choose Backup Print On, the machine will also print the fax.

- 1 Press **Menu**, **2**, **5**, **1**.

```
25.Remote Fax Opt
 1.Fwd/Page/Store
▲ Off
▼ Fax Forward
Select ▲▼ or OK
```

- 2 Press **▲** or **▼** to choose PC Fax Receive.
Press **OK**.

- 3 Press **▲** or **▼** to choose (<USB> or <Parallel>), or your computer name if the machine is connected to a network.

```
25.Remote Fax Opt
 1.Fwd/Page/Store
▲ <USB>
▼ <Parallel>
Select ▲▼ or OK
```

Press **OK**.

- 4 Press **▲** or **▼** to choose On or Off.

```
25.Remote Fax Opt
 Backup Print
▲ Off
▼ On
Select ▲▼ or OK
```

Press **OK**.

- 5 Press **Stop/Exit**.

! IMPORTANT

If you choose Backup Print On, the machine will also print the fax at your machine so you will have a copy. This is a safety feature in case if there is a power failure before the fax is forwarded or a problem at the receiving machine. The machine can store faxes for approximately 60 hours if there is a power failure.

Note

- Before you can set up PC Fax Receive you must install the MFL-Pro Suite software on your PC. Make sure your PC is connected and turned on. (For details see *PC-FAX Receiving* in the *Software User's Guide* on the CD-ROM.)
- If your machine has a problem and is unable to print faxes in memory, you can use this setting to transfer your faxes to a PC. (For details, see *Error and maintenance messages* on page 139.)
- PC Fax Receive is not supported in Mac OS. (See *PC Fax receiving* in the *Software User's Guide* on the CD-ROM.)

Changing Remote Fax Options

If received faxes are left in your machine's memory when you change to another Remote Fax Option, the LCD will ask you the following message:

```
25.Remote Fax Opt
  Erase All Fax?
▲      1. Yes
▼      2. No
-----
Select ▲▼ or OK
```

or

```
25.Remote Fax Opt
  Print All Fax?
▲      1. Yes
▼      2. No
-----
Select ▲▼ or OK
```

- If you press **1**, faxes in the memory will be erased or printed before the setting changes. If a backup copy has already been printed it will not be printed again.
- If you press **2**, faxes in the memory will not be erased or printed and the setting will be unchanged.

If received faxes are left in the machine's memory when you change to PC Fax Receive from another remote fax option (Fax Forward, Paging or Fax Storage), the LCD will ask you the following message:

```
25.Remote Fax Opt
  Send Fax to PC?
▲      1. Yes
▼      2. No
-----
Select ▲▼ or OK
```

- If you press **1**, faxes in the memory will be sent to your PC before the setting changes. Faxes in the memory will be sent to your PC when the PC Fax Receive icon is active on your PC. (See the *Software User's Guide* on the CD-ROM.)

- If you press **2**, faxes in the memory will not be erased or transferred to your PC and the setting will be unchanged.

The LCD will ask you the following message:

```
25.Remote Fax Opt
  Backup Print
▲      Off
▼      On
-----
Select ▲▼ or OK
```

Press **▲** or **▼** to choose On or Off.

Press **OK**.

Press **Stop/Exit**.

! IMPORTANT

If you choose Backup Print On, the machine will also print the fax at your machine so you will have a copy. This is a safety feature in case if there is a power failure before the fax is forwarded or a problem at the receiving machine. The machine can store faxes for approximately 60 hours if there is a power failure.

Turning off Remote Fax Options

- 1 Press **Menu**, **2**, **5**, **1**.

```
25.Remote Fax Opt
  1.Fwd/Page/Store
▲      Off
▼      Fax Forward
-----
Select ▲▼ or OK
```

- 2 Press **▲** or **▼** to choose Off.
Press **OK**.

Note

The LCD will give you options if there are received faxes still in your machine's memory. (See *Changing Remote Fax Options* on page 74.)

- 3 Press **Stop/Exit**.

Remote retrieval

The remote retrieval feature lets you retrieve your stored fax messages when you are not at the machine. You can call your machine from any touch tone telephone or fax machine, then use the Remote Access Code to retrieve your messages.

Setting a Remote Access Code

The Remote Access Code feature lets you access the remote retrieval features when you are away from your machine. Before you use the remote access and retrieval features, you have to set up your own code. The default code is an inactive code: -- -*.

- 1 Press **Menu, 2, 5, 2**.

```
25.Remote Fax Opt
 2.Remote Access

Access Code:---*
Enter & OK Key
```

- 2 Enter a three-digit code using the numbers **0 – 9, * or #**. Press **OK**.
- 3 Press **Stop/Exit**.



Note

Do not use the same code used for your Fax Receive Code (***51**) or Telephone Answer Code (**#51**). (See *Changing the Remote Codes* on page 62.)

You can change your code at any time. If you want to make your code inactive, press **Clear/Back** and then **OK** in 2 to restore the inactive setting -- -*.

Using your Remote Access Code

- 1 Dial your fax number from a telephone or another fax machine using touch tone.
- 2 When your machine answers, immediately enter your Remote Access Code (3 digits followed by *).
- 3 The machine signals if it has received messages:
 - *No beeps*
No messages received.
 - *1 long beep*
Fax message received.
- 4 The machine gives two short beeps to tell you to enter a command (See *Remote fax commands* on page 77). The machine will hang up if you wait longer than 30 seconds before entering a command. If you enter an invalid command the machine will beep three times.
- 5 Press **9 0** to reset the machine when you have finished.
- 6 Hang up.



Note

If your machine is set to **Manual** mode, you can still access the remote retrieval features. Dial the fax number as normal and let the machine ring. After 100 seconds you will hear a long beep to tell you to enter the remote access code. You will then have 30 seconds to enter the code.

Retrieving fax messages

- 1 Dial your fax number from a telephone or another fax machine using touch tone.
- 2 When your machine answers, immediately enter your Remote Access Code (3 digits followed by *). If you hear one long beep, you have messages.
- 3 When you hear two short beeps, use the dial pad to press **9 6 2**.
- 4 Wait for a long beep, and then use the dial pad to enter the number of the remote fax machine where you want your fax messages sent, followed by **##** (up to 20 digits).
- 5 Hang up after you hear your machine beep. Your machine will call the other machine, which will then print your fax messages.



Note

You can insert a pause in a fax number by using the # key.

Changing the Fax Forwarding number

You can change the default setting of your fax forwarding number from another telephone or fax machine using touch tone.

- 1 Dial your fax number from a telephone or another fax machine using touch tone.
- 2 When your machine answers, enter your Remote Access Code (3 digits followed by *). If you hear one long beep, you have messages.
- 3 When you hear two short beeps, use the dial pad to press **9 5 4**.
- 4 Wait for a long beep, and then use the dial pad to enter the new number of the remote fax machine where you want your fax messages forwarded followed by **##** (up to 20 digits).
- 5 Press **9 0** to reset the machine when you have finished.
- 6 Hang up after you hear your machine beep.



Note

You can insert a pause in a fax number by using the # key.

Remote fax commands

Follow the commands below to access features when you are away from the machine. When you call the machine and enter your Remote Access Code (3 digits followed by *), the system will give two short beeps and you must enter a remote command.

Remote commands		Operation details
95	Change the fax forwarding, paging or fax storage settings	
	1 OFF	You can choose OFF after you have retrieved or erased all your messages.
	2 Fax Forwarding	One long beep means the change is accepted. If you hear three short beeps, you cannot make the change because something has not been set up (for example, a fax forwarding or paging number has not been registered). You can register your fax forwarding number by entering 4. (See <i>Changing the Fax Forwarding number</i> on page 76.) Once you have registered the number, fax forwarding will work.
	3 Paging	
	4 Fax Forwarding number	
6 Fax Storage		
96	Retrieve a fax	
	2 Retrieve all faxes	Enter the number of a remote fax machine to receive stored fax messages. (See <i>Retrieving fax messages</i> on page 76.)
	3 Erase faxes from the memory	If you hear one long beep, fax messages have been erased from the memory.
97	Check the receiving status	
	1 Fax	You can check whether your machine has received any faxes. If yes, you will hear one long beep. If no, you will hear three short beeps.
98	Change the Receive Mode	
	1 External TAD	If you hear one long beep, your change has been accepted.
	2 Fax/Tel	
	3 Fax Only	
90	Exit	Press 9 0 to exit remote retrieval. Wait for the long beep, then replace the handset.

10

Polling

Polling lets you set up your machine so other people can receive faxes from you, but they pay for the call. It also lets you call somebody else's fax machine and receive a fax from it, so you pay for the call. The polling feature needs to be set up on both machines for this to work. Not all fax machines support polling.

Polling receive

Polling receive lets you call another fax machine to receive a fax.

1 Make sure you are in Fax mode .

2 Press **Menu, 2, 1, 7**.

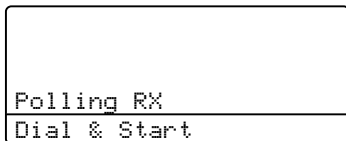

3 Enter the fax number you are polling. Press **Start**.
The LCD will show *Dialing*.

Sequential polling

Sequential polling lets you request documents from several fax machines in one operation. Afterwards, a Sequential Polling Report will be printed.

1 Make sure you are in Fax mode .

2 Press **Menu, 2, 1, 7**.

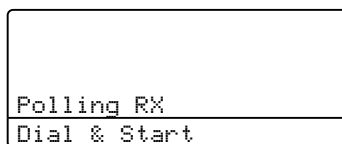

3 Specify the fax machines you want to poll by using One Touch, Speed Dial, Search, a Group or the dial pad. You must press **OK** between each location.

4 Press **Start**.
The machine polls each number or Group number in turn for a document.

Press **Stop/Exit** while the machine is dialing to cancel the polling process.

To cancel all sequential polling receive jobs, press **Menu, 2, 7**. (See *Checking and canceling waiting jobs* on page 47.)

Polled transmit

Polled transmit lets you set up your machine to wait with a document so another fax machine can call and retrieve it.

Setup for polled transmit

- 1 Make sure you are in Fax mode .

- 2 Load your document.

- 3 Press **Menu, 2, 2, 6**.

```
22.Setup Send
 6.Polled TX
▲   On
▼   Off
-----
Select ▲▼ or OK
```

- 4 Press ▲ or ▼ to choose On (or Off). Press **OK**.

- 5 Press **2** to choose 2.No if you do not want to enter more settings when the LCD asks you the following message:

```
22.Setup Send
 Other Settings?
▲   1.Yes
▼   2.No
-----
Select ▲▼ or OK
```

- 6 Press **Start**.

- 7 If you are using the scanner glass, the LCD will prompt you to choose one of the options below:

```
Flatbed Fax:
 Next Page?
▲   1.Yes
▼   2.No (Send)
-----
Select ▲▼ or OK
```

- Press **1** to send another page. Go to step **8**.
- Press **2** or **Start** to send the document.

- 8 Place the next page on the scanner glass, press **OK**. Repeat steps **7** and **8** for each additional page. Your machine will automatically send the fax.



Note

The document will be stored and can be retrieved from any other fax machine until you delete the fax from memory.

To delete the fax from memory, press **Menu, 2, 7**. (See *Checking and canceling waiting jobs* on page 47.)

11

Printing reports

Fax reports

Some fax reports (transmission verification and fax journal) can be printed automatically and manually.

Transmission verification report

This report lists the sender's name or fax number, the time and date of transmission, duration of transmission, number of pages sent, and whether or not the transmission was successful.

- **On:** Prints a report after every fax you send.
- **On+Image:** Prints a report after every fax you send. A portion of the fax's first page appears on the report.
- **Off:** Prints a report *only* if your fax is unsuccessful due to a transmission error. **Off** is the default setting.
- **Off+Image:** Prints a report *only* if your fax is unsuccessful due to a transmission error. A portion of the fax's first page appears on the report.

1 Press **Menu, 2, 4, 1**.

```
24.Report Setting
 1.Transmission
▲   Off
▼   Off+Image
-----
Select ▲▼ or OK
```

2 Press **▲** or **▼** to choose **On**, **On+Image**, **Off** or **Off+Image**. Press **OK**.

3 Press **Stop/Exit**.



Note

- If you choose **On+Image** or **Off+Image**, the image will only appear on the Transmission Verification Report if Real Time Transmission is set to **Off**. (See *Real Time Transmission* on page 45.)
- If your transmission is successful, "OK" will appear next to "RESULT" on the Transmission Verification Report. If transmission is not successful, "NG" will appear next to "RESULT".

Fax Journal

You can set the machine to print a fax journal (activity report) at specific intervals (every 50 faxes, 6, 12 or 24 hours, 2 or 7 days). The default setting is *Every 50 Faxes*, this means that your machine will print the journal when the machine has stored 50 jobs.

If you set the interval to *Off*, you can still print the report by following the steps on the next page.

- 1 Press **Menu, 2, 4, 2**.

```
24.Report Setting
 2.Journal Period
▲   Every 50 Faxes
▼   Every 6 Hours
Select ▲▼ or OK
```

- 2 Press **▲** or **▼** to choose an interval. Press **OK**.
If you choose 7 days, you will be asked to choose a day when you want the 7 day countdown to begin.
- 3 Enter the time to begin printing, in 24 hour format.
Press **OK**.
For example: enter 19:45 for 7:45 PM.

- 4 Press **Stop/Exit**.

If you choose 6, 12, 24 hours, 2 or 7 days, the machine will print the report at the selected time and then erase all jobs from its memory. If the machine's memory becomes full with 200 jobs before the time you chose has passed, the machine will print the journal early and then erase all jobs from memory.

If you want an extra report before it is due to print, you can print it manually without erasing the jobs from memory.

Reports

The following reports are available:

- 1 **Transmission**
Displays the Transmission Verification Report for your last outgoing 200 faxes and prints the last report.
- 2 **Help List**
Prints a list of commonly used functions to help you program your machine.
- 3 **Tel Index List**
Prints a list of names and numbers stored in the One Touch and Speed Dial memory in numerical or alphabetical order.
- 4 **Fax Journal**
Prints a list of information about your last 200 incoming and outgoing faxes. (TX: transmit.) (RX: receive.)
- 5 **User Settings**
Print a list of your current settings.
- 6 **Network Config**
Lists your network settings.

How to print a report

- 1 Press **Menu, 6**.

```
6.Print Reports
 1.Transmission
 2.Help List
 3.Tel Index List
Select ▲▼ or OK
```

- 2 Do one of the following:
 - Press **▲** or **▼** to choose the report you want.
Press **OK**.
 - Enter the number of the report you want to print. For example, press **2** to print the Help List.
- 3 Press **Start**.
- 4 Press **Stop/Exit**.



Copy

Making copies

84

12

Making copies

How to copy

Entering copy mode

Press  (**Copy**) to enter Copy mode.

```
1 — Contrast: -□□■□□+
2 — Quality :Auto
3 — Enlg/Red:100%
4 — Tray    :MP>T1
   Press ▲▼ or Start 01—5
```

```
Quality :Auto
Enlg/Red:100%
Tray    :MP>T1
6 — Bright : -□□■□□+
   Select ◀▶ & OK 01
```

- 1 **Contrast**
- 2 **Quality**
- 3 **Copy ratio**
- 4 **Tray selection**
- 5 **Number of copies**
- 6 **Brightness**

Making a single copy

- 1 Make sure you are in Copy mode .
- 2 Load your document.
- 3 Press **Start**.

Making multiple copies

- 1 Make sure you are in Copy mode .
- 2 Load your document.
- 3 Use the dial pad to enter the number of copies (up to 99).
- 4 Press **Start**.



Note

To sort your copies, see *Sorting copies using the ADF* on page 86.

Stop copying

To stop copying, press **Stop/Exit**.

Copy options (temporary settings)

When you want to quickly change the copy settings temporarily for the next copy, use the temporary **Copy** keys. You can use different combinations.

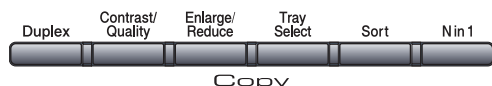

The machine returns to its default settings one minute after copying, unless you have set the Mode Timer to 30 seconds or less. (See *Mode Timer* on page 22.)

Enlarging or reducing the image copied

You can choose the following enlargement or reduction ratios:

Press 	100%*
	97% LTR→A4
	94% A4→LTR
	91% Full Page
	85% LTR→EXE
	83% LGL→A4
	78% LGL→LTR
	70% A4→A5
	50%
	Custom (25-400%)
	Auto
	200%
	141% A5→A4
	104% EXE→LTR

* The factory setting is shown in Bold with an asterisk.

Auto sets the machine to calculate the reduction ratio that best fits the size of paper.

Auto is only available when using the ADF.

Custom (25-400%) allows you to enter a ratio from 25% to 400%.

To enlarge or reduce the next copy follow the instructions below:

- 1 Make sure you are in Copy mode .
- 2 Load your document.
- 3 Use the dial pad to enter the number of copies (up to 99).
- 4 Press **Enlarge/Reduce**. Press **▶**.
- 5 Do one of the following:
 - Press **▲** or **▼** to choose the enlargement or reduction ratio you want.
Press **OK**.
 - Press **▲** or **▼** to choose **Custom (25-400%)**.
Press **OK**.
Use the dial pad to enter an enlargement or reduction ratio from 25% to 400%. (For example, press **5 3** to enter 53%.)
Press **OK**.
- 6 Press **Start**.



Note

Page Layout Options 2 in 1(P), 2 in 1(L), 4 in 1(P) or 4 in 1(L) are *not* available with Enlarge/Reduce.

Improving copy quality

You can choose from a range of quality settings. The default setting is *Auto*.

■ Auto

Auto is the recommended mode for ordinary printouts. Suitable for documents that contain both text and photographs.

■ Text

Suitable for documents containing only text.

■ Photo

Suitable for copying photographs.

To *temporarily* change the quality setting, follow the steps below:

- 1 Make sure you are in Copy mode .
- 2 Load your document.
- 3 Use the dial pad to enter the number of copies (up to 99).
- 4 Press **Contrast/Quality**. Press **▲** or **▼** to choose *Quality*. Press **OK**.
- 5 Press **◀** or **▶** to choose *Auto*, *Text* or *Photo*. Press **OK**.
- 6 Press **Start**.

To change the *default* setting, follow the steps below:

- 1 Press **Menu, 3, 1**.

```
31.Quality
▲ Text
Photo
▼ Auto
Select ▲▼ or OK
```

- 2 Press **▲** or **▼** to choose the copy quality. Press **OK**.
- 3 Press **Stop/Exit**.

Sorting copies using the ADF

You can sort multiple copies. Pages will be stacked in the order 1 2 3, 1 2 3, 1 2 3, and so on.

- 1 Make sure you are in Copy mode .
- 2 Load your document in the ADF.
- 3 Use the dial pad to enter the number of copies (up to 99).
- 4 Press **Sort**.
- 5 Press **Start**.

Changing text copy resolution

You can change the text copy resolution to 1200x600 dpi if you are using the scanner glass and have selected *Text* as the **Contrast/Quality** and an enlargement or reduction ratio of 100%. The default setting is 600 dpi.

- 1 Make sure you are in Copy mode .
 - 2 Place your document on the scanner glass.
 - 3 Press **Menu, 3, 2**.
- ```
32.FB Txt Quality
▲ 1200x600 dpi
▼ 600dpi
Select ▲▼ or OK
```
- 4 Press **▲** or **▼** to choose the text copy resolution. Press **OK**.
  - 5 Press **Stop/Exit**.

## Adjusting Contrast and Brightness

### Contrast

Adjust the contrast to help an image look sharper and more vivid.

To *temporarily* change the contrast setting, follow the steps below:

- 1 Make sure you are in Copy mode .
- 2 Load your document.
- 3 Use the dial pad to enter the number of copies (up to 99).
- 4 Press **Contrast/Quality**.  
Press **▲** or **▼** to choose **Contrast**.  
Press **OK**.

```

Contrast:-□□■□□+▶
Quality :Auto
Enlg/Red:100%
Tray :MP>T1
Bright :-□□■□□+▶
Select ◀ ▶ & OK 01

```

- 5 Press **◀** or **▶** to increase or decrease the contrast.  
Press **OK**.
- 6 Press **Start**.

To change the *default* setting follow the steps below:

- 1 Press **Menu, 3, 4**.

```

34.Contrast
 -□□■□□+
Select ◀ ▶ & OK

```

- 2 Press **◀** or **▶** to increase or decrease the contrast.  
Press **OK**.
- 3 Press **Stop/Exit**.

### Brightness

Adjust the copy brightness to make copies darker or lighter.

To *temporarily* change the copy brightness setting, follow the steps below:

- 1 Make sure you are in Copy mode .
- 2 Load your document.
- 3 Use the dial pad to enter the number of copies (up to 99).
- 4 Press **▲** or **▼** to choose **Bright**.

```

Quality :Auto
Enlg/Red:100%
Tray :MP>T1
Bright :-□□■□□+▶
Select ◀ ▶ & OK 01

```

- 5 Press **▶** to make a lighter copy or press **◀** to make a darker copy.  
Press **OK**.
- 6 Press **Start**.

To change the *default* setting follow the steps below:

- 1 Press **Menu, 3, 3**.

```

33.Brightness
 -□□■□□+
Select ◀ ▶ & OK

```

- 2 Press **▶** to make a lighter copy or press **◀** to make a darker copy.  
Press **OK**.
- 3 Press **Stop/Exit**.

## Making N in 1 copies (page layout)

You can reduce the amount of paper used when copying by using the N in 1 copy feature. This allows you to copy two or four pages onto one page, which lets you save paper.

### ! IMPORTANT

- Please make sure the paper size is set to Letter, A4, Legal or Folio.
- (P) means Portrait and (L) means Landscape.
- You cannot use the Enlarge/Reduce setting with the N in 1 feature.

- 1 Make sure you are in Copy mode .
- 2 Load your document.
- 3 Use the dial pad to enter the number of copies (up to 99).
- 4 Press **N in 1**.
- 5 Press **▲** or **▼** to choose 2 in 1 (P), 2 in 1 (L), 4 in 1 (P), 4 in 1 (L) or Off (1 in 1). Press **OK**.
- 6 Press **Start** to scan the page. If you placed the document in the ADF, the machine scans the pages and starts printing.  
**If you are using the scanner glass, go to step 7.**
- 7 After the machine scans the page, press **1** to scan the next page.

```
Flatbed Copy:
Next Page?
▲ 1.Yes
▼ 2.No
Select ▲▼ or OK
```

- 8 Place the next page on the scanner glass. Press **OK**. Repeat steps 7 and 8 for each page of the layout.
- 9 After all the pages have been scanned, press **2** in step 7 to finish.

### If you are copying from the ADF:

Insert your document face up in the direction shown below:

#### ■ 2 in 1 (P)



#### ■ 2 in 1 (L)

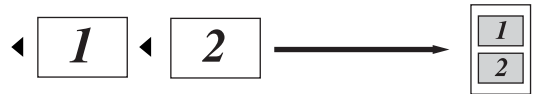

#### ■ 4 in 1 (P)



#### ■ 4 in 1 (L)

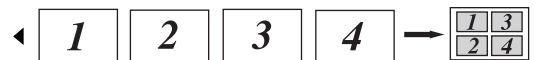

**If you are copying from the scanner glass:**

Insert your document face down in the direction shown below:

■ **2 in 1 (P)**

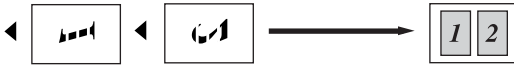

■ **2 in 1 (L)**

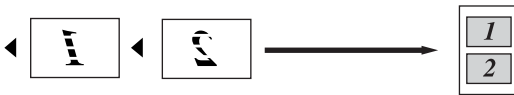

■ **4 in 1 (P)**



■ **4 in 1 (L)**



## Duplex (2-sided) copying

If you want to use the duplex copy feature, load your document in the ADF.

If you get an Out of Memory message while you are making duplex copies, try installing extra memory. (See *Out of memory message* on page 92.)

### Duplex Copy (long edge flip)

**MFC-8480DN**

■ **1 sided → 2 sided L**

Portrait

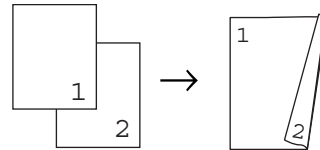

Landscape

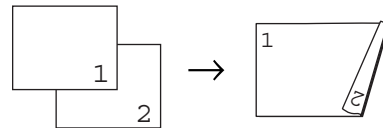

- 1 Make sure you are in Copy mode .
- 2 Load your document.
- 3 Enter the number of copies (up to 99) using the dial pad.
- 4 Press **Duplex** and **▲** or **▼** to select 1sided→2sided L.

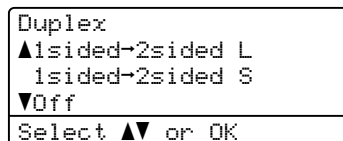

Press **OK**.

- 5 Press **Start** to copy the document.

**MFC-8680DN, MFC-8690DW and MFC-8890DW**

■ **1 sided → 2 sided**

Portrait

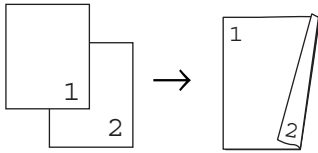

Landscape

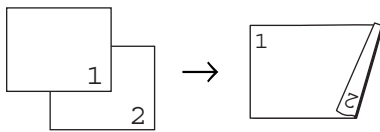

■ **2 sided → 2 sided**

Portrait

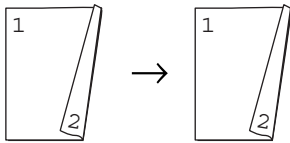

Landscape

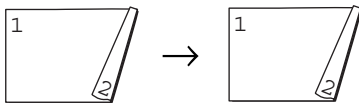

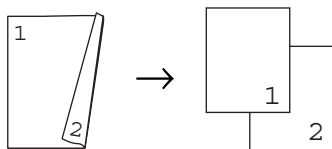

■ **2 sided → 1 sided**

Portrait

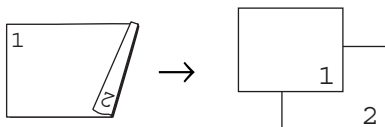

Landscape



1 Make sure you are in Copy mode .

2 Load your document.

3 Enter the number of copies (up to 99) using the dial pad.

4 Press **Duplex** and ▲ or ▼ to select  
1sided → 2sided,  
2sided → 2sided or  
2sided → 1sided.

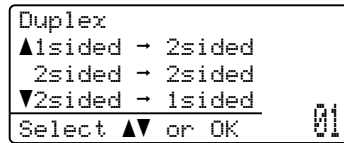

Press **OK**.

5 Press **Start** to copy the document.



**Note**

Duplex copy using a 2-sided legal size document is not available.

**Advanced Duplex Copy (short edge flip)**

**MFC-8480DN**

■ **1 sided → 2 sided S**

Portrait

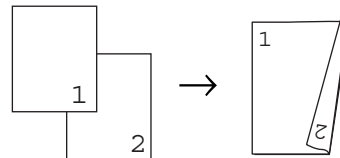

Landscape

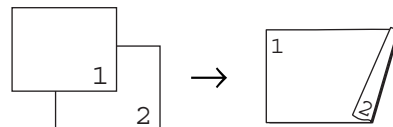

1 Make sure you are in Copy mode .

2 Load your document.

3 Enter the number of copies (up to 99) using the dial pad.

- 4 Press **Duplex** and **▲** or **▼** to select 1sided→2sided S.

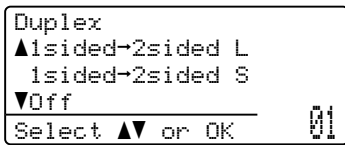

Press **OK**.

- 5 Press **Start** to copy the document.

**MFC-8680DN, MFC-8690DW and MFC-8890DW**

■ **Advanced 2 sided → 1 sided**

Portrait

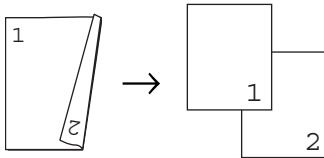

Landscape

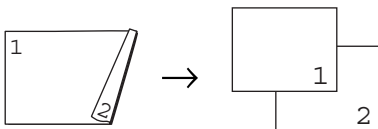

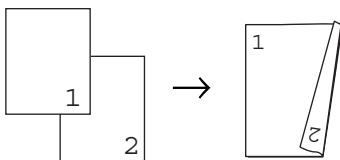

■ **Advanced 1 sided → 2 sided**

Portrait

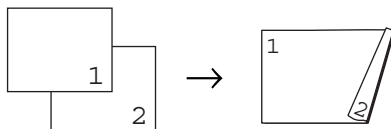

Landscape



- 1 Make sure you are in Copy mode .
- 2 Load your document.
- 3 Enter the number of copies (up to 99) using the dial pad.

- 4 Press **Duplex** and **▲** or **▼** to select Advanced.

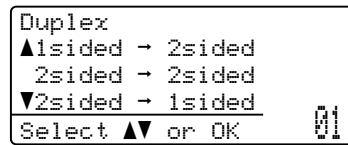

Press **OK**.

- 5 Press **▲** or **▼** to select 2sided → 1sided or 1sided → 2sided. Press **OK**.

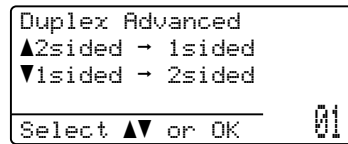

- 6 Press **Start** to copy the document.





**Note**

Duplex copy using a 2-sided legal size document is not available.

## Tray selection

You can change the Tray Use only for the next copy.

- 1 Make sure you are in Copy mode .
- 2 Load your document.
- 3 Use the dial pad to enter the number of copies (up to 99).
- 4 Press **Tray Select**.
- 5 Press ◀ or ▶ to choose the MP>T1, T1>MP, #1 (XXX) <sup>1</sup> or MP (XXX) <sup>1</sup>. Press **OK**.
- 6 Press **Start**.

|                                                                                            |                       |
|--------------------------------------------------------------------------------------------|-----------------------|
| Press<br> | MP>T1 or M>T1>T2      |
|                                                                                            | T1>MP or T1>T2>M      |
|                                                                                            | #1 (XXX) <sup>1</sup> |
|                                                                                            | #2 (XXX) <sup>1</sup> |
|                                                                                            | MP (XXX) <sup>1</sup> |

<sup>1</sup> XXX is the paper size you set in **Menu, 1, 2, 2**.

### Note

- T2 or #2 appears only if the optional paper tray is installed.
- To change the default setting for Tray Select, see *Tray Use in copy mode* on page 23.

## Out of memory message

If the memory becomes full while you are making copies, the LCD message will guide you through the next step.

If you get an **Out of Memory** message while scanning a subsequent page, you will have the option to press **Start** to copy the pages scanned so far, or to press **Stop/Exit** to cancel the operation.

To gain extra memory, you can do the following:

- Print the faxes that are in the memory. (See *Printing a fax from the memory* on page 53.)
- You can turn off Fax Storage. (See *Turning off Remote Fax Options* on page 74.)

### Note

When you get an **Out of Memory** message, you may be able to make copies if you first print incoming faxes in the memory to restore the memory to 100%.





# Direct printing

---

**Printing data from a USB Flash memory drive or a digital camera supporting mass storage**

94

# 13

## Printing data from a USB Flash memory drive or a digital camera supporting mass storage

With the Direct Print feature, you do not need a computer to print data. You can print by just plugging your USB Flash memory drive into the machine's USB direct interface. You can also connect and print directly from a camera set to USB mass storage mode.



### Note

- Some USB Flash memory drives may not work with the machine.
- If your camera is in PictBridge mode, you cannot print data. Please refer to the documentation supplied with your camera to switch from PictBridge mode to mass storage mode.

## Supported file formats

Direct Print supports the following file formats:

- PDF version 1.7<sup>1</sup>
- JPEG
- Exif + JPEG
- PRN (created by Brother driver)
- TIFF (scanned by all MFC or DCP Brother models)
- PostScript® 3™ (created by the Brother BRScrip3 printer driver)
- XPS version 1.0

<sup>1</sup> PDF data that includes a JBIG2 image file a JPEG2000 image file or transparency files is not supported.

## Creating a PRN or PostScript® 3™ file for direct printing



### Note

The screens in this section may vary depending on your application and operating system.

- 1 From the menu bar of an application, click **File**, then **Print**.
- 2 Choose **Brother MFCXXXX Printer** (1) and check the **Print to file** box (2). Click **Print**.

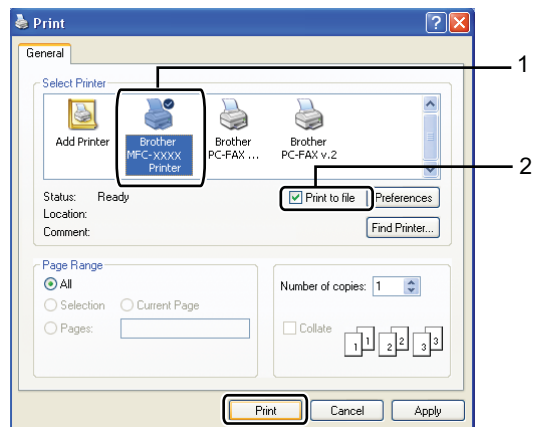

- 3 Choose the folder you want to save the file to and enter the file name if you are prompted to. If you are prompted for a file name only, you can also specify the folder you want to save the file in by entering the directory name. For example:  
C:\Temp\FileName.prn  
If you have a USB Flash memory drive or digital camera connected to your computer, you can save the file directly to the USB Flash memory drive.

# Printing data directly from the USB Flash memory drive or digital camera supporting mass storage

- 1 Connect your USB Flash memory drive or digital camera to the USB direct interface (1) on the front of the machine. Your machine will enter Direct Print mode automatically.

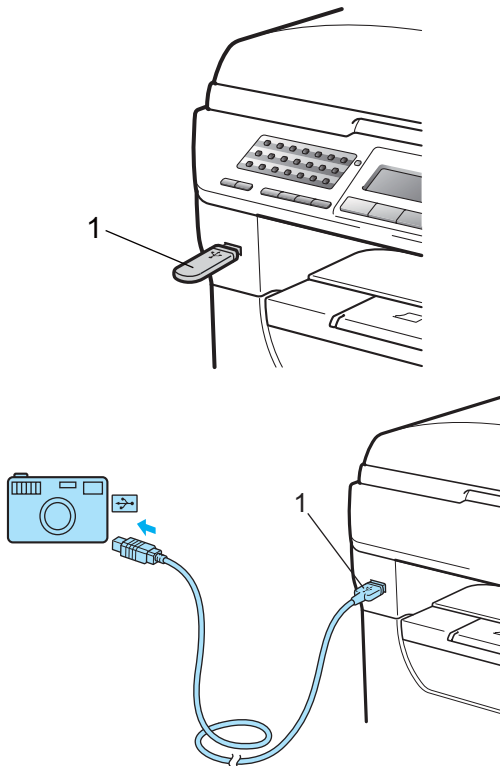

## Note

- If the Direct Print setting of Secure Function Lock 2.0 is set to **Disable** for all users (including Public mode settings), **Not Available** will appear on the LCD and then the machine will go back to the Ready mode. You cannot access the Direct Print function.

- If the current restricted user ID you are using is restricted for the Direct Print function from Secure Function Lock 2.0, but other restricted users (including Public mode settings) are allowed access, **Access Denied** will appear on the LCD and then the machine will ask your name.

If you are a restricted user with access to Direct Print, press **▲** or **▼** to choose your name and enter your four-digit password.

- If your administrator has set a page limit for Direct Print and the machine has already reached the maximum number of pages, the LCD will show **Limit Exceeded** when you insert a USB flash memory drive or digital camera.

2

Press **▲** or **▼** to choose the folder name or file name you want to print.

Press **OK**.

If you have chosen the folder name, press **▲** or **▼** to choose the file name you want to print.

Press **OK**.

```

Direct Print
▲1.FILE0_1.PDF
 2.FILE0_2.PDF
▼3.FILE0_3.PDF
Select ▲▼ or OK

```



## Note

- Your digital camera must be switched from PictBridge mode to mass storage mode.
- If you want to print an index of the files, choose **Index Print**, and then press **OK**. Press **Start** to print the data.

- File names that are stored in your USB Flash memory drive can be displayed using the following characters on the LCD:  
A B C D E F G H I J K L M N O P Q R S T  
U V W X Y Z 0 1 2 3 4 5 6 7 8 9 \$ % ' ` - @  
{ } ~ ! # ( ) & \_ ^

- 3 Do one of the following:
- Press ▲ or ▼ to choose a setting you need to change and press **OK**, and then press ▲ or ▼ to choose an option for the setting and press **OK**.
  - If you do not need to change the current default settings, go to step 4.

```
Print File Set
▲Paper Size
Media Type
▼Multiple Page
Select ▲▼ or OK
```



### Note

- You can choose the following settings:
  - Paper Size
  - Media Type
  - Multiple Page
  - Orientation
  - Duplex
  - Collate
  - Tray Use
  - Print Quality
  - PDF Option
- Depending on the file type, some of these settings may not appear.

- 4 Press **Start** if you have finished.
- 5 Press the dial pad key to enter the number of copies you want. Press **OK**.

```
Direct Print
FILE0_1.PDF
No. of Copies: 1
Press Start
```

- 6 Press **Start** to print the data.

## ! IMPORTANT

- To prevent damage to your machine, **DO NOT** connect any device other than a digital camera or USB Flash memory drive to the USB direct interface.
- **DO NOT** remove the USB Flash memory drive or digital camera from the USB direct interface until the machine has finished printing.



### Note

- If you want to change the default setting for the paper tray to feed paper from, press **Menu, 1, 6, 3** to change the paper tray setting.
- You can change the default settings for Direct Print by using the control panel when the machine is not in the Direct Print mode. Press **Menu, 5** to enter the USB Direct I/F menu. (See *Menu table* on page 172.)

## Understanding the error messages

Once you are familiar with the types of errors that can occur while you print data from the USB Flash memory drive with Direct Print, you can easily identify and troubleshoot any problems.

### ■ Out of Memory

This message will appear if you are working with images that are too large for the machine's memory.

### ■ Unusable Device

This message will appear if you connect an incompatible or broken device to the USB direct interface. To clear the error, unplug the device from the USB direct interface.

(See *Error and maintenance messages* on page 139 for the detailed solution.)





# Software

---

Software and Network features

100

The User's Guide on the CD-ROM includes the **Software User's Guide** and **Network User's Guide**.

The User's Guide on the CD-ROM includes the **Software User's Guide** and **Network User's Guide** for features available when connected to a computer (for example, printing and scanning). These guides have easy to use links that, when clicked, will take you directly to a particular section.

You can find information on these features:

- Printing
- Scanning
- ControlCenter3 (Windows®)
- ControlCenter2 (Macintosh)
- Remote Setup
- Faxing from your computer
- LDAP (MFC-8690DW and MFC-8890DW)
- Network Faxing
- Network Printing
- Network Scanning
- Scan to E-mail Server (I-Fax)  
(MFC-8690DW and MFC-8890DW)
- Wireless Network Users  
(MFC-8690DW and MFC-8890DW)



### Note

See *Accessing the Software User's Guide and Network User's Guide* on page 3.

## How to read the HTML User's Guide

This is a quick reference for using the HTML User's Guide.

### Windows®



### Note

If you have not installed the software, see *Viewing documentation (Windows®)* on page 3.

- 1 From the **Start** menu, point to **Brother, MFC-XXXX** from the programs group, then click **User's Guides in HTML format**.
- 2 Click on the manual you want (**SOFTWARE USER'S GUIDE** or **NETWORK USER'S GUIDE**) from the top menu.

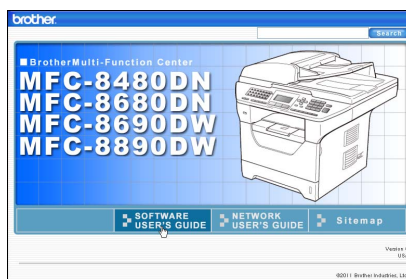

- 3 Click the heading you would like to view from the list at the left of the window.

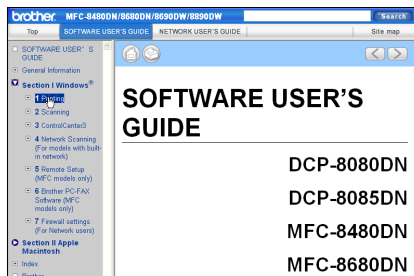



## Macintosh

- 1 Make sure your Macintosh is turned on. Insert the Brother CD-ROM into your CD-ROM drive.
- 2 Double-click the **Documentation** icon.
- 3 Double-click your language folder, and then double-click the top.html file.
- 4 Click on the manual you want (**SOFTWARE USER'S GUIDE** or **NETWORK USER'S GUIDE**) in the top menu, and then click the heading you would like to read from the list at the left of the window.

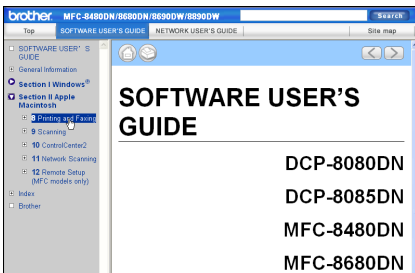





# Appendixes

---

|                                                |     |
|------------------------------------------------|-----|
| <b>Safety and legal</b>                        | 104 |
| <b>Options</b>                                 | 119 |
| <b>Troubleshooting and routine maintenance</b> | 122 |
| <b>Menu and features</b>                       | 170 |
| <b>Specifications</b>                          | 195 |
| <b>Glossary</b>                                | 215 |

# A

## Safety and legal

### Choosing a location

Put your machine on a flat, stable surface that is free of vibration and shocks, such as a desk. Put the machine near a telephone wall jack and a standard grounded AC power outlet. Choose a location where the temperature remains between 50°F and 90.5°F (10°C and 32.5°C) and the humidity is between 20% to 80% (without condensation.)

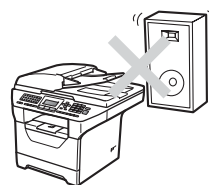
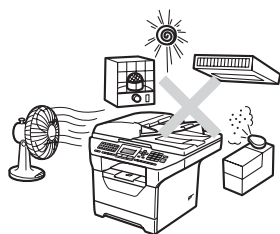

#### **!** WARNING

DO NOT expose the machine to direct sunlight, excessive heat, open flames, salty or corrosive gasses, moisture or dust.

DO NOT place the machine near heaters, air conditioners, electrical fans, refrigerators, water, chemicals or devices that contain magnets or generate magnetic fields.

## **⚠ CAUTION**

Avoid placing your machine in a high-traffic area.

---

DO NOT connect your machine to an AC power outlet controlled by wall switches or automatic timers.

---

DO NOT connect your machine to an AC power outlet on the same circuit as large appliances or other equipment that might disrupt the power supply.

---

Disruption of power can wipe out information in the machine's memory.

---

Avoid interference sources, such as speakers or the base units of non-Brother cordless telephones.

---

DO NOT put objects on top of the machine.

---

## To use the machine safely

Please keep these instructions for later reference and read them before attempting any maintenance. If you do not follow these safety instructions, there is a possibility of a fire, electrical shock, burn or suffocation.

### WARNING



There are high voltage electrodes inside the machine. Before you clean the inside of the machine, make sure you have unplugged the telephone line cord first and then the power cord from the AC power outlet. Doing this will prevent an electrical shock.

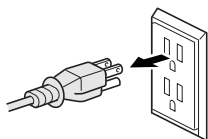

DO NOT handle the plug with wet hands. Doing this might cause an electrical shock. Always make sure the plug is fully inserted.

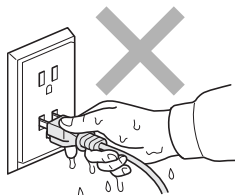

To reduce the risk of shock or fire, use only a No. 26 AWG or larger telecommunication line cord.

This product must be installed near an AC power outlet that is easily accessible. In case of an emergency, you must unplug the power cord from the AC power outlet to shut off the power completely.

Lighting and power surges can damage this product! We recommend that you use a quality surge protection device on the AC power line and on the telephone line, or unplug the cords during a lightning storm.

Plastic bags are used in the packing of your machine and drum unit. Plastic bags are not toys. To avoid the danger of suffocation, keep these bags away from babies and children and dispose of them properly.

---

DO NOT use flammable substances, any type of spray, or an organic solvent/liquid that contains alcohol or ammonia to clean the inside or outside of the machine. See *Routine maintenance* on page 154 for how to clean the machine.



---

DO NOT use a vacuum cleaner to clean up scattered toner. Doing this might cause the toner dust to ignite inside the vacuum cleaner, potentially starting a fire. Please carefully clean the toner dust with a dry, lint-free cloth and dispose of it according to local regulations.

---

Use caution when installing or modifying telephone lines. Never touch telephone wires or terminals that are not insulated unless the telephone line has been unplugged at the wall jack. Never install telephone wiring during a lightning storm. Never install a telephone wall jack in a wet location.

---

When using your telephone equipment, basic safety precautions should always be followed to reduce the risk of fire, electrical shock and injury to people, including the following:

- 1 DO NOT use this product near water, for example, near a bath tub, wash bowl, kitchen sink or washing machine, in a wet basement or near a swimming pool.
- 2 Avoid using this product during an electrical storm. There may be a remote risk of electric shock from lightning.
- 3 DO NOT use this product to report a gas leak in the vicinity of the leak.
- 4 DO NOT dispose of batteries in a fire. They may explode. Check with local codes for possible special disposal instructions.
- 5 Use only the power cord provided with the machine.

SAVE THESE INSTRUCTIONS

---

## ⚠ CAUTION



After you have just used the machine, some internal parts of the machine will be extremely hot. To prevent injury, when you open the front or back cover (back output tray) of the machine, DO NOT touch the shaded parts shown in the illustrations.

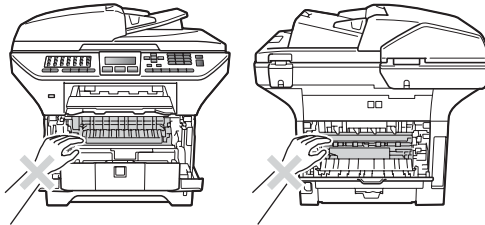

To prevent injuries, be careful not to put your hands on the edge of the machine under the document cover as shown in the illustration.

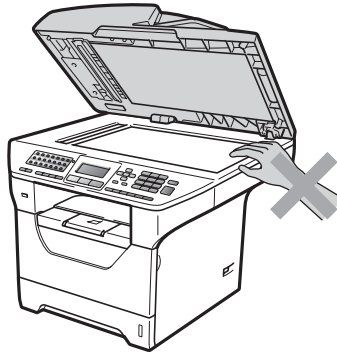

To prevent injuries, be careful not to put your fingers in the areas shown in the illustrations.

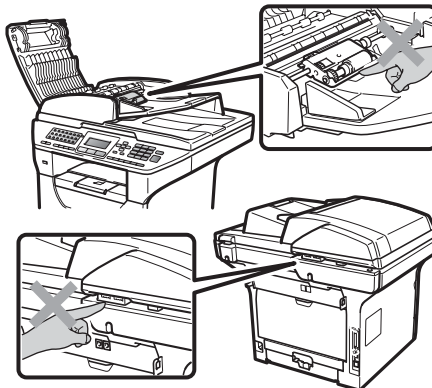



When you move the machine, grasp the side hand holds that are under the scanner.

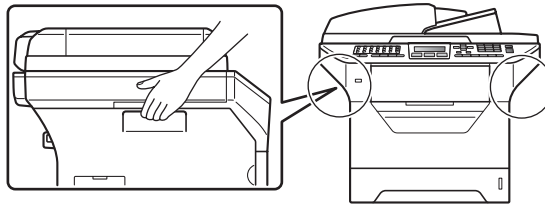

**! IMPORTANT**

The fuser unit is marked with a Caution label. Please DO NOT remove or damage the label.

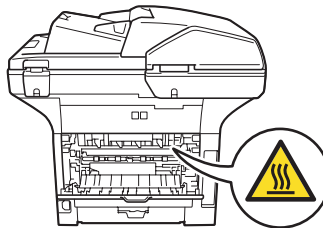

## Important safety instructions

---

- 1 Read all of these instructions.
- 2 Save them for later reference.
- 3 Follow all warnings and instructions marked on the product.
- 4 Be careful not to inhale toner.
- 5 Unplug this product from the wall outlet before cleaning inside of the machine. DO NOT use liquid or aerosol cleaners. Use a dry, lint-free cloth for cleaning.
- 6 DO NOT place this product on an unstable cart, stand, or table. The product may fall, causing serious damage to the product.
- 7 Slots and openings in the cabinet at the back or bottom are provided for ventilation. To ensure reliable operation of the product and to protect it from overheating, these openings must not be blocked or covered. The openings should never be blocked by placing the product on a bed, sofa, rug, or other similar surface. This product should never be placed near or over a radiator or heater. This product should never be placed in a built-in installation unless adequate ventilation is provided.
- 8 This product should be connected to an AC power source within the range indicated on the rating label. DO NOT connect it to a DC power source or inverter. If you are not sure, contact a qualified electrician.
- 9 This product is equipped with a 3-wire grounded plug. This plug will only fit into a grounded power outlet. This is a safety feature. If you are unable to insert the plug into the outlet, call your electrician to replace your obsolete outlet. DO NOT defeat the purpose of the grounded plug.
- 10 Use only the power cord supplied with this machine.
- 11 DO NOT allow anything to rest on the power cord. DO NOT place this product where people can walk on the cord.
- 12 If an extension cord is used with this product, make sure that the total ampere ratings on the products plugged into the extension cord DO NOT exceed the extension cord ampere rating. Also, make sure that the total of all products plugged into the AC power outlet does not exceed 15 amperes (US only).
- 13 Use the product in a well-ventilated area.
- 14 The power cord, including extensions, should be no longer than 16.5 feet (5 meters).  
DO NOT share the same power circuit with other high powered appliances, such as an air conditioner, copier, shredder, and so on.
- 15 DO NOT place anything in front of the machine that will block received faxes. DO NOT place anything in the path of received faxes.
- 16 Wait until pages have exited the machine before picking them up.

17 Never push objects of any kind into this product through cabinet slots, since they may touch dangerous voltage points or short out parts resulting in the risk of fire or electric shock. Never spill liquid of any kind on the product. DO NOT attempt to service this product yourself because opening or removing covers may expose you to dangerous voltage points and other risks and may void your warranty. Refer all servicing to a Brother Authorized Service Center. For the location of your nearest Brother Authorized Service Center, please call:

**In USA:** 1-877-BROTHER (1-877-276-8437)

**In Canada:** 1-877-BROTHER

18 Unplug this product from the AC power outlet and refer all servicing to Brother Authorized Service Personnel under the following conditions:

- When the power cord is damaged or frayed.
- If liquid has been spilled into the product.
- If the product has been exposed to rain or water.
- If the product does not operate normally when the operating instructions are followed. Adjust only those controls that are covered by the operating instructions. Improper adjustment of other controls may result in damage and will often require extensive work by a qualified technician to restore the product to normal operation.
- If the product has been dropped or the cabinet has been damaged.
- If the product exhibits a distinct change in performance, indicating a need for service.

19 To protect your product against power surges, we recommend the use of a power protection device (Surge Protector).

20 To reduce the risk of fire, electric shock and injury to people, note the following:

- DO NOT use this product near appliances that use water, a swimming pool or in a wet basement.
- DO NOT use the machine during an electrical storm (there is the remote possibility of an electrical shock). If you have connected a telephone DO NOT use it to report a gas leak in the vicinity of the leak.
- DO NOT use this product in the vicinity of a gas leak.

## Standard telephone and FCC notices

---

**These notices are in effect on models sold and used in the United States only.**

**When programming emergency numbers or making test calls to emergency numbers:**

- Remain on the line and briefly explain to the dispatcher the reason for the call before hanging up.
- Perform these activities in the off-peak hours, such as early morning or late evening.

This equipment complies with Part 68 of the FCC rules and the requirements adopted by the ACTA. On the backside of this equipment is a label that contains, among other information, a product identifier in the format US: AAAEQ##TXXXX. If requested, this number must be provided to the telephone company.

You may safely connect this equipment to the telephone line by means of a standard modular jack, USOC RJ11C.

A plug and jack used to connect this equipment to the premises wiring and telephone network must comply with the applicable FCC Part 68 rules and requirements adopted by the ACTA. A compliant telephone cord and modular plug is provided with this product. It is designed to be connected to a compatible modular jack that is also compliant. (See installation instructions for details.)

The REN is used to determine the number of devices that may be connected to a telephone line. Excessive RENs on a telephone line may result in the devices not ringing in response to an incoming call. In most but not all areas, the sum of RENs should not exceed five (5.0). To be certain of the number of devices that may be connected to a line, as determined by the total RENs, contact the local telephone company. For products approved after July 23, 2001, the REN for this product is part of the product identifier that has the format US:AAAEQ##TXXXX. The digits represented by ## are the REN without a decimal point (e.g., 06 is a REN of 0.6). For earlier products, the REN is separately shown on the label.

If this equipment causes harm to the telephone network, the telephone company will notify you in advance that temporary discontinuance of service may be required. But if advance notice is not practical, the telephone company will notify the customer as soon as possible. Also, you will be advised of your right to file a complaint with the FCC if you believe it is necessary.

The telephone company may make changes in its facilities, equipment, operations or procedures that could affect the operation of the equipment. If this happens the telephone company will provide advance notice in order for you to make necessary modifications to maintain uninterrupted service.

If trouble is experienced with this equipment, for repair or warranty information, please contact Brother Customer Service. (See *Brother numbers* on page i.) If the equipment is causing harm to the telephone network, the telephone company may request that you disconnect the equipment until the problem is resolved.

Connection to party line service is subject to state tariffs. Contact the state public utility commission, public service commission or corporation commission for information.

If your home has specially wired alarm equipment connected to the telephone line, ensure the installation of this equipment does not disable your alarm equipment. If you have questions about what will disable alarm equipment, call your telephone company or a qualified installer.

If you are not able to solve a problem with your machine, call Brother Customer Service. (See *Brother numbers* on page i.)

**⚠ WARNING**

For protection against the risk of electrical shock, always disconnect all cables from the wall outlet before servicing, modifying or installing the equipment.

**Federal Communications Commission (FCC) Declaration of Conformity (USA only)**

Responsible Party: Brother International Corporation  
100 Somerset Corporate Boulevard  
Bridgewater, NJ 08807-0911 USA  
TEL: (908) 704-1700

declares, that the products

Product Name: MFC-8480DN, MFC-8680DN, MFC-8690DW and MFC-8890DW

Product Options: LT-5300

comply with Part 15 of the FCC Rules. Operation is subject to the following two conditions: (1) This device may not cause harmful interference, and (2) this device must accept any interference received, including interference that may cause undesired operation.

This equipment has been tested and found to comply with the limits for a Class B digital device, pursuant to Part 15 of the FCC Rules. These limits are designed to provide reasonable protection against harmful interference in a residential installation. This equipment generates, uses, and can radiate radio frequency energy and, if not installed and used in accordance with the instructions, may cause harmful interference to radio communications. However, there is no guarantee that interference will not occur in a particular installation. If this equipment does cause harmful interference to radio or television reception, which can be determined by turning the equipment off and on, the user is encouraged to try to correct the interference by one or more of the following measures:

- Reorient or relocate the receiving antenna.
- Increase the separation between the equipment and receiver.
- Connect the equipment into an outlet on a circuit different from that to which the receiver is connected.
- Call the dealer or an experienced radio/TV technician for help.
- This transmitter must not be co-located or operated in conjunction with any other antenna or transmitter.

## **! IMPORTANT**

- Changes or modifications not expressly approved by Brother Industries, Ltd. could void the user's authority to operate the equipment.
- A shielded interface cable should be used to ensure compliance with the limits for a Class B digital device.
- This equipment may not be used on coin service lines provided by the telephone company or connected to party lines.
- Brother cannot accept any financial or other responsibilities that may be the result of your use of this information, including direct, special or consequential damages. There are no warranties extended or granted by this document.
- This machine has been certified to comply with FCC standards, which are applied to the USA only. A grounded plug should be plugged into a grounded AC power outlet after checking the rating of the local power supply for the machine to operate properly and safely.

## **Industry Canada Compliance Statement (Canada only)**

This Class B digital apparatus complies with Canadian ICES-003.

Cet appareil numérique de la classe B est conforme à la norme NMB-003 du Canada.

Operation is subject to the following two conditions: (1) this device may not cause interference, and (2) this device must accept any interference, including interference that may cause undesired operation of this device.

L'utilisation de ce dispositif est autorisée seulement aux conditions suivantes: (1) il ne doit pas produire de brouillage et (2) l'utilisateur du dispositif doit être prêt à accepter tout brouillage radioélectrique reçu, même si ce brouillage est susceptible de compromettre le fonctionnement du dispositif.

## **Laser safety (For 110-120V Models only)**

This equipment is certified as a Class 1 laser product as defined in IEC 60825-1: 2007 specifications under the U.S. Department of Health and Human Services (DHHS) Radiation Performance Standard according to the Radiation Control for Health and Safety Act of 1968. This means that the equipment does not produce hazardous laser radiation.

Since radiation emitted inside the equipment is completely confined within protective housings and external covers, the laser beam cannot escape from the machine during any phase of user operation.

## FDA regulations (For 110-120V Models only)

U.S. Food and Drug Administration (FDA) has implemented regulations for laser products manufactured on and after August 2, 1976. Compliance is mandatory for products marketed in the United States. One of the following labels on the back of the machine indicates compliance with the FDA regulations and must be attached to laser products marketed in the United States.

**Manufactured:**

BROTHER Industries (Vietnam) LTD.

Phuc Dien Industrial Zone Cam Phuc Commune, Cam giang Dist Hai Duong Province, Vietnam.

This product complies with FDA performance standards for laser products except for deviations pursuant to Laser Notice No. 50, dated June 24, 2007.

**Manufactured:**

BROTHER TECHNOLOGY (SHENZHEN) LTD.

NO6 Gold Garden Ind., Nanling Buji, Longgang, Shenzhen, China

This product complies with FDA performance standards for laser products except for deviations pursuant to Laser Notice No. 50, dated June 24, 2007.

### WARNING

Use of controls, adjustments or performance of procedures other than those specified in this manual may result in hazardous invisible radiation exposure.

Internal laser radiation

Max. Radiation Power: 5 mW

Wave Length: 770 – 810 nm

Laser Class: Class 3B

## Disconnect device

This product must be installed near an AC power outlet that is easily accessible. In case of emergencies, you must disconnect the power cord from the AC power outlet to shut off power completely.

## LAN connection

---

### **⚠ CAUTION**

DO NOT connect this product to a LAN connection that is subject to over-voltages.

## International ENERGY STAR® Qualification Statement

---

The purpose of the International ENERGY STAR® Program is to promote the development and popularization of energy-efficient office equipment.

As an ENERGY STAR® Partner, Brother Industries, Ltd. has determined that this product meets the ENERGY STAR® specifications for energy efficiency.





# Libtiff Copyright and License

Use and Copyright

Copyright© 1988-1997 Sam Leffler

Copyright© 1991-1997 Silicon Graphics, Inc.

Permission to use, copy, modify, distribute, and sell this software and its documentation for any purpose is hereby granted without fee, provided that (i) the above copyright notices and this permission notice appear in all copies of the software and related documentation, and (ii) the names of Sam Leffler and Silicon Graphics may not be used in any advertising or publicity relating to the software without the specific, prior written permission of Sam Leffler and Silicon Graphics.

THE SOFTWARE IS PROVIDED "AS-IS" AND WITHOUT WARRANTY OF ANY KIND, EXPRESS, IMPLIED OR OTHERWISE, INCLUDING WITHOUT LIMITATION, ANY WARRANTY OF MERCHANTABILITY OR FITNESS FOR A PARTICULAR PURPOSE.

IN NO EVENT SHALL SAM LEFFLER OR SILICON GRAPHICS BE LIABLE FOR ANY SPECIAL, INCIDENTAL, INDIRECT OR CONSEQUENTIAL DAMAGES OF ANY KIND, OR ANY DAMAGES WHATSOEVER RESULTING FROM LOSS OF USE, DATA OR PROFITS, WHETHER OR NOT ADVISED OF THE POSSIBILITY OF DAMAGE, AND ON ANY THEORY OF LIABILITY, ARISING OUT OF OR IN CONNECTION WITH THE USE OR PERFORMANCE OF THIS SOFTWARE.

## Trademarks

The Brother logo is a registered trademark of Brother Industries, Ltd.

Brother is a registered trademark of Brother Industries, Ltd.

Microsoft, Windows, Windows Server, Outlook and Internet Explorer are registered trademarks of Microsoft Corporation in the United States and/or other countries.

Windows Vista is either a registered trademark or a trademark of Microsoft Corporation in the United States and other countries.

Apple, Macintosh, Safari and TrueType are trademarks of Apple Inc., registered in the United States and other countries.

Intel, Intel Core and Pentium are trademarks of Intel Corporation in the U.S. and other countries.

AMD is a trademark of Advanced Micro Devices, Inc.

PowerPC is a registered trademark of IBM in the United States and/or other countries.

Adobe, Flash, Illustrator, Photoshop, PostScript and PostScript 3 are either registered trademarks or trademarks of Adobe Systems Incorporated in the United States and/or other countries.

Epson is a registered trademark and FX-80 and FX-850 are trademarks of Seiko Epson Corporation.

IBM® is either a registered trademarks or trademarks of International Business Machines Corporation in the United States and/or other countries.

BROADCOM, SecureEasySetup and the SecureEasySetup logo are trademarks or registered trademarks of Broadcom Corporation in the United States and/or other countries.

Wi-Fi and Wi-Fi Alliance are registered trademarks of the Wi-Fi Alliance.

AOSS is a trademark of Buffalo Inc.

Nuance, the Nuance logo, PaperPort and ScanSoft are trademarks or registered trademarks of Nuance Communications, Inc. or its affiliates in the United States and/or other countries.

OpenLDAP is a registered trademark of the OpenLDAP Foundation.

**Any trade names and product names of companies appearing on Brother products, related documents and any other materials are all trademarks or registered trademarks of those respective companies.**

## Options

This machine has the following optional accessories. You can increase the capabilities of the machine with these items.

### Lower tray unit

LT-5300

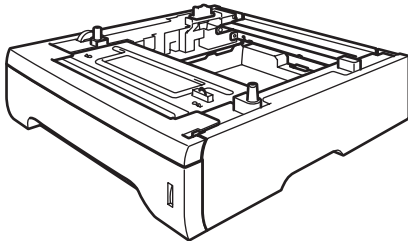

### SO-DIMM memory

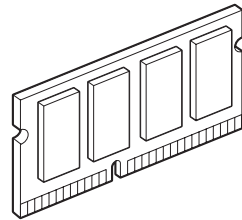

## Optional paper tray (LT-5300)

An optional lower tray can be installed, and it can hold up to 250 sheets of 20 lb (80 g/m<sup>2</sup>) paper.

When an optional tray is installed, the machine can hold up to 550 sheets of plain paper.

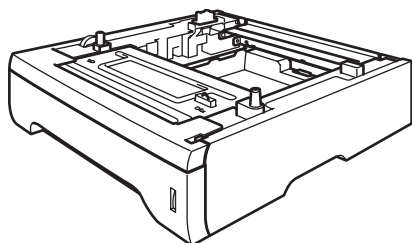

For setup, see the Instructions that we have supplied with the lower tray unit.

## Memory board

This machine has 64 MB of standard memory and one slot for optional memory expansion. You can expand the memory up to 576 MB by installing dual in-line memory modules (SO-DIMMs). When you add the optional memory, it increases the performance for both copier and printer operations.

In general, the machine uses industry-standard SO-DIMM with the following specifications:

Type: 144 pin and 64 bit output

CAS latency: 2

Clock frequency: 100 MHz or more

Capacity: 64, 128, 256 or 512 MB

Height: 1.25 in. (31.75 mm)

Dram Type: SDRAM 2 Bank

### The following web sites sell memory modules:

<http://www.crucial.com/>

<http://www.kingston.com/>

<http://goldenram.com/>

<http://www.buffalo-technology.com/>



### Note

- There might be some SO-DIMMs that will not work with the machine.
- For more information, call Brother Customer Service.

## Installing extra memory

- 1 Turn off the machine's power switch. Unplug the telephone line cord.
- 2 Disconnect the interface cable from the machine, and then unplug the power cord from the AC power outlet.



### Note

Be sure to turn off the machine's power switch before you install or remove the SO-DIMM.

- 3 Remove the SO-DIMM cover and interface access cover.

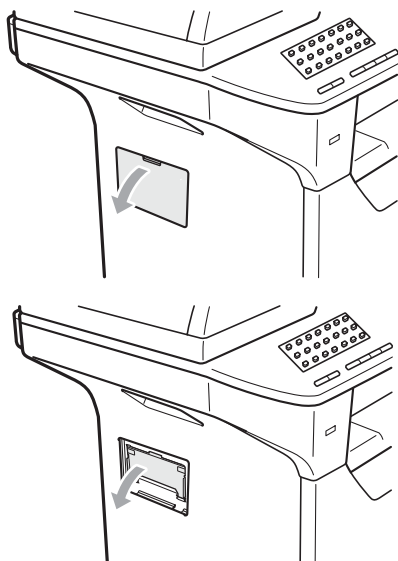

- 4 Unpack the SO-DIMM and hold it by its edges.

## ! IMPORTANT

To prevent damage to the machine from static electricity, DO NOT touch the memory chips or the board surface.

- 5 Hold the SO-DIMM by the edges and align the notches in the SO-DIMM with the protrusions in the slot. Insert the SO-DIMM diagonally (1), then tilt it toward the interface board until it clicks into place (2).

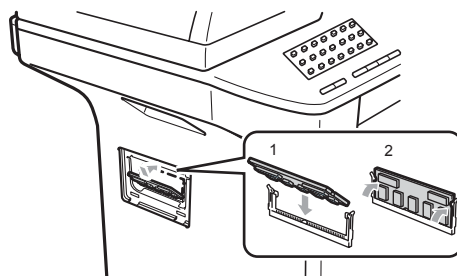

- 6 Put the interface access cover and the SO-DIMM cover back on.
- 7 Plug the machine's power cord back into the AC power outlet first, and then connect the interface cable.
- 8 Plug in the telephone line cord. Turn on the machine's power switch.



### Note

To make sure that you have installed the SO-DIMM properly, you can print the user settings page that shows the current memory size. (See *How to print a report* on page 81.)

## Troubleshooting

### ! IMPORTANT

For technical help, you must call the country where you bought the machine. Calls must be made **from within** that country.

### If you are having difficulty with your machine

If you think there is a problem, check the chart below and follow the troubleshooting tips. You can solve most problems by yourself.

If you need additional help, the Brother Solutions Center offers the latest FAQs and troubleshooting tips.

Visit us at <http://solutions.brother.com/>.

### Printing or printing received faxes

| Difficulties                                                                                                                                                               | Suggestions                                                                                                                                                                                                      |
|----------------------------------------------------------------------------------------------------------------------------------------------------------------------------|------------------------------------------------------------------------------------------------------------------------------------------------------------------------------------------------------------------|
| <ul style="list-style-type: none"> <li>■ Condensed print</li> <li>■ Horizontal streaks</li> <li>■ Top and bottom sentences are cut off</li> <li>■ Missing lines</li> </ul> | Usually this is caused by a poor telephone connection. If your copy looks good, you probably had a bad connection, with static or interference on the telephone line. Ask the other party to send the fax again. |
| Poor print quality                                                                                                                                                         | See <i>Improving the print quality</i> on page 131.                                                                                                                                                              |
| Vertical black lines when receiving                                                                                                                                        | The corona wire for printing may be dirty. Clean the corona wire. (See <i>Cleaning the corona wire</i> on page 157.)                                                                                             |
|                                                                                                                                                                            | The sender's scanner may be dirty. Ask the sender to make a copy to see if the problem is with the sending machine. Try receiving from another fax machine.                                                      |
|                                                                                                                                                                            | If the problem continues, call Brother Customer Service at 1-877-BROTHER (1-877-276-8437) (in USA) or 1-877-BROTHER (in Canada).                                                                                 |
| Received faxes appear as split or blank pages.                                                                                                                             | If the received faxes are divided and printed on two pages or if you get an extra blank page, your paper size setting may not be correct for the paper you are using. (See <i>Paper Size</i> on page 23.)        |
|                                                                                                                                                                            | Turn on Auto Reduction. (See <i>Printing a reduced incoming fax</i> on page 52.)                                                                                                                                 |

## Telephone line or connections

| Difficulties                             | Suggestions                                                                                                                                                                                                                                                                                                                                 |
|------------------------------------------|---------------------------------------------------------------------------------------------------------------------------------------------------------------------------------------------------------------------------------------------------------------------------------------------------------------------------------------------|
| Dialing does not work.                   | Check for a dial tone.                                                                                                                                                                                                                                                                                                                      |
|                                          | Change <b>Tone/Pulse</b> setting. (See the <i>Quick Setup Guide</i> .) (Canada only)                                                                                                                                                                                                                                                        |
|                                          | Check all line cord connections.                                                                                                                                                                                                                                                                                                            |
|                                          | Check that the machine is plugged in and switched on.                                                                                                                                                                                                                                                                                       |
| The machine does not answer when called. | Send a manual fax by pressing <b>Hook</b> or by lifting the handset of an external telephone and dialing the number. Wait to hear fax receiving tones before pressing <b>Start</b> .                                                                                                                                                        |
| The machine does not answer when called. | Make sure the machine is in the correct receive mode for your setup. (See on page 48.) Check for a dial tone. If possible, call your machine to hear it answer. If there is still no answer, check the telephone line cord connection. If you do not hear ringing when you call your machine, ask your telephone company to check the line. |

## Receiving Faxes

| Difficulties          | Suggestions                                                                                                                                                                                                                                                                                                           |
|-----------------------|-----------------------------------------------------------------------------------------------------------------------------------------------------------------------------------------------------------------------------------------------------------------------------------------------------------------------|
| Cannot receive a fax. | Make sure your machine has a dial tone by pressing the <b>Hook</b> key. If you hear static or interference on your fax line, please contact your local telephone company.                                                                                                                                             |
| Cannot receive a fax. | Check all line cord connections. Make sure the telephone line cord is plugged into the telephone wall jack and the <b>LINE</b> jack of the machine. If you subscribe to DSL or VoIP services, please contact your service provider for connection instructions.                                                       |
| Cannot receive a fax. | Make sure the machine is in the correct Receive Mode. This is determined by the external devices and telephone subscriber services you have on the same line as the Brother machine. (See <i>Receive Mode settings</i> on page 50.)                                                                                   |
| Cannot receive a fax. | If you have a dedicated fax line and want your Brother machine to automatically answer all incoming faxes, you should select <b>Fax Only</b> mode.                                                                                                                                                                    |
| Cannot receive a fax. | If your Brother machine shares a line with an external answering machine, you should select the <b>External TAD</b> mode. In <b>External TAD</b> mode, your Brother machine will automatically receive incoming faxes and voice callers will be able to leave a message on your answering machine.                    |
| Cannot receive a fax. | If your Brother machine shares the line with a Voice Mail subscriber service, please see <i>Voice Mail</i> on page 54.                                                                                                                                                                                                |
| Cannot receive a fax. | If your Brother machine is on a line with the Distinctive Ring subscriber service, please see <i>Distinctive Ring</i> on page 54.                                                                                                                                                                                     |
| Cannot receive a fax. | If your Brother machine shares a line with other telephones and you want it to automatically answer all incoming faxes, you should select the <b>Fax/Tel</b> mode. In <b>Fax/Tel</b> mode, your Brother machine will automatically receive faxes and produce a pseudo/double-ring to alert you to answer voice calls. |
| Cannot receive a fax. | If you do not want your Brother machine to automatically answer any incoming faxes, you should select the <b>Manual</b> mode. In <b>Manual</b> mode, you must answer every incoming call and activate the machine to receive faxes.                                                                                   |

## Receiving Faxes (continued)

| Difficulties                                 | Suggestions                                                                                                                                                                                                                                                                                                                                                                                                                                                                                                                                                                                                                                                                                                                                                                                                                                                                                                                                                                                                                                                                                                                                                                                                                                                                                                                                                                                                                                                                                                                                                                                                                                                                                                                                                                                                                                                                                                                                                                                                                                                                                                                                                                                                                                                                                                                                                                                                                                                                                                                                                                                                                                                                                                                                                                                                                                                                                                                                                                                                                                                                                                                                                         |
|----------------------------------------------|---------------------------------------------------------------------------------------------------------------------------------------------------------------------------------------------------------------------------------------------------------------------------------------------------------------------------------------------------------------------------------------------------------------------------------------------------------------------------------------------------------------------------------------------------------------------------------------------------------------------------------------------------------------------------------------------------------------------------------------------------------------------------------------------------------------------------------------------------------------------------------------------------------------------------------------------------------------------------------------------------------------------------------------------------------------------------------------------------------------------------------------------------------------------------------------------------------------------------------------------------------------------------------------------------------------------------------------------------------------------------------------------------------------------------------------------------------------------------------------------------------------------------------------------------------------------------------------------------------------------------------------------------------------------------------------------------------------------------------------------------------------------------------------------------------------------------------------------------------------------------------------------------------------------------------------------------------------------------------------------------------------------------------------------------------------------------------------------------------------------------------------------------------------------------------------------------------------------------------------------------------------------------------------------------------------------------------------------------------------------------------------------------------------------------------------------------------------------------------------------------------------------------------------------------------------------------------------------------------------------------------------------------------------------------------------------------------------------------------------------------------------------------------------------------------------------------------------------------------------------------------------------------------------------------------------------------------------------------------------------------------------------------------------------------------------------------------------------------------------------------------------------------------------------|
| <p>Cannot receive a fax.<br/>(continued)</p> | <p>Another device or service at your location may be answering the call before your Brother machine answers. To test this, lower the ring delay setting:</p> <ul style="list-style-type: none"> <li>■ If the answer mode is set to <b>Fax Only</b> or <b>Fax/Tel</b>, reduce the ring delay to 1 ring. (See <i>Ring Delay</i> on page 50.)</li> <li>■ If the answer mode is set to <b>External TAD</b>, reduce the number of rings programmed on your answering machine to 2.</li> <li>■ If the answer mode is set to <b>Manual</b>, <i>do not</i> adjust the ring delay setting.</li> </ul> <p>Have someone send you a test fax:</p> <ul style="list-style-type: none"> <li>■ If you received the test fax successfully, your machine is operating properly. Remember to reset your ring delay or answering machine setting back to your original setting. If receiving problems recur after resetting the ring delay, then a person, device, or subscriber service is answering the fax call before the machine has a chance to answer.</li> <li>■ If you were not able to receive the fax, then another device or subscriber service may be interfering with your fax reception or there may be a problem with your fax line.</li> </ul> <p>If you are using a telephone answering machine (<b>External TAD</b> mode) on the same line as the Brother machine, make sure your answering machine is set up correctly. (See <i>Connecting an external TAD (telephone answering device)</i> on page 57.)</p> <ol style="list-style-type: none"> <li>1 Plug the telephone line cord directly from the wall telephone jack to your Brother machine's <b>LINE</b> jack.</li> <li>2 Remove the protective cap from your Brother machine's <b>EXT</b> jack, and then plug the telephone line cord from your answering machine into the <b>EXT</b> jack.</li> <li>3 Set your answering machine to answer within 4 rings.<br/><br/>If you are having problems receiving faxes or voice messages, set your answering machine to answer within 2 or 3 rings.</li> <li>4 Record the outgoing message on your answering machine. <ul style="list-style-type: none"> <li>■ Record five seconds of silence at the beginning of your outgoing message.</li> <li>■ Limit your speaking to 20 seconds.</li> <li>■ End your outgoing message with your Fax Receive Code for people sending manual faxes. For example: "After the beep, leave a message or press *51 and Start to send a fax."</li> </ul> </li> <li>5 Set your answering machine to answer calls.</li> <li>6 Set your Brother machine's Receive Mode to <b>External TAD</b>. (See <i>Receive Mode settings</i> on page 50.)</li> </ol> <p>Make sure your Brother machine's Easy Receive feature is turned On. Easy Receive is a feature that allows you to receive a fax even if you have answered the call on an external or extension telephone. (See <i>Easy Receive</i> on page 51.)</p> <p>If you often get transmission errors due to possible interference on the telephone line, try changing the Compatibility setting to <b>Basic (for VoIP)</b>. (See <i>Telephone line interference</i> on page 138.)</p> |



## Sending faxes

| Difficulties                                       | Suggestions                                                                                                                                                                                                                                                                                                                                                                                                                                                                                                                                                                                                                                                                                                                                                                                                                              |
|----------------------------------------------------|------------------------------------------------------------------------------------------------------------------------------------------------------------------------------------------------------------------------------------------------------------------------------------------------------------------------------------------------------------------------------------------------------------------------------------------------------------------------------------------------------------------------------------------------------------------------------------------------------------------------------------------------------------------------------------------------------------------------------------------------------------------------------------------------------------------------------------------|
| Poor sending quality.                              | Try changing your resolution to <i>Fine</i> or <i>S.Fine</i> . Make a copy to check your machine's scanner operation. If the copy quality is not good, clean the scanner. (See <i>Cleaning the scanner</i> on page 155.)                                                                                                                                                                                                                                                                                                                                                                                                                                                                                                                                                                                                                 |
| Transmission Verification Report says 'RESULT:NG'. | There is probably temporary noise or static on the line. Try sending the fax again. If you are sending a PC Fax message and get 'RESULT:NG' on the Transmission Verification Report, your machine may be out of memory. To free up extra memory, you can turn off fax storage (see <i>Turning off Remote Fax Options</i> on page 74), print fax messages in memory (see <i>Printing a fax from the memory</i> on page 53) or cancel a delayed fax or polling job (see <i>Checking and canceling waiting jobs</i> on page 47). If the problem continues, ask the telephone company to check your telephone line.<br><br>If you often get transmission errors due to possible interference on the telephone line, try changing the Compatibility setting to <i>Basic</i> (for VoIP). (See <i>Telephone line interference</i> on page 138.) |
| Vertical black lines when sending.                 | Black vertical lines on faxes you send are typically caused by dirt or correction fluid on the glass strip. (See <i>Cleaning the scanner</i> on page 155.)                                                                                                                                                                                                                                                                                                                                                                                                                                                                                                                                                                                                                                                                               |

## Handling incoming calls

| Difficulties                               | Suggestions                                                                                                                                                                                                                                                                                                                                                                                                                                                                                                                                                                                                                                                                                                                                                                                                                                               |
|--------------------------------------------|-----------------------------------------------------------------------------------------------------------------------------------------------------------------------------------------------------------------------------------------------------------------------------------------------------------------------------------------------------------------------------------------------------------------------------------------------------------------------------------------------------------------------------------------------------------------------------------------------------------------------------------------------------------------------------------------------------------------------------------------------------------------------------------------------------------------------------------------------------------|
| The machine 'Hears' a voice as a CNG Tone. | If Easy Receive is set to On, your machine is more sensitive to sounds. It may mistakenly interpret certain voices or music on the line as a fax machine calling and respond with fax receiving tones. Deactivate the machine by pressing <b>Stop/Exit</b> . Try avoiding this problem by turning Easy Receive to Off. (See <i>Easy Receive</i> on page 51.)                                                                                                                                                                                                                                                                                                                                                                                                                                                                                              |
| Sending a Fax Call to the machine.         | If you answered on an external or extension telephone, press your Fax Receive Code (the default setting is *51). When your machine answers, hang up.                                                                                                                                                                                                                                                                                                                                                                                                                                                                                                                                                                                                                                                                                                      |
| Custom features on a single line.          | If you have Call Waiting, Call Waiting/Caller ID, Caller ID, RingMaster, Voice Mail, an answering machine, an alarm system or other custom feature on a single telephone line with your machine, it may create a problem sending or receiving faxes.<br><br><b>For Example:</b> If you subscribe to Call Waiting or some other custom service and its signal comes through the line while your machine is sending or receiving a fax, the signal can temporarily interrupt or disrupt the faxes. Brother's ECM feature should help overcome this problem. This condition is related to the telephone system industry and is common to all devices that send and receive information on a single, shared line with custom features. If avoiding a slight interruption is crucial to your business, a separate line with no custom features is recommended. |

## Menu access difficulties

| Difficulties                                                                     | Suggestions                                                                                                                                                                                                                                                                                   |
|----------------------------------------------------------------------------------|-----------------------------------------------------------------------------------------------------------------------------------------------------------------------------------------------------------------------------------------------------------------------------------------------|
| The machine beeps when you try to access the Setup Receive and Setup Send menus. | If Fax  is not illuminated, press it to turn on Fax mode. The Setup Receive setting ( <b>Menu, 2, 1</b> ) and Setup Send setting ( <b>Menu, 2, 2</b> ) are available only when the machine is in Fax mode. |

## Copy difficulties

| Difficulties                           | Suggestions                                                                                                                                                                                                                                                                                                     |
|----------------------------------------|-----------------------------------------------------------------------------------------------------------------------------------------------------------------------------------------------------------------------------------------------------------------------------------------------------------------|
| Cannot make a copy.                    | <ul style="list-style-type: none"> <li>■ Make sure that <b>Copy</b>  is illuminated. (See <i>Entering copy mode</i> on page 84.)</li> <li>■ Contact your administrator to check your Secure Function Lock settings.</li> </ul> |
| Vertical black line appears in copies. | Black vertical lines on copies are typically caused by dirt or correction fluid on the glass strip, or the corona wire for printing is dirty. (See <i>Cleaning the scanner</i> on page 155 and <i>Cleaning the corona wire</i> on page 157.)                                                                    |

## Printing difficulties

| Difficulties                                                                               | Suggestions                                                                                                                                                                                                                                                                                                                                                                                                                                                                                                                                                                                                                                                                                                                                                                                                                                                                                                                                                                                                                                                                                                                                                                                                                                                                                                                                                                                                           |
|--------------------------------------------------------------------------------------------|-----------------------------------------------------------------------------------------------------------------------------------------------------------------------------------------------------------------------------------------------------------------------------------------------------------------------------------------------------------------------------------------------------------------------------------------------------------------------------------------------------------------------------------------------------------------------------------------------------------------------------------------------------------------------------------------------------------------------------------------------------------------------------------------------------------------------------------------------------------------------------------------------------------------------------------------------------------------------------------------------------------------------------------------------------------------------------------------------------------------------------------------------------------------------------------------------------------------------------------------------------------------------------------------------------------------------------------------------------------------------------------------------------------------------|
| No printout.                                                                               | <ul style="list-style-type: none"> <li>■ Check that the machine is plugged in and the power switch is turned on.</li> <li>■ Check that the toner cartridge and drum unit are installed properly. (See <i>Replacing the drum unit</i> on page 164.)</li> <li>■ Check the interface cable connection on both the machine and your computer. (See the <i>Quick Setup Guide</i>.)</li> <li>■ Check that the correct printer driver has been installed and chosen.</li> <li>■ Check to see if the LCD is showing an error message. (See <i>Error and maintenance messages</i> on page 139.)</li> <li>■ Check that the machine is online:<br/><br/>(Windows® Vista®) Click the <b>Start</b> button, <b>Control Panel</b>, <b>Hardware and Sound</b>, and then <b>Printers</b>. Right-click <b>Brother MFC-XXXX Printer</b>. Make sure that <b>Use Printer Offline</b> is unchecked.<br/><br/>(Windows® XP and Windows Server® 2003) Click the <b>Start</b> button and choose <b>Printers and Faxes</b>. Right-click <b>Brother MFC-XXXX Printer</b>. Make sure that <b>Use Printer Offline</b> is unchecked.<br/><br/>(Windows® 2000) Click the <b>Start</b> button and choose <b>Settings</b> and then <b>Printers</b>. Right-click <b>Brother MFC-XXXX Printer</b>. Make sure that <b>Use Printer Offline</b> is unchecked.</li> <li>■ Contact your administrator to check your Secure Function Lock settings.</li> </ul> |
| The machine prints unexpectedly or it prints garbage.                                      | <ul style="list-style-type: none"> <li>■ Pull out the paper tray and wait until the machine stops printing. Then turn off the machine's power switch and disconnect from the power for several minutes. (The machine can be turned off for approximately 60 hours without losing faxes stored in the memory.)</li> <li>■ Check the settings in your application to make sure it is set up to work with your machine.</li> <li>■ If you are using the parallel port connection, check that the port is BRMFC and not LPT1.</li> </ul>                                                                                                                                                                                                                                                                                                                                                                                                                                                                                                                                                                                                                                                                                                                                                                                                                                                                                  |
| The machine prints the first couple of pages correctly, then some pages have text missing. | <ul style="list-style-type: none"> <li>■ Check the settings in your application to make sure that it is set up to work with your machine.</li> <li>■ Your computer is not recognizing the machine's input buffer's full signal. Make sure that you connected the interface cable correctly. (See the <i>Quick Setup Guide</i>.)</li> </ul>                                                                                                                                                                                                                                                                                                                                                                                                                                                                                                                                                                                                                                                                                                                                                                                                                                                                                                                                                                                                                                                                            |

### Printing difficulties (continued)

| Difficulties                                                                                                       | Suggestions                                                                                                                                    |
|--------------------------------------------------------------------------------------------------------------------|------------------------------------------------------------------------------------------------------------------------------------------------|
| The headers or footers appear when the document displays on the screen but they do not show up when it is printed. | There is an unprintable area on the top and bottom of the page. Adjust the top and bottom margins in your document to allow for this.          |
| The machine does not print on both sides of the paper even though the printer driver setting is Duplex.            | Check the paper size setting in the printer driver. You need to choose A4, Letter, Legal or Folio [16 to 28 lb (60 to 105 g/m <sup>2</sup> )]. |
| The machine is not printing or has stopped printing and the machine's status LED is yellow.                        | Press <b>Job Cancel</b> .<br>As the machine cancels the job and clears it from the memory it may produce an incomplete printout.               |

### Scanning difficulties

| Difficulties                        | Suggestions                                                                                                                                                                    |
|-------------------------------------|--------------------------------------------------------------------------------------------------------------------------------------------------------------------------------|
| TWAIN errors appear while scanning. | Make sure that the Brother TWAIN driver is chosen as the primary source. In PaperPort™ 11SE, click <b>File, Scan or Get Photo</b> and choose the <b>Brother TWAIN driver</b> . |
| OCR does not work.                  | Try increasing the scanning resolution.                                                                                                                                        |
| Network scanning does not work.     | See <i>Network difficulties</i> on page 128.                                                                                                                                   |

### Software difficulties

| Difficulties                                         | Suggestions                                                                                                      |
|------------------------------------------------------|------------------------------------------------------------------------------------------------------------------|
| Cannot install software or print.                    | Run the <b>Repair MFL-Pro Suite</b> program on the CD-ROM. This program will repair and reinstall the software.  |
| Cannot perform '2 in 1' or '4 in 1' printing.        | Check that the paper size setting in the application and in the printer driver are the same.                     |
| The machine does not print from Adobe® Illustrator®. | Try to reduce the print resolution. (See <i>Advanced tab</i> in the <i>Software User's Guide</i> on the CD-ROM.) |

## Paper handling difficulties

| Difficulties                                                                       | Suggestions                                                                                                                                                                                                                                                                                                                                                                                                                                                                                                                                                                                                                        |
|------------------------------------------------------------------------------------|------------------------------------------------------------------------------------------------------------------------------------------------------------------------------------------------------------------------------------------------------------------------------------------------------------------------------------------------------------------------------------------------------------------------------------------------------------------------------------------------------------------------------------------------------------------------------------------------------------------------------------|
| The machine does not load paper.<br>The LCD shows No Paper or a Paper Jam message. | <ul style="list-style-type: none"> <li>■ If there is no paper, load a new stack of paper into the paper tray.</li> <li>■ If there is paper in the paper tray, make sure it is straight. If the paper is curled, you should straighten it. Sometimes it is helpful to remove the paper, turn the stack over and put it back into the paper tray.</li> <li>■ Reduce the amount of paper in the paper tray, and then try again.</li> <li>■ Check that the MP tray mode is not chosen in the printer driver.</li> <li>■ If the LCD shows Paper Jam message and you still have a problem, see <i>Paper jams</i> on page 147.</li> </ul> |
| The machine does not feed paper from the MP tray.                                  | <ul style="list-style-type: none"> <li>■ Fan the paper well and put it back in the tray firmly.</li> <li>■ Make sure that MP tray mode is chosen in the printer driver.</li> </ul>                                                                                                                                                                                                                                                                                                                                                                                                                                                 |
| How do I print on envelopes?                                                       | You can load envelopes from the MP tray. Your application must be set up to print the envelope size you are using. This is usually done in the Page Setup or Document Setup menu of your application. (See your application's manual for more information.)                                                                                                                                                                                                                                                                                                                                                                        |
| What paper can I use?                                                              | You can use thin paper, plain paper, thick paper, bond paper, recycled paper, envelopes, labels and transparencies that are made for laser machines. (For details, see <i>Acceptable paper and other print media</i> on page 14.)                                                                                                                                                                                                                                                                                                                                                                                                  |
| There is a paper jam.                                                              | (See <i>Paper jams</i> on page 147.)                                                                                                                                                                                                                                                                                                                                                                                                                                                                                                                                                                                               |

## Print quality difficulties

| Difficulties               | Suggestions                                                                                                                                                                                                                                                                                                                                                                                  |
|----------------------------|----------------------------------------------------------------------------------------------------------------------------------------------------------------------------------------------------------------------------------------------------------------------------------------------------------------------------------------------------------------------------------------------|
| Printed pages are curled.  | <ul style="list-style-type: none"> <li>■ Low quality thin or thick paper or not printing on the recommended side of the paper could cause this problem. Try turning over the stack of paper in the paper tray.</li> <li>■ Make sure that you choose the Paper Type that suits the print media type you are using. (See <i>Acceptable paper and other print media</i> on page 14.)</li> </ul> |
| Printed pages are smeared. | The Paper Type setting may be incorrect for the type of print media you are using, or the print media may be too thick or have a rough surface. (See <i>Acceptable paper and other print media</i> on page 14 and <i>Basic tab</i> in the <i>Software User's Guide</i> on the CD-ROM.)                                                                                                       |
| Printouts are too light.   | <ul style="list-style-type: none"> <li>■ If this problem occurs when making copies or printing received faxes, turn Toner Save mode to Off in the machine menu settings. (See <i>Toner Save</i> on page 27.)</li> <li>■ Set Toner Save mode to Off in the Advanced tab in the printer driver. (See <i>Advanced tab</i> in the <i>Software User's Guide</i> on the CD-ROM.)</li> </ul>        |

## Network difficulties

| Difficulties                       | Suggestions                                                                                                                                                                                                                                                                                                                                                                                                                                                                                                                                                                                                              |
|------------------------------------|--------------------------------------------------------------------------------------------------------------------------------------------------------------------------------------------------------------------------------------------------------------------------------------------------------------------------------------------------------------------------------------------------------------------------------------------------------------------------------------------------------------------------------------------------------------------------------------------------------------------------|
| Cannot print over a wired Network. | <p>If you are having Network problems see the <i>Network User's Guide</i> on the CD-ROM for more information.</p> <p>Make sure your machine is powered on and is on-line and in the Ready state. Print the Network Configuration list to see your current Network settings. (See <i>How to print a report</i> on page 81.) Reconnect the LAN cable to the hub to verify that the cable and network connections are good. If possible, try connecting the machine to a different port on your hub using a different cable. If the connections are good, the lower LED of the back panel of the machine will be green.</p> |

## Network difficulties (continued)



| Difficulties                                                                                                                                                   | Suggestions                                                                                                                                                                                                                                                                                                                                                                                                                                                                                                                                                                                                                                                                                                                                                                                                                                                                                                                                                                                                                                                                                                                                                                                                                                                                                                                                                                                                                                                                                                                                                                                                                                                                                                                                                                                                                                                                                                                                                                                                                                                                                                                                                                                                                                                                                                                                                                                                                                                                                                                                                                                                                                                                                                                                                                                                                                                                                                        |
|----------------------------------------------------------------------------------------------------------------------------------------------------------------|--------------------------------------------------------------------------------------------------------------------------------------------------------------------------------------------------------------------------------------------------------------------------------------------------------------------------------------------------------------------------------------------------------------------------------------------------------------------------------------------------------------------------------------------------------------------------------------------------------------------------------------------------------------------------------------------------------------------------------------------------------------------------------------------------------------------------------------------------------------------------------------------------------------------------------------------------------------------------------------------------------------------------------------------------------------------------------------------------------------------------------------------------------------------------------------------------------------------------------------------------------------------------------------------------------------------------------------------------------------------------------------------------------------------------------------------------------------------------------------------------------------------------------------------------------------------------------------------------------------------------------------------------------------------------------------------------------------------------------------------------------------------------------------------------------------------------------------------------------------------------------------------------------------------------------------------------------------------------------------------------------------------------------------------------------------------------------------------------------------------------------------------------------------------------------------------------------------------------------------------------------------------------------------------------------------------------------------------------------------------------------------------------------------------------------------------------------------------------------------------------------------------------------------------------------------------------------------------------------------------------------------------------------------------------------------------------------------------------------------------------------------------------------------------------------------------------------------------------------------------------------------------------------------------|
| <p>The network scanning feature does not work.</p> <p>The network PC Fax Receive feature does not work.</p> <p>The network printing feature does not work.</p> | <p>(Windows®) The firewall setting on your PC may be rejecting the necessary network connection. Follow the instructions below to configure your firewall. If you are using a personal firewall software, see the User's Guide for your software or contact the software manufacturer.</p> <p><b>(Windows® XP SP2)</b></p> <ol style="list-style-type: none"> <li>1 Click the <b>Start</b> button, <b>Control Panel</b>, <b>Network and Internet Connections</b> and then <b>Windows Firewall</b>. Make sure that <b>Windows Firewall</b> on the <b>General</b> tab is set to On.</li> <li>2 Click the <b>Advanced</b> tab and <b>Settings...</b> button of the <b>Network Connection Settings</b>.</li> <li>3 Click the <b>Add</b> button.</li> <li>4 To add port 54925 for network scanning, enter the information below:             <ol style="list-style-type: none"> <li>1. In <b>Description of service</b>: Enter any description, for example "Brother Scanner".</li> <li>2. In <b>Name or IP address (for example 192.168.0.12) of the computer hosting this service on your network</b>: Enter "Localhost".</li> <li>3. In <b>External Port number for this service</b>: Enter "54925".</li> <li>4. In <b>Internal Port number for this service</b>: Enter "54925".</li> <li>5. Make sure <b>UDP</b> is chosen.</li> <li>6. Click <b>OK</b>.</li> </ol> </li> <li>5 Click the <b>Add</b> button.</li> <li>6 To add port 54926 for network PC Fax, enter the information below:             <ol style="list-style-type: none"> <li>1. In <b>Description of service</b>: Enter any description, for example "Brother PC Fax".</li> <li>2. In <b>Name or IP address (for example 192.168.0.12) of the computer hosting this service on your network</b>: Enter "Localhost".</li> <li>3. In <b>External Port number for this service</b>: Enter "54926".</li> <li>4. In <b>Internal Port number for this service</b>: Enter "54926".</li> <li>5. Make sure <b>UDP</b> is chosen.</li> <li>6. Click <b>OK</b>.</li> </ol> </li> <li>7 If you still have trouble with your network connection, click the <b>Add</b> button.</li> <li>8 To add port 137 for network scanning, network printing and network PC Fax receiving, enter the information below:             <ol style="list-style-type: none"> <li>1. In <b>Description of service</b>: - Enter any description, for example "Brother PC Fax receiving".</li> <li>2. In <b>Name or IP address (for example 192.168.0.12) of the computer hosting this service on your network</b>: Enter "Localhost".</li> <li>3. In <b>External Port number for this service</b>: Enter "137".</li> <li>4. In <b>Internal Port number for this service</b>: Enter "137".</li> <li>5. Make sure <b>UDP</b> is chosen.</li> <li>6. Click <b>OK</b>.</li> </ol> </li> <li>9 Make sure if the new setting is added and is checked, and then click <b>OK</b>.</li> </ol> |



## Network difficulties (continued)

| Difficulties                                                                                                                                                                      | Suggestions                                                                                                                                                                                                                                                                                                                                                                                                                                                                                                                                                                                                                                                                                                                                                                                                                                                                                                                                                                                                                                                                                                                                                                                                                                                                                                                                                                                                                                                                                                                                                                                                                                                                                                                                                        |
|-----------------------------------------------------------------------------------------------------------------------------------------------------------------------------------|--------------------------------------------------------------------------------------------------------------------------------------------------------------------------------------------------------------------------------------------------------------------------------------------------------------------------------------------------------------------------------------------------------------------------------------------------------------------------------------------------------------------------------------------------------------------------------------------------------------------------------------------------------------------------------------------------------------------------------------------------------------------------------------------------------------------------------------------------------------------------------------------------------------------------------------------------------------------------------------------------------------------------------------------------------------------------------------------------------------------------------------------------------------------------------------------------------------------------------------------------------------------------------------------------------------------------------------------------------------------------------------------------------------------------------------------------------------------------------------------------------------------------------------------------------------------------------------------------------------------------------------------------------------------------------------------------------------------------------------------------------------------|
| <p>The network scanning feature does not work.</p> <p>The network PC Fax Receive feature does not work.</p> <p>The network printing feature does not work.</p> <p>(continued)</p> | <p><b>(Windows Vista®):</b></p> <ol style="list-style-type: none"> <li>1 Click the <b>Start</b> button, <b>Control Panel</b>, <b>Network and Internet</b>, <b>Windows Firewall</b> and click <b>Change settings</b>.</li> <li>2 When the <b>User Account Control</b> screen appears, do the following. <ul style="list-style-type: none"> <li>■ Users who have administrator rights: Click <b>Continue</b>.</li> <li>■ For users who do not have administrator rights: Enter the administrator password and click <b>OK</b>.</li> </ul> </li> <li>3 Make sure that <b>Windows Firewall</b> on the <b>General</b> tab is set to On.</li> <li>4 Click the <b>Exceptions</b> tab.</li> <li>5 Click the <b>Add port...</b> button.</li> <li>6 To add port 54925 for network scanning, enter the information below: <ol style="list-style-type: none"> <li>1. In <b>Name</b> Enter any description. (for example "Brother Scanner")</li> <li>2. In <b>Port number</b>: Enter "54925".</li> <li>3. Make sure <b>UDP</b> is chosen. Then click <b>OK</b>.</li> </ol> </li> <li>7 Click the <b>Add port...</b> button.</li> <li>8 To add port 54926 for Network PC Fax, enter the information below: <ol style="list-style-type: none"> <li>1. In <b>Name</b> Enter any description. (for example "Brother PC Fax")</li> <li>2. In <b>Port number</b> Enter "54926".</li> <li>3. Make sure <b>UDP</b> is chosen. Then click <b>OK</b>.</li> </ol> </li> <li>9 Make sure that the new setting is added and is checked, and then click <b>Apply</b>.</li> <li>10 If you still have trouble with your network connection such as network scanning or printing, check <b>File and Printer Sharing</b> box in the <b>Exceptions</b> tab and then click <b>Apply</b>.</li> </ol> |
| <p>Your computer cannot find your machine.</p>                                                                                                                                    | <p><b>(Windows®)</b> The firewall setting on your PC may be rejecting the necessary network connection. (For details, see the instructions above.)</p> <p><b>(Macintosh)</b> Re-select your machine in the Device Selector application located in <b>Macintosh HD/Library/Printers/Brother/Utilities/DeviceSelector</b> or from the Model pop-up menu of ControlCenter2.</p>                                                                                                                                                                                                                                                                                                                                                                                                                                                                                                                                                                                                                                                                                                                                                                                                                                                                                                                                                                                                                                                                                                                                                                                                                                                                                                                                                                                       |

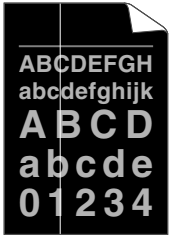
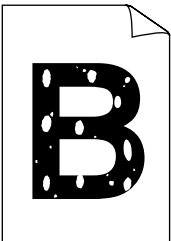
## Improving the print quality

| Examples of poor print quality                                                                                              | Recommendation                                                                                                                                                                                                                                                                                                                                                                                                                                                                                                                                                                                                                                                                                                                                                                                           |
|-----------------------------------------------------------------------------------------------------------------------------|----------------------------------------------------------------------------------------------------------------------------------------------------------------------------------------------------------------------------------------------------------------------------------------------------------------------------------------------------------------------------------------------------------------------------------------------------------------------------------------------------------------------------------------------------------------------------------------------------------------------------------------------------------------------------------------------------------------------------------------------------------------------------------------------------------|
|  <p><b>White lines across the page</b></p> | <ul style="list-style-type: none"> <li>■ Make sure that you use paper that meets our specifications. A rough surfaced paper or thick print media can cause the problem. (See <i>Acceptable paper and other print media</i> on page 14.)</li> <li>■ Make sure that you choose the appropriate media type in the printer driver or in the machine's Paper Type menu setting. (See <i>Acceptable paper and other print media</i> on page 14 and <i>Basic tab</i> in the <i>Software User's Guide</i> on the CD-ROM.)</li> <li>■ The problem may disappear by itself. Print multiple pages to clear this problem, especially if the machine has not been used for a long time.</li> <li>■ The drum unit may be damaged. Put in a new drum unit. (See <i>Replacing the drum unit</i> on page 164.)</li> </ul> |
|  <p><b>White lines down the page</b></p>  | <ul style="list-style-type: none"> <li>■ Wipe the laser scanner windows with a dry, lint-free soft cloth. (See <i>Cleaning the laser scanner window</i> on page 155.)</li> <li>■ Make sure that a torn sheet of paper is not inside the machine covering the scanner window.</li> <li>■ The toner cartridge may be damaged. Put in a new toner cartridge. (See <i>Replacing a toner cartridge</i> on page 161.)</li> <li>■ The drum unit may be damaged. Put in a new drum unit. (See <i>Replacing the drum unit</i> on page 164.)</li> </ul>                                                                                                                                                                                                                                                            |
|  <p><b>Hollow print</b></p>              | <ul style="list-style-type: none"> <li>■ Make sure that you use paper that meets our specifications. (See <i>Acceptable paper and other print media</i> on page 14.)</li> <li>■ Choose <b>Thick paper</b> mode in the printer driver, choose <i>Thick</i> in the machine's Paper Type menu setting or use thinner paper than you are currently using. (See <i>Paper Type</i> on page 22 and <i>Basic tab</i> in the <i>Software User's Guide</i> on the CD-ROM.)</li> <li>■ Check the machine's environment. Conditions such as high humidity can cause hollow print. (See <i>Choosing a location</i> on page 104.)</li> <li>■ The drum unit may be damaged. Put in a new drum unit. (See <i>Replacing the drum unit</i> on page 164.)</li> </ul>                                                        |
|  <p><b>Gray background</b></p>           | <ul style="list-style-type: none"> <li>■ Make sure that you use paper that meets our specifications. (See <i>Acceptable paper and other print media</i> on page 14.)</li> <li>■ Check the machine's environment. Conditions such as high temperatures and high humidity can increase the amount of background shading. (See <i>Choosing a location</i> on page 104.)</li> <li>■ The toner cartridge may be damaged. Put in a new toner cartridge. (See <i>Replacing a toner cartridge</i> on page 161.)</li> <li>■ The drum unit may be damaged. Put in a new drum unit. (See <i>Replacing the drum unit</i> on page 164.)</li> </ul>                                                                                                                                                                    |

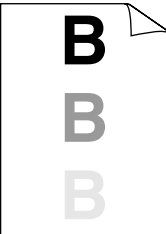
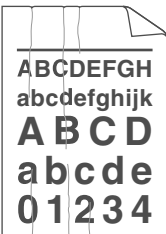
| Examples of poor print quality                                                                                                                      | Recommendation                                                                                                                                                                                                                                                                                                                                                                                                                                                                                                                                                                                                                                                                                                                                                                                                                                                                                                              |
|-----------------------------------------------------------------------------------------------------------------------------------------------------|-----------------------------------------------------------------------------------------------------------------------------------------------------------------------------------------------------------------------------------------------------------------------------------------------------------------------------------------------------------------------------------------------------------------------------------------------------------------------------------------------------------------------------------------------------------------------------------------------------------------------------------------------------------------------------------------------------------------------------------------------------------------------------------------------------------------------------------------------------------------------------------------------------------------------------|
|  <p data-bbox="203 548 356 575"><b>Page skewed</b></p>             | <ul style="list-style-type: none"> <li data-bbox="477 293 1216 378">■ Make sure that the paper or other print media is loaded properly in the paper tray and that the guides are not too tight or too loose against the paper stack.</li> <li data-bbox="477 394 1216 448">■ Set the paper guides correctly. (See <i>Loading paper in the standard paper tray</i> on page 10.)</li> <li data-bbox="477 463 1216 517">■ If you are using the MP tray, see <i>Loading paper in the multi-purpose tray (MP tray)</i> on page 12.</li> <li data-bbox="477 533 828 560">■ The paper tray may be too full.</li> <li data-bbox="477 575 1216 629">■ Check the paper type and quality. (See <i>Acceptable paper and other print media</i> on page 14.)</li> </ul>                                                                                                                                                                   |
|  <p data-bbox="244 911 315 938"><b>Ghost</b></p>                   | <ul style="list-style-type: none"> <li data-bbox="477 649 1216 726">■ Make sure that you use paper that meets our specifications. Rough-surfaced paper or thick paper may cause the problem. (See <i>Acceptable paper and other print media</i> on page 14.)</li> <li data-bbox="477 741 1216 857">■ Make sure that you choose the proper media type in the printer driver or in the machine's Paper Type menu setting. (See <i>Acceptable paper and other print media</i> on page 14 and <i>Basic tab</i> in the <i>Software User's Guide</i> on the CD-ROM.)</li> <li data-bbox="477 873 1216 927">■ The drum unit may be damaged. Put in a new drum unit. (See <i>Replacing the drum unit</i> on page 164.)</li> <li data-bbox="477 942 1216 1027">■ The fuser unit may be contaminated. Call Brother Customer Service at 1-877-BROTHER (1-877-276-8437) <b>(in USA)</b> or 1-877-BROTHER <b>(in Canada)</b>.</li> </ul> |
|  <p data-bbox="164 1302 392 1329"><b>Wrinkles or creases</b></p> | <ul style="list-style-type: none"> <li data-bbox="477 1047 1216 1101">■ Check the paper type and quality. (See <i>Acceptable paper and other print media</i> on page 14.)</li> <li data-bbox="477 1116 1216 1170">■ Make sure that paper is loaded properly. (See <i>Loading paper in the standard paper tray</i> on page 10.)</li> <li data-bbox="477 1186 1216 1240">■ Turn over the stack of paper in the tray or rotate the paper 180° in the input tray.</li> </ul>                                                                                                                                                                                                                                                                                                                                                                                                                                                    |

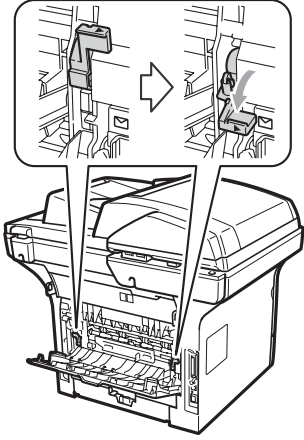
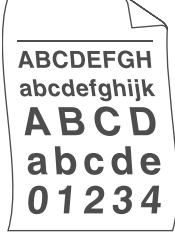

| Examples of poor print quality                                                                                   | Recommendation                                                                                                                                                                                                                                                                                                                                                                                                                           |
|------------------------------------------------------------------------------------------------------------------|------------------------------------------------------------------------------------------------------------------------------------------------------------------------------------------------------------------------------------------------------------------------------------------------------------------------------------------------------------------------------------------------------------------------------------------|
|  <p><b>Envelope Creases</b></p> | <ol style="list-style-type: none"> <li>1 Open the back cover.</li> <li>2 Pull the blue lever until the mark (▶) reaches beside the mark (✉) as shown below.</li> <li>3 Resend the print job.</li> </ol>  <p><b>Note</b></p> <p>When you have finished printing, open the back cover and reset the two blue levers back to their original position.</p> |
|  <p><b>Curled or wavy</b></p> | <ul style="list-style-type: none"> <li>■ Check the paper type and quality. High temperatures and high humidity will cause paper to curl.</li> <li>■ If you do not use the machine often, the paper may have been in the paper tray too long. Turn over the stack of paper in the paper tray. Also, fan the paper stack and then rotate the paper 180° in the paper tray.</li> </ul>                                                      |

**Examples of poor print quality**

**Recommendation**



**Curled**

- Turn the paper over in the paper tray, and print again. (Excluding Letterhead paper) If the problem remains, switch the Anti-Curl Lever as follows:

- 1 Open the back cover.

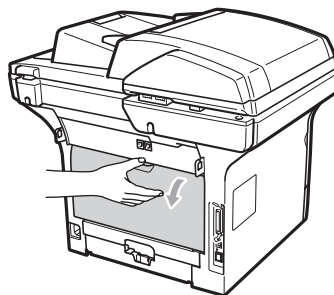

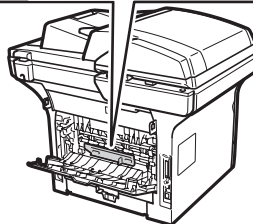
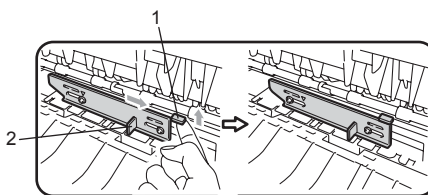

- 2 Lift the lever (1) and slide the lever (2) in the direction of the arrow.



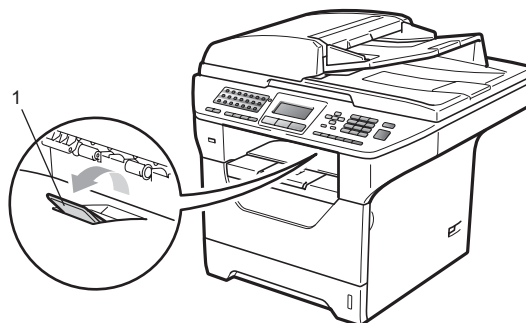

- Lift up the Output Tray Support Flap (1).

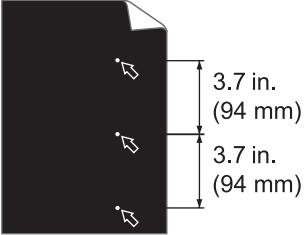
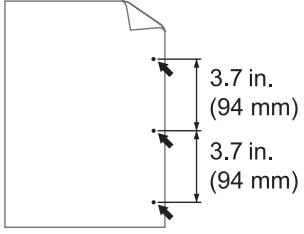

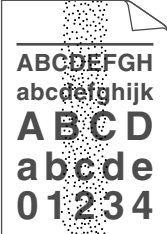
- Choose **Reduce Paper Curl** mode in the printer driver. (See *Other Print Options (For Windows®)* or *Print Settings (For Macintosh)* in the *Software User's Guide* on the CD-ROM.)

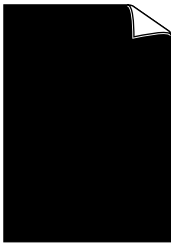
| Examples of poor print quality                                                                                                                                                                                                                                                                               | Recommendation                                                                                                                                                                                                                                                                                                                                                                                                                                                                                                                                                                                                                                                                                                                                                                                                                                                                                                                                                                           |
|--------------------------------------------------------------------------------------------------------------------------------------------------------------------------------------------------------------------------------------------------------------------------------------------------------------|------------------------------------------------------------------------------------------------------------------------------------------------------------------------------------------------------------------------------------------------------------------------------------------------------------------------------------------------------------------------------------------------------------------------------------------------------------------------------------------------------------------------------------------------------------------------------------------------------------------------------------------------------------------------------------------------------------------------------------------------------------------------------------------------------------------------------------------------------------------------------------------------------------------------------------------------------------------------------------------|
|  <p><b>White Spots on black text and graphics at 3.7 in. (94 mm) intervals</b></p>  <p><b>Black Spots at 3.7 in. (94 mm) intervals</b></p> | <ul style="list-style-type: none"> <li>■ Make ten copies of a blank, white sheet of paper. (See <i>Making multiple copies</i> on page 84.) If the problem is not solved, the drum unit may have glue from a label stuck on the OPC drum surface. Clean the drum unit. (See <i>Cleaning the drum unit</i> on page 158.)</li> <li>■ The drum unit may be damaged. Put in a new drum. (See <i>Replacing the drum unit</i> on page 164.)</li> </ul>                                                                                                                                                                                                                                                                                                                                                                                                                                                                                                                                          |
|  <p><b>Faint</b></p>                                                                                                                                                                                                       | <ul style="list-style-type: none"> <li>■ Check the machine's environment. Conditions such as humidity, high temperatures, and so on, may cause this print fault. (See <i>Choosing a location</i> on page 104.)</li> <li>■ If the whole page is too light, Toner Save mode may be on. Turn off Toner Save mode in the machine menu settings or <b>Toner Save</b> mode in the printer <b>Properties</b> of the driver. (See <i>Toner Save</i> on page 27 or <i>Advanced tab</i> in the <i>Software User's Guide</i> on the CD-ROM.)</li> <li>■ Clean the scanner window and the corona wire of the drum unit. (See <i>Cleaning the laser scanner window</i> on page 155 and <i>Cleaning the corona wire</i> on page 157.)</li> <li>■ The toner cartridge may be damaged. Put in a new toner cartridge. (See <i>Replacing a toner cartridge</i> on page 161.)</li> <li>■ The drum unit may be damaged. Put in a new drum unit. (See <i>Replacing the drum unit</i> on page 164.)</li> </ul> |
|  <p><b>Toner specks</b></p>                                                                                                                                                                                               | <ul style="list-style-type: none"> <li>■ Make sure that you use paper that meets our specifications. Rough-surfaced paper may cause the problem. (See <i>Acceptable paper and other print media</i> on page 14.)</li> <li>■ Clean the corona wire and the drum unit. (See <i>Cleaning the corona wire</i> on page 157 and <i>Cleaning the drum unit</i> on page 158.)</li> <li>■ The drum unit may be damaged. Put in a new drum unit. (See <i>Replacing the drum unit</i> on page 164.)</li> <li>■ The fuser unit may be contaminated. Call Brother Customer Service at 1-877-BROTHER (1-877-276-8437) (in USA) or 1-877-BROTHER (in Canada).</li> </ul>                                                                                                                                                                                                                                                                                                                                |

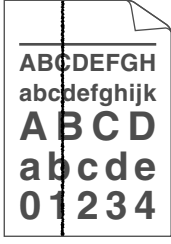
| Examples of poor print quality                                                                                                                                                                              | Recommendation                                                                                                                                                                                                                                                                                                                                                                                                                                                                                                                                                                                                                                                                                                                                                                                                                                                                                                                                                                                                                      |
|-------------------------------------------------------------------------------------------------------------------------------------------------------------------------------------------------------------|-------------------------------------------------------------------------------------------------------------------------------------------------------------------------------------------------------------------------------------------------------------------------------------------------------------------------------------------------------------------------------------------------------------------------------------------------------------------------------------------------------------------------------------------------------------------------------------------------------------------------------------------------------------------------------------------------------------------------------------------------------------------------------------------------------------------------------------------------------------------------------------------------------------------------------------------------------------------------------------------------------------------------------------|
|  <p data-bbox="230 556 329 581"><b>All black</b></p>                                                                       | <ul style="list-style-type: none"> <li data-bbox="477 291 1218 378">■ Clean the corona wire inside the drum unit by sliding the blue tab. Be sure to return the blue tab to the home position (▲). (See <i>Cleaning the corona wire</i> on page 157.)</li> <li data-bbox="477 394 1157 446">■ The drum unit may be damaged. Put in a new drum unit. (See <i>Replacing the drum unit</i> on page 164.)</li> <li data-bbox="477 461 1218 548">■ The fuser unit may be contaminated. Call Brother Customer Service at 1-877-BROTHER (1-877-276-8437) <b>(in USA)</b> or 1-877-BROTHER <b>(in Canada)</b>.</li> </ul>                                                                                                                                                                                                                                                                                                                                                                                                                   |
|  <p data-bbox="113 859 440 911"><b>Black toner marks across the page</b></p>                                               | <ul style="list-style-type: none"> <li data-bbox="477 595 1195 647">■ Make sure that you use paper that meets our specifications. (See <i>Acceptable paper and other print media</i> on page 14.)</li> <li data-bbox="477 662 1218 749">■ If you use label sheets for laser machines, the glue from the sheets may sometimes stick to the OPC drum surface. Clean the drum unit. (See <i>Cleaning the drum unit</i> on page 158.)</li> <li data-bbox="477 765 1218 817">■ Do not use paper that has clips or staples because they will scratch the surface of the drum.</li> <li data-bbox="477 832 1208 884">■ If the unpacked drum unit is in direct sunlight or room light, the unit may be damaged.</li> <li data-bbox="477 900 1208 952">■ The toner cartridge may be damaged. Put in a new toner cartridge. (See <i>Replacing a toner cartridge</i> on page 161.)</li> <li data-bbox="477 967 1157 1020">■ The drum unit may be damaged. Put in a new drum unit. (See <i>Replacing the drum unit</i> on page 164.)</li> </ul> |
|  <p data-bbox="159 1315 397 1340"><b>Line across the page</b></p>                                                        | <ul style="list-style-type: none"> <li data-bbox="477 1051 1218 1137">■ Clean the laser scanner window and the corona wire inside the drum unit. (See <i>Cleaning the laser scanner window</i> on page 155 and <i>Cleaning the corona wire</i> on page 157.)</li> <li data-bbox="477 1153 1157 1205">■ The drum unit may be damaged. Put in a new drum unit. (See <i>Replacing the drum unit</i> on page 164.)</li> </ul>                                                                                                                                                                                                                                                                                                                                                                                                                                                                                                                                                                                                           |
|  <p data-bbox="131 1619 426 1705"><b>Black lines down the page<br/>Printed pages have toner stains down the page</b></p> | <ul style="list-style-type: none"> <li data-bbox="477 1354 1218 1441">■ Clean the corona wire inside the drum unit by sliding the blue tab. Be sure to return the blue tab to the home position (▲). (See <i>Cleaning the corona wire</i> on page 157.)</li> <li data-bbox="477 1456 1208 1508">■ The toner cartridge may be damaged. Put in a new toner cartridge. (See <i>Replacing a toner cartridge</i> on page 161.)</li> <li data-bbox="477 1524 1157 1576">■ The drum unit may be damaged. Put in a new drum unit. (See <i>Replacing the drum unit</i> on page 164.)</li> <li data-bbox="477 1591 1178 1678">■ The fuser unit may be smudged. Call Brother Customer Service at 1-877-BROTHER (1-877-276-8437) <b>(in USA)</b> or 1-877-BROTHER <b>(in Canada)</b>.</li> </ul>                                                                                                                                                                                                                                                |

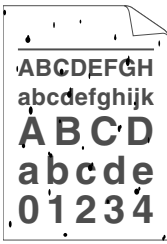
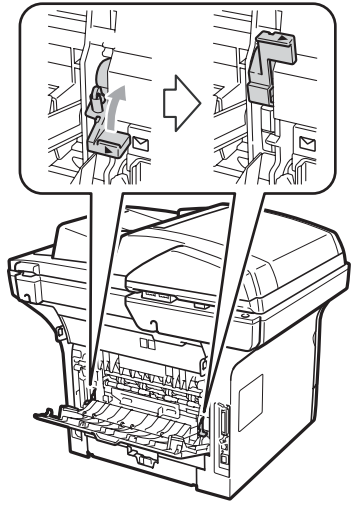
| Examples of poor print quality                                                                                                   | Recommendation                                                                                                                                                                                                                                                                                                                                                                                                                                                                                                                                                                                                                                                                                                                            |
|----------------------------------------------------------------------------------------------------------------------------------|-------------------------------------------------------------------------------------------------------------------------------------------------------------------------------------------------------------------------------------------------------------------------------------------------------------------------------------------------------------------------------------------------------------------------------------------------------------------------------------------------------------------------------------------------------------------------------------------------------------------------------------------------------------------------------------------------------------------------------------------|
|  <p data-bbox="240 550 377 589">Poor fixing</p> | <ul style="list-style-type: none"> <li data-bbox="500 289 1248 357">■ Open the back cover and make sure that the two blue levers on the left and right hand sides are in the up position.</li> </ul>  <ul style="list-style-type: none"> <li data-bbox="500 888 1255 985">■ Choose <b>Improve Toner Fixing</b> mode in the printer driver. (See <i>Other Print Options</i> (For Windows®) or <i>Print Settings</i> (For Macintosh) in the <i>Software User's Guide</i> on the CD-ROM.)</li> </ul> <p data-bbox="528 994 1200 1052">If this selection does not provide enough improvement, choose <b>Thicker Paper</b> in <b>Media Type</b> setting.</p> |

## Setting Dial Tone detection

Setting the Dial Tone to `Detection` will shorten the Dial Tone detect pause.

- 1 (USA) Press **Menu, 0, 4**.  
(Canada) Press **Menu, 0, 5**.

```
04.Dial Tone
▲ Detection
▼ No Detection
Select ▲▼ or OK
```

- 2 Press **▲** or **▼** to choose `Detection` or `No Detection`. Press **OK**.
- 3 Press **Stop/Exit**.

## Telephone line interference

If you are having difficulty sending or receiving a fax due to possible interference on the telephone line, we recommend that you adjust the Equalization for compatibility to reduce the modem speed for fax operations.

- 1 Press **Menu, 2, 0, 1**.

```
20.Miscellaneous
 1.Compatibility
▲ High
▼ Normal
Select ▲▼ or OK
```

- 2 Press **▲** or **▼** to choose `Basic (for VoIP)`, `Normal` or `High`.

- `Basic (for VoIP)` cuts the modem speed to 9600 bps. and turns the error correction mode (ECM) off.

For a standard telephone line: If you regularly experience interference on your standard telephone line try this setting.

If you are using VoIP: VoIP service providers offer fax support using various standards. If you regularly experience fax transmission errors try this setting.

- `Normal` sets the modem speed at 14400 bps.
- `High` sets the modem speed at 33600 bps.

Press **OK**.

- 3 Press **Stop/Exit**.



### Note

When you change the `Compatibility` to `Basic (for VoIP)`, the ECM feature is not available.

## Error and maintenance messages

As with any sophisticated office product, errors may occur and consumable items may need to be replaced. If this happens, your machine identifies the error or required routine maintenance and shows the appropriate message. The most common error and maintenance messages are shown below.

You can correct most errors and perform routine maintenance by yourself. If you need more help, the Brother Solutions Center offers the latest FAQs and troubleshooting tips.

Visit us at <http://solutions.brother.com/>.

| Error Message                    | Cause                                                                                                                                                                                                                                                                   | Action                                                                                                                                                                                                                                                                                                                                                                                                                                                                                                                                                                                    |
|----------------------------------|-------------------------------------------------------------------------------------------------------------------------------------------------------------------------------------------------------------------------------------------------------------------------|-------------------------------------------------------------------------------------------------------------------------------------------------------------------------------------------------------------------------------------------------------------------------------------------------------------------------------------------------------------------------------------------------------------------------------------------------------------------------------------------------------------------------------------------------------------------------------------------|
| Access Error                     | The device is removed from the USB direct interface while the data is processing.                                                                                                                                                                                       | Press <b>Stop/Exit</b> . Reinsert the device and try to print with Direct Print.                                                                                                                                                                                                                                                                                                                                                                                                                                                                                                          |
| Cartridge Error                  | The toner cartridge is not installed properly.                                                                                                                                                                                                                          | Pull out the drum unit, take out the toner cartridge that is indicated on the LCD, and put it back into the drum unit again.                                                                                                                                                                                                                                                                                                                                                                                                                                                              |
| Comm. Error                      | Poor telephone line quality caused a communication error.                                                                                                                                                                                                               | Send the fax again or connect the machine to another telephone line. If the problem continues, call the telephone company and ask them to check your telephone line.                                                                                                                                                                                                                                                                                                                                                                                                                      |
| Connection Fail                  | You tried to poll a fax machine that is not in Polled Waiting mode.                                                                                                                                                                                                     | Check the other fax machine's polling setup.                                                                                                                                                                                                                                                                                                                                                                                                                                                                                                                                              |
| Cooling Down<br>Wait for a while | The temperature of the drum unit or toner cartridge is too hot. The machine will pause its current print job and go into cooling down mode. During the cooling down mode, you will hear the cooling fan running while the LCD shows Cooling Down, and Wait for a while. | <p>Make sure that you can hear the fan in the machine spinning and that the exhaust outlet is not blocked by something.</p> <p>If the fan is spinning, remove any obstacles that surround the exhaust outlet, and then leave the machine turned on but do not use it for several minutes.</p> <p>If the fan is not spinning disconnect the machine from the power for several minutes, then reconnect it. (The machine can be turned off for approximately 60 hours without losing faxes stored in the memory. See <i>Transferring your faxes or Fax Journal report</i> on page 144.)</p> |
| Cover is Open                    | The front cover is not closed completely.                                                                                                                                                                                                                               | Close the front cover of the machine.                                                                                                                                                                                                                                                                                                                                                                                                                                                                                                                                                     |
| Cover is Open                    | The fuser cover is not closed completely or paper was jammed in the back of the machine when you turned on the power.                                                                                                                                                   | <ul style="list-style-type: none"> <li>■ Close the fuser cover of the machine.</li> <li>■ Make sure paper is not jammed inside the back of the machine, and then close the fuser cover and press <b>Start</b>.</li> </ul>                                                                                                                                                                                                                                                                                                                                                                 |
| Disconnected                     | The other person or other person's fax machine stopped the call.                                                                                                                                                                                                        | Try to send or receive again.                                                                                                                                                                                                                                                                                                                                                                                                                                                                                                                                                             |

| Error Message            | Cause                                                                                                        | Action                                                                                                                                                                                                                                                                                                    |
|--------------------------|--------------------------------------------------------------------------------------------------------------|-----------------------------------------------------------------------------------------------------------------------------------------------------------------------------------------------------------------------------------------------------------------------------------------------------------|
| Document Jam             | The document was not inserted or fed properly, or the document scanned from the ADF was too long.            | See <i>Document jams</i> on page 145 or <i>Using the automatic document feeder (ADF)</i> on page 20.                                                                                                                                                                                                      |
| DR Mode in Use           | The machine is set to Distinctive Ring mode. You cannot change the Receive Mode from Manual to another mode. | Set Distinctive Ring to OFF. (See <i>Turning off distinctive ring</i> on page 57.)                                                                                                                                                                                                                        |
| Drum Error               | The corona wire on the drum unit needs to be cleaned.                                                        | Clean the corona wire on the drum unit. (See <i>Cleaning the corona wire</i> on page 157.)                                                                                                                                                                                                                |
|                          | The drum unit has reached the end of its life.                                                               | Replace the drum unit. (See <i>Replacing the drum unit</i> on page 164.)                                                                                                                                                                                                                                  |
| Duplex Disabled          | The duplex tray is not installed properly.                                                                   | Remove the duplex tray and install it again.                                                                                                                                                                                                                                                              |
| Fuser Error              | The temperature of fuser unit does not rise at a specified temperature within specified time.                | Turn the power switch off, wait a few seconds, and then turn it on again. Leave the machine for 15 minutes with the power on. The machine can be turned off for approximately 60 hours without losing faxes stored in the memory. (See <i>Transferring your faxes or Fax Journal report</i> on page 144.) |
|                          | The fuser unit is too hot.                                                                                   |                                                                                                                                                                                                                                                                                                           |
| Jam Duplex               | The paper is jammed in the duplex tray.                                                                      | (See <i>Paper jams</i> on page 147.)                                                                                                                                                                                                                                                                      |
| Jam Rear                 | The paper is jammed in the back of the machine.                                                              | (See <i>Paper jams</i> on page 147.)                                                                                                                                                                                                                                                                      |
| Jam Inside               | The paper is jammed inside the machine.                                                                      | (See <i>Paper jams</i> on page 147.)                                                                                                                                                                                                                                                                      |
| Jam MP Tray              | The paper is jammed in the MP tray of the machine.                                                           | (See <i>Paper jams</i> on page 147.)                                                                                                                                                                                                                                                                      |
| Jam Tray 1<br>Jam Tray 2 | The paper is jammed in the paper tray of the machine.                                                        | (See <i>Paper jams</i> on page 147.)                                                                                                                                                                                                                                                                      |
| No Paper                 | The machine is out of paper or paper is not properly loaded in the paper tray.                               | Do one of the following: <ul style="list-style-type: none"> <li>■ Refill the paper in the paper tray or MP tray.</li> <li>■ Remove the paper and load it again.</li> </ul>                                                                                                                                |
| No Response/Busy         | The number you dialed does not answer or is busy.                                                            | Verify the number and try again.                                                                                                                                                                                                                                                                          |
| No Toner                 | The toner cartridge or the drum unit and toner cartridge assembly is not installed properly.                 | Re-install the toner cartridge or the drum unit and toner cartridge assembly.                                                                                                                                                                                                                             |
| No Tray                  | The paper tray is not completely closed.                                                                     | Close the paper tray properly.                                                                                                                                                                                                                                                                            |



| Error Message               | Cause                                                                                                        | Action                                                                                                                                                                                                                                                                                                                                                                                                                                                                                                                                                                                                                                                                                                                                             |
|-----------------------------|--------------------------------------------------------------------------------------------------------------|----------------------------------------------------------------------------------------------------------------------------------------------------------------------------------------------------------------------------------------------------------------------------------------------------------------------------------------------------------------------------------------------------------------------------------------------------------------------------------------------------------------------------------------------------------------------------------------------------------------------------------------------------------------------------------------------------------------------------------------------------|
| Out of Memory               | The machine's memory is full.                                                                                | <p><b>Fax sending or copy operation in progress</b></p> <p>Do one of the following:</p> <ul style="list-style-type: none"> <li>■ Press <b>Start</b> to send or copy the scanned pages.</li> <li>■ Press <b>Stop/Exit</b> and wait until the other operations in progress finish, and then try again.</li> <li>■ Clear the data from the memory. (See <i>Out of memory message</i> on page 47 or page 92.)</li> </ul> <p><b>Print operation in process</b></p> <p>Do one of the following:</p> <ul style="list-style-type: none"> <li>■ Reduce print resolution. (See <i>Advanced tab</i> in the <i>Software User's Guide</i> on the CD-ROM.)</li> <li>■ Clear the faxes from the memory. (See <i>Out of memory message</i> on page 92.)</li> </ul> |
| Print Unable XX             | The machine has a mechanical problem.                                                                        | Disconnect the machine from the power for several minutes, then reconnect it. (The machine can be turned off for approximately 60 hours without losing faxes stored in the memory. See <i>Transferring your faxes or Fax Journal report</i> on page 144.)                                                                                                                                                                                                                                                                                                                                                                                                                                                                                          |
| Protected Device            | The protect switch of the USB Flash memory drive is on.                                                      | Turn off the protect switch of the USB Flash memory drive.                                                                                                                                                                                                                                                                                                                                                                                                                                                                                                                                                                                                                                                                                         |
| Rename the File             | There is already a file on the USB Flash memory drive with the same name as the file you are trying to save. | Change the file name of the file on the USB Flash memory drive or the file you are trying to save.                                                                                                                                                                                                                                                                                                                                                                                                                                                                                                                                                                                                                                                 |
| Replace Parts<br>Drum       | The drum unit is the end of its life.                                                                        | Replace the drum unit.<br>(See <i>Replacing the drum unit</i> on page 164.)                                                                                                                                                                                                                                                                                                                                                                                                                                                                                                                                                                                                                                                                        |
|                             | The drum unit counter was not reset when a new drum was installed.                                           | <ol style="list-style-type: none"> <li>1 Open the front cover, and then press <b>Clear/Back</b>.</li> <li>2 Press <b>1</b> to reset.</li> </ol>                                                                                                                                                                                                                                                                                                                                                                                                                                                                                                                                                                                                    |
| Replace Parts<br>Fuser Unit | It is time to replace the fuser unit.                                                                        | <p>Call Brother Customer Service to replace the fuser unit.</p> <p>1-877-BROTHER (1-877-276-8437) (in U.S.A)</p> <p>1-877-BROTHER (in Canada)</p>                                                                                                                                                                                                                                                                                                                                                                                                                                                                                                                                                                                                  |

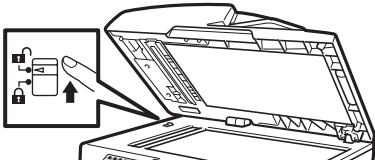

| Error Message               | Cause                                                                       | Action                                                                                                                                                                                                                                                   |
|-----------------------------|-----------------------------------------------------------------------------|----------------------------------------------------------------------------------------------------------------------------------------------------------------------------------------------------------------------------------------------------------|
| Replace Parts<br>Laser Unit | It is time to replace the laser unit.                                       | Call Brother Customer Service to replace the laser unit.<br>1-877-BROTHER (1-877-276-8437) (in U.S.A)<br>1-877-BROTHER (in Canada)                                                                                                                       |
| Replace Parts<br>PF Kit MP  | It is time to replace the paper feeding kit for the MP tray.                | Call Brother Customer Service to replace the PF Kit MP.<br>1-877-BROTHER (1-877-276-8437) (in U.S.A)<br>1-877-BROTHER (in Canada)                                                                                                                        |
| Replace Parts<br>PF Kit 1   | It is time to replace the paper feeding kit for Tray 1.                     | Call Brother Customer Service to replace the PF Kit 1.<br>1-877-BROTHER (1-877-276-8437) (in U.S.A)<br>1-877-BROTHER (in Canada)                                                                                                                         |
| Replace Parts<br>PF Kit 2   | It is time to replace the paper feeding kit for Tray 2.                     | Call Brother Customer Service to replace the PF Kit 2.<br>1-877-BROTHER (1-877-276-8437) (in U.S.A)<br>1-877-BROTHER (in Canada)                                                                                                                         |
| Replace Toner               | The toner cartridge is at the end of its life and printing is not possible. | Replace the toner cartridge with a new one.<br>(See <i>Replacing a toner cartridge</i> on page 161.)                                                                                                                                                     |
| Scan Unable XX              | The machine has a mechanical problem.                                       | Disconnect the machine from the power for several minutes, then reconnect it. (The machine can be turned off for approximately 60 hour without losing faxes stored in the memory. See <i>Transferring your faxes or Fax Journal report</i> on page 144.) |
|                             | Document is too long for duplex scanning.                                   | Press <b>Stop/Exit</b> . Use the suitable size of paper for duplex scanning. (See <i>Scan</i> on page 201.)                                                                                                                                              |
| Scanner Locked              | The scanner lock is locked.                                                 | Open the document cover, and then release the scanner lock lever.<br><br>Press <b>Stop/Exit</b> .<br><br>                                                            |

| Error Message   | Cause                                                                                                                                              | Action                                                                                                                          |
|-----------------|----------------------------------------------------------------------------------------------------------------------------------------------------|---------------------------------------------------------------------------------------------------------------------------------|
| Size mismatch   | The paper in the tray is not the correct size.                                                                                                     | Load the correct size of paper in the tray and set the "Paper Size" ( <b>Menu, 1, 2, 2</b> (See <i>Paper Size</i> on page 23)). |
| Toner Low       | If the LCD shows <b>Toner Low</b> , you can still print; however, the machine is telling you that the toner cartridge is near the end of its life. | Order a new toner cartridge now.                                                                                                |
| Too Many Files  | There are too many files stored on the USB Flash memory drive.                                                                                     | Reduce the number of files stored on the USB Flash memory drive.                                                                |
| Too Many Trays  | More than one optional tray is installed.                                                                                                          | The maximum number of optional trays is one. Remove any additional trays.                                                       |
| Unusable Device | An incompatible or broken device has been connected to the USB direct interface.                                                                   | Remove the USB Flash memory drive from the USB direct interface. Turn the machine off and then on again.                        |

## Transferring your faxes or Fax Journal report

---

If the LCD shows:

- Print Unable XX
- Scan Unable XX

We recommend transferring your faxes to another fax machine or to your PC. (See *Transferring faxes to another fax machine* on page 144 or *Transferring faxes to your PC* on page 144.)

You can also transfer the Fax Journal report to see if there are any faxes you need to transfer. (See *Transferring Fax Journal report to another fax machine* on page 144.)



### Note

---

If there is an error message on the machine's LCD, after the faxes have been transferred, disconnect the machine from the power source for several minutes, and then reconnect it.

---

## Transferring faxes to another fax machine

If you have not set up your Station ID, you cannot enter fax transfer mode. (See *Setting your station ID* in the *Quick Setup Guide*.)

- 1 Press **Menu, 9, 0, 1**.
- 2 Do one of the following:
  - If the LCD shows **No Data**, there are no faxes left in the machine's memory. Press **Stop/Exit**.
  - Enter the fax number to which faxes will be forwarded.
- 3 Press **Start**.

## Transferring faxes to your PC

You can transfer the faxes from your machine's memory to your PC.

- 1 Make sure that you have installed **MFL-Pro Suite** on your PC, and then turn on **PC-Fax Receiving** on the PC. (For details about PC Fax Receive, see *PC-FAX receiving* in the *Software User's Guide on the CD-ROM*.)
- 2 Make sure that you have set **PC Fax Receive** on the machine. (See *PC Fax Receive* on page 73.) If faxes are in the machine's memory when you set up PC Fax Receive, the LCD will ask if you want to transfer the faxes to your PC.
- 3 Do one of the following:
  - To transfer all faxes to your PC, press **1**. You will be asked if you want a backup print.
  - To exit and leave the faxes in the memory, press **2**.
- 4 Press **Stop/Exit**.

## Transferring Fax Journal report to another fax machine

If you have not set up your Station ID, you cannot enter fax transfer mode. (See *Setting your station ID* in the *Quick Setup Guide*.)

- 1 Press **Menu, 9, 0, 2**.
- 2 Enter the fax number to which the Fax Journal report will be forwarded.
- 3 Press **Start**.

## Document jams

If the document is jammed, follow the steps below.

### ! IMPORTANT

After removing a jammed document, check that no paper scraps are left in the machine that could cause another jam.

### Document is jammed in the top of the ADF unit

- 1 Take out any paper from the ADF that is not jammed.
- 2 Open the ADF cover.
- 3 Pull the jammed document out to the left.

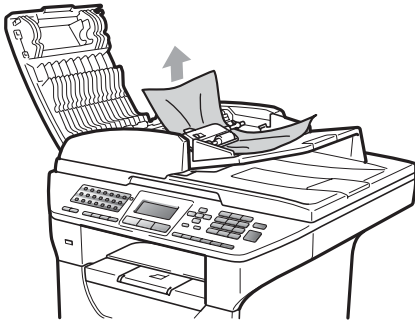

- 4 Close the ADF cover.
- 5 Press **Stop/Exit**.

### Document is jammed under the document cover

- 1 Take out any paper from the ADF that is not jammed.
- 2 Lift the document cover.
- 3 Pull the jammed document out to the right.

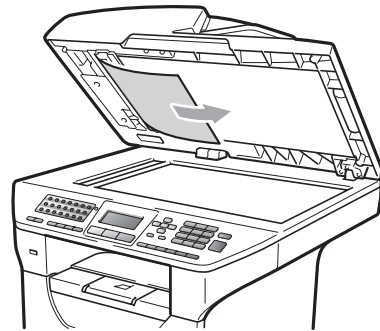

- 4 Close the document cover.
- 5 Press **Stop/Exit**.

## Document is jammed at the output tray

- 1 Take out any paper from the ADF that is not jammed.
- 2 Pull the jammed document out to the right.

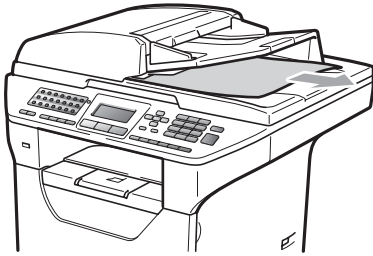

- 3 Press **Stop/Exit**.

## Document is jammed in the duplex slot

- 1 Take out any paper from the ADF that is not jammed.
- 2 Pull the jammed document out to the right.



- 3 Press **Stop/Exit**.

## Paper jams

To clear paper jams, please follow the steps in this section.

### ! IMPORTANT

Please confirm that you have installed both a toner cartridge and a drum unit in the machine. If you have not installed a drum unit or have installed the drum unit improperly, then this may cause a paper jam in your Brother machine.



#### Note

If the error message remains, open and close the front cover and fuser cover firmly to reset the machine.

### ! IMPORTANT

To prevent damage to the machine caused by static electricity, DO NOT touch the electrodes shown in the illustration.

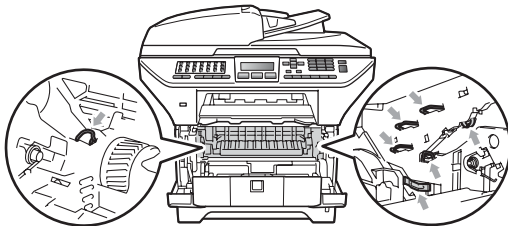

#### Note

The LCD names for the paper trays are as follows:

- Standard paper tray: Tray 1
- Optional lower tray: Tray 2
- Multi-purpose tray: MP Tray

## Paper is jammed in the MP tray

If the LCD shows Jam MP Tray, follow these steps:

- 1 Remove the paper from the MP tray.
- 2 Remove any jammed paper from in and around the MP tray.

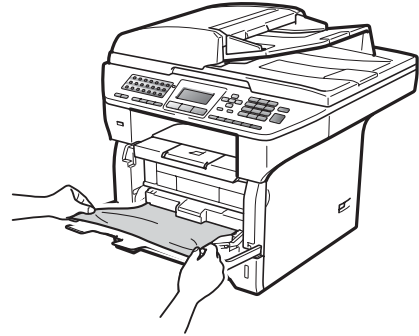

- 3 Close the MP tray. Then open the front cover and close it to reset the machine. Open the MP tray again.
- 4 Fan the paper stack, and then put it back in the MP tray.

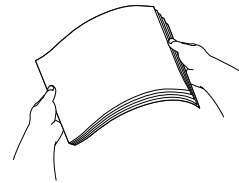

- 5 When loading paper in the MP tray, make sure that the paper stays under the maximum paper height guides on both sides of the tray.

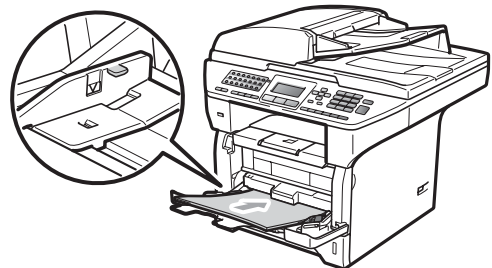

## Paper is jammed in Paper Tray 1 or Tray 2

If the LCD shows Jam Tray 1 or Jam Tray 2, follow these steps:

- 1 Pull the paper tray completely out of the machine.

For Jam Tray 1:

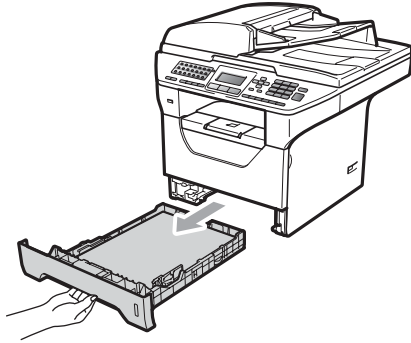

For Jam Tray 2:

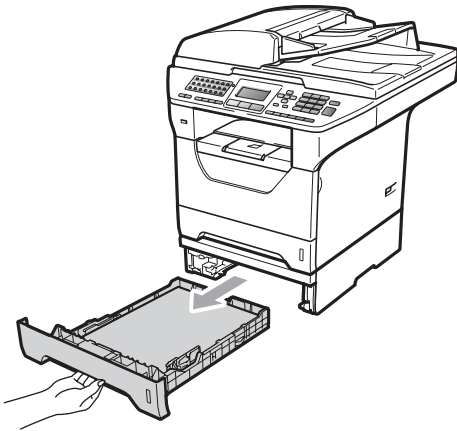

- 2 Use both hands to slowly pull out the jammed paper.

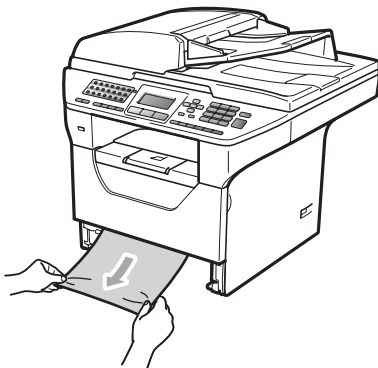

- 3 Make sure the paper is below the maximum paper mark (▼) of the paper tray. While pressing the blue paper-guide release lever, slide the paper guides to fit the paper size. Make sure that the guides are firmly in the slots.
- 4 Put the paper tray firmly back in the machine.

### ! IMPORTANT

DO NOT take out the standard paper tray while paper is feeding from a lower paper tray as this will cause a paper jam.



### Paper is jammed inside the machine

- 1 Turn off the machine's power switch. Unplug the telephone line cord first, disconnect all cables, and then unplug the power cord from the AC power outlet.
- 2 Pull the paper tray completely out of the machine.
- 3 Use both hands to slowly pull out the jammed paper.

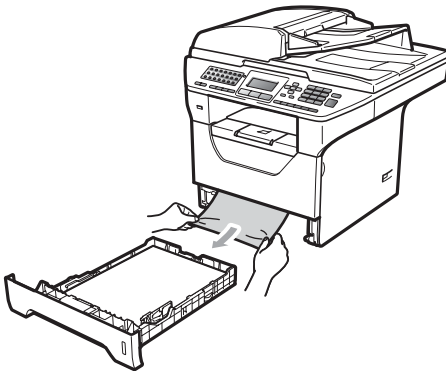

- 4 Press the front cover release button and open the front cover.

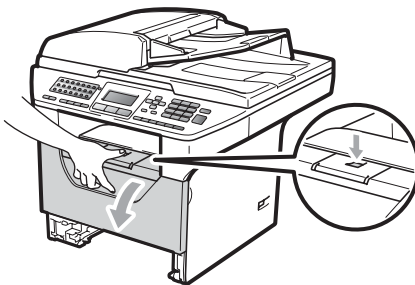

### ⚠ CAUTION

#### 🔥 HOT SURFACE

After you have just used the machine, some internal parts of the machine will be extremely hot. Wait at least 10 minutes for the machine to cool down before attempting to clear the paper jam.

- 5 Slowly take out the drum unit and toner cartridge assembly. The jammed paper may be pulled out with the drum unit and toner cartridge assembly, or this may release the paper so you can pull it out of the paper tray opening.

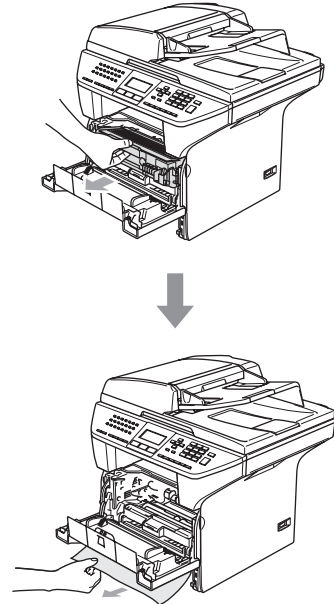

### ! IMPORTANT

We recommend that you place the drum unit and toner cartridge assembly on a clean, flat surface with a sheet of disposable paper or cloth underneath it in case you accidentally spill or scatter toner.

To prevent damage to the machine from static electricity, **DO NOT** touch the electrodes shown in the illustration.

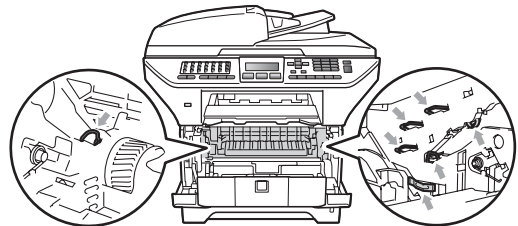

- Put the drum unit and toner cartridge assembly back in the machine.

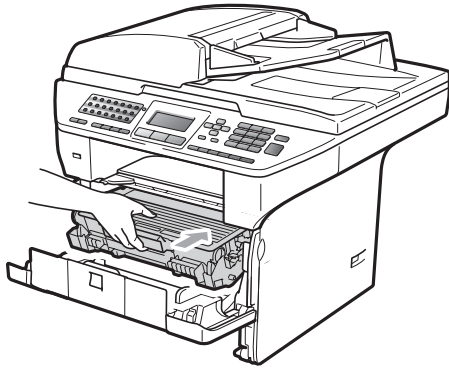

- Close the front cover.
- Put the paper tray firmly back in the machine.
- Plug the machine's power cord back into the AC power outlet first, and reconnect all cables and the telephone line cord. Turn on the machine's power switch.

## Paper is jammed inside the drum unit and toner cartridge assembly

- Turn off the machine's power switch. Unplug the telephone line cord first, disconnect all cables, and then unplug the power cord from the AC power outlet.
- Press the front cover release button and open the front cover.

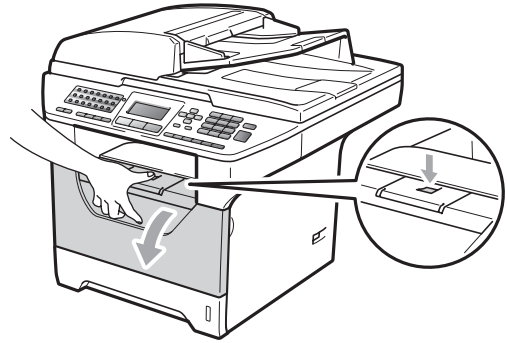

### **⚠ CAUTION**

#### **🔥 HOT SURFACE**

After you have just used the machine, some internal parts of the machine will be extremely hot. Wait at least 10 minutes for the machine to cool down before attempting to clear the paper jam.

- Slowly take out the drum unit and toner cartridge assembly.

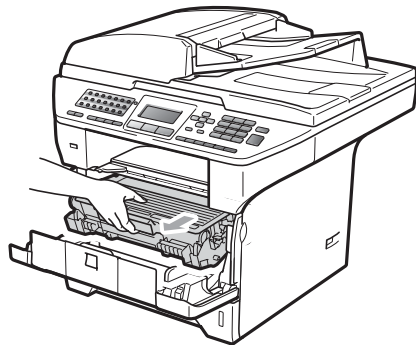

## ! IMPORTANT

We recommend that you place the drum unit and toner cartridge assembly on a clean, flat surface with a sheet of disposable paper or cloth underneath it in case you accidentally spill or scatter toner.

- 4 Push down the blue lock lever and take the toner cartridge out of the drum unit. Take out the jammed paper if there is any inside the drum unit.

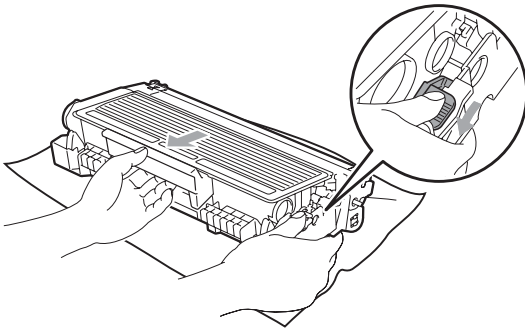

## ! IMPORTANT

- Handle the toner cartridge carefully. If toner scatters on your hands or clothes, wipe or wash it off with cold water at once.
- To avoid print quality problems, DO NOT touch the shaded parts shown in the illustrations below.

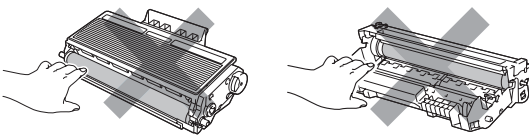

- 5 Clear the jammed paper if there is any inside the drum unit.

- 6 Put the toner cartridge back into the drum unit until you hear it lock into place. If you put it in properly, the blue lock lever will lift automatically.

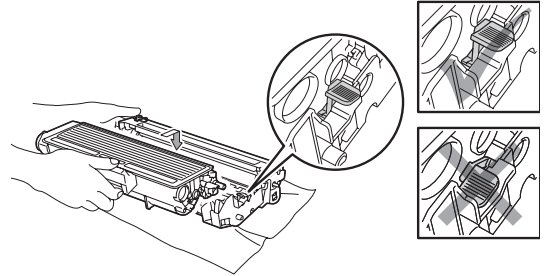

- 7 Put the drum unit and toner cartridge assembly back in the machine.

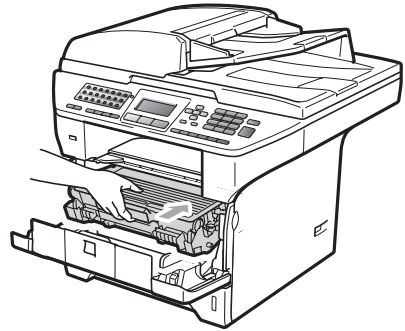

- 8 Close the front cover.
- 9 Plug the machine's power cord back into the AC power outlet first, and reconnect all cables and the telephone line cord. Turn on the machine's power switch.

## Paper is jammed at the back of the machine

- 1 Turn off the machine's power switch. Unplug the telephone line cord first, disconnect all cables, and then unplug the power cord from the AC power outlet.
- 2 Press the front cover release button and open the front cover.

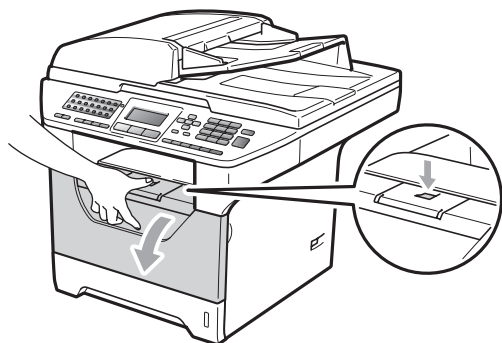

### ⚠ CAUTION

#### 🔥 HOT SURFACE

After you have just used the machine, some internal parts of the machine will be extremely hot. Wait at least 10 minutes for the machine to cool down before attempting to clear the paper jam.

- 3 Slowly take out the drum unit and toner cartridge assembly.

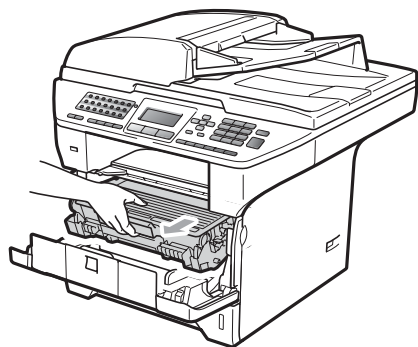

### ! IMPORTANT

We recommend that you place the drum unit and toner cartridge assembly on a clean, flat surface with a sheet of disposable paper or cloth underneath it in case you accidentally spill or scatter toner.

- 4 Open the back cover (back output tray).

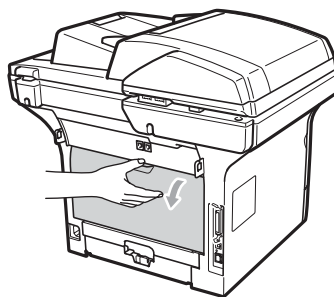

- 5 Pull the tabs at the left and right hand sides toward you to open the fuser cover (1).

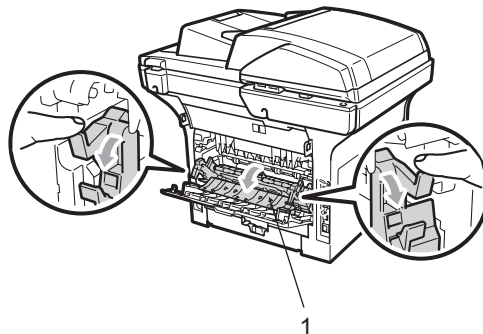

- 6 Pull the jammed paper out of the fuser unit.

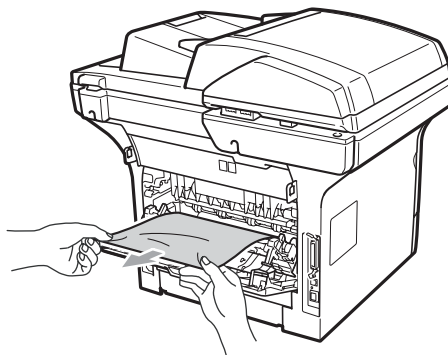

- 7 Close the fuser cover and back cover (back output tray).
- 8 Put the drum unit and toner cartridge assembly back in the machine.

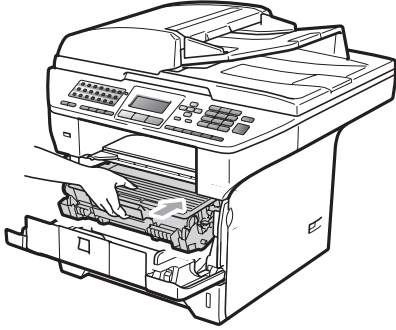

- 9 Close the front cover.
- 10 Plug the machine's power cord back into the AC power outlet first, and reconnect all cables and the telephone line cord. Turn on the machine's power switch.

### Paper is jammed in the duplex tray

- 1 Pull the duplex tray completely out of the machine.

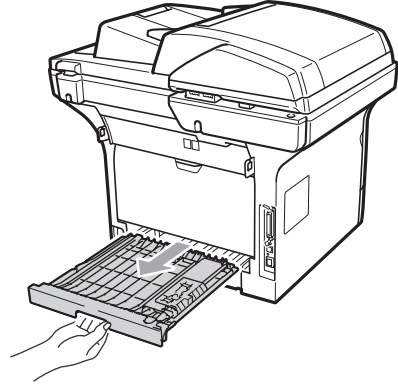

- 2 Pull the jammed paper out of the machine or the duplex tray.

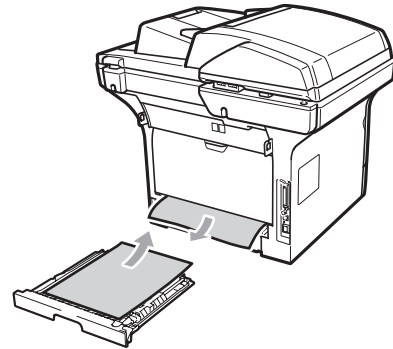

- 3 Put the duplex tray back in the machine.

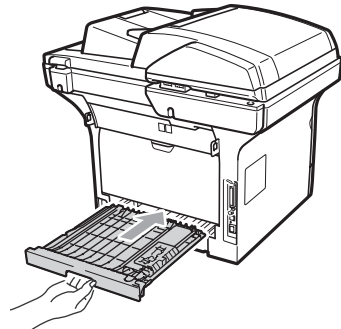

## Routine maintenance

### ⚠ WARNING

Use neutral detergents.

DO NOT use cleaning materials that contain ammonia, alcohol, any type of spray, or any type of flammable substance to clean the outside or inside of the machine. Doing this may cause a fire or electrical shock. (For more information see *Important safety instructions* on page 110.)

### ! IMPORTANT

The drum unit contains toner, so handle it carefully. If toner scatters on your hands or clothes, wipe or wash it off with cold water at once.

## Cleaning the outside of the machine

- 1 Turn off the machine's power switch. Unplug the telephone line cord first, disconnect all cables, and then unplug the power cord from the AC power outlet.
- 2 Pull the paper tray completely out of the machine.

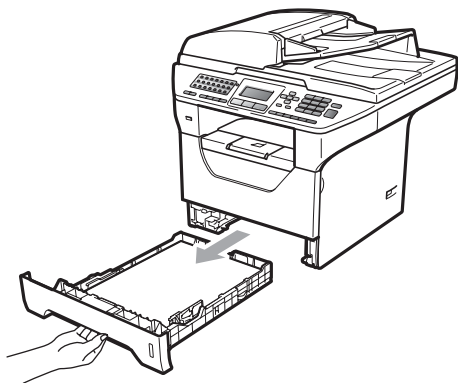

- 3 Wipe the outside of the machine with a dry, lint-free soft cloth to remove dust.

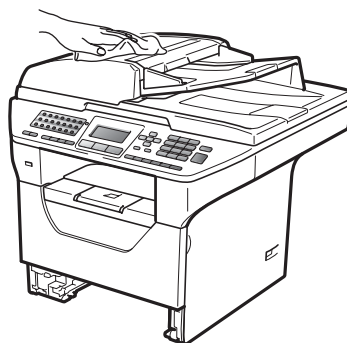

- 4 Remove anything that is stuck inside the paper tray.
- 5 Wipe the inside and the outside of the paper tray with a dry, lint-free soft cloth to remove dust.

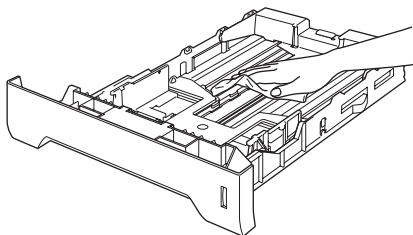

- 6 Re-load the paper and put the paper tray firmly back in the machine.
- 7 Plug the machine's power cord back into the AC power outlet first, and reconnect all cables and telephone line cord. Turn on the machine's power switch.

## Cleaning the scanner

- 1 Turn off the machine's power switch. Unplug the telephone line cord first, disconnect all cables and then unplug the power cord from the AC power outlet.
- 2 Lift the document cover (1). Clean the white plastic surface (2) and scanner glass (3) underneath it with a soft lint-free cloth moistened with water.

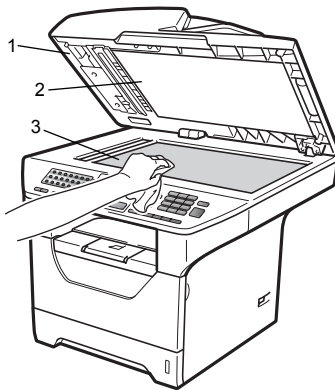

- 3 In the ADF unit, clean the white bar (1) and the scanner glass strip (2) underneath it with a soft lint-free cloth moistened with water.

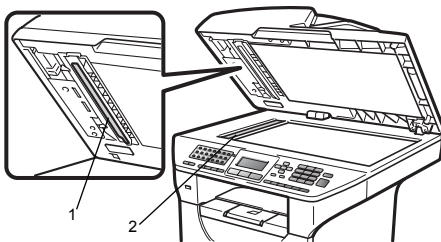

- 4 Plug the machine's power cord back into the AC power outlet first, and reconnect all cables and telephone line cord. Turn on the machine's power switch.



### Note

In addition to cleaning the scanner glass and glass strip with a soft lint-free cloth moistened with water, run your finger tip over the glass to see if you can feel anything on it. If you feel dirt or debris, clean the glass again concentrating on that area. You may need to repeat the cleaning process three or four times. To test, make a copy after each cleaning.

## Cleaning the laser scanner window

### ⚠ WARNING

DO NOT use cleaning materials that contain ammonia, alcohol, any type of spray, or any type of flammable substance to clean the inside or outside of the machine. Doing this may cause a fire or electrical shock.

### ! IMPORTANT

DO NOT touch the laser scanner window with your fingers.

- 1 Before you clean the inside of the machine, turn off the machine's power switch. Unplug the telephone line cord first, and then unplug the power cord from the AC power outlet.



- 2 Open the front cover and slowly take out the drum unit and toner cartridge assembly.

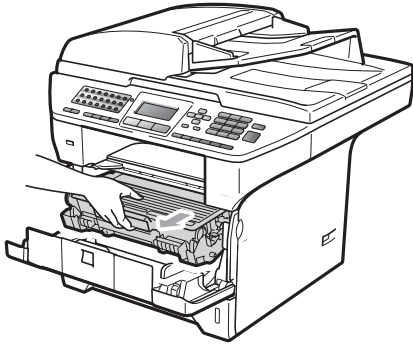

## ⚠ CAUTION

### ⚠ HOT SURFACE

After you have just used the machine, some internal parts of the machine will be extremely hot. To prevent injury, when you open the front or back cover (back output tray) of the machine DO NOT touch the shaded parts shown in the illustration. If you do this you may get burned.

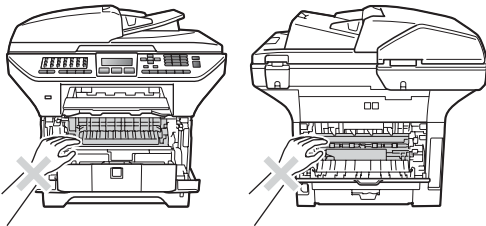

## ! IMPORTANT

- To prevent damage to the machine caused by static electricity, DO NOT touch the electrodes shown in the illustration.

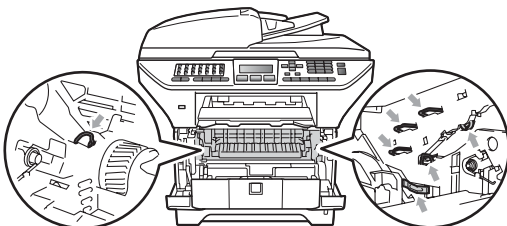

- We recommend that you place the drum unit on a clean, flat surface with a sheet of disposable paper or cloth underneath it in case you accidentally spill or scatter toner.

- 3 Wipe the laser scanner window (1) by wiping it with a dry, lint-free soft cloth.

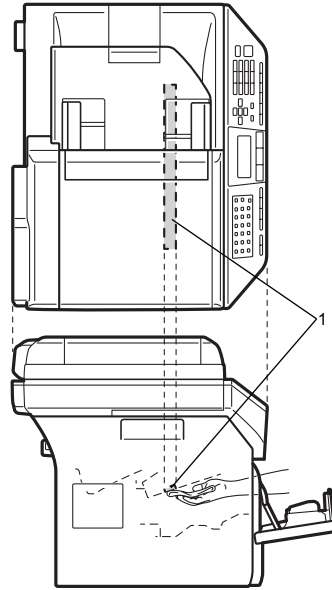

- 4 Put the drum unit and toner cartridge assembly back in the machine.

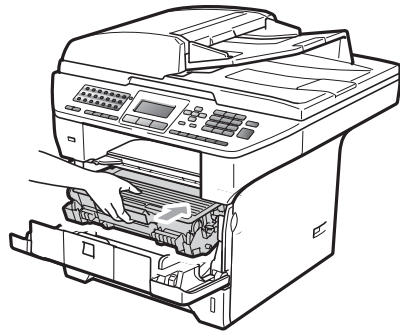

- 5 Close the front cover.
- 6 Plug the machine's power cord back into the AC power outlet first, and then plug in the telephone line cord. Turn on the machine's power switch.



## Cleaning the corona wire

If you have print quality problems, clean the corona wire as follows:

- 1 Turn off the machine's power switch. Unplug the telephone line cord first, disconnect all cables, and then unplug the power cord from the AC power outlet.
- 2 Open the front cover and slowly take out the drum unit and toner cartridge assembly.

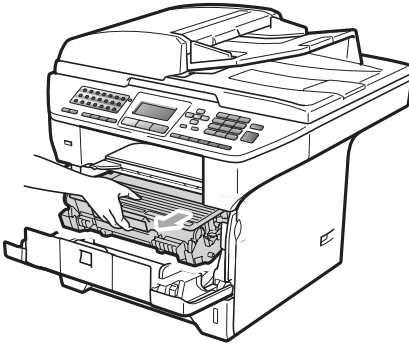

### ! IMPORTANT

- We recommend that you place the drum unit and toner cartridge assembly on a clean, flat surface with a sheet of disposable paper or cloth underneath it in case you accidentally spill or scatter toner.
- Handle the toner cartridge carefully. If toner scatters on your hands or clothes, wipe or wash it off with cold water at once.
- To prevent damage to the machine caused by static electricity, DO NOT touch the electrodes shown in the illustration.

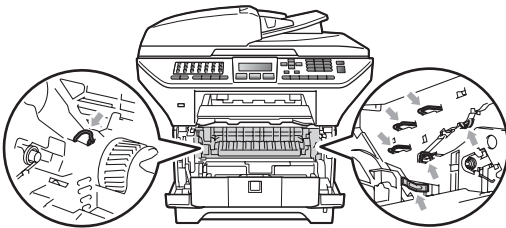

- 3 Clean the corona wire inside the drum unit by gently sliding the blue tab from right to left and left to right several times.

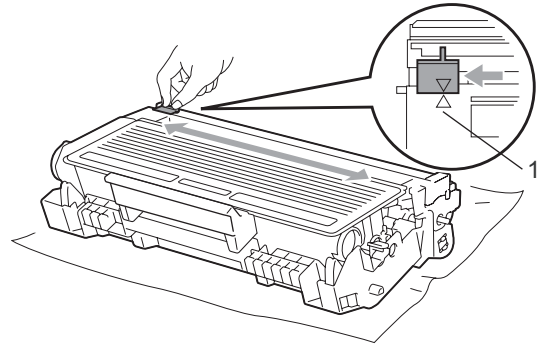

### Note

Be sure to return the blue tab to the home position (▲) (1). If you do not, printed pages may have a vertical stripe.

- 4 Put the drum unit and toner cartridge assembly back in the machine.

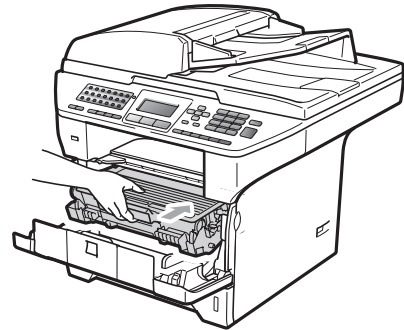

- 5 Close the front cover.

- 6 Plug the machine's power cord back into the AC power outlet first, and then reconnect all cables and telephone line cord. Turn on the machine's power switch.

### ! IMPORTANT

To avoid print quality problems, DO NOT touch the shaded parts shown in the illustrations below.

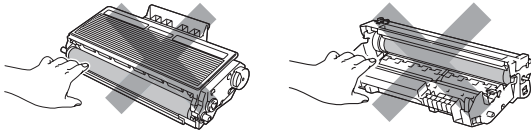

## Cleaning the drum unit

If you have print quality problems, clean the drum unit as follows.

- 1 Turn off the machine's power switch. Unplug the telephone line cord first, and then unplug the power cord from the AC power outlet.
- 2 Open the front cover and slowly take out the drum unit and toner cartridge assembly.

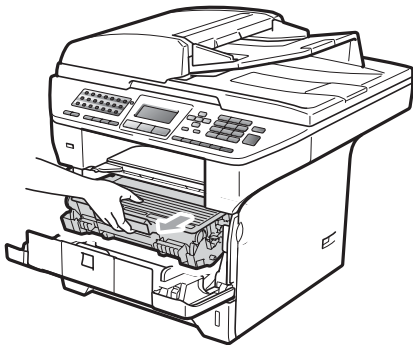

### ! IMPORTANT

- We recommend that you put the drum unit and toner cartridge assembly on a clean, flat surface with a sheet of disposable paper or cloth underneath it in case you accidentally spill or scatter toner.

- To prevent damage to the machine caused by static electricity, DO NOT touch the electrodes shown in the illustration.

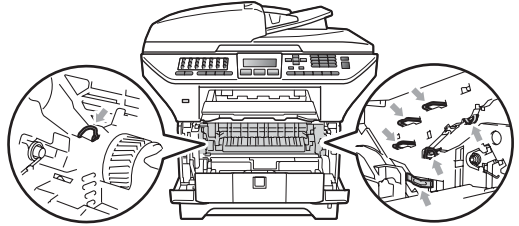

- 3 Push down the blue lock lever and take the toner cartridge out of the drum unit.

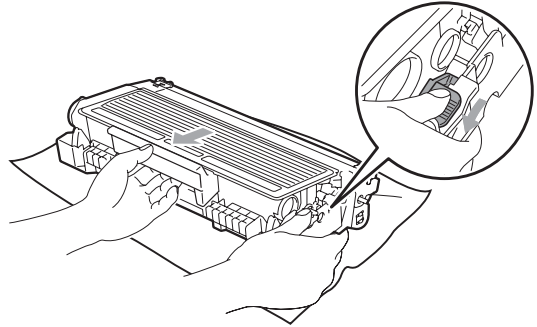

### ! IMPORTANT

- Handle the toner cartridge carefully. If toner scatters on your hands or clothes, wipe or wash it off with cold water at once.
- To avoid print quality problems, DO NOT touch the shaded parts shown in the illustrations below.

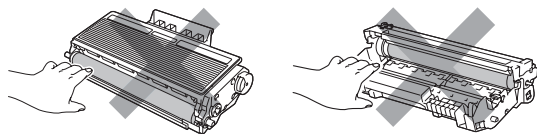

- 4 Put the print sample in front of the drum unit, and find the exact position of the poor print.

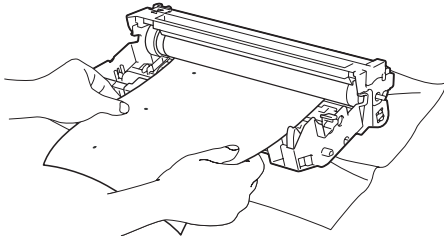

- 5 Turn the drum unit gear by hand while looking at the surface of the OPC drum (1).

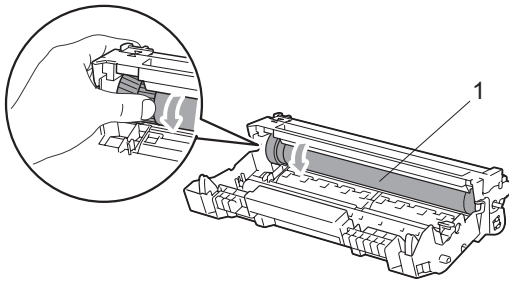

- 6 When you have found the mark on the drum that matches the print sample, wipe the surface of the OPC drum with a dry cotton swab until the dust or glue on the surface comes off.

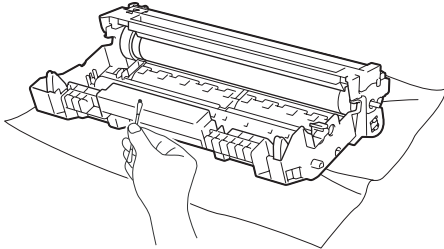

- 7 Put the toner cartridge back into the drum unit until you hear it lock into place. If you put the cartridge in properly, the blue lock lever will lift automatically.

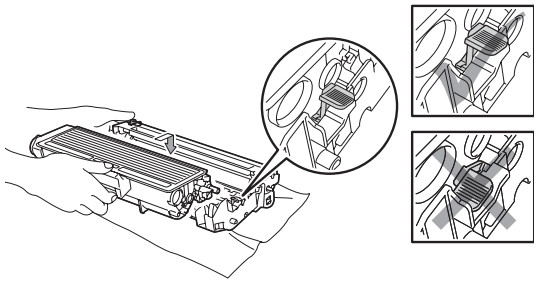

- 8 Put the drum unit and toner cartridge assembly back in the machine.

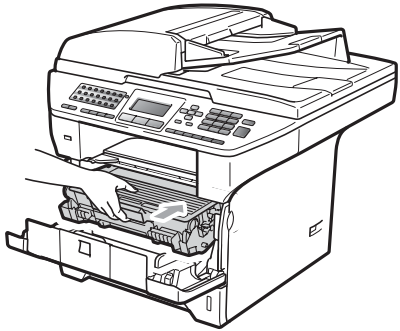

- 9 Close the front cover.  
10 Plug the machine's power cord back into the AC power outlet first, and then reconnect all cables and telephone line cord. Turn on the machine's power switch.

**! IMPORTANT**

- The drum is photosensitive so **DO NOT** touch it with your fingers.
- **DO NOT** clean the surface of the photosensitive drum with a sharp object.
- **DO NOT** use a scrubbing or wiping motion because this might damage the drum.

## Replacing the consumable items

You will need to replace the consumable items when the machine indicates that the life of the consumable is over.

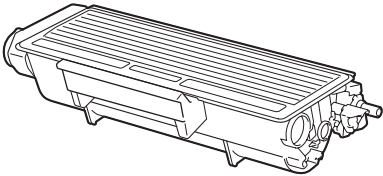
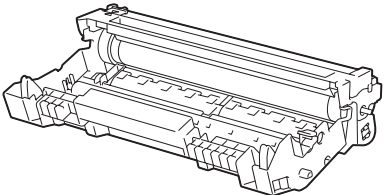
| Toner cartridge                                                                   | Drum unit                                                                          |
|-----------------------------------------------------------------------------------|------------------------------------------------------------------------------------|
|  |  |
| Order No. TN-620, TN-650                                                          | Order No. DR-620                                                                   |

### ! IMPORTANT

- We recommend placing used consumable items on a sheet of paper to prevent accidentally spilling or scattering the material inside.
- Be sure to reseal the consumable items tightly so that the material inside does not spill.

### Note

- Go to <http://www.brother.com/original/index.html> for instructions on how to return your used consumable items to the Brother collection program. If you choose not to return your used consumable, please discard the used consumable according to local regulations, keeping it separate from domestic waste. If you have questions, call your local waste disposal office.
- If you use paper that is not a direct equivalent for the recommended paper, the life of consumable items and machine parts may be reduced.

## Replacing a toner cartridge

The High Yield toner cartridges can print approximately 8,000 pages<sup>1</sup> and the Standard toner cartridges can print approximately 3,000 pages<sup>1</sup>. Actual page count will vary depending on your average type of document (i.e., standard letter, detailed graphics). The machine is supplied with the TN-620 toner cartridge that will need to be replaced after approximately 3,000 pages<sup>1</sup>. When a toner cartridge is running low, the LCD shows **Toner Low**.

<sup>1</sup> Approx. cartridge yield is declared in accordance with ISO/IEC 19752.



### Note

It is a good idea to keep a new toner cartridge ready for use when you see the **Toner Low** warning.

## CAUTION

### HOT SURFACE

After you have just used the machine, some internal parts of the machine will be extremely hot. To prevent injury, when you open the front or back cover (back output tray) of the machine **DO NOT** touch the shaded parts shown in the illustration. If you do this you may get burned.

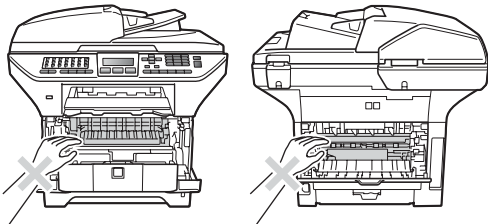

- 1 Press the front cover release button and open the front cover.

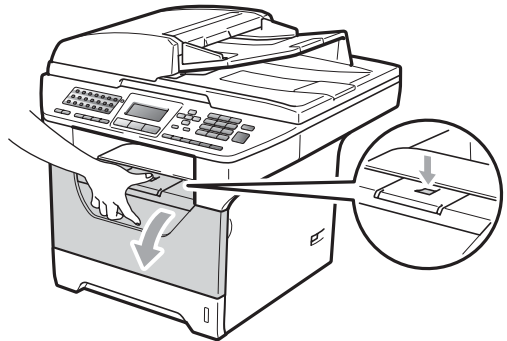

- 2 Slowly take out the drum unit and toner cartridge assembly.

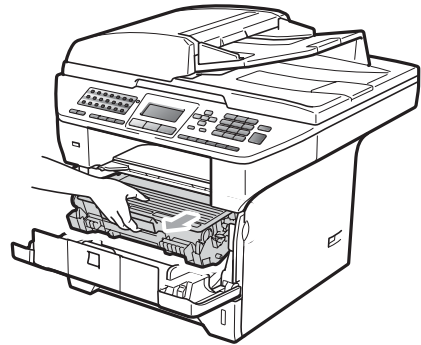

## IMPORTANT

- We recommend that you put the drum unit and toner cartridge assembly on a clean, flat surface with a sheet of disposable paper or cloth underneath it in case you accidentally spill or scatter toner.
- To prevent damage to the machine caused by static electricity, **DO NOT** touch the electrodes shown in the illustration.

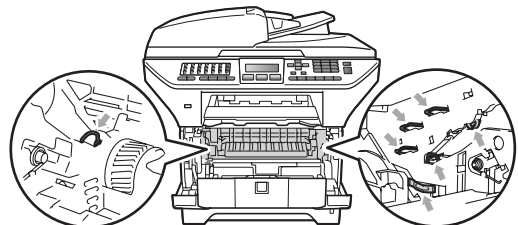

- 3 Push down the blue lock lever and take the used toner cartridge out of the drum unit.

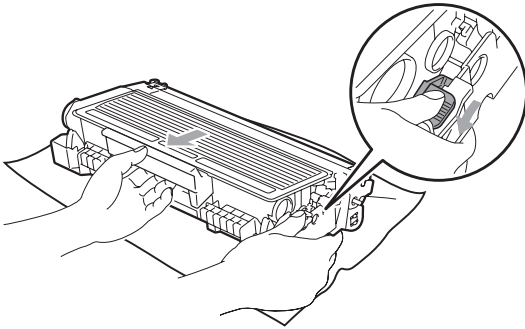

## **! WARNING**

DO NOT put a toner cartridge into a fire. It could explode, resulting in injuries.

## **! IMPORTANT**

- Handle the toner cartridge carefully. If toner scatters on your hands or clothes, wipe or wash it off with cold water at once.
- To avoid print quality problems, DO NOT touch the shaded parts shown in the illustrations.

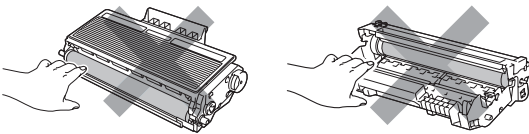

- Brother strongly recommends that you DO NOT refill the toner cartridge provided with your machine. We also strongly recommend that you continue to use only Genuine Brother Brand replacement toner cartridges. Use or attempted use of potentially incompatible toner and/or cartridges in the Brother machine may cause damage to the machine and/or may result in unsatisfactory print quality. Our warranty coverage does not apply to any problem that is caused by the use of unauthorized third party toner and/or cartridges. To protect your investment and obtain premium performance from the Brother machine, we strongly recommend the use of Genuine Brother Supplies.
- Wait to unpack the new toner cartridge until immediately before you put it in the machine. If a toner cartridge is left unpacked for a long time, the toner life will be shortened.
- Be sure to seal up the used toner cartridge tightly in a suitable bag so that toner powder does not spill out of the cartridge.

- 4 Unpack the new toner cartridge. Gently shake it from side to side several times to distribute the toner evenly inside the cartridge.

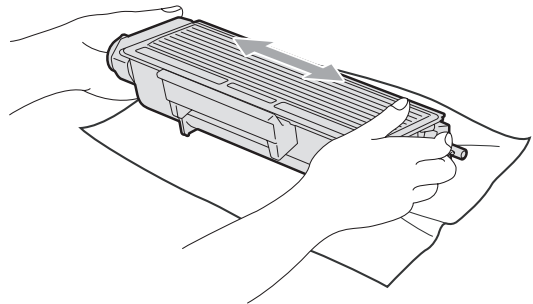

- 5 Pull off the protective cover.

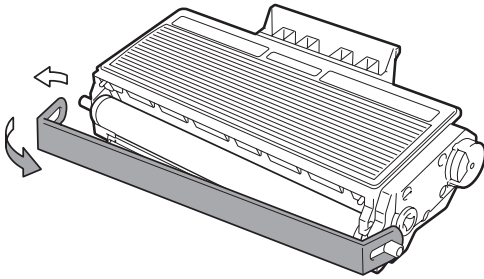

- 6 Put the new toner cartridge firmly into the drum unit until you hear it lock into place. If you put it in properly, the lock lever will lift automatically.

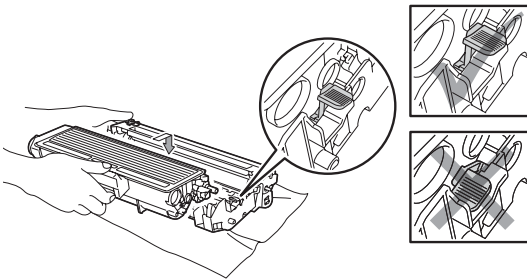

**Note**

Make sure that you put in the toner cartridge properly or it may separate from the drum unit.

- 7 Clean the corona wire of the drum unit by gently sliding the blue tab from right to left and left to right several times.

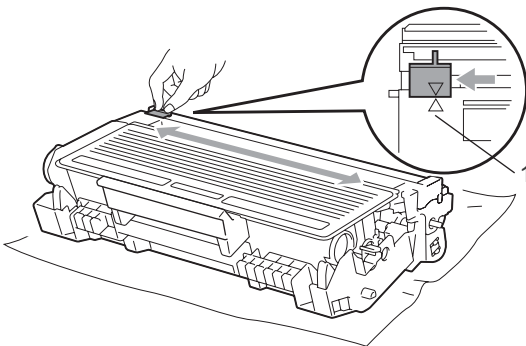

**Note**

Be sure to return the blue tab to the home position (▲) (1). If you do not, printed pages may have a vertical stripe.

- 8 Put the drum unit and toner cartridge assembly back in the machine.

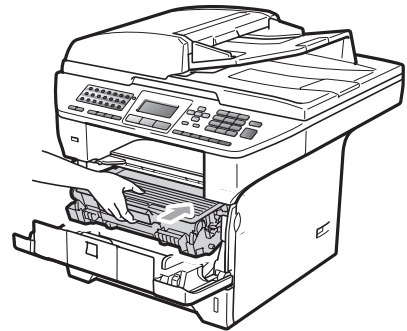

- 9 Close the front cover.

**Note**

DO NOT turn off the machine's power switch or open the front cover until the LCD returns to the standby state.



## Replacing the drum unit

The machine uses a drum unit to create print images on paper. If the LCD shows *Replace Parts Drum*, the drum unit is near the end of its life and it is time to buy a new one. Even if the LCD shows *Replace Parts Drum*, you may be able to continue printing without having to replace the drum unit for a while. However, if there is a noticeable deterioration in the output print quality (even before *Replace Parts Drum* appears), then the drum unit should be replaced. You should clean the machine when you replace the drum unit. (See *Cleaning the laser scanner window* on page 155.)

### ! IMPORTANT

While removing the drum unit, handle it carefully because it may contain toner. If toner scatters on your hands or clothes, wipe or wash it off with cold water at once.

### Note

The drum unit is a consumable item, and it is necessary to replace it periodically. There are many factors that determine the actual drum life, such as temperature, humidity, type of paper and how much toner you use for the number of pages per print job. The estimated drum life is approximately 25,000 pages<sup>1</sup>. The actual number of pages your drum will print may be significantly less than this estimate. Because we have no control over the many factors that determine the actual drum life, we cannot guarantee a minimum number of pages that will be printed by your drum.

<sup>1</sup> Drum yield is approximate, and may vary by type of use.

### ! CAUTION

#### ! HOT SURFACE

After you have just used the machine, some internal parts of the machine will be extremely hot. To prevent injury, when you open the front or back cover (back output tray) of the machine DO NOT touch the shaded parts shown in the illustration. If you do this you may get burned.

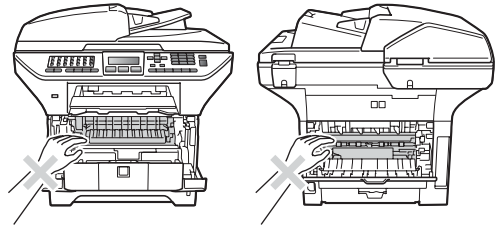

- 1 Press the front cover release button and open the front cover.

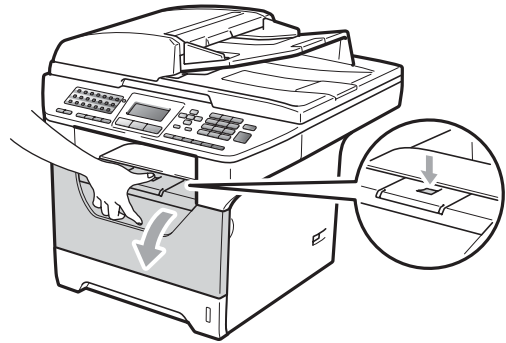

- 2 Slowly take out the drum unit and toner cartridge assembly.

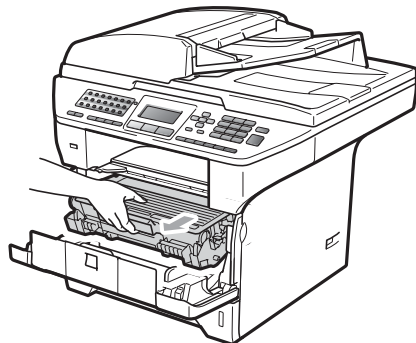



## ! IMPORTANT

- We recommend that you put the drum unit and toner cartridge assembly on a clean, flat surface with a sheet of disposable paper or cloth underneath it in case you accidentally spill or scatter toner.
- To prevent damage to the machine caused by static electricity, **DO NOT** touch the electrodes shown in the illustration.

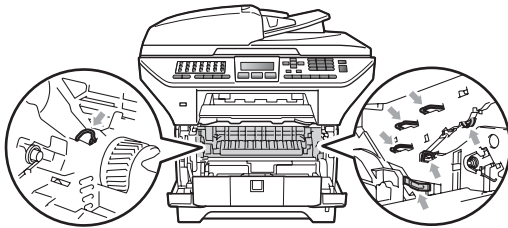

- 3 Push down the blue lock lever and take the toner cartridge out of the drum unit.

## ! IMPORTANT

- To avoid print quality problems, **DO NOT** touch the shaded parts shown in the illustrations.

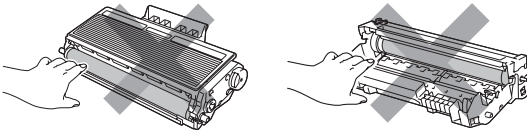

- Wait to unpack a new drum unit until immediately before you put it in the machine. Exposure to direct sunlight or room light may damage the drum unit.
- Be sure to seal up the used drum unit tightly in a bag so that toner powder does not spill out of the unit.

- 4 Unpack the new drum unit.

- 5 Put the toner cartridge firmly into the new drum unit until you hear it lock into place. If you put the cartridge in properly, the blue lock lever will lift automatically.

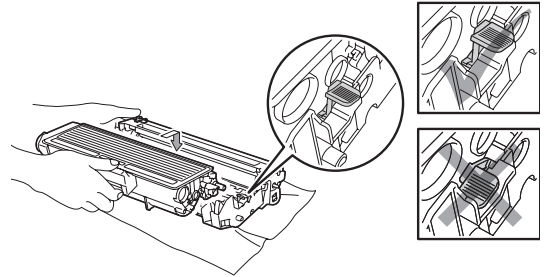

### Note

Make sure that you put in the toner cartridge properly or it may separate from the drum unit.

- 6 Put the new drum unit and toner cartridge assembly in the machine. Do not close the front cover.

- 7 Press **Clear/Back**.

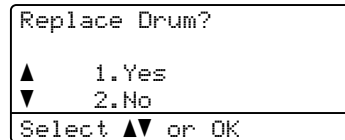

To confirm you are installing a new drum, press **1**.

- 8 When the LCD shows *Accepted*, close the front cover.

## Replacing periodic maintenance parts

The periodic maintenance parts will need to be replaced regularly to maintain the print quality. The parts listed below will have to be replaced after printing approximately 50,000 pages for PF KitMP and 100,000 pages for PF Kit1, PF Kit2, Fuser and Laser. When the following messages appear on the LCD please call Brother Customer Service: (in USA) 1-877-BROTHER (1-877-276-8437) (in Canada) 1-877-BROTHER

| LCD message                 | Description                            |
|-----------------------------|----------------------------------------|
| Replace Parts<br>PF Kit MP  | Replace paper feeding kit for MP tray. |
| Replace Parts<br>PF Kit 1   | Replace paper feeding kit for Tray 1.  |
| Replace Parts<br>PF Kit 2   | Replace paper feeding kit for Tray 2.  |
| Replace Parts<br>Fuser Unit | Replace fuser unit.                    |
| Replace Parts<br>Laser Unit | Replace laser unit.                    |

## Machine Information

### Checking the Serial Number

You can see the machine's Serial Number on the LCD.

- 1 Press **Menu, 8, 1.**

```
81.Serial No.
XXXXXXXXXX
```

- 2 Press **Stop/Exit.**

### Checking the Page Counters

You can see the machine's Page Counters for copies, printed pages, reports and lists, faxes or a summary total.

- 1 Press **Menu, 8, 2.**

```
82.Page Counter
▲ Total :XXXXXX
▼ Fax/List :XXXXXX
```

- 2 Press **▲ or ▼** to see Total, Fax/List, Copy or Print.

```
82.Page Counter
▲ Copy :XXXXXX
▼ Print :XXXXXX
```

- 3 Press **Stop/Exit.**

## Checking the remaining life of parts

You can see the remaining life of the machine's drum unit and periodic maintenance parts on the LCD.

- 1 Press **Menu**, **8**, **3**.

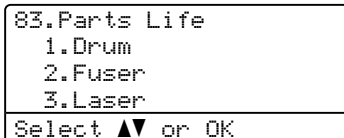

- 2 Press **▲** or **▼** to choose 1.Drum, 2.Fuser, 3.Laser, 4.PF Kit MP, 5.PF Kit 1 or 6.PF Kit 2<sup>1</sup>. Press **OK**.

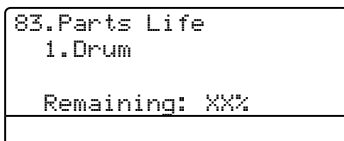

<sup>1</sup> PF Kit 2 appears only when the optional LT-5300 tray is installed.

- 3 Press **Stop/Exit**.



### Note

The life check will be accurate only if you have reset the drum counter when you installed a new drum unit. It will not be accurate if that part's life counter was reset during the life of the used part.

## Reset

The following reset functions are available:

- 1 Network

You can reset the print server back to its default factory settings such as the password and IP address information.

- 2 Address & Fax

Address & Fax resets the following settings:

- Address Book  
(One-Touch Dial, Speed-Dial and Setup Groups)
- Programmed fax jobs in the memory  
(Polled TX, Delayed Fax and Delayed Batch)
- Station ID  
(Name and Number)
- Coverpage Msg  
(Comments)
- Remote Fax Option  
(Remote Access Code, Fax Storage, Fax Forwarding, Paging and PC-Fax)
- Report settings  
(Transmission Verification Report, Tel Index List and Fax Journal)
- Setting Lock Password

- 3 All Settings

You can reset all the machine settings back to the settings that were set at the factory.

Brother strongly recommends you use this operation when you dispose of the machine.



### Note

Unplug the interface cable before you choose Network or All Settings.

## How to reset

- 1 (USA) Press **Menu, 0, 6**.  
(Canada) Press **Menu, 0, 7**.

```
06.Reset
 1.Network
 2.Address & Fax
 3.All Settings
Select ▲▼ or OK
```

- 2 Press ▲ or ▼ to choose the reset you want.  
Press **OK**.
- 3 Press ▲ or ▼ to choose 1.Reset or 2.Exit.  
Press **OK**.
- 4 If you choose 1.Reset in step 3, you will be asked to reboot the machine.  
Press ▲ or ▼ to choose 1.Yes or 2.No.  
Press **OK**.  
If you choose 1.Yes, the machine will begin the Restart.



### Note

You can also reset the Network settings by pressing **Menu, 7, 0**.

## Packing and shipping the machine

### ⚠ CAUTION

If you pack the machine soon after turning off the power make sure the machine has cooled down completely.

When you transport the machine, use the packing materials that came with your machine. If you do not pack the machine properly, you could void your warranty. The machine should be adequately insured with the carrier.

- 1 Turn off the machine's power switch.
- 2 Unplug the machine from the telephone wall jack.
- 3 Unplug all the cables and AC power cord from the machine.
- 4 Push the Scanner Lock Lever down to lock the scanner. This lever is located on the left of the scanner glass.

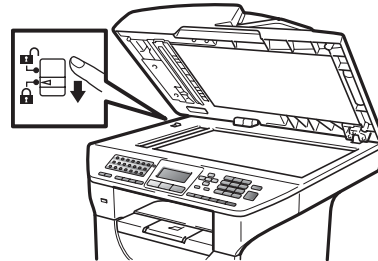

### ! IMPORTANT

Damage caused to your machine by failure to lock the scanner before packing and shipping may void your warranty.

- 5 Press the front cover release button and open the front cover.

- 6 Take out the drum unit and toner cartridge assembly. Leave the toner cartridge installed in the drum unit.
- 7 Put the drum unit and toner cartridge assembly into a plastic bag and seal the bag.
- 8 Close the front cover.
- 9 Put the styrofoam piece marked "FRONT" into the original carton (1). Pack the drum unit and toner cartridge assembly (2) and put it in as shown below (3). Wrap the machine in the plastic bag and put it in the original carton (4). Put the printed material behind the machine (5).

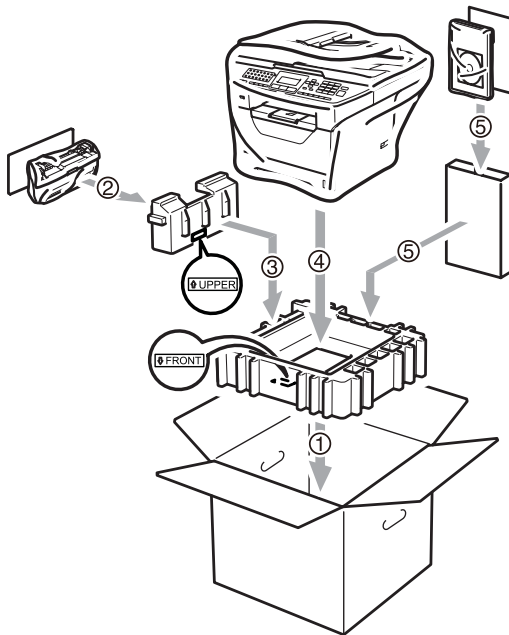

- 10 Put the two styrofoam pieces into the carton matching the front of the machine to the "FRONT" mark on one of the styrofoam pieces, and the back of the machine to the "REAR" mark on the other styrofoam pieces (6). Put the AC power cord and printed materials in the original carton as shown below (7).

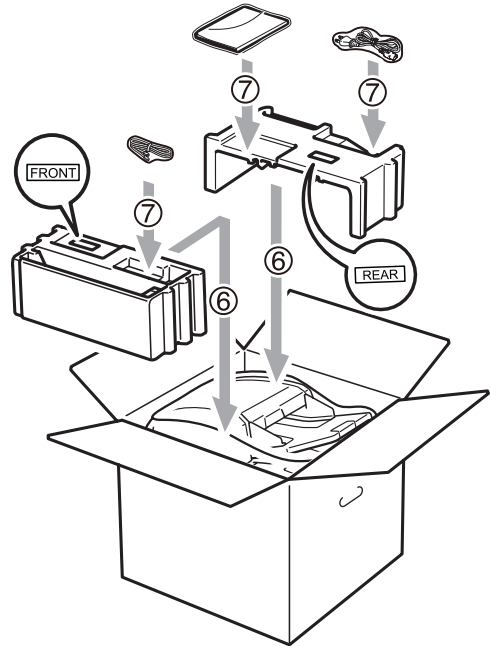

**Note**

If you are returning your machine to Brother as part of the Exchange Service, pack only the machine. Keep all separate parts, including the drum unit and toner cartridge assembly, and printed materials to use with your 'Exchange' machine.

- 11 Close the carton and tape it shut.

# D

## Menu and features

### On-screen programming

Your machine has been designed to be easy to use. The LCD provides on-screen programming using the menu keys.

We have created step by step on-screen instructions to help you program your machine. Simply follow the steps as they guide you through the menu selections and programming options.

### Menu table

You can program your machine by using the *Menu table* on page 172. These pages list the menu selections and options.

Press **Menu** followed by the menu numbers to program your machine.

For example, to set *Beeper* volume to *Low*:

- 1 Press **Menu**, **1**, **3**, **2**.
- 2 Press **▲** or **▼** to choose *Low*.
- 3 Press **OK**.

### Memory storage

Your menu settings are stored permanently, and in the event of a power failure will *not* be lost. Temporary settings (for example, Contrast, Overseas Mode) *will* be lost. Also, during a power failure the machine will retain the date and time and any fax messages that are in the memory for approximately 60 hours.

### Menu keys

|                       |                                                                              |
|-----------------------|------------------------------------------------------------------------------|
|                       |                                                                              |
| <b>Menu</b><br>       | Access the menu.                                                             |
|                       | Go to the next menu level.<br>Accept an option.                              |
| <b>Clear/Back</b><br> | Exit the menu by pressing repeatedly.<br>Go back to the previous menu level. |
| <br><br>              | Scroll through the current menu level.                                       |
|                       | Go back to the previous menu level or forward to the next menu level.        |
|                       | Exit the menu.                                                               |

## How to access the menu mode

---

- 1 Press **Menu**.
- 2 Choose an option.
  - Press **1** for General Setup menu.
  - Press **2** for Fax menu.
  - Press **3** for Copy menu.
  - Press **4** for Printer menu.
  - Press **5** for USB Direct I/F menu.
  - Press **6** for Print Reports menu.
  - Press **7** for Network menu.
  - Press **8** for Machine Info. menu.
  - Press **9** for Service menu. <sup>1</sup>
  - Press **0** for Initial Setup.

<sup>1</sup> This will appear only when the LCD shows an error message.

You can also scroll through each menu level by pressing **▲** or **▼** for the direction you want.

- 3 Press **OK** when the option you want appears on the LCD.  
The LCD will then show the next menu level.
- 4 Press **▲** or **▼** to scroll to your next menu selection.
- 5 Press **OK**.  
When you have finished setting an option, the LCD will show *Accepted*.
- 6 Press **Stop/Exit** to exit Menu mode.

# Menu table

The factory settings are shown in Bold with an asterisk.

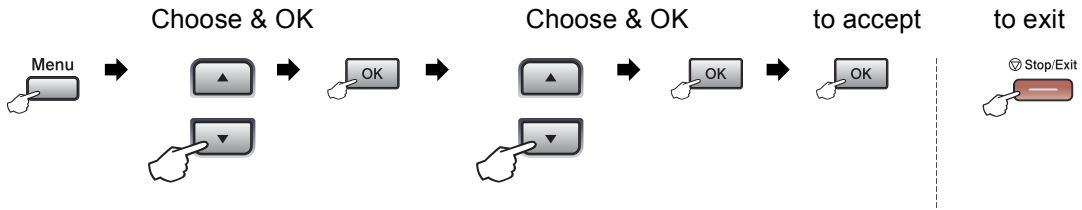

| Main Menu       | Submenu                                                                | Menu Selections |              | Options                                                                     | Descriptions                                                                                                                                  | Page                                                                        |
|-----------------|------------------------------------------------------------------------|-----------------|--------------|-----------------------------------------------------------------------------|-----------------------------------------------------------------------------------------------------------------------------------------------|-----------------------------------------------------------------------------|
| 1.General Setup | 1.Mode Timer                                                           | —               | —            | 0 Sec<br>30 Secs<br>1 Min<br><b>2 Mins*</b><br>5 Mins<br>Off                | Sets the time to return to Fax mode and the time the machine will change from individual user to Public mode when using Secure Function Lock. | 22<br>33                                                                    |
|                 |                                                                        | 2.Paper         | 1.Paper Type | 1.MP Tray                                                                   |                                                                                                                                               | Thin<br><b>Plain*</b><br>Thick<br>Thicker<br>Transparency<br>Recycled Paper |
|                 | 2.Tray#1                                                               |                 |              | Thin<br><b>Plain*</b><br>Thick<br>Thicker<br>Transparency<br>Recycled Paper | Sets the type of paper in the paper tray.                                                                                                     | 22                                                                          |
|                 | 3.Tray#2<br>(This menu only appears if you have the optional tray #2.) |                 |              | Thin<br><b>Plain*</b><br>Thick<br>Thicker<br>Recycled Paper                 | Sets the type of paper in the optional paper tray #2.                                                                                         | 22                                                                          |



| Main Menu                      | Submenu                | Menu Selections |                                                                        | Options                                                                                    | Descriptions                                              | Page |
|--------------------------------|------------------------|-----------------|------------------------------------------------------------------------|--------------------------------------------------------------------------------------------|-----------------------------------------------------------|------|
| 1.General Setup<br>(Continued) | 2.Paper<br>(Continued) | 2.Paper Size    | 1.MP Tray                                                              | A4<br><b>Letter*</b><br>Legal<br>Executive<br>A5<br>A5 L<br>A6<br>B5<br>B6<br>Folio<br>Any | Sets the size of the paper in the MP tray.                | 23   |
|                                |                        |                 | 2.Tray#1                                                               | A4<br><b>Letter*</b><br>Legal<br>Executive<br>A5<br>A5 L<br>A6<br>B5<br>B6<br>Folio        | Sets the size of the paper in the paper tray.             | 23   |
|                                |                        |                 | 3.Tray#2<br>(This menu only appears if you have the optional tray #2.) | A4<br><b>Letter*</b><br>Legal<br>Executive<br>A5<br>B5<br>B6<br>Folio                      | Sets the size of the paper in the optional paper tray #2. | 23   |
|                                | 3.Volume               | 1.Ring          | Off<br>Low<br><b>Med*</b><br>High                                      | Adjusts the ring volume.                                                                   | 25                                                        |      |

| Main Menu                      | Submenu                 | Menu Selections | Options                                                                                                                                              | Descriptions                                      | Page |
|--------------------------------|-------------------------|-----------------|------------------------------------------------------------------------------------------------------------------------------------------------------|---------------------------------------------------|------|
| 1.General Setup<br>(Continued) | 3.Volume<br>(Continued) | 2.Beeper        | Off<br>Low<br><b>Med*</b><br>High                                                                                                                    | Adjusts the volume level of the beeper.           | 25   |
|                                |                         | 3.Speaker       | Off<br>Low<br><b>Med*</b><br>High                                                                                                                    | Adjusts the speaker volume.                       | 26   |
|                                | 4.Auto Daylight         | —               | On<br><b>Off*</b>                                                                                                                                    | Changes for Daylight Savings Time automatically.  | 26   |
|                                | 5.Ecology               | 1.Toner Save    | On<br><b>Off*</b>                                                                                                                                    | Increases the page yield of the toner cartridge.  | 27   |
|                                |                         | 2.Sleep Time    | Range varies depending on model.<br><b>005Min*</b>                                                                                                   | Conserves power.                                  | 27   |
|                                | 6.Tray Use              | 1.Copy          | Tray#1 Only<br>Tray#2 Only<br>MP Only<br><b>MP&gt;T1&gt;T2*</b><br>T1>T2>MP<br>(Tray#2 or T2 appears only if you installed the optional paper tray.) | Selects the tray that will be used for Copy mode. | 23   |
|                                |                         | 2.Fax           | Tray#1 Only<br>Tray#2 Only<br>MP Only<br>MP>T1>T2<br><b>T1&gt;T2&gt;MP*</b><br>(Tray#2 or T2 appears only if you installed the optional paper tray.) | Selects the tray that will be used for Fax mode.  | 24   |

| Main Menu                      | Submenu                                                  | Menu Selections  | Options                                                                                                                                              | Descriptions                                     | Page                                                                                                             |                                                 |
|--------------------------------|----------------------------------------------------------|------------------|------------------------------------------------------------------------------------------------------------------------------------------------------|--------------------------------------------------|------------------------------------------------------------------------------------------------------------------|-------------------------------------------------|
| 1.General Setup<br>(Continued) | 6.Tray Use<br>(Continued)                                | 3.Print          | Tray#1 Only<br>Tray#2 Only<br>MP Only<br><b>MP&gt;T1&gt;T2*</b><br>T1>T2>MP<br>(Tray#2 or T2 appears only if you installed the optional paper tray.) | Selects the tray that will be used for PC print. | 25                                                                                                               |                                                 |
|                                |                                                          | 7.LCD Contrast   | —                                                                                                                                                    | -□□□■+<br>-□□■□+<br>-□■□□+*<br>-■□□□+<br>-■□□□+  | Adjusts the contrast of the LCD.                                                                                 | 28                                              |
|                                | 8.Security                                               | 1.Function Lock  |                                                                                                                                                      |                                                  | Can restrict selected machine operation for up to 25 individual users and all other non-authorized Public users. | 30                                              |
|                                |                                                          | 2.Setting Lock   |                                                                                                                                                      |                                                  | Stops unauthorized users from changing the machine's current settings.                                           | 34                                              |
|                                | 9.Document Scan                                          | 1.Glass ScanSize |                                                                                                                                                      | A4<br><b>Letter*</b><br>Legal/Folio              | Adjusts the scan area of the scanner glass to the size of the document.                                          | 40                                              |
|                                |                                                          | 2.File size      | 1.Color                                                                                                                                              | Large<br><b>Middle*</b><br>Small                 | You can set your own default settings of the data compression rate.                                              | See <i>Software User's Guide</i> on the CD-ROM. |
|                                |                                                          |                  | 2.Gray                                                                                                                                               | Large<br><b>Middle*</b><br>Small                 |                                                                                                                  |                                                 |
|                                | 3.Duplex Scan<br>(MFC-8680DN, MFC-8690DW and MFC-8890DW) |                  | <b>Long edge*</b><br>Short edge                                                                                                                      | Chooses the duplex scanning format.              | 38                                                                                                               |                                                 |

| Main Menu | Submenu                               | Menu Selections  | Options                                         | Descriptions                                                                                                                                       | Page                                                 |
|-----------|---------------------------------------|------------------|-------------------------------------------------|----------------------------------------------------------------------------------------------------------------------------------------------------|------------------------------------------------------|
| 2.Fax     | 1.Setup Receive<br>(In Fax mode only) | 1.Ring Delay     | 00<br>01<br>02<br>03<br>04*                     | Sets the number of rings before the machine answers in Fax Only or Fax/Tel mode.                                                                   | 50                                                   |
|           |                                       | 2.F/T Ring Time  | 20Secs*<br>30Secs<br>40Secs<br>70Secs           | Sets the pseudo/double-ring time in Fax/Tel mode.                                                                                                  | 50                                                   |
|           |                                       | 3.Easy Receive   | On*<br>Off                                      | Receives fax messages without pressing <b>Start</b> .                                                                                              | 51                                                   |
|           |                                       | 4.Remote Codes   | On* (*51, #51)<br>Off                           | Allows you to answer all calls at an extension or external telephone and use codes to turn the machine on or off. You can personalize these codes. | 61                                                   |
|           |                                       | 5.Auto Reduction | On*<br>Off                                      | Cuts the size of incoming faxes.                                                                                                                   | 52                                                   |
|           |                                       | 6.Print Density  | -□□□■+<br>-□□■□+<br>-□■□□+*<br>-■□□□+<br>-■□□□+ | Makes printouts darker or lighter.                                                                                                                 | 51                                                   |
|           |                                       | 7.Polling RX     | —                                               | Sets up your machine to poll another fax machine.                                                                                                  | 78                                                   |
|           |                                       | 8.Fax Rx Stamp   | On<br>Off*                                      | Prints the received time and date on the top of the received faxes.                                                                                | 53                                                   |
|           |                                       | 9.Duplex         | On<br>Off*                                      | Prints receive faxes on both sides of the paper.                                                                                                   | 52                                                   |
|           |                                       | 2.Setup Send     | 1.Contrast                                      | Auto*<br>Light<br>Dark                                                                                                                             | Changes the lightness or darkness of faxes you send. |
|           | 2.Fax Resolution                      |                  | Standard*<br>Fine<br>S.Fine<br>Photo            | Sets the default resolution for outgoing faxes.                                                                                                    | 44                                                   |

| Main Menu            | Submenu                     | Menu Selections  | Options                                                   | Descriptions                                                                                          | Page |
|----------------------|-----------------------------|------------------|-----------------------------------------------------------|-------------------------------------------------------------------------------------------------------|------|
| 2.Fax<br>(Continued) | 2.Setup Send<br>(Continued) | 3.Delayed Fax    | —                                                         | Sets the time of day in 24 hour format that the delayed faxes will be sent.                           | 46   |
|                      |                             | 4.Batch TX       | On<br>Off*                                                | Combines delayed faxes going to the same fax number at the same time of day into one transmission.    | 46   |
|                      |                             | 5.Real Time TX   | Next Fax:On<br>Next Fax:Off<br>On<br>Off*                 | Sends a fax without using the memory.                                                                 | 45   |
|                      |                             | 6.Polled TX      | On<br>Off*                                                | Sets up your machine with a document to be retrieved by another fax machine.                          | 79   |
|                      |                             | 7.Coverpg Setup  | Next Fax:On<br>Next Fax:Off<br>On<br>Off*<br>Print Sample | Automatically sends a cover page you have programmed.                                                 | 42   |
|                      |                             | 8.Coverpage Msg  | —                                                         | Sets up your own comments for the fax cover page.                                                     | 42   |
|                      |                             | 9.Overseas Mode  | On<br>Off*                                                | If you are having difficulty sending faxes overseas, set this to On.                                  | 46   |
|                      | 3.Address Book              | 1.One Touch Dial | —                                                         | Stores up to 40 One Touch Dial numbers, so you can dial by pressing one key (and <b>Start</b> ).      | 65   |
|                      |                             | 2.Speed Dial     | —                                                         | Stores up to 300 Speed Dial numbers, so you can dial by pressing only a few keys (and <b>Start</b> ). | 67   |
|                      |                             | 3.Setup Groups   | —                                                         | Sets up to 20 Group numbers for Broadcasting.                                                         | 69   |
|                      | 4.Report Setting            | 1.Transmission   | On<br>On+Image<br>Off*<br>Off+Image                       | Sets initial setup for Transmission Verification Report.                                              | 80   |

| Main Menu                                    | Submenu                         | Menu Selections                        | Options                                                                        | Descriptions                                                                                                                                                                                                                                                                                           | Page |
|----------------------------------------------|---------------------------------|----------------------------------------|--------------------------------------------------------------------------------|--------------------------------------------------------------------------------------------------------------------------------------------------------------------------------------------------------------------------------------------------------------------------------------------------------|------|
| 2.Fax<br>(Continued)                         | 4.Report Setting<br>(Continued) | 2.Journal Period                       | Off                                                                            | Sets the interval for automatic printing of the Fax Journal.                                                                                                                                                                                                                                           | 81   |
|                                              |                                 |                                        | Every 50 Faxes*                                                                |                                                                                                                                                                                                                                                                                                        |      |
|                                              | Every 6 Hours                   |                                        |                                                                                |                                                                                                                                                                                                                                                                                                        |      |
|                                              | Every 12 Hours                  |                                        |                                                                                |                                                                                                                                                                                                                                                                                                        |      |
|                                              | Every 24 Hours                  |                                        |                                                                                |                                                                                                                                                                                                                                                                                                        |      |
|                                              | Every 2 Days                    |                                        |                                                                                |                                                                                                                                                                                                                                                                                                        |      |
|                                              | Every 7 Days                    |                                        |                                                                                |                                                                                                                                                                                                                                                                                                        |      |
|                                              | 5.Remote Fax Opt                | 1.Fwd/Page/Store<br><br>(Backup Print) | Off*                                                                           | Sets the machine to forward fax messages, to call your pager, to store incoming faxes in the memory (so you can retrieve them while you are away from your machine), or to send faxes to your PC.<br><br>If you choose Fax Forward or PC Fax Receive, you can turn on the safety feature Backup Print. | 71   |
|                                              |                                 |                                        | Fax Forward                                                                    |                                                                                                                                                                                                                                                                                                        |      |
|                                              |                                 |                                        | Paging                                                                         |                                                                                                                                                                                                                                                                                                        |      |
|                                              |                                 |                                        | Fax Storage                                                                    |                                                                                                                                                                                                                                                                                                        |      |
|                                              | PC Fax Receive                  |                                        |                                                                                |                                                                                                                                                                                                                                                                                                        |      |
|                                              | 2.Remote Access                 | ---                                    | ---                                                                            | Sets your own code for Remote Retrieval.                                                                                                                                                                                                                                                               | 75   |
| ---                                          |                                 |                                        | Prints incoming faxes stored in the memory.                                    | 53                                                                                                                                                                                                                                                                                                     |      |
| ---                                          |                                 |                                        |                                                                                |                                                                                                                                                                                                                                                                                                        |      |
| 6.Dial Restrict.                             | 1.Dial Pad                      | Off*                                   | You can set the machine to restrict dialing when using the dial pad.           | 36                                                                                                                                                                                                                                                                                                     |      |
|                                              |                                 | Enter # twice                          |                                                                                |                                                                                                                                                                                                                                                                                                        |      |
|                                              |                                 | On                                     |                                                                                |                                                                                                                                                                                                                                                                                                        |      |
|                                              |                                 | On                                     |                                                                                |                                                                                                                                                                                                                                                                                                        |      |
| 2.One Touch Dial                             | Off*                            | Enter # twice                          | You can set the machine to restrict the dialing of One Touch numbers.          | 36                                                                                                                                                                                                                                                                                                     |      |
|                                              |                                 |                                        |                                                                                |                                                                                                                                                                                                                                                                                                        | On   |
| 3.Speed Dial                                 | Off*                            | Enter # twice                          | You can set the machine to restrict the dialing of Speed Dial numbers.         | 36                                                                                                                                                                                                                                                                                                     |      |
|                                              |                                 |                                        |                                                                                |                                                                                                                                                                                                                                                                                                        | On   |
| 4.LDAP Server<br>(MFC-8690DW and MFC-8890DW) | Off*                            | Enter # twice                          | You can set the machine to restrict the dialing of LDAP Server numbers.        | 36                                                                                                                                                                                                                                                                                                     |      |
|                                              |                                 |                                        |                                                                                |                                                                                                                                                                                                                                                                                                        | On   |
| 7.Remaining Jobs                             | ---                             | ---                                    | You can check which jobs are in the memory and lets you cancel scheduled jobs. | 47                                                                                                                                                                                                                                                                                                     |      |

| Main Menu            | Submenu          | Menu Selections | Options                                         | Descriptions                                                                                                                                                                                                   | Page |
|----------------------|------------------|-----------------|-------------------------------------------------|----------------------------------------------------------------------------------------------------------------------------------------------------------------------------------------------------------------|------|
| 2.Fax<br>(Continued) | 0.Miscellaneous  | 1.Compatibility | High*<br>Normal<br>Basic (for VoIP)             | Adjusts the equalization for transmission difficulties.<br><br>VoIP service providers offer fax support using various standards. If you regularly experience fax transmission errors, choose Basic (for VoIP). | 138  |
|                      |                  | 2.Distinctive   | Off*<br>Set                                     | Uses the telephone company's Distinctive Ring subscriber service to register the ring pattern with the machine.                                                                                                | 54   |
| 3.Copy               | 1.Quality        | —               | Text<br>Photo<br>Auto*                          | You can choose the Copy resolution for your type of document.                                                                                                                                                  | 86   |
|                      | 2.FB Txt Quality | —               | 1200x600dpi<br>600dpi*                          |                                                                                                                                                                                                                | 86   |
|                      | 3.Brightness     | —               | -□□□■+<br>-□□□■+<br>-□■□□+*<br>-□■□□+<br>-■□□□+ | Adjust the brightness for copies.                                                                                                                                                                              | 86   |
|                      | 4.Contrast       | —               | -□□□■+<br>-□□□■+<br>-□■□□+*<br>-□■□□+<br>-■□□□+ | Adjusts the contrast for copies.<br><br>You can change to the higher Copy resolution when you make a text copy with 100% ratio using the scanner glass.                                                        | 86   |

| Main Menu         | Submenu          | Menu Selections     | Options                                                                                     | Descriptions                                                                                                                                    | Page                                            |
|-------------------|------------------|---------------------|---------------------------------------------------------------------------------------------|-------------------------------------------------------------------------------------------------------------------------------------------------|-------------------------------------------------|
| 4. Printer        | 1. Emulation     | —                   | Auto (EPSON)*<br>Auto (IBM)<br>HP LaserJet<br>BR-Script 3<br>Epson FX-850<br>IBM Proprinter | Chooses the emulation mode.                                                                                                                     | See <i>Software User's Guide</i> on the CD-ROM. |
|                   | 2. Print Options | 1. Internal Font    | 1. HP LaserJet<br>2. BR-Script 3                                                            | Prints a list of the machine's internal fonts.                                                                                                  |                                                 |
|                   |                  | 2. Configuration    | —                                                                                           | Prints a list of the machine's printer settings.                                                                                                |                                                 |
|                   |                  | 3. Test Print       | —                                                                                           | Prints a test page.                                                                                                                             |                                                 |
|                   | 3. Duplex        | —                   | Off*<br>On (Long Edge)<br>On (Short Edge)                                                   | Enables or disables duplex printing. You can also choose long edge or short edge duplex printing.                                               |                                                 |
| 4. Reset Printer  | —                | 1. Reset<br>2. Exit | Restores the printer settings to the original factory default settings.                     |                                                                                                                                                 |                                                 |
| 5. USB Direct I/F | 1. Direct Print  | 1. Paper Size       | A4<br>Letter*<br>Legal<br>Executive<br>A5<br>A5 L<br>A6<br>B5<br>B6<br>Folio                | Sets the paper size when printing directly from the USB flash memory drive.<br><br>A5 L and A6 size are not available for the optional Tray #2. | 95                                              |
|                   |                  | 2. Media Type       | Thin<br>Plain*<br>Thick<br>Thicker<br>Recycled Paper                                        | Sets the media type when printing directly from the USB flash memory drive.                                                                     | 95                                              |



| Main Menu                       | Submenu                       | Menu Selections | Options                                                                                                                                             | Descriptions                                                                                          | Page                                            |
|---------------------------------|-------------------------------|-----------------|-----------------------------------------------------------------------------------------------------------------------------------------------------|-------------------------------------------------------------------------------------------------------|-------------------------------------------------|
| 5.USB Direct I/F<br>(Continued) | 1.Direct Print<br>(Continued) | 3.Multiple Page | 1in1*<br>2in1<br>4in1<br>9in1<br>16in1<br>25in1<br>1 in 2x2 pages<br>1 in 3x3 pages<br>1 in 4x4 pages<br>1 in 5x5 pages                             | Sets the page style when printing multiple pages directly from the USB Flash memory drive.            | 95                                              |
|                                 |                               | 4.Orientation   | Portrait*<br>Landscape                                                                                                                              | Sets the page orientation when printing directly from the USB Flash memory drive.                     | 95                                              |
|                                 |                               | 5.Collate       | On*<br>Off                                                                                                                                          | Enables or disables the page collation when printing directly from the USB Flash memory drive.        | 95                                              |
|                                 |                               | 6.Print Quality | Normal*<br>Fine                                                                                                                                     | Sets the print quality option when printing directly from the USB Flash memory drive.                 | 95                                              |
|                                 |                               | 7.PDF Option    | Document*<br>Document&Markup<br>Document&Stamps                                                                                                     | Sets the PDF option whether to print comments (Markup) or stamps in the PDF file along with the text. | 95                                              |
|                                 |                               | 8.Index Print   | Simple*<br>Details                                                                                                                                  | Sets the index print option, simple format or details.                                                | 95                                              |
|                                 | 2.Scan to USB                 | 1.Resolution    | Color 100 dpi*<br>Color 200 dpi<br>Color 300 dpi<br>Color 600 dpi<br>Gray 100 dpi<br>Gray 200 dpi<br>Gray 300 dpi<br>B&W 200 dpi<br>B&W 200x100 dpi | Sets the resolution to send the scanned data to USB Flash memory drive.                               | See <i>Software User's Guide</i> on the CD-ROM. |
|                                 |                               | 2.File Name     | —                                                                                                                                                   | Enter the file name of the scanned data.                                                              |                                                 |

| Main Menu        | Submenu          | Menu Selections | Options                      | Descriptions                                                                                                  | Page |
|------------------|------------------|-----------------|------------------------------|---------------------------------------------------------------------------------------------------------------|------|
| 6.Print Reports  | 1.Transmission   | 1.View on LCD   | —                            | You can view the Transmission Verification Report for your last 200 outgoing faxes and print the last report. | 81   |
|                  |                  | 2.Print Report  | —                            |                                                                                                               |      |
|                  | 2.Help List      | —               | —                            | Prints the Help List so you can see at-a-glance how to quickly program your machine.                          | 81   |
|                  | 3.Tel Index List | 1.Numeric       | —                            | Lists name and numbers stored in the One-Touch and Speed-Dial memory, in numerical or alphabetical order.     | 81   |
|                  |                  | 2.Alphabetic    | —                            |                                                                                                               |      |
|                  | 4.Fax Journal    | —               | —                            | Lists information about your last 200 incoming and outgoing faxes. (TX means Transmit. RX means Receive.)     | 81   |
|                  | 5.User Settings  | —               | —                            | Lists your settings.                                                                                          | 81   |
| 6.Network Config | —                | —               | Lists your Network settings. | 81                                                                                                            |      |

| Main Menu                                      | Submenu  | Menu Selections | Options                                                                                                              | Descriptions                                                              | Page                                           |
|------------------------------------------------|----------|-----------------|----------------------------------------------------------------------------------------------------------------------|---------------------------------------------------------------------------|------------------------------------------------|
| 7.Network<br>(MFC-8480DN<br>and<br>MFC-8680DN) | 1.TCP/IP | 1.Boot Method   | Auto*<br>Static<br>RARP<br>BOOTP<br>DHCP                                                                             | Chooses the BOOT method that best suits your needs.                       | See <i>Network User's Guide</i> on the CD-ROM. |
|                                                |          | 2.IP Address    | [000-255]. [000-255]. [000-255]. [000-255]                                                                           | Enter the IP address.                                                     |                                                |
|                                                |          | 3.Subnet Mask   | [000-255]. [000-255]. [000-255]. [000-255]                                                                           | Enter the Subnet mask.                                                    |                                                |
|                                                |          | 4.Gateway       | [000-255]. [000-255]. [000-255]. [000-255]                                                                           | Enter the Gateway address.                                                |                                                |
|                                                |          | 5.Node Name     | BRNXXXXXXXXXXXX                                                                                                      | Enter the Node name.                                                      |                                                |
|                                                |          | 6.WINS Config   | Auto*<br>Static                                                                                                      | Chooses the WINS configuration mode.                                      |                                                |
|                                                |          | 7.WINS Server   | (Primary)<br>[000-255]. [000-255]. [000-255]. [000-255]<br>(Secondary)<br>[000-255]. [000-255]. [000-255]. [000-255] | Specifies the IP address of the primary or secondary WINS server.         |                                                |
|                                                |          | 8.DNS Server    | (Primary)<br>[000-255]. [000-255]. [000-255]. [000-255]<br>(Secondary)<br>[000-255]. [000-255]. [000-255]. [000-255] | Specifies the IP address of the primary or secondary DNS server.          |                                                |
|                                                |          | 9.APIPA         | On*<br>Off                                                                                                           | Automatically allocates the IP address from the link-local address range. |                                                |

| Main Menu                                                | Submenu                  | Menu Selections | Options                                                                                                                                             | Descriptions                                                                                                                                                                     | Page                                           |
|----------------------------------------------------------|--------------------------|-----------------|-----------------------------------------------------------------------------------------------------------------------------------------------------|----------------------------------------------------------------------------------------------------------------------------------------------------------------------------------|------------------------------------------------|
| 7. Network<br>(MFC-8480DN and MFC-8680DN)<br>(Continued) | 1. TCP/IP<br>(Continued) | 0. IPv6         | On<br><br>Off*                                                                                                                                      | Enable or Disable the IPv6 protocol. If you want to use the IPv6 protocol, visit <a href="http://solutions.brother.com/">http://solutions.brother.com/</a> for more information. | See <i>Network User's Guide</i> on the CD-ROM. |
|                                                          | 2. Ethernet              | —               | Auto*<br><br>100B-FD<br>100B-HD<br>10B-FD<br>10B-HD                                                                                                 | Chooses the Ethernet link mode.                                                                                                                                                  |                                                |
|                                                          | 3. Scan To FTP           | —               | Color 100 dpi*<br>Color 200 dpi<br>Color 300 dpi<br>Color 600 dpi<br>Gray 100 dpi<br>Gray 200 dpi<br>Gray 300 dpi<br>B&W 200 dpi<br>B&W 200x100 dpi | Chooses the file format to send the scanned data via FTP.                                                                                                                        |                                                |
|                                                          | 4. ScanTo Network        | —               | Color 100 dpi*<br>Color 200 dpi<br>Color 300 dpi<br>Color 600 dpi<br>Gray 100 dpi<br>Gray 200 dpi<br>Gray 300 dpi<br>B&W 200 dpi<br>B&W 200x100 dpi | You can scan a black and white or color document directly to a CIFS server on your local network or on the internet.                                                             |                                                |
|                                                          | 5. Time Zone             | —               | UTCXXX:XX                                                                                                                                           | Sets the time zone for your country.                                                                                                                                             |                                                |
|                                                          | 0. Network Reset         | 1. Reset        | 1. Yes<br>2. No                                                                                                                                     | Restore all network settings to factory default.                                                                                                                                 |                                                |
|                                                          | 2. Exit                  | —               |                                                                                                                                                     |                                                                                                                                                                                  |                                                |

| Main Menu                                                | Submenu      | Menu Selections                                                                                                                                                                  | Options        | Descriptions                                                                                                         | Page                                                                      |                                                |
|----------------------------------------------------------|--------------|----------------------------------------------------------------------------------------------------------------------------------------------------------------------------------|----------------|----------------------------------------------------------------------------------------------------------------------|---------------------------------------------------------------------------|------------------------------------------------|
| 7. Network<br>(MFC-8690DW and MFC-8890DW)<br>(Continued) | 1. Wired LAN | 1. TCP/IP                                                                                                                                                                        | 1. BOOT Method | Auto*<br>Static<br>RARP<br>BOOTP<br>DHCP                                                                             | Chooses the BOOT method that best suits your needs.                       | See <i>Network User's Guide</i> on the CD-ROM. |
|                                                          |              |                                                                                                                                                                                  | 2. IP Address  | [000-255]. [000-255]. [000-255]. [000-255]                                                                           | Enter the IP address.                                                     |                                                |
|                                                          |              |                                                                                                                                                                                  | 3. Subnet Mask | [000-255]. [000-255]. [000-255]. [000-255]                                                                           | Enter the Subnet mask.                                                    |                                                |
|                                                          |              |                                                                                                                                                                                  | 4. Gateway     | [000-255]. [000-255]. [000-255]. [000-255]                                                                           | Enter the Gateway address.                                                |                                                |
|                                                          |              |                                                                                                                                                                                  | 5. Node Name   | BRNXXXXXXXXXXXX                                                                                                      | Enter the Node name.                                                      |                                                |
|                                                          |              |                                                                                                                                                                                  | 6. WINS Config | Auto*<br>Static                                                                                                      | Chooses the WINS configuration mode.                                      |                                                |
|                                                          |              |                                                                                                                                                                                  | 7. WINS Server | (Primary)<br>[000-255]. [000-255]. [000-255]. [000-255]<br>(Secondary)<br>[000-255]. [000-255]. [000-255]. [000-255] | Specifies the IP address of the primary or secondary WINS server.         |                                                |
|                                                          |              |                                                                                                                                                                                  | 8. DNS Server  | (Primary)<br>[000-255]. [000-255]. [000-255]. [000-255]<br>(Secondary)<br>[000-255]. [000-255]. [000-255]. [000-255] | Specifies the IP address of the primary or secondary DNS server.          |                                                |
|                                                          |              |                                                                                                                                                                                  | 9. APIPA       | On*<br>Off                                                                                                           | Automatically allocates the IP address from the link-local address range. |                                                |
| 0. IPv6                                                  | On<br>Off*   | Enable or Disable the IPv6 protocol. If you want to use the IPv6 protocol, visit <a href="http://solutions.brother.com/">http://solutions.brother.com/</a> for more information. |                |                                                                                                                      |                                                                           |                                                |

| Main Menu                                                | Submenu                     | Menu Selections   | Options        | Descriptions                                                                                                         | Page                                                              |                                                |
|----------------------------------------------------------|-----------------------------|-------------------|----------------|----------------------------------------------------------------------------------------------------------------------|-------------------------------------------------------------------|------------------------------------------------|
| 7. Network<br>(MFC-8690DW and MFC-8890DW)<br>(Continued) | 1. Wired LAN<br>(Continued) | 2. Ethernet       | —              | Auto*<br>100B-FD<br>100B-HD<br>10B-FD<br>10B-HD                                                                      | Chooses the Ethernet link mode.                                   | See <i>Network User's Guide</i> on the CD-ROM. |
|                                                          |                             | 3. Set to Default | —              | 1. Reset<br>2. Exit                                                                                                  | Restore the wired network setting to factory default.             |                                                |
|                                                          |                             | 4. Wired Enable   | —              | On*<br>Off                                                                                                           | Enable or Disable the Wired LAN manually.                         |                                                |
|                                                          | 2. WLAN                     | 1. TCP/IP         | 1. BOOT Method | Auto*<br>Static<br>RARP<br>BOOTP<br>DHCP                                                                             | Chooses the BOOT method that best suits your needs.               |                                                |
|                                                          |                             |                   | 2. IP Address  | [000-255]. [000-255]. [000-255]. [000-255]                                                                           | Enter the IP address.                                             |                                                |
|                                                          |                             |                   | 3. Subnet Mask | [000-255]. [000-255]. [000-255]. [000-255]                                                                           | Enter the Subnet mask.                                            |                                                |
|                                                          |                             |                   | 4. Gateway     | [000-255]. [000-255]. [000-255]. [000-255]                                                                           | Enter the Gateway address.                                        |                                                |
|                                                          |                             |                   | 5. Node Name   | BRXXXXXXXXXXXXXX                                                                                                     | Enter the Node name.                                              |                                                |
|                                                          |                             |                   | 6. WINS Config | Auto*<br>Static                                                                                                      | Chooses the WINS configuration mode.                              |                                                |
|                                                          |                             |                   | 7. WINS Server | (Primary)<br>[000-255]. [000-255]. [000-255]. [000-255]<br>(Secondary)<br>[000-255]. [000-255]. [000-255]. [000-255] | Specifies the IP address of the primary or secondary WINS server. |                                                |
|                                                          |                             |                   | 8. DNS Server  | (Primary)<br>[000-255]. [000-255]. [000-255]. [000-255]<br>(Secondary)<br>[000-255]. [000-255]. [000-255]. [000-255] | Specifies the IP address of the primary or secondary DNS server.  |                                                |

| Main Menu                                                | Submenu                | Menu Selections          |               | Options                                                                                        | Descriptions                                                                                                                                                                     | Page                                           |
|----------------------------------------------------------|------------------------|--------------------------|---------------|------------------------------------------------------------------------------------------------|----------------------------------------------------------------------------------------------------------------------------------------------------------------------------------|------------------------------------------------|
| 7. Network<br>(MFC-8690DW and MFC-8890DW)<br>(Continued) | 2. WLAN<br>(Continued) | 1. TCP/IP<br>(Continued) | 9. APIPA      | On*<br>Off                                                                                     | Automatically allocates the IP address from the link-local address range.                                                                                                        | See <i>Network User's Guide</i> on the CD-ROM. |
|                                                          |                        |                          | 0. IPv6       | On<br>Off*                                                                                     | Enable or Disable the IPv6 protocol. If you want to use the IPv6 protocol, visit <a href="http://solutions.brother.com/">http://solutions.brother.com/</a> for more information. |                                                |
|                                                          |                        | 2. Setup Wizard          | On<br>Off     | —                                                                                              | You can configure your print server.                                                                                                                                             |                                                |
|                                                          |                        | 3. SES/WPS/AOSS          | On<br>Off     | —                                                                                              | You can easily configure your wireless network settings using the one-button push method.                                                                                        |                                                |
|                                                          |                        | 4. WPS w/PIN Code        | On<br>Off     | —                                                                                              | You can easily configure your wireless network settings using WPS with a PIN code.                                                                                               |                                                |
|                                                          |                        | 5. WLAN Status           | 1. Status     | Active (11b)<br>Active (11g)<br>Wired LAN Active<br>WLAN OFF<br>AOSS Active<br>Connection Fail | You can see the current wireless network status.                                                                                                                                 |                                                |
|                                                          |                        |                          | 2. Signal     | Strong<br>Medium<br>Weak<br>None                                                               | You can see the current wireless network signal strength.                                                                                                                        |                                                |
|                                                          |                        |                          | 3. SSID       | —                                                                                              | You can see the current SSID.                                                                                                                                                    |                                                |
|                                                          |                        |                          | 4. Comm. Mode | Ad-hoc<br>Infrastructure                                                                       | You can see the current Communication Mode.                                                                                                                                      |                                                |

| Main Menu                                                | Submenu                | Menu Selections   | Options                                                | Descriptions                                                                                   | Page                                                                  |                                                |
|----------------------------------------------------------|------------------------|-------------------|--------------------------------------------------------|------------------------------------------------------------------------------------------------|-----------------------------------------------------------------------|------------------------------------------------|
| 7. Network<br>(MFC-8690DW and MFC-8890DW)<br>(Continued) | 2. WLAN<br>(Continued) | 6. Set to Default | —                                                      | 1. Reset<br>2. Exit                                                                            | Restore the wireless network setting to factory default.              | See <i>Network User's Guide</i> on the CD-ROM. |
|                                                          |                        | 7. WLAN Enable    | —                                                      | On<br>Off*                                                                                     | Enable or disable the wireless LAN manually.                          |                                                |
|                                                          | 3. E-mail/IFAX         | 1. Mail Address   | —                                                      | —                                                                                              | Enter the mail address. (Up to 60 characters)                         |                                                |
|                                                          |                        | 2. Setup Server   | 1. SMTP Server                                         | Name?<br>(up to 64 characters)<br>IP Address?<br>[000-255]. [000-255].<br>[000-255]. [000-255] | Enter the SMTP server address.                                        |                                                |
|                                                          |                        |                   | 2. SMTP Port                                           | [00001-65535]                                                                                  | Enter the POP3 port number.                                           |                                                |
|                                                          |                        |                   | 3. Auth. for SMTP                                      | None*<br>SMTP-AUTH<br>POP bef. SMTP                                                            | Selects the security method for E-mail notification.                  |                                                |
|                                                          |                        |                   | 4. POP3 Server                                         | Name?<br>(up to 64 characters)<br>IP Address?<br>[000-255]. [000-255].<br>[000-255]. [000-255] | Enter the POP3 server address.                                        |                                                |
|                                                          |                        |                   | 5. POP3 Port                                           | [00001-65535]                                                                                  | Enter the POP3 port number.                                           |                                                |
|                                                          |                        |                   | 6. Mailbox Name                                        | —                                                                                              | Enter the mail box name. (Up to 60 characters)                        |                                                |
|                                                          |                        |                   | 7. Mailbox Pwd                                         | —                                                                                              | Enter the password to login to the POP3 server. (Up to 32 characters) |                                                |
|                                                          |                        |                   | 8. APOP                                                | On<br>Off*                                                                                     | Enables or disables APOP.                                             |                                                |
| 3. Setup Mail RX                                         | 1. Auto Polling        | On*<br>Off        | Automatically checks the POP3 server for new messages. |                                                                                                |                                                                       |                                                |



| Main Menu                                                | Submenu                       | Menu Selections                 |                              | Options                         | Descriptions                                                                                                                                        | Page                                           |                                                              |
|----------------------------------------------------------|-------------------------------|---------------------------------|------------------------------|---------------------------------|-----------------------------------------------------------------------------------------------------------------------------------------------------|------------------------------------------------|--------------------------------------------------------------|
| 7. Network<br>(MFC-8690DW and MFC-8890DW)<br>(Continued) | 3. E-mail/IFAX<br>(Continued) | 3. Setup Mail RX<br>(Continued) | 2. Poll Frequency<br>(01-60) | 10Min*                          | Sets the interval for checking for new messages on the POP3 server.                                                                                 | See <i>Network User's Guide</i> on the CD-ROM. |                                                              |
|                                                          |                               |                                 | 3. Header                    | All<br>Subject+From+To<br>None* | Selects the contents of the mail header to be printed.                                                                                              |                                                |                                                              |
|                                                          |                               |                                 | 4. Del Error Mail            | On*<br>Off                      | Deletes error mails automatically.                                                                                                                  |                                                |                                                              |
|                                                          |                               |                                 | 5. Notification              | On<br>MDN<br>Off*               | Receives notification messages.                                                                                                                     |                                                |                                                              |
|                                                          |                               | 4. Setup Mail TX                | 1. Sender Subject            | —                               | Displays the subject that is attached to the Internet Fax data.                                                                                     |                                                |                                                              |
|                                                          |                               |                                 | 2. Size Limit                | On<br>Off*                      | Limits the size of E-mail documents.                                                                                                                |                                                |                                                              |
|                                                          |                               |                                 | 3. Notification              | On<br>Off*                      | Sends notification messages.                                                                                                                        |                                                |                                                              |
|                                                          |                               | 5. Setup Relay                  | 1. Rly Broadcast             | On<br>Off*                      | Relays a document to another fax machine.                                                                                                           |                                                |                                                              |
|                                                          |                               |                                 | 2. Relay Domain              | Relay XX:                       | Registers the Domain name.                                                                                                                          |                                                |                                                              |
|                                                          |                               |                                 | 3. Relay Report              | On<br>Off*                      | Prints the Relay Broadcast Report.                                                                                                                  |                                                |                                                              |
|                                                          |                               | 4. Scan To E-mail               | —                            | —                               | Color 100 dpi*<br>Color 200 dpi<br>Color 300 dpi<br>Color 600 dpi<br>Gray 100 dpi<br>Gray 200 dpi<br>Gray 300 dpi<br>B&W 200 dpi<br>B&W 200x100 dpi |                                                | Chooses the file format to send the scanned data via e-mail. |

| Main Menu                                               | Submenu          | Menu Selections |               | Options                                                                                                                                             | Descriptions                                                                                                         | Page                                           |
|---------------------------------------------------------|------------------|-----------------|---------------|-----------------------------------------------------------------------------------------------------------------------------------------------------|----------------------------------------------------------------------------------------------------------------------|------------------------------------------------|
| 7.Network<br>(MFC-8690DW and MFC-8890DW)<br>(Continued) | 5.Scan To FTP    | —               | —             | Color 100 dpi*<br>Color 200 dpi<br>Color 300 dpi<br>Color 600 dpi<br>Gray 100 dpi<br>Gray 200 dpi<br>Gray 300 dpi<br>B&W 200 dpi<br>B&W 200x100 dpi | Chooses the file format to send the scanned data via FTP.                                                            | See <i>Network User's Guide</i> on the CD-ROM. |
|                                                         | 6.ScanTo Network | —               | —             | Color 100 dpi*<br>Color 200 dpi<br>Color 300 dpi<br>Color 600 dpi<br>Gray 100 dpi<br>Gray 200 dpi<br>Gray 300 dpi<br>B&W 200 dpi<br>B&W 200x100 dpi | You can scan a balck and white or color document directly to a CIFS server on your local network or on the internet. |                                                |
|                                                         | 7.Fax to Server  | —               | —             | On<br>Off*                                                                                                                                          | You can store a prefix/suffix address in the machine and can send a document from a fax server system.               |                                                |
|                                                         | 8.Time Zone      | —               | —             | UTCXXX:XX                                                                                                                                           | Sets the time zone for your country.                                                                                 |                                                |
|                                                         | 0.Network Reset  | 1.Reset         | 1.Yes<br>2.No |                                                                                                                                                     | Restores all network settings to factory default.                                                                    |                                                |
|                                                         | 2.Exit           |                 |               |                                                                                                                                                     |                                                                                                                      |                                                |

| Main Menu       | Submenu                                             | Menu Selections                                                         | Options                                        | Descriptions                                                                                                                                           | Page                           |
|-----------------|-----------------------------------------------------|-------------------------------------------------------------------------|------------------------------------------------|--------------------------------------------------------------------------------------------------------------------------------------------------------|--------------------------------|
| 8.Machine Info. | 1.Serial No.                                        | —                                                                       | —                                              | You can check the serial number of your machine.                                                                                                       | 166                            |
|                 | 2.Page Counter                                      | —                                                                       | Total<br>Fax/List<br>Copy<br>Print             | You can check the number of total pages the machine has printed during its life.                                                                       | 166                            |
|                 | 3.Parts Life                                        | 1.Drum<br>2.Fuser<br>3.Laser<br>4.PF Kit MP<br>5.PF Kit 1<br>6.PF Kit 2 | —                                              | You can check the percentage of a machine part's life that remains available.<br><br>PF Kit 2 appears only when the optional LT5300 tray is installed. | 167                            |
| 0.Initial Setup | 1.Receive Mode                                      | —                                                                       | Fax Only*<br>Fax/Tel<br>External TAD<br>Manual | Chooses the receive mode that best suits your needs.                                                                                                   | 48                             |
|                 | 2.Date&Time                                         | —                                                                       | —                                              | Puts the date and time on the LCD and in headings of faxes you send.                                                                                   | See <i>Quick Setup Guide</i> . |
|                 | 3.Station ID                                        | —                                                                       | Fax:<br>Tel:<br>Name:                          | Sets your name and fax number to appear on each page you fax.                                                                                          |                                |
|                 | 4.Tone/Pulse (in Canada)                            | —                                                                       | Tone*<br>Pulse                                 | Chooses the dialing mode.                                                                                                                              |                                |
|                 | 4.Dial Tone (in USA)<br>5.Dial Tone (in Canada)     | —                                                                       | Detection<br>No Detection*                     | You can shorten the dial tone detect pause.                                                                                                            | 138                            |
|                 | 5.Dial Prefix (in USA)<br>6.Dial Prefix (in Canada) | —                                                                       | —                                              | Sets a prefix number that will always be added before the fax number every time you dial.                                                              | 29                             |

| Main Menu                      | Submenu                                           | Menu Selections | Options                 | Descriptions                                                                                                         | Page                           |
|--------------------------------|---------------------------------------------------|-----------------|-------------------------|----------------------------------------------------------------------------------------------------------------------|--------------------------------|
| 0.Initial Setup<br>(Continued) | 6.Reset<br>(in USA)<br><br>7.Reset<br>(in Canada) | 1.Network       | 1.Reset<br><br>2.Exit   | You can reset the print server back to its default factory settings, such as the password and IP address information | 167                            |
|                                |                                                   | 2.Address & Fax | 1.Reset<br><br>2.Exit   | Restores all stored phone number and fax settings.                                                                   | 167                            |
|                                |                                                   | 3.All Settings  | 1.Reset<br><br>2.Exit   | Restores all the machine settings to the factory default settings.                                                   | 167                            |
|                                | 0.Local Language                                  | —               | (Choose your language.) | Allows you to change the LCD language for your country.                                                              | See <i>Quick Setup Guide</i> . |

## Entering text

When setting certain menu selections, such as the Station ID, you will need to type text characters. The dial pad keys have letters printed on them. The keys: **0**, **#** and **\*** do *not* have printed letters because they are used for special characters.

Press the appropriate dial pad key the number of times shown in this reference table to access the character you want.

| Press Key | one time | two times | three times | four times | five times | six times | seven times | eight times | nine times |
|-----------|----------|-----------|-------------|------------|------------|-----------|-------------|-------------|------------|
| 1         | @        | .         | /           | 1          | @          | .         | /           | 1           | @          |
| 2         | a        | b         | c           | A          | B          | C         | 2           | a           | b          |
| 3         | d        | e         | f           | D          | E          | F         | 3           | d           | e          |
| 4         | g        | h         | i           | G          | H          | I         | 4           | g           | h          |
| 5         | j        | k         | l           | J          | K          | L         | 5           | j           | k          |
| 6         | m        | n         | o           | M          | N          | O         | 6           | m           | n          |
| 7         | p        | q         | r           | s          | P          | Q         | R           | S           | 7          |
| 8         | t        | u         | v           | T          | U          | V         | 8           | t           | u          |
| 9         | w        | x         | y           | z          | W          | X         | Y           | Z           | 9          |

For menu selections that do not allow lower case character selection, please use this reference table.

| Press Key | one time | two times | three times | four times | five times |
|-----------|----------|-----------|-------------|------------|------------|
| 2         | A        | B         | C           | 2          | A          |
| 3         | D        | E         | F           | 3          | D          |
| 4         | G        | H         | I           | 4          | G          |
| 5         | J        | K         | L           | 5          | J          |
| 6         | M        | N         | O           | 6          | M          |
| 7         | P        | Q         | R           | 7          | P          |
| 8         | T        | U         | V           | 8          | T          |
| 9         | W        | X         | Y           | 9          | W          |

### Inserting spaces

To enter a space in a fax number, press ► once between numbers. To enter a space in a name, press ► twice between characters.

### Making corrections

If you entered a letter incorrectly and want to change it, press ◀ to move the cursor to the incorrect character, and then press **Clear/Back**.

### Repeating letters

To enter a character on the same key as the previous character, press ► to move the cursor right before pressing the key again.

## Special characters and symbols

Press \*, # or 0, then press ◀ or ▶ to move the cursor to the symbol or character you want. Press **OK** to choose it. The symbols and characters below will appear depending on your menu selection.

|         |     |                                                                                                                                                     |
|---------|-----|-----------------------------------------------------------------------------------------------------------------------------------------------------|
| Press * | for | (space) ! " # \$ % & ' ( ) * + , - . / €                                                                                                            |
| Press # | for | : ; < = > ? @ [ ] ^ _ \ ~ '   { }                                                                                                                   |
| Press 0 | for | (For Wired model)<br>Á Â Ã Ä Ç È É Ê Ë Ì Í Î Ï Ó Ô Õ Ö Ø Ù Ú Û Ü<br>(For Wireless model)<br>Á Â Ã Ä Ç È É Ê Ë Ì Í Î Ï Ó Ô Õ Ö Ø Ù Ú Û Ü 0 \ {   } ~ |

## General

|                                     |                                                                                                                                                                                   |
|-------------------------------------|-----------------------------------------------------------------------------------------------------------------------------------------------------------------------------------|
| <b>Printer Type</b>                 | Laser                                                                                                                                                                             |
| <b>Print Method</b>                 | Electrophotography by semiconductor laser beam scanning                                                                                                                           |
| <b>Memory Capacity</b>              | 64 MB                                                                                                                                                                             |
| <b>LCD (liquid crystal display)</b> | 22 characters × 5 lines                                                                                                                                                           |
| <b>Power Source</b>                 | 110-120 V AC 50/60 Hz                                                                                                                                                             |
| <b>Power Consumption</b>            | Peak: 1080 W<br>Copying: Average 680 W <sup>1</sup><br>Sleep: (MFC-8480DN)<br>Average 18 W<br>(MFC-8680DN, MFC-8690DW and<br>MFC-8890DW)<br>Average 19 W<br>Standby: Average 85 W |

<sup>1</sup> When making a copy from one sheet

### Dimensions

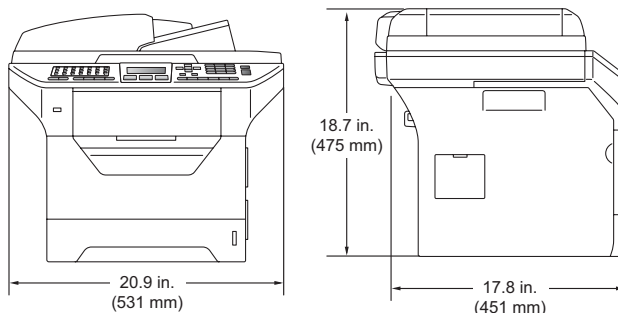

|                    |                                                                                                                                                                    |
|--------------------|--------------------------------------------------------------------------------------------------------------------------------------------------------------------|
| <b>Weight</b>      | With Drum/Toner Unit: 40.3 lb (18.3kg)<br>(MFC-8480DN)<br>41.0 lb (18.6kg)<br>(MFC-8680DN, MFC-8690DW and<br>MFC-8890DW)                                           |
| <b>Noise level</b> | Sound power<br>Operating (Copying): LwAd = 6.95 Bell<br>Standby: LwAd = 4.6 Bell<br>Sound pressure<br>Operating (Copying): LPAM = 56 dBA<br>Standby: LPAM = 30 dBA |

|                                        |                                                                                                                                                                          |
|----------------------------------------|--------------------------------------------------------------------------------------------------------------------------------------------------------------------------|
| <b>Temperature</b>                     | Operating: 50° F to 90.5° F (10 to 32.5° C)<br>Storage: 41° F to 95° F (5 to 35° C)                                                                                      |
| <b>Humidity</b>                        | Operating: 20 to 80% (without condensation)<br>Storage: 10 to 90% (without condensation)                                                                                 |
| <b>ADF (automatic document feeder)</b> | Up to 50 pages (Staggered) 20 lb (80 g/m <sup>2</sup> )<br>Recommended Environment for Best Results:<br>Temperature: 68° F to 86° F (20 to 30° C)<br>Humidity: 50% - 70% |
| <b>Paper Tray</b>                      | Paper: Xerox 4200 (20 lb/Letter)<br>250 Sheets 20 lb (80 g/m <sup>2</sup> )                                                                                              |
| <b>Paper Tray 2 (option)</b>           | 250 Sheets 20 lb (80 g/m <sup>2</sup> )                                                                                                                                  |



# Print media

## Paper Input

### Paper Tray

- Paper Type: Thin Paper, Plain Paper, Bond Paper, Transparencies <sup>1</sup> or Recycled Paper
- Paper Size: Letter, A4, B5(ISO), A5, A5(Long Edge), B6(ISO), A6, Executive, Legal and Folio
- Paper Weight: 16 to 28 lb (60 to 105 g/m<sup>2</sup>)
- Maximum Paper Tray Capacity: Up to 250 sheets of 20 lb (80 g/m<sup>2</sup>) Plain Paper

### Multi-purpose tray (MP tray)

- Paper Type: Thin Paper, Plain Paper, Thick Paper, Bond Paper, Transparencies, Recycled Paper, Envelopes or Labels <sup>1</sup>
- Paper Size: Width: 2.75 to 8.50 in. (69.8 to 216 mm)  
Length: 4.57 to 16 in. (116.0 to 406.4 mm)
- Paper Weight: 16 to 43 lb (60 to 163 g/m<sup>2</sup>) <sup>2</sup>
- Maximum Multi-purpose tray Capacity: Up to 50 sheets of 20 lb (80 g/m<sup>2</sup>) Plain Paper  
Up to 3 envelopes

<sup>1</sup> For transparencies and labels, we recommend removing printed pages from the output paper tray immediately after they exit the machine to avoid the possibility of smudging.

<sup>2</sup> 16 to 28 lb (60 to 105 g/m<sup>2</sup>) for duplex print.

### Paper Tray 2 (option)

- Paper Type: Thin Paper, Plain Paper, Bond Paper or Recycled Paper
- Paper Size: Letter, A4, B5 (ISO), A5, B6 (ISO), Executive, Legal and Folio
- Paper Weight: 16 to 28 lb (60 to 105 g/m<sup>2</sup>)
- Maximum paper tray capacity: Up to 250 sheets of 20 lb (80 g/m<sup>2</sup>) Plain Paper

|                        |                     |                                                                      |
|------------------------|---------------------|----------------------------------------------------------------------|
| <b>Paper Output</b>    | ■ Output Tray:      | Up to 150 sheets (face-down print delivery to the output paper tray) |
|                        | ■ Back Output Tray: | One sheet (face-up print delivery to the back output tray)           |
| <b>Duplex Printing</b> | ■ Paper Size:       | Letter, Legal and Folio                                              |
|                        | ■ Paper Weight:     | 16 to 28 lb (60 to 105 g/m <sup>2</sup> )                            |
|                        | ■ Manual Duplex:    | Yes                                                                  |
|                        | ■ Automatic Duplex: | Yes                                                                  |

# Fax

|                                                                               |                                                                                                                                                                                                                                                                                        |
|-------------------------------------------------------------------------------|----------------------------------------------------------------------------------------------------------------------------------------------------------------------------------------------------------------------------------------------------------------------------------------|
| <b>Compatibility</b>                                                          | ITU-T Super Group 3                                                                                                                                                                                                                                                                    |
| <b>Duplex Fax (Receive)</b>                                                   | Yes                                                                                                                                                                                                                                                                                    |
| <b>Coding System</b>                                                          | MH/MR/MMR/JBIG                                                                                                                                                                                                                                                                         |
| <b>Modem Speed</b>                                                            | Automatic Fallback: 33,600 bps                                                                                                                                                                                                                                                         |
| <b>Single-Sided Document Size</b>                                             | ADF Width: 5.8 to 8.5 in. (148 to 215.9 mm)<br>ADF Length: 5.8 to 14 in. (148 to 355.6 mm)<br>Scanner Glass Width: Max. 8.5 in. (215.9 mm)<br>Scanner Glass Length: Max. 14 in. (355.6 mm)                                                                                             |
| <b>2-Sided (Duplex) Document Size</b> (MFC-8680DN, MFC-8690DW and MFC-8890DW) | ADF Width: 5.8 to 8.5 in. (148 to 215.9 mm)<br>ADF Length: 5.8 to 11.7 in. (148 to 297.0 mm)                                                                                                                                                                                           |
| <b>Scanning Width</b>                                                         | Max. 8.2 in. (208 mm)                                                                                                                                                                                                                                                                  |
| <b>Printing Width</b>                                                         | Max. 8.2 in. (208 mm)                                                                                                                                                                                                                                                                  |
| <b>Gray Scale</b>                                                             | 8 bit levels                                                                                                                                                                                                                                                                           |
| <b>Polling Types</b>                                                          | Standard, Sequential                                                                                                                                                                                                                                                                   |
| <b>Contrast Control</b>                                                       | Automatic/Light/Dark (manual setting)                                                                                                                                                                                                                                                  |
| <b>Resolution</b>                                                             | Horizontal: 203 dot/inch (8 dot/mm)<br>Vertical<br><ul style="list-style-type: none"> <li>■ Standard: 98 line/in. (3.85 line/mm)</li> <li>■ Fine: 196 line/in. (7.7 line/mm)</li> <li>■ Photo: 196 line/in. (7.7 line/mm)</li> <li>■ Superfine: 392 line/in. (15.4 line/mm)</li> </ul> |
| <b>One Touch Dial</b>                                                         | 40 (20 × 2)                                                                                                                                                                                                                                                                            |
| <b>Speed Dial</b>                                                             | 300 stations                                                                                                                                                                                                                                                                           |
| <b>Groups</b>                                                                 | Up to 20                                                                                                                                                                                                                                                                               |
| <b>Broadcasting</b>                                                           | 390 stations                                                                                                                                                                                                                                                                           |
| <b>Automatic Redial</b>                                                       | Yes, 1 time after 5 minutes                                                                                                                                                                                                                                                            |
| <b>Ring Delay</b>                                                             | 0, 1, 2, 3 or 4 rings                                                                                                                                                                                                                                                                  |
| <b>Communication Source</b>                                                   | Public switched telephone network                                                                                                                                                                                                                                                      |
| <b>Memory Transmission</b>                                                    | Up to 600 <sup>1</sup> /500 <sup>2</sup> pages                                                                                                                                                                                                                                         |
| <b>Out of Paper Reception</b>                                                 | Up to 600 <sup>1</sup> /500 <sup>2</sup> pages                                                                                                                                                                                                                                         |

<sup>1</sup> 'Pages' refers to the 'Brother No. 1 Chart' (a typical business letter, Standard resolution, JBIG code). Specifications and printed materials are subject to change without prior notice.

<sup>2</sup> 'Pages' refers to the 'ITU-T Test Chart #1' (a typical business letter, Standard resolution, JBIG code). Specifications and printed materials are subject to change without prior notice.

# Copy

|                                                                               |                                                                                                                                                                                            |
|-------------------------------------------------------------------------------|--------------------------------------------------------------------------------------------------------------------------------------------------------------------------------------------|
| <b>Copy Speed</b>                                                             | Up to 32 pages/minute (Letter size) <sup>1</sup>                                                                                                                                           |
| <b>Copy Speed for Duplex</b>                                                  | Up to 14 sides/minute (Letter size) <sup>1</sup>                                                                                                                                           |
| <b>Color/Monochrome</b>                                                       | Monochrome                                                                                                                                                                                 |
| <b>Single-sided Document Size</b>                                             | ADF Width: 5.8 to 8.5 in. (148 to 215.9 mm)<br>ADF Length: 5.8 to 14 in. (148 to 355.6 mm)<br>Scanner Glass Width: Max. 8.5 in. (215.9 mm)<br>Scanner Glass Length: Max. 14 in. (355.6 mm) |
| <b>2-Sided (Duplex) Document Size</b> (MFC-8680DN, MFC-8690DW and MFC-8890DW) | ADF Width: 5.8 to 8.5 in. (148 to 215.9 mm)<br>ADF Length: 5.8 to 11.7 in. (148 to 297.0 mm)                                                                                               |
| <b>Copy Width:</b>                                                            | Max. 8.26 in. (208 mm)                                                                                                                                                                     |
| <b>Multiple Copies</b>                                                        | Stacks or Sorts up to 99 pages                                                                                                                                                             |
| <b>Reduce/Enlarge</b>                                                         | 25% to 400% (in increments of 1%)                                                                                                                                                          |
| <b>Resolution</b>                                                             | Max. 1200 × 600 dpi (print) <sup>2</sup>                                                                                                                                                   |
| <b>First Copy Out Time</b>                                                    | Less than 10.5 seconds (from Ready state) <sup>3</sup>                                                                                                                                     |

<sup>1</sup> The copy speed may change depending on the type of document you copy.

<sup>2</sup> 1200 × 600 dpi when copying with Text quality, 100% ratio and from scanner glass.

<sup>3</sup> The first copy out time may vary depending on scanner lamp warm up time.

# Scan

|                                                                                        |                                                                                                                                                                                                |
|----------------------------------------------------------------------------------------|------------------------------------------------------------------------------------------------------------------------------------------------------------------------------------------------|
| <b>Color/Monochrome</b>                                                                | Yes/Yes                                                                                                                                                                                        |
| <b>Duplex Scanning</b><br>(MFC-8680DN,<br>MFC-8690DW and<br>MFC-8890DW)                | Yes                                                                                                                                                                                            |
| <b>TWAIN Compliant</b>                                                                 | Yes (Windows® 2000 Professional/XP/<br>XP Professional x64 Edition/Windows Vista®)<br>Mac OS X 10.3.9 or greater <sup>1</sup>                                                                  |
| <b>WIA Compliant</b>                                                                   | Yes (Windows® XP/Windows Vista®)                                                                                                                                                               |
| <b>Color Depth</b>                                                                     | 24 bit color                                                                                                                                                                                   |
| <b>Resolution</b>                                                                      | Up to 19200 × 19200 dpi (interpolated) <sup>2</sup><br>Up to 600 × 2400 dpi (optical) (From Scanner Glass)<br>Up to 600 × 1200 dpi (optical) (From ADF)                                        |
| <b>Single-Sided Document Size</b>                                                      | ADF Width: 5.8 to 8.5 in. (148.0 to 215.9 mm)<br>ADF Length: 5.8 to 14 in. (148.0 to 355.6 mm)<br>Scanner Glass Width: Max. 8.5 in. (215.9 mm)<br>Scanner Glass Length: Max. 14 in. (355.6 mm) |
| <b>2-Sided (Duplex) Document Size</b><br>(MFC-8680DN,<br>MFC-8690DW and<br>MFC-8890DW) | ADF Width: 5.8 to 8.5 in. (148.0 to 215.9 mm)<br>ADF Length: 5.8 to 11.7 in. (148.0 to 297.0 mm)                                                                                               |
| <b>Scanning Width</b>                                                                  | Max. 8.26 in. (212 mm)                                                                                                                                                                         |
| <b>Gray Scale</b>                                                                      | 8 bit levels                                                                                                                                                                                   |

<sup>1</sup> For the latest driver updates, visit us at <http://solutions.brother.com/>

<sup>2</sup> Maximum 1200 × 1200 dpi scanning with the WIA driver in Windows® XP/Windows Vista® (resolution up to 19200 × 19200 dpi can be chosen by using the Brother scanner utility)

# Print

|                                        |                                                                                                                                                                                                                                                                                                 |
|----------------------------------------|-------------------------------------------------------------------------------------------------------------------------------------------------------------------------------------------------------------------------------------------------------------------------------------------------|
| <b>Emulations</b>                      | PCL6, BR-Script3 (PostScript <sup>®</sup> 3), IBM Pro-Printer XL, Epson FX-850                                                                                                                                                                                                                  |
| <b>Printer Driver</b>                  | Host-Based Driver for Windows <sup>®</sup> 2000 Professional/<br>XP/XP Professional x64 Edition/Windows Vista <sup>®</sup> /<br>Windows Server <sup>®</sup> 2003 <sup>1</sup> /Windows Server <sup>®</sup> 2003 x64 Edition <sup>1</sup> /<br>Windows Server <sup>®</sup> 2008 <sup>1</sup>     |
|                                        | BR-Script3 (PPD file) for Windows <sup>®</sup> 2000 Professional/<br>XP/XP Professional x64 Edition/Windows Vista <sup>®</sup> /<br>Windows Server <sup>®</sup> 2003 <sup>1</sup> /Windows Server <sup>®</sup> 2003 x64 Edition <sup>1</sup> /<br>Windows Server <sup>®</sup> 2008 <sup>1</sup> |
|                                        | Macintosh Printer Driver for Mac OS X 10.3.9 or greater <sup>2</sup>                                                                                                                                                                                                                            |
|                                        | BR-Script3 (PPD file) for Mac OS X 10.3.9 or greater <sup>2</sup>                                                                                                                                                                                                                               |
| <b>Resolution</b>                      | 1200 dpi, HQ1200 (2400 × 600 dpi), 600 dpi, 300 dpi                                                                                                                                                                                                                                             |
| <b>Print Speed for Simplex</b>         | Up to 32 pages/minute (Letter size) <sup>3</sup>                                                                                                                                                                                                                                                |
| <b>Print Speed for Duplex Printing</b> | Up to 14 sides/minute (Letter size)                                                                                                                                                                                                                                                             |
| <b>First Print Out Time</b>            | Less than 8.5 seconds (from Ready state and standard tray)                                                                                                                                                                                                                                      |

<sup>1</sup> Print only via network.

<sup>2</sup> For the latest driver updates, visit us at <http://solutions.brother.com/>

<sup>3</sup> The print speed may change depending on the type of document you print.

# Interfaces

|                                                    |                                                                                                                                                                    |
|----------------------------------------------------|--------------------------------------------------------------------------------------------------------------------------------------------------------------------|
| <b>Parallel</b>                                    | A bi-directional shielded parallel cable that is IEEE 1284 compliant and no longer than 6 feet (2.0 m). <sup>1</sup>                                               |
| <b>USB</b>                                         | Use a USB 2.0 interface cable that (type A/B) is no longer than 6 feet (2.0 m). <sup>2 3 4</sup>                                                                   |
| <b>Ethernet</b>                                    | Use an Ethernet UTP cable category 5 or greater.                                                                                                                   |
| <b>Wireless LAN</b><br>(MFC-8690DW and MFC-8890DW) | Your machine supports IEEE 802.11b/g wireless communication with your wireless LAN using Infrastructure mode or a wireless Peer-to-Peer connection in Ad-hoc mode. |

E

- <sup>1</sup> Parallel cable is not supported for Window Vista®, Windows Server® 2003, Windows Server® 2003 x64 Edition and Windows Server® 2008.
- <sup>2</sup> Your machine has a Hi-Speed USB 2.0 interface. The machine can also be connected to a computer that has a USB 1.1 interface.
- <sup>3</sup> Third party USB ports are not supported for Macintosh.
- <sup>4</sup> MFC-8680DN and MFC-8690DW include the USB cable.

# Direct Print feature

## Compatibility

PDF version 1.7 <sup>1</sup>, JPEG, Exif + JPEG, PRN (created by Brother printer driver), TIFF (scanned by all Brother MFC or DCP models), PostScript<sup>®</sup>3<sup>™</sup> (created by Brother BR-Script 3 printer driver), XPS version 1.0.

<sup>1</sup> PDF data that includes a JBIG2 image file, a JPEG2000 image file or transparency files is not supported.



# Computer requirements

| Minimum System Requirements and Supported PC Software Functions |                                                               |                                                                                                                  |             |                 |                            |                  |                                          |                                                                             |
|-----------------------------------------------------------------|---------------------------------------------------------------|------------------------------------------------------------------------------------------------------------------|-------------|-----------------|----------------------------|------------------|------------------------------------------|-----------------------------------------------------------------------------|
| Computer Platform & Operating System Version                    |                                                               | Processor Minimum Speed                                                                                          | Minimum RAM | Recommended RAM | Hard Disk Space to install |                  | Supported PC Software Functions          | Supported PC Interface <sup>3</sup>                                         |
|                                                                 |                                                               |                                                                                                                  |             |                 | For Drivers                | For Applications |                                          |                                                                             |
| Windows <sup>®</sup> Operating System <sup>1</sup>              | Windows <sup>®</sup> 2000 Professional <sup>5</sup>           | Intel <sup>®</sup> Pentium <sup>®</sup> II or equivalent                                                         | 64 MB       | 256 MB          | 150 MB                     | 310 MB           | Printing, PC Fax <sup>4</sup> , Scanning | USB, 10/100 Base Tx (Ethernet), Wireless 802.11 b/g <sup>6</sup> , Parallel |
|                                                                 | Windows <sup>®</sup> XP Home <sup>®</sup> <sup>2 5</sup>      |                                                                                                                  | 128 MB      |                 |                            |                  |                                          |                                                                             |
|                                                                 | Windows <sup>®</sup> XP Professional <sup>2 5</sup>           |                                                                                                                  |             |                 |                            |                  |                                          |                                                                             |
|                                                                 | Windows <sup>®</sup> XP Professional x64 Edition <sup>2</sup> | 64-bit (Intel <sup>®</sup> 64 or AMD64) supported CPU                                                            | 256 MB      | 512 MB          |                            |                  |                                          |                                                                             |
|                                                                 | Windows Vista <sup>®</sup> <sup>2</sup>                       | Intel <sup>®</sup> Pentium <sup>®</sup> 4 or equivalent<br>64-bit (Intel <sup>®</sup> 64 or AMD64) supported CPU | 512 MB      | 1 GB            | 500 MB                     | 500 MB           |                                          | USB, 10/100 Base Tx (Ethernet), Wireless 802.11 b/g <sup>6</sup>            |

E

|                                              |                                                                             |                                                                                      |        |        |       |        |                                                        |                                                                                               |
|----------------------------------------------|-----------------------------------------------------------------------------|--------------------------------------------------------------------------------------|--------|--------|-------|--------|--------------------------------------------------------|-----------------------------------------------------------------------------------------------|
| Windows®<br>Operating<br>System <sup>1</sup> | Windows<br>Server®<br>2003<br>(print only<br>via<br>network)                | Intel® Pentium® III<br>or equivalent                                                 | 256 MB | 512 MB | 50 MB | N/A    | Printing                                               | 10/100<br>Base Tx<br>(Ethernet),<br>Wireless<br>802.11 b/g <sup>6</sup>                       |
|                                              | Windows<br>Server®<br>2003 x64<br>Edition<br>(print only<br>via<br>network) | 64-bit (Intel®64<br>or AMD64)<br>supported CPU                                       |        |        |       |        |                                                        |                                                                                               |
|                                              | Windows<br>Server®<br>2008<br>(print only<br>via<br>network)                | Intel® Pentium® 4<br>or equivalent<br>64-bit (Intel®64<br>or AMD64)<br>supported CPU | 512 MB | 2 GB   | 50 MB | N/A    |                                                        |                                                                                               |
| Macintosh<br>Operating<br>System             | Mac OS<br>X 10.3.9 -<br>10.4.3                                              | PowerPC®<br>G4/G5,<br>PowerPC® G3<br>350MHz                                          | 128 MB | 256 MB | 80 MB | 400 MB | Printing,<br>PC Fax<br>send <sup>4</sup> ,<br>Scanning | USB <sup>3</sup> ,<br>10/100<br>Base Tx<br>(Ethernet),<br>Wireless<br>802.11 b/g <sup>6</sup> |
|                                              | Mac OS<br>X 10.4.4<br>or greater                                            | PowerPC®<br>G4/G5, Intel®<br>Core™<br>Processor                                      | 512 MB | 1 GB   |       |        |                                                        |                                                                                               |

<sup>1</sup> Internet Explorer® 5.5 or greater.

<sup>2</sup> For WIA, 1200x1200 resolution. Brother scanner Utility enables to enhance up to 19200 x 19200 dpi.

<sup>3</sup> Third party USB/Parallel ports are not supported.

<sup>4</sup> PC Fax supports black and white only.

<sup>5</sup> PaperPort™ 11SE supports Microsoft® SP4 or higher for Windows® 2000 and SP2 or higher for XP.

<sup>6</sup> Wireless feature is available for MFC-8690DW and MFC-8890DW.

For the latest driver updates, visit us at <http://solutions.brother.com/>.

All trademarks, brand and product names are property of their respective companies.

## Consumable items

### Toner Cartridge Life

Standard Toner Cartridge:

**TN-620:**

Approx. 3,000 pages  
(Letter)<sup>1</sup>

High-Yield Toner Cartridge:

**TN-650:**

Approx. 8,000 pages  
(Letter)<sup>1 2</sup>

### Drum Unit

**DR-620:**

Approx. 25,000 pages  
(Letter)<sup>3</sup>

<sup>1</sup> Approx. cartridge yield is declared in accordance with ISO/IEC 19752.

<sup>2</sup> MFC-8680DN and MFC-8690DW include a High-Yield Toner Cartridge.

<sup>3</sup> Drum yield is approximate, and may vary by type of use.

# Ethernet wired network

|                                 |                                                                                                                                                                                                                                                                                                                                                                                                                                                                                                                                                                                                                                                                                                                                                                                                                                                                                        |
|---------------------------------|----------------------------------------------------------------------------------------------------------------------------------------------------------------------------------------------------------------------------------------------------------------------------------------------------------------------------------------------------------------------------------------------------------------------------------------------------------------------------------------------------------------------------------------------------------------------------------------------------------------------------------------------------------------------------------------------------------------------------------------------------------------------------------------------------------------------------------------------------------------------------------------|
| <b>Network board model name</b> | NC-6800h type2                                                                                                                                                                                                                                                                                                                                                                                                                                                                                                                                                                                                                                                                                                                                                                                                                                                                         |
| <b>LAN</b>                      | You can connect your machine to a network for Network Printing, Network Scanning, PC Fax and Remote Setup. <sup>1 2</sup>                                                                                                                                                                                                                                                                                                                                                                                                                                                                                                                                                                                                                                                                                                                                                              |
| <b>Support for</b>              | Windows <sup>®</sup> 2000 Professional, Windows <sup>®</sup> XP, Windows <sup>®</sup> XP Professional x64 Edition, Windows Vista <sup>®</sup> , Windows Server <sup>®</sup> 2003 <sup>2</sup> , Windows Server <sup>®</sup> 2003 x64 Edition <sup>2</sup> , Windows Server <sup>®</sup> 2008 <sup>2</sup><br>Mac OS X 10.3.9 or greater <sup>3 4</sup>                                                                                                                                                                                                                                                                                                                                                                                                                                                                                                                                 |
| <b>Protocols</b>                | IPv4: ARP, RARP, BOOTP, DHCP, APIPA (Auto IP), WINS/NetBIOS name resolution, DNS Resolver, mDNS, LLMNR responder, LPR/LPD, Custom Raw Port/Port9100, IPP/IPPS, FTP Client and Server, TELNET Server, HTTP/HTTPS Server, SSL/TLS, TFTP Client and Server, SMTP Client, APOP, POP before SMTP, SMTP AUTH, SNMPv1/v2c/v3, ICMP, LLTD responder, Web Services Print, CIFS Client, SNTP, LDAP (MFC-8690DW and MFC-8890DW), POP3/SMTP (MFC-8690DW and MFC-8890DW)<br>IPv6: (Turned off as default) NDP, RA, DNS resolver, mDNS, LLMNR responder, LPR/LPD, Custom Raw Port/Port9100, IPP/IPPS, FTP Client and Server, TELNET Server, HTTP/HTTPS server, SSL/TLS, TFTP Client and Server, SMTP Client, APOP, POP before SMTP, SMTP AUTH, SNMPv1/v2c/v3, ICMPv6, LLTD responder, Web Services Print, CIFS Client, SNTP, LDAP (MFC-8690DW and MFC-8890DW), POP3/SMTP (MFC-8690DW and MFC-8890DW) |
| <b>Network type</b>             | Ethernet 10/100 BASE-TX Auto Negotiation (Wired LAN)                                                                                                                                                                                                                                                                                                                                                                                                                                                                                                                                                                                                                                                                                                                                                                                                                                   |

**Management utilities**<sup>5</sup>

BRAdmin Light for Windows<sup>®</sup> 2000 Professional, Windows<sup>®</sup> XP, Windows<sup>®</sup> XP Professional x64 Edition, Windows Vista<sup>®</sup>, Windows Server<sup>®</sup> 2003, Windows Server<sup>®</sup> 2003 x64 Edition, Windows Server<sup>®</sup> 2008 and Mac OS X 10.3.9 or greater<sup>4</sup>

BRAdmin Professional for Windows<sup>®</sup> 2000 Professional, Windows<sup>®</sup> XP, Windows<sup>®</sup> XP Professional x64 Edition, Windows Vista<sup>®</sup>, Windows Server<sup>®</sup> 2003, Windows Server<sup>®</sup> 2003 x64 Edition and Windows Server<sup>®</sup> 2008

Web BRAdmin for Windows<sup>®</sup> 2000 Professional, Windows<sup>®</sup> XP, Windows<sup>®</sup> XP Professional x64 Edition, Windows Vista<sup>®</sup>, Windows Server<sup>®</sup> 2003, Windows Server<sup>®</sup> 2003 x64 Edition and Windows Server<sup>®</sup> 2008

Client computers with a web browser supporting Java.

<sup>1</sup> PC Fax Send for Mac

<sup>2</sup> Print only via network

<sup>3</sup> Mac OS X 10.3.9 or greater (mDNS)

<sup>4</sup> For the latest driver updates, visit us at <http://solutions.brother.com/>

<sup>5</sup> BRAdmin Professional and Web BRAdmin are available as a download from <http://solutions.brother.com/>

# Ethernet wireless network (MFC-8690DW and MFC-8890DW)

|                                 |                                                                                                                                                                                                                                                                                                                                                                                                                                                                                                                                                                                                                                                                                                                                                                           |
|---------------------------------|---------------------------------------------------------------------------------------------------------------------------------------------------------------------------------------------------------------------------------------------------------------------------------------------------------------------------------------------------------------------------------------------------------------------------------------------------------------------------------------------------------------------------------------------------------------------------------------------------------------------------------------------------------------------------------------------------------------------------------------------------------------------------|
| <b>Network board model name</b> | NC-7600w type2                                                                                                                                                                                                                                                                                                                                                                                                                                                                                                                                                                                                                                                                                                                                                            |
| <b>LAN</b>                      | You can connect your machine to a network for Network Printing, Network Scanning, PC Fax and Remote Setup <sup>1 2</sup> .                                                                                                                                                                                                                                                                                                                                                                                                                                                                                                                                                                                                                                                |
| <b>Support for</b>              | Windows <sup>®</sup> 2000 Professional, Windows <sup>®</sup> XP, Windows <sup>®</sup> XP Professional x64 Edition, Windows Vista <sup>®</sup> , Windows Server <sup>®</sup> 2003 <sup>2</sup> , Windows Server <sup>®</sup> 2003 x64 Edition <sup>2</sup> , Windows Server <sup>®</sup> 2008 <sup>2</sup><br><br>Mac OS X 10.3.9 or greater <sup>3 4</sup>                                                                                                                                                                                                                                                                                                                                                                                                                |
| <b>Protocols</b>                | IPv4: ARP, RARP, BOOTP, DHCP, APIPA (Auto IP), WINS/NetBIOS name resolution, DNS Resolver, mDNS, LLMNR responder, LPR/LPD, Custom Raw Port/Port9100, IPP/IPPS, FTP Client and Server, TELNET Server, HTTP/HTTPS Server, SSL/TLS, TFTP Client and Server, SMTP Client, APOP, POP before SMTP, SMTP AUTH, SNMPv1/v2c/v3, ICMP, LLTD responder, Web Services Print, CIFS Client, SNTP, LDAP, POP3/SMTP<br><br>IPv6 (Turned off as default) NDP, RA, DNS resolver, mDNS, LLMNR responder, LPR/LPD, Custom Raw Port/Port9100, IPP/IPPS, FTP Client and Server, TELNET Server, HTTP/HTTPS server, SSL/TLS, TFTP Client and Server, SMTP Client, APOP, POP before SMTP, SMTP AUTH, SNMPv1/v2c/v3, ICMPv6, LLTD responder, Web Services Print, CIFS Client, SNTP, LDAP, POP3/SMTP |
| <b>Network type</b>             | IEEE 802.11 b/g (Wireless LAN)                                                                                                                                                                                                                                                                                                                                                                                                                                                                                                                                                                                                                                                                                                                                            |

**Management utilities**<sup>5</sup>

BRAdmin Light for Windows<sup>®</sup> 2000 Professional, Windows<sup>®</sup> XP, Windows<sup>®</sup> XP Professional x64 Edition, Windows Vista<sup>®</sup>, Windows Server<sup>®</sup> 2003, Windows Server<sup>®</sup> 2003 x64 Edition, Windows Server<sup>®</sup> 2008 and Mac OS X 10.3.9 or greater<sup>4</sup>

BRAdmin Professional for Windows<sup>®</sup> 2000 Professional, Windows<sup>®</sup> XP, Windows<sup>®</sup> XP Professional x64 Edition, Windows Vista<sup>®</sup>, Windows Server<sup>®</sup> 2003, Windows Server<sup>®</sup> 2003 x64 Edition and Windows Server<sup>®</sup> 2008

Web BRAdmin for Windows<sup>®</sup> 2000 Professional, Windows<sup>®</sup> XP, Windows<sup>®</sup> XP Professional x64 Edition, Windows Vista<sup>®</sup>, Windows Server<sup>®</sup> 2003,

Windows Server<sup>®</sup> 2003 x64 Edition and Windows Server<sup>®</sup> 2008  
Client computers with a web browser supporting Java.

<sup>1</sup> PC Fax Send for Mac

<sup>2</sup> Print only via network

<sup>3</sup> Mac OS X 10.3.9 or greater (mDNS)

<sup>4</sup> For the latest driver updates, visit us at <http://solutions.brother.com/>

<sup>5</sup> BRAdmin Professional and Web BRAdmin are available as a download from <http://solutions.brother.com/>.

# Authentication and encryption for wireless users only

---

## Authentication method

The Brother machine supports the following methods:

- Open system

Wireless devices are allowed to access the network without any authentication.

- Shared key

A secret pre-determined key is shared by all devices that will access the wireless network. The Brother machine uses the WEP keys as the pre-determined key.

- WPA-PSK/WPA2-PSK

Enables a Wi-Fi Protected Access Pre-Shared Key (WPA-PSK/WPA2-PSK), which enables the Brother wireless machine to associate with access points using TKIP for WPA-PSK or AES for WPA-PSK and WPA2-PSK (WPA-Personal).

- LEAP

Cisco LEAP (Light Extensible Authentication Protocol) has been developed by Cisco Systems, Inc. and enables the Brother wireless product to associate with access points using CKIP encryptions.

- EAP-FAST

EAP-FAST (Extensible Authentication Protocol - Flexible Authentication via Secured Tunnel) has been developed by Cisco Systems, Inc. which uses user ID and password for authentication, and symmetric key algorithms to achieve a tunneled authentication process.

The Brother machine supports the following inner authentications:

- EAP-FAST/NONE

MS-CHAPv2 is used for Provisioning, and the method of EAP-FAST corresponding to second phase authentication method.

- EAP-FAST/MS-CHAPv2

Method of EAP-FAST corresponding to CCXv4 that uses MS-CHAPv2 for the inner method.

- EAP-FAST/GTC

Method of EAP-FAST corresponding to CCXv4 that uses GTC for the inner method.

## Encryption methods

Encryption is used to secure the data that is sent over the wireless network. The Brother machine supports the following encryption methods:

- WEP

By using WEP (Wired Equivalent Privacy), the data is transmitted and received with a secure key.



**■ TKIP**

TKIP (Temporal Key Integrity Protocol) provides per-packet key mixing a message integrity check and re-keying mechanism.

**■ AES**

AES (Advanced Encryption Standard) is Wi-Fi authorized strong encryption standard.

**■ CKIP**

The original Key Integrity Protocol for LEAP by Cisco Systems, Inc.

**Network key**

There are some rules for each security method:

**■ Open system/Shared key with WEP**

This key is a 64-bit or 128-bit value that must be entered in an ASCII or hexadecimal format.

- 64 (40) bit ASCII:

Uses 5 text characters. e.g. "WLAN" (this is case sensitive).

- 64 (40) bit hexadecimal:

Uses 10 digits of hexadecimal data. e.g. "71f2234aba"

- 128 (104) bit ASCII:

Uses 13 text characters. e.g. "Wirelesscomms" (this is case sensitive)

- 128 (104) bit hexadecimal:

Uses 26 digits of hexadecimal data. e.g. "71f2234ab56cd709e5412aa2ba"

**■ WPA-PSK/WPA2-PSK and TKIP or AES**

Uses a Pre-Shared Key (PSK) that is 8 or more characters in length, up to a maximum of 63 characters.

**■ LEAP**

Uses User ID and Password.

- User ID: less than 64 characters in length.
- Password: less than 32 characters in length.

**■ EAP-FAST**

Uses User ID and Password.

- User ID: less than 64 characters in length.
- Password: less than 32 characters in length.

## Wireless one-push configuration

---

If your wireless access point supports either SecureEasySetup™, Wi-Fi Protected Setup (PBC<sup>1</sup>) or AOSS™, you can configure the machine easily without knowing your wireless network settings. By pushing a button on the wireless LAN router / access point and using the menu on the machine, you can set up the wireless network and security settings. See the User's Guide for your wireless LAN router / access point for instructions on how to access one-push mode.

<sup>1</sup> Push Button Configuration



### Note

---

Router access points that support SecureEasySetup, Wi-Fi Protected Setup or AOSS™ have the symbols shown below.



For MFC-8890DW only



This is a comprehensive list of features and terms that appear in Brother manuals. Availability of these features depends on the model you purchased.

**ADF (automatic document feeder)**

The document can be placed in the ADF and scanned one page at a time automatically.

**Auto Reduction**

Reduces the size of incoming faxes.

**Automatic fax transmission**

Sending a fax without picking up the handset of the external telephone or pressing **Hook**.

**Automatic Redial**

A feature that enables your machine to redial the last fax number after five minutes if the fax did not go through because the line was busy.

**Backup Print**

Your machine prints a copy of every fax that is received and stored in memory. This is a safety feature so you will not lose messages during a power failure.

**Batch Transmission**

As a cost saving feature, all delayed faxes to the same fax number will be sent as one transmission.

**Beeper Volume**

Volume setting for the beep when you press a key or make an error.

**Broadcasting**

The ability to send the same fax message to more than one location.

**Cancel Job**

Cancels a programmed print job and clears the machine's memory.

**CNG tones**

The special tones (beeps) sent by fax machines during automatic transmission to tell the receiving machine that a fax machine is calling.

**Coding method**

Method of coding the information contained in the document. All fax machines must use a minimum standard of Modified Huffman (MH). Your machine is capable of greater compression methods, Modified Read (MR), Modified Modified Read (MMR) and JBIG, if the receiving machine has the same capability.

**Communication error (or Comm. Error)**

An error during fax sending or receiving, usually caused by line noise or static.

**Compatibility group**

The ability of one fax unit to communicate with another. Compatibility is assured between ITU-T Groups.

**Contrast**

Setting to compensate for dark or light documents, by making faxes or copies of dark documents lighter and light documents darker.

**Delayed Fax**

Sends your fax at a specified later time that day.

**Distinctive Ring**

A subscriber service purchased from the telephone company that gives you another telephone number on an existing telephone line. The Brother machine uses the new number to simulate a dedicated fax line.

**Dual Access**

Your machine can scan outgoing faxes or scheduled jobs into memory at the same time it is sending a fax or receiving or printing an incoming fax.

### **Easy Receive**

Enables your machine to respond to CNG tones if you interrupt a fax call by answering it.

### **ECM (Error Correction Mode)**

Detects errors during fax transmission and resends the pages of the fax that had an error.

### **Extension telephone**

A telephone on the fax number that is plugged into a separate telephone wall jack.

### **External telephone**

A telephone that is plugged into the EXT jack of your machine.

### **F/T Ring Time**

The length of time that the Brother machine pseudo/double-rings (when the Receive Mode setting is Fax/Tel) to notify you to pick up a voice call that it answered.

### **Fax Forwarding**

Sends a fax received into the memory to another pre-programmed fax number.

### **Fax Journal**

Lists information about the last 200 incoming and outgoing faxes. TX means Transmit. RX means Receive.

### **Fax Receive Code**

Press this code (\* 5 1) when you answer a fax call on an extension or external telephone.

### **Fax Storage**

You can store faxes in the memory.

### **Fax tones**

The signals sent by sending and receiving fax machines while communicating information.

### **Fax/Tel**

You can receive faxes and telephone calls. Do not use this mode if you are using a telephone answering device (TAD).

### **Fine resolution**

Resolution is 203 × 196 dpi. It is used for small print and graphs.

### **Gray Scale**

The shades of gray available for copying and faxing photographs.

### **Group number**

A combination of One Touch and Speed Dial numbers that are stored on a One Touch key or in a Speed Dial location for Broadcasting.

### **Help List**

A printout of the complete Menu table that you can use to program your machine when you do not have the User's Guide with you.

### **Journal Period**

The pre-programmed time period between automatically printed Fax Journal Reports. You can print the Fax Journal on demand without interrupting the cycle.

### **LCD (liquid crystal display)**

The display screen on the machine that shows interactive messages during On-Screen Programming and shows the date and time when the machine is idle.

### **Manual fax**

When you lift the handset of your external telephone or press **Hook** so you can hear the receiving fax machine answer before you press **Start** to begin transmission.

### **Menu mode**

Programming mode for changing your machine's settings.

### **OCR (optical character recognition)**

The bundled ScanSoft™ PaperPort™ 11SE with OCR or Presto! PageManager software application converts an image of text to text you can edit.

**One Touch**

Keys on the machine's control panel where you can store numbers for easy dialing. You can store a second number on each key if you press **Shift** and the One Touch key together.

**Out of Paper Reception**

Receives faxes into the machine's memory when the machine is out of paper.

**Overseas Mode**

Makes temporary changes to the fax tones to accommodate noise and static on overseas telephone lines.

**Paging**

This feature enables your machine to call your pager when a fax is received into its memory.

**Pause**

Allows you to place a 3.5 second delay in the dialing sequence while you are dialing using the dial pad or while you are storing One Touch and Speed Dial numbers. Press **Redial/Pause** as many times as needed for longer pauses.

**Polling**

The process of a fax machine calling another fax machine to retrieve waiting fax messages.

**Pulse (Canada only)**

A form of rotary dialing on a telephone line.

**Real Time Transmission**

When memory is full, you can send faxes in real time.

**Remaining Jobs**

You can check which programmed fax jobs are waiting in the memory and cancel the jobs individually.

**Remote Access Code**

Your own four-digit code (— — —\*) that allows you to call and access your machine from a remote location.

**Remote Retrieval Access**

The ability to access your machine remotely from a touch tone telephone.

**Resolution**

The number of vertical and horizontal lines per inch.

**Ring Delay**

The number of rings before the machine answers in Fax Only and Fax/Tel modes.

**Ring Volume**

Volume setting for the machine's ring.

**Scanning**

The process of sending an electronic image of a paper document into your computer.

**Search**

An electronic, alphabetical listing of stored One Touch, Speed Dial and Group numbers.

**Speed Dial**

A pre-programmed number for easy dialing. You must press **Search/Speed Dial**, then enter the three-digit Speed Dial location and press **Start** to begin the dialing process.

**Station ID**

The stored information that appears on the top of faxed pages. It includes the sender's name and fax number.

**TAD (telephone answering device)**

You can connect an external device or answering machine to the EXT. jack of your machine.

**Telephone Answer Code (Fax/Tel mode only)**

When the machine answers a voice call, it pseudo/double-rings. You can pick up at an extension telephone by pressing this code (**#51**).

**Tel Index List**

A listing of names and numbers stored in One Touch and Speed Dial memory, in numerical order.

### **Temporary settings**

You can choose certain options for each fax transmission and copy without changing the default settings.

### **Tone**

A form of dialing on the telephone line used for Touch Tone telephones.

### **Transmission**

The process of sending faxes over the telephone lines from your machine to the receiving fax machine.

### **Transmission Verification Report**

A report for each transmission, that shows its date, time and number.

### **User Settings List**

A printed report that shows the current settings of the machine.

## A

|                                          |    |
|------------------------------------------|----|
| Accessories and supplies .....           | ii |
| ADF (automatic document feeder)          |    |
| faxing .....                             | 38 |
| using .....                              | 20 |
| Answering machine (TAD)                  |    |
| connecting .....                         | 58 |
| Apple Macintosh                          |    |
| See Software User's Guide on the CD-ROM. |    |
| Automatic                                |    |
| fax receive .....                        | 49 |
| easy receive .....                       | 51 |
| fax redial .....                         | 64 |

## B

|                                         |             |
|-----------------------------------------|-------------|
| Broadcasting .....                      | 41          |
| canceling .....                         | 41          |
| setting up groups for .....             | 69          |
| Brother                                 |             |
| accessories and supplies .....          | ii          |
| Brother numbers .....                   | i           |
| Customer Service .....                  | i           |
| FAQs (frequently asked questions) ..... | i           |
| product support .....                   | i           |
| service centers .....                   | i           |
| warranties .....                        | iii, iv, vi |

## C

|                                          |     |
|------------------------------------------|-----|
| Canceling                                |     |
| broadcast in process .....               | 41  |
| fax jobs in memory .....                 | 47  |
| jobs awaiting redial .....               | 47  |
| remote fax options .....                 | 74  |
| Cleaning                                 |     |
| corona wire .....                        | 157 |
| drum unit .....                          | 158 |
| laser scanner window .....               | 155 |
| scanner glass .....                      | 155 |
| Connecting                               |     |
| external TAD (answering machine) .....   | 57  |
| external telephone .....                 | 61  |
| two-line external TAD or telephone ..... | 59  |
| Consumable items .....                   | 160 |

|                                          |        |
|------------------------------------------|--------|
| Control panel overview .....             | 6      |
| ControlCenter2 (for Macintosh)           |        |
| See Software User's Guide on the CD-ROM. |        |
| ControlCenter3 (for Windows®)            |        |
| See Software User's Guide on the CD-ROM. |        |
| Copy                                     |        |
| contrast .....                           | 84, 87 |
| duplex .....                             | 89, 90 |
| Enlarge/Reduce key .....                 | 85     |
| enter copy mode .....                    | 84     |
| keys .....                               | 7, 85  |
| multiple .....                           | 84     |
| N in 1 (page layout) .....               | 88     |
| out of memory .....                      | 92     |
| quality .....                            | 86     |
| single .....                             | 84     |
| sort (ADF only) .....                    | 86     |
| temporary settings .....                 | 85     |
| tray selection .....                     | 92     |
| using ADF .....                          | 86, 88 |
| using scanner glass .....                | 88, 89 |
| Cordless telephone (non-Brother) .....   | 61     |
| Cover page .....                         | 42     |
| custom comments .....                    | 43     |
| for all faxes .....                      | 43     |
| for next fax only .....                  | 43     |
| printed form .....                       | 43     |
| Custom Ringing .....                     | 54     |

## D

|                                            |    |
|--------------------------------------------|----|
| Data Ident-A-Call .....                    | 54 |
| Delayed batch transmission .....           | 46 |
| Dialing                                    |    |
| a pause .....                              | 65 |
| access codes and credit card numbers ..... | 70 |
| automatic fax redial .....                 | 64 |
| dial prefix .....                          | 29 |
| groups (broadcasting) .....                | 41 |
| manual .....                               | 63 |
| one touch .....                            | 63 |
| restricting dialing .....                  | 36 |
| speed dial .....                           | 63 |
| using the Search key .....                 | 64 |

|                                   |            |
|-----------------------------------|------------|
| Direct print .....                | 94         |
| Direct key .....                  | 95         |
| specification .....               | 204        |
| Distinctive Ring                  |            |
| choosing ring pattern .....       | 56         |
| setting ring pattern .....        | 56         |
| turning off .....                 | 57         |
| Document                          |            |
| how to load .....                 | 20, 21     |
| jam .....                         | 145        |
| Drum unit                         |            |
| checking (remaining life) .....   | 167        |
| cleaning .....                    | 157, 158   |
| replacing .....                   | 164        |
| Dual access .....                 | 45         |
| Duplex (2-sided)                  |            |
| copying .....                     | 89, 90     |
| printing                          |            |
| from USB flash memory drive ..... | 96         |
| troubleshooting .....             | 146        |
| Duplex key (2-sided) .....        | 38, 89, 90 |

## E

|                                      |                |
|--------------------------------------|----------------|
| EAP-FAST .....                       | 212            |
| Enlarge/Reduce key .....             | 85             |
| Envelopes .....                      | 12, 14, 17, 18 |
| Equalization .....                   | 138            |
| Error messages on LCD .....          | 139            |
| Comm. Error .....                    | 139            |
| No Paper .....                       | 140            |
| Out of Memory .....                  | 141            |
| Print Unable XX .....                | 141            |
| Scan Unable XX .....                 | 142            |
| Extension telephone, using .....     | 61             |
| External telephone, connecting ..... | 61             |

## F

|                             |        |
|-----------------------------|--------|
| Fax codes                   |        |
| changing .....              | 62, 75 |
| fax receive code .....      | 61     |
| remote access code .....    | 75     |
| telephone answer code ..... | 61     |
| Fax forwarding              |        |
| changing remotely .....     | 76, 77 |
| programming a number .....  | 71     |

|                                         |                |
|-----------------------------------------|----------------|
| Fax storage .....                       | 72             |
| printing from memory .....              | 53             |
| turning off .....                       | 74             |
| turning on .....                        | 72             |
| Fax, stand-alone                        |                |
| receiving .....                         | 48             |
| at end of conversation .....            | 53             |
| easy receive .....                      | 51             |
| fax forwarding .....                    | 77             |
| fax receive stamp .....                 | 53             |
| from extension telephone .....          | 60, 61         |
| into memory (fax storage) .....         | 72             |
| paging .....                            | 72             |
| polling receive .....                   | 78             |
| reducing to fit on paper .....          | 52             |
| retrieving from a remote site .....     | 76, 77         |
| ring delay, setting .....               | 50             |
| sequential polling .....                | 78             |
| telephone line interference .....       | 138            |
| sending .....                           | 38             |
| at end of conversation .....            | 47             |
| broadcasting .....                      | 41             |
| canceling from memory .....             | 47             |
| contrast .....                          | 44             |
| delayed batch .....                     | 46             |
| delayed fax .....                       | 46             |
| from ADF .....                          | 38             |
| from memory (dual access) .....         | 45             |
| from scanner glass .....                | 39             |
| manual .....                            | 47             |
| overseas .....                          | 46             |
| polled transmit .....                   | 79             |
| real time transmission .....            | 45             |
| resolution .....                        | 44             |
| telephone line interference .....       | 138            |
| Fax/Tel mode                            |                |
| answering at extension telephones ..... | 61             |
| easy receive .....                      | 51             |
| F/T ring time (double-ring) .....       | 50             |
| fax receive code .....                  | 61             |
| receiving faxes .....                   | 61             |
| ring delay .....                        | 50             |
| telephone answer code .....             | 61             |
| Folio .....                             | 15, 23, 40, 52 |

## G

|                               |          |
|-------------------------------|----------|
| Gray scale .....              | 199, 201 |
| Groups for broadcasting ..... | 69       |



## H

|                       |          |
|-----------------------|----------|
| HELP .....            | 81       |
| Help List .....       | 81       |
| LCD messages .....    | 170      |
| Menu Table .....      | 170, 172 |
| using menu keys ..... | 170      |
| Hook key .....        | 8, 61    |

## I

|                    |    |
|--------------------|----|
| Ident-A-Call ..... | 54 |
| Ident-A-Ring ..... | 54 |

## J

|                               |     |
|-------------------------------|-----|
| Jacks                         |     |
| convert to RJ11 jack          |     |
| triplex adapter .....         | 59  |
| EXT                           |     |
| external telephone .....      | 61  |
| TAD (answering machine) ..... | 57  |
| Jams                          |     |
| document .....                | 145 |
| paper .....                   | 147 |

## L

|                                    |                |
|------------------------------------|----------------|
| Labels .....                       | 12, 14, 15, 19 |
| LCD (liquid crystal display) ..... | 6, 170         |
| contrast .....                     | 28             |
| Help List .....                    | 81             |

## M

|                                          |     |
|------------------------------------------|-----|
| Machine information                      |     |
| checking remaining life of drum unit and |     |
| periodic maintenance parts .....         | 167 |
| page counts .....                        | 166 |
| status LED .....                         | 9   |
| Macintosh                                |     |
| See Software User's Guide on the         |     |
| CD-ROM.                                  |     |
| Maintenance, routine .....               | 154 |
| checking the remaining life of drum      |     |
| unit and periodic maintenance parts ...  | 167 |
| replacing                                |     |
| drum unit .....                          | 164 |
| toner cartridge .....                    | 161 |

|                                    |          |
|------------------------------------|----------|
| Manual                             |          |
| dialing .....                      | 63       |
| receive .....                      | 48, 49   |
| transmission .....                 | 47       |
| Memory                             |          |
| adding SO-DIMM (option) .....      | 120      |
| installing .....                   | 121      |
| storage .....                      | 170      |
| Menu Table .....                   | 170, 172 |
| using menu keys .....              | 170      |
| Mode, entering                     |          |
| copy .....                         | 84       |
| fax .....                          | 38       |
| scan .....                         | 7        |
| Multi-line connections (PBX) ..... | 60       |

## N

|                                  |    |
|----------------------------------|----|
| N in 1 (page layout) .....       | 88 |
| Network                          |    |
| faxing                           |    |
| See Software User's Guide on the |    |
| CD-ROM.                          |    |
| printing                         |    |
| See Network User's Guide on the  |    |
| CD-ROM.                          |    |
| scanning                         |    |
| See Software User's Guide on the |    |
| CD-ROM.                          |    |

## O

|                            |                 |
|----------------------------|-----------------|
| One touch                  |                 |
| changing .....             | 68              |
| setting up .....           | 65              |
| using .....                | 63              |
| Out of Memory message .... | 47, 92, 97, 141 |

## P

|                                        |        |
|----------------------------------------|--------|
| Packing and shipping the machine ..... | 168    |
| Page layout (N in 1) .....             | 88     |
| Paging .....                           | 72     |
| programming your pager number ...      | 71, 72 |

|                                           |          |
|-------------------------------------------|----------|
| Paper .....                               | 14, 197  |
| how to load .....                         | 10       |
| jam .....                                 | 147      |
| recommended .....                         | 14, 16   |
| size .....                                | 15, 23   |
| size of document .....                    | 200, 201 |
| tray capacity .....                       | 15       |
| type .....                                | 15, 22   |
| PaperPort™ 11SE with OCR                  |          |
| See Software User's Guide on the          |          |
| CD-ROM and Help in the PaperPort™         |          |
| 11SE application to access How-to-Guides. |          |
| PC Fax                                    |          |
| See Software User's Guide on the          |          |
| CD-ROM.                                   |          |
| Personalized Ring .....                   | 54       |
| Polling                                   |          |
| polled transmit .....                     | 79       |
| polling receive .....                     | 78       |
| sequential polling .....                  | 78       |
| Power failure .....                       | 170      |
| Print                                     |          |
| difficulties .....                        | 122, 126 |
| drivers .....                             | 202      |
| fax from memory .....                     | 53       |
| paper jams .....                          | 147      |
| quality .....                             | 128, 131 |
| reports .....                             | 81       |
| resolution .....                          | 202      |
| Secure Keys .....                         | 8        |
| specifications .....                      | 202      |
| Printing                                  |          |
| See Software User's Guide on the          |          |
| CD-ROM.                                   |          |
| Programming your machine .....            | 170      |

## Q

|                                          |          |
|------------------------------------------|----------|
| Quality                                  |          |
| copying .....                            | 86       |
| printing .....                           | 128, 131 |
| Quick dial .....                         | 65       |
| access codes and credit card             |          |
| numbers .....                            | 70       |
| broadcasting .....                       | 41       |
| using groups .....                       | 41       |
| group dial                               |          |
| changing .....                           | 68       |
| setting up groups for broadcasting ..... | 69       |

|                           |    |
|---------------------------|----|
| one touch dial            |    |
| changing .....            | 68 |
| custom scan profile ..... | 65 |
| setting up .....          | 65 |
| using .....               | 63 |
| search .....              | 64 |
| speed dial                |    |
| changing .....            | 68 |
| custom scan profile ..... | 67 |
| setting up .....          | 67 |
| using .....               | 63 |

## R

|                                  |            |
|----------------------------------|------------|
| Redial/Pause key .....           | 64, 65, 70 |
| Reducing                         |            |
| copies .....                     | 85         |
| incoming faxes .....             | 52         |
| Remote retrieval .....           | 75         |
| access code .....                | 75         |
| commands .....                   | 77         |
| getting your faxes .....         | 76         |
| Remote setup                     |            |
| See Software User's Guide on the |            |
| CD-ROM.                          |            |
| Replacing                        |            |
| drum unit .....                  | 164        |
| toner cartridge .....            | 161        |
| Reports .....                    | 80, 81     |
| Fax Journal .....                | 81         |
| journal period .....             | 81         |
| Help List .....                  | 81         |
| how to print .....               | 81         |
| Network Configuration .....      | 81         |
| Tel Index List .....             | 81         |
| Transmission Verification .....  | 80         |
| User Settings .....              | 81         |
| Resolution                       |            |
| copy .....                       | 200        |
| fax (standard, fine, superfine,  |            |
| photo) .....                     | 44, 199    |
| print .....                      | 202        |
| scan .....                       | 201        |
| setting for next fax .....       | 44         |
| Resolution key .....             | 8, 44      |
| Restricted users .....           | 32         |
| Ring delay, setting .....        | 50         |
| RingMaster .....                 | 54         |

## S

|                                          |                        |
|------------------------------------------|------------------------|
| Safety instructions                      | 110                    |
| Scanner glass                            |                        |
| faxing                                   | 39                     |
| using                                    | 21                     |
| Scanning                                 |                        |
| See Software User's Guide on the CD-ROM. |                        |
| Search/Speed Dial key                    | 63, 64, 69             |
| Secure key                               | 8                      |
| Security                                 |                        |
| restricting dialing                      | 36                     |
| Secure function lock                     |                        |
| administrator password                   | 30                     |
| Public user                              | 31                     |
| restricted users                         | 32                     |
| Setting lock                             | 34                     |
| Serial number                            |                        |
| how to find                              | See inside front cover |
| Service centers                          | i                      |
| Shipping the machine                     | 168                    |
| SimpleBiz Fax & Alternate Number         |                        |
| Ringing                                  | 54                     |
| Sleep time                               | 27                     |
| Smart Ring                               | 54                     |
| Sort                                     | 86                     |
| Speed dial                               |                        |
| changing                                 | 68                     |
| setting up                               | 67                     |
| using                                    | 63                     |
| Status LED                               | 9                      |

## T

|                                            |            |
|--------------------------------------------|------------|
| TAD (telephone answering device), external | 48, 49, 59 |
| connecting                                 | 57, 58     |
| recording OGM                              | 58         |
| with two-line jack                         | 59         |
| Teen Ring                                  | 54         |
| Telephone line                             |            |
| connections                                | 58         |
| difficulties                               | 123        |
| interference                               | 138        |
| multi-line (PBX)                           | 60         |
| roll over lines                            | 58         |
| two-line telephone system                  | 59         |
| Temporary copy settings                    | 85         |

|                              |            |
|------------------------------|------------|
| Text, entering               | 193        |
| Toner cartridge, replacing   | 161        |
| Toner save                   | 27         |
| Transparency                 | 10, 12, 14 |
| Tray selection               | 92         |
| Tray use, setting            |            |
| copy                         | 23         |
| fax                          | 24         |
| print                        | 25         |
| Troubleshooting              | 122        |
| document jam                 | 145        |
| error messages on LCD        | 139        |
| if you are having difficulty |            |
| copy quality                 | 126        |
| incoming calls               | 125        |
| network                      | 128        |
| paper handling               | 128        |
| print quality                | 128, 131   |
| printing                     | 122, 126   |
| scanning                     | 127        |
| software                     | 127        |
| telephone line               | 138        |
| maintenance messages on LCD  | 139        |
| paper jam                    | 147        |
| Two-line telephone system    | 59         |

## V

|                 |    |
|-----------------|----|
| Voice Mail      | 54 |
| Volume, setting |    |
| beeper          | 25 |
| ring            | 25 |
| speaker         | 26 |

## W

|                                                               |     |
|---------------------------------------------------------------|-----|
| Warranties                                                    |     |
| Canada                                                        | vi  |
| Notice-Disclaimer                                             | iii |
| USA                                                           | iv  |
| Windows®                                                      |     |
| See Software User's Guide on the CD-ROM.                      |     |
| Wireless Network                                              |     |
| See Quick Setup Guide and Network User's Guide on the CD-ROM. |     |
| World Wide Web                                                | i   |

## **EQUIPMENT ATTACHMENT LIMITATIONS (Canada only)**

### **NOTICE**

This product meets the applicable Industry Canada technical specifications.

### **NOTICE**

The Ringer Equivalence Number is an indication of the maximum number of devices allowed to be connected to a telephone interface. The termination on an interface may consist of any combination of devices subject only to the requirement that the sum of the RENs of all the devices does not exceed five.

## **RESTRICTIONS DE RACCORDEMENT D'ÉQUIPEMENT (Canada seulement)**

### **AVIS**

Ce produit est conforme aux caractéristiques techniques appropriées d'Industrie Canada.

### **AVIS**

L'indice d'équivalence de la sonnerie est une indication du nombre maximal d'appareils qu'il est permis de brancher sur une interface téléphonique. La terminaison d'une interface peut consister en n'importe quelle combinaison d'appareils à la condition que la somme des indices d'équivalence de la sonnerie de tous les appareils ne dépasse pas cinq.

Brother International Corporation  
100 Somerset Corporate Boulevard  
P.O. Box 6911  
Bridgewater, NJ 08807-0911 USA

Brother International Corporation (Canada) Ltd.  
1 rue Hôtel de Ville,  
Dollard-des-Ormeaux, QC, Canada H9B 3H6

**brother**®

**Visit us on the World Wide Web**  
**<http://www.brother.com/>**

These machines are made for use in the USA and Canada only. We cannot recommend using them overseas because it may violate the Telecommunications Regulations of that country and the power requirements of your machine may not be compatible with the power available in foreign countries. **Using USA or Canada models overseas is at your own risk and may void your warranty.**