

Before you can use the machine, you must set up the hardware and install the software. Please read this "Quick Setup Guide" for the correct setup procedure and installation instructions.

Step 1



Setting Up the machine

Step 2



Installing the Drivers & Software



Setup is Complete!

Keep this "Quick Setup Guide", User's Guide and supplied CD-ROM in a convenient place for quick and easy reference at all times.

Setting Up
the machine

Windows®
USB

Windows®
Parallel





Installing the Drivers & Software
Windows NT® 4.0
Parallel

Windows®
Network

Macintosh®
USB





Macintosh®
Network

Network
Administrators

 Warning	 Caution	 Improper Setup	 Note	 User's Guide
<p>Warnings tell you what to do to prevent possible personal injury.</p>	<p>Cautions specify procedures you must follow or avoid to prevent possible damage to the machine or other objects.</p>	<p>Improper Setup icons alert you to devices and operations that are not compatible with the machine.</p>	<p>Notes tell you how you should respond to a situation that may arise or give tips about how the current operation works with other features.</p>	<p>Indicates reference to the User's Guide.</p>

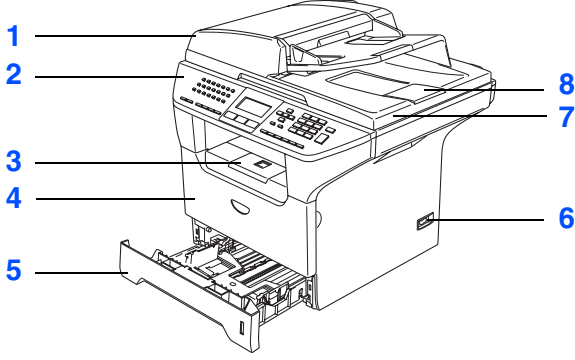
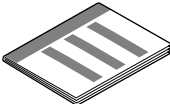
Getting Started

Carton Components

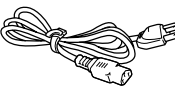
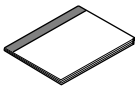
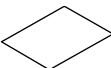
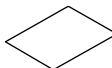
 <p>1. Automatic Document Feeder (ADF) 2. Control Panel 3. Face-down Output Tray Support Flap (Support Flap) 4. Front Cover 5. Paper Tray 6. Power Switch 7. Document Cover 8. ADF Document Output Support Flap</p>	 <p>Quick Setup Guide</p>	
 <p>Drum Unit Assembly (including Toner Cartridge)</p>	 <p>CD-ROMs One CD-ROM for Windows® and Macintosh® One CD-ROM for Windows Vista®</p>	
 <p>USB Cable</p>	 <p>AC Power Cord</p>	 <p>Telephone Line Cord</p>
	 <p>Product Registration and Test Sheet (USA only)</p>	 <p>Accessory Order Form</p>

Carton components may differ from one country to another.

Save all packing materials and the carton in case for any reason you must ship your machine.



The USB interface cable is a standard accessory. Please purchase the appropriate interface cable if you intend to use the Parallel or Network interface.

Do NOT connect the interface cable at this time. Connecting the interface cable is done during the software installation process.

■ **USB interface cable**

Please make sure you use a USB 2.0 interface cable that is no longer than 6 feet (2.0 meters).

When you use a USB cable, make sure you connect it to the USB port of your computer and not to a USB port on a keyboard or non-powered USB hub.

■ **Parallel interface cable**

Please make sure you use a Parallel interface cable that is no longer than 6 feet (2.0 meters).

Use a shielded interface cable that is IEEE 1284-compliant.

■ **Network cable**

Use a straight-through Category 5 (or greater) twisted-pair cable for 10BASE-T or 100Base-TX Fast Ethernet Network.

Control Panel

MFC-8670DN

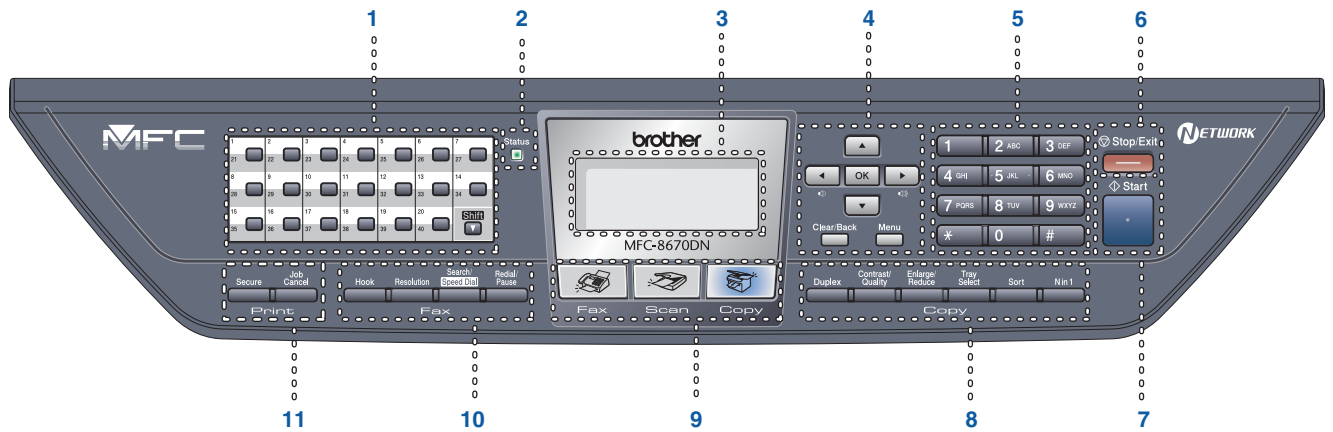

1	One Touch keys	2	Status LED	3	LCD (Liquid Crystal Display)
4	Menu keys	5	Dial Pad	6	Stop/Exit key
7	Start key	8	Copy keys	9	Mode keys
10	Fax and telephone keys	11	Print keys		



For the details of the control panel, see "Control panel overview" in Chapter 1 of the User's Guide.



When you move the machine, grasp the side handholds that are under the scanner. Do NOT carry the machine by holding it at the bottom.

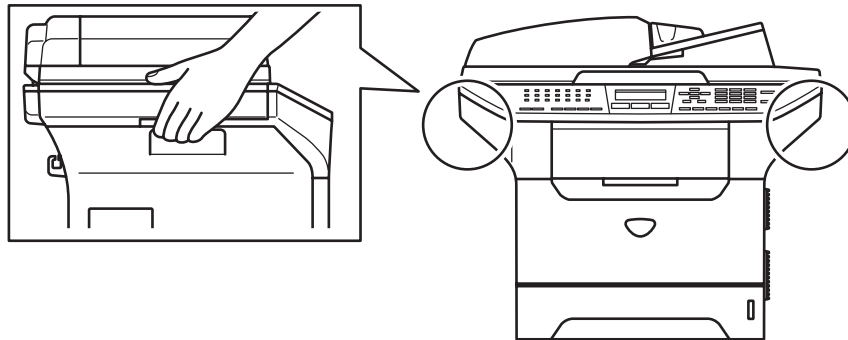

Table of Contents

Step 1 Setting Up the machine

1. Install the Drum Unit and Toner Cartridge Assembly	4
2. Load Paper in the Paper Tray	5
3. Release the Scanner Lock	6
4. Install the Power Cord and Phone Line	6
5. Setting the Date and Time	8
6. Setting Automatic daylight saving time	8
7. Setting your Station ID	9
8. Choosing the correct Receive Mode	10
9. Tone and Pulse dialing mode (Canada only)	11
10. Selecting Your Language (Canada only)	11
11. Setting the LCD Contrast	11
12. Sending in the Product Registration and Test Sheet (USA Only)	11

Step 2 Installing the Drivers & Software

Windows®	Supplied CD-ROM “MFL-Pro Suite”	12
	For USB Interface Cable Users (For Windows® 98/98SE/Me/2000 Professional/XP/XP Professional x64 Edition/Windows Vista®) ..	14
	For Parallel Interface Cable Users (For Windows® 98/98SE/Me/2000 Professional/XP/XP Professional x64 Edition) ..	17
	For Windows NT® Workstation Version 4.0 Users	20
Macintosh®	For Network Interface Cable Users (For Windows® 98/98SE/Me/NT/2000 Professional/XP/XP Professional x64 Edition/Windows Vista®) ...	22
	For USB Interface Cable Users	27
	■ For Mac OS® 9.1 to 9.2	27
	■ For Mac OS® X 10.2.4 or greater	29
	For Network Interface Cable Users	33
	■ For Mac OS® 9.1 to 9.2	33
■ For Mac OS® X 10.2.4 or greater	35	

■ For Network Users and Administrators

BRAdmin Professional configuration utility (For Windows® 98/98SE/Me/2000 Professional/XP/XP Professional x64 Editon Users) ..	40
BRAdmin Light configuration utility (For Windows Vista® users)	42
BRAdmin Light configuration utility (For Mac OS® X users)	43

■ Options and Consumables

Options	44
Replacement Consumables	44

Step 1

Setting Up the machine

1 Install the Drum Unit and Toner Cartridge Assembly



Do NOT connect the interface cable. Connecting the interface cable is done during the software installation process.

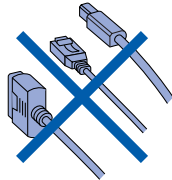

- 1 Open the front cover by pressing the front cover release button (1).

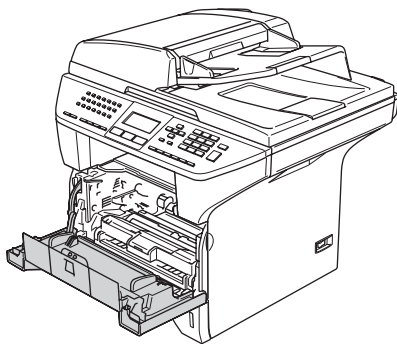
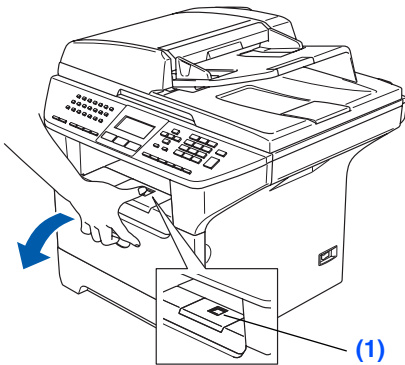

- 2 Unpack the drum unit and toner cartridge assembly.

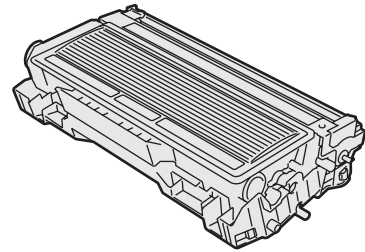

- 3 Gently rock the drum assembly from side to side several times to distribute the toner evenly inside the assembly.

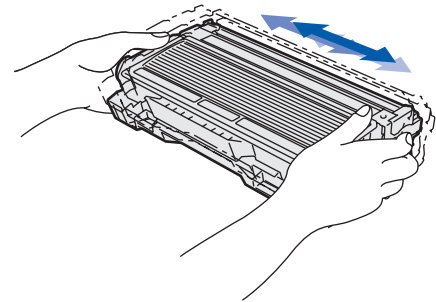

- 4 Put the drum unit assembly into the machine until it clicks into place.

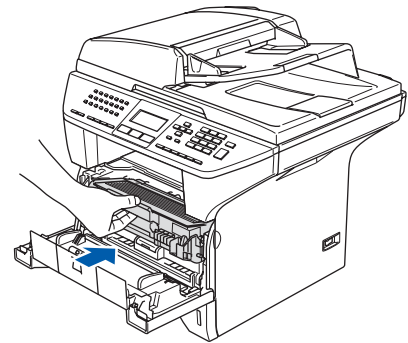

- 5 Close the front cover of the machine.

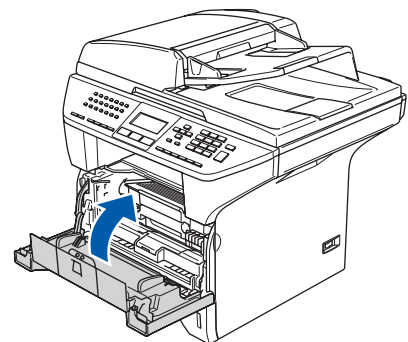

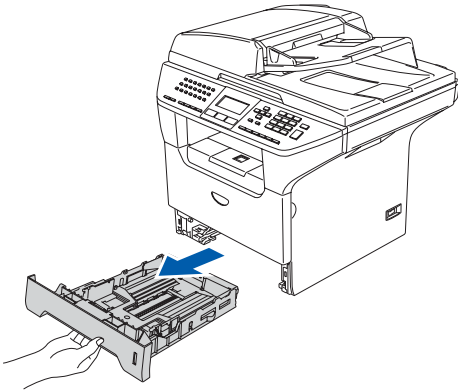

2 Load Paper in the Paper Tray

- 1 Pull the paper tray completely out of the machine.

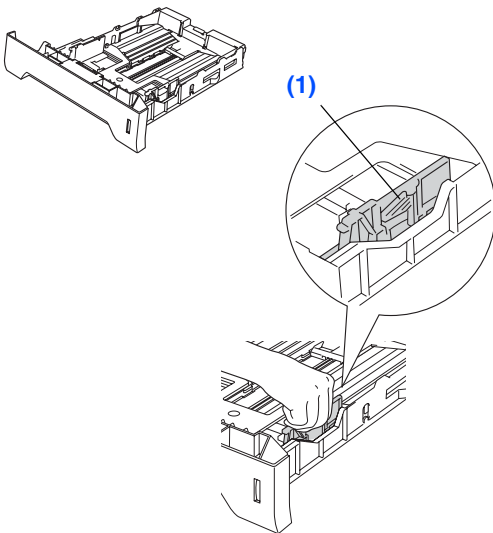

- 2 While pressing the paper guide release lever (1), slide the adjusters to fit the paper size. Check that the guides are firmly in the slots.



 For Legal size paper, press the lever (1) located at the back of the tray and pull out the back of the paper tray. Move the tray lock button (2) to the lock position.

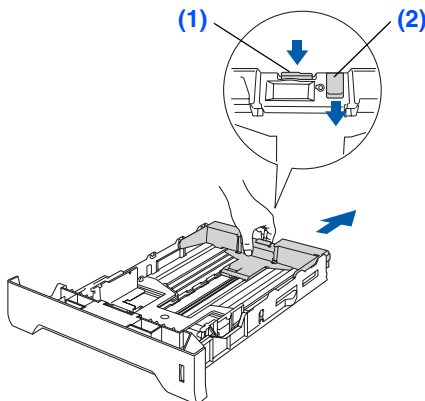

- 3 Fan the stack of paper well to avoid paper jams and misfeeds.

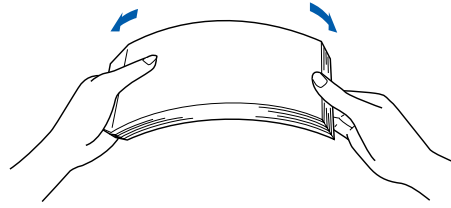

- 4 Put paper in the paper tray. Check that the paper is flat in the tray and below the maximum paper mark (1).

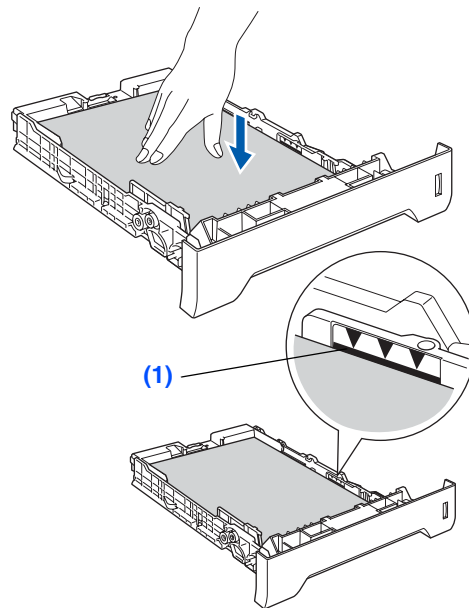

- 5 Put the paper tray firmly back into the machine and unfold the output tray support flap (1) before you use the machine.

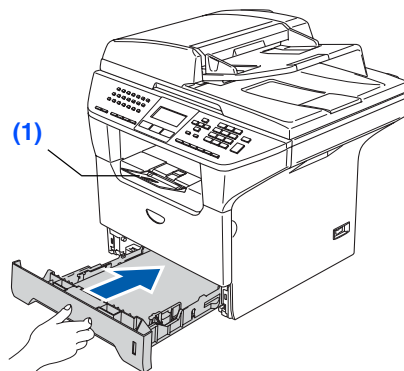

 For details on supported paper specifications, see "Acceptable paper and other media" in Chapter 2 of the User's Guide.

Step 1

Setting Up the machine

3 Release the Scanner Lock

- 1 Push the lever (1) up to unlock the scanner. (The gray scanner lock lever is located at the back left side, under the document cover (2).)

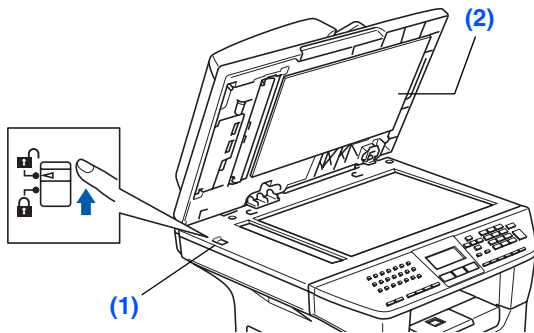

4 Install the Power Cord and Phone Line

 Do not connect the Parallel or USB cable yet.

- 1 Make sure that the power switch is off. Connect the AC power cord to the machine.

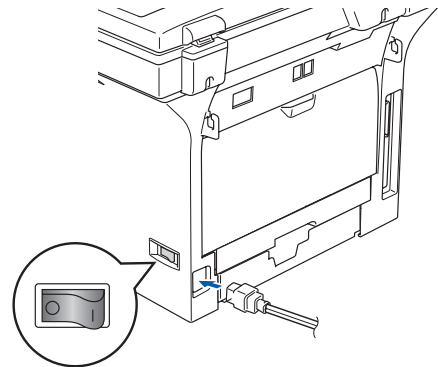

- 2 Plug the AC power cord into an AC outlet. Turn the power switch on.



 *If **Scanner Locked** appears on the LCD, immediately release the scanner lock and press **Stop/Exit**.*

- 3 Connect one end of the telephone line cord to the jack on the machine marked **LINE** and the other end to a modular wall jack.

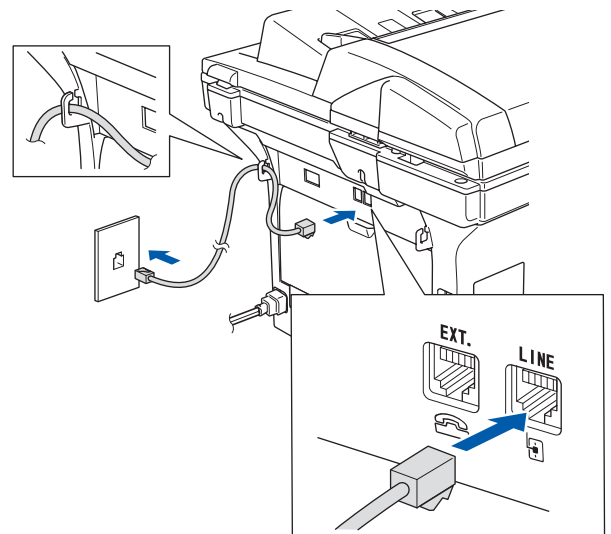

Warning

- The machine must be grounded using a 3-prong plug.
- Since the machine is grounded through the power outlet, you can protect yourself from potentially hazardous electrical conditions on the telephone network by keeping the power cord connected to your machine when you connect it to a telephone line. Similarly, you can protect yourself when you want to move your machine by disconnecting the telephone line first and then the power cord.



If you are sharing one phone line with an external telephone, connect it as shown below.

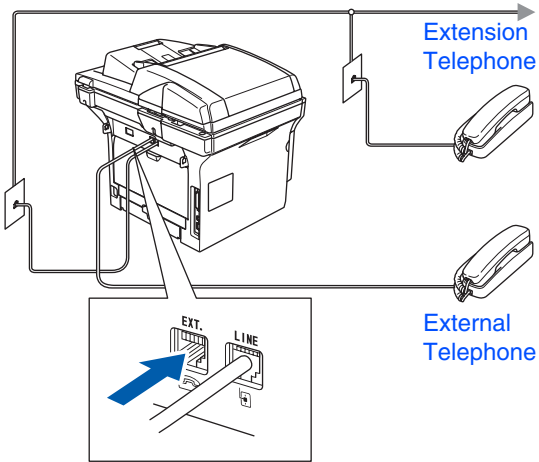

If you are sharing one phone line with an external telephone answering device, connect it as shown below.

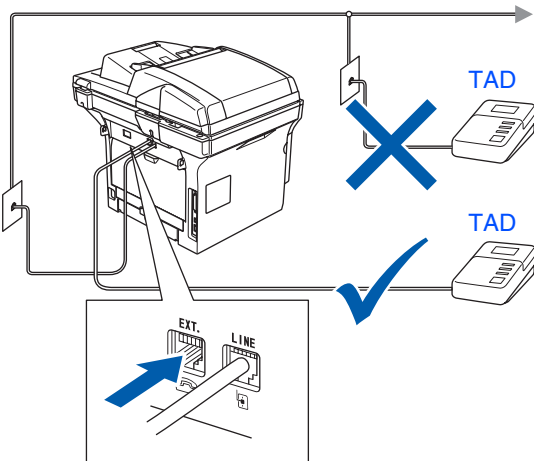

Please set the receive mode to **External TAD**.

For more details, see "Choosing the correct Receive Mode" on page 10 and "Connecting an external TAD (Telephone Answering Device)" in Chapter 7 of the User's Guide.

5

Setting the Date and Time

The machine displays the date and time, and prints it on every fax you send.

- 1 Press **Menu**.
- 2 Press **0**.
- 3 Press **2**.
- 4 Enter the last two digits of the year on the dial pad, and then press **OK**.

02.Date/Time
Year:2008
Enter & OK Key

(e.g. Enter **0, 8** for 2008.)

- 5 Enter the two digits for the month on the dial pad, and then press **OK**.

02.Date/Time
XX/XX/2008
Month:03
Enter & OK Key

(e.g. Enter **0, 3** for March.)

- 6 Enter the two digits for the day on the dial pad, and then press **OK**.

02.Date/Time
03/XX/2008
Day:25
Enter & OK Key

(e.g. Enter **2, 5**.)

- 7 Enter the time in 24-hour format on the dial pad, and then press **OK**.

02.Date/Time
03/25/2008
Time:15:25
Enter & OK Key

(e.g. Enter **1, 5, 2, 5** for 3:25 P.M.)

- 8 Press **Stop/Exit**.



If you make a mistake, press **Stop/Exit** to start from Step 1.

6

Setting Automatic daylight saving time

You can set the machine to change automatically for Daylight Saving Time.

It will set itself forward one hour in the Spring, and back one hour in the Fall.

- 1 Press **Menu, 1, 5**.

15.Auto Daylight
▲ On
▼ Off
Select ▲▼ and OK

- 2 Press  or  to select **On**, or **Off**. Press **OK**.

- 3 Press **Stop/Exit**.

7 Setting your Station ID

You should store your name and fax number to be printed on all fax pages that you send.

- 1 Press **Menu**.
- 2 Press **0**.
- 3 Press **3**.
- 4 Enter your fax number (up to 20 digits) on the dial pad, and then press **OK**.

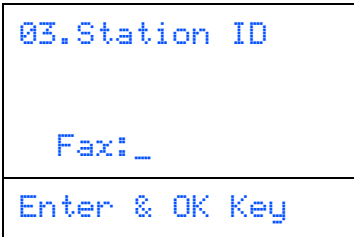

- 5 Enter your telephone number (up to 20 digits) on the dial pad, and then press **OK**. (If your telephone number and fax number are the same, enter the same number again.)

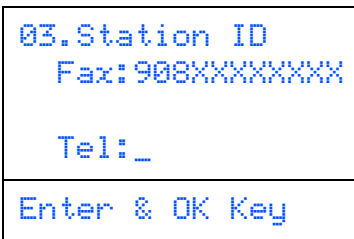

- 6 Use the dial pad to enter your name (up to 20 characters), and then press **OK**.

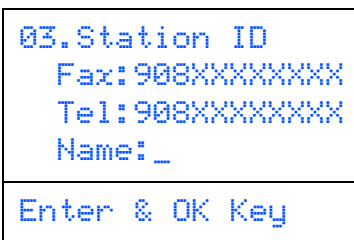

- Refer to the following chart for entering your name.
- If you need to enter a character that is on the same key as the previous character, press to move the cursor to the right.
- If you entered a letter incorrectly and want to change it, press to move the cursor under the incorrect character, press **Clear/Back**.

Press key	One time	Two times	Three times	Four times
2	A	B	C	2
3	D	E	F	3
4	G	H	I	4
5	J	K	L	5
6	M	N	O	6
7	P	Q	R	S
8	T	U	V	8
9	W	X	Y	Z

For more details, see "Entering Text" in Chapter D of the User's Guide.

- 7 Press **Stop/Exit**.

NOTICE (For USA)

The Telephone Consumer Protection Act of 1991 makes it unlawful for any person to use a computer or electronic device to send any message via a telephone fax machine unless such messages clearly contain, in a margin at the top or bottom of each transmitted page, or on the first page of the transmission, the date and time it is sent and an identification of the business or other entity or other individual sending the message and the telephone number of the sending machine or such business, other entity or individual.

To program this information into your machine, see *Setting the Date and Time* on page 8 and *Setting your Station ID* on page 9.

8 Choosing the correct Receive Mode

The correct Receive mode is determined by the external devices and telephone subscriber services (Voicemail, Distinctive Ring, etc.) you have (or will be using) on the same line as the Brother machine.

Will you be using a Distinctive Ring number for receiving faxes?

Brother uses the term "Distinctive Ring" but other telephone companies have other names for this service such as Custom Ringing, RingMaster, Personalized Ring, Teen Ring, Ident-A-Call, and Smart Ring. See Distinctive Ring in Chapter 7 of the User's Guide for instruction on setting up your machine using this feature.

Will you be using Voicemail on the same telephone line as your Brother machine?

If you have Voicemail on the same telephone line as your Brother machine, there is a strong possibility that Voice mail and the Brother machine will conflict with each other when receiving incoming calls. See Voice Mail in Chapter 7 of the User's Guide for instructions on setting up your machine using this service.

Will you be using a Telephone Answering Device on the same telephone line as your Brother machine?

Your external telephone answering device (TAD) will automatically answer every call. Voice messages are stored on the external TAD and fax messages are printed. Choose [External TAD](#) as your receive mode. See the instructions on the next page.

Will you be using your Brother machine on a dedicated fax line?

Your machine automatically answers every call as a fax. Choose [Fax Only](#) as your receive mode. See the instructions on the next page.

Will you be using your Brother machine on the same line as your telephone?



Do you want to receive voice calls and faxes automatically

The [Fax/Tel](#) receive mode is used when sharing the Brother machine and your telephone on the same line. Choose [Fax/Tel](#) as your receive mode. See the instructions on the next page.

Important Note: You can not receive voice messages on either Voicemail or an answering machine when choosing the [Fax/Tel](#) mode.

Do you expect to receive very few faxes?

Choose [Manual](#) as your receive mode. You control the phone line and must answer every call yourself. See the instructions on the next page.

- 1 Press **Menu**.
- 2 Press **0**.
- 3 Press **1**.
- 4 Press  or  to select the mode.
Press **OK**.
- 5 Press **Stop/Exit**.



For more details, see "Receiving a fax" in Chapter 6 of the User's Guide.

9 Tone and Pulse dialing mode (Canada only)

Your machine comes set for Tone dialing service. If you have Pulse dialing service (rotary), you need to change the dialing mode.

- 1 Press **Menu**.
- 2 Press **0**.
- 3 Press **4**.
- 4 Press or to select Pulse (or Tone). Press **OK**.
- 5 Press **Stop/Exit**.

10 Selecting Your Language (Canada only)

- 1 Press **Menu**.
- 2 Press **0**.
- 3 Press **0**.
- 4 Select your language (**English** or **French**) by using or , and then press **OK**.
- 5 Press **Stop/Exit**.

11 Setting the LCD Contrast

You can change the contrast to help the LCD look lighter or darker.

- 1 Press **Menu**.
- 2 Press **1**.
- 3 Press **8**.
- 4 Press to increase the contrast.
—OR—
Press to decrease the contrast.
Press **OK**.
- 5 Press **Stop/Exit**.

12 Sending in the Product Registration and Test Sheet (USA Only)

- 1 Fill out the Product Registration and Test Sheet.

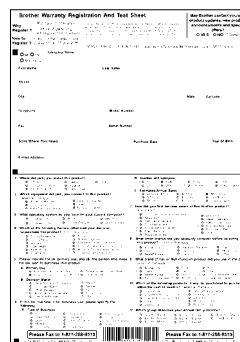

- 2 Place the sheet face up in the Automatic Document Feeder.

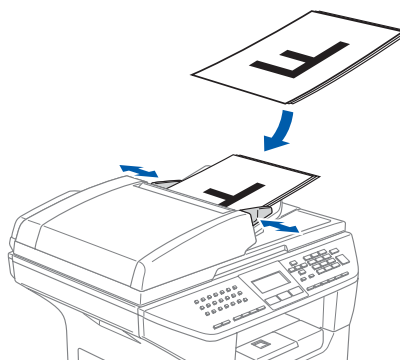

Make sure (**Fax**) is illuminated in Blue.

- 3 Enter the toll-free fax number:
1-877-268-9575.

- 4 Press **Start**.

You will receive a confirmation fax of your Product Registration.
■ You can also register your product online using the On-Line Registration link from the installation CD-ROM or go to <http://www.brother.com/registration>

Go to the next page to
install the drivers & software

Supplied CD-ROM “MFL-Pro Suite”



Before installing the driver and software, please make sure that the supplied CD-ROM you are using matches your operation system.

For Windows Vista® use the supplied CD-ROM labeled Windows Vista®.

The CD-ROM includes the following items:

Windows®

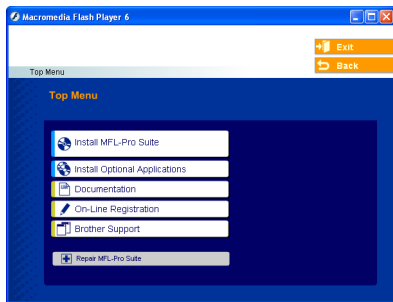

Install MFL-Pro Suite

You can install the MFL-Pro Suite and multifunction drivers.



Install Optional Applications (Install Other Drivers or Utilities)

You can install additional MFL-Pro Suite software utilities.



Documentation (User's Guide)

View the User's Guide and other document in PDF format (Viewer included). The User's Guide on the CD-ROM includes the Software and Network User's Guide for features available when connected to a computer (e.g. Printing, Scanning and networking details).



On-Line Registration

You will be pointed to the Brother Product Registration Web page for quick registration of your machine.



Brother Support

View contact information for Brother Customer Service and how to locate a Brother Authorized Service Center.



Repair MFL-Pro Suite

(For USB and Parallel cable users only)

If you experience errors while installing the MFL-Pro Suite, you can use this function to automatically repair and re-install the software.



MFL-Pro Suite includes Printer Driver, Scanner Driver, ScanSoft® PaperPort® SE with OCR, Brother ControlCenter2 and True Type® fonts.

PaperPort® SE is a document management application for viewing scanned documents.

Macintosh®



Start Here OS 9.1-9.2

You can install the printer driver, scanner driver and Presto!® PageManager® for Mac OS® 9.1 - 9.2.



Start Here OSX

You can install the MFL-Pro Suite that includes the printer driver, scanner driver and the Brother ControlCenter2 for Mac OS® 10.2.4 or greater. You can also install Presto!® PageManager® to add OCR capability to the Brother ControlCenter2 and easily scan, share and organize photos and documents.



Readme.html

You can get important information and troubleshooting tips.



Documentation

View the User's Guide and other document in PDF format (Viewer included). The User's Guide on the CD-ROM includes the Software and Network User's Guide for features available when connected to a computer (e.g. Printing, Scanning and networking details).



Brother Solutions Center

You can access the Brother Solutions Center, a Web site offering information about your Brother product including FAQs, User's Guides, Driver updates and Tips for using your machine.



On-Line Registration

You will be pointed to the Brother Product Registration Web Page for quick registration of your machine.



Follow the instructions on this page for your operating system and interface cable.
 For the latest drivers and to find the best solution for your problem or question, access the Brother Solutions Center directly from the driver or go to <http://solutions.brother.com>

Setting Up
the machine

Windows®



USB Interface Cable Users Go to page 14
 (For Windows® 98/98SE/Me/2000 Professional/XP/XP Professional x64 Edition/Windows Vista®)

Windows®
USB



Parallel Interface Cable Users Go to page 17
 (For Windows® 98/98SE/Me/2000 Professional/XP/XP Professional x64 Edition)

Windows®
Parallel



Windows NT® Workstation Version 4.0 Users Go to page 20
 (For Parallel Interface Cable Users)

Windows NT® 4.0
Parallel



Network Interface Cable Users..... Go to page 22
 (For Windows® 98/98SE/Me/NT/2000 Professional/XP/XP Professional x64 Edition/Windows Vista®)

Windows®
Network

Macintosh®



USB Interface Cable Users
 ■ For Mac OS® 9.1 to 9.2 Go to page 27
 ■ For Mac OS® X 10.2.4 or greater Go to page 29

Macintosh®
USB



Network Interface Cable Users
 ■ For Mac OS® 9.1 to 9.2 Go to page 33
 ■ For Mac OS® X 10.2.4 or greater Go to page 35

Macintosh®
Network

For Network Users and Administrators..... Go to page 40

Network
Administrators

Step 2

Installing the Drivers & Software



For USB Interface Cable Users

(For Windows® 98/98SE/Me/2000 Professional/XP/XP Professional x64 Edition/Windows Vista®)

Make sure that you have finished the instructions from Step 1 “Setting Up the machine” on pages 4 through 11.



Please close any applications running before installing the MFL-Pro Suite.



■ If this window does not appear, use Windows® Explorer to run the **setup.exe*** program from the root folder of the Brother CD-ROM.

* **start.exe** for Windows Vista®

■ For Windows Vista®, when the **User Account Control** screen appears, click **Allow**.

- 1 Turn off and unplug the machine from the AC outlet and disconnect it from your computer, if you already connected an interface cable.

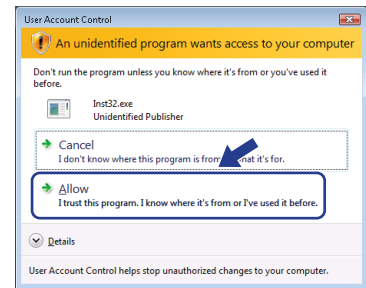
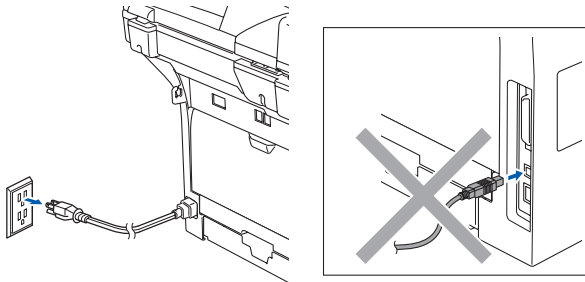

- 2 Turn on your computer. (For Windows® 2000 Professional/XP/XP Professional x64 Edition/Windows Vista®, you must be logged on with Administrator rights.)

- 5 After reading and accepting the ScanSoft® PaperPort® SE License Agreement, click **Yes**.

- 3 Put the supplied CD-ROM into your CD-ROM drive. If the model name screen appears, choose your machine. If the language screen appears, choose your language.

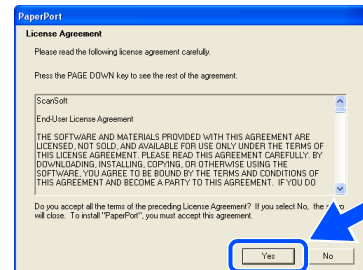

Make sure that the supplied CD-ROM you are using matches your operating system. For Windows Vista® use the supplied CD-ROM labeled Windows Vista®.

The installation of PaperPort® SE will automatically start and is followed by the installation of MFL-Pro Suite.

- 4 The CD-ROM main menu will appear. Click **Install MFL-Pro Suite**.

- 6 When the Brother MFL-Pro Suite Software License Agreement window appears, click **Yes** if you agree to the Software Licence Agreement.

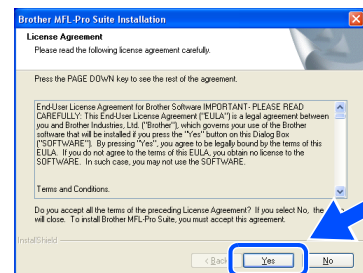
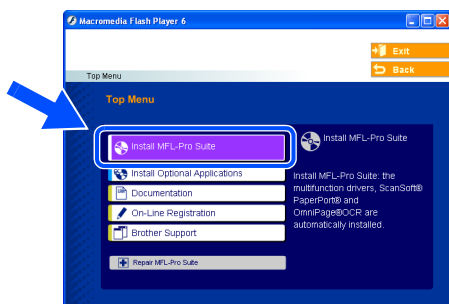

- 7 Choose **Local Connection**, and then click **Next**. The installation will continue.

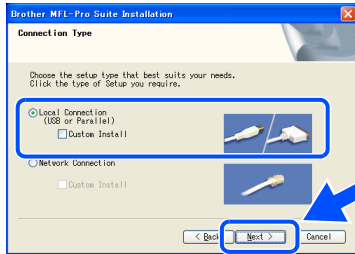

- For Windows Vista®, when this screen appears, click the check box and click **Install**.

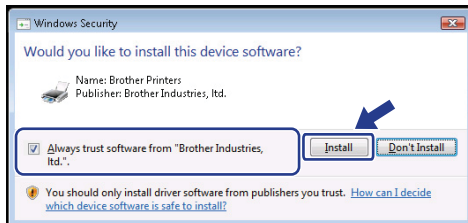

- If you want to install the PS driver (Brother's BR-Script Driver), choose **Custom Install** and then follow the on-screen instructions. When the **Select Components*** screen appears, check **PS Printer Driver**, and then continue following the on-screen instructions.

* **Select Features** for Windows Vista®

- 8 When this screen appears, connect the USB interface cable to your PC, and then connect it to the machine.

(For Windows® XP/XP Professional x64 Edition/
Windows Vista®)

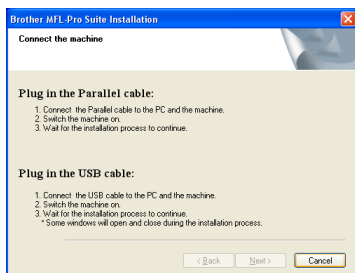

(For Windows® 98/98SE/Me/2000)

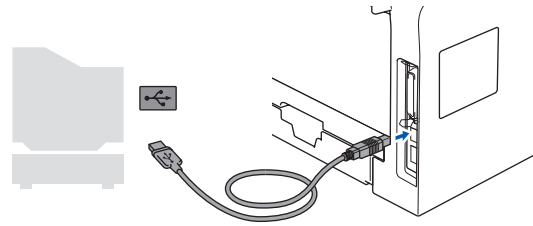
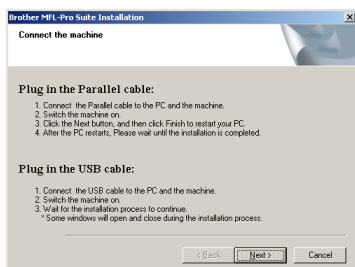

DO NOT connect the machine to a USB port on a keyboard or a non-powered USB hub. Brother recommends that you connect the machine directly to your computer.

- 9 Plug in the power cord and turn on the machine.

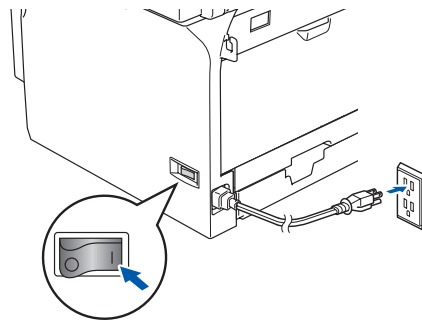

It will take a few seconds for the installation screens to appear.

The installation of the Brother drivers will automatically start. The installation screens appear one after another. Please wait, it will take a few seconds for all the screens to appear.



DO NOT try to cancel any of the screens during this installation.

Continued ..



For USB Interface Cable Users

(For Windows® 98/98SE/Me/2000 Professional/XP/XP Professional x64 Edition/Windows Vista®)

- 10 When the On-Line Registration screen is displayed, make your selection and follow the on-screen instructions. Once you have completed the registration process, close your web browser to return to this window. Then click **Next**.

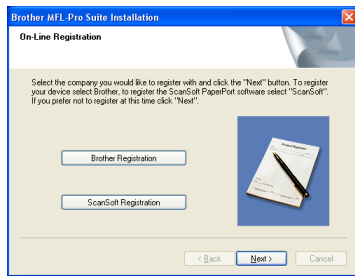

- 11 Click **Finish** to restart your computer. (After restarting the computer, for Windows® 2000 Professional/XP/XP Professional x64 Edition/Windows Vista®, you must be logged on with Administrator rights.)

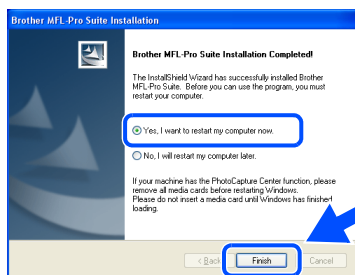

After restarting the computer, the **Installation Diagnostics** will run automatically. If the installation is unsuccessful, the installation results window will be shown. If the **Installation Diagnostics** shows a failure, please follow the on-screen instruction or read on-line help and FAQs in **Start/All Programs (Programs)/Brother/MFL-Pro Suite MFC-XXXX** (where XXXX is your model name).



The MFL-Pro Suite (including, Printer driver and Scanner driver) has been installed and the installation is now complete.

For Parallel Interface Cable Users (For Windows® 98/98SE/Me/2000 Professional/XP/XP Professional x64 Edition)

Make sure that you have finished the instructions from Step 1 “Setting Up the machine” on pages 4 through 11.

 Please close any applications running before installing the MFL-Pro Suite.

- 1 Turn off and unplug the machine from the AC outlet and disconnect it from your computer, if you already connected an interface cable.

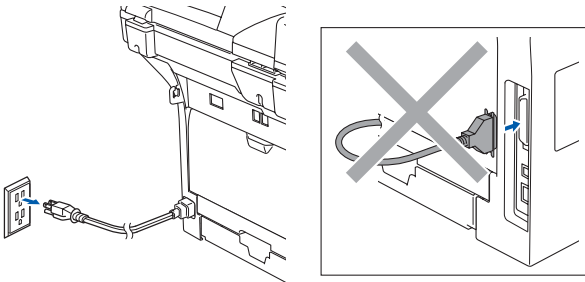



- 2 Turn on your computer.
(For Windows® 2000 Professional/XP/XP Professional x64 Edition, you must be logged on with Administrator rights.)
- 3 Put the supplied CD-ROM into your CD-ROM drive. If the model name screen appears, choose your machine. If the language screen appears, choose your language.

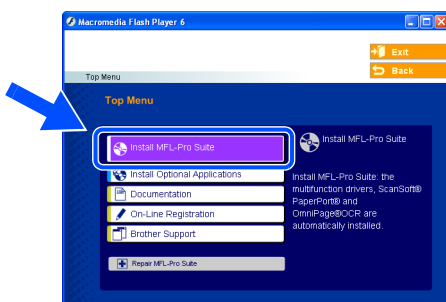

 Make sure that the supplied CD-ROM you are using matches your operating system. For Windows Vista® use the supplied CD-ROM labeled Windows Vista®.

- 4 The CD-ROM main menu will appear. Click **Install MFL-Pro Suite**.



 ■ If this window does not appear, use Windows® Explorer to run the **setup.exe** program from the root folder of the Brother CD-ROM.

- 5 After reading and accepting the ScanSoft® PaperPort® SE License Agreement, click **Yes**.

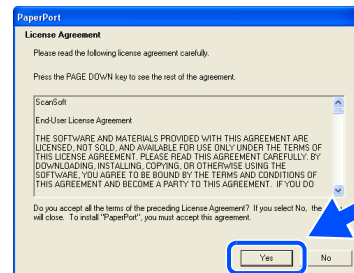

The installation of PaperPort® SE will automatically start and is followed by the installation of MFL-Pro Suite.

- 6 When the Brother MFL-Pro Suite Software License Agreement window appears, click **Yes** if you agree to the Software License Agreement.

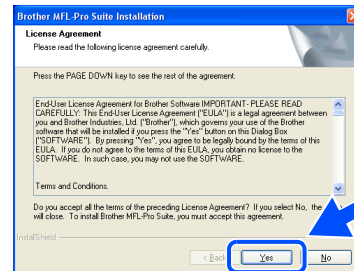

Continued ..

Step 2

Installing the Drivers & Software



For Parallel Interface Cable Users

(For Windows® 98/98SE/Me/2000 Professional/XP/XP Professional x64 Edition)

- 7 Choose **Local Connection**, and then click **Next**. The installation will continue.

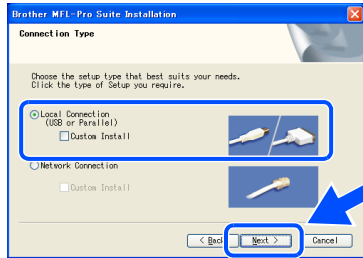

■ If you want to install the PS driver (Brother's BR-Script Driver), choose **Custom Install** and then follow the on-screen instructions. When the **Select Components** screen appears, check **PS Printer Driver**, and then continue following the on-screen instructions.

- 8 When this screen appears, connect the parallel interface cable to your PC, and then connect it to the machine.

(For Windows® XP/XP Professional x64 Edition)

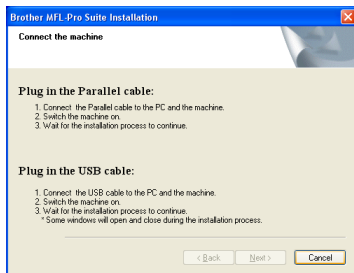

(For Windows® 98/98SE/Me/2000)

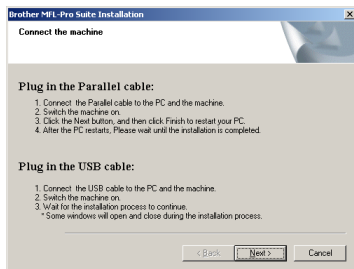

DO NOT plug in the power cord before connecting the parallel interface cable. It may cause damage to your machine.

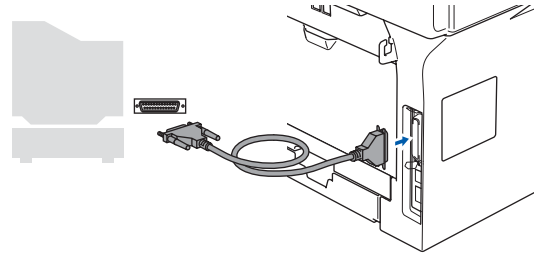

Brother recommends that you connect the machine directly to your computer.

- 9 Plug in the power cord and turn on the machine.

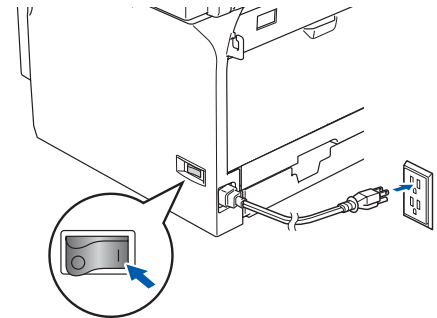

- 10 For Windows® 98/98SE/Me/2000 Professional users, click **Next**.

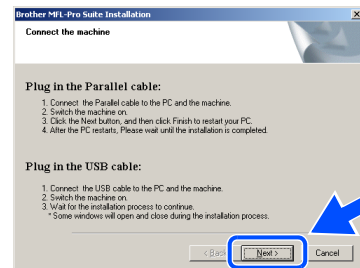

For Windows® XP/XP Professional x64 Edition users, wait for a while since the installation of the Brother drivers will automatically start. The screens appear one after another.



DO NOT try to cancel any of the screens during this installation.

- 11 When the On-Line Registration screen is displayed, make your selection and follow the on-screen instructions. Once you have completed the registration process, close your web browser to return to this window. Then click **Next**.

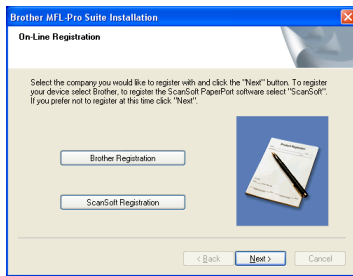

- 12 When the following screen appears, click **Finish** and wait as the PC restarts Windows® and continues the installation.

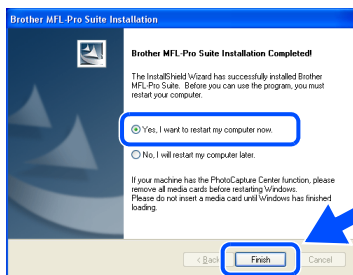

- 13 After the computer restarts, the installation of the Brother drivers will automatically start. Follow the instructions on the screen. (For Windows® 2000 Professional/XP/XP Professional x64 Edition, you must be logged on with Administrator rights.)



After restarting the computer, the **Installation Diagnostics** will run automatically. If the installation is unsuccessful, the installation results window will be shown. If the **Installation Diagnostics** shows a failure, please follow the on-screen instruction or read on-line help and FAQs in **Start/All Programs (Programs)/Brother/MFL-Pro Suite MFC-XXXX** (where XXXX is your model name).

- OK!** The MFL-Pro Suite (including, Printer driver and Scanner driver) has been installed and the installation is now complete.



For Windows NT[®] Workstation Version 4.0 Users

Make sure that you have finished the instructions from Step 1 “Setting Up the machine” on pages 4 through 11.



Please close any applications running before installing the MFL-Pro Suite.

- 1 Turn off and unplug the machine from the AC outlet.
- 2 Turn on your computer. You must be logged on with Administrator rights.



DO NOT plug in the power cord before connecting the parallel interface cable. It may cause damage to your machine.

- 3 Connect the parallel interface cable to your computer, and then connect it to the machine.

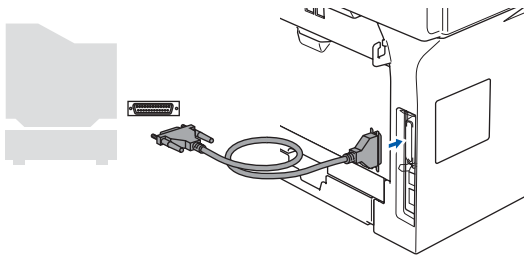

Brother recommends that you connect the machine directly to your computer.

- 4 Plug in the power cord and turn on the machine.

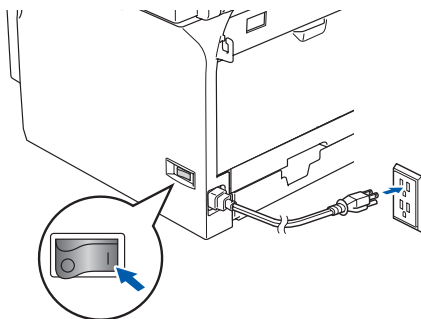

- 5 Put the Supplied CD-ROM into your CD-ROM drive. If the model name screen appears, choose your machine. If the language screen appears, choose your language.



Make sure that the supplied CD-ROM you are using matches your operating system.

- 6 The CD-ROM main menu will appear. Click **Install MFL-Pro Suite**.

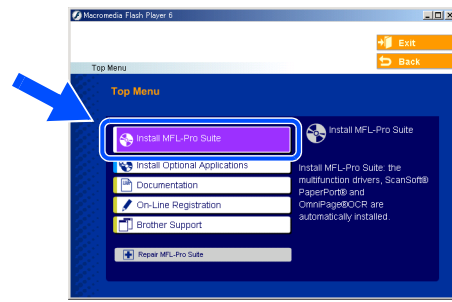

If this window does not appear, use Windows[®] Explorer to run the **setup.exe** program from the root folder of the Brother CD-ROM.

- 7 After reading and accepting the ScanSoft[®] PaperPort[®] SE License Agreement, click **Yes**.



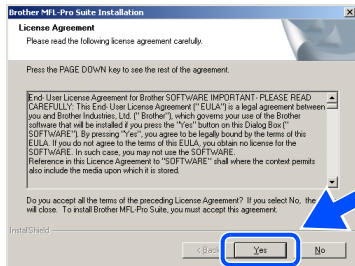

The installation of PaperPort[®] SE will automatically start and is followed by the installation of MFL-Pro Suite.

- 8 When the Brother MFL-Pro Suite Software License Agreement window appears, click **Yes** if you agree to the Software License Agreement.

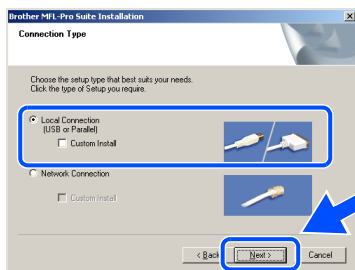

- 9 Choose **Local Connection**, and then click **Next**. The installation will continue.



-  If you want to install the PS driver (Brother's BR-Script Driver), choose **Custom Install** and then follow the on-screen instructions. When the **Select Components** screen appears, check **PS Printer Driver**, and then continue following the on-screen instructions.

- 10 When the On-Line Registration screen is displayed, make your selection and follow the on-screen instructions. Once you have completed the registration process, close your web browser to return to this window. Then click **Next**.

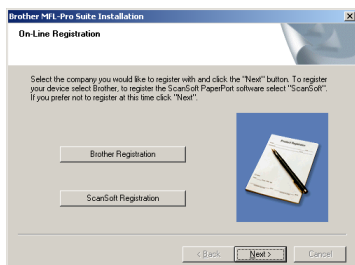

- 11 Click **Finish** and wait as the PC restarts Windows® and continues the installation. (You must be logged on with Administrator rights.)

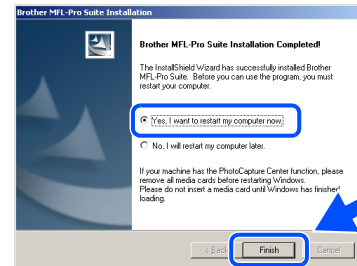

After restarting the computer, the **Installation Diagnostics** will run automatically. If the installation is unsuccessful, the installation results window will be shown. If the **Installation Diagnostics** shows a failure, please follow the on-screen instruction or read on-line help and FAQs in **Start/Programs/Brother/MFL-Pro Suite MFC-XXXX** (where XXXX is your model name).



OK! The MFL-Pro Suite (including, Printer driver and Scanner driver) has been installed and the installation is now complete.

Step 2

Installing the Drivers & Software



For Network Interface Cable Users

(For Windows® 98/98SE/Me/NT/2000 Professional/XP/XP Professional x64 Edition/Windows Vista®)

Make sure that you have finished the instructions from Step 1 “Setting Up the machine” on pages 4 through 11.

- 1 Turn off and unplug the machine from AC outlet.
- 2 Connect the network cable to the machine, and then connect it to a free port on your hub.

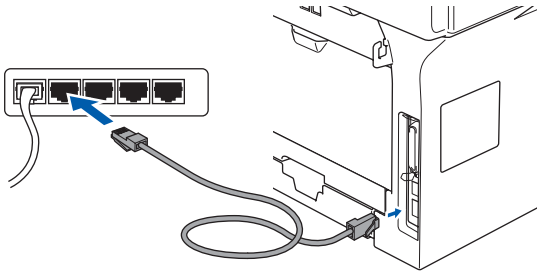

- 3 Plug in the power cord and turn on the machine.

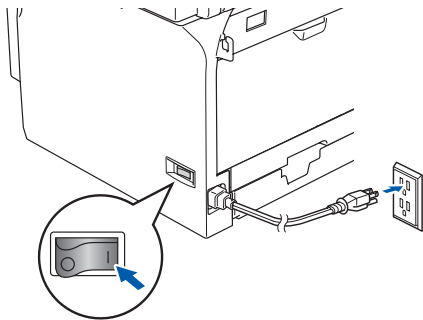

- 4 Turn on your computer.
(For Windows® 2000 Professional/XP/XP Professional x64 Edition/Windows NT® 4.0/Windows Vista®, you must be logged on with Administrator rights.)
Close any applications running before installing the MFC-Pro Suite.

Before installation, if you are using Personal Firewall software, disable it. Once you are sure that you can print after the installation, re-start your Personal Firewall software.

- 5 Put the supplied CD-ROM into your CD-ROM drive. If the model name screen appears, choose your machine. If the language screen appears, choose your language.



Make sure that the supplied CD-ROM you are using matches your operating system. For Windows Vista® use the supplied CD-ROM labeled Windows Vista®.

- 6 The CD-ROM main menu will appear. Click **Install MFL-Pro Suite**.

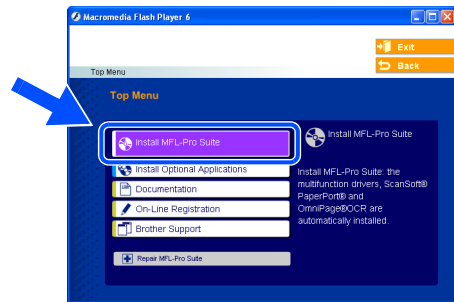

- If this window does not appear, use Windows® Explorer to run the **setup.exe*** program from the root folder of the Brother CD-ROM.
* **start.exe** for Windows Vista®
- For Windows Vista®, when the **User Account Control** screen appears, click **Allow**.

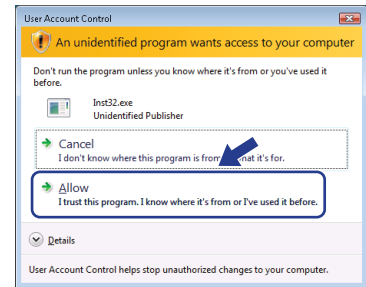

- 7 After reading and accepting the ScanSoft® PaperPort® SE License Agreement, click **Yes**.

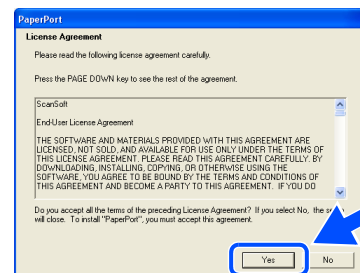

The installation of PaperPort® SE will automatically start and is followed by the installation of MFL-Pro Suite.

- 8 When the Brother MFL-Pro Suite Software License Agreement window appears, read the agreement, then click **Yes** if you agree to its terms.

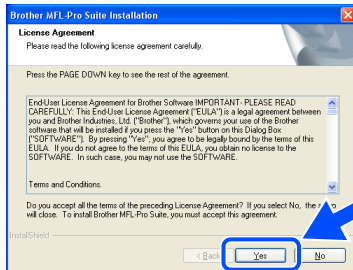

- 9 Choose **Network Connection** and then click **Next**.

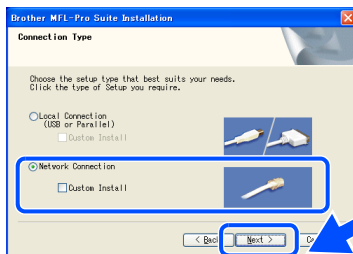

- If you want to install the PS driver (Brother's BR-Script Driver), choose **Custom Install** and then follow the on-screen instructions. When the **Select Components*** screen appears, check **PS Printer Driver**, and then continue following the on-screen instructions.
* **Select Features** for Windows Vista®

- 10 The installation of the Brother drivers will automatically start. The installation screens appear one after another. Please wait, it will take a few seconds for all the screens to appear.

DO NOT try to cancel any of the screens during this installation.

- 11 If the machine is configured for your network, select your machine from the list and then click **Next**.

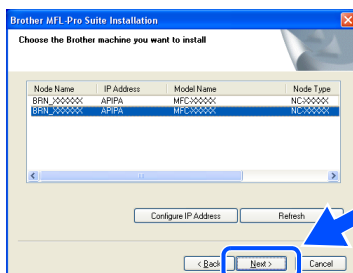

This window will not appear if there is only one of this Brother model connected on the network, it will be selected automatically.

- 12 If the machine is not yet configured for use on your network, the following screen appears.



Click **OK**.

The **Configure IP Address** will appear. Enter the proper IP address information for your network by following the on-screen instructions.



For Windows Vista®, when this screen appears, click the check box and click **Install**.



- 13 When the On-Line Registration screen is displayed, make your selection and follow the on-screen instructions. Once you have completed the registration process, close your web browser to return to this window. Then click **Next**.

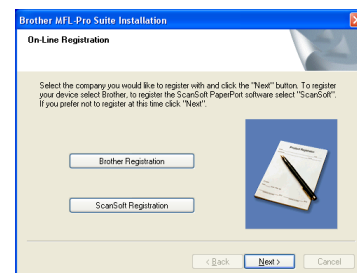

Continued ..



For Network Interface Cable Users

(For Windows® 98/98SE/Me/NT/2000 Professional/XP/XP Professional x64 Edition/Windows Vista®)

- 14 Click **Finish** to restart your computer. (For Windows® 2000 Professional/XP/XP Professional x64 Edition/Windows NT® 4.0/Windows Vista®, you must be logged on with Administrator rights.)

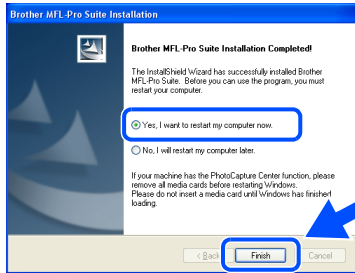

- OK!** The MFL-Pro Suite (including, Printer driver and Scanner driver) has been installed and the installation is now complete.



- After restarting the computer, the **Installation Diagnostics** will run automatically. If the installation is unsuccessful, the installation results window will be shown. If the **Installation Diagnostics** shows a failure, please follow the on-screen instruction or read on-line help and FAQs in **Start/All Programs (Programs)/Brother/MFL-Pro Suite MFC-XXXX** (where XXXX is your model name).

- Once you are sure that you can print after the installation, restart your Firewall software.

- Firewall settings on your PC may reject the necessary network connection for Network Scanning and PC-Fax.

If you are using the Windows® Firewall follow the instructions for Windows® XP SP2, XP Professional x64 Edition or Windows Vista®. If you are using a personal Firewall software, see the User's Guide for your software or contact the software manufacturer.

- Windows® XP SP2 and XP Professional x64 Edition users:

- 1 Click the **Start** button, **Control Panel**, **Network and Internet connections** and then **Windows Firewall**. Make sure that Windows Firewall on the **General** tab is set to **On**.

- 2 Click the **Advanced** tab and **Settings...** button.

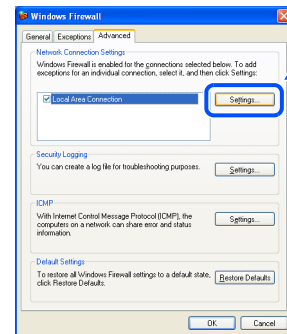

- 3 Click the **Add** button.
- 4 To add port 54925 for network scanning, enter the information below:
 - 1) In **Description of service**: - Enter any description, for example "Brother Scanner".
 - 2) In **Name or IP address (for example 192.168.0.12) of the computer hosting this service on your network**: - Enter "Localhost".
 - 3) In **External Port Number for this service**: - Enter "54925".
 - 4) In **Internal Port number for this service**: - Enter "54925".
 - 5) Make sure **UDP** is selected.
 - 6) Click **OK**.

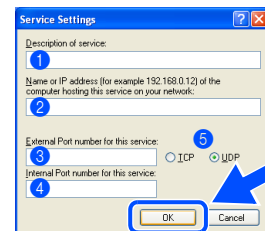

- 5 Click the **Add** button.
- 6 To add port 54926 for Network PC-Fax, enter the information below:
 - 1) In **Description of service**: - Enter any description, for example "Brother PC-Fax".
 - 2) In **Name or IP address (for example 192.168.0.12) of the computer hosting this service on your network**: - Enter "Localhost".
 - 3) In **External Port Number for this service**: - Enter "54926".
 - 4) In **Internal Port number for this service**: - Enter "54926".
 - 5) Make sure **UDP** is selected.
 - 6) Click **OK**.

- 7 If you still have trouble with your network connection, click the **Add** button.
- 8 To add port 137 for both network scanning and Network PC-Fax receiving, enter the information below:
 - 1) In **Description of service**: - Enter any description, for example "Brother PC-Fax Receiving".
 - 2) In **Name or IP address (for example 192.168.0.12) of the computer hosting this service on your network**: - Enter "Localhost".
 - 3) In **External Port Number for this service**: - Enter "137".
 - 4) In **Internal Port number for this service**: - Enter "137".
 - 5) Make sure **UDP** is selected.
 - 6) Click **OK**.
- 9 Make sure if the new settings are added and are checked, and then click **OK**.

■ **Windows Vista® users:**

- 1 Click the **Start** button, **Control Panel**, **Network and Internet**, **Windows Firewall** and click **change settings**.
- 2 When the **User Account Control** screen appears, do the following.
 - For Users who have administrator rights: Click **Continue**.

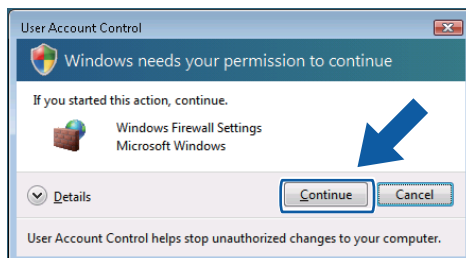

- **Users who do not have administrator rights:** Enter the administrator password and click **OK**.

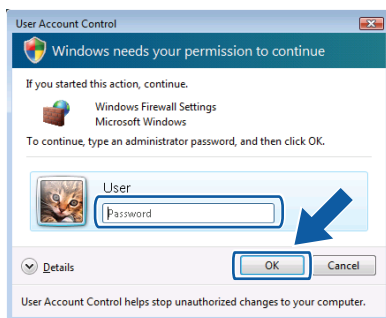

- 3 Make sure that Windows Firewall on the **General** tab is set to **On**.

- 4 Click the **Exceptions** tab.

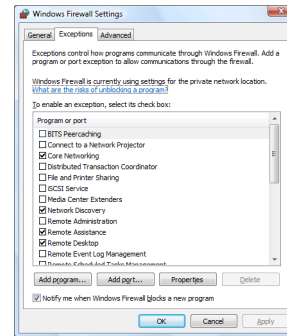

- 5 Click the **Add port...** button.
- 6 To add port 54925 for network scanning, enter the information below:
 - 1) In **Name**: Enter any description, for example "Brother Scanner".
 - 2) In **Port number**: Enter "54925".
 - 3) Make sure **UDP** is selected. Then, click **OK**.

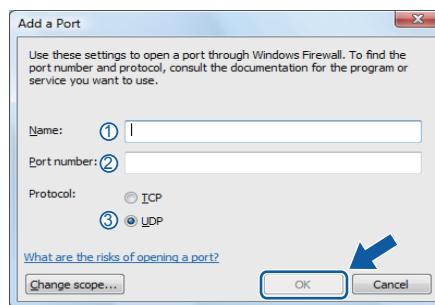

- 7 Click the **Add port...** button.
- 8 To add port 54926 for Network PC-Fax, enter the information below:
 - 1) In **Name**: Enter any description, for example "Brother PC-Fax".
 - 2) In **Port number**: Enter "54926".
 - 3) Make sure **UDP** is selected. Then, click **OK**.
- 9 Make sure that the new setting is added and is checked, and then click **OK**.

Continued ...



For Network Interface Cable Users

(For Windows® 98/98SE/Me/NT/2000 Professional/XP/XP Professional x64 Edition/Windows Vista®)

- 10 If you still have trouble with your network connection such as Network Scanning or Printing, check the **File and Printer Sharing** box in the Exceptions tab and then click **OK**.

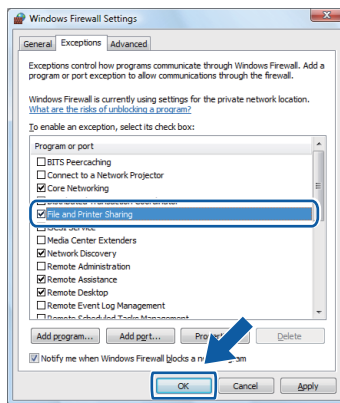

- For Network installations, the **Repair MFL-Pro Suite** selection from the main menu is not supported.
- Network Scanning, Network Remote Setup, Network PC-FAX Receiving are not supported in Windows NT® 4.0.
- For configuration of advanced network functions such as Scan to FTP, see the Software and Network User's Guides located on the CD-ROM.

 For USB Interface Cable Users

For Mac OS® 9.1 to 9.2

Make sure that you have finished the instructions from Step 1 “Setting Up the machine” on pages 4 through 11.

- 1 Turn off and unplug the machine from the AC outlet and disconnect it from your Macintosh®, if you already connected an interface cable.

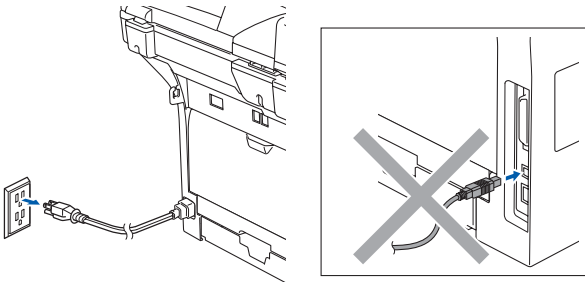

- 2 Turn on your Macintosh®.
- 3 Insert the supplied CD-ROM for Macintosh® into your CD-ROM drive.



- 4 Double-click the **Start Here OS 9.1-9.2** icon to install the printer and scanner drivers. If the language screen appears, choose your language.

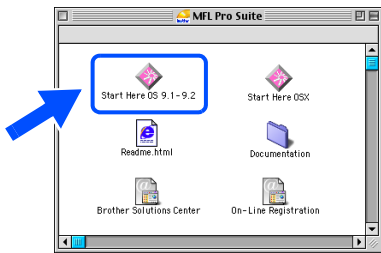

- 5 Click **MFL-Pro Suite** to install.

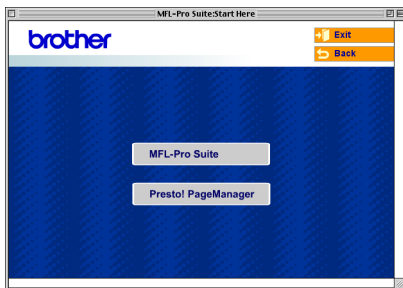

- 6 Follow the on-screen instructions, and restart your Macintosh®.
- 7 Connect the USB interface cable to your Macintosh®, and then connect it to the machine.

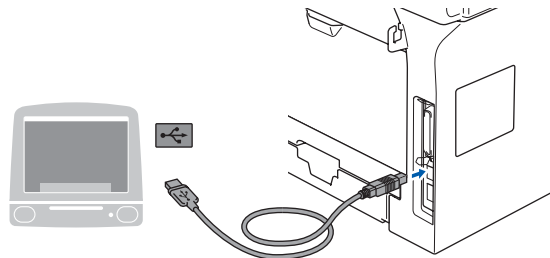

! DO NOT connect the machine to a USB port on a keyboard or a non-powered USB hub.

- 8 Plug in the power cord and turn on the machine.

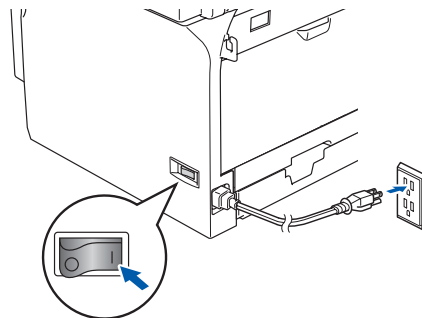

- 9 From the Apple® menu, click the **Chooser**.



Continued ... 



For USB Interface Cable Users

- 10 Click the **Brother Laser** icon.
On the right side of the **Chooser**, choose the machine to which you want to print.
Close the **Chooser**.

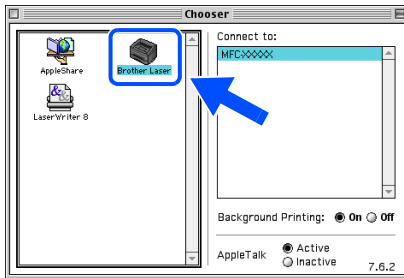

- OK!** The printer and scanner drivers have been installed.



The Brother ControlCenter2 is not supported in Mac OS® 9.x.

- 11 To install Presto!® PageManager®, click the **Presto! PageManager** icon and follow the on-screen instructions.



You can easily scan, share and organize photos and documents using Presto!® PageManager®.

- OK!** Presto!® PageManager® has been installed and the installation is now complete.

For Mac OS® X 10.2.4 or greater

Make sure that you have finished the instructions from Step 1 “Setting Up the machine” on pages 4 through 11.

 For Mac OS® X 10.2.0 to 10.2.3 user, upgrade to Mac OS® X 10.2.4 or greater. (For the latest information for Mac OS® X, visit <http://solutions.brother.com>)

- 1 Turn off and unplug the machine from the AC outlet and disconnect it from your Macintosh®, if you already connected an interface cable.

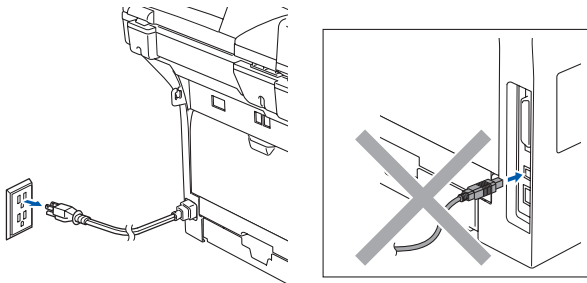

- 2 Turn on your Macintosh®.
- 3 Insert the supplied CD-ROM for Macintosh® into your CD-ROM drive.



- 4 Double-click the **Start Here OSX** icon to install the drivers and MFL-Pro Suite. If the language screen appears, choose your language.



- 5 Click **MFL-Pro Suite** to install.

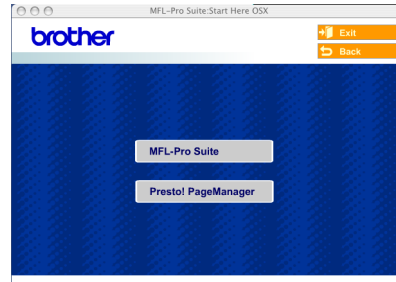

- 6 Follow the on-screen instructions, and restart your Macintosh®.

- 7 **For Mac OS® X 10.5 users** → Connect the USB cable to your Macintosh and then to the machine.

For Mac OS® X 10.2.4 to 10.4.x users → Wait for the **DeviceSelector** window to appear before connecting the USB cable.

After the **DeviceSelector** window appears, connect the USB interface cable to your Macintosh® and then to the machine.



 The **DeviceSelector** window will not appear if you have connected a USB interface cable to the machine before restarting your Macintosh®, if you are overwriting a previously installed version of the Brother software, or if you are using Mac OS® X 10.5. If you encounter this problem continue with the installation but skip Step 12. You should choose your Brother machine from the Model pull-down list in the main screen of ControlCenter2 (For details, see the Software User's Guide on the CD-ROM).

Continued ...

For USB Interface Cable Users

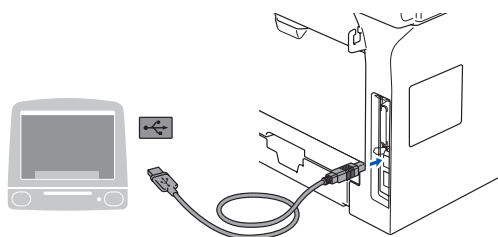

! DO NOT connect the machine to a USB port on a keyboard or a non-powered USB hub.

- 8 Plug in the power cord and turn on the machine.

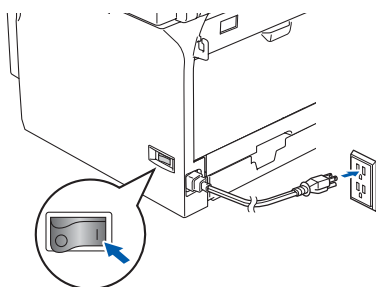

For Mac OS® X 10.5 users
→ Go to 9

For Mac OS® X 10.2.4 to 10.4.x users
→ Go to 12

- 9 The Brother software will search for the Brother device. During this time the following screen will appear.

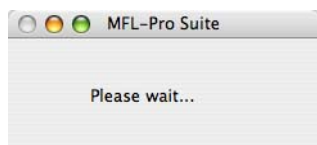

- 10 When this screen appears, click **OK**.

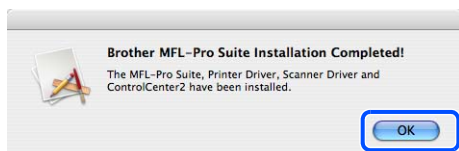

- OK!** The MFL-Pro Suite drivers and Brother Control Center2 have been installed.

For configuration of advanced network functions such as Scan to FTP, see the Software and Network User's Guides located on the CD-ROM.

- 11 To install Presto!® PageManager®, click the **Presto! PageManager** icon and follow the on-screen instructions.

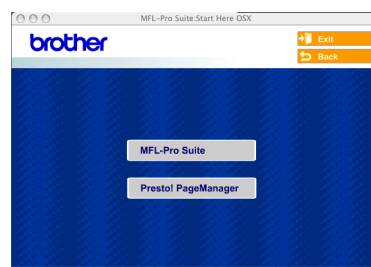

When Presto!® PageManager® is installed OCR capability is added to the Brother ControlCenter2. You can easily scan, share, and organize photos and documents using Presto!® PageManager®.

- OK!** Presto!® PageManager® has been installed and the installation is now complete.

- 12 Choose **USB** and then click **OK**.

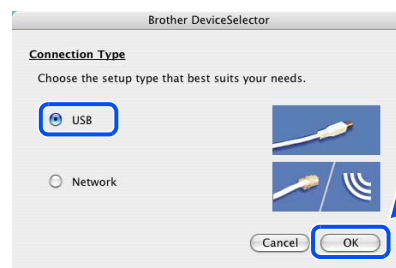

- 13 Click **Go**, then choose **Application**.

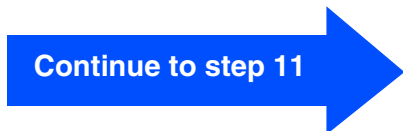
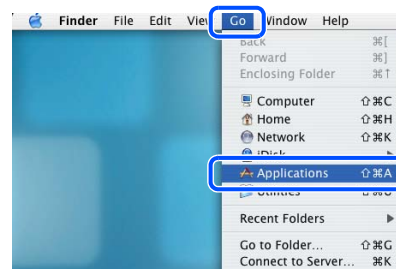

- 14 Double-click the **Utilities** folder.



- 15 Double-click the **Print Setup Utility** icon.



*For Mac OS® X 10.2.x users, open **Print Center** icon.*

- 16 Click **Add**.

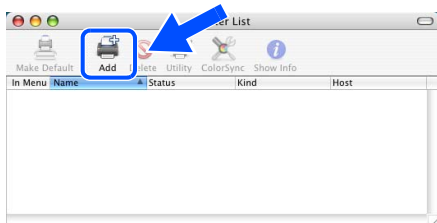

For Mac OS® X 10.2.4 to 10.3.x users

→ *Go to 17*

For Mac OS® X 10.4 users

→ *Go to 18*

- 17 Choose **USB**.

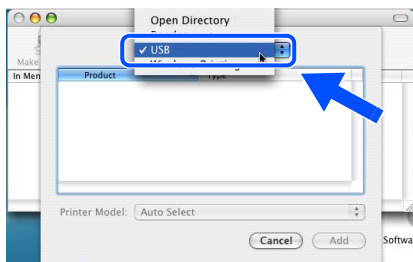

- 18 Choose your model name, and then click **Add**.

For Mac OS® X 10.2.4 to 10.3 users:

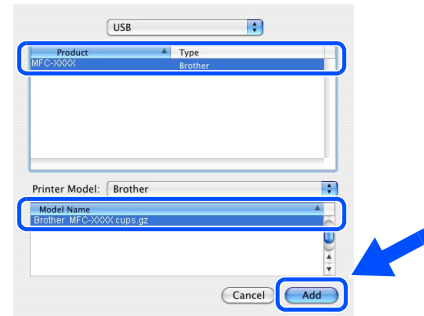

For Mac OS® X 10.4.x users:

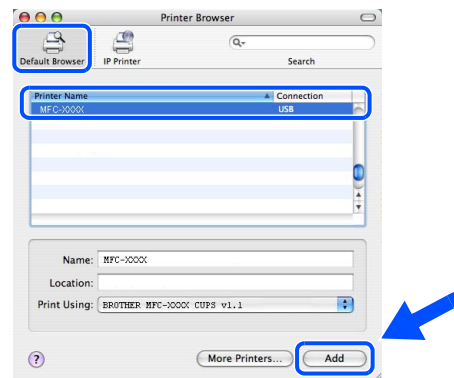

- 19 Click **Printer Setup Utility**, then choose **Quit Printer Setup Utility**.

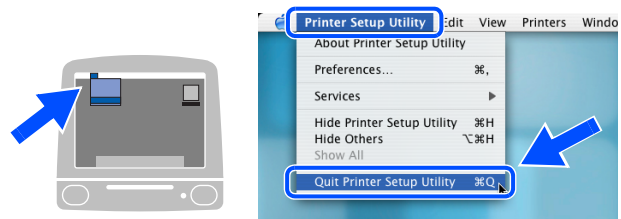

- OK!** The MFL-Pro Suite, drivers and Brother ControlCenter2 have been installed.

Continued ...



For USB Interface Cable Users

- 20 To install Presto!® PageManager® , click the **Presto! PageManager** icon and follow the on-screen instructions.

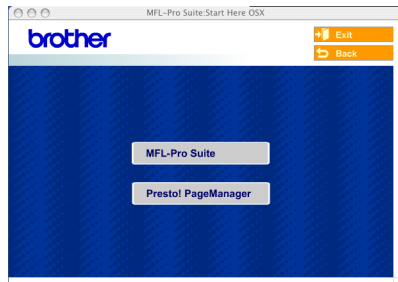

When Presto!® PageManager® is installed OCR capability is added to the Brother ControlCenter2. You can easily scan, share, and organize photos and documents using Presto!® PageManager®.



Presto!® PageManager® has been installed and the installation is now complete.

 For Network Interface Cable Users

For Mac OS® 9.1 to 9.2

Make sure that you have finished the instructions from Step 1 “Setting Up the machine” on pages 4 through 11.

- 1 Turn off and unplug the machine from the AC outlet.

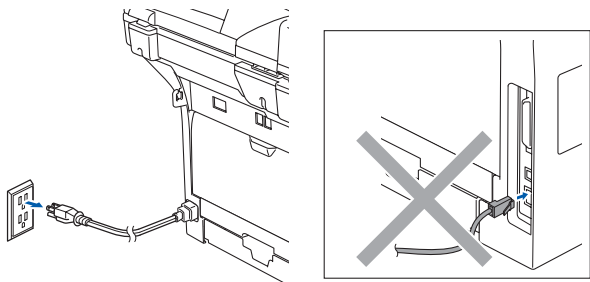

- 2 Turn on your Macintosh®.
- 3 Insert the supplied CD-ROM for Macintosh® into your CD-ROM drive.



- 4 Double-click the **Start Here OS 9.1-9.2** icon to install the printer driver. If the language screen appears, choose your language.

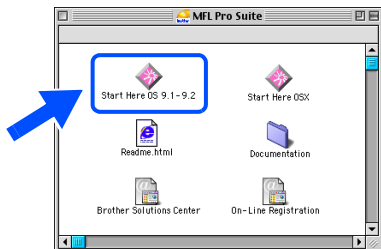

- 5 Click **MFL-Pro Suite** to install.



- 6 Follow the on-screen instructions, and restart your Macintosh®.

- 7 Connect the network interface cable to the machine, and then connect it to a free port on your hub.

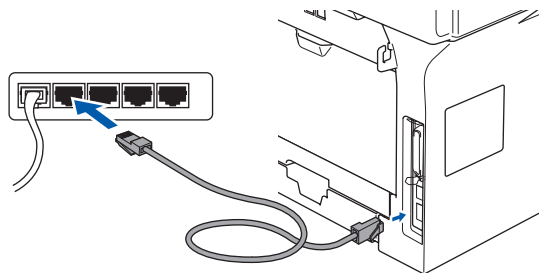

- 8 Plug in the power cord and turn on the machine.

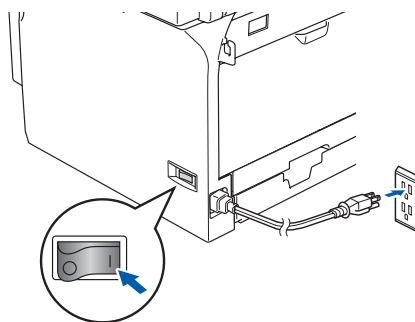

- 9 From the Apple® menu click **Chooser**.



Setting Up
the machine

Installing the Drivers & Software

Macintosh®
USB

Macintosh®
Network

Network
Administrators



For Network Interface Cable Users

- 10 Click the **Brother Laser (IP)** icon, and then choose **BRN_XXXXXX**.
Close the **Chooser**.

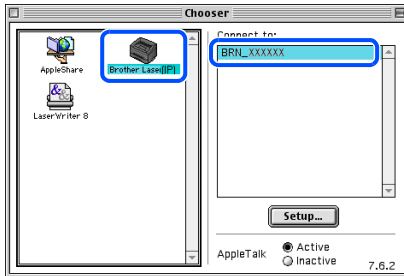

XXXXXX are the last six digits of the Ethernet address.

- OK!** The Printer driver has been installed.



The Brother ControlCenter2 and Network Scanning are not supported in Mac OS® 9.x.

- 11 To install Presto!® PageManager®, click the **Presto! PageManager** icon and follow the on-screen instructions.



You can easily scan, share and organize photos and documents using Presto!® PageManager®.

- OK!** Presto!® PageManager® has been installed and the installation is now complete.

For Mac OS® X 10.2.4 or greater

Make sure that you have finished the instructions from Step 1 “Setting Up the machine” on pages 4 through 11.

- 1 Turn off and unplug the machine from the AC outlet and disconnect it from your Macintosh® if you already connected an interface cable.

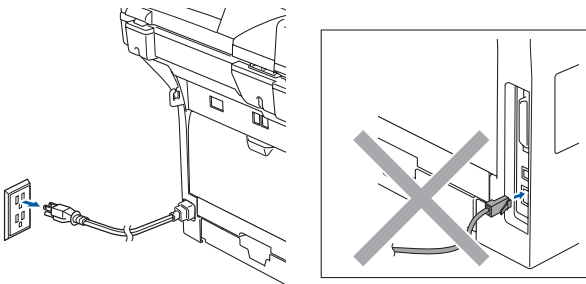

- 2 Turn on your Macintosh®.
- 3 Insert the supplied CD-ROM for Macintosh® into your CD-ROM drive.



- 4 Double-click the **Start Here OSX** icon to install the drivers and MFL-Pro Suite. If the language screen appears, choose your language.



- 5 Click **MFL-Pro Suite** to install.

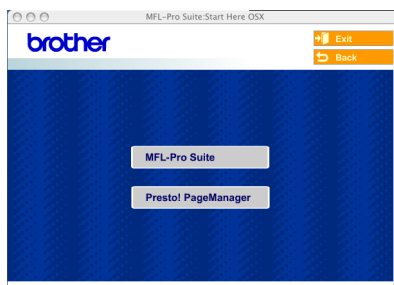

- 6 Follow the on-screen instructions, and restart your Macintosh®.

- 7 **For Mac OS® X 10.5 users** →
Connect the network cable to the machine, then connect it to a free port on your hub.

For Mac OS® X 10.2.4 to 10.4.x users →
Wait for the **DeviceSelector** window to appear before connecting the network cable.

After the **DeviceSelector** window appears, connect the network interface cable to the machine, and then connect it to a free port on your hub.



The **DeviceSelector** window will not appear if you have also connected a Network interface cable to the machine before restarting your Macintosh®, if you are overwriting a previously installed version of the Brother software, or if you are using Mac OS® X 10.5. If you encounter this problem continue with the installation skipping Steps 12 to 14. You should select your Brother machine from the Model pull-down list in the main screen of ControlCenter2. (For details, see the Software Use's Guide on CD-ROM.)

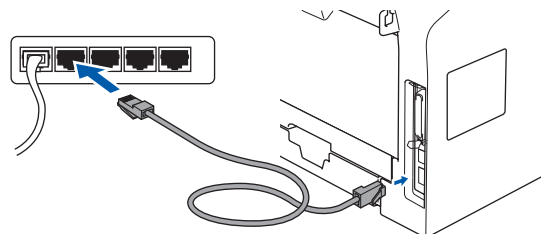

Continued ...



For Network Interface Cable Users

- 8 Plug in the power cord and turn on the machine.

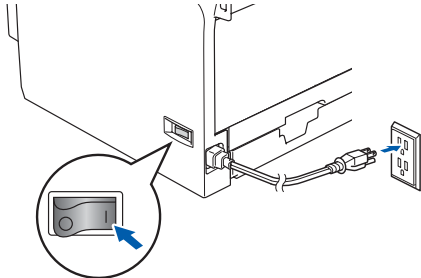

For Mac OS® X 10.5 users

→ Go to 9

For Mac OS® X 10.2.4 to 10.4.x users

→ Go to 12

- 9 The Brother software will search for the Brother device. During this time the following screen will appear.

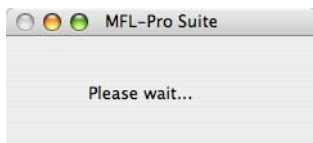

- If the machine is configured for your network, choose the machine from the list, and then click **OK**. This window will not appear if there is only one machine connected on the network, it will be chosen automatically. Go to step 10.

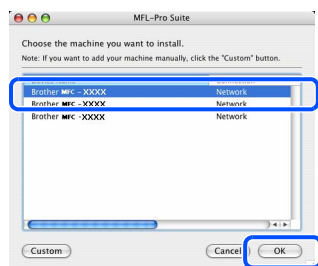

- If this screen appears click **OK**.



Enter a name for your Macintosh® in **Display Name** up to 15 characters long and click **OK**.

Go to step 10

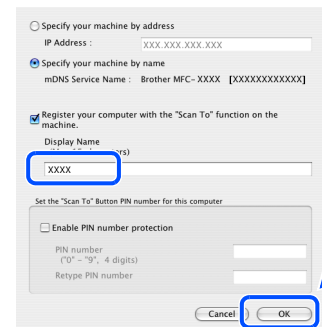

- If you want to use the machine's Scan key to scan over the network you must check the **Register your computer with the "Scan To" function on the machine**.

- The name you enter will appear on the machine's LCD when you press the **Scan** key and choose a scan option. (For more information, see *Network Scanning in the Software User's Guide on the CD-ROM.*)

- 10 When this screen appears, click **OK**.

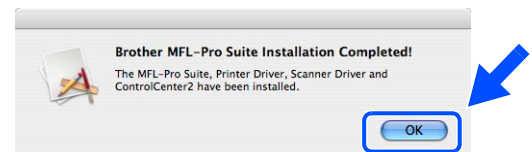

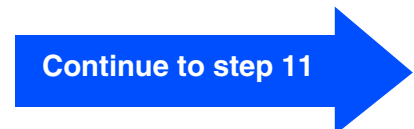

- OK!** The MFL-Pro Suite drivers and Brother Control Center2 has been installed.

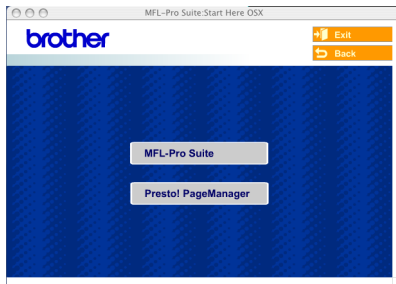

For configuration of advanced network functions such as Scan to FTP, see the *Software and Network User's Guides* located on the CD-ROM.

- 11 To install Presto!® PageManager®, click the **Presto! PageManager** icon and follow the on-screen instructions.



 When Presto!® PageManager® is installed OCR capability is added to the Brother ControlCenter2. You can easily scan, share, and organize photos and documents using Presto!® PageManager®.

- OK!** Presto!® PageManager® has been installed and the installation is now complete.

- 12 Choose **Network** and then click **OK**.

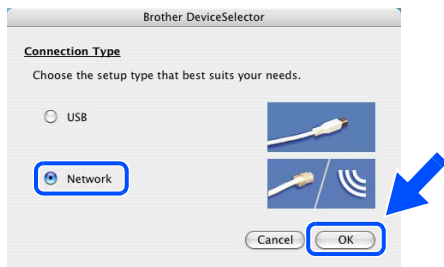

- 13 If you want to use the **Scan** key on the machine, you must check **Register your computer with the "Scan To" functions at the machine** box and enter a name you want to use for your Macintosh® in **Display Name**. The name you enter will appear on the machine's LCD when you press the **Scan** key and choose a scan option. You can enter any name up to 15 characters long. (For more information on network scanning, see Chapter 10 of the Software User's Guide on the CD-ROM.)

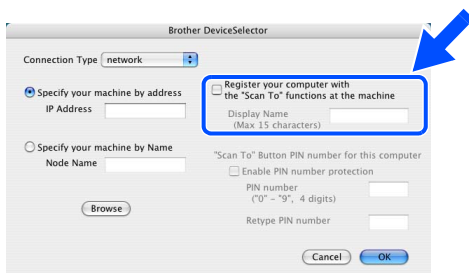

- 14 Click **Browse**.

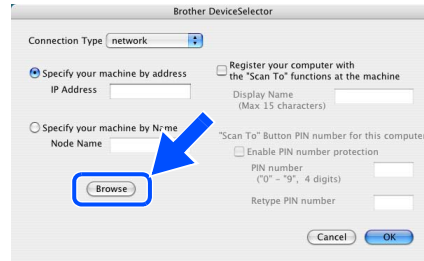

- 15 Choose your model name, and then click **OK**. Click **OK** again to close the **DeviceSelector**.

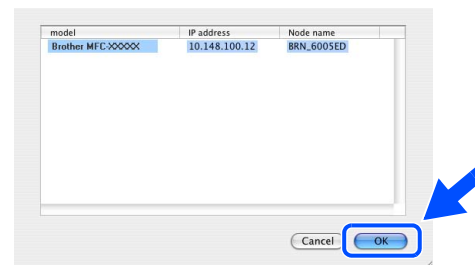

- 16 Click **Go**, then choose **Applications**.

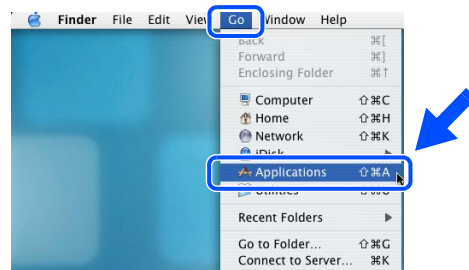

- 17 Double-click the **Utilities** folder.

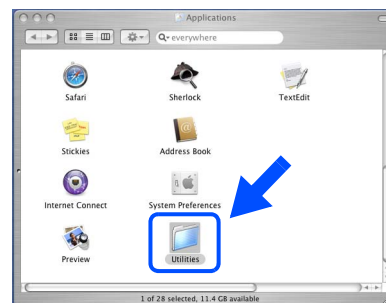

Continued ... 

For Network Interface Cable Users

- 18 Double-click the **Print Setup Utility** icon.



*For Mac OS® X 10.2.x users, open **Print Center** icon.*

- 19 Click **Add**.

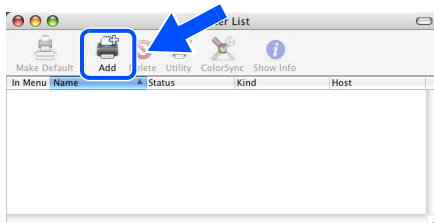

*For Mac OS® X 10.2.4 to 10.3.x users
→ Go to 20*

*For Mac OS® X 10.4 users
→ Go to 21*

- 20 Make the selection shown below.



- 21 Choose your model name and then click **Add**.

For Mac OS® X 10.2.4 to 10.3 users:

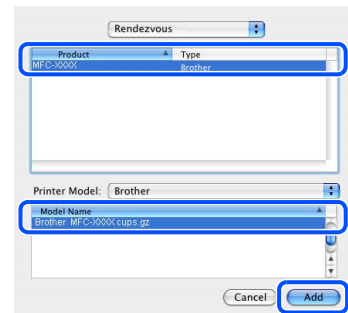

For Mac OS® X 10.4.x users:

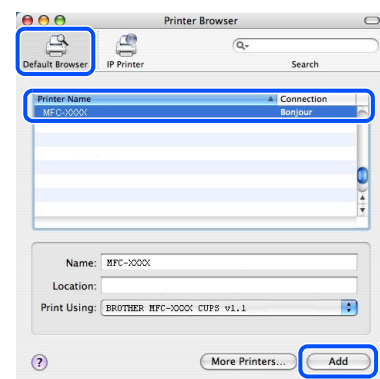

- 22 Click **Printer Setup Utility**, then choose **Quit Printer Setup Utility**.

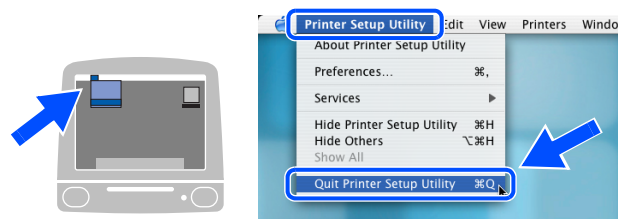

- OK!** The **MFL-Pro Suite, Printer driver, Scanner driver and ControlCenter2** have been installed.

*For configuration of advanced network functions such as Scan to FTP, see the **Software and Network User's Guides** located on the CD-ROM.*

- 23 To install Presto!® PageManager®, click the **Presto! PageManager** icon and follow the on-screen instructions.

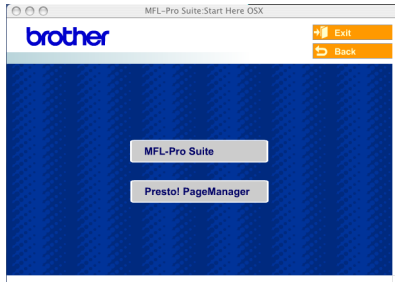

When Presto!® PageManager® is installed OCR capability is added to the Brother ControlCenter2. You can also easily scan, share, and organize photos and documents using Presto!® PageManager®.



Presto!® PageManager® has been installed and the installation is now complete.

BRAdmin Professional configuration utility (For Windows® 98/98SE/Me/2000 Professional/XP/XP Professional x64 Editon Users)

The BRAdmin Professional utility is designed to manage your Brother network connected devices such as network-ready Multifunction devices and/or network-ready printers in a Local Area Network (LAN) environment.

For more information on BRAdmin Professional and BRAdmin Light, go to <http://solutions.brother.com>

Installing the BRAdmin Professional configuration utility

- 1 Put the supplied CD-ROM into your CD-ROM drive.
The opening screen will appear automatically.
Follow the on-screen instructions.



Make sure that the supplied CD-ROM you are using matches to your operating system.

- 2 Click the **Install Optional Applications** icon on the main menu screen.

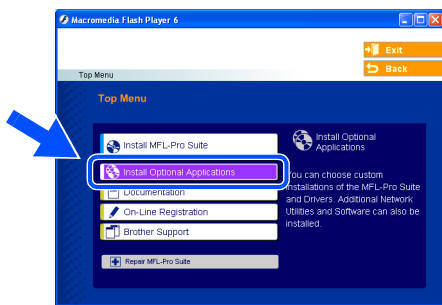

- 3 Click **BRAdmin Professional** and follow the on-screen instructions.

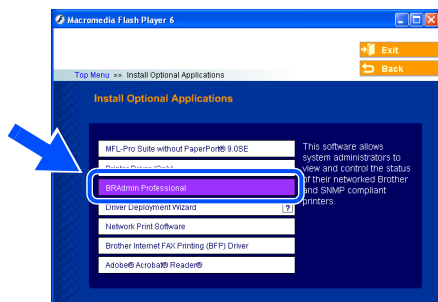

Setting your IP Address, Subnet Mask and Gateway using BRAdmin Professional

- 1 Start BRAdmin Professional, and select **TCP/IP**.

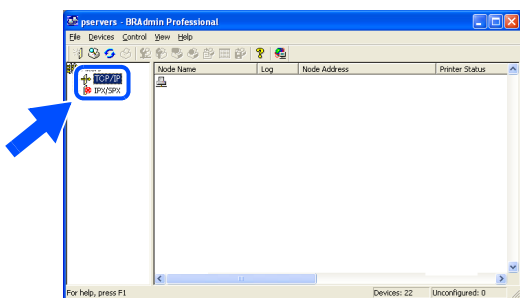

- 2 Click **Devices**, then choose **Search Active Devices**. BRAdmin will search for new devices automatically.

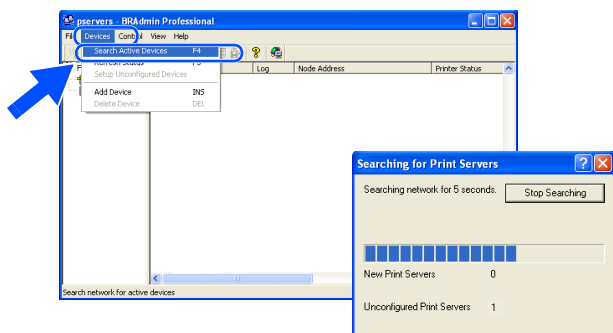

- 3 Double-click the new device.

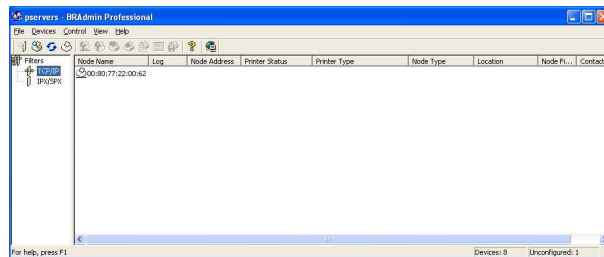

 The default password for the print server is **"access"**. You can use BRAdmin Professional or a web browser to change this password.

- 4 Enter the **IP Address, Subnet Mask and Gateway**, and then click the **OK** button.

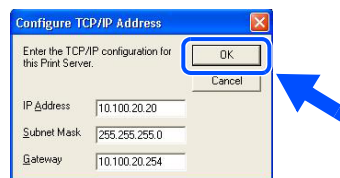

- 5 The address information will be saved to the machine.

 For more information on network administration, please see the *Network User's Guide* in the programs menu or go to <http://solutions.brother.com>

Setting Up
the machine

Windows®
USB

Windows®
Parallel

Windows NT® 4.0
Parallel

Windows®
Network

Macintosh®
USB

Macintosh®
Network

Network
Administrators

BRAdmin Light configuration utility (For Windows Vista® users)

The BRAdmin Light is a utility for initial setup of Brother network connected devices. It can also search for Brother products on your network, view the status and configure basic network settings, such as IP address.

For more information on BRAdmin Light, visit us at <http://solutions.brother.com>.



- If you require more advanced printer management, use the latest Brother BRAdmin Professional utility version that is available as a download from <http://solutions.brother.com>.
- Make sure that you are using the Vista CD-ROM.

Installing the BRAdmin Light configuration utility



The default password for the print server is 'access'. You can use BRAdmin Light to change this password.

- 1 Click **Install Other Drivers or Utilities** on the menu screen.



- 2 Click **BRAdmin Light** and follow the on-screen instructions.

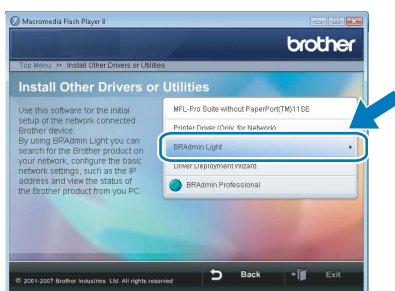

- 3 When the **User Account Control** screen appears, click **Allow**.

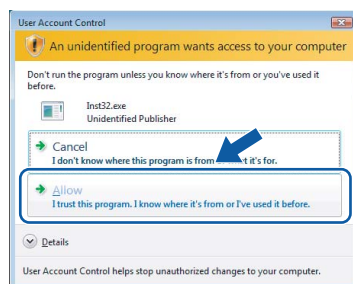

Setting your IP address, Subnet Mask and Gateway using BRAdmin Light



If you have a DHCP/BOOTP/RARP server in your network, you don't have to do the following operation. Because the print server will automatically obtain its IP address.

- 1 Start BRAdmin Light. It will search for new devices automatically.

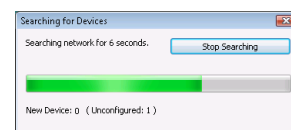

- 2 Double-click the unconfigured device.

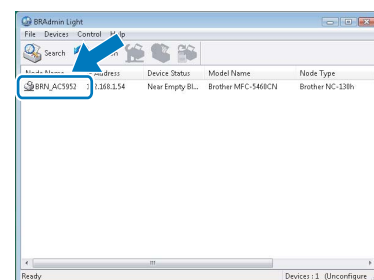

- 3 Choose **STATIC** for the **Boot Method**. Enter the **IP Address**, **Subnet Mask** and **Gateway**, and then click **OK**.

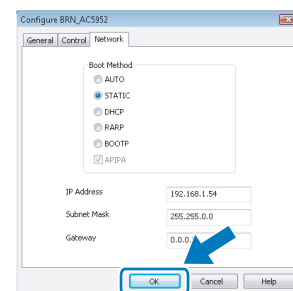

- 4 The address information will be saved to the machine.

BRAdmin Light configuration utility (For Mac OS[®] X users)

The Brother BRAdmin Light software is a Java™ application that is designed for the Apple Mac OS[®] X environment. It supports some of the features of the Windows BRAdmin Professional software. For example, using the BRAdmin Light software, you can change some network settings on Brother's network ready printers and multifunction devices. The BRAdmin Light software will be installed automatically when you install the MFL-Pro Suite. If you have already installed the MFL-Pro Suite, you don't have to install it again. For more information on BRAdmin Light, visit us at <http://solutions.brother.com>.

Setting your IP address, Subnet Mask and Gateway using BRAdmin Light



- If you have a DHCP/BOOTP/RARP server in your network, you don't have to do the following operation. The print server will automatically obtain its own IP address. Make sure that version 1.4.1_07 or later of Java™ client software is installed on your computer.
- The default password for the print server is "access". You can use BRAdmin Light to change this password.

- 1 Double-click the **Macintosh HD** icon on your desktop.

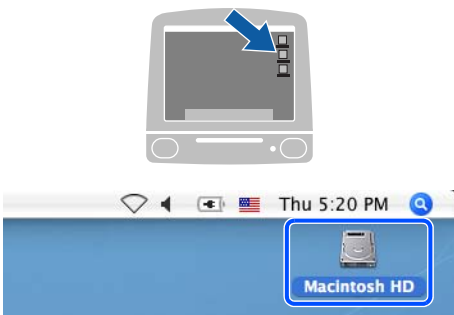

- 2 Choose **Library**, **Printers**, **Brother** and then **Utilities**.

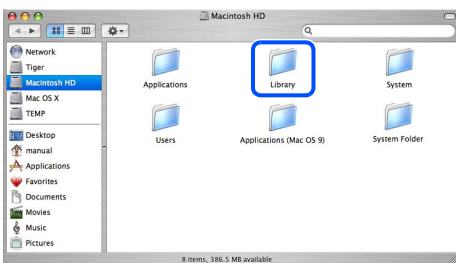

- 3 Double-click the **BRAdminLight.jar** file. Run the BRAdmin Light software. BRAdmin Light searches new devices automatically.

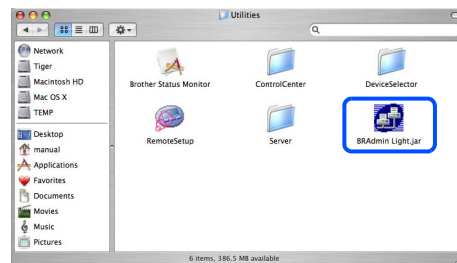

- 4 Double-click the new device.

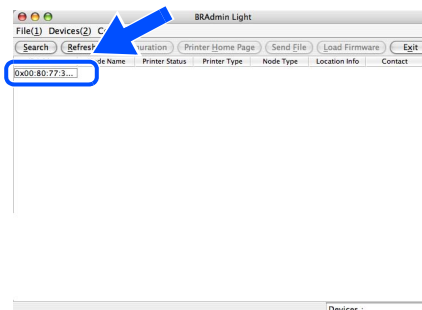

- 5 Enter the **IP Address**, **Subnet Mask** and **Gateway**, and then click **OK**.

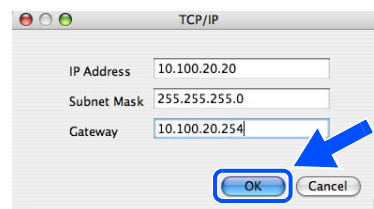

- 6 The address information will be saved to the printer.

Options and Consumables

Options

The machine has the following optional accessories. You can expand the capabilities of the machine by adding these items.

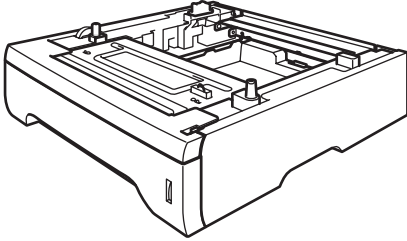
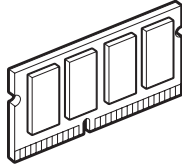
Lower Tray Unit	Memory
LT-5300	
 <p>Second lower paper tray unit expands total input capacity up to 500 sheets.</p>	 <p>You can expand the memory by installing a (144-pin DIMM) memory module. For more details, see "Memory Board" in Chapter B of the User's Guide.</p>

Replacement Consumables

When the time comes to replace consumables, an error message will be indicated on the LCD. For more information about the consumables for your machine, visit <http://solutions.brother.com> or contact your local Brother re-seller.

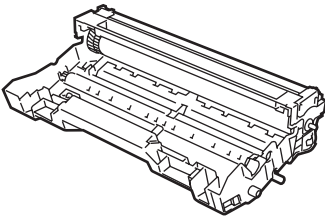
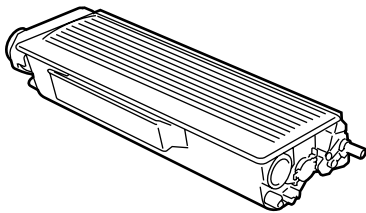
Drum Unit	Toner Cartridge
DR-520	TN-550 / TN-580
	

Trademarks

The Brother logo is a registered trademark of Brother Industries, Ltd.

Brother is a registered trademark of Brother Industries, Ltd.

Multi-Function Link is a registered trademark of Brother International Corporation.

Windows Vista[®] is either a registered trademark or a trademark of Microsoft Corporation in the United States and other countries.

Microsoft, Windows, Windows NT and Windows Server are registered trademark or a trademark of Microsoft Corporation in the United States and/or other countries.

Macintosh and True Type are registered trademarks of Apple Inc.

Postscript and Postscript 3 are registered trademarks or trademarks of Adobe Systems Incorporated.

PaperPort is a registered trademark of ScanSoft, Inc.

Presto! PageManager is a registered trademark of NewSoft Technology Corporation.

Each company whose software title is mentioned in this manual has a Software License Agreement specific to its proprietary programs.

All other brand and product names mentioned in this manual are registered trademarks of their respective companies.

Compilation and Publication

Under the supervision of Brother Industries, Ltd., this manual has been compiled and published, covering the latest product descriptions and specifications.

The contents of this manual and the specifications of this product are subject to change without notice.

Brother reserves the right to make changes without notice in the specifications and materials contained herein and shall not be responsible for any damages (including consequential) caused by reliance on the materials presented, including but not limited to typographical and other errors relating to the publication.

This product is designed for use in a Professional Environment.

©2006 Brother Industries, Ltd. ©1998-2006 TROY Group, Inc.

©1983-2006 PACIFIC SOFTWARES INC.

This product includes the "KASAGO TCP/IP" software developed by Elmic Systems, Inc. ALL RIGHTS RESERVED.

brother®

US/CAN