

NETWORK CAMERA

VB-C50FSi/VB-C50Fi

User's Manual

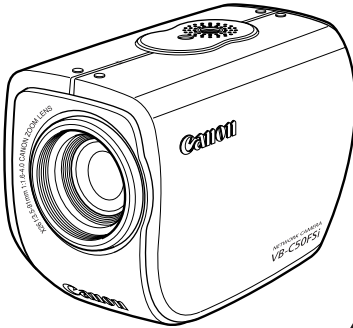

VB-C50FSi

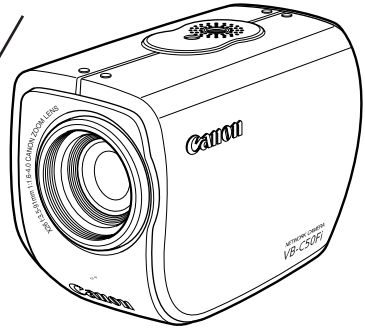

VB-C50Fi

Please read this User's Manual carefully before operation.
Be sure to read the "⚠ Safe Use of Equipment" section before using
this equipment. Store this manual in a readily accessible location for
future reference.

Introduction

Thank you for purchasing the Canon Network Camera VB-C50FSi/VB-C50Fi (referred to hereafter as the VB-C50FSi/VB-C50Fi).

This User's Manual describes how to set up and use the VB-C50FSi/VB-C50Fi. Read this manual carefully before using the VB-C50FSi/VB-C50Fi to ensure effective operation. In particular make sure that you read the "△ Safe Use of Equipment" in this manual, as well as the supplied CD-ROM ReadMe file.

For the latest information (firmware, software, manual and the hardware and software requirements, etc.) please refer to our WebView Product web page: <http://www.canon.com/webview>

Exclusion of Liability

If the Product is connected to a recording device (for example a VCR), Canon Inc. accepts no responsibility whatsoever for any financial losses that may be incurred as a result of the loss of recorded information or images, regardless of the internal or external cause of the loss.

On Copyrights

Videos, images or sounds taken or recorded with your VB-C50FSi/VB-C50Fi may not be utilized or published, without consent of copyright holders, if any, except in such a way as permitted for personal use under relevant copyright law.

Notes

1. The unauthorized transfer of all or any part of the contents of this Manual is forbidden.
2. The contents of this Manual are subject to change without notice.
3. Every effort has been made to ensure that this Manual is flawless. However, if you find any oversights, please let us know.
4. Notwithstanding the above, Canon accepts no responsibility for any effects resulting from the use of this Manual.

Trademark Notices

- Canon and Canon logo are registered trademarks of Canon Inc.
- Microsoft and Windows are registered trademarks of Microsoft Corporation in the United States and other countries.
- Windows is legally recognized as Microsoft Windows Operating System.
- Java and all Java-based marks are trademarks or registered trademarks of Sun Microsystems, Inc. in the United States and other countries.
- Other brand or product names in this manual may be trademarks or registered trademarks of their respective companies.

This product uses software based on the GNU General Public License (GPL), GNU Lesser General Public License (LGPL) and the BSD License. For each of the licenses, see GPL.txt, LGPL.txt and COPYING.txt in the LICENSE folder on the CD-ROM.

If you require the source code for a program based on GPL or LGPL, please see the following web site:

<http://www.canon.com/webview/webview-tech/>

Alternatively contact either the place of purchase or your nearest Canon Sales Company.

Usage Notice of Audio (VB-C50FSi only)

* Features related to audio transmission (audio sent from camera servers to viewers) written in this manual can be only used with the Model Name “VB-C50FSiN”.

Please refer to P.1-10 to confirm the Model Name of your VB-C50FSi.

- The audio and video may be out of sync.*
- The audio stream may be interrupted according to the performance of your PC and the network environment.
- You cannot record audio with the viewer software.*
- You can receive audio using the Viewer for PC or the Admin Viewer.*
- You can send audio and video to up to 50 clients. However, if there are a large number of clients, the audio stream may be interrupted.*
- The audio stream may be interrupted if you use a proxy server.
- The audio stream may be interrupted if you use anti-virus software.

Request concerning disclosure of live videos and audio

With respect to the disclosure of live videos and audio, we request that sufficient consideration be given to matters of privacy and rights not to be photographed.

Canon considers the following points concerning such matters when it operates camera sites for which it has been responsible to install and operate:

- We take measures such as adding limitations on zoom magnifications so that people cannot make special specifications.
- When videos are taken of specific buildings, interiors and the like, we install the camera only after receiving approval from the administrator.

Please note that the operator of the camera site and not Canon has full responsibility regarding the disclosure of live videos and audio.

* Audio features are only available on the VB-C50FSi.

© Copyright 2005 CANON INC.

ALL RIGHTS RESERVED

Package Contents

The VB-C50FSi/VB-C50Fi package contains the following items. If any of these items is missing, please contact the retailer from which you purchased the product.

1. VB-C50FSi main unit (or VB-C50Fi main unit)

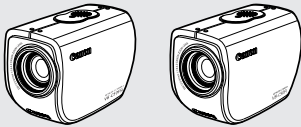

2. AC adapter PA-V16 (VB-C50Fi NTSC model only)

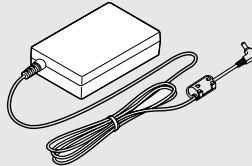

3. AC cable (1 meter/3 ft.) (VB-C50Fi NTSC model only)

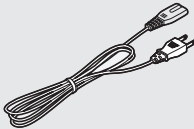

* The cable length may differ depending on the country in which the product was purchased.

5. User's Manual (This document)

6. Warranty card (NTSC model only)

4. CD-ROM



CD-ROM contents

ReadMe-J.txt (Japanese text containing precautions etc. other than those in this document)

ReadMe-E.txt (English text containing precautions etc. other than those in this document)

VBSetup.exe (Initial settings tool → P.2-8)*

MANUAL folder (PDF versions of this document and the Viewer software User's Manual)*

vbfiles folder (File system sets of sample pages etc.)

LICENSE folder (License documents for software built into the VB-C50FSi/VB-C50Fi)

VBTools folder (Bundled software installer set)*

SOUND folder (Sound sample files for Audio Playback)

* For the latest information of the bundled software and manual, please refer to our WebView Product web page:
<http://www.canon.com/webview>

Contents

Introduction	ii
Package Contents.....	iv
How to Read This Manual.....	ix
⚠ Safe Use of Equipment.....	x
Maintenance	xv

Chapter 1 Before Using the VB-C50FSi/VB-C50Fi

Features of the VB-C50FSi/VB-C50Fi	1-2
Hardware and Software Requirements	1-4
Viewer Software	1-4
VB Initial Setup Tool	1-5
VB Administration Tools	1-5
VBCollector	1-5
Multipoint Recording Software for Monitoring Use (Sold separately)	1-8
Viewer Software for Monitoring Use (Sold separately)	1-8
System Components and Their Operation	1-9
Multi-Terminal Module VB-EX50 (Sold Separately)	1-11

Chapter 2 Setting Up

Setup Workflow	2-2
1. Set Up the Camera	2-4
Using the Wide Converter	2-5
2. Connect the Camera to the Network	2-6
Turning the Power ON and OFF	2-7
3. Perform Initial Settings for the Camera	2-8
4. Check Operation of the Camera	2-11
5. Install the Software	2-13
Viewer Software Overview	2-14
Viewer Software Types	2-14
Features of the Viewer Software	2-14

Chapter 3 Basic Settings

What Can I Do on Each of the Settings Pages?	3-2
Accessing the Settings Title Page	3-3
Settings Title Page	3-4
Setting Up the Administrator Password and Ethernet etc. (System and Network)	3-5
Setting Camera Control, Image Size and Quality (Camera and Video)	3-8

Presetting Best Shot (Preset)	3-12
Setting Up the HTTP, Camera and Audio Servers (Server)	3-15
Setting User Access Privileges (Access Control)	3-20
Setting the Date and Time (Date and Time)	3-23
Setting Up Name Server Address and Mail etc. (Miscellaneous)	3-25
Using the Administration Tools (Administration Tools)	3-28

Chapter 4 VB Administration Tools

Overview of VB Administration Tools	4-2
Installing the VB Administration Tools	4-2
VBAdmin Startup Panel	4-3
Panorama Creation Tool	4-3
View Restriction Tool	4-3
Preset Setting Tool	4-3
Schedule Setting Tool	4-4
Log Viewer	4-4
Admin Viewer	4-4
Starting Up VB Administration Tools	4-5
View Restriction Tool	4-7
View Restriction Tool Display Screen	4-8
Setting View Restrictions	4-10
Preset Setting Tool	4-13
Preset Setting Tool Display Screen	4-14
Setting Presets	4-16
Preset Tour	4-19
Schedule Setting Tool	4-22
Schedule Setting Tool Display Screen (Toolbar)	4-23
Normal Schedule	4-24
Special Schedule	4-28
Resetting Schedule Settings	4-32
Setting Up Service	4-33
Timer Setting Tool	4-34
Motion Detection Setting Tool	4-37
Night Mode Setting Tool	4-48
External Device Input Setting Tool	4-50
External Device Output Setting Tool	4-53
Log Viewer	4-58
Viewing the Log	4-59
Admin Viewer	4-61
Starting Up Admin Viewer	4-62
Operating External Devices and Motion Detection	4-62
Enabling/Disabling View Restrictions	4-64

Operating a Camera	4-64
Camera-Specific Functions	4-66
Sending and Receiving* Audio (VB-C50FSi only)	4-67
Shade Correction	4-69
Auto Reconnection Function	4-69
Restoring the Default Exposure and Focus Settings When Closing the Admin Viewer ..	4-70

Chapter 5 Creating Web Pages for Video Distribution

Web Pages for Video Distribution	5-2
Viewer Overview	5-4
Viewer for Java	5-4
Viewer for PC	5-5
Viewing Sample Pages	5-6
Using the Viewer for Java to Distribute Videos	5-7
Using the Viewer for Java to Create a Web Page	5-7
Saving Web Page Data	5-8
Example of Using the Viewer for Java to Create a Web Page	5-9
Viewer for Java Parameters	5-17
Using the Viewer for PC to Distribute Videos	5-21
Setting Up the Web Server	5-21
Creating wvh Files	5-22
Example of a Web page Using the Viewer for PC	5-23
Distributing Videos Using a Browser Only	5-24
Displaying the Live Video at Access as a Still Picture	5-24
Displaying a Specified Number Of Live Video Frames As a Video at Access	5-24
Displaying Live Video from a Specified Zoom Magnification as Still Pictures	5-25
Example of Video Distribution Using One Global Address	5-26
Distributing Still Images to a Mobile Phone	5-27
Overwriting Sample Pages	5-28

Chapter 6 Using the Picture Recording Function

Using the Still Picture Recording Function	
Linked to an External Device	6-2
Sample Application Combining a Door-opening Sensor	6-2
Using the Audio Playback/Recording Function	
Linked to an External Device	6-4
Sample Application Combining a Speaker, Microphone and Door-opening Sensor....	6-4
Using the Still Picture Recording Function	
with a Predetermined Schedule	6-6
Sample Application Using a Timer	6-6
Using the Motion Detection Function with a Predetermined Schedule ...	6-8
Sample application in combination with a warning device	6-8

Using VBCollector	6-11
Installing VBCollector	6-12
Starting Up VBCollector	6-13
Registering a Server	6-13
Registering Tasks	6-16
Executing and Canceling Tasks	6-18
Details Displayed on the Task View	6-20
Starting/Stopping the Service	6-20
Automatic Downloading by Notification	6-21
Viewing Recorded Images and Playing Back Recorded Audio	6-23
Viewing Logs	6-32
Setting Retention Period and Disk Space	6-36

Chapter 7 Appendix

Troubleshooting	7-2
Log Messages	7-4
The VB-C50FSi/VB-C50Fi Log Messages	7-4
The VBCollector Log Messages	7-12
Specifications	7-16
External Device I/O Terminals	7-17
System Configuration	7-18
Example of Basic System Configuration – Viewing Videos Using a Viewer	7-18
Viewer Software Functions	7-18
Sample Network Configurations	7-19
Sample LAN Environment Configuration	7-19
Sample Configuration in an ISP Environment	7-19
Upgrading the Firmware Remotely	7-20
Restoring the Factory Default Settings	7-21
Restoring the Factory Default Settings from the Administration Tools Page via a Web Browser	7-21
Restoring the Factory Default Settings from the Reset Switch	7-22
Factory Default Setting	7-23
Data Capacity of Recorded Pictures and Audio	7-25
Amount of Memory	7-25
Frame Sizes	7-25
Amount of Audio Data	7-26
Index	7-27

How to Read This Manual

For information about setting up the VB-C50FSi/VB-C50Fi



**User's Manual
(This document)**

Read this manual carefully before using the VB-C50FSi/VB-C50Fi.

For information about using the Viewer



**Viewer Software
User's Manual
(Viewer-E.pdf)**

This manual describes how to use the Viewer for Java and the Viewer for PC.

Sections where the user should refer to this manual are indicated by the  icon accompanied by the relevant page number.

Safe Use of Equipment



An exclamation point, within a triangle, is intended to alert the user to the presence of important operating and maintenance (servicing) instructions in the literature accompanying the equipment.

Important Warnings

CAUTION:

TO REDUCE THE RISK OF ELECTRIC SHOCK, DO NOT REMOVE COVER (OR BACK). NO USER-SERVICEABLE PARTS INSIDE. REFER SERVICING TO QUALIFIED SERVICE PERSONNEL.

The serial number of this equipment may be found on the rear side of the VB-C50FSi/VB-C50Fi. No others have the same serial number as yours.

You should record the number and other vital information here and retain this book as a permanent record of your purchase to aid identification in case of theft.

Date of Purchase

Dealer Purchased from

Dealer Address

Dealer Phone No.

Model No. VB-C50FSi or VB-C50Fi

Serial No.

For Users in the UK (PA-V16)

When replacing the fuse only a correctly rated approved type should be used and be sure to re-fit the fuse cover.

The AC adapter can be connected to the VB-C50FSi/VB-C50Fi from a standard AC power outlet. Please check your instruction manual to make sure that your VB-C50FSi/VB-C50Fi is compatible with this adapter.

- The socket-outlet should be installed near the equipment and should be easily accessible.
- Unplug the apparatus from the wall outlet before cleaning or maintaining.

Important Operational Instructions

WARNING:

TO REDUCE THE RISK OF ELECTRIC SHOCK, DO NOT EXPOSE THIS EQUIPMENT TO RAIN OR MOISTURE.

CAUTION:

TO REDUCE THE RISK OF ELECTRIC SHOCK AND TO REDUCE ANNOYING INTERFERENCE, USE THE RECOMMENDED ACCESSORIES ONLY.

FDA regulation

This Network Camera has not been evaluated by the Food and Drug Administration (FDA) for use as a medical device. When incorporated into a system with medical applications, FDA regulations may apply. Therefore, please consult your legal advisor to determine whether FDA regulations apply.

FCC NOTICE

Network Camera, Model Name: VB-C50FSiN, VB-C50FSiP, VB-C50FiN, VB-C50FiP

This device complies with Part 15 of the FCC Rules. Operation is subject to the following two conditions: (1) This device may not cause harmful interference, and (2) this device must accept any interference received, including interference that may cause undesired operation.

Note: This equipment has been tested and found to comply with the limits for a Class B digital device, pursuant to Part 15 of the FCC Rules. These limits are designed to provide reasonable protection against harmful interference in a residential installation. This equipment generates, uses and can radiate radio frequency energy and, if not installed and used in accordance with the instructions, may cause harmful interference to radio communications. However, there is no guarantee that interference will not occur in a particular installation. If this equipment does cause harmful interference to radio or television reception, which can be determined by turning the equipment off and on, the user is encouraged to try to correct the interference by one or more of the following measures:

- Reorient or relocate the receiving antenna.
- Increase the separation between the equipment and receiver.
- Connect the equipment into an outlet on a circuit different from that to which the receiver is connected.
- Consult the dealer or an experienced radio/TV technician for help.

Use of shielded cable is required to comply with class B limits in Subpart B of Part 15 of FCC Rules.

Do not make any changes or modifications to the equipment unless otherwise specified in the manual. If such changes or modifications should be made, you could be required to stop operation of the equipment.

Canon U.S.A. Inc.

One Canon Plaza, Lake Success, NY 11042, U.S.A.

Tel No. (516) 328-5600

Canadian Radio Interference Regulations

This Class B digital apparatus complies with Canadian ICES-003.

Réglementation canadienne sur les interférences radio

Cet appareil numérique de la classe B est conforme à la norme NMB-003 du Canada.

Dieses Produkt ist zum Gebrauch im Wohnbereich, Geschäfts- und Gewerbebereich sowie in Kleinbetrieben vorgesehen.

△ IMPORTANT SAFETY INSTRUCTIONS

In these safety instructions, the word “equipment” refers to the Canon Network Camera VB-C50FSi/VB-C50Fi and all its accessories.

1. Read Instructions - All the safety and operating instructions should be read before the equipment is operated.
2. Retain Instructions - The safety and operating instructions should be retained for future reference.
3. Heed Warnings - All warnings on the equipment and in the operating instructions should be adhered to.
4. Follow Instructions - All operating and maintenance instructions should be followed.
5. Cleaning - Unplug this equipment from the wall outlet before cleaning.
Wipe the equipment with a clean soft cloth. If necessary, put a cloth in diluted neutral detergent and wring it well before wiping the equipment with it. Finally, clean the equipment with a clean dry cloth. Do not use benzene, thinner or other volatile liquids or pesticides as they may damage the product's finish. When using chemically-treated cleaning cloths, observe those precautions accordingly.
6. Accessories - Do not use accessories not recommended in this manual as they may be hazardous. Always use specified connection cables. Connect devices correctly.
7. Water and Moisture - Hazard of electric shock - Do not use the equipment near water or in rainy/moist situations. Do not put a heater near this equipment.
8. Placing or Moving - Do not place on an unstable cart, stand, tripod, bracket or table. The equipment may fall, causing serious injury to a child or adult, and serious damage to the equipment. An equipment and cart combination should be moved with care.

9. Power Sources - The PA-V16 AC adapter should be operated only from the type of power source indicated on the marking label. If you are not sure of the type of power supply to your home, consult your equipment dealer or local power company.
10. Polarization - The PA-V16 AC adapter is equipped with a polarized 2-prong plug (a plug having one blade wider than the other). The 2-prong polarized plug will fit into the power outlet only one way. This is a safety feature. If you are unable to insert the plug fully into the outlet, try reversing the plug. If the plug still fails to fit, contact your electrician to replace your obsolete outlet. Do not defeat the safety purpose of the polarized plug.
11. Power Cord Protection - Power cords should be routed so that they are not likely to be walked on or pinched by items placed upon or against them. Pay particular attention to plugs and the point from which the cords exit the equipment.
12. Outdoor Antenna Grounding - If an outside antenna is connected to the equipment, be sure the antenna is grounded so as to provide some protection against voltage surges and built-up static charges. Section 810 of the National Electrical Code, ANSI/NFPA No.70-1984, provides information with respect to proper grounding of the mast and supporting structure, grounding of the lead-in wire to an antenna discharge unit, size of grounding conductors, location of antenna, antenna discharge unit, connection to grounding electrodes, and requirements for the grounding electrode. See figure 1.

fig-1

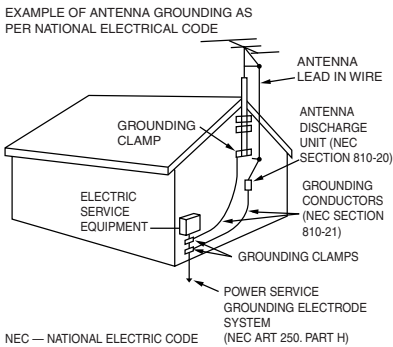

13. **Lightning** - For added protection of this equipment during a lightning storm, or when it is left unattended and unused for long periods of time, disconnect it from the wall outlet and disconnect the antenna. This will prevent damage to the equipment due to lightning and power-line surges.
14. **Power Lines** - An outside antenna system should not be located in the vicinity of overhead power lines or other electric light or power circuits, or where it can fall into such power lines or circuits. When installing an outside antenna system, extreme care should be taken to keep from touching such power lines or circuits as contact with them might be fatal.
15. **Overloading** - Do not overload wall outlets and extension cords as this can result in a risk of fire or electric shock.
16. **Object and Liquid Entry** - Never push objects of any kind into this equipment through openings as they may touch dangerous voltage points or short out parts that could result in a fire or electric shock. Be careful not to spill liquid of any kind onto the equipment.
17. **Servicing** - Do not attempt to service this equipment yourself as opening or removing covers may expose you to dangerous voltage or other hazards. Refer all servicing to qualified personnel.
18. **Damage Requiring Service** - Disconnect this equipment from the wall outlet and all power sources including batteries, and refer servicing to qualified service personnel under the following conditions.
 - a. When the power-supply cord or plug is damaged.
 - b. If any liquid has been spilled onto, or objects have fallen into, the equipment.
 - c. If the equipment has been exposed to rain or water.
 - d. If the equipment does not operate normally even if you follow the operating instructions. Adjust only those controls that are covered by the operation instructions. Improper adjustment of other controls may result in damage and will often require extensive work by a qualified technician to restore the equipment to its normal operation.
 - e. If the equipment has been dropped or the cabinet has been damaged.
 - f. When the equipment exhibits a distinct change in performance. This indicates a need for service.
19. **Replacement Parts** - When replacement parts are required, be sure the service technician has used replacement parts that are specified by Canon or that have the same characteristics as the original part. Unauthorized substitutions may result in fire, electric shock or other hazards.
20. **Safety Check** - Upon completion of any service or repairs to this equipment, ask the service technician to perform safety checks to determine that the equipment is in safe operating order.
21. Do not install the equipment in the following locations as this can cause a fire or electric shock:
 - Hot locations
 - Close to a fire
 - Very humid or dusty locations

- Locations exposed to direct sunlight
- Locations exposed to salt spray
- Close to flammable solvents (alcohol, thinners, etc.)

22. When any of the following occurs, immediately switch OFF the equipment, unplug it from the main power supply and contact your nearest Canon supplier. Do not continue to use the equipment as this can cause a fire or electric shock.

- The equipment emits any smoke, heat, abnormal noise, or unusual odor.
- A metal object falls into the equipment.
- The equipment is damaged in some way.

23. Please observe the following when using the equipment. Failure to do so can result in a fire or electric shock.

- Do not use flammable sprays near the equipment.
- Do not subject the equipment to strong impacts.

⚠ **Notes on Using PoE Hubs**

⚠ **CAUTION:**

- Only use IEEE 802.3af-compliant PoE hubs or midspans. See our WebView Product web page <http://www.canon.com/webview> for details.
- When both of a PoE hub and the AC Adapter are connected to the VB-C50FSi, it runs on the power supply from the PoE hub.
- Some PoE hubs allow the current used by each port to be restricted, but the VB-C50FSi may not operate correctly when such restrictions are applied. Do not use such restrictions with the VB-C50FSi.
- Some PoE hubs allow the total current consumed on each port to be restricted, but the hub may not operate correctly if multiple ports are used. Refer to the user's manual for your PoE hub.
- Use a cable that conforms to the category 5 or higher standard as the LAN cable (max. 100 m).

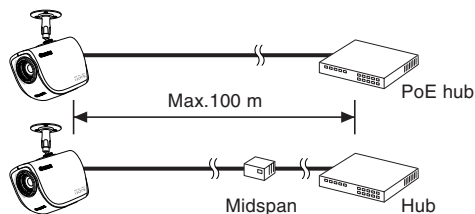



Notes on Using the Motion Detection Function and VBCollector

The Motion Detection Function (→ P.4-37) and VBCollector (→ P.6-11) are not suited to applications where high levels of reliability are required. Therefore, we recommend that you not use these functions for monitoring or other purposes if consistently high levels of reliability are required. Canon accepts no liability whatsoever for faults resulting from the use of the Motion Detection Function and VBCollector.

Maintenance

Cleaning the Equipment

1. **Unplug the AC adapter from the wall outlet.**
If you are using a PoE hub or midspan, disconnect the LAN cable also (VB-C50FSi only).
2. **Carefully wipe the equipment with a soft cloth that has been moistened with water or a mild detergent.**

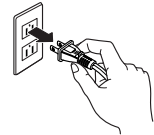

WARNING:

Do not use flammable solvents such as alcohol, benzene or thinners.

The use of such substances can cause a fire or electric shock.

3. **Wipe with a dry cloth.**
4. **When you have finished, plug the AC adapter back in to the wall outlet.**

Cleaning the Lens

Use a commercially available lens cleaner to remove any soiling from the lens.

- The auto-focus may not function correctly if the surface of the lens is dirty.
- Scratches on the surface of the lens will cause image defects.

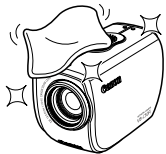

Icons Used in This Instruction Manual



Indicates important information that must be observed or actions that are prohibited during an operation. These notes must be read to prevent possible faults or damage to the equipment.



Indicates supplementary information or a reference to an operation. Users are advised to read these memos.



Refer to the PDF manual on the supplied CD-ROM.

Chapter **1**

Before Using the VB-C50FSi/VB-C50Fi

This chapter describes the features of the VB-C50FSi/VB-C50Fi, the hardware and software requirements, and the name and functions of the system components.

Features of the VB-C50FSi/VB-C50Fi

The VB-C50FSi/VB-C50Fi is a system that distributes live videos via the Internet or an intranet. It can be used in a wide range of applications, such as distributing live videos from a Web site or monitoring. The system is configured for the VB-C50FSi/VB-C50Fi and viewer software. Please use the supplied viewer software for viewing videos distributed by the VB-C50FSi/VB-C50Fi and controlling cameras (→ P.1-4, 2-14).

■ Broadband Video Distribution function

The VB-C50FSi/VB-C50Fi is capable of capturing videos at up to 30 fps (NTSC)/25 fps (PAL). Motion-JPEG type is used to compress video images. For networking, auto-negotiation between Ethernet 100Base-TX/10Base-T is provided and a leased line or ADSL can also be used through a router. Since video quality and the frame rate can be freely set, videos can be distributed under conditions that best suit the network bandwidth.

* Please refer to P.1-10 to confirm whether your VB-C50FSi/VB-C50Fi is PAL model or NTSC model.

■ Concurrent video is distributed up to 50 clients

Up to 50 clients can view video at the same time from a single VB-C50FSi/VB-C50Fi.

■ High-performance 26x zoom camera and video distribution server functions housed in a single unit

The camera capable of full zoom function (high-performance 26x zoom) and its server functions for distributing videos through a network are compactly housed in a single unit. By simply connecting a LAN cable and a power supply, the unit can distribute live videos from any location* where it is installed.

* The unit cannot be installed in locations subject to direct sunlight, high temperatures, high humidity, or other adverse conditions (→ P.xiii, xiv).

■ Can be mounted on ceilings, etc.

The VB-C50FSi/VB-C50Fi can be installed on the ceiling or a wall using a mounting arm*.

* The unit cannot be installed in locations subject to direct sunlight, high temperatures, high humidity, or other adverse conditions (→ P.xiii, xiv).

■ Built-in PoE (Power over Ethernet) function (VB-C50FSi)

By using an IEEE 802.3af-compliant PoE hub or midspan, power can be supplied to the VB-C50FSi via a LAN cable. This simplifies the installation process since there is no need to fit power outlets at each camera location.

* Use only approved PoE hubs or midspans. (→ P.2-6)

* The LAN cable used to connect the VB-C50FSi to a PoE hub or midspan should be no more than 100 meters long.

■ Remote camera control from the viewer

The VB-C50FSi/VB-C50Fi comes with two types of viewer software: the Viewer for PC and the Viewer for Java. The viewers give you full remote control of the camera zoom magnification of the VB-C50FSi/VB-C50Fi, allowing you to view videos with plenty of ambiance.

■ Shade Correction function

If the background of an image is bright, making the subject difficult to see, you can adjust the contrast of the darker areas to make it easier to see. Unlike backlight compensation, the shade correction feature allows image processing without adversely affecting the existing lighter regions.

■ Zoom Position Preset function

If often-used camera zoom positions and related items are saved in advance as presets, the camera can be controlled from the viewer by simply selecting a desired preset. Up to 10 presets can be stored.

■ View Restriction function

You can set restrictions on camera zoom magnifications. For example, if the VB-C50FSi/VB-C50Fi is showing camera footage on the Internet, it is possible to distribute videos while protecting privacy (→ P.iii, “Request concerning disclosure of live videos and audio”).

■ More powerful security functions

The destinations for video distributions can be restricted based on passwords. Up to 50 clients can be registered.

■ Using preset schedules or links with external devices to record pictures or audio*

Using the Multi-Terminal Module (→ P.1-11), you can set picture and audio recording* based on ON/OFF input from an external device and from previously-set schedules. If VBCollector is used, images and sound recorded* by the VB-C50FSi/VB-C50Fi can be automatically collected so that you can view the images and play back the audio data* on a PC.

* Audio recording and Audio Playback functions are only available on the VB-C50FSi.

* Only available with a particular model of the VB-C50FSi (→ P.iii)

■ Audio Playback (VB-C50FSi)

Using the Multi-Terminal Module (→ P.1-11), you can connect a speaker with amp to the camera. Then, you can register your favorite audio files or sample files recorded on a CD-ROM and play the registered files based on ON/OFF input from an external device and from previously-set schedules.

■ Audio transmission (VB-C50FSi)

Using the Multi-Terminal Module (→ P.1-11), you can connect a microphone* and speaker with amp to the camera and then send and receive audio* via the Viewer.

* Only available with a particular model of the VB-C50FSi (→ P.iii)

■ Night mode shooting

By canceling the infrared cut filter, you can increase the camera’s sensitivity and take pictures even in very dimly lit situations.

■ Motion detection function

You can perform external device control, video and audio recording* by detecting changes in the image caused by motion of people or objects.

* Only available with a particular model of the VB-C50FSi (→ P.iii)

■ Service settings with schedule function

You can start up motion detection and external device services by setting up a visual and easy-to-understand schedule in the calendar.

Hardware and Software Requirements

For the latest information (firmware, software, manual and the hardware and software requirements, etc.), please refer to our **WebView Product web page**:<http://www.canon.com/webview>

Viewer Software (→ Viewer Software User's Manual)

The viewer software that is supplied with the VB-C50FSi/VB-C50Fi lets you view the video captured by the VB-C50FSi/VB-C50Fi and control the camera.

Viewer for Java Ver. 3.6

Operating System/ Web Browser	Windows 2000 (SP4)/Microsoft Internet Explorer 6.0 (SP1), Netscape 7.1 or 7.2 Windows XP (SP1a)/Microsoft Internet Explorer 6.0 (SP1), Netscape 7.1 or 7.2 Windows XP (SP2)/Microsoft Internet Explorer 6.0 (SP2), Netscape 7.1 or 7.2 Windows Server 2003 Standard Edition /Microsoft Internet Explorer 6.0, Netscape 7.1 or 7.2 Windows Server 2003 Standard Edition (SP1) /Microsoft Internet Explorer 6.0 (SP1), Netscape 7.1 or 7.2
Java VM	MSVM Release 5.0.0.3810 (Java VM provided by Microsoft) Java Plug-in 1.4.2 (Java VM provided by Sun Microsystems)

- * Java VM must be installed beforehand. If the Java VM provided by Microsoft has not been installed, please access Sun Microsystems Website to download the Java VM provided by Sun Microsystems.
- * This viewer may not run stably on operating systems and Web browsers other than those listed above.

Viewer for PC Ver. 3.6

Operating System/ Web Browser	Windows 2000 (SP4)/Microsoft Internet Explorer 6.0 (SP1), Netscape 7.1 or 7.2 Windows XP (SP1a)/Microsoft Internet Explorer 6.0 (SP1), Netscape 7.1 or 7.2 Windows XP (SP2)/Microsoft Internet Explorer 6.0 (SP2), Netscape 7.1 or 7.2 Windows Server 2003 Standard Edition /Microsoft Internet Explorer 6.0, Netscape 7.1 or 7.2 Windows Server 2003 Standard Edition (SP1) /Microsoft Internet Explorer 6.0 (SP1), Netscape 7.1 or 7.2
------------------------------------------	------------------------------------------------------------------------------------------------------------------------------------------------------------------------------------------------------------------------------------------------------------------------------------------------------------------------------------------------------------------------------------------------------------------------------------------------------------

- * Must be installed from the supplied CD-ROM (→ P.2-13).



- The manual for the viewer software is on the supplied CD-ROM (Viewer-E.pdf).
- Although older versions of viewers can be used, some of the features are different. Therefore, we recommend you to use the latest version.

VB Initial Setup Tool Ver. 2.1 (→ P.2-8)

This tool is for performing initial settings for the VB-C50FSi/VB-C50Fi.

Operating System/ Web Browser	Windows 2000 (SP4)/Microsoft Internet Explorer 6.0 (SP1) Windows XP (SP1a)/Microsoft Internet Explorer 6.0 (SP1) Windows XP (SP2)/Microsoft Internet Explorer 6.0 (SP2) Windows Server 2003 Standard Edition/Microsoft Internet Explorer 6.0 Windows Server 2003 Standard Edition (SP1)/Microsoft Internet Explorer 6.0 (SP1)
------------------------------------------	-------------------------------------------------------------------------------------------------------------------------------------------------------------------------------------------------------------------------------------------------------------------------------------------------------------------------------------------

VB Administration Tools Ver. 2.2 (→ P.4-2)

This tool lets you set view restrictions and presets visually and easily. You can also set schedules with this tool.

Operating System/ Web Browser	Windows 2000 (SP4)/Microsoft Internet Explorer 6.0 (SP1) Windows XP (SP1a)/Microsoft Internet Explorer 6.0 (SP1) Windows XP (SP2)/Microsoft Internet Explorer 6.0 (SP2) Windows Server 2003 Standard Edition/Microsoft Internet Explorer 6.0 Windows Server 2003 Standard Edition (SP1)/Microsoft Internet Explorer 6.0 (SP1)
------------------------------------------	-------------------------------------------------------------------------------------------------------------------------------------------------------------------------------------------------------------------------------------------------------------------------------------------------------------------------------------------

* Must be installed from the supplied CD-ROM (→ P.2-13).

VBCollector Ver. 3.0 (→ P.6-11)

This tool is for collecting and viewing pictures and audio recorded* by the VB-C50FSi/VB-C50Fi on a PC.

* Only available with a particular model of the VB-C50FSi (→ P.iii)

Operating System/ Web Browser	Windows 2000 (SP4)/Microsoft Internet Explorer 6.0 (SP1) Windows XP (SP2)/Microsoft Internet Explorer 6.0 (SP2) Windows Server 2003 Standard Edition/Microsoft Internet Explorer 6.0 Windows Server 2003 Standard Edition (SP1)/Microsoft Internet Explorer 6.0 (SP1)
Hard Disk	Minimum 4 GB required for each camera server. 30 GB or larger recommended (NTFS format)

* Must be installed from the supplied CD-ROM (→ P.2-13).

* Pictures saved in VBCollector version 2.1 or earlier cannot be viewed in VBCollector 3.0. During installation, you can choose whether to uninstall old versions of VBCollector (→ P.6-12).

* If you configure your system to record pictures per second with camera servers and perform the maximum of 16 tasks (→ P.6-17) at the same time, it is recommended that you use a desktop PC with Pentium 4 2.2 GHz and 512 MB RAM or greater.

* It is recommended that you configure to collect up to 10,000 still pictures/day per a camera server. If the total amount of still pictures exceeds this value, it may take several minutes to display all the pictures.

* Running VBCollector on a PC that is already running the Network Video Recorder VK-64/VK-16 (sold separately) is not recommended due to the high CPU load. They should be run on separate PCs.



Note

Using the VB-C50FSi/VB-C50Fi with Windows XP SP2...

If you use the VB Initial Setup Tool or VBCollector with Windows XP SP2, you will need to change your Windows firewall settings on your PC.

VB Initial Setup Tool

If you installed the VB Initial Setup Tool on a PC with Windows XP SP2 and try to launch the tool, you may encounter a Windows Security Alert dialog.

If the Windows Security Alert dialog appears, click Unblock. Once you click the Unblock button, the dialog box will not be displayed again.

Settings are now complete.

VBCollector

If you installed the VBCollector on a PC with Windows XP SP2 and used the Automatic Download by Notification function, please follow the procedures as described below.

After installation of the VBCollector:

1. From the Windows Start menu, launch the Control Panel.

2. In Control Panel, select Windows Firewall.

If Windows Firewall is not shown, select "Security Center" and then select "Windows Firewall".

3. In the Windows Firewall dialog box, select the Exception tab and then click Add Program.

4. In the Add a Program dialog box, click Browse.

In the Browse dialog box, select the location where you installed the VBCollector and enter the file name as "VBCICSM.exe".

5. In the Windows Firewall dialog box, your program is now listed. Make sure it is enabled (checked). Click OK to close the dialog box.

Settings are now complete.

If you finish setting the VB Initial Setup Tool (initial settings) or wish to stop the Automatic Download by Notification function using VBCollector, we recommend you to restore your Windows firewall settings on your PC.

1. Launch the Windows Firewall dialog box and then select the "Exception" tab (Refer to 1, 2 and 3 processes of the "VBCollector" for details).

2. Select a program you wish to restore and click "Delete".

VB Initial Setup Tool: VB Initial Setup Tool Ver. 2.1

VBCollector: VBCICSM.exe

3. A confirmation dialog appears. Click "Yes" to delete the program.



Using the VB-C50FSi/VB-C50Fi with Windows Server 2003...

Note

With Windows Server 2003 Standard Edition running Microsoft Internet Explorer 6.0 and Windows Server 2003 Standard Edition (SP1) running Microsoft Internet Explorer 6.0 (SP1), the default security level for the Internet or intranet sites in Internet Explorer is “High”. As a result, windows such as the settings window do not function normally unless you first register the site in the contents block dialog box that appears when you access the camera server top page (→ P.2-11). Register the site to ensure normal functioning.

1. When you access the camera server top page in Internet Explorer, the dialog box shown at right appears.

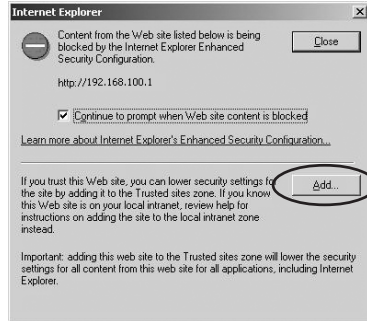

2. Click the [Add] button. The dialog box for adding Trusted sites then appears.



3. Enter the IP address of the VB-C50FSi/VB-C50Fi in the “Add this Web site to the zone” box and then click the [Add] button to register the camera as a trusted site.

For more information on registering trusted sites, click “Learn more about Internet Explorer’s Enhanced Security Configuration...” in the dialog box in step 1 and refer to the summary provided.

If you have enabled the Windows firewall settings with Windows Server 2003 Standard Edition (SP1), please refer to the “Using the VB-C50FSi/VB-C50Fi with Windows XP SP2...” (→ P.1-6) and follow the instructions.

1

Before Using the VB-C50FSi/VB-C50Fi

Multipoint Recording Software for Monitoring Use (Sold separately)

Videos distributed from the VB-C50FSi/VB-C50Fi can be recorded, and recorded video can be displayed with the software.

Network Video Recorder VK-64/VK-16 v1.1 (Viewer System Requirements)

	Minimum	Recommended
CPU	Pentium III, 700 MHz or greater	Pentium 4 2.2 GHz or greater
Operating System	Windows 2000 Server* Windows 2000 Professional* Windows XP Professional (with SP1 recommended, SP2) Windows Server 2003 Standard Edition without SP (with SP1 recommended) *With SP3 or SP4 (SP4 recommended).	Windows XP Professional (with SP1)
Memory	256 MB RAM or greater	1 GB RAM or greater For more than 16 Camera Servers, 1 GB or greater required.
Hard Disk	2 GB HDD or greater	
Display	1024 × 768 with 16 bit color	1024 × 768 with 16 bit color A high performance video card is desirable. With PCI video cards, display performance may be reduced.

Network Video Recorder VK-64/VK-16 v1.1 (Storage Server System Requirements)

	Minimum	Recommended
CPU	Pentium III 1 GHz or greater	Pentium 4 2.2 GHz or greater
Operating System	Windows 2000 Server* Windows 2000 Professional* Windows XP Professional (with SP1 recommended, SP2) Windows Server 2003 Standard Edition without SP (with SP1 recommended) *With SP3 or SP4 (SP4 recommended).	Windows 2000 Server (with SP4) Windows XP Professional (with SP1) Windows Server 2003 Standard Edition (with SP1)
Memory	768 MB RAM or greater	1 GB RAM or greater For more than 48 Camera Servers, 1.5 GB or greater required.
Hard Disk	20 GB HDD or greater, SCSI or IDE, NTFS formatted	

The requirements for Storage Server will vary according to the environment you will use (number of Camera Servers, setting of recording frame rate etc.). Please contact dealers that handle Canon products for further information.

Viewer Software for Monitoring Use (Sold separately)

If WebView Livescope MV Ver. 2.1 is used, up to 16 viewer screens can be displayed and monitored. There is also a limited edition of MV Ver. 2.1, called MV LE, which allows up to 4 viewer screens to be displayed.

WebView Livescope MV Ver. 2.1/LE

PC	CPU: Pentium III 600 MHz or greater, RAM: 128 MB or greater Hard disk capacity: 50 MB or greater (MV), 20 MB or greater (LE)
Operating System	Windows Me/Windows 2000 (SP1)/Windows XP
Web Browser	Microsoft Internet Explorer 5.0 required
Display	XGA (1024 × 768) or better, 16-bit color display or better

System Components and Their Operation

Front

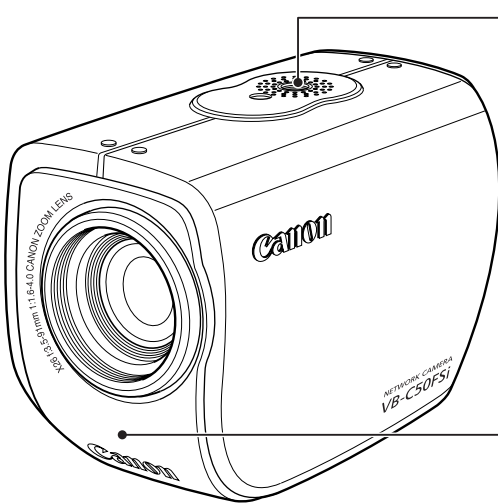

Screw hole for arm mounting

LAN status LED

The LED blinks during communication.

100Base-TX Green

10Base-T Orange

* You can set the LED to always light up even during communication. In this case, you can select from a green, orange or red light color. You can also set the LED not to light up (→ P.3-27).



Note

The only outwardly visible difference between the VB-C50FSi and VB-C50Fi is the model name printed on the casing. The names and functions of the components are the same.

1

Before Using the VB-C50FSi/VB-C50Fi

Rear

On the rear of the VB-C50FSi/VB-C50Fi there are the MAC address required for network settings, a Reset switch that returns the factory default settings and the serial number.

MAC address

The MAC address is required when setting the IP address and making other network settings. Please make a note of it before installing this unit (→ P.2-9).

Model Name

	VB-C50FSi	VB-C50Fi
NTSC	VB-C50FSiN	VB-C50FiN
PAL	VB-C50FSiP	VB-C50FiP

Serial No.

The serial number for this unit is shown here.

Reset switch

You can revert all settings of the unit to the factory default settings by pressing this button with a thin-tipped object while turning on the power switch, and keeping the button pressed for more than five seconds after turning on (→ P.7-22).

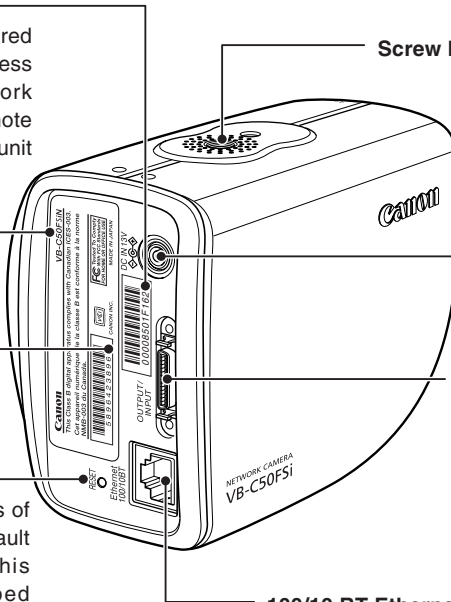

Screw hole for arm mounting

Power connection socket

Multi-connector

You can connect the Multi-Terminal Module VB-EX50 to the VB-C50FSi/VB-C50Fi via the connector (→ P.1-11).

100/10 BT Ethernet connector

(100Base-TX, 10Base-T Auto-Negotiation)
On the VB-C50FSi, this can also be used to connect to a PoE hub or midspan.

* The connector is oriented differently on the VB-C50Fi.

Bottom

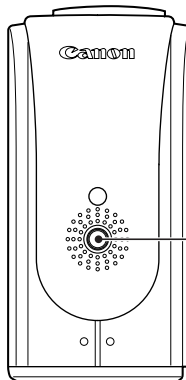

Screw hole for tripod mounting

Multi-Terminal Module VB-EX50 (Sold Separately)

Using the Multi-Terminal Module VB-EX50, you can connect external devices such as different kinds of sensors, a microphone* and speaker to the unit, and you can store images by sensor response, or send and receive* audio (→ P.7-17).

Please note that the Multi-Terminal Module VB-EX50 is an optional product and is therefore sold separately.

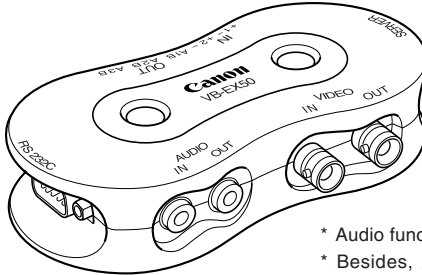

- * Audio function is available with VB-C50FSi.
- * Besides, Audio input is only available with a particular model of the VB-C50FSi (→ P.iii).

Example of Use

With the Multi-Terminal Module, you can perform settings such as the following.

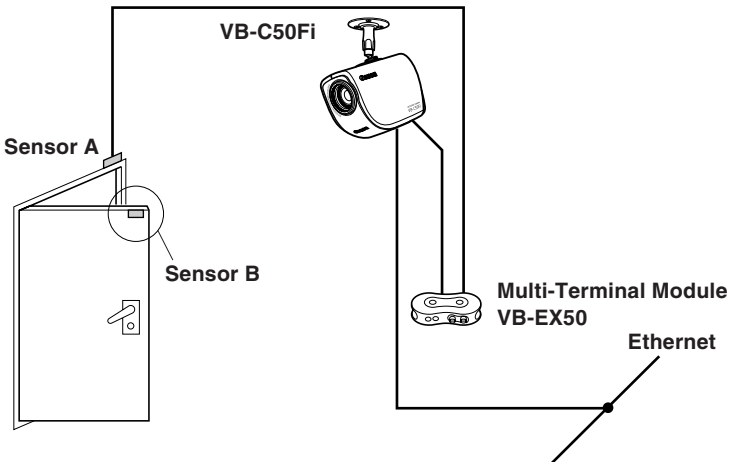

- The door open-close sensor responds when the door is opened and with the VB-C50Fi installed on the ceiling, you can photograph an image and monitor the scene every second for 3 seconds before the door opens and for 7 seconds after the door is opened (→ P.6-2).



Tip

By using a speaker with amp and microphone* connected to the VB-C50FSi, the Viewer Administrator can converse with the person in front of the camera, hear and record* the sounds in the background (→ P.3-18, 3-19)

* Only available with a particular model of the VB-C50FSi (→ P.iii)

1

Before Using the VB-C50FSi/VB-C50Fi

Chapter



Setting Up

This chapter explains how to set up the VB-C50FSi/VB-C50Fi, run initial checks, and confirm that the camera's images are displayed correctly.

Setup Workflow

The flow for setting up and checking the camera's images involves performing various settings after the device is set up and your PC and the network are connected via the hub. Then, check to see if you can display images from the camera.

1 Set up the camera

Set up the device.
Make sure the device is set up properly (→ P.2-4).



VB-C50FSi

2 Connect the camera to the network

Connect the camera and your PC via the hub (→ P.2-6).

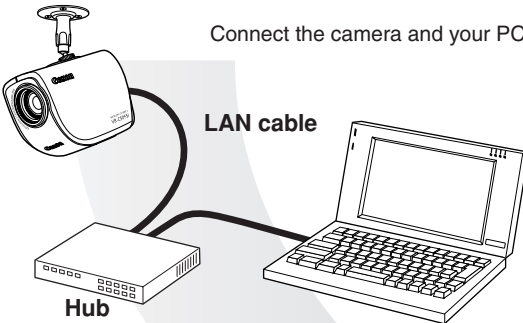

3 Perform initial settings for the camera

Insert the CD-ROM provided into your PC and perform initial settings following instructions on the screen (→ P.2-8).

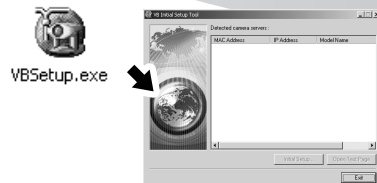
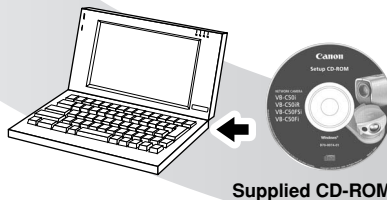

5 Install the software

Install the required software in advance for operating the camera (→ P.2-13).



4 Check operation of the camera

Access the device with your PC, then display to check the image from the top page of the camera server (→ P.2-11).

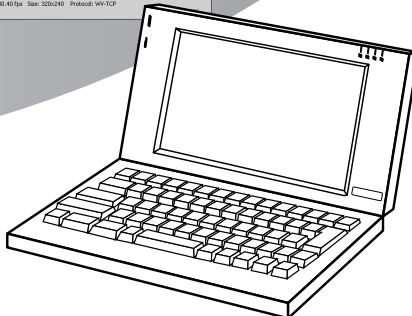
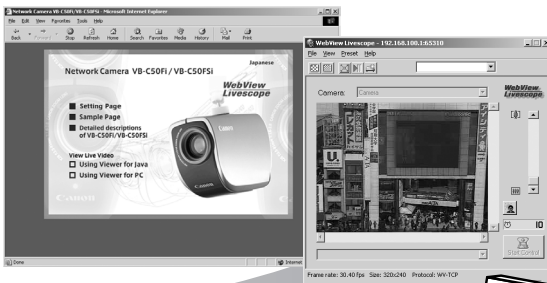

1. Set Up the Camera

Firstly, set up the camera. Read the following carefully and make sure the camera is set up properly.

Mounting the Camera to the Ceiling or Wall

Attach a mounting arm (not included) to the ceiling or a wall and firmly attach the camera to the arm.

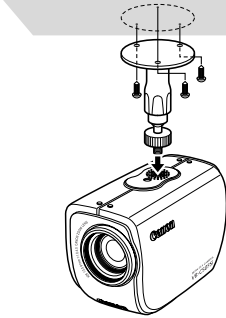

When Using a Tripod

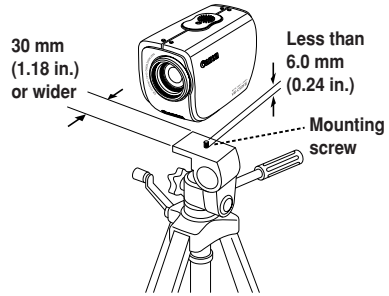

WARNING:

Install the camera securely.

- When installing the VB-C50FSi/VB-C50Fi on the ceiling or a wall, contact your Canon dealer.
- When installing the VB-C50FSi/VB-C50Fi on the ceiling or a wall, check that it is strong enough to bear the weight of the VB-C50FSi/VB-C50Fi including the mounting arm. Installation in a weak location could result in the VB-C50FSi/VB-C50Fi falling and causing serious injury. Check that the ceiling can hold either 3 times the weight of the camera and arm or 8kgs (whichever is heavier) for 1 minute.
- When attaching the arm to the ceiling, make sure that the screws are tightly fastened. The arm and camera may fall if the screws are not tightly fastened, which may cause serious injury.
- At least once a year, check for looseness in the camera installation mount. (If the optional wide converter is used, check the converter mount also).
- Do not install the arm in a place that shakes or vibrates frequently as the screws may come loose causing the camera to fall or be damaged, which in turn may cause serious injury.



Note

- The MAC address required when making network settings is shown on the rear of the VB-C50FSi/VB-C50Fi (→ P.1-10). Please make a note of it before installing this unit.
- Always use a tripod mounting screw that is less than 6.0 mm (0.24 in.) in length. The use of screws 6.0 mm (0.24 in.) long or longer could damage the camera. Also, the tripod seat used should be at least 30 mm (1.18 in.) in diameter.

Using the Wide Converter

The optional Wide Converter WL-37 can be used to provide wide-angle shots (approx. 0.74× the normal focal distance).

Mount the wide converter correctly so that it is level and fitted securely onto the camera. When mounted correctly, the wide converter should turn roughly 3 times before stopping.

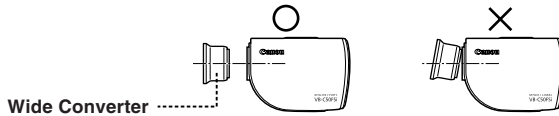

Note

- The camera may not operate correctly if a wide converter other than the WL-37 is used.
- Be sure to install the VB-C50FSi/VB-C50Fi firmly because the weight of the camera increases when the optional Wide Converter WL-37 is attached.
- If you use the optional Wide Converter WL-37, set the zoom lens to the wide-angle end. If you set the zoom lens to the telephoto end, the image resolution will be affected and the auto focus might have problems.

Setup is now complete.

2. Connect the Camera to the Network

Next, connect the camera. Connect the camera to the network by connecting the camera and PC via the hub with a LAN cable .

* Do not plug the AC cable power plug into the wall socket yet.

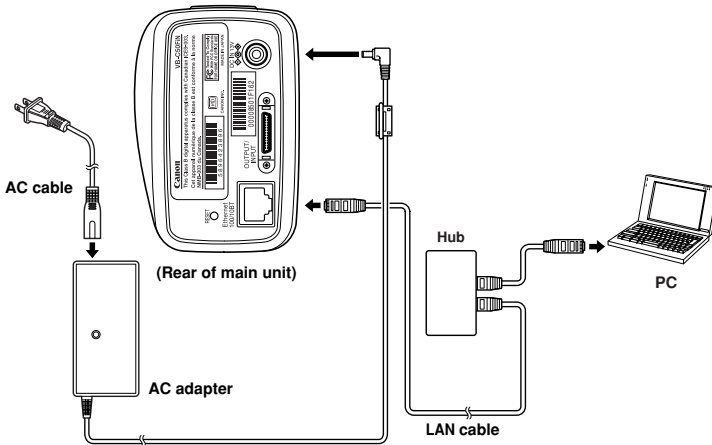

The VB-C50FSi is equipped with a PoE (Power over Ethernet) function. This allows power to be supplied to the camera from an IEEE 802.3af-compliant PoE hub or midspan via a LAN cable.

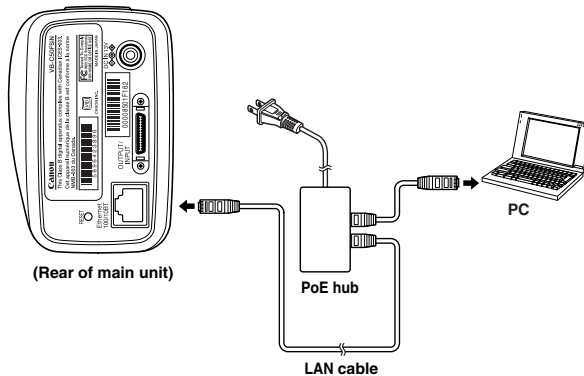

Note

- Use only approved PoE hubs or midspans. See our WebView Product web page <http://www.canon.com/webview> for details.
- For information on how to use the PoE hub or midspan, refer to the user's manual supplied with the hub.
- The LAN cable used to connect the VB-C50FSi to a PoE hub should be no more than 100 meters long.

Turning the Power ON and OFF

The VB-C50FSi/VB-C50Fi itself does not have a power switch. You can switch the VB-C50FSi/VB-C50Fi on by plugging the AC adapter into a wall outlet. The LED flashes when the VB-C50FSi/VB-C50Fi is communicating. When the power supply is turned ON, the LED momentarily flashes.

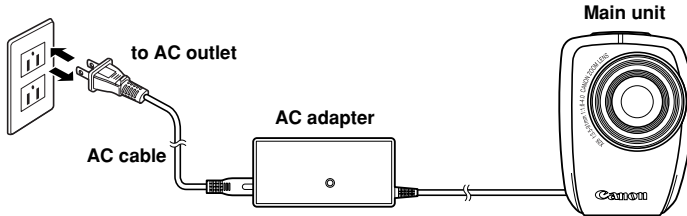

When power is supplied to the VB-C50FSi via a LAN cable using a PoE hub, connecting the LAN cable to a hub that is being supplied with power will turn the VB-C50FSi on.

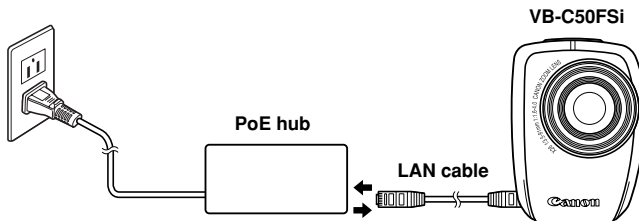

Note

- Wait at least 5 seconds before turning the power back on after shutting it off. Turning it on too quickly may result in a malfunction. Observe the precautions given in “ \triangle Safe Use of Equipment/ \triangle IMPORTANT SAFETY INSTRUCTIONS” (→ P.xii).
- If the picture and audio recording* function is being used, shutting off the power or restarting the VB-C50FSi/VB-C50Fi will delete all the pictures and audio*.
- * Only available with a particular model of the VB-C50FSi (→ P.iii)
- For information on turning the PoE hub on and off, refer to the user's manual supplied with the hub.
- When power is supplied to the VB-C50FSi from a PoE hub, the AC adapter can also be connected to the camera. In this configuration, because the PoE hub power supply takes priority when power is supplied from the hub, the AC adapter power is not used. If the PoE supply is cut, the power supply is automatically switched to the AC adapter.

The network connection is now complete.

3. Perform Initial Settings for the Camera

Once your PC and the camera are connected, perform the initial settings next. The instructions here follow on from “2. Connect the Camera to the Network”, where one camera is connected to a PC as an example.

Installation Example

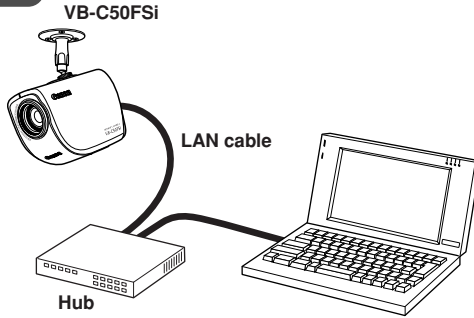

1. Turn on the network device (in this case, the hub) and then your PC.



Note

- Do not turn on the camera at this stage.
- If you are using a PoE hub or midspan with the VB-C50FSi, do not connect the LAN cable.

2. Insert the CD-ROM provided into your PC and from Explorer etc. double-click “VBSetup.exe” to start the VB Initial Setup Tool. Turn on the VB-C50FSi/VB-C50Fi. If you are using a PoE hub or midspan, connect the LAN cable.

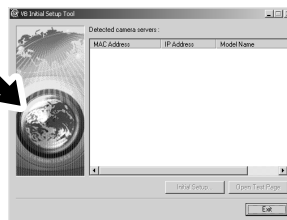
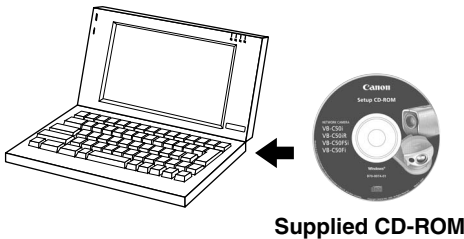

3. The camera connected to the network is automatically detected and its MAC address, IP address and model name are displayed.

The factory default setting is:

IP address : 192.168.100.1

The MAC address can be found on the white label attached on the rear of the unit.

Note that VBSetup.exe cannot be used across subnets.

Click the MAC address to select it, and click the “Initial Setup” button.

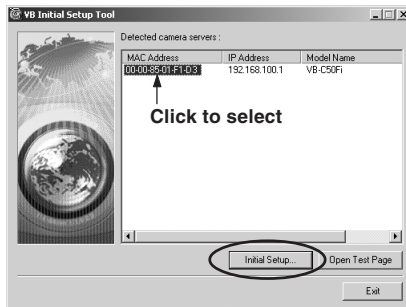

4. Enter the user name “root” and the factory default password “VB-C50i” and enter the IP address and subnet mask.

If you want to specify a default gateway address, enable the “Set the default route to Ethernet” check box and then enter the default gateway address.

Although the time zone and video signal can also be specified here, there is basically no need to change the time zone setting.

Once you have entered your settings, click the “OK” button.

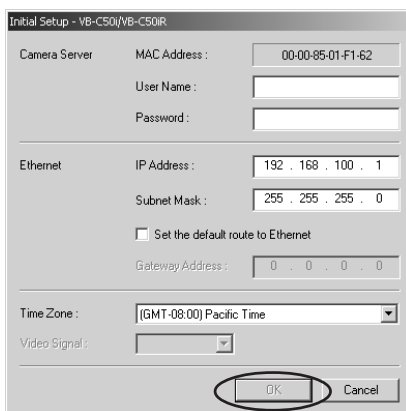

Note

For Windows XP SP2 users, see “Using the VB-C50FSi/VB-C50Fi with Windows XP SP2” (→ P.1-6). This Note holds true for users who have turned on Windows Firewall with Window Server 2003 Standard Edition (SP1).



Tip

- The factory default password for the VB-C50FSi/VB-C50Fi is “VB-C50i”.
- The MAC address for this unit is shown on the rear of the VB-C50FSi/VB-C50Fi (→ P.1-10).
- The IP address **192.168.100.1** is used as the factory default setting. Please set an IP address that suits the environment in which the VB-C50FSi/VB-C50Fi is to be used.

5. A setup progress window appears and your settings will be saved.

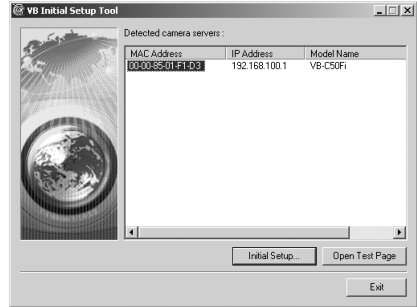

Note

- Set the IP address to a value that suits your environment.
- Where the IP address has been automatically obtained from the DHCP server, you cannot change the IP address setting from the VB Initial Setup Tool. Change the IP address from the Network Settings page (→ P.3-6).
- Please consult with your network administrator for the IP address, subnet mask and default gateway address settings.
- If 20 minutes or more have passed since the VB-C50FSi/VB-C50Fi was turned on, the VB-C50FSi/VB-C50Fi stops sending requests for IP addresses allocation and they cannot be detected using this tool. If this occurs, restart the VB-C50FSi/VB-C50Fi.
- To restore the factory default settings, refer to page 7-21.
- If you are using the Multi-Terminal Module and are changing the connection of the VB-C50FSi/VB-C50Fi and external camera, be sure to do this after having turned off the power of these 2 devices. After changing the connection, turn on the external camera first and then the VB-C50FSi/VB-C50Fi.

Initial settings are now complete.

4. Check Operation of the Camera

When you have completed the initial setup, check that the VB-C50FSi/VB-C50Fi works normally. Use the sample page to simplify checking.

1. Select the MAC address you want to check operation of and then click the "Open Test Page".

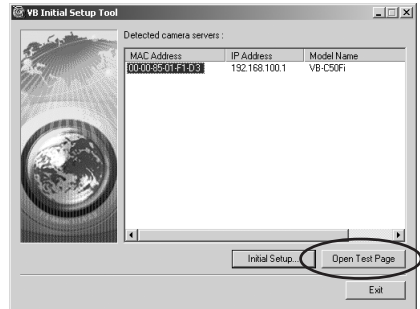

2. Your Web browser starts up and the top page of the camera server appears. Click the "Using Viewer for Java" or the "Using Viewer for PC" and check that the video is displayed properly.

Below is a description of what happens when you click "Using Viewer for Java".

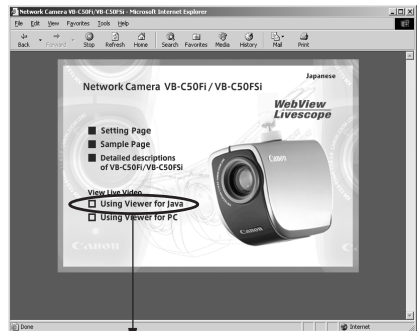

Camera Selection box
Allows you to switch cameras when an external camera is connected.

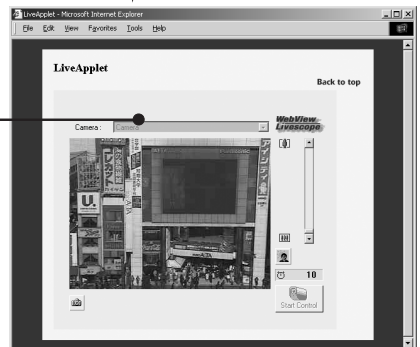

For Windows Server 2003 users, see "Using the VB-C50FSi/VB-C50Fi with Windows Server 2003" (→ P.1-7).



Tip

- To use the Viewer for Java, you need to install Java VM beforehand. See the web site for more details.
WebView Product web site <http://www.canon.com/webview>
- To use the Viewer for PC, you must install the Viewer for PC beforehand (→ P.2-13).

Check of operation is now complete.

5. Install the Software

You must install software to display images from the camera and to manage the camera. There are 3 types of software you can install.

- VB Administration Tools: Software for managing the camera (→ P.4-2).
 - Viewer for PC: Software for displaying images from the camera (→ P.2-14).
 - VBCollector: Software that allows you to collect pictures and audio recorded* by the camera on a PC and view the recorded images and play back the audio data* on the PC (→ P.6-11). When using older versions of VBCollector, please refer to page 6-12.
- * Only available with a particular model of the VB-C50FSi (→ P.iii)

1. Check that all other applications are closed, insert the CD-ROM included with the camera into the CD-ROM drive of your PC and follow the steps below.

- ① Double-click [My Computer] on the desktop.
If you are using Windows XP, click the [Start] button and then [My Computer].
- ② Double-click the CD-ROM icon displayed and then double-click the [VBTools] folder.
- ③ Double-click [VBToolsInstall.exe] to start the installation.



VBToolsInstall

2. Once the starting screen has appeared, select the installation method.

Easy Installation: VB Administration Tools and Viewer for PC are automatically installed. The basic software required is installed easily.

Custom Installation: Select whether you want to install the VB Administration Tools, the Viewer for PC or the VBCollector.



3. Follow the instructions on the screen to install the software.

Installation is now complete.

Viewer Software Overview

By using the Viewer software, you can view images sent from the VB-C50FSi/VB-C50Fi on a PC, as well as control the camera. Below is an outline of the Viewer software. For details, please refer to “Viewer Overview” (→ P.5-4) or to the Viewer Software User’s Manual (Viewer-E.pdf) on the CD-ROM.

Viewer Software Types

There are 2 types of viewers described below.

● Viewer for PC

When started up, this viewer displays as a separate window. The viewer is installed beforehand on the PC to be used. For installation details, please refer to “5. Install the Software” in this Chapter (→ P.2-13).



● Viewer for Java

The viewer appears in the Web browser. You need to install Java VM beforehand. See the web site for more details.

WebView Product web site

<http://www.canon.com/webview>



Features of the Viewer Software

- **Pan, tilt control***: You can control pan and tilt with the scroll bars.
- **zoom control**: You can control zoom with the scroll bars.
- **Backlight adjustment**: You can brighten the image when it is dark due to backlight.
- **Panorama window display***: You can control the camera by clicking on the panorama window or by dragging the frame inside the window.
- **Image saving and printing**: You can save and print snapshots of live images.
- **Audio reception (Viewer for PC only)**: You can receive audio sent from the VB-C50FSi. (Only available with a particular model.)

* Not available with the VB-C50FSi/VB-C50Fi.

Hardware and Software Requirements

Please refer to “Hardware and Software Requirements” (→ P.1-4).

Handling of Video and Audio

Please refer to “Introduction” (→ P.iii).

Chapter

3

Basic Settings

This chapter describes the basic settings for the VB-C50FSi/ VB-C50Fi such as network connection, camera control, date and time setting and mail. Be sure to perform these settings after setting up.

*** The VB Administration Tools (→ P.4-2) described in Chapter 4 provide a convenient way to set view restrictions as well as presets.**

What Can I Do on Each of the Settings Pages?

Proceed to each of the settings pages from the Settings Title Page where you can perform various settings for the VB-C50FSi/VB-C50Fi. The settings you can perform on each of the pages are shown below. For more details, see the reference pages.

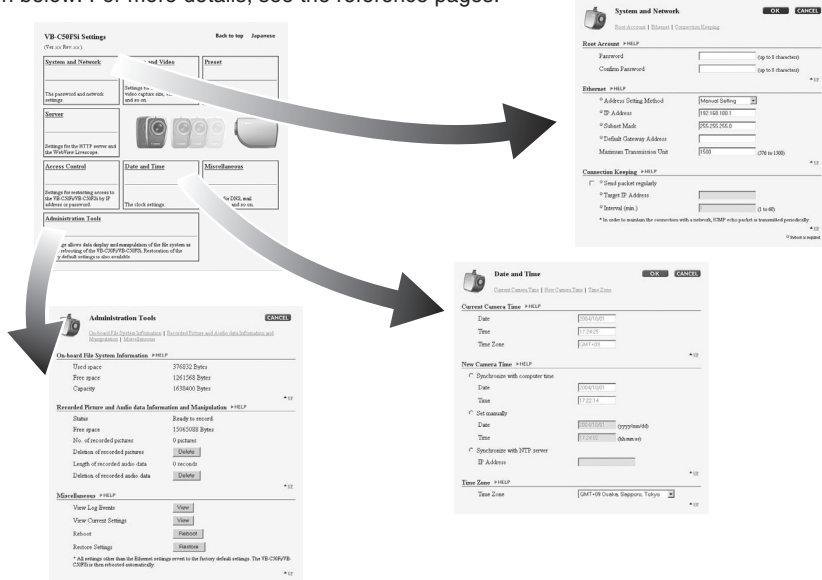

- **System and network**
For setting administrator passwords and networks (Ethernet, network connection function) (→ P.3-5)
- **Camera and Video**
For setting video capture (image size and quality etc.), camera control (shutter speed, focus, home position and view restriction etc.), camera names (→ P.3-8)
- **Preset**
For setting Presets (specified zoom magnification) and Preset Tour (→ P.3-12)
- **Server**
For setting maximum number of clients, maximum connection time, restricting service time, HTTP, camera and audio servers (VB-C50FSi only) (→ P.3-15)
- **Access Control**
For setting authorized user accounts and authorized/restricted host specification (→ P.3-20)
- **Date and time**
For setting current camera time display, new camera time and time zone (→ P.3-23)
- **Miscellaneous**
For setting DNS (name server address), mail addresses for sending recorded pictures, external devices such as sensor and LED (→ P.3-25)
- **Administration Tools**
Display of used/free space and capacity of on-board file system, display of recorded data status and deletion of recorded data, miscellaneous (display of event log and current settings, reboot and restore the factory default settings) (→ P.3-28)



The VB Administration Tools described in Chapter 4 provides a convenient way to set view restrictions and presets.

Accessing the Settings Title Page

The various settings on the VB-C50FSi/VB-C50Fi are specified by using a browser to access Web pages on the VB-C50FSi/VB-C50Fi. To begin with, access the **Settings Title Page**.



Note

This manual uses the IP address 192.168.100.1 (the factory default setting) below as an example to describe the detail settings. Please enter the actual IP address that is set in your VB-C50FSi/VB-C50Fi.

1. Use the browser to access <http://192.168.100.1/admin/>.

Enter the IP address which you set up in “Perform Initial Settings for the Camera” (→ P.2-8). Alternatively, access the top page of the camera server (→ P.2-11) and click the “Setting Page”.

2. Enter the user name and password.

In the factory default settings, the user name is “root” and the password is “VB-C50i” (→ P.7-23).

* The password for the VB-C50FSi/VB-C50Fi is “VB-C50”. Be sure to change the password on the System and Network settings page (→ P.3-5).



The Setting Title Page appears.

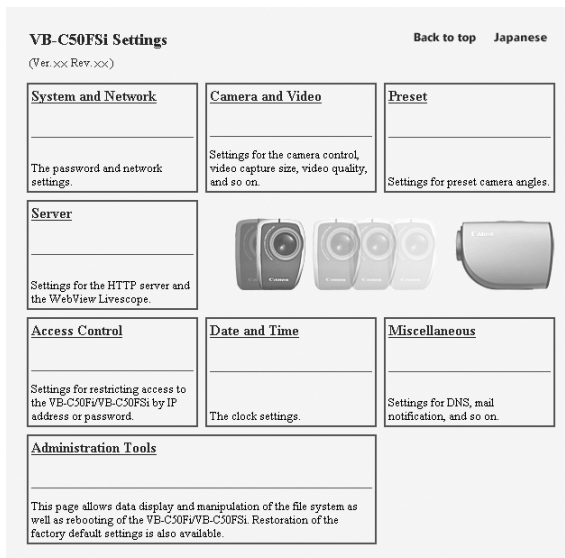

* VB-C50FSi screen

Settings Title Page

From the Settings Title Page, you can move to each settings page, confirm the settings after changing, and save the changes to the VB-C50FSi/VB-C50Fi's memory or restart.

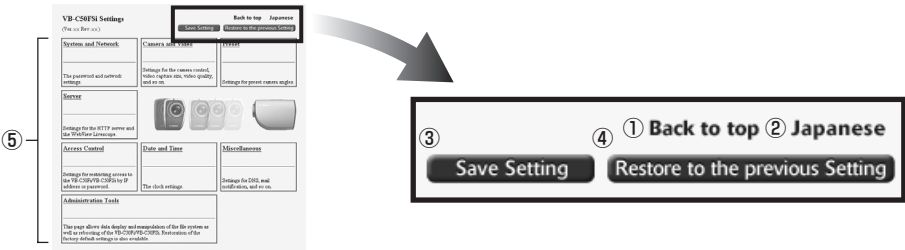

① “Back to top” button

Click “Back to top” to move to the top page of the camera server.

② “Japanese” or “English” button

Click this display to show the settings page in Japanese. The display then changes to “English” and when clicked, switches back to the English settings page.

③ “Save Setting” or “Save Setting and Reboot” button

Make changes on any of the pages, click the “OK” button and return to the Settings Title Page. At this stage, however, changes to the settings have not yet been sent to the VB-C50FSi/VB-C50Fi. Click the “Save Setting” button and the changes are confirmed and sent to the VB-C50FSi/VB-C50Fi. Where it is necessary to restart the VB-C50FSi/VB-C50Fi to make the change, the “Save Setting and Reboot” button is displayed.

Where the setting values have not been changed, these 2 buttons are not displayed.

④ “Restore to the previous Setting” button

Click if you want to discard the changes you have made to the settings on each page. All changes are cancelled and return to the values before you made the change.

⑤ Each of the settings page titles

Click to move to each settings page.



Note

- Do not open multiple web browser windows at the same time to change settings in parallel.
- Do not use the “Back” and “Forward” buttons in your browser to move between settings pages. Due to the effects of caching, there are possibilities that an old settings page will appear, settings will return to their original values, or unintended changes will occur.
- When you change the settings, you should always click the “Save Setting”, or the “Save Setting and Reboot” button.



Tip

- If you are using the camera to record video and audio*, rebooting deletes all the recorded video and audio.*

* Only available with a particular model of the VB-C50FSi (→ P.iii)

- Those settings that require the VB-C50FSi/VB-C50Fi to be restarted for the changes to take effect are indicated with a red mark.

○ Address Setting Method

Manual Setting



You can perform the following settings with System and Network.

- **Root Account:** For setting up passwords.
- **Ethernet:** For setting up IP addresses and other settings necessary for connection to the network.
- **Connection Keeping:** For setting up the function whereby packets are periodically transmitted and there is automatic dial-up by the router so that the connection with the network is not broken.

When you have made changes to the settings, click the “OK” button to return to the Settings Title Page. If you do not make any changes, click the “Cancel” button.

Root Account



① “Password”

Set the password. Up to 8 ASCII characters can be used (spaces or printable characters). The default setting is “VB-C50i”.

② “Confirm Password”

Confirm the password in the field above.



- For reasons of system security, you must change the root account password. However, be sure to remember the password (→ P.7-23) so that you do not forget it.
- If you have forgotten the password, press the Reset switch and restore the factory default settings (→ P.7-22). **However, note that all settings are restored to the factory default settings.**

Ethernet

Ethernet ▶HELP		
①	<input type="radio"/> Address Setting Method	Manual Setting
②	<input type="radio"/> IP Address	192.168.100.1
③	<input type="radio"/> Subnet Mask	255.255.255.0
④	<input type="radio"/> Default Gateway Address	
⑤	<input type="radio"/> Maximum Transmission Unit	1500 (376 to 1500)

① “Address Setting Method”

Select an address setting method from “Auto Setting (DHCP)” or “Manual Setting”. If you select “Auto Setting (DHCP)”, you can use the values automatically obtained from the DHCP server for “IP Address”, “Subnet Mask” and “Default Gateway Address”. If you select “Manual Setting”, directly enter values which suit your environment.

② “IP Address”

Enter a network interface-specific IP address.

③ “Subnet Mask”

Enter the subnet mask specified for the network to be connected.

④ “Default Gateway Address”

Set this item when you want to connect to a different subnet within the intranet or a wide area network such as the Internet.

⑤ “Maximum Transmission Unit”

Enter the maximum transmission unit size to be sent at one time. There is normally no need to change this from 1500.

If you are using ADSL, the efficiency of data transmission may be improved if you slightly lower the value. When you are using Ethernet, maintain the value at 1500.



Note

- Contact the network administrator for the IP address, subnet mask and default gateway address settings.
- Take particular care with the IP address, subnet mask and default gateway address settings. If errors are found in any of these items, you may be completely unable to access the VB-C50FSi/VB-C50Fi via Ethernet and it may only be possible to recover the problem by using the Initial Setup Tool (→ P.2-8) to correct the error.

Connection Keeping

Connection Keeping ▶HELP

① ◦ Send packet regularly

② ◦ Target IP Address

③ ◦ Interval (min.) (1 to 60)

* In order to maintain the connection with a network, ICMP echo packet is transmitted periodically.

▲UP

- ① **“Send packet regularly”**
Check to enable this function.
- ② **“Target IP Address”**
Specify where the packet should be sent.
- ③ **“Interval (min.)”**
Specify the interval at which a packet should be sent from 1 to 60 (min.).

Setting Camera Control, Image Size and Quality (Camera and Video)



Camera and Video

OK

CANCEL

[Video Capture](#) | [Camera Control](#) | [Camera Names](#)

You can perform the following settings with Camera and Video.

- Video Capture: For setting image size and quality.
- Camera Control: For setting the camera shutter speed, focus, home position and view restrictions.
- Camera Names: Enter camera names. A camera name is required when you use an external camera or the VK-64.

When you have made changes to the settings, click the “OK” button to return to the Settings Title Page. If you do not make any changes, click the “Cancel” button.

Video Capture

Video Capture ▶HELP

① Video Capture Size

Video Transmission

Motion Detection

Picture Recording

② Video Quality (Q-Factor)

Small Size (160x120)

Medium Size (320x240)

Large Size (640x480)

③ Interlace Mode

④ Use External Video Input

▲UP

① “Video Capture Size”

Select an image size for “Video Transmission”, “Motion Detection” and “Picture Recording”. For “Motion Detection”, select either “Medium Size” or “Small Size” as the image size.

*Please refer to P.1-10 to confirm whether your VB-C50FSi/VB-C50Fi is PAL model or NTSC model.

Large Size: 640 × 480 (NTSC), 768 × 576 (PAL)

Medium Size: 320 × 240 (NTSC), 384 × 288 (PAL)

Small Size: 160 × 120 (NTSC), 192 × 144 (PAL)

② “Video Quality (Q-Factor)”

Select a value from 10-100 (in 10 levels) . The greater the value, the better the quality. However, since data size will also be larger, higher-quality pictures may lower the frame rate (→ P.7-25). Also, if you select “Not used”, you cannot set that size in “Video Capture Size”.

③ “Interlace Mode”

Select either “Weave (Interlace)” (for subjects which move a little) or “Bob (Non-Interlace)” (for subjects which move a lot), according to the range of the movement.

You can obtain high-resolution video if you set “Video Capture Size” to “Large Size”. However if the subjects move quickly and sharply, you may encounter comb-shaped blurs in the video. “Bob” is more effective for quickly moving subjects.

④ “Use External Video Input”

You can use an external video input connected to the Multi-Terminal Module VB-EX50 with the switching method (→ P.1-11).

Camera Control

The screenshot shows the 'Camera Control' menu with the following settings:

- ① Shutter Speed: Auto
- ② Focus Mode: Auto
- ③ Home Position:
 - Zoom: (1.97 to 41.26)
 - Brightness: Standard
 - Return to Home Position when nobody has a control privilege.
- ④ Apply View Restriction:
 - Telephoto: (1.97 to 41.26)
 - Wide-angle: (1.97 to 41.26)
- ⑤ Wide Converter: Not used

① “Shutter Speed”

Set the camera shutter speed. Select the shutter speed for the camera from “Auto”, “1/60” or “1/100” for NTSC, or “Auto”, “1/50” or “1/120” for PAL.

② “Focus Mode”

Set the focusing mode for the camera.

Select the focusing mode for the camera from “Auto” (for auto focus), “Auto (for domes)” (for the camera used in combination with a dome housing so that auto focus does not focus on the camera dome wall surface) or “Fixed at infinity” (for focusing on infinity).

* “Auto (for domes)” and “Fixed at infinity” is not available if you configure the Night Mode settings (→ P.4-48, 4-66).



Note

If dust or rain adheres to the dome, focusing may occur on the dome wall. Please place the dome wall and the camera as closely together as possible when using.



- The camera may have difficulty focusing automatically on subjects of the type shown below.



Subjects with little or no contrast (a white wall, for example)

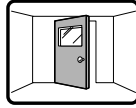

Angled subjects



Highly reflective subjects

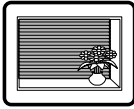

Subjects that consist entirely of oblique or horizontal lines or stripes

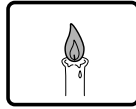

Insubstantial subjects such as flames or smoke

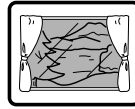

Subjects seen through glass

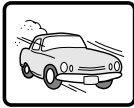

Quickly moving subjects

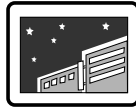

Night views or dark places

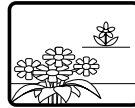

Far and near subjects in a frame

- The figure below shows the effective focusing range. At some zoom settings, the camera may not be able to focus on the subject.

Changes in the distance from the camera to the subject

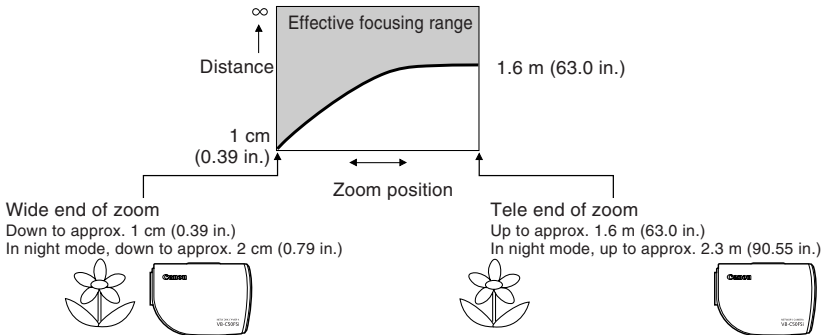

③ “Home Position”

Specify a home position for the camera.

“Zoom”

Set the value for the camera’s angle of zoom.

“Brightness”

Set the target value for the camera’s auto exposure feature. Select “Brighter” if the picture is too dark due to backlight or other factors.

“Return to Home Position when nobody has a control privilege”

When this option is checked and the home position is specified, the camera is returned to the specified settings if there is no request for control privileges.

④ “Apply View Restriction”

If you check the “Apply View Restriction” option, the settings below are enabled. Use this setting to prevent clients from seeing certain camera zoom positions. **Using the VB Administration Tools is a convenient way to set the view restrictions** (→ P.4-7).

“Telephoto, Wide-angle”

Set the zoom angles provided to users. (Specify settings so that the telephoto setting is less than or equal to the wide-angle setting.)

⑤ “Wide Converter”

When you have attached a wide converter to the camera, be sure to select “Used”.

Camera Names

① Camera Names ▶HELP

Built-in Camera

Camera Name (up to 15 characters)

External Camera

Camera Name (up to 15 characters)

▲UP

① “Camera Name”

Used in the camera selection box on the viewers. This setting is required.

Presetting Best Shot (Preset)



You can perform the following settings with Preset.

- Common Settings: For setting the tour schedule of present position.
- Preset 1-10: You can register up to 10 specified zoom magnifications as preset positions.

When you have made changes to the settings, click the “OK” button to return to the Settings Title Page. If you do not make any changes, click the “Cancel” button.

Common Settings

Common Settings ▶HELP

Restrict Camera Control to Presets

Auto Preset Tour Not used

Tour Schedule

Up
Down
Delete

Preset Speed (Z) Pause (sec.)
1 1 0 Add

Restrict Preset Tour Time

Start Time Hour 0 (0 to 23)
Minute 0 (0 to 59)

End Time Hour 0 (0 to 23)
Minute 0 (0 to 59)

▲UP

① **“Restrict Camera Control to Presets”**

Camera control by using the Viewer for PC and the Viewer for Java can be restricted to the preset zoom positions specified in Preset 1-10.

“Auto Preset Tour”

Select a Preset Tour setting from the following options.

“Not used”

Preset Tour does not operate.

“For Viewers”

Operates if any of the Viewer for Java, Viewer for PC or Admin Viewer is connecting.

“Always”

Preset Tour always operates.

“Tour Schedule”

Select the Preset number you want to set up in the Tour Schedule from “Preset” below, and after setting “Speed (Z)” and “Pause (sec.)”, click the “Add” button and the Presets are listed. You can also set up the start time and end time of the Preset Tour.

“Up” button and “Down” button

Select a Preset in the list, click the “Up” or “Down” button to change the order of the Preset Tour.

“Delete” button

Delete the selected Preset.

“Preset”

Select the number of the Preset you want to set up.

“Speed (Z)”

Set up the camera speed when zooming. The larger the numeric value, the faster the camera will move.

“Pause (sec.)”

Set the length of time the camera will pause in the Preset position, from 0-120 seconds in units of five seconds.

“Add” button

Add the Preset you have set to the Tour Schedule.

② **“Restrict Preset Tour Time”**

Select to set the start time and end time of the Tour Schedule.



Tip

- Even if you have set Auto Preset Tour to “For Viewers” or “Always”, the Preset Tour will not work while you are controlling the camera with the Viewer for PC or the Admin Viewer etc.
- If “Restrict Camera Control to Presets” is selected, the presets can be displayed alone without displaying the camera control GUI on the Viewer for Java (→ P.5-13).

Preset 1-10

Preset 1 ▶HELP

① Application Picture Recording only
 Picture Recording and Video Transmission

② Preset Name (up to 15 characters)

③ Camera Parameter

Zoom (1.97 to 41.26)

Brightness ▼

▲UP

Preset 2 ▶HELP

Application Picture Recording only
 Picture Recording and Video Transmission

Preset Name (up to 15 characters)

Camera Parameter

Zoom (1.97 to 41.26)

Brightness ▼

▲UP

① **“Application”**

Use these options to specify whether this preset can be used only for picture recording or is also made available in the viewers. If it is also provided in the viewers, always specify the preset name.

② **“Preset Name”**

Enter a name consisting of up to 15 alphanumeric characters.

③ **“Camera Parameter”**

Set the video capture settings to be provided.

“Zoom”

Set the value for the camera’s angle of zoom.

“Brightness”

Set the target value for the camera’s auto exposure feature. Select “Brighter” if the picture is too dark due to backlight or other factors.



Note

Changes in the preset settings are not applied to the viewer while it is connected.



Tip

You can make preset settings more easily with the VB Administration Tools. Please use the VB Administration Tools for the settings (→ P.4-13).

Setting Up the HTTP, Camera and Audio Servers (Server)



Server

OK

CANCEL

[Common Settings](#) | [HTTP Server](#) | [Camera Server](#) | [Audio Server](#)

* VB-C50FSi screen

You can perform the following Settings with Server.

- **Common Settings:** For setting up the environment where users can connect to the VB-C50FSi/VB-C50Fi.
- **HTTP Server:** For setting web page distribution and managing the VB-C50FSi/VB-C50Fi.
- **Camera Server:** For setting up the viewing of video from the VB-C50FSi/VB-C50Fi.
- **Audio Server:** For setting up audio-related items (VB-C50FSi only).

When you have made changes to the settings, click the “OK” button to return to the Settings Title Page. If you do not make any changes, click the “Cancel” button.

Common Settings

Common Settings ▶ HELP

①	Maximum Number of Clients	<input type="text" value="50"/>	(1 to 50)
②	Maximum Connection Time (sec.)	<input type="text" value="0"/>	(0 to 65535)
③	<input type="checkbox"/> Restrict Service Time		
	Start Time	Hour	<input type="text" value="0"/> (0 to 23)
		Minute	<input type="text" value="0"/> (0 to 59)
	End Time	Hour	<input type="text" value="0"/> (0 to 23)
		Minute	<input type="text" value="0"/> (0 to 59)

▲ UP

① “Maximum Number of Clients”

Set the maximum number of clients who can connect to the VB-C50FSi/VB-C50Fi at the same time, up to 50.

② “Maximum Connection Time (sec.)”

Set the length of time for each client can connect to the VB-C50FSi/VB-C50Fi, in units of seconds.

③ “Restrict Service Time”

Select to set the length of time for which a user can connect to the VB-C50FSi/VB-C50Fi.



Tip

If you want to restrict time to distribute video and audio*, use “Restrict Service Time”.

* Only available with a particular model of the VB-C50FSi (→ P.iii)

HTTP Server

HTTP Server ▶HELP

① HTTP Port (1 to 65535)

② Global Address for Web Pages ▼

IP Address

Port Name (up to 15 characters)

▲UP

① “HTTP Port”

Set the TCP port number for the HTTP. Enter a value between 1 and 65535. The default setting is 80.

② “Global Address for Web Pages”

If a private address has been set in the VB-C50FSi/VB-C50Fi and you want to use the router’s NAT functions to have a fixed global address for the VB-C50FSi/VB-C50Fi (→ P.5-26), enter a global address here, and this will let you view sample pages (→ P.5-6).

If “IP Address” is selected, enter the IP address specified in “IP Address”. If “Host Name” is selected, the host name specified in “DNS” in “Miscellaneous” is used. Perform any necessary settings in “DNS” (→ P.3-25).

Camera Server

Camera Server ▶HELP	
①	Video Transmission Port <input type="text" value="65310"/> (1 to 65535)
②	Camera Control Port <input type="text" value="65311"/> (1 to 65535)
③	Maximum Frame Rate (fps) <input type="text" value="30"/> (0.1 to 30)
④	Maximum Transmission Rate (Mbps) <input type="text" value="0"/> (0 to 10)
⑤	Control Queue Length <input type="text" value="50"/> (0 to 50)
⑥	Camera Control Time (sec.) <input type="text" value="20"/> (1 to 3600)
⑦	Camera Stabilization Time (msec.) <input type="text" value="1500"/> (0 to 10000)

① “Video Transmission Port”

Set the TCP port number for the video transmission protocol. Enter a value between 1 and 65535. The default setting is 65310. Normally, there is no need to change this setting.

② “Camera Control Port”

Set the TCP port number for the camera control protocol. Enter a value between 1 and 65535. The default setting is 65311. Normally, there is no need to change this setting.

③ “Maximum Frame Rate (fps)”

Set the maximum number of frames captured per second. The maximum frame rate is 30.0 fps (NTSC)/25.0 fps (PAL) and enter a number between 0.1 and 30.0 (NTSC)/25.0 (PAL).

*Please refer to P.1-10 to confirm whether your VB-C50FSi/VB-C50Fi is PAL model or NTSC model.

④ “Maximum Transmission Rate (Mbps)”

Set the upper limit of the volume of data to be transmitted in one second. This function is used to reduce the load on the network. The maximum is 10Mbps and enter an integer of 0 to 10. 0 means unlimited.

⑤ “Control Queue Length”

Set the length of the queue when multiple clients are waiting for control privileges under the viewer.

Enter a value between 0 and 50. The maximum number is 50. When set to “0”, only the Admin Viewer is permitted to control the camera.

⑥ “Camera Control Time (sec.)”

Set the maximum time for which camera control privileges can be maintained under the viewer. Enter a value between 1 and 3600.

⑦ “Camera Stabilization Time (msec.)”

When the GetStillImage command (→ P.5-25) has been requested, this setting specifies the delay to allow the camera to stabilize before a still picture is captured. Enter a value between 0 and 10000. The maximum delay is 10000 milliseconds.

Audio Server (VB-C50FSi only) ①-⑤, ⑧ are only displayed with a particular model (→ P.iii).

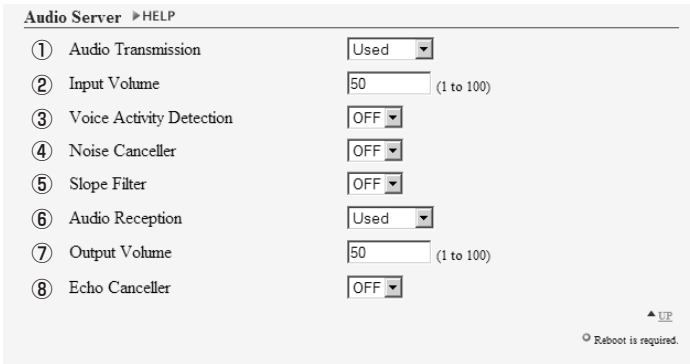

① **“Audio Transmission”**

Set “Audio Transmission” to “Used” to send audio to the Viewer for PC or Admin Viewer, that is input into the microphone connected to the Multi-Terminal Module (→ P.1-11).

② **“Input Volume”**

Set the volume of the input audio in a range from 1-100. The larger the numeric value, the louder the audio will be.

③ **“Voice Activity Detection”**

Set “Voice Activity Detection” to “ON” to pause the transmission of audio data when the server does not detect any valid audio data from the microphone. Doing this reduces the network bandwidth that you are using.

④ **“Noise Canceller”**

Set “Noise Canceller” to “ON” to cancel noise in the audio.

⑤ **“Slope Filter”**

Set “Slope Filter” to “ON” to cancel any low pitch noise such as outdoor wind sound.

Audio Transmission

- Input Volume
- Voice Activity Detection
- Noise Canceller
- Slope Filter

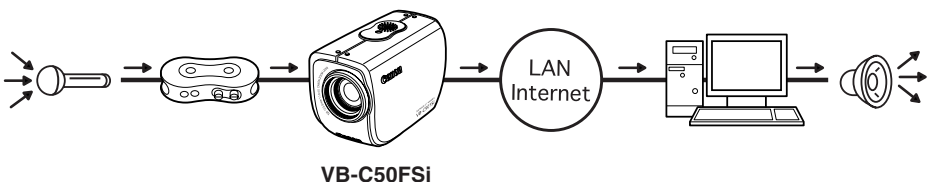

⑥ “Audio Reception”

Set “Audio Reception” to “Used” to receive audio which has been sent from the Admin Viewer and output to the speaker with amp connected to the Multi-Terminal Module (→ P.1-11).

⑦ “Output Volume”

Set the volume of output audio in a range from 1-100. The larger the numeric value, the louder the audio will be.

⑧ “Echo Cancellor”

Set “Echo Cancellor” to “ON” to prevent acoustic echo when transmitting and receiving audio from the speaker with amp and microphone connected to the Multi-Terminal Module (→ P.1-11).

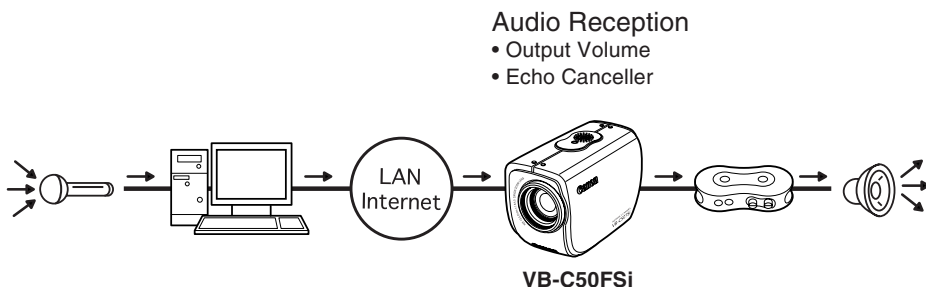

Note

- Use the Multi-Terminal Module (→ P.1-11) when connecting a microphone* or speaker to the VB-C50FSi.
- Setting “Noise Canceller”, “Slope Filter”, and “Echo Cancellor” to “ON” may have an effect on the audio volume and quality. Set “ON” or “OFF” according to the environment where you install and how you use the VB-C50FSi.*
- When sending or receiving audio*, please read carefully “Usage Notice of Audio” (→ P.iii).
- Use the VB Administration Tools to view or modify the settings for Audio Playback and recording*.

* Only available with a particular model (→ P.iii)

Setting User Access Privileges (Access Control)



You can perform the following settings with Access Control.

- Authorized User Account: Register users who may connect to the VB-C50FSi/VB-C50Fi.
- Authorized/Restricted Host Specification: Control whether a specific host is to have access or not.

When you have made changes to the settings, click the “OK” button to return to the Settings Title Page. If you do not make any changes, click the “Cancel” button.

Authorized User Account

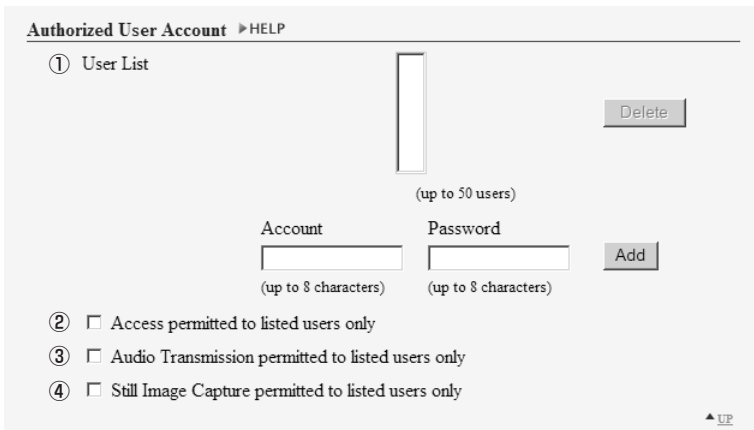

* VB-C50FSi screen

① “User List”

Only users registered in this list are permitted to connect to the VB-C50FSi/VB-C50Fi. You can register a maximum of 50 users in addition to the user name (root).

“Delete”

Select a user from the User List and click the delete button to remove the user from the list.

“Add” / “Change”

You can add authorized users to the User List by entering their account names and passwords and then clicking the [Add] button. The [Add] button changes to [Change] when you select an authorized user. You can change the password by entering a new password, and then clicking the [Change] button.



② “Access permitted to listed users only”

When this option is checked, only users registered in the User List are permitted to connect to the VB-C50FSi/VB-C50Fi.

● Access using the Viewer Ver.3.1 or before and WebView Livescope MV Ver.1.0 is prohibited.

③ “Audio Transmission permitted to listed users only” (VB-C50FSi only)*

When this option is checked, only users registered in the User List are permitted to receive audio.

* Only displayed with a particular model (→ P.iii)

④ “Still Image Capture permitted to listed users only”

When this option is checked, only users registered in the User List are permitted to capture still images.

It is useful when distributing video as a still picture (→ P.5-24).

Authorized/Restricted Host Specification

* VB-C50FSi screen

① “Host List”

In this Host List, you can in detail whether of how access from the hosts is permitted or denied. See the next page for the description format.

② “Apply this list to HTTP server”

When this is selected, the Host List is applied to the host that can access the HTTP server. In this case, control extends also to the Viewer for Java, etc. Use this when you want to restrict access not only from the viewer but also to the Web page.

③ “Apply this list to Video Transmission”

Select to apply the Host List to a host who may have access to the VB-C50FSi/VB-C50Fi. Use “Apply this list to Video Transmission” if you want to restrict access from the Viewer for Java and Viewer for PC etc.

④ “Apply this list to Audio Transmission” (VB-C50FSi only)*

When this is selected, the Host List is applied to the host that can receive audio.

* Only displayed with a particular model (→ P.iii)

⑤ “Apply this list to Still Image Capture”

When this is selected, the Host List is applied to the host that can capture still images.



Note

- If you do not make a Host List, access is permitted to any hosts.
- If the Host List provided prohibits access for all hosts, the Host Restriction function is disabled and access is permitted to all hosts.
- To prohibit access over HTTP connection via a proxy server, the address of the proxy server should be set.
- When you set a host list which leads to prohibit yourself, restore the factory default settings.



Tip

The Host Restriction function applies to hosts running client applications such as viewer. Access restrictions are imposed using a list made up of one or more entries written using the format described below.

Listing Format

[!] addr [-addr2]

- “addr” is written in standard IP address format.
- Because the IP addresses in the “addr” and “addr2” parameters define the range of IP addresses, if an IP address A is higher than “addr” and lower than “addr2”, A is included in the addr-addr2 range. The addr2 parameter can be omitted, in which case it is taken to be the same value as addr.
- For a host IP address A for which access permission is to be authorized or restricted, the first entry that includes A is requested from the top of the list of authorized/restricted hosts. If the entry obtained begins with “!”, access is denied. If not, access is authorized.
- Redundant or contradictory entries included in the list are automatically deleted.
- If the given address does not belong to any of the entries, access is authorized.

Listing Guidelines

If the list of authorized and restricted hosts contains an error, access that was originally permitted may subsequently be denied. To avoid this problem, compile the lists very carefully using the examples below as a guide.

Example 1: To prohibit access from a host

```
!172.20.0.0
```

Access from the host with an IP address of 172.20.0.0 is prohibited.

Example 2: To prohibit access from hosts in a given address range

```
!172.20.0.0-172.20.0.20
```

Access from hosts with IP addresses from 172.20.0.0 to 172.20.0.20 is prohibited.

Example 3: To authorize access from hosts in a given address range while prohibiting access from other hosts

```
172.20.0.10-172.20.0.12
```

```
!0.0.0.0-255.255.255.0
```

Access is only authorized from hosts with IP addresses from 172.20.0.10 to 172.20.0.12.

Example 4: To prohibit access from hosts in a given address range while permitting access from one host within that range

```
172.20.0.10
```

```
!172.20.0.0-172.20.0.20
```

Access from hosts with IP addresses from 172.20.0.0 to 172.20.0.20 is prohibited, except for the host at 172.20.0.10, from which access is permitted.

Example 5: To prohibit access from hosts in a given address range while permitting access from a range of hosts within that range

```
172.20.0.10-172.20.0.15
```

```
!172.20.0.0-172.20.0.20
```

Access from hosts with IP addresses from 172.20.0.0 to 172.20.0.20 is prohibited, except for the hosts with addresses between 172.20.0.10 and 172.20.0.15, from which access is permitted.

Setting the Date and Time (Date and Time)



Date and Time

OK

CANCEL

[Current Camera Time](#) | [New Camera Time](#) | [Time Zone](#)

You can perform the following settings with Date and Time.

- **Current Camera Time:** Displays the time set up for the camera.
- **New Camera Time:** For setting up the time on the VB-C50FSi/VB-C50Fi.
- **Time Zone:** Select the appropriate time zone from the list.

When you have made changes to the settings, click the “OK” button to return to the Settings Title Page. If you do not make any changes, click the “Cancel” button.

Current Camera Time

Current Camera Time ▶HELP

①	Date	2004/10/01
	Time	17:24:25
②	Time Zone	GMT+09

▲UP

① “Date” and “Time”

Display the date and time currently set on the VB-C50FSi/VB-C50Fi.

② “Time Zone”

The time difference with Greenwich Mean Time is displayed.

New Camera Time

New Camera Time ▶HELP

① Synchronize with computer time

Date

Time

② Set manually

Date (yyyy/mm/dd)

Time (hh:mm:ss)

③ Synchronize with NTP server

IP Address

▲UP

① “Synchronize with computer time”

Set to the date and time of the PC currently accessing the VB-C50FSi/VB-C50Fi via a Web browser.

② “Set manually”

Select this item when the date and time are to be manually entered. In the Date field, enter the year, month and day in yyyy-mm-dd format; in the Time field, enter the time in hh:mm:ss 24-hour format.

For example, for January 23, 2004, 1:23:04 p.m., enter “2004/01/23” and “13:23:04”.

③ “Synchronize with NTP server”

Set to the date and time of the NTP server when the IP address of an NTP server has been entered.



Tip

Even if you have selected “Synchronize with NTP server”, the date and time will not change if the VB-C50FSi/VB-C50Fi cannot connect with the NTP server, for example, because the IP address for the NTP server is not correct.

Time Zone

Time Zone ▶HELP

① Time Zone ▼

▲UP

① “Time Zone”

Select the time difference with Greenwich Mean Time from the list.

Setting Up Name Server Address and Mail etc. (Miscellaneous)



Miscellaneous

OK

CANCEL

[DNS](#) | [Mail](#) | [External Device Names](#) | [LED](#)

You can perform the following settings with Miscellaneous.

- DNS: Register the Name Server Address and Host Name for registering host names such as Mail Server Host.
- Mail: For setting up the mail addresses which are to receive recorded pictures and log messages.
- External Device Names: For setting up the names for the external devices to be used with WebView Livescope MV etc.
- LED: For setting the LED on the VB-C50FSi/VB-C50Fi to turn on or off.

When you have made changes to the settings, click the “OK” button to return to the Settings Title Page. If you do not make any changes, click the “Cancel” button.

DNS

DNS ▶ HELP

①	Name Server Address 1	<input type="text"/>
	Name Server Address 2	<input type="text"/>
②	<input type="checkbox"/> Register Host Name	
	Host Name	<input type="text"/> (up to 63 characters)

▲ UP

① “Name Server Address 1-2”

Enter the name server address you want to register. If you are only registering one, leave the field “Name Server Address 2” blank.

② “Register Host Name”

Select and enter the host name you want to register. You can register a host name in “Name Server Address 1”.



Tip

If you are operating the VB-C50FSi/VB-C50Fi with “Auto Setting (DHCP)” (→ P.3-6), it is useful to register the “Register Host Name” setting. Settings are required before being able to register in the DNS server. For information about DNS server settings, please consult your system administrator.

Mail

Mail ▶ HELP

①	Mail Server Host	<input type="text"/>	(up to 63 characters)
②	Sender's(From) Mail Address	<input type="text"/>	(up to 63 characters)
③	Recipient(To) Mail Address	<input type="text"/>	(up to 63 characters)
④	<input type="checkbox"/> POP before SMTP		
⑤	User Name	<input type="text"/>	(up to 31 characters)
	Password	<input type="text"/>	(up to 31 characters)
⑥	POP Server	<input type="text"/>	(up to 63 characters)

▲ UP

- ① **“Mail Server Host”**
Specify the SMTP server.
- ② **“Sender’s (From) Mail Address”**
Specify the mail sender.
- ③ **“Recipient (To) Mail Address”**
Specify the mail recipient.
- ④ **“POP before SMTP”**
Select if the mail host server requires POP user authentication.
- ⑤ **“User Name” and “Password”**
Specify the settings in “User Name” and “Password” necessary for authentication.
- ⑥ **“POP Server”**
Specify the POP server.

External Device Names

External Device Names ▶HELP

① External Input Device 1
Device Name (up to 15 characters)

External Input Device 2
Device Name (up to 15 characters)

② External Output Device 1
Device Name (up to 15 characters)

External Output Device 2
Device Name (up to 15 characters)

External Output Device 3
Device Name (up to 15 characters)

▲UP

① “External Input Device 1-2”

“Device Name”

To distinguish between the different external devices connected to the Multi-Terminal Module, be sure to enter a device name. Enter a device name consisting of up to 15 alphanumeric characters.

② “External Output Device 1-3”

“Device Name”

To distinguish between the different external devices connected to the Multi-Terminal Module, be sure to enter a device name. Enter a device name consisting of up to 15 alphanumeric characters.

LED

LED ▶HELP

① LED Setting ▼

▲UP

① “LED Setting”

Select the status of the LED located on the front of the camera from “Blinks during Communication”, “Steady Green LED”, “Steady Orange LED”, “Steady Red LED” and “Turn the LED OFF”. If the image is obstructed by the reflected LED, select “Turn the LED OFF”.

Using the Administration Tools (Administration Tools)



Administration Tools

CANCEL

[On-board File System Information](#) | [Recorded Picture and Audio data Information and Manipulation](#) | [Miscellaneous](#)

* VB-C50FSi screen

You can use the following items with the Administration Tools.

- On-board File System Information: Displays the status of VB-C50FSi/VB-C50Fi's memory.
- Recorded Picture and Audio data* Information and Manipulation: Displays the status of pictures and audio* recorded in the VB-C50FSi/VB-C50Fi and deletes recorded pictures and audio*.
- * Only available with a particular model of the VB-C50FSi (→ P.iii)
- Miscellaneous: Confirm settings for the VB-C50FSi/VB-C50Fi and initialization.

If you do not make any changes, click the "Cancel" button.

On-board File System Information

① On-board File System Information ▶HELP

Used space	376832 Bytes
Free space	1261568 Bytes
Capacity	1638400 Bytes

▲UP

① "On-board File System Information"

The On-board File System displays the used space, free space and capacity (used space + free space) of VB-C50FSi/VB-C50Fi's memory in bytes.



Tip

- Since the work area for the VB-C50FSi/VB-C50Fi is included in the free space on the on-board file system, files may not be created when the free space becomes approximately 100KB (→ P.5-8).

Recorded Picture and Audio data* Information and Manipulation

① Recorded Picture and Audio data Information and Manipulation ▶HELP

Status	Ready to record.
Free space	15065088 Bytes
No. of recorded pictures	0 pictures
Deletion of recorded pictures	<input type="button" value="Delete"/>
Length of recorded audio data	0 seconds
Deletion of recorded audio data	<input type="button" value="Delete"/>

▲UP

① “Recorded Picture and **Audio data*** Information and Manipulation”

This section displays the status of recording, the amount of free space available, the number of recorded images and the duration of **recorded audio*** (VB-C50FSi only). The “Delete” button for deleting recorded pictures can also be used to delete all the recorded pictures, and the “Delete” button for deleting recorded audio (VB-C50FSi only) can also be used to delete all the recorded audio*.

* Only available with a particular model (→ P.iii)

Miscellaneous

Miscellaneous ▶ HELP

①	View Log Events	View
②	View Current Settings	View
③	Reboot	Reboot
④	Restore Settings	Restore

* All settings other than the Ethernet settings revert to the factory default settings. The VB-C50Fi is then rebooted automatically.

▲ UP

① “View Log Events”

Click the “View” button to see the historical log files of the VB-C50FSi/VB-C50Fi’s operation, such as connection with viewers, etc.

② “View Current Settings”

Display a list of current settings.

③ “Reboot”

Reboot the VB-C50FSi/VB-C50Fi.

④ “Restore Settings”

All but the password setting, Ethernet address setting, IP address, subnet mask and default gateway of the VB-C50FSi/VB-C50Fi will be restored to the factory default settings. Click “Restore”-“OK” buttons and the VB-C50FSi/VB-C50Fi will be rebooted automatically.



Note

- Do not turn the VB-C50FSi/VB-C50Fi power off while the “Restore Settings” operation. Turning the power off before completion may prevent it from starting up properly.
- Using “Restore Settings” deletes all saved web page data (→ P.5-8). Back up your data before using this function.



Tip

- We recommend that you make a note of current server settings before you restore the factory default settings in “Restore Settings” (→ P.7-23).
- While the Reset switch can also be used to restore the factory default settings, note that this resets all the settings (→ P.7-22).

Chapter **4**

VB Administration Tools

Chapter 4 describes practical ways of operating the VB-C50FSi/VB-C50Fi using the VB Administration Tools to set view restrictions, set presets and schedules, view logs and use the Admin Viewer. Review the necessary basic settings in Chapter 3 before proceeding to Chapter 4.

*** Although view restrictions and presets can be set by following the procedures described in Chapter 3, the VB Administration Tools provides more visual-based and easy way to use.**

Overview of VB Administration Tools

VB Administration Tools comprises “VBAAdmin Startup Panel”, “View Restriction Tool”, “Preset Setting Tool”, “Schedule Setting Tool”, “Log Viewer” and “Admin Viewer” applications. Operations such as setting the VB-C50FSi/VB-C50Fi or viewing pictures from a remote location with special privileges, checking operating status or obtaining logs are easily performed through the Internet or an intranet.

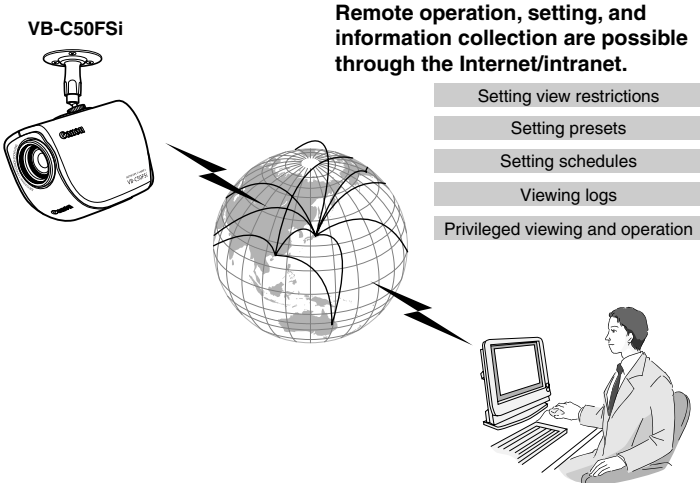

Installing the VB Administration Tools

If you performed the Easy Installation in “5. Install the Software” in Chapter 2 “Setting up” (→ P.2-13), the VB Administration Tools has already been installed. If this is the case, a VB Administration Tools shortcut icon has been created on the desktop of your PC. A shortcut is also created in the same way if you select “Programs” from the “Start” menu and then “WebView Livescope”.

If the VB Administration Tools has not yet been installed, see page 2-13.



Note

VB Administration Tools cannot be installed or operate normally on a PC where the VB-C50FSi/VB-C50Fi-related applications listed below have been installed. Please uninstall these applications before installing the VB Administration Tools:

- VB Administration Tools Ver.1.0/1.1
- WebView Livescope Helper Viewer Ver. 3.1 or earlier
- WebView Livescope Camera Server
- WebView Livescope Manager
- WebView Livescope MV Manager Ver. 1.0
- WebView Livescope MV Station Ver. 1.0

VBAdmin Startup Panel (→ P.4-5)

This is the main panel of VB Administration Tools. The tools are started up from this panel.

Install VB Administration Tools first from the supplied CD-ROM.

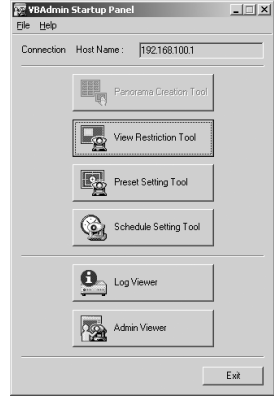

Panorama Creation Tool

* Not available with the VB-C50FSI/VB-C50Fi.

View Restriction Tool (→ P.4-7)

This tool enables easier, more visual setting of view restrictions. Restrictions can be set by operating the mouse.

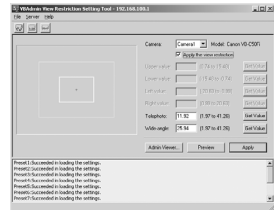

Preset Setting Tool (→ P.4-13)

This tool enables easier, more visual setting of camera preset positions and a home position. Presets can be set by operating the mouse. You can also enter settings for a Preset Tour with which you can tour and monitor two or more presets within a specified start and end time.

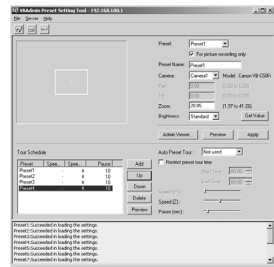

Schedule Setting Tool (→ P.4-22)

With the Schedule Setting Tool you can set up the following services to perform automatically on a specified day or time.

- **Timer:** Records pictures and audio* into the VB-C50FSi/VB-C50Fi and performs Audio Playback* at specified times.
- **Motion Detection:** Detects variations between images and automatically triggers picture and audio* recording. Also, an audio file can be registered and Audio Playback be performed when motion is detected*.
- **Night Mode:** Takes shots in dark conditions.
- **External Device input:** Records pictures and audio* or performs Audio Playback* in response to reactions by external devices such as sensors.
- **External Device Output:** Automatically operates an external device such as a light by a time setting.

You can set the time and content of a Service on the calendar in the Schedules Setting display screen.

* Audio recording and Audio Playback functions are only available on the VB-C50FSi.

* Besides, audio recording is only available with a particular model of the VB-C50FSi (→ P.iii).

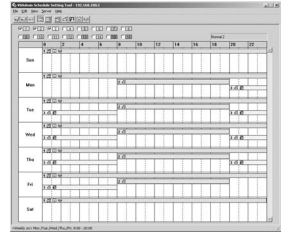

Log Viewer (→ P.4-58)

This tool enables viewing of operation status logs that are output to the VB-C50FSi/VB-C50Fi.



Admin Viewer (→ P.4-61)

This viewer is aimed at administrators of the VB-C50FSi/VB-C50Fi. It has special privilege functions not available in the Viewer for PC or Viewer for Java, such as exclusive rights of camera control, operation of external devices and motion detection. You can use it when setting presets and view restrictions etc.

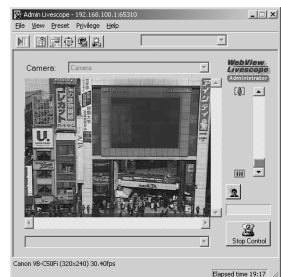

Starting Up VB Administration Tools

To Start Up...

1. Double-click the “VB Admin Tools” desktop icon or select “VB Admin Tools” from the “Start” menu.

Starting up from the desktop icon



VB Admin Tools

Starting up from the “Start” menu

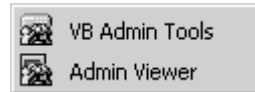

2. The Server Setting dialog box appears.

To use VB Administration Tools, it must first be connected to the VB-C50FSi/VB-C50Fi. Enter the required information in the fields and click the “OK” button.

The screenshot shows the 'Server Setting' dialog box with the following fields and options:

- 1. Host Name: 192.168.100.1
- 2. Administrator Account: root
- 3. Administrator Password: [masked]
- 4. HTTP Port: 80
- 5. URL for settings: http://192.168.100.1 / admin
- 6. Proxy: Use HTTP Proxy Server, Host Name: [empty], Port: 8080
- 7. FTP: Use PASV mode

- ① **Host Name** (→ P.3-6)
Specify the IP address or host name of the VB-C50FSi/VB-C50Fi.
- ② **Administrator Account**
Enter the administrator account “root” for the VB-C50FSi/VB-C50Fi.
- ③ **Administrator Password** (→ P.3-5)
Enter the administrator password that has been set in the VB-C50FSi/VB-C50Fi. (The default setting is “VB-C50i”)
- ④ **HTTP Port** (→ P.3-16)
Enter the HTTP port number that has been set in the VB-C50FSi/VB-C50Fi. (The default setting is 80.)
- ⑤ **URL for settings**
Enter “admin” as the administrator URL. (This cannot be changed.)
- ⑥ **Proxy**
 - *Please consult with the network administrator for proxy settings.
 - **“Use HTTP Proxy Server”**
Check this item if connecting to the VB-C50FSi/VB-C50Fi via a proxy server.
 - **“Host Name”**
Specify the host name or IP address of the proxy server.
 - **“Port”**
Enter the port number of the proxy server. (The default setting is 8080.)
 - **“Load IE proxy information”**
Click to automatically collect proxy server information set in Internet Explorer.

⑦ FTP

To use the Log Viewer of the VB Administration Tools, it is necessary to connect to the VB-C50FSi/VB-C50Fi using FTP to perform various settings. Select either “PASV mode” or “PORT mode”.

- “Use PASV mode”

Check this item if selecting the PASV mode. Normally, there is no need to change this setting. Clear the check box if using the PORT mode.

3. The VBAAdmin Startup Panel starts up.

The five tools---“View Restriction Tool”, “Preset Setting Tool”, “Schedule Setting Tool”, “Log Viewer” and “Admin Viewer”---can be started up from the Startup Panel by clicking on each button.

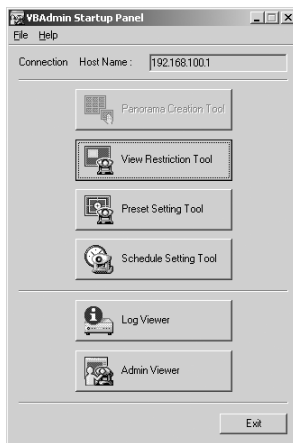

If the connection is broken after the VB Admin Startup Panel has started up, choose Connect from the File menu. The Server Setting dialog box then appears.

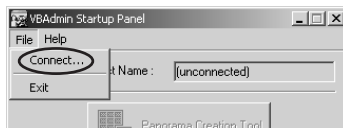

Tip

- The View Restriction Tool, Preset Setting Tool and Schedule Setting Tool cannot be started up simultaneously. You can launch the Log Viewer and Admin Viewer at the same time.
- If the connection to the VB-C50FSi/VB-C50Fi is made through a proxy server, the Log Viewer and Admin Viewer cannot be used.
- If you have connected to network camera servers excluding the VB-C50FSi/VB-C50Fi, some parts of the display of the VB Administration Tools start panel are different from the above example.

View Restriction Tool

The View Restriction Setting Tool is a tool that allows you to set the zoom range easily with the mouse.

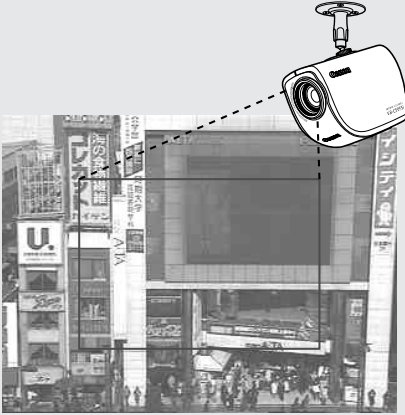

The View Restriction Tool lets you easily set view restrictions in cases where you want to set restrictions on zoom when videos are distributed live or in other such instances.

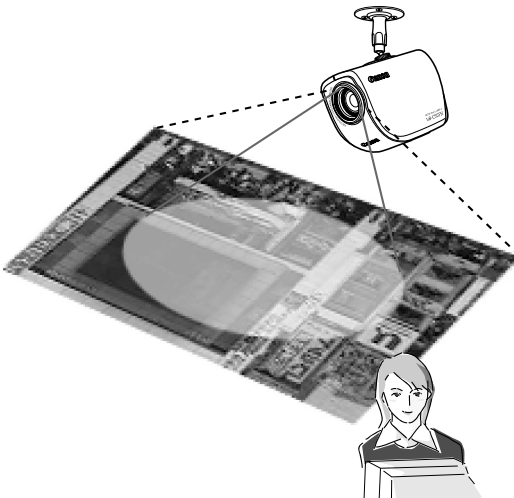
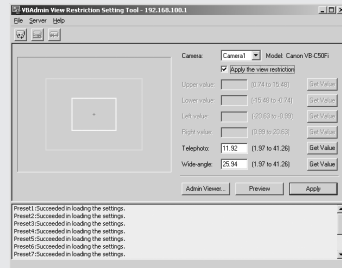

Only the range set in the view restriction is displayed in the viewer.



View Restriction Tool Display Screen

An overview of the functions of the GUI displayed when the View Restriction Tool starts up is shown below.

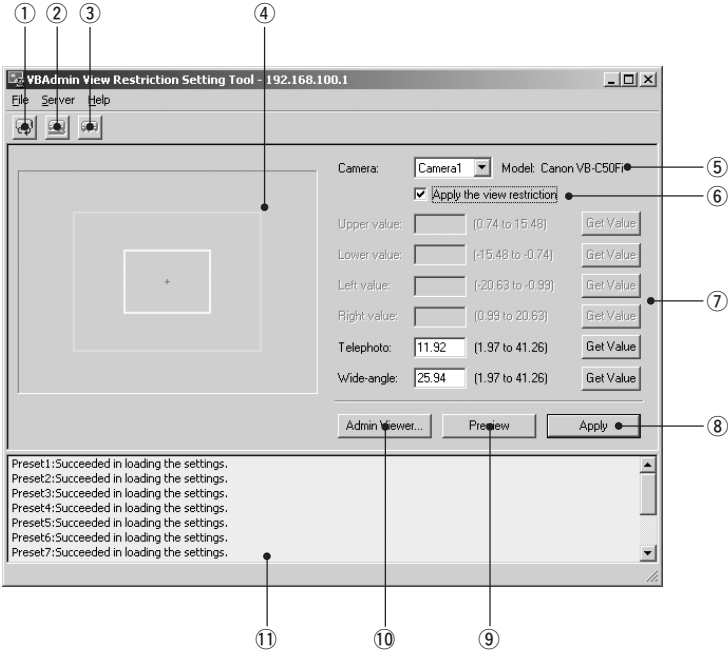

① **“Load Settings” button**

Loads the view restriction settings set in the VB-C50FSi/VB-C50Fi.

② **“Save Settings” button**

The View Restriction setting value set and applied with this tool is saved to the VB-C50FSi/VB-C50Fi.

After setting the view restrictions, be sure to click the “Save Settings” button to save the settings to the VB-C50FSi/VB-C50Fi.

③ **“Stop Communication” button**

Click this button during communication to disconnect the VB-C50FSi/VB-C50Fi.

④ **Panorama Preview**

A View Restriction preview frame is displayed in which the View Restriction setting values are redisplayed. You can, by dragging with the mouse, change the shape of the frame which will then be reflected in the View Restriction setting values.

- View Restriction Preview frames

Wide-angle Preview Frame (green) Zoom field of view (wide angle) restriction area

Telephoto Preview Frame (yellow) Zoom field of view (telephoto) restriction area

⑤ Camera Selection box

Another camera cannot be selected with the VB-C50FSi/VB-C50Fi.

⑥ “Apply the view restriction”

View restriction settings are applied when this item is selected.

⑦ View Restriction Value Input boxes and “Get Value” button

The view restriction settings can be edited by entering values in the View Restriction Value Input boxes. When the “Get Value” button is clicked, the current angle of the camera can be retrieved and reflected in each setting value listed below.

- View restriction setting values

Telephoto Value for the telephoto limit of the view restriction. The zoom value of the selected camera angle is obtained using the “Get Value” button.

Wide-angle Value for the wide-angle limit of the view restriction. The zoom value of the selected camera angle is obtained using the “Get Value” button.

* Upper value, Lower value, Left value and Right value cannot be set with the VB-C50FSi/VB-C50Fi.

⑧ “Apply” button

Applies the current view restriction settings to the VB-C50FSi/VB-C50Fi. At this stage, the edited settings are not yet saved to the VB-C50FSi/VB-C50Fi. Be sure to click the “Save Setting” button to save the settings to the VB-C50FSi/VB-C50Fi.

⑨ “Preview” button

Clicking this button allows checking of the set values specified in the View Restriction Value Input boxes with the View Restriction Preview frame.

⑩ “Admin Viewer” button

This button can be used to start up Admin Viewer.

⑪ Status List

Displays the results of communication between this tool and the VB-C50FSi/VB-C50Fi. Warning messages are displayed in blue and error messages are displayed in red.



Note

- You cannot set view restriction for an external camera. For this reason, the only camera you can select in the Camera Selection box is “Camera 1”.
- Edited content is not saved to the VB-C50FSi/VB-C50Fi when the “Apply” button is clicked. The edited content will only come into effect when the “Save Setting” button is clicked.

Setting View Restrictions

You can set up a view restriction by either entering a value in the view restriction setting input box or by using the following 2 methods. Select the way which suits your environment or according to your preference.

■ Changing Settings from the View Restriction Preview Frame

The View Restriction Preview frame can be used to set view restrictions.

To Make Settings...

1. Select “Apply the view restriction”.



2. Set the view restrictions by using the mouse to move or change the shape of the “Telephoto Preview Frame (yellow)”, and “Wide-angle Preview Frame (green)” .

When enlarging or reducing the Telephoto Preview and Wide-angle Preview frames, the vertical:horizontal ratio is fixed.

At this point, you can also enter and set values in the View Restriction Value Input boxes.

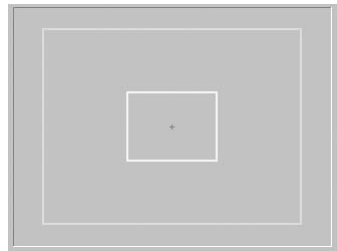

3. Click the “Apply” button.

Check the Status List to be sure the values were applied correctly. Then when the “Save Settings” button is clicked, the values will be saved to the VB-C50FSi/VB-C50Fi.

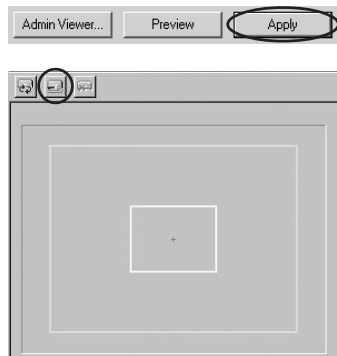

■ Retrieving Values from the Camera Zoom Position of the Admin Viewer and Changing Settings

Admin Viewer can be used to set the view restriction while confirming camera images.

To Make Settings...

1. Select “Apply the view restriction”.
2. Click the “Admin Viewer” button to start it up.
3. In Admin Viewer, click the “Start Control” button to obtain control rights for the camera.

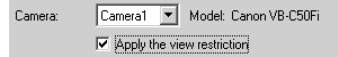

4. Move the camera angle to the position you want to set with the Telephoto, and Wide-angle values, then click the “Get Value” button for each.

The values retrieved using the “Get Value” button can be checked in the View Restriction Value Input boxes, or with the View Restriction Preview frame.

At this point, you can also enter and set values in the View Restriction Value Input boxes.

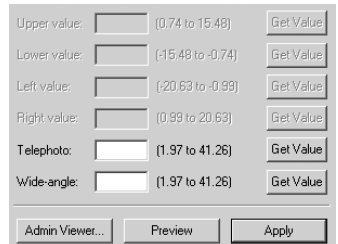

5. Click the “Apply” button.

Check the Status List to be sure the values were sent correctly. Then when the “Save Settings” button is clicked, the values will be saved to the VB-C50FSi/ VB-C50Fi.

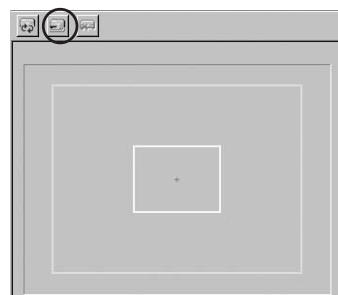



Note

After the view restrictions have been set, please check to be sure that the view restrictions are correctly reflected in the Viewer. When checking from the Admin Viewer, choose “View Restriction” - “ON” from the “Privilege” menu bar (→ P.4-64).



Tip

- When you want to clear the view restriction settings, clear the “Apply the view restriction” check box, click the “Apply” button and then the “Save Settings” button.
- Even if the “Apply the view restriction” is selected, view restriction is not applied when an input box is left blank. In this case, the maximum value is applied.

Preset Setting Tool

The Preset Setting Tool enables you more visually and easily to set Presets and home position. Presets are set by operating the mouse. You can also enter settings for a Preset Tour with which you can tour and monitor two or more Presets within a specified start and end time.

After setting presets, set the preset tour.

The screenshot of the 'WebView Preset Setting Tool' shows a 'Preset' section with fields for Name, Preset Name, Camera, Position, Zoom, and Refresh. Below this is a 'Tour Schedule' table with columns for Preset, Start, and End. The table contains three rows of data. At the bottom, there are 'Add Preset Tour' and 'Preset' buttons, and a list of error messages.

Reflecting preset settings in the viewer

The screenshot shows the 'WebView Livoscope' window with a camera view of a building facade. A red circle highlights the 'Select camera presets' button at the bottom of the camera control panel. The status bar at the bottom indicates 'Frame rate: 30.40 fps Size: 320x240 Protocol: WV-TCP Elapsed time 00:11'.

Executing a preset tour

The sequence of three screenshots shows the camera view transitioning from a wide shot of the building facade to a closer view of the entrance area, demonstrating the execution of a preset tour.

Preset Setting Tool Display Screen

The display screen for the Preset Setting Tool is divided into the “Preset Settings Area” and the “Preset Tour Settings Area”. A maximum of 10 Presets and home positions can be set. In the “Preset Tour Settings Area”, you can enter settings for a Preset Tour with which you can tour and monitor two or more presets within a specified start and end time. Below is a description of the “Preset Setting Area” screen.

See page 4-19 for information about the “Preset Tour Setting Area”.

■ Preset Setting Area Display Screen

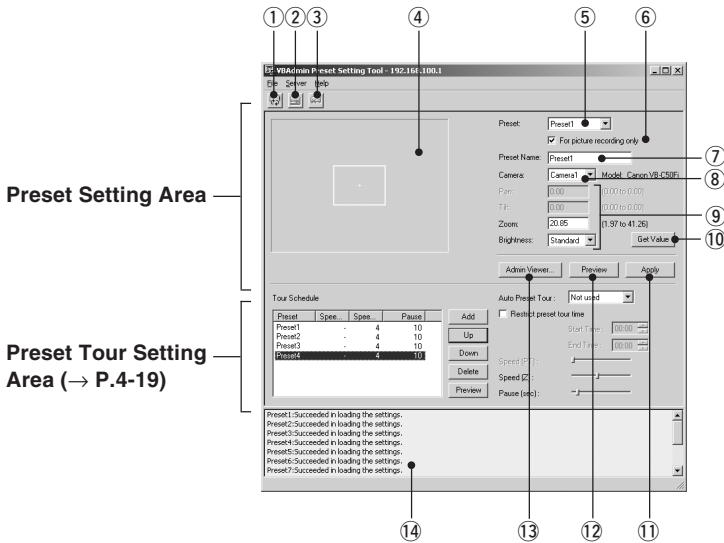

① “Load Settings” button

Loads the Preset and Preset Tour settings currently set in the VB-C50FSi/VB-C50Fi.

② “Save Settings” button

Saves the set and applied Preset and Preset Tour settings made with this tool to the VB-C50FSi/VB-C50Fi.

Be sure to save Preset and Preset Tour settings with the “Save Settings” button.

③ “Stop Communication” button

This button can be clicked during communication with the VB-C50FSi/VB-C50Fi to abort the connection.

④ Panorama Preview

A yellow Preset Preview frame is displayed in which the Preset settings are redisplayed. You can, by dragging the mouse, change the shape of the frame which will then be reflected in the Preset settings.

⑤ Preset Selection box

Select the preset to set or “Home”. “Home” is the setting for home position.

⑥ “For picture recording only”

When this is checked, presets are used for picture recording only; when it is not checked, presets can be used not only for picture recording but for the viewer as well. If you selected “Home” in the Preset Selection box, this setting will be grayed out (setting not possible).

⑦ Preset Name

A name can be assigned to the preset. If you selected “Home” in the Preset Selection box, this setting will be grayed out (setting not possible).

⑧ Camera Selection box

Another camera cannot be selected with the VB-C50FSi/VB-C50Fi.

⑨ Camera Parameters

Enter the angle of view of the zoom you want to set in “Zoom”.

- Camera Angles

Zoom Sets the zoom ratio (field of view angle).

* Pan position and tilt position cannot be set with the VB-C50FSi/VB-C50Fi.

- Brightness

Sets the target value for the camera’s auto exposure feature. Select “Brighter” if the picture is too dark due to backlight or other factors.

⑩ “Get Value” button

When the Get Value button is clicked, the current angle of the camera selected at the VB-C50FSi/VB-C50Fi is retrieved as camera parameters.

⑪ “Apply” button

Settings for current Presets and Tour Schedules are applied to the VB-C50FSi/VB-C50Fi, and you can proceed to the next Preset setting. At this stage, the edited settings are not yet saved to the VB-C50FSi/VB-C50Fi. Be sure to click the Save Settings button to save the settings to the VB-C50FSi/VB-C50Fi.

⑫ “Preview” button

The settings for camera parameters are reflected in the Preset Preview frame. The camera zoom position for the VB-C50FSi/VB-C50Fi also switches to this Preset and you can confirm from the Admin Viewer.

⑬ “Admin Viewer” button

This button can be used to start up Admin Viewer.

⑭ Status List

Displays the results of communication between this tool and the VB-C50FSi/VB-C50Fi. Warning messages are displayed in blue and error messages are displayed in red.



Note

Edited content will not be reflected in the viewer accessed to the VB-C50FSi/VB-C50Fi at the stage when the Apply button is clicked. After confirming the edited content, be sure to click the Save Settings button to save the settings to the VB-C50FSi/VB-C50Fi.

Setting Presets

You can set up Presets by either entering a value in the camera parameters or by using the following 2 methods. Select the way which suits your environment or according to your preference.

■ Changing Settings from the Preset Preview Frame

The Preset Preview frame can be used to set presets.

To Make Settings...

1. From the Preset Selection box, select the preset to be set and enter a name in “Preset Name”.
2. Set the preset by dragging the Preset Preview frame displayed in the Preview and changing the shape of the frame.

You can also enter and set values in the camera parameters.

3. Click the “Apply” button.

Check the Status List to be sure the values were applied correctly. Then when the “Save Settings” button is clicked, the values will be saved to the VB-C50FSi/ VB-C50Fi.

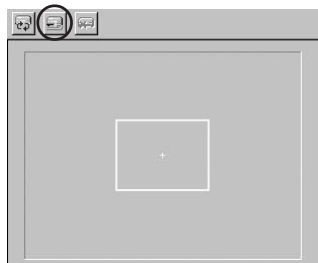
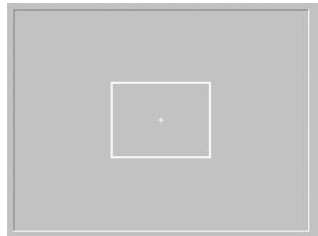
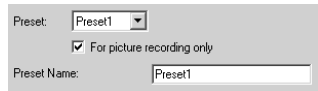

■ Retrieving Values from the Camera Zoom Position of the Admin Viewer and Changing Settings

Start up Admin Viewer and set the camera zoom position as a preset.

To Make Settings...

1. From the Preset Selection box, select the preset to be set, and enter the “Preset Name”.
2. Click the “Admin Viewer” button to start it up.
3. Click the “Start Control” button in the Admin Viewer to obtain camera control rights for the camera.



4. Move the camera zoom position to the position you want to set preset camera zoom position, then click the “Get Value” button.

The values retrieved using the Get Value button can be checked in the Preset settings input boxes, or with the Preset Preview frame.

At this point, you can also enter and set values in the camera parameters.

5. Click the “Apply” button.

Check the Status List to be sure the values were applied correctly. Then when the Save Settings button is clicked, the values will be saved to the VB-C50FSi/ VB-C50Fi.

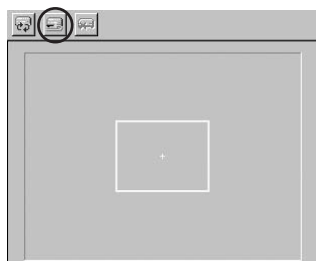



Tip

- You can set a maximum of 10 presets.
- Changes in the preset settings are not reflected to the viewer while it is connected.
- After the presets have been set, please check to be sure that the presets are correctly reflected in the Viewer.
- Once presets have been set, they cannot be deleted. If you do not want to these presets to be used, select “For picture recording only” (→ P.4-15) so that the presets cannot be used in the Viewer for PC.

Preset Tour

A Preset Tour can tour and monitor two or more specified Presets.

You can also set Preset Tour with “Presetting Best Shot” in Chapter 3, “Basic Settings” (→ P.3-12).

■ Preset Tour Settings Area Display Screen

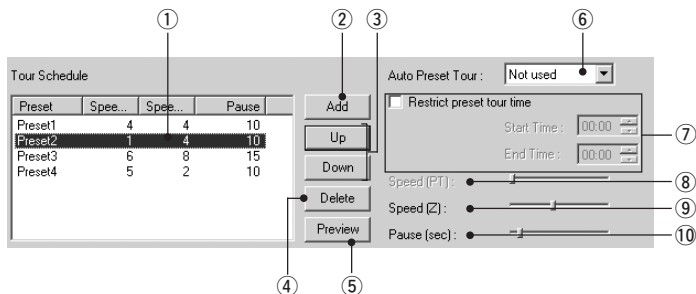

① Tour Schedule list

Displays a list of the presets which have Preset Tour settings.

② “Add” button

Adds a preset to the Tour Schedule List.

③ “Up” and “Down” button

Select a Preset from the list, and click the “Up” or “Down” button to change the order of the Preset Tour. The Preset Tour commences from the preset at the top of the list.

④ “Delete” button

Deletes the selected Preset.

⑤ “Preview” button

Reflects the settings for the selected preset in the Preset Preview frame. The camera zoom positions set in the device switch to the specified values and can be confirmed from the Admin Viewer.

⑥ Auto Preset Tour

Select an option for a Preset Tour from the following.

Not Used: Preset Tour does not operate.

For Viewers: Operates if any of the Viewer for Java, Viewer for PC or Admin Viewer is connecting.

Always: Preset Tour always operates.

⑦ “Restrict preset tour time”

Click to set the start time and end time of the Preset Tour.

⑧ Speed (PT)

* Not available with the VB-C50FSi/VB-C50Fi.

Continued on the following page. ➔

⑨ **Speed (Z)**

Sets the speed at which the camera moves when zooming, within a range of 1-8. By moving the slide bar from left to right, the numeric value becomes larger and the speed increases.

⑩ **Pause (sec)**

Sets the time for which the camera pauses in the preset position, within a range of 0-120 seconds in units of five seconds.



Tip

Preset Tour does not operate when the camera is being controlled with the Viewer for PC, or the Admin Viewer and so on.

■ Setting Preset Tour

Setting up

1. Select an option from Auto Preset Tour.

Select either “For Viewers” or “Always”.

2. Select the preset number you want to add to the Tour Schedule from the Preset setting area and click the “Add” button.

The preset is registered in the Tour Schedule list. You can register a maximum of 10 presets.

3. Select a preset in the Tour Schedule list and with the slide bars in Speed (Z) and Pause (sec), set the speed for zooming for each preset and the number of seconds for the pause in preset position.

Click the “Preview” button (→ P.4-19) to display the set value in the Preset setting area. Also, the camera zoom position switches to the preset and you can check from the Admin Viewer.

4. To set the duration of the Preset Tour, select “Restrict preset tour time” and enter a start time and end time.

You cannot set Start Time and End Time on the same time.

5. Click the “Apply” button.

Check the status list that the settings have been correctly applied and click the “Save Settings” button to save the settings to the device.



Tip

You cannot add a home position to the Tour Schedule list.

Schedule Setting Tool

With the Schedule Setting Tool, you can set up Timer, Motion Detection, Night Mode, External Device Input and External Device Output services to perform automatically on a specified day of the week or time of the day. You can set the start and end time and the content of the service on the calendar in the Schedules Setting screen.

1. Select either Normal Schedule or Special Schedule and enter settings for the schedule.

● Normal Schedule

Enter settings for a schedule of one week from Sunday to Saturday.

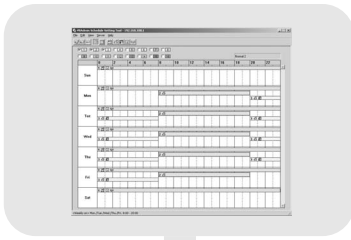

● Special Schedule

Enter settings for a schedule of special days.

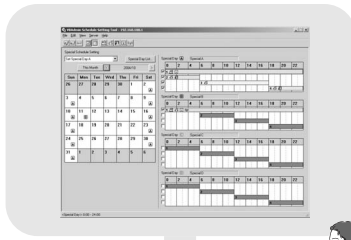

2. Enter settings for the Services (→ P.4-33).

- **Timer:** Records pictures and audio* into the VB-C50FSi/VB-C50Fi and performs Audio Playback* at specified times. (→ P.4-34).
- **Motion Detection:** When part of an image changes due to the movement of an object, the VB-C50FSi/VB-C50Fi performs picture recording, audio recording* or Audio Playback* (→ P.4-37).
- **Night Mode:** Takes shots in dark conditions (→ P.4-48).
- **External Device Input:** Sets camera operation for external device input (→ P.4-50).
- **External Device Output:** Sets the output time to external devices and the repetition interval etc. (→ P.4-53).

* Audio recording and Audio Playback functions are only available on the VB-C50FSi.

* Besides, audio recording is only available with a particular model of the VB-C50FSi (→ P.iii).

3. Once settings are completed, click the “Save Settings” button to save the settings, and close the setting screen for the services.

4. Once all the Schedules have been set, click the “Save Settings” button in the Schedule Setting screen to save the settings, and close the Schedule Setting Tool.



Tip

- Pictures and audio* are recorded in the VB-C50FSi/VB-C50Fi memory. The amount of data that can be recorded varies depending on the free space available in the camera's memory. To record large amounts of data, use VBCollector (→ P.6-11).
- You can check the amount of available memory, the number of recorded pictures and the duration of recorded audio data* in “Administration Tools” on the settings page (→ P. 3-28).

* Only available with a particular model of the VB-C50FSi (→ P.iii)

Schedule Setting Tool Display Screen (Toolbar)

There are two kinds of Schedule settings, Normal Schedule and Special Schedule. The buttons in the toolbar below can be used for both Normal and Special Schedules.

With these buttons, you can load and save setting information, stop communication, select Normal schedule (→ P.4-24) and Special schedule (→ P.4-28) as well as open each service setting screen (→ P.4-34, 4-37, 4-48, 4-50, 4-53).

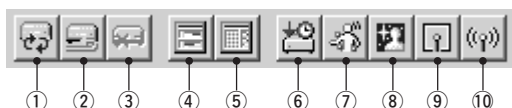

- ① **“Load Settings” button**
Loads the schedule settings currently set in the VB-C50FSi/VB-C50Fi.
- ② **“Save Settings” button**
Saves the schedule setting edited using the Schedule Setting Tool to the VB-C50FSi/VB-C50Fi.
After setting the schedule function, be sure to click the “Save Settings” button to save the settings.
- ③ **“Stop Communication” button**
Click this button during communication with the VB-C50FSi/VB-C50Fi to abort the connection.
- ④ **“Normal schedule” button**
Displays the Normal Schedule Setting screen (→ P.4-24).
- ⑤ **“Special schedule” button**
Displays the Special Schedule Setting screen (→ P.4-28).
- ⑥ **“Timer setting tool” button**
Opens the Timer Setting Tool (→ P.4-34).
- ⑦ **“Motion detection setting tool” button**
Opens the Motion Detection Setting Tool (→ P.4-37).
- ⑧ **“Night mode setting tool” button**
Opens the Night Mode Setting Tool (→ P.4-48).
- ⑨ **“External device input setting tool” button**
Opens the External Device Input Setting Tool (→ P.4-50).
- ⑩ **“External device output setting tool” button**
Opens the External Device Output Setting Tool (→ P.4-53).



Note

After setting, be sure to click the “Save Settings” button to save the settings.

Normal Schedule

With Normal Schedule, you can set up a schedule of one week from Sunday to Saturday. For example, during the weekend when there is nobody in the office from 6:00pm on Friday to 9:00am on Monday, the Motion Detection service will operate each week during the period of time you have specified and automatically monitor the office.

■ Normal Schedule Display Screen

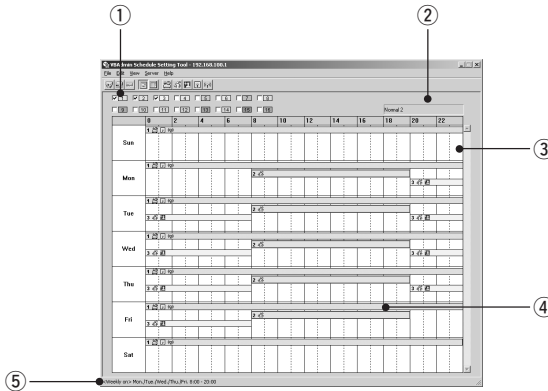

① **Schedule selection checkbox**

Check to select the number of the schedule you want to set up. Up to 16 types of schedules can be set.

② **Schedule Name**

Displays the name of the schedule you have selected.

③ **Weekly Calendar**

Displays the schedule by the day, start and end time.

④ **Schedule track**

The schedule track is the schedule as a graph on the calendar. Double-click to set services, start and end times, which are displayed by different colors according to the number of the schedule.

⑤ **Schedule track setting details display**

Displays the setting details of the schedule track dragged on the calendar.

■ Setting Up a Normal Schedule

To Make Settings...

1. With the Normal Schedule displayed, select an optional schedule number.

The schedule track for the number you have selected is displayed in the weekly calendar. At this stage, the correct start and end time and services are not set up in the schedule track.

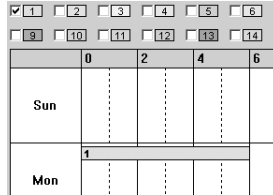

Tip

You can change the color of the schedule track by right-clicking a schedule number and selecting “Color Setting”.

2. Double-click the schedule track.

The Normal Schedule Settings dialog box appears. Enter settings for the schedule.

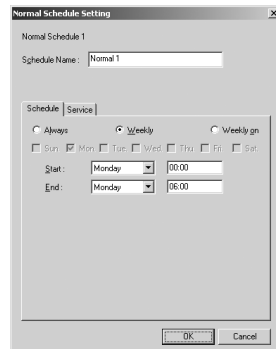

3. Enter the name of the schedule.

You can enter a maximum of 15 characters for the schedule name.

4. Display the Schedule tab and enter settings for the day of the week and start and end times.

Always: The schedule is effective at all times from Sunday to Saturday.

Weekly: You can set the day and the time the schedule starts and ends (e.g. from 1:00pm on Monday to 7:00am on Tuesday).

Weekly on: You can set the same start time and end time for two or more days of the week (e.g. from 8:30am to 5:30pm on Monday, Wednesday and Friday).

Please note that there is a limit of 24 hours from the start time to the end time.

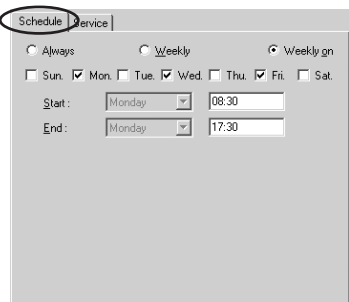



Tip

- On Weekly setting, if you specify the same time and the same day in start and end time, end time will be the same time in the following week, and the schedule is applied to all time periods.
- On Weekly on setting, if you specify the same start and end time, the end time will be on the following day at the same time.
- If you enter “24:00” as the start or end time, the time will be registered as “23:59”. To set “24:00”, enter “00:00” on the following day.

5. Display the Service tab and enter settings for the services you want to use.

Select the checkboxes for the services you want to use and select a setting number. Next click “Detail” to open the Service Setting Tool to set the content of the setting.

There are 5 types of services. See the reference page for how to set up services and more information about each service.

Timer: (→ P.4-34)

Motion Detection: (→ P.4-37)

Night Mode: (→ P.4-48)

External Device Input: (→ P.4-50)

External Device Output: (→ P.4-53)

Once the settings for each schedule are completed, save the settings and close the Schedule Setting Tool.

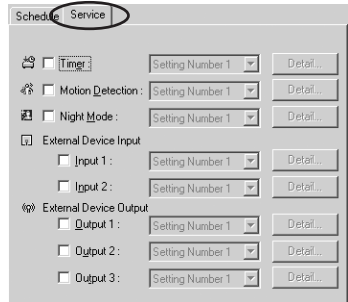

Tip

- You can register different settings for each setting number. The number of setting numbers you can register depends on the service.
- The Service Setting screen can also be displayed by clicking a button on the toolbar for each service.
- A setting number entered from the Service Setting tab in the Schedule Setting screen cannot be changed in each Service Setting screen.

6. When you have completed setting the sub-schedule tracks, click “OK” button.

If you want to set two or more schedule tracks, select another number in the schedule selection checkbox, and make settings in the same way.

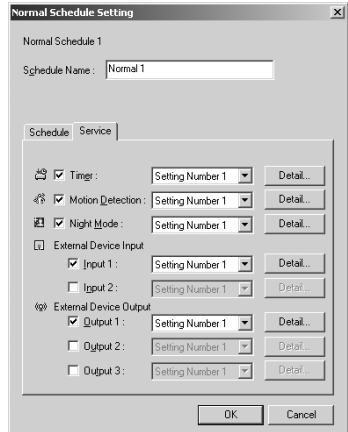

Tip

- You can register different settings for each setting number. The number of setting numbers that can be registered differs depending upon the service.
- An icon for the service you have set up appears in the schedule track in the calendar. However, where the schedule track is short, it may be that not all of icons are displayed.

The icons displayed for each service are as follows:



“Timer”



“Motion Detection”



“Night Mode”



“External Device Input”



“External Device Output”

- The days and start and end times set in the Schedule tab are shown by the position and length of a schedule track. You can change the position and length of the schedule track by directly dragging it with the mouse. However, the schedule track cannot display a period of time shorter than 10 minutes and therefore periods of time shorter than 10 minutes are also displayed as periods of 10 minutes.
- You cannot set 2 schedules which have the same service with the same start and end time. If you try to do so, a warning message is displayed.

7. After setting all the schedule tracks, be sure to click “Save Settings” button to save the settings.



Tip

If you have set a Normal Schedule and a Special Schedule (→ P.4-28) with the same start and end time, the Special Schedule will have priority over the Normal Schedule.

This completes the settings for the normal schedule.

Special Schedule

With Special Schedule, you can set up a schedule on one specific day of the week. For example, on a public holiday when there is nobody in the office, set up a service to automatically monitor the office.

■ Special Schedule Display Screen

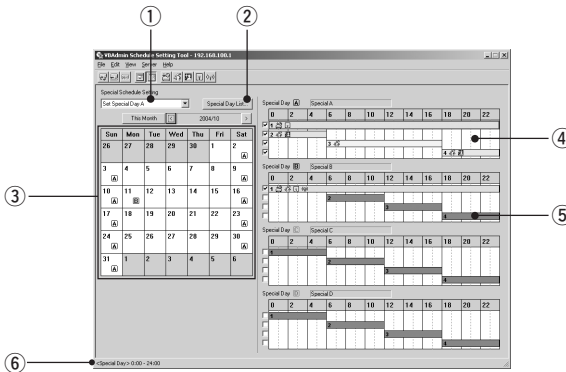

① Set Special Day selection box

Select the special day you want to register from special days A-D or select "Erase Special Day".

② "Special Day List" button

Click to display the Special Day List dialog box. The dates of all registered Special Days are displayed as a list. You can also add, delete and edit the date, as well as delete all dates.

③ Monthly Calendar

The Special Days registered on each date are displayed.

④ Special Day Schedule

The content of the settings for each Special Day is displayed. You can set the Special Day Schedule with a maximum of the 4 special days from A-D.

⑤ Sub-schedule track

The Sub-schedule track is the schedule as a graph on the Special Day Schedule. Double-click to set up services and start and end times. You can set a maximum of 4 Sub-schedule tracks for each Special Day Schedule.

⑥ Sub-schedule track setting details display

Displays the setting details of the sub-schedule track dragged on the Special Day Schedule.

■ Setting Up a Special Schedule

To Make Settings...

1. With the Special Schedule displayed, select from the Special Day selection box the Special Day you want to register in the Schedule.

Click the date on which you want to register a Schedule and the Special Day you have selected is registered.

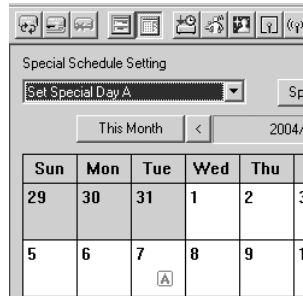
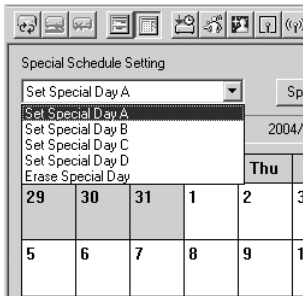

Tip

- You can only set one type of Special Day per day.
- You can set one Special Day a maximum of 32 times.
- You can also set up a Schedule by right-clicking on a date on the calendar.
- You can add, delete, edit and delete all from the Special Day List dialog box by clicking the Special Day List button.

2. Select the optional sub-schedule track from the Special Day Schedule to be used.

In each Special Day Schedule, 4 Sub-schedule tracks have been provided. Select a Sub-schedule track to activate.

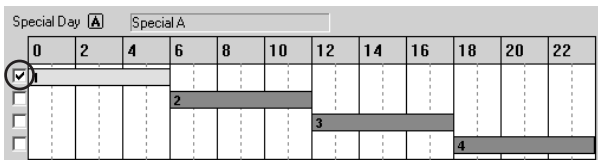

Continued on the following page. ➔

3. Double-click the sub-schedule track.

The Special Schedule Settings dialog box appears. Enter settings for the schedule.

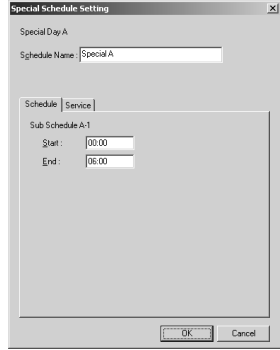

4. Enter the name of the Special Day Schedule.

You can enter a maximum of 15 characters for the Special Day Schedule. The schedule name you enter here is the name for the Special Day schedule (A–D), which is different from the Sub-schedule name. You cannot set a name for a Sub-schedule.

5. Display the Schedule tab and enter settings for start and end times of the schedule.

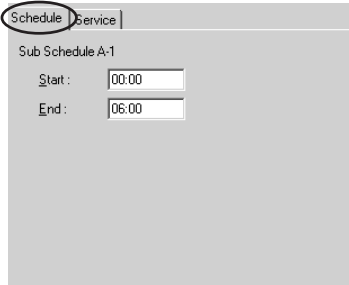

Tip

- Enter a schedule between 0:00 and 24:00. However, be sure to enter an end time which is later than the start time.
- You cannot enter 24:00 as a start time.

6. Display the Service tab and enter settings for the services.

For more information about the services you can set, please see page 4-26.



Tip

- The Service Setting screen can also be displayed by clicking a button on the toolbar for each service.
- A setting number entered from the Service Setting tab in the Schedule Setting screen cannot be changed in each Service Setting screen.

7. When you have completed setting the sub-schedule tracks, click “OK” button.

If you want to set two or more special days, select another special day from the Special Day selection box, and make settings in the same way.

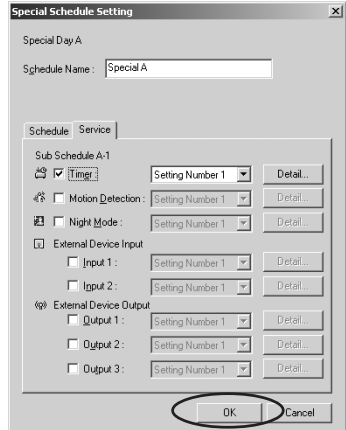

Tip

- An icon for the service you have set up appears in the schedule track in the calendar. However, where the schedule track is short, it may be that not all of icons are displayed.

The icons displayed for each service are as follows:



“Timer”



“Motion Detection”



“Night Mode”



“External Device Input”



“External Device Output”

- The days and start and end times set in the Schedule tab are shown by the position and length of a schedule track. You can change the position and length of a sub-schedule track by directly dragging it with the mouse. However, the schedule track cannot display a period of time shorter than 15 minutes and therefore periods of time shorter than 15 minutes are also displayed as periods of 15 minutes.
- You cannot set 2 schedules which have the same service with the same start and end time. If you try to do so, a warning message will be displayed.
- You can copy and paste information about a Special Day to another Special Day. For example, to copy information from Special Day A to Special Day B, right-click in Special A Schedule and select “Copy from Special Day A”. In Special Day B Schedule, right-click in the same way and select “Paste to Special Day B”.

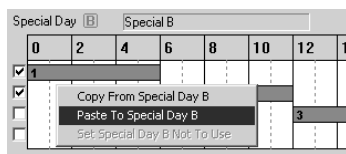
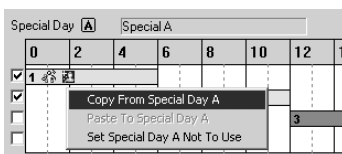

8. Once all the schedules have been set, click the “Save Settings” button in the Schedule Setting screen to save the schedules.



Tip

- If you have set up a Normal Schedule (→ P.4-24) and a Special Schedule with the same start and end time, the Special Schedule will have priority over the Normal Schedule.
- If you want to execute a Special day schedule on the same month and day each year, right-click the Special Day registered on the date in the monthly calendar, and select “Every Year”. When you have done so, the Special Day on the calendar is displayed in red.
- You cannot set “Every Year” on 29 February of a leap year.

This completes the settings for the special schedule.

Resetting Schedule Settings

Resets schedules you have set.

1. In the Normal or Special Schedule Setting screen, select “Initialize normal (special) schedules” from Edit in the menu bar.



Tip

- If you want to reset normal and special schedules at the same time, select “Initialize all schedules and service settings” from Edit in the menu bar.

Setting Up Service

Set up the services to be performed in the schedules.

To open the settings screen for each service, in the “Service” tab in the Schedule Setting screen, select the service you want to set up, select a setting number and click “Detail”.

“Service tab” in the Schedule Setting screen

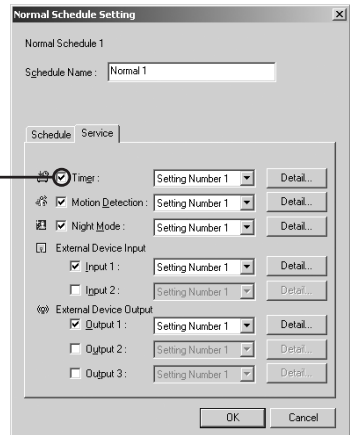

Select the service you want to make settings for, select a setting number and click the “Detail” button.

There are 5 types of services you can set up.

- **Timer:** Records pictures and audio* into the VB-C50FSi/VB-C50Fi and performs Audio Playback* at specified times. (→ P.4-34).
- **Motion Detection:** When part of an image changes due to the movement of an object, the VB-C50FSi/VB-C50Fi performs picture recording, audio recording* or Audio Playback* (→ P.4-37).
- **Night Mode:** Takes shots in dark conditions (→ P.4-48).
- **External Device Input:** Sets camera operation for external device input (→ P.4-50).
- **External Device Output:** Sets the output time to external devices and the repetition interval etc. (→ P.4-53).

* Audio recording and Audio Playback functions are only available on the VB-C50FSi.

* Besides, audio recording is only available with a particular model of the VB-C50FSi (→ P.iii).



Note

- Once the services have been set, click the “Save Settings” button on the Schedule Settings screen to save the settings, and close the settings screen.
- You can also start up each of the service setting screens from the toolbar (→ P.4-23). In such case, select a setting number in each service setting screen.

Timer Setting Tool

The section below describes the “Picture Recording” function that takes still images and records audio* at specified times and records them in the VB-C50FSi/VB-C50Fi. It also describes the “Audio Playback” function that plays back audio.

* Only available with a particular model of the VB-C50FSi (→ P.iii)

■ Timer Setting Tool Display Screen

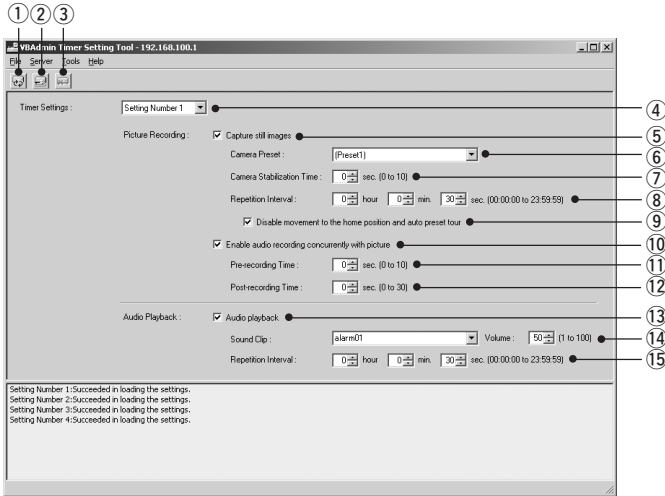

① “Load Settings” button

Loads the timer settings currently set in the VB-C50FSi/VB-C50Fi.

② “Save Settings” button

Saves the timer settings edited using this Tool.

After setting the timer function, be sure to click the “Save Settings” button to save the settings.

③ “Stop Communication” button

Click this button during communication with the VB-C50FSi/VB-C50Fi to abort the connection.

④ **Timer Setting box**

Select the setting timer number you want to use.

⑤ **Capture still images**

Check to capture images at the set repetitive intervals and record to the VB-C50FSi/VB-C50Fi.

⑥ **Camera Preset**

Select a zoom position while recording picture. Select from “Does not specify” or from preset names already set.

⑦ **Camera Stabilization Time**

Starts capturing images after waiting for the specified time for the camera to stabilize after moving. The maximum time is 10 seconds.

⑧ Repetition Interval

Sets the interval between repeated image recording. Repetition Interval can be set to a maximum of 23 hours, 59 minutes and 59 seconds. If you set Repetition Interval to 0, a still image is only recorded once at the start of the scheduled time.

⑨ Disable movement to the home position and auto preset tour

Check to deactivate movement to home position and Preset Tour during picture recording. You can only enter a tick if a preset is specified in “Camera Preset” and “Repetition Interval” is set to more than 30 seconds.

⑩ Enable audio recording concurrently with picture*

Check to record audio at a set time. Set up the “Pre-recording Time” and “Post-recording Time” below.

* Only available with a particular model of the VB-C50FSi (→ P.iii)

⑪ Pre-recording Time*

Records audio for the specified time before picture recording begins. Set a duration between 0 and 10 seconds.

* Only available with a particular model of the VB-C50FSi (→ P.iii)

⑫ Post-recording Time*

Records audio for the specified time after picture recording ends. Set a duration between 0 and 30 seconds.

* Only available with a particular model of the VB-C50FSi (→ P.iii)

⑬ Audio playback (VB-C50FSi only)

Check for playback of audio at the set repetition interval. Set up the “Sound Clip”, “Volume” and “Repetition Interval” below.

⑭ Sound Clip and Volume (VB-C50FSi only)

Set the audio for playback. Select from the registered playback audio names. Set the volume at which the audio is to be played back, between 1 and 100.

⑮ Repetition Interval (VB-C50FSi only)

Set the interval between playback of audio. You can set an interval to a maximum of 23 hours, 59 minutes and 59 seconds. If you set Repetition Interval to 0, the audio will play back only once at the start of the scheduled time.



Note

- When recording consecutive audio files, set the Pre-recording Time and Post-recording Time so that the total duration is longer than Repetition Interval (so that the next recording begins before the recording process ends). The consecutive recorded audio files are created in 120-second segments.
- Specify the audio recording volume, noise canceller and slope filter settings on the Audio Server settings page (→ P. 3-19).
- You cannot set 0 seconds for both the Pre-recording Time and Post-recording Time.

■ Setting Up Picture Recording

To Make Settings...

1. With the Schedule Setting Tool, open the Timer Setting Tool.

In the Service tab of the Schedule Setting screen for a Normal or Special Schedule, check “Timer”, select a setting number and click the “Detail” button (→ P.4-33) .

2. Check “Capture still images” and set “Camera Preset”, “Camera Stabilization Time”, “Repetition Interval”, “Disable movement to the home position and auto preset tour”, “Enable audio recording concurrently with picture”, “Pre-recording Time” and “Post-recording Time”*.

* Only available with a particular model of the VB-C50FSi (→ P.iii)

3. Click the “Save Settings” button to save the settings and close the Timer Setting screen.

■ Setting Up Audio Playback (VB-C50FSi only)

To Make Settings...

1. With the Schedule Setting Tool, open the Timer Setting Tool.

In the Service tab of the Normal or Special Schedule Setting screen, check “Timer”, select a setting number and click the “Detail” button (→ P.4-33).

2. Check “Audio playback” and set “Sound Clip”, “Volume” and “Repetition Interval”.

3. Click the “Save Settings” button to save the settings and close the Timer Setting screen.



Tip

- Sample sound files are contained on the CD-ROM.
- For registering and deleting audio files, see “Audio Playback Settings dialog box” (→ P. 4-57).

Motion Detection Setting Tool

The section below describes the motion detection function which records pictures, sends data to external devices and records data in the log when there is a variation in all or part of the picture resulting from objects moving around.



Note

Notes on Using This Function

The Motion Detection Function is not suited to applications where high levels of reliability are required. Therefore, we recommend that you not use these functions for monitoring or other purposes if consistently high levels of reliability are required. Canon accepts no liability whatsoever for faults resulting from the use of the Motion Detection Function.

■ Motion Detection Setting Tool Display Screen (Live Mode)



- ① **“Load Settings” button**
Loads the motion detection settings currently set in the VB-C50FSi/VB-C50Fi.
- ② **“Save Settings” button**
Saves the current motion detection settings edited using this tool to the VB-C50FSi/VB-C50Fi.
After setting the motion detection function, be sure to click the “Save Settings” button to save the settings to the VB-C50FSi/VB-C50Fi.
- ③ **“Stop Communication” button**
Click this button during communication with the VB-C50FSi/VB-C50Fi to abort the connection.
- ④ **Mode tab (Live, Video)**
 - **Live mode**
For picture display, camera control and recording of the picture displayed.
 - **Video mode**
For adjusting motion detection sensitivity (→ P.4-47) during play back of the picture recorded in Live Mode.

⑤ **Camera Selection box**

For selecting a camera.

⑥ **Viewer**

For picture display and camera control in the same way as a normal viewer.

⑦ **Motion detection area frame**

Displays with a dotted frame the area within which motion is to be detected. The frame can be reshaped and moved by dragging the mouse.

⑧ **“Rec. Start” button**

Starts recording of the picture.

⑨ **Setting number selection box**

Select the number of the setting you want to use.

⑩ **Settings tabs (Camera, Area, Recording, Output, Audio/Tracking)**

• **Camera tab**

For setting the frame rate and camera positions (→ P.4-40).

• **Area tab**

For selecting the area within which motion is to be detected and the sensitivity, area ratio and duration for each area (→ P.4-41).

• **Recording tab**

For setting the duration of picture and audio recording* when the camera detects motion (ON event) or when the camera can no longer detect motion (OFF event), and for setting the recording interval (→ P.4-43).

* Only available with a particular model of the VB-C50FSi (→ P.iii)

• **Output tab**

For setting output of data to an external device (→ P.4-44).

• **Audio/Tracking tab**

Sets Audio Playback (VB-C50FSi only) (→ P.4-44).

⑪ **Display motion detection status of the server**

Check to display the results of motion detection by the server. You can check whether or not the settings are activated in the device (→ P.4-45).

■ Flow of Motion Detection Settings

A summary of the procedures for motion detection is given below. Please refer to each reference page for information about detailed setting content.

1. Open the Motion Detection Tool.

The Motion Detection Tool Setting screen appears (→ P.4-37 “Motion Detection Setting Tool Display Screen”).

Enter settings for motion detection in the Settings tabs on the right of the screen. There are 5 Settings tabs - “Camera”, “Area”, “Recording”, “Output” and “Audio/Tracking”.

* The Audio/Tracking tab cannot be used with the VB-C50Fi.

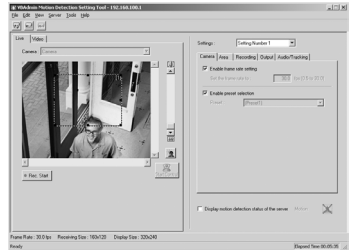

2. For setting the camera frame rate and the camera position for detection (See the “Camera” tab → P.4-40).
3. For setting the detection area (See the “Area” tab → P.4-41).
4. For setting the sensitivity of the motion detection at what degree of variation in the image activates the motion detection (See the “Area” tab → P.4-41).
5. For setting actions to be performed when motion detection is activated (“Recording” tab → P.4-43).
6. If necessary, set output to an external device and Audio Playback (“Output” tab → P.4-44, “Audio/Tracking” tab → P.4-44).
7. Save the settings.



Tip

You can set the level of motion detection in the “Area” tab, while checking the viewer image on the left side of the screen. See “Motion detection status and screen display” (→ P.4-46) about screen display in this case. You can also adjust the level of motion detection during play back in Video Mode of images recorded in Live Mode (→ P.4-47).

■ Setting Up Motion Detection

To Make Settings...

1. Open the Motion Detection Setting Tool with the Schedule Setting Tool.

In the Service tab in a Normal or Special Schedule Setting screen, check Motion Detection, select a setting number and click “Detail” (→ P.4-33).

2. Set the camera frame rate and the camera position for detection (Camera tab).

Set the camera frame rate and camera position.

For camera position, either set your own area for detection in the Live Mode Viewer or select a Preset in the Camera tab.

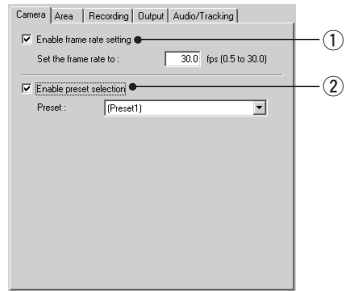

① “Enable frame rate setting”

Check to set the frame rate for camera shooting. Enter a value within a range of 0.5-30.0 fps (NTSC)/25.0 fps (PAL).

* Please refer to P.1-10 to confirm whether your VB-C50FSi/VB-C50Fi is PAL model or NTSC model.

② “Enable preset selection”

Check to select a camera position from a preset.



Note

The frame rate specified in the “Maximum Frame Rate” (→ P.3-17) must be higher than the one specified using this tool.



Tip

- When the network traffic is high, the specified frame rate may not be achieved.
- When a slow frame rate is set, motion detection is applied to images sampled from the captured video. In this way, motion can be detected even in slowly moving objects.
- The frame rate specified above only applies to the motion detection.

3. Create a motion detection area (Area tab)

Create an area in the viewer within which motion detection is to be performed (motion detection area). You can create a maximum of 4 motion detection areas, and reshape and move each area frame by dragging the mouse. Change the shape by dragging the black boxes on the 4 corners and sides of the frame, and move the frame by dragging the inside of it with the mouse. Also, you can set a separate level of motion detection in each area. See step 4 for how to set up the level of motion detection.

① Used Area

Check the number of the motion detection area to be used and the detection area frame is displayed in the Viewer. You can create a maximum of 4 motion detection areas.

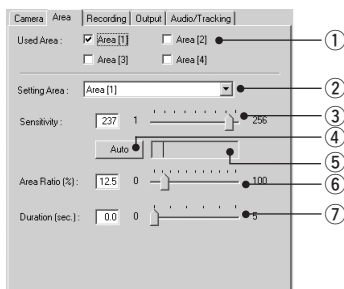

4. Setting the level of motion detection for the motion detection area (Area tab)

These settings determine how great the variation must be (sensitivity), how large the changed area must be as a proportion of the whole detection area (area ratio), and how long the variation must continue (duration) before it is recognized as motion and the specified action is performed.

You can also set the level of motion detection for the device by checking in Video Mode the image recorded with Live Mode (→ P.4-47).

② Setting Area

If you have created two or more motion detection areas, you can set separate levels of motion detection in each area frame. In Setting Area, select a setting number.

③ Sensitivity

Select the sensitivity of the motion detection in a range of 1-256. Either enter the setting or set sensitivity by dragging the slide bar. The larger the numeric value, the higher the degree of sensitivity will be.

④ “Auto” button

The “Auto” button sets sensitivity automatically. For several seconds after clicking the “Auto” button, the VB-C50FSi/VB-C50Fi assumes that there is no motion in the image in the motion detection area and, based on this information, sets the camera at optimum sensitivity. Set when there is no motion.

⑤ Detection indicator

Displays the area ratio of motion detected by the device in real time in the form of a graph (→ P.4-46).

⑥ Area Ratio

When the proportion of the area in which the device has detected motion (displayed in a red or yellow rectangle) has exceeded the specified value for the area of the selected detection area frame (blue frame), the device detects motion and performs the specified picture recording etc. (However, even if the area ratio value is exceeded, the device does not detect motion unless the number of seconds specified in Duration has passed). Set within a range of 0-100%, by either entering a numeric value or by dragging the slide bar.

⑦ Duration

When the situation where the motion has exceeded the area ratio continuous for more than the duration time, the device detects motion and performs picture recording etc. Set within a range of 0-5 seconds, by either entering a numeric value or by dragging the slide bar.



Tip

- If Sensitivity is set at a low level, the device does not recognize the motion even during great variations in the image inside the motion detection area frame. Also, if the area ratio and duration of the motion in the part of the image where motion occurred in the area frame do not reach the set values, the device does not perform detection and the specified actions such as picture recording are not performed.
- You can select a setting area by clicking the motion detection area frame in the Viewer you want to specify. The selected motion detection area frame is displayed as a blue frame.
- If you set the setting area to “Not specified”, the results of detection in all the motion detection areas you have created are displayed in each area frame. Also, even if you click an area which does not fall within any of the motion detection area frames in the Viewer, the setting area is set as “Not specified”.

5. Enter the settings for Recording when the device detects motion (Recording tab).

Enter the settings for picture recording time and recording interval when the device detects motion (ON event) or when the device no longer detects motion (OFF event).

The screenshot shows the 'Recording' tab of the Schedule Setting Tool. It contains the following settings:

- Recording at ON event:** Checked (1)
- Recording at OFF event:** Unchecked (2)
- Pre-event Recording time:** 4 sec. (0 to 10) (3)
- Recording interval:** 1.0 sec. (0.1 to 1.0)
- Post-event Recording time:** 8 sec. (0 to 10)
- Recording interval:** 1.0 sec. (0.1 to 1.0)
- Enable audio recording concurrently with picture:** Unchecked (3)
- E-mail notification on picture recording:** Unchecked (4)
- Recording between ON event and OFF event:** Checked (5)
- Recording interval between events:** 10 sec. (1 to 10)

① “Recording at ON event”

Check for picture recording when the device detects motion (ON event).

② “Recording at OFF event”

Check for picture recording when the device no longer detects motion (OFF event).

Pre-event Recording time (sec.)

For setting the required number of seconds within a range of 0-10 seconds for recording pictures before an ON or OFF event.

Pre-event Recording interval (sec.)

For setting the interval of time for picture recording before an ON and OFF event within a range of 0.1-1.0 seconds.

Post-event Recording time (sec.)

For setting the required number of seconds within a range of 0-10 seconds for recording pictures for a fixed time after an ON or OFF event.

Post-event Recording interval (sec.)

For setting the interval of time for picture recording after an ON and OFF event within a range of 0.1-1.0 seconds.

③ “Enable audio recording concurrently with picture”*

Check to record audio for the time set for picture recording. If you enter a value of 0 both for the Pre-event Recording time and Post-event Recording time, the VB-C50FSi performs audio recording with the following configuration:

Pre-event Recording time: 1 second

Post-event Recording time: 0 second

* Only available with a particular model of the VB-C50FSi (→ P.iii)

④ “E-mail notification on picture recording”

Check to send an e-mail containing the recorded image in conjunction with ON/OFF events. The e-mail notification is sent only once soon after an event occurs.

⑤ “Recording between ON event and OFF event”

Check to record pictures when the camera is detecting motion (between an ON event and the next OFF event).

Recording interval between events (sec.)

Sets an interval of 1 to 10 seconds between picture recordings when the camera is detecting motion (between an ON event and the next OFF event).



Tip

- See “Relationship between ON and OFF events and picture/audio recording*” (→ P.4-55) for the relationship between ON and OFF events in the picture and audio recording* settings.

* Only available with a particular model of the VB-C50FSi (→ P.iii)

- See “Setting Up Name Server Address and Mail etc.” (→ P.3-25) for addressing of mail messages and communication methods and “E-mail Notification Settings dialog box” (→ P.4-56) for setting content of e-mails.

6. Enter the settings for output to an external device when the device detects motion (Output tab).

* The settings in this step are optional.

Set output to an external device when the device has detected motion (ON event) or when the device has finished detecting motion (OFF event).

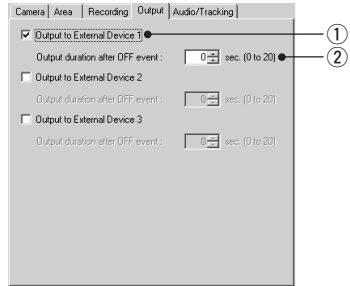

① Output to External Devices 1-3

Check for Output to External Devices 1-3.

② Output duration after OFF event (sec.)

When the camera is outputting data to an external device and output has to continue after the camera detects an OFF event, use this option to set a duration between 0 and 20 seconds for which output continues.

7. Set Audio Playback when the device detects motion (VB-C50FSi only) (Audio/Tracking tab).

* The settings in this step are optional.

Set Audio Playback when the device detects motion (ON event) or when the device has finished detecting motion (OFF event).

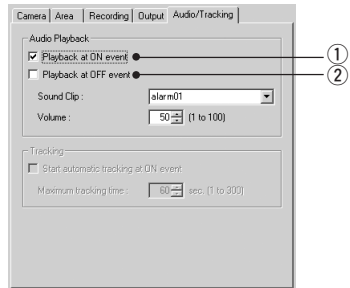

① Playback at ON event

Check for audio playback when the device detects motion (ON event).

② Playback at OFF event

Check for audio playback when the device has finished detecting motion (OFF event).

Sound Clip and Volume

Set the audio for playback. Select from the registered sound clip names. Set the volume at which the audio is to be played back, between 1 and 100.



Tip

For registering and deleting audio files, see “Audio Playback Settings dialog box” (→ P.4-57).

Continued on the following page. →

8. Check motion detection status in the server.

To confirm the operating level of motion detection with the settings you have made, check “Display motion detection status of the server”. Motion detection status is displayed as the icon below.

You cannot save the settings with “Display motion detection status of the server” checked. Remove the check to save the settings.



[Detection disabled]



[Detected]



[Not detected]



Note

- Because the video distribution frame rate may be lowered when the data is sent via a proxy server, connection without using a proxy server is recommended while setting the motion detection.
- The motion detection settings should be adjusted and set in conditions that are as close as possible to those for actual operation.
- For detailed information on specifying the settings, see Page 6-8.



Tip

- Please note that each result of the following features may not match completely: the “Motion detected (peak block)” shown in this tool, the motion detection status of the server and actual status of motion detection.
- When “Display motion detection status of the server” option is selected, external device and log output, and picture recording are not performed.
- Because the Motion Detection Function detects motion by comparing consecutive image frames, small movements are less likely to be detected when the video quality (→ P.3-8) is poor.
- When the VB-C50FSi/VB-C50Fi Motion Detection Function is enabled, the processing load on the VB-C50FSi/VB-C50Fi is high. Consequently, the video distribution frame rate may be lowered than when the function is disabled.

9. Click the “Save Settings” button in the Schedule Setting screen to save the settings, and close the Motion Detection Setting screen.

This completes the settings for motion detection.



Motion detection status and screen display



The area in which the VB-C50FSi/VB-C50Fi is performing motion detection appears in a blue frame in the Viewer.

The selected sensitivity at which the VB-C50FSi/VB-C50Fi is performing motion detection appears as a yellow or red rectangle in the motion detection frame.

Yellow rectangle: Where the device has detected motion, but because Area Ratio and Duration have not reached their setting value, the device does not detect motion.

Red rectangle: Where the device has detected motion, and Area Ratio and Duration has reached its setting value, the device detects motion.

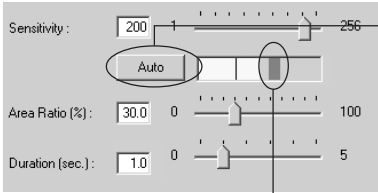

Where there is a variation in the image, the value set in Area Ratio is displayed as a vertical line in the indicator. The indicator displays in the following 2 colors.

Green: The area of the motion detected by the device has not reached Area Ratio.
Yellow: The area of the motion detected by the device has reached Area Ratio.

When "Sensitivity", "Area Ratio" and "Duration" are satisfied, and the VB-C50FSi/VB-C50Fi detects motion and performs specified actions such as picture recording, a red peak block appears. You can set the degree of motion for which the peak block is displayed while monitoring the actual image.

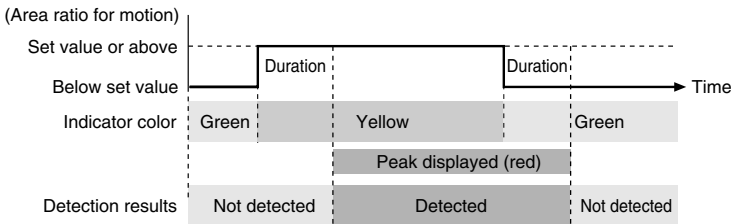

When the situation where the motion has exceeded the area ratio continues for longer than the time set in "Duration", the VB-C50FSi/VB-C50Fi detects motion and a peak block appears. When there is motion detection and the peak block has appeared, only Duration will maintain motion detection status, even if less than the specified Area Ratio.



Setting the motion detection level while checking recorded images

To set the level of motion detection at motion detection is activated, it is useful to make adjustments to settings while checking actual actions in the Viewer. Because with the device you can set the level of motion detection by checking in Video Mode the pictures recorded in Live Mode (→ P.4-37) in the Mode tab, you do not need to repeat the actual actions in front of the camera.

1. Select Video Recording Options from Tools in the menu bar and the Video Recording Options setting dialog box is displayed.

Video Recording Options setting dialog box

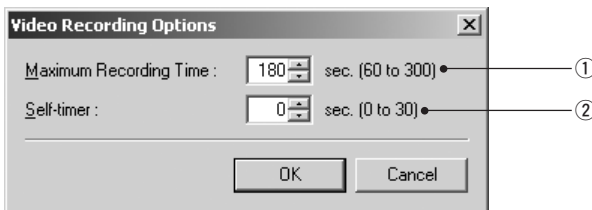

① Maximum Recording Time (sec.)

Sets maximum recording time, for 60-300 seconds.

② Self-timer (sec.)

Sets the time until recording starts after clicking "Rec. Start", from 0-30 seconds.

2. Align the camera position and click the "Rec. Start" button in Live Mode.

Starts picture recording at the camera position currently shown in the Viewer. Record pictures necessary for adjusting the level of motion detection such as performing actions in front of the camera.

To stop recording, click the "Stop Recording" button.

3. Adjust the motion detection level in the Area tab while checking the video in Video Mode.

① List of recorded video

Displays a list of recorded video.

② "Delete" button

Deletes the selected video from the list.

③ Control buttons

From the left, performs Move to Start, Rewind, Play, Fast Forward and Move to End. Check Loop Playback to repeat play back of the video.

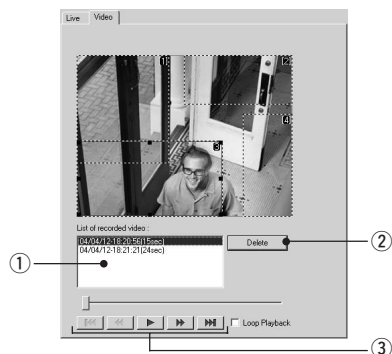

Night Mode Setting Tool

Below is a description of the Night Mode function with which you can take pictures in dark conditions.

■ Night Mode Setting Display Screen

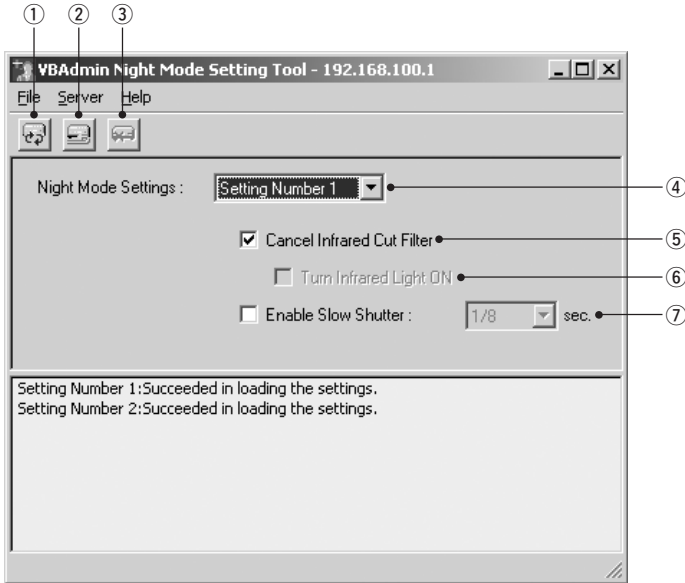

① **“Load Settings” button**

Loads the Night Mode settings currently set in the VB-C50FSi/VB-C50Fi.

② **“Save Settings” button**

Saves the Night Mode settings edited using this Tool.

After setting the Night Mode function, be sure to click the “Save Settings” button to save the settings.

③ **“Stop Communication” button**

This button can be clicked during communication with the VB-C50FSi/VB-C50Fi to abort the connection.

④ **Setting number selection box**

Select the number of the setting you want to use.

⑤ **Cancel Infrared Cut Filter**

Check to remove the camera’s Infrared Cut Filter to enable shooting with black-and white images using infrared light.

⑥ **Turn Infrared Light ON**

* Not available with the VB-C50FSi/VB-C50Fi.

⑦ **Enable Slow Shutter**

Check to select a shutter speed for the camera.

■ Setting Up Night Mode

To Make Settings...

1. With the Schedule Setting Tool, open the Night Mode Setting Tool.

In the Service tab of the Schedule Setting screen for a Normal or Special Schedule, check Night Mode, select a setting number and click the “Detail” button (→ P.4-33), or click the “Night mode setting tool” button on the toolbar.

If you have opened the Night Mode Tool from the toolbar, select a setting number from the setting number selection box in the Night Mode Setting screen.

2. Check Cancel Infrared Cut Filter and/or Enable Slow Shutter as required.

3. Click the “Save Settings” button to save the settings and close the Night Mode Setting screen.



Note

- If you have selected “Enable Slow Shutter”, the exposure will be manual, and the aperture and gain will be at maximum.
Change the shutter speed and adjust brightness according to your operating environment and photographic subject.
- If you specify a shutter speed of 1/30 seconds or slower for NTSC, or 1/25 seconds or slower for PAL, auto focus will not operate.



Tip

- In Night Mode, focusing with Auto Focus may be difficult or may appear to be out of focus.
- “Auto (for domes)” and “Fixed at infinity” configured with Focus Mode (→ P.3-9) is not available if you check the “Cancel Infrared Cut Filter”.

External Device Input Setting Tool

Below is a description of the External Device Input function which performs video recording when a signal from an external device connected to the Multi-Terminal Module (→ P.1-11) such as a sensor is sent to the VB-C50FSi/VB-C50Fi.

■ External Device Input Setting Tool Display Screen

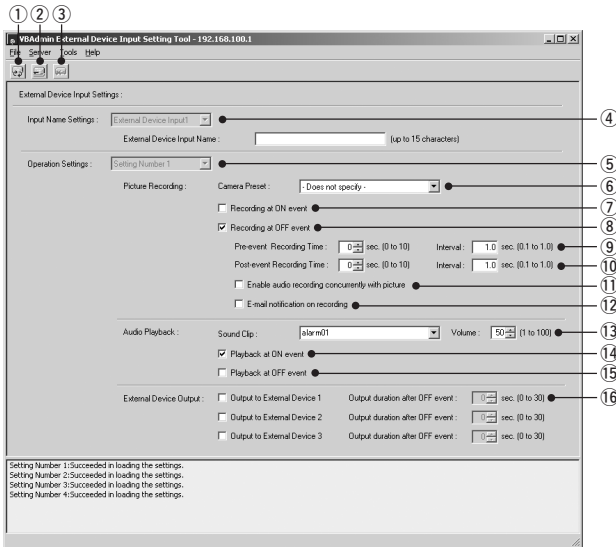

① **“Load Settings” button**

Loads the External Device Input settings currently set in the VB-C50FSi/VB-C50Fi.

② **“Save Settings” button**

Saves the External Device Input settings edited using this Tool.

After setting the External Device Input function, be sure to click the “Save Settings” button to save the settings.

③ **“Stop Communication” button**

This button can be clicked during communication with the VB-C50FSi/VB-C50Fi to abort the connection.

④ **Input Name Settings**

Select an External Device Input 1 or 2 and enter an External Device Input Name.

⑤ **Setting number selection box**

Select the number of the setting you want to use.

⑥ **Camera Preset**

Select the camera position for picture recording. Select from “Not specified” or “registered preset names”.

⑦ **Recording at ON event**

Check to perform picture recording when there is ON input from the external device.

⑧ **Recording at OFF event**

When selected, performs picture recording when input from the external device is OFF.

⑨ Pre-event Recording Time (sec.) and Interval

Enter the required number of seconds, within a range of 0-10 seconds for picture recording before an ON and/or OFF event. Also enter an interval for performing picture recording, within a range of 0.1-1.0 seconds.

⑩ Post-event Recording Time (sec.) and Interval

Enter the required number of seconds, within a range of 0-10 seconds for picture recording following an ON and/or OFF event. Also enter an interval for performing picture recording, within a range of 0.1-1.0 seconds.

⑪ Enable audio recording concurrently with picture*

Check to record audio for the time set for picture recording. If you enter a value of 0 both for the Pre-event Recording time and Post-event Recording time, the VB-C50FSi performs audio recording with the following configuration:

Pre-event Recording time: 1 second

Post-event Recording time: 0 second

* Only available with a particular model of the VB-C50FSi (→ P.iii)

⑫ E-mail notification on recording

Check to send an e-mail of the recorded picture.

⑬ Sound Clip and Volume (VB-C50FSi only)

Set the audio for playback. Select from the registered sound clip names. Set the volume at which the audio is to be played back, between 1 and 100.

⑭ Playback at ON event (VB-C50FSi only)

Check for audio playback when there is ON input from an external device.

⑮ Playback at OFF event (VB-C50FSi only)

Check for audio playback when input from an external device is OFF.

⑯ Output to External Device 1-3 and Output duration after OFF event (sec.)

Check to perform output to an external device at OFF event. Enter a time for performing output in the range of 0-30 seconds.

■ Setting Up External Device Input**To Make Settings...****1. With the Schedule Setting Tool, open the External Device Input Setting Tool.**

In the Service tab of the Schedule Setting screen for a Normal or Special Schedule, check Input 1 or Input 2 in External Device Input, select a setting number and click the “Detail” button (→ P.4-33), or click the “External input device setting tool” button on the toolbar.

If you have opened the External Device Input Tool from the toolbar, select an External Device Input Name and setting number in the External Device Input Setting screen.

2. Perform picture recording operations.

Check either Recording at ON event or Recording at OFF event, and select a Camera Preset. Also, enter the required number of seconds and the interval for picture recording before or after an ON or OFF event.

If you check “Enable audio recording concurrently with picture”, audio is recorded for the time set for picture recording*.

* Only available with a particular model of the VB-C50FSi (→ P.iii)

If you check “E-mail notification on recording” you can send recorded pictures as e-mail when an event occurs. The e-mail notification is sent only once soon after an event occurs.



Tip

See “Setting Up Name Server Address and Mail etc.” (→ P.3-25) for the addresses of mail messages and communication methods and “E-mail Notification Settings dialog box” (→ P.4-56) for setting content of mail messages.

3. Specify the Audio Playback operation settings.

Check “Playback at ON event” or “Playback at OFF event” and select the playback sound clip name and volume.



Tip

For registering and deleting audio files, see “Audio Playback Settings dialog box” (→ P.4-57).

4. Set external device output operations.

Tick one of “Output to External Device 1” to “Output to External Device 3” options and specify the “Output duration after OFF event” setting.

5. Click the “Save Settings” button to save the settings and close the External Device Input Setting screen.



Tip

See “Relationship between ON and OFF events and picture/audio recording” (→ P.4-55) for the relationship between ON and OFF events in the picture and audio recording* settings.

* Only available with a particular model of the VB-C50FSi (→ P.iii)

External Device Output Setting Tool

The section below describes the output settings to an external device connected to the Multi-Terminal Module (→ P.1-11).

■ External Device Output Settings Tool Display Screen

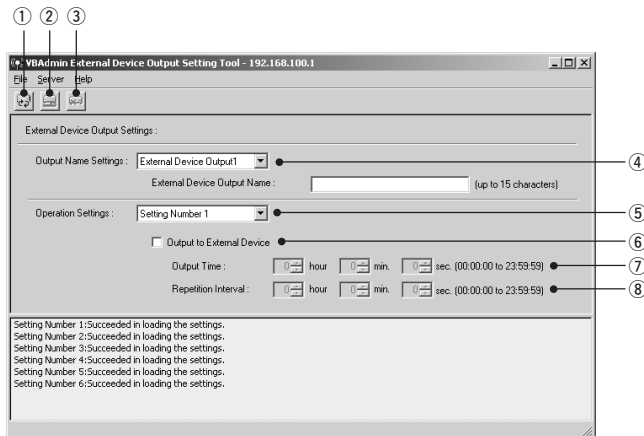

① “Load Settings” button

Loads the External Device Output settings currently set in the VB-C50FSi/VB-C50Fi.

② “Save Settings” button

Saves the External Device Output settings edited using this Tool.

After setting the External Device Output function, be sure to click the “Save Settings” button to save the settings.

③ “Stop Communication” button

This button can be clicked during communication with the VB-C50FSi/VB-C50Fi to abort the connection.

④ Output Name Settings

Select an External Device Output 1-3 and enter an External Device Output Name.

⑤ Operation settings

Select the number of the setting you want to use.

⑥ Output to External Device

Perform output to the selected external device.

⑦ Output Time

Set the length of time for output to the selected external device, to a maximum of 23 hours, 59 minutes and 59 seconds.

⑧ Repetition Interval

Set the interval at which output is to be executed, to a maximum of 23 hours, 59 minutes and 59 seconds. If you set the Repetition Interval to 0, output only occurs once at the start of the scheduled time.

■ Setting Up External Device Output

To Make Settings...

1. With the Schedule Setting Tool, open the External Device Output Setting Tool.

In the Service tab of the Schedule Setting screen for a Normal or Special Schedule, check Output1-3 in External Device Output, select a setting number and click the “Detail” button (→ P.4-33), or click the “External device output setting tool” button on the toolbar.

If you have opened the External Device Output Tool from the toolbar, select an External Device Output Name and setting number in the External Device Output Setting screen.

2. Check Output to External Device and set Output Time and Repetition Interval.

3. Click the “Save Settings” button to save the settings and close the External Device Output Setting screen.



Tip

If you set Output Time at more than Repetition Interval, output continues without interruption.



Tip

Relationship between ON and OFF events and picture/audio recording*

* Only available with a particular model of the VB-C50FSi (→ P.iii)



The figures below show the methods (A-D) of picture and audio recording that use motion detection and external device input based on the timing of ON and OFF events.

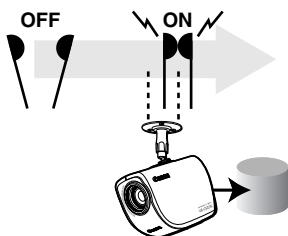

A: Pre-event recording for an ON event
Pictures: For 0-10 seconds at intervals of 0.1-1.0 seconds
Audio: For 0-10 seconds

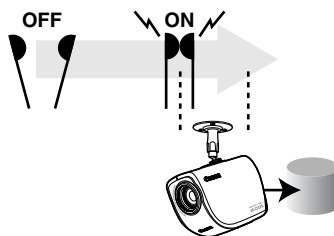

B: Post-event recording for an ON event
Pictures: For 0-10 seconds at intervals of 0.1-1.0 seconds
Audio: For 0-10 seconds

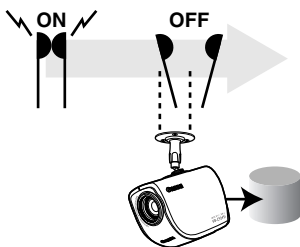

C: Pre-event recording for an OFF event
Pictures: For 0-10 seconds at intervals of 0.1-1.0 seconds
Audio: For 0-10 seconds

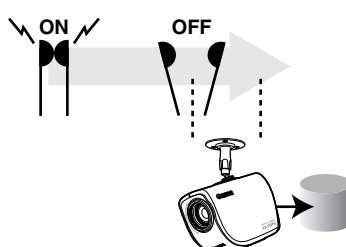

D: Post-event recording for an OFF event
Pictures: For 0-10 seconds at intervals of 0.1-1.0 seconds
Audio: For 0-10 seconds

- For A and C, recording is controlled to the pre-event recording time, and for B and D, it is controlled to the post-event recording time.
- If you select “Recording between ON event and OFF event” in the motion detection settings, you can also record pictures during ON events (between B and C) (→ P.4-43).
- If you select “Enable audio recording concurrently with picture”, you can record audio for the time specified for picture recording (→ P.4-43).



E-mail Notification Settings dialog box

When pictures have been recorded, you can send the recorded picture and data in an e-mail. Settings for sending mail messages are performed in the E-mail Notification Settings dialog box.

Select E-mail Notifications Settings from Tools in the menu bar in the Motion Detection Setting screen or External Device Input Setting screen and the dialog box appears.

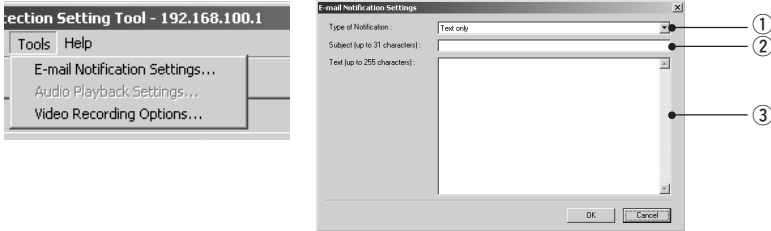

① Type of Notification

Select a notification setting from “Text only” or “Text and recorded picture”.

② Subject (up to 31 characters)

Enter the subject of the e-mail.

③ Text (up to 255 characters)

Enter the text of the e-mail (text). The list of parameters below using the percentage symbol (%) can be included in the text of a “Text and recorded pictures” message.

Parameter	Description	Values
%n	Reason for shot (number)	1 (external device input 1), 2 (external device input 2), 129 (Motion detection)
%N	Reason for shot (text)	“External Device Input Name” (“External Device Input 1/2” if omitted), Motion detection
%X	Image width	No. of horizontal pixels
%Y	Image height	No. of vertical pixels
%Q	Video quality	10-100
%C	Camera number	1-2
%D	Camera name	“Camera Name” setting
%Z	Zoom position	0.1 ~ 300
%V	Camera server	VB-C50i
%y	Year of shot	2000-2038
%m	Month of shot	1-12
%d	Date of shot	1-31
%w	Day of shot	0-6 (correspond to Sun. to Sat.)
%H	Hour of shot	00-23
%M	Minute of shot	00-59
%S	Second of shot	00-59
%z	Time zone of shot	-1200 to +1200
%a	Weekday of shot	Sun, Mon, Tue, Wed, Thu, Fri, Sat
%b	Name of month of shot	Jan, Feb, Mar, Apr, May, Jun, Jul, Aug, Sep, Oct, Nov, Dec
%t	Tab	
%q	***	
%%	%'	

* For undefined characters, the '%' is deleted.

* With the exception of %, %q and %%, you cannot use the same parameter multiple times on the same line.
(The parameter including %' is ignored from the second instance onwards.)



Tip

Audio Playback Settings dialog box (VB-C50FSi only)

To play back audio, you have to register the audio file you want to play back. Settings for registering or deleting audio files are performed in the Audio Playback Setting dialog box. Select “Audio Playback Settings” from Tools in the menu bar in the Timer Settings screen, Motion Detection Setting screen or External Device Input Setting screen and the dialog box appears.

1. From the “Sound Clip List” in the Audio Playback Settings box, select the “Unregistered” item and click the “Edit” button.

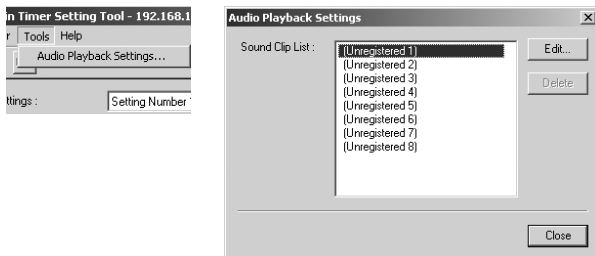

2. The Audio Playback Edit dialog box appears. Click the “Browse” button and select the audio file you want to set.

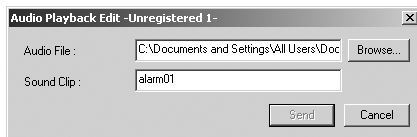

3. Enter a name for the Audio Playback and click the “Send” button.

Click the “Close” button in the Audio Playback Settings dialog box to close the dialog box.

- You can set the audio file playback time up to 120 seconds, and you can only playback “.wav” and “.au” (μ-law, PCM 8bit. Sampling frequency 8000Hz, mono) files.
- If you wish to use audio files other than those listed above, you need to convert file formats. See our WebView Product web page <http://www.canon.com/webview> for details.
- To delete registered audio, select the audio file you want to delete from the “Sound Clip List” and click the “Delete” button.

Log Viewer

The Log Viewer is a tool for downloading log files, and viewing and managing the operating status of the device. The Log Viewer provides monitoring of illegal access and a way of dealing with errors etc.

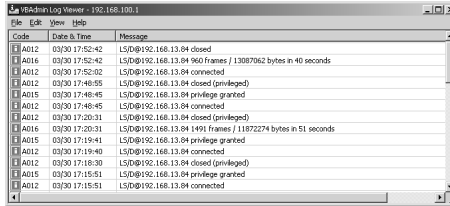

Tip

- The Log Viewer is only for viewing logs and cannot be used to delete logs.
- To save a log, choose Save from the File menu bar. Logs can be saved as text files.

■ Downloading Log Files

To Download...

1. When Log Viewer is started up from the VBAAdmin Startup Panel, it automatically retrieves the most recent log file and displays it.

To retrieve a list of log files, choose Download from the File menu bar.

When the list is retrieved, a list of log files appears in the dialog box. Select the log file you want to view by clicking on it, then click the Download button and the selected file will be downloaded.

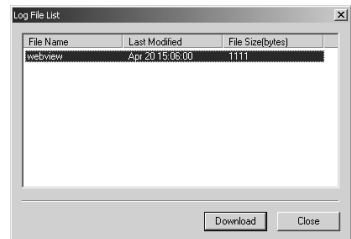
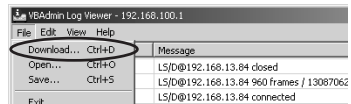

Tip

- Click "Cancel" in the dialog box during downloading to stop the download.

Viewing the Log

The following content is displayed in the log.

● Code

The log displays error codes. For error codes, refer to Log Messages (→ P.7-4). Error codes are displayed with one of 4 types of icons according to level.



Information level



Error level



Warning level



Unknown

● Date & Time

The date and time when the log was generated is displayed.

● Message

Log messages are displayed.

■ Saving a Log to a File/Opening a Saved File

You can save a displayed log to a file as well as view a previously saved log file.

To Save...

Choose “Save” from the “File” menu bar.

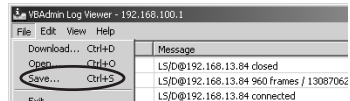

To View...

Choose “Open” from the “File” menu bar and select the log file you want to view.

■ Copying and searching a log

You can copy or search a displayed log.

To Copy...

Select the log you want to copy by clicking on it, then choose “Copy” from the “Edit” menu bar.

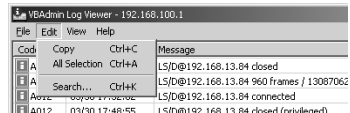

To Search...

Choose “Search” from the “Edit” menu bar, enter the character string you want to search and click the “Search” button.

■ Using Selection Criteria to Display Logs

Logs can be filtered according to error type, code, or date and time so that only the required information is displayed.

To Make Settings...

1. Choose “Filter” from the “View” menu bar.

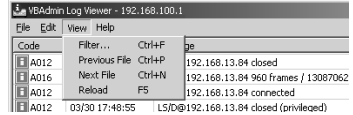

2. The Filter dialog box appears.

Set the following selection criteria and click “OK” to display only the logs that match those criteria.

If filtering is not required, click “Cancel”.

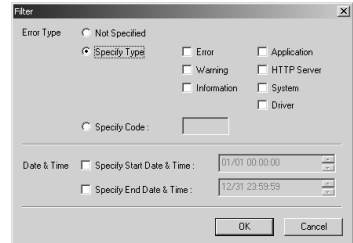

[Error Type]

To filter by error type, check “Specify Type” or “Specify Code”. Otherwise check “Not Specified”.

● Specify Type

–Specifying the levels of the logs

From Error, Warning, and Information, select the error levels to be displayed.

–Specifying the modules that output the logs

From Application, HTTP Server, System, and Driver, select the output source modules to be displayed.

● Specify Code

Specify the error code of the logs. The error codes of the logs are compared to the characters that are entered and only logs with matching error codes will be displayed. For example, if “A0” is entered, logs whose error codes start with “A0” will be displayed.

[Date & Time]

● Specify Start Date & Time

Logs generated after the specified date and time can be displayed by selecting this item and entering a date and time.

● Specify End Date & Time

Logs generated before the specified date and time can be displayed by selecting this item and entering a date and time.



Tip

- There is no log message related to the driver in the VB-C50FSi/VB-C50Fi.
- “Application” and “System” correspond to the log messages list (→ P.7-4).
- Application: Log messages related to applications (→ P.7-4).
These log messages refer to applications such as WebView and picture recording.
- System: Log messages related to the system (→ P.7-11).

Admin Viewer

Admin Viewer is a viewer which has functions for managing the VB-C50FSi/VB-C50Fi. It has special privilege functions that the Viewer for PC and Viewer for Java do not have, such as exclusive access to camera control functions, and external device and motion detection operation. This viewer is used when setting view restrictions and presets.

[Special privileges of Admin Viewer]

- Connections are also possible outside service times (→ P.3-15).
- Connection time is unlimited.
- Exclusive camera control privileges. Invalidates control privileges held by and requests obtained from other viewers.
- Ignores view restrictions.
- Operates external devices and motion detection.
- External device input and motion detection notification (→ P.4-62).
- Camera control by clicking or using dialog boxes (→ P.4-64).
- You can set the camera-specific features and audio sending/receiving*.
- * Only available with a particular model of the VB-C50FSi (→ P.iii)
- If the connection is aborted, you can specify that the connection is automatically restored (→ P.4-69).
- You can specify that the exposure and focus settings revert to their defaults when you close the Admin Viewer (→ P.4-70).

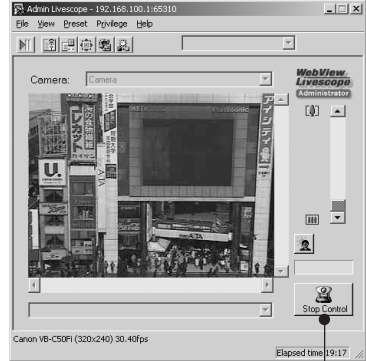

“Control” button

Click this button to obtain camera control privileges.



Note

About the special privileges of administrators

Since Admin Viewer has more special privileges than the Viewer for PC and Viewer for Java, please keep in mind the following points when using Admin Viewer:

- Since connection time is unlimited, please exit the viewer after viewing.
- When camera control privileges have been obtained, Admin Viewer forcibly continues to obtain these privileges. After viewing, be sure to exit the viewer or click the Control button again to release these privileges.
- When making settings, keep in mind that images outside the view restrictions are displayed also in the Viewer for PC and Viewer for Java that are connected simultaneously with Admin Viewer.
- When sending/receiving audio*, please read carefully “Usage Notice of Audio” (→ P.iii).

* Only available with a particular model of the VB-C50FSi (→ P.iii)



Tip

Since most operations and settings of Admin Viewer are common with the Viewer for PC, basic camera control and the like are omitted here. This chapter describes only the functions and operations that are unique to Admin Viewer.

The manual for the viewer is provided on the supplied CD-ROM (Viewer-E.pdf).

Starting Up Admin Viewer

To Start Up...

1. Click the “Admin Viewer” on the VBAAdmin Startup Panel or double-click the “Admin Viewer” icon on the desktop.

When the Admin Livescope window appears, click the File then the Connect. The “Camera server address setting” dialog box appears. Enter the following items:

- Host Name (The IP address set on the VB-C50FSi/VB-C50Fi, → P.3-6)
- User Name (root) ● Password (→ P.3-5)

Then click the “OK” button. The video will then be displayed.

Operating External Devices and Motion Detection

■ Setting Notification of Changes in External Device Input and Motion Detection Status

A message box can be displayed in the event of a change in external device input and motion detection status.

To Make Settings...

1. Choose Setup Properties from the View menu bar.
2. When the Setup properties dialog box appears, click the “Display option” tab.

Check to be sure the “Display notification message for external device input and motion detection” check box is selected, then click “OK”.

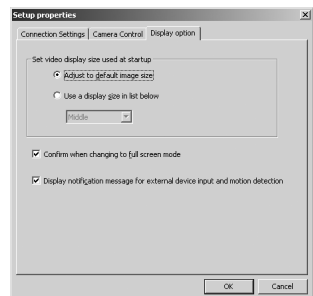
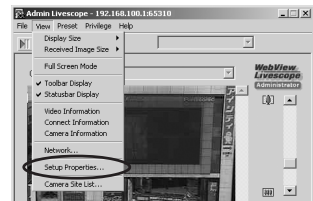

A message appears in the event a change occurs in the external device input status or when motion is detected.

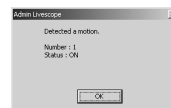

Note

If the Admin Viewer window is minimized or in full-screen mode, the notification message for external device input appears after the normal display is restored. Also, this message is not displayed when the External Device Input & Motion Detect dialog box is displayed.

■ Displaying and Saving the External Device Input and Motion Detection Status

The external device input and motion detection status can be displayed and, when required, saved as a log.

To Make Settings...

1. Choose External Device Input from the Privilege menu bar.
2. The External Device Input & Motion Detect dialog box appears and the external device input and motion detection status is displayed.

To save this content as a log, click “Save”, then specify a file name and where it should be saved.

To clear the content in the display, click “Clear”.

To close the dialog box, click “Close”.

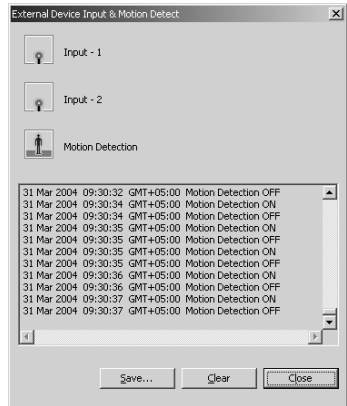
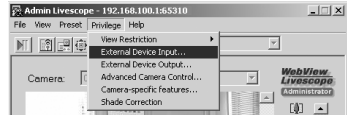

■ Operating External Device Output

The ON/OFF status of external device output can be changed.

To Make Settings...

1. Click the “Start Control” button to get camera control privileges, then choose External Device Output from the Privilege menu bar.
2. The External Device Output dialog box appears.

The external device output status can be changed using the ON/OFF buttons for each terminal.

To close the dialog box, click “Close”.

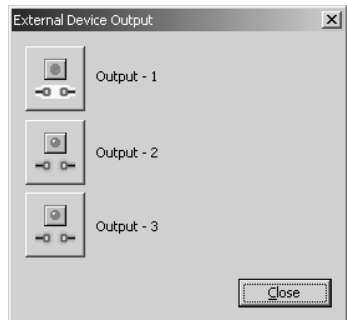
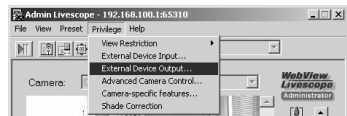

Depending on the settings content, some operations are not available from Admin Viewer.

Enabling/Disabling View Restrictions

View restrictions can be enabled or disabled when controlling the camera.

To Make Settings...

1. Choose either “ON” or “OFF” from View Restriction in the Privilege menu bar.

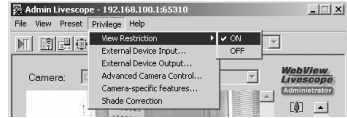

Operating a Camera

The Admin Viewer provides camera control methods not available in the Viewer for PC or Viewer for Java.

■ Advanced Camera Control

In the dialog box, you can set the focus and speed, and control the zoom by pressing the respective button to start and releasing the button to stop.

How to Operate and Set Up

1. Click the “Advanced camera control” button on the toolbars.

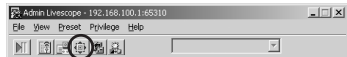

2. The Advanced Camera Control box appears.

- ① Pan & Tilt/Home buttons

* Not available with the VB-C50FSi/VB-C50Fi.

- ② “AF/MF” button

Displays a dialog box for switching between Auto Focus and Manual Focus.

Auto: Auto focus.

Auto (for domes): For the camera used in combination with a dome housing so that auto focus does not focus on the dome wall surface.

Fixed at infinity: Enables focusing on infinity.

* “Auto (for domes)” and “Fixed at infinity” is not available if you configure the Night Mode settings (→ P.4-48, 4-66).

Manual: Hold Down the Far or Near buttons to adjust the focus.

- ③ “Speed” button

Displays a dialog box for camera operation speed.

Zoom speed: Select a zoom speed from Fast or Slow.

* With the VB-C50FSi/VB-C50Fi, you cannot change the Pan/tilt speed and Focus speed.

- ④ “Zoom” button

Lets you zoom in or zoom out. Zoom occurs when the button is held down and stops when it is released.

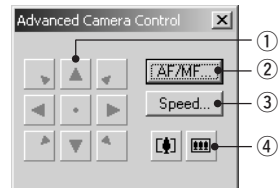

Tip

When you set the “Focus Mode” to the “Fixed at Infinity”, the VB-C50FSi/VB-C50Fi zooms in and zooms back to adjust the focus automatically.

■ Clicking the Screen to Control the Camera

You can control the zoom operation by clicking and holding the mouse in the viewer to start and releasing the mouse to stop.

How to Operate and Set Up

1. Choose Setup Properties from the View menu bar.

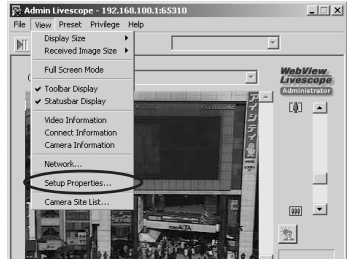

2. When the Setup properties dialog box appears, click the Camera Control tab.

Check to be sure the “Use the arrow buttons to control the camera when connected to a VB150 or newer model” check box is selected, then click “OK”.

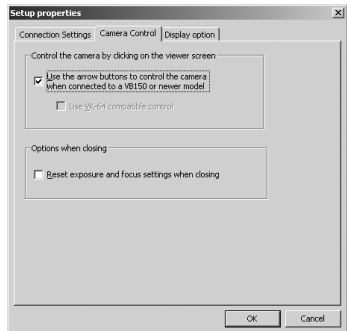

3. If the message “Try new property settings. OK?” appears, click “OK”, and click the “Start Control” button to obtain camera control privileges.

When the mouse cursor is set over the viewer, it changes to a minus icon on the center right and a plus icon on the center left. Click and hold to enable zoom operation.

* When using the VK-64, we recommend that you check “Use VK-64 compatible control”.

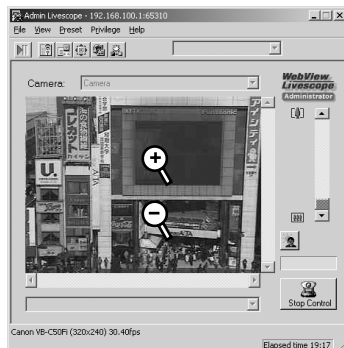
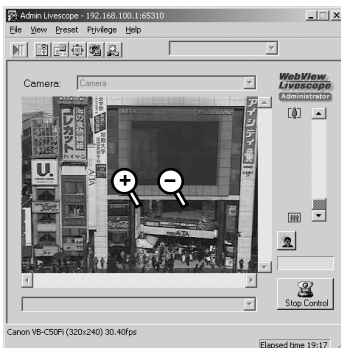

When “Use VK-64 compatible control” is checked.

Camera-Specific Functions

You can set up camera-specific features such as settings for exposure, digital zoom and night mode.

How to Operate and Set Up

1. Click the “Camera-specific features” button on the toolbar.
2. The Camera-specific features dialog box appears.

① Exposure

Select from Auto Exposure and Manual Exposure.

② Auto Exposure

The 4 buttons to the right become active when you select Auto Exposure. From the left the 4 buttons are No Backlight Compensation, Low Backlight Compensation, Medium Backlight Compensation and High Backlight Compensation, and the higher the compensation, the brighter the image becomes. Click a button to activate the backlight compensation you need.

③ “Manual Exposure”

You can set Fixed Aperture, Fixed Shutter Speed and Fixed Gain.

Fixed Aperture

The further to the left you move the slide bar, the more closed the aperture and the darker the image.

Conversely, the further to the right you move the slide bar, the more open the aperture and the brighter the image.

Fixed Shutter Speed

Fixes shutter speed. If you specify a fast shutter speed (1/125, 1/250 etc.), the darker the image becomes. Conversely, if you specify a slow shutter speed (1/1, 1/2 etc.) the brighter the image becomes.

Fixed Gain

The further to the left you move the slide bar, the lower the gain (sensitivity for brightness) and the darker the image. Conversely, the further to the right you move the slide bar, the higher the gain and the brighter the image.

④ Digital zoom

You can enlarge the image using the digital zoom. When you use zoom, other images sent to the Viewer are enlarged also.

* Digital zoom is not available if you configure the “Manual Exposure” or Night Mode.

⑤ “Night vision”

Set up night mode with Night Vision.

Night Mode

Check to cancel the Infrared Cut Filter, enabling you to see infrared images. In such case, the images are in black and white.

* “Auto (for domes)” and “Fixed at infinity” (→ P.4-64) is not available if you configure the Night Mode settings.

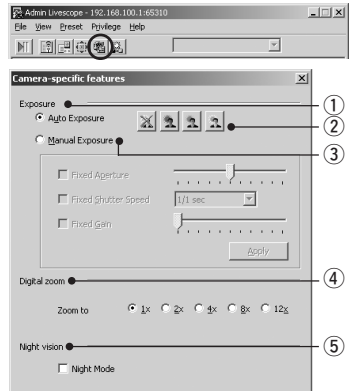

Sending and Receiving* Audio (VB-C50FSi only)

You can send and receive* audio with the VB-C50FSi through the speakers and microphone* installed on the optional Multi-Terminal Module on the camera. Below are settings for sending and receiving audio* by the administrator.

* Only available with a particular model (→ P.iii)

■ Sending Audio

Perform settings for an administrator to send audio to the VB-C50FSi.

How to Operate and Set Up

1. Click the “Microphone setting” button on the toolbar.

2. The Microphone setting dialog box appears.

① **Microphone button**

Click to turn on the administrator’s microphone and enable transmission of audio. Click again to turn the microphone off and stop transmission.



“Play audio also when using the microphone”*

Selecting “Play audio also when using the microphone” plays the received audio even when the “Microphone” button is “ON”. We recommend that you deselect this item if the audio from the microphone played on the speaker is hard to hear.

* Only available with a particular model (→ P.iii)

② **Volume slide bar**

Adjust the volume of the input in the microphone.

③ **“Use silence detection to reduce network traffic”**

Select to temporarily stop transmission of audio data when the audio is turned to mute. In this way, you can reduce traffic on the network you are using.

Use the default sensitivity setting: Operates at default sensitivity.

Set the sensitivity manually: Sets the sensitivity for detection by moving the slide bar. The further to the left you move the slide bar, the lower the degree of detection sensitivity becomes and there will be silence detection if the sound is not softer. The further to the right you move the slide bar, the higher the degree of detection sensitivity and there will be silence detection if the sound is not louder.

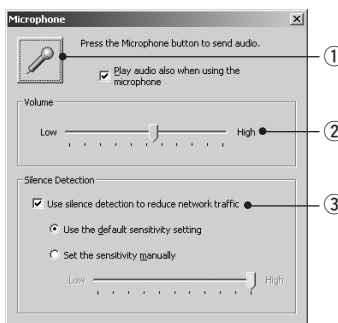

Please make microphone settings in Windows for audio transmission.

Continued on the following page. →



Tip

- The “Microphone setting” button will not appear in the following cases.
 - If Audio Reception has not been set to “Used” in the Audio Server settings page (→ P.3-19).
 - If “Send and receive audio data” in the “Connection Settings” tab in the Setup properties dialog box is not checked.
 - When connected to a camera server which does not support audio.
- When you minimize the Viewer, audio transmission temporarily stops even if the “Microphone” button is on.
- If you activate another application with the “Microphone” button on, the task bar icon flashes.

■ Playing Received Audio (VB-C50FSi only)

Specify the settings when the administrator receives/plays audio from the VB-C50FSi.

How to Operate and Set Up

1. Click the “Audio” button on the Toolbar.



2. The Audio settings dialog box is displayed.

① Play audio data

You can play audio from the microphone connected to the VB-C50FSi by selecting “Play audio data”.

② Volume slide bar

Adjust the speaker volume

③ Mute

Selecting “Mute” turns the sound off.

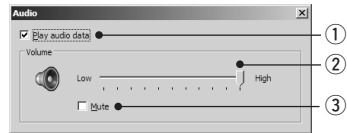

Tip

- The “Audio setting” button will not appear in the following cases.
 - If Audio Transmission has not been set to “Used” in the Audio Server settings page (→ P.3-18).
 - If “Send and receive audio data” in the “Connection Settings” tab in the Setup properties dialog box is not checked.
 - When connected to a camera server which does not support audio.
- When you minimize the Viewer, audio transmission temporarily stops.
- To play audio, see “Usage Notice of Audio” (→ P.iii).

Shade Correction

If the background of an image is bright, making the subject difficult to see, you can adjust the contrast of the darker areas to make it easier to see. Unlike backlight compensation, the shade correction feature allows image processing without adversely affecting the existing lighter regions.

How to Operate and Set Up

1. Click the “Shade Correction” button on the toolbar.
2. The Shade Correction dialog box appears.

- ① **Shade Correction**
Check for shade correction.
- ② **Shade Correction slide bar**
Adjust the level of shade correction.

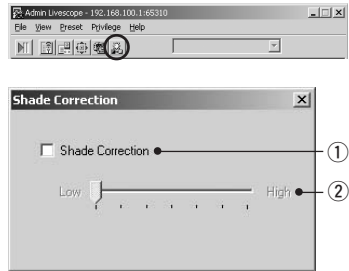

Auto Reconnection Function

When the Auto Reconnection function is enabled, the connection is automatically reestablished when the connection to the VB-C50FSi/VB-C50Fi is aborted due to network difficulties or because the VB-C50FSi/VB-C50Fi is rebooted. If reconnection fails, another reconnection attempt is made 30 seconds later. If an audio connection is current when the connection is aborted, the audio connection is also automatically reestablished.

How to Operate and Set Up

1. Choose “Setup Properties” from the “View” menu bar.
2. When the Setup properties dialog box appears, click the “Connection Settings” tab. Tick the “Reconnect automatically” option in “Auto reconnection” and then click the “OK” button.
3. When the “Try new property settings. OK?” message appears, click “OK”.

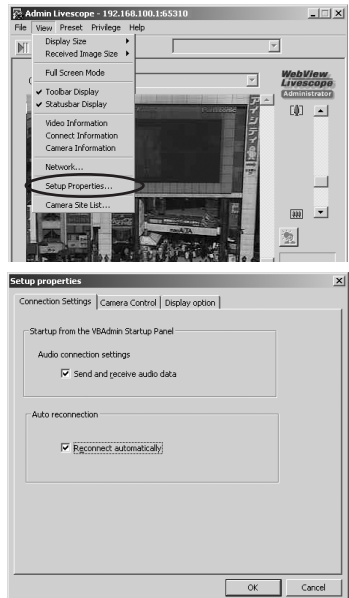

Restoring the Default Exposure and Focus Settings When Closing the Admin Viewer

When you use manual exposure in the camera-specific functions (→ P.4-66) or manual focusing in the advanced camera controls (→ P.4-64), you can specify that the exposure and focus settings revert to their defaults (Auto exposure and Auto focus) when you close the Admin Viewer. At the next startup, the default exposure and focus settings will apply.

How to Operate and Set Up

1. Choose “Setup Properties” from the “View” menu bar.
2. When the Setup properties dialog box appears, click the “Camera Control” tab.
Tick the “Reset exposure and focus settings when closing” option in “Options when closing” and then click the “OK” button.
3. When the “Try new property settings. OK?” message appears, click “OK”.

The exposure settings revert to their defaults when you release the control privileges.

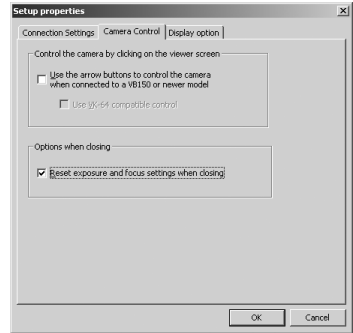

Chapter



Creating Web Pages for Video Distribution

This chapter describes how to use the VB-C50FSi/VB-C50Fi to webcast information.

Picture data can be distributed in various ways, including displaying video or still pictures and displaying multiple images on a Web page.

Web Pages for Video Distribution

To distribute picture data by VB-C50FSi/VB-C50Fi, you create a dedicated Web page. The viewers that can be used with the VB-C50FSi/VB-C50Fi are “Viewer for Java (with or without camera control function)” and “Viewer for PC”, and detailed parameters can be specified for each of these. You need to determine which of these viewers is supported and create the Web page for the viewer.

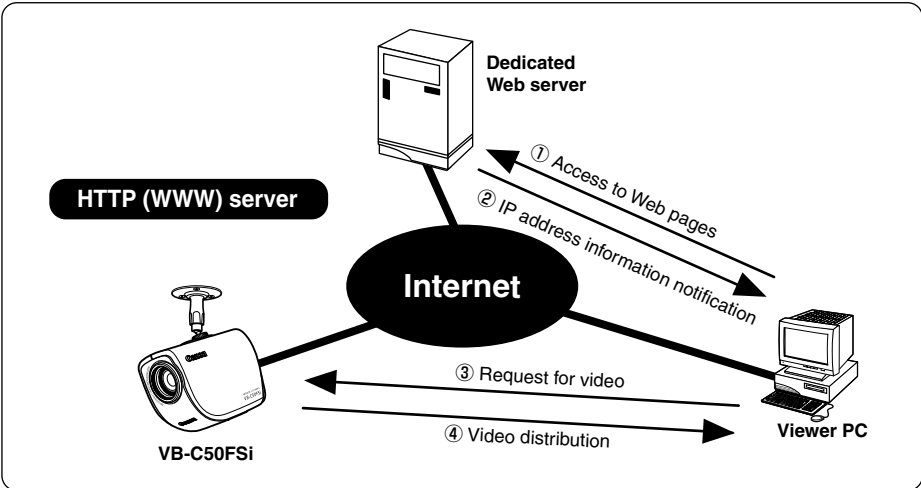

If you select a link requesting video in step ①, a file that includes the IP address information for the VB-C50FSi/VB-C50Fi is sent from the Web server in step ②. If you are using the Viewer for Java, the applet is downloaded to the viewer PC from the VB-C50FSi/VB-C50Fi in response to the request in step ③ and the video is distributed.

■ Example of a Web page for video distribution (VB-C50FSi/VB-C50Fi's built-in page)

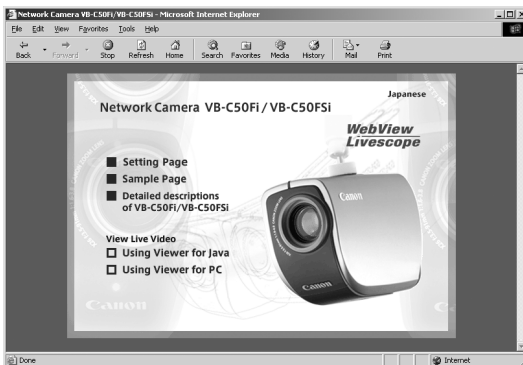

The above page is built into the VB-C50FSi/VB-C50Fi and can be accessed from the URL below.
http://192.168.100.1/*

* The underlined portion is a sample IP address. Enter the actual IP address set for the VB-C50FSi/VB-C50Fi (→ P.3-6).



The VB-C50FSi/VB-C50Fi includes a built-in Web server. If the content of the Web pages used for distributing videos is stored onto the flash memory in the VB-C50FSi/VB-C50Fi, the VB-C50FSi/VB-C50Fi can be used by itself for distributing Web pages and videos over the Web. Please refer to page 5-8 for procedures on how to save Web page data.



You can use the Language setting function for the Browser to create a multi-lingual Web site. For example, if you set the French-language top page as index-fr.html and the English-language top page as index.html and supply users with a URL address terminates in slash, such as <http://192.168.100.1/sample/>, the server will transmit a file that corresponds with the language setting for the Browser. For further information on the Language setting function for the Browser, refer to the Browser Help.

* The underlined portion is a sample IP address. Enter the actual IP address set for the VB-C50FSi/VB-C50Fi (→ P.3-6).

Viewer Overview

There are 2 types of viewers: the Viewer for Java and the Viewer for PC.

For a detailed explanation of the Viewers, please refer to "Viewer Software Overview" (→ P.2-14) or to the Viewer Software User's Manual (Viewer-E.pdf) on the CD-ROM.

Viewer for Java

The Viewer for Java provides 2 types of viewers: LiveApplet containing video display and camera control functions, and Glimpse containing a video display function. Because both viewers use the WebView-HTTP transfer protocol, data can pass through firewalls with no need for special settings.

LiveApplet

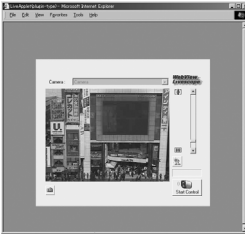

Video display
function
Camera control
function

Glimpse



Video display
function

* To use the Viewer for Java, you need to install Java VM beforehand. See the web site for more details.

WebView Product web site

<http://www.canon.com/webview>

Viewer for PC

The Viewer for PC provides video display and camera control functions. In addition to WebView-HTTP, the VB-C50FSi/VB-C50Fi also supports Canon's WebView-TCP transfer protocol.



Video display
function
Camera control
function

* You need to install the Viewer for PC from the "VBToolsInstall.exe" file on the supplied CD-ROM (→ P.2-13).



Note

Viewer Software User's Manual is provided on the CD-ROM supplied with the VB-C50FSi/VB-C50Fi (Viewer-E.pdf).

Viewing Sample Pages

Ready-made video distribution sample pages are provided with the VB-C50FSi/VB-C50Fi. Follow the procedure below to view these pages. Refer to these pages when creating your own Web pages.

Viewing the Pages

1. Launch your Web browser and enter the following URL:

<http://192.168.100.1/sample/>

* The underlined portion is a sample IP address. Enter the actual IP address set for the VB-C50FSi/VB-C50Fi (→ P.3-6).

2. The following pages appear. Click the sample pages you wish to view.

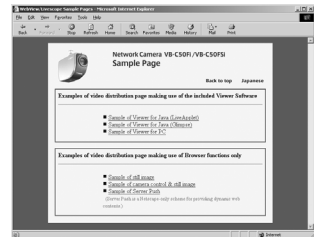

Examples of sample pages

JavaApplet sample 1



This is a LiveApplet sample page which distributes live videos and allows users to control the camera.

JavaApplet sample 2



This is a sample page which combines LiveApplet and Glimpse.

Still picture request page using JavaScript

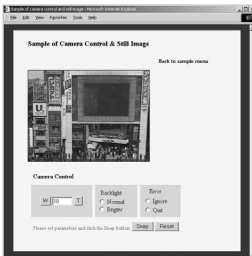

This is a sample page which displays a live still picture.

Using the Viewer for Java to Distribute Videos

This section describes how to use the Viewers for Java to provide videos. Application examples are also given.

Using the Viewer for Java to Create a Web Page

When you use the Viewer for Java, the viewer applet to be used must be incorporated into the Web page you provide. However, this is not especially difficult. The page can be created using the HTML normally used to include an applet.

LiveApplet

```
<applet codebase="http://192.168.100.1/-wvdoc-01-/LiveApplet/"
  code="LiveApplet.class" archive="LiveApplet.zip"
  width=450 height=380>
<param name=url value="http://192.168.100.1/">
<param name=cabbase value="LiveApplet.cab">
<param name=controller_style value="no_pantilt">
</applet>
```

Glimpse

```
<applet codebase="http://192.168.100.1/-wvdoc-01-/Glimpse/"
  code="Glimpse.class" archive="Glimpse.zip"
  width=160 height=120>
<param name=url value="http://192.168.100.1/">
<param name=cabbase value="Glimpse.cab">
</applet>
```

Enter the attributes of the applet between the <applet> and </applet> tags.

Enter the Applet parameters using the <param> tag.

* The underlined portion is a sample IP address. Enter the actual IP address set for the VB-C50FSi/VB-C50Fi (→ P.3-6).

If you are using a VB-C50FSi/VB-C50Fi LiveApplet, always specify the parameter below.

```
<param name=controller_style value="no_pantilt">
```

Saving Web Page Data

The VB-C50FSi/VB-C50Fi is equipped with a Flash memory where Web page data can be saved. Data is saved by transferring the data files using FTP. The data is placed as a file under /usr/html/local.

Device	File system (accessed by an ftp client)	URL (accessed from a Web browser)
On-board flash memory	ftp://IP address/usr/html/local	http://IP address/local/



Note

- Output performance may suffer if there is insufficient free space in the on-board file system. Ensure that only the minimum amount of data required is stored in the on-board file system (→ P.3-28).
- Using “Restore Settings” (→ P.3-29, 7-21) deletes all saved data. Back up your data before using this function.

Example of Using the Viewer for Java to Create a Web Page

This section describes an example in which the Viewer for Java is used to create a Web page. Use this example to create your own original Web page.

■ Embed the Viewer for Java, and Display a Text in a Separate Frame

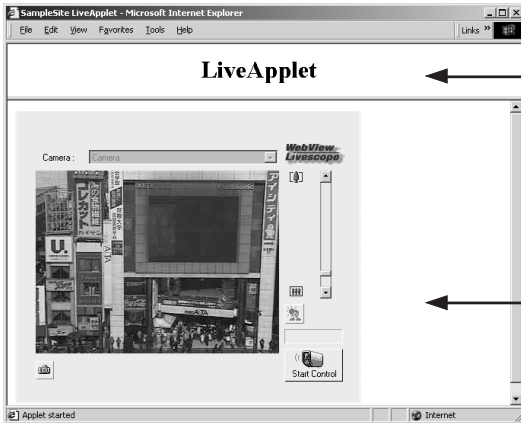

1 Frame settings

2 The text displayed in a separate frame

3 Frame with the embedded Viewer for Java



Tip

Writing IP Addresses

Using the Web server functions built into the VB-C50FSi/VB-C50Fi, IP addresses can be expressed as `<_I_P_A_D_D_R_>` (all upper-case characters, including the angle brackets) or as `<_W_E_B_S_E_R_V_E_R_>` (html-compatible only, all in upper-case characters, including the angle brackets) in the 3 file types (html, wvh and wvp) used by the Web server in the VB-C50FSi/VB-C50Fi.

Since `<_I_P_A_D_D_R_>` or `<_W_E_B_S_E_R_V_E_R_>` is replaced with the actual address when the VB-C50FSi/VB-C50Fi is accessed, the Web page does not need to be changed even when the VB-C50FSi/VB-C50Fi's IP address is changed. NAT can also be supported by specifying a global address for the Web page (→ P.5-26).

1 sample.htm

```
<html>
<head>
<title>SampleSite LiveApplet</title>
</head>
<frameset rows="70,*">
<frame src="header.htm">
<frame src="lvappl.htm">
</frameset>
</html>
```

2 header.htm

```
<html>
<head>
<title>LiveApplet comment</title>
</head>
<body>
<center><h1>LiveApplet</h1></center>
</body>
</html>
```

3 lvappl.htm

```
<html>
<head>
<title>LiveApplet</title>
</head>
<body>
<applet codebase="http://<_W_E_B_S_E_R_V_E_R_>/vwdoc-01-/LiveApplet/"
        code="LiveApplet.class" archive="LiveApplet.zip"
        width=450 height=380>
<param name=cabbage value="LiveApplet.cab">
<param name=url value="http://<_W_E_B_S_E_R_V_E_R_>/">
<param name=controller_style value="no_pantilt">
</applet>
</body>
</html>
```

■ Using Glimpse and LiveApplet Together

This section describes how to create a Web page that allows clients to use Glimpse to download quickly and view live video at a low frame rate, and then use LiveApplet to view video at a high frame rate and control the camera when they find videos they are particularly interested in.



← 1 Glimpse embedded in the page

Click the button to display the page in which LiveApplet is embedded.



↑ 2 Pop-up LiveApplet window

1 glimps.htm

```
<html>
<head>
<script language="JavaScript">
<!--
function clicked(btn) {
    url = btn.name
    window.open(url,"LiveApplet", "width=490,height=400")
}
// -->
</script>
<title>Glimpse</title>
</head>
<body>
<table>
<form name="form">
<tr><td><center>
<applet codebase="http://<_W_E_B_S_E_R_V_E_R_>/-wvdoc-01-/Glimpse/"
    code="Glimpse.class" archive="Glimpse.zip"
    width=160 height=120>
<param name=cabbase value="Glimpse.cab">
<param name=url value="http://<_W_E_B_S_E_R_V_E_R_>/">
</applet>
</center></td></tr>
<tr><td><center>
<input type="Button" name="popup.htm" value="click me"
onClick="clicked(this)">
</center></td></tr>
</form>
</table>
</body>
</html>
```

2 popup.htm

```
<html>
<head>
<title>LiveApplet</title>
</head>
<body>
<center>
<applet codebase="http://<_W_E_B_S_E_R_V_E_R_>/-wvdoc-01-/LiveApplet/"
    code="LiveApplet.class" archive="LiveApplet.zip"
    width=450 height=380>
<param name=cabbase value="LiveApplet.cab">
<param name=url value="http://<_W_E_B_S_E_R_V_E_R_>/">
<param name=controller_style value="no_pantilt">
</applet>
</center>
</body>
</html>
```

■ Providing “LiveApplet” with Camera Control Restricted to Presets

This section describes how to create a Web page that only displays preset operations and does not show the camera control GUI.



```
<applet ..... width=320 height=240>
```

```
<param name=controller_style value="preset_only"> ..... ①
```

① specifies the camera control user interface.

“no_pantilt”: The usual style.

“preset_only”: Preset operation only is displayed.

“none”: Not displayed.

■ Modifying the Startup and Disconnection Screens

You can modify the image files (JPEG or GIF images) shown in the startup and disconnection screens.

■ Nothing Specified

Startup screen



Disconnection screen



■ Certain Images Specified

Startup screen



Disconnection screen

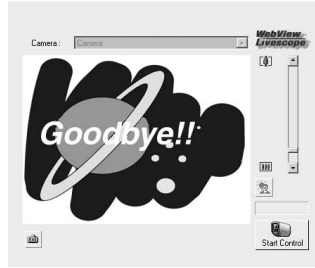

If no particular image is specified, the “connecting to hostname” (when the hostname parameter is specified) or “now connecting” animation is displayed at startup and the “disconnected hostname” (when the hostname parameter is specified) or “disconnected” is displayed at disconnection. You can modify the screens to show any image by providing images for the startup and disconnection screens and setting the parameters. The image size is automatically adjusted to the size specified in the video_width parameter. The display time for the specified screen at startup can also be specified.

```
<param name=open_image value="/local/images/opening.jpg"> ..... ①  
<param name=open_image_time value="3000"> ..... ②  
<param name=close_image value="/local/images/closing.jpg"> ..... ③
```

- ① specifies the file name for the startup image screen.
- ② specifies the display time for the startup image screen (in milliseconds).
- ③ specifies the file name for the disconnection image screen.



Note

You must use the absolute path name (name that begins with “/”) to specify the path for the image file displayed (→ P.5-8).



Tip

- At startup, the default character string that is displayed while a connection to the VB-C50FSi/VB-C50Fi is being established is “now connecting”, but there is also a parameter called “connect_msg” for changing this character string. For additional parameters for changing display character strings, see page 5-17.
- If the user’s service time has been set (→ P.3-15), screen images are not displayed outside the specified time.

■ Displaying the Host Name, Frame Count and Other Information on the Video Screen

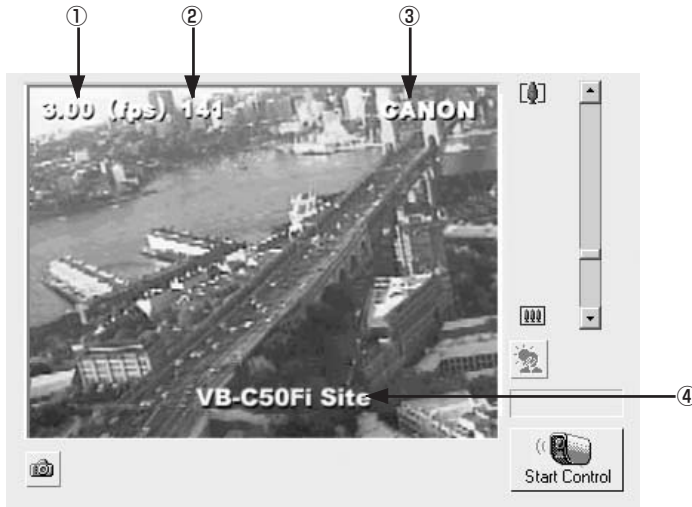

```

<param name=show_fps value="on"> _____ ①
<param name=show_counter value="on"> _____ ②
<param name=hostname value="CANON"> _____ ③
<param name=show_hostname value="on"> _____ ③
<param name=comment value="VB-C50Fi site"> _____ ④
<param name=show_comment value="on"> _____ ④

```

- ① specifies whether the frame rate is displayed on the screen.
 "on": Displayed.
 "off": Not displayed.
- ② specifies whether the frame count is displayed on the screen.
 "on": Displayed.
 "off": Not displayed.
- ③ specifies the host name (any text string) to be displayed on the screen and whether the host name is displayed.
 "on": Displayed.
 "off": Not displayed.
- ④ specifies a comment to be displayed on the screen and whether the comment is displayed.
 "on": Displayed.
 "off": Not displayed.

■ Displaying Bitmap Images on the Video Screen

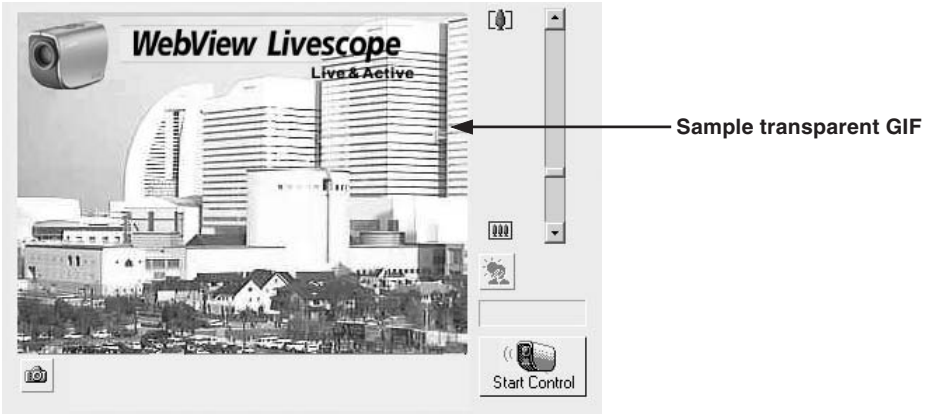

```
<param name=superimpose value="/local/logos/newlogo.gif,0,0">
```

* The underlined portion "x,y" specifies the display position. When x,y = 0,0, the image is displayed in the top left corner. If "x,y" is omitted, the image is displayed in the center of the frame.

■ Specifying the Background Color

```
<html>  
<body bgcolor=#cccccc>  
<applet codebase=http://...code="LiveApplet.class" width=450 height=380>  
<param name=url value="http://<_W_E_B_S_E_R_V_E_R_>">  
  <param name=bg_color value="#cccccc">  
<param name=controller_style value="no_pantilt">  
</applet>  
</body>  
</html>
```

■ Pasting a Picture to the Background

```
<param name=bg_image value="/local/images/back.gif"> ..... ①  
<param name=image_offset value="0,0"> ..... ②
```

- ① specify the displayed picture file.
- ② specify to display it at x,y (underlined portion).

Viewer for Java Parameters

You can specify applet parameters to provide an applet tailored to modify the behavior or appearance of applets. Refer to the table below to ensure that you thoroughly understand the parameters.

■ LiveApplet

Parameter Name	Omissible	Description
auto_connect	Yes	Specifies whether or not connection to the camera server should be established at the same time that the applet starts up. Select "on" or "off". When "on" is selected, connection is established when the applet starts up and moving pictures are displayed. With "off", the connection is not established when the applet starts up and the character string that was specified with the "no_connect_msg" parameter is displayed. The "connect()" method is called up to establish connections.
bg_color	Yes	Use this parameter to set the background color. The parameter specification format is "#RRGGBB" (values between 0 and 255 for each component color expressed as a hexadecimal). E.G. White: "#FFFFFF", Grey: "#AAAAAA", Green: "#00FF00" If this parameter is omitted, the default background color is used.
bg_image	Yes	The picture displayed in the background of LiveApplet can be specified. A JPEG or GIF image can be specified. The WebView Livescope logo is not displayed if specified. If not specified, the default picture is used. (Refer to image_offset about the display position.)
capture_size	Yes	Specifies the size of the image when LiveApplet is started. There are 4 sizes: 80 × 60, 160 × 120, 320 × 240 and 640 × 480 for NTSC, and 96 × 72, 192 × 144, 384 × 288 and 768 × 576 for PAL. The default is the specified size in the Video Transmission of the Camera and Video Setting Page (→ P.3-8). capture_size is unrelated to the size of the image displayed on the monitor of your PC. To change the size of the image on the monitor, specify video_width.
click_action	Yes	Specifies behavior when a moving picture display area is clicked. "pt" specifies pan and tilt; "none" specifies no reaction. The default is "pt".
close_image	Yes	You can use this parameter to specify the screen displayed in the video display window at the time of disconnection. Specify the name of a JPEG or GIF image. If this parameter is omitted, the default disconnection screen is displayed.
comment	Yes	This parameter specifies the comment text string displayed as an overlay on the applet. If this parameter is omitted, no comment is displayed.
connect_msg	Yes	Specifies the character string that is displayed while connection to the camera server is being established. The default is "now connecting".
controller_style	Yes	Specifies the GUI style for controlling the camera. "normal" specifies the usual GUI style; "preset_only" specifies preset operation only; "none" specifies that the entire GUI will not be displayed. With "preset_only", only the Start Control button, the Camera Control Status window, the Preset Selection Box, and the Snapshot button are displayed. "no_pantilt" displays the UI for the VB-C50FSI/VB-C50Fi.
disconnect_msg	Yes	Specifies the character string that is displayed when the connection to the camera server is aborted. The default is "disconnected".
error_msg	Yes	Specifies the character string that is displayed when connection to the camera server has failed. The default is "can't connect".
font_size	Yes	Specifies the display size for connect_msg, disconnect_msg, error_msg, no_connect_msg, and too_many_msg. The default makes size dependent on the display area.

Parameter Name	Omissible	Description
gui-type	Yes	Specifies whether the panorama window should be pop-up displayed or embedded in the page. Specify "embed" for making it an embedded display. When specifying "embed", the Width and Height of the applet tags must be specified a little larger (E.G. width=500; height=660).
hostname	Yes	This parameter specifies the host name displayed in the applet. This value is used as the host name in messages displayed during connection, etc. If this parameter is omitted, no host name is displayed.
image_offset	Yes	Specifies the display position of the picture file specified at bg_image. With the upper left coordinates of the picture at "0,0" and the right direction given as x and the down direction as y, image_offset is specified as "x,y". The default is "335,0".
no_connect_msg	Yes	Specifies the character string to be displayed following applet startup when auto_connect is "off". The default is "no connection".
open_image	Yes	You can use this parameter to specify the screen that appears in the video display window until the first video image appears. Specify the name of a JPEG or GIF image. If this parameter is omitted, the default startup screen is displayed.
open_image_time	Yes	When a startup screen is specified in the "open_image" parameter, this parameter specifies the display time. The time is specified in milliseconds (1/1000 sec.), and the default value is 0. The image is displayed until the first video frame appears. Values from 0 to 30000 (30 seconds) can be specified.
overlay_font_color	Yes	Specifies the color of the character string specified for "comment" and "hostname". The color is specified at "#RRGGBB". The default is yellow.
show_capture	Yes	This function specifies whether the Snapshot button is displayed. Specify "on" or "off". The default value is "on". The button is always displayed unless "off" is explicitly specified.
show_comment	Yes	This function displays the comment as an overlay on the video image. Specify "on" or "off". The default value is "off". Note that this parameter is only valid if the "comment" parameter is specified.
show_counter	Yes	This function displays the frame count as an overlay on the video image. Specify "on" or "off". The default value is "off".
show_fps	Yes	This function displays the frame rate as an overlay on the video image. Specify "on" or "off". The default value is "off".
show_hostname	Yes	This function displays the host name as an overlay on the video image. Specify "on" or "off". The default value is "off". Note that this parameter is only valid if the "hostname" parameter is specified.
show_logo	Yes	Specifies whether or not the WebView Livescope logo should appear in the upper right of the screen. It appears if show_logo is "on" and does not appear if it is "off".
show_panobutton	Yes	Specify whether or not to display the panorama window pop-up button.
show_toolbar	Yes	Function for displaying the buttons to change the image size when LiveApplet is running. Specify "on" or "off". The default value is "off".
superimpose	Yes	This function displays a bitmap image as an overlay on the video image. Specify the image using the "bitmap-filename,x,y" format. Use the GIF format for bitmap images (transparent GIFs supported). The "x,y" parameters specify the coordinates of the bitmap image position on the video frame. If "x,y" is omitted, the image is displayed in the center of the video frame.
too_many_msg	Yes	Specifies the character string that is displayed when connection to the camera server fails because the limit on the number of connections was exceeded. The default is "too many clients".
url	No	Specify the URL of the HTTP server for applet access. Specify the IP address and port number that match those specified in the codebase attribute.
video_width	Yes	This parameter specifies the video image display size (in pixels). Specify the width. The display sizes are 80 to 640, and any value can be set as the width. The height is calculated as 3/4 of the specified width. E.G. video_width="240" (height = 240 × 3/4 = 180.)

■ Glimpse

Parameter Name	Omissible	Description
auto_connect	Yes	Specifies whether or not connection to the camera server should be established simultaneously with applet startup. Specify either "on" or "off". When "on", a connection is established simultaneously with applet startup; when "off", no connection is established when the applet starts up and the character string specified for no_connect_msg is displayed. The connect() method is called up in order to make connections.
capture_size	Yes	Specifies the size of the image when Glimpse is started. There are 4 sizes: 80 × 60, 160 × 120, 320 × 240 and 640 × 480 for NTSC, and 96 × 72, 192 × 144, 384 × 288 and 768 × 576 for PAL. The default is the specified size in the Video Transmission of the Camera and Video Setting Page (→ P.3-8). capture_size is unrelated to the size of the image displayed on the monitor of your PC. To change the size of the image on the monitor, specify with width and height of the applet tag.
comment	Yes	This parameter specifies the comment text string displayed as an overlay on the applet. If this parameter is omitted, no comment is displayed.
connect_msg	Yes	Specifies the character string to be displayed while a connection to the camera server is being established. The default is "now connecting".
disconnect_msg	Yes	Specifies the character string to be displayed when a connection to the camera server is disconnected. The default is "disconnected".
error_msg	Yes	Specifies the character string to be displayed when an attempt to connect to the camera server has failed. The default is "can't connect".
font_size	Yes	Specifies the font size for connect_msg, disconnect_msg, error_msg, and no_connect_msg, when these messages are displayed. The default is to depend on the display area.
hostname	Yes	This parameter specifies the host name displayed in the applet. This value is used as the host name in messages displayed during connection, etc. If this parameter is omitted, no host name is displayed.
no_connect_msg	Yes	Specifies the character string to be displayed after the applet starts up, if "off" is specified for auto_connect. The default is "no connection".
show_counter	Yes	This function displays the frame count as an overlay on the video image. Specify "on" or "off". The default value is "off".
show_hostname	Yes	This function displays the host name as an overlay on the video image. Specify "on" or "off". The default value is "off". Note that this parameter is only valid if the "hostname" parameter is specified.
sleep	Yes	This parameter specifies the interval (in milliseconds) at which the screen is updated. If this parameter is omitted, the screen is updated at 5-second intervals. Because the Glimpse applet is designed to be used for displaying multiple sites as a list, this parameter is provided as a means of reducing the processing load. Intervals between 0 and 300,000 ms (5 minutes) can be set. If 0 is specified, the interval is not adjusted.
url	No	Specify the URL of the HTTP server for applet access. Specify the IP address and port number that match those specified in the codebase attribute.

■ Applet Tag Descriptions

Attribute Name	Omissible	Description
archive	Yes	Specify LiveApplet.zip or Glimpse.zip.
code	No	This parameter specifies the applet file name. Enter "LiveApplet.class" or "Glimpse.class". If this parameter is not specified correctly, the applet (LiveApplet or Glimpse) is not downloaded.
codebase	No	This parameter specifies the directory that contains the applet. http://HTTP server IP address: port number/directory/ If this parameter is not specified correctly, the applet (LiveApplet or Glimpse) is not downloaded. Directories are fixed for each applet. Directory (LiveApplet)=-wvdoc-01-/LiveApplet Directory (Glimpse)=-wvdoc-01-/Glimpse
height	No	This parameter specifies the size of the area acquired for the applet (in pixels). For LiveApplet, if the value specified is smaller than the LiveApplet drawing area, the applet may not be displayed correctly. If the camera control function GUI is to be added (controller_style=normal), add about 140 to the value. E.G. For an image size of 320 × 240, height=380. For Glimpse, because the areas used for the applet and for the video display are the same size, specify the same value as the image height. E.G. For an image size of 320 × 240, height=240.
width	No	This parameter specifies the size of the area acquired for the applet (in pixels). For LiveApplet, if the value specified is smaller than the LiveApplet drawing area, the applet may not be displayed correctly. If the camera control function GUI is to be added (controller_style=normal), add about 130 to the value. E.G. For an image size of 320 × 240, width=450. For Glimpse, because the areas used for the applet and for the video display are the same size, specify the same value as the image width. E.G. For an image size of 320 × 240, width=320.



Tip

When specifying an address included in the codebase attribute of the applet tag and a URL parameter of the LiveApplet, specify one that can be accessed from the client's PC. This is particular necessary when using NAT (→ P.5-26).

Using the Viewer for PC to Distribute Videos

This section describes how to use the Viewer for PC to provide videos. Application examples are also given.

If a client is using the Viewer for PC to receive videos, the video sender must set up the Web server and create the necessary wvh files.



Tip

- The settings below are not required if the VB-C50FSi/VB-C50Fi's built-in Web server is used.
- See page 5-8 for saving Web page data.

Setting Up the Web Server

Set up the Web server to be used for providing Web pages. Add the MIME type to the Web server software and specify the extension. Refer to the manual for your Web server software for details.

MIME type video/x-webview-h

Extension wvh

For Apache

In the settings for added the MIME type in Apache, edit the "mime.types" file in the "conf" directory.

- Use the following syntax to add the required MIME type to the PC:

```
type/subtype extension
```

- The settings for Viewer are as follows:

```
video/x-webview-h wvh
```



Note

If the MIME setting is not specified correctly for the Web server, you may not be able to launch the Viewer for PC. Be sure to specify the setting correctly.

Creating wvh Files

This section describes how to create the wvh file required for launching the Viewer for PC application.

1. Use a text editor or similar program to create a new text file and type the following type of code in the file:

(Example) 192.168.100.1 65310
192.168.100.1 65311
wvhttp:192.168.100.1 80
wvaudio:192.168.100.1 80 (Only available with a particular model of the VB-C50FSi)

* The underlined portion is a sample IP address. Enter the actual IP address that was set on the VB-C50FSi/VB-C50Fi (→ P.3-6).

- The first line gives the IP address (or host name) of the VB-C50FSi/VB-C50Fi and the TCP port number used for the video transmission. The default setting is 65310 (→ P.3-17). The default setting will be used if no particular value is specified.
- The second line gives the IP address (or host name) of the VB-C50FSi/VB-C50Fi and the TCP port number used for the camera control. The default setting is 65311 (→ P.3-17). The default setting will be used if no particular value is specified.
- The third line gives the setting for the Viewer for PC to use HTTP protocol. After “wvhttp:”, type in the IP address of the VB-C50FSi/VB-C50Fi and “80” as the HTTP port number. As a result of this, you will be able to view video from the VB-C50FSi/VB-C50Fi through firewalls.
- The fourth line is settings to listen to audio on the PC viewer. After “wvhttp:”, type in the IP address of the VB-C50FSi and “80” as the HTTP port number. As a result of this, you can receive audio from the VB-C50FSi. To receive audio, you need to set “Audio Transmission” to “Used” in the Audio Server settings (→ P.3-18).*

* Only available with a particular model (→ P.iii)



Tip

Instead of an IP address, you can also type in <_I_P_A_D_D_R_> (→ P.5-9).

Example: <_I_P_A_D_D_R_> 65310

<_I_P_A_D_D_R_> 65311

wvhttp:<_I_P_A_D_D_R_> 80

wvaudio:<_I_P_A_D_D_R_> 80 (Only available with a particular model of the VB-C50FSi)

2. After you save the text file and quit the text editor program, create a wvh file by changing the file name and extension.

Be sure to add the “.wvh” extension, as in “WebView.wvh”.



Tip

Viewer for PC supports WebView Livescope protocol and HTTP protocol.

- **WebView Livescope protocol:**
Cannot be viewed through firewalls. This protocol is primarily for clients who are connected directly to the Internet.
- **HTTP protocol:**
In general, this protocol is used with Web browsers. By using this protocol, clients inside firewalls can view video by penetrating fire walls. The Viewer for Java also uses this protocol.

Example of a Web page Using the Viewer for PC

This section describes a sample Web page in which the Viewer for PC is used.

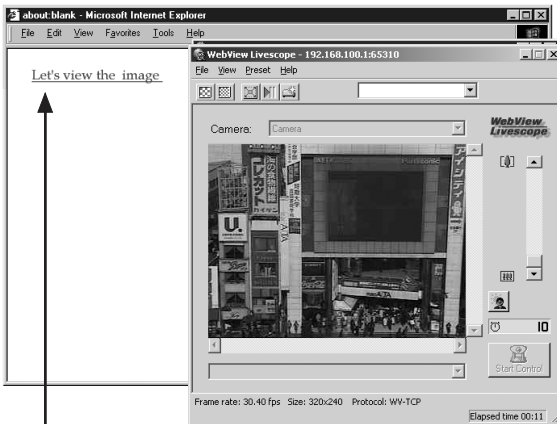

1 Click the link to launch the Viewer.

Include the tags that link to the wvh file in the text or images in the Web page.

```
1 <A HREF="WebView.wvh">Let's view the image</A>
```



Tip

To use the sample page template in the VB-C50FSi/VB-C50Fi to supply videos, specify
.

Distributing Videos Using a Browser Only

You can also use the WebView-HTTP protocol to provide videos from the VB-C50FSi/VB-C50Fi directly to a Web browser. Some example of this are described in this section.

Displaying the Live Video at Access as a Still Picture

When a client accesses the Web page that provides videos, the video shot at that point can be supplied as a still picture.



```
<IMG SRC=http://192.168.100.1/-wvhttp-01-/GetStillImage>
```

(or)

```
<IMG SRC=http://192.168.100.1/-wvhttp-01-/GetOneShot>
```

* The underlined portion is a sample IP address. Enter the actual IP address set for the VB-C50FSi/VB-C50Fi (→ P.3-6).

Displaying a Specified Number Of Live Video Frames As a Video at Access

The Server Push format provided as an extended function by Netscape Communications Corp. can be used to distribute multiple-frame images. However, these images can only be displayed on Netscape Navigator. In the coding example below, 100 frames of live video are distributed when the client accesses the server.



```
<IMG SRC=http://192.168.100.1/-wvhttp-01-/GetOneShot?frame_count=100>
```

* The underlined portion is a sample IP address. Enter the actual IP address set for the VB-C50FSi/VB-C50Fi (→ P.3-6).



Setting `frame_count=no_limit` removes the limits on the number of image frames.

Displaying Live Video from a Specified Zoom Magnification as Still Pictures

By specifying the camera zoom magnification as a parameter in the HTML code beforehand, you can display the picture from a specified camera zoom magnification. The example below displays a still picture shot with the camera zoom at 10x.

```
<IMG SRC=http://192.168.100.1/-vvhhttp-01-/GetStillImage?z=100>
```

* The underlined portion is a sample IP address. Enter the actual IP address set for the VB-C50FSi/VB-C50Fi (→ P.3-6).

■ GetStillImage Parameters

Parameter	Description
z or zoom	Specifies camera zoom. “z” is ten times the zoom ratio of the widest angle, and “zoom” is the view angle in 0.01° units (horizontal direction). If this parameter is omitted, camera zoom is not controlled.
b or back_light	Specifies camera backlight compensation. When this parameter is set to on, the picture captured will be bright and when this parameter is set to off, the picture captured will be dark. If this parameter is omitted, camera backlight compensation is not controlled.
delay	Waiting time until camera focus is stabilized (in milliseconds). Specified in the range 0 to 10000.
option	Specifies how errors are dealt with. When “skip_on_error” is specified, the process will be continued. When “quit_on_error” is specified, the process will be aborted. The following errors can occur: failure to acquire camera control right, loss of camera control, camera selection errors and camera control errors. To omit, the default value is “quit_on_error”.
seq	Allows any number (sequence number) to be specified to avoid displaying old still pictures (numeric value).
v or image_size	Specifies picture display size. This can be set to 160 × 120, 320 × 240, and 640 × 480 for NTSC, and 192 × 144, 384 × 288, and 768 × 576 for PAL. The formats for specifying “v” and “image_size” are different: “v” specifies the horizontal dimension only and uses the format “v=640”, for instance, while “image_size” specifies both horizontal and vertical dimensions and uses the format “image_size=320 × 240”, for instance.



Note

If old still pictures are displayed, you can prevent this recurring by specifying a sequence number in the seq parameter.

Example of Video Distribution Using One Global Address

One fixed global address is required if the VB-C50FSi/VB-C50Fi is being used to distribute live videos on the Internet. An Internet service provider (ISP) that offers a single-address fixed global address service can be used. In this case, a router with NAT function is required.

Example: In this example, we use the global address 192.168.1.10 assigned by the ISP. We also set the local address 192.168.100.2 in the VB-C50FSi/VB-C50Fi (and 192.168.100.1 for the router).

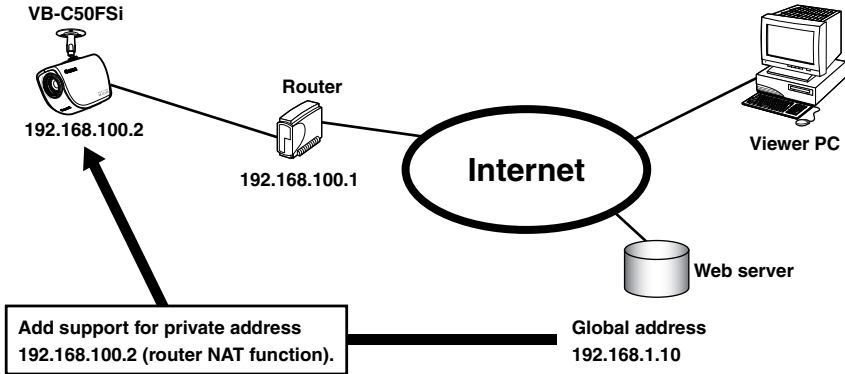

A sample page of the VB-C50FSi/VB-C50Fi is automatically generated based on the IP address that was actually assigned (192.168.100.2 in this case). In this case, this page cannot be viewed in the Viewer for Java or the Viewer for PC when "http://192.168.100.2/sample/" is accessed through the Internet.

Set "Global Address for Web Pages" (→ P.3-16) to 192.168.1.10. If you are not using the VB-C50FSi/VB-C50Fi's Web server, describe the Web pages for distributing videos as follows:

Set the Viewer for Java description (→ P.5-7) as follows:

```
<applet codebase="http:// 192.168.1.10/-wvdoc-01-/LiveApplet/"
  code="LiveApplet.class" archive="LiveApplet.zip"
  width=450 height=380>
<param name=url      value="http:// 192.168.1.10/">
<param name=cabbase  value="LiveApplet.cab">
<param name=controller_style value="no_pantilt">
</applet>
```

Set the wvh file description of the Viewer for PC (→ P.5-22) as follows:

```
192.168.1.10 65310
192.168.1.10 65311
wvhttp: 192.168.1.10 80
wvaudio: 192.168.1.10 80 (Only available with a particular model of the VB-C50FSi)
```

* The underlined portion is a sample IP address. Enter the actual IP address set for the Global Address for Web Pages (→ P.3-16).



Contact respective manufacturers for details on setting the router.

Distributing Still Images to a Mobile Phone

You can view still images and control the camera using the Web service of a mobile phone. You can easily create still image distribution pages for mobile phones with HTML which uses the command still.jpg. Sample pages for still image distribution for mobile phones have been provided for the VB-C50FSi/VB-C50Fi. See below for how to view them.

1. Start up your browser and enter the following URL.

http://192.168.100.1:80/mobile/index.html

* The underlined portion is a sample IP address:HTTP port number. Enter the actual IP address and HTTP port number that were set on the VB-C50FSi/VB-C50Fi (→ P.3-6, 3-16).

2. Select the language (English or Japanese).

3. The sample page appears.

The sample page has been created in such a way that you can control the camera. Adjust the zoom and brightness, and specify the camera position. You can perform the operation corresponding to each key by pressing the dial keys on your mobile phone.



Note

- Depending on the model of the mobile phone, there may be cases where the images do not appear or where it is not possible to control the camera.
- Some mobile phones have limited functionality. For more details, see the WebView Product web page:
<http://www.canon.com/webview>



Tip

- You can control the camera only when other users do not have control privileges.
- The sample screen above is for when the VB-C50FSi/VB-C50Fi is being used. If you are using an external camera, the camera control link does not appear.

Overwriting Sample Pages

You can change screen displays and the content of operations by overwriting the HTML file below the “mobile” folder on the CD-ROM.

```
POS1.htm
<CENTER>
<IMG
SRC="/-vwhttp-01-/still.jpg?camera_id=1&
zoom=6135&image_size=160x120&option=skip_on_error"
ALT="position1"><BR>
</CENTER>
```

For example, to change the control position for Position [1], overwrite the underlined value in “pos1.html”. See the table below for details of the parameters of the still.jpg command.



Note

- If you are going to overwrite the sample pages, please do so after you have copied the “mobile” folder to your PC.
- Please delete the “mobile” folder beforehand if it is already saved in the VB-C50FSi/ VB-C50Fi.

■ still.jpg parameters

Command	Description
camera_id	Specifies the camera when you switch between cameras. 1 is this camera, and 2 is an external camera. When there is no specification, you are deemed to have specified the current camera.
z or zoom	Specifies the zoom magnification of the camera. z is ten times zoom magnification of maximum wide angle and zoom is in units of 0.01°.
b or back_light	Specifies camera backlight compensation. When this parameter is set to on, the picture captured will be bright and when this parameter is set to off, the picture captured will be dark. If this parameter is omitted, camera backlight compensation is not controlled.
v or image_size	Specifies image size. You can specify 160 × 120, 320 × 240, and 640 × 480 for NTSC, and 192 × 144, 384 × 288, and 768 × 576 for PAL. The format for v and image_size is different. v only specifies horizontal size, e.g. v=640. image_size specifies vertical and horizontal size, e.g. image_size=320 × 240.
option	Specifies how errors are dealt with. When “skip_on_error” is specified, the process will be continued. When “quit_on_error” is specified, the process will be aborted. The following errors can occur: failure to acquire camera control right, loss of camera control, camera selection errors and camera control errors. To omit, the default value is “quit_on_error”.



Tip

Specifying with the current position which appears as “d” and the percentage for the current angle which appears as “c” (percentage) is also possible for z (zoom). For example:
z=c200 sets twice the current zoom magnification.

Chapter



Using the Picture Recording Function

This chapter describes a couple of specific examples of the Picture Recording function using the VB-C50FSi/VB-C50Fi. Still images and audio files can be automatically recorded using input from an external device, motion detection or schedule settings.

Using the Still Picture Recording Function Linked to an External Device

By combining various sensors and switches to operate according to External Device Input settings, it is possible to construct a monitoring system that responds to external events. Still pictures are recorded in the VB-C50FSi/VB-C50Fi's memory (→ P.3-28).

Sample Application Combining a Door-opening Sensor

This is a monitoring system in which the VB-C50Fi installed in the ceiling records pictures every second for 3 seconds before the doors opens and 7 seconds after the door opens between 5 p.m. and 6 a.m. Connect the devices below to each connector of the Multi-Terminal Module and set up. Please note that the Multi-Terminal Module is an optional product and is sold separately.

Installation Example

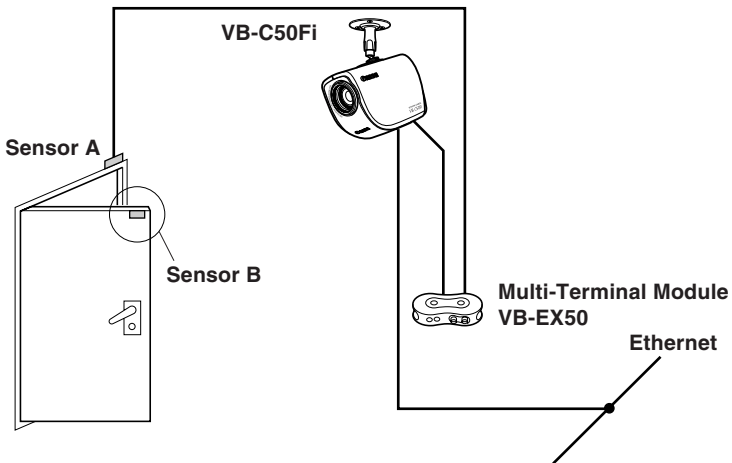

When the door opens and sensor B mounted on it separates from sensor A, an ON event occurs at external device inputs IN⁺ and IN⁻. In response to this event, the VB-C50Fi records pictures at the entrance and stores them.



Tip

Please refer to the Multi-Terminal Module User's Manual for how to connect the Multi-Terminal Module to the VB-C50FSi/VB-C50Fi.

Sample Still Picture Recording Settings

Settings specified on the “Camera and Video” page (→ P.3-8)

Specify the appropriate settings for the VB-C50Fi being used.

Settings specified on the “Preset” page (→ P.3-12)

Set a camera zoom position that shoots the open doorway as Preset 1.

Photographic conditions specified in “External Device Input Setting Tool” (→ P.4-50)

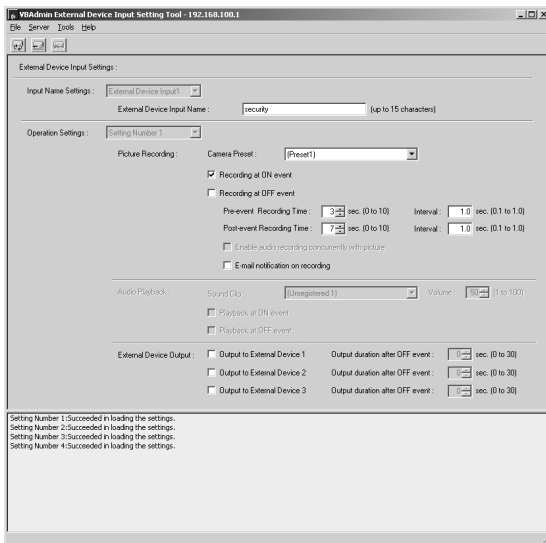
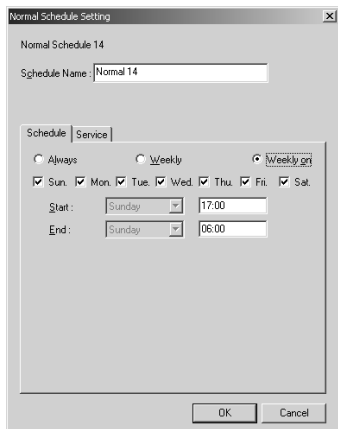

- In the “Normal Schedule Setting” screen (→ P.4-25), select a schedule and then select “Weekly on” in the “Schedule” tab. Select all the days of the week, set the start time to “17:00” and the end time to “06:00”.
- In the “Service” tab, select “Input 1” in “External Device Input”, then select “Setting Number” and click the “Detail” button.
- Enter the external device input name.
- Set “Camera Preset” to “Preset1”.
- Select “Recording at ON event”.
- Set “Pre-event” to “3” seconds and “Interval” to “1.0” second. An image will then be recorded every second for 3 seconds before the door is opened.
* With pre-event recording, the image is not recorded from the moment external input turns on.
- Set “Post-event” to “7” seconds and “Interval” to “1.0” second. An image will then be recorded every second for 7 seconds from the moment the door is opened.
* With post-event recording, the image is recorded from the moment external input turns on.

Using the Audio Playback/Recording* Function Linked to an External Device

* The Audio Recording function is available with a particular model of the VB-C50FSi (→ P.iii).

With the VB-C50FSi, by using the Audio Playback and audio recording* functions in the External Device Input settings, it is possible to construct a monitoring system that issues audio alert using previously saved sounds and captures video and audio* in response to external events. Photographed still images and recorded audio files* are stored in the VB-C50FSi's memory (→ P.3-28)

* This example uses the VB-C50FSi audio recording function and does not apply to the VB-C50Fi.

Sample Application Combining a Speaker, Microphone and Door-opening Sensor

Each day between 5 pm. and 6 am., this monitoring system emits an audio alert whenever the door opens and the VB-C50FSi mounted on the ceiling records images shot at 1-second intervals from 3 seconds before the door opens to 7 seconds after the door closes. It also records audio* during that period. Install the devices below connected to the respective connectors on the Multi-Terminal Module.

Installation Example

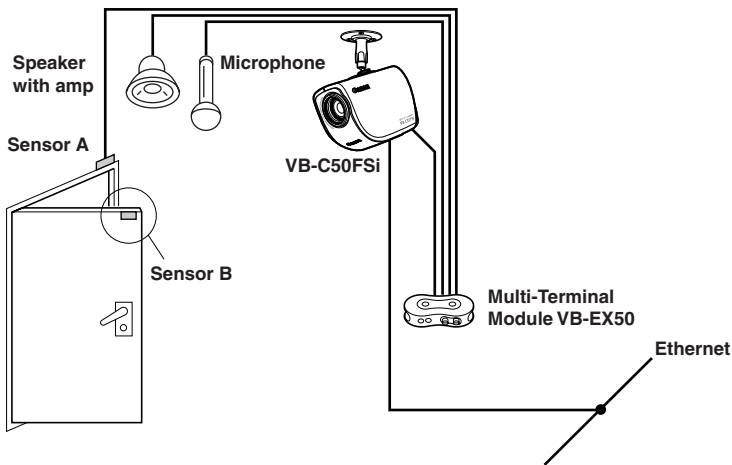

When the door opens and sensor B mounted on it separates from sensor A, an ON event occurs at external device inputs IN⁺ and IN⁻.

In response to this event, the VB-C50FSi emits the stored audio alert from the speaker with amp, shoots and records pictures of the doorway and records any audio* picked up by the microphone.



Tip

Please refer to the Multi-Terminal Module User's Manual for how to connect the Multi-Terminal Module to the VB-C50FSi.

Sample Settings

Settings specified on the “Camera and Video” page (→ P.3-8)

Specify the appropriate settings for the VB-C50FSi being used.

Settings specified on the “Preset” page (→ P.3-12)

Set a camera angle that shoots the open doorway as Preset 1.

Photographic conditions specified in “External Device Input Setting Tool” (→ P.4-50)

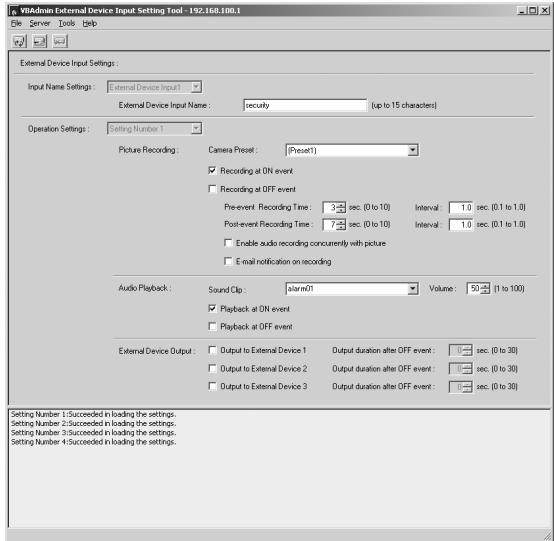
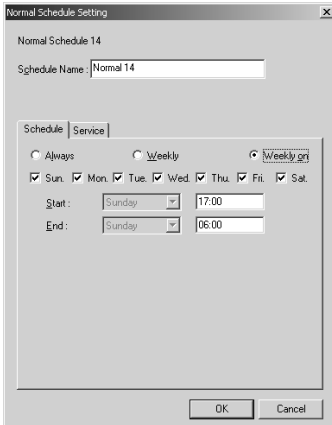

- In the “Normal Schedule Setting” screen (→ P.4-25), select a schedule and then select “Weekly on” in the “Schedule” tab. Select all the days of the week, set the start time to “17:00” and the end time to “06:00”.
- In the “Service” tab, select “Input 1” in “External Device Input”, then select “Setting Number” and click the “Detail” button.
- Enter the external device input name.
- Set “Camera Preset” to “Preset1”.
- Select “Recording at ON event”.
- Set “Pre-event” to “3” seconds and “Interval” to “1.0” second. An image will then be recorded every second for 3 seconds before the door is opened.
* With pre-event recording, the image is not recorded from the moment external input turns on.
- Set “Post-event” to “7” seconds and “Interval” to “1.0” second. An image will then be recorded every second for 7 seconds from the moment the door is opened.
* With post-event recording, the image is recorded from the moment external input turns on.
- Select “Enable audio recording concurrently with picture”.*
* Only available with a particular model of the VB-C50FSi (→ P.iii)
- Select “Playback at ON event” in “Audio Playback”, then select “Sound Clip”. Register a playback sound beforehand (→ P.4-57). Use “Volume” to check the sound played back and set the adequate volume.

Using the Still Picture Recording Function with a Predetermined Schedule

By using the “Schedule” setting, you can construct a monitoring system that records pictures according to a predetermined schedule. Recorded still pictures are stored in the VB-C50FSi/VB-C50Fi’s memory (→ P.3-28).

Sample Application Using a Timer

This is a monitoring system used in art galleries and similar facilities in which the exhibits are monitored. Still pictures are captured at 10-minute intervals by a VB-C50Fi mounted on the ceiling.

Installation Example

Following the schedule set in advance, the VB-C50Fi records and stores pictures.

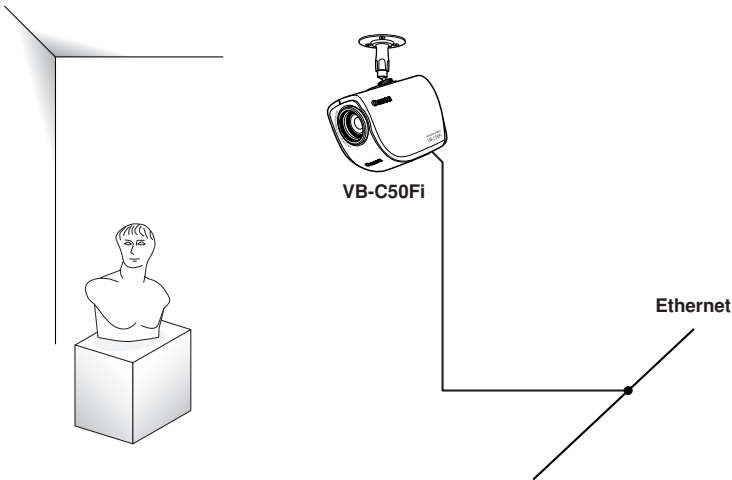

Sample Still Picture Recording Settings

Settings specified on the “Camera and Video” page (→ P.3-8)

Specify the appropriate settings for the VB-C50Fi being used.

Settings specified on the “Preset” page (→ P.3-12)

Set the camera zoom position focusing on the object to Preset 1.

Photographic conditions specified in “Timer Setting Tool” (→ P.4-34)

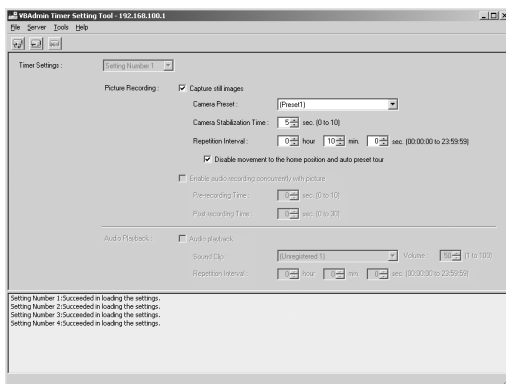
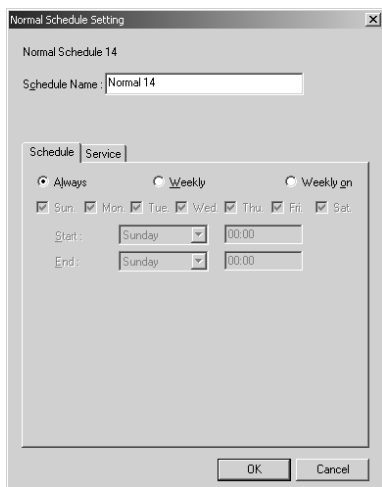

- In the “Normal Schedule Setting” screen (→ P.4-25), select a schedule and then select “Always” in the “Schedule” tab.
- In the “Service” tab, select “Timer”, then select “Setting Number” and click the “Detail” button.
- Select “Capture still image”.
- Set “Camera Preset” to “Preset1”.
- To take a photograph after the position of the camera has stabilized, set “Camera Stabilization Time” to “5” seconds.
- Set “Repetition Interval” to “10” minutes.



Note

- The number of still pictures that can be recorded depends on size of the pictures. Check the average file size per still picture in advance (→ P.3-8 and 3-28).
- Still pictures beyond VB-C50FSi/VB-C50Fi’s capacity can be recorded if VBCollector is used to download still pictures recorded by the VB-C50FSi/VB-C50Fi (→ P.6-11).

Using the Motion Detection Function with a Predetermined Schedule

By running the motion detection function according to a schedule, you can construct a monitoring system that records pictures in accordance with a preset schedule and that operates in response to variations in the video image from the area covered by the camera. The recorded pictures are stored in the VB-C50FSi/VB-C50Fi's memory (→ P.3-28).

Sample application in combination with a warning device

In this monitoring system, a warning tone is emitted when someone enters through the door and the VB-C50Fi camera mounted on the ceiling captures a still picture. Connect the devices below to each connector of the Multi-Terminal Module and set up.

Installation Example

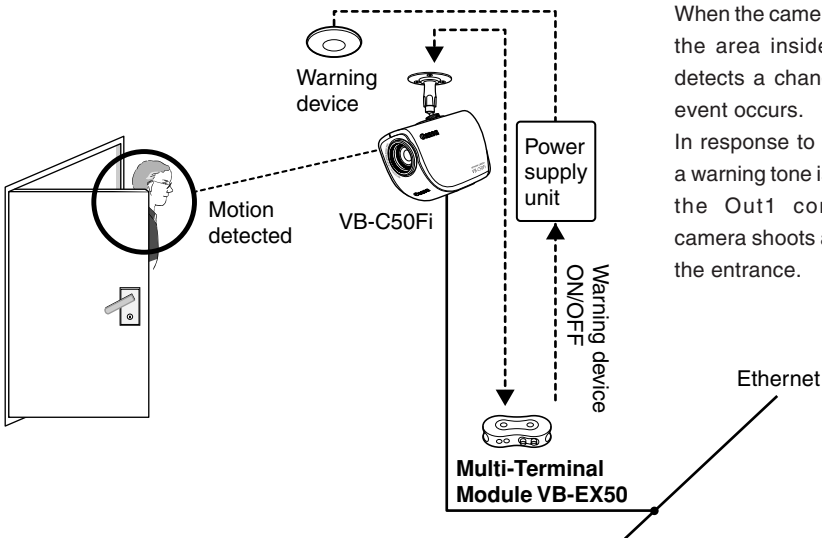

When the camera shooting the area inside the door detects a change, an ON event occurs.

In response to that event, a warning tone is issued by the Out1 control, the camera shoots a picture of the entrance.



Tip

Please refer to the Multi-Terminal Module User's Manual for how to connect the Multi-Terminal Module to the VB-C50FSi/VB-C50Fi.

Sample Still Picture Recording Settings

Settings specified on the “Camera and Video” page (→ P.3-8)

Specify the appropriate settings for the VB-C50Fi being used.

Settings specified on the “Preset” page (→ P.3-11)

Set the camera zoom position for the area just inside the door as Preset 1.

Settings specified in the “Motion Detection Setting Tool” (→ P.4-37)

- In the “Normal Schedule Setting” screen (→ P.4-25), select a schedule and then select “Weekly” in the “Schedule” tab. Set the start on “Friday” at “22:00” and the end on “Monday” at “07:00”.
- In the “Service” tab, select “Motion Detection”, then select “Setting Number” and click the “Detail” button.

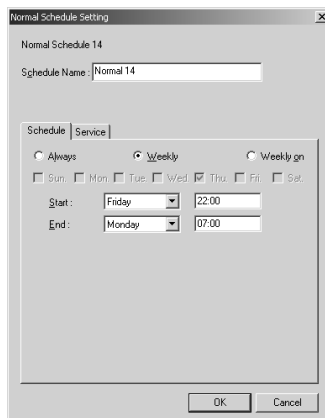

- In the “Camera” tab (→ P.4-40), set the place of motion to “Preset 1”.
- In the “Area” tab (→ P.4-41), select “Area [1]” in “Used Area”.

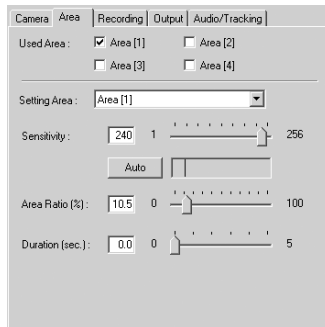

- To set the level of motion detection sensitivity that will trigger an ON event, shoot a simulation of the actual event and reproduce the amount of change that is acknowledged as an incursion. In this situation, in order to capture the picture variation that is recognized as the door opening and someone entering the room, first position the motion detection frame on the center of the door.



- Next, set the sensitivity, area ratio and duration.

To ensure that the event is not triggered by unrelated lighting changes or small movements, set the “Duration” parameter so that picture changes lasting a second or less are ignored and then set the “Area Ratio” parameter so changes that occupy 30% or less of the total picture are also ignored.

- Reproduce the intrusion, or using the recorded image, check whether the change in the image has been captured in the yellow rectangle in the Viewer. If the change is not recognized, increase the sensitivity. On the other hand, if yellow or red rectangles are displayed even if there is no change in the image, reduce the sensitivity.

- Once the yellow rectangle in the viewer reliably captures the intruder, check that the peak display in the detection indicator gives a “Motion detected” result. “Motion detected” is displayed in the viewer in a red rectangle. If there is no “Motion detected”, adjust the sensitivity, area ratio and duration settings. Check “Display motion detection status of the server” and the results of motion detection are displayed as an icon (→ P.4-45).

- In the “Recording” tab (→ P.4-43), select “Recording at ON event”.
- Set “Pre-event Recording Time (sec.)” to “4”, and “Recording interval before event (sec.)” to “1.0”. An image will then be recorded every second for 4 seconds before motion is detected.
- Set “Post-event Recording Time (sec.)” to “8” and “Recording interval after event (sec.)” to “1.0”. An image will then be recorded every second for 8 seconds from the moment motion is detected.
- Select “Recording between ON event and OFF event” and set “Recording interval between events (sec.)” to “10”.

* During “Motion detected”, images are recorded at intervals of 10 seconds.

- In the “Output” tab (→ P.4-44), select “Output to External Device 1” and set “Output duration after OFF event (sec.)” to “10” seconds.

* Set the Warning device (external device 1) to simultaneously signal with “Motion detected” and turn off 10 seconds after the OFF event.

Sensitivity : 200 1 256
 Area Ratio (%) : 30.0 0 100
 Duration (sec.) : 1.0 0 5



Display motion detection status of the server Motion: OFF

Camera | Area | Recording | Output | Audio/Tracking |

Recording at ON event
 Recording at OFF event

Pre-event Recording time : 4 sec. (0 to 10)
 Recording interval : 1.0 sec. (0.1 to 1.0)

Post-event Recording time : 8 sec. (0 to 10)
 Recording interval : 1.0 sec. (0.1 to 1.0)

Enable audio recording concurrently with picture
 E-mail notification on picture recording

Recording between ON event and OFF event
 Recording interval between events : 10 sec. (1 to 10)

Camera | Area | Recording | Output | Audio/Tracking |

Output to External Device 1
 Output duration after OFF event : 10 sec. (0 to 20)

Output to External Device 2
 Output duration after OFF event : 0 sec. (0 to 20)

Output to External Device 3
 Output duration after OFF event : 0 sec. (0 to 20)

Using VBCollector



All audio-related features available using the VBCollector can only be used with a particular model of the VB-C50FSi (→ P.iii).

VBCollector is a tool for collecting still images and audio recorded using the VB-C50FSi/VB-C50Fi recording function. The images and audio are recorded in response to input from external devices, timer settings or detected motion. VBCollector accesses the server at specific times on a daily, weekly or monthly basis, and then downloads the recorded pictures and audio. The recorded pictures and audio are in turn saved on the PC on which VBCollector is installed, making it easy to view and play back the downloaded pictures and audio in VBCollector. This also means that data can still be saved when the allowable limit on the number of pictures and the duration of audio that the VB-C50FSi/VB-C50Fi can record and save has been exceeded. VBCollector also allows you to export logs containing information relating to task execution.



Pictures and audio recorded with the VB-C50FSi/VB-C50Fi's recording function

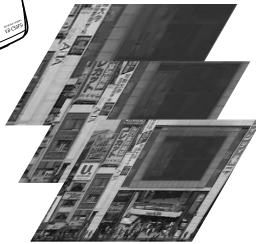

Data periodically and automatically collected for each task

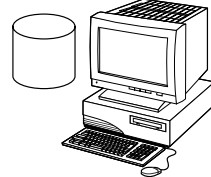

Task Name	Server Name	Next Run Time	Last Result	Latest error	Schedule
task1	VB-C50FSi	2005/06/14 22:20	Succeeded	2005/06/13 22:23	Start Time:2005/06/09 22:20 Interv...
task2	VB-C50FSi	2005/06/14 22:24			Start Time:2005/06/13 22:24 Interv...
task3	VB-C50FSi				Start Time:2005/06/13 22:24
task4	VB-C50FSi	2005/06/20 22:24			Start Time:2005/06/13 22:24 Interv...

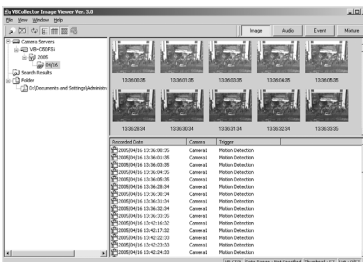

Installing VBCollector

As described in “Install the Software” in Chapter 2 “Setting up” (→ P.2-13), select Custom Installation to install VBCollector.

Select “Programs” from the Start menu, then “WebView Livescope” and a shortcut will be created.



Note

When Using Older Versions of VBCollector

- Images downloaded using VBCollector version 2.1 or earlier cannot be viewed in VBCollector 3.0. If you have VBCollector version 2.1 or earlier already installed, a dialog box appears giving you the option of choosing whether you want to uninstall the old version. If you wish to view images saved in the old version, select “Yes”.

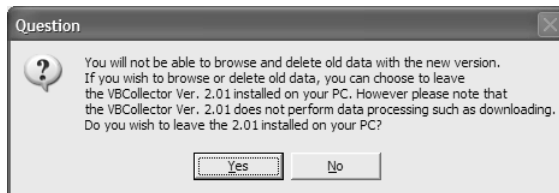

If you select “No” to uninstall the old version, the old version is uninstalled and VBCollector 3.0 is then installed.

[Before uninstalling the old version]

Uninstalling the old version of VBCollector does not delete images recorded using that version and the images cannot be deleted from VBCollector 3.0. Use the old version to delete the images before installing VBCollector 3.0.

[Retaining your settings]

Regardless of whether you uninstall the old version of VBCollector, the settings are retained and applied in VBCollector 3.0, with the following exceptions. Specify these settings after VBCollector 3.0 is installed.

- “What to do when the free space falls below the specified value” (→ P.6-36)
- “Set max. number of data per download” (→ P.6-36)

After specifying the settings, conduct thorough testing beforehand to ensure that tasks run normally before commencing operation.

[If you retain an old version]

- You can launch the old version from “VBCollector Task View” in the Start menu.
- Launching the old version will not make tasks for that old version run.
- To uninstall an old version, relaunch the VBCollector 3.0 Installer and use the Installer for the uninstallation. You cannot uninstall old versions of VBCollector properly using the Windows “Add or Remove Programs” feature.

- To uninstall VBCollector 3.0, use the VBCollector 3.0 Installer to uninstall the currently installed copy of VBCollector 3.0 and then cancel the subsequent installation process. If you use the Windows “Add or Remove Programs” feature to uninstall VBCollector 3.0, you will no longer be able to install VBCollector version 2.1 or earlier.
- VBCollector cannot be installed on a PC where MV Ver. 2.0 or a later version is already installed.

Starting Up VBCollector

VBCollector is started up by choosing it from Start menu.

To Start Up VBCollector...

Choose [Program]-[WebView Livescope]-[VBCollector Task View Ver. 3.0] from the Start menu to start up VBCollector.

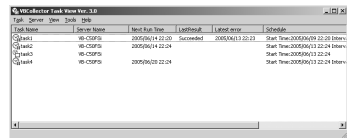
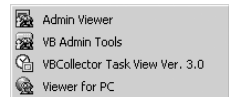

Registering a Server

To use VBCollector to download pictures and audio recorded on the network camera server (hereafter referred to as the “server”), the server must first be registered.

■ Adding a Server

Add a new server for downloading data in VBCollector.

To Add a New Server...

1. To add a server, choose “Add” from the Server menu bar, or click the “Add” button on the Server List dialog box that appeared when Edit from the Server menu bar was selected.

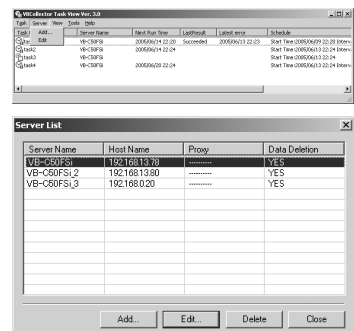

2. Enter each item in the various fields and click the “OK” button.

① **Server Name**

Assign a name for recognizing the Server (optional).

② **Data Directory**

Enter the name of the folder in which downloaded data is to be saved, or click the “Browse” button to select a folder. Refer to the following Tip for information on downloading data to a shared folder on the network.

“Delete data on the server”

Ticking this checkbox deletes the downloaded data from the server.

③ **Server Information**

“Host Name” (→ P.3-6)

Specify an IP address or a host name.

“HTTP Port” (→ P.3-16)

Enter the HTTP port number set in the server.

“Administrator Account”

Enter an administrator account registered in the server (root).

“Administrator Password” (→ P.3-5)

Enter the administrator password registered in the server (The default setting is VB-C50i).

“Settings Page URL”

Enter the “Path” to the setting title page set in the server (admin).

④ **Proxy**

“Use Proxy Server”

Select this if the connection is to be made via a proxy server.

“Host Name”

Specify the proxy server host name or IP address.

“Port”

Enter the proxy server port number. (The default value is 8080.)

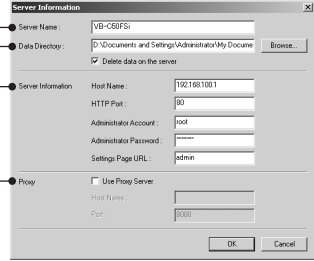

Note

- Operate VBCollector with an authority greater than PowerUsers.
- NTFS is recommended for such file systems containing the installation folder and Data Directory.
- When NTFS is used as the file system, set the permissions to allow reading and writing to the installation folder and Data Directory. Functionality is limited if you do not have access privileges.



Tip

Downloading data to a shared folder on the network

- You cannot specify a path name that uses a network drive in the “Data Directory” setting. Use UNC notation to specify the path name.
 \\PC name\shared directory name[\path]
 E.G.) \\Server\Share\path

- Set the folder access privileges for the “Data Directory” folder so that read/write operations can be performed from PC with VBCollector installed.
- Make the logon account setting for VBCollector task scheduler service in the following procedure (→ P.6-36). Administrator privileges are required to perform these settings.
 1. Choose “Options” from the “Tools” menu bar.
 2. Select [Specify an account for downloading] under [Details] in the option dialog.
 3. Enter your user name and password.
 4. Click the “OK” button.
 - * Specify an account from which you can log on to the download destination PC.
 - * Set the folder access privileges so that read and write operations can be performed from the download execution account to the folder in which VBCollector is installed (the default setting is C:\Program Files\Canon\WebView\VB\VBCollector\3.0).
 - * Only users who have Administrator privileges can be registered.
 5. Restart the service (→ P.6-20).

■ Editing Server Information

Content of the registered server information can be edited.

To Edit Server Information...

1. Choose “Edit” from the “Server” menu bar, and when the Server List dialog box appears, select the server name to be edited and click the “Edit” button.

To delete a registered server, click the “Delete” button.

2. As with the procedure for adding servers, change all desired items and click the “OK” button.

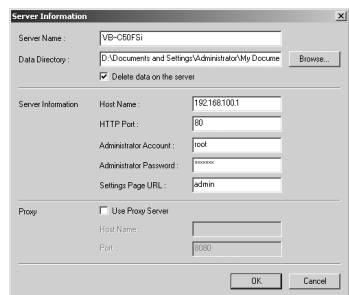
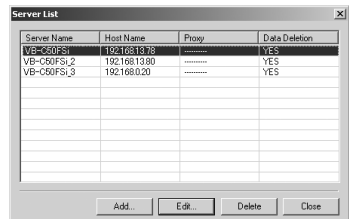
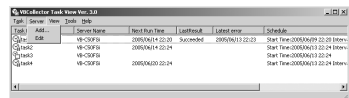

Downloaded data is not deleted when a server is deleted. To delete downloaded data, first use the “Deleting Files” procedure in the VBCollector Image Viewer (→ P.6-31) and then delete the server.

Registering Tasks

■ Adding a Task

Add a new task for downloading images and audio.

To Add a New Task...

1. To add a task, choose “New Task” from the “Task” menu bar.



2. Enter each item in the various items and click the “OK” button.

① Task Name

Assign a name to the task.

“Enable this setting”

Select “Enable this setting” if the task is to be performed according to the schedule. If not selected, the added task will not be executed.

② Server Name

Select the server from which the VBCollector downloads recorded pictures. If there are no servers registered in the list, you can register servers by selecting a blank column and clicking the “Server Settings” button.

“Server Settings”

Any download server name can be registered (→ P.6-13). After registration, it can be selected from the “Server Name” column.

③ Schedule

“Start Date”

Set the date which is to be the starting point of the schedule. The task will be executed after the specified start date according to the criteria specified below.

“Start Time”

Set the time when the task is to start up (in 24-hour format).

“Once”

Select if the task is to be executed only once. The task will be executed only once at the start time on the start date.

“Daily”

Select if the task is to be executed once every certain number of days. This number of days can be specified between 1 and 31.

“Weekly”

Select if the task is to be executed every certain number of weeks on a certain day of the week. Set the number of weeks between 1 and 53, and specify the day of the week.

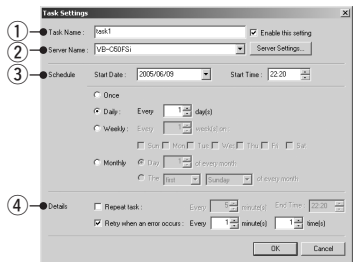

“Monthly”

Select if the task is to be executed every month on a certain day of the month. Set this day between 1 and 31. Or a day of the week for a certain week of the month can also be specified.

④ Details**“Repeat task”**

Select if task is to be executed in repetition in time units. Downloads occur in repetition only for the specified number of times at specified intervals starting from the start time specified in the schedule. If not selected, download occurs once at the start time specified in the schedule. Once the End Time is reached, the task is not performed. Data can be downloaded at intervals of some minutes or by specifying a number. Enter a value between 5 and 1439 as the number of minutes. Times up to the Start Time plus 23:59 can be specified as the End Time.

“Retry when an error occurs”

Select this item if a task is to be executed again in the event a download does not end normally after a task is executed. The task will be executed again a specified number of times at specified time intervals. During this time, if the download is completed normally, further tasks will not be repeated. Specify the number of times and the time interval at which a task is to be re-executed. For the number of times, enter a value between 1 and 10; for the interval, enter a value between 1 and 10.

**Note**

- Up to 16 tasks can be executed by VBCollector simultaneously. Please be sure not to load a schedule with 17 or more tasks to be executed. VBCollector is also not able to execute multiple tasks simultaneously to the same server. Please take care to ensure that multiple tasks are not executed to the same server by taking such measures as leaving a sufficient time space between the “Start Time” of each task.
- If you execute a maximum of 16 tasks simultaneously, please confirm performance of the PC on which VBCollector is installed (→ P.1-5).
- When Log S015 “The task was running longer than the execution interval.” is reported, review the settings for the schedules such as reducing the number of tasks to be performed at the same time. If you use Windows 2000 SP4, try performing a Windows Update as it may improve the performance.

■ Editing Tasks

The details of a registered task can be edited.

To Edit a Task...

1. In the Task View, select the task to be edited by clicking on its name, then choose “Edit Task” from the “Task” menu bar.

Or, double-click on the task to be edited.

To delete a registered task, choose “Delete Task” from the “Task” menu bar.

2. As with procedure to add a new task, change all desired items and click the “OK” button.

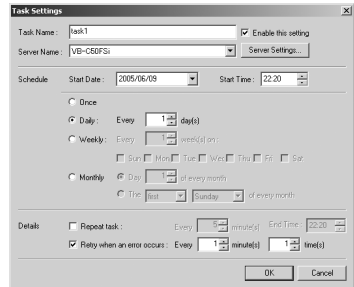
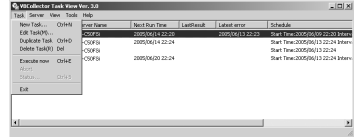

Executing and Canceling Tasks

■ Executing a Task

To execute registered tasks, select “Enable this setting” in the Task Settings dialog box.

Registered tasks are executed automatically according to pre-determined schedule.

If you want a task to be executed immediately, select the desired task on the Task View and choose “Execute now” from the “Task” menu bar.

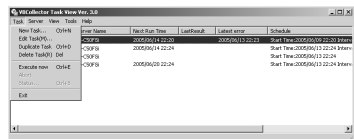

■ Canceling a Task

To disable a registered task, clear “Enable this setting” at Task Settings. To abort the execution of a task, in the Task View, click on the task to be aborted, and choose “Abort” in the “Task” menu bar.



■ Check Task Status

During the execution of any task, the download status can be checked.

To Check Task Status...

1. During the execution of a task, choose “Status” from the “Task” menu bar. Alternatively, select and right-click the task for which you want to display the status and select “Status” in the pop-up menu.

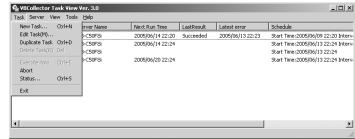

2. Check the download status and click the “Close” button to close the dialog box.

If you want to cancel downloading, click the “Abort” button.

① **Status**

Shows the progress of download.

② **Host Name**

Shows the host name of download server set in the server information (→ P.6-14).

Data Directory

Shows the name of Data Directory to save downloaded data, as set in the server information (→ P.6-14).

“Delete data on the server”

Ticking this option deletes the downloaded data from the server. In order to change the checking status, change the setting in the server information (→ P.6-14).

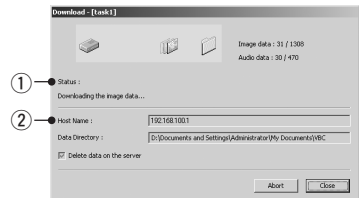

Details Displayed on the Task View

The execution status can be checked on the Task View.

● Task Name

The names that were specified at Task Settings are displayed here. The status of each task is displayed as an icon at the left of the name.

Task Name	Server Name	Start Run Time	LastRun	Last error	Schedule
Client	W-CSP01	2005/06/14 22:00	Succeeded	2005/06/13 22:02	Start time 2005/06/09 22:02 19h
Client	W-CSP01	2005/06/14 22:24			Start time 2005/06/13 22:24 19h
Client	W-CSP01	2005/06/20 22:24			Start time 2005/06/13 22:24 19h



Running

This task is currently being executed.



Waiting

This task is currently standing by to be executed at the next scheduled execution time.



Disabled

“Enable this setting” for this task is not selected at Task Settings and this task is currently not being executed.



Not scheduled

This task is not currently scheduled for execution.



Settings damaged

Inconsistencies have occurred in this task’s settings and the task may not be executed.

● Server Name

The server names that were specified at Task Settings are displayed here.

● Next Run Time

The date and time when the task is to be executed next is displayed here.

● Last Result

The last results achieved by the task and the task end time are displayed here.

● Latest error

If errors occurred while the task was running, the date and time of the most recent error is displayed here.

● Schedule

The start date, start time and execution interval for each task are displayed here.



Tip

An automatic download (→ P.6-21) is displayed as with the task name “Task by Notification”.

■ Refresh Task View Display Content

To refresh the Task View content to reflect the most recent information, choose “Refresh” from the “View” menu bar.

Starting/Stopping the Service

The task scheduler service can be started and stopped.

To Make Settings...

Choose “Start Service” or “Stop Service” from the “Tools” menu bar. If the service has started, Stop Service is enabled in the menu; if the service is stopped, Start Service is enabled.

When the Confirmation dialog box appears, click OK.

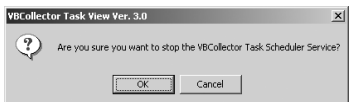

Automatic Downloading by Notification

You will not be able to record image and audio data if there is insufficient space on the server. The VB-C50FSi/VB-C50Fi can receive a low server capacity notification sent from the server when available space on the server falls below the value set, and automatically downloads the data to a specified PC, thereby increasing the available space on the server.

1. Choose “Automatic Download by Notification” in the “Tools” menu bar.

2. Perform the settings relating to notification.

① Server List

Displays a list of the servers from which the data can be downloaded. The settings relating to notification of each server registered with this tool (→ P.6-13) are shown in this list.

“Server Name”

Displays the names of the servers registered with this tool.

“Notification”

Displays the setting for whether the server will send a low server warning message when available space on the server reaches the value set (→ P.6-22).

“Free Space (MB)”

Displays the setting value for available space on the server. When available space has fallen below this setting, the server sends a low server capacity warning message.

“Host”

Displays the name of the host which will send the low server capacity warning message.

“Port”

Displays the TCP port of the host.

② Server status display area

Displays the status of the selected server. Depending on the server conditions, you may or may not be able to specify settings in the “Server Setting” button and the “Notification Settings” button.

“The Notification Function is available for this server”

Both the “Server Setting” and “Notification Settings” buttons are available.

“This server does not support the Notification Function” and “Failed to connect to this server”

The “Server Setting” button is available but the “Notification Settings” button is not.

“This server information is invalid”

The “Server Setting” button is available but the “Notification Settings” button is not.

“None”

Neither the “Server Setting” button nor the “Notification Settings” button is available.

③ Reception Port No.

Specifies the TCP port number which will receive the low server capacity warning message from the server. The default is 1906.

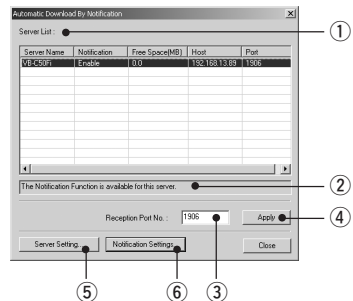

④ “Apply” button

Saves a change to the reception port number in the registry. If you make a change, a dialog box is displayed. Click “Yes” and the transmission port of each server is also changed.

⑤ “Server Setting” button

Displays a dialog box with information about the selected server for editing (→ P.6-13).

⑥ “Notification Settings” button

For performing notification settings for the selected server.

3. Click the “Notification Settings” button to set a value for available space for the server to give a low server capacity notification.

① “Send notification when server space gets low”

Select to send a low server capacity notification when available space on the server is insufficient.

② “Available disk space of the server”

Set a value for available space at which the server will send a low server capacity notification.

When available space on the server falls below the value set, a low server capacity notification is sent.

* For Windows XP SP2 users, see “Using the VB-C50FSi/VB-C50Fi with Windows XP SP2” (→P.1-6). This Note holds true for users who have turned on Windows Firewall with Windows Server 2003 Standard Edition (SP1).

③ “Host Address”

Select an address if you run VBCollector on a PC that has several IP addresses.

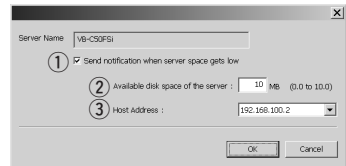

Tip

- Where “Host” is displayed as “(other)” or where the transmission port and the reception port are different, you cannot receive a low server capacity notification.
- “-----” is displayed where server information such as the host name or the HTTP port number has not been entered correctly, or in the case of servers other than the VB-C50FSi/VB-C50Fi which support the low server capacity notification function.
- If “Host” is not “(other)” or “Port” is not “Reception Port No.” in the selected server, a message asking you to confirm whether it is okay to change the setting values will be displayed. Click the “Yes” button and a dialog box appears.
- If the server that sends the notification is in the middle of a task, there is no automatic downloading during normal tasks.
- Data on the server is deleted regardless of the data deletion settings on the server.
- If large images are recorded each second or audio is recorded continuously, the server may run out of capacity before it can send a notification, and picture and audio recording may stop working.
- When the server capacity falls below the set value, a notification will be sent from the server every 30 seconds.

Viewing Recorded Images and Playing Back Recorded Audio



Playing back of Recorded Audio can only be used with a particular model of the VB-C50FSi (→ P.iii)

Data downloaded according to the task schedule is saved in the folders specified in the “Server Information”. You can use simple procedures in VBCollector to view the recorded images, play back audio and for other tasks such as playing images and sounds as animations, viewing detailed information and performing filtered searches.



Playback of recorded images and audio is not synchronized (VB-C50FSi only).

■ Launch the VBCollector Image Viewer

To Launch the Image Viewer

1. Choose “Display Data” from the “Tools” menu bar.

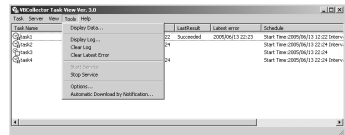

■ VBCollector Image Viewer Window Details



① “Search data” button

Searches for data on the camera server according to the date/time, camera or trigger.

② “Delete data” button

Deletes the selected data.

③ “Refresh” button

Updates the contents of the screen to show the latest information.

④ **“Toggle folder tree” button**

Switches between displaying and hiding the folder tree display area (12).

⑤ **“Toggle data list” button**

Switches between displaying and hiding the list display area (14).

⑥ **“Toggle thumbnail image” button**

Switches between displaying and hiding the thumbnail image display area (13).

⑦ **“Close all detail display windows” button**

Closes all the detail display windows that are currently open.

⑧ **Image display mode: “Image” button**

Shows a list containing only the images in the selected folder.

The image thumbnails appear in the thumbnail display area and the “Recorded Date”, “Camera” and “Trigger” information appears in the list display area in the sequence in which the data was downloaded.

⑨ **Audio display mode: “Audio” button**

Shows a list in the list display area containing only the audio files in the selected folder.

The “Rec. Start Time” and “Recording Period” information appears in the list display area in the sequence in which the data was downloaded. When you select an audio data in the list display area, thumbnails of the images shot while the audio was being recorded appear in the thumbnail display area.

* Only available with a particular model of the VB-C50FSi (→ P.iii)

⑩ **Event display mode: “Event” button**

Shows a list in the list display area containing only the image capture and audio recording events in the selected folder.

The “Occurrence Date”, “Event”, “Rec. Start Time” and “Recording Period” information appears in the list display area in the sequence in which the data was downloaded. When you select an event in the list display area, thumbnails images appear in the thumbnail display area. For a image capture event, the corresponding image thumbnails captured within 30 seconds before and after the event appear, and for an audio recording event, thumbnails of the images shot while the audio was being recorded are displayed.

⑪ **Combined display mode: “Mixture” button**

Shows a list in the list display area containing the image and audio data in the selected folder.

The image thumbnails or audio icons appear in the thumbnail display area and the “Recording Date”, “Camera”, “Trigger” and “Recording Period” information appears in the list display area in the sequence in which the data was recorded. In the list display area, images shot while the audio was being

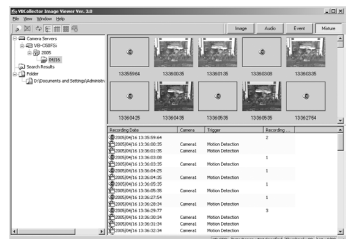
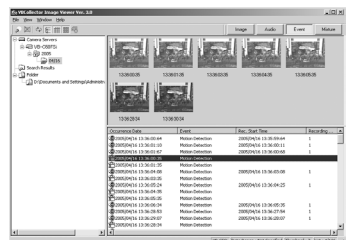
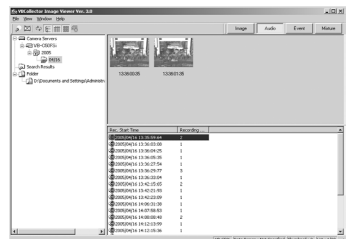
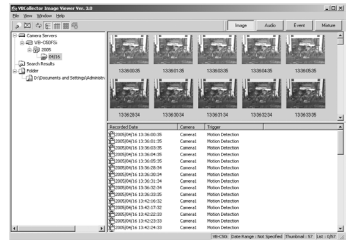

recorded are indicated by yellow and white highlighting alternately.

* Audio file display is only available on the VB-C50FSi.

⑫ **Folder tree display area**

Displays the data managed in the VBCollector Image Viewer in a folder tree format.

⑬ **Thumbnail display area**

Shows the thumbnail images contained in the folder selected in the folder tree area or the thumbnail images associated with the data selected in the list display area.

⑭ **List display area**

Shows a list of the data in the folder selected in the folder tree area.



Tip

Using the Display Modes

You can use the 4 display modes to make viewing or playing back recorded data more efficient. (Audio recording and playback is only available on the VB-C50FSi.)

- **Image display mode:** This mode shows a list of image data and is useful for finding a desired image from thumbnail images and for viewing the progress of changes in images.
- **Audio display mode:** This mode shows a list of audio data and is useful for viewing images captured during a period of audio event, and for viewing and playing the recorded video and audio data at the same time.
- **Event display mode:** This mode shows only the image capture and audio recording event recorded using external device input or motion detection and does not show audio or video data recorded using the timer. This mode is useful for viewing or playing only the recorded video and audio data when an event occurs.
- **Combined display mode:** This mode shows recorded video and audio data according to the date and time they were recorded. This mode is useful for checking all the recorded data in chronological order. In the list display area, image data shot while audio was being recorded are identified in color, making it easier to check the recording circumstances. It is also possible to select consecutive data, and play the recorded video and audio data at the same time.

You can also switch between display modes when you select the search results folder created during a search (→ P.6-28) and view the contents as a list. The different display modes can be used to good effect after you have filtered the recorded data according to date and time, camera or trigger.

* You can specify the initial display mode used when you launch the VBCollector Image Viewer by selecting “Options” from “View” in the menu bar and then selecting “List View” > “Startup Mode”.

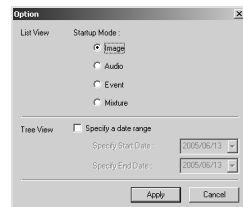

■ Viewing Detailed Data Information

You can view the data information, enlarge and reduce images, and play back audio (VB-C50FSi only).

To View Data Information...

1. Double-click a thumbnail or data in the list display area. Alternatively, select a thumbnail or data and then choose “Display Details” from the “File” menu bar.

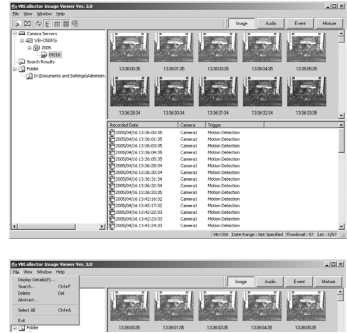

2. The detailed data information appears.

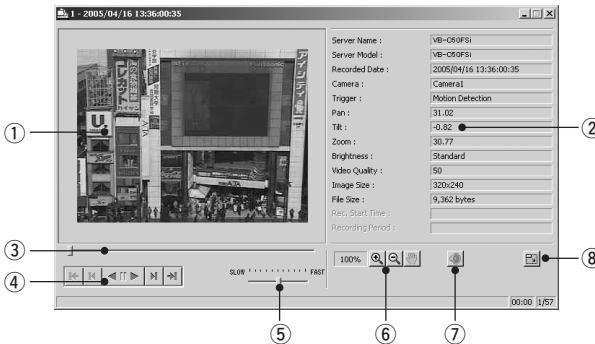





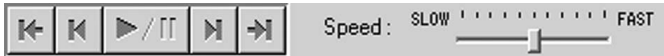

- 1 **Image display area**
Shows the selected image. If the image is too large to fit in the display area, scroll bars can be used to view other parts of the image.
- 2 **Recording information display area**
Shows detailed data information.
- 3 **“Display position” bar**
Shows the data display position. Drag the button along the bar to move the display position.
- 4 **Animation control area**
Used to control animations.
- 5 **“Playback speed” bar**
Drag the button along the bar to change the speed of the animation.
- 6 **Enlarge/Reduce control area**
Enlarges or reduces images.
- 7 **“Audio” button (VB-C50FSi only)**
Selects whether or not to play an audio file.
* If you selected “Display Details” from the Image display mode, the Audio button does not appear.
- 8 **“Resize” button**
Changes the window size.

● Animation

Images can be consecutively displayed.



	[Top] button	Shows the first image.
	[Prev] button	Shows the previous image.
	[Play/Pause] button	Plays/pauses the animation.
	[Next] button	Shows the next image.
	[Last] button	Shows the final image.
	[Speed] bar	Adjust the speed for animation playback.
	[Audio] button	Plays an animation with sound. (VB-C50FSi only)



Note

When you use the “Audio” button to play an animation with sound, the animation is played according to the audio playback speed, but they are not synchronized. Also, you cannot use the “Playback speed” bar while the “Audio” button is enabled. (VB-C50FSi only)









Tip

During animation, the “Top”, “Prev”, “Next” or “Last” button cannot be used. If you want to use any, click the “Play/Pause” button to stop the animation.

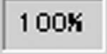
● Zoom in/out

Images can be zoomed in/out.



	[Magnification]	Shows the current magnification (10~500%).
	[Zoom in] button	Enlarges images by 10%.
	[Zoom out] button	Reduces images by 10%.
	[Move] button	If any image size is greater than the display area, you can move the image display position. Clicking the “Move” button to position the mouse cursor on the image changes the cursor to  . Move  while pressing the left mouse button on the image. The image display position will be moved.

● **Change window size**

As window size, large or normal size is available and is automatically selected depending on the initial image size. However, you can also change it manually.



[Large size] button

When it is clicked, the window will be displayed in large size. It appears when normal window size is displayed.



[Normal size] button

When it is clicked, the window will be displayed in normal size. It appears when large window size is displayed.

■ **Finding Data**

You can search for data on the camera server by date/time, camera or trigger.

To Find Data...

1. **Select the server to be searched in the folder tree display area and then either click the “Search data” button or choose “Search” from the “File” menu bar.**
2. **The “Search” dialog box appears.**



Set the search criteria shown as shown below and click the “OK” button. The search results then appear showing a list of data that match the selected criteria.

① **Search Name**

A folder with the name you entered is created in the “Search Results” folder and the search results appear in the folder. If you specify the name of an existing folder as the search name, the previous search results are discarded and replaced by the new search results.

② **Date & Time**

Specify a date from the start date and end date, and a time range from the start time and end time fields.

③ **Camera**

Data is retrieved from the ticked camera numbers. This criterion cannot be used to filter audio or event data.

④ **Trigger**

Data is retrieved for the ticked triggers. This criterion cannot be used to filter audio data.

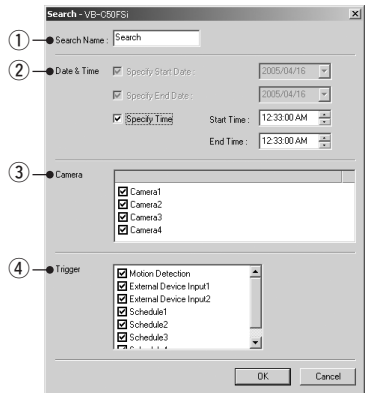

3. A list of search results is displayed.

A folder with the name you entered is created in the “Search Results” folder and the search results appear as a list in the folder.

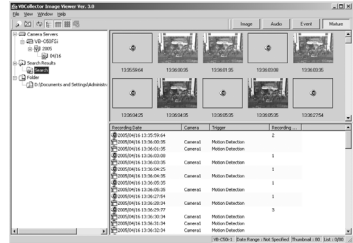

● Filtered searches

To filter the search results using yet another search criteria, select the “Search Name” folder to be searched and click the “Search data” button. The search criteria for the previous search are displayed, so you need to reset the criteria.

● Deleting search results

Right-click the “Search Name” folder and select “Delete Search Result” from the menu that appears. This deletes the “Search Name” folder but does not delete the downloaded data.



Tip

- The image and audio data in the search results folder are simply aliases of the recorded data in the search results folder and are not the recorded data themselves or copies of those data.
- To extract unwanted data in a search and then delete the recorded data, right-click the “Search Name” folder and select “Delete data”.
- To use the image or audio data in the search results in applications other than VBCollector Image Viewer, see “Extracting Files” (→ P.6-30).

2. Specify the folder containing the files to be managed.

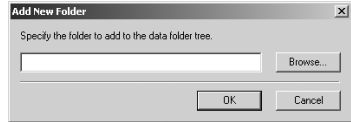

3. A folder with the specified name is created inside “Folder” in the folder tree display area and the files in the folder can then be managed.

You can hide a folder selected from the folder tree by right-clicking the folder and choosing “Hide Folder” from the menu that appears. This does not delete the files in the folder.

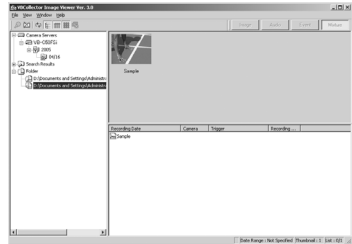

■ Deleting Data

Use the procedure below to delete downloaded data and data in folders.

To Delete Data...

1. Select the folder containing the files to be deleted in the folder tree display area and then click the “Delete Data” button or choose “Delete” from the “File” menu bar.
2. Click “Yes” in the confirmation dialog box to delete the files.

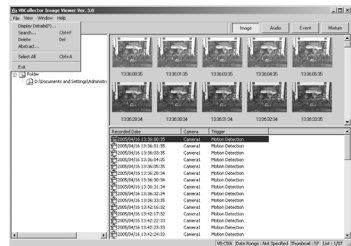

Note

Because downloaded images and audio are collected and saved in the proprietary format used for file management by the VBCollector Image Viewer, deleting individual data may not reduce the amount of disk space taken up by downloaded images and audio. Selecting and deleting a large quantity of data from the list may also take some time. For this reason, we recommend that you delete downloaded image and audio data in units of one or more folders.

Viewing Logs

VBCollector outputs logs concerning the execution of tasks. To view a log, choose “Display Log” from the “Tools” menu bar.

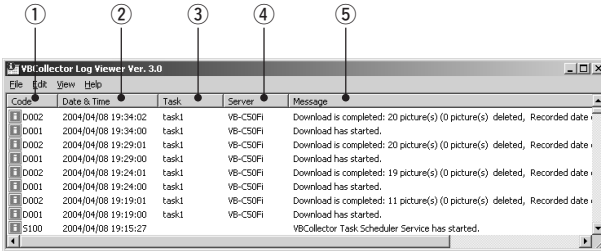

The following information about logs is displayed:

① Code

Identification codes are displayed here. 4 types of icons representing the level are also displayed with these codes.



Information level



Warning level



Error level



Unknown

② Date & Time

The date and time when the log was generated is displayed here.

③ Task

The name of the task that output the log is displayed here.

④ Server

The name of the server to which the task performs downloads is displayed here.

⑤ Message

The log's message is displayed here.

■ Displaying Logs According to Selection Criteria

Logs can be filtered according to error type, code, or date and time etc. so that only the required information is displayed.

To Make Settings...

1. Choose “Filter” from the “View” menu bar.

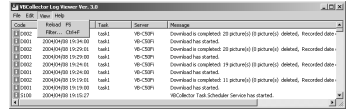

2. The Filter dialog box appears.

To display only the logs that match the specified criteria, enter the criteria below and click the “OK” button. If no changes are required, click the “Cancel” button.

① Specify Task

Select if filtering by task name, then enter the task name.

② Specify Server

Select if filtering by server name, then enter the server name.

③ Error Type

Specify the error type when filtering by error type.

“Not Specified”

Selecting this item disables priority and code settings.

“Specify Priority”

From Error, Warning, or Information, select the error level to be displayed.

“Specify Code”

Select if only logs with the corresponding identification code are to be displayed, then enter the identification code.

④ Date & Time

Filters logs by output date and time.

“Specify Start Date & Time”

When this item is selected and a date and time is entered, logs generated **after** the specified start date and time are displayed.

“Specify End Date & Time”

When this item is selected and a date and time is entered, logs generated **before** the specified end date and time are displayed.

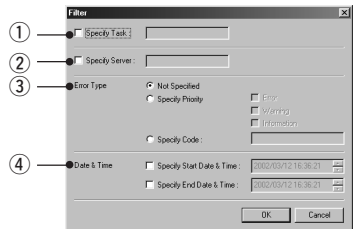

■ Search Logs

Logs can be searched using character strings. This function is convenient in case of searching any target log from among numbers of logs.

To Search Logs...

1. Choose “Search” from the “Edit” menu bar.

2. Enter the character string you want to search in “Search for” and click the “Search” button.

Searching begins from the top of the logs.

If you select any log, searching will be started from the selected log. Clicking the “Cancel” button closes the search dialog.

“Match case”

When it is selected, capital and small letters will be distinguished and only those strings, which exactly coincide with the entered character string, will be searched.

3. A line containing the relevant character string will be highlighted.

Pressing “F3” on the keyboard starts forward search. Pressing “Shift+F3” makes backward search. When searching is completed after taking a round, the message “Search complete.” will be displayed to terminate searching. If the relevant string is not found, the message “The search item was not found.” will be displayed to quit searching.

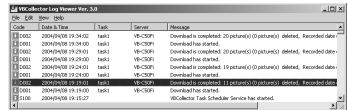
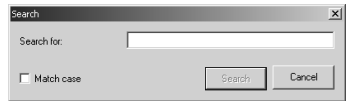
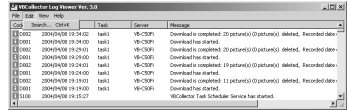

■ Selecting Log Files

The initial log file of VBCollector is saved as “vbrpd.log” file in the “SYSTEM” folder within the VBCollector-installed directory. When the file exceeds the size of 10 MB, it will be renamed as “vbrpd01.log”, creating a new “vbrpd.log” file within the same folder to save the log. Log files can be created up to 11 (with names from “vbrpd.log” to “vbrpd10.log”): The newest log file is always named as “vbrpd.log” and the older ones are renamed increasing their numbers whenever a new one is created. VBCollector Log Viewer can selectively display any of the created log files.

To Select Log Files...

1. Choose “Open” from the “File” menu bar.

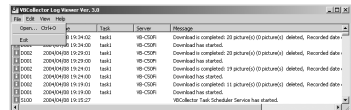

2. Choose the log file you want to display and click “Open”.

The selected log will be displayed.

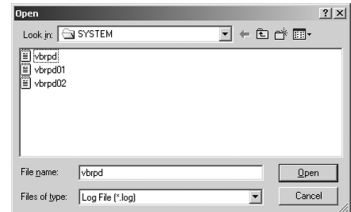

Setting Retention Period and Disk Space

You can set the file retention period and specify the action to be taken if the specified data capacity on the drive used for saving downloaded data is exceeded.

To Make Settings...

1. Choose “Options” from the “Tools” menu bar.

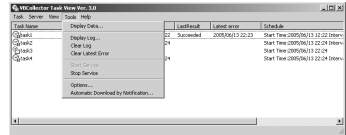

2. Enter information for each item in the Option dialog box displayed and click the “OK” button.

① Retention Period

Specify a max. retention period to save data:

If you tick this option, files are deleted when they exceed the designated storage time. Set a period between 2 and 100 days as the file retention period and specify the time at which file deletion starts in the “Start Time” field.

② Disk Space

What to do when the free space falls below the specified value:

Specify the action to be taken when the amount of free space available on the drive containing the folder used for saving files while tasks are running drops below the level specified in “Free Space”. Set a value between 300 and 2000 MB.

- “Does not execute task”

The task is not performed when the scheduled execution time is reached.

- “Delete old data”

Deletes downloaded data stored on the server in blocks of 1 day at a time, starting with the oldest stored data, until the designated amount of free disk space is available.

③ Details

“Set max. number of data per download”

Ticking this option allows you to set the maximum number of files that can be downloaded from the server at one time. Set a value from 1 to 30,000 for images and from 1 to 500 for audio files*.

* Only available with a particular model of the VB-C50F5i (→ P.iii)

“Specify an account for downloading”

Ticking this option allows you to specify the execution account for downloading. (Only users who have Administrator privileges can be registered.)

Set this option when you want to download files from the server to a shared folder on the network from the server (→ P.6-14).

After ticking this option, enter your user name and password.

You must restart the service after setting this option.

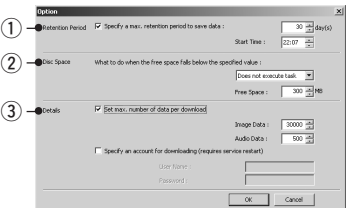



Note

- When there is no more free space on the drive on which the files are saved, Log S023 “Execution failure: Available space on the server gets low.” or D029 “Download is aborted because of insufficient free space.” is output.
- If you specify settings to delete old data, please consider the possibility that the images you have downloaded the previous day may also be deleted.

Chapter



Appendix

Troubleshooting

Before you contact your Canon dealer or service outlet, check the items listed below. If a log message is displayed, refer to the log message list for the log details and the appropriate response.

The VB-C50FSi/VB-C50Fi does not start up.

- Check that the AC cable is connected correctly.
- Switch the VB-C50FSi/VB-C50Fi off and then on again (→ P.2-7).
- If you are using a PoE hub or midspan, check whether the LAN cable is connected correctly. Use only approved PoE hubs or midspans (P.2-7).

VBSetup.exe does not work.

- Check that the LAN cable used for setup is connected correctly.
- Try turning off the power to the VB-C50FSi/VB-C50Fi, then turning it on again (→ P.2-7). There will no longer be any effect on VBSetup.exe 20 minutes or more after power is turned on.
- Check to see if the VB-C50FSi/VB-C50Fi and the PC running VBSetup.exe are connected to the same network segment.
- VB setup.exe may not run on Windows XP SP2. In that case, see “Using the VB-C50FSi/VB-C50Fi with Windows XP SP2” (→ P.1-6). This Note holds true for users who have turned on Windows Firewall with Windows Server 2003 Standard Edition (SP1).

The VB-C50FSi/VB-C50Fi sample page does not appear.

- Check that the LAN cable is connected correctly.
- Check that the VB-C50FSi/VB-C50Fi network settings are correct. In particular, check that the IP address, subnet mask and default gateway address settings are valid for the network you are using.
- If you have changed the IP address, the new IP address does not take effect until the VB-C50FSi/VB-C50Fi is rebooted.
- If access control for the VB-C50FSi/VB-C50Fi is being used, check the settings (→ P.3-20).
- Check that the IP address or URL settings in the viewer software are correct.
- When using the router's NAT function, be sure the VB-C50FSi/VB-C50Fi's IP address in the Web page is correct (→ P.5-26).

The video does not appear.

- Check that the viewer software is correctly installed (→ P.7-18). Please refer also to the Viewer Software User's Manual (Viewer-E.pdf) contained on the supplied CD-ROM.
- If the video quality is poor, check the quality settings on the VB-C50FSi/VB-C50Fi (→ P.3-8). Also, check settings such as the number of background colors as on the viewer PC.
- You can limit the number of viewers that can access the VB-C50FSi/VB-C50Fi at the same time. When this limit is exceeded, a message is displayed instead of a video (→ P.3-15).
- If you cannot see the video using the Viewer for Java, check your system environment such as the browser version (→ P.1-4). To use the Viewer for Java, you need to install Java VM beforehand. See the web site for more details.

WebView Product web site

<http://www.canon.com/webview>

I can't control the camera.

- Check to see if the camera zoom position is restricted to a preset (→ P.3-13).

The viewer is disconnected

- Check that the network or PC you are using is working properly.
- Reboot the PC and try connecting again.

I forgot the password.

- All factory default settings can be restored by using the Reset switch (→ P.7-22). The default administration password is "VB-C50i". The VB-C50FSi/VB-C50Fi's settings will need to be made again, since all network settings such as the IP addresses and subnet masks are also restored to the factory defaults. Saved web page data is also deleted.

I cannot record pictures or audio.

- The amount of data that can be recorded depends on the setting. Delete recorded files that are no longer needed (→ P.3-28).
- Check that the camera is on and the cable has been connected properly.
- The audio recording function is available with a particular model of the VB-C50FSi (→ P.iii).

I cannot play back audio.

- The audio file settings may be incorrect. Specify the settings again (→ P.4-57).

There are many recorded pictures than configured.

- If you set the recording interval of Motion Detection settings (→ P.4-43) longer than that of External Device Input settings (→ P.4-51), the number of motion-triggered pictures may be larger than configured.
Configure the same value to both of the two items.



Note

If you have a problem, consult the ReadMe also. The ReadMe file may contain important information not included in this manual. Be sure to read the file.

Log Messages

The VB-C50FSi/VB-C50Fi Log Messages

The Syslog log messages are classified into the following 5 categories. Classification details are dealt with in the UNIX syslog.

Classification	Level	Fault Severity
crit	Error	Critical fault at the software level (stops task operation)
err	Error	Fault involving a malfunction (operation interrupted)
warning	Warning	Fault not involving malfunction
notice	Warning	Fault outside the system
info	Information	Information on correct operation

■ Camera Server-related Log Messages

●A001 Camera server startup failure (crit)

Message	no %1 installed
%1	sources protocols
Explanation	Capture and initialization of protocols has failed, and the camera server has failed to start.
Response	If rebooting does not solve this problem, there is a malfunction. Contact an authorized Canon service representative.

●A002 Protocol initialization failure (err)

Message	%1 protocol not installed
%1	Protocol type (LS/C LS/D LS/H)
Explanation	Initialization of WebView has failed. The setting information may be corrupted.
Response	Correct the settings or return to factory-shipped settings.

●A007 View restriction setting error (warning)

Message	inconsistent view restriction for camera[1]
Explanation	The view restriction settings are corrupted. The camera control functions on the affected camera cannot be used.
Response	Restore the factory default settings or reset the view restrictions.

●A008 Compatibility error in the view restrictions settings (warning)

Message	unacceptable view restriction for camera[1]
Explanation	Even in the telephoto field of view, the view restriction settings cannot be satisfied in the horizontal or vertical direction. When this occurs, the zoom setting is fixed at the telephoto field of view, and camera head control is prohibited in directions that do not satisfy the permitted field of view restrictions.
Response	Set appropriate values for the view restrictions.

●A010 Camera control driver start and stop (info)

Message	%1 driver for camera[1] %2
%1	Camera type (Canon VB-C50FSi Canon VB-C50Fi)
%2	started stopped
Explanation	The camera control device was detected and the driver started up, or a camera control device error was detected and the driver stopped.

●A011 Camera control device error (warning)

Message	%1[1] malfunction (%2)
%1	Camera type (Canon VB-C50FSi Canon VB-C50Fi)
%2	Error (read write timeout ...)
Explanation	Camera control device I/O error.
Response	There is a malfunction if it occurs repeatedly. Contact an authorized Canon service representative.

●A012 WebView Livescope client start and stop (info)

Message	%1@%2 %3
%1	Client type (LS/D LS/H)
%2	Client host IP address
%3	connected closed
Explanation	Connection and disconnection of TCP version WebView client (LS/D) and HTTP version WebView client (LS/H) excluding still images.

●A014 Access prohibited due to host restriction (notice)

Message	LS@%1 access denied
%1	Client host IP address
Explanation	Access from the client was denied due to host restrictions.

●A015 WebView Administrator Viewer start (info)

Message	%1@%2 privilege granted
%1	Type of clients (LS/C LS/D)
%2	Client host IP address
Explanation	The WebView Administrator Viewer has started operation.

●A016 Amount of transmitted video data (info)

Message	%1@%2 %3 frames / %4 bytes in %5 seconds
%1	Client type (LS/D LS/H)
%2	Client host IP address
%3	Number of frames
%4	Number of bytes
%5	Video transmission time
Explanation	This shows the results of video transmission for a video transmission client.

●A022 Applet archive load failure (warning)

Message	archive/%1 not found
%1	Applet archive name (glimpse.cab glimpse.zip lvapplet.cab lvapplet.zip imagemap.gif digits.gif)
Explanation	Applet archive file does not exist or is corrupted.
Response	Copy the missing (or damaged) file in the '/archive' applet from the CD-ROM and reboot.

●A023 Detection in change of point of contact (err)

Message	a %1 detected at In%2
%1	point of contact device input change (front-edge rear-edge pulse notch)
%2	Point of contact input terminal number (1 to 2)
Explanation	A change was detected at point of contact device terminal In1 or In2. front-edge denotes OFF → ON, rear-edge denotes ON → OFF, pulse denotes OFF → ON → OFF, and notch denotes ON → OFF → ON. pulse and notch are brief (10-20 milliseconds) ON and OFF periods detected during OFF and ON states respectively.

Detection of motion (err)

Message	motion %1
%1	Motion (detected appeared disappeared stopped)
Explanation	Detection of motion started or stopped.

●A050 Access permission when restricting user access (info)

Message	user %1 access granted
%1	User name
Explanation	During user access restriction, access has been granted to a specified user. This message is output for both TCP version clients and HTTP version clients.

●A101 User specification abnormality when restricting user access (notice)

Message	user %1 not found
%1	User name
Explanation	During user access restriction, an unknown user has been specified. This message is not output for HTTP version clients (the H043 message is output).

●A102 Password mismatch when restricting user access (notice)

Message	user %1 password mismatch
%1	User name
Explanation	During user access restriction, the wrong password has been specified. This message is not output for HTTP version clients (the H044 message is output).

■ Audio Server-related Log Messages**●B001 Audio server startup and shut down (info)**

Message	%1 wvaudio
%1	starting shutdown
Explanation	The audio server has started/shut down.

●B011 Audio client connected (info)

Message	[%1] %2 connected n=%3
%1	Client type (send rcv)
%2	Client host IP address
%3	Total number of clients
Explanation	The audio client has connected.

●B012 Audio client disconnected (info)

Message	[%1] %2 closed [%3]
%1	Client type (send rcv)
%2	Client host IP address
%3	Disconnection type (active passive timeout senderr)
Explanation	Disconnection with the audio client.

●B101 Received unusual request (notice)

Message	%1 unusual request[%2]
%1	Client host IP address
%2	Abnormality type (400 404 ...)
Explanation	Request denied by command error (400) or parameter error (404).

●B102 Client connection denied (notice)

Message	%1 request denied[%2]
%1	Client host IP address
%2	Denial type (41 42 ...)
Explanation	Client connection denied by authentication error (41), timeout (42), lack of resources (43), audio file error (44), non-corresponding codec specification (45) non-corresponding stream specification (46), user level restriction (47), host restriction (48), client number restriction (49), operating mode (4a) and file number (50).
Response	41: Check user name and password at connection or user list. 42: Check the service time. 43: Reconnect or restart. 44: Check audio file registration 45 to 47: Use corresponding client software. 48: Check the host access restriction setting. 49: Check the maximum number of clients setting. 4a: Check that the Use Audio Server setting is enabled. 50: Check the specified file number.

●B103 Client access forced disconnection (notice)

Message	%1 access denied[%2]
%1	Client host IP address
%2	Denial type (41 42 ...)
Explanation	There was a forced disconnection because access was forbidden since settings have been changed, although the access had been permitted at first (the same denial type as B102).

●B111 Audio file error (notice)

Message	[%1] file not found [%2]
%1	Command (play)
%2	File number
Explanation	There is no audio file registered.
Response	Check audio file registration.

●B201 File operation error (warning)

Message	[%1] io error
%1	Command (play)
Explanation	Failed to operate the file.
Response	Reboot if it occurs repeatedly.

●B202 Suspension due to resource shortage (warning)

Message	[%1] resource shortage
%1	Command (play stop)
Explanation	Stopped the operation because of temporary scarcity of internal resources.
Response	Reboot if it occurs repeatedly.

●B301 Transmission audio device error

Message	cannot use audio device for tx[%1:%2]
%1	Error processing (open ld buff read)
%2	Error number
Explanation	An error in the audio device has been detected. Only the audio server will restart.
Response	If not restored automatically, contact an authorized Canon service representative.

●B302 Reception audio device error (err)

Message	cannot use audio device for rx[%1:%2]
%1	Error processing (open1 open2 ioctl write)
%2	Error number
Explanation	An error in the audio device has been detected. Only the audio server will restart.
Response	If not restored automatically, contact an authorized Canon service representative.

●B401 Audio device initialization failed (crit)

Message	audio device initialization error[%1]
%1	Error number
Explanation	Initialization of the audio device has failed. The audio server will shut down.
Response	If rebooting does not solve this problem, there is a malfunction. Contact an authorized Canon service representative.

●B402 Audio server initialization failure (crit)

Message	wvaudio initialization error[%1]
%1	Error number
Explanation	Initialization of the audio server has failed. The audio server will shut down.
Response	If rebooting does not solve this problem, there is a malfunction. Contact an authorized Canon service representative.

●B403 Settings change failure (crit)

Message	cannot set config[%1]
%1	Error number
Explanation	Renewal of the setting values has failed. The audio server will shut down.
Response	If rebooting does not solve this problem, there is a malfunction. Contact an authorized Canon service representative.

■ System-related Log Messages

●S004 System start and stop (info)

Message	%1 webview
%1	starting and stopping
Explanation	Starting and stopping of the video server (webview).

●S005 System settings changed (info)

Message	System settings updated
Explanation	The VB software settings were modified without a reboot.

●S028 POP authentication failure (warning)

Message	POP Authentication failed
%1	POP Authentication failed during mail transmission.

●H043 User not found (notice)

Message	HTTPD: %1: user %2 not found: %3
%1	Client host IP address
%2	User name
%3	URL
Explanation	You have specified an unknown user in user authentication.

●H044 Password mismatch (notice)

Message	HTTPD: %1: user %2: password mismatch: %3
%1	Client host IP address
%2	User name
%3	URL
Explanation	You have specified a mistaken password in user authentication.

The VBCollector Log Messages

The VBCollector log messages are classified into the following 3 categories.

Level	Fault Severity
Error	Fault which affects task execution
Warning	Fault which does not affect task execution
Information	Information on correct operation

■ Log messages output by Task Scheduler Service

●S100 (info)

Message	VBCollector Task Scheduler Service has started.
---------	-------------------------------------------------

●S101 (info)

Message	VBCollector Task Scheduler Service has stopped.
---------	-------------------------------------------------

●S102 (err)

Message	Stops the VBCollector Task Scheduler Service because the year of 2038 has arrived.
---------	------------------------------------------------------------------------------------

●S104 (err)

Message	Failed to start the VBCollector Task Scheduler Service.
---------	---------------------------------------------------------

●S001 (err)

Message	Execution failure: Failed to get task information.
---------	----------------------------------------------------

●S002 (err)

Message	Execution failure: Another task has already accessed the same server.
---------	-----------------------------------------------------------------------

●S003 (err)

Message	Execution failure: The number of tasks concurrently executable is beyond the limit.
---------	-------------------------------------------------------------------------------------

●S005 (err)

Message	Execution failure: Failed to execute the task.
---------	------------------------------------------------

●S011 (err)

Message	Execution failure: Access to the data directory was denied.
Explanation	The drive for storing files does not exist or the service could not log on to the remote host specified as Data Directory.

●S015 (warning)

Message	The task was running longer than the execution interval.
Explanation	The specified task did not end before the start time of the next task.

●S019 (err)

Message	The account information is invalid.
Explanation	The user information cannot be recognized, or the user specified does not belong to the Administrators group on the local computer. (Applies when a service logon account was specified in the Service panel.)

●S020 (info)

Message	Deleted the data '%1'.
%1	Deletion date (yyyy/mm/dd)

●S021 (err)

Message	Could not delete the data '%1' because it is in use.
%1	Recording date (yyyy/mm/dd)

●S023 (err)

Message	Execution failure: Available space on the server gets low.
---------	------------------------------------------------------------

●S024 (info)

Message	Start deleting downloaded data from the oldest one because of insufficient free space.
---------	----------------------------------------------------------------------------------------

●S025 (info)

Message	Start deleting downloaded data which retention period has been expired.
---------	-------------------------------------------------------------------------

■ Log messages while downloading

●D001 (info)

Message	Download has started.
---------	-----------------------

●D002 (info)

Message	Download is completed: image=%1audio=%2 [delete:image=%3 audio=%4]
%1	No. of downloaded images
%2	No. of downloaded audio files
%3	No. of deleted images
%4	No. of deleted audio files

●D003 (warning)

Message	Download has aborted.
---------	-----------------------

●D010 (err)

Message	Not enough memory.
---------	--------------------

●D011 (err)

Message	Communication error.
---------	----------------------

●D020 (err)

Message	Cannot start because the server is recreating the list of the recorded pictures.
---------	----------------------------------------------------------------------------------

●D021 (err)

Message	Cannot start because the server is deleting the recorded pictures.
---------	--------------------------------------------------------------------

●D022 (err)

Message	No storage device is found on the server.
---------	-------------------------------------------

●D023 (err)

Message	The server does not support the required function.
---------	----------------------------------------------------

●D025 (err)

Message	Could not perform data deletion and audio file download because login as Administrator failed.
---------	------------------------------------------------------------------------------------------------

●D029 (err)

Message	Download is aborted because of insufficient free space.
---------	---------------------------------------------------------

●D035 (info)

Message	The number of downloaded data has reached to the limit.
Explanation	Output when the download limit for a single download has been reached.

●D050 (err)

Message	Failed to start the downloader.
---------	---------------------------------

●D051 (err)

Message	Downloader was stopped due to time-out.
---------	-----------------------------------------

●D052 (err)

Message	Download was completed abnormally. [code=%1 h]
Explanation	The completion code is an unforeseen code.

●D054 (err)

Message	Received invalid response from the server.
---------	--------------------------------------------

●D055 (err)

Message	Downloader was shut down.
---------	---------------------------

Specifications

VB-C50FSi/VB-C50Fi	
Video signal	Conforms to NTSC/PAL
Image Sensor	1/4-inch CCD
Number of pixels	[NTSC] use: 340,000 (effective 630,000) [PAL] use: 400,000 (effective 740,000)
Synchronization	Internal
Scanning Method	2 : 1 interlaced
Min. subject illumination	Normal mode: 1 lux (at 1/30 sec.)
Imaging modes	Normal mode, Night mode
Focusing	Auto/Manual Wide-angle: 0.01 m (0.03 ft.) to inf.; Telephoto: 1.6 m (5.25ft.) to inf. (In night mode, Wide-angle: 0.02 m (0.07 ft.) to inf.; Telephoto: 2.3 m (7.55ft.) to inf.)
Aperture	Auto iris servo system
Lens	Focal length 3.5 to 91.0 mm, f/1.6 to f/4.0, 26 × power zoom (shooting at infinity)
Infrared cut filter	Power-driven insertion/removal (normal mode/night mode)
Lens filter diameter	37 mm, pitch=0.75 mm
White Balance	TTL system, Auto
Operating system	Linux
Protocols	TCP/IP, HTTP, DHCP, FTP, WebView (from Canon)
Video compression method	Motion-JPEG compression (video quality variable), JPEG compression (for still pictures)
Video compression rate	NTSC: 0.1 fps to 30 fps (variable) PAL: 0.1 fps to 25 fps (variable)
Sound compression method	μ-law PCM 8bit (sampling frequency 8000Hz mono) (VB-C50FSi)
Output image sizes	NTSC: 160 × 120, 320 × 240, 640 × 480 PAL: 192 × 144, 384 × 288, 768 × 576
Display image sizes	NTSC: 80 × 60, 160 × 120, 320 × 240, 640 × 480 PAL: 96 × 72, 192 × 144, 384 × 288, 768 × 576
Server	HTTP, FTP, WebView Livescope
Log management	syslog format
Camera control	zoom, brightness, shutter speed, focus speed, view restriction, control time restriction
Connection restrictions	Access control (password), video connection time, service period, number of concurrent connections (maximum of 50)
Network	Ethernet × 1 (RJ45, 100Base-TX/10Base-T auto-negotiation)
Display LED	Status display of network
Multi-connector	Video IN/OUT: NTSC/PAL composite (1 each) Audio IN/OUT: monaural, mini-jack (1) (VB-C50FSi) IN: Electret condenser monaural microphone input, plug-in power (3.3 V) OUT: Line-level output External Device I/O: Input = 2, Output = 3 RS-232C (It will not be used) *Connector for using the Multi-Terminal Module VB-EX50 (sold separately)
Dimensions	66.2 × 134.2 × 97.0 mm (2.60 × 5.28 × 3.81 in.) (W × D × H) (Excludes protruding parts)
Weight	VB-C50FSi: Approx. 530 g (Approx. 1.17 lb) VB-C50Fi: Approx. 480 g (Approx. 1.05 lb)
Operating environment	Temperature 0–40°C, humidity 20–85% RH (condensation free)
Power	AC adapter, IEEE 802.3af (VB-C50FSi) Power consumption 25W or less (AC adapter), 12.95W or less (IEEE 802.3af)

*Please refer to P.1-10 to confirm whether your VB-C50FSi/VB-C50Fi is PAL model or NTSC model.

AC Adapter	
Model	PA-V16
Input	100–240 V AC 50/60 Hz
Output	13V DC 1.8 A (max.)
Polarity	Exterior (-) interior (+)
Size	58 × 118 × 25 mm (2.28 × 4.65 × 0.98 in.) (W × D × H) (excluding attachments)
Weight	Approx. 230 g (Approx. 0.50 lb) (excluding cable)

* These specifications are subject to change without notice due to product improvements, etc.

External Device I/O Terminals

You can use Input/Output external devices together with the Multi-Terminal Module VB-EX50.

External Device Input Terminals (IN⁺, IN⁻)

The external device input terminals consist of 2 terminals (IN⁺, IN⁻). The ‘-’ terminal is grounded on the inside of the main unit. By connecting 2 cables to the + and ‘-’ terminals and then electrically short-circuiting across the terminals (ON) or separating the connection (OFF), an interrupt can be generated for the internal controller. See “Schedule Setting Tool” in Chapter 4 “VB Administration Tools” (→ P.4-22) for information on the settings.

Connect any sensors and switches to terminals with electrically separate GND terminals and power supplies.

External Device Output Terminals (OUT A, OUT B, OUT C)

The external device output terminals consist of 3 terminals (OUT A, OUT B, OUT C). There is no distinction between “+” and “-” with OUT A, OUT B and OUT C. The Internal controller switches the 2 output terminals to disconnected or connected condition. The output terminals use photo couplers and are separate from the internal circuit in the VB-C50FSi/VB-C50Fi.

* External input status can be checked and external output status can be controlled using Admin Viewer (→ P.4-62).

Loads connected to the output terminals should be within the following ratings:

Rating across the output terminals: Up to 50 V DC

Continuous load current: 100 mA or less

Internal Connection Chart

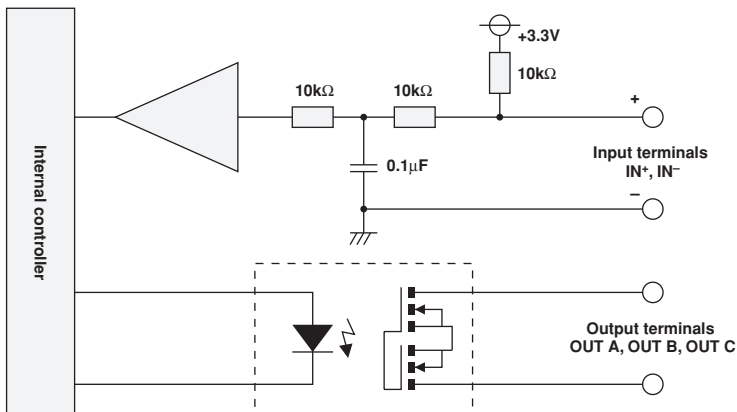

Tip

You need the Multi-Terminal Module VB-EX50 (→ P.1-11) to set input/output external device.

System Configuration

Example of Basic System Configuration - Viewing Videos Using a Viewer

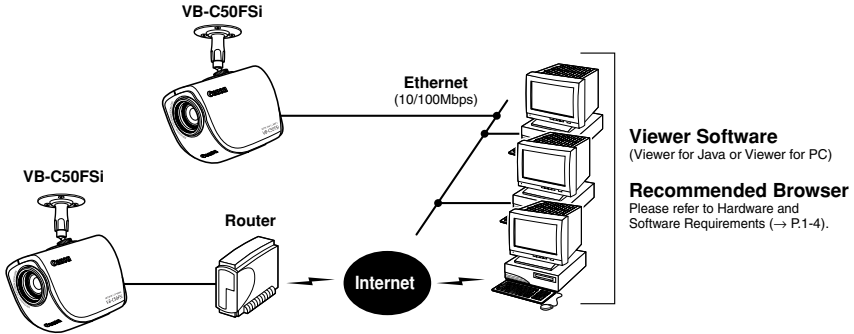

This system configuration consists of the VB-C50FSi/VB-C50Fi with **Viewer Software** (→ P.1-4). The Viewer Software consists of the **Viewer for PC** and the **Viewer for Java**. Viewer for PC must be installed in advance from the supplied CD-ROM. To use the Viewer for Java, you need to install Java VM beforehand.

Viewer Software Functions

Viewer Software	Functions
Viewer for Java	<ul style="list-style-type: none"> • Videos from the VB-C50FSi/VB-C50Fi can be displayed by a Web browser that can run Java applet. To use the Viewer for Java, you need to install Java VM beforehand. • Because the Viewer for Java is automatically downloaded and does not need to be pre-installed, unlike the Viewer for PC, it is compatible with any platform that supports Java-capable environments. • Because it uses the HTTP protocol, the Viewer for Java penetrates firewalls. However, it may not run stably on some platforms or browser types. Also, because the Viewer is downloaded when the Web page loads, start-up times and execution speeds are slower than the Viewer for PC.
Viewer for PC	<ul style="list-style-type: none"> • An application for viewing videos from the VB-C50FSi/VB-C50Fi that is launched from a Web browser. • The Viewer for PC must be pre-installed. • Install Viewer for PC from the supplied CD-ROM. • Compared with the Viewer for Java, start-up is faster because the Viewer does not need to be downloaded. This Viewer is recommended for users who use the viewer frequently. • Because it supports the HTTP protocol, the Viewer for PC penetrates firewalls unscathed.



Note

- Install the Viewer for PC from the “VBToolsInstall.exe” file on the supplied CD-ROM (→ P.2-13).
- The User’s Manual for the viewer software is provided on the supplied CD-ROM (Viewer-E.pdf).
- To connect the VB-C50FSi/VB-C50Fi to the Internet, you require a leased line connection to an Internet service provider or a LAN-type dial-up IP connection. If you are using a LAN-type dial-up connection, check that the connection supports bidirectional calling.

Sample Network Configurations

This section describes some typical installation modes for the VB-C50FSi/VB-C50Fi.
Be sure to assign an IP address to the VB-C50FSi/VB-C50Fi that matches your environment.

Sample LAN Environment Configuration

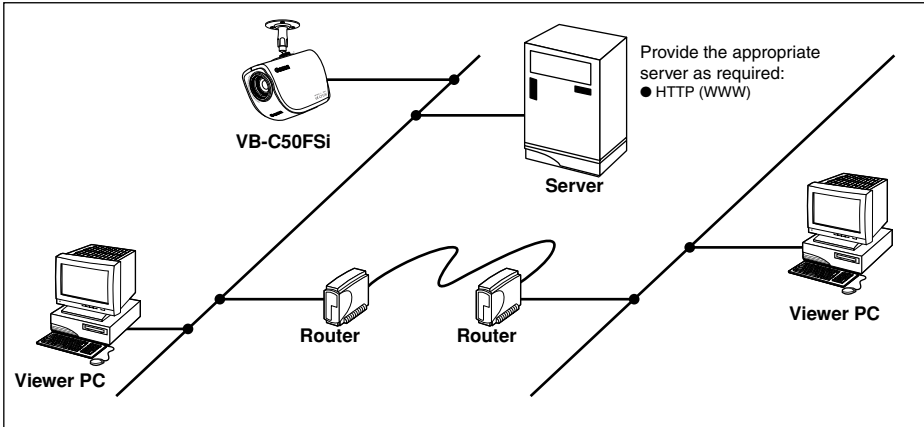

This example shows the VB-C50FSi/VB-C50Fi connected to a LAN by Ethernet. In this configuration, videos can be seen by viewers in the same Ethernet segment as the VB-C50FSi/VB-C50Fi and by viewers with access to that segment.

Sample Configuration in an ISP Environment

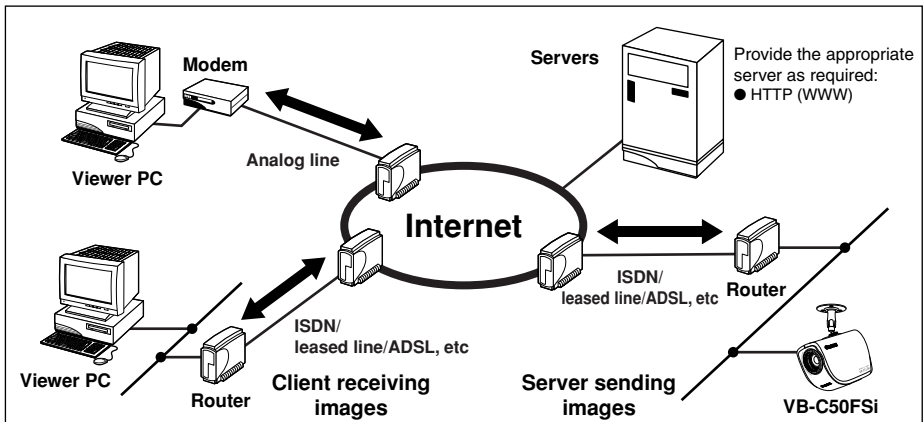

This example shows an environment in which the VB-C50FSi/VB-C50Fi is connected to an ISP (Internet service provider). In this configuration, videos can be seen by viewers capable of accessing the ISP.

Bidirectional communication is required between the VB-C50FSi/VB-C50Fi and the ISP, and a fixed IP address must be set for the VB-C50FSi/VB-C50Fi (→ P.5-26).

Upgrading the Firmware Remotely

Get the new firmware from the WebView Product web site: <http://www.canon.com/webview>, and upgrade in command prompt. The firmware file is called “Firmware_new.bin” and is saved on your PC in “My Documents”.

1. Open command prompt.

C:\Documents and Settings\xxxx> is displayed on the screen.

2. Specify the folder containing the firmware.

Enter: C:\Documents and Settings\xxxx>cd My Documents

3. Use the ftp command and connect to the VB-C50FSi/VB-C50Fi.

Enter: C:\Documents and Settings\xxxx\My Documents>ftp 192.168.100.1

4. Enter Administrator account and password.

Enter: User (192.168.100.1: (none)): root

Password: VB-C50i

*Enter the password you are actually using. For more details about changing passwords, please refer to “Setting Up the Administrator Password and Ethernet etc.” (→ P.3-5).

5. Change to binary mode.

Enter: ftp> binary

6. Send the firmware to the VB-C50FSi/VB-C50Fi.

Enter: ftp> put Firmware_new.bin flash

7. Transmission begins.

It normally takes 1-2 minutes to complete transmission.

8. Notification of completion.

“The system upgraded completed successfully” is displayed.

9. Log out of the VB-C50FSi/VB-C50Fi and close command prompt.

Enter: ftp> bye

C:\Documents and Settings\xxxx\My Documents> exit



Note

- Do not turn the power off until you have confirmed that the VB-C50FSi/VB-C50Fi has restarted. Turning the power off before completion may prevent it from starting up properly.
- Upgrading the firmware deletes all saved web page data (→ P.5-8). Back up your data before using this function.



Tip

- The underlined portion is a sample IP address. Enter the actual IP address that was set on the VB-C50FSi/VB-C50Fi (→ P.3-6).
- The user name logged onto the PC is displayed in “xxxx”.

Restoring the Factory Default Settings

Since the VB-C50FSi/VB-C50Fi supports a wide variety of functions, we recommend that you make a note of the settings for each function (→ P.7-23). If you want to redo the settings from the beginning because you have forgotten them or for some other reason, first restore the factory default settings.

* Please refer to page 7-23 for more about the factory default settings.

Restoring the Factory Default Settings from the Administration Tools Page via a Web Browser

1. Launch the Web browser and display the settings title page.

The VB-C50FSi/VB-C50Fi's IP address, user name, and administration password are required when displaying the settings title page (→ P.3-3).

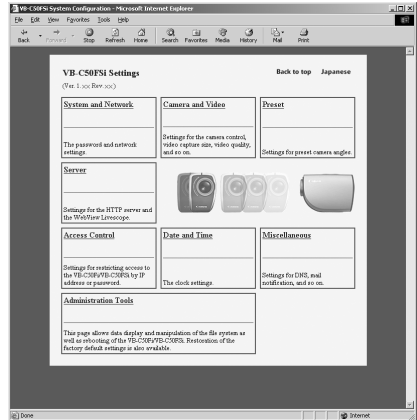

2. On the settings title page, click “Administration Tools”.

The Administration Tools page appears.

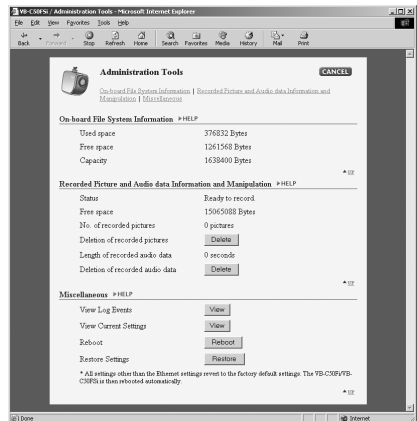

3. Click the “Restore” button for “Restore Settings”.

When the “Restore” button is clicked, the confirmation message appears. To proceed with restoring the default settings, click the “OK” button.

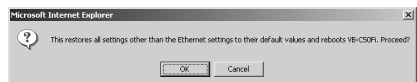



Note

- Do not turn the VB-C50FSi/VB-C50Fi power off while the Restoring operation. Turning the power off before completion may prevent it from starting up properly.
- If you click the “OK” button at this point, it will not possible to abort the process to restore the default settings. Click the “Cancel” button if you do not wish to restore the default settings.
- Using “Restore Settings” deletes all saved web page data (→ P.5-8). Back up your data before using this function.

4. The VB-C50FSi/VB-C50Fi’s factory default settings are restored.

Settings other than the Administrator password, or network-related settings such as the VB-C50FSi/VB-C50Fi’s IP address, subnet mask, and default gateway address are returned to factory default settings.

Restoring the Factory Default Settings from the Reset Switch

If the VB-C50FSi/VB-C50Fi’s IP address or administration password are not known or have been forgotten, the VB-C50FSi/VB-C50Fi cannot be operated over a network. In this case, press the Reset switch at the rear of the unit.

1. Turn off the VB-C50FSi/VB-C50Fi.

See page 2-7 “Turning the Power ON and OFF” for procedures on how to turn OFF and ON the VB-C50FSi/VB-C50Fi’s power switch.

2. While pressing the Reset switch, turn on the power and keep the Reset switch pressed from more than 5 seconds.

The Reset switch is located toward the rear on the bottom. Use a thin tipped object such as the end of a paper clip to press the Reset switch.

All settings in the VB-C50FSi/VB-C50Fi will be returned to the factory default settings.

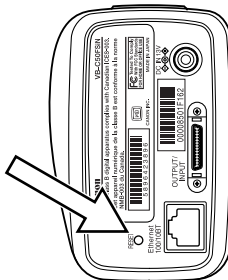

Note

If the Reset switch is pressed and all factory default settings are restored, the VB-C50FSi/VB-C50Fi’s network-related settings such as IP address, subnet mask, and default gateway address are all also restored to the factory default settings, making it impossible to operate the VB-C50FSi/VB-C50Fi from a PC connected to it. Use “VBSetup.exe” on the supplied CD-ROM to set an IP address appropriate to the environment you will be using (→ P.2-8). Saved web page data (→ P.5-8) is also deleted. Back up your data before using this function.

Factory Default Settings

Item	Setting	Item Setting 1			Item setting 2		
		(m)	(d)	(y)	(m)	(d)	(y)
<ul style="list-style-type: none"> ● Administrator ID ● Administrator password 	root VB-C50i						
<ul style="list-style-type: none"> ● Settings page path 	admin						
<ul style="list-style-type: none"> ● Ethernet <ul style="list-style-type: none"> Address Setting Method IP Address Subnet Mask Default Gateway Address Maximum Transmission Unit ● Connection Keeping <ul style="list-style-type: none"> Send packet regularly Target IP Address Interval(min.) 	Manual Setting 192.168.100.1 255.255.255.0 1500 NO 1						
<ul style="list-style-type: none"> ● Video Capture <ul style="list-style-type: none"> Video Capture Size Video Transmission Motion Detection Picture Recording Video Quality(Q-Factor) <ul style="list-style-type: none"> Small Size Medium Size Large Size Interlace Mode Use External Video Input ● Camera Control <ul style="list-style-type: none"> Shutter Speed Focus Mode Home Position <ul style="list-style-type: none"> Zoom Brightness Return to Home Position when nobody has a control privilege Apply View Restriction <ul style="list-style-type: none"> Telephoto Wide-angle Wide Converter ● Camera names <ul style="list-style-type: none"> Built-in Camera External Camera 	Medium Size Small Size Medium Size 50 50 50 Weave (Interlace) NO Auto Auto Standard NO NO Not used Camera Camera2						
<ul style="list-style-type: none"> ● Preset(Common Settings) <ul style="list-style-type: none"> Restrict Camera Control to Presets <ul style="list-style-type: none"> Auto Preset Tour Tour Schedule Restrict Preset Tour Time ● Preset(Preset1-20) <ul style="list-style-type: none"> Application Preset Name Camera Parameter <ul style="list-style-type: none"> Zoom Brightness 	NO Not used NO Picture Recording only Standard						

Factory Default Settings

Item	Setting	Item Setting 1			Item setting 2		
		(m)	(d)	(y)	(m)	(d)	(y)
<ul style="list-style-type: none"> ● Server(Common Settings) <ul style="list-style-type: none"> Maximum Number of Clients 50 Maximum Connection Time (sec.) 0 Restrict Service Time NO ● HTTP Server <ul style="list-style-type: none"> HTTP Port 80 Global Address for Web Pages IP Address IP Address Port Name ● Camera Server <ul style="list-style-type: none"> Video Transmission Port 65310 Camera Control Port 65311 Maximum Frame Rate (fps) 30 (NTSC)/25 (PAL) Maximum Transmission Rate (Mbps) 0 Control Queue Length 50 Camera Control Time (sec.) 20 Camera Stabilization Time (msec.) 1500 ● Audio Server <ul style="list-style-type: none"> Audio Transmission Not used Input Volume 50 Voice Activity Detection OFF Noise Canceller OFF Slope Filter OFF Audio Reception Not used Output Volume 50 Echo Canceller OFF 							
<ul style="list-style-type: none"> ● Authorized User Account <ul style="list-style-type: none"> User List Access permitted to listed users only NO Audio Transmission permitted to listed users only NO Still image Capture permitted to listed users only NO ● Authorized/Restricted Host Specification <ul style="list-style-type: none"> Host List Apply this list to HTTP Server NO Apply this list to Video Transmission NO Apply this list to Audio Transmission NO Apply this list to Still Image Capture NO 							
<ul style="list-style-type: none"> ● Current Camera Time ● New Camera Time <ul style="list-style-type: none"> Synchronize with computer time Set manually Synchronize with NTP server NO ● Time Zone +9 (Japan time) 							
<ul style="list-style-type: none"> ● DNS <ul style="list-style-type: none"> Name Server Address Register Host Name NO Host Name ● Mail <ul style="list-style-type: none"> Mail Server Host Sender's(From) Mail Address Recipient(To) Mail Address POP before SMTP NO User Name Password POP Server ● External Device Names ● LED Blinks during communication 							

Data Capacity of Recorded Pictures and Audio*

* Audio recording is only available with a particular model of the VB-C50FSi.

This section provides information that may help you in specifying and configuring various settings using the VB-C50FSi/VB-C50Fi.

The VB-C50FSi/VB-C50Fi can be used in a wide range of applications with its feature to temporarily store recorded pictures and audio data* in the memory. You can download these recorded pictures and audio data* on a PC using VBCollector (→ P.6-11), which is installed on the bundled CD-ROM.



The information provided in this section is an indication only.

Please be sure to confirm under the actual conditions before starting operations.

Amount of Memory

The maximum memory capacity of the VB-C50FSi/VB-C50Fi which can be used to store recorded pictures and audio data* is approx. 14MB.

However please note that the used space will vary according to various settings related to picture and audio recording*, such as Video Capture Size, Video Quality, recording interval, recording frequency, audio recording status* and the size of audio data files*.

Frame Sizes

The data sizes per frame may vary according to the following factors:

- [Video Capture Size] (→ P.3-8)
- [Video Quality] (→ P.3-8)
- Complexity of the image

However it is important to note that, depending on the subject, the frame sizes may vary substantially.

In addition to the above factors, the recording frequency and settings of [Recording Interval] affect the actual space taken by the picture recording.

If you wish to confirm the data amount of an image per frame, select Video information from View in the menu bar in the Admin Viewer or the Viewer for PC.

The Video information dialog box appears.

The value shown as Size is the actual data amount of the image.

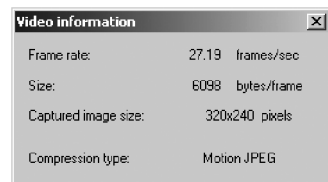

Video information dialog box



- If you set the Video Quality to 100, the amount of data becomes enormously large.
- The recorded pictures are saved in the VB-C50FSi/VB-C50Fi memory in units of 8KB. For example, an image data of 5KB takes the memory of 8KB, and an image data of 10KB consumes the memory of 16KB.

Amount of Audio Data*

Regardless of the volume, and even if there is no recorded audio data, the amount of audio data is approx. 8KB per second.



The actual amount of audio data will vary according to the timing of recording.

Index

A

AC adapter	iv, 2-6
AC cable	iv, 2-6
Access Control	3-20
Account	4-5, 6-14
Adding a Server	6-13
Admin Viewer	4-61
Special Privilege	4-61
Starting Up	4-62
Operating a Camera	4-64
Camera-Specific Functions	4-66
Sending and Receiving Audio	4-67
Administration Tools	3-28
Advanced camera control	4-64
Apache	5-21
Applet Tag	5-20
Area Ratio	4-42
Area tab	4-41
Audio	
Transmission	3-18
Input Volume	3-18
Reception	3-19
Output Volume	3-19
Sending	4-67
Playing	4-68
Audio button	4-68
Audio Playback function	4-57
Audio Recording	4-34, 4-43, 4-55
Audio Server	3-18
Audio/Tracking Tab	4-44
Authorized User Account	3-20
Authorized/Restricted Host Specification	3-21
Auto Preset Tour	3-13, 4-19
Automatic Downloading	6-21
Automatic sensitivity setting	4-41

B

Background	5-16
Backlight adjustment	2-14
Bitmap	5-16
Brightness	3-11

C

Camera Control	3-9
Camera Control Port	3-17
Camera Control Time	3-17
Camera Names	3-11
Camera Parameter	3-14
Camera Server	3-17
Camera Stabilization Time	3-17, 4-34
Camera tab	4-40
Camera-Specific Functions	4-66
Capacity warning message	6-21

CD-ROM	iv, 2-8, 2-13
Check operation	2-11
Connection Keeping	3-7
Control Queue Length	3-17
Custom Installation	2-13

D

Date	3-23
Date and Time	3-23
Default Gateway Address	3-6
Detection area	4-41
Detection indicator	4-41
Digital zoom	4-66
DNS	3-25
Duration	4-42

E

Easy Installation	2-13
Echo Cancellor	3-19
E-mail Notifications	4-56
Error codes	4-59
Ethernet	3-6
Ethernet connector	1-10
Events	4-55
Exposure	4-66
External Device Input	4-50
Display Screen	4-50
Setting Up	4-51
Setting Notification	4-62
Displaying and Saving	4-63
External Device Input Terminals	7-17
External Device Names	3-27
External Device Output	4-53
Display Screen	4-53
Setting Up	4-54
Operating	4-63
External Device Output Terminals	7-17
External Video Input	3-9

F

Factory Default Settings	7-23
Restoring	7-21
Filtering	4-60
Focus	3-10
Focus Mode	3-9
Frame rate	4-40

G

Gain	4-66
GetStillImage	5-25
Glimpse	5-4, 5-19
Global Address	3-16
Example of Video Distribution	5-26

H

Home Position	3-11
Host List	3-21
Host Name	4-5
Host Specification	3-21
HTTP Port	3-16, 4-5
HTTP Server	3-16
Hub	2-2, 2-6, 2-8

I

Infrared Cut Filter	4-48
Initial Setup Tool	2-8
Install	2-13
Interlace Mode	3-9
IP address	2-9, 3-6

L

LAN cable	2-6
LED	1-9, 3-27
Live Mode	4-37, 4-47
LiveApplet	5-4, 5-17
Log	4-59, 6-32
Saving	4-59
Copying	4-59
Searching	4-59, 6-34
Selecting	4-60, 6-33, 6-35
Log Events	3-29
Log Messages	7-4

M

MAC address	1-10
Mail	3-26
Mail Address	3-26
Maximum Connection Time	3-15
Maximum Frame Rate	3-17
Maximum Number of Clients	3-15
Maximum Recording Time	4-47
Maximum Transmission Rate	3-17
Maximum Transmission Unit	3-6
Microphone button	4-67
Microphone setting button	4-67
MIME type	5-21
Mobile Phone	5-27
Mode tab	4-37
Monthly Calendar	4-28
Motion Detected	4-46
Motion Detection	4-37
Display Screen	4-37
Flow	4-39
Setting Up	4-40
Setting Notification	4-62
Displaying and Saving	4-63
Motion Detection area	4-38, 4-41
Motion Detection status in the server	4-45

Multi-connector	1-10
Multi-Terminal Module	1-11

N

Name Server Address	3-25
Network Video Recorder VK-64	1-8
Night Mode	4-48
Display Screen	4-48
Setting Up	4-49
Camera-Specific Functions	4-66
Normal Schedule	4-24
Display Screen	4-24
Setting Up	4-25
NTP server	3-24

O

OFF event	4-43, 4-50, 4-55
ON event	4-43, 4-50, 4-55
On-board File System Information	3-28
Output tab	4-44

P

Password	2-9, 3-5, 3-26, 6-14
Peak Block	4-46
Picture Recording	4-55
PoE hub	xiv, 2-6, 2-7
POP before SMTP	3-26
POP Server	3-26
Power connection socket	1-10
Preset	3-12, 4-13
Display Screen	4-14
Setting	4-16
Preset Name	3-14, 4-15
Preset Preview Frame	4-16
Preset Setting Area	4-14
Preset Tour	4-19
Setting	4-21
Preset Tour Settings Area	4-19
Proxy	4-5, 6-14

Q

Q-factor	3-8
----------------	-----

R

Reboot	3-29
Reception Port No.	6-21
Recorded Images	6-23
Deleting	6-31
Viewing	6-23
Recorded Picture	3-28
Recording between ON event and OFF event	4-43
Recording interval between events	4-43
Recording tab	4-43
Repetition Interval	4-35, 4-53

Reset switch	1-10, 7-22
Restore Settings	3-29
Restore to the previous Setting button	3-4
Root Account	3-5

S

Sample Network Configurations	7-19
Save Setting and Reboot button	3-4
Save Setting button	3-4
Schedule name	4-24
Schedule Setting	4-22
Schedule tab	4-25, 4-30
Schedule track	4-24
Screw hole for arm mounting	1-9, 1-10
Screw hole for tripod mounting	1-10
Self-timer	4-47
Sensitivity	4-41
Serial No.	1-10
Server	3-15
Service	4-33
Service tab	4-26, 4-30
Setting Up Service	4-33
Settings Tabs	4-38
Settings Title Page	3-4
Shade Correction	4-69
Shared folder	6-14
Shutter speed	3-9
Slope Filter	3-18
Slow Shutter	4-48
Special Day Schedule	4-28
Special Schedule	4-28
Display Screen	4-28
Setting Up	4-29
Specifications	7-16
Status List	4-9
Subnet Mask	2-8, 3-6
Sub-schedule track	4-28
System and Network	3-5
System component	1-9
System Configuration	7-18

T

Task	6-16
Adding	6-16
Editing	6-18
Executing	6-18
Canceling	6-18
Checking	6-19
Task View	6-20
TCP port number	3-17
Time	3-23
Time Zone	3-24
Timer	4-34
Display Screen	4-34
Setting Up	4-36

Tour Schedule	3-13
Troubleshooting	7-2

U

Upgrading the Firmware	7-20
User List	3-20
User name	2-9, 3-26

V

VB Administration Tools	4-2
Hardware and Software Requirements	1-5
Installing	4-2
Starting Up	4-5
VB Initial Setup Tool	2-8
Hardware and Software Requirements	1-5
VBAdmin Startup Panel	4-6
VBCollector	6-11
Hardware and Software Requirements	1-5
Installing	6-12
Starting Up	6-13
Older versions	1-5, 6-12
VBCollector Image Viewer	6-23
VBSetup.exe	2-8
VBToolsInstall.exe	2-13
Video Capture	3-8
Video Capture Size	3-8
Video Mode	4-37, 4-47
Video Quality	3-8
Video Recording	4-47
Video Transmission Port	3-17
View Restriction	4-7
Display Screen	4-8
Setting	4-10
View Restriction Preview Frame	4-8, 4-10
Viewer	5-4
Viewer for Java	2-14, 5-4, 7-18
Hardware and Software Requirements	1-4
Viewer for PC	2-14, 5-5, 7-18
Hardware and Software Requirements	1-4
Viewer Software	2-14

W

Web page	5-2
Web Pages for Video Distribution	5-2
Web Server	5-21
WebView Livescope MV	
Hardware and Software Requirements	1-8
Weekly Calendar	4-24
Wide Converter	2-5, 3-11
Wvh Files	5-22

Z

Zoom	3-11
------------	------



CANON INC. ——— 30-2, Shimomaruko 3-chome, Ohta-ku, Tokyo 146-8501, Japan

U.S.A. ————— **CANON U.S.A.,INC. NEW JERSEY OFFICE**
100 Jamesburg Road, Jamesburg, NJ 08831 USA

CANON U.S.A.,INC. CHICAGO OFFICE
100 Park Blvd., Itasca, IL 60143 USA

CANON U.S.A.,INC. LOS ANGELES OFFICE
15955 Alton Parkway, Irvine, CA 92618 USA

CANON U.S.A.,INC. HONOLULU OFFICE
210 Ward Avenue, Suite 200 Honolulu, HI 96814 USA

● **If you have any questions, call the Canon U.S.A. Information Center toll-free at 1-800-828-4040 (U.S.A. only)**

CANADA ————— **CANON CANADA INC. NATIONAL HEADQUARTERS**
6390 Dixie Road, Mississauga, Ontario L5T 1P7

CANON CANADA INC. CALGARY
2828, 16th Street, N.E, Calgary, Alberta T2E 7K7

CANON CANADA INC. MONTRÉAL
5990 Côte-de-Liesse, Montréal, Québec H4T 1V7

● **If you have any questions, call the CANON CANADA Customer Information Centre toll-free at 1-800-OK-CANON (652-2666) (Canada only)**

MEXICO ————— **CANON MEXICANA, S. DE R.L.DE C.V.**
Boulevard Manuel Avila Camacho, No. 138 PB, Pisos 15, 16 y 17
Col Lomas de Chapultepec C.P. 11000 México, D.F. México

CENTRO Y SURAMERICA — **CANON LATIN AMERICA, INC.**
703 Waterford Way, Suite 400, Miami, FL 33126, USA

ASIA ————— **CANON SINGAPORE PTE. LTD.**
1 HarbourFront Avenue, #04-01, Keppel Bay Tower Singapore 098632

CANON HONGKONG CO., LTD.
19/F., The Metropolis Tower, 10 Metropolis Drive, Hunghom, Kowloon, Hong Kong

OCEANIA ————— **CANON AUSTRALIA PTY.LTD.**
1 Thomas Holt Drive, North Ryde, Sydney, N.S.W. 2113, Australia

EUROPE ————— **CANON EUROPA N.V.**
Bovenkerkerweg 59-61, P.O. Box 2262, 1180 EG Amstelveen, The Netherlands
CANON EUROPE LTD.
6 Roundwood Avenue, Stockley Park, Uxbridge Middlesex, UB11 1JA, United Kingdom