



January, 2003

P800/P802



Preface

The P800/P802 White Paper is designed to give the reader a deeper understanding of the features and applications of the P800 and P802.

In this document, the term 'P800' is used to denote all models and 'P802' to denote the Chinese model. The differences and additional features of the Chinese language models are described in more detail in the section 'Chinese Models in Detail'

The paper gives an overview of the key points of the P800 and a summary specification. The main operational points of the product are explained. Each functional area is then described in detail.

Features, specification and User Interface (UI) design are subject to change.



This White Paper is published by:

Sony Ericsson Mobile Communications AB
SE-164 84 Kista, Sweden

Phone: +46 8 508 78000

www.SonyEricsson.com

January 2003

Publication number: LZT 123 943 R2C

This document is published by Sony Ericsson Mobile Communications AB, without any warranty.

Improvements and changes to this text necessitated by typographical errors, inaccuracies of current information or improvements to programs and/or equipment, may be made by Sony Ericsson Mobile Communications AB at any time and without notice. Such changes will, however, be incorporated into new editions of this document. Any hard copies of this documents are to be regarded as temporary reference copies only.

Contents

Preface	2
Contents	3
P800/802 Overview	8
P800 Standard Version and P802 Chinese Version	8
Features and Specification Summary	9
Accessories	11
P800 Controls and Operation	12
Flip Closed (FC mode)	13
Flip Open (FO mode)	14
Flip Removed	15
Application UI Outline	16
Status Bar	17
P800 Memory Organisation	18
Data Storage Locations	18
User Storage	19
User Storage configuration in a new P800	19
Action when P800 is Initialised	21
Action at Master Reset	22
Folder View of Internal Storage	23
Phone and PIM Applications	24
Phone	24
Contacts	26
Calendar	27
Tasks	27
Jotter	28
Time, Voice Memo and Calculator	28
Multimedia	29
Audio Formats	29
Loudspeaker Characteristics	30
Stereo Headphone Characteristics	30
Image formats	31
Colour Screen	31
Media Format and Application Summary	32
Notes to Media Format and Application Summary Table	33
Data Flow Summary	34
Beaming	34
Viewer	34
Messages	34
Application Behaviour	35
PC Suite for P800	35
P800 Audio Player	36
Imaging	37
Built-In CommuniCam	37
Pictures	38
Using Images	38
Video Playback and Streaming	39
MPEG-4 Standard	39
Video Compression	39
Audio Compression	39
File Format	39
3GPP PSS (Packet Switched Streaming) Standard	39
What is streaming?	39
Applications	40

User scenarios.....	40
Standards, architecture and protocol	40
P800 Video Player	40
Locally Stored Clips.....	40
Streaming Support in the P800	41
MIME Support.....	41
Recommended Settings	41
Memory Stick® Duo®	42
Physical and Electrical Properties.....	42
PC and Apple Mac Support	42
Wide Industry Support	43
Memory Stick Usage Cases in the P800	43
Compatibility with other Memory Stick devices.....	43
Memory Stick inserted in to a PC.....	44
Messaging	45
EMS (Enhanced Messaging Service)	45
Examples of EMS contents and applications	46
EMS Media Objects in the P800	46
EMS Display in the P800.....	47
MMS (Multimedia Messaging Service)	48
Benefits.....	48
MMS objects.....	48
SMIL presentations	49
Templates.....	52
Notification and download	52
Interoperability and Conformance	52
Media Object Summary.....	53
Composing a multimedia message	54
Receiving a multimedia message.....	55
Receiving a multimedia message on other terminals.....	55
MMS technical features.....	56
E-Mail	57
P800 E-Mail Features.....	57
Technical Explanation of E-Mail.....	58
E-Mail Fetch and Delete Operation	59
Area Information.....	61
Document Viewer	62
Document Types Supported	63
Browser, M-Services and MeT	64
M-Services	64
MeT – Mobile electronic Transactions	64
MeT Example	65
P800 Browser.....	66
Content Types Supported	66
Browser UI.....	67
Browser Security.....	68
World Wide Web.....	68
WAP Security	68
Certificates.....	68
WIM Locks (PIN Codes).....	69
Push Services	69
Service Indication (SI)	69
Service Loading (SL).....	69
Opera Browser	69
Symbian OS Operating System.....	70
Open Environment.....	70

C++	70
Java	71
P800/UIQ Feature Support.....	72
Developer Support	73
Sony Ericsson Advanced Developer Support	73
Sony Ericsson Basic Developer Support	73
Sony Ericsson Online Support	73
Developer Tools	73
Metrowerks Code Warrior Development Studio for Symbian Version 2	73
Symbian OS v7.0 UIQ SDK for Sony Ericsson P800/802.....	74
Metrowerks Code Warrior Wireless Studio 7	74
Sun One Studio	75
Personalisation and Customisation	76
User Personalisation	76
Wallpaper and Application Shortcuts	76
Screen Saver.....	76
Picture Phone Book.....	77
Ringtones	77
Other Audio Personalisation.....	78
Sony Ericsson Content	79
Sample Image Content.....	79
Audio Content.....	80
Video	81
MMS Templates	82
PC Software for Personalisation	83
Sony Ericsson Image Editor	83
Sony Ericsson MMS Home Studio	83
Over-The-Air (OTA) Configuration	84
Sony Ericsson WAP Configurator	84
Factory Customisation	84
Games	85
Solitaire	85
Chess	85
Men In Black II™: Alien Pursuit.....	85
Stunt Run	86
Bluetooth™ Wireless Technology.....	87
Benefits of Bluetooth wireless technology in the P800	87
Bluetooth Usage Cases with the P800	88
Synchronization & Data Transfer.....	89
SyncML – An Open Standard for Synchronisation	89
SyncML Background	89
What is SyncML?.....	89
Designed for the requirements of the wireless world	89
Benefits of a common synchronization protocol.....	90
Which information can be synchronized?	90
Remote Synchronisation	91
PC Suite for P800	91
Local Synchronisation	91
File Transfer Utility.....	92
Backup and Restore	93
Language Change Utility	93
Software Installation Utility	93
Dial-Up Networking Wizard	93
Other PC Suite for P800 Content.....	93
Object Exchange – ‘Send As’	94
GPRS, HSCSD and CSD Connections	95

Using the P800 as a Modem.....	95
Technical Explanation of CSD, HSCSD and GPRS	97
Circuit Switched Data (CSD).....	97
High Speed Circuit Switched Data (HSCSD).....	98
GPRS	100
Chinese Models In Detail.....	103
Product Name and Languages	103
Input Methods	103
FC Character Input.....	103
FO Character Input.....	104
Chinese Dictionary.....	105
Lunar Calendar	106
Contacts	106
WuZiQi – Five Stone Chess.....	107
User Storage.....	107
SIM Application Toolkit.....	108
SIM-AT Services supported by the P800.....	108
CD-ROM Contents.....	110
PC Suite for P800	110
Multimedia for P800	111
P800 Consumer Package.....	112
Terminology and Abbreviations	112
Terminology and Abbreviations	113
Related Information	118
Links.....	118
Useful References.....	119
MMS	119
SymbianOS and UIQ.....	119
Java	119
Trademarks and Acknowledgements.....	120
Technical Specifications	121
General.....	121
Battery Life	121
GPRS Maximum Data Rates (kbps).....	121
HSCSD Maximum Data Rates (kbps).....	121
Screen	121
Keypad	122
Input.....	122
Third Party Application Support.....	122
Telephony.....	123
Personal Organiser	123
Integrated CommuniCam	123
Pictures (Image Viewer).....	123
Image Editor	124
Video Player	124
Audio Player	124
Messaging: SMS	124
Messaging: EMS	124
Messaging: MMS.....	124
Messaging: E-Mail.....	124
Document Viewer	125
Integrated browser technical data	126
M-Services.....	126
MeT	126
User Personalisation	126
Bluetooth Wireless Technology technical data	127

Infrared Transceiver technical data 127
Remote Synchronisation 127
Local Synchronisation 127
PC Suite for P800..... 127
PC Utilities 127
Security..... 128
Remote Configuration 128
Games 128

P800/802 Overview

- Tri-Band E-GSM 900, GSM 1800, GSM 1900
- GPRS 4+1 slot and HSCSD 2+1 slot
- Large 4096 colour touch screen
- 5-way Jog Dial
- Memory Stick® Duo® Slot
- Bluetooth™, IrDA, and USB connectivity
- Symbian OS Platform: C++ and Java™ SDKs
- Integrated Digital Camera
- Video and Audio Players
- Image & Sound Personalisation
- Multimedia Messaging (MMS)
- SMS, EMS and E-Mail
- Document Viewers
- Combined Web and WAP browser
- M-Services & MeT
- Personal Organiser
- PC and remote synchronisation (SyncML)



P800 Standard Version and P802 Chinese Version



P800 – Standard Version

- Europe, Middle East, Americas, Latin Asia
- Latin characters (a, b, c...) on the flip
- Latin character handwriting recognition



P802 - Chinese version

- Mainland China, Hong Kong, Taiwan
- Chinese Flips and input methods
- Chinese handwriting recognition
- Chinese dictionary
- Lunar calendar
- Chinese games

Features and Specification Summary

General

Size: 117 x 59 x 27 mm
Weight: 158g with flip
OS: Symbian OS™ V7.0
Processor: ARM 9
User storage: 12 Mbyte (P800); 9 Mbyte (P802)

Memory Stick® Duo®

Slot for Memory Stick Duo
16Mbyte Memory Stick Duo supplied
Memory Stick Duo Adaptor supplied

Battery Life

Talk time: Up to 13 hours
Standby time: Up to 400 hours

GSM

Tri-band E-GSM 900, GSM 1800 and GSM 1900

GPRS

Slots: 4+1
Coding scheme: CS-1, CS-2, CS-3, CS-4
Downlink rate: Up to 53.6 kbps (CS-2)
Uplink rate: Up to 13.4 kbps (CS-2)
(CS-2 quoted as this is the fastest scheme in use today)

HSCSD

Timeslots: 2+1 at 9.6 or 14.4 kbps
Download rate: Up to 28.8 kbps
Upload rate: Up to 14.4 kbps

Screen

Type: TFT
Size, flip closed: 208 x 144 pixels, 40 x 28 mm
Size, flip open: 208 x 320 pixels, 40 x 61 mm
Pixel Size: 0.192 mm
Colour depth: 12-bit (4096 colours)
Surface: Touch-sensitive, anti-reflective
Illumination: Front-light

Input (P800)

Flip Closed: Keypad; numeric and characters
Flip Open: Natural handwriting recognition
On-screen virtual keyboard

Input (P802)

Flip Closed: Keypad; Numeric, Stroke, Pinyin, Bopomofo
Flip Open: Chinese character recognition
English character recognition
Stroke, Pinyin, Bopomofo.

Third Party Application Support

SDKs: C++
PersonalJava™
J2ME™ CLDC 1.0 / MIDP

Phone

Office Handsfree (loudspeaker) function.
Voice dial, voice answer, 'magic word' activation
Picture Phone Book – picture of contact displayed.
Polyphonic ringtones
Flight mode – use P800 as PDA with phone off.
SIM-AT
USSD

Personal Organiser

Contacts (Address Book)
Calendar (Diary)
Tasks ('To-Do' list)
Jotter (Text and colour 'ink' sketches)
Voice Memo (Dictaphone)
Time (World Clock)
Calculator
(P802) English-Chinese-English Dictionary
(P802) Lunar Calendar

Integrated CommuniCam

Image size: 640 x 480 pixels (VGA)
320 x 240 pixels (QVGA)
160 x 120 pixels (QQVGA)
Colour depth: 24 bit (16.78 million colours)
Storage format: JPEG/JFIF; 3 quality levels
Capacity: Approx 200 (VGA, 12Mbyte free)

Audio Player

Formats: MP3, WAV, AU, AMR, MIDI, RMF
Features: Playlists, Loop, Automatic pause

Pictures (Image Viewer)

Formats: JPEG, BMP, GIF (inc. animated), MBM, PNG, WBMP
Sharing via: IR, Bluetooth, MMS, e-mail, PC file transfer, Memory Stick

Video Player

File Format: 3GP, MP4
Streaming: RTSP according to 3GPP

Messaging

SMS
EMS
MMS
E-Mail (multiple accounts and PC sync)

Document Viewers

On-board: Microsoft® Word
Microsoft® Excel
Microsoft® PowerPoint®
Adobe® Acrobat® (PDF)

Approx. 20 more supplied on CD-ROM

Integrated Browser

WAP Version: 2.0
Markup HTML 3.2 (excluding Frames & Javascript)
languages: WML 1.3
WBXML
xHTML Basic
xHTML Mobile Profile
cHTML
Scripting: Compiled WML scripts
Style sheets: WCSS
Security: WTLS Class 1, 2, 3
TLS/SSL
Certificates: Pre-install & download
WTLS, X.509
WIM: WIM interface including SIM-WIM

M-Services

Compliant with M-Services specification, phase 1

MeT (Mobile Electronic Transactions)

Compliant with MeT specification, version 1.0

User Personalisation

Wallpaper
Screen Saver
Ringtones (Polyphonic)
Alarm tones

Bluetooth

Specification: Version 1.1
Coverage area: Up to 10 metres (33 feet)
Profiles: Generic Access Profile
Serial Port Profile
Generic Object Exchange Profile
Dialup Networking Profile
Object Push Profile
Headset Profile

Infrared Port

Maximum speed: 115.2kbps

Remote Synchronization

Synchronisation with SyncML compliant servers:
Data: Contacts, Calendar, Tasks
Bearer: HTTP
Protocol: SyncML

Local Synchronization

Data: Contacts, Calendar, Tasks,
Jotter text notes, E-Mail
PC Applications: Lotus® Organizer® 5 & 6
Lotus® Notes® 4.6, 5.0
Microsoft® Outlook® 98, 2000,
2002
Bearer: Bluetooth™, IrDA, USB
Protocol: SyncML

PC Connectivity Solutions

Use the P800 as a wireless modem
2-way File transfer (e.g. pictures, documents)
Backup & Restore user data & settings
Software Installation Utility
Language Change Utility

PC Utilities

Sony Ericsson Image Editor
Sony Ericsson MMS Composer
GPRS Wizard

Security

Device lock
Password generators from RSA Security and
Secure Computing.

Remote Configuration (OTA)

Ericsson/Nokia OTA Settings Specification
WAP Forum specification
Smart Messaging

Games

Chess (including multi-player over SMS)
Solitaire
Five Stones Chess (P802 only)
Stunt Run (on CD-ROM)
Men In Black (on CD-ROM)

Accessories

Accessory	Product name
Advanced Car Handsfree	HCA-20
Bluetooth Car Kit	HCB-30
Bluetooth Headset	HBH-30
Bluetooth Headset	HBH-60
Bluetooth Handsfree	HBH-20
P800 Car Holder	HCH-32
Advanced Music Mute	
Gooseneck Microphone	HCE-14
Micro Travel Charger	CMT-10
Portable Handsfree	HPB-10
Standard Battery	BST-15
Cigarette Lighter Adapter	CLA-11
System Cable	HCC-20
Travel Charger	CTR-10
Serial Cable	
Deskstand	DSS-20
USB Cable	DCU-11
P800 Accessory Pack	TBD
Case	TBD



HCB-30



HBH-30



CMT-10



DCU-11



Memory Stick

Note: Memory stick sizes, availability and channels to be confirmed.

P800 Controls and Operation

The P800 has a large touch-screen and a flip. This provides fast and convenient one-handed operation with the flip closed plus large touch-screen sophistication with the flip open.

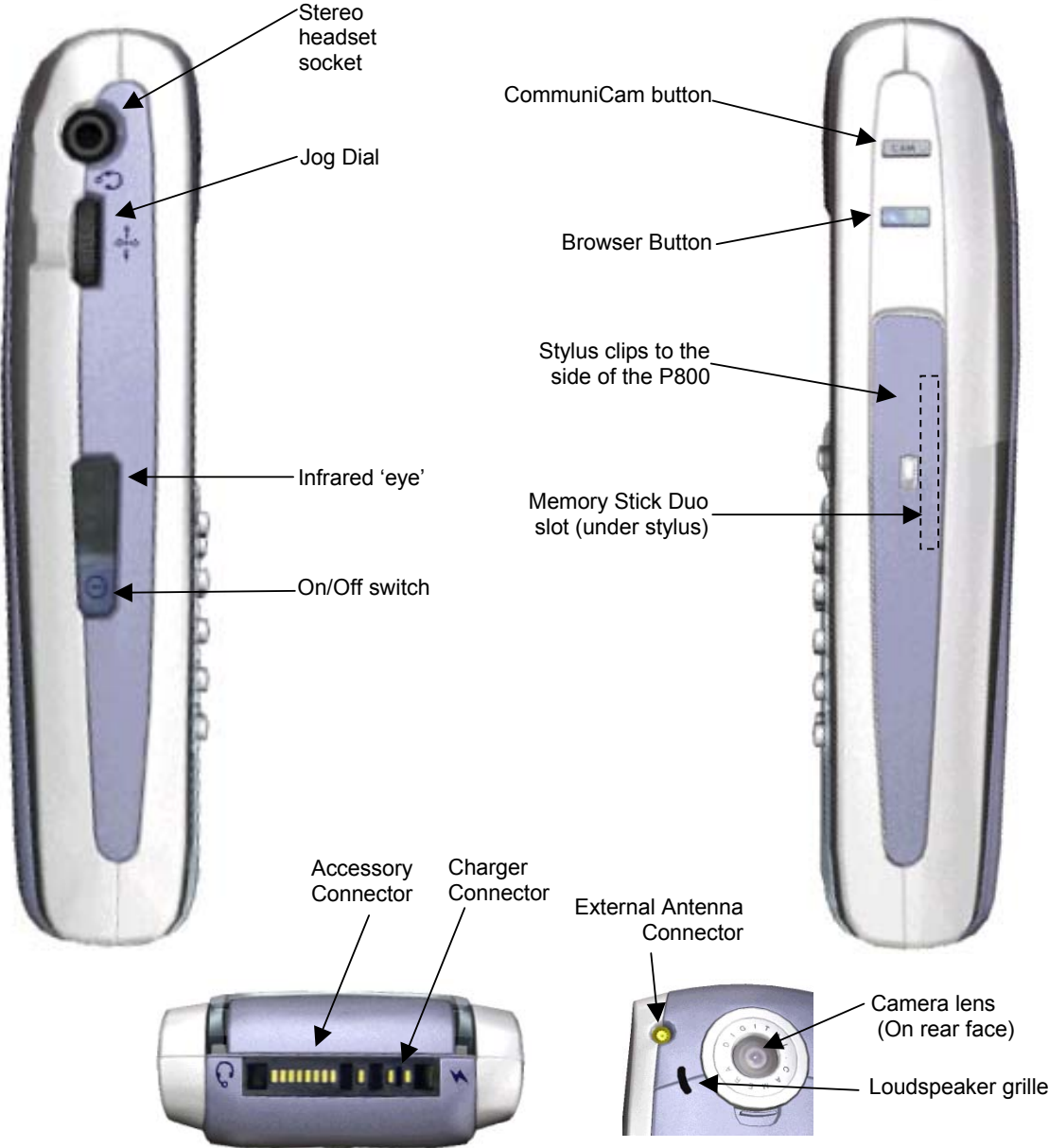

Flip Closed (FC mode)

With the flip closed, known as 'flip closed' or FC mode, the P800 can be used like a conventional mobile telephone with the added benefit of Jog Dial.



Rotating the Jog Dial takes the user through a menu of the most important applications. Clicking the Jog Dial or pressing OK will select the application, for example the Calendar.

The standby screen may be personalised with photographs. The user may also personalise the application menu.

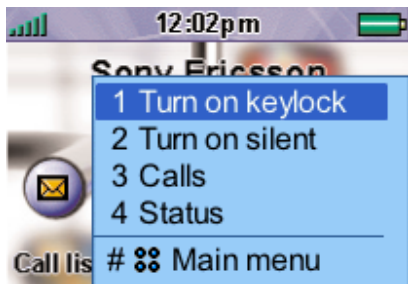

Pressing the Menu button brings up a set of options relevant for the current application. The Jog Dial may be used to make a selection, or the corresponding numeric key on the keypad may be pressed as a shortcut.

During a phone call, the user has access to most applications, making it possible to look up appointments, contacts, etc whilst chatting on the phone.



The P800 enables Latin characters to be entered via the keys on the flip. Characters are selected by pressing the key until the required one is shown. The P802 supports Chinese character input using Stroke, Pinyin and Bopomofo.

Flip Open (FO mode)

When the flip is opened, the large touch-screen is revealed. In 'flip open' mode, the stylus may be used to navigate and enter data. The Jog Dial provides further navigation and selection capability. The User Interface is Symbian's established UIQ design, adapted for the narrower 208 pixel screen.

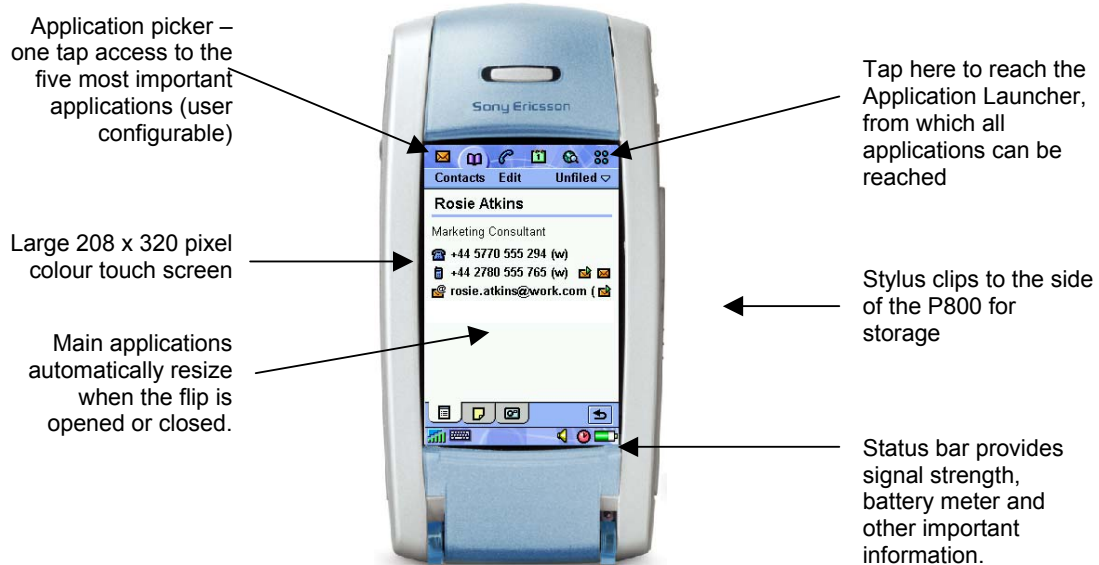

The stylus is used to operate the touch-screen and enter text:

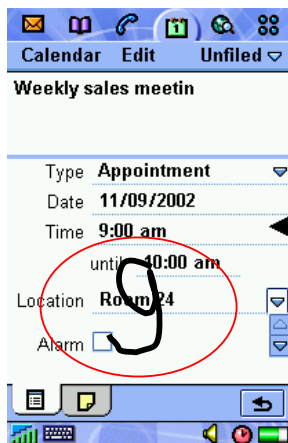

Text may be entered using natural handwriting over the whole screen. Lower case letters are entered below the ◀ symbol, uppercase in line with it and numbers above it.

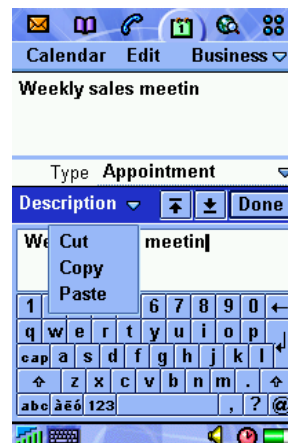

An on-screen keyboard is also available at all times by tapping on the keyboard icon in the status bar. Symbol and special character keyboards may be selected when required. Cut, Copy and Paste functions are available here.

In FO mode, the P802 offers Stroke, Pinyin and Bopomofo input methods plus Chinese character recognition. Numeric and English characters can also be entered using the character recognition.

Flip Removed



The flip may also be removed. A 'flip replacement' cover is clipped in place instead of the flip:



When the flip is open or removed, a 'virtual flip' can be displayed on the screen. It works in exactly the same way as the hardware flip, except that the buttons are represented on the touch screen. The main uses of the virtual flip are:

- FC input methods (especially for the Chinese versions)
- SIM-AT
- Keylock



The virtual flip is enabled or disabled in the Control Panel. When enabled, the symbol  is shown in the status bar. Tapping the symbol displays the virtual flip. The virtual flip is 'opened' (removed from the screen) by tapping the arrow symbol .

Application UI Outline

P800 applications generally follow the style guidelines established for Symbian UIQ applications.



The user may select five important applications and display them on the 'application picker' strip across the top of the screen. The sixth icon at the right always switches to the Application Launcher.

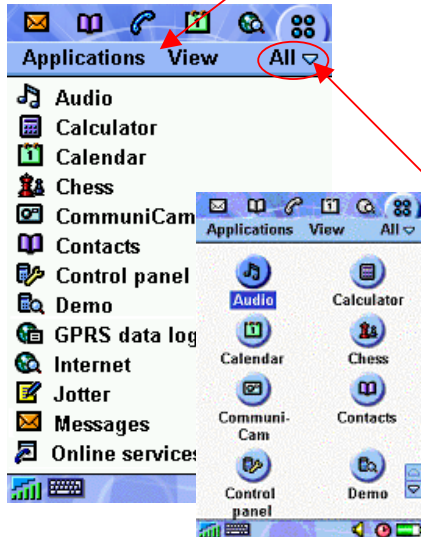

All applications are listed in the Application Launcher. The user may select list view with small icons and text, or a 'finger-size' icon display of 8 applications per page. One tap on the list-row or icon will launch (switch to) the desired application.

The Folder feature enables the user to group applications into logical folders such as 'games' and 'work'. This feature is carried through into many applications, enabling contacts, appointments, notes etc. to be organised effectively.

The Jog Dial can also be used to navigate up and down; clicking on an application will navigate to it.

There is no concept of starting or closing applications; simply navigating to them. When an application is used for the first time it will start in its basic state, which is typically a list view. If the user navigates from application A to application B (using, say, the Application Picker,) application A will close any open dialogs and views and return to its initial state ready for the next time it is used. Data is saved. There are some exceptions, for example the browser stays at the current page.

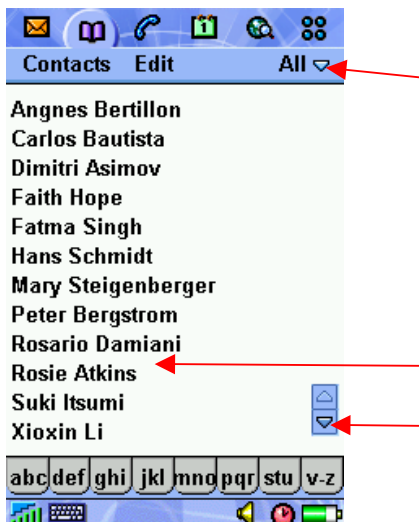

Here is an example of a list view. This is the normal state of the Contacts application.

Tapping on the folder drop-down, the list can be filtered to show just one folder, for example business or personal.

Contacts	Edit	All
Angnes Bertillo		All
Carlos Bautista		Business
Dimitri Asimov		Personal
Faith Hope		Tennis Club
Fatma Singh		Unfiled
Hans Schmidt		Edit folders

A tap on the desired item will open the detail view.

Lists typically scroll a page at a time. The scroller may be found in the lower corner of the screen.

As in the application launcher, the Jog Dial can be used to select an item. This provides a useful 'one-handed' way of operating the P800 in FO mode.



Here is the detail view in the contacts application. The most important information is displayed directly. Further information is organised by using tabs; in this case notes and a picture.

A conventional menu structure is provided for tasks and actions.



Changing the folder here will re-classify this entry. Entries default to 'all' or 'unfiled'.

Tapping on a telephone number will navigate to the phone application to make a call. Similarly, tapping an E-Mail address will navigate to the E-Mail application and create a new E-Mail to the contact.

Management functions such as delete, copy to Memory Stick or Send As are performed in detail view.

As before, the Jog Dial can be used to perform these operations one-handed. Scrolling the Jog Dial will move the highlight and pressing Select will initiate the chosen action (telephone call, new e-mail etc.)

Status Bar

The status bar shows the normal items such as signal strength and battery meter. In FO mode, the icons may be tapped to see further information and access relevant settings. Tapping the keyboard icon whilst entering text enables the user to switch between handwriting recognition and on-screen keyboard. More icons are used to indicate temporary conditions such as , Bluetooth activity, ongoing call and internet connection status.

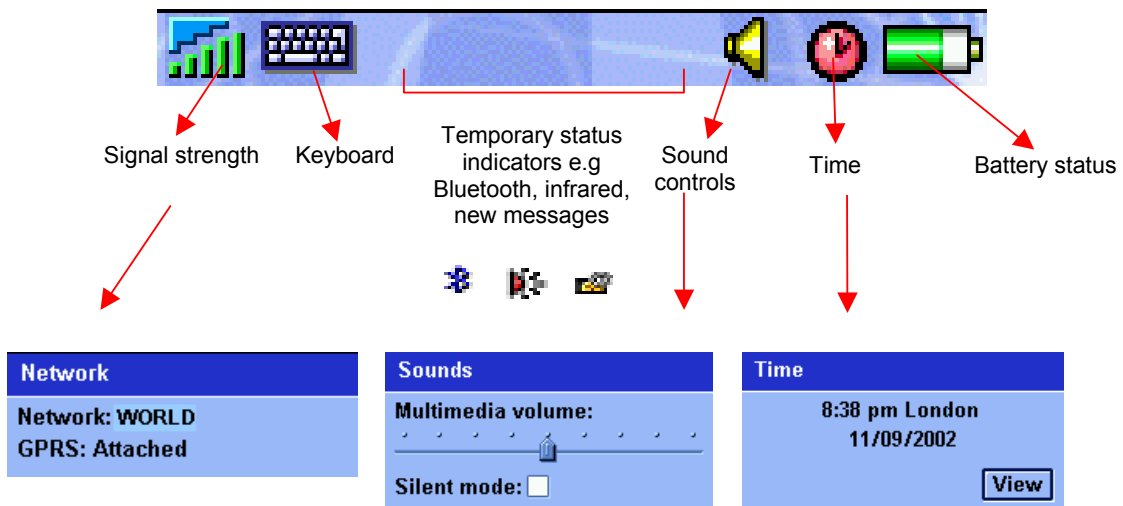

P800 Memory Organisation

Data Storage Locations

The P800 is divided into two parts:

- A GSM phone part, having flash memory. This is very similar to a conventional mobile phone such as the T68i
- An 'Organizer' part running Symbian OS and having a large amount of flash and RAM memory plus a Memory Stick slot and ability to exchange files with a PC.

Note: The 'Phone' application which provides the phone MMI exists on the Symbian OS part of the P800; the GSM stack resides in the GSM phone part.

The diagram below shows the memory organisation of a P800:

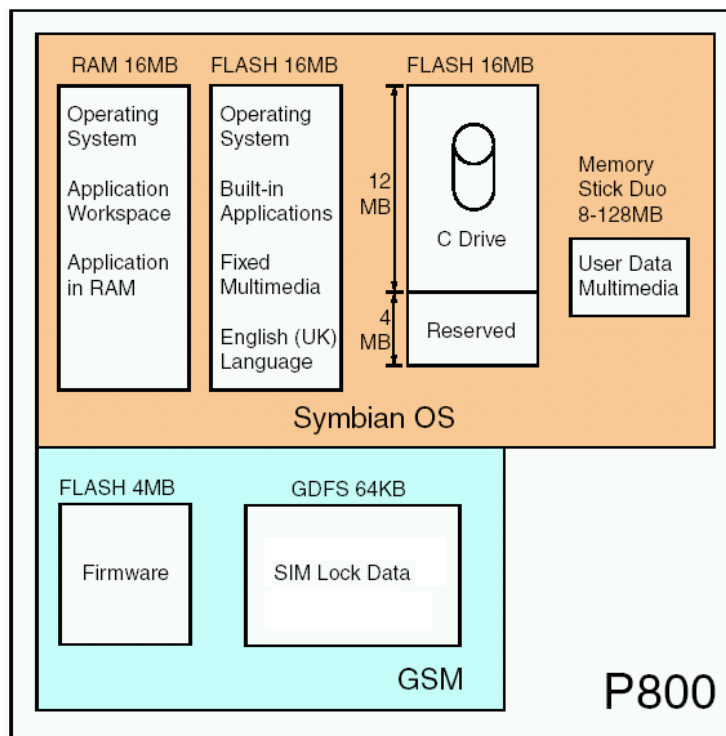

The RAM (Random Access) memory is controlled by the Symbian OS operating system and is not used to store any user or program data. All use is dynamic and managed by the OS. The RAM is totally re-initialised when the P800 is started.

Two banks of 16Mbyte flash memory are built into the P800, making a total of 32Mbyte. Flash memory retains data even with no power applied. Unlike some PDA devices, the P800 does not require a small 'memory backup' battery. Data stored on the P800 is therefore not subject to loss due to such a battery running down.

The first bank is used like a ROM. It stores the Symbian OS (UIQ) operating system, the built-in applications and some essential multimedia information like a default ring tone. It also stores the language files for UK English. This is the default language of the P800.

Note: The extensive MMI of the P800 means that it is impractical to hold many languages inside the phone, as is done for some other models.

The second 16Mbyte bank of flash memory is divided into two parts. The first 4 Mbyte is reserved. It is essentially an extension of the ROM area.

The rest of the second bank provides a 'C:' drive of 12 Mbyte capacity. This behaves just like a normal disk drive. Some folders can even be viewed and managed from a connected PC. In the Chinese version the reserved area is 7Mbyte and the C: drive is 9Mbyte

When a P800 is updated at a Sony Ericsson Service Point, or over the internet using the Sony Ericsson Update Service, all three banks of flash memory will be rewritten. User data that has previously been backed up to a PC can be restored to the C: drive afterwards.

User Storage

The user storage space (C: drive) is shared across applications without any imposed restrictions, apart from the whole space becoming full. For example, one user might use the entire user storage space for photographs, in which case over 200 can be stored. Another user might load a third party street map application and a number of street maps. In this case, the application will take up some of the storage space and so will each map. When space becomes limited, the user can choose to remove some maps.

Unlike a PC, the user does not need to be aware of the underlying filing system. Applications will always make sensible choices and store information automatically, simplifying management of data. Third party applications may implement more complex file management solutions where required.

Additional storage space is available by using Memory Stick Duo. A 16Mbyte Memory Stick Duo is included with the P800. Any number of Memory Stick Duos may be used with the P800. See 'Memory Stick Duo' later in this paper for more information. Memory Sticks up to 128Mbyte capacity are supported.

Depending on the application, data can be beamed, mailed, uploaded to the web or transferred over the link to a PC in order to archive and create free user space on the P800 – see 'Synchronisation and Data Transfer' later in this paper.

User Storage configuration in a new P800

Applications and information are placed in the internal storage of the P800 in the factory. This provides sample demonstration, educational, multimedia and fun content so that the P800 can be used directly out of the box. Much of this can be deleted by the user in order to make the space available for personal use.

This section describes the case for a generic (non-customised) P800.

User Data

This space is initially empty. Normal uses are:

- User-data associated with built-in applications (e.g. Messaging, Contacts)
- Applications installed by the user
- Multimedia content added by the user

Settings

Settings such as dial-up networking and e-mail account information. Initially Empty.

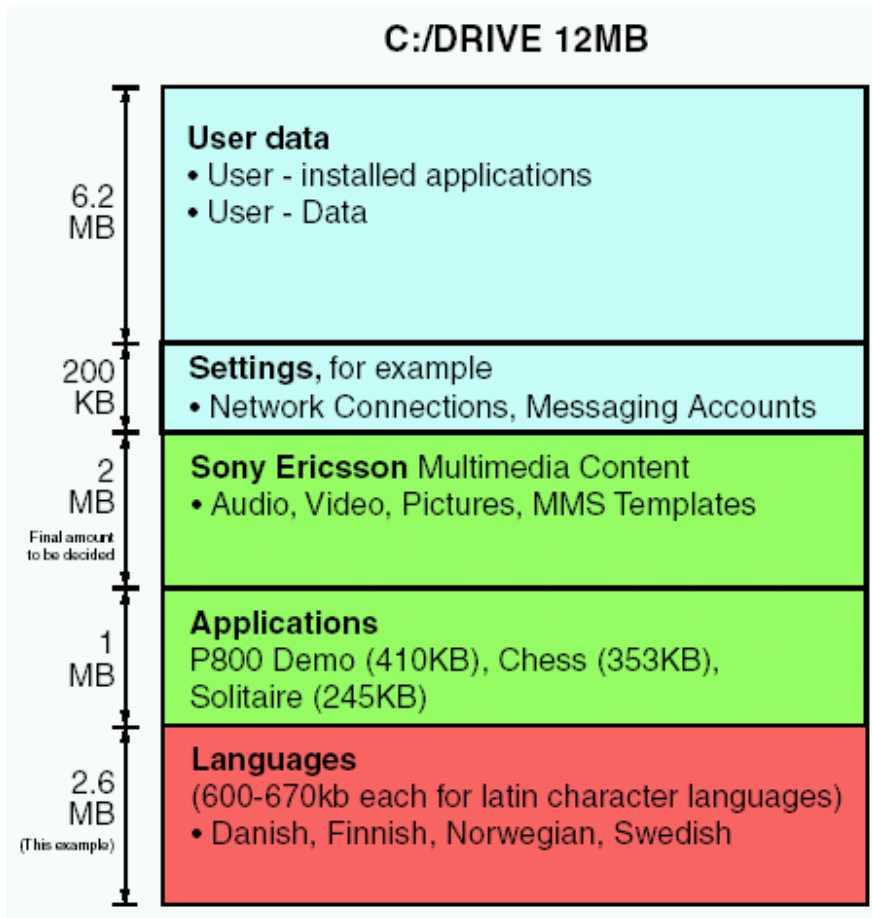

Empty



Populated with data files in the factory; user can use and delete these files and applications.



Files are loaded in the factory and may be deleted only by the Startup and Master Reset process.

Sony Ericsson Multimedia Content

Sound, pictures, video and other files chosen to show off the capabilities of the P800. This is described in more detail in 'Customisation and Personalisation' later in this document.

Application Files

Three applications are stored on the C drive: Chess, Solitaire and P800 Demonstration. The user may uninstall them in order to free space on the C: drive.

Language Files

The generic P800 is prepared for different markets. A maximum of 6 languages can be placed in this area. This is set by convention; the file system does not impose any limit other than overall

capacity. A 'Load Module' is constructed containing the languages for a given market. Therefore a number of load modules is specified for the P800 to cover all required markets.

Language is selected at First Startup and Master Reset.

Action when P800 is Initialised

When the P800 is first started, the user is prompted to select a language as part of the initialisation procedure. The P800 is then restarted.

If the user selected UK English, all of the alternative language files will be deleted, making 2.6MB extra space free on the C: drive in the above example.

If the user selected any language other than UK English, then the selected language files are retained on the C: drive and the other language files are deleted. In this example, we assume that the user has selected Swedish and therefore the Danish, Finnish and Norwegian files are deleted during the restart procedure. In this case, approximately 1950KB is made free on the C: drive.

The diagram below illustrates this for a generic P800, where the free user data area on the C: drive grows to 8.15MB.

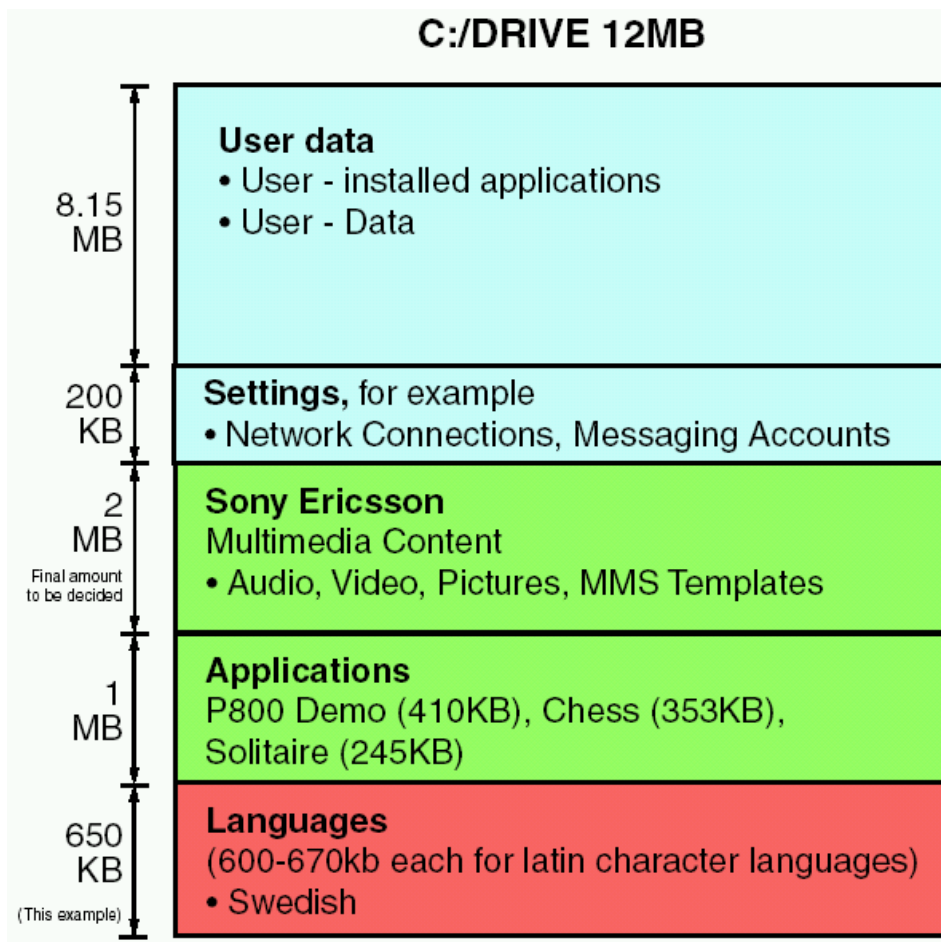

P800 C: drive contents after first user initialisation

Action at Master Reset

Master Reset will delete everything on the C: drive except for Languages and (if selected by the user) user-installed applications.

If a newly-initialised P800 goes through a Master Reset, the C: drive will look like this afterwards. If the user had included user-installed applications, then the P800 Demo, Chess and Solitaire would be deleted also.

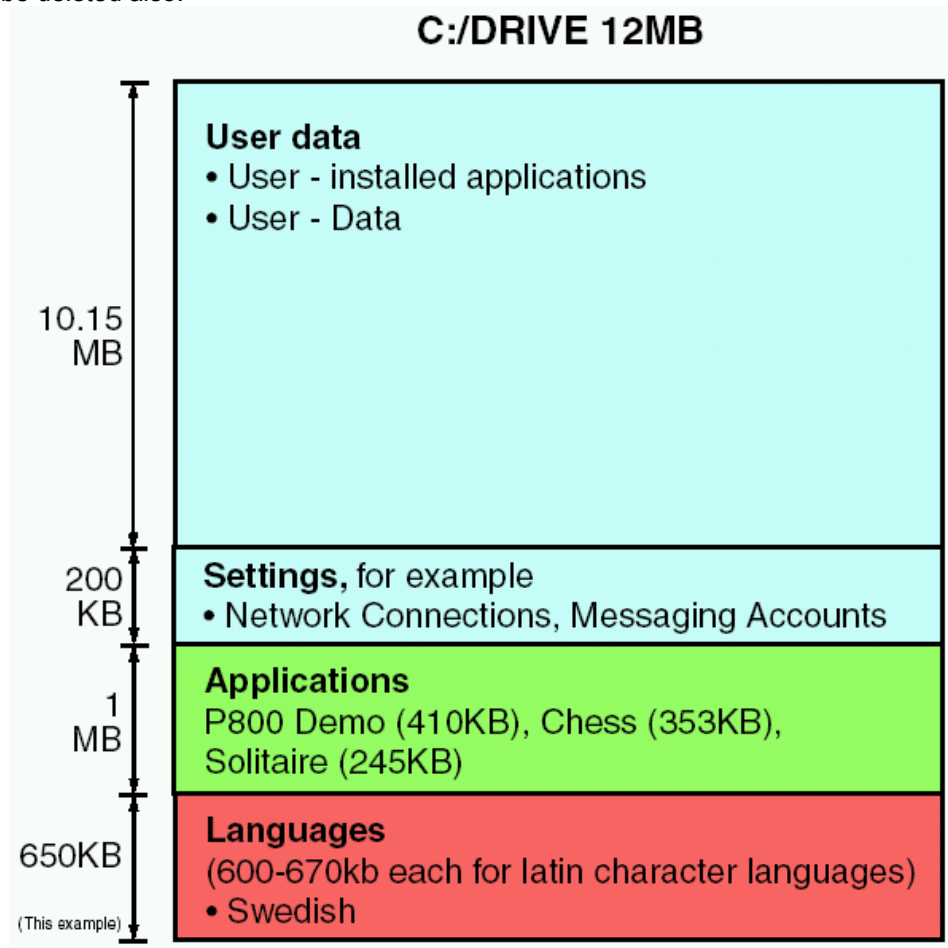

P800 C: Drive after Initialisation and Master Reset

Data can be restored as follows:

If the user has previously backed up the P800 using the PC Suite, then the C: drive can be restored to the exact condition it was in when the backup was made.

Otherwise, data can be re-loaded from the following places:

- Sony Ericsson Multimedia Content from the P800 Multimedia CD-ROM
- Applications Chess, Solitaire and P800 Demo from the P800 Multimedia CD-ROM

Since Multimedia content is easily transferable using Memory Stick, infrared or Bluetooth wireless technology beaming, it is simple to restore favourite content from someone else's P800.

Folder View of Internal Storage

This section explains in more detail how the data is organised on the C: drive.

Note: The actual file and folder structure on the P800 is not exactly as shown in this document.

When viewed from a PC using PC Suite for P800, the 'C:' drive is named 'Phone Memory', but only a subset of the folders is accessible from the PC.

Language files are represented by the **Language Files** folder. The user has no access to this data.

Multimedia is stored in a structure beneath the **Media Files** folder. There is a folder for each media type: audio, video and image. Documents (such as Microsoft Word files) are stored under the **Document** folder. An **Other** folder provides a place for files that do not fit into the other categories.

Beneath each media type and documents, the material on the P800 is broken into Folders. For each named folder in the related P800 application, a folder is created beneath the applicable media type. For example if the user creates a 'MyMP3' folder in the Audio Player application, a 'MyMP3' subfolder is created beneath the audio folder. **Unfiled** folders are created in the initial folder structure and all material, including Sony Ericsson Multimedia Content, is placed in the **unfiled** folder by default.

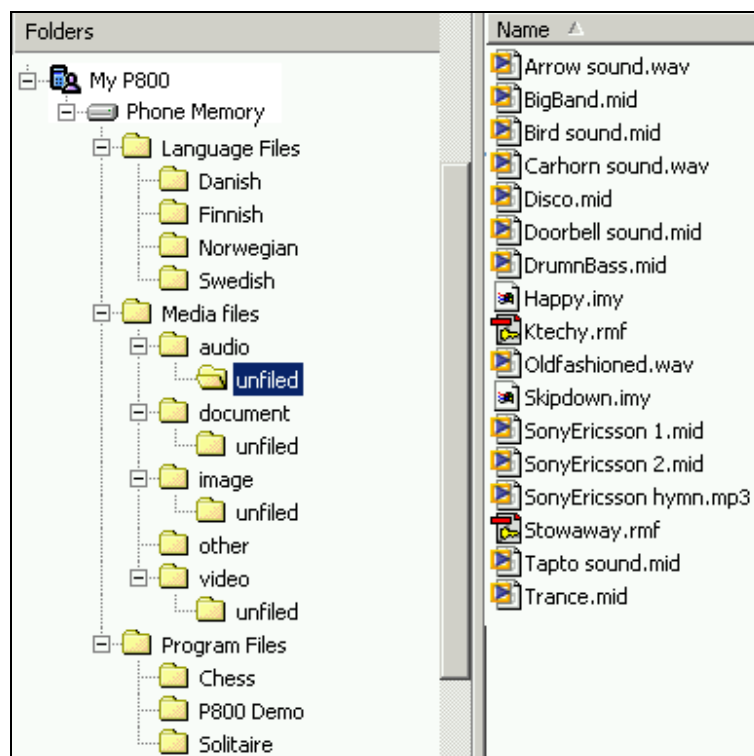

Generic P800 C: drive folder structure (simplified)

In the above diagram, the folder structure is shown and the Sony Ericsson Multimedia Content (audio) files can be seen.

Phone and PIM Applications

Phone

The P800 is a full-featured mobile phone having full integration with the other functions of the device, including third party applications.

The phone includes useful and fun features such as:

- Personalised ringtones – conventional or polyphonic ringtones can be set in Contacts, giving audible indication of who is calling. Supported formats are AMR, Au, iMelody, MIDI, RMF (Beatnik) and WAV.
- Picture Phone Book – if there is a picture of the person in Contacts, it will be displayed when making outgoing calls and when receiving the CLI with an incoming call.
- Quick access back to the entry in Contacts, making it easy to try an alternative number or send an E-Mail if the contact is unavailable or busy.
- Voice dialling – make a call by speaking the contact's name. The contact's name may be recorded when entering/editing the entry in Contacts. The call is made by pressing the OK button on the flip or the button on the headset. If a 'magic word' is recorded, contacts may be dialled by saying the magic word followed by the contact name. It is then not necessary to press any buttons.
- Voice answer – an incoming call may be answered or sent busy signal, using the words recorded for 'answer' and 'busy'. There is 40 seconds of storage space allocated for voice dialling and voice answer. This is enough for approximately 50 words (contact names plus 'magic word', 'answer' and 'busy')
- Access to most other applications whilst talking on the phone.
- Office handsfree (speakerphone) which is enabled when the flip is open, making it easy to access applications such as Calendar and Jotter whilst talking.
- Flight mode enables the P800 to be used as a PDA in situations where radio transmitters may not be used. The GSM and Bluetooth transmitters (and receivers) are switched off.



In FC mode, the phone is driven by the keypad, like a conventional mobile phone.

If the flip is opened, the phone application re-scales itself to the full screen size. Other P800 flip closed applications are able to do this too.



A traditional keypad view is available.



The shortcut view provides one-touch dialling to 9 contacts.

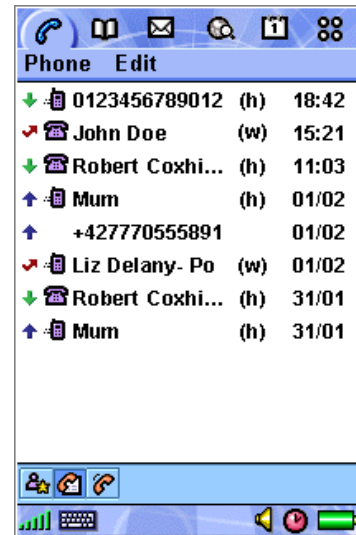

A call log view provides summary details of calls made, received and missed. Full details can be viewed from here.

The shortcut view automatically takes pictures from Contacts and places them under the shortcut button. The Jog Dial also works in this view; scroll to highlight the desired contact and press Select to call.

Contacts

The P800's Contacts application holds the details of all the user's contacts. It is available in FC and FO modes and is fully integrated with the phone and other PIM applications. Each contact can contain multiple phone numbers and E-Mail addresses, name and address details, personal notes and a photograph of the contact or other image. This information will typically be synchronised in to the P800 to begin with; contact data can also be added and edited on the P800 itself. Local and remote synchronisation is possible to the SyncML standard.

Contact data can be beamed in or out using Infrared and Bluetooth. It can also be sent and received using messaging. See the Object Exchange section for full details.

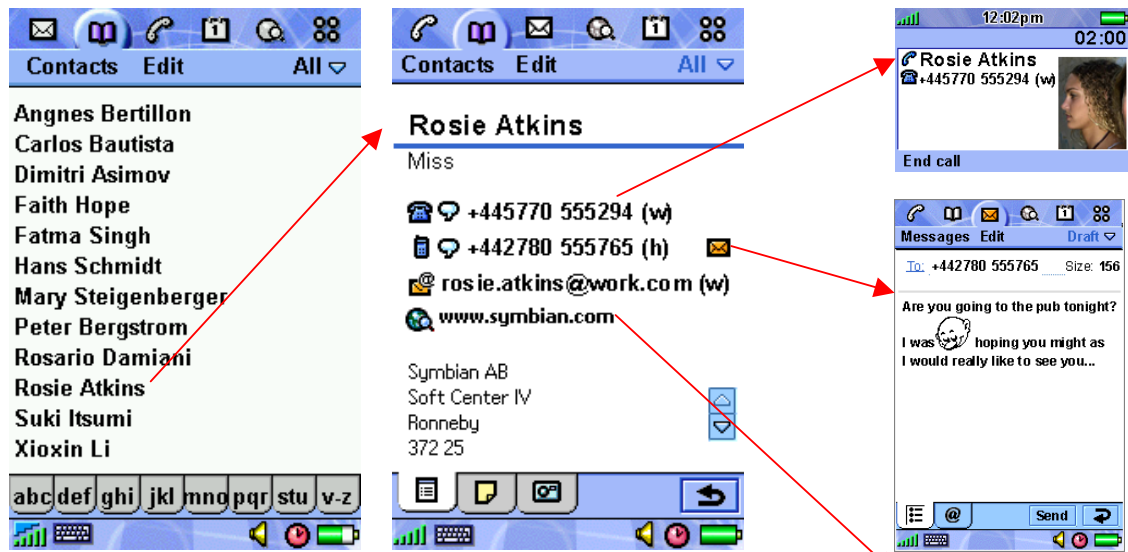

Contacts are displayed in a list, which may be filtered by folder such as business or personal. Use the Jog Dial or stylus to select the required person.

Key communication details are displayed first. One tap will initiate a phone call, new message or URL in the browser. The Jog Dial can also be used.

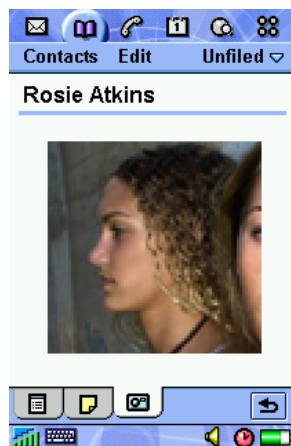

Photograph of Rosie stored in Contacts.

A voice dial tag can be recorded, enabling Rosie to be called by saying her name.

A personal ringtone sound can also be set. It will be played whenever Rosie calls and her CLI is passed to the P800.

Picture formats supported:
BMP, GIF, JPG, MBM, PNG, WBMP.

Audio formats for ringtones:
AMR, AU, iMelody, MIDI, RMF, WAV.

Calendar

The Calendar application keeps track of appointments and events and enables reminder alarms to be set. The alarm sound can be personalised, using any of the supported sound formats. Appointments can be shared using Infrared and Bluetooth beaming and also messaging. Local & remote synchronisation are both supported using SyncML. The P802 supports the lunar calendar.



Week and month views provide a high level view of free and occupied time.



Convenient daily summary view.

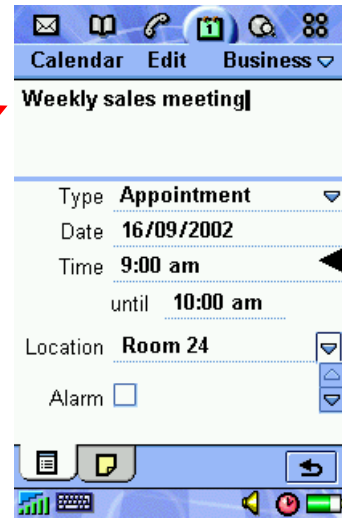

One tap shows the details of an appointment.

Tasks

Tasks is a simple yet powerful application which manages a list of tasks to be done. Task items may be beamed, exchanged using messaging and synchronised locally and remotely using SyncML.

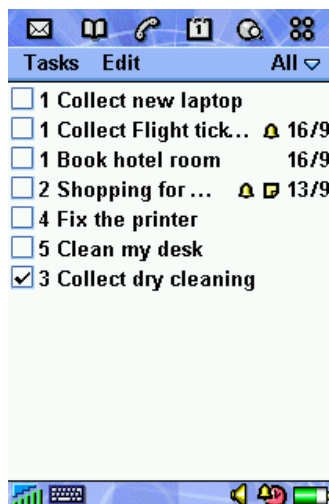

List of current tasks

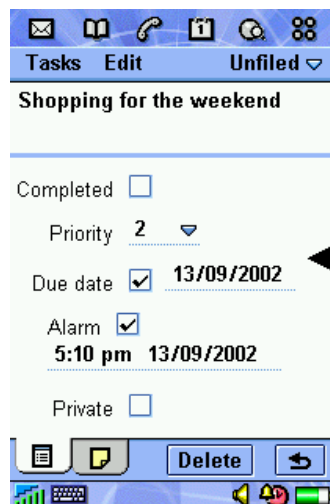

Detail view of a task



Notes attached to a task.

Jotter

The Jotter application provides a quick means of making notes in either text or sketch format.



Notes are displayed in a list format for fast reference. The pencil indicates a sketch.

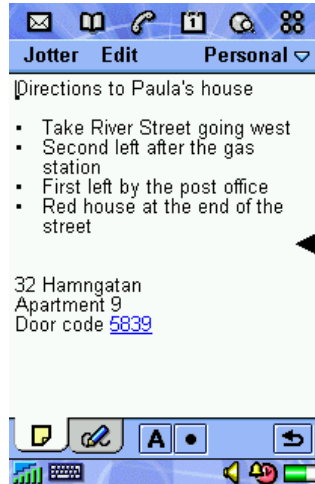

Text notes can be input using handwriting recognition or the virtual keyboard.



Diagrams and sketches can be made in colour, using the stylus like a pen.

Time, Voice Memo and Calculator

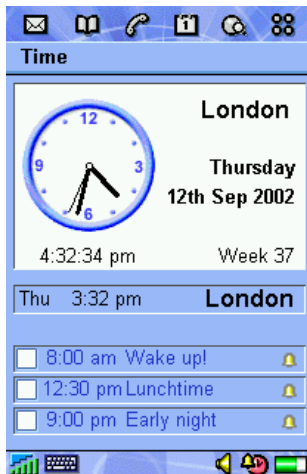

Time is a sophisticated alarm clock which can show the time both locally and in another time zone. Alarms can be set. The alarm signal can be personalised using sound clips.

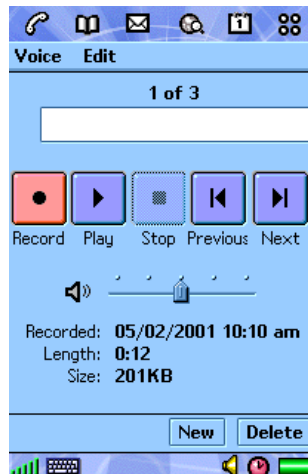

Voice Memo is a simple screen-driven dictation machine with the added advantage that recordings can be beamed and exchanged via messaging. It can also be used to record a personal ringtone.

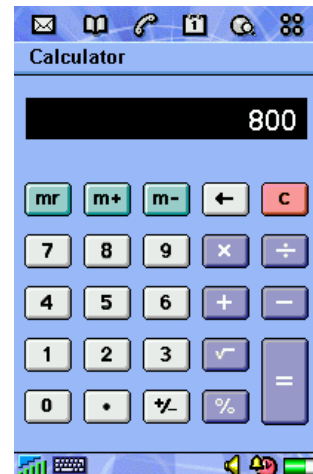

Calculator performs like a standard desk calculator, and is always available from the application launcher.

Multimedia

The P800 has extensive multimedia capability in many applications. This section explains the different standards supported and provides a summary of capability by application.

Audio Formats

The table below explains the various audio formats supported by the P800, together with indicative file sizes for 60 seconds of playback.

Format	Example File Size	Description
AAC		Advanced Audio Coding. This is one of the audio compression formats defined within the MPEG-2 standard. Compared to MP3 it has more advanced features and is more efficient. AAC is commonly used as the audio component of an MPEG-4 video file or stream. The P800 Video Player can play AAC format audio which is encoded into an MPEG-4 file or stream. Such audio-only content is not common.
AMR	94kB (12.2 kbps)	Adaptive Multi Rate. AMR is a speech compression format that is highly optimised for the mobile environment, requiring as little as 4.75kbps bandwidth. AMR is used to convey voice recordings in MMS, when the P800 records at a rate of 12.2kbps. Sample rate is 8kHz and processing is done on 20ms frames.
AU	1.35MB (22.05 kHz)	Similar to WAV, this is an audio format commonly used in the Macintosh, unix and java worlds. It is not commonly used for content on mobile devices.
iMel-ody	6kB	A format commonly used for monophonic ringtones.
MIDI	20kB	MIDI means Musical Instrument Digital Interface. MIDI specifies a format which describes music in a binary format which may then be stored as a file. Unlike the other formats, MIDI is not a recording of music but a description which enables a local synthesizer to play the music from the instructions included in the MIDI file. MIDI is ideal for polyphonic ringtones. The P800 includes the Beatnik mini-BAE™ (Beatnik Audio Engine) providing support for General MIDI Level 1.
MP3	960kB (128kbps)	MPEG1 Layer 3 audio compression. MP3 is a very popular format for downloading songs from the internet. It is also increasingly available in personal and in-car audio equipment. MP3 files can be created with different size/quality compromises.
RMF	72kB	Rich Music Format™ A file format developed by Beatnik combining the compact size of MIDI files with the high quality of sampled sound.
WAV	1.35MB (22.05 kHz)	This is an typically used for short 'alert' sounds. The size of files is determined by sample rate, bits-per-sample and mono/stereo.

Loudspeaker Characteristics

General

The P800's built-in loudspeaker is most sensitive to middle and high frequencies; tones below 400Hz generate distortion instead of bass. Therefore, sampling frequency for WAV should not be reduced below 16kHz, otherwise the characteristic low frequency sampling 'ringing' will be very distinct compared to that of a more linear system.

Recommended WAV file format for the loudspeaker is 22.050kHz sampling rate, 8-bit samples and 1-channel (mono).

Recommended MP3 setting for playback over the loudspeaker is 64kbps mono.



P800 Loudspeaker

Ringtones

The stimuli should be kept around 4 kHz in order to generate high SPL (~90dB SPL@40cm) ring tones (see frequency response in figure below).

The speaker will accentuate with-in this band and alter the timbre of the ringer tones for frequencies around 2kHz. E.g. a square wave at 500Hz will not sound the same as a square wave at 2 kHz as is the case for a more linear system.

Recommendation: Keep the bandwidth of stimuli as narrow as possible. For discrete signals (~80dB SPL@40cm) the band broadens to 2-5 kHz. These types of stimuli can be generated at a larger bandwidth as an analogue to the above reasoning.

Stereo Headphone Characteristics

The P800 is supplied with a pair of high quality stereo headphones.

Recommended WAV file format for playback over the headphones is 44.1kHz sampling rate, 16-bit samples and 2-channel (stereo). Files to this standard are very large – use WAV only for short bursts of sound.

Recommended MP3 settings are 128kbps stereo.



Image formats

The table below explains the various image formats supported by the P800, together with indicative file sizes for a QVGA (320 x 240 pixel) image.

Format	Example File Size	Description
BMP	226kB	Microsoft Windows Bitmap. A graphics format defined by Microsoft supporting 1, 4, 8 or 24 bit colour depth. No compression, so files can be very large. Used for icons and very small images.
GIF	42kB	Graphics Interchange Format. Highly compressed by limiting the colour palette to 16 or 256 colours. GIF is therefore good for icons and diagrams. When a Jotter sketch is send as an e-mail attachment, the GIF format is used.
GIF (animated)	210kB (5 frames)	A GIF file containing a number of images in a timed and repeating sequence. Some P800 applications display only the first image in the sequence.
JPEG (.JPG)	13kB	An image compression format managed by the Joint Photographic Experts Group. The format supports various degrees of compression, enabling different quality/file-size balances to be provided in one standard. JPG files support millions of colours and are therefore good for 'real life' photographs.
MBM		Multi Bitmap. This is a Symbian OS format for colour and greyscale bitmap images.
PNG	166kB	Portable Network Graphics. PNG compresses images with millions of colours no loss of detail, but has comparatively large file size. It is not commonly used.
WBMP		Wireless BitMap. Part of the WAP specifications, an image format optimised for small mobile devices. The P800 supports Black and White, 2-bit greyscale and 6-bit colour modes, according to ETSI 3GPP TS 23.040

Colour Screen

Images having more than 4096 colours will be adjusted to display optimally within the capabilities of the P800 screen.

Images larger than the display area will generally be scaled to fit the application window.

The Image Viewer uses 192 x 144 pixels in full screen mode.

Screen Specification

Type:	TFT
Size, flip closed:	208 x 144 pixels, 40 x 28 mm
Size, flip open:	208 x 320 pixels, 40 x 61 mm
Pixel Size:	0.192 mm
Pixel Density:	132 DPI (Dots Per Inch)
Colour depth:	12-bit (4096 colours)
Surface:	Touch-sensitive, anti-reflective
Illumination:	Front-light

Media Format and Application Summary

This table summarises the P800 applications and shows which audio, image and video formats are supported by each. It also shows the storage locations that can be accessed in each case. A description of the MPEG-4 and 3GPP video formats is provided in the Video Player section of this document.

Application	Usage Case	Audio Formats								Image Formats						Video Formats		Storage Access		Notes	
		AAC	AMR	AU	iMelody	MIDI	MP3	RMF	WAV	BMP	GIF	GIF/animated	JPG	MBM	PNG	WBMP	MPEG4/File	MPEG4/Stream	Internal		Memory Stick
Phone	Ringtones		✓	✓	✓	✓		✓	✓										✓	✓	7
Phone	Picture Phonebook									✓	✓	✓ ¹⁷	✓	✓	✓	✓					1
Phone	Speed Dial image									✓	✓	✓ ¹⁷	✓	✓	✓	✓					2
Phone	Background image									✓	✓	✓ ¹⁷	✓	✓	✓	✓					
Audio Player	Play		✓	✓	✓	✓	✓	✓	✓										✓	✓	16
Video Player	Play	✓	✓														✓	✓ ¹⁹	✓	✓	3
Contacts	Personal Ringtones		✓	✓	✓	✓		✓	✓										✓	✓	7
Contacts	Picture of contact									✓	✓	✓ ¹⁷	✓	✓	✓	✓			✓	✓	4, 5
CommuniCam	Save photo												✓						✓	✓	6
Pictures	View photos									✓	✓	✓	✓	✓	✓	✓			✓	✓	
Time	Alarm		✓	✓	✓	✓		✓	✓										✓	✓	7
Calendar	Alarm		✓	✓	✓	✓		✓	✓										✓	✓	7
Tasks	Alarm		✓	✓	✓	✓		✓	✓										✓	✓	7
Voice Memo	Record/play								✓										✓		8,9
EMS	Media objects				✓					✓											10
MMS	Playback		✓	✓	✓	✓		✓	✓	✓	✓	✓		✓	✓	✓ ¹⁵					11
MMS	Compose		✓	✓ ¹²	✓ ¹²	✓ ¹²		✓	✓ ¹²	✓ ¹²	✓	✓		✓ ¹²	✓				✓	✓	
E-Mail	Display attachment	✓ ¹⁸	✓ ¹³	✓ ¹³	✓ ¹³	✓ ¹³	✓ ¹³	✓ ¹³	✓ ¹³	✓ ¹⁴	✓ ¹⁴	✓ ¹⁴	✓ ¹⁴	✓ ¹⁴	✓ ¹⁴	✓ ¹⁴	✓ ¹⁵				
E-Mail	Attach and send	✓ ¹⁸	✓	✓	✓	✓	✓	✓	✓	✓	✓	✓	✓	✓	✓	✓	✓			✓	✓
Browser	Play/Display		✓	✓	✓	✓	✓	✓	✓	✓	✓	✓	✓	✓	✓	✓			✓ ²⁰	✓ ²⁰	
System	Screensaver									✓	✓	✓	✓	✓	✓	✓			✓	✓	

Notes to Media Format and Application Summary Table

- 1 The number dialled or incoming CLI is matched to a contact. The picture stored against that contact is displayed in thumbnail format.
- 2 The speed dial button is linked to a contact. The current picture of that contact is displayed in thumbnail format.
- 3 Audio must be encoded in file or stream. Audio-only file or stream is supported.
- 4 The source may be in the formats and locations indicated.
- 5 A copy of the image is stored in the Contacts database.
- 6 Pictures Remaining is calculated for the currently selected storage location.
- 7 Some system default sounds and options are also available. These may not be modified or deleted by the user.
- 8 Stored in internal storage. May be played in Voice Memo or selected as ringtones only.
- 9 Playback of Voice Memo recordings only; all other audio playback is in the Audio Player.
- 10 Limited to Black and White, 8x8, 16x16 and 32x32 pixel. Stored inside the Messaging/EMS application.
- 11 An MPEG4 attachment can be played by transferring control to the video player.
- 12 The user will be warned that these formats may not be supported on the receiving mobile phone.
- 13 Played via Audio Player.
- 14 Displayed in Pictures.
- 15 Played via Video Player.
- 16 By default the Audio Player lists only MP3 files. Display of the rest can be turned on via the Edit | Preferences menu. Select 'Other' to see iMelody.
- 17 The first frame of the animated GIF is displayed as a static image.
- 18 When encoded in an MPEG4 file. Played by the Video Player. See also note 3.
- 19 Streaming is initiated by clicking on a content link in the Browser. The Video Player is then started with the URL of the link.
- 20 Locally stored content can be accessed via the <file:///> URL, for example, [File:d:///Media%20files/document/menu/menu.htm](file:///Media%20files/document/menu/menu.htm)

Data Flow Summary

The diagram below shows a generalised view of the ways in which data can be imported, stored and exported. Data is stored in a generic multimedia structure for images, audio, documents, video and other. Therefore an image received as an e-mail attachment can be saved and used by any application capable of reading it.

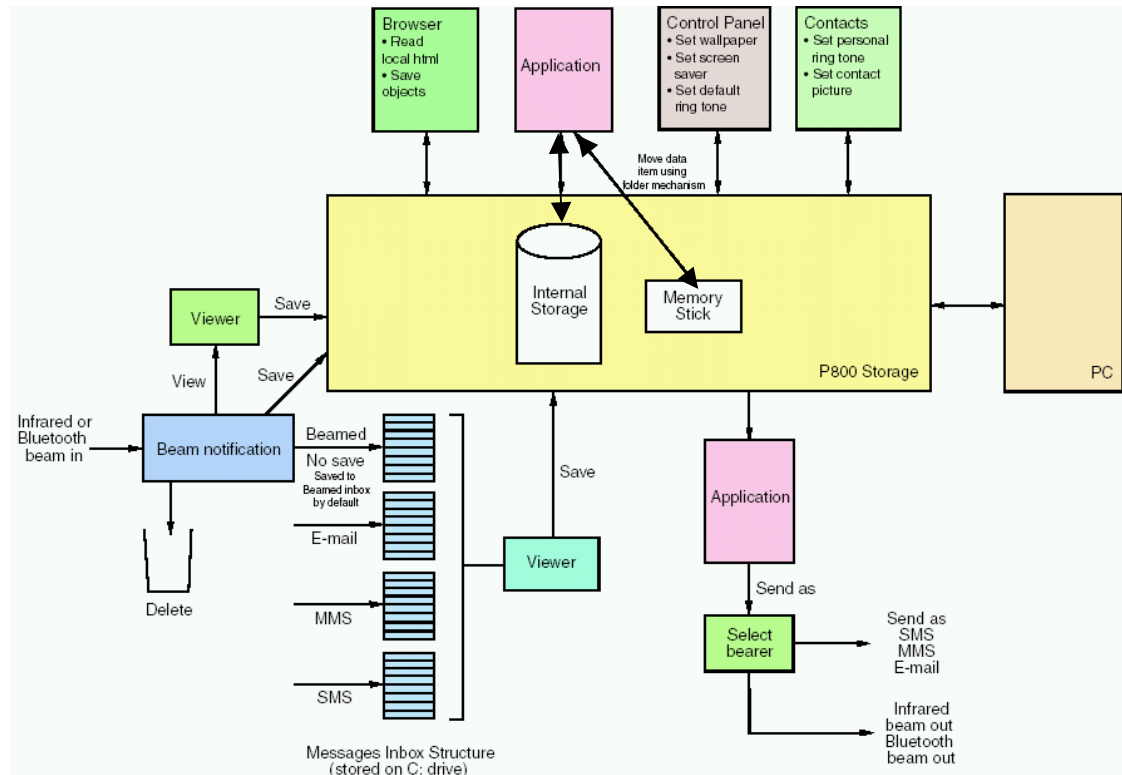

Beaming

When an infrared or Bluetooth beamed object is received, the user is immediately notified via a dialog box on screen. The object can be viewed, saved or deleted. If no action is taken, the object is saved in the Beamed Inbox in Messages.

The Send As command in many applications allows an item of data to be beamed from the P800. For more information see 'Synchronisation and Data Transfer' later in this document.

Viewer

The 'Viewer' boxes in the diagram are instances of P800 applications that show selected details of the object and provide an option to save the object and/or go back.

Messages

Objects embedded in or attached to messages can be viewed and saved via the Viewer mechanism described above. Wallpaper and ringtones can be set directly from MMS messages.

The Send As command in many applications allows objects to be sent from the P800. It is also possible to add multimedia attachments whilst composing MMS and e-mail messages.

Application Behaviour

This section highlights certain application capabilities that are useful to understand.

Browser

The Browser is able to read HTML based content from local storage. More importantly, a long tap on an object such as a picture will display a menu, from which it is possible to save the object to storage. This enables images to be collected and saved in internal or Memory Stick storage.

Folder Mechanism

Almost all applications use folders to allow the user to sort information into useful groups. This mechanism can also be used to move an object between the Internal Storage and the Memory Stick. The Media Format and Application Summary table above shows which built-in applications have this ability. A separate application menu function, where provided, enables an object to be copied between Internal Storage and Memory Stick.

Control Panel

Wallpaper. Screen Saver and default ringtone are set here. Refer to 'Personalisation and Customisation' later in this document for more information.

Contacts

In Contacts, the user can select a picture from the P800 storage and save a copy against a contact. A compatible audio file can be linked to a contact and played as a ringtone when that contact is identified as the calling party.

PC Suite for P800

The PC Suite for P800 enables multimedia content to be freely copied and moved between the P800 storage and a connected PC. The Internal Storage and Memory Stick appear as separate drives when viewed from the PC. See 'Synchronisation and Data Transfer' later in this document for more information.

P800 Audio Player

The P800 Audio Player is a multi-format digital audio player which enables the user to play a selection of favourite songs.

Audio Player Specification

Formats:	MP3, WAV, AU, AMR, MIDI, RMF, iMelody
Features:	Playlists, Loop, Automatic pause

Songs may be stored in the internal P800 user storage and on Memory Stick. The folder system enables the user to organise songs into groups and create simple playlists of MP3 songs. It also allows songs to be moved between internal and Memory Stick storage.

Songs may be collected in numerous ways, including internet download, file transfer from the PC using SyncStation and, of course, Memory Stick.

The Audio Player is intelligently aware of other applications on the P800:

- Playback is paused when a telephone call is made or received
- Playback is paused if the user starts another application which requires the audio channels to be dedicated to it.
- Playback of MP3 files continues if the user switches to another FO application or closes the flip, providing music whilst using other applications such as PIM or Messages.

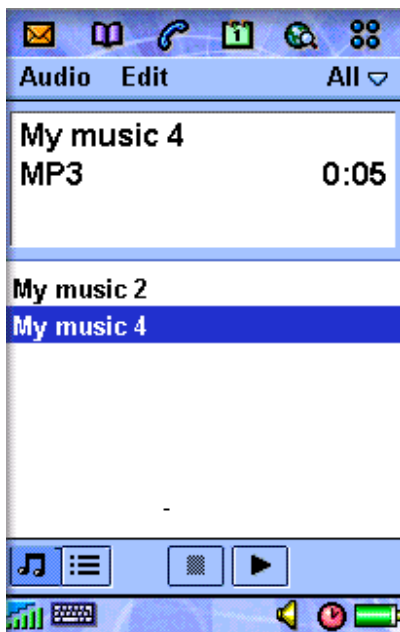

The Audio Player is started from the Application Launcher and is accessed in Flip Open mode.

Folder 'All' is selected. It contains the songs listed in the lower half of the screen.

'My music 4' is currently selected. Details are displayed at the top of the screen including type and duration. MP3 song information is read from ID3 tags in the file and includes artist, album, filename and copyright. ID3 1.x and 2.0 is supported.

In list view  audio files are presented in a list and may be played one by one.

In playlist view  songs can be played in a consecutive list one after the other. A Loop function enables the playlist to be repeated automatically, providing continuous music.

By default Audio lists only MP3 files, since this is most convenient for using the application as a personal music player. Other audio material can be viewed by selecting Edit, Preferences and ticking the required file types. Select 'Other' to see RMF and iMelody files.

Imaging

Built-In CommuniCam



The P800 has a built-in camera capable of taking still pictures up to 640 x 480 pixel (VGA) resolution (307200 pixels) and 24 bit colour depth. 320 x 240 (QVGA) and 160 x 120 (QQVGA) pixel sizes are also selectable. The camera may be used in Flip Closed mode for fast point-and-shoot pictures using the screen as the viewfinder. The lens is recessed into the back of the P800. With the flip open, the viewfinder is supplemented with graphical controls and access to camera settings. The viewfinder is always 160 x 120 pixels, irrespective of the resolution at which the picture is taken. A dedicated hardware button provides fast access to the camera application.

Images are stored in the P800's filing system and are therefore available for other applications to use. The number of images that can be stored depends on the available file space, which is shared with other applications. In FO mode, the viewfinder will give an estimation of the number of images remaining, assuming that all of the free storage is available for the camera application and using the current settings for size and quality. Approximate JPEG file sizes are 50kbytes for VGA, 18kbytes for QVGA and 3kbytes for QQQVGA.

Images are placed into a user-definable folder on either internal or Memory Stick storage. They may be viewed and organised in the Pictures application, and are available for use by other P800 and third party applications.



In Flip Closed mode, the camera is optimised for 'point-and-shoot' speed:

- Dedicated CommuniCam button
- Ready/Busy indicator
- Delay Timer icon . The timer gives an audible 15 second 'countdown' to the shot.

The first press on the CommuniCam button will switch on the viewfinder. Each further press on the button will then act as a shutter and take a picture.

With the flip open, additional on-screen controls are:

- Shutter
- View all pictures (shortcut to Pictures)

Settings are accessed via the CommuniCam menu and include:

- Image size
- High/Medium/Low quality (low uses least storage space)
- Brightness and Contrast
- Backlight mode (when there is light behind the subject in the viewfinder)
- Flicker-free mode (for fluorescent lighting)
- White Balance (automatic or one of 4 pre-set values)

Pictures remaining is calculated based on the current settings plus available space on the selected storage location (internal or Memory Stick).

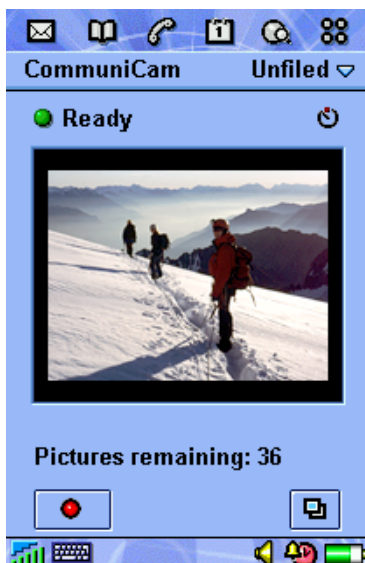

Pictures

Pictures is the P800's image viewer. It enables you to view and organise your photographs, including pictures taken by the built-in camera plus images loaded from elsewhere, such as received via E-Mail or stored on a Memory Stick. Pictures supports image types JPEG, BMP, GIF (including animated), MBM, PNG and WBMP.



Thumbnail viewing – images may be ordered by name, date, size or type. Tap an image to see it full-screen. Alternatively, a textual list including name, size and date may be displayed.

Shortcut button to the Camera.



In full screen mode, the user can browse through the images and organise them:

- Categorise into folders
- Rename or delete
- Send as E-Mail or MMS

The viewing area is 192 x 144 pixels.



Images may be viewed 'actual size', meaning that each pixel of the source image is presented on one pixel of the screen. A full size 640 x 480 image from the camera will require 3 taps on the horizontal scroll bar to scan across it.

Using Images



Pictures may be loaded up to the internet. Sony Style Imaging is an on-line album enabling you to share your pictures and video clips. www.sonystyle-imaging.com

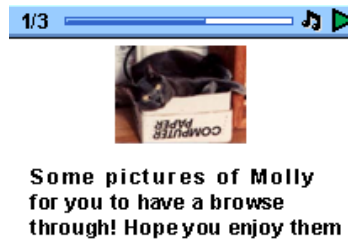

Pictures can be easily sent as a Multimedia Message. Simply select a picture, add a message and send just like an SMS or build a slide show with several images and your favourite sound clips.

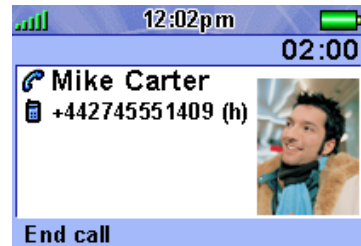

Pictures of your friends can be saved in Contacts. When a contact calls (or the user calls that contact), the picture is displayed with the details of the call. This is known as 'Picture Phone Book'

Video Playback and Streaming

The P800 Video Player plays video content that is locally stored or streamed. It can also play audio-only material which is encapsulated within an MPEG file or stream.

MPEG-4 Standard

MPEG-4 was developed in 1998 by the Motion Pictures Expert Group, and has been incorporated into the 3GPP specifications for mobile multimedia. The earlier standards, MPEG-1 and MPEG-2 are widely in use for multimedia CD-ROMS and digital broadcast television for example. MPEG-4 has new functionality enabling to support both small mobile terminals and larger fixed devices within one standard. It has been adopted by 3GPP.

MPEG-4 has the following advantages:

- Flexible range of bit-rates supported, from 9.6kbps to 6Mbps (compared to 1.5 to 12Mbps for MPEG-2)
- High error resiliency
- Variable frame rate, enabling optimisation based on the transmission path and the overall load on the server.

Video Compression

The video compression component of the standard is called MPEG-4 Visual and covers a range of bitrates and functionalities. Profiles are used to describe functionality packages. Simple Visual Profile provides efficient and error-resilient coding of video content, and is supported by the P800 Video Player.

MPEG-4 Visual is also broken down into levels, describing such things as frame size, bitrate and buffer capacity. Level 0 is targeted at mobile devices and provides for a frame size up to 176 x 144 pixels at maximum rate of 15 frames per second.

Audio Compression

AAC (Advanced Audio Coding) is one of the audio compression formats defined within the MPEG-2 standard. Compared to MP3 it has more advanced features and is more efficient.

The 3GPP standard uses AMR for audio coding, though this is actually outside of the MPEG-4 standard. This is because AMR is highly optimised for the mobile environment, requiring as little as 4.75kbps bandwidth.

File Format

The file format defined by MPEG-4 has extension MP4. It is applicable for both streaming and local storage/playback. MP4 uses a structured yet flexible method to describe and encapsulate multimedia material.

3GPP PSS (Packet Switched Streaming) Standard

What is streaming?

Streaming is a method of making audio, video and other multimedia available in near real-time, over the Internet or corporate intranets. Streaming media to computers has been used during the last few years, and now, with GPRS, EDGE and UMTS, the technique is can be used with mobile phones.

The name 'streaming' refers to the technique it is based on. Previously it was necessary to download an entire file to the hard disk or mobile phone and then play it, whereas through streaming the user can begin to watch or hear the content of a requested file after only a short delay. The data in the file is broken into small packets that are sent in a continuous flow, a stream, to the end-user's computer or mobile phone. It is then possible to begin viewing the file from the beginning as the rest of the packets are transferred to the end-user's machine or mobile phone while playing. The short delay at the start is to enable a small amount of data to be buffered. The data buffer enables playback to continue uninterrupted despite variations in the rate of received data.

Applications

The applications which can be built on top of the streaming services, can be classified into on-demand and live information delivery applications. Examples of the first category are music and video, news-on-demand applications as well as on-demand instructions material. Delivery of radio and television programmes are examples of live information delivery applications.

User scenarios

- Streaming of music on demand
- Streaming of news (video, audio) on demand
- Streaming of movie trailers on demand
- Streaming and download of video on demand
- Live streaming of music/video (broadcast)

Standards, architecture and protocol

Sony Ericsson supports the architecture, protocols and codecs for the PSS (Packet Switched Streaming) within the 3GPP system, as well as supports all ongoing standardization activities within 3GPP. Sony Ericsson constantly works to follow standards and to ensure interoperability between business solutions, and also stands up to meet additional market requirements within this area. The relevant 3GPP specification is TS 26.233 "Transparent end-to-end packet switch streaming service (PSS)." The PSS includes media codecs for video, still images, bitmap graphics, text, audio, and speech.

P800 Video Player

The P800 Video Player is used in Flip Open mode.

Locally Stored Clips

Video clips may be downloaded from the internet or copied over from a connected PC. Video files are large compared to still images. The demonstration videos Sony Ericsson has shown on the P800 require approximately 1 Mbyte storage per minute. Video files may be stored on Memory Stick as well as internal storage.

Files must be .3GP or .MP4 having video coded in MPEG-4 Simple Visual Profile and audio in AAC or AMR format.



Video files can be stored on the P800, organised into user-defined folders if required. Tapping a filename will start playback.



The user may pause, rewind or fast-forward the playback.

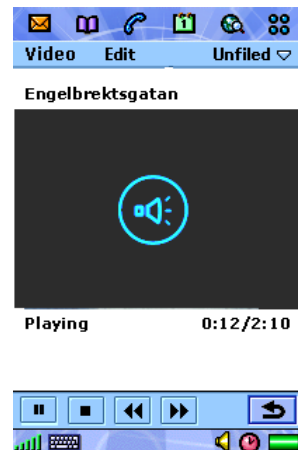

The Video Player will also play audio-only material. (AAC or AMR encoded in an MPEG-4 wrapper)

Streaming Support in the P800

The Video Player can be launched from hyperlinks in the Browser or in messages. Content is streamed using RTSP (Real Time Streaming Protocol) session control according to 3GPP specification.

Audio support is AAC and GSM-AMR according to 3GPP

The following video codec support is provided according to 3GPP:

- MPEG-4 Simple Visual Profile Level 0
- H263 Profile 0 Level 10
- H263 Profile 3 Level 10

MIME Support

The P800 Video Player registers support for the following MIME types:

MIME type	Extension	Notes
video/mp4	.MP4	
video/3gpp	.3GP	
audio/3gpp	.3GP	All 3GPP treated as video
video/x-pv-pvx	.PVX	
application/sdp	.SDP	

Recommended Settings

The table shows the recommended video coder settings to optimise video for the P800.

	Video Bandwidth	Video Size	Audio Sample/Bit Rate	Audio Channels
Video + AAC	64kbps	192 x 144	22.05kHz / 32kbps	Stereo
Video + AMR	64kbps	192 x 144	8.00kHz / 12.2kbps	Mono

Memory Stick[®] Duo[®]

Memory Stick[®] provides a convenient way of adding storage and other functions to a wide range of devices. The P800 supports Memory Stick[®] Duo[®], a miniature version of the Memory Stick series which is just one third the volume of standard Memory Sticks. Memory Stick Duo starts at 8Mbytes and has a roadmap which foresees sizes up to 1Gbyte in the future. A 16 Mbyte Memory Stick Duo is supplied and sizes up to 128Mbyte are supported.



Via a Memory Stick Duo Adaptor, Memory Stick Duo can be plugged into any standard size Memory Stick slot. The two types have full electrical and file system compatibility.



Physical and Electrical Properties

Memory Stick Duo is very space-efficient. It is 20mm wide, 1.6mm high and 31mm deep, having volume 992 mm³. Memory Stick Duo weighs 2 grams.

The electrical contact consists of 10 pins in a structure which prevents direct touch, providing high reliability. A serial protocol is defined for Memory Stick. This is optimised for the larger capacity memories that will be available in the future. Current maximum transfer speed is 2.45Mbyte/second to read data and 1.8Mbyte/second when writing data. An erasure prevention switch protects important content and data.



PC and Apple Mac Support

PCs and Apple Macs may be enabled for Memory Stick via built-in Memory Stick slots, Floppy Disk adaptors, PC Card adaptors, USB adaptors and even a Memory Stick enabled mouse. (Memory Stick Duo Adaptor required)



Wide Industry Support

Memory Stick is supported by a wide range of companies including major names in consumer electronics, computing, automotive, mobile phone, photographic and semiconductor sectors of industry. As at 14th November 2002, 376 companies have declared support at www.memorystick.org

Memory Stick compliant products include PCs, PDAs, digital cameras, portable music players, printers, projectors and entertainment robots. Future applications include home and car audio, game machines and multimedia kiosks.

Memory Sticks are currently marketed by Sony, SanDisk, Lexar Media, I-O Data Device Inc. and Apacer Technology. As of October 2002, there were already over 30 million Memory Sticks in use worldwide. (Source: <http://www.memorystick.com/en>)

Memory Stick Usage Cases in the P800

Any number of Memory Stick Duo units can be used with a P800, providing virtually unlimited storage opportunities. Here are the main usage cases:

- Additional storage for pictures taken with the CommuniCam
- Images from the CommuniCam can be transferred to other image-aware devices such as PCs and printers.
- Transfer of data and media (sound, pictures, video clips, documents etc) between the P800 and a PC or Mac
- Save data and media from the P800 on to a Memory Stick, for example to make backup copies of important files.
- Transfer of data and media between P800s.
- New applications may be installed from a Memory Stick.
- Third party applications can make use of Memory Stick storage.
- Data can be transferred over SyncStation between a Memory Stick in the P800 and a connected PC.
- Personalise the P800 using media on a Memory Stick, for example ring signals, alarm sounds and pictures of contacts.
- Use media on a Memory Stick when composing MMS messages

Specifically, the following built-in applications are enabled to work with the Memory Stick: CommuniCam, Pictures, Video Player, Audio Player, E-Mail (attachments), Viewers (e.g. Word), MMS (media), Browser, Phone (ring signals, screensaver), Contacts (pictures of contacts; ringtones).

Compatibility with other Memory Stick devices

The P800 defines its own folder structure on a Memory Stick, within the vendor-specific area and this is the only area that is accessed. Other devices must therefore access the same folder structure in order to interact with P800 files and media. For a PC or Mac, this is easily done by browsing to the required folder on the Memory Stick. Memory Stick enabled devices with no browsing capability may be unable to share data with the P800. For example, it may not be possible for the P800 to read images taken on a Memory Stick enabled digital camera without first using a PC to copy them to the images folder within the P800 folder structure.

Magic Gate, the copyright protection mechanism available with Memory Stick, is not supported on the P800.

Memory Stick inserted in to a PC

Using the supplied Memory Stick Duo Adaptor, the P800's Memory Stick Duo may be inserted into a memory-stick enabled PC.

In the example below, the Sony Vaio PC locates the Memory Stick on the S: drive. The memory stick is new and has been initialised by the P800. Note that some capacity is taken up by the filing system.

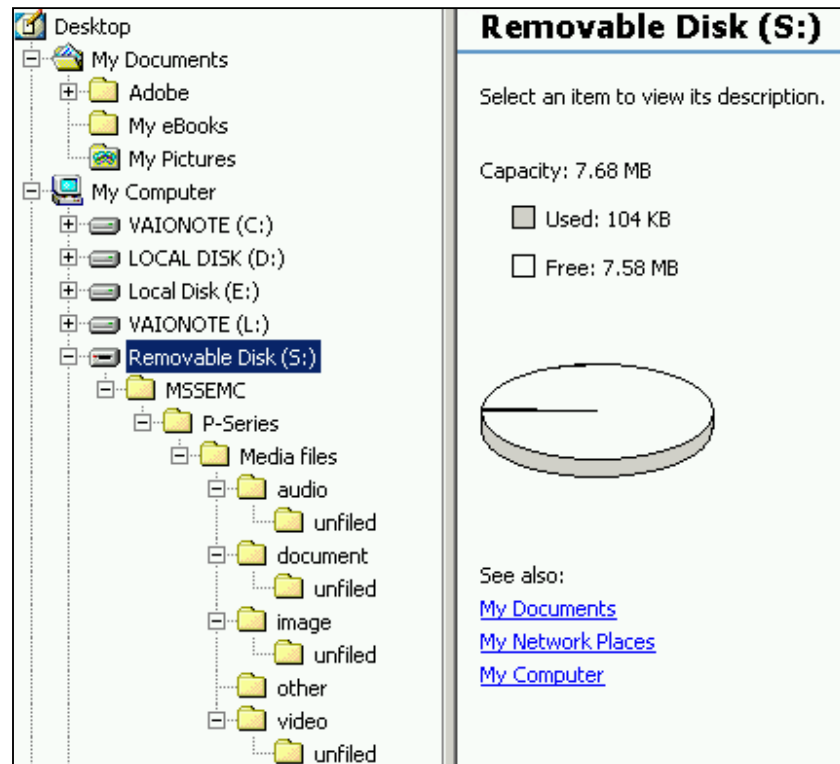

Folders **MMSEMC** and **P-Series** identify the data structure as that of the P800, according to defined Memory Stick conventions. Media data is stored in the standard P800 structure.

Messaging

The P800 Messages application has integrated support for SMS, EMS, MMS and E-Mail from a unified UI. Messages may be addressed using the contacts data and hyperlinks are supported in all message types to create E-Mails, call telephone numbers and navigate directly to web and WAP pages that are referenced in the text.

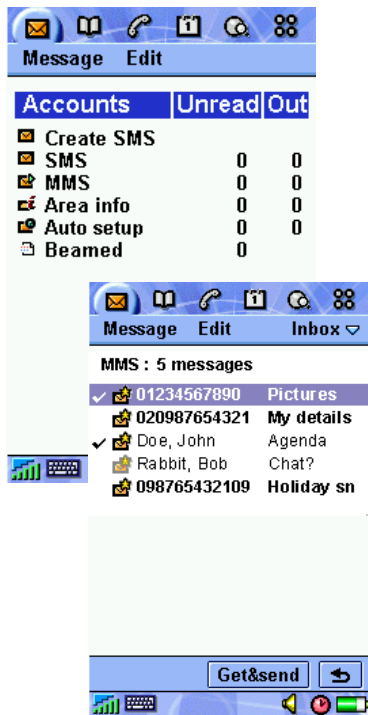

- With the Short Message Service, a user can send text messages containing up to 160 characters to and from GSM mobile stations (up to 70 characters using Chinese text)
- With concatenated SMS, the user can write a longer message and the P800 will automatically send it using more than one SMS.
- EMS (Enhanced Messaging Service) enables the user to include graphics, sounds and font attributes as part of a text message, which can then be sent over the normal GSM/SMS service. Such messages may also be received and the extra media objects saved.
- MMS provides true multimedia capability with real pictures, sound and time-based sequencing.
- The E-Mail client supports POP3 and IMAP4 E-Mail and multiple accounts may be set up, for example business and personal.
- Attachment viewers are included for Microsoft® Word, Excel, PowerPoint® and Adobe® Acrobat® (PDF), with approx. 20 more available from the CD-ROM
- Area information (SMS Cell Broadcast) is a type of text message sent to subscribers in a certain network area.
- Over The Air setup messages are held in a special 'Auto Setup' mailbox
- Incoming beamed items will be found in the 'Beamed' mailbox

EMS (Enhanced Messaging Service)

Enhanced Messaging Service (EMS) adds new powerful functionality to the well-known SMS standard. With it, mobile phone users can add life to SMS text messaging in the form of pictures, animations, sound and formatted text. This gives the users new ways to express feelings, moods and personality in SMS messages. As well as messaging, users will enjoy collecting and swapping pictures and ring signals and other melodies.

EMS uses existing SMS infrastructure and industry standards, keeping investments to a minimum for operators and providing a familiar user interface and compatibility with existing phones and with other manufacturers. EMS is part of the 3GPP standards.

An EMS message can be sent to a mobile phone that does not support EMS, or only supports part of EMS. All the EMS elements i.e. text formatting, pictures, animations and sounds are located in the message header. The EMS contents will be ignored by a receiving phone that does not support the standard. Only the text message will be displayed to the receiver. This is true consumer-friendly standardization. EMS is compatible to SMS across most of the range of mobile

phones from the oldest to the newest. Some companies in the mobile phone industry have developed their own messaging technologies, which only work with their own phone models. Network operators are in favour of EMS because it is universal – many of the major mobile phone manufacturers are constructively improving and developing the EMS standards even further for implementation in their products.

Examples of EMS contents and applications

A wide range of contents, applications and services may be developed. Below is a list of examples and areas where messaging can be enhanced with EMS:

- User-to-user message
- Message notifications for voicemail, e-mail, unified messaging.
- Illustrated news & commercials

EMS Media Objects in the P800

Sounds and melodies

EMS sound is in the form of simple melodies according to the iMelody standard. Multiple sounds may be included in a message.

A library of sounds is included with the P800. Additional sounds may be copied from incoming EMS messages and pasted in to a new message. Sounds from received messages can also be stored in the 'Melody' folder within the EMS 'Insert object' menu.

EMS also has pre-defined sounds such as "Chime high" and "Notify." Rather than sending the complete sound to the receiving phone, EMS sends a 'token' instructing the receiving phone to play that sound according to its own library. When the P800 receives a message that includes an EMS pre-defined sound, it will be played in polyphonic form.

The P800 does not include a melody composer for EMS, neither is it possible to set ringtones from melodies received in EMS messages as the P800 is better suited to polyphonic ringtones.

Pictures and Animations

EMS pictures and animations are in the form of small bitmaps. These are transmitted in binary black and white (meaning that there are no scales of grey in between). Multiple pictures can be added to a message.



A library of pictures is included with the P800. Images from received messages may also be saved to the 'User Defined' folder within the EMS 'Insert object' menu. These images can then be edited and re-used.

Pictures may be added to a message by copying and pasting them from received messages.

New images can be created using a simple grid and pen editor. Animations may not be created or edited.

EMS also has pre-defined images such as smileys. Rather than sending the bitmap, a simple token is sent to instruct the receiving phone to display the pre-defined image. The P800 will

display these images in colour, since a pre-defined image is always displayed from local P800 storage.



Example stored colour animation for EMS

The P800 does not support the use of EMS to set background images because other methods are more appropriate for the large size and colour capability of the P800's screen.

Text

There are 3 text font sizes. **Bold**, *italic*, underline and ~~strike through~~ styles are available, and text may be aligned left, centre or right.

Concatenated messages

A part of the EMS standard is the support for concatenated messages, which means that the phone is able to automatically combine several messages both when creating and receiving EMS. This is useful to be able to build and display messages with rich content, since the amount of information in each SMS is limited by the SMS standards.

EMS Display in the P800

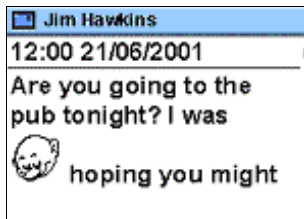

Receiving an EMS message in FC mode

In the P800, the extra facilities of EMS are integrated with the SMS UI, making it easy for the user to enrich an ordinary text message. A selection of icons and sound objects is included and more can be added via M-Service download.

Objects in received messages may be saved for re-use when composing outgoing messages, so as well as messaging users will enjoy collecting and swapping pictures, ring signals and other melodies.

Simply tap on the required object to copy or save it.

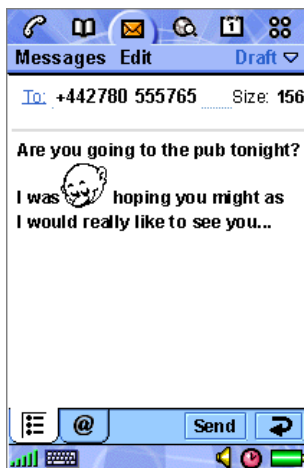

Composing an EMS message in FO mode.

One message may contain several EMS objects, such as a pictures, animations and sounds..

Messages may be created using the keypad to enter text in FC mode, or using handwriting recognition or virtual keyboard in FO mode.

MMS (Multimedia Messaging Service)

One of the key features in the P800 is the Multimedia Messaging Service (MMS), expected to become the preferred messaging method of mobile terminal users, since the ability to send real pictures and sound greatly enhances the messaging experience. An MMS message from the P800 can contain text, graphics, animations, photographic images, audio clips, ring melodies and even a video clip.

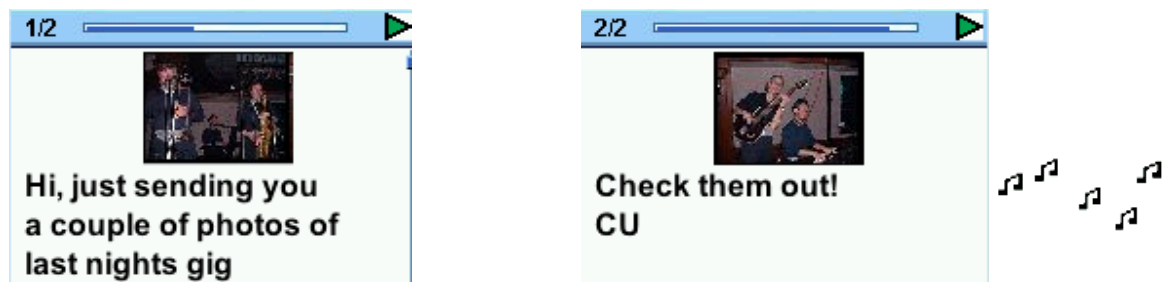

Defined and specified by 3GPP as a standard for third generation implementation, MMS completes the potential of messaging. Sending digital postcards and multiple-slide style presentations is expected to be among the most popular user applications of MMS. Eagerly awaited by young users in particular, MMS is projected to fuel the growth of related market segments. Using the Wireless Application Protocol (WAP) as bearer technology and powered by the high speed transmission technologies GPRS, EDGE and UMTS (W-CDMA), Multimedia Messaging allows users to send and receive messages that combine text and media in slides, having a built-in timing sequence decided by the sender. The messages may include any combination of text, graphics, photographic images, speech and music clips. MMS will serve as the default mode of messaging on all terminals, making total content exchange second nature. From utility to sheer fun, it offers benefits at every level and to every kind of user.

Benefits

Essentially enabling the mobile terminal to serve as image processor and conveyor, Multimedia Messaging accommodates the exchange of important visual information as readily as it facilitates fun. Business and leisure usage of MMS will be dynamically merged, resulting in enhanced personal efficiency for users and increased network activity for operators. In short, MMS affords total usage for total communication. Because MMS uses WAP as its bearer technology and is being standardized by 3GPP, it has wide industry support and offers full interoperability, which is a major benefit to service providers and end users. Ease-of-use resulting from both the gradual steps of the messaging evolution and the continuity of user experience gained from interoperability is assured.

The MMS server, through which MMS messages are sent, supports flexible addressing (to both normal phone numbers (MSISDN) and e-mail accounts), which makes user interface more friendly and allows greater control for operators. The MMS server, moreover, is responsible for the instant delivery feature of MMS.

MMS objects

Although MMS is a direct descendant of SMS, the difference in content is dramatic. The size of an average SMS message is about 140 bytes, while the maximum size of an MMS message is limited only by the memory. Multimedia Messages will initially be in the range 30k-100kbytes. The P800 is optimised for messages up to 200kbytes. In the P800 the MMS inbox is only constrained by the amount of available user storage.

An MMS message can contain one or more of the following:

Text

Much larger amounts of text can be used in MMS messages when compared with SMS. Thousands of characters can be included in a message.

Audio

MMS provides the ability to send and receive recorded audio and polyphonic sounds in messages. Not only can users share a favourite song or ring signal with a friend, they can also use the mobile phone to record sound and send it along with a message. Because sound includes speech as well as music, this extra dimension of an MMS message makes for enhanced immediacy of expression and communication. Rather than sending a downloaded birthday jingle in EMS, for example, a user can send a clip of his or her own personal rendition of "Happy Birthday".

Pictures

With the built-in CommuniCam, users can take a snapshot and immediately send it using the 'Send As MMS' facility. The ability to send pictures is one of the most exciting attributes of MMS, as it allows users to share meaningful moments with friends, family and colleagues.

Mobile picture transmission also offers inestimable utility in business applications, from sending on-site pictures of a construction project to capturing and storing an interesting design concept for later review. The ability to put text and pictures in a message allows users to create their own electronic postcards, an application that is expected to substantially cut into the traditional postcard-sending market.

The P800 supports the following image formats for MMS: GIF (including animated), JPEG, PNG, WBMP and BMP. Images may also be edited during message creation.

Video

The P800 can play MPEG4 video clips attached to MMS messages. They are opened as an attachment and played in the Video Player. Note that the MMS message is closed and control is transferred to the Video Player.

PIM Objects

With MMS in the P800, it is easy to send and receive business cards (vCard), Calendar and Tasks entries (vCal) and Jotter notes (text content is added to a slide). Received PIM objects are listed under the 'Attachments' tab.



SMIL presentations

SMIL stands for Synchronized Multimedia Integration Language and is pronounced "smile". SMIL in the P800 allows the user to create and transmit multiple-slide style presentations on the mobile device. SMIL is an advanced XML-based protocol, and Sony Ericsson MMS supports a subset of this protocol. Using a simple media editor, users can incorporate audio and animated GIFs along with still images, animations and text to assemble full multimedia presentations. The idea of SMIL is to allow the user to customize the page timing in slide presentations. The user can decide in which order the image and text will be displayed, as well as for how long the images and text lines are to be shown in the display. The user never sees the underlying SMIL code and does not need to understand it.

The P800 has an implementation of SMIL 2.0 Basic Profile. Messages created by the P800 use a subset of SMIL as defined in the Conformance Specification (see below).

SMIL Example

As an example, consider a two-slide message. In this case it was created using the Sony Ericsson MMS Home Studio described in the Personalisation and Customisation section of this document.

		<p>Slide 1 Picture (Slide_1.jpg) Text "this is my new car" Audio: Slide_1.midi</p>	<p>Slide 2 Picture (Slide_2.jpg) No text Audio: Slide_2.amr</p>
---	---	---	--

The following files are used:

Name ▲	Size	Type
mms	1 KB	SMIL Multimedia Presentation
Slide	1 KB	Text Document
Slide_1	13 KB	JPEG Image
Slide_1	11 KB	MIDI Sequence
Slide_2	8 KB	AMR File
Slide_2	10 KB	JPEG Image
texts	1 KB	XML Document

Slide.txt contains the text for slide 1. The SMIL conveyed in the mms.smil file looks like this example:

```

<smil>
<head>
<meta name="title" content="untitled" />
<meta name="author" content="MMS" />
<layout>
<root-layout width="160" height="160" />
<region id="Image" width="160" height="120" left="0" top="0" />
<region id="Text" width="160" height="20" left="0" top="120" />
</layout>
</head>
<body>
<par dur="35.723s">

<audio src="Slide_1.mid" end="35.723s" />
<text src="Slide.txt" region="Text" />
</par>
<par dur="6.026s">

<audio src="Slide_2.amr" end="6.026s" />
</par>
</body>
</smil>

```

The components of the message will be encapsulated, like in the example below:

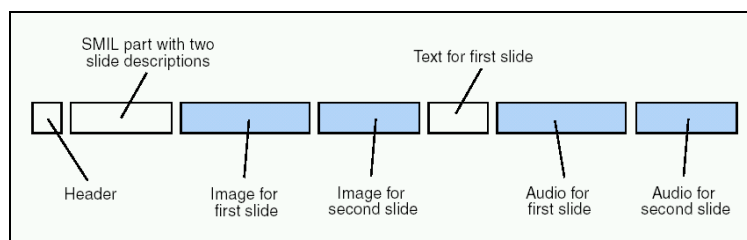

Media Object Timing

Timing of individual media objects must be within the overall slide time except for audio. This provides plenty of flexibility and greatly reduces the complexity of building a presentation.

The user may add text, an image and a sound clip to each slide. The timing of each within the slide can be adjusted. The default timings are as follows:

Object type	Start Point (Seconds from start of slide)	Default Duration (Seconds)
Text	0	5 seconds
Image	0	5 seconds
Animation	0	Duration of animation
Audio	0	Duration of audio clip
No Content	0	5 seconds

The user is not allowed to shorten the duration of a slide such that any media item would be truncated, meaning that the minimum duration of a slide is never less than the duration of the longest object within it.

The following example helps explain P800 timing behaviour:

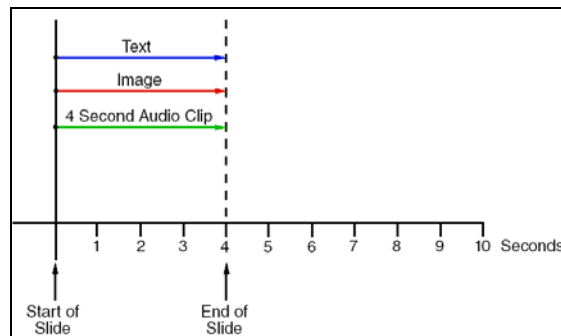
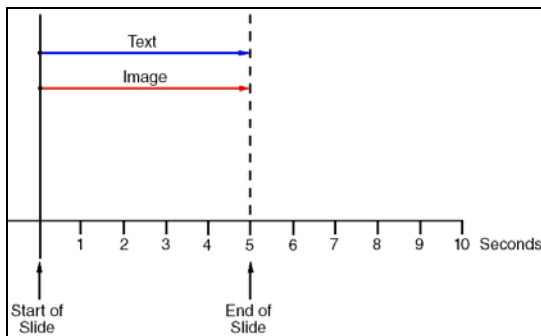

The user creates a new message using the Blank template. An image and some text is added. Both of these are set to last 5 seconds, which is the default duration of a slide

A 4-second audio clip is now added. The duration of the slide is now set to the duration of the clip and the display time of the image and text objects is shortened too.

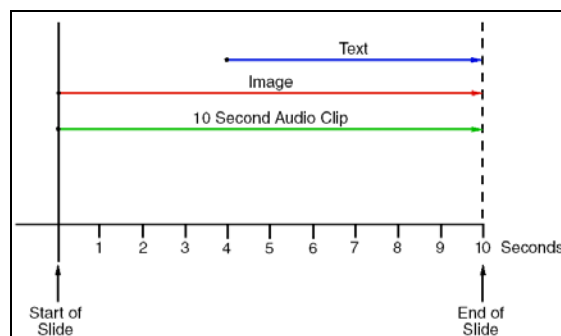
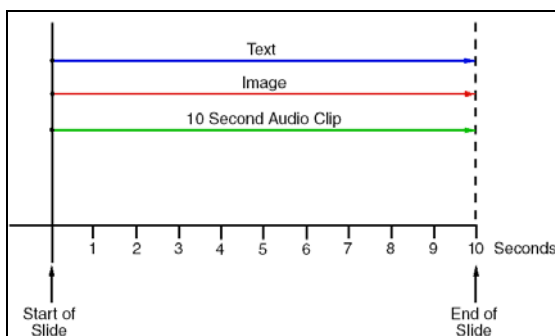

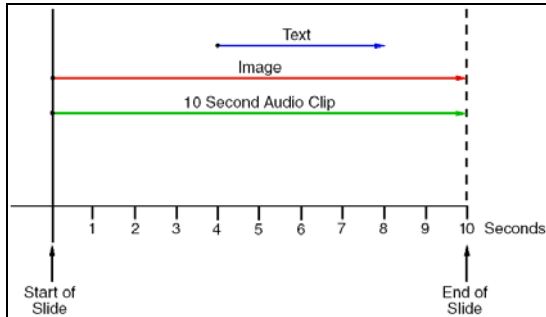

The user may shorten slide duration to less than the duration of the audio track. If there is audio on the next slide, the audio will be stopped and the track for the next slide will be played.

If there is no audio on the next slide, the audio track will continue playing until it finishes or a later slide is displayed which has its own audio track.

If **Page time** is un-checked, then the display time for the text can be set to shorter than the page duration.

Special case where audio can continue playing after the end of a slide.

Templates

A template is a predefined message containing one or more slides. It may be modified by the user to quickly produce an attractive message. The Blank template is the default – in this case nothing is pre-selected and the user may create slides as required.

Users may store a favourite message as a template. Templates can also be deleted.

The P800 comes with 8 pre-defined templates, all of which have sound and an animated image (GIF format, 160 x 120 pixels). These and other useful content pre-loaded by Sony Ericsson are described in 'Personalisation and Customisation' later in this document.

Notification and download

Incoming multimedia messages are normally notified to the user as soon as they arrive, in the same way as text messages. Basic download options are:

- On – always download the message
- Home only – messages are downloaded only when connected to the home network.
- Off – download messages manually.

Additionally, filters may be set, based on:

- Message size
- Message class (Advertisement, Information)
- Anonymous sender (exclude messages from senders not listed in Contacts, or where sender information has been hidden)

Interoperability and Conformance

MMS is a very flexible and extendable specification. To help mobile operators launch MMS services that are consistent and reliable, Sony Ericsson, Nokia, Motorola, Siemens, CMG, Converse and Logica have worked together to produce a Conformance Specification ('MMS Conformance Document V2.0.0'). This provides additional guidelines that are intended to make sure that messages sent between different products are played back correctly.

The main areas covered by the specification are:

- Picture formats (JPEG/JFIF, GIF, WBMP) and size (160 x 120 pixels)
- Sound format (AMR)
- Slide layout (2 objects plus sound, layout is the same for all slides)
- SMIL subset (all timing elements are within a slide)
- Maximum message size of 30kbytes

The P800 has much greater capability than that stated above. The user may therefore choose between two conformance modes: Standard and None. The setting may be found in Control Panel, Messaging accounts, MMS, Advanced. Standard mode is useful when sending messages to smaller MMS-capable phones.

In Standard mode, the user may select any media items, but will be warned if the selection falls outside of the standard. For example:

- Selection of a VGA (640 x 480) sized image will result in the warning “Recipient may not support this image size” being displayed. The user can choose to continue composing the MMS message, or select a different image. The image can be reduced to 160 x 120 pixels by taking it into the editor.
- If the message is greater than 30kbytes in size the warning “Recipient may not support this size of message” will be displayed

When ‘None’ is selected, no warnings are displayed.

When non-conformant messages are received, they will be displayed within the capability of the SMIL player. If the message is edited, objects may only be saved. If the message is saved as a template or forwarded then objects can be deleted or changed and new slides can be added.

Media Object Summary

The table below shows the media standards supported by MMS on the P800.

Standard	Media Type	Conformance Mode	
		Standard	None
US-ASCII (IANA MIBEnum 3)	Text	Y	Y
UTF-8 (IANA MIBEnum 100)	Text	Y	Y
UTF-16 (IANA MIBEnum 1000) with explicit BOM (Byte Order Mark)	Text	Y	Y
UCS-2 ISO/IEC 10646	Text		Y
AMR	Audio	Y	Y
AU	Audio		Y
IMelody	Audio		Y
MIDI	Audio		Y
RMF	Audio		Y
WAV	Audio		Y
JPEG/JFIF	Image	Y	Y
GIF-87a	Image	Y	Y
GIF-89a (spec includes animated)	Image	GIF89	Y
WBMP	Image	Y	Y
BMP	Image		Y
PNG	Image		Y

The MMS player will render all of the above formats. The display window for images is 200 x 120 pixels in FC mode and 200 x 200 pixels in FO mode. These are the optimal sizes for images where MMS messages are composed specifically for the P800. Incoming images larger than this will be re-scaled to fit within the window, preserving aspect ratio.

Composing a multimedia message

Multimedia messages may be created in FC or, as shown below, in FO mode.



Composing an multimedia message is like building a small slide presentation. A typical slide will consist of a picture, some text and a sound. Text and sound can be added to complete a slide.

The user can set the duration of the slide. If a sound is added, the slide duration is set to the duration of the sound clip.

Slides can be chained together to make a sequence. Timing elements can be added to control the display of images and text within a slide. The user can preview the message before sending and make any timing adjustments via the UI. Slide order may also be changed.

Multimedia messages can be created using any suitable media in the user storage space – including media downloaded from the internet, synchronised from a PC or created on the P800 itself. Simply tap the placeholder in the slide template and select the required item.



An image editor is provided so that images may be modified before sending. The available functions are:

- Crop (Select a part of the picture, for example just the cat)
- Rotate
- Pen (Draw on the picture in a choice of colour and thickness)
- Scale (Resize image)
- Undo and Undo All operations

The pen function enables notes and drawings to be made on images. These become part of the image and cannot be erased separately from the image itself. The annotated image (with pen) is saved separately and sent with the message, leaving the original image unmarked.

The MMS message is compiled using MIME standards and consists of the following parts:

- One part containing the description of the slides, using MMS SMIL.
- One part containing the actual contents of the slides – text, images and sound.

Receiving a multimedia message

Incoming MMS messages typically arrive just like SMS messages – automatic delivery with notification to the user. Messages are located in the MMS Inbox.

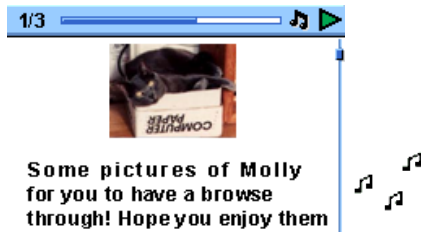

FC playback of a multimedia message



FO playback

Receiving a multimedia message on other terminals

Interoperability is dependent upon the capability of the receiving terminal and the MMS server in the mobile network. Here are some examples.



The Sony Ericsson T68i is enhanced with MMS, enabling multimedia messages to be exchanged with excellent compatibility.

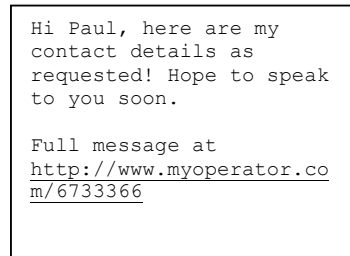

A mobile without MMS may be sent the text by SMS together with a URL which enables the picture and message to be seen via the WAP browser.

MMS technical features

The MMS standard, just like SMS, offers store and forward transmission (instant delivery) of messages, rather than a mailbox-type model. MMS is a person-to-person communications solution, meaning that the user gets the message directly into the mobile. He or she doesn't have to call the server to get the message downloaded to the mobile. GPRS enables a continuous connection and rapid transfer of data.

Architecture

The P800 communicates with the WAP Gateway using WAP transport protocols. That data is transported between the WAP Gateway and the MMS Relay using HTTP protocol.

The MMS Relay is at the centre of an MMS system. The MMS-C is primarily a message store. In some implementations the MMS-C is combined with the MMS Relay. The MMS Relay is linked to other MMS-Relays in order to forward MMS messages to external networks. The MMS relay can also send an MMS over e-mail using the SMTP protocol over the internet. The Relay can also format messages as SMS and send them via the SMS-C, enabling users of non-MMS terminals to receive MMS messages and view the text as SMS and the whole message via Web or WAP.

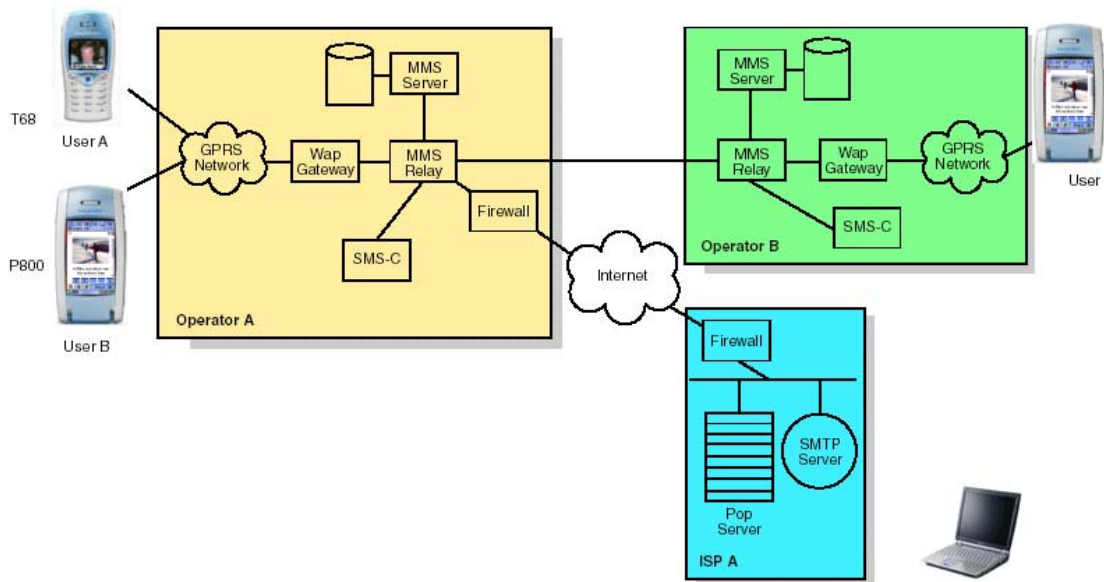

Example Usage Cases

User A will address a multimedia message to user B's mobile number (MS-ISDN). The completed message will be sent via the WAP Gateway to the MMS-Relay. The MMS-Relay will store the message at the MMS-C and send a notification to User B's T68i. The T68i will retrieve the message (depending on user settings) and the user will be able to read it from the MMS Inbox.

If User A sends an MMS to a user on a different network, the MMS-Relay will forward the message to the correct MMS-Relay in the target network (assuming interconnect agreements are in place) and the message will be stored in the MMS-C in the target network. It will be retrieved and read by the recipient's mobile phone in the same way.

If User A sends an MMS to an e-mail address, the MMS-Relay will package the contents and use SMTP to send the message as an e-mail over the internet.

Message conversion

The MMS-C is able to perform limited message conversion - for example, from MMS to SMS – so that processing and air time is not wasted in sending messages to mobile terminals that do not have adequate capability to receive them. It also handles service aspects such as store and forward, guaranteed delivery, subscriber preferences, operator constraints, and billing information. The MMS-C also vouches for high quality messaging, e.g. by format conversion. This means that the MMS-C recognizes which formats are supported in the mobile phone, and adapts the MMS messages to these formats. The WAP User Agent Profile (UAProf) is used to communicate the handset's capabilities to the MMS server. These features depend on the configuration of the MMS servers and will therefore be operator-dependent.

OTA configuration

Users can easily get MMS into their phone. MMS is configurable via OTA, meaning that the user does not have to configure the settings manually. The configuration is done by the operator.

E-Mail

P800 E-Mail Features

The P800 E-Mail client supports the following standards:

POP3	Post Office Protocol 3	POP is used to copy, move and delete messages from an incoming mail server in the network
IMAP4	Internet Message Access Protocol	IMAP is also used to copy, move and delete messages from an incoming mail server. IMAP has more features than POP, but the P800 behaves in the same manner whichever is used.
MIME	Multipurpose Internet Mail Extension	MIME is a protocol describing data, for example to define the attachments included in an e-mail.

These standards are supported by most Internet Service Providers and many corporate environments. Any number of E-Mail accounts may be set up – a typical configuration will be one business and one personal account. OTA configuration of E-Mail and ISP accounts is supported. E-Mail accounts and associated ISP accounts may be remotely configured over the air.

Built-in password generators from RSA Security and Secure Computing and make it possible for the P800 to connect corporate networks which use these popular access controls, so allowing corporate e-mail to be used.

When connected via GPRS, automatic polling can be used so that E-Mail is automatically collected and presented in the Inbox. Controls are provided to filter messages based on size, enabling cost and download time to be managed. Another option enables only e-mail headers to be presented in the inbox. Headers are quick to download. The user may read and select headers and request the message to be downloaded.

Attachments may be viewed using the built-in viewers for Microsoft® Word, Excel, PowerPoint® and Adobe® Acrobat® (PDF). More viewers may be loaded from the supplied CD-ROM. See Viewer section for more information.

A signature may be set up so that essential details are automatically copied to the end of each outgoing E-Mail.

The supplied PC Suite for P800 enables E-Mail to be synchronised with Microsoft® Outlook® and Lotus® Notes®. During synchronisation, new e-mail from the PC is transferred in to the

corresponding 'Synchronised e-mail account' inbox on the P800. Messages and replies written using this account on the P800 are transferred and sent via the PC.

Web and WAP based E-Mail can, of course, be accessed using the P800's browser.

Technical Explanation of E-Mail

Configuring and using the E-Mail client in Messages is very straightforward in most cases, especially where the e-mail service is provided by the mobile operator. Reading e-mail from third-party ISP services will normally work over GPRS with no problems. Sending e-mail may require some special configuration, however. This section provides a basic explanation of the end-to-end path involved in an e-mail transaction and some of the issues that may be encountered when using GPRS. Note that all examples refer to a POP server, but equally apply to an IMAP server.

A more detailed explanation of GSM and GPRS is given in the chapter 'Technical Explanation of CSD, HSCSD and GPRS' later in this document.

A common PC solution is to connect to the internet using a modem and a circuit-switch call over the public telephone network. In the diagram below, User B's laptop PC uses this method to connect to the internet using Internet Service Provide ISP B.

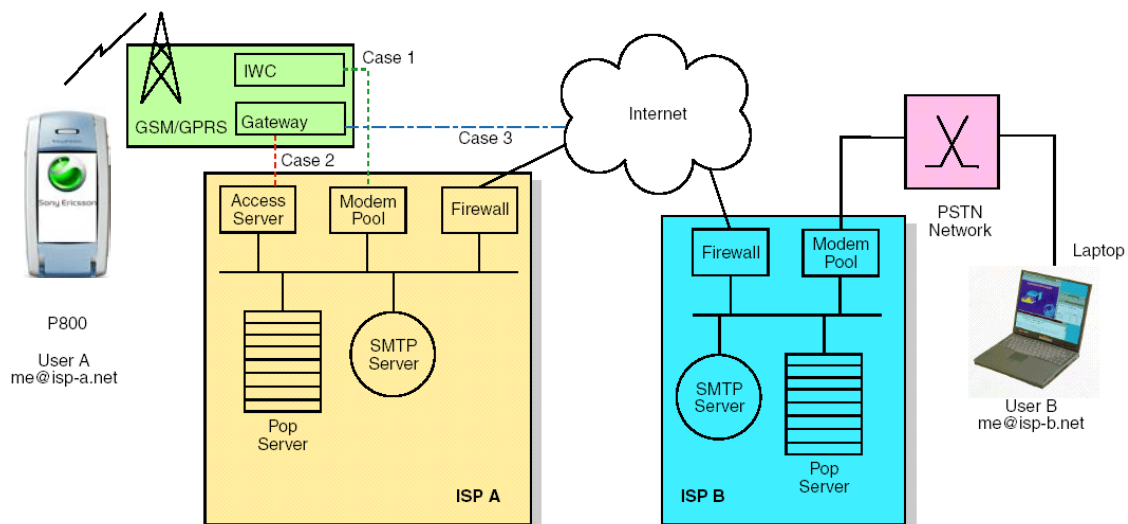

User B has an e-mail address me@isp-b.net and communicates with the POP server at ISP B to receive mail and uses the SMTP server at ISP B to send mail. Note that these servers are inside the ISP's facility and that a firewall exists between the ISP and the internet itself.

When me@isp-b.net sends an e-mail to me@isp-a.net, the e-mail client on User B's laptop will connect to the SMTP server and ISP B, which will in turn connect over the internet to the POP server at ISP-A and transfer the message. The e-mail will be stored here until User A connects to retrieve waiting messages.

User A has a P800 and therefore several different ways of connecting to the internet:

1. Using CSD/HSCSD to an ISP service offered by the network operator or a third party
2. Using GPRS to connect to an e-mail service offered by the network operator
3. Using GPRS to connect to an e-mail service offered by a third party

In case (1) User A will connect using a circuit –switched call in much the same way as User B. A circuit-switch call will be established from the Interworking Centre (IWC) at the mobile operator to the modem bank at ISP-A. The P800 Messages application will perform a 'Get&Send' operation. Messages will access the POP server at ISP A and collect waiting messages.

If User A now replies to the message and selected 'Send Now' on the P800 whilst connected to internet, the Messages application will connect to the SMTP server at ISP A, which will in turn connect to the POP server at ISP B and the message will be transferred.

In Case (2) everything happens as in case (1) except that the connection to the ISP is made directly from the GSM/GPRS network using TCP/IP networking rather than modems. Because everything is managed by the mobile operator, the POP and SMTP servers can be made available.

In case (3) the P800 will be connected to the internet via the GSM/GPRS network and the route to the servers is over the internet. Most ISPs allow a connection from the internet to the POP server since access to the POP server is password-controlled. In other words, the firewall at ISP A will allow the connection from the P800 Messages application to the POP server to be made. The P800 will therefore be able to collect mail over GPRS.

Sending e-mail requires access to the SMTP server. The ISP will have configured the SMTP server to behave differently when the user is accessing it from the internet. This is done as a precaution against it being used to send spam (unwanted e-mail). E-mail send is therefore likely to fail when connected over GPRS and trying to use the third party ISP settings for SMTP.

Typical configurations include:

- Block all external access to the SMTP Server
- SMTP server works provided the sender address is in a domain belonging to the ISP.
- SMTP server works provided the recipient is in a domain belonging to the ISP.
- SMTP server works only after a successful login has been made to an associated POP server.
- SMTP server requires a username and password

There are a number of possible workarounds:

- Switch to an e-mail service offered by the mobile operator
- Check if the SMTP server can be accessed in 'Secure Mode' using a password.
- Find out if the mobile operator has an SMTP server configured to work where the sender e-mail address belongs to a different domain.
- Try checking the mail on the POP server and then sending – some ISPs will allow access to the SMTP server from a user who has recently successfully logged in to the POP sever
- Ask the ISP to allow external access from the IP number range used by the mobile operator's GPRS service
- Connect to the ISP using CSD or HSCSD when e-mail needs to be sent

E-Mail Fetch and Delete Operation

The P800 is designed to work both as the only means of accessing e-mail and to work together with a PC which accesses the same e-mail account. It is useful to explain how each case works.

Basic Operation

The P800 Messages application fetches e-mail from the POP server using the COPY method. This means that each e-mail is copied from the sever and therefore two copies exist, one at the server and one in the P800 e-mail inbox.

When a message in the P800 inbox is deleted, the P800 will delete it from the server the next time it connects and does a 'Get&Send' operation.

	1	1	1	1	1	1	
	2	2	2	3	2	3	
	3	3	3	4	3	4	
	4	4	4	6	4	6	
	5	5	5		5		
	6	6	6		6		
P800	Server	P800	Server	P800	Server	P800	Server
Starting state		Get&Send 1		Deletions		Get&Send 2	

In the above example, there are 6 waiting e-mails on the POP server when the P800 does the first Get&Send for the mail account. After the Get&Send all 6 e-mails are copied to the P800 inbox (header only or body, depending on advanced settings). The user then deletes messages 2 and 5. After the second Get&Send, messages 2 and 5 have also gone from the POP server.

If the P800 discovers during a Get&Send that a message has been deleted from the server, for example by another e-mail client, then it will also be deleted from the P800 inbox.

Sent messages are stored in the P800. Sent e-mails will need to be deleted as required to free up storage space.

E-Mail account accessed only by the P800

The P800 e-mail inbox will stay synchronised with the POP mailbox at the ISP. The action of tidying up the P800 inbox will automatically tidy the POP server inbox upon the next Get&Send operation for the e-mail account in question.

E-Mail account accessed by the P800 and another device

A common configuration is to use the P800 to access e-mail whilst on the move, but to maintain a master copy of e-mail on a PC.

The E-Mail client on the PC must be set to copy from the server. For example, in Microsoft Outlook Express this is done by selecting Tools, Accounts, Properties, Advanced tab and tick 'Leave a copy of messages on server'

All messages will now be received at both the P800 and the PC.

From time to time it will be necessary to delete messages on the P800 in order to create free storage. Before doing this, ensure that the PC has already collected the messages that will be deleted on the P800.

E-Mail account accessed by the P800 and another device – Alternative

If the P800 is only used for reading mail when away from the PC and it is not required to retain any mail on the P800 after it has been copied to the PC then this alternative may be preferred.

Leave the PC e-mail client on the default setting of MOVE messages from the server (i.e. do not leave a copy of the message on the server). In this case the behaviour will be as follows:

1. PC Sends and receives e-mail before leaving the office.
2. P800 inbox will be emptied if 'Get&Send' is performed immediately after the PC
3. New messages through the day will be received on the P800
4. Upon return to the office, a Send and Receive on the PC will collect the day's messages, minus any that were deleted on the P800.
5. P800 inbox will be emptied if 'Get&Send' is performed immediately after the PC

Area Information

Area Information, commonly known as SMS Cell Broadcast, is a method of sending text messages to mobile phones within a certain part of the network. For example, traffic news can be sent to users in a single cell or a group of cells. It is not widely deployed by network operators.

Information is organised into numbered channels. The user selects the required channels in the P800 Control Panel, Messaging Accounts, CBS tab. The requested text messages are received and placed in the 'Area info' mailbox.

Cell Information may be switched on and off in the Control Panel. When enabled and supported by the network, the ID of the current cell (or group of cells) will be displayed underneath the network operator name in the FC phone display. This is often the telephone area code or postal code of the current location.

Document Viewer

The P800 Viewer application enables the user to manage and view a wide range of document formats. A set of plug-ins is included for common document types and more can be loaded from the Multimedia for P800 CD-ROM. Viewer will list the documents that it finds on Internal and Memory Stick storage. Documents can be opened from the list.



Viewer is also automatically started when opening an e-mail attachment, in which case the user can also choose to save the document.

Exact options whilst viewing a document depend on the document type. For example, when viewing a Microsoft® Word document, draft (text only), Normal (text, tables, graphics) and Page (whole page on the screen) views are available. Text can be copied from the document and pasted into, for example, a Jotter note or an e-mail.

Viewer supports a subset of functionality in each case, for example Word headers and footers will not be displayed.

Documents can be exchanged using Memory Stick, infrared, Bluetooth wireless technology, MMS and e-mail.



When viewing a PDF document, it can be fitted to the width of the screen or to the window.

It is also possible to zoom in and out.

Document Types Supported

Document type	Group	Location	Notes
Adobe® Acrobat® (PDF)	Built-in	Built-in	
Microsoft® Excel	Built-in	Built-in	
Microsoft® Powerpoint®	Built-in	Built-in	
Microsoft® Word	Built-in	Built-in	
Rich Text File (RTF)	Extended Office	CD	
Microsoft® Project	Extended Office	CD	
Microsoft® Visio®	Extended Office	CD	
Microsoft® Excel	Extended Office	CD	Older formats
Microsoft® Powerpoint®	Extended Office	CD	Older formats
Microsoft® Word	Extended Office	CD	Older formats
Corel® Wordperfect®	Wordperfect	CD	4.0 to 8.0
Corel® Wordperfect® Graphics	Wordperfect	CD	
Corel® Presentations	Wordperfect	CD	
Corel® Quattro® Pro	Wordperfect	CD	
Lotus® 1-2-3®	Lotus	CD	
Lotus® Ami Professional Draw	Lotus	CD	
PKZip®	Archive	CD	
Gnu Zip	Archive	CD	
CGM	Graphics	CD	
Fax	Graphics	CD	
PCX	Graphics	CD	
Ichitaro	Other	CD	
Microsoft® Outlook® message file	Other	CD	
PFS: First Choice	Other	CD	
PFS: Write	Other	CD	

Browser, M-Services and MeT

The P800 features an integrated browser capable of browsing WAP, Web (HTML) and cHTML content from a common User Interface (UI).

M-Services

M-Services is a set of feature guidelines published by the GSM Association with the support of leading mobile network operators and handset manufacturers. These include easy start-up for the user, better user experiences, easy download of contents, and simple charging models. Technically, the guidelines cover existing standards including WAP, MMS, EMS, SIM-AT and SyncML. Requirements are also made in the areas of UI, MIME descriptors, media formats and codecs.

For developers and operators, this means that a standardised yet rich set of services can be deployed simply. Users will be able to enjoy a new world of consistently available and advanced mobile internet services such as:

- Pictures
- Wallpapers
- Screensavers
- Audio / Ring signals
- Games

The P800's large colour touch-screen, dedicated browser access button and large amount of memory exceed the requirements of M-Services. The UI meets many of the recommendations. Since the P800 has a proper filing system for storage of media, download content is typically stored to file such that it is available to many applications including the P800's personalisation settings. The P800 supports both WAP Provisioning and the established Ericsson/Nokia OTA provisioning standards – see Personalisation and Customisation section for more details.

MeT – Mobile electronic Transactions

With the introduction of WAP it has become possible to access mobile Internet services and undertake mobile e-commerce transactions. One of the key elements is the ability for any phone to operate with any service in this mobile e-commerce environment. This is why Sony Ericsson, Motorola, Nokia, Panasonic, NEC, Siemens and others have teamed together to create a common industry framework for mobile commerce - the Mobile electronic Transactions (MeT) initiative. Members come from handset manufacturers, financial institutes, mobile operators, security specialists and technology /solutions vendors. The MeT initiative co-operates with MasterCard International's Global Mobile Commerce Forum.

MeT has the aim of establishing a framework for secure mobile transactions, ensuring a consistent user experience independent of device, service and network. It is a global initiative to ensure that interoperable mobile transaction solutions are developed around the world - enabling consumers to access goods and services seamlessly wherever they may be.

MeT builds upon existing industry standards such as WAP, WTLS, WIM and WPKI.

MeT covers the following core functions:

Initiation	Providing the Personal Trusted Device (PTD) with key pairs for authentication and signing.
Registration	Providing the PTD with certificates associated with its keys.
Secure Connection	Establish an encrypted link with the server in order to keep information private.
User Authentication	Prove the identity of an individual or an application.
Digital Signatures	Authorise a contract by means of a user signing text (see example below)

The P800 fulfils the compliance requirements for MeT version 1.0, (February 2001), according to the following MeT specifications:

- Met Core Specification
- MeT PTD Security Requirements
- MeT CUE Consistent User Experience

More information on MeT may be found at <http://www.mobiletransaction.org/>

MeT Example

Whilst shopping around for a new television set, the user finds a good price from a store and decides to order immediately. The store requests a 'signed text' confirmation from the customer:

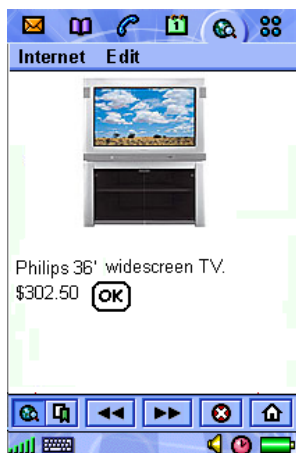

As with many online transactions, the user enters all the details and must then press OK to confirm the transaction.

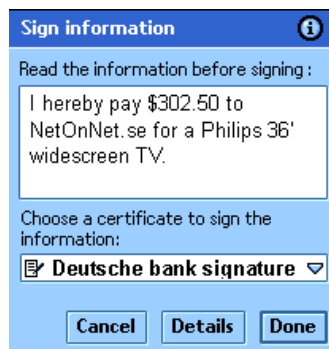

The user is requested to sign the transaction using a suitable certificate.



The certificate has a related signature PIN. The user enters the PIN to confirm the transaction.

P800 Browser

Content Types Supported

The P800 browser, called "Internet," supports all of the following content types within a single browser, directly or via a gateway/proxy.

World Wide Web (WWW) - HTML



The WWW is the most popular method of publishing information on the internet and on company intranets. Content is organised using the Hypertext Markup Language (HTML).

The P800 browser can read HTML pages and therefore gives access to a vast amount of existing material. Of course, much of the content on the WWW is aimed at large screens and will therefore require scrolling on the P800. However some websites, and more frequently those of interest to the mobile user, have 'low graphics' or 'mobile friendly' options which are better suited to small screens.

HTML 3.2 is supported, minus some features that are applicable to large screen devices such as PCs. The main points to note are that the P800 browser does not support Frames or Javascript

Wireless Application Protocol (WAP) - WML

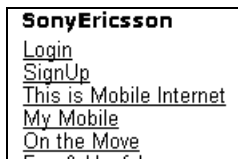

WAP uses Wireless Markup Language (WML), which is like HTML but specially optimised for mobile devices. The P800 browser is compliant with WML 1.3 and therefore gives access to a world of existing WAP content. The large touch screen and multiple WAP accounts make it easy to access and surf WAP pages

Wireless Application Protocol (WAP) 2.0 – xHTML



Extensible Hypertext Markup Language, xHTML, is a combination of HTML 4.0 and XML, managed by the World Wide Web Consortium. xHTML Basic provides a common subset of features to enable the design of pages that will work on small handheld devices, yet rich enough for content authoring. In WAP 2.0, xHTML Basic is extended with additional markups to create xHTML Mobile Profile. This is the core markup language for WAP 2.0.

WAP 2.0 introduces many new facilities including colour graphics, animation, large file downloading and improved menu handling.

The P800 browser supports xHTML Mobile Profile.

cHTML



Compact HTML is a version of HTML optimised for small handheld devices. It is widely used in Japan. The P800 browser will display cHTML content where it is available on the internet or from mobile operators over GSM/GPRS.

Browser UI

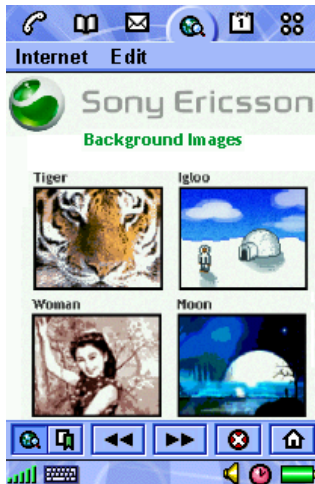

The browser is always close at hand, having a dedicated hardware button. It may also be reached from the application picker and the application launcher.

The browser is used in FO mode.

The touch screen makes navigation very quick and simple – just tap a bookmark or a link to navigate. The Jog Dial can also be used to scroll the page. To work with an object on a page, such as an image, tap and hold it. A menu will be displayed listing available options such as Save, Copy, Send As.

To open a new URL, click Internet and select Open Page. Local HTML content can be browsed, for example from the Memory Stick:
<file:///d:/Media%20files/document/menu/menu.htm>

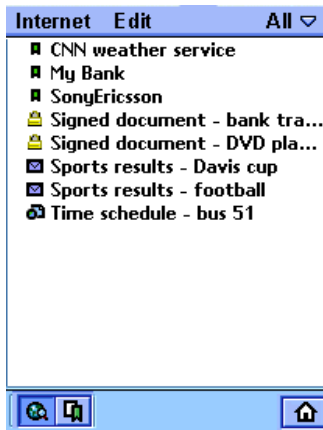

Bookmarks and other information is presented in a simple list view. Just tap the text of a bookmark to view the page. Tap the icon to view the bookmark details. As in the R380, WAP Accounts may be stored in a bookmark, ensuring that the correct WAP/internet service provider is used to access the required page.

Pages may be saved to local storage. They are kept in the bookmarks list and may be opened offline.

WAP Push messages are received within the browser and presented in the list view.

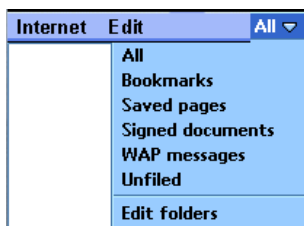

The user may organise bookmarks into user-defined folders, for example creating a folder of sports bookmarks and a folder of transport bookmarks.

It is also possible to view a list of all signed documents (see MeT example above) and access incoming WAP Push messages.

Browser Security

World Wide Web

The P800 supports the TLS/SSL to provide a secure encrypted link between the browser and the website. This method is commonly used for secure transactions on the WWW. An icon in the display indicates when a secure connection is in use.

WAP Security

When using certain WAP services the user may want a secure connection between the phone and the WAP gateway, for example when using banking services. An icon in the display indicates when a secure connection is used. The P800 is based on the WAP 2.0 specifications where security functionality is specified with a technology called Wireless Transport Layer Security (WTLS) and WAP TLS Profile..

The WAP protocols that handle the connection, its transport and its security are structured in protocol layers. The security is handled by the WTLS layer operating above the transport protocol layer. There are 3 WTLS classes that define the levels of security for a WTLS connection:

- WTLS class 1 involves encryption with no authentication.
- WTLS class 2 involves encryption with server authentication.
- WTLS class 3 involves encryption with both server and client authentication

Server authentication Requires a server certificate stored at the server side and a root certificate stored at the client side.

Client authentication Requires a client certificate stored at the client side and a trusted certificate stored at the server side.

A Wireless Identity Module (WIM) can contain both trusted and client certificates, private keys and algorithms needed for WTLS handshaking, encryption/decryption and signature generation. The WIM module can be placed on a SIM card and will then be referred to as a SWIM card.

Certificates

To use secure connections, the user needs to have certificates saved in the phone. User certificates can be downloaded. There are two types of certificates:

Certificate authority A certificate used to verify that a WAP site is genuine. If the phone has a stored certificate of a certain type, it means the user can trust all WAP gateways which present a certificate that can be verified by the trusted certificate. Certificates can be preinstalled in the phone, pre-installed in the SWIM, or downloaded from the trusted supplier's WAP page.

User certificate A personal certificate that verifies the user's identity. A bank that the user has a contract with may issue this kind of certificate. User certificates can be pre-installed in the SWIM card.

The P800 is loaded with WTLS/X509 certificates from Baltimore, CTE Cybertrust, Entrust, GlobalSign and VeriSign.

WIM Locks (PIN Codes)

There are two types of WAP security locks (PIN codes) for the WIM on SIM. The locks protect the subscription from unauthorized use when browsing. The locks should typically be supplied from the supplier of the SWIM.

Access lock	An access lock protects the data in the WIM. The user is asked to enter the PIN code the first time the SWIM card is accessed when establishing a connection.
Signature lock	A signature lock is used for confirming transactions - like a digital signature.

Push Services

These are useful for sending updated WAP site contents or WAP links to mobile users. Examples of services that can be implemented using push services:

- Notifications about new E-Mails, voice mails, etc. Instant messaging and chat
- News, sport results, weather forecasts, financial information (stock quotes etc.)
- Personal Information Manager (PIM) - delivery of contacts, meeting requests etc.
- Interactive games, e.g. play poker with a friend

There are two different forms of Push services, Service Indication and Service Loading. Reception of push messages and automatic load of URL (see below) may be turned on and off in the P800 user preference settings.

Service Indication (SI)

A Service Indication message contains a short text message and a URL. In the P800, these types of messages are typically stored in the WAP messages inbox which is integrated with the bookmark list in the browser application. When the user opens a message, both the text message and the URL will be displayed. The user has the options to postpone the message, load the URL or to delete the message.

Service Loading (SL)

A Service Loading message contains a URL. When such a message is sent to the P800, the URL will automatically be loaded into the browser application if the user is currently browsing the same site; otherwise it will be treated as a Service Indication message.

Opera Browser

Opera Software produces a fast standards-compliant browser for multiple platforms including UIQ. The Opera browser supports frames, javascript, plug-ins and much more whilst having a very compact code size. Opera has developed a technology called Small Screen Rendering which reformats full websites to fit the small screens of mobile devices without the need for scrolling. This technology resides in the browser and does not depend on any additional server capability in the network. Opera has demonstrated this technology on the P800 and is currently porting it to UIQ. For further information visit <http://www.opera.com/>

Symbian OS Operating System

Symbian is the company that developed the Symbian OS technology. Symbian OS is the operating system for Wireless Information Devices, and can be found in a wide range of PDA, 'communicator' and 'smartphone' designs. The Symbian OS technology delivers application and communication capabilities in a small package - it has a robust system kernel, powerful object-oriented middleware, industry-standard communication protocol suites, and an optimised implementation of Sun's Java™ language. Symbian OS is the largest-selling operating system for smartphones and communicators.

The P800 is based on Symbian OS v7.0 and the established UIQ UI. Sony Ericsson and Symbian have been actively working with software developers for some time, and a range of UIQ-based applications have already been publicly demonstrated. Sony Ericsson is also an active participant in developer events such as the Symbian Developer Conference and Java One.

Third party applications may make use of the communications, display and storage facilities of the P800. Such applications may therefore be much more powerful than browser-based applications, enabling games to be faster and more exciting, for example. Applications from other PDA OSs and from the PC world may be expected to be ported across to the P800. Applications already available for Symbian OS (for example, on Psion products) may be ported by the supplier to run on the P800.

The P800 supports Java-based applications. Java technology is platform-independent, portable, modular and secure. Java applications are easy to develop, deploy and maintain. Because it supports both PersonalJava™ and J2ME CLDC/MIDP (see next page), the P800 is ready to run many applications written for handheld computers and mobile phones.

The P800 has 12 Mbyte user data space in which settings, user data and third party applications are stored. (9Mbyte on the P802). Applications are easily downloaded directly to the P800 using the browser, or may be installed from a connected PC.

Key consumer applications for the consumer include games, instant messaging, chat, information and entertainment. Corporate applications may be deployed, extending information access to the P800.

Open Environment

Applications may be written in both C++ and Java. Supported Java environments are PersonalJava™ and J2ME CLDC/MIDP, both of which are optimised for quick start-up time.

C++

C++ is the most comprehensive and flexible programming environment, which enables rich applications to be developed. C++ applications will run faster than those written in Java.

Java

Java is a widely used and extensible programming platform, which makes the development of personalized applications and content much easier. Originally developed by Sun in 1991, Java is a programming language used to develop applications – utility programs, games, plug-ins etc. – for different hardware and software platforms. Users of Java-enabled devices can install new applications and games to make their devices more personal and adapt them to specific needs.

Sun marketed Java as a “write once, run anywhere” concept, which at the time was a good description of Java’s strength. Simply put, Sun based the Java concept on two parts, the Java application and the Java interpreter, known as the Java Virtual Machine (JVM). A Java application cannot run by itself, it needs an interpreter that translates the code and runs the program. This was really the secret behind Java’s ability to work on various platforms. A developer could write an application without having to think about different computers and operating systems as long as hardware and software manufacturers included Java Virtual Machines in their products.

Even if “write once, run anywhere” still applies to some degree, the evolution of handheld computers and telecommunications forced Sun to adapt Java to the requirements of mobile devices with small displays and slow connections. This has led, among other things, to the development of PersonalJava and subsequently to Java 2 Micro Edition, (J2ME).

PersonalJava™

PersonalJava, also known as pJava, is an edition of Java appropriate for mobile devices such as PDAs. It is suited to more powerful mobile phones and PDAs, such as the P800, and has a richer development environment and can interact more extensively with the P800 functionality compared to J2ME MIDP/CLDC.

PersonalJava was transferred into the J2ME platform in 1999, becoming the J2ME CDC/Personal Profile. However, CDC/Personal Profile has not really taken off yet and, pending its breakthrough, PersonalJava will still be a powerful option for years to come.

The P800 includes Symbian’s implementation of PersonalJava according to the Sun Microsystems ‘PersonalJava Application Environment Specification (PJAE)’ version 1.1.1, January 7, 1999. That version corresponds to a Sun JDK 1.1.7 implementation.

PersonalJava applications can make use of the following services:

- TCP/IP network communication
- Graphical User interface library – AWT widgets are mapped on to Symbian OS controls where applicable)
- JavaBeans support
- Virtual Keyboard and Jog Dial (up, down, select) input
- File System access
- Time/Date sensing
- JNI – Java Native Interface

PersonalJava applications are typically transferred to the P800 from a connected PC.

PersonalJava applications are used in FO mode. If the flip is closed, the application will receive an event and may choose to close or continue running in the background. There is no UI available in FC mode.

J2ME CLDC/MIDP

J2ME CLDC 1.0 (Java2 Micro Edition, Connected Limited Device Configuration, version 1.0) is an edition of Java aimed at small resource-constrained mobile devices where the runtime environment must fit into a few hundred kilobytes of memory (as compared to the 2.5Mb required for a typical PersonalJava environment).

MIDP (Mobile Information Device Profile) defines a programming API which has gained wide industry acceptance, and many MIDP compliant mobile phones are anticipated to come to market. A large number of applications for this environment is therefore to be expected.

The P800 supports this J2ME CLDC 1.0 / MIDP 1.0 environment. Applications may make use of the following services:

- Persistent storage (RecordStore class only – no access to the rest of the filing system)
- J2ME canvas size is 208 x 172
- Touch Screen
- Virtual Keyboard and Jog Dial (up, down, select) input

J2ME/CLDC uses a security model, often referred to as a sandbox. The sandbox includes a number of system components working together to ensure that untrusted applications cannot gain access to system resources.

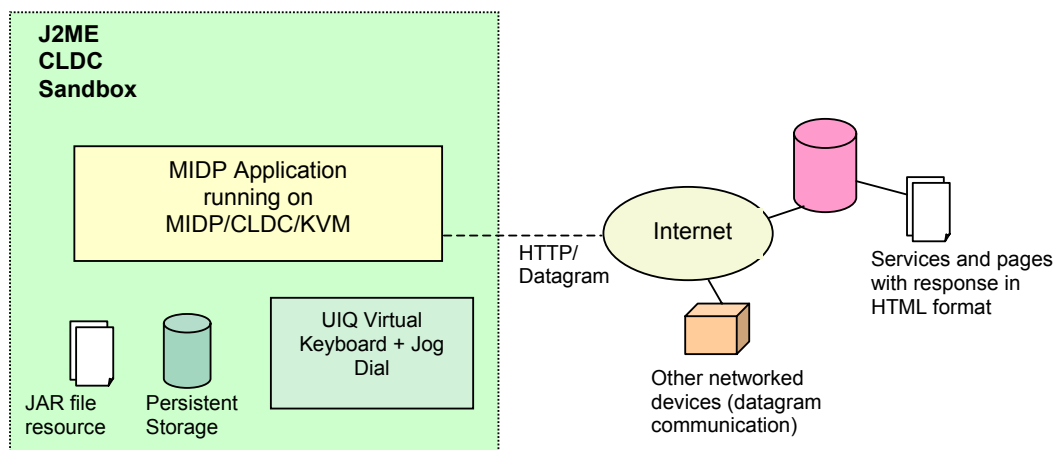

MIDP applications can interact with arbitrary remote services that exist as a URL. Data may also be exchanged with remote devices that accept an HTTP or datagram connection.

Applications are typically downloaded from the mobile operator's portal or the internet.

Applications are used in FO mode. When the flip closes, the instance of the Virtual Machine is not visible, but the user may return to the application by selecting it from the Application Launcher.

P800/UIQ Feature Support

The P800 has features that are currently not accessible through the UIQ SDK, including the Camera, Memory Stick, MMS, Browser and Audio/Video Player APIs.

Developer Support



A range of developer support options are available:

Sony Ericsson Advanced Developer Support

Our most comprehensive annual support service package, the Advanced Developer Support equips professional developers with everything they need to successfully develop world-class applications for Sony Ericsson products. With this support contract, developers get access to a high-quality online support with fast response and resolution times and up to 50 technical support incidents. They also get access to early technical product information and development tools as well as the complete range of interactive and static online support resources. This service requires a paid subscription.

Sony Ericsson Basic Developer Support

The Basic Developer Support is an annual support service package that provides developers with all the basics to successfully develop world-class applications for Sony Ericsson products. With this support contract, developers get access to a high-quality online support with same-day response and resolution times, five technical support incidents as well as the ability to purchase more. They also get access to complete technical product information and development tools as well as the whole range of interactive and static online support resources. This service requires a paid subscription.

Sony Ericsson Online Support

Some online resources are available to all developers for free, all that is needed is to register as an Ericsson Mobility World Community member. After registration, access is granted to selected technical product information and development tools as well as limited access to interactive and static online support resources.

Developer Tools

Metrowerks Code Warrior Development Studio for Symbian Version 2

CodeWarrior™ Development Studio for Symbian OS is Sony Ericsson's choice for native application development on Symbian OS. CodeWarrior is the essential toolset for developing advanced applications for the P800. CodeWarrior's native C/C++ support, its award-winning integrated development environment (IDE), and its tight integration with Symbian OS v7.0 UIQ SDK give provide everything needed to get applications to market quickly.

For full details, refer to <http://www.metrowerks.com>

Professional Edition

The professional edition (\$1495) offers these features:

- Support for all Symbian OS v7 target applications
- Support for Symbian OS v7-based Software Development Kits
- Integrated x86 emulation debugging support
- Integrated Symbian descriptor presentation in debugger
- Integrated and updated Symbian build components, including AIF, Resource Compiler, Bitmap Compiler, and .sis file compiler
- Integrated remote debugging on development boards and Symbian OS v7-based smartphones with MetroTRK (target resident kernel)
- Specify multiple development board targets

Personal Edition

The personal edition (\$495) offers these features:

- UIQ SDK for Symbian OS v7 Sony Ericsson P800
- Windows x86 emulation debugging support
- Symbian descriptor presentation in debugger
- Updated Symbian build components including AIF, Resource Compiler, Bitmap Compiler and .sis compiler.

CodeWarrior™ Wireless Development Kit for Symbian OS™ (P800 development kit)

This development kit includes everything required to get started developing killer applications on the Sony Ericsson P800 phone. It includes CodeWarrior Development Studio for Symbian OS, Personal Edition, one pre-commercial sample of the Sony Ericsson P800 and all the necessary cabling you need to get started.



The kit costs \$1150. For further information, go to <http://www.SonyEricsson.com/developer>

Symbian OS v7.0 UIQ SDK for Sony Ericsson P800/802

The UIQ SDK is used to build applications for the Sony Ericsson P800/P802 phones. The SDK contains library files, documentation, sample code, tools and utilities for building P800 applications in C++ and for creating installation files of C++ and Personal Java applications. It also includes a UIQ emulator, which requires CodeWarrior Development Studio for Symbian OS to run C++ applications.

The SDK is a free download from <http://www.SonyEricsson.com/developer>

Recommendations (Java development)

The UIQ SDK includes support for both Personal Java and J2ME CLDC/MIDP and can be used with Integrated Development Environments (IDE) for Java such as Java ONE Studio 4 (Mobile Edition required for J2ME CLDC/MIDP and Community Edition required for Personal Java) or CodeWarrior Wireless Studio. Use the IDE to build the executable Java file (.JAR file) and then test it in the UIQ emulator or in the IDE's Java emulator.

Recommendations (C++ development)

To speed up development, Sony Ericsson encourages testing of a C++ application in the UIQ emulator. However, this requires that the C++ code is compiled with CodeWarrior Development Studio for Symbian OS.

Metrowerks Code Warrior Wireless Studio 7

Code Warrior Wireless Studio 7 is a professional tool for wireless Java development. It includes the following features:

- CodeWarrior tools for Java v6 was the first development tool in the world to comprehensively support J2ME
- Compile, Link, Preverify, Obfuscate, Optimize, Package, and Run or Emulate your application in a single step
- Develop applications for J2SE, PersonalJava, or J2ME CLDC/MIDP Platforms
- Full support for JDK 1.1.x, 1.2.x, 1.3.x and 1.4

Wireless Studio 7 costs \$599. For full details, go to:

http://www.metrowerks.com/MW/Develop/Wireless/Wireless_Studio/default.htm

Sun One Studio

Sun™ ONE Studio 4 update 1 is the latest release in the Sun ONE Studio line of Integrated Development Environments (IDEs) for Java™ technology.

For full details go to: <http://www.sun.com/software/sundev/jde/buy/index.html>

Community Edition

The Community Edition supports development in both pJava and MIDP.

- Create stand-alone applications, applets, and JavaBeans[tm] components, or build database-aware Web applications
- Supports development of JavaBeans components, JavaServer Pages™, (JSP™), Servlets, and JDBC™

Mobile Edition

The Mobile Edition supports the development of MIDP applications:

- Develop and test MIDlet applications. Source level debugging is available using the integrated debugger.
- Mount multiple third party emulators and SDKs to the IDE and rapidly switch emulator devices.

Personalisation and Customisation

The P800 may be personalised by the user and customised at the factory:

- By the User (via the UI, including interactive M-Services).
- By the User via PC-based utility applications.
- Via Over The Air (OTA) configuration, initiated by operator, user or IT helpdesk.
- In the factory or at a Sony Ericsson Service Point, on behalf of a mobile operator.

User Personalisation

Wallpaper and Application Shortcuts



The user may set a static image to be the background 'wallpaper' for the FC standby screen. Image size is 208 x 144 pixels and formats JPEG, GIF, BMP, WBMP, MBM and PNG are supported. Larger images, for example, a 640x480 picture from the CommuniCam, will be resized to fit.

Wallpaper images may be selected from internal or Memory Stick storage. They can also be downloaded via M-Services, beamed in to the P800 using Bluetooth or Infrared, or transferred in over the PC link.



The application shortcut buttons may be personalised by the user. They will disappear after a short period to reveal more of the wallpaper image. Rotating the Jog Dial will redisplay them. They user may switch them on all the time.

Wallpaper is set in Control Panel, Display. A useful shortcut is to tap the battery icon  in the FO Status Bar and select Settings. Wallpaper can also be set directly from a received MMS message.

Screen Saver



A 'screen saver' image is displayed after a period of inactivity. The user can switch this facility on and off and select the delay period before the screen saver is displayed. Image size is 208 x 320 and format is the same as the Wallpaper image above, with the addition of support for animated GIF. Note that use of animated GIF increases power consumption. The top part of the image is displayed in FC mode and the entire image is displayed in FO mode.

Device lock may be used in combination with the screen saver. Upon pressing a button or touching the screen, the user will be prompted to activate keys and/or enter the device lock code.

When the screen saver or screen blanker is deactivated, the P800 will revert to the state it was in before the screen saver was activated.

Picture Phone Book

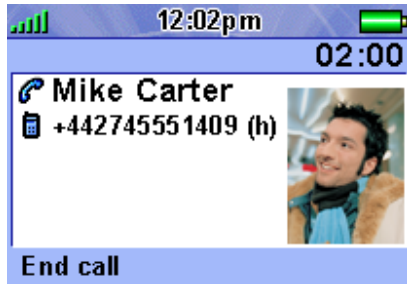

The user may store a picture of each person in Contacts. When an incoming call is received with CLI matching that contact, the contact's picture will be displayed together with the other information. The contact's picture is also displayed when making a call.

Pictures are easily taken using the built-in camera, though of course other images can be loaded in to Contacts. A copy of the picture is held in the Contacts database, therefore the original picture may be deleted or renamed without losing the copy stored in Contacts.

Ringtones



The user can add as many ringtones as desired, subject only to available file space. Ringtones may be collected from many sources including Memory Stick, M-Services, MMS and transfer from a PC.

Any compatible audio file in the multimedia storage (Internal or Memory Stick) can be selected as a ringtone. The P800 can play both iMelody format ringtones and the following polyphonic formats: AMR, AU, MIDI, RMF (Beatnik) and WAV.

A system default ringtone is provided. This is the ringtone when the P800 is first initialised. It cannot be deleted and is retained after a Master Reset.

The user may select a user default ringtone in the Phone application. In FO mode select Edit, Preferences, Sounds and alerts. This will now be played where no Personal ringtone is identified for the incoming call.

A Personal ringtone may be selected for a contact – simply select the required ringtone whilst entering or editing the contact's details. When the Calling Line Identification (CLI) of the incoming call is matched to a contact, the Personal ringtone for that contact will be played.

Ringtones are played directly from the Internal or Memory Stick storage. Therefore, if they are renamed or deleted (using the Audio application), or located on the Memory Stick and it is removed, the P800 will instead play the system default ringtone.

The flow diagram on the next page illustrates the logic for ringtone selection when an incoming call arrives.

If no CLI information is available, then only a default ringtone can be played. If the user has selected a personalised default ringtone and it is available (can be read from the internal storage or Memory Stick) then it will be played, otherwise the system default will be played.

If CLI information is available, the P800 checks the Contacts database to find a contact with the telephone number in question. If a Personal ringtone has been set for this contact, it will be played. If the ringtone has been deleted, moved, renamed or exists on a Memory Stick that is unplugged, then the system default ringtone will be played.

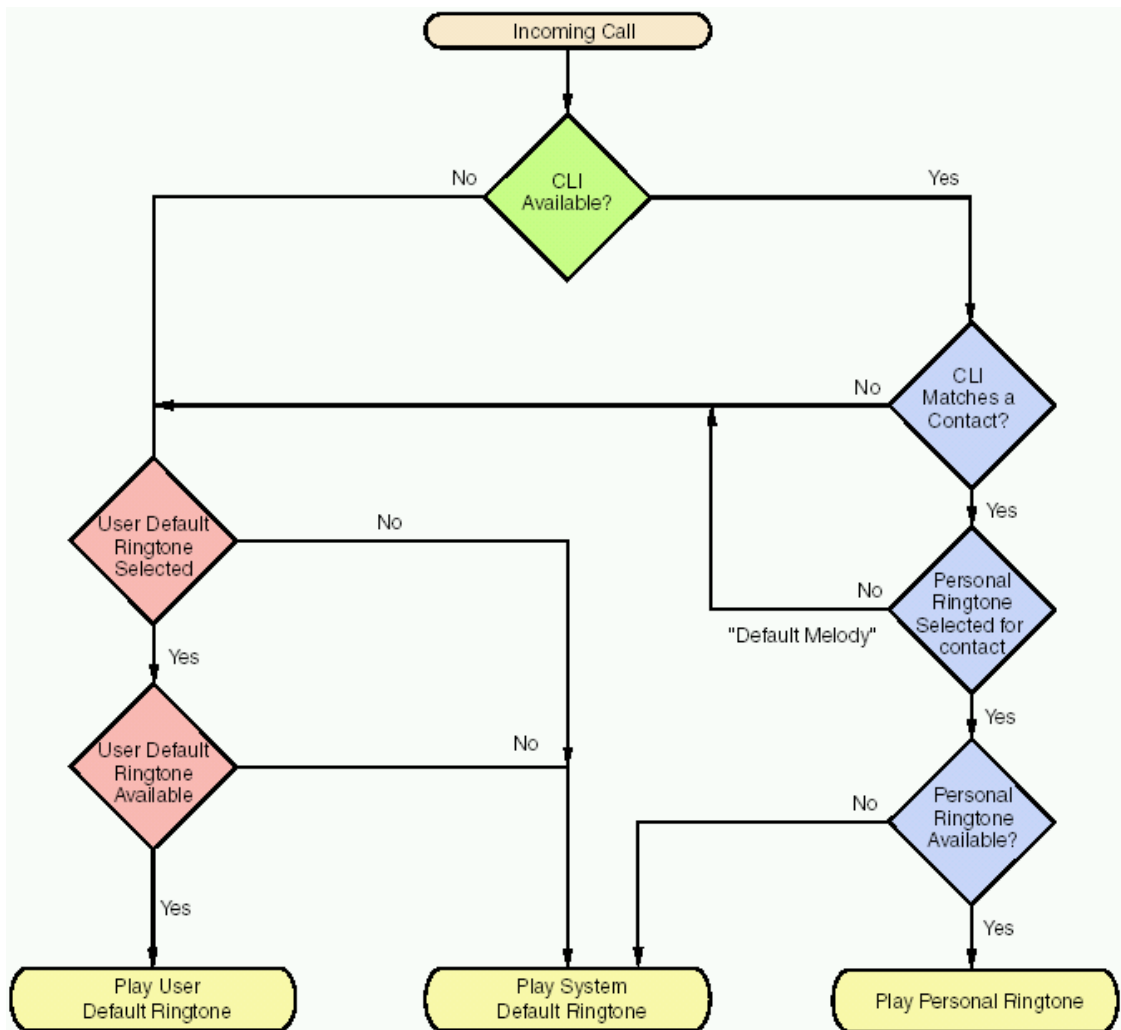

Other Audio Personalisation

The following sounds are may also be personalised in the P800:

- Time (alarm)
- Calendar (reminder alerts)
- Tasks (reminder alerts)
- Messaging (notification of new message)

Sony Ericsson Content

The P800 is supplied with a variety of multimedia material in order to demonstrate the applications and provide the user with a 'starter pack' of useful and fun content. The material supplied on the P800 itself is selected to be acceptable in all cultures and to be independent of time. More contemporary and localised content can be made available via download.

The table below summarises the multimedia content provided in the P800's internal storage, on the Multimedia ROM and from wap.sonyericsson.com. Exact content is subject to change.

Content type	Internal Storage	Extra on CD	Total on Cd	Web/WAP
Wallpapers	9	3	12	30
Screensaver	2		1	
Animated GIF	1	1	2	
Ring melodies	11	2	13	22
Sound effects	5	2	7	7
Music MP3	1		1	
Video Clip	1		1	1
EMS Images	66			
EMS Animations	15			
MMS Templates	8		8	19
MMS Pictures	2			8

The content loaded in the internal storage (apart from EMS) can be deleted by the user and will be lost on Master Reset. It may be restored from the Multimedia CD.

Sample Image Content



Example Wallpaper pictures



Example GIF animation – can be used in MMS messages.

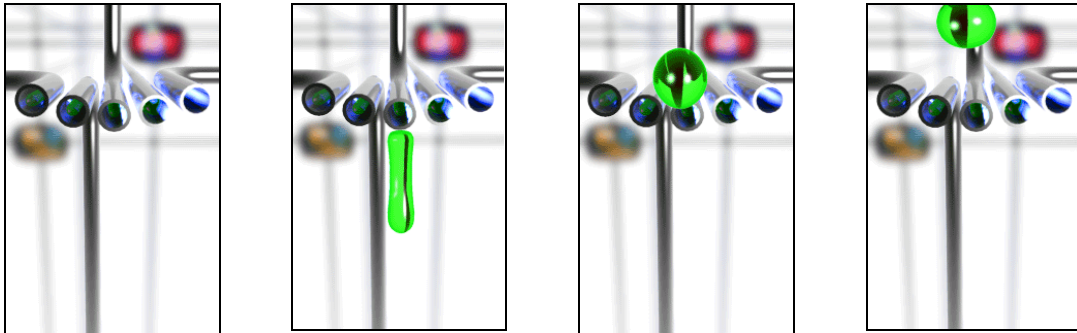

Example screen saver



Example MMS pictures

Audio Content

Ringtones

Name	Type	Size	Location	Notes
System Default	Midi		Fixed	Retained at Master Reset
BigBand	Midi	14kB	Internal	
DrumnBass	Midi	7kB	Internal	
Happy	iMelody	< 1kB	Internal	
Ktechy	RMF	48kB	Internal	
Lithium	Midi	< 1kB	Internal	
Oldfashioned	WAV	35kB	Internal	
Skipdown	iMelody	< 1kB	Internal	
Stowaway	RMF	34kB	Internal	
Techno	Midi	16kB	Internal	
Trance	Midi	10kB	Internal	
Zinc	Midi	< 1kB	Internal	
Frenitian	RMF	65kB	CD	
Samba	Midi	15kB	CD	
Disco	Midi	15kB	WAP/Web	
Flower	Midi	12kB	WAP/Web	
Europium	Midi	4kB	WAP/Web	
Lutetium	Midi	4kB	WAP/Web	
Xenon	Midi	4kB	WAP/Web	
March	Midi	13kB	WAP/Web	
See-through	RMF	24kB	WAP/Web	
Semba	Midi	17kB	WAP/Web	

Sound Effects

Name	Type	Size	Location	Notes
Default alerts			Fixed	Retained at Master Reset
Arrow sound	WAV	13kB	Internal storage	
Bird	Midi	5kB	Internal storage	
Car horn	WAV	23kB	Internal storage	
Door bell	Midi	1kB	Internal storage	
Tap to	Midi	1kB	Internal storage	
Car brakes	WAV	39kB	CD	
Rooster	WAV	107kB	CD	
Drum roll	Midi	5kB	WAP/Web	
Plane	WAV	60kB	WAP/Web	
Ring-futuristic	Midi	11kB	WAP/Web	
Ring-symphony	Midi	8kB	WAP/Web	

Music

Name	Type	Size	Location
Lateral Thinking	MP3	800kB	Internal Storage

Video

Sony Ericsson 'World of Connectivity' (713kB)



MMS Templates

Each template has an animation and a sound clip.



Confused



Congratulations



I am late



I miss you



Invitation



Let's go party



Love you



OK

PC Software for Personalisation

Two PC applications may be downloaded from www.sonyericsson.com. The Image Editor is also available on the P800 Multimedia CD.

Sony Ericsson Image Editor

The Sony Ericsson Image Editor lets the user crop, zoom, rotate and adjust colour, contrast and brightness settings for many PC image file formats, and send them directly to the P800. The image can then be used by any application that can access image files on the P800 storage.

Typical uses are to create Wallpapers, prepare pictures of contacts and images to use in MMS messages.

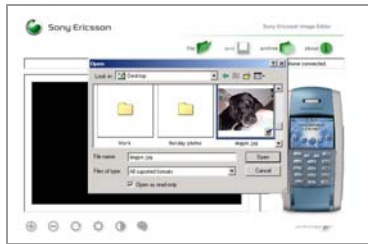

Pictures can be selected from the PC's hard disk or other media.



The required image can be zoomed and cropped. Brightness, contrast and colour balance can also be changed. The edited image is previewed on a replica of the P800.

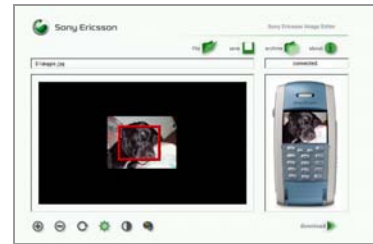

When it is ready, the image can be transferred to the P800 using cable, infrared or Bluetooth.

Sony Ericsson MMS Home Studio

The MMS Home Studio allows MMS messages on to be quickly and easily composed on a PC. The result may be previewed in a P800 emulator on the PC screen and then downloaded to the P800 via infrared, cable or Bluetooth wireless technology.

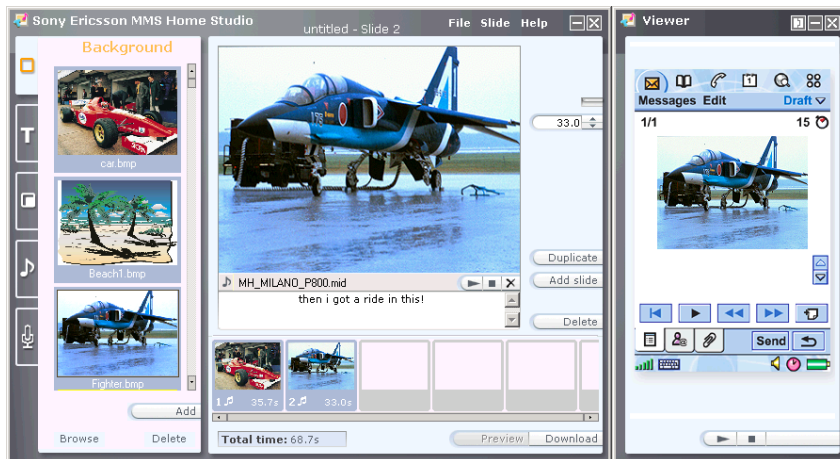

A collection of images and sounds is supplied. Images can be loaded from the PC and are converted to 160 x 120 pixels and the user's choice of BMP, GIF or JPG. Sound recordings can be made, or existing sound files imported for use with MMS. Composed messages may be stored in MMS Home Studio.

Over-The-Air (OTA) Configuration

OTA remote configuration provides simple set-up of services. The user is spared the task of finding complex technical information and then manually entering it via the UI. Instead, a web request or a call to be the mobile operator's helpdesk is all that is necessary – the appropriate settings can then be sent via SMS directly to the P800.

OTA configuration using the Ericsson/Nokia Over The Air Settings Specification enables the following parameters to be provisioned:

- WAP Account (Account name & WAP Gateway settings; Like a WAP Profile on the R380)
- ISP Settings (Bearer information, username, password)
- Bookmark (name and URL)
- SyncML settings
- MMS Settings

The following parameters may be remotely configured according to WAP Forum specifications:

- WAP Account
- ISP Settings

Further OTA configuration is provided using Nokia Smart Messaging. It is used to set up E-Mail accounts, specifically:

- ISP (Bearer information, username, password, IP and DNS addresses, login script)
- E-Mail account (Username, password, address, server details)

Sony Ericsson WAP Configurator

Sony Ericsson's WAP Configurator provides WAP settings for many networks as a free service to owners of Sony Ericsson mobile phones. It may be found at <http://www.sonyericsson.com/>.

Factory Customisation

Factory customisation will be available to mobile operators and volume customers. This enables the hardware, applications, settings and media to be tailored to customer needs, including:

- Customised One-button Internet Access
- Pre-configured settings. ISP, WEB / WAP, GPRS etc
- Pre-loaded content, including screensavers, wallpapers, ring tones, local WAP/WEB pages, pictures, demonstration MMS messages.
- Bookmarks
- Pre-loaded applications. Games, extended security, 3rd party applications
- Organiser entries. Calendar, contacts, Jotter notes, Voice notes etc.
- Certificates
- Customised Flip
- SIM lock

Customisation is carried out by loading the P800 with a uniquely identifiable customisation package, made up from the following elements:

- Default values for user configurable settings
- Default values for hidden settings (i.e. settings unavailable to the user via the UI. Hidden settings are used to switch between customisation alternatives anticipated in the generic system software).
- Preloaded user data (i.e. content such as welcome documents and messages, notes, contacts, etc.)
- Preinstalled executables (i.e. executable wizards, 3rd party applications, etc.)

Games

The P800 is supplied with 4 games. Many more can be loaded thanks to the P800's support for third party applications written in C++, PersonalJava and J2ME CLDC/MIDP.

Solitaire



A solitaire game is included. Options to tap or drag-and-drop for moves and high-score facility. Solitaire is pre-loaded into the user storage area. It may be uninstalled to make more space. It is included on the Multimedia for P800 CD for later re-installation.

Chess



The P800 includes a sophisticated Chess application which includes the ability to play remotely with another player over SMS.

Players are created by selecting them from Contacts or giving them local names within the Chess application. Players may be:

- Local (Computer) – Play against the P800, selecting a suitable skill level.
- Local (Human) – 2 players can use the P800 as a chess board.
- Remote (Human) – Play against another person, exchanging moves using SMS.

Each move is timed and a list of moves may be viewed. It is possible to step backwards and forwards through a game.

Each game is given a name and it may be suspended and saved at any time. The user may therefore have a number of games stored at any time, moving between them as required.

Chess is pre-loaded into the user storage area. It may be uninstalled to make more space. It is included on the Multimedia for P800 CD for later re-installation.

Men In Black II™: Alien Pursuit



The Men In Black agents are once again called to handle an emergency situation. A transporter carrying alien criminals lands on the roof of a shopping mall. Men In Black agents C and R must clean up the mess and hunt down the aliens that are running loose.

This game is provided on the Multimedia for P800 CD-ROM and must be installed before use.

To play, select which agent you want to be. You will be automatically moved through the shopping mall. Aliens are running around. You can shoot them using the stylus. Your basic weapon has a capacity of 6 shots. It is reloaded by tapping the gun icon  or rolling the Jog Dial. Shooting certain aliens will win you a weapon upgrade. The aliens are armed and will shoot back if you are not quick!

You start with 5 style points  and can collect more by eliminating certain aliens. Shooting a civilian will cause you to lose a style point. Agents with no style points are suspended!



The game is suspended by events such as incoming phone calls. When the application is re-started from the Application Launcher, it will continue from the start of the level which was last being played.

Stunt Run



Stunt Run puts you at the wheel of your chosen stunt car on the Sony Ericsson race track! Select a car with your preferred balance of acceleration, top speed and handling and proceed to the starting grid of an easy, normal or hard circuit.

Touch the buttons at the left hand end of the screen for reverse, forwards and fast-forward movement. Use the Jog Dial to steer the car.



The game can be played in Single Player, Multiplayer and Tournament form. The demo mode shows a car driving round the circuit.

This game is provided on the Multimedia for P800 CD-ROM and must be installed before use.

Bluetooth™ Wireless Technology

The P800 features built-in Bluetooth wireless technology. Its short-range radio link operates in the globally available 2.4 GHz frequency band, ensuring fast and secure communications up to a range of 10 metres.

Bluetooth wireless technology is designed to operate also in noisy radio frequency environments, providing reliable and high data throughput. To achieve this, techniques such as frequency hopping and error correction are used. To enforce data security, data can optionally be encrypted.

Bluetooth wireless technology facilitates instant connections, which are maintained even when the devices are not within line of sight. High-quality voice transmission is provided under adverse conditions, making it possible to use a headset connection to the P800 at all times.

Sony Ericsson is a founding partner of the Bluetooth Special Interest Group (SIG). Examples of Bluetooth wireless technology devices that are available now or are expected to be available in the near future include:

- Headsets for wireless voice transmission and remote call control
- PC cards for Bluetooth wireless technology in laptops and PDAs
- MP3 music player
- Other phones for exchanging business cards, ring signals, playing games etc.
- Digital still and motion video cameras
- Printers, hard disks and other storage devices
- Handheld scanners for text, barcodes and images

Please note that restrictions upon the use of Bluetooth may exist in a few countries. Contact a Sony Ericsson representative to check if the use of Bluetooth is restricted in your country. If you are unsure, the Bluetooth function should be switched off until you know the possible scope of any restrictions.

Benefits of Bluetooth wireless technology in the P800

No cables	Bluetooth wireless technology gives a true wireless connection to headset, computers, networks, printers and other devices.
Radio Link	Bluetooth does not require line-of-sight alignment. For example, when using the P800 to connect a laptop to the internet, a Bluetooth link between the laptop and the P800 can be established even when the P800 is placed in a jacket pocket, or placed near a window for better (GSM/GPRS) reception
Several devices	The P800 can maintain several devices, which you trust, in a pairing list, enabling rapid and safe connection when those devices are in range
High transmission speed	Comparable to USB.
Secure and fast	Data connection with a Bluetooth PC/laptop turns the phone into a modem for connecting to the Internet and for data transfer (no need to find and plug in cables or to align infrared sensors).
Synchronisation	Fast synchronization of calendar and phone book with PC/laptop and PDA.

- Beaming Quick exchange of business cards, calendar events and melodies with other phones and devices.
- Low power Low power consumption.

Bluetooth Usage Cases with the P800



Bluetooth Headset

- Make and receive calls using the buttons on the handset and voice command.
- Multiple headsets can be defined, for example a Bluetooth personal headset and a Bluetooth car kit.



Laptop PC / PDA

- Connect to P800 over Bluetooth and use it as a modem to connect to the internet.
- Synchronise data.



Mobile Devices

- Share business cards and appointments using vCard and Vcal
- Share photographs and sound clips

Synchronization & Data Transfer

In everyday life, access to an updated calendar and details of friends and business colleagues is greatly appreciated. To be truly mobile, users must be able to carry their important information with them. Equipping mobile phones with Personal Information Manager (PIM) programs like calendars, task lists and address books gives users access to their most important data anywhere and anytime. The information is kept updated by synchronizing with the information at the office or at home. The growing use of groupware such as Microsoft® Outlook® and Lotus® Notes® means that more and more meetings are booked electronically in daily business life.

The P800 uses the SyncML protocol for synchronisation. This means that it has compatibility to synchronise with a wide variety of devices over a number of different communications media.

SyncML – An Open Standard for Synchronisation

SyncML Background

Leading the way in providing remote synchronization capability, Sony Ericsson realizes that interoperability of remote synchronization is of utmost importance if mobile data usage is to become as widespread as generally predicted. That is why Ericsson, along with IBM, Lotus, Motorola, Matsushita, Nokia, Palm Inc., Psion and Starfish Software, founded the SyncML initiative in February 2000. Supported by more than 600 software and hardware developers, the SyncML initiative seeks to develop and promote a globally open standard for remote synchronization, called SyncML. Unlike many other synchronization platforms, SyncML is an open industry specification that offers universal interoperability. Because it uses a common language, called XML, for specifying the messages that synchronize devices and applications, SyncML has been called the only truly future-proof platform for enabling reliable and immediate update of data. The benefit for the end user is that SyncML can be used almost anywhere and in a wide variety of devices, regardless of application or operating system

What is SyncML?

SyncML is the common language for synchronizing all devices and applications over any network. SyncML leverages Extensible Markup Language (XML), making SyncML a truly future-proof platform. With SyncML any personal information, such as E-Mail, calendars, task lists, contact information and other relevant data, will be consistent, accessible and up to date, no matter where the information is stored. For example, a calendar entry made to a mobile device on a business trip is equally available to a secretary in a network calendar. SyncML is the ultimate choice for remote synchronization.

The P800 uses SyncML for both local synchronization (for example, with a PC using Bluetooth or a cable connection) and remote synchronisation over HTTP.

Designed for the requirements of the wireless world

SyncML is designed specifically with the wireless world's tight requirements in mind. SyncML minimizes the use of bandwidth and can deal with the special challenges of wireless synchronization, such as relatively low connection reliability and high network latency. SyncML supports synchronization over WAP, HTTP or OBEX. As an open, future-proof standard, SyncML is the synchronization choice for any device or application of the mobile information society. For more information on SyncML, see <http://www.syncml.org/>.

Benefits of a common synchronization protocol

End users	Today's user of mobile devices probably uses a different synchronization product with every device. Each technology can synchronize only a few applications, or is limited to a particular type of network connection. This arrangement is expensive to install, confusing to configure and operate, and costly to administer. With SyncML, users will be able to buy devices that synchronize with a broader range of data.
Device manufacturers	Device manufacturers will benefit from a common protocol that will make the device interoperable with a broader range of applications, services, and network and transmission technologies
Service providers	Service providers moving into the growth arena of application hosting are particularly concerned that a proliferation of synchronization technologies will make it impossible to deploy and support their customers in a cost-effective manner. To support the range of data types and devices in use today, service providers must install and configure multiple server infrastructures, maintain and support that infrastructure, and maintain compatibility and performance. The alternative now available, to use a single solution for data connectivity, involves the risk of a tight coupling to a propriety solution. With SyncML, they will be able to provide connectivity to a wider selection of applications.
Application developers	Choosing to support multiple synchronization technologies enables an application to support more types of devices and networked data, but that choice comes at a cost. With SyncML, application developers will be able to develop an application that can connect to a more diverse set of devices and network data.
Network operators	As multiple applications that need remote synchronization over WAP are developed, there will be an automatic growth of revenue for network operators.

Which information can be synchronized?

The P800 supports synchronisation of the following data types:

Application	Remote Sync	Local Sync
Contacts	✓	✓
Calendar	✓	✓
Tasks	✓	✓
Jotter (text part only)		✓
E-Mail	**	✓

** The E-mail implementation is slightly proprietary and therefore not fully Sync-ML compliant. Note that E-Mail can of course be fetched remotely using the Messaging application.

Remote Synchronisation

Remote synchronisation takes place over the air using HTTP and is the ideal way to keep the P800 up to date. Using GPRS, the P800 can be continuously connected to the remote synchronisation server.

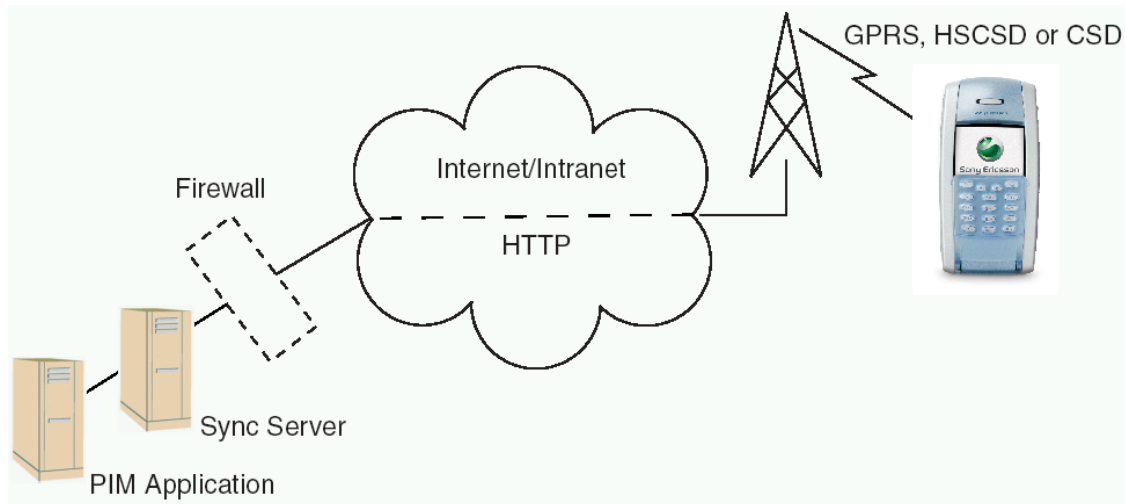

Synchronisation services will be offered by mobile operators, third-party service providers and as added capability to corporate PIM applications. Corporate PIM applications such as Microsoft® Exchange and Lotus® Notes® can be supplemented with SyncML capability.

PC Suite for P800

Local Synchronisation

 The P800 is supplied with PC software for local synchronisation. It may be loaded from the PC Suite for P800 CD-ROM.

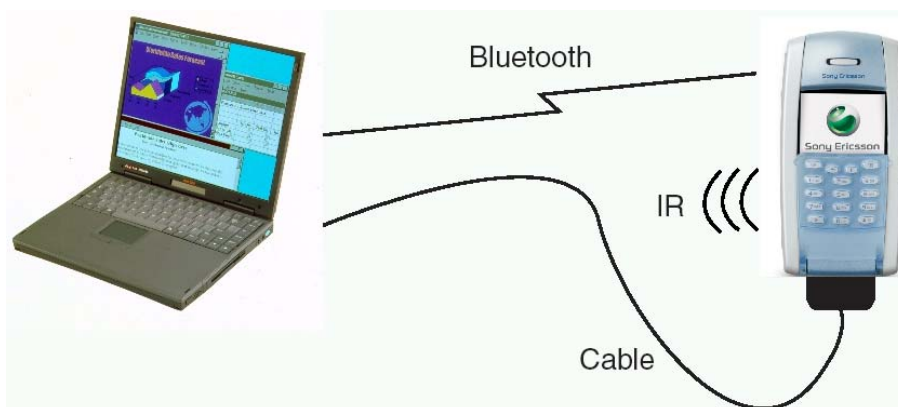

Bluetooth, Infrared or Cable

The P800 always synchronizes using SyncML, regardless of connection type. It connects via Bluetooth wireless technology, infrared or cable. The cable is connected either directly to the phone or to the desktop charger.

Automatic synchronization

Synchronisation can be configured to start automatically, given that a suitable synchronization program must be running on the other device:

- When the USB cable is plugged in to the P800.
- When the P800 is placed in to the desk stand, and the desk stand is connected to the other device.
- When Bluetooth is activated on both devices and they come into operating range
- When infrared is activated on both devices and the infrared sensors are aligned.

Intelligent process

A synchronization engine performs the task of synchronizing. For local synchronization, the synchronization engine is an application that runs on the desktop computer. The synchronization engine compares, updates and resolves conflicts to ensure that the information in the phone is the same as that in the computer.

Compatibility

The supplied PC software enables synchronisation with the following applications:

- Lotus® Organizer® 5 & 6
- Lotus® Notes® 4.6, 5.0
- Microsoft® Outlook® 98, 2000, 2002

The PC requirements are as follows:

- Microsoft® Windows® 2000, Me, XP
- Minimum recommended hardware configuration for the version of Windows in use.
- 30Mb free space on hard disk

File Transfer Utility

 A utility is provided which enables files to be transferred to and from a P800 connected to a PC. It makes the P800 appear as a device in Windows Explorer. The Internal Storage and Memory Stick appear as two drives connected to the device:

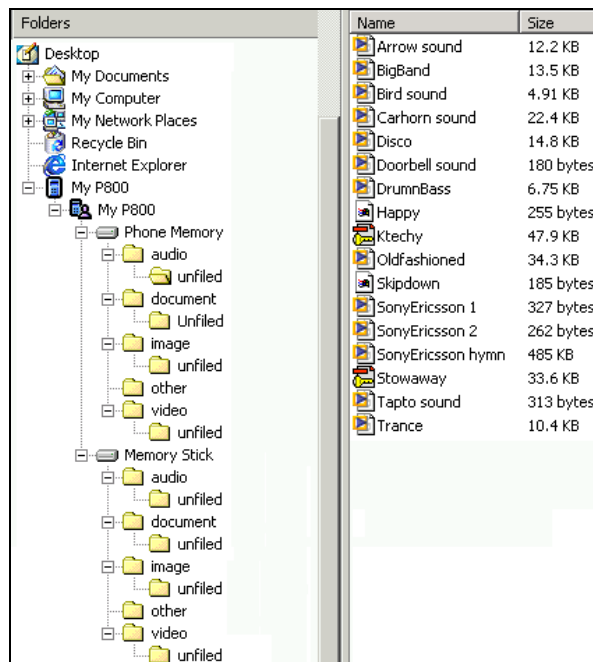

View of the P800 internal and Memory Stick storage in Windows Explorer

Typical uses for this include:

- Archiving pictures taken on the P800 to PC storage
- Moving images to the P800 to use in personalisation, MMS messages etc.
- Moving sound clips to the P800 for personalisation.
- Store work documents (Word, Excel etc) on the P800 to read whilst on the move.

Backup and Restore

 Backup is initiated from the connected PC. Note that the Syncstation desk stand must be used for backup and not infrared or Bluetooth wireless technology. Files in the user data area (which includes loaded third party applications) are backed up to PC storage.

The restore utility takes stored data from the PC and places it back on to the P800.

Language Change Utility

 The P800 has a larger, richer UI compared to an ordinary mobile phone. Applications often have help information also. Consequently, it is impractical to store many languages on the P800 at the same time. To facilitate language change, a PC utility is provided which enables the required language to be loaded on to the P800.

Software Installation Utility

 This utility enables P800 applications to be installed from the PC.

Dial-Up Networking Wizard

 This utility assists the user to create GPRS, HSCSD and CSD connection definitions in the Windows Dial-Up Networking folder. All the necessary information can be entered in a logical way. Set Infrared status to Modem in the Control Panel to use this facility over infrared.

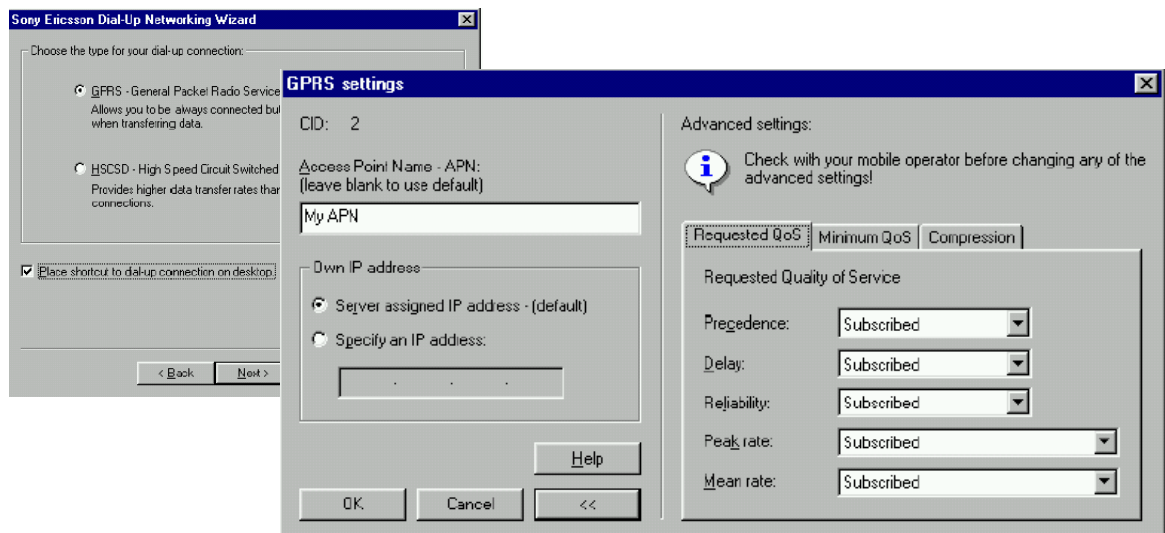

Other PC Suite for P800 Content

- Interactive learning video
- User Guide and Quick Guide documentation in local languages
- Drivers for USB and using the P800 as a modem

Object Exchange – ‘Send As’

The P800 makes it possible to transfer objects over Bluetooth, infrared and Messaging. This is presented to the user via ‘Send As’ commands in applications. Simply select an item such as a contact, select ‘Send As’ and select the method to be used for sending. Typical applications are to beam an appointment to other people, or to receive a new background image.

Application (Data Type)	Bearer >	IR	Bluetooth	SMS	MMS	E-Mail
Contact (vCard)		✓	✓	✓	✓	✓
Appointment (vCal)		✓	✓	✓	✓	✓
Tasks (vCal)		✓	✓	✓	✓	✓
Jotter **		✓	✓	✓	✓	✓
Image		✓	✓		✓	✓
Sound Clip (Ringtone)		✓	✓		✓	✓
Bookmark		✓	✓	✓	✓	✓
Voice Memo (Voice Notes)		✓	✓		✓	✓
Third Party Applications (‘Send As’ API)		✓	✓	✓	✓	✓

** SMS is text only; option to send the picture as GIF using the other bearers.

Note that the P800 messaging application enables the user to add objects into EMS and MMS messages. See Messaging section.

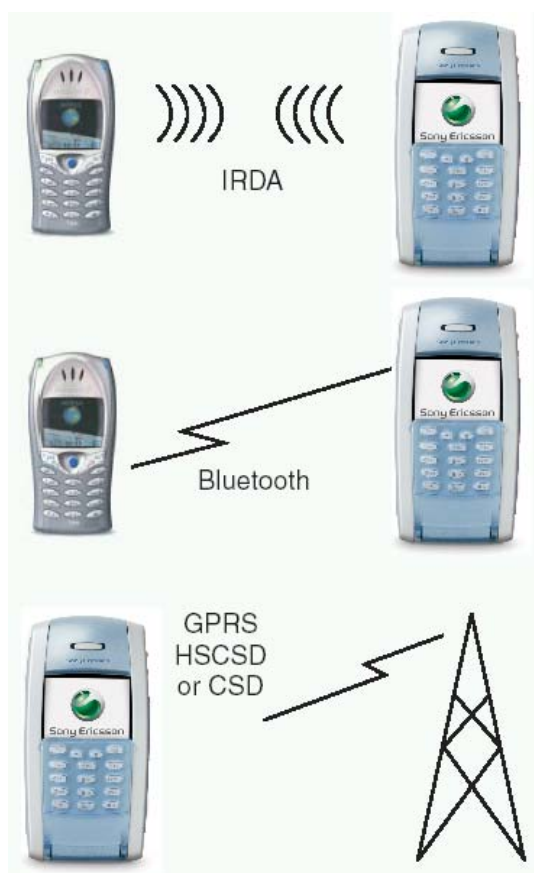

To perform a ‘Send As’ beam operation using infrared, the two devices are lined up and the sender initiates the transfer.

To beam over Bluetooth, a scan finds the other devices within range. The user can then select the required device and send the information across.

When sending over SMS, MMS or E-Mail, the required message type is created with the selected object attached. It is then sent over the air.

GPRS, HSCSD and CSD Connections

The introduction of GPRS (General Packet Radio Services) is one of the key steps in the evolution of today's GSM networks for enhancing the capabilities of data communication. Data traffic is increasing enormously (over both wired and wireless networks), with the growth in demand for Internet access and services paralleling that for mobile communications. Users want access to the Internet while they are away from their offices and homes, and surveys have found that the vast majority of business professionals want the ability to send and receive E-Mail, browse the Web and transmit text and graphics on a portable device. That is why the main applications driving Mobile Internet development are E-Mail clients and Web browsers.

The demand for high-speed Internet access will be the key driver for coming generations of wireless services, and GPRS can deliver the necessary speed. GPRS allows innovative services to be created, enabling new and previously inaccessible market segments to be addressed and increasing customer loyalty.

GPRS applications can be developed as both horizontal and vertical. Vertical applications are specific, including those for operations such as reaching police and emergency, taxi, delivery or automated services (vending machines, supervision, vehicle tracking). Horizontal applications are more generic and include those for Internet access, E-Mail, messaging, e-commerce and entertainment.

GPRS is able to take advantage of the global coverage of existing GSM networks. Applications developed for GPRS can be deployed on a large scale and can reap the associated benefits. GPRS also provides a secure medium for connections to private networks, banking and financial services.

The P800 supports connection to the internet, company intranets and mobile operator WAP services over GPRS, HSCSD and CSD. These will be explained in more detail later in this paper. A typical configuration will be to use GPRS for a continuous connection to the net. With GPRS, the P800 sends data in "packets" at a very high speed. The P800 remains connected to the network at all times, using transmission capacity only when data are sent or received. This enables E-Mail to be automatically fetched, whilst the browser is always available for immediate use. Third Party applications such as instant messaging clients will also benefit from a GPRS 'always on' connection.

Using the P800 as a Modem

The P800 contains a complete GSM/GPRS modem enabling it to be used to connect external devices such as laptop PCs to the internet or corporate intranet. The P800 is connected to the laptop using infrared, Bluetooth or cable, and will connect over the air using GPRS, HSCSD or CSD. Set Infrared status to Modem in the Control Panel to use this facility over infrared.

The P800 appears to the laptop like a normal modem, having an AT command set compatible with industry de facto extensions and ETSI 07.07. Note that SMS and SMSCB are not supported over this channel. A Windows modem driver file is supplied on the PC Suite CD-ROM.

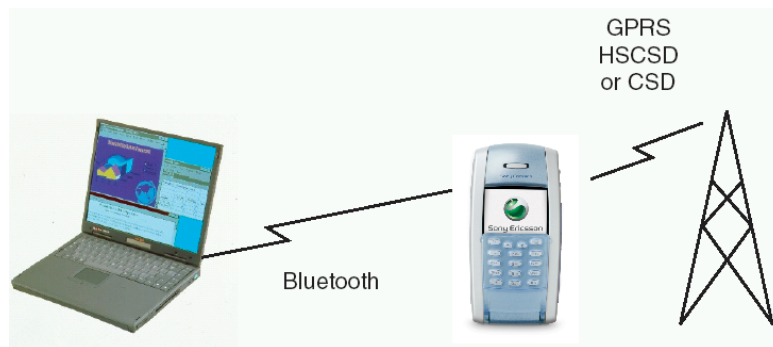

Once paired with a Bluetooth-enabled laptop, the P800 is ready to make an immediate connection to the Internet or corporate network. Because Bluetooth is wire-free and requires no line-of-sight alignment, laptop can be positioned for maximum comfort whilst the P800 can remain in a jacket pocket, briefcase or even be placed up to 10 metres away to get optimal reception.



Infrared may also be used to link the P800 with other devices. Range is typically up to 1 metre. The two infrared 'eyes' must be kept in line of sight, at an angle of no more than approximately 30 degrees.

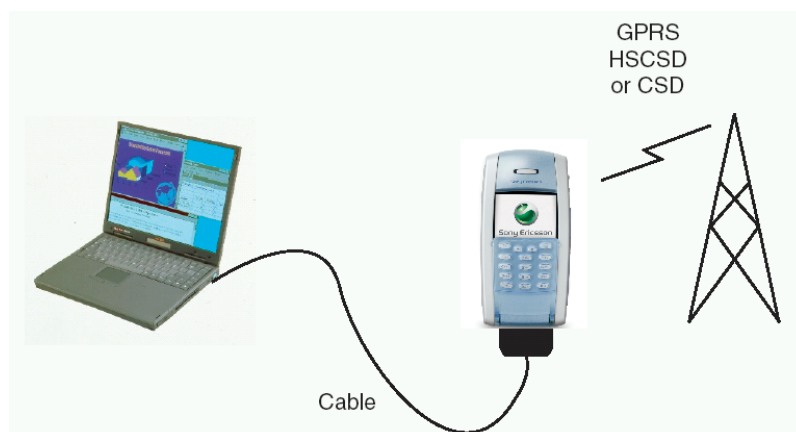

Or a USB cable may be used.

Technical Explanation of CSD, HSCSD and GPRS

This section provides an overview of the way data communication works in a GSM network environment. This will help you to understand the characteristics of the different solutions supported by the P800 and the parameters which govern the data transmission speeds available.

Circuit Switched Data (CSD)

A modem and landline is a common way to connect to the internet and company networks. The modem establishes a telephone call to the remote server which is 'circuit-switched', meaning that a telephone circuit is maintained for the duration of the connection, irrespective of whether data flows or not. The connection has a fixed bandwidth and is normally charged on a connected-time basis.

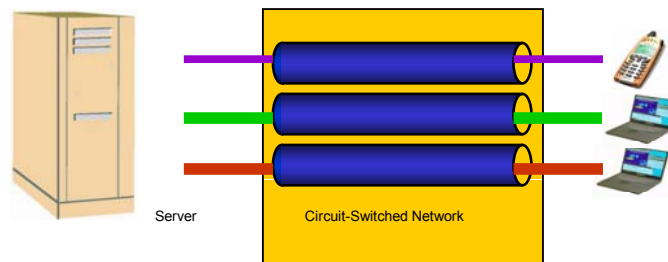

In GSM networks, this facility is widely available and is called Circuit Switched Data (CSD). It is very similar to using a modem, but is subject to lower data transmission speeds due to the connection taking place over the GSM wireless network. The standard speed of operation for CSD is 9.6kbps transmit and receive. 14.4kbps is available in some GSM networks. The P800 will operate at the higher speed where it is available.

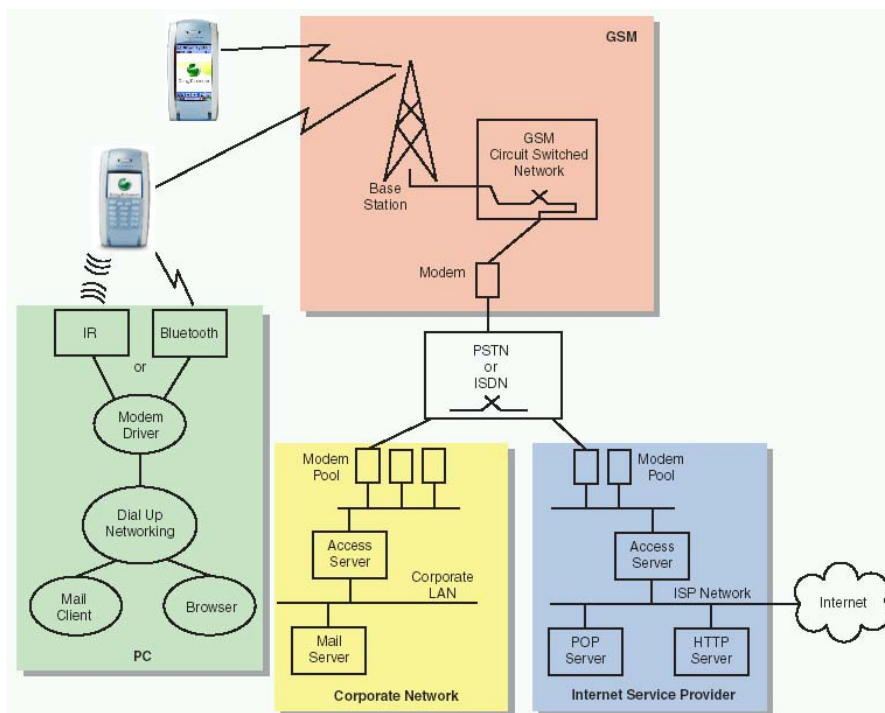

The above diagram shows an end-to-end overview of a circuit switched data call via the GSM network. When establishing a data call, the P800 will be connected via the GSM network to what you may think of as a 'modem' within the network, rather like the GSM network is acting as a

wireless RS232 cable. The modem makes a PSTN or ISDN call to the Point Of Presence telephone number of the required resource, for example your Internet Service Provider or company modem pool for intranet access. Since the modem in the GSM network operates to common standards, no special configuration is required at the ISP or company remote access servers. The limitation on transmission speed (9.6kbps or 14.4kbps) is due to the lower bandwidth of the wireless connection from the P800 to the modem.

As well as making data calls itself (built-in E-Mail, browsing and other applications), the P800 may be connected to a PC using USB cable, infrared or Bluetooth. In this case it acts like a modem. Either way, a standard CSD call is limited to 9.6kbps or 14.4kbps.

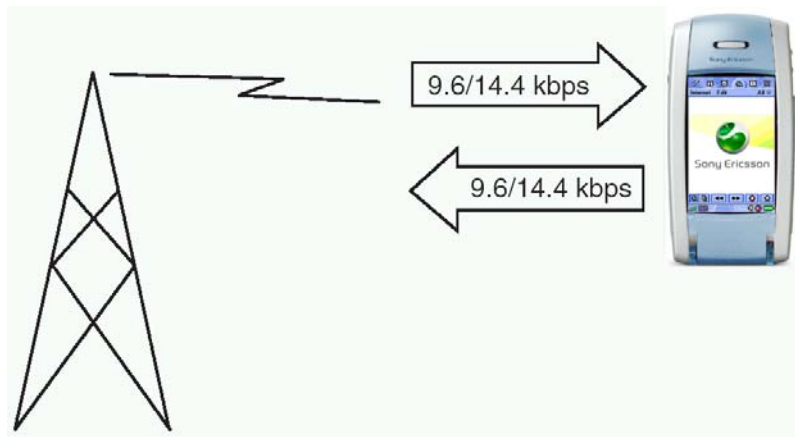

High Speed Circuit Switched Data (HSCSD)

HSCSD operates in a similar manner to CSD, but allocates more radio capacity between the P800 and base station in order to increase the overall speed of the connection. Some explanation of the GSM system will help explain the characteristics of HSCSD.

A GSM mobile phone making a voice call will digitise the speech into a very efficient compressed data stream. One radio channel has enough capacity to carry 8 of these data streams, so the channel is divided into 8 repeating timeslots. The phone is allocated a radio channel and timeslot and will send the data stream in bursts over that channel. Other phones in the cell may make use of the other timeslots in the channel. A separate receive channel and timeslot is allocated and works in the same way.

When making a CSD call, the data is similarly sent in bursts over one of the 8 timeslots in the transmit channel. The basic data rate of this transmission is 9.6kbps, but some networks are upgraded to a data rate of 14.4kbps.

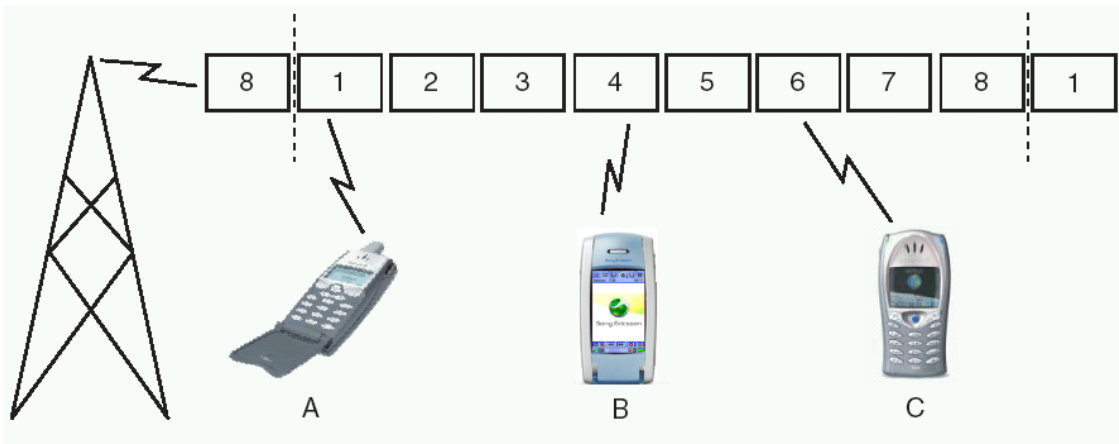

In the above example, terminal A is a phone using one timeslot for a voice call, terminal B is a P800 using one timeslot for a CSD data call and terminal C is a phone using one timeslot for a CSD WAP session. In each case, the timeslot is allocated whether data is transmitted or not.

In order to achieve higher data rates, the GSM terminal may be allocated more timeslots within the transmit and receive channels. Since common applications such as browsing benefit from having high data receive rates without requiring high transmit rates, HSCSD configurations are typically *asymmetric*, meaning that data speed in one direction (receive) is higher than the data speed in the other (transmit). This also saves battery life.

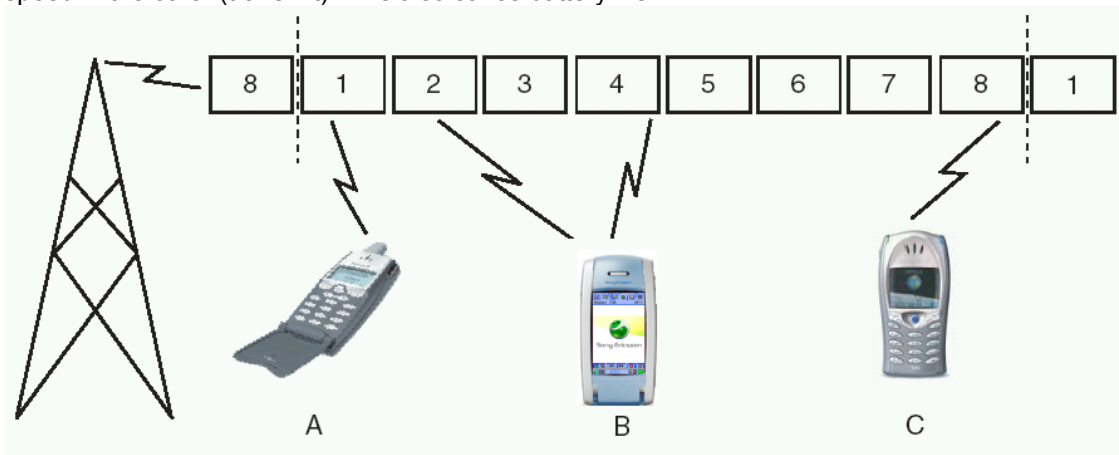

The slot allocation and hence the speed is set by the GSM network when the call is initiated, and may be dynamically altered depending on network conditions such as the number of active users in each cell. In the above example, the P800 (terminal B) has been allocated 2 receive timeslots.

The HSCSD maximum data rates (kbps) using the P800 are shown below.

	9.6kbps per timeslot	14.4kbps per timeslot
Rx	19.2	28.8
Tx	9.6	14.4

The timeslot usage is not linked to demand from applications – an HSCSD connection will be maintained even if no data is flowing. The data 'pipe' is (as far as practicable) maintained fully open for you whether data flows or not. HSCSD connections are typically charged by connection duration in the same way as CSD calls.

Here is a summary of the slot usages in HSCSD. One 'uplink' and 1 to 2 'downlinks'.

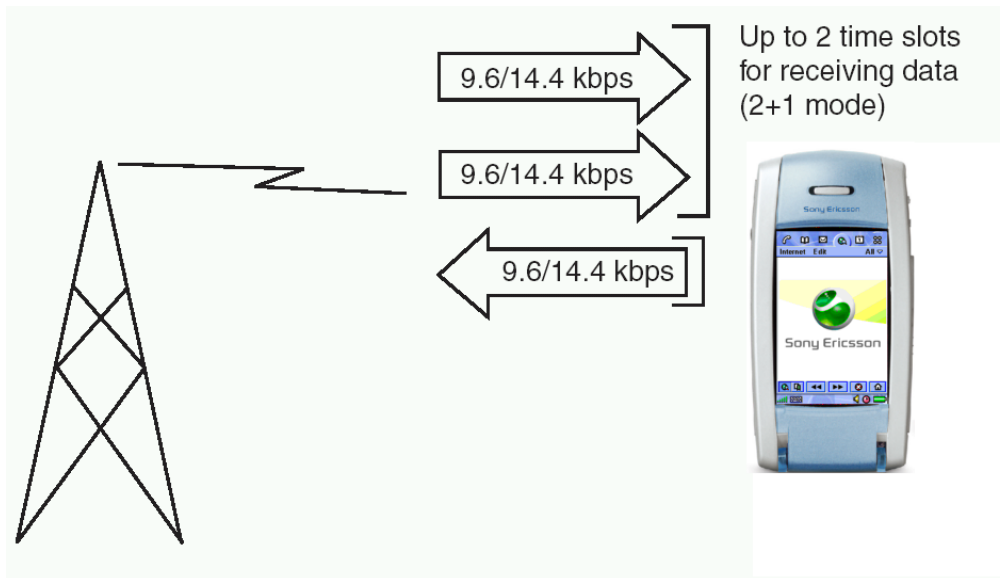

Analogue and ISDN (V110) Bearer Service Types

CSD and HSCSD are capable of Analogue and, where supported by the mobile operator, ISDN connections. ISDN offers faster call set-up time and can increase the performance of an HSCSD connection due to the limitations in analogue modem technology. The simplest option is to test ISDN bearer mode, and switch to analogue if no connection can be made. Note that due to network limitations, analogue is often the only bearer that works when the user is roaming.

GPRS

GPRS mode combines the speed advantages of multi-timeslot working with packet data efficiency. Instead of utilizing a constant stream of timeslots in a circuit-switched call, GPRS mode sends/receives data in small packets, as needed, much like IP on the internet. Capacity is only used when data is being sent or received, which means that it is possible to be "constantly" connected so that applications have immediate access to networked servers. The radio resources are shared between users in a much more efficient way than is possible using circuit-switched methods – timeslots are dynamically allocated to those users who are transmitting and receiving data. The service is typically charged by the amount of data transferred.

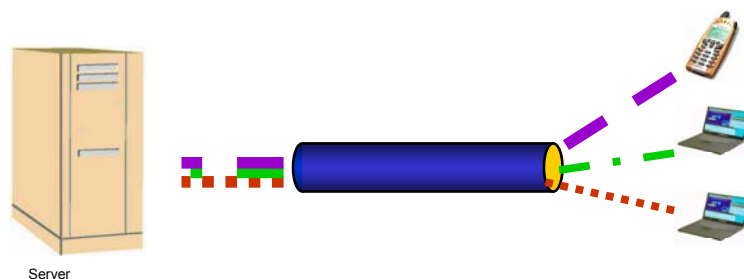

Connection set-up is fast and the P800 will normally be left connected for the whole time it is switched on. When applications need to transfer large amounts of data such as files, images etc, it is possible to increase bandwidth by using more timeslots for the duration of the transfer. The P800 supports up to 4+1 timeslots receive + transmit. The GSM network will dynamically allocate timeslot resources depending on current network conditions.

The capacity of each timeslot depends on the network and four coding schemes are defined, CS-1 to CS-4. These are different to the capacities in HSCSD due to the differences between circuit-switched and packet data operation. GPRS networks are typically launched using CS-1 and CS-2 only, limiting maximum speeds to those shown in **bold** below. The P800 supports CS-3 and CS-4 and will operate at the higher speeds where introduced by mobile operators.

	CS-1 9.05kbps	CS-2 13.4kbps	CS-3 15.6kbps	CS-4 21.4kbps
Rx	36.2	53.6	62.4	85.6
Tx	9.05	13.4	15.6	21.4

The diagram below shows how the P800 in GPRS mode will send data in packets, combining timeslots when extra bandwidth is required, up to a maximum of 4 for received data and 1 for transmitted data

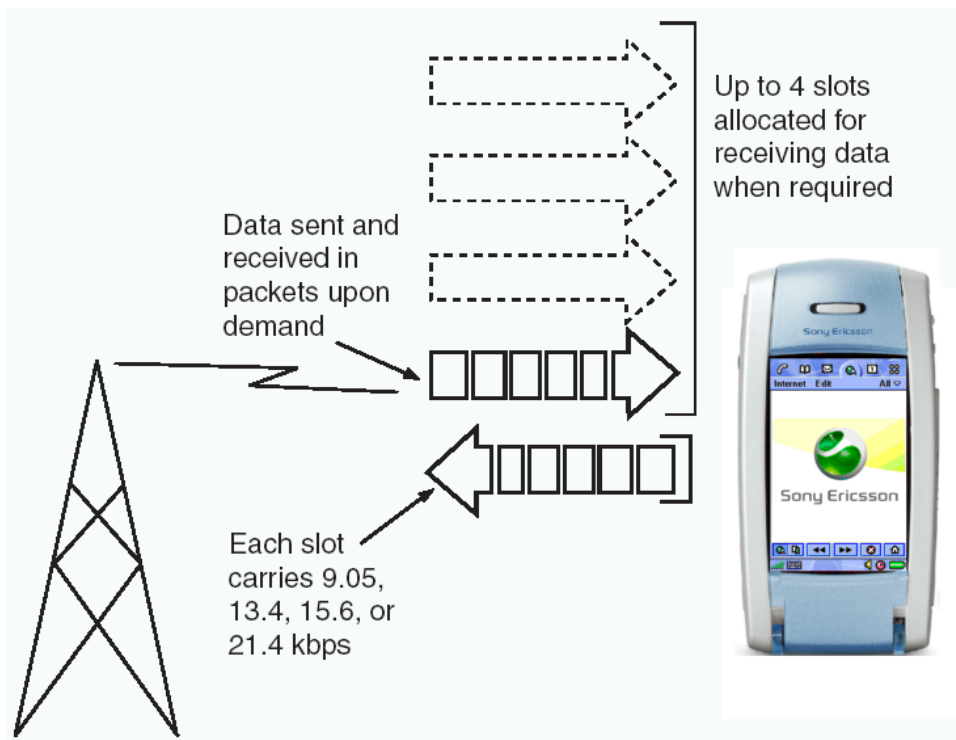

Applications such as Messaging and the integrated browser will automatically initiate CSD, HSCSD and GPRS connections, warning you if your desired action requires another connection to be cut. Whilst a CSD/HSCSD connection is terminated after the transaction or a period of inactivity, the GPRS connection will be maintained. This means that, for example, Web and WAP pages may be browsed without any connect delay, and that the E-Mail client can automatically poll for new messages.

When using the P800 as a modem to a PC, the GPRS connection is initiated from the PC as usual by selecting a Windows® DUN connection, either explicitly within the DUN folder or implicitly via the usual way that Windows enables applications to request connections. Where a GPRS connection is defined in the DUN entry, the P800 will initiate a GPRS attach and connect to the GPRS network.

The required GPRS server resource is defined by an Access Point Name (APN) rather than a telephone number. Example APNs might be

Corporation.operator.country	Connect to your corporate intranet via a VPN
Internet.operator.country	Connect to internet via the mobile operator's ISP
Wap.operator.country	Connect to the mobile operator's WAP service

The Access Server in the GSM/GPRS network will make the connection to the requested resource. Access control and security is performed using standard components such as Radius servers.

Once connected, the user may simply leave the connection in place and access the remote resources as and when required.

The diagram below shows the end-end connection route for a GPRS connection. The P800 and PC ends are the same as before. The mobile operator is enabled to provide direct packet data access to WAP and internet resources. By establishing a suitable Virtual Private Network (VPN) connection to the corporate network, it is possible for the mobile user to access corporate intranet facilities. Your mobile operator will be able to advise you on the available VPN options. Typical methods are IPsec tunnelling over the internet, leased line and frame relay.

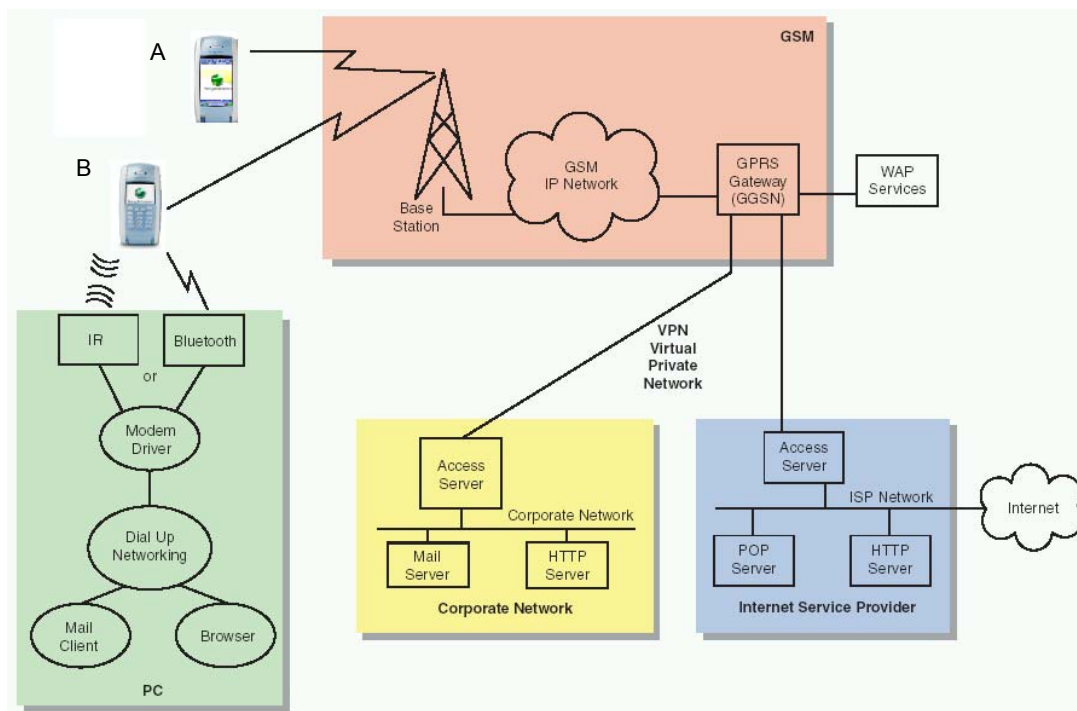

The P800 (A) is connected to the Internet Service Provider and may browse the web and check mail. This connection is left open, enabling the mailserv to be polled periodically.

Using the P800 as a modem (B), it may be linked to a laptop PC using either infrared or Bluetooth. A GPRS connection can be made to the corporate network enabling intranet and mail services to be accessed.

The P800 may also be configured to access the corporate network directly using the built-in Browser and Messaging applications.

Chinese Models In Detail

This section provides more information about the extra features of the P800/P802 for Chinese language markets and the differences when compared to the P800 latin character set models.

Product Name and Languages

Market	Product Name	Default Language for UI, Dictionary and printed manual	Alternative UI Language
China	P802	Simplified Chinese (ZS)	
Hong Kong	P800	Traditional Chinese Hong Kong (ZH)	
Singapore	P800	Simplified Chinese (ZS)	English (EN)
Taiwan	P800	Traditional Chinese Hong Kong (ZH)	

There are basically two written languages of Chinese – Traditional and Simplified. Traditional Chinese is used in Taiwan, with a variant in Hong Kong. Simplified Chinese is primarily used in the People's Republic of China (PRC). British English is available as an alternative.

Input Methods

Market	Product Name	Flip Keys	Default Input Method	Alternative Input Method
China	P802	Strokes, Latin	Pinyin	Strokes
Hong Kong	P800	Strokes, Latin	Strokes	Pinyin
Singapore	P800	Strokes, Latin	Pinyin	Strokes
Taiwan	P800	BoPoMoFo, Strokes, Latin	BoPoMoFo	Strokes

Strokes is an input method based on the basic building blocks of Chinese characters. A Stroke is a component of a Chinese character written with one motion of the brush to paper.

Pinyin is a method of writing down the pronunciation of Chinese characters using the letters of the Latin alphabet, according to rules that have been standardised in the PRC.

BoPoMoFo is a method of writing Chinese characters using letters of the Chinese phonetic alphabet. This method is also known as Zhuyin and is mainly used in Taiwan.

FC Character Input

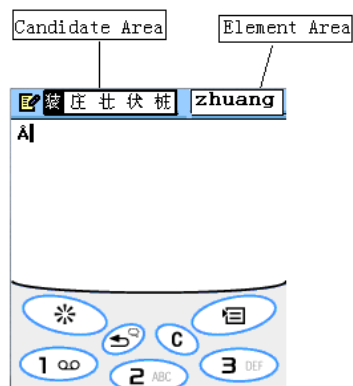

There are two different flip designs, one with Strokes and one with BoPoMoFo characters. Latin characters (a, b, c...) are included on both. Pressing the * key enables the user to switch between available input methods.

Elements are entered using keys 1-9 and matching Chinese characters are displayed in the candidate area. The Jog Dial may be used to assist in character selection.

This is the Stokes keypad. Note the additional symbols on keys 1-9 and 0.



FO Character Input Virtual Keyboard

Virtual keyboards are provided to enable the user to input elements. The top area is where selected characters are displayed to make up the sentence. An element display area shows the selected element(s). Candidates are displayed within a candidates area, and may be selected.



Pinyin Virtual Keyboard.
Includes an elements and a candidate display area.



Strokes Virtual Keyboard.
Includes a components area



BoPoMoFo Virtual Keyboard.
Includes an elements and a candidate display area.

Handwriting Recognition

The user writes text directly on to the screen. The shapes drawn persist until the character is interpreted. Simplified Chinese is supported on the P802 and Traditional Chinese on the P800 (Chinese).

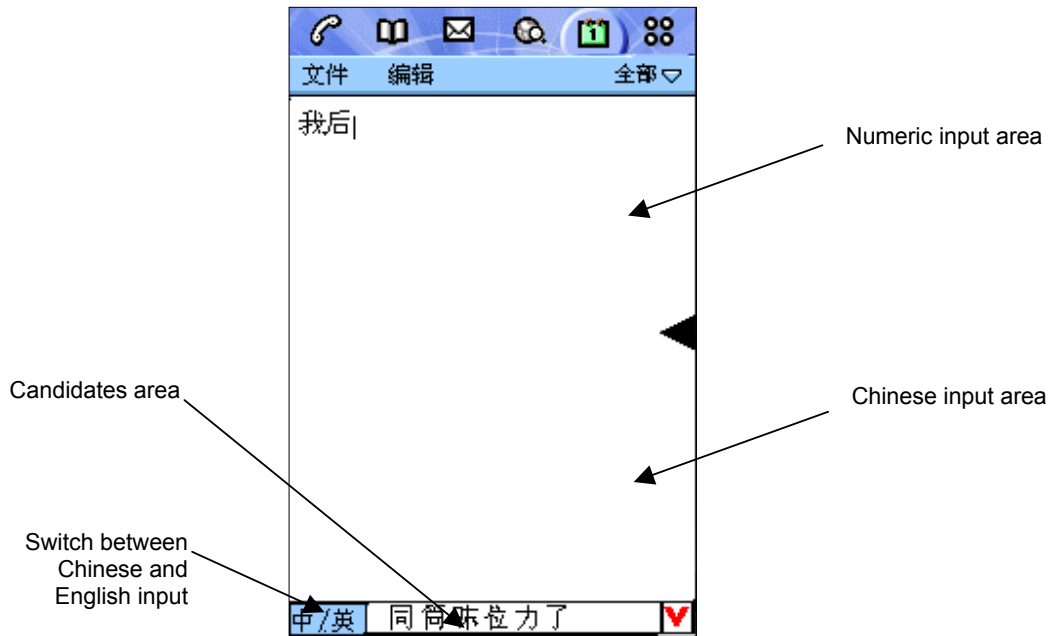

Chinese Dictionary

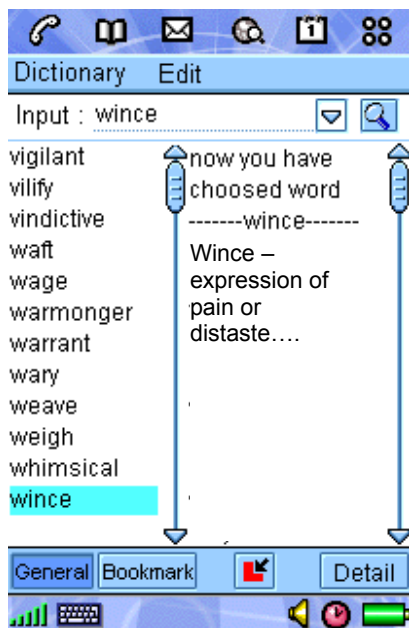

The P802 has a standalone Chinese-English / English-Chinese dictionary. Both Traditional and Simplified Chinese versions are supplied on the CD-ROM. The user may load the version required.

Lunar Calendar

The P802 has two calendars, one based on the Western solar calendar system and one based on the Chinese lunar system. Before the solar calendar was adopted, China exclusively followed a lunar to decide the times of planting, harvesting and festival occasions. Today the solar calendar is used for most practical matters of daily life but the lunar calendar is still important because it determines numerous seasonal holidays such as the Traditional New Year. When Chinese is the selected language, the lunar calendar is the default.

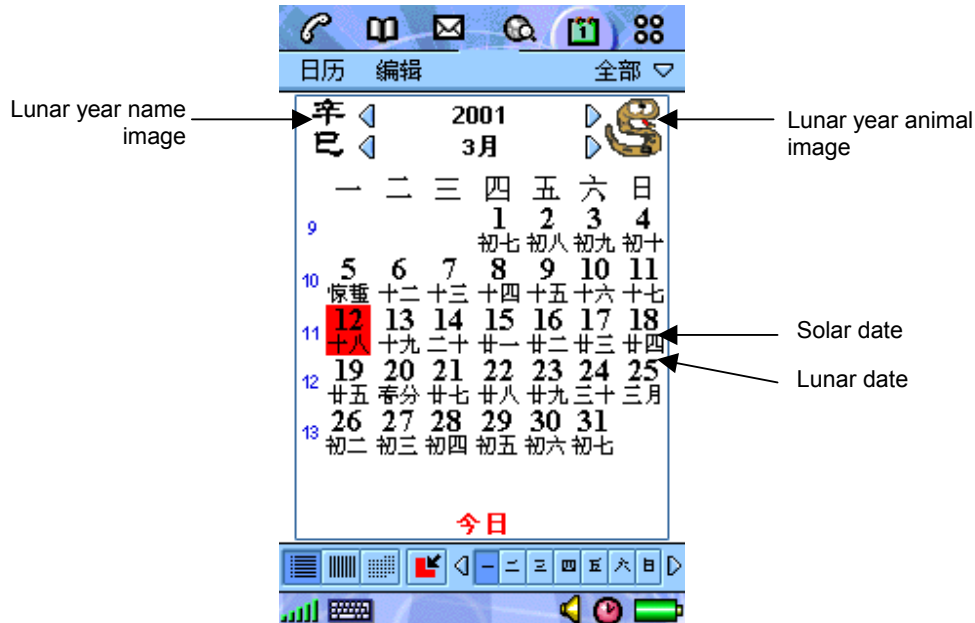

Contacts

Chinese and English names are grouped separately. Chinese names may be sorted by Pinyin, Stroke or BoPoMoFo (depending which two of these are present).

WuZiQi – Five Stone Chess

The P802 has a well-known Chinese game called WuZiQi. The name means 'Five Stone Chess' and the goal is to get five stones in one line. The other games on the P802 are Chess and Solitaire. Further games will be provided on the P802 CD-ROM.

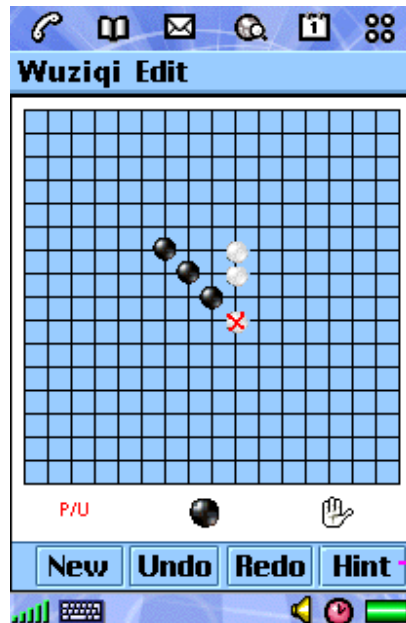

User Storage

The Chinese UI and input methods need more storage space compared to the Latin character version. Internal user storage space for messages, dictionary, applications, contacts, images etc is therefore reduced to 9Mbytes in the P802 (compared to 12Mbyte in the P800).

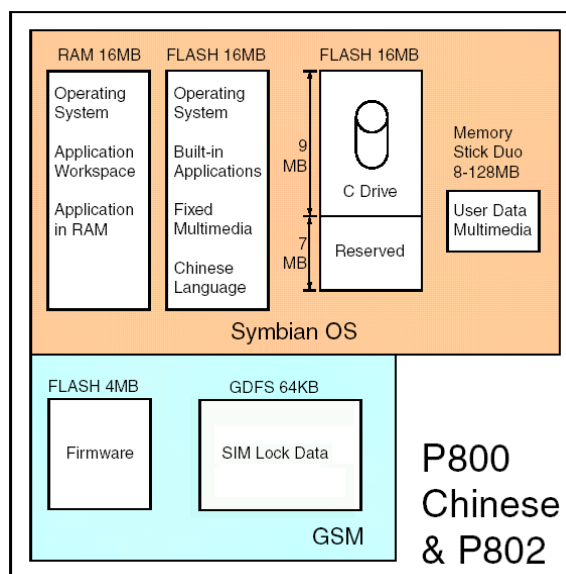

SIM Application Toolkit

SIM Application Toolkit (SIM-AT) is a method of developing small applications for mobile phones. User interaction is via the screen and keyboard, whilst connectivity is provided by means of SMS and USSD transports. SIM-AT can also be used to initiate phone calls. A typical application is to provide a simple menu-based interface to value-added services provided by the mobile operator. The application is stored and distributed on the SIM card. SIM-AT offers a powerful way to deploy programs and services to users, without the need for new or upgraded equipment. All necessary set-up and programming is distributed to users over the air, directly to their phones.

The P800 supports SIM-AT according to GSM 11.14 in order to protect investment in SIM-AT based applications and to enable users to continue using the services and applications on their SIM cards. The applications are accessed from within the UI of the P800's Phone application.

The P800 also has much richer application environments including WAP, Web, C++ and Java. These enable applications to be created with a much better UI and superior connectivity such as TCP/IP over the internet.

SIM-AT Services supported by the P800

Service	Description
CALL CONTROL	This will enable the SIM to allow, bar or modify a call (supplementary service operation or USSD operation).
DISPLAY TEXT	Text is displayed on the screen according to the request from the SIM application: Priority: Normal, High Clear Message: Automatic after delay, Wait for user. Alphabet: UCS2, packed and unpacked SMS default
EVENT DOWNLOAD	The Event Download enables the ME to report on events to the SIM: <ul style="list-style-type: none">• Location Status• Idle Screen Available• Language Selection• Call Connected• Call Disconnected• Browser Termination
GET INKEY	Request the user to enter a single character. <ul style="list-style-type: none">• 0-9 *# + only or alphabet set• Yes/No Response• SMS default or UCS2 character set
GET INPUT	Request the user to enter a number of characters. <ul style="list-style-type: none">• 0-9 *# + only or alphabet set• SMS default or UCS2 character set• Input echoed or secret• Packed or unpacked.
LAUNCH BROWSER	The P800 will launch the integrated browser.

PLAY TONE	Play supervisory tones (e.g. Dial tone, Busy tone) as defined in GSM 02.40.
PROFILE DOWNLOAD	Profile downloading provides a mechanism for the ME to tell the SIM what it is capable of.
PROVIDE LOCAL INFORMATION	Send current known locality information to the SIM: <ul style="list-style-type: none">• MCC, MNC, LAC and Cell Identity• IMEI• Network Measurement Results• Date, time and time zone• Language Setting• Timing Advance
REFRESH	The Refresh command enables the SIM to inform the P800 that data on the SIM has changed and the P800 needs to be updated: <ul style="list-style-type: none">• SIM Initialisation and Full File Change Notification• File Change Notification• SIM Initialisation and File Change Notification• SIM Initialisation• SIM reset
SELECT ITEM	Allows the user to select one alternative from a menu.
SEND DTMF	If there is an active call, play the requested DTMF tone(s) down the line.
SEND SHORT MESSAGE	Send an SMS containing data provided by the application. <ul style="list-style-type: none">• Packing by the ME if required
SEND SS	Send an SS request to the network.
SEND USSD	Send a USSD request to the network.
SET UP CALL	Set up a voice call: <ul style="list-style-type: none">• If not currently busy on another call• If not currently busy on another call, with redial• Putting all calls (if any) on hold• Putting all calls (if any) on hold, with redial• Disconnecting all other calls• Disconnecting all other calls, with redial
SET UP EVENT LIST	The SIM supplies a list of events to the P800. When one of these events occurs, the details will be provided to the SIM: <ul style="list-style-type: none">• Location Status• Idle screen available• Language selection• Browser Termination
SET UP IDLE MODE TEXT	The P800 displays text from the SIM on the phone's idle screen.
SET UP MENU	Define the SIM Application Menu.

CD-ROM Contents

The P800 is shipped with two CD-ROMS: PC Suite for P800 and Multimedia for P800.

PC Suite for P800

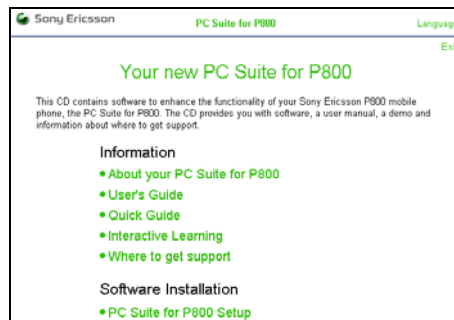

The PC Suite for P800 CD-ROM includes the following:

Local Synchronisation	PC software for synchronising PIM data between the P800 and PC applications such as Microsoft® Outlook® and Lotus® Notes® and Lotus Organizer. Described elsewhere in this paper.
Backup and Restore	Utility to back up the data from the P800 for storage on a PC. Restore enables data to be returned to the P800, for example, after a software upgrade. This operation must be performed using the P800 Deskstand.
File Manager	Enables Windows Explorer to see the P800 as a device and the internal and Memory Stick storage as two disk-drives on the device. Multimedia files may be copied between the PC and the P800.
Software Installer	Utility to install new applications from the PC.
Language Change Utility	Enables the user to load a different language from the CD-ROM and switch the P800 UI to that language..
Dial-Up Networking Wizard	Wizard for GPRS and HSCSD settings
Chinese Dictionaries	(P802 only) Standalone dictionary for looking up Chinese words. Supplied in Simplified Chinese, Traditional Chinese Hong Kong and Traditional Chinese Taiwan
Drivers	.inf file enabling the P800 to be configured to the PC as a data modem; USB driver.
Interactive Learning	Interactive learning video
Manuals	User Guide and Quick Start Guide in Acrobat® PDF format. Available in all supported languages

Multimedia for P800

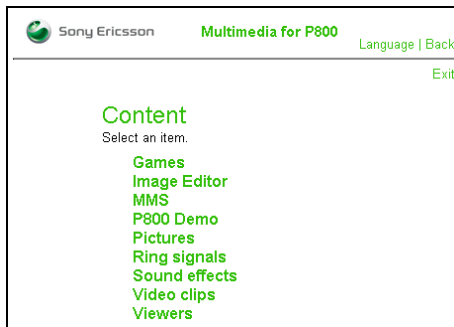

Games	Solitaire and Chess (Backup copies to reinstall in case of Master Reset or user uninstall) Men in Black II - Shoot out game based on the Men in Black II movie Stunt Run - High resolution car game
Sony Ericsson Image Editor	Image editor enabling the user to crop, rotate, zoom and adjust images and then send them to the P800.
MMS	8 MMS Templates. These are copies of the templates loaded on the P800 in the factory.
P800 Demo	Demo application that is also pre-installed on the P800 in the factory. (Backup copy to reinstall in case of Master Reset or user uninstall)
Pictures	A selection of images to use with the P800. See 'Personalisation and Customisation' for more information.
Ring Signals	A selection of ring signals to use with the P800. See 'Personalisation and Customisation' for more information.
Sound effects	A selection of sound effects to use with the P800. See 'Personalisation and Customisation' for more information.
Video	A copy of the pre-installed video clip "World of Connectivity"
Viewers	A package of additional viewer plug-ins to enable the document viewer to read more formats. 6 selectable bundles: <ol style="list-style-type: none">1. Extended Office2. Lotus3. Wordperfect4. Archive5. Graphics6. Other

Refer to the Viewer section for more information.

P800 Consumer Package

The exact contents of the P800 package depend on the localization.

The basic contents are as follows:

- P800
- Standard Battery
- Travel charger
- 16 MB Memory Stick Duo
- Memory Stick Adapter
- SyncStation with USB
- Stereo Portable Handsfree
- Protective bag
- Wrist strap
- 3 extra stylus
- Flip replacement
- PC Suite for P800 CD
- Multimedia for P800 CD

Sony Ericsson

Jitter
Handwritten notes and drawings to save or send.

Integrated camera
Send pictures via MMS or e-mail. Save pictures in photo album.

Calendar
Appointments, Synchronization.

Video
Video clip do work at. Streaming video.

Wide screen games
Stunt Run and Men in Black II - Alien Pursuit.

The Memory Stick Duo™ is a brand of the Sony Group Inc. registered trademark. It is a registered trademark of Sony Group Inc. in the USA and other countries. It is a registered trademark of Sony Group Inc. in the USA and other countries. It is a registered trademark of Sony Group Inc. in the USA and other countries.

symon Memory Stick Duo™ **Bluetooth SyncML**

P800



P800 with stereo handsfree and images from the P800 box sleeve

Sony Ericsson

P800

<p>Kit contents</p> <ul style="list-style-type: none"> - P800 - Standard Battery - Travel Charger - 16 MB Memory Stick Duo™ - Memory Stick™ Adapter - SyncStation with USB - Stereo Portable Handsfree - Protective bag - Wrist strap - 3 extra stylus - Flip replacement - PC Suite for P800 CD and Multimedia for P800 CD 	<p>PC system requirements</p> <ul style="list-style-type: none"> - IBM® compatible Pentium 166 MHz (minimum) - Windows® ME/2000/XP - USB 1.1 port - CD-ROM drive - 80 MB free hard disk space 	<p>Main features</p> <p>Imaging. Integrated camera, image viewer and photo gallery</p> <p>Video. Streaming video and Video Player for downloaded clips</p> <p>Sound. MP3 Player and polyphonic ring signals</p> <p>Messaging. Multimedia Messaging (MMS), text with pictures and sound, and e-mail with attachments and viewers</p> <p>Internet. Web, WAP and cHTML browsing</p>	<p>Storage. Up to 12 MB internal memory for data and applications plus 16 MB Memory Stick Duo™</p> <p>Organizer. Contacts with photos, calendar and notes with PC synchronization</p> <p>Connectivity. Bluetooth™, infrared and USB connections</p> <p>Java™, Java CLDC/MIDP for additional applications</p> <p>Games. 4 games, including Men in Black II - Alien Pursuit and Stunt Run in wide-screen mode</p>	
--	---	---	--	--

Sony Ericsson

P800

Terminology and Abbreviations

3G

Generic term for the third generation mobile systems which will offer voice and faster data services compared to today's 2G (e.g. GSM) and '2.5G' (e.g. GPRS) solutions.

3GPP

3rd Generation Partnership Project. Collaboration between a number of telecommunications standards bodies to specify 3G. 3GPP also maintains and develops the specifications for GSM.

AAC

Advanced Audio Codec.

AMR

Adaptive Multi-Rate. 3GPP standard for speech coding (compression).

AU, .au

Format for audio data files.

AWT

Abstract Windowing Toolkit. A Java Graphical User Interface library.

BAE

Beatnik Audio Engine™

Bearer

Path over which data flows. Specifically in CSD and HSCSD, the type of telephony link from the GSM network to the server – PSTN or ISDN.

Bluetooth

Bluetooth wireless technology is a secure, fast, point-to-multipoint radio connection technology. It is a specification for a small-form factor, low-cost radio solution providing links between mobile computers, mobile phones and other portable handheld devices, and connectivity to the internet. Available from the Bluetooth Special Interest Group (SIG), <http://www.bluetooth.com>.

Bookmark

A URL and header/title stored in the phone, enabling the user to go directly to a Web or WAP page.

BMP

Microsoft Windows Bitmap. A graphics format defined by Microsoft supporting 1, 4, 8 or 24 bit colour depth. No compression, so files can be large.

bps

Bits per second – rate of data flow.

CB

Cell Broadcast. Type of SMS message.

cHTML

A version of HTML optimized for small devices.

CLDC

Connected Limited Device Configuration. The J2ME 'configuration' implemented in the P800. CLDC specifies a runtime environment with specifically limited resources, suitable for memory-constrained devices.

CLI

Calling Line Identity. Shows the number of the person calling you in your mobile phone display. The P800 will also display the name and photograph of the caller if they are in Contacts. You can then make an informed choice as to whether or not to take the call. Bear in mind that not all numbers can be displayed. To use this service, it must be supported by your network.

COM Port

Defines a serial/RS-232 port within the Windows® environment. May be physical (COM1 port on the rear of the PC) or virtual (COM5 port communicating with a PC card modem)

CS

Circuit Switched. Connection from A to B which has a fixed bandwidth and is maintained over a period of time, for example a voice telephone call.

CS-1 to CS-4

Coding Scheme. Determines the data rate per timeslot in GPRS.

CSD

Circuit Switched Data. CSD is a GSM service providing a CS data connection at a rate of 9.6 or 14.4kbps.

CSS

Cascading Style Sheet. A feature of browsers.

DTMF

Dual Tone Multi Frequency. A method of coding digits as a combination of two audible tones.

DUN

Dial-Up Networking.

ECML

Electronic Commerce Modelling Language.

EFR

Enhanced Full Rate, speech coding. Provides better speech quality than HR or FR.

e-GSM

Extended GSM. New frequencies specified by the European Radio Communications Committee (ERC) for GSM use when additional spectrum is needed (Network-dependent). It allows operators to transmit and receive just outside GSM's core 900MHz frequency band. This extension gives increased network capability.

EMS

Enhanced Messaging Service. An extension of SMS enabling pictures, animations, sound and text formatting to be added to text messages. 3GPP has included EMS in the standards for SMS.

ETSI

European Telecommunications Standards Institute. www.etsi.org

FC, FC mode

Flip Closed – used in this document to refer to the P800 with the flip closed.

FCC

Federal Communications Commission. US government agency which regulates radio communications.

FR

Full Rate, speech coding.

FO, FO mode

Flip Open. Used in this document to refer to the P800 when the flip is open.

GGSN

Gateway GPRS Support Node

GIF

Graphics Interchange Format. Format for storing images which also supports animated images. Highly compressed by limiting the colour palette to 16 or 256 colours.

G-MIDI

General MIDI. Specifies a minimum level of performance compatibility.

GPRS

General Packet Radio Services.

GSM

Global System for Mobile Communications. GSM is the world's most widely-used digital mobile phone system, now operating in over 160 countries around the world.

GSM 900

The GSM system family includes GSM 900, GSM 1800 and GSM 1900. There are different phases of roll-out for the GSM system and GSM phones are either phase 1 or phase 2 compliant.

GSM 1800

Also known as DCS 1800 or PCN, this is a GSM digital network working on a frequency of 1800 MHz. It is used in Europe and Asia-Pacific.

GSM 1900

Also known as PCS. Refers to a GSM system running in the 1900MHz band. Used in the USA and Canada, for instance.

HR

Half Rate, speech coding.

HSCSD

High Speed Circuit Switched Data.

HTML

HyperText Markup Language.

HTTP

HyperText Transfer Protocol.

IMAP4

Internet Message Access Protocol version 4. Used to collect E-Mail from a mail server. Has more features than POP3.

iMelody

A format for monophonic ringtones.

IrDA

Infrared Data Association.

ISDN

Integrated Services Digital Network. Can provide circuit-switched data connections in multiples of 64 kbps.

ISP

Internet Service Provider.

J2ME

Java2 Micro Edition. An edition of the Sun Microsystems Java programming/runtime environment specifying two runtime environment 'configurations' aimed at small devices.

Java Phone

An API in Java for interacting with a phone.

JFIF

JPEG File Interchange Format

JNI

Java Native Interface

JPEG

Joint Photographic Experts Group, best known for the .JPG format for still image compression.

JVM

Java Virtual Machine

kbps

Kilobits per second – rate of data flow.

KVM

'Kilo' Virtual Machine

LAN

Local Area Network.

MBM

Multi Bitmap. Image file format on Symbian OS.

ME

Mobile Equipment. (Phone excluding SIM card)

MeT

Mobile Electronic Transactions. An initiative founded by Ericsson, Nokia and Motorola to establish a secure and consistent framework for mobile transactions.

MIDI

Musical Instrument Digital Interface. MIDI defines a protocol and file format which enables music to be described and stored in binary form.

MIDP

Mobile Information Device Profile. An API (or 'profile' in J2ME nomenclature) defined to enable a standard programming API for mobile devices. MIDP compliant applications execute in the restricted environment defined by the CLDC.

MIME

Multipurpose Internet Mail Extensions. A protocol defining how messages are sent on the internet. For example, MIME is used to describe how attachments are encoded and what type of data they contain.

MMS

Multimedia Messaging Service. Logical extension of SMS and EMS, MMS defines a service enabling sound, images and video to be combined into multimedia messages.

MMS-C

MMS Service Centre

MO

Mobile Origination. For example, an SMS message sent from a mobile terminal.

MP3

MPEG Audio Layer 3. An audio compression technology that is part of MPEG-1 and MPEG-2 specifications. Commonly used to distribute music on the internet and on portable players.

MPEG

Moving Picture Experts Group. A working group of ISO/IEC in charge of the development of standards for coded representation of digital audio and video.

MS

Mobile Station. (Phone and SIM card)

MT

Mobile Termination.

OS

Operating System, such as Symbian OS, Linux, Microsoft® Windows®.

OTA

Over-the Air Configuration. To provide settings for the phone by way of sending a message, SMS, over the network to the phone. This reduces the need for the user to configure the phone manually.

PC

Personal Computer.

PCS

Personal Communications Services, often used to describe GSM1900 networks.

PDF

Portable Document Format. A format created by Adobe for storing and distributing documents.

PDP

Packet Data Protocol.

Personal Java

An edition of Java appropriate for mobile devices such as PDAs.

Phone book

A memory in the SIM card where phone numbers can be stored and accessed by name or position.

PIM

Personal Information Management. Generic term for applications such as Contacts, Calendar, Tasks etc.

PKI

Public Key Infrastructure.

PNG

Portable Network Graphics. PNG compresses images with millions of colours no loss of detail, but has comparatively large file size. It is not commonly used.

Polyphonic

"Many sounds". The maximum number of notes an instrument can play at the same time, commonly 16 in MIDI devices.

POP3

Post Office Protocol. Used to collect E-Mail from a mail server.

PSTN

Public Switched Telephone Network, for example ordinary analogue phone line for speech and/or computer modem.

PTD

Personal Trusted Device. Concept in MeT

QCIF

Quarter Common Intermediate Format. A video format size of 176 x 144 pixels.

QQVGA

Quarter Quarter VGA, 160 x 120 pixels.

QVGA

Quarter VGA size, typically refers to a portrait oriented screen 240 pixels wide x 320 pixels high.

RADIUS

Remote Access Dial-In Service. Facility at the ISP or corporation to manage remote data connections.

PDA

Personal Digital Assistant. A handheld computer having functions such as address book, calendar etc.

PNG

Portable Network Graphics. Format for storing images on file with data compression but without lowering of quality (loss of information).

RAS

Remote Access Service.

RMF

Rich Music Format™ A file format developed by Beatnik combining the compact size of MIDI files with the high quality of MP3 and WAV.

Rx

Receive

SC

Service Centre (for SMS).

SDK

Software Development Kit

Service Provider

A company that provides services and subscriptions to mobile phone users.

SIM card

Subscriber Identity Module card – a card that must be inserted in any GSM-based mobile terminal. It contains subscriber details, security information and memory for a personal directory of numbers. The card can be a small plug-in type or credit card-sized, but both types have the same functions. The P800 uses the small plug-in card.

SIM-AT

SIM Application Toolkit – a means of providing simple applications that are stored on the SIM card.

SMIL

Synchronized Multimedia Integration Language. Used by MMS to describe how media objects are to be played.

SMS

Short Message Service. Allows messages of up to 160 characters to be sent and received via the network operator's message centre to a mobile phone.

SMSCB

SMS Cell Broadcast.

SMTP

Simple Mail Transfer Protocol. Protocol used to send E-Mail from an E-Mail client via an SMTP server.

SS

Supplementary Service

SWIM

A SWIM card is a SIM card containing a WIM

TCP/IP

Transmission Control Protocol/Internet Protocol.

TE

Terminal Equipment. Generic term for GSM terminals such as phones and PC cards.

Terminal Adaptor

Generic term for the equipment terminating a digital comms line such as an ISDN2 line. The P800 is a Terminal Adaptor since it interfaces to GSM digital data services.

TLS

Transport Layer Security. Used by Web browsers, for example.

Tx

Transmit

UI

User Interface. Sometimes called 'Man-Machine Interface'.

URL

Uniform Resource Locator. Points to a service or information on the internet, for example:

<http://www.ericsson.com/mms/demo>

USSD

Unstructured Supplementary Services Data. Narrow-band GSM data service. For example entering *79*1234# might return the stock price for stock 1234.

V.110

ETSI standard for data over an ISDN circuit.

V.120

ETSI standard for data over an ISDN circuit.

vCal; vCalendar

vCalendar defines a transport and platform-independent format for exchanging calendar and scheduling information for use in PIMs/PDAs and group schedulers. vCalendar is specified by IETF.

vCard

vCard automates the exchange of personal information typically found on a traditional business card, for use in applications such as internet mail, voice mail, Web browsers, telephony applications, call centres, video conferencing, PIMs /PDAs, pagers, fax, office equipment, and smart cards. vCard is specified by IETF.

VGA

Video Graphics Array. Graphics standard introduced by IBM, having a resolution of 640 x 480 pixels.

VPN

Virtual Private Network.

WAP

Wireless Application Protocol. Handheld devices, low bandwidth, binary coded, a deck/card metaphor to specify a service. A card is typically a unit of interaction with the user, that is, either presentation of information or request for information from the user. A collection of cards is called a deck, which usually constitutes a service.

WAV

Waveform audio. Format for storing sound.

WBMP

Wireless BitMap. Part of the WAP specifications, an image format optimised for small mobile devices.

WBXML

Wireless Binary Extensible Markup Language.

WIM

Wireless Identity Module.

WML

Wireless Markup Language. A markup language used for authoring services, fulfilling the same purpose as HyperText Markup Language (HTML) does on the World Wide Web (WWW). In contrast to HTML, WML is designed to fit small handheld devices.

WTLS

Wireless Transport Layer Security. Part of WAP, WTLS provides privacy, data integrity and authentication on transport layer level between two applications.

WWW

World Wide Web.

xHTML

Extensible Hypertext Markup Language

XML

Extensible Markup Language

Related Information

Links

http://www.SonyEricsson.com/P800	P800 website
http://www.SonyEricsson.com/developer	Sony Ericsson developer information
http://www.ericsson.com/mobilityworld/	Information for application developers
http://www.ericsson.com/gprs	Information on the GPRS system
http://www.gsmworld.com/	General information on GSM
http://www.3gpp.org/	Home of the 3 rd Generation Partnership Project
http://www.etsi.org/	Home of the European Telecommunications Standards Institute.
http://www.mobiletransaction.org/	MeT – Mobile electronic Transaction homepage
http://www.symbian.com/	Information on Symbian and Symbian OS
http://www.metrowerks.com/	Code Warrior tools for Symbian OS
http://www.syncml.org/	SyncML homepage
http://www.bluetooth.com/	Home of the Bluetooth Special Interest Group
http://www.irda.org/	Home of the Infrared Data Association
http://www.wapforum.com/	Home of the WAP forum
http://www.imc.org/	Home of the Internet Mail Consortium
http://www.rsasecurity.com/	RSA Security provides the SecurID [®] two-factor authentication solution.
http://www.securecomputing.com/	Secure Computing provides the SafeWord [™] authentication and access control solution.
http://java.sun.com/	The source for Java technology.
http://www.memorystick.org/	Technical specifications and Supporting Companies' site for Memory Stick.
http://www.memorystick.com/	Information site by 'memorystick.com' Business Centre within Sony Corp.
http://www.midi.org/	MIDI Manufacturer's Association site for information on MIDI.
http://www.beatnik.com/	Beatnik provides enhanced audio solutions including the RMF format.

Useful References

MMS

From <http://www.ericsson.com/mobilityworld/>

Sony Ericsson MMS Developer's Guide, November 1, 2002
MMS Developer's Guide, October 31, 2001
MMS Conformance version 2.0.0, September 27, 2002,

SymbianOS and UIQ

UIQ Style Guide, http://www.symbian.com/technology/UI/uiq_styleguide/index.html
Designing for UIQ, <http://www.ericsson.com/mobilityworld/>

Java

[1] J2ME(TM) Connected Limited Device Configuration (CLDC)
Specification version 1.0a May 19,2000. 59 pages
Sun Microsystems Inc.
See: <http://java.sun.com/products/cldc/>

[2] Mobile Information Device Profile (JSR-37)
JCP Specification Java 2 Platform, Micro Edition, 1.0a
September 15, 2000. 284 pages
See: <http://java.sun.com/products/midp>

[3] The Java Virtual Machine Specification
Tim Lindholm/Frank Yellin ISBN 0-201-43294-3, Addison Wesley Pub. Co, 496 pages

[4] The Java (tm) Programming Language, Third Edition
Ken Arnold, James Gosling, David Holmes, ISBN: 0-201-70433-1 Addison Wesley Pub. Co, 624 pages

[5] Programming Wireless Devices with the Java 2 Platform, Micro Edition
Roger Riggs, Antero Taivalsaari, Mark VandenBrink, ISBN 0-201-74627-1, Addison Wesley Pub. Co, 345 pages

[6] Wireless Java – Developing with Java2, Micro Edition
Jonathan Knudsen, ISBN 1-893115-50-X, a! Press, 226 pages

[7] MIDP API's for Wireless Applications (Sun Whitepaper)
"A Brief Tour for Software Developers", Sun Microsystems, Inc.
<http://java.sun.com/products/midp/midp-wirelessapps-wp.pdf>

[7] Applications for Mobile Devices (Sun Whitepaper)
"Helpful Hints for Application Developers and User Interface Designers using the Mobile Information Device Profile", Sun Microsystems, Inc.
<http://java.sun.com/products/midp/midpwp.pdf>

[8] PersonalJava Application Environment Specification 1.1.1 (Final)
Sun Microsystems, Inc. January 7, 1999, 19 pages

[9] Over The Air User Initiated Provisioning Recommended Practice
for the Mobile Information Device Profile, Version 1.0, May 7, 2001
Sun Microsystems, Inc. 24 pages

[10] Java Native Interface (JNI) Online Tutorial, Sun Microsystems, Inc.
<http://java.sun.com/docs/books/tutorial/native1.1/index.html>

[11] PersonalJava FAQ (Sun Microsystems Inc. web page)
<http://java.sun.com/products/personaljava/faq.html>

[12] Wireless Java for Symbian devices, Johnathan Allin, John Wiley and Sons Ltd., ISBN 0471486841.

[13] Java in Sony Ericsson mobile Phones, White Paper, May be downloaded from
<http://www.ericsson.com/mobilityworld/>

Trademarks and Acknowledgements

Symbian and all Symbian-based marks and logos are trademarks of Symbian Limited.

Microsoft, Windows, PowerPoint and Outlook are registered trademarks or trademarks of Microsoft Corporation in the United States and/or other countries.

Lotus, Lotus Notes, Lotus Organizer and 1-2-3 are registered trademarks of Lotus Development Corporation and/or IBM Corporation. Lotus Mobile Notes is a trademark of Lotus Development Corporation and/or IBM Corporation.

Adobe and Acrobat are either registered trademarks or trademarks of Adobe Systems Incorporated in the United States and/or other countries.

Corel, Wordperfect and Quattro Pro are trademarks or registered trademarks of Corel Corporation or Corel Corporation Limited in Canada, the United States and/or other countries.

Java and all Java-based marks are trademarks or registered trademarks of Sun Microsystems, Inc. in the U.S. and other countries.

All other trademarks are the property of their respective owners.

Technical Specifications

General

Product name	P800 (Latin and Chinese versions) P802 (Chinese version for People's Republic of China)
Size	117 x 59 x 27 mm
Weight	158 grams with battery and flip 148 grams with battery, flip removed.
System and power class	E-GSM 900 Class 4 GSM 1800 Class 1 GSM 1900 Class 1
Antenna	Built in
Speech Coding	HR, FR, EFR supported where available, for high speech quality.
SIM Card	Small plug-in card, 3V or 5V type
Operating System	Symbian OS v7.0 Based on the 'UIQ' design.
Processor	ARM 9
Internal User storage	For settings, user data (e.g. images, contacts, messages) and third party applications: P800: 12Mbyte P802: 9Mbyte (dictionary not activated)
Additional Storage	Memory Stick Duo, up to 128Mbyte size supported. 16 Mbyte Memory Stick Duo supplied, plus Adapter

Battery Life

Standard battery	Talk Time: up to 13 hours Standby time: up to 400 hours
------------------	--

GPRS Maximum Data Rates (kbps)

		CS-1 9.05kbps	CS-2 13.4kbps	CS-3 15.6kbps	CS-4 21.4kbps
4 + 1	Rx	36.2	53.6	62.4	85.6
	Tx	9.05	13.4	15.6	21.4

Speed achieved depends on the Coding Scheme supported by the GSM Network.

HSCSD Maximum Data Rates (kbps)

		9.6kbps per timeslot	14.4kbps per timeslot
2 + 1	Rx	19.2	28.8
	Tx	9.6	14.4

Screen

Display type	TFT
Display size	Flip closed: 208 x 144 pixels, 40 x 28 mm Flip open: 208 x 320 pixels, 40 x 61 mm
Pixel size	0.192 mm
Colour resolution	12-bit (4096 colours)
Screen surface	Touch-sensitive, anti-reflective
Illumination	Front-light

Keypad

16 hard plastic keys on hinged/removable flip
 Jog Dial, 4-way (up, down, towards, away) + select.
 Browser button to switch to integrated browser
 CommuniCam button – switches to camera viewfinder and acts as shutter.
 On-Off button

Input

	P800 (Standard version)	P800/P802 (Chinese versions)
Flip Closed	Numeric keypad on flip Latin characters on number keys	Numeric keypad on flap Stroke Pinyin Bopomofo
Flip Open	Touch-screen Natural character recognition On-screen virtual keyboard	Touch-screen Chinese character recognition English character recognition Numeric character recognition Stroke Pinyin Bopomofo

Third Party Application Support

SDKs	C++ PersonalJava™ J2ME CLDC 1.0 / MIDP
Load formats	C++ or Java™ applications in Symbian SIS format. MIDP installation (JAR/JAD) from Browser or connected PC
Security	Support for signed applications

Telephony

Handsfree options:	Built-in Office Speakerphone Portable Handsfree Bluetooth Headset (optional accessory) Stereo Headset (optional accessory)
Picture Phone Book	Picture of contact displayed when making outgoing call Picture of caller displayed when incoming call CLI matches entry in Contacts. (See Contacts and Personalisation for details)
Personal ringtones	Sound clips as personal ringtones and default ringtone: AMR, AU, iMelody, MIDI, RMF (Beatnik) and WAV.
Voice control	Voice Dialling Voice Answering (answer or send 'busy') Magic Word activation 40 seconds storage for approx. 50 words and contact names
Other features:	Support for calling cards Access most applications whilst on a phone call Flight mode, enabling P800 to be used as a PDA in locations where radio transmitters must be switched off. GSM and Bluetooth are switched off when in flight mode.
SIM-AT	SIM Application Toolkit according to GSM 11.14
USSD	Incoming and outgoing

Personal Organiser

Applications	Contacts (Address Book) Calendar (Diary) Tasks ('To-Do' list) Jotter (Text and 'ink' notes) Voice Memo (Dictaphone) Time (World Clock) Calculator (P802 only) English-Chinese-English Dictionary (P802 only) Lunar Calendar
--------------	---

Integrated CommuniCam

Image Size	640 x 480 pixels (VGA) 320 x 240 pixels (QVGA) 160 x 120 pixels (QQVGA)
Colour depth	24 bit (16.78 million colours)
Storage format	JPEG/JFIF, 3 quality (compression) levels, user-selectable.
Other features	Delay timer Brightness and Contrast settings White Balance (4 pre-set values plus automatic) Flicker-free setting (for fluorescent lighting) Backlight mode (when there is light behind the subject) CommuniCam button switches to viewfinder and acts as the shutter.

Pictures (Image Viewer)

Formats	JPEG, BMP, GIF (including animated), MBM, PNG, WBMP
Sharing via	IR, Bluetooth, MMS, E-Mail, PC file transfer, Memory Stick

Image Editor

Usage	The Image Editor is available when composing MMS messages.
Functions	Crop, Rotate, Rescale
Electronic ink (draw on picture)	Colour, pen size, eraser function

Video Player

File Format	.MP4 (MPEG4)
Streaming transport	RTSP according to 3GPP
Video coding	MPEG-4 Simple Visual Profile Level 0 H263 Profile 0 Level 10 H263 Profile 3 Level 10
Audio coding	AAC, AMR

Audio Player

File Format	AMR, AU, MP3, WAV G-MIDI level 1 with 16 voices polyphony RMF
Features:	Playlists, Loop, Automatic pause on telephone call.

Messaging: SMS

Classes	0, 1 and 2
Bearer	GSM and GPRS
Broadcast	Basic & Extended channel
Concatenated	up to 255 messages

Messaging: EMS

Standards compliance	3GPP 23.040 Version 4
Supported objects	Sounds, Melodies, Pictures, Animations
Image editor	User may create and edit icons (16x16 and 32x32 pixels)

Messaging: MMS

Image formats	GIF (Including animated), JPG, BMP, WBMP, PNG
Audio format	AMR, AU, iMelody, MIDI, WAV
Presentation	SMIL
Conformance	3GPP 23.140 V5.0 Nokia/Ericsson 'MMS Conformance Document V2.0.0'

Messaging: E-Mail

Incoming mail server support	POP3, IMAP4
Outgoing mail server support	SMTP
Content coding	MIME compliant
Attachment Viewers	VCard, vCal, Pictures, Video Player, Audio Player Document viewers as below
Other features	Automatic download of messages over GPRS 'always on' connection

Document Viewer

Document type	Group	Location	Notes
Adobe® Acrobat® (PDF)	Built-in	Built-in	
Microsoft® Excel	Built-in	Built-in	
Microsoft® Powerpoint®	Built-in	Built-in	
Microsoft® Word	Built-in	Built-in	
Rich Text File (RTF)	Extended Office	CD	
Microsoft® Project	Extended Office	CD	
Microsoft® Visio®	Extended Office	CD	
Microsoft® Excel	Extended Office	CD	Older formats
Microsoft® Powerpoint®	Extended Office	CD	Older formats
Microsoft® Word	Extended Office	CD	Older formats
Corel® Wordperfect®	Wordperfect	CD	4.0 to 8.0
Corel® Wordperfect® Graphics	Wordperfect	CD	
Corel® Presentations	Wordperfect	CD	
Corel® Quattro® Pro	Wordperfect	CD	
Lotus® 1-2-3®	Lotus	CD	
Lotus® Ami Professional Draw	Lotus	CD	
PKZip®	Archive	CD	
Gnu Zip	Archive	CD	
CGM	Graphics	CD	
Fax	Graphics	CD	
PCX	Graphics	CD	
Ichitaro	Other	CD	
Microsoft® Outlook® message file	Other	CD	
PFS: First Choice	Other	CD	
PFS: Write	Other	CD	

Integrated browser technical data

Markup Languages	HTML 3.2 (excluding features such as Frames and Javascript that are not relevant to a small screen device) WML 1.3 WBXML xHTML Basic xHTML Mobile Profile cHTML
WAP version	2.0
Scripting	Compiled WML scripts
Style sheets	WCSS
Images	BMP, WBMP, GIF (including animated), JPEG
Bearer	GPRS, HSCSD, CSD
Security	WTLS Class 1, 2, 3; WTLS Cipher RC5 with key length 128 TLS/SSL; TLS Cipher RC4 with key length 128
Certificates	Pre-installed: Baltimore, Entrust, GlobalSign, RSA and VeriSign. Download WTLS, X509
WIM	WIM interface including SIM-WIM (SWIM)
Bookmarks	Yes, number only limited by available user storage
Bookmark import/export	IrDA, Bluetooth, SMS, MMS, E-Mail
Home Page	Yes
Cache	15 – 120kbyte user-configurable; 30kbyte default.
Clear cache function	Yes
Hyperlinks	<u>Underlined</u> in text Image according to Style Sheet.
WAP Accounts (WAP Profiles)	Yes. Integrated with bookmarks. Quantity only limited by available user storage.
OTA Support	Ericsson/Nokia OTA WAP Forum Provisioning

M-Services

Compliant with M-Services specification, Phase 1

MeT

Compliant with MeT specification, version 1.0

User Personalisation

Wallpaper FC only	BMP, GIF, JPEG, MBM, PNG, WBMP 208 x 144 pixels (Visible only in FC mode)
Screen saver FC and FO	BMP, GIF, JPEG, MBM, PNG, WBMP Animated GIF supported; note that animation uses more power. 208 x 320 pixels FO image size 208 x 144 pixels visible area with flip closed (same image as FO)
Ringtones and Alarm tones	AMR, AU, iMelody, MIDI, RMF, WAV Recommended format for WAV files is PCM, 22,050Hz, 8 bit, Mono, often called 'radio quality'
Picture Phonebook	BMP, GIF, JPEG, MBM, PNG, WBMP (Picture formats that may be loaded into Contacts)
Application selection	Application available via FC on-screen icons. Applications available from Application Picker in FO mode.

Bluetooth Wireless Technology technical data

<i>Bluetooth</i> compatibility statement	This product is manufactured to comply with the Bluetooth specification 1.1.
Coverage area	Up to 10 metres (33 feet)
<i>Bluetooth</i> functions	Generic Access Profile Serial Port Profile Generic Object Exchange Profile Dialup Networking Profile Object Push Profile Headset Profile

Infrared Transceiver technical data

Data transmission rate	Max speed between phone and IrDA device (e.g. PC, another phone) SIR: up to 115,200 bps
------------------------	--

Remote Synchronisation

Data	Contacts Calendar Tasks
Bearer	HTTP
Protocol	SyncML

Local Synchronisation

Data	Contacts Calendar Tasks Jotter Text Notes E-Mail
Bearer	Bluetooth IrDA USB
Protocol	SyncML
PC Applications supported	Lotus Organizer 5 & 6 Lotus Notes 4.6 & 5.0 Microsoft® Outlook® 98, 2000, 2002

PC Suite for P800

Local Synchronisation (as above)
Drag-and-drop file transfer between the P800 and the PC. (e.g. Word documents, JPEG images)
Backup and Restore of user data and settings
Software Installation Utility
Language Change Utility
Dial-Up Networking Wizard
Drivers for P800 to be used as a wireless modem
Interactive Learning Video
Soft copies of user documentation

PC Utilities

Sony Ericsson Image Editor
Sony Ericsson MMS Home Studio

Security

Data protection	SIM PIN (at power on) Device Lock (at power on and/or activated by screensaver)
Browser	TLS, SSL, WTLS, Certificate handling
Third party applications	Support for signed applications
Intranet Access	SecureID [®] from RSA Security SafeWord from Secure Computing

Remote Configuration

Ericsson/Nokia OTA Settings specification	WAP Account (Account name and WAP Gateway information) ISP Settings (Bearer information, username, password) Bookmark (name and URL) SyncML settings MMS Settings
WAP Forum specifications	WAP Account ISP Settings
Smart Messaging Specification	ISP Settings E-Mail account

Games

Solitaire
Chess, including multi-player games over SMS
Men In Black (Load from Multimedia for P800 CD)
Stunt Run (Load from Multimedia for P800 CD)