



OPERATING INSTRUCTIONS FOR YOUR

Cobra® Intenna®

CORDLESS TELEPHONE

“The antenna is in the phone,
not in your way...and the sound is incredible.”

MODEL CP-2505





Cobra® Intenna®
Cordless Telephone Model CP-2505
Table of Contents

SUBJECT	PAGE
Important Safety Instructions	2, 3
Introduction	4
Installation Information	5
Quick Set-Up Guide	6
Wall-Mounting Instructions.....	7
Using Your Phone.....	8
Answering/Placing Calls at the Base.....	8
Answering/Placing Calls Away From The Base.....	8
Cordless Phone Operational Features	9
Battery Saver Circuitry	9
Channel Selection	9
Compander Noise Reduction	9
Digital Security	9
Flash	9
Hearing Aid Compatibility.....	10
Hold	10
<i>Intenna</i> System	10
Last Number Redial	10
Memory Dialing (Storage)	10
Memory Dialing (Recall)	10
Out-of-Range Signal.....	11
Power Protector™ System	11
Private Call™ Voice Scrambling System	11
Pulse/Tone Switch	11
Ringer Switch	11
Secur-Loc®	11
Rechargeable Handset Battery Information	12
Handset Battery Recharging	12
Replacing the Handset Battery	12, 13
Handset Battery Disposal.....	13
Cleaning The Charging Contacts	13
About Cordless Phone Performance	14
<i>Intenna</i> Cordless Telephone Troubleshooting Guide	15
If You Think You Need Service	16
Registered with the FCC.....	16
Limited One-Year Warranty	17
Cordless Phone Accessories	Inside Back Cover



Important Safety Instructions

When using your telephone equipment, basic safety precautions should always be followed to reduce the risk of fire, electric shock and injury to persons, including the following:

1. Read and understand all instructions.
2. Follow all warnings and instructions marked on the product.
3. Unplug this product from the wall outlet before cleaning. Do not use liquid cleaners or aerosol cleaners. Use a damp cloth for cleaning.
4. Do not locate base unit near water, for example, near a bath tub, wash bowl, kitchen sink, or laundry tub, in a wet basement or near a swimming pool.
5. Do not place this product on an unstable cart, stand or table. The product may fall, causing serious damage to the product.
6. Slots and openings in the cabinet and the bottom or back are provided for ventilation, to protect it from overheating; these openings must not be blocked or covered. The openings should never be blocked by placing the product in the bed, sofa, rug or other similar surface. This product should never be placed near or over a radiator or heat register. This product should not be placed in a built-in installation unless proper ventilation is provided.
7. This product should be operated only from the type of power source indicated on the marking label. If you are not sure of the type of power supply to your home, consult your dealer or local power company.
8. Do not allow anything to rest on the power cord. Do not locate this product where the cord will be abused by persons walking on it.
9. Do not overload outlets and extension cords as this can result in the risk of fire or electric shock.
10. Never push objects of any kind into this product through cabinet slots as they may touch dangerous voltage points or short out parts that could result in a risk of fire or electric shock. Never spill liquid of any kind on the product.
11. To reduce the risk of electric shock, do not disassemble this product, but take it to qualified servicemen when service or repair work is required. Opening or removing covers may expose you to dangerous voltages or other risks. Incorrect reassembly can cause electric shock when the appliance is subsequently used.
12. Avoid using telephone (other than a cordless type) during an electrical storm. There may be a remote risk of electric shock from lightning.
13. Do not use the telephone to report a gas leak in the vicinity of the leak.
14. Unplug this product from the wall outlet and refer servicing to qualified service personnel under the following conditions:
 - A. When the power supply cord or plug is damaged or frayed.
 - B. If liquid has been spilled into the product.
 - C. If the product has been exposed to rain or water.
 - D. If the product does not operate normally by following the operating instructions. Adjust only those controls that are covered by the operating instructions because improper adjustment of other controls may result in damage and will often require extensive work by a qualified technician to restore the product to normal operation.
 - E. If the product has been dropped or the cabinet has been damaged.
 - F. If the product exhibits a distinct change in performance.



Important Safety Instructions (continued)

The cordless handset operates on batteries, please read and follow instructions:

- A. Use only the battery pack supplied with the unit or identical replacement.
- B. Do not dispose of battery pack in a fire. The cells may explode. Check with local codes for possible disposal instruction.
- C. Since released electrolyte is corrosive and may cause damage to eyes or skin and may be toxic if swallowed:
 - C1. Do not open or mutilate battery pack.
 - C2. Always replace the entire battery pack rather than reusing one or more cells.
 - C3. Do not expose batteries to heat or flame.
- D. Exercise care in handling the battery pack in order not to "short" the battery contacts with conducting materials such as rings, bracelets, and keys. The battery or conductor may overheat and cause burns.

The base also has a back-up battery, please read and follow these instructions:

- A. Do not attempt to recharge the battery provided with or identified for use with this product. The battery may leak corrosive electrolyte or explode.
- B. Do not attempt to rejuvenate the battery provided with or identified for use with this product by heating it. Sudden release of the battery electrolyte may occur causing burns or irritation to the eyes or skin.
- C. Remove the battery from this product if the product will not be used for a long period of time (several months or more) since during this time the battery could leak in the product.
- D. Properly dispose of "dead" batteries as soon as possible since "dead" batteries are more likely to leak in a product.
- E. Do not store this product or the battery provided with or identified for use with this product in high-temperature areas. Batteries that are stored in a freezer or refrigerator for the purpose of extending shelf life should be protected from condensation during storage and defrosting. Batteries should be stabilized at room temperature prior to use after cold storage.

- 15. Never install telephone wiring during a lightning storm.
- 16. Never install telephone jacks in wet locations unless the jack is specifically designed for wet locations.
- 17. Never touch uninsulated telephone wires or terminals unless the telephone line has been disconnected at the network interface.
- 18. Use caution when installing or modifying telephone lines.

Save These Instructions

WARNING: TO PREVENT FIRE OR ELECTRIC SHOCK HAZARD DO NOT EXPOSE THIS PRODUCT TO RAIN OR MOISTURE

THE LIGHTNING FLASH AND ARROW POINT WITHIN THE TRIANGLE IS A WARNING SIGN ALERTING YOU OF "DANGEROUS VOLTAGE" INSIDE THE PRODUCT.

CAUTION
RISK OF ELECTRIC SHOCK
DO NOT OPEN

CAUTION: TO REDUCE THE RISK OF ELECTRIC SHOCK DO NOT REMOVE COVER (OR BACK). NO USER SERVICEABLE PARTS INSIDE. REFER SERVICING TO QUALIFIED SERVICE PERSONNEL.

THE EXCLAMATION POINT WITHIN THE TRIANGLE IS A WARNING SIGN ALERTING YOU OF IMPORTANT INSTRUCTIONS ACCOMPANYING THE PRODUCT.

SEE MARKING ON BOTTOM/BACK OF PRODUCT



How To Use Your

Cobra® Intenna®

Cordless Telephone Model CP-2505

U.S. PATENT 4876709
U.S. PATENT 5351284

Introduction

Thank you for your purchase of a Cobra® *Intenna*® Cordless Telephone — **the world's first and only full-range-power cordless telephone without any external antennas!**

No more extending, bending, or breaking the antennas found on other cordless phones — your Cobra *Intenna* **conceals its antenna systems inside the handset and base**, where they should be, out of your way.

Now you can install your new Cobra *Intenna* cordless phone virtually anywhere. Without cumbersome external antennas to worry about, put your new phone anywhere a corded phone can go! Then enjoy the freedom of using your new cordless phone all over the house as well as outside in your yard.

Your new Cobra Model CP-2505 has **25 selectable channels** (the maximum number available) for optimum interference-free use, and 10-number memory dialing. The CP-2505 is also equipped with an extra-life battery which allows you to keep the phone away from the base for up to 14 days between recharges, **Clear Call® PLUS Circuitry with compander noise-reduction system** to ensure corded-phone sound quality, Private Call™ voice scrambling, and Power Protector™ reserve power for operation during power outages.

Please take a moment to review this booklet and become familiar with all of the many user-friendly convenience features built into your new Cobra *Intenna* Cordless Phone.

If you need further assistance installing or using your new *Intenna* Cordless Telephone, please **call our consumer "hotline" at 1-773-889-3087**, 8 a.m. to 8 p.m. CST, Monday through Friday (except holidays).

NOTE: The advanced channel scanning technique employed by the CP-2505 ensures that a clear channel is chosen. The TALK button flashes during scanning. In the presence of radio interference (such as another cordless telephone or baby monitor) there may be slight delay in accessing the line when placing a call.

NOTE: Some cordless telephones operate at frequencies that may cause interference to nearby TV's and VCR's. To minimize or prevent such interference, the base of the cordless telephone should not be placed near or on top of TV's or VCR's. If interference is experienced, moving the cordless telephone base further away from the TV or VCR will often reduce or eliminate the interference.

CAUTION: Any changes or modifications not expressly approved by Cobra could void the user's authority to operate the equipment.



Installation Information

Maximum range is obtained by installing the base unit in the highest living area of your home. The location you choose must be near an electrical outlet and a telephone wall jack.

HANSET

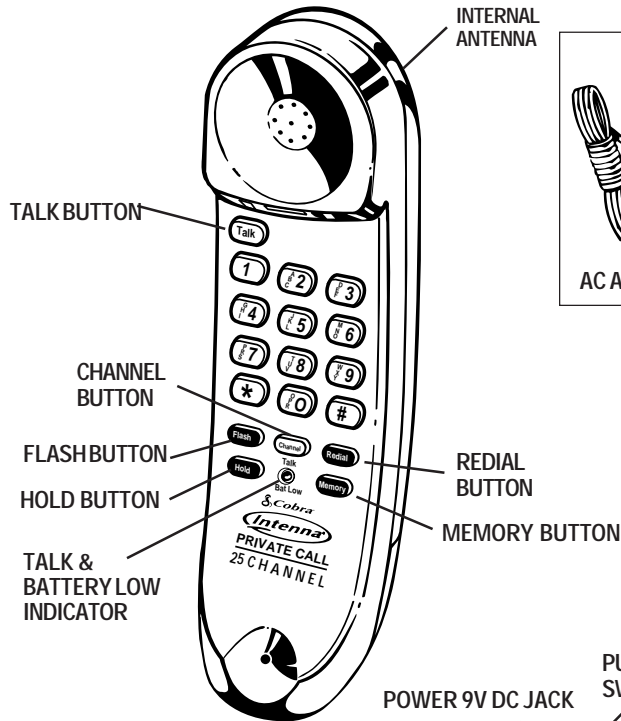

BASE UNIT

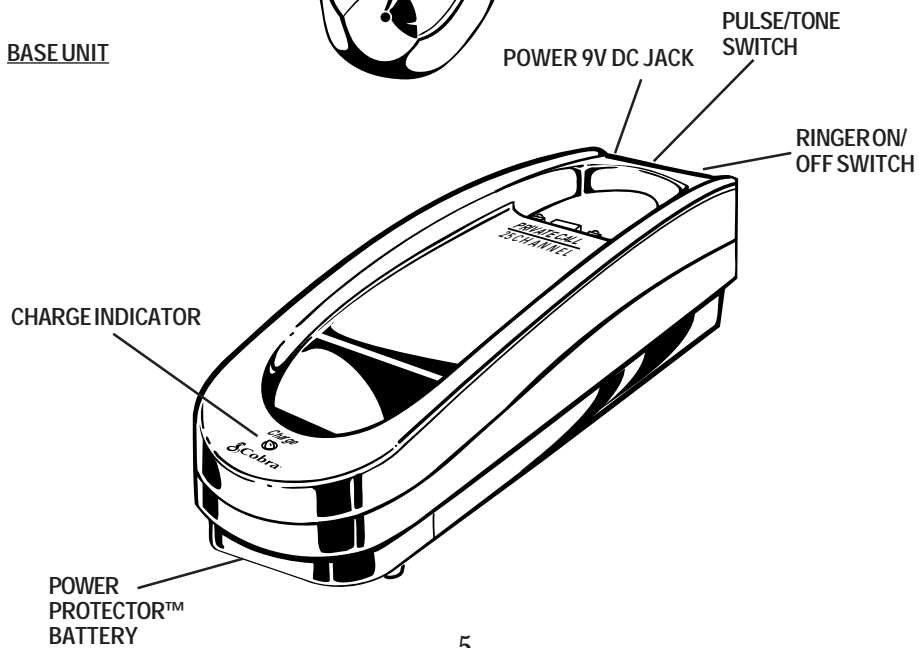

Quick Set-Up Guide

The following basic steps enable quick and easy installation of your new Cobra *Intenna* Cordless Phone for use on a desk or countertop. You are encouraged to review this complete instruction manual to become familiar with all of the operating instructions and features of your new phone.

NOTE: Before using, connect your new system to AC power (see instructions below) to charge it overnight (at least 12 hours) for optimum conditioning of the rechargeable battery inside the cordless handset.

- 1 Insert round connector of power adapter into POWER jack (at rear of cordless phone's base; see diagram #1 below). Plug power adapter into a standard 120 VAC household electrical outlet. Then place handset in base so CHARGE indicator lights (see p. 12).

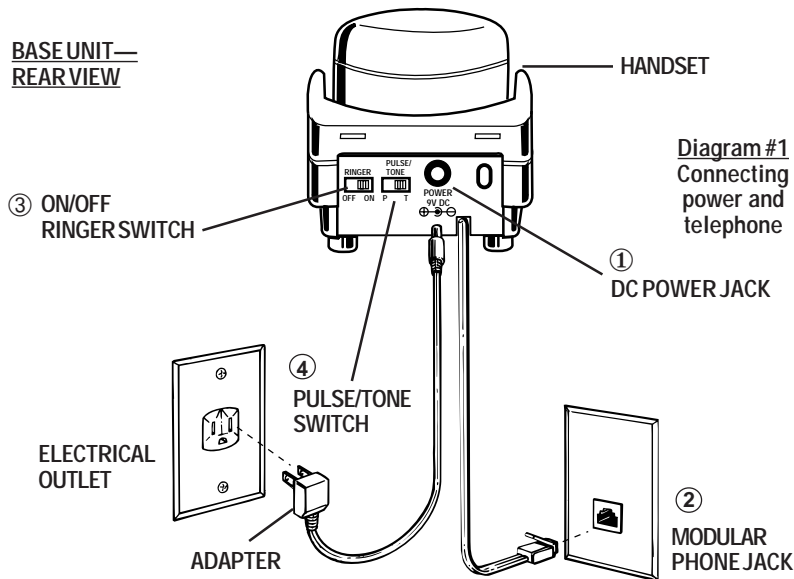

- 2 After charging, remove the twist-tie from the phone cord and plug the modular telephone connector into the phone jack on your wall (see above).
- 3 Make sure that the RINGER switch is ON (located on base; see p. 11 for details).
- 4 Set the PULSE/TONE switch (at the rear of the base) for proper operation (see page 11 for details).

Note: Make sure you have charged handset in base 12 hours before using.

- 5 Install the 9V battery for Power Protector™ operation in the base as shown in the illustration.

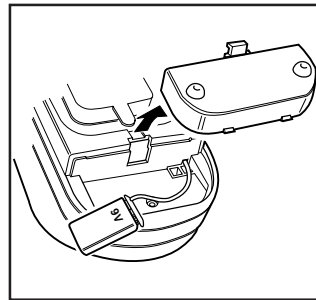

Wall Mounting Instructions

The following steps enable installation on a **new or existing telephone wall-mounting plate or directly onto a wall**. (Your Cobra *Intenna* is designed to be used with any AT & T, GTE, local phone company or other wall-mounting plates that can be purchased from most local electronics stores.)

- Run telephone cord through cord wrap channel on bottom of base. (As shown).
- Plug modular phone connector into telephone wall jack.
- Align mounting studs on the plate to the holes on the bottom of the *Intenna* base; push base onto studs and slide down on the wall plate.

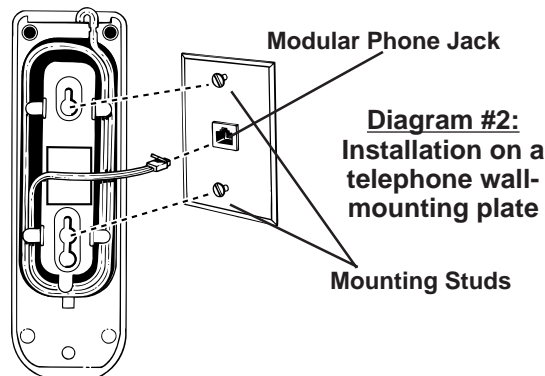

- Attach the power adapter to the POWER connection (on the base of the phone) and plug into a household AC power outlet.
- To install directly on any wall, you'll need to provide two screws and wall anchors; follow these steps:
 - Drill two holes $3\frac{1}{4}$ " apart and insert the wall anchors.
 - Drive the screws into the anchors until the head of each screw is protruding about $\frac{1}{8}$ " from the wall.
 - Align the holes in the cordless base over the screw heads; push base in and slide down on screws (see diagram #3).
 - Plug modular phone connector into telephone wall jack; attach the power adapter to the POWER connection (on the base of the phone) and plug into to a household AC power outlet.

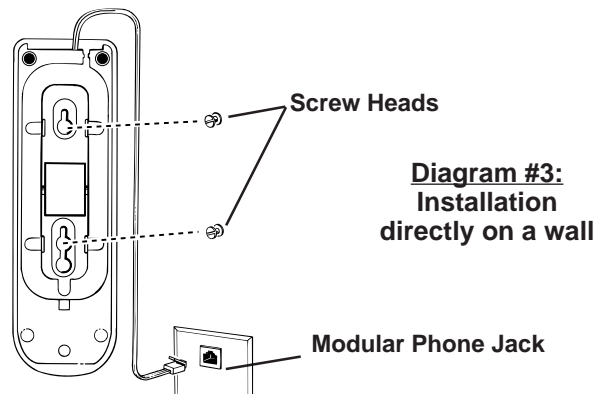

Using Your Phone

After charging the handset batteries overnight (at least 12 hours), your Cobra *Intenna* cordless phone will be ready for use.

ANSWERING/PLACING CALLS AT THE BASE

- To answer a call, just pick up handset from base when the phone rings. TALK indicator will automatically light. When call is completed, return handset to base without pressing TALK button; your phone automatically disconnects.
- To place a call, pick-up handset from base and press and release the TALK button (indicator will light). When you hear the dial tone, place your call.

ANSWERING/PLACING CALLS AWAY FROM THE BASE

- The TALK indicator must be off (not lit) when the handset is away from the base. The phone is ready to ring if a call is received (RINGER Switch on the base must be in ON position).
- Press and release the TALK button (indicator will light) to answer or place a call.
- Press and release the TALK button when finished with a call. TALK indicator light will go off and the call will be disconnected.

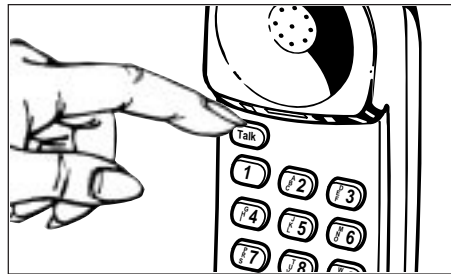

Note: The advanced channel scanning technique employed by the CP-2505 ensures that a clear channel is chosen. The TALK button flashes during scanning. In the presence of radio interference (such as another cordless telephone or baby monitor) there may be a slight delay in accessing the line when placing a call.

Cordless Phone Operational Features

The following features offer state-of-the-art performance and the ultimate in user-friendly convenience with your new Cobra *Intenna* cordless telephone.

BATTERY SAVER CIRCUITRY

The handset of this phone may be kept away from the base (TALK indicator OFF) up to 14 days at a time. In this condition, it is ready for you to answer or place calls by pressing and releasing the TALK button.

Note: A warning beep tone will sound and the TALK/BAT indicator will flash when the handset battery needs recharging (see p. 12). The duration of the battery charge will depend on your actual use of the phone in its remote location.



CHANNEL SELECTION

25 selectable channels are built into your Cobra *Intenna* for optimum interference-free use.

If interference begins during a conversation:

- Press and release the CHANNEL button on the handset. Your phone will automatically scan and advance to the next clear channel. A confirmation tone (two double beeps) will sound to indicate a successful channel change.
- If an alert tone (3 beeps) sounds, channel change was unsuccessful. In that case, move closer to the phone base and press CHANNEL button again.



COMPANDER NOISE REDUCTION

Your Cobra *Intenna* has the Cobra Clear Call[®] PLUS compander noise-reduction system to minimize background noise for optimum audio performance. The sound of your phone will be comparable to the performance of a corded phone.

DIGITAL SECURITY

Your Cobra *Intenna* features 65,000 combinations of digital security coding (in accordance with FCC regulations) to reduce the chance of interference from your neighbors' cordless phones. These inaudible, electronic codes are transmitted automatically by your phone to establish a secure link between your cordless handset and base.

FLASH

This feature briefly interrupts the phone line so that you may access some of the advanced features— like “Call Waiting” and “Three-Way Calling”— that may be offered at extra cost by your local telephone company. Press and release the FLASH button on the handset to answer a second phone call or place a conference call if you subscribe to these services.



HEARING AID COMPATIBILITY

Your cordless telephone handset is compatible with inductively coupled hearing aids (HAC).

HOLD

After you put a call on hold, your *Intenna* automatically releases when you, or someone else, picks up another handset on the same line. No need to come back and turn it off, because it turns itself off automatically.

Intenna SYSTEM

The revolutionary, patented *Intenna* hidden-antenna system is a Cobra exclusive. *Intenna* is the world's first and only full-range-power cordless telephone that conceals the handset and base antennas inside the phone and out of the way. No more antennas to extend, bend or break. Cobra's hidden antennas are perfectly matched to your phone's microprocessor circuitry for optimum performance offering the ultimate in user-friendly convenience.

LAST NUMBER REDIAL

Each time you dial, the phone number you're calling is automatically saved in a special REDIAL memory. To call that number again at a busy signal, press FLASH (without hanging up) to get a new dial tone, then press and release the REDIAL button. If you wish to try the call in a few minutes, use TALK to access the dial tone, then press and release the REDIAL button. The number will automatically be redialed.

MEMORY DIALING (STORAGE)

Your Cobra *Intenna* cordless phone enables you to store up to ten frequently dialed phone numbers or emergency numbers. With the TALK indicator light off, press and release the MEMORY button; enter the digits of the phone number you wish to store, up to 16 digits; press and release the MEMORY button again. Now assign your memory number a position by entering any keypad number from 0 to 9. You will hear a confirmation beep. Repeat until all ten numbers are entered. NOTE: for automated banking or alternate long distance service, you may need to program a number which is longer than 16 digits. You will need to divide the number between two memory I.D. numbers. Follow the steps above.

MEMORY + TELEPHONE NUMBER + MEMORY + I.D. # (0-9) = CONFIRMATION TONE

MEMORY DIALING (RECALL)

To call a number stored in memory, press TALK to get a dial tone; press MEMORY button. Press the keypad number you assigned to that number and your phone will automatically dial the number. NOTE: for longer numbers which you have stored in two different I.D. numbers, follow steps above, pressing MEMORY button again before entering the second number. Use the memory sticker card provided to write down the names of each memory position. Keep this in any convenient place.

TALK + MEMORY + I.D.# 0-9 = MEMORY DIAL



OUT-OF-RANGE SIGNAL

If three beeps are heard immediately after the TALK button is pressed, the handset is too far away from the base. The handset and TALK indicator will automatically turn off. Move closer to the base and then try your call again.

POWER PROTECTOR™ SYSTEM

Although the handset is battery powered, the base obtains its power from the AC outlet. No AC, no power. This could be of critical importance should an emergency occur during a power failure. Many homes are now exclusively cordless, leaving them without means to quickly contact emergency services in this situation.

Power Protector helps solve that problem. In the *Intenna* CP-2505, a 9 volt battery allows the base to continue working in the event of a power failure. The phone will be usable for up to 2 hours continuously (and up to 3 hours with occasional use)—long enough in most cases for the power to be restored.

Replacement of the Power Protector battery with a fresh high quality alkaline battery is recommended every six months and after a power outage over 30 minutes. Please refer to page 6 for instructions.

PRIVATE CALL™ VOICE SCRAMBLING SYSTEM

This feature is automatically activated whenever you use your phone. Built-in voice scrambling allows complete calling privacy by scrambling the signals between the handset and the base and between the base and the handset, making it unlikely that an outside source such as another cordless phone, scanner or baby monitor to pick up a conversation from your phone. This ensures that you will always have totally private telephone conversations.

PULSE/TONE SWITCH

Your Cobra *Intenna* cordless phone can be used with any phone system because it is switchable from pulse to tone dialing (see switch on back of the base) depending on which service you are using. Mixed PULSE and TONE dialing may be used (to access certain long-distance or computerized banking services, for example) by selecting PULSE with the base switch and then using the ★ button on the handset to temporarily switch to TONE dialing. Hanging up resets to PULSE.

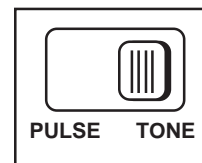

RINGER SWITCH

The OFF/ON switch (located on back of the base) controls your cordless handset's electronic ringer; no ring will sound in the OFF position.

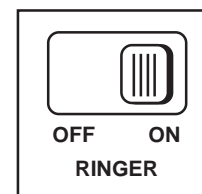

SECUR-LOC®

This exclusive Cobra electronic circuitry is an added security measure to protect your phone line from being accidentally accessed by a neighbor's cordless phone. Secur-Loc activates automatically when your cordless handset is placed into its base.

Rechargeable Handset Battery Information

NOTE: Before using your new Cobra *Intenna* cordless telephone for the first time, you must charge the battery overnight (at least 12 hours) for optimum long-life conditioning of the nickel-cadmium rechargeable handset battery.

BATTERY RECHARGING

When your cordless handset battery needs recharging, the following alerts will remind you to immediately return the handset to the base for recharging (this normally requires at least 12 hours of continuous charging):

1. The TALK/BAT LOW indicator on the handset will flash.
2. A warning (2 beeps every 30 seconds) will sound while you are using the phone. This indicates you have only a few minutes of battery power remaining to complete your conversation before the phone disconnects.
3. When handset has been away from the base and needs recharging, it will beep at 30 second intervals for five minutes. After this time, the handset will seem "dead". It will not flash or beep, nor will you be able to get a dial tone. Return handset to base for recharging.

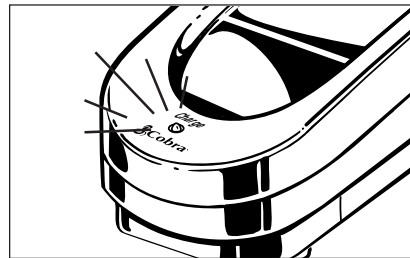
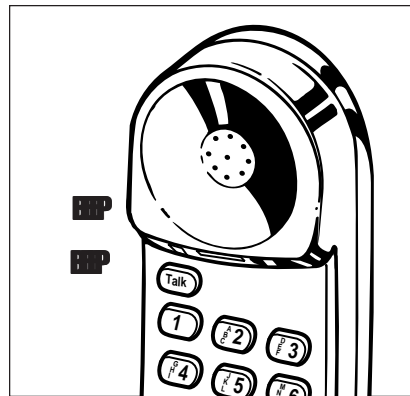
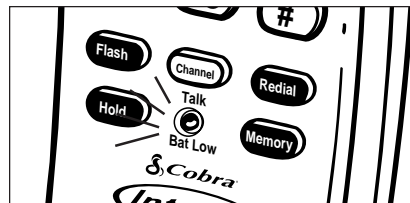

NOTE: The CHARGE indicator will remain on as long as the handset is in the base, even after the batteries are fully recharged. **The batteries will not be damaged if the handset remains in the base continuously;** the charging system is self-adjusting and will never over-charge the batteries.

REPLACING THE HANDSET BATTERY

The rechargeable NiCad battery in your cordless phone may need to be replaced if the handset will not function when the TALK button is pressed after recharging for 12 hours.

Replacement batteries are available direct from Cobra (see accessories order form at the end of this booklet or call 1-773-889-3087).



REPLACING THE HANDSET BATTERY (continued)

1. To remove the battery door, press and slide downward.
2. Carefully disconnect the battery pack and dispose of it properly. See BATTERY DISPOSAL below.
3. To replace, observe connection orientation and connect the new battery and replace the door. Return the handset to the base and charge the battery overnight (at least 12 hours).

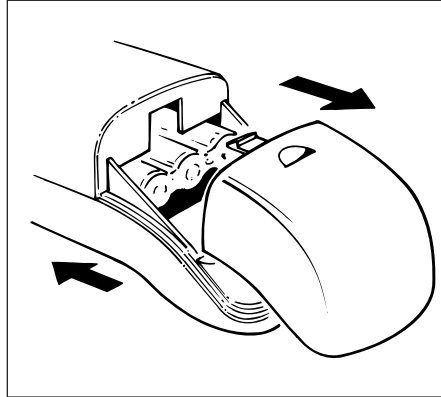

HANDSET BATTERY DISPOSAL

The rechargeable nickel cadmium (NiCad) battery in this product must be recycled or disposed of properly in compliance with all applicable laws. Certain states or municipalities require recycling and have established collection programs. Please contact your local waste removal authority for instructions, or return to Cobra for recycling. Wrap batteries carefully and mail postage prepaid to:

Cobra Electronics Corporation
6500 W. Cortland Street
Chicago, IL 60707
Attn: Battery Recycling

"Contains Nickel-Cadmium Rechargeable Battery. Must be recycled or disposed of properly."

DO NOT PUT BATTERIES INTO FIRE OR EXPOSE TO HIGH HEAT. THEY MAY EXPLODE.

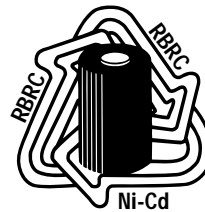

CLEANING THE CHARGING CONTACTS

Clean the two metal charging contacts on the base and handset with a soft, dry cloth on a regular basis to ensure optimum performance of the battery-charging system. Rubbing alcohol may be used if more thorough cleaning is required.



About Cordless Phone Performance

Your Cobra *Intenna* cordless phone uses radio transmission to communicate between the base and handset. It is thus subject to occasional interference—static or buzzing noises, for example. These conditions may be caused by electrical motors on household appliances, fluorescent lights, electrical storms and other sources.

These steps will enhance the maximum performance of your new phone:

- **Change channels by pressing the CHANNEL button on the handset if you experience interference.**
- **Don't cover the upper section of the cordless handset with your hand** (see diagram below). This may block the internal antenna located at the top of the handset, possibly reducing the phone's range and audio clarity. Always hold the handset at the middle or close to the bottom.



INCORRECT



CORRECT

Hold the cordless handset at the middle or bottom area of your phone for best performance and range.

- **Avoid resting the handset on your shoulder** during conversations; this may also block the performance of the internal antenna.
- **Avoid plugging your phone's power cord into an active AC outlet** that also provides power for a major appliance or for charging units for cordless appliances (vacuums, screwdrivers, etc.) or other electronic devices.



***Intenna* Cordless Telephone Troubleshooting Guide**

If your cordless phone does not seem to operate properly, please check the following and refer to the appropriate sections in this booklet for detailed information:

- **The phone is dead; no indicator lights are on:** Are the power adapter and telephone cord connected?
- **Handset beeps during conversations or when away from the base:** The batteries need recharging; return the handset to the base for overnight recharging.
- **Hearing poor audio or added interference during calls:** Don't cover the top section of the handset with your hand or rest the phone on your shoulder. This blocks the special internal Cobra *Intenna* handset antenna.
- **Handset disconnects, loses performance and/or beeps three times when in use away from the base:** You may be out of range or your batteries may need recharging. Move closer to the base and/or recharge batteries.
- **Unable to make a call due to interference:** Select a new channel.
- **Handset won't work after a power outage or after disconnecting phone from AC power and then reconnecting it:** Return the handset to the base for about 15 seconds to automatically match the security coding.
- **Handset seems "dead.":** Battery power has run out; return handset to base and charge for at least 12 hours. If handset still seems dead, unplug the handset battery for 15 seconds and plug back in and then place the handset back on the base for at least 5 minutes. Check that charge LED lamp is illuminated.
- **Memory dialing does not work:** Handset battery may have become completely discharged; recharge handset in cradle (12 hours) then re-enter your memory dialing numbers (see p. 10).
- **Power Failure Reset:** Power Protector™ Circuitry will preserve the codes set in the handset and base, however, if the battery in the base is low in power, you must return the cordless handset to the base for about 15 seconds. This automatically matches the digital security codes.



For technical assistance, please call our Automated Help Desk which can assist you by answering the most frequently asked questions about Cobra products.

773-889-3087

24 hours a day, 7 days a week.

A Consumer Service Representative can be reached through this same number 8:00 am - 8:00 pm, Monday through Friday, CST.

Technical assistance is also available on-line in the Frequently Asked Questions (FAQ) section at www.cobraelec.com or by e-mail to productinfo@cobraelec.com

If You Think You Need Service, Call 1-773-889-3087

You may be asked to send your unit to the Cobra factory. It will be necessary to furnish the following, in order to have the product serviced and returned.

1. For Warranty Repair, include some form of proof-of-purchase, such as a mechanical reproduction or carbon or a sales receipt. If you send the original receipt it cannot be returned.
2. Send the entire product. Must include base, handset, cords and power adapter furnished with the product.
3. Enclose a description of what is happening with the unit. Include a typed or clearly printed name and address of where the unit is to be returned.
4. Pack unit securely to prevent damage in transit. If possible, use the original packing material.
5. **Ship prepaid and insured by way of a traceable carrier (to avoid loss in transit) such as United Parcel Service (UPS), Roadway Parcel Service (RPS) or First Class Mail to Cobra Factory Service, Cobra Electronics Corporation, 6500 W. Cortland St., Chicago, IL 60707.**
6. If the unit is in warranty, upon receipt of your unit it will either be repaired or exchanged depending on the model. Please allow approximately 3 to 4 weeks before contacting us for status. If the unit is out of warranty a letter will automatically be sent informing you of the repair or replacement charge. If you have any questions, please call 1-773-889-3087 for assistance.

Registered with the FCC

Please note: This cordless telephone operates under part 15 and part 68 of FCC rules. Operation is subject to two conditions: 1) It may not interfere with radio communications, and 2) It must accept any interference received, including that which may cause undesirable operation. See the Operational Features section of this booklet for ways to reduce interference.

Your telephone company is required by the Federal Communications Commission to allow you to connect FCC registered telephones to their lines.

The FCC requires you to provide information, if requested by the local telephone company, about the connection of an FCC registered telephone to their lines. They may ask you for the FCC registration number and the ringer equivalence number (REN), both of which are on the bottom of the base. They may also ask for the Universal Service Order Code (USOC) number, which is RJ-11C.

It is illegal to use this phone on a party line or to connect it to a coin-operated telephone.



Limited One-Year Warranty

COBRA ELECTRONICS CORPORATION warrants that its COBRA cordless telephone products, and the component parts thereof, will be free of defects in workmanship and materials for period of one (1) year from the date of first consumer purchase. This warranty may be enforced by the first consumer purchaser, provided that the product is utilized within the U.S.A.

Cobra will, without charge, repair or replace, at its option, defective cordless telephone products or component parts upon delivery to the Cobra factory Service Department, accompanied by proof of the date of first consumer purchase, such as a duplicated copy of a sales receipt.

You must pay any initial shipping charges required to ship the product for warranty service. The return charges will be at Cobra's expense if the product is repaired or replaced under warranty. For further details concerning procedures for obtaining service, see the "If You Need Service" section of this Owner's Manual.

Exclusions: This limited warranty does not apply 1) to any product damaged by accident, improper line voltage or weather related circumstances; 2) in the event of misuse or abuse of the product or as a result of unauthorized alterations or repairs; 3) to non-defective original equipment Nickel Cadmium rechargeable batteries; 4) if the serial number has been altered, defaced or removed; or 5) if the owner of the product resides outside the U.S.A.

All implied warranties, including warranties of merchantability and fitness for a particular purpose, are limited in duration to the length of this warranty.

Cobra shall not be liable for any incidental, consequential or other damages, including, without limitation, damages resulting from loss of use or cost of installation.

Some states do not allow limitations on how long an implied warranty lasts and/or do not allow the exclusion or limitation of incidental or consequential damages, so the above limitations may not apply to you.

This limited warranty gives you specific legal rights, and you may also have other rights which vary from state to state.

COBRA ELECTRONICS CORPORATION

6500 W. Cortland Street
Chicago, Illinois 60707

In addition to its exclusive series of *Intenna* cordless telephones and answering systems, Cobra is also one of America's leading brands of CB radios and accessories, and TRAPSHOOTER® STEALTH™ radar/laser detectors.

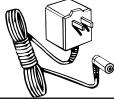

Cobra Cordless Phone Accessories

Description	Part No.	Cost Ea. X Qty. = Amount		
NICKEL-CADMIUM BATTERY PACK ASSEMBLY WITH CONNECTOR For use with model CP-2505	213-013-9-001	\$15.00		
 AC POWER ADAPTER For use with model CP-2505	768-026-N-001	\$10.00		

(Prices subject to change without notice.)

** Illinois residents add 7%	Amount _____
** Cook Co.residents add .75% (7.75% total)	(Tax if applicable**) _____
** Chicago residents additional 1% (8.75% total)	
** Indiana residents add 5%	Shipping / handling <u> \$3.75 </u>
** Michigan residents add 4%	
** Minnesota residents add 6%	Total* _____
** Ohio residents add 6%	
** Wisconsin residents add 5%	

Cobra Accessories Dept.
6500 W. Cortland St., Chicago, IL 60707

Order by phone: 1-773-889-3087 (Press 1 from the main menu) 8 am - 8 pm, M-F CST
Fax to: 1-773-622-2269

Please print clearly

Name _____

Address (Not P.O. Box) _____

City _____ State _____ Zip _____

Telephone No. (_____) _____

Credit Card No. _____ Exp. Date _____

Customer Signature _____

Circle One: Visa MasterCard Discover

Allow 4 to 6 weeks for delivery. Offer valid in Continental U.S. only.



Cobra Electronics Corporation
6500 W. Cortland Street
Chicago, IL 60707