



Operating Instructions for your Cobra®  
6 Band® Extra Sensory Detection®

# Radar/Laser Detector

Model ESD-6050



Nothing comes close to a Cobra™

# Introduction



*Use of this product is not intended to, and does not, ensure that the motorist and any passenger will not be involved in a traffic accident. It is only intended to alert the motorist that an emergency or service vehicle equipped with a CODE 3, or Cobra® Safety Alert Transmitter is in the area as defined by the range of the product. Please call your local Fire/Police department to verify if coverage exists in your area. Motorists are expected to exercise all due caution while using this product, and to observe and follow all applicable traffic laws. Operators of emergency or service vehicles are also expected to exercise all due caution while using this product, and to observe and follow all applicable traffic laws.*

1.



2.



3.



## Introduction

Congratulations! You have just purchased the most sophisticated RADAR/LASER DETECTOR available today. This booklet contains instructions and information designed so that you will be able to understand how the Cobra® ESD-6050 works and how radar and (LIDAR) laser are used. Enjoy your Cobra® ESD-6050 Radar/Laser Detector and **drive safely.**

## Federal Law Governing Use of Radar Detectors

It is not against Federal Law to receive radar transmissions on your COBRA® Radar Detector. The Communications Act of 1934 guarantees your right to receive radio transmissions on any frequency. Local laws that contravene the Communications Act of 1934, while illegal, may be enforced by your local law enforcement officials until and unless they are prohibited from doing so by Federal Court action.

**WARNING:** Before leaving your car, make sure that you conceal your radar detector. This will reduce the possibility of break-in and theft of your unit.

## Included with your ESD-6050

1. Windshield Bracket
2. Hook and Loop Material
3. Power Cord

1. On/Off Volume Control
2. Mute Button
3. Audio Alerts Speaker
4. Highway/City Button
5. Band Indicators
6. Windshield Bracket Mount
7. 12V DC Power Jack

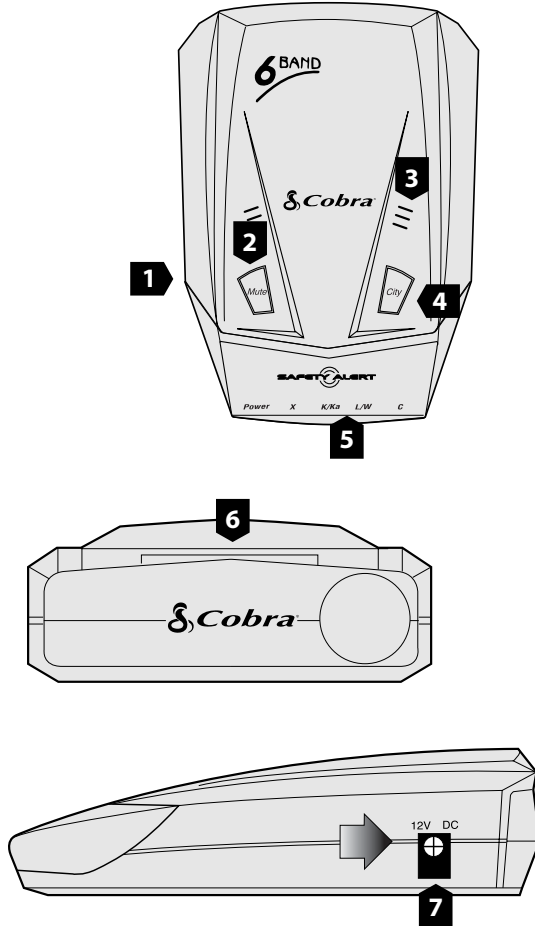

Thank you for purchasing the Cobra® ESD-6050 Radar/Laser Detector. Properly used, this Cobra® product will give you many years of reliable service.

## Customer Support

Should you encounter any problems with the product or not understand its many features, please refer to this owner's manual. If, after referring to the manual, you still need help, call Cobra® Customer Service at 773.889.3087.

## Cobra® Customer Service

Live operators are available  
M-F 8:00 am - 8:00 pm CST  
at: 773.889.3087

Automated Technical  
Assistance available 24 hours  
a day, seven days a week.  
E-mail questions to:  
productinfo@cobra.com

Cobra® on the Web:  
Frequently Asked Questions  
(FAQ) can be found on-line at:  
www.cobra.com



# How to Use Your Cobra® ESD® Radar/Laser Detector

## Contents

<b>Introduction</b> .....	A1
Safety Alert®	
Federal Law Governing Radar Detectors	
Included Accessories	
<b>Controls &amp; Indicators</b> .....	A2
<b>Our Thanks to You</b> .....	A3
Customer Support .....	A3
<b>Features</b> .....	1
<b>Installation</b> .....	2
<b>Quick Start</b> .....	5
LED Displays.....	6
<b>Operation</b> .....	7
Turning On .....	7
Highway/City Mode .....	8
<b>Detection</b> .....	9
Band Detection.....	9
Audible Alarm Indicator .....	9
Instant On Detection.....	10
Radar .....	10
Safety Alert .....	10
VG-2 Undetectable .....	11
Laser .....	11
Radar/VG-2/Laser Alerts.....	12
Facts About Safety Alert®.....	13
Radar Frequencies.....	14
Facts About Lidar (Laser) .....	14
<b>Maintenance</b> .....	15
<b>Specifications</b> .....	16
<b>Limited One Year Warranty</b> .....	17
<b>Optional Accessories</b> .....	18
<b>Order Form</b> .....	19
<b>If You Think You Need Service</b> .....	Back Cover

## Features of This Product

- Safety Alert® Traffic Warning System
- Separate Visual and Audio Alarms
- VG-2 Undetectable
- Auto and Manual Muting
- Superior Audio Volume
- Adjustable Windshield Mounting Bracket

## Location

### Location

Selecting the proper location to mount the Cobra® ESD-6050 is very important for optimum performance. Both radar and laser transmissions pass through glass but not through other objects. For this reason the Cobra® ESD-6050 lenses must not be blocked. It is best to locate your detector as low on the front windshield as possible.

Examples of metal in the windshield area that can block or weaken incoming radar/laser signals:

1. Windshield wiper blades.
2. Mirrored sun screens.
3. Regular tinted glass does not affect radar reception, although the darker tint at the top of the tinted windshield prevents laser light from penetrating.
4. Heated windshields, currently available as an option for some Ford® (Instaclear) and GM® (Electriclear vehicles act as an impenetrable barrier to radar signals). If in doubt, check with your dealer to see if this applies to your vehicle.

## Windshield Mounting

### Windshield Mounting

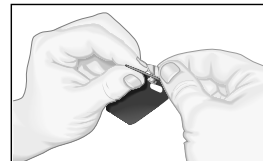

- 1 Attach cups to bracket.



- 2 Attach bracket to windshield.

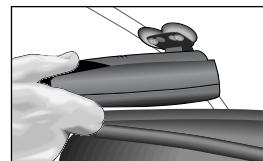

- 3 Attach detector to bracket.

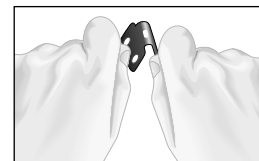

- 4 Bend bracket for correct detection angle (if needed). Do not use the ESD-6050 to bend bracket.

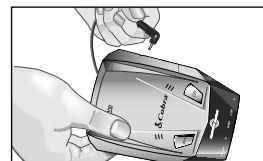

- 5 Plug power cord into detector.



- 6 Plug power cord into cigarette lighter.

## Dash Mounting

### Note

It will be easy for you to remove and reinstall your Cobra® ESD-6050 detector at any time using this hook and loop material on the dashboard.

**Remember:** Without the means to adjust the angle of the detector (when mounted as above), be sure you that your Cobra® ESD-6050 has a level, clear view of the road before you attach the hook and loop material.

### Dash Mounting

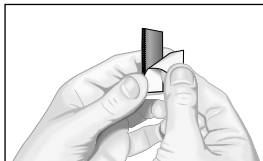

- 1 Peel protective paper off one side of hook and loop material.

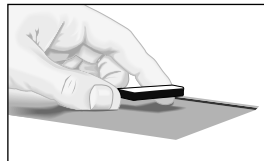

- 2 Place on dash.

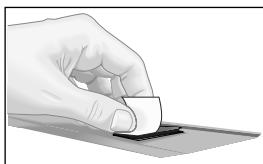

- 3 Peel top paper off.

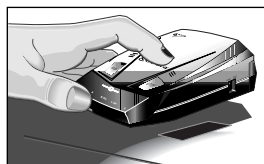

- 4 Place detector on hook and loop pad.

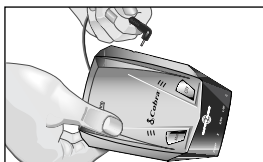

- 5 Plug power cord into detector.



- 6 Plug power cord into cigarette lighter.

### Turn On and Adjust Volume

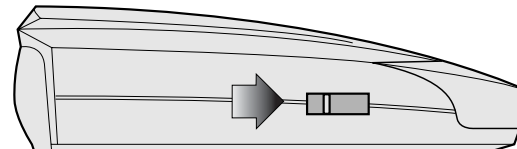

- 1 Rotate ON-OFF Volume Control to left (away from you). An audible "tone" will indicate the unit is on. PWR LED on front of unit is illuminated.

### Turn On and Adjust Volume

## Set Highway/ City Mode

### Set Highway/City Mode

#### City

For urban driving—reduces number of X-Band audible alerts.

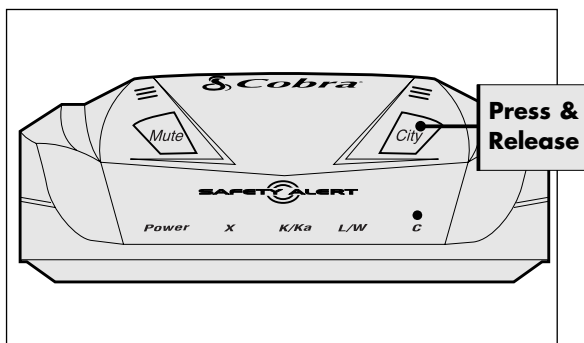

Press and release  CITY button.

CITY LED will illuminate green while in City mode

#### Highway

For all other driving.

### Set Muting Mode

#### Auto Muting

Automatically reduces volume of alert in progress after 4 seconds.

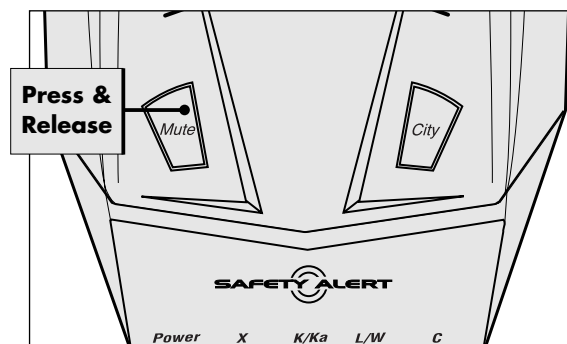

#### Manual Muting

1 Press and release  MUTE button to reduce volume of alert in progress.

#### To Switch Between Modes

1 Press and release  MUTE Button when no signal is being received.

One “beep” = Mute

Two “beep” = Auto Mute

## Set Muting Mode

## Highway/City Mode

### Note

*In or near cities, there are many sources of false radar signals such as microwave relay towers and automatic door openers.*

### Note

*City = "Beep"  
Highway = "Beep-Beep"*

## Highway/City Mode

The Highway/City function is controlled by a 2-step button. The Highway mode is automatically engaged when the unit is powered up. In the City mode, false radar alerts will be reduced.

### To engage City Mode:



- 1 Press and release  CITY button and the LED on the front of the unit will illuminate green. A single beep confirms City mode. The X LED will be visible showing you are receiving a signal.

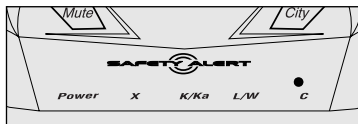

CITY LED will illuminate green while in CITY mode.

### To reactivate the Highway Mode:

- 1 Press and release  CITY button again. A double beep confirms Highway Mode.

## Band Detection

This detector is designed to detect X, K, Superwide Ka Band Radar, Laser (including LTI 20-20, Ultra Lyte and ProLaser technologies), VG-2, and Safety Alert signals.

## Audible Alarm

A different alert tone will sound for X, K, KA, Laser/Safety Alert, and VG-2

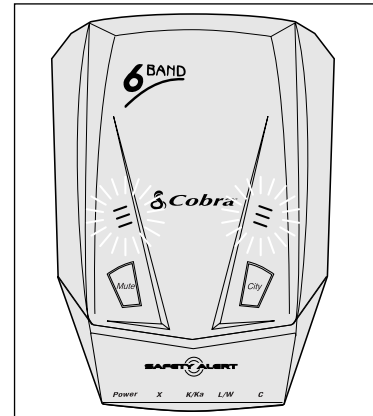

## Band Detection

## Audible Alarm



## Radar

### Radar

The display will show the band (X, K/Ka). The signal strength will be indicated by increasing frequency of the beeps and the blinking indicators.



## Instant-On Detection

### Instant-On Detection

The Cobra® ESD-6050 is also designed to detect Instant-on speed monitoring signals. **Immediate action is required when warning is given.**

## Safety Alert® Traffic Warning System

### Safety Alert® Traffic Warning System

Indicator "L/W" will blink.



## VG-2 Undetectable

The Cobra® ESD-6050 is undetectable by police VG-2 detection devices. It will alert you when one is in use near your vehicle.



The L/W LED on the front of the unit will blink.

## Laser

The L/W LED will blink.



## VG-2 Alert

## Laser

### Note

The display does not indicate signal strength.

## Radar/VG-2/ Laser Alerts

### Radar/VG-2/Laser Alerts

Type of Audible Signal	Interpretation and Response
Your COBRA® ESD-6050 starts to signal slowly, then increases in rate very rapidly.	Most likely police radar. <b>FULL ALERT.</b>
Your COBRA® ESD-6050 signals just once.	Most likely a false source, or could be pulsed radar. <b>Exercise Caution.</b>
Very fast signal rate instantly.	Radar or VG-2 close by has been suddenly switched on. <b>FULL ALERT.</b>
Slow signal rate as you approach hill or bridge. Sharp increase in signal rate as you reach hill or bridge.	Most likely police radar on other side of hill or bridge. <b>FULL ALERT.</b>
Short-term, weak signaling; series of such signals.	Most likely a false radar source. <b>Exercise Caution.</b>
Laser	<b>Use Full Caution.</b> There are no false laser signals.
Safety Alert	An emergency vehicle is approaching, you are in the vicinity of a railroad crossing, or you are approaching a road hazard (construction site, accident scene, etc.).

## Facts About the Safety Alert® Traffic Warning System

FCC-approved Safety Alert Transmitters emit microwave radar signals to indicate the presence of a safety-related concern. Depending on the frequency of these signals, as set on the transmitter, the outgoing signal can indicate whether the transmitter is on a speeding emergency vehicle or train, or at a stationary road hazard location. These microwave signals are located in the K-band and as a result, any radar detector which detects K-band radar will detect these Safety signals as standard K-band radar alerts. However, unlike a standard radar detector, your Cobra® ESD-6050 is designed to differentiate between a standard K-band alert and a Safety Alert warning. Safety technology is relatively new so the number of transmitters in operation is still growing. You may not receive Safety Alert on a daily basis and should not be surprised to encounter some emergency vehicles, road hazards or trains not yet equipped with these transmitters, therefore failing to provide a signal. As Safety Transmitters become more prevalent (the number of operating transmitters is growing every day), these Safety Alerts will become more common. The Safety Alert Transmitter is in use in all 50 states in limited quantities.

## Facts About Safety Alert® Traffic Warning System

## Radar Frequencies

### Radar Frequencies

There are now three frequencies that have been approved by the FCC (Federal Communications Commission) for use in speed monitoring equipment. They are:

X Band (10.525 GHz), K Band (24.150 GHz)  
Ka Band (33.400-36.000 GHz)

Your Cobra® ESD-9000 can detect signals in all three radar bands including photo radar and STALKER radar which use the Ka band, and Cobra®'s Safety Alert signals on the K band.

## Facts About LIDAR (Laser)

*LIDARs must have a clear line of sight to target a vehicle during the entire measurement interval. Intervening objects such as signposts, utility poles, tree branches, etc., will prevent a valid speed reading.*

### Facts About LIDAR (Laser)

#### What is LIDAR?

LIDAR stands for Light Detection And Ranging. While everyone refers to it as LASER the correct name is LIDAR.

#### How does LIDAR work?

LIDAR operates a lot like RADAR. Like RADAR, it spreads out. Not as quickly, but it does spread, as shown on the diagram below.

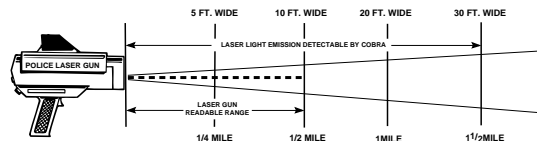

## Facts About LIDAR (Laser)

### Does weather have any effect on LIDAR?

Yes, rain, snow, smoke, fog, and airborne dust particles will all reduce the effective range, and if sufficiently dense, may prevent its operation.

### Can LIDAR operate through glass?

No, LIDAR guns cannot obtain readings through any glass. But the laser pulse can be received through glass to easily and quickly trigger a laser detector's alarm.

### Can LIDAR operate while moving?

No, since LIDAR is line of sight, an officer cannot drive, aim, and shoot while driving.

### Is a LIDAR DETECTOR legal to use?

Yes, it is legal in all 50 states.

## Maintenance

Your COBRA® ESD-6050 RADAR/LASER DETECTOR will give you years of trouble-free service with minimum maintenance.

### Replacing Power Cord Fuse

Unscrew cap of cigarette lighter adapter and remove fuse. Replace with 1-ampere fuse only.

### Troubleshooting

If your COBRA® LASER DETECTOR ESD-6050 isn't operating, we suggest you make the following checks:

1. Is the power cord properly connected?
2. Is the fuse OK?
3. Is the cigarette lighter socket clean and free from corrosion?

## Maintenance

## Specifications

### GENERAL SPECIFICATIONS

#### A. FREQUENCIES

- |                 |                          |
|-----------------|--------------------------|
| 1. X BAND       | 10.525 GHz $\pm$ 50 MHz  |
| 2. K BAND       | 24.150 GHz $\pm$ 100 MHz |
| 3. Ka BAND      | 33.4 - 36.0 GHz          |
| 4. VG-2         | 11.4 GHz - 11.7 GHz      |
| 5. Safety Alert | 24.07, 24.11, 24.19 GHz  |
| 6. Laser        | 300 THz - 375 THz        |

#### B. UNIT DIMENSIONS

3.6" x 2.8" x 1.1"

**COBRA® ELECTRONICS CORPORATION** warrants that its COBRA® 6 Band® Radar/Laser Detectors, and the component parts thereof, will be free of defects in workmanship and materials for period of one (1) year from the date of first consumer purchase. This warranty may be enforced by the first consumer purchaser, provided that the product is utilized within the U.S.A.

COBRA® will, without charge, repair or replace, at its option, defective 6 band® Radar/Laser Detectors, products or component parts upon delivery to the COBRA® factory Service Department, accompanied by proof of the date of first consumer purchase, such as a duplicated copy of a sales receipt.

You must pay any initial shipping charges required to ship the product for warranty service, but the return charges will be at Cobra®'s expense, if the product is repaired or replaced under warranty.

**Exclusions:** This limited warranty does not apply; 1) to any product damaged by accident; 2) in the event of misuse or abuse of the product or as a result of unauthorized alterations or repairs; 3) if the serial number has been altered, defaced or removed; 4) if the owner of the product resides outside the U.S.A.

**All implied warranties, including warranties of merchantability and fitness for a particular purpose are limited in duration to the length of this warranty.**

**COBRA® shall not be liable for any incidental, consequential or other damages; including, without limitation, damages resulting from loss of use or cost of installation.**

**Some states do not allow limitations on how long an implied warranty lasts and/or do not allow the exclusion or limitation of incidental or consequential damages, so the above limitations may not apply to you.**



**Cobra® Electronics Corporation**

6500 West Cortland Street  
Chicago, Illinois 60707  
[www.cobra.com](http://www.cobra.com)

# Optional Accessories

# Accessory Order Form

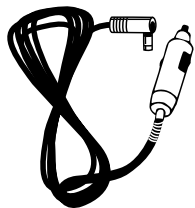

**Straight 12V DC Power Cord**  
Includes plug and fuse  
420-080-N-001

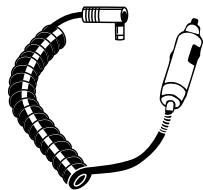

**Curled 12V DC Power Cord**  
Includes plug and fuse  
420-080-N-002

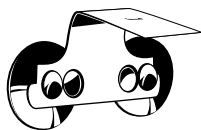

**Windshield Mounting Bracket**  
Includes suction cups  
545-139-N-001

**You Can Find These Fine Accessories At Your Local Cobra® Dealer**

If you wish, you can order directly from Cobra®.

**Order by phone**

Call 773.889.3087 (Press 1 from the main menu)  
8 a.m.-6 p.m. M-F CST.)

**Order by mail or fax**

Please call 773.889.3087 or visit [www.cobra.com](http://www.cobra.com) for pricing, fill out order form on next page and mail/fax directly to Cobra®.

**Order over the Internet**

Visit our website at:  
[www.cobra.com](http://www.cobra.com)

Item #	Description	Cost Ea.	Qty.	Amount
420-080-N-001	Straight 12V Power Cord			
420-080-N-002	Curled 12V Power Cord			
545-139-N-001	Windshield Mounting Bracket			

Prices subject to change without notice.

**Tax Table**

Illinois residents add 8.75%  
Indiana residents add 5%  
Michigan residents add 6%  
Ohio residents add 5%  
Wisconsin residents add 5%

Subtotal	_____
(Tax if applicable)	_____
Shipping/handling	\$4.00
<b>Total</b>	_____

For credit card orders fill out order form and fax to: 773.622.2269 or call 773.889.3087 (Press 1 from the main menu) 8:00 am - 6:00 pm, M-F, CST.

Make check or money order (no stamps) payable to:  
Cobra® Accessories Department  
6500 West Cortland Street  
Chicago, IL 60707 USA  
Attn: Accessories Department

Please print clearly

Name \_\_\_\_\_

Address (No P.O. Box) \_\_\_\_\_

City \_\_\_\_\_ State \_\_\_\_\_

Zip \_\_\_\_\_

Telephone (\_\_\_\_) \_\_\_\_\_

Credit Card No. \_\_\_\_\_ Exp. Date \_\_\_\_\_

Customer Signature \_\_\_\_\_

Circle One: Visa   MasterCard   Discover

*Allow 2 to 3 weeks for delivery. Offer valid in Continental U.S. only.*



© 2000 Cobra® Electronics Corporation  
6500 West Cortland Street  
Chicago, IL 60707  
www.cobra.com



## If You Think You Need Service

*For technical assistance, please call our Automated Help Desk which can assist you by answering the most frequently asked questions about Cobra® products.*

**(773) 889-3087**

*24 hours a day, 7 days a week.*

*A Consumer Service Representative can be reached through at 773.889.3087*

*8:00 am - 6:00 pm, Monday through Friday, CST.*

*Technical assistance is also available on-line in the Frequently Asked Questions (FAQ) section at [www.cobra.com](http://www.cobra.com) or by e-mail to [productinfo@cobra.com](mailto:productinfo@cobra.com)*

***If you think you need service call 773.889.3087***

***"If your product should require factory service please call Cobra® first before sending your unit in. This will ensure the fastest turn-around time on your repair."***

You may be asked to send your unit to the Cobra® factory. It will be necessary to furnish the following in order to have the product serviced and returned.

1. For Warranty Repair include some form of proof-of-purchase, such as a mechanical reproduction or carbon of a sales receipt. If you send the original receipt it cannot be returned.
2. Send the entire product.
3. Enclose a description of what is happening with the unit. Include a typed or clearly print name and address of where the unit is to be returned.
4. Pack unit securely to prevent damage in transit. If possible, use the original packing material.
5. Ship prepaid and insured by way of a traceable carrier such as United Parcel Service (UPS) or First Class Mail to: Cobra® Factory Service, Cobra® Electronics Corporation, 6500 West Cortland Street, Chicago, IL 60707 USA.
6. If the unit is in warranty, upon receipt of your unit it will either be repaired or exchanged depending on the model. Please allow approximately 3 to 4 weeks before contacting us for status. If the unit is out of warranty a letter will automatically be sent informing you of the repair charge or replacement charge. If you have any questions, please call 773.889.3087 for assistance.

© 2000 Cobra® Electronics Corporation  
Printed in Thailand

Part No. 480-263-P001

**The Cobra® line of quality products also includes:**

- **CB Radios**
- **microTalk® Radios**
- **Radar/Laser Detectors**
- **GPS**
- **SafetyAlert® Traffic Warning Systems**
- **Accessories**
- **HighGear™ Accessories**

**Nothing comes close to a Cobra™**