

DXP, DXP Plus, FXS, and FXT Digital Communications System Attendant Manual

This publication supports both
Impact and Impact SCS LCD Speakerphones

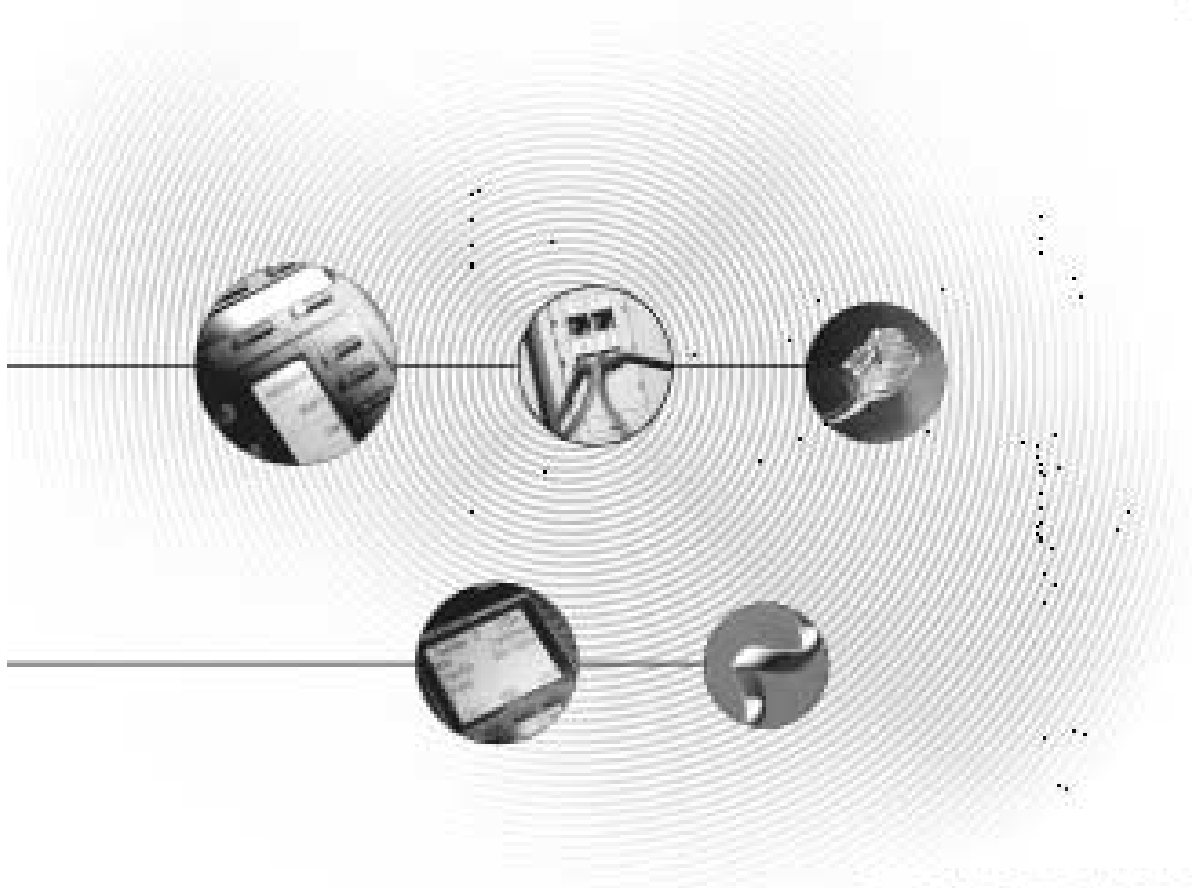

COMDIAL
The Rising Star

This Attendant Guide is for the following system:

**DXP, DXP Plus, FXS and FXT
Digital Communication Systems**

This Attendant Guide applies to the following telephone models:

- Impact 8012S-** Rev. A and later.
- Impact 8024S-** Rev. A and later.
- Impact SCS 8324S-** Rev. A and later.
- Impact SCS 8312S-** Rev. A and later.
- Impact SCS 8324F-** Rev. A and later.

Contact your Comdial dealer for updates of this as well as other Comdial publications.

About This Book

As a system attendant, you must be familiar with the operation of your individual station and the entire digital communication system. This attendant manual serves as both an introduction to the individual speakerphone and system for new users and a reference for experienced users.

Introduction

The first chapter of the manual describes the initial setup and adjustments necessary to begin using your speakerphone.

- 1 Getting Started

Basic Operation

The basic operation chapters define often-used features and provide instructions for their use. These chapters are titled as follows:

- 2 Answering Calls
- 3 Making Calls

Advanced Operation

The chapters that describe the advanced features of the DXP, DXP Plus, FXS and FXT systems are as follows:

- 4 Advanced Call Handling
- 5 Nonverbal Messaging
- 6 Programming
- 7 Other Advanced Features

In addition to the chapters which describe the advanced features of individual stations, this manual also includes a chapter to describe the features of the system which are programmed by the attendant.

- 8 Attendant Features

Following the advanced feature descriptions are two reference tables to provide a brief summary of useful information for quick recall.

- | | |
|-------------------|-----------------------|
| Appendix A | Quick Reference Guide |
| Appendix B | Display Abbreviations |

Also, tips on speakerphone use for the new user are described in Appendix C. Many general phrases and abbreviations which may not be familiar to users are defined in the glossary and all the features available for the DXP, DXP Plus, FXS and FXT systems are described in Appendix E. Finally, an index completes the manual.

Appendix C	Speakerphone Characteristics
Appendix D	Glossary
Appendix E	Feature Networking Support
	Index

NOTE: Throughout this book, all references to fixed buttons (keypad, *DSS/BLF*, *SPEAKER*, *HOLD*, etc...) are printed in upper case, italic type; for example, "**PRESS INTERCOM.**"

All references to interactive buttons (which are used to make selections on the speakerphone display) are printed in upper case, bold italic type; for example, "**SELECT OPTIONS .**"

Also, to eliminate confusion, the text of this guide instructs users to "**PRESS**" fixed buttons of the telephone and "**SELECT**" interactive buttons as in the examples above. Instructions to "**DIAL**" refer to numbers or symbols on the keypad.

What is an Attendant?

The attendant of a telephone system is typically the first person to answer an incoming call and usually directs incoming calls to the proper person or department within the system. In addition to call control, the attendant controls system-wide operating features such as night transfer (of ringing) and the system clock. Additionally, the attendant is responsible for programming such items as system speed dial numbers and LCD messages that are available to many of the system users.

The system provides two attendant positions at default (stations 1 and 2, intercom 1001 and 1002); however, installers can assign any or all stations (up to 96 total) as attendant stations if they wish. Installers can also assign up to four DSS/BLF consoles to each attendant position where needed. In addition to the many installer-enabled feature buttons that the system can make available at any station, the system provides the attendant position with several special purpose installer-enabled feature buttons to enhance call processing. These special purpose buttons are described in Chapter 8.

The system also provides capabilities for either a local stand-alone system or a system-to-system network. System-to-system networking connects several DXP, DXP Plus, FXS and FXT systems together in an arrangement that allows unified communications through the system. For a complete list of features and their properties see Appendix E, Feature Networking Support.

Notes

Contents

1	Getting Started	1
	Setting Up Your Speakerphone.	1
	Understanding the Basic Functions	6
	Your Speakerphone's Buttons	8
	Your Speakerphone's Display Lights.	9
2	Answering Calls	13
	Answering Outside Calls	13
	Answering Intercom Calls	14
	Night-Transferred Calls - Line Access From Any Station	15
	Holding Calls	16
	Directed Station Hold	18
	Monitored Stations	19
	Call Pickup	20
	Receiving Subdued Off-Hook Voice Announcements (SOHVA)	22
	Do Not Disturb Condition.	24
	Voice Announce Blocking	25
	Caller ID (Automatic Number Identification)	26

3	Making Calls	27
	Making Outside Calls	27
	Making Intercom Calls	28
	Automatic Dialing	29
	Redialing	30
	Sending Subdued Off-Hook Voice Announcements (SOHVA)	32
	Camping On - Busy Station, Automatic Callback	33
	Advanced Camping On Options	34
	Paging	36
	Programmed Button Display	37
	Overriding A Call Or A Do Not Disturb Condition At Another Telephone (Executive Override)	38
4	Advanced Call Handling.	39
	Waiting For A Line (Queuing)	39
	Conferencing	40
	Call Forwarding	42
	Call Forward Outside System (CFOS)	44
	Call Parking	46
	Call Transferring	48
	Other Call Transferring Options	50
	Diverting All Incoming Calls To Another Station	52
5	Nonverbal Messaging	53
	LCD Message Delivery	53
	Message Waiting Light and Messaging	56
	Response Message Delivery	58

6	Programming	59
	DSS Numbers	59
	Speed Dial Numbers	60
	Feature Access Codes	62
	LCD Feature Buttons	64
	Reminder Alert	66
	Response Message Button	67
7	Other Features	69
	Line Groups	69
	Automatic Redial	70
	Tracker Paging System	72
	Direct Inward System Access (DISA)	74
	Auxiliary Jack	76
	Account Codes	78
	Authorization Codes	79
	E and M Tie Lines	80
	Dial By Name	82
	Background Music	83
	Volume Control	84
	Default Volume Control	86
	Automatic Set Relocation	87
	Monitoring A Conversation Between Two Telephones (Service Observing)	88
	Switching The Dialing Mode Between Pulse And Tone	88
	IMIST Module	89

8	Attendant Features	91
	LCD Messages	91
	Station Enabling and Disabling	94
	Telephone Line Enabling and Disabling	94
	Mark Problem Line	95
	Message Waiting Enabling or Disabling	95
	System Telephone Naming	96
	Telephone Line Naming.	98
	Station Message Detailed Accounting (SMDA) Reports	100
	System Speed Dial Numbers	102
	Digital Voice Announce (DVA)	104
	Night Transfer Of Ringing Mode	110
	Call Transfer - Attendant Calls To The Alternate Attendant Telephone	110
	Overflow Transfer	111
	Other Special Attendant Buttons.	112
	System Clock	114
	System Status Log	114
	DSS/BLF Console Operation	116
A	Feature Access Codes	119
B	Display Abbreviations	125
C	Speakerphone Characteristics	129
D	Glossary.	131
E	Feature Networking Support.	139

1

Getting Started

Congratulations and thank you for using a Comdial telephone system! Your digital speakerphone is supported by a communication system with hundreds of built-in, standard features. This manual serves as a helpful guide for using these various functions.

The sections in this introductory chapter help you initially set up your speakerphone and become familiar with the controls and indicators. The remaining sections are titled as follows:

- Setting Up Your Speakerphone
- Understanding the Basic Functions
- Your Speakerphone's Buttons
- Your Speakerphone's Display Lights

After setting up your individual station, you are ready to begin your duties as the system attendant. Chapter 8, *Attendant Features*, contains instructions on station and line enabling, station naming, and other system level actions that you should accomplish to effectively begin operation of your Comdial digital system.

Setting Up Your Speakerphone

When your new speakerphone arrives, the system installer unpacks your speakerphone and connects the line to a system jack. The following sections describe a few initial adjustments that allow you to quickly begin making and answering calls with some of the most basic features.

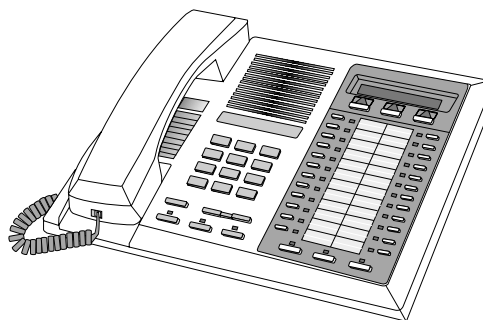

An 8024 LCD Speakerphone

Positioning Your Speakerphone

You should adjust the position of the speakerphone on your desk or table to suit your individual needs and maximize the performance of the sound activated features. When using your speakerphone, the microphone and loudspeaker are farther from you than when you use a handset. Some positioning tips to consider include:

- For the microphone to best detect your voice, speak within three feet of it and face the speakerphone.
- Background noise may prevent the sound-activated switches from operating properly. Avoid placing the speakerphone where it will detect sounds from typewriters, keyboards, printers, paging systems, and other equipment.
- Place the telephone on a hard surface and away from table edges. Do not place the telephone in corners or enclosures. Do not let obstructions come between you and the microphone.

If you are using an Impact SCS model, your telephone has an adjustable pedestal to allow you to select the most comfortable viewing angle. When you receive the telephone, the pedestal is in its lowest position—flush against the pedestal.

- **To adjust the pedestal (Models 8312S, 8324S and 8324F only),**

1. **GRASP** the rear of the pedestal base firmly with one hand **AND LIFT** the rear portion of the telephone upward with your other hand.
2. **LIFT** the telephone upward with one hand **AND RAISE** the telephone supporting arms upward with your other hand. (Notice there are three sets of notches under the telephone corresponding to the three positions available.)
3. When the telephone is at the desired height, **SELECT** the closest pair of notches **AND INSERT** the supporting arms in the notches. **PRESS DOWN** *slightly* on the telephone until you feel the supporting arms snap into place.

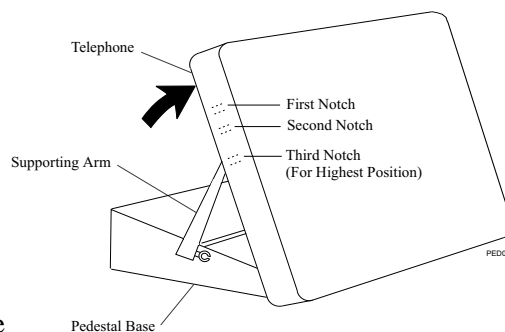

Adjusting The Pedestal

Also remember, as with any piece of electronic equipment, your telephone may be damaged by contact with liquids. So please try to place the telephone in an area that is free from the danger of spills.

Setting Display Contrast

You can darken or lighten the contrast of the display for best viewing.

- **To adjust the display contrast,**
 1. **SELECT OPTIONS.**
 2. **SELECT NEXT** until the **DISP** option appears.
 3. **SELECT DISP.** Your display will read **CONTRAST LEVEL**
 4. **SELECT LIGHT** or **DARK** once for each degree of change desired.
 5. **PRESS SPEAKER** to end.

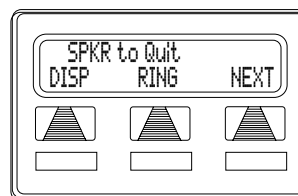

Select Display

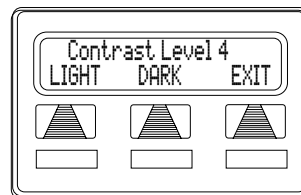

Setting the Contrast Level

Setting a Personal Ringing Tone

You can choose one of eight different ring tones for your telephone. Often, when several telephones are located close together, each user chooses a different personal ring tone.

- **To select one of the ring tones, proceed as follows:**
 1. **SELECT OPTIONS.**
 2. **SELECT NEXT** until the **RING** option appears.
 3. **SELECT RING.**
 4. **SELECT UP OR DOWN** to choose ring tone in display (a new tone will sound at each up or down press).
 5. **SELECT EXIT** to return to main display.
 6. **PRESS SPEAKER** to end.

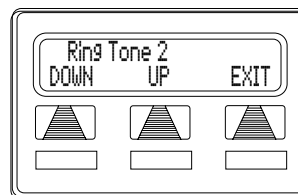

Selecting the Ring Tone

Setting Volume Levels

The volume control on your telephone is a multi-purpose control you can use to set the volume (loudness) of the ringer, the speaker, and the handset.

- **To set the ringer loudness level,**
 1. While your telephone is on-hook and idle, **PRESS** the **VOLUME UP OR VOLUME DOWN** button once for each change in loudness you desire. The ringer sounds once for each change as an example of the current setting.

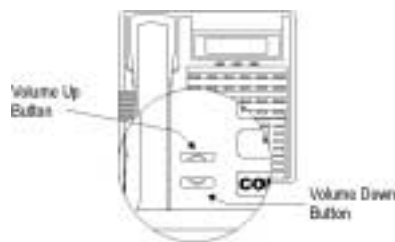

SCS Volume Buttons

NOTE: If you set the ringer to the **OFF** position, your telephone sounds a short ring burst once for each call you receive at your station.

- **To set the speaker and handset loudness levels,**
 1. **PRESS** **INTERCOM** button.
 2. **PRESS** the **VOLUME UP OR VOLUME DOWN** button once for each change in speaker volume that you desire.
 3. **LIFT** handset.
 4. **PRESS** the **VOLUME UP OR VOLUME DOWN** button once for each change in handset volume that you desire.

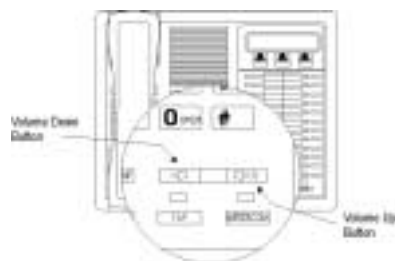

Volume Buttons

NOTE: When a call ends, the system resets the speaker and handset volume of all future calls to the programmed (default) setting. For instructions in setting your speakerphone's default volume, see *Default Volume Control* section in the system specific Advanced Features chapter.

Answering and Making Calls

Your speakerphone is now properly configured to answer and make calls to both stations within your system (intercom calls) and outside lines. Remember that when dialing an outside number, you must first select a line to connect your system to the local exchange.

- **When you hear outside ringing (two long bursts),**

1. **PRESS** flashing line button **OR SELECT ANS.**
2. **SPEAK** toward telephone **OR LIFT** handset if privacy is desired.

- **When you hear intercom ringing (two short bursts),**

1. **PRESS INTERCOM OR SELECT ANS.**
2. **SPEAK** toward telephone **OR LIFT** handset if privacy is desired.

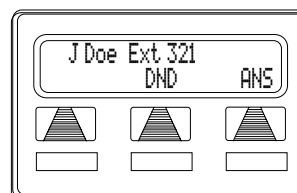

LCD Display Incoming Call

- **To dial an outside number manually,**

1. **PRESS INTERCOM.**
2. **DIAL**  **OR** other line button to select line (See *Line Groups* in the system specific Advanced Features chapters for more information on selecting an outside line).
3. **LISTEN** for dial tone.
4. **DIAL** number.
5. **LIFT** handset if privacy is desired.

- **To dial an intercom number manually,**

1. **PRESS INTERCOM.**
2. **DIAL** extension number (called telephone will ring or sound a tone).
3. **SPEAK** toward telephone **OR LIFT** handset if privacy is desired.

Understanding the Basic Functions

Your speakerphone provides many versatile features for your use. These features are explained in terms of what they allow you to do.

Alphanumeric Display (Liquid Crystal Display—LCD)

- Displays time, day, date, and active call information.
- Keeps you apprized of the status of your telephone.
- Provides programming prompts.

Auxiliary Jack (available only on Impact 8024S)

- Allows you to connect a headset, an external amplified ringer, a tape recorder, or an external paging amplifier to your telephone.

Message-Waiting Light

- Indicates that a message awaits pick up.

Microphone Opening

- Allows hands-free operation of speakerphone (speak clearly toward microphone opening).

Speaker

- Sounds distant party's voice.
- Sounds ringing and call-in-progress tones.

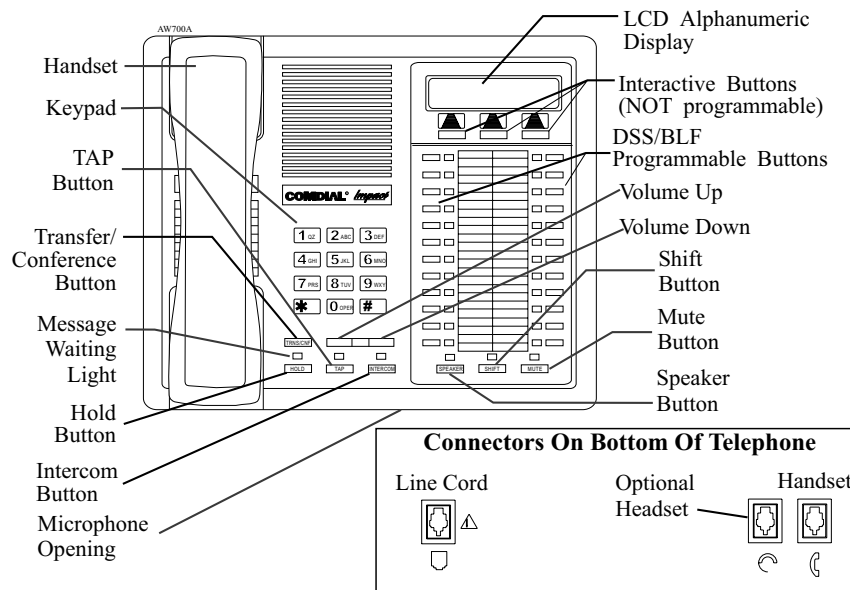

Impact 8024S-** LCD Speakerphone

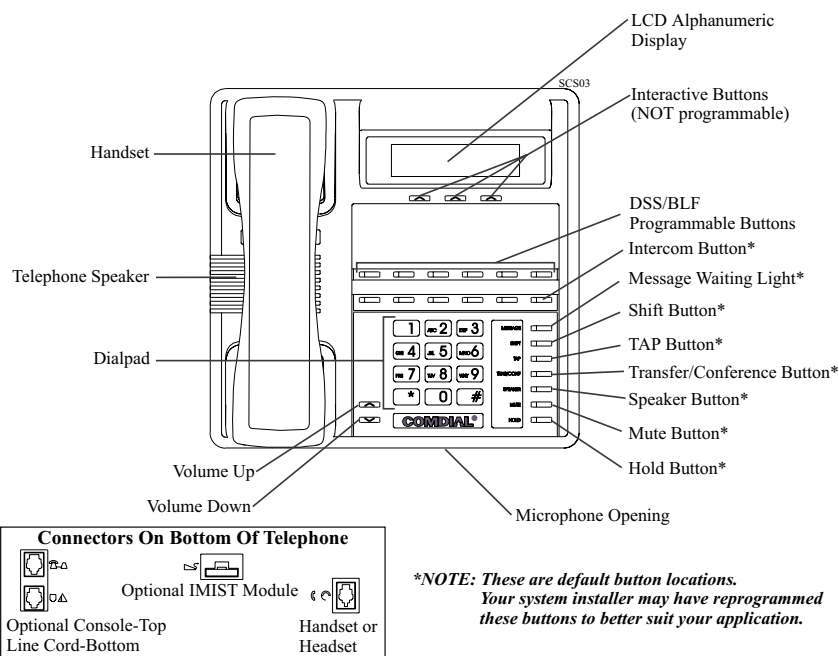

Impact SCS 8312S-** LCD Speakerphone

Your Speakerphone's Buttons

Hold Button (HOLD)

- Places a line or intercom call on hold.
- Stores pauses in number sequences during programming.
- Scrolls through LCD response messages.
- If multiple held calls feature is available, scans or scrolls through calls placed on hold (when hold light is flashing).

Interactive Buttons (located below alphanumeric display)

- Provide quick and easy access to system features.
- Provide straightforward button programming without dialing codes (the interactive buttons themselves, however, are not programmable).

Intercom Button (INTERCOM)

- Selects an intercom line.
- Allows you to initiate many of the telephone's features.

Mute Button (MUTE)

- Keeps the person on the line from hearing your conversation.

Direct Station Select/Busy Lamp Field Buttons (DSS/BLF)

- Allow you to store numbers for automatic dialing functions.
- Allow you to store telephone extension numbers for Direct Station Selection (DSS).
- May be programmed as a feature button.
- May be designated a line button by your system installer.

Shift Button (SHIFT)

- Allows you to enter a second tier for storing and/or automatically dialing speed dial numbers. (That is, you can store two speed dial numbers at every programmable button location—one in the regular tier and one in the second tier). You activate the shift function by pressing this button and turning the shift light on before storing or automatically dialing a speed dial number from the second tier.

Speaker Button (SPEAKER)

- Turns your speaker on or off.
- Disconnects a call when you are on a handsfree call.
- Ends or cancels programming.

Tap Button (TAP)

- Recalls dial tone or generates a hookflash.
- Retrieves held calls or last call placed on hold.

Transfer/Conference Button (TRNS/CNF)

- Transfers calls.
- Sets up conference calls.

Volume Control (VOLUME UP or VOLUME DOWN)

- Regulates the volume of the ringer, speaker, handset, headset, background music, and group listening mode.

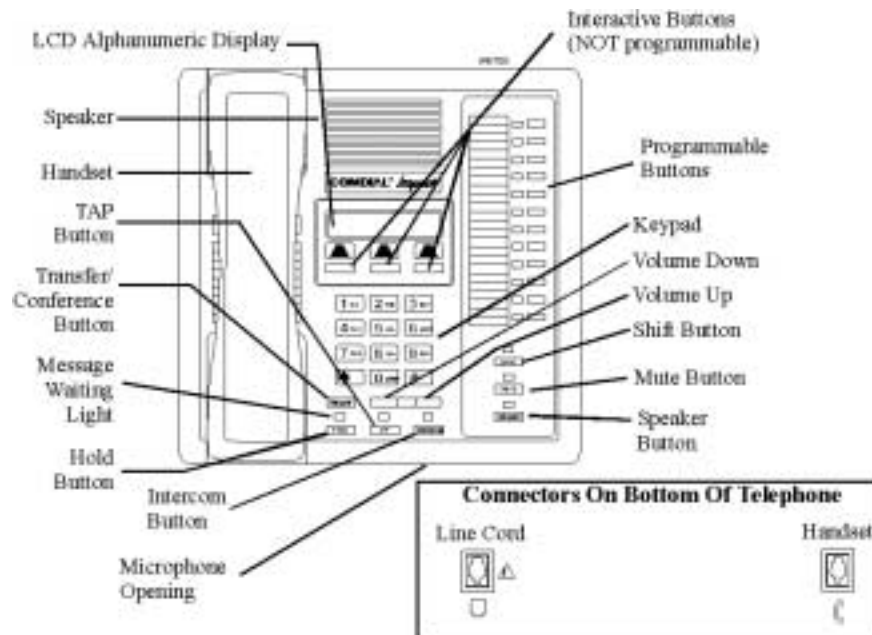

Impact 8012S-** LCD Speakerphone

Your Speakerphone's Display Lights

The lights (LEDs) on your LCD speakerphone indicate the status of lines, features, and intercoms.

Busy Lamp Field (BLF) lights (next to a Direct Station Select/Busy Lamp Field or DSS/BLF button):

- Steady red = station is in use.
- Flashing red = station is receiving a call.
- Winking red with repetitive off = message-waiting light set for you by station associated with that DSS button.

Next to a line button:

- Steady green = this is your line, either on-hook (in a handsfree mode) or off-hook, when the line is active.
- Steady red = another station is using this line.
- Flashing red = a call is coming in on this line.
- Flashing orange = this line will be answered when you lift the handset.
- Winking green with repetitive off periods = your line is on hold.
- Winking red = the call has been placed on hold by another station.
- Fluttering orange = your line has recalled from hold.
- Fluttering red = the line put on hold by another station has recalled.

NOTE: You can find the programmable buttons that the installer designates *line* buttons in the same location as the *DSS/BLF* buttons. Ensure that these buttons are labeled correctly to indicate their unique features.

Next to a fixed feature or programmable feature button:

- Steady red = the feature is on.
- Steady off = the feature is off.

NOTE: You can find the programmable buttons that the installer designates *feature* button through user programming in the same location as the *DSS/BLF* buttons. Ensure that these buttons are labeled correctly to indicate their unique features.

Above the MUTE button:

- On steady = called party cannot hear your conversation.

Next to INTERCOM button:

- Steady green with a quick flash = you are using your intercom.
- Fluttering red = an LCD message is set on your telephone for others to receive when calling.
- Flashing orange = someone is calling your extension or a call is being transferred to you.

Above the HOLD button:

- Winking red (Non-SCS Models only) = message awaits pick up.
- Winking green with repetitive off periods = a line is on hold at your station.

Next to the MESSAGE button (SCS Series Models only):

- Winking green = message awaits pick up.

Above the SPEAKER button:

- On steady (with the telephone on hook and busy) = speakerphone mode is active.
- On steady (with telephone on hook and idle) = background music is turned on.
- Flashing = feature viewing and programming is in progress.

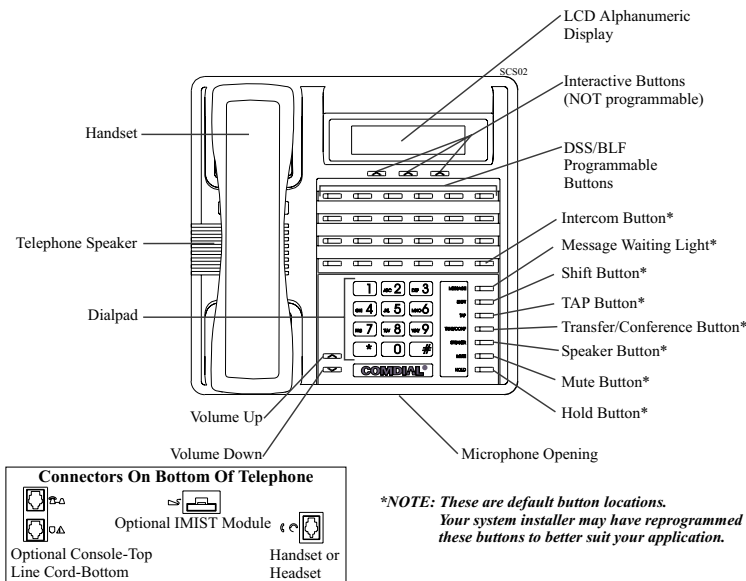

Impact SCS 8324F-** and Impact SCS 8324S-**

Notes

2

Answering Calls

Answering Outside Calls

A call that rings on an outside line sounds long, single-tone bursts and lights the line status light. If the installer enabled ringing line preference at your station, an orange light flashes next to the line that your station answers when you lift the handset; a red light flashes for any other ringing line.

Also, when an outside call rings at your station, the LCD screen displays the system line number of the incoming call (for example, L123) and any caller ID information that your station is programmed to receive. In addition to simply lifting the handset, your other options for answering the call are displayed above the interactive buttons.

- ***When you hear outside ringing (two long bursts) and observe an orange flashing light,***

1. For speakerphone, **PRESS** flashing line button **OR SELECT ANS AND SPEAK** toward telephone.
2. For privacy, **LIFT** handset.
3. **SELECT DND** if you do not wish to answer the call at this time.

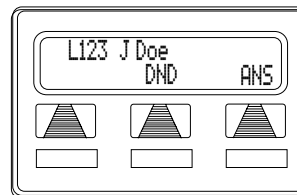

Outside Call On Line 123

- ***When you hear outside ringing (two long bursts) and observe a red flashing light,***

1. **PRESS** flashing line button **OR SELECT ANS**.
2. **SPEAK** toward telephone **OR LIFT** handset if privacy is desired.
3. **SELECT DND** if you do not wish to answer the call at this time.

NOTE: For more information on setting **DND** at your station, see section titled *Do Not Disturb Condition* on page 24.

Answering Intercom Calls

An intercom call is one that is made from one system telephone to another. Your station receives intercom calls in one of two ways depending upon system programming. With a *tone-first* setting, the telephone rings in a distinctive pattern and the user of the receiving station must take action to answer.

- ***When you hear an intercom tone followed by a caller's voice,***

1. **SPEAK** toward the telephone to answer, **OR LIFT** handset if privacy is desired.

In a *voice-first* setting, a short tone is followed by the caller's voice heard on the speaker. As with an incoming outside call, the LCD screen displays caller ID information and your other options for answering the call.

- ***When you hear intercom ringing (two short bursts),***

1. **PRESS INTERCOM OR SELECT ANS.**
2. **SPEAK** toward telephone **OR LIFT** handset if privacy is desired.
3. **SELECT DND** if you do not wish to answer the call at this time.

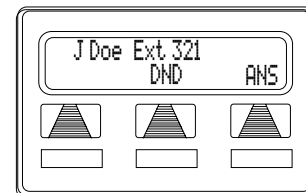

Intercom Call From J Doe

NOTE: For more information on setting **DND** at your station, see section titled *Do Not Disturb Condition* on page 24.

When your system installer makes the option available to system users, you can block all voice announce intercom calls to your station if you wish. See the section titled *Voice Announce Blocking* on page 25.

Night-Transferred Calls - Line Access From Any Station

You can use your attendant station to manually place the system in the night ringing mode by dialing a code or pressing a preprogrammed button. This mode overrides the direct, day 1, and day 2 automatic ringing modes. While this feature is active, calls on lines assigned to delayed and night ringing both ring at the various stations. No other ringing occurs unless the installer has arranged for a loud ringing bell or other external ringing device to sound when calls appear on those assigned lines during the night ringing mode. These calls may be answered at any telephone in the system if a user dials the proper code.

- ***If your telephone rings,***
 1. **PRESS** line button with flashing light.
 2. **LIFT** handset to talk.

The installer can assign one or more of the four system relays to track the ring signal on any or all lines that he or she assigns to them. The installer can arrange for the tracked ringing to be during the direct, delayed, day 1, day 2, or night ringing modes. Typically, the installer wires a relay so that its contact actuation causes an external bell or other device to sound.

You can hear this external ringer and dial a code. When you do this, you can answer any line that the installer has assigned to that external ringer through the relay programming.

- ***When you hear loud ringing anywhere in the system,***
 1. **LIFT** handset.
 2. **PRESS INTERCOM.**
 3. **CHOOSE** ringing zone:
 - **DIAL** 6 5 through 6 8 to select ringing zone (1-4).
 - **DIAL** 6 9 to answer for any zone.

Holding Calls

This feature allows you to temporarily disconnect from a current call yet retain it so that it can be retrieved. When you place a call on hold, you are free to use your telephone for other calls or features and then return to the held call. At a multiline telephone, you can put a call on hold manually, by pressing the *HOLD* button, or automatically (if programmed), by pressing another line button.

You can place a call on hold in either an exclusive or non-exclusive manner. With a regular or non-exclusive hold, you can pick up the held call at your telephone or another user can pick the call up at a telephone sharing the held call line.

- **To place a call on hold (non-exclusive),**
 1. **PRESS HOLD.** The light above your *HOLD* button begins to blink.

- **To retrieve a held call,**
 1. **PRESS** line button of the held call (with winking green light), **OR PRESS TAP.**

NOTE: Unless you use your *HOLD* button to scroll through the calls on hold, *TAP* always retrieves the last number placed on hold, regardless of whether you have line appearance for the line on which the call is holding.

2. **SPEAK** toward telephone **OR LIFT** handset if privacy is desired.

Exclusive Hold

Exclusive hold prohibits a user from retrieving a held call at any station other than the one where someone placed it on hold. The exclusive hold condition also links the held call to the timed hold recall time-out feature. After time-out, audible and visual signaling occurs and the exclusive hold condition reverts to a normal hold condition. The installer enables or disables exclusive hold as a class of service feature.

- **To place a call on exclusive hold,**
 1. **PRESS HOLD** twice.

- **To retrieve exclusive hold,**
 1. **PRESS** line button of held call (with winking green light), **OR PRESS TAP.**
 2. **SPEAK** toward telephone **OR LIFT** handset if privacy is desired.

Hold Recalls

After a call has been on hold for the period of time (set by the installer of your system), the system causes four quick hold recall tone bursts to sound at your telephone, the flash rate of the line button becomes faster and the light becomes orange.

If the call is on exclusive hold, it will revert to manual hold after the hold recall period (you will hear four short tone bursts at 12-second intervals). Calls that revert to manual hold can be picked up from any telephone with line appearance for the recalling line (or you can use the group or directed call pickup buttons, **GPKUP** or **DPKUP**).

- **If a held line is recalling, choose one of the following:**
 1. **PRESS HOLD** (station button) **OR SELECT HOLD** (interactive button) to place the call on hold at your station and restart hold timer
 2. **PRESS** line button (with flashing orange light) **OR SELECT ANS** to retrieve the call.

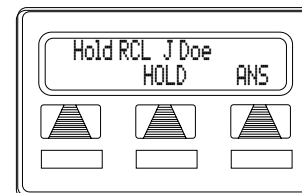

A Recalling Held Line

Directed Station Hold

This feature allows you to pick up the last call placed on hold at another station. This feature does not allow you to pick up exclusive hold calls or calls that are in the process of being transferred. In addition, this feature allows you to place a call on hold at another station and have this call appear to be the one that has been on hold there for the longest time.

- **To place a call on directed station hold,**
 1. **ANSWER** call.
 2. **PRESS INTERCOM OR TRNS/CNF** if intercom call.
 3. **DIAL** *90.
 4. **DIAL** extension number of station to receive held call.
 5. **HANG UP.**

NOTE: Features such as hold recall apply to the station that received the directed hold call and not to the station that sent the directed hold call.

- **To retrieve a held call at another station,**
 1. **PRESS INTERCOM.**
 2. **DIAL** #90.
 3. **DIAL** extension number of station that is holding the call.
 4. **ANSWER** call.

Often, you will have more than one call on hold at your station. You know you can retrieve the last call placed on hold simply by pressing *TAP*; however, if you do not have line appearance for a line on which another call is holding, the system provides a way for you to access that call before servicing the last call you placed on hold.

- **To scan your held calls and retrieve a specific one:**
 1. **REPEATEDLY PRESS HOLD** to scan held call list.
 2. **PRESS TAP** to retrieve call.

Monitored Stations

When the installer assigns the personal intercom number of one telephone to appear at a button on another telephone, the button and its associated light provide a direct station select (DSS) busy lamp field (BLF) feature. With this feature, the user can monitor the status of the appearing station. If the installer also assigns a DSS status button to the telephone, the user can press it to select between monitoring all of the telephone status or just its personal intercom status.

When the station monitoring feature is off, the status light shows the state of the monitored telephone. If the user's telephone has a status button, he or she can press it to show the busy/idle state of just the personal intercom number of the monitored telephone.

When the station monitoring feature is on, the status light shows activity status (idle, ringing, busy, and hold) of the monitored telephone.

- ***To monitor another telephone,***

1. **OBSERVE** the BLF light indications next to the Direct Station Select (*DSS/BLF*) button:
 - Off = Station is idle
 - Flashing (if enabled) = Station has an incoming call
 - On = Station is busy

Your telephone may have the personal intercom number of another telephone appearing at a programmable button location. You can press the *DSS/BLF* button to call that telephone or to answer a call that is ringing at the monitored station if you wish.

- ***To call an idle monitored station or to answer one that is ringing,***

1. **NOTE** the BLF light condition.
2. **PRESS** assigned *DSS/BLF* button.
3. **SPEAK** toward telephone, **OR LIFT** handset if privacy is desired.

Call Pickup

In addition to using your speakerphone's *DSS/BLF* buttons to access calls, the system offers two other distinct methods to answer incoming calls that are ringing at other stations.

Group Call Pickup

The installer often arranges several telephones together in a user group. Up to 16 different groups can exist with any number of stations in a group. If your telephone is so arranged, you can answer calls that are ringing at other stations within your particular group.

- ***To answer a call that is ringing within your group,***
 1. **PRESS INTERCOM.**
 2. **DIAL** .
 3. **SPEAK** toward telephone, **OR LIFT** handset if privacy is desired.

Directed Call Pickup

Also, you can answer a call that is ringing at any telephone in the system if you know the ringing telephone's extension number.

- ***To answer a call that is ringing at any telephone in the system,***
 1. **PRESS INTERCOM.**
 2. **DIAL** .
 3. **DIAL** extension number of ringing telephone.
 4. **SPEAK** toward telephone, **OR LIFT** handset if privacy is desired.

If you have programmed a PICK UP button on your telephone (see *Feature Buttons* in the chapter titled *Programming* on page 64 of this guide), you may make a call pick-up (either within your group or at a specific station inside or outside your group) using that button.

For a discussion on using a *DSS/BLF* button to answer an incoming call, see *Monitored Stations* section on page 19.

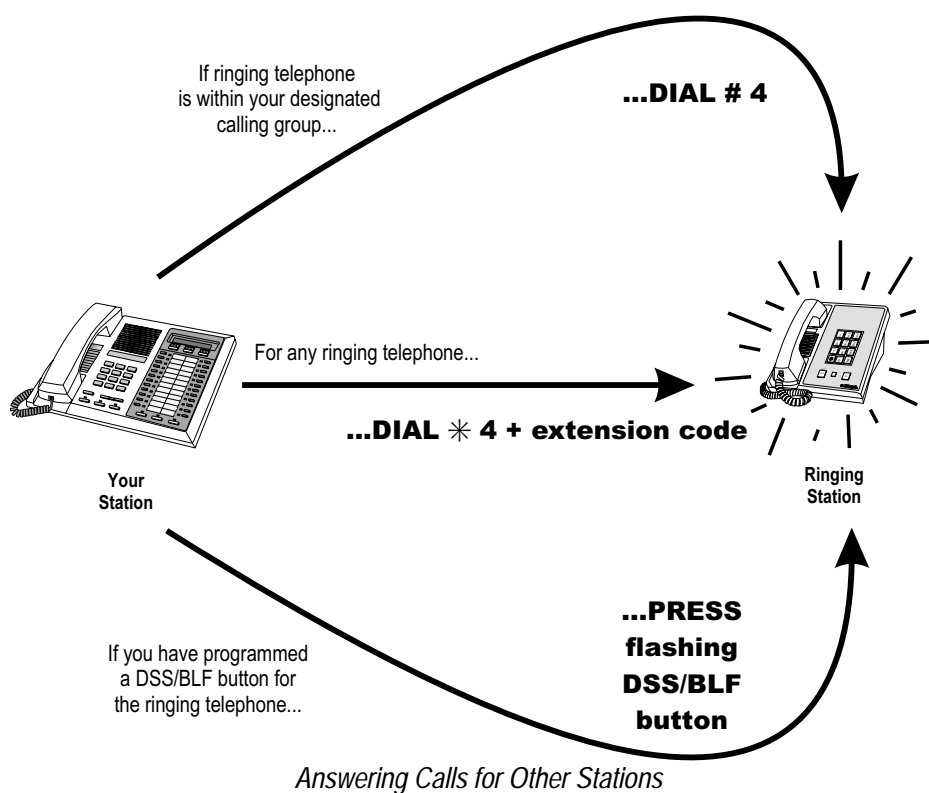

Receiving Subdued Off-Hook Voice Announcements (SOHVA)

Handling an Incoming SOHVA

This feature allows an intercom caller to break into your call by making an announcement through your handset receiver. With SOHVA, the announcement is delivered and responded to in a subdued manner that prevents the distant party from hearing either the announcement or the response. A tone alert precedes the announcement and is delivered to the handset receiver of the telephone ahead of the announcement.

You can respond to the announcement in a verbal or non-verbal manner. You deliver a verbal response by pressing and holding the MUTE button or appropriate interactive button and speaking into the handset.

- **To respond to a SOHVA verbally,**
 1. **SELECT AND HOLD REPLY.**
 2. **SPEAK** into handset. Distant party cannot hear your response.
 3. **RELEASE REPLY** after response is complete to return to distant party.

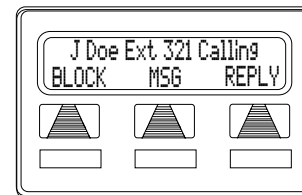

Incoming SOHVA

You can respond with a non-verbal response by pressing a programmed button to send a message to be shown on the display of the announcing station (if it is an LCD speakerphone).

- **To respond to a SOHVA nonverbally through Response Messaging,**
 1. **SELECT MSG.**
 2. **SELECT HAVE HOLD OR TAKE MSG.** (Message appears in the display of the telephone making the SOHVA).
 3. **CONTINUE** your current call with distant party. (SOHVA caller is automatically disconnected from your telephone).

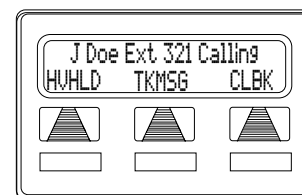

Message Response

NOTE: A station that is currently active in speakerphone mode can not receive a SOHVA.

Blocking a SOHVA

You can also block an incoming SOHVA with the interactive buttons or by previously programming your speakerphone for Voice Announce Block. See Voice Announce Blocking section on page 25 for more information.

- **To respond to a SOHVA by blocking,**
 1. **SELECT BLOCK** when you hear SOHVA tone. (SOHVA call is disconnected).

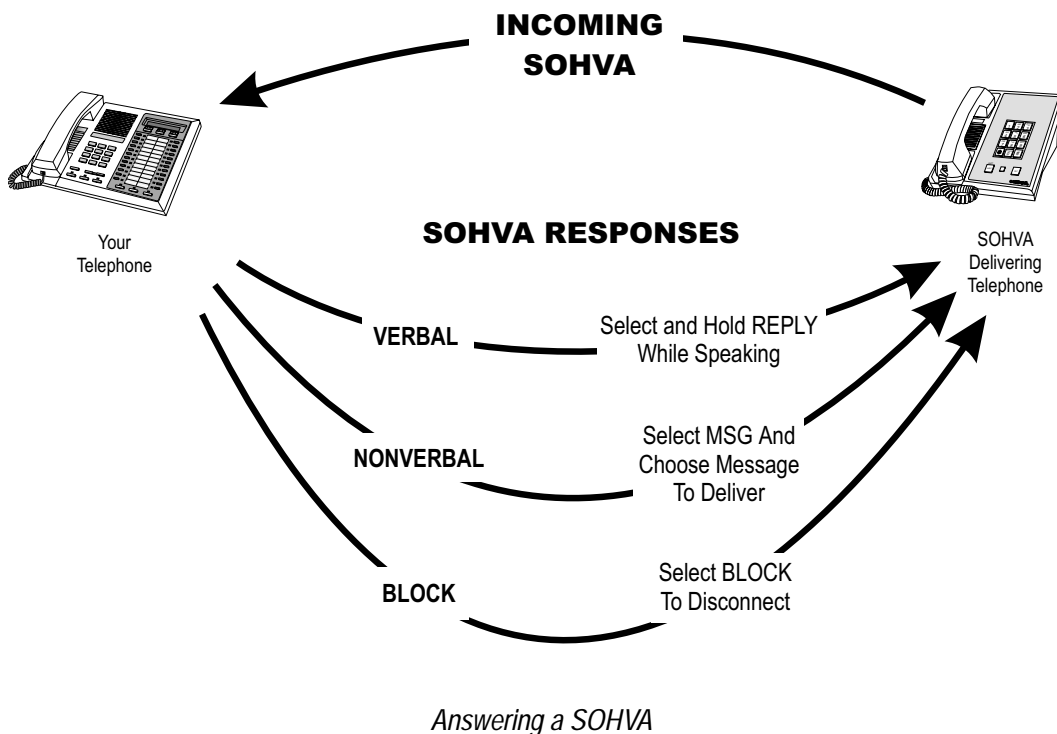

Do Not Disturb Condition

You can set your telephone to a do not disturb mode using the designated interactive or programmable button. The associated indicator turns on as an indication of active DND and an appropriate message appears in the display of LCD speakerphones. Under the DND condition, an outside call forwards to another station according to the call forwarding feature. An intercom number call does not ring at a DND station and the system sends a fast busy signal to the caller to distinguish the DND condition from a standard busy line. No paging announcements are received on the DND station. Even though your station is in the DND mode, you can still make outgoing calls and access other features.

- **To enable DND, proceed as follows:**

1. **SELECT OPTIONS.**
2. **SELECT NEXT** until the **DND** option appears.
3. **SELECT DND.**
4. **SELECT ON.**
5. **SELECT EXIT.**
6. **PRESS SPEAKER** to end.

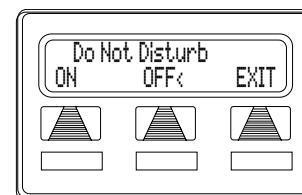

Setting Do Not Disturb

- **To disable the DND condition,**

1. **REPEAT** the above procedure, **BUT SELECT OFF** instead of **ON** at step 4.

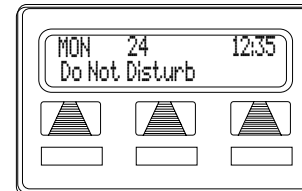

Station With DND Set

- **To set a Do Not Disturb condition at your telephone when a call rings at your station,**

1. **HEAR** ringing and notice incoming call information in display.
2. **SELECT DND.** Ringing will stop, caller will hear the do not disturb tone, and your telephone will remain in DND until you disable the feature (described above).

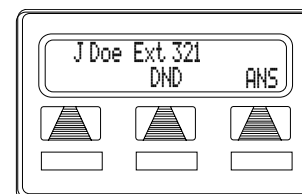

Blocking Calls With DND

Voice Announce Blocking

If your system installer makes this feature available, you can prevent voice announcements such as voice-first intercom calls from sounding over your telephone speaker if you wish. This feature also blocks Subdued Off-Hook Voice Announcements (SOHVA) and generates a tone in response to attempted SOHVAs.

- **To block all voice-announced calls,**

1. **SELECT OPTIONS.**
2. **SELECT NEXT** until **VAB** appears.
3. **SELECT VAB.**
4. **SELECT ON** to block.
5. **PRESS SPEAKER** to end.

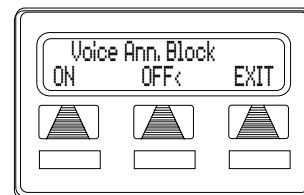

- **To unblock all voice-announced calls,**

1. **SELECT OPTIONS.**
2. **SELECT NEXT** until **VAB** appears.
3. **SELECT VAB.**
4. **SELECT OFF** to unblock.
5. **PRESS SPEAKER** to end.

Caller ID (Automatic Number Identification)

When installed by system programming, the Caller ID feature allows you to view incoming call numbers before you answer them. Incoming call numbers flash in the lower half of the LCD. If you answer the call, the number appears in the upper half of the LCD.

The system also stores numbers that ring on your line but receive no answer. If the call has been returned by someone else, dialing the * key reveals who returned the call. Everyone sharing your line can scroll through the stored numbers and choose which calls to return.

- ***To scroll through ring-no answer numbers stored on your system (CID light is flashing),***
 1. **SELECT** the programmed CALLER ID button on your telephone. Your LCD will display the calling number, date, and time the call came in. The most recent call appears first in the list.
 2. **SELECT** the programmed CALLER ID button each time you wish to display the next most recent ring-no answer call to your line.
 3. To dial one of the numbers in the redial queue, **SELECT** the programmed SAVED NUMBER REDIAL button. The system will automatically dial the number.

Depending on your system programming, when a call is returned it might remain in the ring-no answer queue or the system might delete it from the ring-no answer queue. Your system installer can tell you how the feature is programmed. If the system is programmed to leave a returned number in the redial queue, the display shows a *S character next to the returned numbers.

- ***To determine who viewed the number and returned the call,***
 1. **DIAL** .

3

Making Calls

Making Outside Calls

You can manually dial a number over any telephone line you select. Or, if the installer assigned a prime line or the idle line preference feature to your LCD speakerphone, the system automatically selects a line for use when you lift the handset.

- **To dial an outside number manually,**
 1. **PRESS INTERCOM.**
 2. **DIAL**  **OR** other line button to select line (See *Line Groups* section on page 69 for more information on selecting an outside line).
 3. **LISTEN** for dial tone.
 4. **DIAL** number.
 5. **LIFT** handset if privacy is desired.

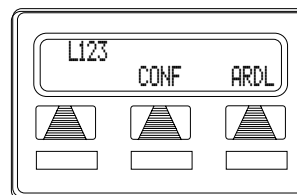

Outside Dialing Display

If your station has an assigned prime line, you will not have to select a line before dialing outside your system.

- **To dial an outside number using your prime line,**
 1. **PRESS SPEAKER OR LIFT** handset if privacy is desired. Outside line is automatically selected.
 2. **LISTEN** for dial tone.
 3. **DIAL** number.

Making Intercom Calls

There are two methods for making an intercom call. One causes the called telephone to ring (tone-first). The other causes your voice to sound out at the called telephone (voice-first). Your installer can set the system to deliver either tone-first or voice-first calling.

NOTE: The following instructions assume a tone-first setting. You can change a call to voice announce signaling for that call simply by pressing the *INTERCOM* button again after dialing the extension number or by pressing the *DSS/BLF* button again.

- **To manually cause the other telephone to ring (tone calling),**

1. **PRESS INTERCOM.**
2. **DIAL** extension number (called telephone will ring).

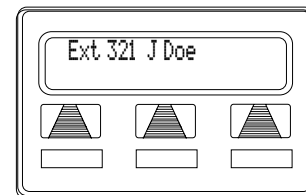

Press Intercom to Display Extension Number

- **To tone call automatically,**

1. **PRESS DSS/BLF** button (called telephone will ring).

NOTE: The following instructions assume a voice-first default setting. Any user can change a call to a tone signaling for that call simply by pressing the *INTERCOM* button again after dialing the extension number or by pressing the *DSS/BLF* button again.

- **To voice announce manually,**

1. **PRESS INTERCOM.**
2. **DIAL** extension number.
3. **SPEAK** your announcement.



Ringling Intercom

- **To voice announce automatically,**

1. **PRESS DSS/BLF** button.
2. **SPEAK** your announcement.

Automatic Dialing

This feature provides one- or two-button speed dialing using programmable buttons at which you have previously stored numbers. There are two types of speed dial numbers: (1) numbers that you store for your own use (personal speed dial numbers), and (2) numbers that the system attendant stores for everyone's use (system speed dial numbers).

- **To automatically dial a speed dial number stored at one of the programmable buttons on your station, choose one of the following:**
 1. **PRESS** programmed speed dial button (line selection is usually a part of the stored speed dial number).
 2. **PRESS SHIFT AND** programmed speed dial button (to choose number stored as second choice at that button).
- **To speed dial a personal speed dial number stored at the dial pad,**
 1. While on hook, **DIAL** speed dial number on dial pad (0 to 9).
- **To speed dial a system speed dial number stored at the dial pad,**
 1. While on hook, **DIAL** * AND system speed dial number.



Speed Dialing Options

Redialing

Redial - Last-Dialed Number

The system provides each station with a last number redial feature. This feature saves 16-digits of the last outside number dialed at the station. A newly dialed number always replaces a previously dialed number. When you press the last number redial button, the system will choose a line and redial the saved number.

- **To redial the last-dialed number,**
 1. **PRESS SPEAKER OR HANG UP** handset to disconnect current ringing or busy tone.
 2. **DIAL**  .
 3. **LISTEN** for ringing or busy tone over the telephone speaker.

Redial Programming (Storing Numbers)

When you use last number redial, you will overwrite the temporary system-saved number with subsequent dialing activity. However, you can also permanently save a number that remains available until you overwrite it by saving a different number at the same storage location.

Non-programmed buttons at multiline telephones are available for you to dynamically save dialed numbers. To save a number, you press any non-programmed button before hanging up after you dial the number. To dial the saved number, you press the same button and the system automatically dials the saved number.

- **To permanently store a number you've just dialed,**
 1. **SELECT SAVE.**
 2. **PRESS** unused programmable button.
 3. **PRESS SPEAKER.**

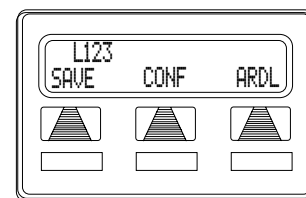

Saving a Dialed Number

- **To permanently store a number you've just dialed (alternate method),**
 1. **DIAL** number.
 2. **PRESS** programmed SAVED NUMBER REDIAL button (see *Feature Buttons* section on page 64 for set up details).

- *To dial the saved number,*
 1. **PRESS SPEAKER OR LIFT** handset if privacy desired.
 2. **PRESS** button where number is saved, **OR PRESS** programmed **SAVED NUMBER REDIAL** button.

You can dial digits and save them while on a call, which is useful should the distant party tell you of a number to call and you wish to save that number for later redial.

- *To store a number while you are on a call,*
 1. **PRESS** programmed **SAVE NUMBER REDIAL** button twice (the display prompts you to dial a number).
 2. **DIAL** the number that you wish to save (the system immediately saves the number for later redial; it does not dial it over the line you are on now).
- *To later redial the saved number,*
 1. **PRESS** line button to select a line.
 2. **PRESS** programmed **SAVE NUMBER REDIAL** button (system automatically dials the number that you saved earlier).

Sending Subdued Off-Hook Voice Announcements (SOHVA)

You can make a private voice announcement to another station that is off-hook and busy on a call if the installer has arranged the system to provide this feature. With SOHVA, the announcement is delivered and responded to in a subdued manner that prevents the distant party from hearing either the announcement or the response. A tone alert precedes the announcement and is delivered to the handset receiver of the telephone ahead of the announcement.

- **Make a SOHVA announcement using the SOHVA button as follows:**

1. **MAKE** intercom call **AND HEAR** busy tone. If called station is on outside line, ring-back tone is heard, but SOHVA is still available.
2. **SELECT SOHVA AND HEAR** several quick tone bursts.
3. **MAKE** announcement (busy tone means that the called telephone is in speakerphone mode and you cannot make announcement, that your SOHVA has been denied through system programming, or that the called party has blocked your SOHVA).
4. **WAIT** on line for reply (either verbal or LCD reply).

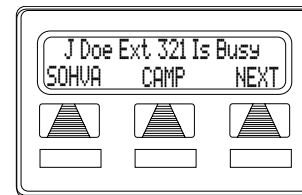

Making a SOHVA

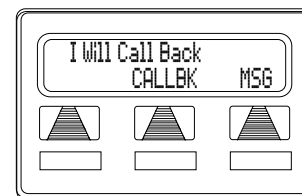

Receiving an LCD Reply

The receiving station can respond to the announcement in a verbal or non-verbal manner. They affect a verbal response by pressing and holding the MUTE button or appropriate interactive button and speaking into the handset. They effect non-verbal response by pressing a programmed button to send a message to be shown on the display of the announcing station (if it is an LCD speakerphone). The announcing station is automatically disconnected after the response message is displayed.

Camping On - Busy Station, Automatic Callback

After calling another station and encountering a busy signal or a ring with no answer, a user can camp on to that station, hang up, and wait to be called back by the system when that station becomes idle or when the user returns. Likewise, you can camp-on to a busy line, hang up, and wait to be called back when it becomes idle.

- **To camp on at any busy station,**

1. **SELECT CAMP.**
2. Your telephone immediately hangs up. When the station you called becomes available, your telephone will ring with five short tone bursts.

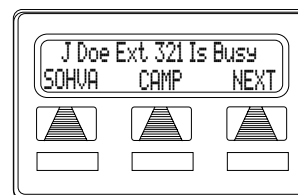

Camping On Selection

When the busy station becomes idle, the system rings your station and starts a timer. You must take it off hook as soon as it rings and as soon as you do, the camped-on telephone rings.

- **When you hear five short tone bursts,**

1. **PRESS INTERCOM.** The other telephone will start ringing.

NOTE: If you do not press *INTERCOM* after the ring back tones within the time limit set by the installer, the call back is canceled.

- **To cancel the call back before your telephone sounds the tone bursts,**

1. **PRESS INTERCOM AND DIAL** # 6.

- **To camp on at a station with a Do Not Disturb condition set,**

1. **SELECT CAMP.** A call back will occur when called station is no longer set in the Do Not Disturb mode.

Advanced Camping On Options

Camping On - Idle Station, Automatic Callback

If you call another station and hear ringing but receive no answer, you can press a button that will cause the system to ring your telephone when any activity is initiated at that station.

- ***To camp on at a station for which you hear ringing but receive no answer,***
 1. **SELECT CALLBK.** Callback will occur after any activity is initiated at dialed station.
- ***To cancel the camp-on condition,***
 1. **PRESS INTERCOM AND DIAL** # 6.
 2. **HANG UP OR PRESS SPEAKER** to end.



Requesting Callback

Camping On - Busy Station, Wait For An Answer (Call Waiting)

If the telephone you have called is busy, you can send a call-waiting tone to the telephone and wait on the line for an answer (you must be using the handset for this feature to work).

- ***To activate call waiting when you hear a busy signal,***
 1. **DIAL** * 6 (called party hears tone).
 2. **WAIT** on line for reply.
 3. Called party can place the current call on hold or disconnect from the call to answer your call-waiting tone, or choose to ignore your call-waiting tone and continue current conversation.
- ***To cancel call waiting,***
 1. **PRESS INTERCOM AND DIAL** # 6.
 2. **HANG UP OR PRESS SPEAKER** to end.

- **To answer a call-waiting tone if you receive one while on a call,**
 1. **HEAR** short tone burst in receiver.
 2. **PLACE** current call on hold, **OR** complete call **AND HANG UP** (waiting call will ring at your telephone).
 3. **LIFT** handset to answer call.

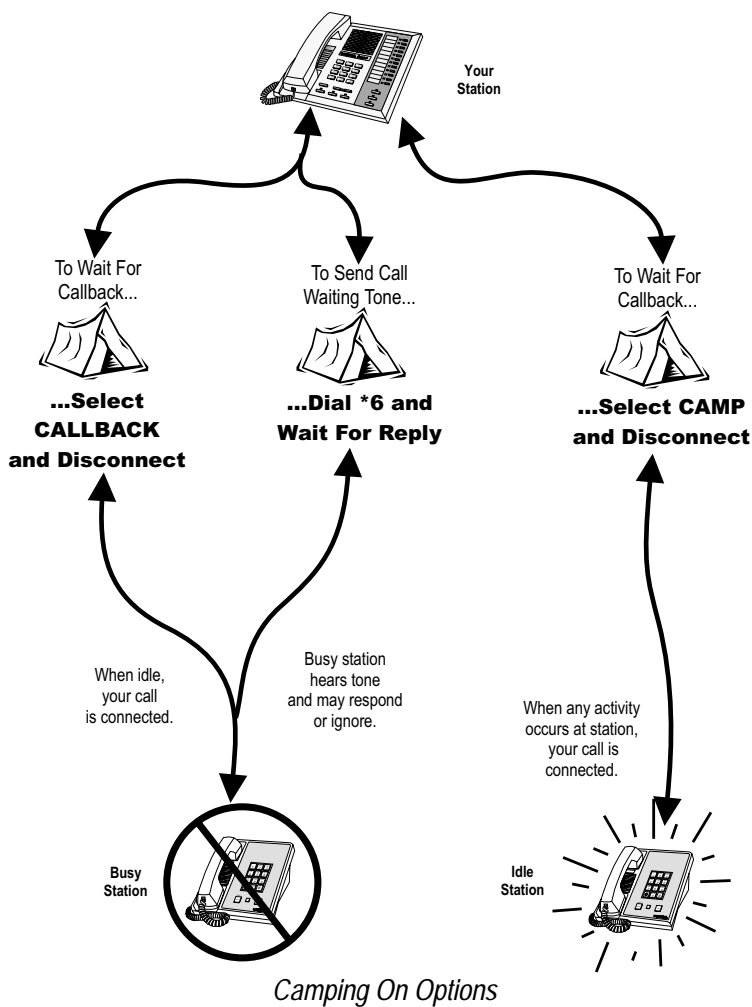

Paging

Your system provides an all-call or a zone page feature that you access by dialing special codes. This arrangement sounds your voice announcement through the telephone speakers. All-call sounds the announcement through all telephones, while zone paging sounds the announcement only through those telephones located in a specific area. Check with your system administrator to determine the type of paging and access method you should use. If your day-to-day operation requires that you send many paging announcements, you can program a special all-call/zone paging button to give quick access to the feature. See the programming section of this user's guide for details.

Your installer can arrange your system with an external paging unit that you access by pressing a line button or by dialing a special code. This unit sounds the voice announcement over an external speaker unit. Check with your system administrator for specific information on how to operate with such an arrangement.

- **To send a paging announcement,**

1. **LIFT** handset.
2. **PRESS INTERCOM.**
3. **DIAL** through for zones 1–8.

NOTE: Zone 1 (code) provides an all-call function in the default mode.

4. **MAKE** announcement.
5. **REMAIN** on line if awaiting a reply (known as a Meet-Me page), **OR HANG UP** handset.

At times other telephone users may page you with instructions to meet them on line. This is known as a Meet-Me page. You can go to the nearest telephone, dial a code, and be in contact with the paging party.

- **To reply to a Meet-Me page,**

1. **LIFT** handset of nearest telephone.
2. **PRESS INTERCOM.**
3. **DIAL** .
4. **MEET** paging party on line.

Programmed Button Display

Button Functions Display (Button Query)

You can cause the display to identify the function of each button on your telephone.

- **To button query your telephone,**
 1. **SELECT** OPTIONS.
 2. **SELECT NEXT** until the **QUERY** option appears.
 3. **SELECT QUERY**.
 4. **PRESS** the button in question.
 5. **READ** the displayed information (display will hold for few seconds before the telephone returns to idle).

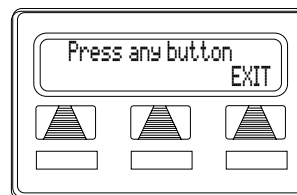

Button Query

Status Of Busy Lines and Stations (Busy DSS/BLF Button Inquiry)

This feature provides you with a means to identify both a station that is busy on a line and the line on which the station is busy. The system presents the identified line or station information on the user's telephone display for 10 seconds after he or she requests that information. If the system installer has not given your telephone this feature, the system presents busy information to the display without identifying the line or station involved.

- **To identify the station that occupies a busy line,**
 1. **PRESS** DSS/BLF button for busy line.
 2. **READ** your display for intercom number of station that is busy on line.
- **To identify the line that a busy station occupies,**
 1. **PRESS** DSS/BLF button for busy station.
 2. **READ** your display for the busy station's line number.

Overriding A Call Or A Do Not Disturb Condition At Another Telephone (Executive Override)

You can override a call in progress or a Do Not Disturb condition at another telephone if the system installer has enabled the executive override feature at your telephone. (If the feature is not enabled, an error tone sounds and screen options remains displayed.) Conditions for executive override are as follows:

- Calling station has class of service that enables busy override.
- Calling station is switched to override voice path.
- Called party may respond and will be heard by calling station and outside party.
- When the calling party dials the override code, the called party receives several tone bursts.

The executive advisory tone allows installers to configure the system to provide an audible tone whenever you activate the executive override feature. installers can select this tone as either a one time tone or as a periodic reoccurring tone. If installers choose a reoccurring tone, they must also select the time interval between the reoccurring tones.

- ***To override an in-progress call at another telephone,***
 1. **MAKE** intercom call **AND HEAR** a busy signal.
 2. **DIAL** *03 (all parties will hear several tone bursts).
 3. **JOIN** in-progress call.
- ***To override a Do Not Disturb condition at another station,***
 1. **PRESS OVER** to disable the Do Not Disturb condition at the called station.
 2. **SPEAK** your announcement (if in voice-first mode) **OR HEAR** ring-back tone (if in tone-first mode).

<p>NOTE: This action disables DND condition at the other telephone until DND is reset.</p>

4**Advanced Call Handling****Waiting For A Line (Queuing)**

If all the lines in a line group are busy, you can place your telephone in a queue to await an idle line.

- ***To queue for a line group,***
 1. **PRESS INTERCOM.**
 2. **DIAL** the line group access code (see Line Group Access code table on page 69 for your system's codes).
 3. **HEAR** busy tone.
 4. **DIAL** .

- ***If you have line appearance for a particular line and wish to queue for it,***
 1. **OBSERVE** the busy status light (LED).
 2. **PRESS INTERCOM.**
 3. **DIAL** .
 4. **PRESS** line button.
 5. When line group is free, your telephone sounds several short tone bursts. When you hear this, lift handset, hear dial tone, and place call.

- ***To cancel line queuing or line group queuing,***
 1. **PRESS INTERCOM.**
 2. **DIAL** .

Conferencing

When your telephone is joined together with several other telephones on the same call, the effect is called conferencing. You can make conference calls that involve up to five parties (seven for DXP, DXP Plus, FXS and FXT systems), including you as the originating party, in any combination of outside lines and intercom parties.

NOTE: When setting up a conference call with outside lines and internal telephones, you must call the outside lines first.

- **To set up a conference call that includes any combination of outside lines and intercom parties,**

1. **MAKE** first call.
2. **SELECT CONF**. Call is placed on hold automatically.
3. **SELECT** next line **AND MAKE** next call.
4. **SELECT CONF** to establish conference.
5. **PRESS TRNS/CNF** button to add more parties.

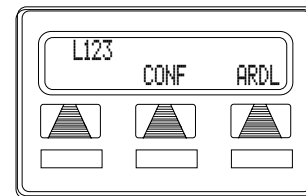

Establishing a Conference

- **To continue conversation on remaining line after other outside lines have dropped out of conference,**
 1. **PRESS HOLD**.
 2. **PRESS** the line button of the remaining party.
- **To retrieve a line from hold and bring that party back into the conference,**
 1. **PRESS TRNS/CNF**.
 2. **PRESS** line button.
 3. **PRESS TRNS/CNF**.

If you are involved in a conference call with two outside lines, you can drop out of this established conference call and leave the outside lines in the conference with each other. This is known as an unsupervised conference call.

- **To drop out of a conference call you initiated involving outside lines (creating an unsupervised conference),**
 1. **DIAL #** (lines remain lighted and in use until one or both outside parties disconnect; when only one party drops out of an unsupervised conference, the other party remains on hold until he hangs up or the line is answered).

- **To rejoin an unsupervised conference between two outside lines,**
 1. **PRESS TAP** or **DSS/BLF** button of one of the conferencing stations.

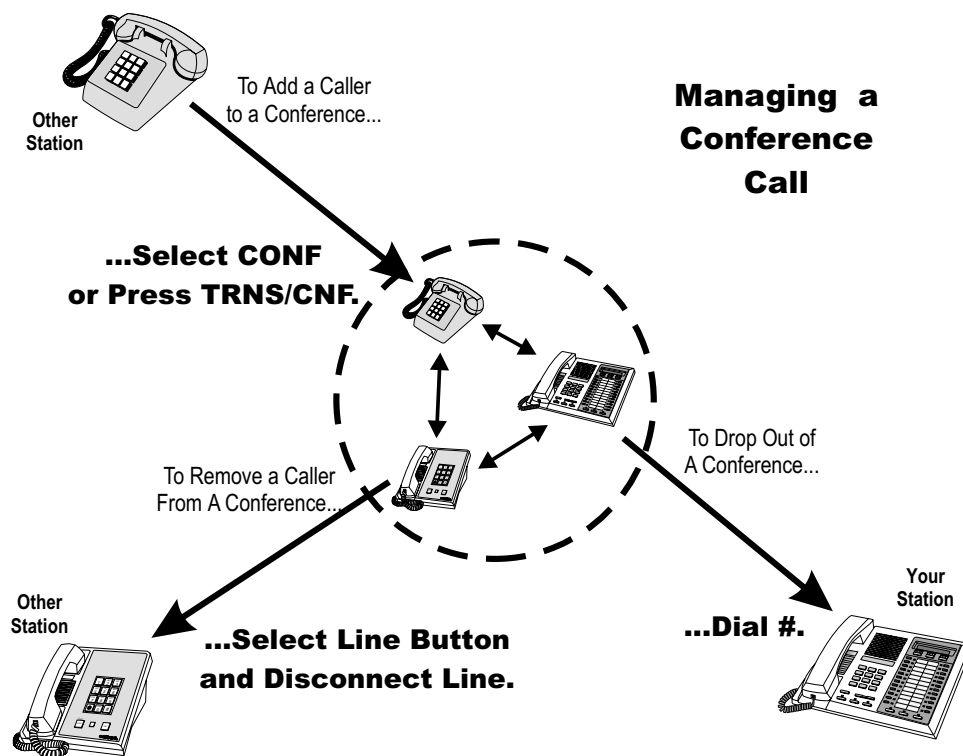

Conferencing Options

Call Forwarding

You can forward the calls that normally ring at your telephone to another telephone for answering. Call forwarding provides several options that can be programmed by you locally at your station. For example, you can forward just the prime line and intercom calls or forward every call that rings at your station.

Also, you can control whether the calls forward immediately or after a preprogrammed number of rings (this is true of busy calls as well, which ring in a subdued manner) that is set by the installer. When the telephone is set to ring several times before forwarding, you have a chance to end the current call before the incoming call is forwarded.

For each internal call received while call forward is enabled, your telephone sounds a ring reminder (short tone burst) to remind you that your calls are being forwarded.

- **To forward your calls,**

1. **SELECT OPTIONS.**
2. **SELECT NEXT** until the **CFWD** option appears.
3. **SELECT CFWD.**
4. **SELECT SET.**
5. Choose one of the following call forwarding options,
 - **SELECT PERS** to forward prime line and intercom calls.
 - **SELECT ALL** to forward all calls.
 - **SELECT NEXT AND No ANS** to forward calls that ring at your station but receive no answer after a preprogrammed number of rings (**THEN PRESS PERS** to forward your prime line and intercom calls, **OR PRESS ALL** to forward all calls that ring with no answer at your telephone).
6. **DIAL** extension number of telephone to receive your forwarded calls.
7. **PRESS SPEAKER** to end. Display shows **FWD**.

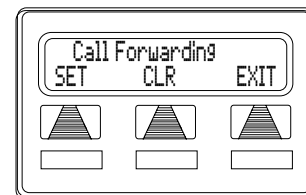

Selecting Call Forwarding

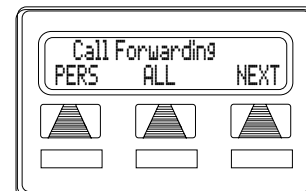

Call Forwarding Options

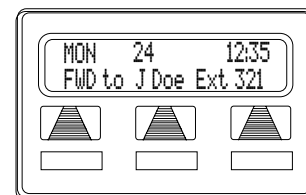

Call Forwarding Active

- **To cancel call forwarding,**
 1. **SELECT OPTIONS.**
 2. **SELECT NEXT** until the **CFWD** option appears.
 3. **SELECT CFWD.**
 4. **SELECT CLR** to disable call forwarding.
 5. **PRESS SPEAKER** to end.

The installer can assign a call forward button to individual telephones. If your telephone has a call forward button available at a programmable button location that includes an associated light, the light turns on when you press the button.

If a telephone has an LCD display, it shows a call forward message along with the extension number or name of the station receiving the forwarded calls.

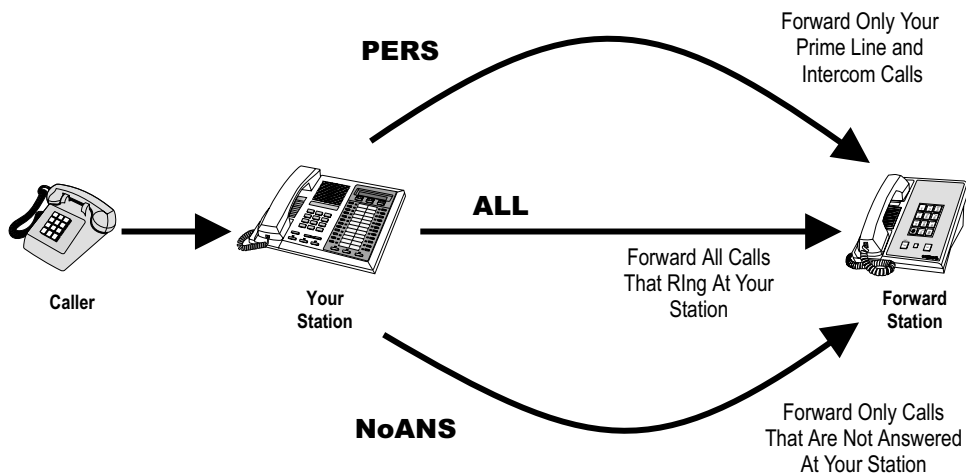

Call Forwarding Options

Call Forward Outside System (CFOS)

The Call Forward Outside System (CFOS)* feature allows you to forward incoming or transferred line calls or intercom calls to telephone numbers that are outside the system. The CFOS feature forwards calls over any available outbound lines or line groups and does not use any conference circuits. Since CFOS involves outbound calls, those calls are subject to all line access, toll restriction, and automatic route selection restrictions normally imposed on your calls.

You activate or deactivate CFOS by dialing a feature code, pressing a preprogrammed button or pressing an interactive button on an LCD speakerphone. Once you activate CFOS, you select the outbound line or line group in any of the normal line selections methods. You also designate the forward destination by dialing the number or pressing a speed dial button. (If you do not make a line and destination choice, the system uses the most recently used selections.)

The Call Forward Outside System (CFOS) feature also includes forwarding outside of the system for direct and transferred personal intercom calls. Also, the feature provides ring no-answer (RNA) capability to the CFOS of both line and personal intercom calls. With this RNA capability, the system rings a station a programmed number of rings and then forwards the call outside the system based upon the programmed CFOS setting.

- **To activate CFOS with your LCD speakerphone,**

1. **SELECT** OPTIONS.
2. **SELECT** NEXT until CFWD appears.
3. **SELECT** CFWD.
4. **SELECT** SET.
5. **SELECT** NEXT until CFOS appears.
6. **SELECT** CFOS.
7. **CHOOSE** a type of CFOS and **SELECT** the desired interactive button (to switch the type of CFOS you wish to select, **PRESS** TGL):
 - **SELECT** Item for intercom calls.
 - **SELECT** Line for prime line calls.

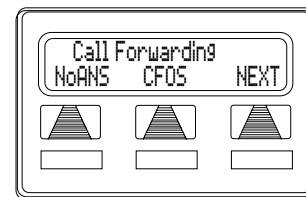

Selecting CFOS

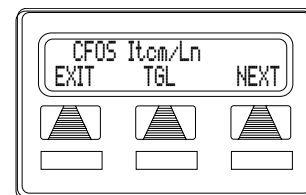

Choose CFOS Type

- **SELECT** Item/Ln for all calls
 - **SELECT** RNA Item for ring-no-answer intercom calls
 - **SELECT** RNA Line for ring-no-answer prime line calls
 - **SELECT** RNA Item/Ln for all ring-no answer calls
8. **SELECT** outbound line (**PRESS** line button, **DIAL** appropriate code, or do nothing and let previously selected line remain in effect). If you want to change the destination, you must enter something for the outbound line.
 9. **SELECT** forward destination (dial number, press speed dial button, or do nothing and let previously selected destination remain in effect).
 10. **PRESS** *SPEAKER* to end (display shows CFOS).

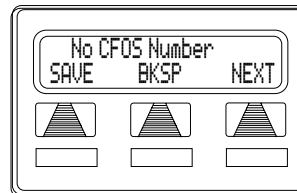

Set Forward Destination

- **To deactivate CFOS, choose one of the following:**
 1. **SELECT** CFOS interactive button **OR**,
 2. **PRESS** *INTERCOM AND DIAL* .
- **To join an active CFOS call from the CFOS-enabled station,**
 1. Note flashing *HOLD* light indicating active CFOS call, and press *TAP*. Join CFOS-forwarded party and CFOS destination in a conference call.

* Comdial has taken reasonable steps in the design of all product features, including CFOS, which protect against unauthorized or fraudulent access to, or use of, a system, or which protect against unauthorized, fraudulent or unaccounted-for access to, or use of, long distance lines. However, no system is entirely invulnerable or immune from unauthorized or fraudulent access or use, or unaccounted-for access or use, and therefore Comdial disclaims any and all liability, and makes no warranty, express or implied, relating to unauthorized or fraudulent access or use, or unaccounted-for access or use.

Call Parking

Parking a Call

You can place a call on hold in the system so that it can be answered from any station, even though it may not have a line appearance for the call. You accomplish this by placing the call in one of many park orbits, where the call remains until it is answered. Those calls that you can park include intercom calls, outside calls, and conference calls.

You park calls in predefined zones and then retrieve them by dialing an intercom feature code or by pressing a preprogrammed call park button. The system can hold 90 calls in park zones (also referred to as orbits) where they are retrievable by all users in the system.

- ***To park a call in orbit,***
 1. While on the call, **PRESS INTERCOM OR PRESS TRNS/CNF** if intercom call.
 2. **DIAL** * .
 3. **DIAL** code for park orbit (9 1 0 to 9 9 9 for orbit 10–99).
 4. Remember the code for later use or make it known to those who need to know it in order to retrieve the call.

- ***To retrieve a call that was placed on hold in the system (parked),***
 1. **PRESS INTERCOM.**
 2. **DIAL** #.
 3. **DIAL** code for orbit (9 1 0 to 9 9 9 for orbit 10–99), **OR PRESS** programmed PARK button.

Handling Park Recalls

If a call remains unanswered after the park recall time has ended, the system returns the call to the parking station where it rings. If that telephone includes an LCD display, a message appears on it that shows the park orbit number of the returning call as well as the line number. The system installer sets the call park recall times.

- **To answer a park recall,**
 1. **SELECT ANS.** The call will then connect to your station.
- **To place a park recall on hold at your station,**
 1. **SELECT HOLD.** After the call remains on hold for a period of time, it rings back to your telephone as a hold recall.
- **To re-park a park recall and restart the park timer,**
 1. **ANSWER/RETRIEVE** call.
 2. **SELECT PARK** (the system places the call back in its original park orbit where it remains until it is answered or recalls again).

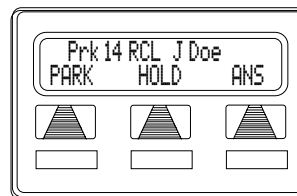

A Park Recall

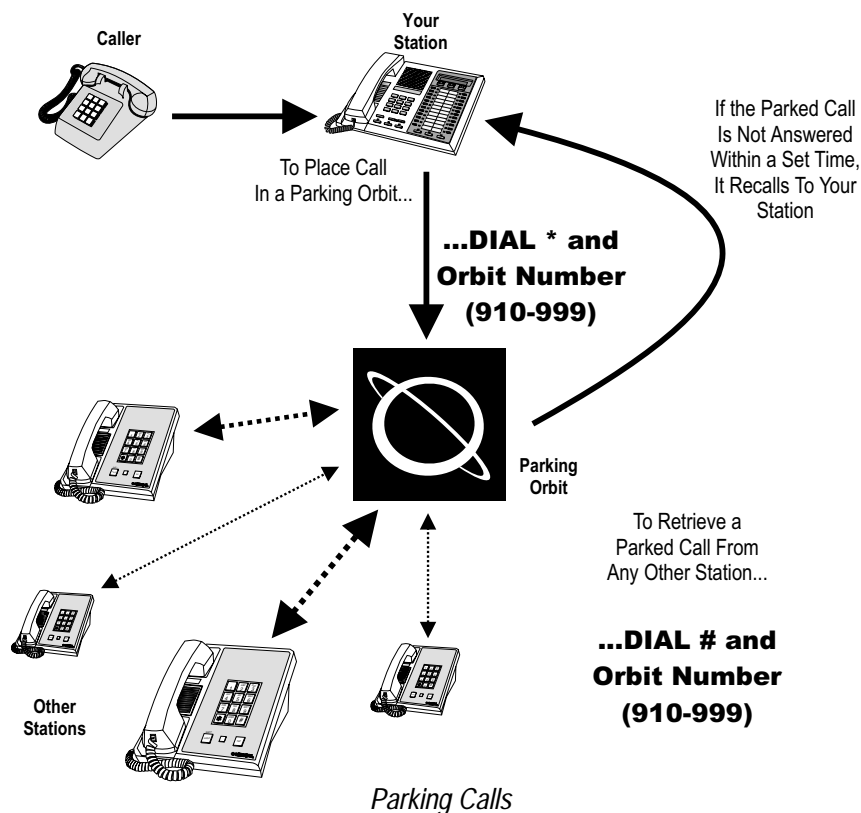

Call Transferring

Screened Call Transfers

You can answer a call at your LCD speakerphone and transfer it to another telephone. If you first identify the caller to the party receiving the transfer (giving that user the opportunity to prepare for the call), you have made a *screened transfer*.

- **To screen and transfer a call to another telephone in the system,**
 1. **ANSWER** call.
 2. **PRESS TRNS/CNF** (call is automatically placed on hold).
 3. **DIAL** extension number of telephone to receive transfer, **OR PRESS DSS/BLF** button for that extension.
 4. **ANNOUNCE** call when intercom party answers.
 5. **PRESS SPEAKER** to disconnect (if in speakerphone mode), **OR HANG UP**.

The intercom party then has the call (if he or she answered the screened transfer with the handset). If you announce the transfer over the speaker, the intercom party's telephone will ring with the transferred call after you hang up.

- **If the intercom party is busy, take one of the following steps (if made available at your telephone by installer programming):**

1. **SELECT RECON** to reconnect the call to your station,
2. **SELECT SOHVA** to interrupt the call and tell the intercom party that a call awaits,
3. **SELECT MSG** to leave a message-waiting indication at the called station.

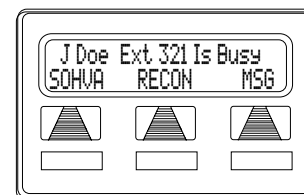

Attempting a Transfer

- **If the intercom party does not answer their telephone when ringing, take one of the following steps:**
 1. **SELECT RECON** to reconnect the call to your station.
 2. **SELECT MSG** to leave a message-waiting indication at the station.

Unscreened Call Transfers

Unscreened call transfer allows you to transfer both line and intercom calls from your station to another station or group without first announcing them. The unscreened transferred call appears at the other station where it rings if that station is idle or automatically camps-on and awaits an answer if that station is busy.

- **To transfer an unscreened call to another system telephone,**
 1. **ANSWER** call.
 2. **PRESS TRNS/CNF** (call is automatically placed on hold).
 3. **DIAL** extension number of telephone to receive transfer, **OR PRESS DSS/BLF** button for that extension.
 4. **PRESS SPEAKER** to disconnect (if in speakerphone mode), **OR HANG UP**. The transfer will ring at the called telephone.

The call automatically rings back to your station after a programmed recall period. There is no limit as to how many calls that can be camped onto another station.

- **If an unscreened transfer call is not answered and recalls to your telephone, you can take one of the following steps:**

1. **PRESS HOLD** to place the call on hold at your telephone.
2. **SELECT ANS** to return to the call.
3. **SELECT SEND** to retry the transfer.

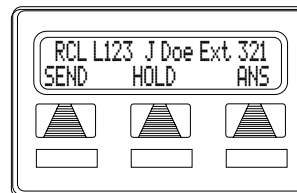

*Attempted Transfer of Line
123 To J Doe Is Recalling*

NOTE: For a description of more system features that transfer calls, see *Other Call Transferring Options* section on page 50.

Other Call Transferring Options

Hot Transfer

A hot transfer is a type of screened transfer. This feature is useful for transferring calls to people who need to work in a handsfree mode. Once you announce the call and the system completes the transfer, the person receiving the transfer can simply begin speaking toward his or her speakerphone to answer the call.

- **To make a hot transfer to another telephone in the system,**
 1. **ANSWER** call.
 2. **PRESS TRNS/CNF** (the system automatically places the call on hold).
 3. **DIAL** extension number of telephone to receive the transfer **OR PRESS DSS/BLF** button for that extension.
 4. **ANNOUNCE** call.
 5. **PRESS TRNS/CNF**.
 6. **PRESS SPEAKER** to disconnect (if in speakerphone mode) **OR HANG UP**. The person receiving the transfer then has the call.

Quick Transfer

When the installer programs the quick transfer method on your telephone, you can deliver an automatic transfer of an incoming line call without pressing the *TRNS/CNF* button.

- **To do a quick screened transfer,**
 1. **ANSWER** call.
 2. **DIAL** intercom number for transfer location.
 3. When party at transfer location answers, **ANNOUNCE** call.
 4. **HANG UP, SELECT RELEASE, OR PRESS SPEAKER** button.

- **To do a quick unscreened transfer,**
 1. **ANSWER** call.
 2. **DIAL** intercom number for transfer location.
 3. **HANG UP, SELECT RELEASE, OR PRESS SPEAKER** button.

Call Transferring Summary			
Transfer option	What are the sender's actions after answering original call?	How is the transferred call delivered to the receiver?	Best suited for:
Screened Transfer	<ol style="list-style-type: none"> 1. Press TRNS/CNF 2. Dial extension 3. Announce call 4. Disconnect 	Normal intercom ringing (two short bursts) and the introduction of the call; if answered in speakerphone mode, ringing will also follow the transfer	Normal transfers that require introduction.
Unscreened Transfer	<ol style="list-style-type: none"> 1. Press TRNS/CNF 2. Dial extension 3. Disconnect 	Normal intercom ringing (two short bursts)	Expected transfers that need no introduction.
Hot Transfer	<ol style="list-style-type: none"> 1. Press TRNS/CNF 2. Dial extension 3. Announce call 4. Press TRNS/CNF 5. Disconnect 	Transfer introduction followed directly by the incoming call	Personnel who must receive speakerphone calls in a hands-free mode.
Quick Transfer (with intro)	<ol style="list-style-type: none"> 1. Dial extension 2. Announce call 3. Disconnect 	Intercom ringing (two short bursts) and the introduction of the call; if answered in speakerphone mode, ringing will also follow the transfer	Normal transfers from attendants and operators who handle a large number of incoming calls which require transfer.
Quick Transfer (without intro)	<ol style="list-style-type: none"> 1. Dial extension 2. Disconnect 3. Select RELEASE 	Normal intercom ringing (two short bursts)	Expected transfers from attendants and operators who handle a large number of incoming calls which require transfer.

Diverting All Incoming Calls To Another Station

Call diverting permits you to send an incoming call to another station that you have previously designated. You can divert an incoming call to the designated station whether you are busy or idle. After a user determines where to forward a call and activates the call forward button, the system will immediately forward the call once the line rings.

You must first program a CALL FORWARD button using the instructions on page 64 to make call diverting available.

- ***To identify the station to receive diverted calls,***
 1. **PRESS INTERCOM.**
 2. **DIAL** .
 3. **DIAL** extension number of station to receive diverted call.

- ***To divert calls to the designated station,***
 1. **HEAR** ringing **AND/OR SEE** flashing line status light.
 2. **PRESS** programmed CALL FORWARD button (system immediately forwards ringing call to station you designated).

5

Nonverbal Messaging

LCD Message Delivery

You can set standard and system supplied custom display messages by dialing a specific code at your telephone. When another user places a call from an LCD speakerphone, the preset LCD message from your station will flash on the caller's LCD. When you set a message, the intercom number light at your telephone flashes to indicate that the feature is active.

- **To turn on a message from your telephone,**

1. **PRESS INTERCOM AND DIAL** * 0 2.
2. **DIAL** the desired code number from your message list (01–30) on the next page, **OR PRESS HOLD** button to scroll through the available messages **AND DIAL #** to select.

NOTE: See following page for LCD dialing codes.
--

- For a “Back At” message, dial the code for time numbers and colon from dialing codes table.
(For example, **DIAL** # 0 0 0 1 2 9 0 4
0 5 for the time 01:45).
 - For a “Call” message, dial code for telephone number of your new location.
(For example, **DIAL** # 0 9 0 7 0 8 1 5
0 2 0 2 0 0 0 0 for the number 978–2200).
3. **DIAL** # **AND PRESS SPEAKER** to end message.
- **To turn off the message and your intercom light,**
1. **PRESS INTERCOM AND DIAL** # 0 2.

Dialing Code Table				
Character	Dialing Code		Character	Dialing Code
1	01		8	08
2	02		9	09
3	03		0	00
4	04		space	12
5	05		–	15
6	06		:	29
7	07			

LCD MESSAGE LIST (Write the attendant supplied messages here.)	
Dial Code	Message
01	Back at (default message 1)
02	Call (default message 2)
03	Ask them to hold (default message 3)
04	Take a message (default message 4)
05	I will call back (default message 5)
06	
07	
08	
09	

LCD MESSAGE LIST (Write the attendant supplied messages here.)	
Dial Code	Message
10	
11	
12	
13	
14	
15	
16	
17	
18	
19	
20	
21	
22	
23	
24	
25	
26	
27	
28	
29	
30	

Message Waiting Light and Messaging

A special feature access code allows you to control the message waiting (MW) light at other stations in the system. When the message waiting light is turned on at a station, the user can automatically call the station that turned it on. Stations that include an LCD display show the source of the message.

The installer can program one station as the central message desk and arrange it for exclusive message waiting control. The central message desk user can control message waiting lights and deliver messages to and from all other stations in the system. The installer can also provide a programmable button for placing and retrieving message waiting calls. Single line telephones only utilize central message desk signaling. A station can have as many 8 message waiting lights stacked at one time.



Installers can take programming action to enable or disable the stutter intercom dial tone received at a station to indicate a message waiting. You can program this item as a station COS parameter.

- ***To turn on the message-waiting light (and a broken dial tone) at another station that is idle or busy,***
 1. **PRESS INTERCOM.**
 2. **DIAL**  **3.**
 3. **DIAL** extension number **OR PRESS DSS/BLF** button of station to be alerted. The message-waiting light of called station will flash.

- ***You can also turn on the message-waiting light and broken dial tone at another station when that station is busy,***
 1. **HEAR** the busy tone **AND REMAIN** on the line.
 2. **SELECT MSG.**
 3. **HANG UP.**



Leaving a LCD Message

- **To turn off the message waiting light at a busy or idle station,**
 1. **PRESS INTERCOM.**
 2. **DIAL**  .
 3. **DIAL** extension number **OR PRESS** DSS/BLF button of station that was alerted. The message-waiting light of called station will turn off.

- **To turn off the message-waiting light during message-delivering conversation,**
 1. **PRESS INTERCOM** once if off-hook, twice if on-hook.

- **To receive a message at an alerted station,**
 1. **OBSERVE** flashing message waiting light and the LCD message indicating who called for you.
 2. **SELECT CALL** to dial the messaging station automatically.
 3. **SELECT CLEAR** to clear the message from your station.



Receiving a Message

Response Message Delivery

By programming one or more RESPONSE MESSAGE buttons on your LCD speakerphone, you can respond with a variety of messages to many calling situations. This response message button lets you make a non-verbal response to subdued off-hook voice announce calls or intercom calls using the attendant-prepared response messages (see page 55 for attendant prepared messages).

A scrolling RESPONSE MESSAGE button allows the sender to select from several different messages which have been programmed by the system attendant. A fixed RESPONSE MESSAGE button sends the same message you previously select each time it is pressed.

- ***To send an LCD message when you call and receive busy signal or no answer,***
 1. While still on the call, **PRESS** the appropriate RESPONSE MESSAGE button to send a preselected message to the other telephone,
 2. If a scrolling Response Messaging was programmed, continue to **PRESS** RESPONSE MESSAGE button **AND DIAL #** when your display shows the message you wish to send.

- ***To send an LCD message to a caller who has initiated a SOHVA or intercom call from another LCD telephone,***
 1. **HEAR** the SOHVA tone or voice announcement in your handset or headset.
 2. **PRESS** the appropriate fixed RESPONSE MESSAGE button to send a preselected message to the calling telephone,
 3. If a scrolling Response Messaging was programmed, continue to **PRESS** RESPONSE MESSAGE button **AND DIAL #** when your display shows the message you wish to send.

For instructions on storing a RESPONSE MESSAGE button, see page 67.

6

Programming

DSS Numbers

Storing another stations extension number at a DSS/BLF programmable location allows you to monitor that station, dial with the press of one button, or pick up or hold calls at that station quickly and conveniently.

- *To store an intercom number as a DSS number,*

NOTE: Storing DSS numbers at button locations will overwrite any previously stored numbers.

1. **SELECT OPTIONS.**
2. **SELECT NEXT** until the **DSS** option appears.
3. **SELECT DSS.**
4. **PRESS** programmable button to choose **DSS/BLF** button location.
5. **DIAL** extension number.
6. **REPEAT** the previous steps, **OR SELECT EXIT.**
8. **PRESS SPEAKER** to end.

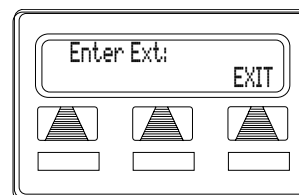

Designating an Extension

CAUTION

Do not attempt to program interactive buttons; doing so can cause the system to make features unavailable. If you inadvertently program interactive buttons, you can retrieve their functions in the following manner:

1. **PRESS INTERCOM** **[*][*][1]**
2. **PRESS** the interactive button to be reprogrammed
3. **DIAL** **[9][1]**, **[9][2]**, or **[9][3]** (for buttons from left to right).

Speed Dial Numbers

Station speed dialing is a feature that lets you dial lengthy numbers using one or two buttons, store frequently used feature dialing codes, and store intercom extension numbers of frequently called telephones. You can store speed dial numbers* at any unused programmable button, or if the installer assigns a shift button to your telephone, or one exists as a fixed feature button, you can store a speed dial number at a second level under any programmable button.

- * The Federal Communications Commission (FCC) requires that when programming emergency numbers and/or making test calls to emergency numbers:
1. Remain on the line and briefly explain to the dispatcher the reason for the call;
 2. Perform such activities in the off-peak hours, such as early morning or late evening.

- **To store an outside number as a speed dial number, follow the display prompts and proceed as follows:**

1. **SELECT** OPTIONS.
2. **SELECT NEXT** until **SDIAL** option appears.
3. **SELECT SDIAL** to choose speed dial programming.
4. **PRESS** programmable button **OR** dial pad button (**0-9**) to choose storage location (remember, to access second level storage at a programmable button, press **SHIFT** first).

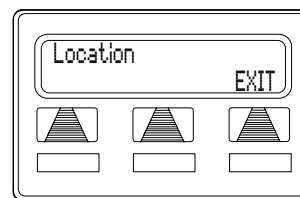

Choosing a Button



Speed Dialing Options

5. **CHOOSE** your speed dial route from the following list:
- **PRESS** line button to select outside line,
 - **DIAL** to select prime line or last line used,
 - **DIAL** to to select line group,
 - **PRESS** *INTERCOM* button or dial to select intercom.

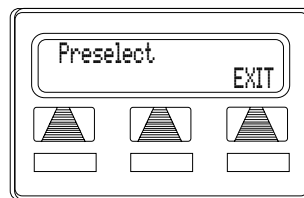

Selecting Line or Intercom

NOTE: You may need a pause between numbers to compensate for differences in response time between your system and the host system (ask your attendant about this). To store a pause, press *HOLD*, then continue dialing. If your system is behind a host system that needs a hookflash to access a feature, press *TAP* to store a hookflash, then continue dialing.

6. **DIAL** number (up to 16-digits long).
7. **SELECT** *SAVE* to store the number.
8. **REPEAT** previous steps until all numbers are stored, **OR** **SELECT** *EXIT*.
9. **PRESS** *SPEAKER* to end.

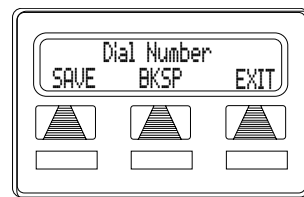

Dialing a Speed Number

Feature Access Codes

In addition to the system features that you program using the interactive buttons, you can program several other features by using their access codes. The feature codes are programmed like speed dial numbers and can occupy the same programmable buttons on your telephone. Access codes are listed in *Appendix A, Feature Access Codes* found on page 119.

- **To store a system feature access code,**

1. **SELECT OPTIONS.**
2. **SELECT NEXT** until **SDIAL** option appears.
3. **SELECT SDIAL** to choose speed dial programming.
4. **PRESS** programmable button **OR** dial pad button (**0–9**) to choose storage location (remember, to access second level storage at a programmable button, press *SHIFT* first).
5. **PRESS INTERCOM** when prompted to preselect line.
6. **DIAL** access code associated with feature.
7. **SELECT SAVE** to store the number.
8. **REPEAT** previous steps until all numbers are stored, **OR SELECT EXIT**.
9. **PRESS SPEAKER** to end.

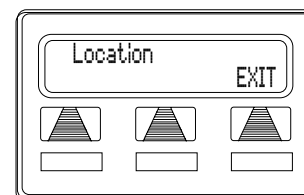

Choose a Location

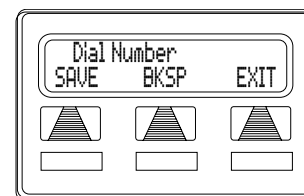

Dial the Access Code

- **To manually store an access code,**

1. **PRESS INTERCOM.**
2. **DIAL** .
3. **PRESS** programmable button.
4. **DIAL** access code for feature.
5. **PRESS SPEAKER** to end.
6. **LABEL** button location.

As you program numbers, fill in the identification strips on your telephone as well as these tables.

Speed Dial Numbers, Features or DSS Locations (Programmable Buttons)			
1			13
2			14
3			15
4			16
5			17
6			18
7			19
8			20
9			21
10			22
11			23
12			24

Personal Speed Dial Numbers (Keypad Buttons)			
1			6
2			7
3			8
4			9
5			0

LCD Feature Buttons

You can create feature access buttons to make operation easier. To do this, use the interactive buttons to select the feature you want to store, and then store it on a programmable button (see the instructions on the next page).

- **Account Code Button (ACCT)**—allows you to enter an account code for call record purposes.
- **Auxiliary Pager (APAGE)**—selects external pager operation through the auxiliary jack.
- **Auxiliary Recorder (ARECD)**—selects tape recorder operation through the auxiliary jack.
- **Auxiliary Ringer (ARING)**—selects auxiliary ringer operation through the auxiliary jack.
- **Call Forward Button (CFWD)**—allows you to forward all of your calls to another telephone.
- **Camp-On With Automatic Call Back (CAMP)**—allows you to camp on to a station. The system calls you back as soon as the called station becomes idle or occupied.
- **Camp-On (Call Waiting) (CAMP)**—when calling a busy station, this feature allows you to send a call waiting tone to the station and to wait on-line for a reply.
- **Clear Features (CLEAR)**—clears a currently active or engaged feature.
- **Do Not Disturb Button (DND)**—prevents other telephones from ringing your telephone.
- **Group Listen Button (GPLSN)**—allows others to hear a conversation over the telephone speaker while you use the handset or headset; the distant party can hear only the conversation transmitted through the handset or headset microphone.
- **Headset (HDSET)**—enables headset operation through the auxiliary jack.
- **Music Button (MUSIC)**—allows you to enable or disable background music; also allows you to choose from two pre-programmed music sources.
- **Page Button (PAGE)**—provides one-button access to paging.
- **Park Button (PARK)**—parks calls in preselected park orbit.

- **Pick-Up Button (PCKUP)**—allows you to pick up a call ringing elsewhere in your system.
- **Privacy Release Button (PRIU)**—allows other telephones which share a line appearance for current call to join.
- **Saved Number Redial Button (SAVE)**—redials the last number saved
- **Voice-Announce Block Button (VAB)**—blocks voice announcements.

Programming of the feature access buttons may require several selections involving many LCD screens. If you are not familiar with an abbreviation, consult *Appendix B, Display Abbreviations* on page 125.

- **To create a feature access button,**
 1. **SELECT** OPTIONS.
 2. **SELECT NEXT** until the FEAT option appears.
 3. **SELECT FEAT.**
 4. **SELECT NEXT** repeatedly until desired feature choice is displayed.
 5. **SELECT** one of the buttons below the current display to choose desired selection.
 6. **RESPOND** to any menu prompts associated with feature (see example for Pickup).
 7. **PRESS** programmable button for storage location.
 8. **REPEAT** steps 3 through 7 for other features, **OR SELECT EXIT** to end programming.
- **To clear a feature button assignment,**
 1. **REPEAT** the above procedure, but **SELECT CLEAR** before selecting storage location button.

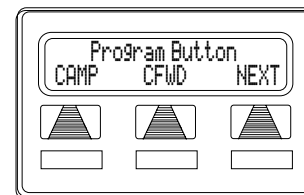

Selecting a Feature

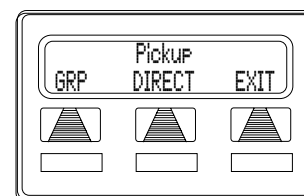

Responding to Prompts to Program a Pickup Button

Reminder Alert

You can set up to two reminder alerts to sound at your LCD speakerphone so that you will remember important regular events or occasional events.

- **To set a reminder alert at your telephone,**

1. **SELECT OPTIONS.**
2. **SELECT NEXT** until the **ALERT** option appears.
3. **SELECT ALERT.**
4. **SELECT 1 OR 2** to select available alert designation; if you have already programmed an alert for 1, select 2 to set a second alert condition.
5. **SELECT ON** (**SELECT OFF** to turn off an alert that has already been set).
6. **DIAL** reminder time using the numbers on the dial pad (remember to add a zero [0] before single digit times: 01 for one o'clock, 02 for 2 o'clock, etc.).
7. **SET AM** or **PM.**
8. **SELECT SAVE.**
9. **PRESS SPEAKER** to quit.

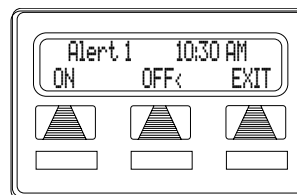

Setting an Alert

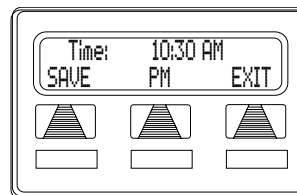

Setting the Alert Time

When an alert sounds at the set time, you hear four short tone bursts, which will continue until acted upon. If you are not at your station to hear the alert when it sounds, your telephone's ring tone changes to the alert tone for every incoming call until you respond to the alert.

- **To respond to an alert after it sounds, choose one of the following:**

1. **SELECT CLEAR** to turn off the alert.
2. **SELECT SET** to reset the alert for the same time the following day.

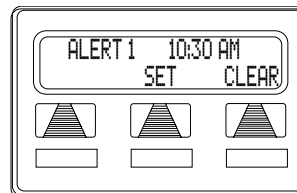

Responding to an Alert

Response Message Button

You may program a RESPONSE MESSAGE button, which allows you to send an LCD message to a caller who has initiated a SOHVA or intercom call from another LCD speakerphone, or to send an LCD message to another LCD speakerphone that you call and receive a busy signal or no answer.

- ***To store a scrolling RESPONSE MESSAGE button, proceed as follows (user may press button repeatedly to choose from up to 30 system supplied messages),***
 1. **PRESS INTERCOM.**
 2. **DIAL** .
 3. **PRESS** programmable button for RESPONSE MESSAGE button location.
 4. **DIAL** .
 5. **DIAL** to save programming.
 6. **PRESS SPEAKER** to end.
 7. **LABEL** button location.

- ***To store a fixed RESPONSE MESSAGE button (delivers the same message each time it is pressed),***
 1. **PRESS INTERCOM.**
 2. **DIAL** .
 3. **PRESS** programmable button for RESPONSE MESSAGE button location.
 4. **DIAL** message number (**01-30**) from list of messages.

NOTE: Programmed messages available for use are created by the system attendant and listed in a table on page 55.

5. **DIAL** to save programming.
6. **PRESS SPEAKER** to end.
7. **LABEL** button location.

Notes

7

Other Features

Line Groups

Some systems have telephone lines arranged into line groups that may be accessed for outside calling instead of selecting an individual line button. The installer can use this feature to reserve certain lines for certain clusters of stations for a tenant-service arrangement.

- ***If your system has line groups, access them as follows:***
 1. **PRESS INTERCOM.**
 2. **DIAL** desired line group access code,

Line Group Access Codes		
Line Group	Default Code	Active Code*
1	9	
2 through 11	8 0 through 8 9	
12 through 16	6 0 through 6 4	

* If your system installer has reassigned the line group access codes, write them here for future reference.

3. **LISTEN** for outside dial tone.
4. **DIAL** desired number.
5. **LIFT** handset to talk.

Automatic Redial

With this feature, the system automatically redials a busy or unanswered outside call. Once you activate automatic redial, the station selects the line, automatically dials the number, and waits for a response. (It dials and then waits 30 seconds for an answer.) If the called station does not answer, the redialing station disconnects, waits one minute, and then repeats the sequence. The station will repeat this procedure for approximately 10 minutes.

The feature cycle is timed and does not have busy and ring-no-answer detection circuitry. Because of this, if you are operating handsfree when the called party answers, you must take the handset off-hook to prevent being cut off by the timing cycle.

You must program an AUTOMATIC REDIAL button at one of the designated programmable button locations on their telephones before you can use it. See the instructions on page 64 to program an AUTOMATIC REDIAL button.

- ***To use the automatic redial feature to redial a busy or unanswered number,***

1. While on the call, **SELECT ARDL OR PRESS** the AUTOMATIC REDIAL button programmed by your installer.
2. The system repeatedly dials the number until you cancel the feature or the system has dialed the number a preprogrammed number of times (determined by your system installer).
3. The AUTOMATIC REDIAL light flashes between redials and turns on steady during redialing.
4. **IF** your installer has enabled answer supervision on your line, the system automatically cancels automatic redialing and turns the AUTOMATIC REDIAL light off.
5. **IF** answer supervision is **NOT** enabled, **SELECT ARDL OR** the programmed AUTOMATIC REDIAL button while on the call to cancel automatic redialing,

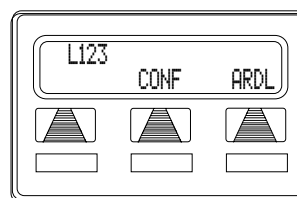

Initiating Autore dial

The enhanced automatic dialing feature adds a multiple redial feature. When installers enable this option, the station can have multiple numbers queued for ARD (automatic redial). When you enable multiple ARD, a station can store up to the last 10 numbers the user dials.

- ***To scroll through numbers in your redial queue if your telephone is currently idle,***
 1. **SELECT ARDL OR** the programmed AUTOMATIC REDIAL button. The display shows the last number dialed.
 2. Choose one of the following:
 - **SELECT REMOVE** to remove the number from the redial queue.
 - **SELECT NEXT** to scroll to the next number in the queue.
 - **SELECT EXIT** to exit from the redial queue.

- ***To interrupt the redialing procedure so that you can scroll through numbers in your redial queue,***
 1. While your telephone is in the process of dialing a number, **SELECT ARDL** or the programmed AUTOMATIC REDIAL button twice. This treats the number as answered, cancels automatic redialing for that number, and puts the number back in the automatic redial queue. The display shows the last number dialed.
 2. **CHOOSE** from one of the following:
 - **SELECT REMOVE** to remove the number from the redial queue.
 - **SELECT NEXT** to scroll to the next number in the queue.
 - **SELECT EXIT** to exit from the redial queue.

- ***To cancel the automatic redial feature, choose one of the following:***
 1. **PERFORM** any user activity at the station (go on-hook, select the speaker button, etc...),
 2. **DIAL** **#72** to delete all numbers from the redial queue,
 3. **SELECT ARDL** or the programmed AUTOMATIC REDIAL button while the number you wish to remove from the redial queue is ringing.

Tracker Paging System

When installed with your system, the Tracker Paging System option allows you to send call back and parked call messages to Tracker pagers assigned to station extension numbers. Along with the parked call message, the system parks the call in orbit for retrieval by the paged party. The type of message that the system delivers (either alphanumeric or numeric-only) is dependent upon the Tracker pager model in use at the station.

When outside callers call into a system that has both a Tracker Paging option and a voice mail option installed, the system gives these callers the option of either leaving a message or tracking the person that they are calling.

If you have a Tracker pager assigned to your personal intercom number, you can receive messages that someone else sends you. The system automatically installs the Tracker pager for your use; however, you can disable it when you do not wish to receive paged messages and when you leave at the end of your day. Of course, if you do disable your Tracker pager at the end of your day, be sure to enable it at the beginning of your next day.

Your LCD speakerphone includes an interactive **TRACK** button; however, if your day-to-day operation includes extensive Tracker usage, such as your attendant function, the installer may include a **TRACK** button at a programmable button location.

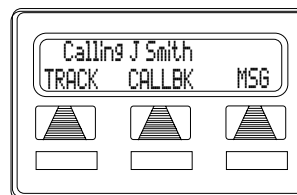

- **To track a called party after receiving a ring—no answer,**

1. **MAKE** an intercom call to someone **AND RECEIVE** no answer.
2. **SELECT TRACK.**
3. **HEAR** confirmation beep (Tracker page accepted) **OR HEAR** busy tone (Tracker page not accepted).
4. **PRESS SPEAKER** to end.



Initiating a Tracker Page

- **To track a called party without first calling them,**

1. **PRESS INTERCOM AND DIAL**  .
2. **DIAL** extension number.
3. **HEAR** confirmation beep (Tracker page accepted) **OR HEAR** busy tone (Tracker page not accepted).
4. **PRESS SPEAKER** to end.

- ***To use Tracker to transfer a call to a park orbit for retrieval and transmit the call's park orbit code and caller ID information (if available),***
 1. **ANSWER** call **AND SELECT TRANS.**
 2. **DIAL** extension number.
 3. If the called station does not answer or is busy, **SELECT TRACK.**
 4. **HEAR** confirmation beep (Tracker page accepted) **OR HEAR** busy tone (Tracker page not accepted).
 5. **PRESS SPEAKER** button to end.

- ***To retrieve a call that you parked using the Tracker option,***
 1. **PRESS HOLD** button to scroll your held calls, (display shows **PAGE** and extension number of each parked call).
 2. **PRESS TAP** to retrieve the displayed parked call.

- ***If you receive a parked call message on your Tracker pager,***
 1. **GO** to any system station.
 2. **PRESS INTERCOM.**
 3. **DIAL** Tracker pager orbit code (# to #).
 4. **RETRIEVE** call.

- ***To enable or disable a Tracker pager at your station,***
 1. **PRESS INTERCOM.**
 2. **DIAL** # to enable, **OR DIAL** # to disable.
 3. **PRESS SPEAKER** to end.

Direct Inward System Access (DISA)

The Direct Inward System Access (DISA)* feature allows you to call into the digital communications system from an external telephone. You can call directly to intercom extensions and talk to the intercom parties or, if the system includes a voice mail option, leave messages for them if they are not available. When you call the DISA telephone number and dial your authorization code, the system treats your call as it would treat one coming from a system telephone and permits you to use many of the same features that you can use when you are calling from your assigned station. (Authorization codes are associated with personal or group intercom numbers and are assigned to you by your installer when he or she programs the system.)

If you use your DISA access to make a call through the system and out on an outside line, the system applies all the toll restriction and automatic route selection to the call that the installer has programmed for the line that you are using. If you dial an incorrect authorization code, or the system is busy with other DISA calls, you will either hear an error tone, or the system will automatically route your call to one of the following areas (as determined by your system installer):

- a designated station where you can talk to the system attendant,
- a digital voice announce that will prompt you to take additional action,
- a proprietary voice mail station where you will be prompted to leave a message.

The system allows you three tries at dialing your authorization code before it routes your call as detailed above.

Some systems provide voice prompts to DISA callers and other systems do not. If you encounter voice prompts when you call on the DISA line, follow the prompt directions to complete your call. Further, some systems with voice prompt enhancement, provide a one-digit menu that prompts you to dial a single digit to reach available departments, use system features, or obtain operator assistance.

NOTE: DISA is not recommended for use on loop start lines without disconnect supervision. While DISA will function, Comdial will not be liable for its performance under any condition where disconnect supervision is not provided. Check with your installer for complete details.

* Comdial has taken reasonable steps in the design of all product features, including DISA, which protect against unauthorized or fraudulent access to, or use of, a system, or which protect against unauthorized, fraudulent or unaccounted-for access to, or use of, long distance lines. However, no system is entirely invulnerable or immune from unauthorized or fraudulent access or use, or unaccounted-for access or use, and therefore Comdial disclaims any and all liability, and makes no warranty, express or implied, relating to unauthorized or fraudulent access or use, or unaccounted-for access or use.

- **To make a DISA call to an intercom number,**
 1. **DIAL** number for DISA line (listen for voice prompt if available).
 2. **DIAL** extension number. If station does not answer or is busy you will either hear busy tone or hear voice prompt if available. If you dial an invalid number, you will hear error tone.
 3. **IF** voice prompt provides dialing codes, **DIAL** proper code for services such as: track, message waiting, or voice mail.

- **To make a DISA call to use system features,**
 1. **DIAL** number for DISA line (listen for voice prompt if available),
 2. **DIAL** authorization code (listen for voice prompt if available; otherwise, hear stutter-style dial tone),
 3. **DIAL** feature code **AND LISTEN** for acknowledgment tone.

System Features Available To DISA Callers	Default Dialing Code
Account code entry	* 0 4
Automatic route selection access	9
Call waiting on busy	* 6
Do not disturb override	* 0 3
Intercom dialing/call announcing	Extension number
Message wait off*	# 3
Message waiting set*	* 3
Personal speed dial*	* 0 1
System speed dial	* 0 1 *
Tracker access/retrieval**	* 8 / # 8
Trunk group access	Line group access code
Zone paging	Zone paging code
<p>* You must have an assigned personal intercom number to use this feature.</p> <p>** Your system must provide the Tracker option to activate this feature.</p>	

Auxiliary Jack

NOTE: Some telephones have an auxiliary jack. All other model telephones use the handset jack to plug in a headset.

The auxiliary jack provides an interface for a headset, a tape recorder, an external ringer or an external pager. You must program one of the programmable buttons on your telephone to serve as an enable/disable button for each auxiliary device you plan to connect to your LCD speakerphone. The system will activate only the device that it identifies in the display, and will activate only one device at any time.

The following modes are programmable with the auxiliary jack:

- The **headset mode** allows you to operate your telephone with a headset instead of as a speakerphone or with the handset.

NOTE: The recorder, external ringer, or pager requires external power.

- The **recorder mode** allows you to send your voice and that of the distant party to a tape recorder.
- The **ringer mode** allows an external speaker to sound the ringing of your telephone.
- The **pager mode** allows an external paging device to sound all voice announcements (all-call, zone paging, voice announced intercom calls) sent to your telephone.

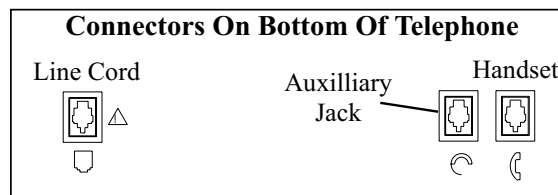

Auxiliary Jack Location

- **Program the enable/disable buttons (at any blank programmable button location) as follows:**

1. **SELECT** OPTIONS.
2. **SELECT** NEXT until the FEAT option appears.
3. **SELECT** FEAT.
4. **SELECT** NEXT until the desired options appear.
5. **SELECT** desired auxiliary feature:

- APAGE to choose pager.
- ARECD to choose recorder.
- ARING to choose external ringer.
- HDSET to choose headset.

7. **PRESS** blank programmable button location to serve as enable/disable button for the feature you've selected.
8. **RETURN** to previous steps to add another device, **OR SELECT** SPEAKER to quit.

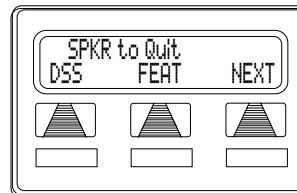

Programming Button

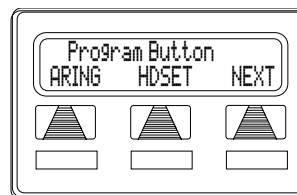

Selecting a Feature

- **To enable an auxiliary mode,**
 1. **SELECT** enable/disable button to enable mode. Light associated with button turns on and display denotes feature.
- **To disable an auxiliary mode,**
 1. **SELECT** enable/disable button. Light associated with button will turn off and display no longer denotes the feature.

CAUTION

With the exception of a headset microphone, do not connect the audio output of any external device to the auxiliary jack. Also, do not connect the tip and ring leads of a telephone line to the auxiliary jack. Do not connect any devices to the auxiliary jack other than those mentioned above.

Account Codes

You can assign account codes to specific calls. The system uses the account codes to identify calls by category, or special grouping, for call accounting purposes. If the installer programs the system to have forced account codes, the user must enter the account code before the call can be placed. If the system does not find a match between a user entered account code and one that the installer has set in the system, the call will not be allowed. Remember, verification alone does not deny users' calls, only forced verification denies.

The installer can arrange for the system to verify that the user entered an account code and to sound an error tone if an invalid account code is entered. He or she may program the system to prompt station users to enter account codes for incoming calls and/or out-going calls if desired. Account codes may be from three to 16 digits in length as set by class of service programming. The system will verify all digits.

- ***To enter account code on an incoming call,***
 1. **IF** available, **PRESS** programmed Account Code button (the call in progress is not interrupted).
 2. **IF** not available, **PRESS INTERCOM AND DIAL** (call is automatically placed on hold).
 3. **DIAL** account code. Your telephone automatically returns to the call after you've dialed the complete account code.

- ***To enter account code on an outgoing call,***
 1. **DIAL** **OR** other line button (the display will prompt for Account Code if programmed to do so).
 2. **PRESS INTERCOM** (call is automatically placed on hold).
 3. **PRESS** programmed Account Code button, **OR DIAL** **AND** account code.
 4. **LISTEN** for dial tone **AND DIAL** number you are calling.

Authorization Codes

Authorization codes give you a *walking class* of service option. Walking class of service provides you with the mobility to use your class of service (COS) features, prime line assignments, and exception numbers on any telephone in the system. This means that you will not be limited by features that are available to the particular telephone that you happen to be using.

Authorization codes are associated with your personal intercom number and are assigned to you by your installer when he or she programs the system. When you enter your assigned authorization code at any system telephone, the code alerts the system to make your normal features available to you. Once you access your telephone features, they remain in effect until any idle time exceeds the authorization code time-out period.

If your telephone includes an installer-programmed LOCK button, you can press it and then dial your authorization code to deny other users access to lines and features at your LCD speakerphone.

- ***To activate walking class of service,***

1. **SELECT** system telephone to use.
2. **PRESS INTERCOM.**
3. **DIAL** .
4. **DIAL** your authorization code.

- ***To lock your telephone,***

1. **PRESS** programmed LOCK button.
2. **DIAL** your authorization code.

NOTE: If you wait longer than two seconds to dial a digit after you press the LOCK button, that pause, and any others that you might include, becomes part of the lock code. You must allow for any pauses at any location that you inserted them in the number string when you unlock your telephone.

- ***To unlock your telephone,***

1. **PRESS** LOCK.
2. **DIAL** our authorization code (remember, include any pauses that you inserted when you locked your telephone).

E and M Tie Lines

E & M tie line operation is typically used in applications where one group of users often need to call parties located in one or more remote locations. In these applications, your system is directly tied to another similar system at the remote site(s).

If your system has been configured for tie line operation, the procedures you use to place calls, transfer calls, and set up conference calls differ slightly from other types of connections. These procedures are described in this section.

- **To make a call on an E & M tie line,**
 1. **DIAL** the E & M access code that was assigned by the installer, **OR IF** your system has been configured by the installer to use Automatic Route Selection (ARS), **DIAL** the ARS access code (9 by default).
 2. **WAIT** until you hear a dial tone, **THEN DIAL** the intercom number for the party you wish to reach at the remote site. You will hear a fast busy signal if you dialed an invalid number.

- **To transfer a call over an E & M tie line,**
 1. **ANSWER** the incoming call.
 2. **SELECT CONF.**
 3. **DIAL** the E & M access code that was assigned by the installer, **OR IF** your system has been configured by the installer to use Automatic Route Selection (ARS), **DIAL** the ARS access code (9 by default).
 4. **WAIT** until you hear a dial tone, **THEN DIAL** the intercom number for the distant party to whom you are transferring the call.
 5. **WAIT** on the line until the called party answers so that you can announce the call (screened transfer), **OR HANG UP** (unscreened transfer). You have created an unattended conference and your station appears as if on hold..
 6. **PRESS TAP** button to rejoin the transferred call.
 7. After rejoining the conference, **PRESS** **#** to place the call on hold again (creating another unattended conference) **OR HANG UP** to terminate the call.

If one of the parties does not hang up or you have not terminated the call, the call will return to you when the line-to-line connection timer expires.

- ***To set up a conference call on an E & M tie line,***
 1. **MAKE** first call.
 2. **SELECT CONF**; call is placed on hold automatically.
 3. **SELECT** next line **AND MAKE** next call.
 4. **SELECT CONF** to establish conference.
 5. Press **TRNS/CNF** button to add more parties for up to a seven party conference (including yourself).

- ***To continue conversation on remaining line after other outside lines have dropped out of conference,***
 1. **PRESS** the line button of the remaining party.

- ***To retrieve a line from hold and bring that party back into the conference,***
 1. **PRESS TRNS/CNF.**
 2. **PRESS** line button.
 3. **PRESS TRNS/CNF.**

NOTE: If all the conference circuits are busy, you will not be able to add a party to the conference.

- ***To drop out of a conference call between you and two outside lines (creating an unsupervised conference),***
 1. **HANG UP** (lines remain lighted and in use until one or both outside parties disconnect).

- ***To rejoin an unsupervised conference between two outside lines,***
 1. **PRESS TAP.**

NOTE: Conference volume levels depend upon the quality of the external lines.

Dial By Name

The Dial By Name feature provides an index of names for you to search through. When you select a name in the index, the system will automatically dial that person's extension number.

- **To use Dial By Name,**

1. **SELECT OPTIONS** to enter the dial by name menu.
2. **SELECT INT** button for intercom calling, **OR SELECT EXT** for speed dial calling.
3. **SELECT ALL** to view all entries **OR DIAL** digits corresponding to the letters in the name you want to locate (for example, dial 266 for Comdial). There is no limit to the number of digits you can dial.
4. The display shows the first existing name match to the dialed digits or shows a **NO MATCH** message if the system can not find a match.
5. **SELECT NEXT** to display the subsequent names in the index until you reach the name you need.
6. **SELECT DIAL** to call the displayed location.
7. **IF** the display says **NO MATCH**, **SELECT BACK** to return to previous screen **OR ENTER** new digits to search for a new name.

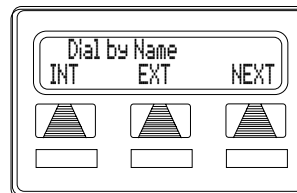

Selecting Dial By Name

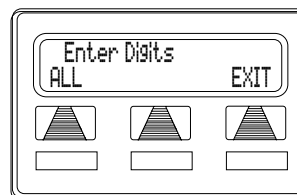

Entering Search

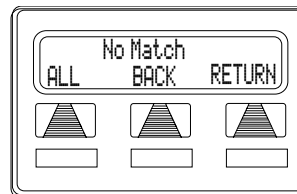

Finding No Match

Alphanumeric Keypad		
1 QZ	2 ABC	3 DEF
4 GHI	5 JKL	6 MNO
7 PRS	8 TUV	9 WXY

Background Music

If the telephone system supplies background music, you can turn it on at your LCD speakerphone while on-hook and idle. The system automatically turns background music off during calls and voice announcements.

- **To turn the music on,**
 1. **SELECT** OPTIONS.
 2. **SELECT** NEXT until the **MUSIC** option appears.
 3. **SELECT** MUSIC.
 4. **SELECT** SET.
 5. **SELECT** SRC 1 or SRC 2 for the music source.
 6. **PRESS SPEAKER** to end (the speaker light turns on when background music is on).
 7. **ADJUST** music volume with the volume buttons.

- **To turn the music off,**
 1. **SELECT** OPTIONS.
 2. **SELECT** NEXT until the **MUSIC** option appears.
 3. **SELECT** MUSIC.
 4. **SELECT** CLR.
 5. **PRESS SPEAKER** to end (the speaker light turns off when background music is off).

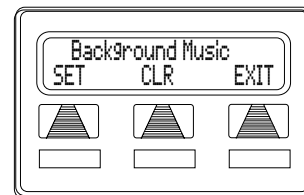

Setting Background Music

Volume Control

Setting Current Volume Level

The volume control on your telephone is a multipurpose control you can use to set the volume (loudness) of the ringer, the speaker, the handset, the headset, background music, and the group listening mode.

- **There are four ringer loudness levels (plus an off position). Set these levels as follows:**

1. While your telephone is on-hook and idle, **PRESS** the **VOLUME UP OR VOLUME DOWN** button once for each change in loudness you desire. The ringer sounds once for each change as an example of the current setting.

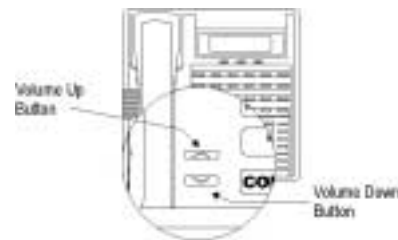

Impact SCS Volume Buttons

NOTE: If you set the ringer to the **OFF** position, your telephone will sound a short ring burst once for each call you receive at your station while the ringer is off.

- **There are eight speaker loudness levels. Set these levels for the current call as follows:**

1. While on a call and in speakerphone mode, **PRESS** the **VOLUME UP OR VOLUME DOWN** button once for each change in loudness that you desire.

- **There are at least eight handset loudness levels that you can set for the current call as follows:**

1. While on a call and in handset mode, **PRESS** the **VOLUME UP OR VOLUME DOWN** button once for each change in loudness that you desire.

NOTE: When the call ends, the system resets the loudness of all future calls to the programmed (default) setting. For instructions in setting your speakerphone's default volume, see *Default Volume Control* section in the system specific Advanced Features chapter.

- **There are eight headset loudness levels that you can set for the current call as follows:**

1. While on a call and in headset mode, **PRESS** the **VOLUME UP OR VOLUME DOWN** button once for each change in loudness that you desire.

- **There are eight group listening loudness levels. Set the level for the current call as follows:**

1. While on a call and in the group listening mode, **PRESS VOLUME UP OR VOLUME DOWN** button once for each change in loudness you desire.

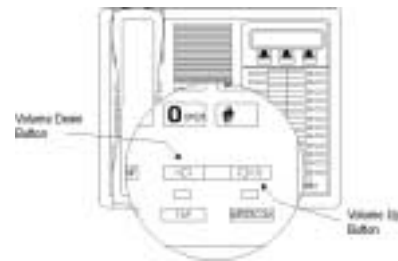

Impact Volume Buttons

- **There are eight background music loudness levels. To set the level,**

1. While background music is on at your station, **PRESS VOLUME UP OR VOLUME DOWN** button once for each change in loudness you desire. This level remains set for background music until you change it again, even if you turn off the feature and then reactivate it.

Muting Your Speakerphone

By using the **MUTE** button, you can block transmission of your voice to the distant party. You can do this whether you are using the handset or the speaker.

- **To mute your station,**
 1. **PRESS MUTE** (mute function and light turn on). You can still hear the distant party, but he or she cannot hear you.
- **To speak to the distant party,**
 1. **PRESS MUTE** again (mute function and light turn off).

Default Volume Control

You can set a permanent loudness level for any volume control setting. The level will remain at this volume (referred to as the default setting) until you change the setting.

- **To set a permanent speaker, headset, handset, or group listening loudness for all future calls,**

1. **PRESS INTERCOM.**
2. **ACTIVATE** speaker, headset, handset, or group listen mode to be affected.
3. While in that mode, **PRESS VOLUME UP** or **VOLUME DOWN** button to adjust loudness.
4. **DIAL** **OR PRESS** programmed SAVE button to hold the loudness at the last setting for all future calls (until you change the default again).
5. **REPEAT** this procedure in each mode until you've set all default volume levels.

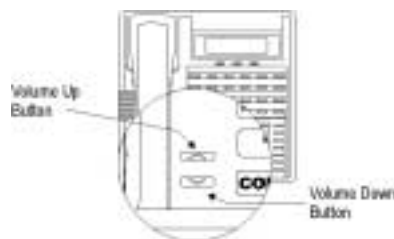

Impact SCS Volume Buttons

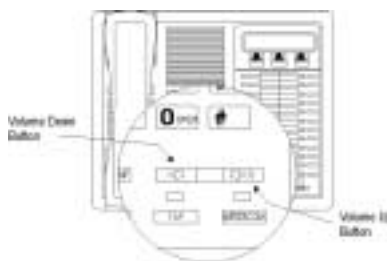

Impact Volume Buttons

Automatic Set Relocation

If your installer has equipped your system with automatic set relocation, when you move your telephone to a new location, the system gives you a choice (through a display prompt) as to whether you want to keep your previous programming or use the programming in the new location.

- ***To maintain the extension number and programming features from the old location,***
 1. **CONNECT** the telephone line cord to the new jack.
 2. **OBSERVE** the flashing HOLD light **AND PRESS HOLD** while the light is still flashing (your telephone immediately assumed the features from the previous location).

NOTE: If you do not select a button after installing the telephone, the system automatically defaults to the programming from the previous location.

- ***To assume the extension number and programming features from the new location,***
 1. **CONNECT** the telephone line cord to the new jack.
 2. **OBSERVE** the flashing HOLD light **AND DIAL**  while the light is still flashing (your telephone immediately assumes the features from the new location).

Monitoring A Conversation Between Two Telephones (Service Observing)

If your LCD speakerphone provides the installer-programmed Service Observing feature, you can use it to monitor a conversation or activity at another telephone in an undetected manner. You can use this feature while you are in the speakerphone mode or off-hook.

- ***To monitor another station at any time,***
 1. **PRESS INTERCOM.**
 2. **DIAL** .
 3. **DIAL** extension number of telephone to be monitored.
 4. **PRESS SPEAKER** to end monitoring.

Your system installer may also program a dedicated SERVICE OBSERVE button that may be used in place of the feature access code.

Switching The Dialing Mode Between Pulse And Tone

If the telephone service in your locality is pulse (rotary dialing), the installer arranges your telephone to dial in this manner. If you need to send tones during a dialing sequence (for example, to send bank-by-telephone tones), you can convert to tone dialing mode while dialing. The system will switch back to pulse dialing when you end your call.

You can store a as part of a speed dial number to cause an automatic switch from pulse to tone where needed in a number sequence.

- ***To convert to tone dialing at any time during dialing or while on an active call,***
 1. **DIAL** .

IMIST Module

Impact SCS 8324F-**, 8324S-**, and 8312S-** speakerphones equipped with the optional IMIST module can support an IST device (modem, FAX machine, industry-standard telephone, etc.) in addition to the LCD speakerphone.

Depending on system programming, the IST device may be used to make outgoing calls and receive incoming calls. The functionality of the IMIST module depends on the type of system you are using:

- The IMIST module functions on a DXP system with the appropriate digital station board, but the IMIST module will not have its own extension number and will not function simultaneously with the speakerphone.
- On a DXP Plus system, the IMIST module functions simultaneously with the speakerphone and has its own extension number if your system has the appropriate digital station board and memory board. If your system does not have the optional enhanced memory board, the IMIST module will function like the one on the DXP system described above. Check with your system installer for complete details.
- On an FXS or FXT system, the speakerphone and IMIST module can function simultaneously and the IMIST module has its own extension number.

NOTE: The IMIST module does not provide voltage to light a message waiting light. Message waiting lights on devices plugged into the IMIST module will not function.

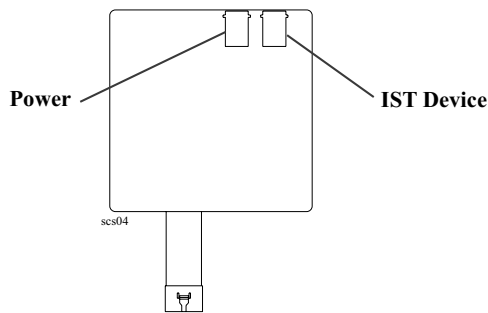

IMIST Module

Notes

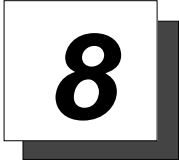

Attendant Features

LCD Messages

System users send and receive non-verbal messages for display on their LCD speakerphones. The system provides five messages and you can add up to 25 customized messages. You can even store customized messages in place of the default messages if you wish, thus increasing the number of custom messages available. Distribute a list of the LCD messages to the system users for their reference.

- **To store the LCD messages, proceed as follows:**
 1. **WRITE** your messages on the chart on page 93 (each message can have up to 16 characters).
 2. **USE** the letter code table on page 92 to assign a number to each character **AND WRITE** these numbers on page 93 on the chart line beside the characters in your message.
 3. **PRESS INTERCOM.**
 4. **DIAL** *#0*12.
 5. **DIAL** a message location number (01 to 30).
 7. **IF** message currently exists at location, **DIAL** # to clear.
 8. **COMPOSE** your messages by dialing the 2-digit codes that relate to the letters.
 9. **DIAL** # to save message.
 10. **REPEAT** previous step until all messages are stored.
 11. **PRESS SPEAKER** to end.

LCD Message Examples

- Create the LCD message "TAKE MESSAGE" and program into message location number 3.

1. PRESS INTERCOM AND DIAL *#0*12.

2. DIAL 03#.

3. DIAL code numbers for message as follows:

Dialing Codes for "TAKE MESSAGE"											
T	A	K	E		M	E	S	S	A	G	E
81	21	52	32	12	61	32	73	73	21	41	32

4. DIAL # AND PRESS SPEAKER to end.

Letter Code Table For LCD Messages							
Character	Code	Character	Code	Character	Code	Character	Code
A	21	S	73	j	54	SPACE	12
B	22	T	81	k	55	;	17
C	23	U	82	l	56	/	18
D	31	V	83	m	64	"	19
E	32	W	91	n	65	.	27
F	33	X	92	o	66	,	28
G	41	Y	93	p	74	:	29
H	42	Z	13	q	14	1	01
I	43	a	24	r	75	2	02
J	51	b	25	s	76	3	03
K	52	c	26	t	84	4	04
L	53	d	34	u	85	5	05
M	61	e	35	v	86	6	06
N	62	f	36	w	94	7	07
O	63	g	44	x	95	8	08
P	71	h	45	y	96	9	09
Q	11		46	z	16	0	00
R	72						

LCD Message List (* indicates default message)													
Msg.	Message Text	Letter Codes (max. 16 characters)											
01*	Back at												
02*	Call												
03*	Ask Them To Hold												
04*	Take A Message												
05*	I Will Call Back												
06													
07													
08													
09													
10													
11													
12													
13													
14													
15													
16													
17													
18													
19													
20													
21													
22													
23													
24													
25													
26													
27													
28													
29													
30													

Station Enabling and Disabling

You can disable a station and make it unavailable for system use if it becomes unusable for some reason.

- **To disable a station,**

1. PRESS *INTERCOM*.
2. DIAL *#0*52.
3. DIAL station number (1001 to 1480 for stations 1–480).
4. PRESS # to disable the station (speakerphone displays a * to indicate it is disabled).
5. PRESS *SPEAKER* to end.

- **To re-enable station,**

1. REPEAT the previous procedure.

Telephone Line Enabling and Disabling

You can disable a line and make it unavailable for system use if it becomes unusable for some reason.

- **To disable a line,**

1. PRESS *INTERCOM*.
2. DIAL *#0*32.
3. DIAL code as follows to choose line:
 - DIAL 1# to 99# for lines 1–99,
 - DIAL 100 to 128 for lines 100–128.
4. PRESS # to disable line (LCD speakerphone displays a * to indicate a disabled line).
5. PRESS *SPEAKER* to end.

- *To re-enable line,*
 1. **REPEAT** the previous procedure.

Mark Problem Line

The system installer can arrange the system so that you can mark a line that is not functioning properly.

- *To mark a line,*
 1. **Press** *MARK* or *INTERCOM*.
 2. **Dial** the installer designated code.

Message Waiting Enabling or Disabling

You can enable or disable the message-waiting feature that was assigned to a user through their class of service (COS) programming.

- *Disable a user's message-waiting feature,*
 1. **PRESS** *INTERCOM*.
 2. **DIAL** *#0*417.
 3. **DIAL** the user's COS number.
 4. **DIAL** # to disable the user's message waiting feature.
 5. **PRESS** *SPEAKER* to end.
- *To re-enable the message-waiting feature for the originally assigned user,*
 1. **REPEAT** the previous procedure.

System Telephone Naming

You can assign a name that is either a personal name or a group name to each system telephone. This name can be up to seven letters in length and will show up in the user's display and/or in the called party's display. You can compose a valid name from any alpha-numeric character; however, the first character of a display name must be an alphabetic character. Typical names could be SRVC, MKTG 1, and K SMITH.

When appropriate programming action has been taken by the installer, a second line showing the personal intercom number of the calling station is also displayed.

- **Name the system telephones as follows:**
 1. **USE** letter code table (page 92) to compose names for all telephones requiring them (up to seven letters per name are allowed) and record the names on the station name record (page 97).
 2. **PRESS INTERCOM.**
 3. **DIAL** * # 0 * 5 3.
 4. **SELECT** telephone to be named by dialing the extension number
 - **DIAL** number plus # if extension number is less than 4-digits).
 5. **DIAL** # to clear any current entry.
 6. **DIAL** 2-digit codes that correspond to letters in name (station names must begin with a letter).
 7. **DIAL** # to save name or save cleared name.
 8. **REPEAT** steps 4 through 7 until all telephones are named.
 9. **PRESS SPEAKER** to end.

Station Name Record Sheet (Copy this sheet if you need more record space.)								
Ext.	Station Name	Letter Codes (see pg. 92)						
—	Sample	73	24	64	74	56	35	

Telephone Line Naming

You can assign names to lines to aid users in identifying the proper line to use. A line name can be up to seven letters in length and will show up in the user's display.

- **Name the system telephones as follows:**

1. **USE** letter code table (page 92) to compose names for all lines requiring them (up to seven letters per name are allowed) and record the names on the line name record (page 99).
2. **PRESS INTERCOM.**
3. **DIAL** * # 0 * 3 3.
4. **DIAL** code to choose line:
 - **DIAL** 1 # to 9 9 # for lines 1–99,
 - **DIAL** 1 0 0 to 1 2 8 for lines 100–128.

NOTE: If the desired line code is less than three digits, you must dial # once after you dial the line code.

5. **DIAL** # to clear any current name.
6. **DIAL** 2-digit codes that correspond to letters in name (line names must begin with a letter).
7. **DIAL** # to save name or cleared name.
8. **REPEAT** steps 4 through 7 until all telephones are named.
9. **PRESS SPEAKER** to end.

Line Name Record Sheet (Copy this sheet if you need more record space.)								
Line	Line Name	Letter Codes (see pg. 92)						
—	Sample	73	24	64	74	56	35	

Station Message Detailed Accounting (SMDA) Reports

The system collects detailed call activity data for all stations and makes this available to you in various SMDA reports printed on the system's printer.

- The all records report includes all stored records and is not sorted by any particular group as are the station, line, and account reports. This report is arranged in chronological order.
- The *station report shows all calls that the station user has made and received along with totals and averages. This report is sorted by station number.*
- The *line report shows the number of calls, total minutes busy, number of incomplete calls, and cost for each line. The line report also summarizes line group activity as well.*
- The *account code report shows the same information as the station report except that the records are based upon each account code.*

NOTE: As the system's memory reaches 95% of capacity, all reports are printed automatically.

- **To obtain the all records or other specialized printout,**
 1. **PRESS INTERCOM.**
 2. **DIAL** *#0*82.
 3. **CHOOSE** from the following report options:
 - **DIAL** 1 for all records printout.
 - **DIAL** 2 **AND** station number (# for all stations) for station reports with call information sorted by stations.
 - **DIAL** 3 **AND** line number (# for all lines) for line reports with call information sorted by line.
 - **DIAL** 4 **AND** account code (# for all accounts) for account reports with call information sorted by account numbers.
 4. **DIAL** # to start printout.

As an alternative to requesting specific reports as you want them, you can request the system to generate automatic reports. The type of report and time of day the report is to be printed is programmed by the installer.

- ***To obtain a printout of the automatic report (if programmed) regardless of time and date set by installer),***

1. PRESS INTERCOM.
2. DIAL *#0*82.
3. DIAL 6.
4. DIAL # to print automatic report.

You can view the number of free records or you can delete all stored records to insure that only the latest records are being stored or to provide a known starting point for record storage.

- ***To delete past records from system memory (if allowed by system programming),***

1. PRESS INTERCOM.
2. DIAL *#0*82.
3. DIAL 7.
4. DIAL # to delete past records.

- ***To view number of free records,***

1. PRESS INTERCOM.
2. DIAL *#0*82.
3. DIAL 8.

- ***To abort reports,***

1. PRESS INTERCOM.
2. DIAL *#0*82.
3. DIAL 9.
4. DIAL # to abort reports.

System Speed Dial Numbers

You can store up to 500 system speed dial numbers at your attendant telephone. Typically, these are numbers that are frequently called by many different users and emergency numbers that you want readily available to everyone. Distribute a list of these stored numbers to the system users.

- **To program system speed dial numbers,**
 1. **RECORD** the following information on the system speed dial record sheet:
 - the dialing code of the storage location (**000–999**),
 - the line that will be used to access each outside number,
 - the telephone numbers you are storing.
 2. **PRESS INTERCOM.**
 3. **DIAL** *#0*02.
 4. **DIAL** code for storage location (**000–999**).
 5. **DIAL** code to make your speed dial route selection choice from the following list:
 - **DIAL** 1# to 99# to select lines 1–99 (# must be added if number is less than three digits),
 - **DIAL** 100 to 128 to select lines 100–128,
 - **DIAL** 801 to 816 to select line groups 1–16,
 - **DIAL** 000 to select prime or last line used,
 - **DIAL** 800 to select intercom.
 6. **DIAL** the number to be stored (up to 32-digits long). To store a pause, press **HOLD**, then continue dialing. Press **TAP** to store a hookflash, then continue dialing.
 7. **PRESS TRNS/CNF** to store number.
 8. **DIAL** next storage location, line choice and speed dial number, **AND PRESS TRNS?CNF**.
 9. **REPEAT** previous step until all numbers are stored.
 10. **PRESS SPEAKER** to end.

Digital Voice Announce (DVA)

The Digital Voice Announce (DVA) is an optional external device. It stores pre-recorded announcements and messages and plays them for incoming callers during their calls.

You must record the messages that the DVA plays to the callers in one of two ways: either by delivering them from the telephone handset at your attendant station or by playing the contents of a professionally-supplied tape recording into the DVA memory (see your system installer for tape recorder connection details).

There are 13 unique messages. The first five (plus day and night routing messages) are divided into four separate message types. The total message time is two minutes and you can divide this time as necessary among all the messages or use the entire two minutes for one message if needed. Because of the time constraints, it is a good practice to script your messages ahead of time so that you can read them aloud in a clear and concise manner as you store them in the DVA memory.

As the number of calls increase, you can add more DVAs to handle the additional callers. You can then record the same message on several DVAs by entering the replicate value (see step 6 on the following page).

- **To record a DVA message,**

1. **PRESS INTERCOM.**
2. **DIAL** .
3. **DIAL** .
4. **CHOOSE** voice source:
 - **DIAL** to speak message into handset.
 - **DIAL** to play tape into music-on-hold jack.
 - **DIAL** to play tape into background music jack.
5. **DIAL** to to choose message type (see Table Of Messages on page 109 for message type list).

NOTE: As soon as you perform the next step, the two-minute timer starts running. Be ready to speak your message or press the PLAY button on the tape recorder as soon as you dial the replicate choice.

6. **DIAL** 1 to 9 to choose number of times to replicate message.
 7. **SPEAK** your message (**OR PRESS** the PLAY button on the tape recorder when you're using pre-recorded messages).
 8. **DIAL** # to end message.
 9. **LISTEN** as system automatically plays the message for verification at your attendant station.
 10. **DIAL** # to stop verification playback.
 11. **REPEAT** procedure until you've recorded all messages.
 - **DIAL** 10 to 43 to choose next message type.
 - **DIAL** 1 to 9 to choose replicate quantity (timer starts).
 - **SPEAK** your message (or press the PLAY button), on the tape recorder).
 - **PRESS** # to end message.
 - **HEAR** automatic playback of message.
- *To play a previously recorded DVA message,*
 1. **PRESS INTERCOM.**
 2. **DIAL** *#0*06.
 3. **DIAL** 2.
 4. **DIAL** 10 to 43 to choose message type (see Table Of Messages on page 109 for message type list).
 5. **LISTEN** as system automatically plays the message for verification at your attendant station.
 6. **DIAL** # to stop verification playback.
 7. **DIAL** 10 to 43 to choose next message type to hear.

Digital Voice Announce (Continued)

- *To copy a previously recorded DVA message,*
 1. **PRESS INTERCOM.**
 2. **DIAL** * # 0 * 0 6.
 3. **DIAL** 3.
 4. **DIAL** 1 0 to 4 3 to choose message type (see Table Of Messages on page 109 for message type list).
 5. **DIAL** 1 to 9 to choose number of times to copy message.
 6. **DIAL** 1 0 to 4 3 to choose next message number and type.

NOTE: If your installer has connected more than two DVAs to the system, the system automatically selects the DVA that will receive the copied message. Likewise, the system automatically selects the DVA that it uses for playing back the message to a caller. Additional DVAs become a shared resource for the system's memory and are not dedicated to particular lines.

- *To delete a previously recorded DVA message,*
 1. **PRESS INTERCOM.**
 2. **DIAL** * # 0 * 0 6.
 3. **DIAL** 4.
 4. **DIAL** 1 0 to 4 3 to choose message type (see Table Of Messages on page 109 for message type list)—system prompts for confirmation.
 5. **DIAL** 9 3 7 to confirm delete, **OR DIAL** * to deny delete.
 6. **DIAL** 1 0 to 4 3 to choose next message type to delete.

- **To completely erase all DVA messages (format the DVA),**
 1. **PRESS INTERCOM.**
 2. **DIAL** .
 3. **DIAL** .
 4. **DIAL** to to choose DVA port (your installer can identify the DVA ports for you if necessary).
 5. **DIAL** to confirm formatting, **OR DIAL** to deny formatting.
 6. **DIAL** to to choose next DVA port to format.

Table Of DVA Messages Record DVA messages here. (Copy this sheet if you need more record space.)		
Number*	Message Type	Message
10	Welcome Greeting 1	
11	Welcome Greeting 2	
12	Welcome Greeting 3	
13	Welcome Greeting 4	
14	Day Main Menu 1	
15	Day Main Menu 2	
16	Day Main Menu 3	
17	Day Main Menu 4	
18	Night Main Menu 1	

<p style="text-align: center;">Table Of DVA Messages Record DVA messages here. (Copy this sheet if you need more record space.)</p>		
Number*	Message Type	Message
19	Night Main Menu 2	
20	Night Main Menu 3	
21	Night Main Menu 4	
22	Recall No Answer 1	
23	Recall No Answer 2	
24	Recall No Answer 3	
25	Recall No Answer 4	
26	Recall Busy 1	
27	Recall Busy 2	
28	Recall Busy 3	
29	Recall Busy 4	
30	Please Hold	
31	Password Prompt	
32	Account Code	
33	Dial Feature	
34	Day Routing 1	

Table Of DVA Messages Record DVA messages here. (Copy this sheet if you need more record space.)		
Number*	Message Type	Message
35	Day Routing 2	
36	Day Routing 3	
37	Day Routing 4	
38	Night Routing 1	
39	Night Routing 2	
40	Night Routing 3	
41	Night Routing 4	
42**	Reminder Prompt	
43***	Digit Collection	

* The numbers in the first column index messages within the system. (For example, enter 12 to record Welcome Greeting 3.) The numbers 1 through 4, appearing as part of the message-type name, group similar types of messages together. (For example, if your company has several departments you might assign all group 1 messages to the sales department and all group 2 messages to the customer service department.)

** **Note 1:** Number 42, Reminder Prompt is used in DISA applications to prompt callers, who are making a line to line connection through the DXP, to dial a code. This allows the caller to continue the connection. See your system installer for details.

*** **Note 2:** Number 43, Digit Collection is used in computer telephony applications to prompt callers to enter a string of digits such as a social security number. These digits access a data base causing data about the caller to be displayed on the called party's computer screen. See your system installer for details.

Night Transfer Of Ringing Mode

You can enable an operating mode that automatically transfers all incoming calls to a particular telephone or group of telephones for answering.

- **To enable or disable the night transfer of ringing mode,**
 1. **PRESS INTERCOM.**
 2. **DIAL** * # 0 * 0 3.
 3. **DIAL** 1 to enable the feature, **OR DIAL** 2 to disable the feature.
 4. **PRESS SPEAKER** to end.

NOTE: Your system installer can program a button on your telephone that will enable or disable night transfer of ringing with one touch. If you have this button, the BLF light next to the button will flutter when night transfer of ringing mode is enabled.

Call Transfer - Attendant Calls To The Alternate Attendant Telephone

The system installer can arrange for another telephone to serve as an alternate attendant location. You can transfer all calls that would ring at your telephone to this alternate attendant telephone whenever you wish to do so.

- **To choose an alternate attendant's station to receive your forwarded calls,**
 1. **PRESS INTERCOM.**
 2. **DIAL** * # 0 * 0 4.
 3. **DIAL** your station number **AND DIAL** #.
 4. **DIAL** number of the alternate attendant station **AND DIAL** #.
 5. **PRESS SPEAKER** to end.

- **To transfer calls that would normally ring at your station to the alternate attendant you've selected,**
 1. **PRESS** the installer-programmed ALTERNATE button. (Your LCD will display "Alternate" and the extension number of the alternate attendant.)
- **To return ringing of calls to your telephone,**
 1. **PRESS** the installer-programmed ALTERNATE button again.

Overflow Transfer

By using this feature during peak calling periods, calls that normally ring at your station will also ring at the overflow station. If the installer has programmed the **OVERFLOW** feature access button, you can press this button to select overflow transfer. You can either change the overflow station selected by the installer, or if none was selected, you can enter your own selection from your station.

- **To designate an overflow station,**
 1. **PRESS INTERCOM.**
 2. **DIAL** .
 4. **DIAL** overflow station number:
 - **DIAL** to for stations 1–480.
- **To set the overflow transfer feature,**
 1. **PRESS** the installer-programmed Overflow button. If an overflow attendant is programmed, the light next to the OVERFLOW button will illuminate, and incoming calls will ring at both stations.
- **To cancel the overflow transfer feature,**
 1. **PRESS** the OVERFLOW button again.

Other Special Attendant Buttons

In addition to the many feature buttons the system can make available to any station, the system provides the attendant position with several special-purpose feature buttons to enhance call processing. These special-purpose buttons are described below:

- **Both Button:** This button provides a means for an attendant to establish a conference between the attendant's station, a current call, and the last call that was placed on hold.
- **Queue Button:** When multiple calls are ringing or are on hold at an attendant's station, the system places them in a queue. The attendant can use this button to determine how many calls are queued awaiting service.
- **Serial Call Button:** When a caller wishes to speak to more than one person, the attendant uses this button to place the caller in a serial mode of multiple transfers to each desired party. In the serial mode the system automatically transfers the caller to another party as soon as a present party hangs up. The system places the caller in the serial mode as soon as the attendant hangs up.
- **Test/Busy Button:** This button provides the attendant with a means to test the status of specific lines. Attendants can use this button to determine whether individual lines are idle, busy or on hold. When this button is used, the line is seized if it was idle.

- ***To establish a conference between the attendant station, a held call, and an active call,***
 1. **PRESS** the installer-programmed BOTH button.

- ***If you wish to cancel the conference condition and return one of the lines to hold,***
 1. **PRESS HOLD.**
 2. **PRESS** the line button for the held call you wish to re-engage. The other line remains on hold at your telephone.

- ***To determine how many calls are queued at the attendant position and awaiting service (on hold, parked, or ringing),***
 1. **PRESS** the installer-programmed QUEUE button. The display will indicate how many calls are in the ring queue and the hold queue, respectively. The displayed information remains in the LCD window momentarily.

NOTE: Hold recalls, transfer recalls and park recalls are counted in the ring queue and not the hold queue.

- ***To place an active call in a serial transfer,***
 1. **PRESS** the installer-programmed SERIAL button (the LCD will read 0 SERIAL EXT: , with the first digit indicating how many intercom numbers are already entered; the EXT: indicates a prompt for another intercom number to be placed in the serial).
 2. **DIAL** intercom number **OR PRESS** associated DSS button.
 3. **REPEAT** to add up to two more extensions to the serial.
 4. **PRESS SPEAKER** to end. Serial transfer begins.

- ***To determine the status of individual lines (idle, busy or on hold),***
 1. **PRESS** the installer-programmed TEST/BUSY button (the LCD will display the prompt Enter Line:).
 2. **DIAL** the line number to be tested (001–128).
 - If the line is idle, you will hear a dial tone,
 - If the line is busy, the LCD will display Busy with xxx,
 - If the line is on hold, the LCD will display On hold at xxx (xxx = line number).

System Clock

The system clock provides a date and time for display at LCD speakerphones connected to the system.

- **To program the system clock for current date and time,**

1. **PRESS INTERCOM.**
2. **DIAL** .
3. **DIAL** 2-digits (**01–12**) for month.
4. **DIAL** 2-digits (**01–31**) for day.
5. **DIAL** 2-digits (**00–99**) for year.
6. **DIAL** 2- digits (**00–23**) for hour.
 - **Example:** 8:15 PM = **2015** (enter for hour).
7. **DIAL** 2-digits (**00–59**) for minute.
 - **Example:** 8:15 PM = **2015** (enter for minute).
8. **DIAL** to save.
9. **PRESS SPEAKER** to end.

System Status Log

The system status log gives you information about the status of your system. Status log entries include: system reset, parity (port number), (port number) removed, manual reset, and software reset. Your installer must program a SYSTEM STATUS button on your telephone to provide you with access to the log display. The light located next to the button serves as the SYSTEM STATUS light. If the light turns on, it alerts you to enter the log viewing mode by pressing the SYSTEM STATUS button.

If your system includes T1 telephone line service, your telephone may display a T1 status log as well as the system status log. The T1 status log entries include those transmission errors that exceed their installer-programmed thresholds.

The installer may arrange for the system to sound an external audible alarm (or turn on an external visual alarm) if certain alarm conditions occur with the T1 service— it is the installer's choice whether the external alarm is audible or visual. If a T1 alarm occurs, you must take action to turn off the alarm device.

View the status logs by scrolling through them using the interactive buttons on your telephone. Although you can view a status log and turn off the T1 alarm, your installer must turn off your SYSTEM STATUS light. After viewing a log (and also turning off the external T1 alarm if necessary), inform the system administrator or installer that a system status or T1 alarm condition has occurred, and describe to him or her the displayed log details.

- **To view the log,**
 1. **PRESS** the **SYSTEM STATUS** button (the button flashes red when the log contains entries).
 2. **SELECT SYSTEM** to display the most recent system status log entry, **OR SELECT T1** to display the most recent T1 log entry.
 3. **SELECT INFO** to display the time and date of the current entry.
 4. **SELECT REV** to display the previous entry.
 5. **SELECT FWD** to display the next (more recent) entry.

- **To display the number of entries in the log,**
 1. **DIAL** at any time.

- **To exit the log viewing mode,**
 1. **EITHER PRESS** the **SPEAKER** button, **PRESS** the hookswitch, **OR WAIT** for the 15 second timeout.

- **To turn off the external T1 alarm,**
 1. **PRESS INTERCOM.**
 2. **DIAL** .
 3. **PRESS SPEAKER** to end.

DSS/BLF Console Operation

The IB64X, IB48X, and IB24X *DSS/BLF* consoles have additional buttons and status lights that extend the memory button capability of an adjacent companion telephone. The buttons can be programmed for automatic dialing (speed dial) or direct station selection (DSS) with busy lamp field (BLF) using the instructions provided previously in this guide.

When the installer assigns a *DSS/BLF* console to a station port, the system recognizes it as such and automatically clears (blanks) the console buttons so that you can store numbers at the buttons as you need them.

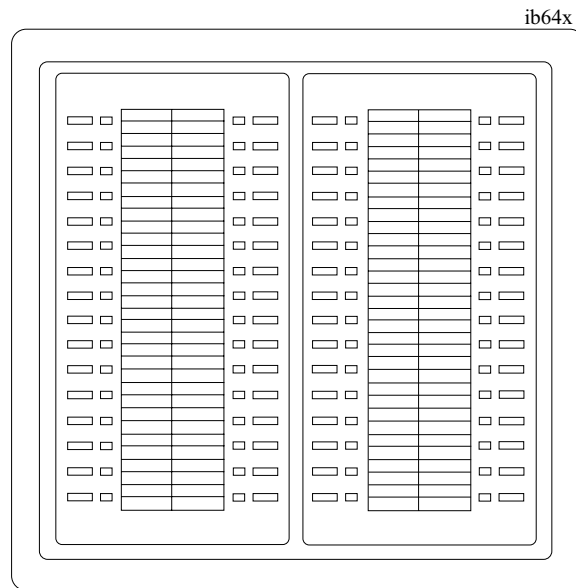

IB64X *DSS/BLF* Console

Accessing The Button Levels

The IB24X and IB48X *DSS/BLF* consoles have four levels of buttons, quadrupling the consoles' button capacity. The four buttons at the bottom of each console allow you to select which button level is currently active. To change button levels, press one of the buttons at the bottom of the console. The leftmost button activates level 1, the next button activates level 2, etc. A light beside the appropriate button lights to indicate which level is currently active.

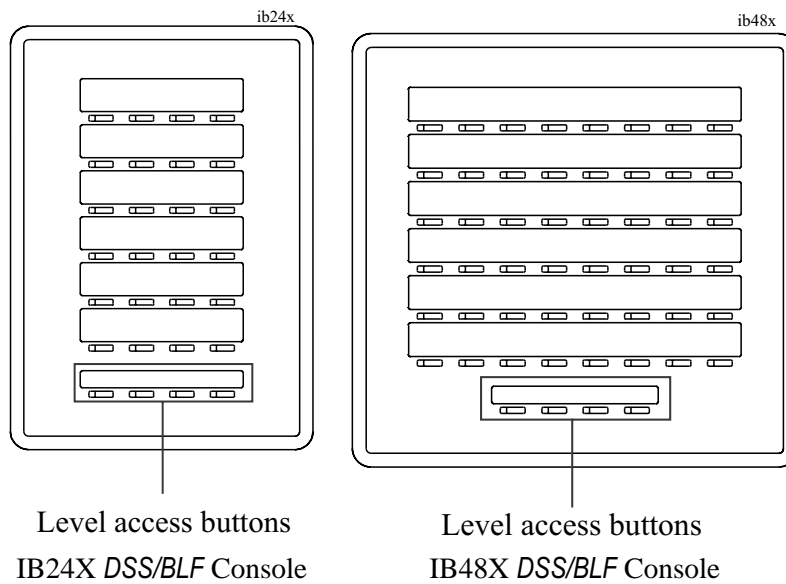

Notes

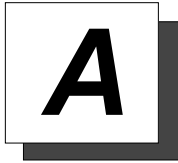

Feature Access Codes

This chart provides you with a quick reference guide of the feature dialing codes. If you wish, you can detach these pages and keep them near your telephone to serve as a stand alone reference. In the *Feature Access Codes* section on page 62 a method is described to program these codes to a button on your station.

Feature	Enable Code	Disable Code
Account Code	INTERCOM + * 0 4 + account code	
All Call	INTERCOM + 7 0	
Attendant Calling	INTERCOM + 0	
Authorization Code	INTERCOM + # 0 8 + authorization code	
Automatic Callback and Call Waiting	INTERCOM + * 6	INTERCOM + # 6
Background Music	INTERCOM + 1 1 or 1 2	INTERCOM + # 1
Call Divert Station	INTERCOM + * 5 5 + extension number	
Call Forward, Personal	INTERCOM + * 5 1 + extension number	INTERCOM + # 5
Call Forward, Ring-No Answer, All Calls	INTERCOM + * 5 4 + extension number	INTERCOM + # 5

Feature	Enable Code	Disable Code
Call Forward, Ring-No Answer, Personal Calls	INTERCOM + *53 + extension number	INTERCOM + #5
Call Forward, All Calls	INTERCOM + *52 + extension number	INTERCOM + #5
Call Park, Orbit 910-990	INTERCOM + * + 910 to 999	
Call Park, Pickup	INTERCOM + # + 910 to 999	
Call Pickup, Directed	INTERCOM + *4 + extension number	
Call Pickup, Group	INTERCOM + #4	
Clear Major Alarm Ring	INTERCOM + #09	
DISA Access	Installer Assigned	
Do Not Disturb	INTERCOM + #01	INTERCOM + #01 (repeat)
Do Not Disturb Override	extension number + *03	
DSS Programming	INTERCOM + **3	
Executive Override	extension number + *03	
Hold, Manual	HOLD	
Hold, Exclusive	HOLD + HOLD	

Feature	Enable Code	Disable Code
Hold, Directed	INTERCOM + *90	
Hold, Directed Pickup	INTERCOM + #90	
LCD Messaging	INTERCOM + *02 + message	INTERCOM + #02
Line Group 1	INTERCOM + 9	
Line Groups 2-11	INTERCOM + 80 to 89	
Line Groups 12-16	INTERCOM + 60 to 64	
Line Pick Up From Any Station, Zones 1-4	INTERCOM + 65 to 68	
Line Pick Up From Any Station, All Zones	INTERCOM + 69	
Meet-Me Answer Page	INTERCOM + 78	
Message Waiting	INTERCOM + *3 + extension number	INTERCOM + #3 + extension number
Message Wait Retrieval	#00	
Operator Access	INTERCOM + 0	
Paging, All Call	INTERCOM + 70	
Paging, Zones 2-8	INTERCOM + 71 to 77	
Paging, Meet-Me	INTERCOM + 78	

Feature	Enable Code	Disable Code
Park Orbit Retrieve	INTERCOM + # + 9 1 0 to 9 9 9	
Park Orbit Send	INTERCOM + * + 9 1 0 to 9 9 9	
Personal Ringing Tones	INTERCOM + * * 4 + tone code (1 to 8)	
Redial Last Dialed Number	#	
Remote Station Disable	INTERCOM + * 0 5 + extension number	INTERCOM + # 0 5 + extension number
Response Message	INTERCOM + * * 6 + button + 0 1 to 3 0	
Service Observing	INTERCOM + # 0 3 + extension number	
Speed Dial, Station	Keypad 1, 2, 3, 4, 5, 6, 7, 8, 9, or 0.	
Speed Dial, System	* 1 0 0 to * 5 9 9	
Speed Dial, Programming	INTERCOM + * * 1	
Station Lock	INTERCOM + # 0 4 + code	
Volume Save	INTERCOM + * * 7	
Voice-Announce Block	INTERCOM + * 2	INTERCOM + # 2

NOTE: The dialing codes provided in this quick reference guide are default values. Your system installer has the ability to renumber these codes.

The following table details several unique dialing codes that are only applicable to single line proprietary and industry-standard telephones.

Feature	Enable Code
Pick Up Last Line	* 0 8
Broker's Call	* 0 7
Speed Dial Access Code	* 0 1
Saved Number Redial	* 0 6
Dial Saved Number	* 0 9
TAP Dialing Code	# #

Notes

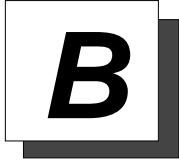

Display Abbreviations

This chart identifies the interactive button abbreviations that appear in your display.

Abbreviation	Feature	Definition
ACCT	Account Codes	Stores a button that enables account code entry.
ALERT	Set Reminder	Sets two reminder alerts that will sound at your station at specified times.
ALL	All Calls Forward	Route all of your calls to a different station location.
ANS	Answer	Answers any call ringing at your station.
APAGE*	Auxiliary Pager	Stores a button that selects auxiliary paging speaker operation through the auxiliary jack.
ARECD*	Auxiliary Recorder	Stores a button that selects tape recorder operation through the auxiliary jack.
ARING*	Auxiliary Ringer	Stores a button that selects auxiliary ringer operation through the auxiliary jack.
ARDL	Automatic Redial	Redials a busy call once a minute for 10 minutes.
BKSP	Backspace	While programming a speed dial number, backspace erases an incorrect entry.
CALL	Call	Calls a station that turned on your message waiting light.

Abbreviation	Feature	Definition
CAMP	Camp On	Has system call you when busy station becomes idle. When chosen as a feature, stores a button that enables the function.
CFWD	Call Forward	Forwards all of your calls to a different station location. When chosen as a feature, stores a button that enables the function
CALLBK	I Will Call Back	Respond to a SOHVA call with a non-verbal message.
CLEAR	Clear Features	Stores a button that clears a currently active or engaged feature.
CLR	Clear	Cancels a call forward condition.
CONF	Conference	Establishes a conference.
DARK	Dark (contrast)	Makes LCD screen darker.
DISP	Display	Adjusts the contrast of your LCD screen.
DND	Do Not Disturb	Makes your station appear busy to other stations. When chosen as a feature, stores a button that enables the function.
DSS	Direct Station Select	Stores a personal intercom number at a DSS button.
EXIT	Exit Selection	Ends a current programming session.
EXT	Speed Dial By Name	Selects speed dial numbers to access through the dial by name interface.
FEAT	Feature	Presents several different features you can store at programmable buttons for later use.

Abbreviation	Feature	Definition
GPLSN	Group Listen	When chosen as a feature, stores a button that enables loud speaker broadcast of distant party's voice.
HDSET	Headset	When chosen as a feature, stores a button that enables headset operation.
HAVE HOLD	Ask Caller To Hold	Send a non-verbal response to a SOHVA caller so he or she will know to place the outside caller on hold.
LIGHT	Light (contrast)	Makes the LCD screen lighter.
MSG	Message	Turns on message waiting light at another station.
MUSIC	Background Music	Turn on the background music at your station. When chosen as a feature, stores a button that enables the function.
NEXT	Next Display	Shows the next display.
NOANS	No Answer/Forward	Forwards calls that ring at your station but receive no answer.
OPTIONS	Options	Selects interactive button features.
OVER	Override	Overrides either a do-not-disturb condition or a busy signal at a station you have called.
PAGE	Paging Zone	When chosen as a feature, stores a button that provides one-button access to paging.
PARK	Park Orbit	When chosen as a feature, stores a button that provides one-button parking of calls.
PCKUP	Pick Up	When chosen as a feature, stores a button that allows you to pick up a call ringing elsewhere.
PERS	Personal	Route your personal intercom calls to a different station location.

Abbreviation	Feature	Definition
PRIV	Privacy	When chosen as a feature, stores a button that releases privacy for a current call.
QUERY	Button Query	Displays program status of any button.
RECON	Reconnect	Reconnect you to a transferred call.
RING	Ring Tone	Select different ringing tones.
SAVE	Save Number	Permanently saves last number you dialed. When chosen as a feature, stores a button that provides the function.
SDIAL	Speed Dial	Programs a number for one-button calling.
SEND	Send Transfer	Re-transfers a previously transferred call that returned to your station.
SET	Set Feature	Enable call forwarding.
SOHVA	Secure Off-Hook Voice Announcement	Sends a subdued off-hook voice announcement to another station.
SRC	Music Source	Selects which music source will supply background music.
TAKE MSG	Take A Message	Send a non-verbal response to a SOHVA caller so he or she will know to take a message from an outside party.
VAB	Voice Announce Block	Inhibits your station from receiving a SOHVA. Also, blocks voice calls sent over the speaker. When chosen as a feature, stores a button that provides the function.

**Available only on 8024S.*

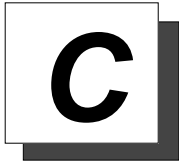

Speakerphone Characteristics

When using your speakerphone, the microphone and loudspeaker are farther away from you than when you use a handset. Both the signal from the loudspeaker and the signal to the microphone must be strengthened.

When microphones and loudspeakers are close together (such as in a speakerphone), additional amplification typically generates a ringing sound (public address systems do this if the volume is too high or the microphone is too close to a loudspeaker).

Full-Duplex Speakerphone Characteristics

The *Impact SCS 8324F-*** speakerphone uses the latest full-duplex speakerphone technology. (Full-duplex technology enables both parties on a speakerphone call to speak simultaneously—half-duplex speakerphones allow only one person to speak at a time.) The *8324F-*** will operate in either full-duplex or half-duplex mode depending on the current line conditions.

At the beginning of each call the telephone must perform a “speech training” test. To achieve optimum performance from the full-duplex speakerphone, Comdial recommends that each user in turn speak about 10 consecutive words to allow the telephone to “train” itself. Note that during the “speech training” test, the speakerphone is operating in half-duplex mode.

Depending on the telephone line conditions and the type of speakerphone at the other end, it may not be possible for the *8324F-*** to operate in full-duplex mode. If the speakerphone at the other end is a half-duplex speakerphone and both parties are in speakerphone mode, the half-duplex speakerphone is the controlling factor, preventing the *8324F-*** from operating in full-duplex mode.

NOTE: Pressing any button (mute, hold, etc.) on the speakerphone while in full-duplex mode causes the system to perform the “speech training” test again. For example, if you press MUTE while in full-duplex mode, when you release the call from mute, the system will perform the entire “speech training” test again.

Speakerphone User Guidelines

- Both parties can not talk at the same time. You must wait for silence out of your loudspeaker before talking. You must stop talking to hear the other party.
- Background noise may prevent the sound-activated switches from operating properly. Avoid placing the speakerphone where it will detect sounds from typewriters, keyboards, printers, paging systems, and other equipment.
- Speak slightly louder than normal and with a clear, authoritative voice. For the microphone to best detect your voice, speak within three feet of it and face the telephone.
- Raising the volume of the loudspeaker makes it easier for the sound-activated switches in your telephone to select the distant party’s voice. Lowering the volume of the loudspeaker makes it easier for the switches to select your voice.
- Since the system takes several seconds to provide the best switching, constant sound patterns—such as elongating your words and playing externally-supplied music—may prevent the sound-activated switches from operating properly.
- Place the telephone on a hard surface and away from table edges. Do not place the telephone in corners or enclosures. Do not let obstructions come between you and the microphone. Rooms with hard, flat surfaces that reflect sound may affect the sound-activated switches.
- If you are using a handset and the other party is using a speakerphone, avoid breathing heavily into your microphone. Avoid other sounds that may affect the distant telephone’s sound-activated switches.
- In some situations, such as when either you or the distant party are in a noisy environment, you may have to lift your handset to ensure a clear conversation.
- When both you and the distant party use speakerphones, the sound-activated switches can occasionally detect both voices simultaneously, thus blocking out both voices.

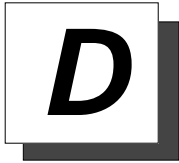

Glossary

A

Account Code

A group of numbers, up to 16 digits in length, entered by station users during incoming or outgoing calls; the system uses account codes to identify the calls by category, or special grouping, for call accounting purposes.

All-Call Paging

Paging through the intercoms of all stations in the system.

Assist Button

A button that you can program that will let you send a message requesting assistance to the LCD of another telephone.

Attendant

Also known as the operator; typically, the first person to answer incoming calls and responsible for directing calls to the proper person or department.

Automatic Callback

System will ring a calling telephone when a busy called telephone becomes idle.

Automatic Dialing (or Autodialing)

Using programmable buttons to store numbers for one- or two-button dialing.

Automatic Redialing

Turning on a program that automatically redials the last number dialed once a minute for 10 minutes.

Automatic Route Selection (ARS)

ARS allows the system to automatically select the least costly line group available to a station to route a call. The system modifies the dialed number, if needed, to match the selected line group. ARS makes routing decisions (which lines to route a call over, if and how to modify a number, and costing information) based entirely upon the programming of the system.

Automatic Station Relocation

Process by which the system automatically recognizes particular stations if they are relocated to a different station port; the same class of service and station features are provided the station at the new port.

B**Block Programming**

To eliminate the need to program each station individually, programmers can assign features or functions to groups of stations.

Button Query

Feature which allows users to display the functions of programmable buttons on LCD telephones.

C**Call Forward**

Designating another telephone to receive intercom calls normally directed to the user's telephone.

Call Forward Outside System (CFOS)

Allows station users to forward incoming or transferred line calls to telephone numbers outside the system.

Call Park

Placing an active call at a particular telephone in system hold (park orbit) and retrieving it by any telephone.

Call Pick-Up

Answering a call at one telephone when it is ringing at another telephone.

Call Transfer

Transferring a call from one station to another. The transfer can be screened, i.e., you find out who is calling and announce them to the party being called; or unscreened, i.e., you transfer the call without identifying the calling party to the called party.

Caller ID

Allows station users to view the originating line number of incoming calls before they are answered.

Camp On

Process that allows a user to wait for a busy or idle line to become available and immediately be called back by the system; also allows users to send a tone to busy telephone to notify the station that a call is waiting.

Central Message Desk

A station that has been assigned to control message waiting lights and deliver messages to other stations in the system.

Class Of Service (COS) Programming

Customized programming of your system by the installer that establishes the basic operating parameters of the system and individual stations.

D**Data Interface Unit (DIU)**

This optional unit provides connections for your standard multiline digital telephone and Industry Standard Telephone (IST) device such as a FAX machine or answering machine.

Departmental Station Operation

The operation of stations that are organized into departments.

Dial By Name

This feature allows users to employ any two-line display, LCD speakerphone and its interactive buttons to search through an index of names, locate a desired station name or system speed dial name, and automatically call the located item.

Digital Voice Announcing (DVA)

The DVA is a line-powered device that provides voice prompts for auto-attendant and transfer, or you can use it to enhance the operation of DISA and Tracker.

Direct Inward System Access (DISA)

An enhancement option that allows outside callers to directly call a station or access certain internal system features, including all line groups and ARS. To prevent fraudulent access and unauthorized use, the caller must use an authorization code and system access code to gain access to outside lines as well as many of the advanced telephone features.

Direct Inward Station Dialing (DISD or DID)

This feature allows an outside party to call an intercom station directly without an attendant's assistance.

Direct Station Selection/Busy Lamp Field (DSS/BLF)

Programmable buttons which allow the user one button to place intercom calls to other stations within your system; the button is sometimes referred to as a DSS button. Busy lamp field or BLF is a term for a light that identifies current call status of DSS station. See telephone layout drawings in Chapter 1 for location.

Do Not Disturb

A mode that disables incoming call ringing and intercom calling.

Dual Tone Multiple Frequency (DTMF)

The tones made by your telephone when you dial.

DXP, DXP Plus, FXS and FXT

Common Code Based Systems; DXP, DXP Plus, FXS and FXT Comdial Communication Systems so named because the programmed function codes of these systems are interchangeable.

Dynamic Line Button

System temporarily assigns a normally unassigned line to an idle line button for certain call handling operations.

E**E&M Tie Lines**

In telephony, a separate pair of leads to your station which are used by system operators for signaling and supervisory purposes.

Exclusive Hold

Only the telephone placing the call on hold can retrieve it.

Executive Override Breaking into a conversation at a busy called telephone. This intrusion is announced by several quick tone bursts over the conversation.

H**Handsfree Answer Inhibit**

A telephone can be set to block voice calls sent to it over the speaker.

Hookflash

Action that occurs when the TAP button is pressed. Needed for activating host system features.

Hookswitch

The switch on a telephone which, when depressed manually or by the handset, disconnects a call.

I**IMIST**

Module which allows the connection of an external device to a Comdial digital telephone.

Industry Standard Telephone (IST)

Analog telephone with only a basic 12 button keypad and no advanced features

Intercom

An internal communication system that allows you to dial another station at your office or location without connecting to the outside telephone system.

K**Keypad**

Buttons  through ,  and  used for dialing.

L**Last Number Redialing**

Automatically dialing the last number dialed.

LCD

Liquid crystal display; the alphanumeric display of several Comdial Digital Telephone models.

Line Groups

Programmers assemble and program outside lines into distinct line groups which users must dial a certain code to access.

Line Queuing

When several telephones share a line and that line is busy, a user can dial a code and hang up to wait for the line to become idle. When the line becomes idle, the user's telephone will ring.

M**Meet-Me Answer Page**

Any user can dial a code in response to an all-call or zone page and be connected to the paging party in a private conversation.

Messaging

Turning on a telephone lamp to let the user know that a message awaits pickup and leaving a message on the display of a telephone that gives information on your status.

Mute

A fixed feature button that keeps a distant party from hearing your conversation. This button also lets you adjust the telephone display contrast from light to dark.

N**Night Transfer**

Transferring incoming calls to a particular station(s) for off-hour answering.

O**Operator Station**

Also known as the attendant station, this system station is programmed to ring when users dial the operator; usually considered the central message desk of the system although multiple attendant stations are possible

P**Paging**

This feature allows station users to dial-up customer provided loudspeaker paging equipment and page over externally placed loudspeakers and determines what paging zones, if any, a station can page over.

Prime Line

A line designated to a particular telephone and automatically selected when the handset is lifted.

Privacy

Line feature, assigned by the programmer, to allow only one station to access a line at any time; no other station has access to the line unless the user makes it available through conferencing.

Programmable Buttons Each telephone or station has buttons that can be user-programmed for autodialing numbers or feature codes, or other special purpose dialing requirements.

Pulse/Tone Switching

Changing from pulse/rotary dial signals to tone/DTMF signals.

Q**Queue**

Method by which a station user waits for an available line by dialing a code and waiting for the system to call back.

R**Response Messaging**

Responding non-verbally to a calling station by pressing a programmed button that sends a message to the calling station's display.

Ring Line Preference

An automatic connection to any outside line ringing at the station when the station handset is taken off-hook.

Ring Tones, Personal

A telephone can be arranged to ring in one of six distinctive tones.

S**Saved Number Redialing**

Saving a last manually dialed number for later autodialing.

Screened Call Transfer

Allows users to first announce and then transfer both line and intercom calls from one station or group to another.

Service Observing

Class of service programming option allows users to enter an in-progress call in an unannounced muted mode to monitor the call.

Speed Dialing

Autodialing using the keypad buttons. Speed dialing can be station calls (personal and accessed by only one specific user) or system calls (numbers used and accessed by anyone in the system).

Station

A single system telephone with an individual identity and feature set assigned by the programmer.

Station Message Detail Accounting (SMDA)

Station message detail accounting provides a record of the incoming and outgoing calls handled by the system on selected lines. This record provides information for accounting and traffic analysis studies.

Subdued Off-Hook Voice Announce (SOHVA)

A private announcement that can be made to a busy party which they hear through the receiver of their handset.

System Alarm Reporting

Allows you to view (through the LCD telephone screen) the various system alarms and the stations with which those alarms are associated.

System Speed Dial

System speed dialing provides system users with a repertory of up to 500 numbers that they can dial from any telephone in the system. The installer or the attendant is responsible for storing the system speed dial numbers.

T**TAP (Flash/Recall)**

Depending on your system's programming, this button gives you a fresh dial tone or activates a hookflash.

Toll Restriction

Class of service feature by which the system allows or denies outgoing calls to selected users over selected lines.

Tone Call

A ringing intercom call.

Tracker Pager

The Tracker optional pager system allows you to send and receive messages to Tracker pagers assigned to station extension numbers.

TRNS/CNF

A fixed feature button that allows you to transfer outside calls and set up conference calls.

U**Unscreened Call Transfer**

Allows users to transfer line or intercom calls from one station or group to another without first announcing them.

Unsupervised Conference

After a establishing a conference between two outside parties, the originator drops out leaving a line to line unsupervised connection with the remaining parties.

V**Voice call**

A verbal intercom call.

Voice Announce Blocking (VAB)

A telephone can be set to block voice calls sent to it over the speaker.

Z**Zone Paging**

Paging through the intercoms of some stations or departments in the system.

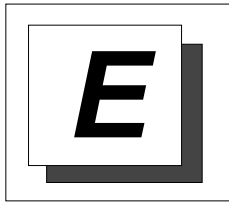

Feature Networking Support

The table below shows all the features available on Set 15A. It identifies whether each feature is for a local stand-alone system or a system-to-system network. System-to-system networking connects several DXP, DXP Plus, FXS and FXT systems together in an arrangement that allows unified communications through the system. Also provided is information on which features Comdial provides remote networking support too.

Feature Name	Type Originating/ Terminating/Both	Remote Networking Support	Feature Parameters	Program Feature
Abandoned Hold Release	Terminating	None	Across Network	
Account Code	Both	None	Across Network	Node/COS
Alarms			Local	Node
A-lead			Local	Node
Alternate Attendant	Terminating	Comdial	Local	Node
ANI (passed across the network but must be enabled per node)	Terminating	Comdial/QSIG	Local (display telephones)	Node
ANI DNIS (passed across the network but must be enabled per node)	Originating	Comdial/QSIG	Local (display telephones)	Node
ANS Detect	Originating	Comdial	Across Network	
ARS	Both	Comdial	Across Network	Node
	N/A	None	Local	Node
Attendant Programing	Both	Comdial	Local	Node
Authorization Code	Originating	None	Local	Node
Auto Hold	Terminating	None	Across Network	Node
Auto Pause	Terminating	None	Across Network	Node
Auto Redial	Originating	None	Across Network	Node

Feature Name	Type Originating/ Terminating/Both	Remote Networking Support	Feature Parameters	Program Feature
Aux Line			Across Network	Node
Aux Ring			Local	Node
Block Program			Across Network	Incoming DID Node
Button, Programable	Both	Comdial	Across Network (with limitations)	Node/Station
Call Costing	Originating	None	Across Network (with limitations)	Node/Station
Call Divert	Terminating	Comdial	Local	Node/Station
Call Forward Default Forward	Terminating	Comdial	Across Network	Node/Station
Call Forward All Immediate	Terminating	Comdial	Across Network	Node/Station
Call Forward All RNA	Terminating	Comdial	Across Network	Node/Station
Call Pickup Directed	Terminating	Comdial	Across Network	Node/Station
Call Pickup Group	Terminating	None	Local	Node/Station
Call Time	Originating	None	Across Network	Node/Station
Call Transfer	Both	Comdial	Across Network	Node/Station
Call Waiting Tone	Terminating	None	Local	Node/Station
Camp On	Terminating	None	Local	Node/Station
CFOS	Both	None	Local	Node/Station
Clock Set			Local	Node
Conference	Both	Comdial/QSIG	Across Network (with limitations)	Station
COS			Local	Node
Day Night Class of Service	Both	Comdial	Local	Node
Delay Hot Line	Terminating	None	Local	Node/Station
Dist Ring	Terminating	None	Local	Node/Station
Dial by Name	Originating	None	Local	Node/Station
Directed Station Hold	Both	None	Local	Node/Station
Disable Station			Local	Node/Station
Disconnect Notification	Both	None	Across Network	

Feature Name	Type Originating/ Terminating/Both	Remote Networking Support	Feature Parameters	Program Feature
DND/inhibit/override	Terminating	Comdial/QSIG	Local	Node
DNIS (passed across the Network but must be enabled per node)	Both	Comdial	Local (display phones)	Node
DSS/BLF	Both	Comdial	Across Network (with limitations)	Node/Station
DTMF Signaling	Both	None	Across Network	
Enhanced Night Mode	Terminating	None	Across Network	Node
Enhanced Ringing	Terminating	None	Across Network	Node
Executive Override	Both	None		
Extended DTMF				
Feature Numbering			Local	Node
Group Listen	Terminating	None	Across Network	Node/Station
Hands Free	Both	None	Across Network	Node/Station
Hold	Terminating	Comdial/QSIG	Across Network	Node/Station
Hunt Group (can access Hunt group across Network but members must be local to each other)	Terminating	Comdial	Across Network	Node
Hunt List	Terminating	None	Local	Node/Station
Idle Line	Both	None	Local	Node
Incoming Call Routing	Both	Comdial	Across Network	Node
Intercom Numbering			Local	Node
Intercom Speed Dial Last Number Dialed	Originating	None	Across Network	Node/Station
LCD Contrast	Both	None	Local Station Only	Node/Station
LCD Messaging	Both	None	Local	Node
Line Group	Both	None	Local or Network Channels	Node
Line Monitoring	Both	Comdial	Local	Node

Feature Name	Type Originating/ Terminating/Both	Remote Networking Support	Feature Parameters	Program Feature
Line Names	Both	Comdial/QSIG	Across Network	Node
Line Queue	Both	None		
Lock	Both	None	Local	Node/Station
Location Codes	Both	None	Local	Node
Mark	Both	None	Local	Node/Station
Message Deposit	Both	Comdial	Local	Node/Station
Message Waiting	Terminating	Comdial	Across Network	Node/Station
Music, Background	Both	None	Local	
Music, On Hold	Both	None	Local	
Mute	Both	None	Across Network	Node/Station
Operator/Network	Both	Comdial	Across Network	Hub
Operator/Node	Both	Comdial	Local	Node
Page	Both	None	Local	Node
Park Orbit	Terminating	None	Local	Node
Personal Ring Tone	Terminating	None	Local Station Only	Node/Station
Prime Line	Originating	None	Local	Node/Station
Privacy	Terminating	None	Local	Node/Station
Pulse Set On	Originating	None	Local	Node
Query (button)	Originating	None	Local	Node/Station
Queue	Terminating	Comdial	Local	Node/Station
Quick Transfer	Terminating	Comdial	Across Network (with limitations)	Node/COS
Recall Call Forward			Across Network (with limitations)	Node/Station
Recall Timing (Hunt Group)	Terminating	Comdial/QSIG	Across Network	Node
Record	Both	Comdial	Across Network	Node/Station
Response Message	Both	None	Local	
Ring Monitoring	Terminating	Comdial	Local	Node/Station
Serial Transfer	Terminating	Comdial/QSIG	Local	
Service Observe	Originating	None	Local	Node/Station

Feature Name	Type Originating/ Terminating/Both	Remote Networking Support	Feature Parameters	Program Feature
Shift for Speed Dials	Both	None	Across Network	Node/Station
Silent for Ringing	Both	None	Local	Node/Station
SLPS—Brokers Mode	Both	None	Local	
SLPS—Dial Saved Number	Originating	None	Across Network	
SLPS—Pick Up Last Line	Terminating	None	Across Network	
SLPS—Save Number	Originating	None	Across Network	
SLPS—TAP	Both	None	Across Network	
SMDA/SMDR	Both	Comdial	Across Network (with limitations)	Node
Softkey	Both	Comdial	Across Network (with limitations)	
SOHVA	Terminating	Comdial	Local	Node/Station
SOHVA Service Observe	Originating	None	Local	Node/Station
Dial	Originating	None	Across Network	Node/Station
System Speed Dial	Both	None	Across Network	Node
Station Monitoring (DSS/BLF)	Both	Comdial	Across Network (with limitations)	Hub only
Station Names	Both	None	Across Network	Node/Station
Station State Query	Originating	Comdial	Across Network	Node/Station
Subdue Ringing	Terminating	Comdial	Local	Node/Station
System Manager Prog	Both	None	Local	
System Parameters	Both	None	Local	Node
TAFAS (line answer from any station)	Both	None	Local	Node/Station
Toll Restriction	Both	None	Across Network	Node/COS
Tracker	Both	Comdial	Local	

Feature Name	Type Originating/ Terminating/Both	Remote Networking Support	Feature Parameters	Program Feature
Transfer to Voice Mail	Both	Comdial	Across Network	Node/Station
Trunk to Trunk Transfer	Both	Comdial	Across Network	
Voice Announce Block	Terminating	Comdial	Across Network	Node/Station
Serial WP Integration			Across Network	Hub and VM
VVP			Across Network	Hub and VM

Index

A

- Account Codes
 - entering for incoming calls, 78
 - entering for outgoing calls, 78
 - programming a button, 64
 - SMDA report regarding, 100
- All-Call Paging, 36
- Answering Calls
 - intercom calls, 14
 - night-transferred calls, 15
 - outside calls, 13
- Attendant
 - display current calls with queue button, 112
 - programming features, 91, 92, 93, 94, 95, 96, 97, 98, 99, 100, 101, 102, 103, 104, 105, 106, 107, 108, 109, 110, 111, 112, 113, 114, 115, 116, 117, 118
 - transferring calls to alternate attendant, 110
 - transferring calls to overflow attendant, 111
- Authorization Codes
 - activating, 79
 - locking station to prevent use, 79
- Automatic Dialing, 29
 - See Also** Speed Dialing
- Automatic Number Identification
 - See** Caller ID
- Automatic Redial, 70
- Automatic Set Relocation, 87
- Auxiliary Jack
 - compatible equipment, 76
 - programming an enable button, 64

B

- Busy Lamp Field (BLF) Light
 - displaying function (button query), 37
 - lighting with station to station messaging, 56
 - location, 7, 11
- Button Locations, 7, 9, 11
- Button Query, 37

C

- Call Forward Outside System, 44
- Call Forwarding
 - See** Forwarding Calls
- Call Parking
 - Parking Calls, 46
- Call Pick-Up
 - answering calls at night, 39
 - answering for any station (directed), 20
 - answering within a group, 20
 - programming a button, 65
- Call Waiting
 - See** Camping On, busy station
- Caller ID, 26
- Calling
 - automatic dialing, 29
 - dialing intercom numbers (tone-first), 28
 - dialing intercom numbers (voice-first), 28
 - dialing outside numbers, 27
 - selecting a line, 69
 - using DISA to intercom call, 75
 - with E&M Tie Lines, 80

- Camping On
 - awaiting answer from busy station, 34
 - awaiting recall from a busy station, 33
 - awaiting recall from a DND station, 33
 - awaiting recall from idle station, 34
 - programming a button, 64
- CFOS
 - See** Call Forward Outside System
- Clearing Feature Buttons, 65
- Conferencing
 - as attendant using the BOTH button, 112
 - creating, 40
 - creating unsupervised conferences, 41
 - with E&M Tie Lines, 81

D

- Dial By Name, 82
- Dialing
 - See** Calling
- Dialing Modes
 - switching between, 88
- Digital Voice Announce (DVA)
 - general description, 104
 - programming messages, 104
 - table of messages, 107
- Direct Inward System Access (DISA)
 - description, 74
 - feature codes, 75
- Direct Station Select (DSS) Button
 - associated lights, 10
 - displaying function (button query), 37
 - functions, 8
 - location, 7, 11
 - programming a location, 59
- Directed Station Hold, 18
- DISA
 - See** Direct Inward System Access

- Display
 - understanding abbreviations, 125, 126, 127, 128
- Diverting Incoming Calls, 52
 - See Also** Forwarding Calls
- Do Not Disturb
 - enabling/disabling operation, 24
 - overriding, 38
 - programming a button, 64
- DSS/BLF Console Operation, 116
- DVA
 - See** Digital Voice Announce

E

- E and M Tie Lines, 80
- Exclusive Hold, 16
- Executive Override, 38

F

- Feature Access Button Programming, 65
- Feature Access Codes
 - storing at programmable location, 62
 - table, 119
 - table listing, 119, 120, 121, 122, 123, 124
 - using DISA codes, 75
- Flash Button
 - See** TAP Button
- Forwarding Calls, 42
 - Call Forward Outside System (CFOS), 44
 - diverting calls, 52
 - handling ring no answer calls, 42
 - programming button, 64
 - redirecting all calls, 42
 - redirecting personal calls, 42

G

- Group Listening
 - basic function, 64
 - programming a button, 64
 - setting the volume, 85

H

- Handset, setting volume, 84
- Headset
 - configuring with auxillary jack, 76
 - setting the volume, 85
- Hold Button
 - functions, 8
 - location, 7 , 11
 - meaning of associated light, 11
- Holding Calls
 - basic instructions, 16
 - handling hold recalls, 17
 - handling multiple calls on hold, 18
 - using directed hold, 18
 - using exclusive hold, 16
- Hot Transfer, 50
 - See Also** Transferring Calls

I

- IMIST Module, 89
- Interactive Buttons
 - reprogramming, 59
- Intercom Button
 - functions, 8
 - location, 7 , 11
 - meaning of associated light, 11

L

- Last Number Redial, 30
- LCD Display Abbreviations, 125 , 126 , 127 , 128
- LCD Messages
 - creating, 91
 - Default message table, 54
 - letter code table for creating, 92
 - selecting from default messages, 53
 - sending, 53
- Lights, Display, 9
- Line Access From Any Station, 15
 - See Also** Night Transfer
- Line Groups, 69
 - queuing for an open line, 39
 - selecting when speed dialing, 61
- Lines
 - disabling, 94
 - naming, 98
 - SMDA report regarding, 100
 - testing, 112

M

- Making Calls
 - See** Calling
- Meet-Me Answer Page, 36
- Message Waiting Light
 - basic function, 6
 - enabling or disabling for system, 95
 - receiving messages using, 57
- Music
 - programming a music enable button, 64
 - selecting, 83
 - setting the volume, 85
- Mute, 85

Mute Button
location, 7 , 11
meaning of associated light, 10

N

Night Transfer
answering calls, 15
See Also Line Access From Any Station
setting up for system, 110

O

Operator
See Attendant
Overflow Transfer, 111

P

Paging
all-call, 36
codes, 36
programming a Paging button, 64
sending a Meet-Me page, 36
sending a page, 36
using the Tracker Paging system, 72
Parking Calls, 46
handling park recalls, 47
orbit codes, 46
programming a Parking button, 64
Privacy Release
programming a button, 65

Q

Queuing
attendant display of current calls, 112
line, 39
using the redial queue, 71
Quick Transfer, 50
See Also Transferring Calls

R

Redialing
automatic, 70
last number dialed, 30
See Also Saved Number Redial
storing numbers for future redial, 30
using a redial queue, 71
Reminder Alert, setting, 63
Response Messaging
fixed response button, 67
See Also LCD Messages, creating
programming a default button, 67
responding to SOHVA using, 22
scrolling response button, 67
sending, 58
Ringer
connecting an external ringer, 77
selecting a personal tone, 3
setting the volume, 84
turning off, 4 , 84

S

Saved Number Redial
programming a button, 65
using with Caller ID, 26

Service Observing, 88

Shift Button

- functions, 8
- location, 7, 11
- storing speed dial numbers using, 60, 62

SMDA

- See** Station Message Detailed Accounting (SMDA)

Speaker Button

- function, 8
- location, 7, 11
- meaning of associated light, 11

Speakerphone

- button functions, 6, 8
- General diagram, 7, 11
- setting the volume, 84
- user guidelines, 130
- using full-duplex technology, 129

Special Attendant Buttons, 112

Speed Dialing

- general description of, 60
- programmed number table, 63
- storing numbers, 60
- system speed dial numbers, 102
- table of system speed dial numbers, 103

Station

- assigned names table, 97
- disabling, 94
- naming, 96
- SMDA report regarding, 100

Station Message Detailed Accounting (SMDA)

- aborting reports, 101
- general description, 100
- obtaining reports, 101
- types of reports, 100

Subdued Off-Hook Voice Announcement (SOHVA)

- blocking all SOHVAs, 23
- making a SOHVA, 32
- responding nonverbally, 22
- See Also** Response Messaging

System Clock, setting, 114

System Speed Dial

- dialing automatically with, 29
- programming, 102
- table of numbers, 103

System Status Log, 114

System Telephone Naming, 96

T

TAP Button

- function, 9
- location, 7, 11

Transfer/Conference Button

- function, 9
- location, 7, 11

Transferring Calls

- making a Hot Transfer, 50
- screened transfers, 48
- to the alternate attendant, 110
- unscreened transfers, 49
- using quick transfer, 50
- using serial call button, 112
- with E&M Tie Lines, 80

TRNS/CNF

- See** Transfer/Conference Button

U

Unsupervised Conferences, 41

V

VAB

- See** Voice Announce Block (VAB)

Voice Announce Block
 programming a button, 65

Volume Control
 initial settings, 84
 setting a default volume, 86

VOLUME DOWN Button
 function, 84
 location, 7, 11

VOLUME UP Button
 function, 84
 location, 7, 11

W

Walking Class of Service
 See Authorization Codes

Z

Zone Paging, 36

Notes

Notes

This manual has been developed by Comdial Corporation (the "Company") and is intended for the use of its customers and service personnel. The information in this manual is subject to change without notice. While every effort has been made to eliminate errors, the Company disclaims liability for any difficulties arising from the interpretation of the information contained herein.

The information contained herein does not purport to cover all details or variations in equipment or to provide for every possible contingency to be met in connection with installation, operation, or maintenance. Should further information be desired, or should particular problems arise which are not covered sufficiently for the purchaser's purposes, contact Comdial, Inside Sales Department, P.O. Box 7266, Charlottesville, Virginia 22906.

Comdial® strives to design the features in our communications systems to be fully interactive with one another. However, this is not always possible, as the combinations of accessories and features are too varied and extensive to insure total feature compatibility. Accordingly, some features identified in this publication will not operate if some other feature is activated.

Comdial® disclaims all liability relating to feature non-compatibility or associated in any way with problems which may be encountered by incompatible features. Notwithstanding anything contained in this publication to the contrary, Comdial makes no representation herein as to the compatibility of features.

GCA70-250.08 07/00
Printed in U.S.A.

Printed in U.S.A.
MKTBUD REV. 1

COMDIAL
The Rising Star

Comdial Corporation
1180 Seminole Trail
Charlottesville, VA
22901-2829
1-800-COMDIAL
www.comdial.com