

hp fax 1020 series



i n v e n t

User Guide

Copyright © 2001–2002 Hewlett-Packard Company
All rights are reserved. No part of the document may be photocopied, reproduced, or translated to another language without the prior written consent of Hewlett-Packard Company.

Publication number: C8580-90106 (Rev. B)

Second edition: April 2002

Printed in South Korea, China, or the European Union

Notice

The information contained in this document is subject to change without notice and should not be construed as a commitment by the Hewlett-Packard Company.

Hewlett-Packard assumes no responsibility for any errors that may appear in this document, nor does it make expressed or implied warranty of any kind with regard to this material, including, but not limited to the implied warranties of merchantability and fitness for a particular purpose. The Hewlett-Packard Company shall not be liable for incidental or consequential damages in connection with, or arising out of the furnishing, performance, or use of this document and program material which it describes.

Note: Regulatory information can be found in the Specification section.

It is not lawful in many places to make copies of the following items. When in doubt, check with a legal representative first.

- Governmental paper or documents
 - Passports
 - Immigration papers
 - Selective service papers
 - Identification badges, cards or insignias
- Governmental stamps:
 - Postage stamps
 - Food stamps
- Checks or drafts drawn on Governmental agencies
- Paper currency, traveler's checks, or money orders
- Certificates of deposit
- Copyrighted works

Safety Information

WARNING

To prevent fire or shock hazard, do not expose this product to any type of moisture.

Always follow basic safety precautions when using this product to reduce risk of injury from fire or electric shock.

WARNING: Potential Shock Hazard

- Read and understand all instructions in the Setup Poster.
- Use only a grounded outlet when connecting the HP Fax to a power source. If you do not know whether the outlet is grounded, check with a qualified electrician.
- Telephone lines can develop hazardous voltages. To avoid electrical shock, do not touch the contacts on the end of the cord, or any of the sockets on the HP Fax. Replace damaged cords immediately.
- Never install telephone wiring during a lightning storm.
- Observe all warnings and instructions marked on the product.
- Unplug this product from wall outlets and telephone jacks before cleaning.
- Do not install or use this product near water or when you are wet.
- Install the product securely on a stable surface.
- Install the product in a protected location where no one can step on or trip over the line cord, and where the line cord will not be damaged.
- If the product does not operate normally, see the Troubleshooting section of this user guide.
- No operator-serviceable parts inside. Refer servicing to qualified service personnel.
- Use in a well ventilated area.

Quick Start

Follow these instructions to quickly use your HP Fax 1020 Series. Later chapters include more detailed instructions.

- **Loading paper** [page Q-2](#)
- **Setting the paper size** [page Q-3](#)
- **Sending a fax** [page Q-4](#)
- **Receiving a fax** [page Q-5](#)
- **Making a copy** [page Q-6](#)
- **Making telephone calls** [page Q-6](#)
- **Receiving telephone calls** [page Q-7](#)
- **Using the answering machine** [page Q-8](#)

Loading paper

To load paper follow these instructions.

- 1 Pull the paper tray cover forward.

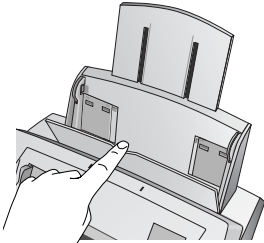

- 2 Fan, neatly stack, then insert up to 100 sheets of paper.

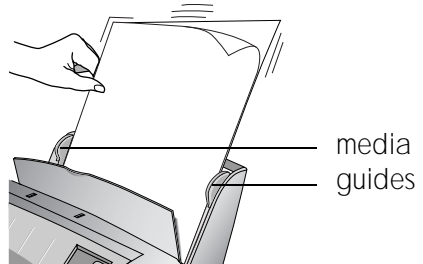
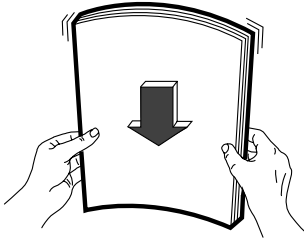

If necessary, **squeeze** and move the media guides until they touch the paper.

- a Squeeze and move the right media guide until it is set to the correct paper size: LTR/LGL or A4.
 - b Squeeze and move the left media guide until it is touching the edge of the paper.
- 3 Push the paper tray cover back into place.

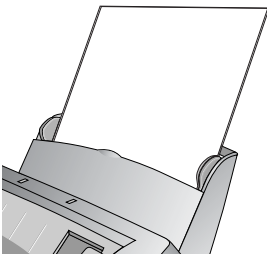

Setting the paper size

The fax machine can print on three paper sizes: Letter, A4, and Legal. Letter or A4 will be the default paper size, depending on the country setting.

Tip! If your faxes are being clipped in width or length, verify that the correct country is selected under the Country and Language menu option. [See “Changing the Country and Language” on page 55.](#)

To change to a different paper size:

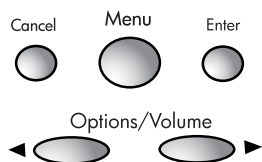

- 1 Press **Menu**.
1: Fax Functions will display.
- 2 Press **4**.
4: Basic Setup will display.
- 3 Press **Enter**.
1: Date & Time will display.
- 4 Press **7**.
7: Paper Size will display.
- 5 Press **Enter**.
The default paper size for your country will display.
- 6 Use the arrow buttons (◀ ▶) to scroll to the new paper size and press **Enter**. The options are Letter, A4, and Legal.
- 7 Press **Cancel** repeatedly to exit the menu.

Loading documents to fax or copy

You can load up to 20 pages in the document feeder. Load the documents face down (printed side toward the machine).

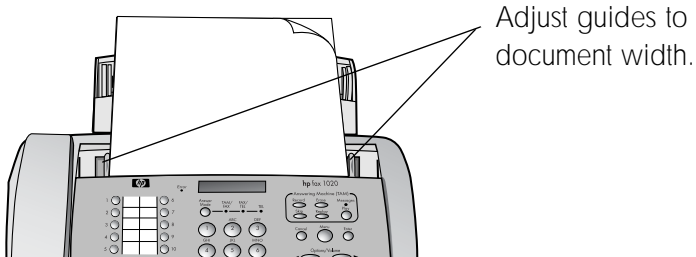

Sending a fax

You can send a fax in one of two ways:

- The standard method scans and sends each page.
- The **Scan & Fax** button scans all of the pages before starting to send. This is very useful for multiple page faxes so that you can ensure all the pages are scanned properly before dialing.

Standard faxing

- 1 Place the document (up to 20 pages) to be sent face down in the document tray.
- 2 Dial the number by using one of these methods:
 - Entering the number and pressing **Start/Copy**.
 - Pressing a **One Touch** button.
 - Pressing the **Speed Dial** button, entering a speed dial code and pressing **Start/Copy**. [See "Using Speed Dialing and Broadcasting" on page 17.](#)

Note: One touch buttons and speed dial codes must have been previously programmed.

Scan & Fax

- 1 Place the document to be sent face down in the document tray.
- 2 Press **Scan & Fax**.
- 3 Dial the number by using one of these methods:
 - Entering the number and pressing **Start/Copy**.
 - Pressing a **One Touch** button.
 - Pressing the **Speed Dial** button, entering a speed dial code and pressing **Start/Copy**. [See "Using Speed Dialing and Broadcasting" on page 17.](#)

Note: One touch buttons and speed dial codes must have been previously programmed.

Receiving a fax

How faxes are received depends on how the **Answer Mode** is set.

TEL Answer Mode

If the Answer Mode is set to TEL, you must manually receive faxes.

- 1 Answer the telephone.
- 2 If you hear fax tones, press the **Start/Copy** button.
- 3 Once you hear fax tones from both machines (this may take several seconds), you may hang up the telephone.

FAX or TAM/FAX Answer Mode

If the Answer Mode is set to FAX or TAM/FAX, the fax machine will answer the telephone, automatically detect fax tones, and receive a fax.

Tip! If you answer the telephone and hear fax tones, press the **Start/Copy** button to receive the fax.

Making a copy

To make a copy, follow these instructions:

- 1 Place the document to be copied face down in the document tray.
- 2 Press **Start/Copy**.
- 3 If you want more than one copy, use the number pad to enter the number of copies.
- 4 Press **Start/Copy**.

Tip! For fewer than 10 copies, you must enter the leading 0; for example, for 3 copies, enter 03.

Making telephone calls

- 1 Pick up the handset or press **Speaker Phone**.
- 2 Dial the number by using one of these methods:
 - Entering the number.
 - Pressing a **One Touch** button.
 - Pressing the **Speed Dial** button, entering a speed dial code, and pressing **Start/Copy**.

Note: One touch buttons and speed dial codes must have been previously programmed. [See "Using Speed Dialing and Broadcasting" on page 17.](#)

Receiving telephone calls

When the telephone rings, pick up the handset or press the **Speaker Phone** button.

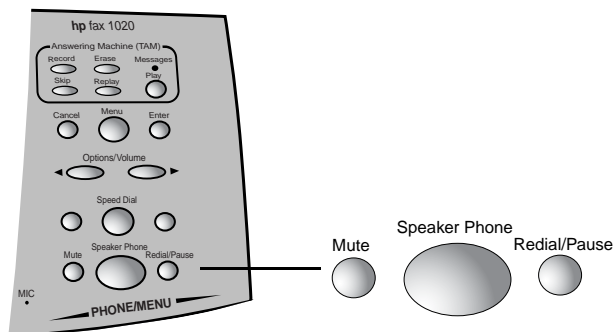

Tip! To hang up the speaker phone, simply press the Speaker Phone button again.

Important: If the fax is already printing and you hear fax tones when you answer the telephone, just press **Start/Copy** to receive the fax. The new fax will print after the previous fax has finished printing.

If the telephone continues to ring after you lift the handset, the fax is busy. To answer the telephone, halt the current activity by pressing the **Stop** or **Cancel** button.

Using the answering machine

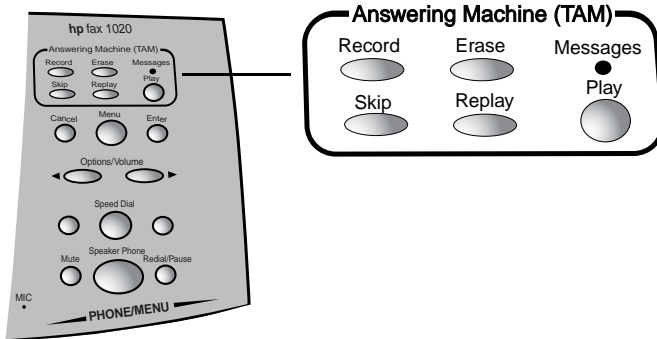

- 1 Press the **Record** button twice.

Tip! In Canada, Latin America, and the U.S. only: for the best sound quality, use the handset to record your OGM instead of the speakerphone. Lift the handset after you have pressed the **Record** button once, then press **Record** again to begin recording your OGM. You must wait until after you have pressed **Record** to pick up the handset.

- 2 Record your outgoing message (OGM) and press **Record** to end the recording.

Note: For best fax reception make your OGM as short as possible; however, it must be at least 2 seconds long.

- 3 Press the **Answer Mode** button on the front panel until **TAM/FAX** is lit.
- 4 To play received messages, press the **Play** button.

Tip! To change your OGM, simply re-record it.

Tip! If you pick up an extension phone while the HP Fax is playing the OGM or recording a message, pressing * then # on the extension phone will turn off the answering machine.

Table of Contents

1	The Front Panel and Menus	1
	The Front Panel	1
	The Menu	3
	Navigating the menu	4
	Entering dates, times, text, and telephone numbers	5
2	Setting Up to Receive Faxes	7
	Setting the Answer Mode	8
	Setting the TAM/FAX Ring	8
	Setting the FAX Ring	10
	Using Answer Pattern (Distinctive Ring Pattern)	12
	Example	12
	Setting the answer pattern	13
	Silent Detect	14
	Using an External Answering Machine	15
	Using Caller ID—U.S. and Canada only	15
	Turning on Caller ID	15
	Printing a list of calls	16
3	Using Speed Dialing and Broadcasting	17
	Setting up Speed Dials and One Touch Buttons	17
	Programming speed dials	18
	Dialing a Programmed Number	19
	Dialing with One-Touch buttons	20
	Dialing with Speed Dial codes	20
	Sending a Fax to Several People	20
	Creating the broadcast list	20
	Sending a broadcast fax	22
	Deleting an Entry	23
	Printing the Speed Dial or Broadcast List	24

Printing the speed dial list	24
Printing the broadcast list	24
4 Answering Machine	25
Recording Outgoing Messages	26
To record the outgoing message	26
To play the outgoing message	26
Listening to Messages	27
Setting Rings	27
Screening Calls	28
Changing the Length of Messages	29
Listening to Messages Remotely	30
Establishing your PIN code	30
Retrieving messages	31
5 Fax Functions.	33
Receiving Faxes	33
Fax polling	33
Sending a Fax	34
Standard method	34
Scan & Fax	35
Sending a fax to multiple numbers	37
Sending your fax at a later time	38
Fax Settings	39
Contrast	39
Resolution	40
Fax reduction	42
Printing Reports	43
Fax Forwarding	45
6 Copy Functions	47
Making Copies	47
Changing Copy Contrast and Resolution	47
Reducing Copies	48
Collating Copies	49
7 Other Features	51
Changing the Date and Time	51
Changing the Fax Header	52

Setting Auto Reports	52
Turning Beep Sounds On and Off	53
Setting ECM	54
Changing the Country and Language	55
Resetting the Defaults	56

8 Telephone Functions 57

Making Telephone Calls	57
Receiving Telephone Calls	58
Changing Volume	58
Handset and speaker volume	59
Ring volume	59
Redialing	60

9 Maintenance and Troubleshooting 61

Cleaning the Print Cartridge	62
Changing Print Cartridges	62
Printing Faxes Stored in Memory	63
Messages on the Display and Error Log	64
Troubleshooting	66
Clearing Paper Jams	68
Clearing document jams	68
Clearing paper jams	69

10 Specifications and Regulatory 71

Paper Types and Sizes	71
Print Cartridge	71
Product Specifications	72
Regulatory Information	74
Use Hewlett-Packard Support Services	78
Warranty	79

11 Index 81

1 The Front Panel and Menus

The Front Panel

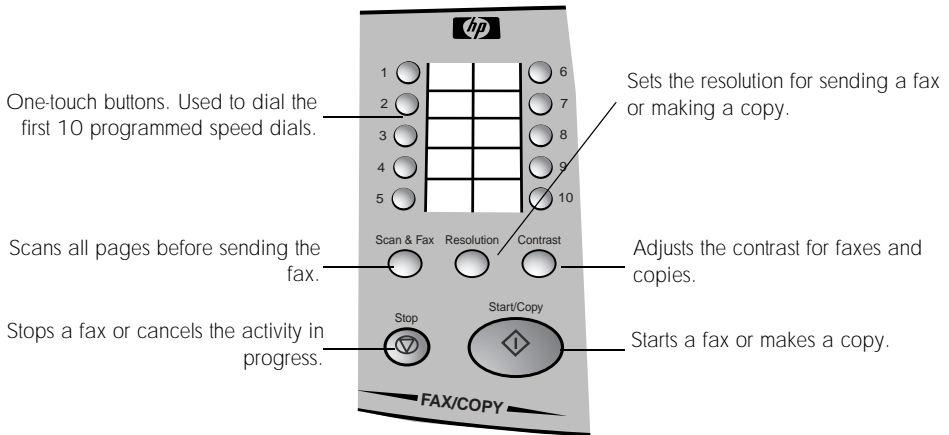

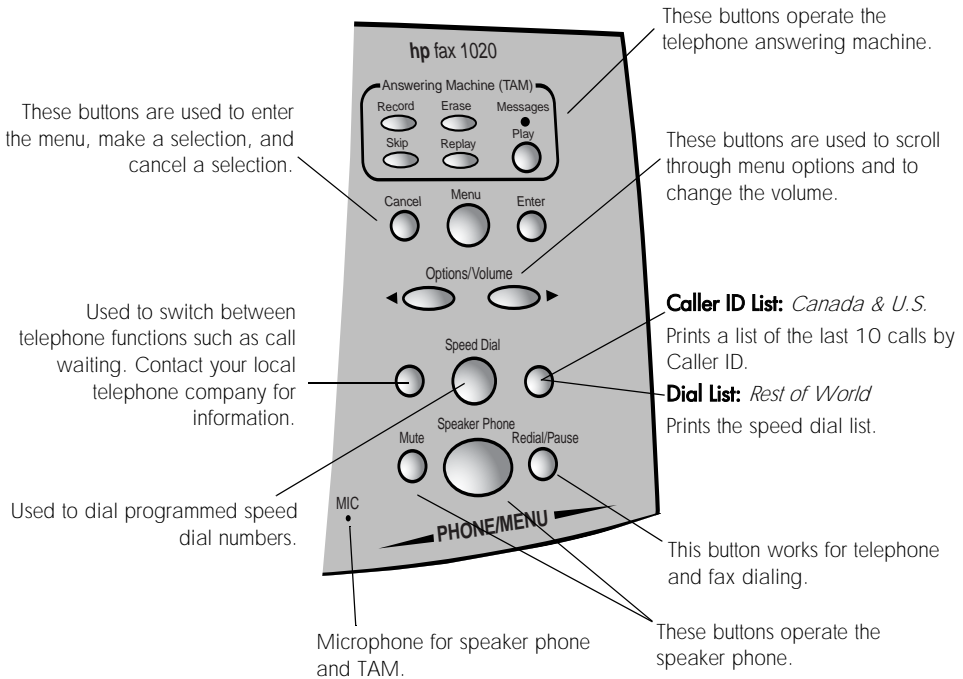
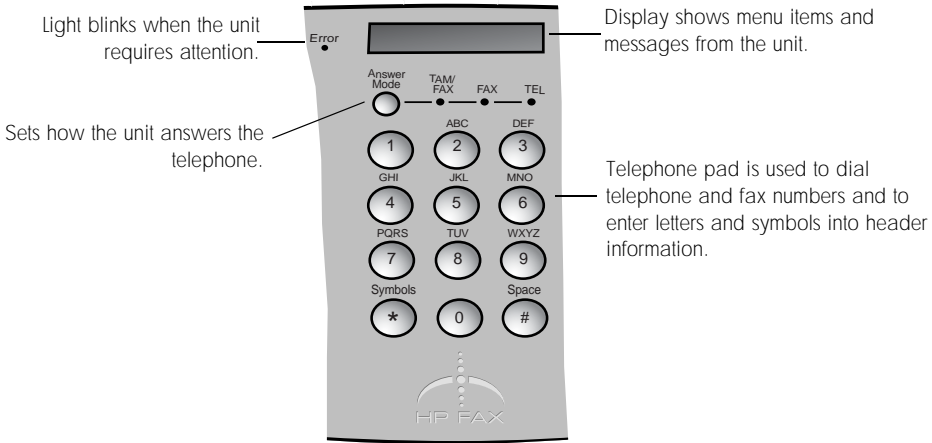

The Menus

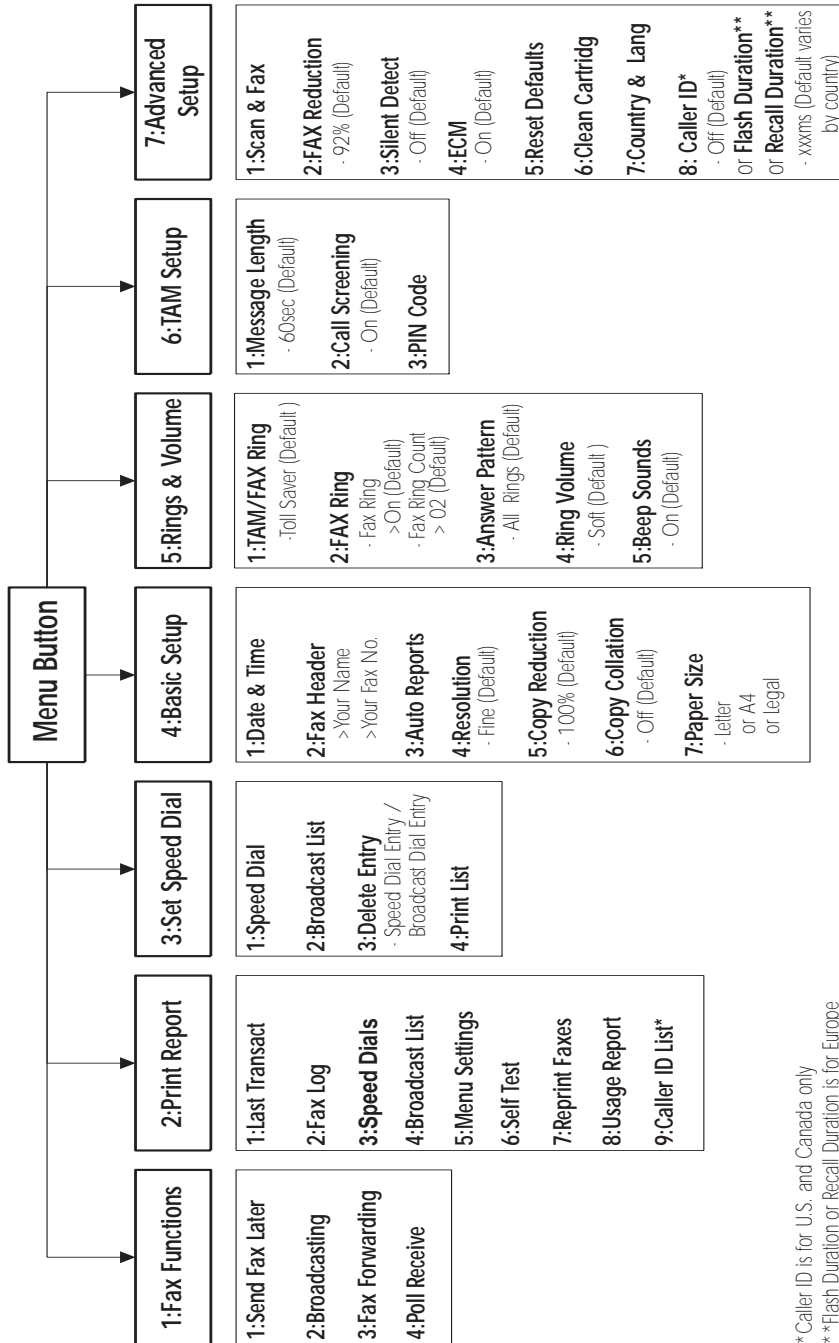

* Caller ID is for U.S. and Canada only

** Flash Duration or Recall Duration is for Europe

Navigating the menus

Use the Menu buttons to navigate the menu items.

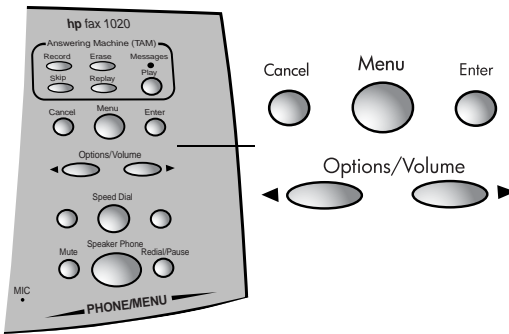

- Press the **Menu** button to access the menu system.
- If you know the menu item number, press that number. For example, you can get to **4: Basic Setup** either by pressing **4** or by using the arrow buttons (◀ ▶).
- Use the arrow buttons (◀ ▶) to scroll through the options on a particular level.
- Use the **Enter** button to select a menu option.
- Use the **Cancel** button to back up a level in the menu.
- Press the **Cancel** button repeatedly to exit the menus.

Example To change the default Resolution setting to Standard, you would take the following steps.

- 1 Press the **Menu** button.
1: Fax Functions will display.
- 2 Press **4**.
4: Basic Setup will display.
- 3 Press **Enter**.
1: Date & Time will display.
- 4 Press **4**.
4: Resolution will display.

- 5 Press **Enter**.
 Fi ne * will display.
 Tip! The * means that Fine is the current setting.
- 6 Press the right arrow button (▶) until **Standard** displays (2 times).
- 7 Press **Enter**.
- 8 Press the **Cancel** button repeatedly to exit the menu.

Entering dates, times, text, and telephone numbers

Some menu items ask you to enter dates, times or text. Here is the information to do that.

Dates The unit will ask you for a 4-digit year, 2-digit month, and a 2-digit day. The display will show the date in the proper format for your country.

Tip! If the date format seems unfamiliar, check that your country is selected under the Advanced Functions menu.

Time The unit will ask you for the time. If your country normally uses a 12-hour clock, you will be asked to choose am or pm.

Text To enter text, press the telephone keypad numbers repeatedly to scroll through the letters.

The letters and numbers scroll as shown next to each button:

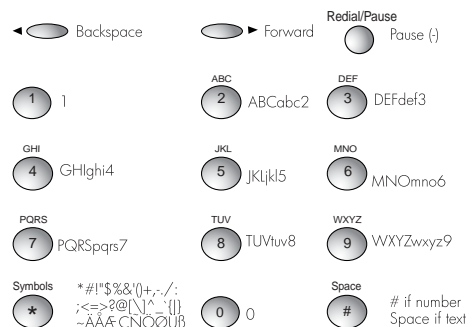

When the correct letter appears, wait for the cursor to move to the next space, then press the number for the next letter.

Telephone numbers To enter a telephone number, including in your header or when programming your speed dial codes, press the telephone keypad numbers. To put a pause or a dash (-) into a telephone number, use the **Redial/Pause** button. When you put a dash between numbers, a pause is entered.

Text and Number Lengths Each entry where you enter text or numbers has a maximum number of characters.

Item	Number of Characters
Fax Header Name	20
Fax Header Telephone Number	20
Speed Dial List Name	20
Speed Dial Telephone Number	32
Broadcast Dial Telephone Number	32
Fax Forward Telephone Number	32
Scan & Fax Telephone Number	200
Send Fax Later Telephone Number	32
Poll to Receive Telephone Number	32
Dialing from Number Pad	200

2 Setting Up to Receive Faxes

Follow these instructions to finish setting up your HP Fax 1020 Series to receive faxes. How the product receives faxes depends on the answer mode you chose when you set up the product.

How are you going to use your HP Fax?

Proceed to...

Fax machine with few or no voice calls.

See "FAX" on [page 8](#).

Telephone and fax machine using the internal answering machine.

See "TAM/FAX" on [page 8](#).

Using Distinctive Ring service to set up a separate telephone number for your fax.

[See "Using Answer Pattern \(Distinctive Ring Pattern\)" on page 12.](#)

As a fax machine with an external answering machine.

[See "Using an External Answering Machine" on page 15.](#)

Setting the Answer Mode

You can send faxes in any answer mode. The answer mode setting determines how the product answers the incoming call. Press the **Answer Mode** button until the light shows under the desired option.

**TAM/
FAX** ● Select this setting to use the integrated telephone answering machine. TAM/FAX allows you to receive both voice and fax calls with voice calls going to the answering machine if you are unable to take the call. See ["Setting the TAM/FAX Ring" on page 8](#) to set up the answering machine.

FAX ● Select this setting to have the product answer as a fax machine. You can pick up voice calls if you answer the telephone before the fax does. See ["Setting the FAX Ring" on page 10](#) to finish setting up your HP Fax.

Note: The internal answering machine will not work in this mode.

TEL ● Select this setting to have the product always answer as a telephone. To receive faxes, press the **Start/Copy** button whenever you hear fax tones.

Note: You will be unable to receive faxes from extension telephones. You must press the Start/Copy button to receive faxes.

Tip! After 12 rings, the TAM will answer the call. This allows you to use the remote access commands to operate your fax machine. See ["Listening to Messages Remotely" on page 30](#).

Setting the TAM/FAX Ring

If you have set the Answer Mode to TAM/FAX (["Setting the Answer Mode" on page 8](#)), you can use this function to select the number of times the telephone will ring before the answering machine will answer.

See ["Answering Machine" on page 25](#) for complete information on using the answering machine.

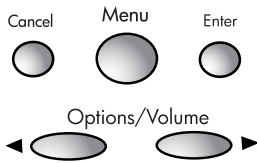

- 1 Press **Menu**.
1: Fax Functions will display.
- 2 Press **5**.
5: Rings & Volume will display.
- 3 Press **Enter**.
1: TAM/FAX Ring will display.
- 4 Press **Enter**.
Toll Saver * will display.
- 5 Use the arrow buttons (◀ ▶) to choose the number of rings to occur before the answering machine answers and press **Enter**.
The options are 1 through 6 and Toll Saver. Toll Saver is the default.
Toll Saver: Toll Saver allows you to save on telephone charges. The telephone will ring 4 times before the answering machine answers *unless* there are new messages. If there are new messages, the telephone will only ring 2 times. This function allows you to hang up before the machine answers when there are no new messages to be heard.
- 6 Press **Cancel** repeatedly to exit the menu.

Setting the FAX Ring

If you have set the Answer Mode to FAX (["Setting the Answer Mode" on page 8](#)), the product will answer the incoming call as a fax machine.

Important: You can answer this line as a telephone only if you answer before the HP fax.

Use this function to choose:

- whether the fax should ring audibly when a call is received
- the number of rings before the fax machine answers

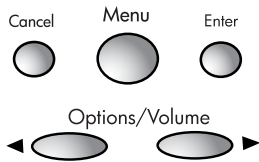

- 1 Press **Menu**.
1: Fax Functions will display.
- 2 Press **5**.
5: Rings & Volume will display.
- 3 Press **Enter**.
1: TAM/FAX Ring will display.
- 4 Press **2**.
2: FAX Ring will display.
- 5 Press **Enter**.
Fax Ring will display.
- 6 Press **Enter**.
On * will display.
- 7 Use the arrow buttons (◀ ▶) to choose whether you want the unit to ring audibly when a call is received. The options are:
 - On (default)
 - Silent

- 8 Press **Enter**.
Fax Ring Count will display.
2 * will display.
- 9 Use the arrow buttons (◀ ▶) to choose the number of rings before the fax machine answers.
1 through 9 are the options. 2 is the default.
- 10 Press **Enter**.
- 11 Press **Cancel** repeatedly to exit the menu.

Using Answer Pattern (Distinctive Ring Pattern)

Distinctive Ring is a service you subscribe to through your local telephone company (not all telephone companies provide this service). The telephone company will assign more than one telephone number to a single telephone line. Each telephone number is assigned a specific ring pattern. Ring patterns that are recognized by your HP Fax are single, double, triple, and double and triple.

If you have questions about how answer patterns work in your area, call your local telephone company.

Important! If you set a distinctive ring pattern, you will be unable to receive voice calls on that telephone number. The HP Fax will immediately answer that ring pattern with fax tones, ignoring all ring count settings. However, in FAX mode, the answering machine will pick up after 12 rings.

Incoming Ring		
Answer Mode	Matches Answer Pattern	Other Ring Pattern
TAM/FAX	Answers immediately with fax tones.	Answers according to TAM/FAX Ring setting.
FAX	Answers immediately with fax tones.	After 12 rings, the answering machine will answer. (The answering machine answers in FAX mode only if distinctive ring is used.)
TEL	Distinctive ring is ignored. You must manually answer the telephone. After 12 rings, the answering machine will answer.	Distinctive ring is ignored. You must manually answer the telephone. After 12 rings, the answering machine will answer.

Example

- You have a single telephone line and answer mode is set to TAM/FAX.
- The telephone company has given you two telephone numbers. One number will produce a Single Ring and one will produce a Double Ring pattern when called. You decide to use the number that produces a Double Ring for faxes.
- Set the HP Fax Answer Pattern to Double Ring.

- When the fax detects a Double Ring pattern, it immediately answers and attempts to receive a fax.
- When the fax detects a Single Ring pattern, the TAM Ring Count will be used before the HP Fax answers the call. Voice calls will be recorded on the answering machine.

Setting the answer pattern

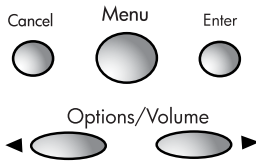

- 1 Press **Menu**.
1: Fax Functions will display.
- 2 Press **5**.
5: Rings & Volume will display.
- 3 Press **Enter**.
1: TAM/FAX Ring will display.
- 4 Press **3**.
3: Answer Pattern will display.
- 5 Press **Enter**.
- 6 Use the arrow buttons (◀ ▶) to choose the ring pattern that you want the unit to answer as a fax only and press **Enter**. The options are:
 - All Rings (default)
 - Single Rings
 - Double Rings
 - Triple Rings
 - Double&Triple

Note: If you do not have Distinctive Ring service, make sure that this feature is set to All Rings.
- 7 Press **Cancel** repeatedly to exit the menus.

Silent Detect

Silent Detect refers to receiving faxes from older machines that do not send fax tones. This setting causes the HP Fax to wait and attempt to receive a fax if it does not hear a voice.

Answer Mode	Silent Detect
FAX	Silent faxes will be automatically received. This setting is unneeded.
TAM/FAX	Set Silent Detect on <i>only</i> if you are expecting faxes from a silent machine. If you use Silent Detect the recommended setting is 7 seconds.

- 1 Press the **Menu** button.
1: Fax Functions will display.
- 2 Press **7**.
- 3 **7: Advanced Setup** will display.
- 4 Press **Enter**.
1: Scan & Fax will display.
- 5 Press **3**.
3: Silent Detect will display.
- 6 Press **Enter**.
Off * will display.
- 7 Use the arrow buttons (◀ ▶) to select the new setting you want and press **Enter**.
Options are 5 to 15 seconds and Off. Off is the default.
- 8 Press the **Cancel** repeatedly to exit the menu.

Important! Turn Silent Detect **Off** after you have received your fax.

Using an External Answering Machine

To use an external answering machine with your HP Fax follow these steps.

- 1 Set the Answer Mode to FAX. [See “Setting the Answer Mode” on page 8.](#)
- 2 Set the Fax Ring Count to be higher than the external answering machine’s ring count. [See “Setting the FAX Ring” on page 10.](#)

For example, set the external answering machine to answer in 4 rings and set the Fax Ring Count to be 6 rings.

The HP Fax will listen for fax tones once the answering machine has answered and will receive a fax if fax tones are heard. Your answering machine may record the fax tones.

Using Caller ID—U.S. and Canada only

Important! This feature is available only on products sold in the U.S. and Canada.

If you subscribe to Caller ID through your local telephone company, you can set your fax machine to display the number or name of the caller when the call is received. In addition, you can print a list of the numbers of the last 10 people who called.

Turning on Caller ID

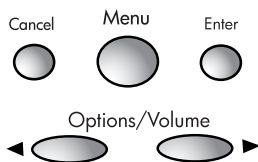

- 1 Press **Menu**.
1: Fax Functions will display.
- 2 Press **7**.
7: Advanced Setup will display.
- 3 Press **Enter**.
1: Scan & Fax will display.

- 4 Press **8**.
8: Caller ID will display.
- 5 Press **Enter**.
- 6 Press the right arrow button (▶) to scroll to **On** and press **Enter**.
- 7 Press **Cancel** repeatedly to exit the menu.

Printing a list of calls

There are two methods of printing a list of calls by Caller ID.

Front panel Press the **Caller ID List** button on the front panel to print a list of the last 10 calls.

Print Report menu You can also print the Caller ID List from the Print Report menu. [See "Printing Reports" on page 43.](#)

3 Using Speed Dialing and Broadcasting

Follow these instructions to set up Speed Dials and One-Touch buttons and to use the Broadcast List.

Speed Dials and One-Touch buttons allow you to program frequently called numbers (both telephone and fax) into your unit so you do not have to dial them each time.

The Broadcasting function allows you to send a fax to a distribution list of up to 30 people.

Setting up Speed Dials and One Touch Buttons.

You can program frequently called numbers into your fax machine. Each speed dial code can be programmed with both a telephone number and a fax number. The first 10 Speed Dial numbers are assigned to the One Touch buttons. Speed Dials can be dialed by pressing the One Touch button or entering the Speed Dial code.

If no document is loaded, pressing a One Touch button or entering a Speed Dial code will dial the telephone number. If a document is loaded, the fax number will be dialed.

Programming speed dials

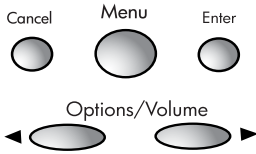

- 1 Press **Menu**.
1: Fax Functions will display.
 - 2 Press **3**.
3: Set Speed Dial will display.
 - 3 Press **Enter**.
1: Speed Dial will display.
 - 4 Press **Enter**.
01: Unassigned will display.
The first unassigned speed dial number is shown. You can use the arrow buttons (◀ ▶) to scroll through the list.
 - 5 Press **Enter**.
 - 6 Enter the name of the person (up to 20 characters) and press **Enter**. [See "Entering dates, times, text, and telephone numbers" on page 5.](#)
 - 7 Enter the fax number of the person and press **Enter**.
 - 8 Enter the telephone number of the person and press **Enter**.
 - 9 Repeat Steps 2–7 to enter another Speed Dial Code.
 - 10 Press **Cancel** repeatedly to exit the menus
- Tip!* Either the fax number or telephone number is optional.

Editing existing speed dial entries To edit existing entries follow these steps.

- 1 Follow Steps 1–4 in Setting Up Speed Dials.
- 2 Use the arrow buttons (◀ ▶) to scroll to the entry you want to change.
- 3 Press **Enter**.
- 4 Enter the new information and press **Enter** after each step.
- 5 Press **Cancel** repeatedly to exit the menus.

Dialing a Programmed Number

Whether the One-Touch buttons and speed dial codes dial telephone or fax numbers depends on whether or not a document is loaded for faxing.

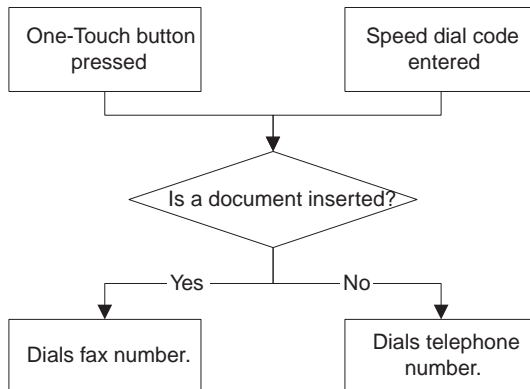

Dialing with One-Touch buttons

The first 10 speed dial codes are assigned to the One-Touch buttons and are dialed by pressing the corresponding button.

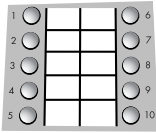

Peel off the protective film before trying to write next to the One-Touch buttons.

Dialing with Speed Dial codes

- 1 Press the **Speed Dial** button.
- 2 Enter the speed dial code.
- 3 Press **Start/Copy** or **Enter**.

Sending a Fax to Several People

You can use the Broadcast List to send a fax to a distribution list of up to 30 locations. First you must create the Broadcast List. Then you can send a fax to the distribution list.

Creating the broadcast list

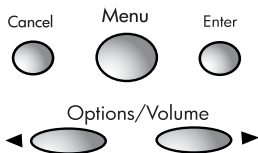

- 1 Press **Menu**.
1: Fax Functions will display.
- 2 Press **3**.
3: Set Speed Dial will display.

- 3 Press **Enter**.
1: Speed Di al will display.
- 4 Press **2**.
2: Broadcast Li st will display.
- 5 Press **Enter**.
Entry(01-30): 01 will display.
- 6 Enter the number you want to assign to this person (01-30) and press **Enter**.
Tip! Enter the leading zero. For number 3, enter 03.
- 7 Enter the fax number and press **Enter**.
- 8 Repeat Steps 2–7 for each person on the list.
- 9 Press **Cancel** repeatedly to exit the menus.

To print the Broadcast List, go to Print Reports and print report 4. [See "Printing Reports" on page 43.](#)

Note: You cannot delete the entire Broadcast List at once. You can delete individual entries using **3: Delete Entry** under **Set Speed Di al s**. [See "Deleting an Entry" on page 23.](#)

Sending a broadcast fax

You must have the Broadcast List already created before you can send a broadcast fax. [See "Creating the broadcast list" on page 20.](#)

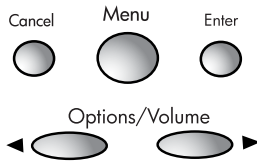

- 1 Place the document face down into the fax. The document must be in the machine before you select Broadcasting.
- 2 Press **Menu**.
1: Fax Functi ons will display.
- 3 Press **Enter**.
1: Send Fax Later will display.
- 4 Press **2**.
2: Broadcasti ng will display.
- 5 Press **Enter**.
Cancel * will display.
- 6 Use the right arrow button (▶) to scroll to **Send Now** then press **Enter**.
The fax will be transmitted to everyone in the Broadcast List.

Deleting an Entry

Use this feature to delete either a speed dial entry or a broadcast list entry.

- 1 Press **Menu**.
1: Fax Functions will display.
- 2 Press **3**.
3: Set Speed Dial will display.
- 3 Press **Enter**.
1: Speed Dial will display.
- 4 Press **3**.
3: Delete Entry will display.
- 5 Press **Enter**.
Speed Dial will display.
- 6 Use the arrow buttons (◀ ▶) to choose between Speed Dial and Broadcast.
- 7 Press **Enter**.
- 8 **Entry: 01** will display.
- 9 Enter the number of the entry you want to delete and press **Enter**.
- 10 Press **Cancel** repeatedly to exit the menus.

Printing the Speed Dial or Broadcast List

You can print lists of your speed dial and broadcast entries. This is especially useful when you need to edit your lists.

Printing the speed dial list

- 1 Press **Menu**.
1: Fax Functions will display.
- 2 Press **3**.
3: Set Speed Dial will display.
- 3 Press **Enter**.
1: Speed Dial will display.
- 4 Press **4**.
4: Print List will display.
- 5 Press **Enter**.

Printing the broadcast list

- 1 Press **Menu**.
1: Fax Functions will display.
- 2 Press **2**.
2: Print Reports will display.
- 3 Press **Enter**.
1: Last Transact will display.
- 4 Press **4**.
4: Broadcast List will display.
- 5 Press **Enter**.

4 Answering Machine

Important! To use the answering machine, the Answer Mode must be set to TAM/FAX. [See “Setting the Answer Mode” on page 8.](#)

Your fax machine includes an integrated telephone answering machine (TAM). The answering machine is digital. You do not need tapes or batteries. It will retain your messages in case of power failure. Follow these instructions to use the answering machine.

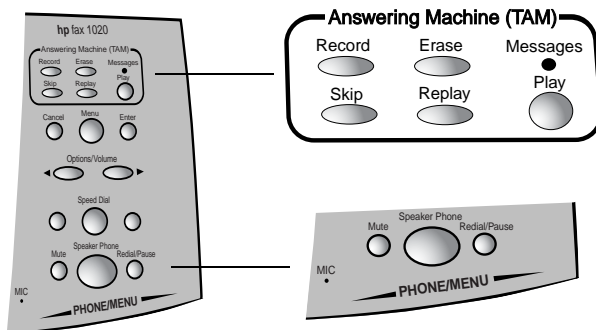

Recording Outgoing Messages

Before using the answering machine, you must record a greeting or outgoing message (OGM). The outgoing message must be between 2 and 40 seconds long. Keep your message as short as possible to ensure that all faxes are received.

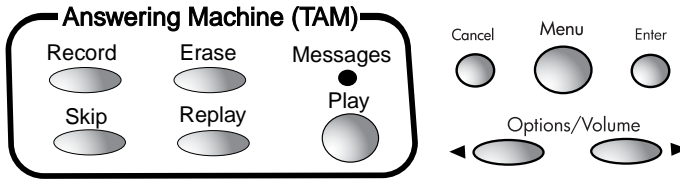

To record the outgoing message

Sample message: You have reached _____, to send a fax press Start now. To leave a voice message, wait for the tone then leave your message.

- 1 Press **Record**. An alternating message will display:

Play: play OGM / Record: rec. OGM

Tip! In Canada, Latin America, and the U.S. only: for the best sound quality, use the handset to record your OGM instead of the speakerphone. Lift the handset after you have pressed the Record button once, then press **Record** again to begin recording your OGM. You must wait until after you have pressed **Record** to pick up the handset.

- 2 Press **Record**.
Recording OGM. . . will display.
- 3 Wait until Recording OGM. . . displays, then record your message and press **Record** to end the message.

The OGM will play for you.

Tip! To change the OGM, simply re-record it.

To play the outgoing message

- 1 Press **Record**. An alternating message will display:

Play: play OGM / Record: rec. OGM

- 2 Press **Play** to play the message.

Listening to Messages

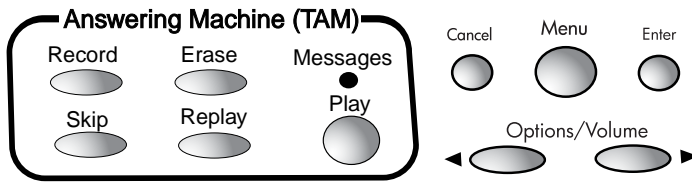

When messages have been received, the Messages light will blink. Use the buttons for the following tasks:

- **Play** — Plays all messages starting with the new ones. Pressing **Play** in the middle of a message will pause it; press **Play** again to restart.
Tip! The date and time of the message will display while the message is playing. The other buttons only work when the date and time is displaying. Wait until the date and time displays before pressing the other buttons.
- **Erase** — Erases the current message. When no messages are playing, you can erase all messages by pressing **Erase** then **Enter**.
- **Replay** — Replays the current message.
- **Skip** — Skips the current message and plays the next one.
- **Cancel** — Stops playing the messages.

Setting Rings

[See "Setting the TAM/FAX Ring" on page 8.](#)

Screening Calls

You can set the answering machine so that you can hear messages as they are being recorded. You can then choose to pick up the telephone. The default setting for Call Screening is On.

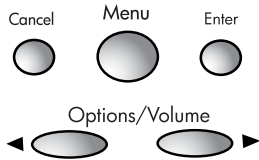

- 1 Press **Menu**.
1: Fax Functions will display.
- 2 Press **6**.
6: TAM Setup will display.
- 3 Press **Enter**.
1: Message Length will display.
- 4 Press **2**.
2: Call Screening will display.
- 5 Press **Enter**.
On * will display.
- 6 Use the arrow buttons (◀ ▶) to choose between On and Off and press **Enter**.
- 7 Press **Cancel** repeatedly to exit the menu.

Tip! If you pick up an extension phone while the HP Fax is playing the OGM or recording a message, pressing * then # on the extension phone will turn off the answering machine.

Changing the Length of Messages

You can change the time available for incoming messages from the default of 60 seconds to 30, 90, or 120 seconds.

The message length will be automatically adjusted for shorter messages. Messages longer than the setting will be cut off.

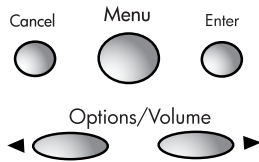

- 1 Press **Menu**.
1: Fax Functions will display.
- 2 Press **6**.
6: TAM Setup will display.
- 3 Press **Enter**.
1: Message Length will display.
- 4 Press **Enter**.
60 sec will display.
- 5 Use the arrow buttons (◀ ▶) to choose the new recording time (30, 60, 90, or 120 seconds) and press **Enter**.
- 6 Press **Cancel** repeatedly to exit the menu.

Listening to Messages Remotely

You can pick up your messages from any touch tone telephone using your PIN (personal identification number) Code. Select a 3-digit number that you will remember.

Important! If you want to access your TAM remotely, you must change the PIN Code from the default *000.

Establishing your PIN code

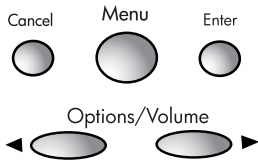

- 1 Press **Menu**.
1: Fax Functions will display.
- 2 Press **6**.
6: TAM Setup will display.
- 3 Press **Enter**.
1: Message Length will display.
- 4 Press **3**.
3: PIN Code will display.
- 5 Press **Enter**.
Pincode: *000 will display.
- 6 Type a new 3-digit code (for example, 487) and press **Enter**.
- 7 Press **Cancel** repeatedly to exit the menu.

Retrieving messages

- 1 Dial your fax machine from any touch tone telephone.
- 2 While the outgoing message is playing, enter an asterisk (*) plus the PIN Code you selected. For example, if your PIN Code is 123, you would enter *123.

Important: You must have changed the PIN Code from the default *000 for remote access to work.

- 3 Once the confirmation tone has played, you can control the answering machine using these codes. Hang up when you are done.

Code	Subcode	Operation
1		Play messages.
	1	Replay message
	2	Skip message.
	4	Pause message. (Press 4 again to resume.)
	8	Erase message. (Press * to confirm.)
3		Record outgoing message. (Press * to finish.)
4		Change answer mode.
	1	TEL (Press * to confirm.)
	2	FAX (Press * to confirm.)
	3	TAM/FAX (Press * to confirm.)
5		Fax forwarding
	1	On. Then enter number. (Press * to confirm. Press # to cancel.)
	2	Off (Press * to confirm.)
6		Change PIN code. (Enter new code and press * to confirm.)
9		Erase all messages. (Press * to confirm.)
*		Confirm change and return to top level of menu.
#		Cancels current item and returns to top level of menu.

Example of remote answering machine use Assume you are travelling away from home and want to check your answering machine and change your PIN code.

Your PIN code is 123. You want to change the PIN code to 456.

- 1 Dial the fax machine.
- 2 While your outgoing greeting is playing, press ***123**.
- 3 To listen to messages, press **1**.
Message 1 begins to play.
- 4 To skip Message 1, press **2**.
Message 2 begins to play.
- 5 To skip message 2, press **2**.
Message 3 begins to play
- 6 To erase Message 3, press **8***.
- 7 Message 3 is erased and you return to the main menu.
- 8 To change the PIN code, press **6** then **456***.

Tip! If you think you made a mistake, for example, by pressing **6 455**, just press **#** to return to the main menu, then press **6 456***.

Important: Press numbers firmly. Entering the numbers too quickly can cause them not to register.

5 Fax Functions

This chapter will introduce you to the various faxing features of the product.

Receiving Faxes

How you receive faxes depends on how Answer Mode is set. Be sure you have set the answer mode to best meet your needs. [See "Setting the Answer Mode" on page 8.](#)

Fax polling

Fax polling allows you to set your unit to call another fax machine and check for a waiting fax and then receive it. The waiting fax must be set up to be polled.

- 1 Press the **Menu** button.
1: Fax Functions will display.
- 2 Press **Enter**.
1: Send Fax Later will display.
- 3 Press 4.
4: Poll Receive will display.
- 4 Press **Enter**.
Enter Fax Number will display.
- 5 Type the fax number of the other machine and press **Enter**.

Sending a Fax

You can send a fax using several methods.

- Standard method—scans and sends each page
- Scan and fax—scans all of the pages before starting to send. This is very useful for multiple page faxes so that you can determine that all pages are scanned properly before sending starts.
- Send later—sends a fax at a later time; for example, when rates are lower.
- Sending to multiple numbers—sends a fax to everyone on a broadcast list

If the call is not completed, the fax will make 2 redial attempts at 3 minute intervals.

Standard method

- 1 Place the document to be sent face down in the document tray.
- 2 Dial the number by:
 - Using the number pad and pressing the **Start/Copy** button.
 - Touching a **One Touch** button.
 - Pressing **Speed Dial** and entering a speed dial code and pressing **Start/Copy**.

Note: One touch buttons and speed dial codes must have been previously programmed.

Dialing with a Calling Card (Monitor Dialing) If you need to listen to the tones (as when using a calling card), simply pick up the handset or press the **Speakerphone** button before dialing. After dialing the fax number, then press **Start/Copy**.

Scan & Fax

Scan & Fax can be used for an individual fax document or set as a default for all faxes. When you use Scan & Fax, all pages of the fax document are scanned before the number is dialed. This feature allows you to make sure that all pages are scanned properly before walking away from the machine.

If Memory Full displays, clear the pages from the fax and resend the document without using Scan & Fax.

Individual To scan and fax this document:

- 1 Insert the document in the tray.
- 2 Press the **Scan & Fax** button.
- 3 Dial the number and press **Start/Copy**.

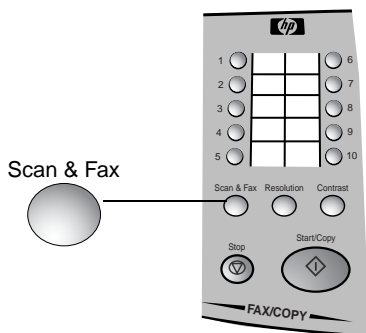

Set as Default To set Scan & Fax as the default for all faxes, follow these steps.

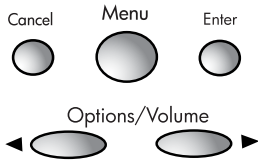

- 1 Press the **Menu** button.
1: Fax Functions will display.
- 2 Press **7**.
7: Advanced Setup will display.
- 3 Press **Enter**.
1: Scan & Fax will display.
- 4 Press **Enter**.
Off * will display.
- 5 Use the arrow buttons (◀ ▶) to scroll to **On** and press **Enter**.
- 6 Press the **Cancel** button repeatedly to exit the menu.

Sending a fax to multiple numbers

To send a fax to a distribution list (also called a broadcast list), you must first have created that distribution list. [See "Creating the broadcast list" on page 20.](#)

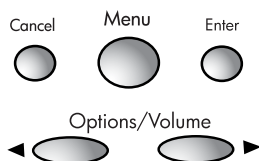

- 1 Place the document into the fax.
- 2 Press **Menu**.
 - 1: Fax Functions will display.
- 3 Press **Enter**.
 - 1: Send Fax Later will display.
- 4 Press **2**.
 - 2: Broadcasti ng will display.
- 5 Press **Enter**.
 - Cancel * will display.
- 6 Press the right arrow button (▶) to scroll to **Send Now** then press **Enter**.

The fax will be transmitted to everyone in the broadcast list.

Canceling a Broadcast Fax Repeat steps 2-6 above and select **Cancel** in step 6.

Sending your fax at a later time

To scan your fax to be sent at a later time (up to 23 hours and 59 minutes later), follow these steps.

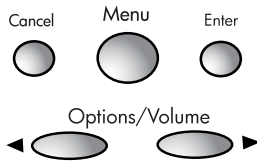

- 1 Insert the document in the document tray.
- 2 Press the **Menu** button.
1: Fax Functi ons will display.
- 3 Press **Enter**.
1: Send Fax Later will display.
- 4 Press **Enter**.
Cancel * will display.
- 5 Use the arrow buttons (◀ ▶) to scroll to **Set Up** and press **Enter**.
Ti me [xx: xx] will display.
- 6 Enter the new time and press **Enter**. (If your local time normally uses am and pm, you will be asked to select that as the next step.)
Enter Fax Number will display.
- 7 Enter the fax number and press **Enter**.
The pages are scanned into the machine and wait in memory until time to be sent.

Fax Settings

Several settings are available to change the appearance of your sent faxes. These settings do not affect incoming faxes.

Contrast

The contrast button on the front panel allows you to lighten or darken the image for the next fax you send or copy you make. Contrast reverts to the middle setting after each use.

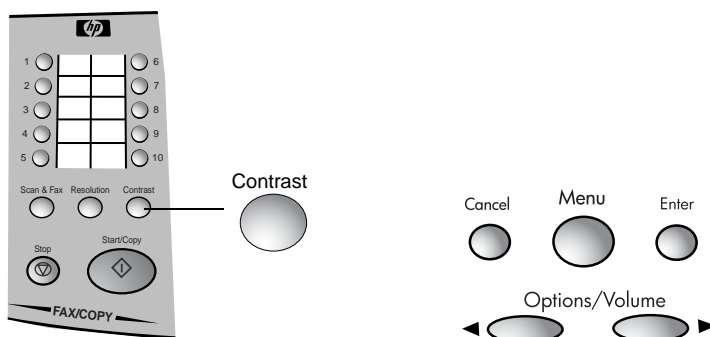

- 1 Insert the document.
- 2 Press the **Contrast** button.
Li ght[■]Dark will display.
- 3 Use the arrow buttons (◀ ▶) to move the solid rectangle to the setting you want and press **Enter**.

Tip! Check the fax send quality by making a copy.

Resolution

Resolution sets the quality of faxes you send and copies you make. You can adjust resolution for an individual fax or copy or for all faxes and copies.

Individual Resolution To set Resolution for an individual fax or copy, use the **Resolution** button on the front panel.

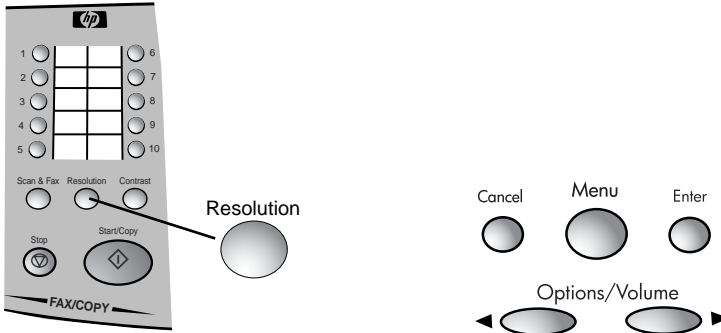

- 1 Insert the document.
- 2 Press the **Resolution** button.
Fi ne will display.
- 3 Press the **Resolution** button until the option you want displays.

The available options are Standard, Fine, and Photo. Choose Photo if your fax contains photos, color, or shades of gray. Photo mode is much slower but will give better quality in those instances.

Tip! Check the fax send quality by making a copy.

Set as Default To set a default resolution for all faxes and copies, follow these steps.

- 1 Press the **Menu** button.
1: Fax Functions will display.
- 2 Press **4**.
4: Basic Setup will display.
- 3 Press **Enter**.
1: Date & Time will display.
- 4 Press **4**.
4: Resolution will display.
- 5 Press **Enter**.
Fine * will display.
- 6 Use the arrow buttons (◀ ▶) to scroll to the setting you want (Standard, Fine, or Photo) and press **Enter**.
- 7 Press the **Cancel** button repeatedly to exit the menus.

Fax reduction

You can set a percentage for received faxes to be reduced. Follow these steps.

- 1 Press the **Menu** button.
1: Fax Functions will display.
- 2 Press **7**.
7: Advanced Setup will display.
- 3 Press **Enter**.
1: Scan & Fax will display.
- 4 Press **2**.
2: Fax Reduction will display.
- 5 Press **Enter**.
92% * will display.
- 6 Use the arrow buttons (◀ ▶) to scroll to the option you want and press **Enter**.

The available options are:

- 50%—minimum
- 72%—Legal to Letter
- 87%—Letter to A4 or A4 to Letter
- 92% —Full/Entire Page (default)
- 100%

Printing Reports

Your HP Fax contains a number of reports that you can print. To print each report, follow these steps.

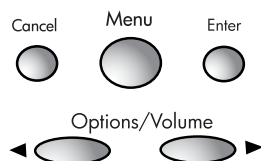

- 1 Press the **Menu** button.
1: Fax Functions will display.
- 2 Press 2.
2: Print Reports will display.
- 3 Press **Enter**.
1: Last Transact will display.
- 4 Use the arrow buttons (◀ ▶) to scroll to the report you want to print and press **Enter**. (You can also press the number of the report.)
- 5 Press the **Cancel** button until the date and time appear.

The reports you can print include:

1:Last Transact	Prints a report of the last fax transaction.
2:Fax Log	Prints an activity report of the last 30 faxes. In some countries, this report can be printed by a front panel button.
3:Speed Dials	Prints a list of the programmed Speed Dial names and numbers. In some countries, this report can be printed by a front panel button.
4:Broadcast List	Prints the Broadcast distribution list.
5:Menu Settings	Prints a map of the menus—including the changeable menu items and their current settings.
6:Self Test	Prints a test page.
7:Reprint Faxes	Prints faxes stored in memory. Especially useful, if you ran out of ink or paper while receiving faxes.

Note: If the fax has lost power, faxes in memory will be lost.

8:Usage Report

This report may be requested or used during product servicing.

9:Caller ID List

If you live in the U.S. or Canada AND you subscribe to Caller ID, this reports prints the last 10 calls and who they were from. This report can also be printed by a front panel button.

Fax Forwarding

Fax forwarding allows you to forward incoming faxes to another fax machine. To use fax forwarding follow these steps.

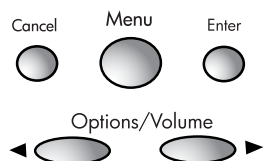

- 1 Press the **Menu** button.
1: Fax Functions will display.
- 2 Press **Enter**.
1: Send Fax Later will display.
- 3 Press **3**.
3: Fax Forwarding will display.
- 4 Press **Enter**.
Cancel * will display.
- 5 Press the right arrow button (▶) to scroll to **Set Up** and press **Enter**.
Enter Fax Number will display.
- 6 Enter the fax number for the faxes to be sent to and press **Enter**.
- 7 Press the **Cancel** button repeatedly to exit the menus.

Note: If the fax cannot be forwarded, it will print at your HP Fax rather than the remote location.

All received faxes remain in the fax memory and can be printed using Reprint Faxes. [See "Printing Faxes Stored in Memory" on page 63.](#)

Turn off fax forwarding Follow these steps to turn off fax forwarding.

- 1 Repeat Steps 1-4 above.
- 2 Press the right arrow button (▶) to scroll to **Cancel** and press **Enter**.

6 Copy Functions

Your HP Fax also functions as a convenience copy machine.

Making Copies

To make copies follow these steps.

- 1 Insert the document.
- 2 Change any desired settings; such as, contrast, resolution, reduction and collation.
- 3 Press the **Start/Copy** button.
- 4 If you want more than one copy, use the number pad to enter the number of copies you want.
- 5 Press the **Start/Copy** button.

Changing Copy Contrast and Resolution

[See "Contrast" on page 39.](#)

[See "Resolution" on page 40.](#)

Reducing Copies

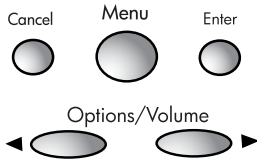

To reduce the size of your copies follow these steps.

- 1 Press the **Menu** button.
1: Fax Functions will display.
- 2 Press **4**.
4: Basic Setup will display.
- 3 Press **Enter**.
1: Date & Time will display.
- 4 Press **5**.
5: Copy Reduction will display.
- 5 Press **Enter**.
100% * will display.
- 6 Use the arrow buttons (◀ ▶) to scroll to the option you want and press **Enter**.
- 7 Press the **Cancel** button repeatedly to exit the menu.
The available options are:
 - 50%—minimum
 - 72%—Legal to Letter
 - 87%—Letter to A4 or A4 to Letter
 - 92% —Full/Entire Page
 - 100% (default)

Collating Copies

To collate your copies, follow these steps.

- 1 Press the **Menu** button.
1: Fax Functions will display.
- 2 Press **4**.
4: Basic Setup will display.
- 3 Press **Enter**.
1: Date & Time will display.
- 4 Press **6**.
6: Copy Collation will display.
- 5 Press **Enter**.
Off * will display.
- 6 Press the right arrow button (▶) to scroll to **On** and press **Enter**.
- 7 Press the **Cancel** button until the date and time display.

If Memory Full displays, remove the page that is halfway through the fax. Try your copy again either with smaller sets of pages or without collation.

7 Other Features

This chapter explains some additional items that you may choose to change.

Changing the Date and Time

- 1 Press the **Menu** button.
1: Fax Functions will display.
- 2 Press **4**.
4: Basic Setup will display.
- 3 Press **Enter**.
1: Date & Time will display.
- 4 Press **Enter**.
Year: will display.
Enter the date and time pressing **Enter** after each entry. If your country normally uses am and pm, you will be asked to choose after entering the time.
- 5 Press **Cancel** repeatedly to exit the menus.

Changing the Fax Header

This information is required by law in many countries.

- 1 Press the **Menu** button.
1: Fax Functions will display.
- 2 Press **4**.
4: Basic Setup will display.
- 3 Press **Enter**.
1: Date & Time will display.
- 4 Press **2**.
2: Fax Header will display.
- 5 Press **Enter**.
Your Name will display.
- 6 Enter your name and press **Enter**. [See "Entering dates, times, text, and telephone numbers" on page 5.](#)
Your Fax No. will display.
- 7 Enter your fax number and press **Enter**.
- 8 Press **Cancel** repeatedly to exit the menus.

Setting Auto Reports

This setting determines when error reports will automatically be printed.

- 1 Press the **Menu** button.
1: Fax Functions will display.
- 2 Press **4**.
4: Basic Setup will display.
- 3 Press **Enter**.
1: Date & Time will display.
- 4 Press **3**.
3: Auto Reports will display.

- 5 Press **Enter**.
Every Error * will display.
- 6 Use the arrow buttons (◀ ▶) to choose an option and press **Enter**.
Available options are: Every Error (default), Send and Error, Send Only, and Off.
- 7 Press **Cancel** repeatedly to exit the menus.

Turning Beep Sounds On and Off

Use this function to turn on and off the beeps.

Important! Turning off the beeps made with button presses also turns off the error beeps.

- 1 Press the **Menu** button.
1: Fax Functions will display.
- 2 Press **5**.
5: Ri ngs and Vol ume will display.
- 3 Press **Enter**.
1: TAM/FAX Ri ng will display.
- 4 Press **5**.
5: Beep Sounds will display.
- 5 Press **Enter**.
On * will display.
- 6 Use the arrow buttons (◀ ▶) to choose an option and press **Enter**.
Available options are: On and Off.
- 7 Press **Cancel** repeatedly to exit the menu

Setting ECM

Error correction mode—Reduces data lost due to poor telephone lines. On good telephone lines, ECM has little to no effect. On poor lines, it increases sending time and possibly telephone charges, but sends the data much more reliably.

- 1 Press the **Menu** button.
1: Fax Functions will display.
- 2 Press **7**.
7: Advanced Setup will display.
- 3 Press **Enter**.
1: Scan & Fax will display.
- 4 Press **4**.
4: ECM will display.
- 5 Press **Enter**.
On * will display.
- 6 Use the arrow buttons (◀ ▶) to choose an option and press **Enter**.
Available options are: On and Off.
- 7 Press **Cancel** repeatedly to exit the menu

Changing the Country and Language

This product is approved for use only in the country in which it was purchased. Local country laws may prohibit the use of this product outside the country of purchase. It is strictly forbidden by law in virtually every country to connect nonapproved telecommunications equipment (fax machines) to public telephone networks.

- 1 Press the **Menu** button.
1: Fax Functions will display.
- 2 Press **7**.
7: Advanced Setup will display.
- 3 Press **Enter**.
1: Scan & Fax will display.
- 4 Press **7**.
7: Country & Lang will display.
- 5 Press **Enter**.
A country will display.
- 6 Use the arrow buttons (◀ ▶) to choose a country and press **Enter**.
A language will display.
- 7 Use the arrow buttons (◀ ▶) to choose a language and press **Enter**.
- 8 Press **Cancel** repeatedly to exit the menu

Resetting the Defaults

- 1 Press the **Menu** button.
1: Fax Functions will display.
- 2 Press **7**.
7: Advanced Setup will display.
- 3 Press **Enter**.
1: Scan & Fax will display.
- 4 Press **5**.
5: Reset Defaults will display.
- 5 Press **Enter**.

8 Telephone Functions

Making Telephone Calls

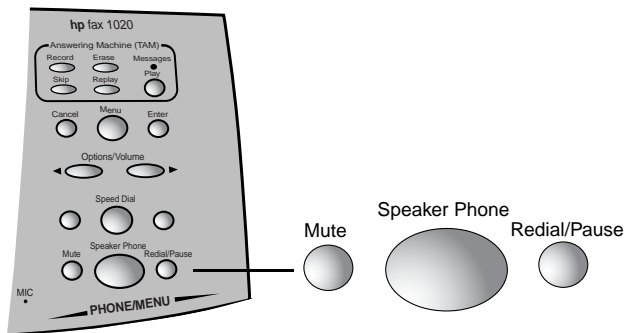

- 1 Pick up the handset or press **Speaker Phone**.
- 2 Dial the telephone number by
 - Using the number pad
 - Touching a one touch button (with no document in the fax)
 - Pressing **Speed Dial**, entering a speed dial code, and pressing **Enter** (with no document in the fax).

Note: One touch keys and speed dial codes must have been previously programmed. [See "Using Speed Dialing and Broadcasting" on page 17.](#)

Receiving Telephone Calls

When the telephone rings, pick up the handset or press the **Speaker Phone** button.

Important: If the fax is already printing and you hear fax tones when you answer the telephone, just press **Start/Copy** to receive the fax. The new fax will print after the previous fax has finished printing.

If the telephone continues to ring after you lift the handset, the fax is busy. To answer the telephone, halt the current activity by pressing the **Stop** or **Cancel** button.

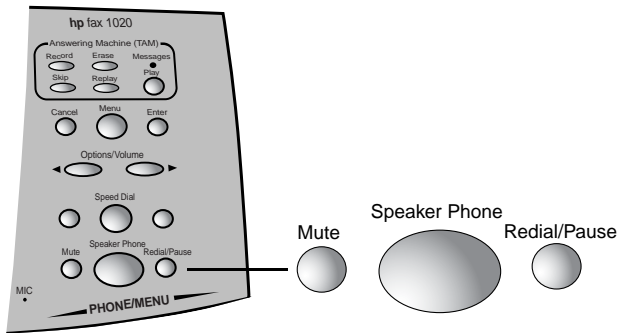

Tip! To hang up the speaker phone, simply press the Speaker Phone button again.

Changing Volume

You can change the volume of the handset (except in Europe), speaker phone, answering machine (call screening, message playback, and OGM playback) and the rings on the telephone.

Handset and speaker volume

Note: In Europe, you can only adjust the volume for the speaker, not the handset.

To adjust the volume for the current call, press the right and left volume buttons repeatedly until the desired level is reached.

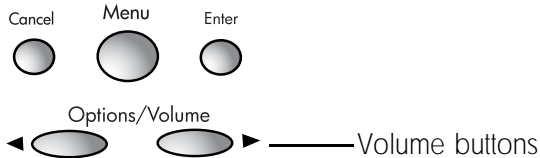

Ring volume

Follow these steps to adjust the ring volume for the unit.

- 1 Press the **Menu** button.
1: Fax Functions will display.
- 2 Press **5**.
5: Rings & Volume will display.
- 3 Press **Enter**.
1: TAM/FAX Ring will display.
- 4 Press **4**.
4: Ring Volume will display.
- 5 Press **Enter**.
Soft * will display.
- 6 Use the arrow buttons (◀ ▶) to scroll to the option you want and press **Enter**.
The available options are Soft, Loud, and Off. Soft is the default.
- 7 Press the **Cancel** button repeatedly to exit the menu.

Redialing

To redial the last number dialed, press the **Redial** button.

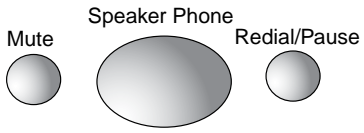

9 Maintenance and Troubleshooting

The procedures and information in this chapter will allow you to maintain your HP Fax and troubleshoot problems you may encounter. This chapter also includes:

- Cleaning print cartridges
- Changing print cartridges
- Printing faxes stored in memory
- Messages
- Troubleshooting

Cleaning the Print Cartridge

If you start seeing streaks or missing parts in your printing, first look at the print cartridge to make sure you still have ink. If you have ink and still have problems, make sure paper is loaded and follow these steps.

- 1 Press **Menu**.
1: Fax Functions will display.
- 2 Press **7**.
- 3 **7: Adv. Setup** will display.
- 4 Press **Enter**.
- 5 **1: Scan & Fax** will display.
- 6 Press **6**.
- 7 **6: Clean Cartridge** will display.
- 8 Press **Enter**.

A series of special printing sequences will clean the cartridge.

- 9 Discard the sheet.

If you clean the cartridge a couple of times and still have print quality problems, replace the print cartridge.

Changing Print Cartridges

When your print cartridge is low on ink, you may see streaks on your faxes or areas of missing ink. To replace the print cartridge follow these instructions.

- 1 Make sure power is on.
- 2 Open the print cartridge doors and wait for the cartridge carriage to move to the center.

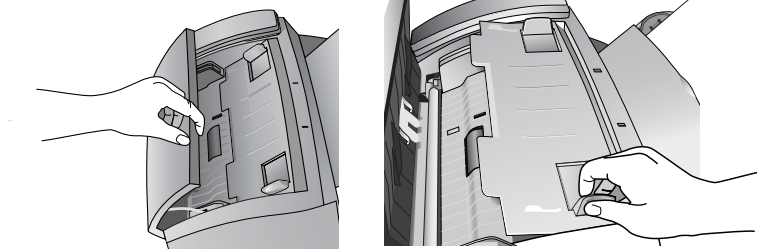

- 3 Remove and replace the print cartridge.

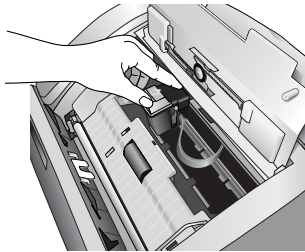

Tip! If the cartridge carriage moves back to the side before you put the cartridge in, shut and re-open the print cartridge doors.

Printing Faxes Stored in Memory

All received faxes are stored in memory. If you run out of paper, have a paper jam, or run out of ink, you can print the faxes that are stored in memory. Print faxes immediately. The fax memory holds a number of pages (around 65) but this memory is overwritten as new faxes arrive.

Note: A power failure or unplugging the fax will cause the faxes in memory to be lost.

- 1 Press **Menu**.
1: Fax Functions will display.
- 2 Press **2**.
2: Print Report will display.
- 3 Press **Enter**.
1: Last Transact will display.

4 Press **7**.

7: Reprint Faxes will display.

5 Press **Enter**.

Tip! Print the Fax Log first to see what faxes you have missed. Press Stop when you have printed the pages you need. The HP Fax will print all pages stored in its memory.

Messages on the Display and Error Log

Message	Meaning	Solution
load paper	No paper in paper tray or paper not loaded properly.	Add paper and press Start . Make sure you pull the paper tray cover forward before inserting paper and then push it back. Fan the pages and stack them neatly to ensure proper loading.
Out of Range	Broadcast entries must be between 01 and 30.	Enter number between 01 and 30.
Fax Memory Full	Fax received memory is full.	Print from memory to clear unprinted faxes.
Bad Ink Nozzle	Ink nozzles are clogged.	Clean print cartridge.
Insert Ink Cart	No ink cartridge, wrong ink cartridge, ink cartridge not seated properly, or ink cartridge failed.	Verify correct part number C6614 hp no. 20 print cartridge. Insert or remove and re-insert ink cartridge. If message continues, replace ink cartridge.
Fax is Busy	Send fax later, broadcast, or fax forwarding already set up.	Cancel current request or wait for completion.
Communic Failure Communication Failure	Could not establish communication.	Check number and try again.
Send Error	Error occurred when sending fax.	Resend, try ECM, or use a lower resolution.

Message	Meaning	Solution
Receive Error	Error occurred when receiving fax.	Ask other party to resend.
No Doc to Poll No Doc Error	Poll to Receive. Fax machine being polled has no document to send.	Check with other party.
Memory Full Memory Full Error	Memory full when collating copies, scan & fax, fax forwarding, or send fax later.	Try again with smaller groups of pages.
Check Document	Problem with document in the automatic document feeder.	Pull document out and reinsert.
Stop Key Pressed	Status message.	Press Stop key again to remove message.
No OGM recorded	No outgoing message is recorded.	You must record an outgoing message.
OGM too short	The outgoing message must be at least 2 seconds long.	Record longer message.
No Fax	In FAX mode, the caller hung up without sending a fax.	Not a problem.

Troubleshooting

Problem	Solution
<p>I answered the telephone and heard fax tones but the HP Fax did not accept the fax.</p>	<p>This can occur when the HP Fax is printing a fax when you answer the telephone. When you answer the telephone and hear fax tones, go to the HP Fax. If Printng Faxes is displaying, lift the handset and press Start/Copy to receive the fax. The new fax will print after the current one is complete. If anything else is displaying, you must press the Stop or Cancel button to halt the activity, then lift the handset and press Start/Copy.</p>
<p>If I am listening to messages or making a copy and the telephone rings, the HP Fax continues to ring even though I picked up the handset.</p>	<p>The HP Fax is busy and cannot answer the telephone until you press the Stop or Cancel button.</p>
<p>Cannot enter a number less than 10.</p>	<p>You must enter the leading 0. 01, 02, etc.</p>
<p>Will not pick up paper from the paper tray. Or, is picking up more than one sheet at a time.</p>	<p>Too much paper or paper improperly loaded. Fan the sheets and stack them carefully before loading the paper. Be sure you open the paper tray cover, load the paper behind the tabs, and shut the cover.</p>
<p>My printouts have horizontal streaks.</p>	<p>Clean the print cartridge.</p>
<p>HP Fax does not answer.</p>	<p>Make sure FAX or TAM/FAX answer mode is selected. Check Answer Pattern setting.</p>
<p>Can I use <i>both</i> the internal TAM and an external TAM.</p>	<p>No.</p>
<p>Faxes are spread over 2 pages.</p>	<p>Sender may be using a different paper size. Use fax reduction of 87% to ensure the fax is on one page.</p>
<p>After a paper jam or running out of paper, I did not receive all my unprinted faxes.</p>	<p>After adding paper or clearing a jam, unprinted faxes will automatically print. Do not do anything else with the fax until this is finished. If you still feel you missed faxes, use Reprint Faxes.</p>
<p>The Identification field is blank on the reports.</p>	<p>The HP Fax was unable to establish enough communication to get the ID.</p>

Problem	Solution
I want to enter a pause in a programmed number to "wait for a dial tone".	Use the Redial/Pause button to insert a one second delay. The pause will display as a - in your number.
I want to put in a new print cartridge but the carriage went back over to the left.	Close and re-open both print cartridge doors to get the carriage to come back out.
I do not hear error beeps any more.	The beep sounds have been turned off. Turn on the beep sounds.
I ran out of ink and my printed faxes were illegible or blank.	Replace the print cartridge and Reprint Faxes from memory. Reprint faxes immediately to avoid losing faxes in memory.
I cannot print faxes from memory.	Your fax may have lost power. A loss of power causes faxes in memory to be lost. Print the fax log to determine what faxes were lost.
It does not beep when I press each button.	You are pressing the buttons faster than it can register. Slow down.
No low ink warning.	The HP Fax does not monitor ink usage. However, the cartridge is transparent when empty. Remove the cartridge and to visually see how much ink is left.
Paper is not being picked up from the paper tray.	Media guides may be too tight. Squeeze and adjust so they are just touching the paper. Remove and fan the paper then reload. Make sure you open the door when adding paper.
Documents are not being picked up from the document tray or more than one page is being picked up at a time.	Media guides in document tray may be too tight. Slide them so they are just touching the paper. Remove and fan the document pages then reload. Make sure the front panel door is completely closed.

Problem	Solution
I'm having trouble receiving faxes in TAM/FAX mode.	Make sure your OGM is as short as possible and reduce the number of rings to answer in TAM/FAX mode. See "Setting the TAM/FAX Ring" on page 8.
The HP Fax makes a screeching noise when the handset/speakerphone is used or when an extension telephone is used that shares the telephone line with the HP Fax.	Both the HP Fax and another telephone device in the same vicinity are off hook and creating interference. Either hang up one device or move them further apart. If no other telephone device is off hook, move the HP Fax so that it is not enclosed by walls or shelves. Putting the HP Fax in an alcove or a bookcase can cause the sound to reflect from the walls into the microphone. Move the HP Fax to the top of a desk or table.
The buttons on the answering machine do not seem to work. I cannot skip or erase a message.	The answering machine buttons only work when the date and time for the message is displayed. Wait until the date and time displays before pressing the button.

Clearing Paper Jams

Clearing document jams

- 1 Open the print cartridge doors.

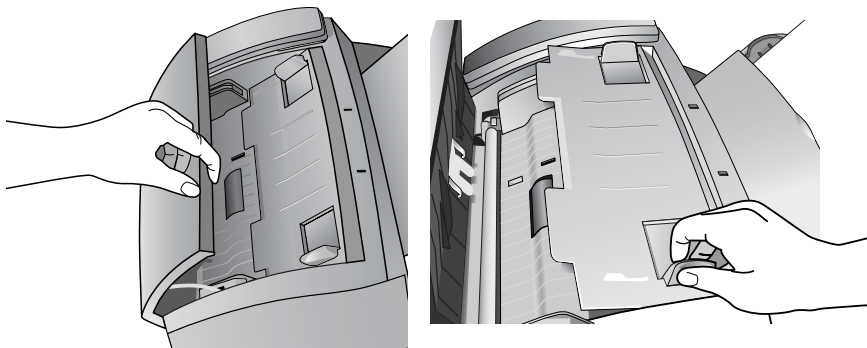

- 2 Carefully pull the paper toward you from the bottom.

Clearing paper jams

- 1 Open the paper tray cover.

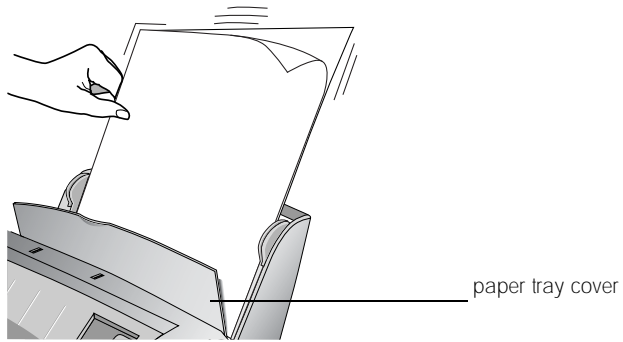

- 2 Carefully pull the paper out.

10 Specifications and Regulatory

This chapter contains product and supplies specifications, ordering information, and regulatory statements.

Paper Types and Sizes

The HP Fax is designed to work optimally with plain paper (cotton bond: 20 lb, 75 g/m²) in the following sizes: A4, Letter, and Legal.

Loading tip: Some papers have a side that's been conditioned for printing. The so-called "print side" is usually indicated on the paper's packaging. *Always load with the print side facing you.*

Print Cartridge

The HP Fax uses the following print cartridge.

20 hp no. 20 black inkjet print cartridge C6614

Product Specifications

The specifications are subject to change without notice.

Applicable Telephone Lines	Public Switched Telephone Network
Dialing Method	Tone only
Compatibility	ITU-T Group 3
Compression Scheme	MH, MR, MMR
Power Supply	100–127V, 50/60 Hz or 200–220V, 50/60 Hz
Display	LCD 16 character
Modem Speeds	14400, 12000, 9600, 7200, 4800, 2400 bps
Halftone (Grayscale) Levels	64 in Photo mode
Power Consumption	50 watts maximum 8 watts standby
Transmission Speed	approximately 8 seconds/page (ITU-T Test Image #1 in standard resolution, MMR compression, memory transmission)
Temperature/Humidity	Operating: 0–40°C (32–104°F), 15–80%RH Recommended: 15–35°C (59–95°F) 20–80%RH
Dimensions	13.8 by 13.3 by 8.4 in. 350.5 by 337.8 by 213.4 mm
Weight	10.26 lb, 4.66 kg
Reception Modes	TEL, FAX, TAM/FAX
Automatic Dialing	
One-touch	10
Speed Dials	100 (1020), 60 (1020xi)
Broadcast List	30
Automatic Redial	twice at 3 minute intervals
Fax Resolution	horizontal: 203 pels per inch vertical: Standard: 98 lpi Fine: 196 lpi Photo: 196, 64-level grayscale
Scanner Resolution	200 dpi, CIS

Print Resolution	300 dpi, Inkjet
Memory Capacity Voice Memory Fax Memory	16 minutes including greeting 65 pages (1020), 50 pages (1020xi) (ITU-T Test Image #1 in standard resolution)
Automatic Document Feeder Capacity	20 sheets of 20 lb (75 g/m ²) bond paper
Caller ID	U.S. and Canada only. Requires subscription from telephone service provider.
Distinctive Ring	Requires subscription from telephone service provider.
Hearing Aid Compatible	Yes
Telephone Function	Standard (cannot be used if power fails)
Paper Tray Capacity	100 sheets of 20 lb (75 g/m ²) bond paper
Paper Weight Document	16 to 32 lb (60 to 120 g/m ²) single sheet 16 to 28 lb (60 to 105 g/m ²) multiple sheets
Paper	16 to 24 lb (60 to 90 g/m ²)
Paper Type	Plain paper
Scanning Width	210 mm A4, 216 mm Legal and Letter
Printing Width	203.1 mm
Paper Sizes	A4 = 210 x 297 mm U.S. letter = 8.5 x 11 in U.S. legal = 8.5 x 14 in
Print Margins	Top margin = 2.0 mm Bottom margin = 14.0 mm Left/Right margins: Letter = 6.4 mm (each) A4 = 3.4 mm (each)
Contrast Controls	Lighten, Normal, Darken
Copy Speed	1.5 cpm based on the ITU-T No. 1 Test Chart in Standard Resolution
Number of Copies	99 (1020), 50 (1020xi)
Reduction	100%, 92%, 87%, 72%, 50%

Regulatory Information

The following sections describe product requirements from various regulatory agencies.

Notice to users of the U.S. telephone network: FCC requirements

This equipment complies with FCC rules, Part 68. On this equipment is a label that contains, among other information, the FCC Registration Number and Ringer Equivalent Number (REN) for this equipment. If requested, provide this information to your telephone company.

An FCC compliant telephone cord and modular plug is provided with this equipment. This equipment is designed to be connected to the telephone network or premises wiring using a compatible modular jack which is Part 68 compliant. This equipment connects to the telephone network through the following standard network interface jack: USOC RJ-11C.

The REN is useful to determine the quantity of devices you may connect to your telephone line and still have all of those devices ring when your number is called. Too many devices on one line may result in failure to ring in response to an incoming call. In most, but not all, areas the sum of the RENs of all devices should not exceed five (5). To be certain of the number of devices you may connect to your line, as determined by the REN, you should call your local telephone company to determine the maximum REN for your calling area.

If this equipment causes harm to the telephone network, your telephone company may discontinue your service temporarily. If possible, they will notify you in advance. If advance notice is not practical, you will be notified as soon as possible. You will also be advised of your right to file a complaint with the FCC. Your telephone company may make changes in its facilities, equipment, operations, or procedures that could affect the proper operation of your equipment. If they do, you will be given advance notice so you will have the opportunity to maintain uninterrupted service.

If you experience trouble with this equipment, please contact the manufacturer, or look elsewhere in this manual, for warranty or repair information. Your telephone company may ask you to disconnect this equipment from the network until the problem has been corrected or until you are sure that the equipment is not malfunctioning.

This equipment may not be used on coin service provided by the telephone company. Connection to party lines is subject to state tariffs. Contact your state's public utility commission, public service commission, or corporation commission for more information.

This equipment includes automatic dialing capability. When programming and/or making test calls to emergency numbers:

- Remain on the line and explain to the dispatcher the reason for the call.
- Perform such activities in the off-peak hours, such as early morning or late evening.

The Telephone Consumer Protection Act of 1991 makes it unlawful for any person to use a computer or other electronic device, including fax machines, to send any message unless such message clearly contains in a margin at the top or bottom of each transmitted page or on the first page of transmission, the date and time it is sent and an identification of the business, other entity, or other individual sending the message and the telephone number of the sending machine or such business, other entity, or individual. (The telephone number provided may not be a 900 number or any other number for which charges exceed local or long-distance transmission charges.) In order to program this information into your fax machine, you should complete the steps described in the software.

Regulatory notices

The following sections are statements from various regulatory agencies.

FCC statement

The United States Federal Communications Commission (in 47 CFR 15.105) has specified that the following notice be brought to the attention of users of this product.

Declaration of Conformity: This equipment has been tested and found to comply with the limits for a Class B digital device, pursuant to part 15 of the FCC Rules. Operation is subject to the following two conditions: (1) this device may not cause harmful interference, and (2) this device must accept any interference received, including interference that may cause undesired operation. Class B limits are designed to provide reasonable protection against harmful interference in a residential installation. This equipment generates, uses, and can radiate radio frequency energy, and, if not installed and used in accordance with the instructions, may cause harmful interference to radio communications. However, there is no guarantee that interference will not occur in a particular installation. If this equipment does cause harmful interference to radio or television reception, which can be determined by turning the equipment off and on, the user is encouraged to try to correct the interference by one or more of the following measures:

- Reorient the receiving antenna.
- Increase the separation between the equipment and the receiver.
- Connect the equipment into an outlet on a circuit different from that to which the receiver is connected.
- Consult the dealer or an experienced radio/TV technician for help.

Product Regulations Manager, Hewlett-Packard Company, San Diego, 858-655-4100.

The user may find the following booklet prepared by the Federal Communications Commission helpful: *How to Identify and Resolve Radio-TV Interference Problems*. This booklet is available from the U.S. Government Printing Office, Washington DC, 20402. Stock No. 004-000-00345-4.

CAUTION Pursuant to Part 15.21 of the FCC Rules, any changes or modifications to this equipment not expressly approved by the Hewlett-Packard Company, may cause harmful interference and void the FCC authorization to operate this equipment.

DOC statement / Déclaration de conformité (Canada)

Le présent appareil numérique n'émet pas de bruits radioélectriques dépassant les limites applicables aux appareils numériques de la class B prescrites dans le Règlement sur le brouillage radioélectrique édicté par le ministère des Communications du Canada.

This digital apparatus does not exceed the Class B limits for radio noise emissions from digital apparatus set out in the Radio Interference Regulations of the Canadian Department of Communications.

Notice to users of the Canadian telephone network

The Industry Canada label identifies certified equipment. This certification means that the equipment meets certain telecommunications network protective, operational and safety requirements as prescribed in the appropriate Terminal Equipment Technical Requirements document(s). The Department does not guarantee the equipment will operate to the user's satisfaction.

Before installing this equipment, users should ensure that it is permissible to be connected to the facilities of the local telecommunications company. The equipment must also be installed using an acceptable method of connection. The customer should be aware that compliance with the above conditions may not prevent degradation of service in some situations.

Repairs to certified equipment should be coordinated by a representative designated by the supplier. Any repairs or alterations made by the user to this equipment, or equipment malfunctions, may give the telecommunications company cause to request the user to disconnect the equipment.

Users should ensure for their own protection that the electrical ground connections of the power utility, telephone lines and internal metallic water pipe system, if present, are connected together. This precaution may be particularly important in rural areas.

CAUTION Users should not attempt to make such connections themselves, but should contact the appropriate electric inspection authority, or electrician, as appropriate.

Notice: The Ringer Equivalence Number (REN) assigned to each terminal device provides an indication of the maximum number of terminals allowed to be connected to a telephone interface. The termination on an interface may consist of any combination of devices subject only to the requirement that the sum of the Ringer Equivalence Numbers of all the devices does not exceed 5.

The REN for this product is 0.6B (AC), 0.4B(DC), based on FCC Part 68 test results.

Notice to all users of the European Economic Area (EEA)



This product is designed to interwork with the analogue telephone networks in the following countries:

Germany	UK	Netherlands
France	Spain	Italy
Belgium	Ireland	Sweden
Austria	Denmark	
Norway	Finland	
Greece	Portugal	

Network compatibility depends on customer selected settings, which must be reset to use the equipment on a telephone network in a country other than where the product was purchased. Contact the vendor or Hewlett-Packard Company if addition product support is necessary.

This equipment comes with a telephone connector specific to the country where it was purchased.

This equipment has been certified by the manufacturer in accordance with Directive 1999/5/EC (annex II) for Pan-European single-terminal connection to the public switched telephone network (PSTN). However, due to differences between the individual PSTNs provided in different countries, the approval does not, of itself, give an unconditional assurance of successful operation on every PSTN network termination point.

In the event of problems, you should contact your equipment supplier in the first instance.

Notice to users of the Irish telephone network

This equipment is designed for DTMF tone dialing.

Notice to users of the German telephone network

The HP Fax products are designed to connect only to the analogue public-switched telephone network (PSTN). Please connect the TAE N telephone connector plug, provided with the HP Fax, into the wall socket (TAE 6) code F.

Geräuschemission

LpA < 70 dB
am Arbeitsplatz
im Normalbetrieb
nach DIN 45635 T. 19

For non-European customers

This product is approved for use only in the country in which it was purchased. Local country laws may prohibit the use of this product outside the country of purchase. It is strictly forbidden by law in virtually every country to connect nonapproved telecommunications equipment (fax machines) to public telephone networks.

Declaration Of Conformity

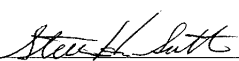
DECLARATION OF CONFORMITY			
According to ISO/IEC Guide 22 and EN45014			
Manufacturer's Name & Address: Hewlett-Packard Company, 16399 West Bernardo Drive, San Diego, CA. 92127-1899, USA,			
declares, that the hp fax 1020 series product Model Number(s): C8580A,C8581A,C8585A,C8586A,C8597A,C8598A Product Options: NONE conforms to the following Product Specifications:			
	Safety	EMC	Telecom
C8580A, C8581A	UL1950,3 rd Edn:1995 CSA22.2 No.950 3 rd Edn:1995	FCC Part 15-Class B ICES-003	FCC Part 68 ICCS-03
C8585A	NOM-016-SCFI-1993	NA	NOM-ISI-SCT-1998
C8586A	EN60950:1992 +A1,A2,A3,A4 & A11	NA	Norma Net 001/92
C8597A, C8598A	EN60950:1992 +A1,A2,A3,A4 & A11	CISPR22:1997-Class B CISPR24:1997 IEC61000-4-2:1995 IEC61000-4-3:1995 IEC61000-4-4:1995 IEC61000-4-5:1995 IEC61000-4-6:1996 IEC61000-4-8:1993 IEC61000-4-11:1994 IEC 1000-3-2:1995 IEC 1000-3-3:1994	TBR 21 1998 TBR 38 1998 EN301437:1999
Supplementary Information:			
The Product herewith complies with the requirements of the Low Voltage Directive 73/23/EEC, EMC Directive 89/336/EEC, and R&TTE Directive 1999/5/EEC and carries the CE marking accordingly.			
<u>3/2/01</u> Date	 Steve Smith, Product Hardware and Regulations Manager		
European Contact: Your local Hewlett-Packard Sales and Service Office or Hewlett-Packard GmbH. Department HQ-TRE, Herrenberger Strasse 130, D-71034 Böblingen (FAX + 49-7031-14-3143)			

Use Hewlett-Packard Support Services

www.hp.com

If you are unable to find the answer you need in the printed documentation supplied with your product or on the web, you can contact one of the HP support services listed in the following pages. If a support service number is not listed for your country, contact your nearest authorized HP dealer for help.

Before calling Customer Support

- 1 Make sure that
 - Your unit is plugged in and turned on.
 - The correct print cartridge is installed properly.
 - The recommended paper is loaded in the input tray.
- 2 Reset your unit by unplugging it and plugging it in again.
- 3 If you need to speak to an HP Customer Support Representative:
 - Have your serial number ready.
 - Print a Self-Test Report.
 - Be prepared to discuss your problem in detail.
- 4 Be near your unit when you call.

Prepare your unit for shipment

If you are requested to send in your unit for service, do the following:

- Remove the print cartridge and place it in an airtight bag so it will not dry out. Do not send the print cartridge with the unit unless asked to do so.
- If you do not have the original packing material, you can request a replacement package set from HP Customer Support. Shipping damage caused by improper packaging is not covered under the warranty.
- Include these items in the box:
 - A brief description of the symptoms (sample prints are helpful).
 - A copy of your sales slip or proof of purchase (to establish the warranty period)
 - Your name, address, and telephone number where you can be reached during the day.

Country or Region	HP Technical Support	Country or Region	HP Technical Support
U.S. during warranty M-F: 6am–10 pm MST, Sat: 9am–4pm MST	(208) 323-2551	Germany	+49 (0) 180 52 58 143 (0.24 DM/min)
U.S. post warranty (per call charge)	(800) 999-1148	Greece	+30 160 73 603
U.S. post warranty (\$2.50 per minute)	(900) 555-1500	Ireland	+353 (0) 662 5525
Austria	+43 (0) 810 00 6080	Italy	+39 (0) 02 264 10350
Belgium (Flemish)	+32 (0) 02 626 8806	Mexico	01-800-472-6684
Belgium (French)	+32 (0) 02 626 8807	Mexico (Mexico City)	5258 9922
Brazil	0800 157751 0800 130999	Netherlands	+31 (0) 20 606 8751
Brazil (São Paulo)	(11) 3747-7799 (11) 4197-4998	Norway	+47 22 11 6299
Canada during warranty	(905) 206-4663	Portugal	+351 21 3176333
Canada post warranty (per call charge)	(877) 621-4722	Spain	+34 902 321 123
Colombia	9-800-114-726	Sweden	+46 (0) 8 619 2170
Denmark	+45 39 29 4099	United Kingdom	+44 (0) 207 512 52 02
Europe (English)	+44 (0) 207 512 5202	Venezuela	0-800-47468368
Finland	+358 (0) 203 47 288	Venezuela (Caracas)	(502) 207-8488
France	+33 (0) 01 43 62 34 34		

Warranty

Hewlett-Packard Limited Global Warranty Statement for Fax 1020 Series Products

Extent of Limited Warranty

Hewlett-Packard ("HP") warrants to the end-user customer ("Customer") that each HP Fax 1020 Series product ("Product"), including related software, accessories, media, and supplies, shall be free from defects in material and workmanship for the duration specified in the paragraph below, which duration begins on the date of purchase by the Customer.

For each hardware Product, the duration of HP's limited warranty is one year for parts and one year for labor. For all other Products, the duration of HP's limited warranty for both parts and labor is ninety days.

For each software Product, HP's limited warranty applies only to a failure to execute programming instructions. HP does not warrant that the operation of any Product shall be uninterrupted or error free.

HP's limited warranty covers only those defects which arise as a result of normal use of a Product, and does not cover any other problems, including those which arise as a result of (a) improper maintenance or modification, (b) software, accessories, media, or supplies not provided or supported by HP, or (c) operation outside the Product's specifications.

For any hardware Product, the use of a non-HP ink cartridge or a refilled ink cartridge does not affect either the warranty to the Customer or any HP support contract with the Customer. However, if Product failure or damage is attributable to the use of a non-HP or refilled ink cartridge, HP shall charge its standard labor and materials charges to service the Product for the failure or damage.

If HP receives, during the applicable warranty period, notice of a defect in any Product, HP shall either repair or replace the defective Product, at HP's option. Where labor charges are not covered by HP's limited warranty, repairs shall be at HP's standard charges for labor.

If HP is unable to repair or replace, as applicable, a defective Product which is covered by HP's warranty, HP shall, within a reasonable time after being notified of the defect, refund the purchase price for the Product.

HP shall have no obligation to repair, replace, or refund until the Customer returns the defective Product to HP.

Any replacement product may be either new or like-new, provided that it has functionality at least equal to that of the Product being replaced. HP products, including each Product, may contain remanufactured parts, components, or materials equivalent to new in performance. HP's limited warranty for each Product is valid in any country or locality where HP has a support presence for the Product and where HP has marketed the Product. The level of warranty service may vary according to local standards. HP shall have no obligation to alter the form, fit, or function of the Product in order to make it operate in a country or locality for which the Product was never intended to operate.

Limitations of Warranty

TO THE EXTENT ALLOWED BY LOCAL LAW, NEITHER HP NOR ITS THIRD PARTY SUPPLIERS MAKE ANY OTHER WARRANTY OR CONDITION OF ANY KIND, WHETHER EXPRESS OR IMPLIED, WITH RESPECT TO THE COVERED HP PRODUCTS, AND SPECIFICALLY DISCLAIM THE IMPLIED WARRANTIES OR CONDITIONS OF MERCHANTABILITY, SATISFACTORY QUALITY, AND FITNESS FOR A PARTICULAR PURPOSE.

Limitations of Liability

To the extent allowed by local law, the remedies provided in this Limited Warranty Statement are the Customer's sole and exclusive remedies.

TO THE EXTENT ALLOWED BY LOCAL LAW, EXCEPT FOR THE OBLIGATIONS SPECIFICALLY SET FORTH IN THIS LIMITED WARRANTY STATEMENT, IN NO EVENT SHALL HP OR ITS THIRD PARTY SUPPLIERS BE LIABLE FOR DIRECT, INDIRECT, SPECIAL, INCIDENTAL, OR CONSEQUENTIAL DAMAGES, WHETHER BASED ON CONTRACT, TORT, OR ANY OTHER LEGAL THEORY AND WHETHER ADVISED OF THE POSSIBILITY OF SUCH DAMAGES.

Local Law

This Limited Warranty Statement gives the Customer specific legal rights. The Customer may also have other rights which vary from state to state in the United States, from province to province in Canada, and from country to country elsewhere in the world.

To the extent this Limited Warranty Statement is inconsistent with local law, this Statement shall be deemed modified to be consistent with such local law. Under such local law, certain disclaimers and limitations of this Statement may not apply to the Customer. For example, some states in the United States, as well as some governments outside the United States (including provinces in Canada), may:

Preclude the disclaimers and limitations in this Statement from limiting the statutory rights of a consumer (e.g. the United Kingdom);

Otherwise restrict the ability of a manufacturer to enforce such disclaimers or limitations; or

Grant the Customer additional warranty rights, specify the duration of implied warranties which the manufacturer cannot disclaim, or not allow limitations on the duration of implied warranties.

FOR CONSUMER TRANSACTIONS IN AUSTRALIA AND NEW ZEALAND, THE TERMS IN THIS LIMITED WARRANTY STATEMENT, EXCEPT TO THE EXTENT LAWFULLY PERMITTED, DO NOT EXCLUDE, RESTRICT, OR MODIFY, AND ARE IN ADDITION TO, THE MANDATORY STATUTORY RIGHTS APPLICABLE TO THE SALE OF THE COVERED HP PRODUCTS TO SUCH CUSTOMERS.

Complete the following information. It is necessary for contacts with the selling dealer or Hewlett-Packard Company:

Date of Purchase:

Serial Number:

Index

A

- A4 paper [3](#)
- answer mode
 - FAX [8](#)
 - TAM/FAX [8](#)
 - TEL [8](#)
- answer pattern [12](#)
- answering [7](#)
- answering machine
 - external [15](#)
 - greeting [26](#)
 - listening [27](#)
 - messages, changing length [29](#)
 - OGM [26](#)
 - PIN code [30](#)
 - playing the OGM [26](#)
 - remote access [30](#)
 - screening calls [28](#)
- auto reports [52](#)

B

- beep sounds [53](#)
- broadcast [20](#), [37](#)
 - deleting [23](#)
 - faxing [22](#)
 - printing list [24](#)
 - sending [22](#)

C

- caller ID [15](#)
- cleaning
 - print cartridge [62](#)
- contrast [39](#)
- copies
 - collating [49](#)
 - contrast [39](#)
 - making [6](#), [47](#)
 - reducing [48](#)
 - resolution [40](#)

country [55](#)

D

- date and time [51](#)
- defaults, reset [56](#)
- delayed fax [38](#)
- dial list [2](#)
- distinctive ring [12](#)
- distribution list, sending a fax to [22](#)
- Documents, loading [4](#)
- double ring [12](#)

E

- ECM [54](#)
- entering
 - symbols [5](#)
 - telephone numbers [5](#)
 - text [5](#)
- error correction mode [54](#)
- error reports [52](#)

F

- FAX [8](#)
- fax
 - broadcast [22](#)
 - contrast [39](#)
 - distribution list [22](#)
 - forwarding [45](#)
 - polling [33](#)
 - redial [34](#)
 - reduction [42](#)
 - resolution [40](#)
 - ring [10](#)
 - send later [38](#)
 - sending [4](#), [34](#)
- fax header [52](#)
- fax machines, silent [14](#)
- faxes in memory, printing [63](#)
- forwarding faxes [45](#)

front panel buttons [1](#)

G

getting help [78](#)

H

handset, volume [58](#)

help [78](#)

hp support [78](#)

I

ink cartridge [71](#)

changing [62](#)

cleaning [62](#)

part number [71](#)

L

language [55](#)

legal paper [3](#)

letter paper [3](#)

loading documents [4](#)

loading paper [2](#)

M

making calls [6](#)

menu

listing [3](#)

using [3](#), [4](#)

message length [29](#)

messages [64](#)

listening [27](#)

microphone [2](#)

N

number length [6](#)

O

OGM

outgoing message [26](#)

P

paper

jam [68](#)

loading [2](#)

size [3](#)

part number, ink cartridge [71](#)

personal identification number [30](#)

PIN code [30](#)

poll receive [33](#)

polling [33](#)

print cartridge [71](#)

changing [62](#)

cleaning [62](#)

part number [71](#)

printing faxes in memory [63](#)

R

receiving faxes [7](#)

redial [34](#), [60](#)

reducing

copies [48](#)

faxes [42](#)

regulatory information [74](#)

reports

automatic [52](#)

printing [43](#)

reset defaults [56](#)

resolution

copy [40](#)

fax [40](#)

S

scan & fax [5](#)

screening calls [28](#)

send fax later [38](#)

silent fax machines [14](#)

speaker, volume [58](#)

specifications [72](#)

speed dials

deleting [23](#)

dialing [19](#)

printing list [24](#)

programming [18](#)

string length [6](#)

symbols, entering [5](#)

T

TAM

greeting [26](#)

listening [27](#)

OGM [26](#)

PIN code [30](#)

playing the OGM [26](#)

remote access [30](#)

TAM/FAX [8](#)

ring [8](#)

TEL [8](#)

telephone [6](#), [7](#)

making calls [57](#)

volume [58](#)

telephone numbers

entering [5](#)

text

entering [5](#)

length [6](#)

triple ring [12](#)

troubleshooting [66](#)

V

volume

changing [58](#)

ring [59](#)

W

warranty [79](#)

Environmental Product Stewardship Program

Protecting the Environment

Hewlett-Packard Company is committed to providing quality products in an environmentally sound manner. This product has been designed with several attributes to minimize impacts on our environment. Please visit HP's Commitment to the Environment website at <http://www.hp.com/abouthp/environment> for more information.

Ozone Production

This product generates no appreciable ozone gas (O₃)

Energy Consumption

Energy usage drops significantly while in ENERGY STAR[®] mode, which saves natural resources, and saves money without affecting the high performance of this product. This product qualifies for ENERGY STAR, which is a voluntary program established to encourage the development of energy-efficient office products.



ENERGY STAR is a U.S. registered service mark of the U.S. EPA. As an ENERGY STAR partner, Hewlett-Packard Company has determined that this product meets ENERGY STAR guidelines for energy efficiency. For more information, see <http://www.energystar.gov>.

Paper Use

This product is suited for the use of recycled paper according to DIN 19309.

Plastics

Plastic parts over 25 grams are marked according to international standards that enhance the ability to identify plastics for recycling purposes at the end of the product's life.

Material Safety Data Sheets

Material Safety Data Sheets (MSDS) can be obtained from the HP web site at

<http://www.hp.com/go/msds>. If you are in the United States or Canada and do not have access to the internet, call the U.S. HP FIRST (fax-on-demand service) at (1) (800) 231-9300. Use Index number 7 for a listing of the material safety data sheets.

International customers without Internet access should call (404)-329-2009 for further information.

Recycling Programs

HP offers an increasing number of product return and recycling programs in many countries, as well as partnering with some of the largest electronic recycling centers throughout the world. HP also conserves resources by refurbishing and reselling some of its most popular products.

HP Fax 1020 Series

This product contains a small Lithium battery that must be removed and disposed of properly at the end of the product's useful life. The battery is located on the Main D/B board.

Battery Specifications

Battery Part Number: Panasonic CR2032

Battery Material: Lithium

Battery Type: Button/Coin Cell Battery

Quantity Per Product: 1

Weight: approximately 3 grams

Lithium Type: Solid

Battery Manufacturer: Panasonic of Japan

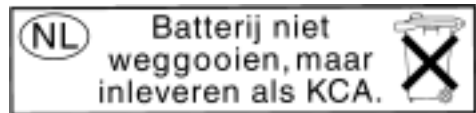



i n v e n t



C8580-90106 (Rev. B)

Printed in South Korea, China, or the European Union, April 2002