

U.S. Rifle, Caliber .30, M1

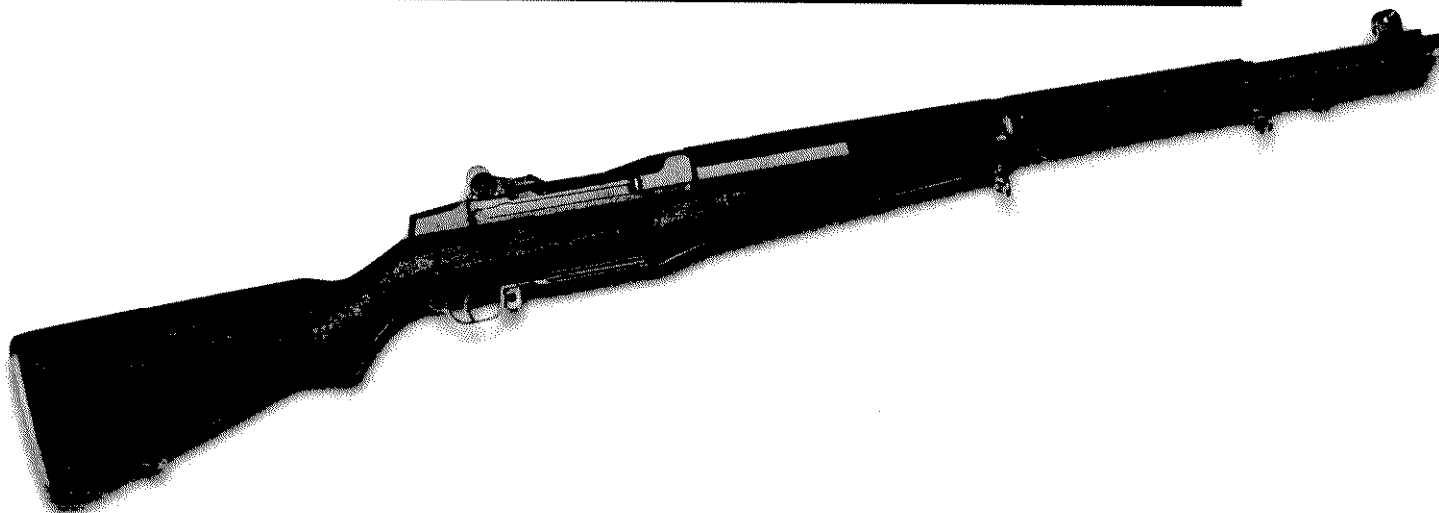

READ THIS FIRST!

"WHEN ALL ELSE FAILS, READ THE INSTRUCTIONS."

You've probably heard that expression. It's humorous only when there's no risk of harm. But a firearm is inherently dangerous. If it is used carelessly or incorrectly, you or someone else can be accidentally killed or maimed.

Gun accidents are rarely the fault of the firearm. A gun is only a machine, with no judgment of its own. It responds to your actions, wise or foolish. Of course it has mechanical safety features, but none as good as the brain of an attentive shooter who knows that momentary carelessness can produce a permanent tragedy.

Trouble is best avoided by anticipating it. This manual offers you lessons learned by others the hard and bitter way. Even if you're an experienced shooter, you might learn something you didn't know before, or be reminded of something you once learned but forgot.

Advice is always more useful when it's not received too late.

Read it now.

© 1997 Xanagraf L.L.C.
Photographs in Figures 14, 19, 20, 23, 26, 27 are with kind permission of the National Rifle Association of America.

NOMENCLATURE (as used in this manual)

US Rifle, Caliber .30, M1

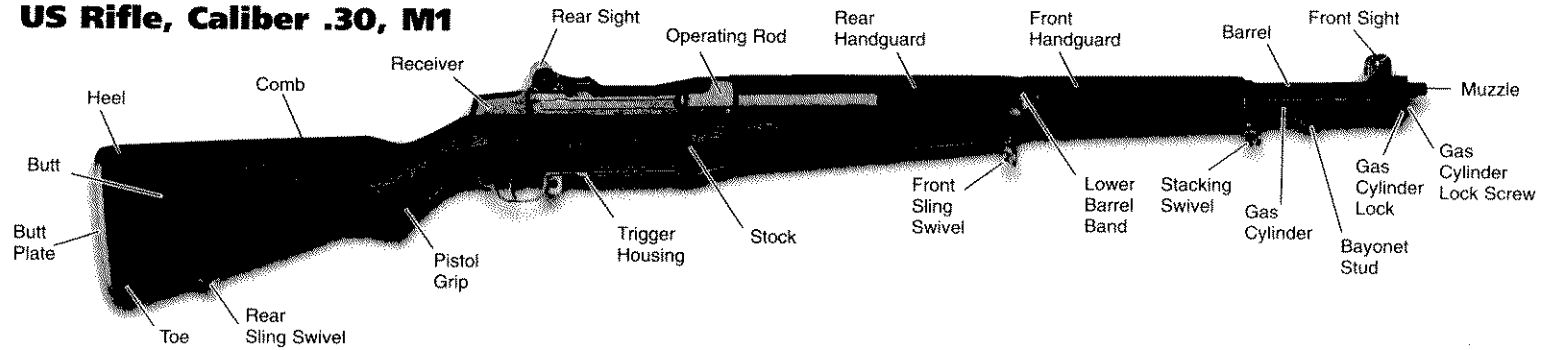

Important terms which are not individual parts:

- Bore:** The hole lengthwise through the barrel through which a fired bullet passes.
- Chamber:** The enlarged rear portion of the bore into which a cartridge is seated for firing.
- Muzzle:** The front face of the barrel from which the bullet emerges.
- Magazine:** The space inside the rifle enclosing a loaded cartridge clip.
- Front, rear, right and left* refer to the rifle as seen by the shooter holding it in a firing position.

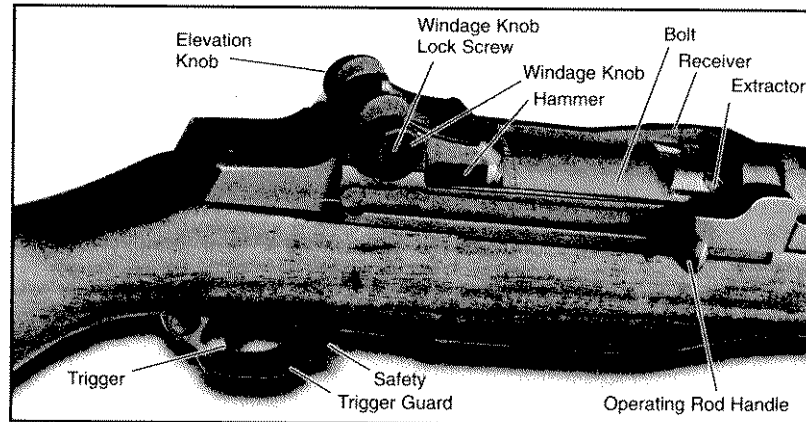

ABSOLUTELY, POSITIVELY THE FIRST STEP

The first step in handling any firearm is to CLEAR it.

The M1 rifle is considered CLEAR when there is no ammunition in the chamber or in the magazine, the bolt is latched to the rear, and the safety is "ON".

TO CLEAR THE RIFLE: Point the muzzle in a safe direction. Pull the operating rod handle fully rearward to eject any cartridge that may be in chamber. Put the safety "ON". If a clip of ammunition is in the receiver, remove it. *Leave the bolt open.* Inspect the chamber and the magazine to make sure no cartridge remains.

Never assume any firearm to be unloaded, and don't accept anyone's assurance. *Look* inside it yourself. When entering or leaving a range or when showing a rifle to others, make sure the bolt is locked open, the safety is on, and all ammunition is removed. That way others can easily see, without operating its mechanism, that the rifle is unloaded.

WARNING!

This M1 rifle is a used, military surplus arm between 40 and 60 years old. Absolutely no assurance is given that this rifle will function properly or be safe to use in the condition in which you receive it. **IT IS SOLD STRICTLY "AS IS", WITH NO WARRANTY EXPRESS OR IMPLIED.**

Do not use this rifle until it has been disassembled and thoroughly cleaned, and carefully examined by a competent gunsmith familiar with its internal mechanism and the design of its safety features. Any unserviceable parts must be replaced and any other deficiencies must be corrected before any attempt is made to load or fire the rifle.

Most original U.S. government-issue parts for the Garand are readily interchangeable, but many aftermarket and foreign-made parts are not, and they are sometimes difficult to distinguish from the genuine. Some of these, as well as original but unserviceable G.I. parts that have been refinished to conceal wear, can lead to dangerous malfunctions.

Regardless of the origin of the parts, do not replace the bolt or the firing pin (or exchange these parts with those from another rifle) unless you have the knowledge and gauges to check that all critical dimensions remain within tolerances. Changing either part without ensuring that it fits properly in your particular rifle can defeat its safety features and create a potentially hazardous condition.

HOW IT WORKS

The M1, also called the Garand after its designer John C. Garand (1888-1974), is a gas-operated semi-automatic rifle fed from a clip holding eight cartridges.

To prepare the rifle for firing, the bolt must be manually opened, which cocks the hammer and exposes the magazine for insertion of a loaded cartridge clip from the top. When the clip is latched and downward thumb pressure is released the bolt runs forward, feeding the first cartridge into the barrel chamber. As the bolt closes it rotates to its locked position. The rifle is now ready for semi-automatic operation: one shot is fired each time the trigger is pressed without further manipulation by the shooter until the ammunition is exhausted.

The semi-automatic cycle of operation is as follows: Pressing the trigger releases the hammer to strike a firing pin mounted in the bolt. The firing pin is driven forward to indent and ignite the primer of the chambered cartridge, firing the first shot. Some of the propellant gas in the barrel passes through a port near the muzzle into the gas cylinder, where it impinges against the piston head of the operating rod. The operating rod is driven rearward, automatically unlocking and pulling open the bolt while compressing the operating rod spring. The rearward movement of the bolt recocks the hammer, and extracts and ejects the fired cartridge case. The operating rod then returns forward, driven by its spring; it pulls the bolt with it to feed another cartridge and closes and locks the bolt for the next shot. This cycle is repeated until the clip is empty. When the last shot has been fired, the clip is automatically ejected from the rifle and the bolt remains open for reloading.

PROTECT EYES & EARS

ALWAYS wear shooting glasses and ear protection. Your vision and hearing are priceless, and irreplaceable.

Shooting glasses will protect your eyes from burns and abrasions caused by powder gas, metallic particles, burning powder grains, lubricant, and similar debris that can spit occasionally from any firearm, particularly a semi-automatic rifle, in normal use.

If something goes seriously wrong and fragments of cartridge case or firearm are sent flying, glasses can mean the difference between future sight and blindness. The best compromise between protection and convenience is offered by high-quality shooting glasses or industrial-grade safety glasses with large-area shatter-resistant polycarbonate lenses at least 3mm thick.

Wear protective glasses even when you're not shooting but others are. Pieces of bullet can spatter back to the firing line from surprisingly long distances. Also keep in mind that fired cartridge cases can be ejected with considerable force; hot, sharp-edged brass can put out an eye.

If you ignore ear protection, you are either already deaf or soon to become so. Hearing loss from gunfire is cumulative and permanent. Many experienced shooters who value their hearing wear *both* ear plugs *and* muffs.

At the range it is common courtesy not to open fire until everyone nearby has their eyes and ears covered.

TO AVOID A CATASTROPHE:

ALWAYS keep the muzzle pointed in a safe direction. Never point any gun —loaded or unloaded— at anything you are not willing to destroy.

ALWAYS assume every gun is loaded until you personally prove otherwise. Don't trust your memory, and never take anyone else's word for it.

ALWAYS keep the safety "ON" and your finger outside the trigger guard until the muzzle is pointed at the target and you are ready to fire.

ALWAYS keep the gun unloaded until it must be ready for use. If there is no need to load it until later, don't.

ALWAYS pay attention where the muzzle is pointing when you (or others nearby) are handling any gun, especially while operating any part of its mechanism. Don't let the muzzle point in an unsafe direction (for example: *at you*).

ALWAYS check for any obstruction in the barrel before loading or whenever there is any reason to suspect blockage. Bore obstructions are a major source of gun explosions.

ALWAYS use high quality ammunition made to American industry standards. Make sure it is clean, dry, in good condition, and of the proper type and caliber for your gun. Defective or improper ammunition is responsible for most malfunctions and blown-up guns.

ALWAYS positively identify your target and be sure there is a safe backstop before you shoot. It's far better than making pathetic excuses afterward.

NEVER mix alcohol or drugs with shooting. There is enough danger without the added hazard of fuzzy judgment.

ALWAYS hold your gun so that you can control the direction of the muzzle if you fall or stumble.

NEVER pull a gun toward you by grasping its muzzle. If it snags on something and fires, the bullet probably won't miss.

NEVER attempt to load or unload a gun inside a vehicle or building (except a properly constructed indoor range); there usually is no safe direction to point the muzzle.

NEVER shoot at a hard object or at water except under carefully controlled conditions. Bullets can glance off hard materials like rock, glass or steel, or skip off the surface of water, fly in unpredictable directions — and kill.

NEVER leave an unattended gun loaded. Guns and ammunition should be stored separately, locked if possible, beyond the reach of children and careless adults.

OPERATION OF THE SAFETY

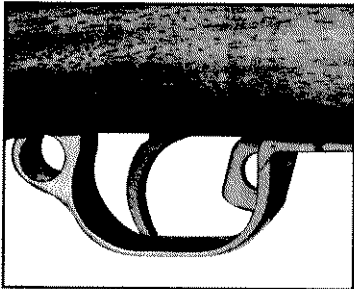

Fig. 1 – Safety "On"

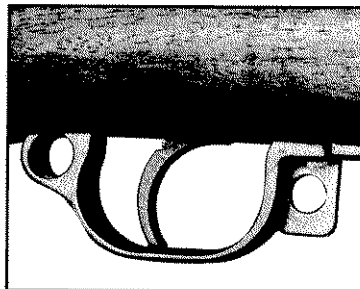

Fig. 2 – Safety "Off"

To put the safety "ON", snap the lever in the front of the trigger guard to its fully rearward position (Fig. 1). This blocks the trigger and locks the hammer, preventing the rifle from being fired if the trigger is pressed. To take the safety "OFF", snap the lever fully forward (Fig. 2); the rifle is now ready to fire when the trigger is pressed.

The safety is operable only if the hammer is cocked. (The hammer is cocked automatically when the bolt is opened.) Note that the bolt can still be operated with the safety "ON". This allows you to load and unload the rifle with added security. The safety can be heard and felt as it engages. Be certain the safety snaps positively in position. If it does not, it may be an indication that something is wrong; partial or

sloppy engagement is unsafe. Practice with the rifle unloaded until you are familiar with its sound and feel.

CAUTION: Keep the muzzle pointed in a safe direction and your finger off the trigger when operating the safety. Malfunctions which may cause a gun to fire as the safety is engaged or disengaged are rare but *can* happen. Even if an accidental firing should occur, nobody will be hurt if you follow this rule.

THREE THINGS TO REMEMBER ABOUT SAFETIES

- 1. NEVER TOTALLY DEPEND ON A MECHANICAL SAFETY.** It is not a substitute for proper gun handling. Like all mechanical devices the safety is subject to breakage or malfunction and can be defeated by wear, abuse, dirt, corrosion, incorrect assembly of the firearm, improper adjustment or repair, or lack of maintenance.
- 2. NO MECHANICAL SAFETY IS "CHILDPROOF" OR "FOOL-PROOF".** No safety ever invented can be relied upon to prevent an accidental shooting by a determined child or a grownup idiot "playing" with a gun.
- 3. TREAT EVERY GUN AS IF YOU EXPECT ITS MECHANICAL SAFETY NOT TO WORK.** You will be astounded at how cautious you become, and how little tolerance you will have for the complacency of others.

AMMUNITION

1. The correct ammunition for the M1 rifle is the U.S. Caliber .30 Rifle Cartridge. Its military loadings include M2 Ball, M2 Armor Piercing, and M72 Match. Commercially this cartridge is known as .30-'06 Springfield, and is available in many different loadings. Do not attempt to use any cartridges in the M1 rifle other than those specifically designated U.S. Caliber .30 Rifle or .30-'06 Springfield.
2. If commercial .30-'06 ammunition is used, select loadings with bullets no heavier than 180 grains. Firing bullets heavier than 180 grains is not unsafe but may develop higher residual pressures at the gas port near the muzzle. This can damage the operating rod, necessitating its replacement.
3. Remember that the M1 rifle was designed solely for U.S. military standard ammunition. Other ammunition may or may not function reliably. In most military semi-automatic rifles including the M1, the firing pin will lightly mark ("dimple") the primer of a cartridge as it is chambered when the bolt closes. Military ammunition has harder (less sensitive) primers than are usually found in commercial ammunition or available to handloaders, and such dimpling is normally insufficient to fire a primer provided the receiver, bolt, firing pin and chamber conform to prescribed design dimensions. However, the use of non-military ammunition with softer (more sensitive) primers reduces the margin of safety and requires the shooter to exercise greater caution. Conditions arising from excessive wear, out-of-specification parts or heavy chamber fouling that might pose no hazard with military cartridges could be dangerous with other ammunition. (See WARNINGS in "Loading and Unloading", page 11, and "Firing the Rifle", page 17).
4. Do not oil cartridges, or spray aerosol lubricants, preservatives or cleaners directly onto cartridges or where excess spray might come into contact with them. Highly penetrative lubricants can migrate inside cartridge cases and contaminate the primer and/or propellant powder. Either a misfire or a failure of the powder to ignite may result. If only the primer ignites, there is danger that the bullet may not exit the barrel, and obstruct the bore.
5. Store ammunition in a cool, dry place, away from sources of heat. Heat shortens the shelf life of ammunition by accelerating the chemical decomposition of primer and propellant.
6. Make a habit of regularly examining your fired cartridge cases, particularly when trying different ammunition. Watch for abnormalities: punctured, loose, or excessively flattened primers; split, deformed or partially separated cases; rough or cratered firing pin indents, torn rims, etc. "Reading" the cases can reveal a lot about the quality of the ammunition and the condition of the rifle, allowing corrective steps to be taken before something ugly happens.
7. Don't mix up ammunition. Keep cartridges in their original box until you are ready to load them. At the range, put only the ammunition for the firearm you are currently using on the shooting bench. Don't put ammunition of different calibers or loads in the same box or loose in your pockets or range bag. It is too easy to pick up and load the wrong cartridge, with potentially disastrous results.

WARNING!

Excessive pressure in the barrel when a shot is fired can blow up even the strongest firearm, and cause death or serious injury to the shooter or others nearby.

Even at normal firing pressure (often in excess of 50,000 pounds per square inch), if the cartridge case bursts the uncontrolled escape of propellant gas from the barrel into the receiver area can be extremely dangerous. Explosions from excessive pressure or burst cartridge cases are most commonly caused by defective or improper ammunition or by an obstruction in the barrel. (See warnings in following section, "Bore Obstructions".)

Defective cartridges may be overloaded or underloaded, incorrectly dimensioned, improperly manufactured or assembled, or assembled from the wrong or faulty components. Defective ammunition also includes cartridges that are dirty, wet, corroded, bent, split, damaged, contaminated with lubricant, or deteriorated from age or poor storage. Corrosion, dirt or other foreign matter on a cartridge can impede complete locking of the bolt, and in combination with other

faults may result in a burst cartridge case; the same is true of a cartridge that is oversized, damaged or deformed. Another defect is a bullet that is loose in the case neck; this condition introduces a high risk of a bore obstruction.

Improper cartridges are those of the wrong caliber or loading for normal use in a particular firearm.

For safety, use only clean, dry, high quality ammunition in good condition manufactured and assembled to industry standards, and of the correct caliber and loading for your firearm. The risks associated with defective cartridges are greatly reduced by using only factory-loaded military or commercial ammunition produced by reputable manufacturers.

Be sure to wipe the chamber and bore dry before loading. Lubricant or preservative interferes with the adhesion between cartridge case and chamber wall that is necessary for safe firing, and subjects the firearm to stress similar to that imposed by excessive pressure.

AMMUNITION

A GRIM SERMON ON RELOADING

The use of reloaded (or "handloaded", "remanufactured", or other non-standard) ammunition is far and away the most common cause of dangerous malfunctions and blown up firearms.

Reloading is a complex science which unfortunately is not as fully understood by many of its practitioners as it deserves to be. It also requires a high order of quality assurance which many have neither the specialized knowledge nor the equipment to establish and maintain.

Many reloaders do not realize that reloading for semi-automatic rifles is not the same as for bolt-action or single shot rifles. In semi-automatic firearms the mechanism, not the shooter, controls feeding, locking, unlocking, extraction and ejection; bolt velocity and bolt energy are far higher. To ensure safety as well as reliability, the reloader must make careful allowance for these differences. Those who do not, for example, appreciate the distinction between chamber headspace and cartridge headspace are not yet qualified. Mistakes they might get away with in a bolt-action or single-shot rifle can be downright dangerous in a semi-automatic.

A reloaded cartridge is no better than the knowledge, skill and care of the person who made it. The catalog is endless of seemingly minor details that, if not gotten right, can produce a major disaster. A cartridge that is improperly resized, primed, charged or assembled, or made from the wrong, defective or outdated components, can be extremely

dangerous in many ways. It can slam-fire, cause a bore obstruction, produce a malfunction that sets the stage for an accidental discharge, inflict progressive damage to the gun, or just blow it up.

Such problems seldom arise from original factory-made military or commercial ammunition from major manufacturers who have the experience and facilities to produce it correctly. It is much safer to use only original factory-made cartridges, and you are emphatically urged to do so.

Some intrepid souls nonetheless will choose to use reloaded ammunition. They should understand that they are embracing an extra and potentially lethal risk, and must accept full responsibility if injury results.

The Civilian Marksmanship Program and the Corporation for the Promotion of Rifle Practice and Firearms Safety, Inc. will accept no responsibility whatsoever for any personal injury or damage to the rifle or other property arising from the use of reloaded ammunition.

BORE OBSTRUCTIONS

WARNING!

Barrel obstructions, especially from a bullet stuck in the bore, are a major cause of firearm explosions and can cause death or serious injury to the shooter or others nearby. Immediately stop shooting and check the barrel for a possible obstruction whenever:

- You have difficulty, or feel unusual resistance, when chambering a cartridge, or
- A shot sounds weak or abnormal, or
- Unburned grains of propellant powder are discovered spilled in the mechanism, or
- You manually retract the operating rod handle to eject an unfired (or misfired) cartridge from the chamber, but only the cartridge case comes out, or
- The bolt stays closed when a shot is fired, or a fired cartridge case is not completely ejected from the rifle.

In such instances a bullet may be lodged in the barrel. Firing a subsequent bullet into the obstructed barrel can produce an explosion.

An obstruction from a stuck bullet can occur if:

- The cartridge has been improperly loaded with insufficient or no propellant powder, or the propellant fails for any reason to ignite. (Ignition of the primer alone will push the bullet out of the cartridge case but usually does not generate sufficient energy to drive the bullet out the muzzle), or
- The bullet is not properly seated tightly in the cartridge case. If such a cartridge is extracted from the chamber without being fired, the bullet may be left behind in the bore at the point where the rifling begins. Attempting to chamber another cartridge may push the first bullet ahead into the bore (or telescope the second bullet rearward into its cartridge case), making room for the bolt to close. If this cartridge is then fired an explosion will almost certainly result.

If you have any reason to suspect that a bullet is obstructing the barrel, immediately unload the firearm and look through the bore. It is not sufficient to merely look in the chamber. A bullet may be lodged some distance down the barrel where it cannot easily be seen.

If a bullet is in the bore, DO NOT try to shoot it out by using another cartridge, or by blowing it out with a cartridge from which the bullet has

BORE OBSTRUCTIONS

been removed, or with a blank cartridge. Unburned powder trapped in the bore behind the stuck bullet can detonate in the confined airspace with devastating results.

Often a bullet lodged in the barrel can be removed by tapping it out with a cleaning rod. It is likely that unburned powder and other fouling will be left in the bore. It is imperative that the bore, chamber, and receiver be thoroughly cleaned to remove all such residue before shooting is resumed.

If the bullet cannot be readily dislodged, take the firearm *and the ammunition* to a gunsmith. Do not use any more ammunition from that lot until both have been examined and the cause of the obstruction determined.

Soil, mud, snow, water, ice, vegetation, mud-wasp nests, etc. are all dangerous inside a gun barrel. If the muzzle of your rifle comes into contact with the ground, or you have reason to suspect that something has gotten into the barrel, unload the rifle and look through the bore. It's not enough to just look at the muzzle; debris can slide some distance inside where it can't easily be seen. If anything is there, clean it out with a rod. Never attempt to shoot it out; the barrel may burst and you could be seriously hurt.

LOADING

TO LOAD THE CARTRIDGE CLIP:

Beginning on the lower left side of the clip, insert a cartridge so that its base is against the rear wall of the clip and its extractor groove engages the vertical inner rib of the clip. Insert the next cartridge on the opposite side, and continue until eight cartridges have been inserted. The last cartridge can be snapped in from the top with a downward rolling motion of the thumb. The top cartridge will then be on the right, making it easier for a right-handed person to lock the clip into the rifle (though cartridges feed equally well from either side).

Left-handed shooters should load the clip so that the top cartridge is on the left. This will reduce the risk of being cut by the exposed lip of the clip when loading with the left hand.

Check the loaded clip to ensure that all the cartridges are uniformly seated. If any stick out further than the others, it will be difficult if not impossible to insert the clip into the rifle. Do not try to align them by rapping the loaded clip against a hard surface as this may drive a bullet back into its cartridge case, creating a potentially dangerous condition. Instead remove the top cartridge and push the projecting cartridge back until its extractor groove is engaged, then replace the top cartridge.

LOADING & UNLOADING

WARNING!

1. Above all, keep the muzzle pointed in a safe direction!
2. Put the safety "ON" before loading or unloading.
3. Keep a firm, controlling grip on the rifle when manually chambering a cartridge. Pay attention *constantly* where the muzzle is pointing. A "slam-fire" (a malfunction in which one shot or a burst of shots is fired when the bolt slams closed) is rare but *can* happen in any semi-automatic firearm, even if the safety is "ON". If a burst is fired unexpectedly while the firearm is being held loosely, recoil may cause the muzzle to suddenly "climb" or twist in an unsafe direction. A firm, controlling grip can prevent dangerous movement if a "slam-fire" ever occurs.
4. Before loading remove any oil or grease present in the barrel. Like water they are incompressible, and can cause a bulged or burst barrel as well as serious injury to the shooter or bystanders.
5. Do not load or unload any firearm inside a vehicle, building or other confined space (except a properly constructed shooting range). Enclosed areas frequently offer no completely safe direction to point the firearm; if an accidental discharge occurs, injury or property damage is almost a certainty.
6. Never manipulate the bolt and trigger of the M1 in a misguided attempt to leave the rifle uncocked but fully loaded with eight shots. *It cannot safely be done.* Since the magazine will accommodate only seven cartridges with the bolt closed, the eighth cartridge must necessarily be chambered. Uncocking the hammer pushes the firing pin directly into contact with the primer of the chambered cartridge. This condition is unstable and dangerous, as the rifle might fire from an impact without the trigger being pulled. If you wish to have the rifle loaded with the chamber empty, load only seven or fewer cartridges.

LOADING

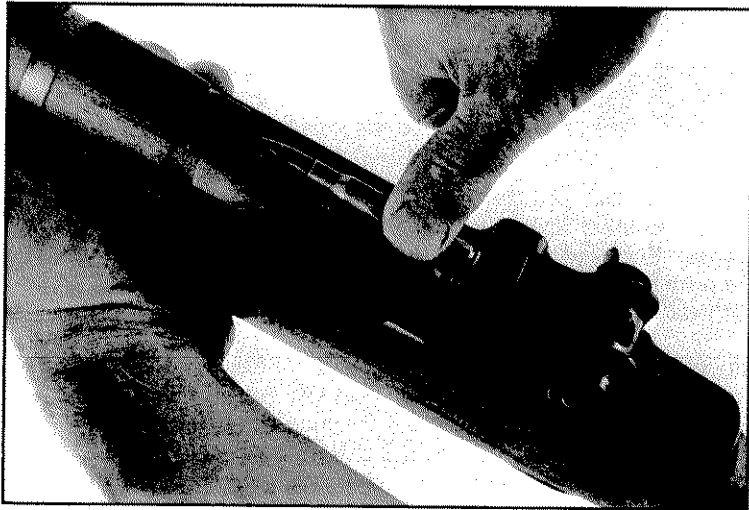

Fig. 3 – Push straight down to load a full clip into the rifle.

TO PREPARE THE RIFLE FOR LOADING:

With the muzzle pointed in a safe direction, pull the operating rod handle smartly all the way to the rear so that the bolt is latched open. Except when reloading in rapid or sustained fire with the rifle pointed at the target, perform all loading and unloading with the safety "ON".

TO LOAD A FULL CLIP:

Hold the rifle at the balance with the left hand and support the butt of the rifle against the thigh or rest the toe of the stock on the bench or on the ground, with the muzzle pointed in a safe direction. Using the right hand, place a full clip on top of the follower. Note that the clip is reversible, i.e., it can be inserted top or bottom first. With the thumb on the center of the top cartridge, shove the clip straight down into the magazine until it latches (Fig. 3). It is not necessary to hold the operating rod handle to the rear since the bolt will move forward only slightly *as long as downward thumb pressure is maintained on the top cartridge*. Flip the hand up and to the right to clear the forward movement of the bolt, which will unlatch when the clip reaches the bottom of the magazine. If necessary smack the operating rod handle forward with the heel of the right hand to assist the bolt to close and lock.

Left-handed shooters may follow the instructions above by reversing "right" and "left". However, it should be recognized that the M1 rifle was designed in an era when all soldiers were taught to shoot right-handed, and no provision was made for ambidextrous use. With experience and practice, left-handed shooters often can improvise satisfactory techniques for the loading and unloading procedures described below, but in general it may be more convenient to temporarily switch to the right-hand side to accomplish these tasks.

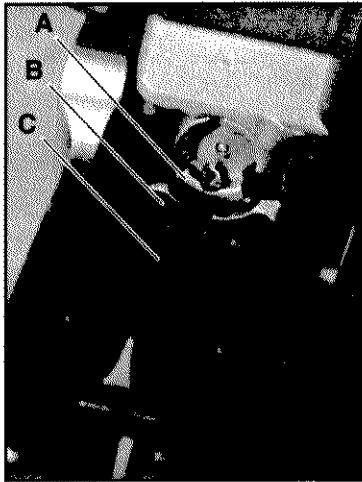

Fig. 4 – Bolt latched open.



Fig. 5 – Bolt open but not latched.

CAUTION: Pay attention to the position of the bolt before putting your fingers in front of it. When latched open (Fig. 4), the bolt (A) will be behind the rear wall of the magazine (B) and not touching the follower (C). However, the bolt usually will stay open even if you fail to draw it back fully (Fig. 5). If the front of the bolt is seen to be resting against the follower (arrow), it is not latched; it is being restrained only by friction from the follower and may suddenly slam shut if disturbed.

A SYMPATHETIC WARNING ABOUT “M1 THUMB”

The bolt of the M1 rifle can slam shut unexpectedly if the shooter has not strictly followed these instructions. If your thumb or finger is in its path, a painful condition called “M1 Thumb” is a strong possibility. In a half-century of military service with the United States and its foreign allies, the M1 has bitten thousands of recruits in this manner. No one ever died from it, but it did lead to a deplorable expansion of vocabulary in many languages. It is best avoided by:

- Making sure that when the bolt is open, it is *latched* open, not resting precariously against the follower.
- Moving your thumb smartly out of the way after inserting a loaded clip.
- Keeping the knife edge of your right hand in front of the operating rod handle, palm beside the stock, whenever you want the bolt to stay open and any part of either hand is in the receiver opening. This position (Fig. 6, page 14) will block any unexpected closure and allow you to securely exert rearward pressure on the handle when required.

If one day you get careless and acquire an M1 Thumb, think of it not as a digit but a diploma. It shows that you’ve learned not to do it again.

LOADING

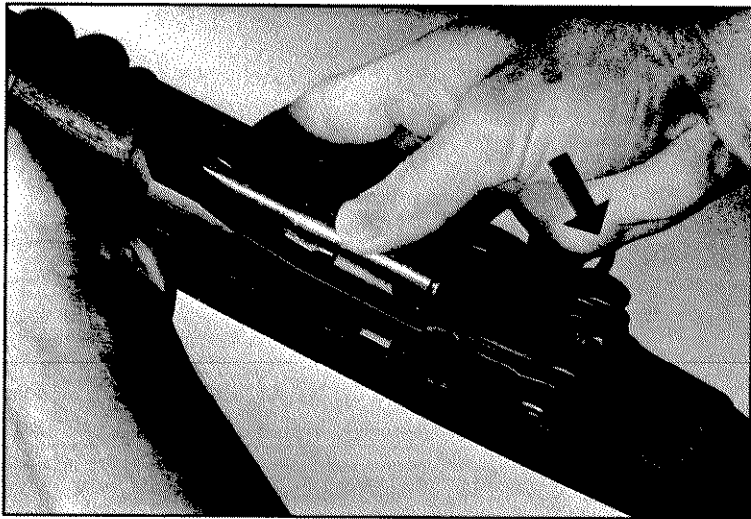

Fig. 6 – Loading a partial clip. Hand blocks, but is not pressing back on the operating rod handle (see arrow).

TO LOAD SINGLE CARTRIDGES WITHOUT A CLIP:

With the muzzle pointed in a safe direction, pull back the operating rod handle until the bolt is latched open. Depress the muzzle below horizontal and insert a cartridge into the chamber. With the knife edge of

the right hand against the operating rod handle, force the handle back slightly, and with the right thumb depress the follower. Let the bolt move forward about an inch, overriding the follower, then flip the hand up and to the right, allowing the bolt to slam closed.

TO LOAD A PARTIAL CLIP:

Hold the rifle as described for loading a full clip, with bolt latched open. Drop an empty clip into the magazine. Place the first cartridge into the clip, on either side of the follower slide. Press a second cartridge into the clip on the opposite side, exerting a downward rolling motion with the thumb toward the center of the clip until the cartridge snaps in place (Fig. 6). Continue inserting cartridges in this manner, with the knife edge of the right hand in front of (but not pressing back on) the operating rod handle to guard against injury to the thumb if the bolt is inadvertently unlatched during this manipulation. The number of cartridges that can be so loaded depends on one's dexterity.

When the last cartridge has been inserted, force the operating rod handle rearward slightly to unlatch the bolt, press down on the clip with the right thumb and allow the bolt to start forward, pushing the top cartridge toward the chamber. Release the handle by flipping the hand up and to the right, allowing the bolt to slam closed. If necessary smack the handle forward with the heel of the hand to assist the bolt to close and lock.

UNLOADING

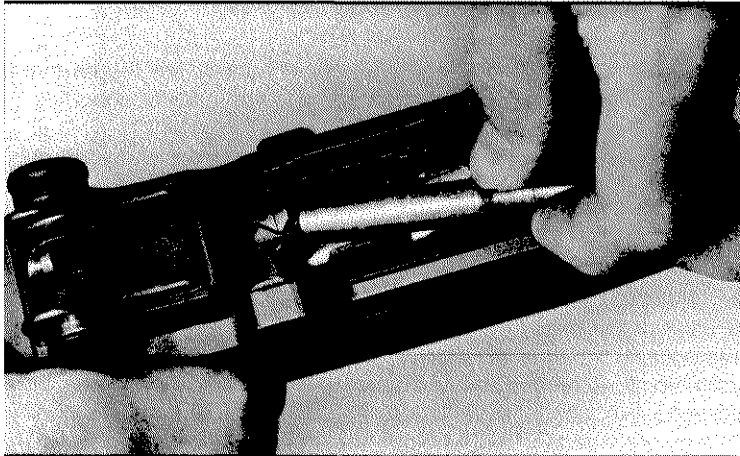

Fig. 7 – Unloading the chamber.

UNLOADING

To unload the chamber, put the safety "ON". Place the rifle butt on the thigh or support the toe of the stock on the bench or on the ground. Make sure the muzzle is pointed in a safe direction. Hook the right thumb over the operating rod handle and pull it slowly rearward. At the same time place the left hand over the receiver opening to catch the cartridge as it is ejected (Fig. 7)

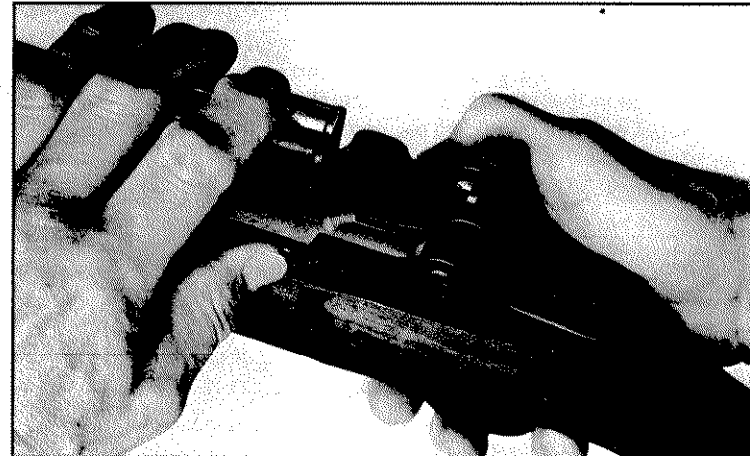

Fig. 8 – Removing the clip. Thumb pressing clip latch.

The clip may now be removed. Finish pulling the operating rod handle fully to the rear and hold it there by wrapping the fingers of the right hand around the front of the trigger guard. With the left palm over the receiver opening, depress the clip latch with the left thumb (Fig. 8). The clip and any remaining cartridges will pop up into your left hand.

Do not let the bolt move forward while unloading as it will push the top cartridge forward and prevent normal ejection of the clip.

UNLOADING

TO UNLOAD THE CHAMBER AND LEAVE THE MAGAZINE LOADED: (This cannot be done if the clip is full.) Clear the chamber, and continue to hold the operating rod handle to the rear. Depress the top cartridge in the clip with the left thumb. Allow the bolt to slide forward about an inch, overriding the cartridge. Lift your left thumb out of the way and let the bolt close, assisting it if necessary. Watch the top cartridge to make certain that the bolt closes without chambering it.

TO CLOSE THE BOLT FROM A LATCHED OPEN POSITION WITH THE RIFLE EMPTY: With the knife edge of the right hand against the operating rod handle, force the handle back slightly, and with the right thumb depress the follower. Let the bolt move forward about an inch, overriding the follower, then lift your thumb out of the way. Move your right hand forward, restraining the operating rod handle to close the bolt gently.

Be gentle when closing the bolt on an empty chamber. In normal operation the brass cartridge case acts to slow and cushion the impact of the steel parts. When the chamber is empty, restraining the operating rod handle and easing the bolt closed will avoid unnecessary battering.

FIRING THE RIFLE

TO FIRE:

1. Keep the safety "ON" and your finger outside the trigger guard until the rifle is pointed at the target and you are ready to shoot.
2. Assume a shooting position, put the butt to your shoulder, point the muzzle at the target and push the safety "OFF". Take aim and squeeze the trigger for each shot. When the last shot has been fired, the clip will eject automatically, and the bolt will remain latched open.
3. If the rifle fails to fire when the trigger is pressed, *keep the muzzle pointed at the target!* Do not assume that because the rifle did not immediately fire, it is therefore safe to handle. The rifle may be in an unstable condition and should be presumed capable of firing unexpectedly until the chamber is unloaded. Follow the procedures described in "Stoppages" (pages 18-20) before turning away from the target.

CAUTION: If your rifle develops any unusual behavior, malfunction or binding, or starts spitting powder gas, or a cartridge primer is punctured, or a cartridge case is bulged or ruptured, or something does not sound or feel quite right, cease fire immediately! Unload the rifle. Check for a bore obstruction. Do not "try one more shot to see if it does it again" (It probably will, but worse; it is amazing how often serious accidents are preceded by warning signs that are ignored). Take the firearm *and the ammunition* to a gunsmith.

WARNING!

1. If you take the safety "OFF" to fire but do not fire immediately, put the safety back "ON". Do not put the loaded rifle down or carry it anywhere without first putting the safety "ON". An accidental firing could easily result from any unintended contact with the trigger.
2. Do not place your fingers over the receiver opening or where they can be struck by the normal reciprocating movement of the operating rod handle. Make certain there is a clear, unobstructed path for safe ejection of fired cases. Do not allow bystanders where they might be struck. The cases are hot and may be ejected with sufficient force to cause a burn or cut, or gouge an unprotected eye.
3. A "slam-fire" can occur when the bolt cycles after a shot is intentionally fired. This is perceived by the shooter as "doubling" or burst firing (discharging two or more shots from one press of the trigger). The usual cause is faulty trigger/sear/hammer engagement or ammunition problems. When firing the rifle always maintain a firm, controlling grip to prevent the muzzle from "climbing" or twisting away from the target if this should occur.
4. Using ammunition with soft commercial primers increases the risk of a slam-fire, especially when combined with inadequately resized or improperly assembled reloads, excessive wear, out-of-specification parts or heavy chamber fouling. Particularly dangerous are "high" or not fully seated primers (or the erroneous use of large *pistol* primers). Periodically check your ammunition by ejecting an unfired cartridge from the chamber. Examine the primer for excessive dimpling from the firing pin. Be aware that any condition or alteration that reduces cartridge headspace also reduces firing pin/primer clearance and can increase dimpling. A very light dimple is normal; if in doubt take both rifle and ammunition to a gunsmith.
5. The bolt must be fully locked to safely contain firing pressure. Incorrectly dimensioned reloads that will not permit the bolt to rotate to its fully locked position without resistance can cause an explosion in the event of a slam-fire. Check reloaded cartridges with a commercially-available gauge to ensure they will chamber freely.

STOPPAGES

TYPES OF STOPPAGES

A **stoppage** is any unintentional interruption in the cycle of operation. While stoppages may be expected from time to time in any semi-automatic firearm, they are rare in a clean, well-maintained and properly lubricated M1 if good ammunition is used.

Stoppages in an M1 rifle usually are caused by cartridges that are defective, dirty, damaged, weak, improper or otherwise unsatisfactory. Stoppages also can result from a dirty rifle (especially a dirty chamber or carbon fouling in the gas cylinder), lack of lubrication, or a broken or deformed part.

A **misfire** is a common type of stoppage in which a chambered cartridge fails to fire when its primer is struck by the firing pin. The bolt is found closed, or nearly so.

There are other types of stoppages, including a **failure to feed** a cartridge from the magazine into the chamber, or a **failure to eject** a fired cartridge case from the rifle. In such instances the bolt may be found either open or closed. By definition such stoppages are not misfires.

Sometimes the bolt is found wedged open or partly open by a cartridge, fired cartridge case, or by a broken or deformed part. Such a stoppage is often called a **jam** because the bolt cannot be fully cycled until the blockage is cleared. A jam also is said to occur when the bolt is closed and cannot manually be opened.

The proper procedure to clear the stoppage depends upon the position in which the bolt is found when the stoppage occurs. And, in order to take corrective action to prevent its recurrence, it is important to identify the type of stoppage and its cause.

TO CLEAR A STOPPAGE:

WHEN THE BOLT APPEARS CLOSED: Wait a few seconds to avoid any possibility of a "hangfire" (delayed ignition of the cartridge), then —while keeping the rifle pointed at the target— pull the operating rod handle all the way to the rear with the little finger of the right hand, palm up (to avoid hand injury if the rifle fires unexpectedly, see Fig. 9). Do not release the handle. *Watch to see what is ejected.*

There are four possibilities:

1. Nothing is ejected. Look in the chamber. If it is empty, the stoppage was not a misfire but a failure to feed. Release the operating rod handle and try to fire again. If more failures to feed occur, clear the rifle and investigate. By itself this type of stoppage is not dangerous, but to ensure reliable functioning its cause must be identified and remedied.

2. A complete cartridge is ejected. Clear the rifle and inspect the ejected cartridge. If its primer has been deeply and centrally indented by the firing pin, a defective primer caused a misfire. Reload and resume firing. If the cartridge primer has a faint or shallow indent the misfire was caused by the bolt not being fully closed. Refer to the "Rx

STOPPAGES

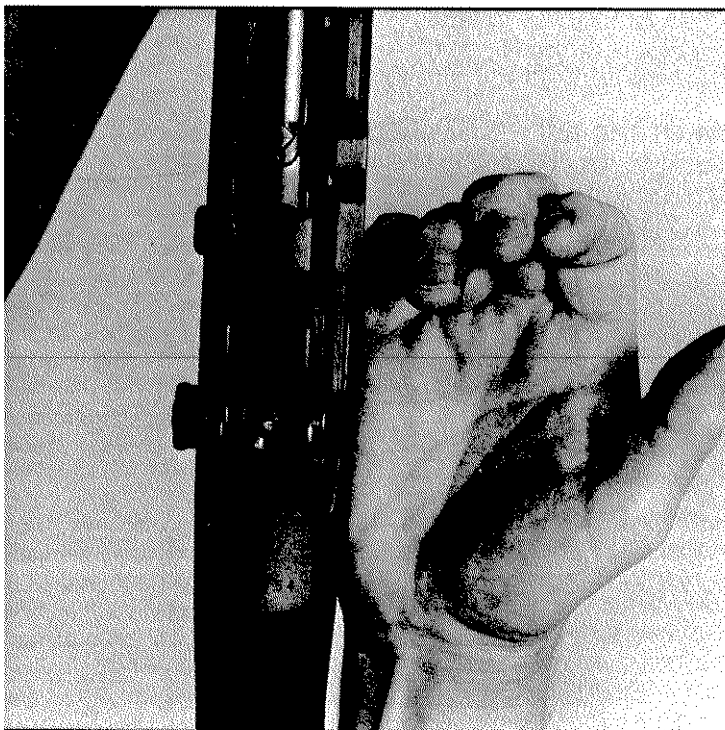

g. 9 – Clear stoppages by retracting operating rod handle with palm up.

for Misfires” section (page 21). If there is no indent at all, check for a broken firing pin. Do not resume firing until the cause of the stoppage has been identified and remedied.

3. A cartridge case only (minus the bullet) is ejected. This situation is potentially very dangerous. It is possible that the bullet is lodged in the bore and an explosion can result if another cartridge is chambered and fired. Immediately clear the rifle and look through the bore for a stuck bullet! Do not attempt to fire another shot until you have taken all necessary precautions and corrective action described in the “Bore Obstructions” section (pages 9-10).

If no bullet is found in the bore, the stoppage resulted from a failure to eject due to a weak cartridge, excessive carbon fouling in the gas cylinder, or a mechanical problem. Such stoppages are likely to continue until their cause has been identified and remedied.

4. Nothing is ejected but an unfired cartridge or a fired cartridge case is stuck in the chamber. This can result from a deformed cartridge, a fouled chamber, or a mechanical problem such as a broken extractor. Keep holding the operating rod handle to the rear. (Releasing the handle will push another cartridge forward and produce a serious jam. Also, if the chamber contains an unfired cartridge the bullet point of the second cartridge might strike and possibly detonate the primer of the chambered one, causing an explosion.) Put the safety “ON”. Eject the clip and remaining ammunition. Depress the follower

STOPPAGES

TO CLEAR A STOPPAGE (continued):

and let the bolt slam closed. Pull back the operating rod handle again to try to extract and eject the chambered cartridge.

If it still won't come out, latch the bolt open. That will free both hands to pry the cartridge out with a tool. The bullet point of a spare cartridge wedged in the extractor groove of the stuck case often works. If you find it necessary to use a cleaning rod from the muzzle to knock it out, do not place any part of your body in front of the muzzle or over the handle end of the cleaning rod! Cartridges have been known to fire from impact. Hold the cleaning rod by its sides only, and keep the muzzle pointed in a safe direction!

After the cartridge has been removed, check the extractor to see that it is undamaged and operating properly. Do not resume firing until the chamber has been thoroughly cleaned and the cause of the failure to extract has been identified and remedied.

WHEN THE BOLT IS JAMMED OPEN: Keep the rifle pointed at the target! Hook the right thumb over the operating rod handle and pull it fully to the rear. Wrap the fingers of the right hand around the trigger guard to hold the bolt back while you remove with your left hand whatever is blocking the way. Sometimes it can be easier (and sometimes harder) if the clip and remaining ammunition are ejected first; this is learned from experience.

Check all complete cartridges involved in the jam and discard any that are bent or damaged. Do not resume firing until the cause of the jam has been identified and remedied.

WHEN THE BOLT IS JAMMED CLOSED. Resist any impulse to stamp on the operating rod handle with your heel as this posture is unstable and places your body in dangerous proximity to the muzzle. Put the safety "ON". (If it will not go on because the hammer is uncocked, unlatch and open the trigger guard; this will cock the hammer. Then close and latch the trigger guard and put the safety "ON".) Hook the right thumb over the operating rod handle and maintain rearward pressure on it. With the rifle pointed in a safe direction, slam the butt squarely rearward against a hard surface while keeping your head and other parts of your body well behind the muzzle. This usually will open the bolt, and your thumb pressure will keep the bolt from bouncing back to a jammed position. Do not resume firing until the cause of the jam has been identified and remedied.

Rx FOR MISFIRES

A **misfire** is usually caused by defective ammunition. However, it also can result from incomplete rotation of the bolt into its fully locked position. When this happens much of the hammer's energy is absorbed forcing the bolt to lock; the firing pin is not struck solidly and the indent on the cartridge primer is seen to be faint or shallow.

If such misfires occur only with the first cartridge of each clip, the most likely cause is incorrect technique in manually chambering the cartridge. The shooter must ensure that when the bolt closes, it is fully locked.

Do not ease the bolt forward or "ride" the operating rod handle with your hand. To ensure complete locking let the bolt freely slam closed. If it hesitates, slap the operating rod handle forward with the heel of the right hand to encourage it; it won't damage the rifle. It's a good habit to tap the handle after the bolt is shut just to make sure. Don't bother after the first shot: a clean M1 with good ammunition has plenty of energy to lock reliably by itself.

Incomplete locking of the bolt also can be caused by oversized, dirty or deformed cartridges, or by other problems. If shallow firing pin indents occur after the first shot in each clip, try other ammunition known to function reliably in another firearm. Also look for dirt or debris in the chamber, on the bolt face, in the locking recesses of the receiver, or in the firing pin tunnel in the bolt. See that the operating rod is not dragging on the inside of the stock or against the rear barrel band. If nothing is obviously amiss, take the rifle and the ammunition to a gunsmith.

Figs. 10 & 11 show safety features of the M1 rifle designed to prevent the hammer from driving the firing pin forward until the bolt is securely locked. The rear of the bolt is seen from inside the receiver. As the bolt moves forward, contact between the firing pin tang (A) and the rear wall of the lower receiver bridge (B) retracts the firing pin until the bolt has rotated clockwise into its locked position, aligning the firing pin with a slot (C) permitting its passage forward. If the bolt is not completely locked, a projecting tang on the hammer face strikes a cam surface (D) on the bolt, forcing it closed before the hammer can reach the firing pin.

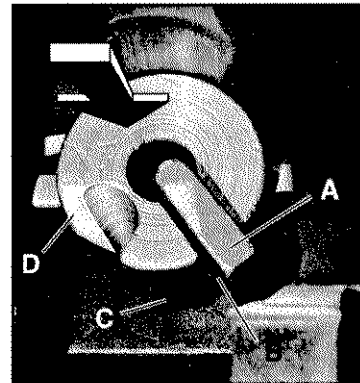

Fig. 10 – Bolt not yet locked. Firing pin tang blocked by receiver bridge.

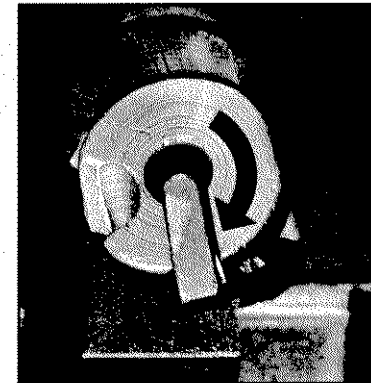

Fig. 11 – Bolt fully locked. Firing pin tang aligned with slot.

MALFUNCTIONS

A **malfunction** is any failure of the rifle to function satisfactorily.

The M1 rifle has proved itself to be extremely rugged and reliable, but it is important to recognize a malfunction if it should occur. Here are some different types and their causes.

Numbers 1 and 2 are dangerous. If either of these malfunctions appear, do not continue to use the rifle. Get it fixed immediately!

1. The safety snaps to the "OFF" position when pressure is applied to the trigger. Usually caused by a broken or worn safety. Take the rifle to a gunsmith.
2. The rifle fires a burst of two shots (or more) with a single pull of the trigger. Usually caused by inadequate hammer, trigger or sear engagement, but there are other possible causes. Take the rifle *and the ammunition* to a gunsmith.
3. The clip ejects on the 7th shot, taking the last cartridge with it. Usually caused by a bent follower arm. Replace the part.
4. The bolt is released before the clip is latched in the magazine. Usually caused by wear or deformation of the operating rod catch, bullet guide, or clip latch. Replace parts as needed.

SIGHTS

TO ADJUST THE SIGHTS: Fire the rifle at a known distance (say, 200 yds.), moving the rear sight until the point of aim coincides with the point of impact. Move the rear sight in the direction you wish to shift the point of impact. For example, if the rifle shoots to the left of the target, the point of impact must be shifted to the right. Move the rear sight to the right.

The rear sight is adjusted by turning the windage and/or elevating knobs (Fig. 1). The knobs move in "clicks". Each click represents one minute of angle, or approximately one inch of movement on the target for each hundred yards of range. Each graduation on the windage scale on the receiver represents four minutes of angle.

Once the aiming point and the point of impact coincide, zero the elevating knob so that its range marking corresponds to the distance to the target. Thereafter the rear sight can be set for a known distance up to 1200 yards by turning the elevating knob to the appropriate marking.

TO ZERO THE ELEVATION KNOB: Two types of rear sights are found. The old type is distinguished by a rectangular lock nut opposite the windage knob. With this type, if the sight was adjusted at 200 yds., tighten the lock nut and loosen the screw in the elevation knob, then reset the knob so that its 200-yd. marking is opposite the index and tighten the screw. With the new type (Fig 12) there is no lock nut so the screw can be loosened only when the sight is at the bottom, and fully retightened only when it is at the top. Count the number of clicks

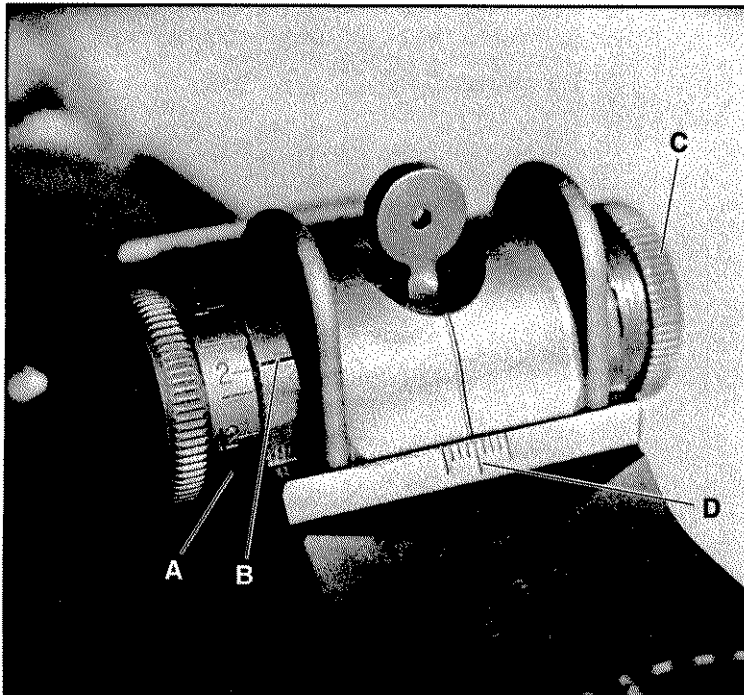

Fig. 12 – Rear Sight, new type, showing elevation knob (A) elevation index (B), windage knob (C) and windage scale (D).

needed to lower the sight from your adjusted setting to the bottom and just break loose the screw. Leave it tight enough to turn the sight. Raise the sight the same number of clicks. Now back out the screw enough to allow the knob to be pulled away from the sight and rotated so that its 200-yd. marking is opposite the index. Retighten the screw as much as you can while holding the elevation knob, then raise the sight to maximum elevation to cinch it down firmly. Check the adjustment; you should have the same number of clicks from the 200-yd. marking to the bottom as were counted before.

REAR SIGHT TENSION: There must be sufficient tension on the rear sight or it will not hold elevation adjustments under recoil. Check tension by running the sight all the way up and two clicks down. With the fingers of the right hand around the pistol grip, press down on the top of the sight aperture with the right thumb (Fig. 13). If the aperture drops, or if sharp clicks are not heard when the elevating knob is turned, the tension must be increased.

First make sure the screw in the center of the elevating knob is tight. Then use a screwdriver to tighten the nut in the center of the windage knob one click at a time. Test the tension after each click. If proper tension cannot be obtained, new parts are needed. Take the rifle to a gunsmith.

When tension is proper the windage knob may be hard to turn. It will turn easier if the screw in the elevating knob is pushed in with a thumb while rotating the windage knob.

SIGHTS



Fig. 13

DISASSEMBLY

FIELD STRIPPING: This consists of disassembly into three main groups: the trigger housing group, the barrel and receiver group, and the stock group.

Clear the rifle. Close the bolt and lower the elevation on the rear sight to zero. Lay the rifle on a table, sights down. Pull the rear of the trigger guard back and up to unlatch it, rotating it up as far as it will go (Fig. 14). Lift the trigger housing group out of the stock (Fig. 15). Separate the barrel and receiver group from the stock group by grasping the rear sight assembly with one hand and slapping upward on the comb of the stock with the other hand (Fig. 16). This completes field stripping.

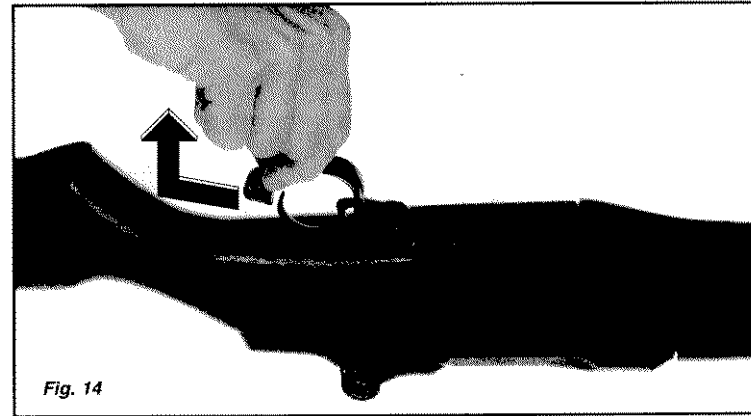
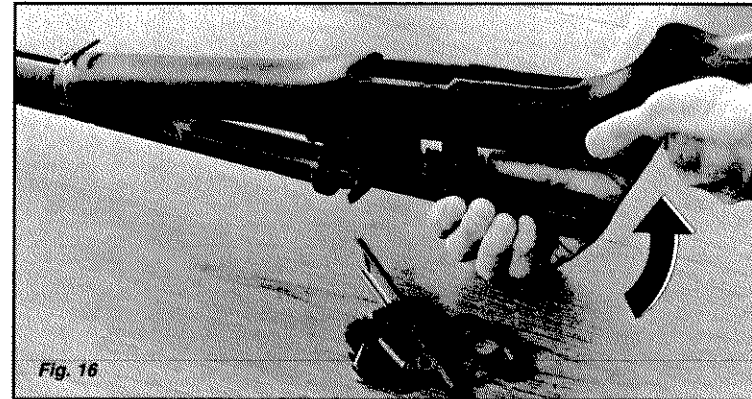
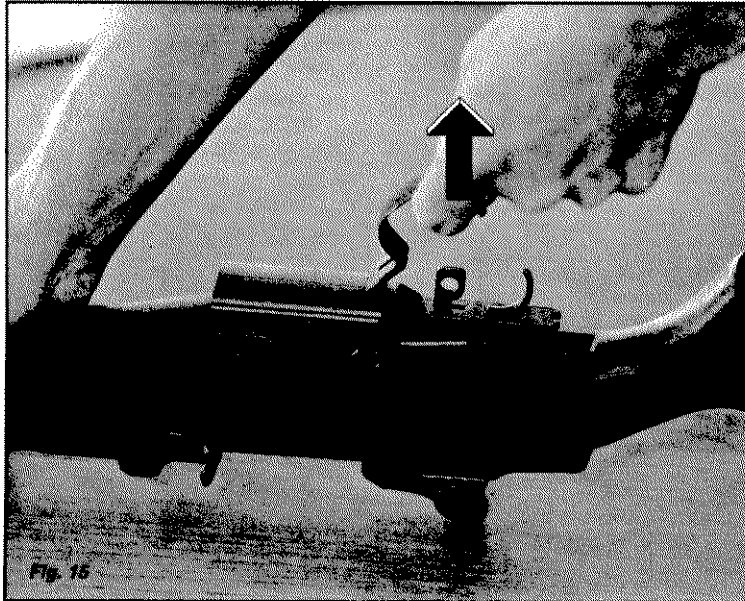
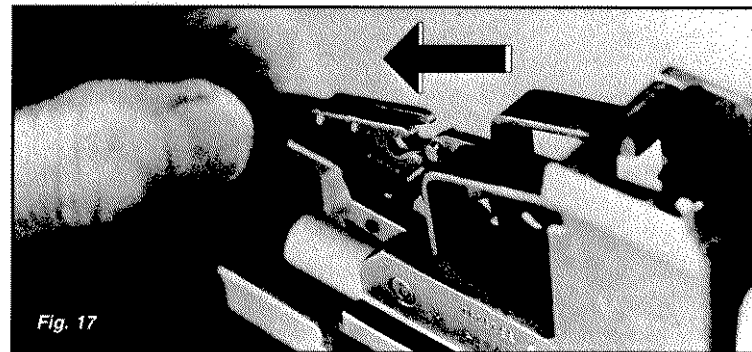

Fig. 14

DISASSEMBLY



TO DISMANTLE THE BARREL AND RECEIVER GROUP: Grasp the follower rod and disengage it from the follower arm by retracting the rod toward the muzzle (Fig. 17). Remove the follower rod and operating rod spring together.



DISASSEMBLY

Push out the follower arm pin (Fig. 18). Grasp the bullet guide, follower arm and operating rod catch assembly and pull them forward off the receiver (Fig. 19). Do not remove the accelerator from the operating catch assembly except to replace it; its pin is riveted. Lift out the follower assembly.

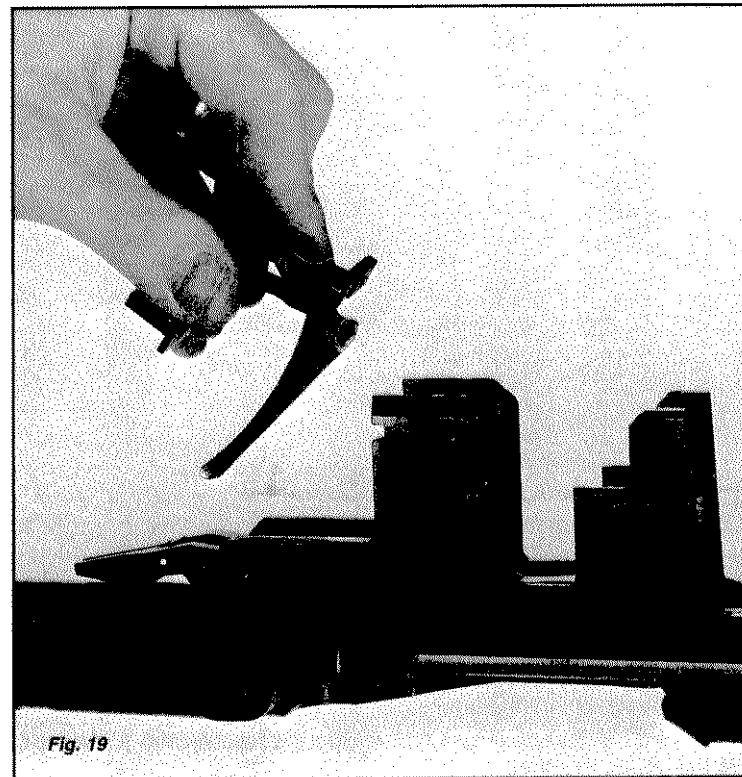
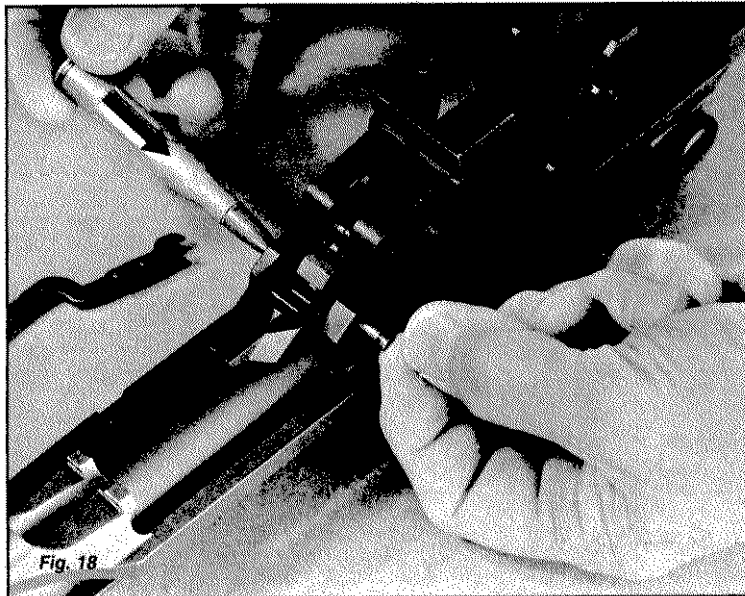

DISASSEMBLY

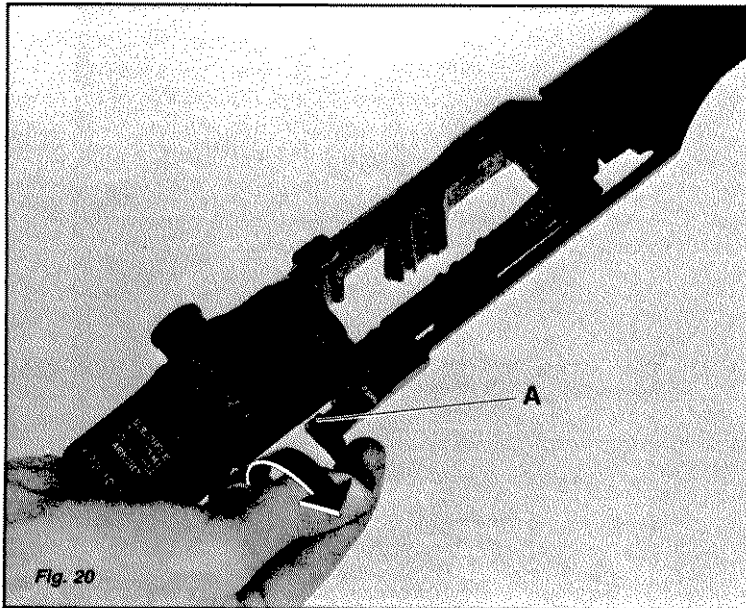

Pull the operating rod to the rear until the rear of its handle is directly under the forward edge of the windage knob. With an upward and outward movement, disengage the guide lug (A) of the operating rod through its

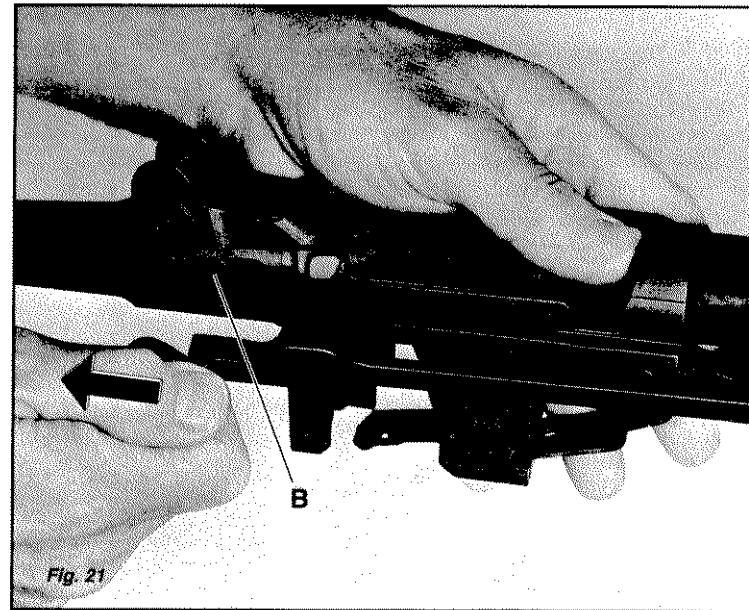

dismount notch (B) in the receiver (Figs. 20 and 21). Remove the operating rod by rotating it downward and pulling it out to the rear. NOTE: The operating rod is bent by design; do not attempt to straighten it!

DISASSEMBLY

Remove the bolt by grasping its right lug and sliding the bolt forward while lifting upward and outward with a rotating motion (Fig. 22).

Figs. 23 and 24: The bolt assembly is held together by the extractor (A). Hold the bolt with the thumb over the ejector (B) to capture it. Insert a screwdriver (or a coin) into the slot between the extractor and the bottom lip of the bolt face (C) and twist to pry up the extractor. The ejector will snap out against the thumb. Remove the extractor then the extractor plunger with its attached spring (D). Lift out the ejector with its attached spring (E). Do not detach the springs. The firing pin (F) will drop out.

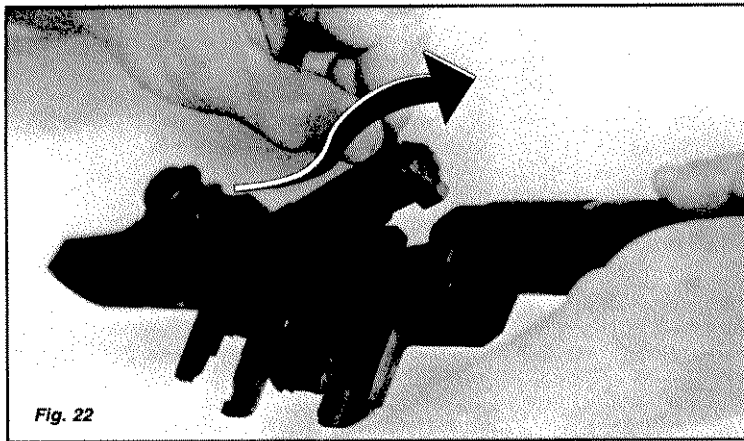

Fig. 22

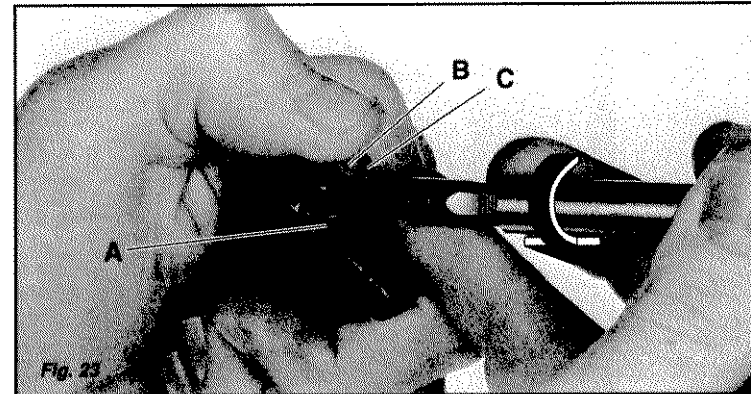

Fig. 23

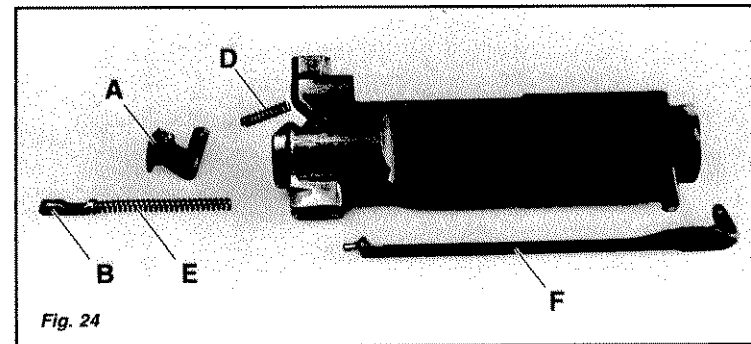
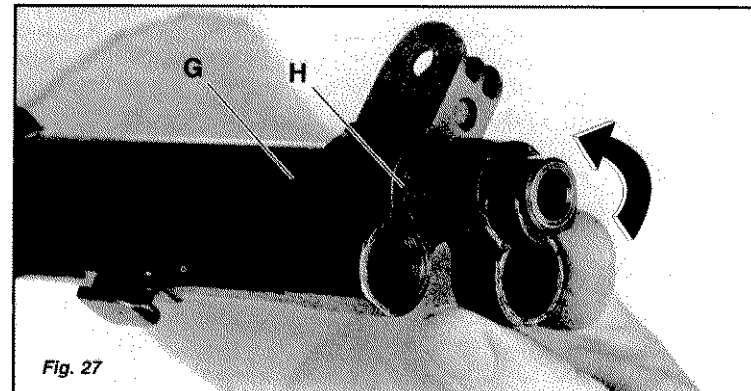
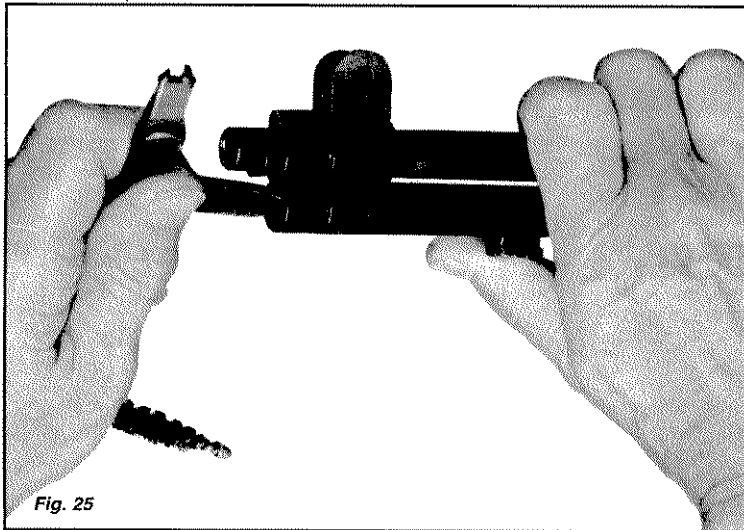

Fig. 24

DISASSEMBLY

To access the gas cylinder for cleaning, unscrew the gas cylinder lock screw with a combination tool or thick-bladed screwdriver (Figs. 25 and 26). Unscrew and remove the gas cylinder lock (Fig. 27). Do not remove the gas cylinder from the barrel for cleaning; if otherwise necessary it can be driven off the barrel by tapping forward on the bayonet stud with a soft wood block. Be careful not to damage the splines (G and H) of the barrel and gas cylinder.



DISASSEMBLY

TO DISASSEMBLE TRIGGER HOUSING GROUP: It attests to John Garand's genius that the only tool needed is a cartridge. While restraining the hammer with your thumb, press the trigger and ease hammer forward to its uncocked position. Do not let the hammer snap forward unrestrained as it may damage the front wall of the trigger housing.

Push the trigger pin from the left until its head is unseated (Fig. 28). Apply pincer pressure with your right hand (Fig. 29) to slightly compress the hammer spring and pull out the trigger pin (A). Slowly release pressure and remove the trigger assembly, hammer spring housing, hammer spring and hammer spring plunger (Fig. 30). Do not remove sear from the trigger assembly unnecessarily. Push out the hammer pin from the left (Fig. 31) and remove the hammer (Fig. 32). Press the upper arm of the safety away from the trigger housing wall (Fig. 33) to unseat the safety pivot stud from its hole (B), and remove the safety. Slide the trigger guard rearward until its wings are aligned with the safety stud hole. Tilt the right wing inward (Fig. 34) until the trigger guard can be removed diagonally. Unseat the clip ejector spring by pushing through access hole with a cartridge (Fig. 35).

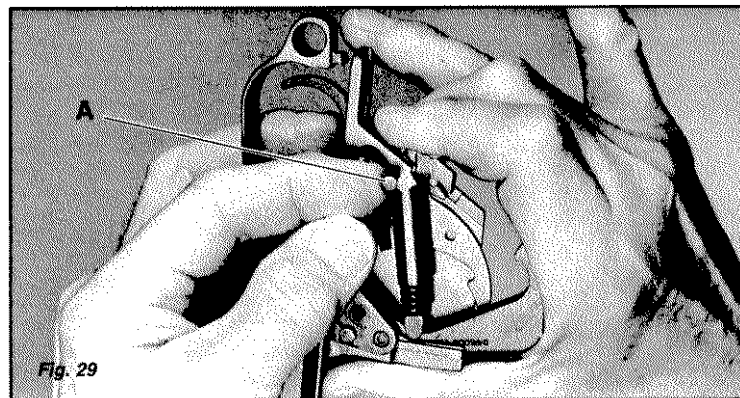

DISASSEMBLY

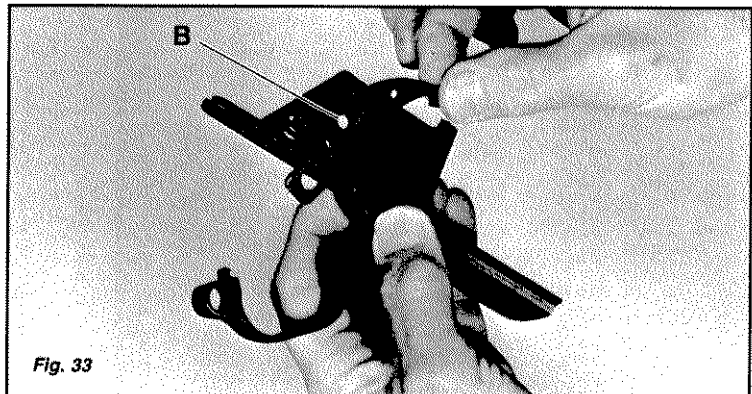
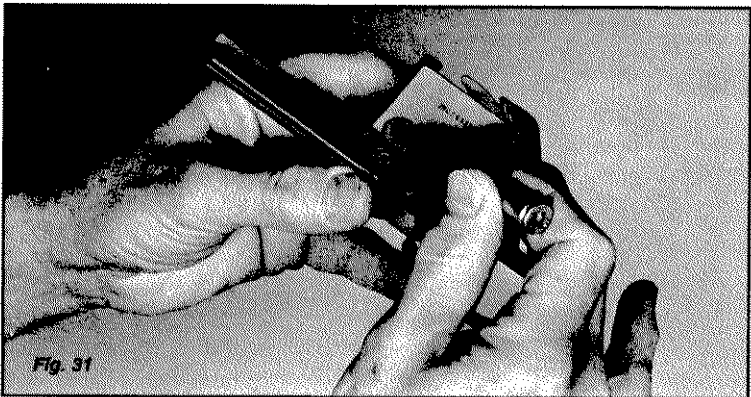
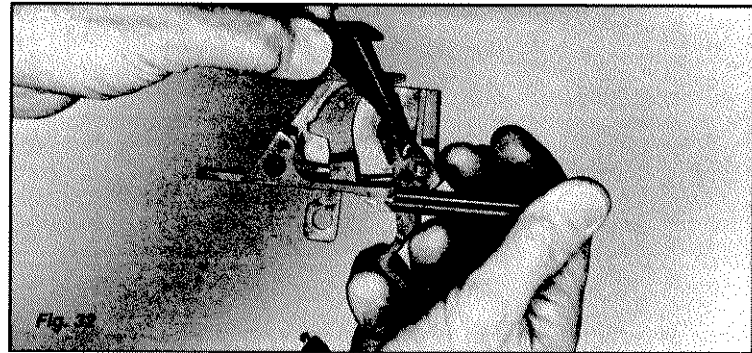
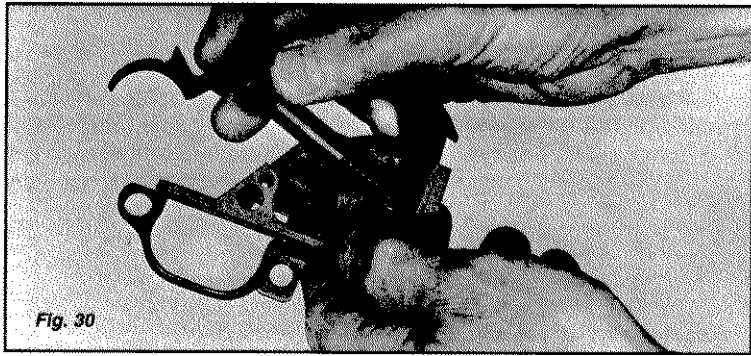

DISASSEMBLY

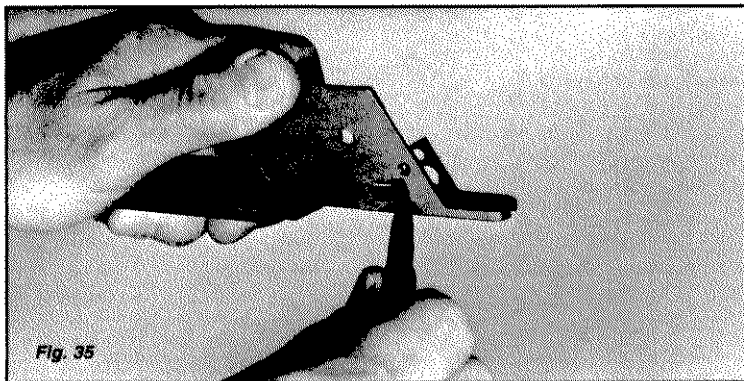
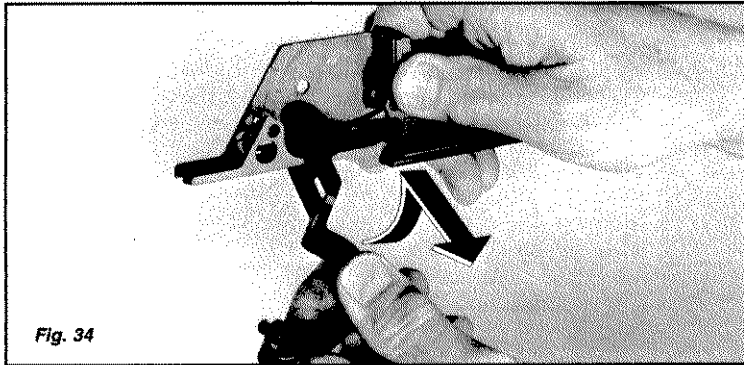

REASSEMBLY

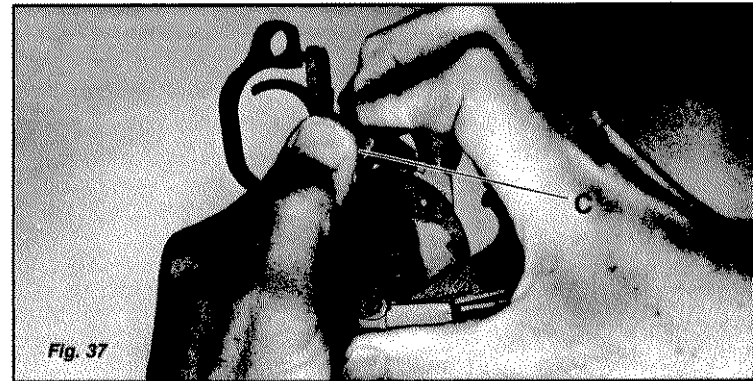
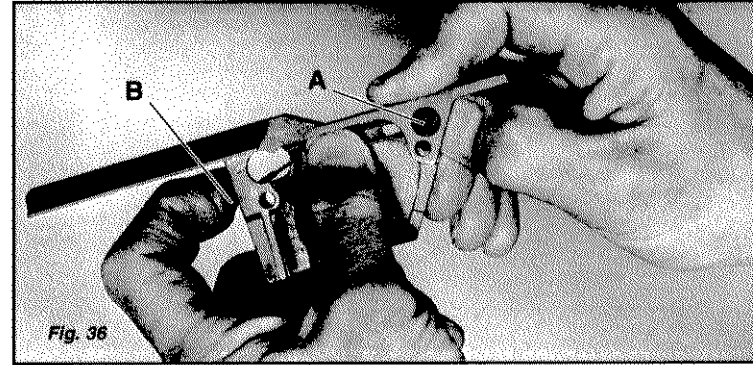

REASSEMBLY

TO REASSEMBLE: Reverse the process.

TIPS: Reinstall clip ejector spring with its long arm nearest floorplate (Fig. 36). Position loop of spring on top of stud (A) and hold it there with your thumb. Use a finger to hold the long arm (B) up into its slot in the front wall of the housing. Flex center of long arm toward you while pressing down with both thumbs until spring snaps in place.

Loosely assemble trigger assembly, hammer spring, hammer spring housing and hammer spring guide and insert them as a unit into trigger housing. (Open side of hammer spring housing faces safety.) Apply pincer pressure (Fig. 37) to align these parts for insertion of the trigger pin. Insert pin loosely, then seat its head (C) by pressing with thumb.

When reassembling bolt (Fig. 38), orient ejector (D) so its clearance notch (E) will permit passage of the extractor shank through its hole in the bolt (F). Use a combination tool, short wooden dowel or fired cartridge case pressed against the bolt face to force the ejector back against its spring until the extractor (G) can be pressed in. **CAUTION:** The spring is strong and can send ejector flying if suddenly released. **WEAR SAFETY GLASSES!**

TEST RIFLE FOR CORRECT REASSEMBLY: Pull operating rod handle fully rearward. Bolt should latch open. Close bolt, put safety "ON" and press trigger. Hammer should not fall. Push safety "OFF" and press trigger. Hammer should fall. If you get different results, you put it together wrong or something is broken.

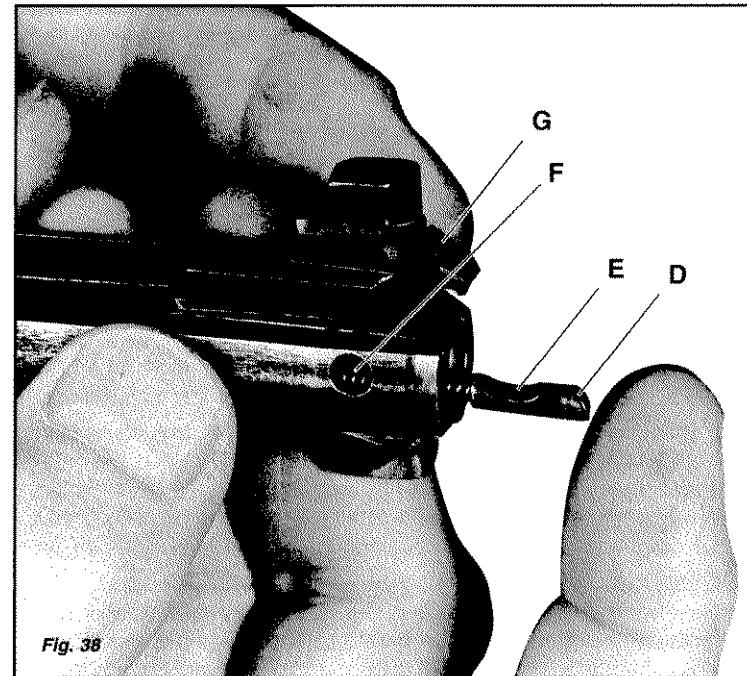

CARE AND CLEANING

WARNING!

1. The *first* step in cleaning any firearm is to make sure it's unloaded. Clear the rifle!
2. The *last* step is to make sure no cleaning patch or other obstruction remains in the bore or chamber.
3. If you discover any damage or mechanical problem, do not continue to use the rifle. Take it to a competent gunsmith immediately. After any immersion in water, or if sand or other foreign matter clogs the mechanism, the rifle should be dismantled for complete and thorough cleaning. Failure to keep the rifle clean and in proper working order can lead to a potentially dangerous malfunctions.
4. All firearms require periodic maintenance and inspection which may reveal a need for adjustment or repair. Have your rifle checked by a competent gunsmith annually even if it seems to be working well, since breakage, undue wear, or other conditions that can dangerously impair functioning may not be obvious to an untrained eye.
5. Remember that a rifle is a precision instrument. Its components can be broken, bent, or burred by unusual abuse, such as a heavy drop on a hard surface. In the event of a severe impact, have the rifle checked by a competent gunsmith to ensure that no internal damage has occurred which may impair its safety or reliability.

Keeping the rifle clean and properly lubricated is important to reliable functioning. After it has been fired, the rifle should be cleaned to remove carbon, primer deposits, powder ashes, and metal fouling.

1. Clean out the barrel with patches and bore cleaner. *Pay particular attention to the chamber to ensure that all fouling is removed.* A late-type G.I. combination tool with chamber-cleaning brush works efficiently, and a small mirror is useful. Dry and oil lightly.
2. Clean carbon deposits from the gas cylinder lock screw, gas cylinder lock, and the operating rod piston with bore cleaner. Do not use abrasives. Carbon deposits can be chipped or scraped out with a small knife or dental pick but be careful not to gouge the metal surfaces. If the lock screw has a valve (for firing rifle grenades) make sure the valve is not held open by foreign particles. Take care not to nick or deform the sharp corners of the operating rod piston. Wipe the parts off and apply oil lightly.
3. Clean the gas cylinder in the same manner as the bore. The lock screw can be turned into the cylinder with the lock removed to help break loose stubborn carbon. Make sure the gas port into the barrel is clear.
4. Clean the face of the bolt with a patch and bore cleaner, paying particular attention to its inside corners, under the extractor hook and the firing pin hole. Make sure the firing pin moves freely. Dry and oil lightly.

CARE AND CLEANING

5. Use patches to clean firing debris from the bolt and all other parts, and from inside the receiver. Clean away contaminated lubricant. Re-oil lightly.
6. Rifle grease such as Lubriplate should be applied to the surfaces shown in the illustrations in Fig. 39. Any surfaces in the mechanism that show bright wear from friction also can profitably be greased sparingly (but do not put oil or grease on the engagement lugs of the hammer, trigger or sear). In addition, a very light film of grease on the forward eight inches of the operating rod will keep carbon from adhering to the rod. Grease should not be used in extreme cold, and the rifle should be left dry in very sandy conditions.
7. A light film of oil on all metal parts will prevent rust. Wipe the oil from the bore, chamber and bolt face before next firing the rifle.
8. If you desire to clean only the bore and chamber without field-stripping (because you will be firing again soon), clean the rifle upside down to keep bore cleaner from running into the stock where it will eventually soften the wood to the detriment of the rifle's accuracy. Before inverting the rifle on a bench, turn the elevation of the rear sight down to zero to protect it from damage.

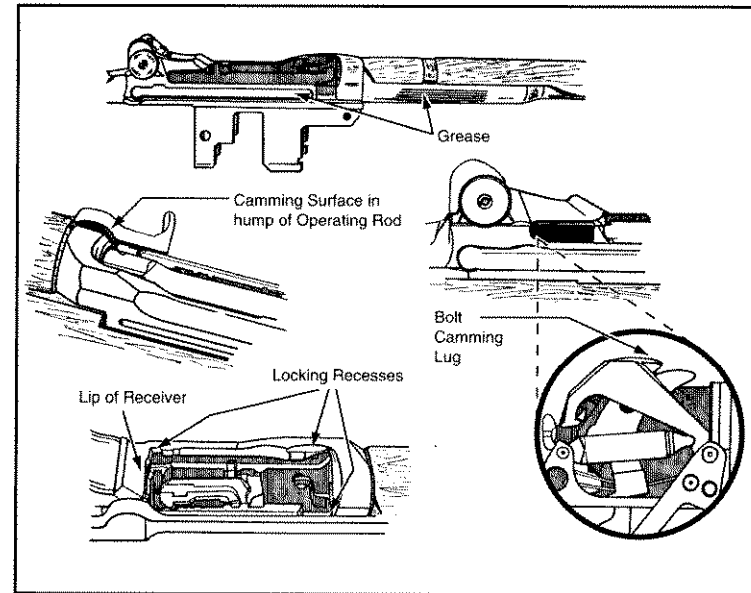

Fig. 39 - Points to apply rifle grease.

MODIFICATIONS OR REPAIRS

WARNING!

Do not attempt to make modifications or repairs to your rifle unless you have the necessary knowledge, training, skill and equipment, and are prepared to take full responsibility for the consequences.

In particular: Because of the potential for uncontrolled fire from incorrect trigger/sear/hammer engagement, do not polish, stone, grind or file any part of the trigger mechanism to lighten or smooth the trigger pull unless you are fully qualified for this specialized work. If you have not carefully studied the design specifications for these parts, or do not have the tools to do it correctly and precisely, don't attempt it. It is not a "kitchen table" job, or a job for untutored amateurs.

Modifications or repairs that are unwisely undertaken or improperly performed can turn a good rifle into a malfunctioning horror, and could lead directly to someone's death or injury.

Bottom line: For modifications or repairs, seek expert help.

TRANSPORTATION AND STORAGE

Unless there is some absolutely compelling reason why it must be done, never transport a loaded rifle in or on a vehicle. When a loaded gun is placed inside a car, truck or plane, or on a motorcycle or RV, the usual risks are suddenly multiplied. It's begging for a gun accident.

And it is difficult to imagine *any* compelling reason to place a loaded rifle inside a case. Unload it before putting it away.

EXPLODED VIEW

PARTS LEGEND

- | | |
|---------------------------|-----------------------------------|
| 1. Barrel | 29. Slide and follower ass'y |
| 2. Lower band | 30. Operating rod |
| 3. Lower band pin | 31. Bullet guide |
| 4. Rear handguard | 32. Follower rod |
| 5. Rear handguard band | 33. Hammer spring plunger |
| 6. Front sight | 34. Hammer spring |
| 7. Front sight screw | 35. Buttplate screw, short |
| 8. Gas cylinder | 36. Buttplate screw, long |
| 9. Clip latch pin | 37. Buttplate |
| 10. Clip latch | 38. Stock ferrule swivel |
| 11. Clip latch spring | 39. Stock ferrule swivel screw |
| 12. Receiver | 40. Stock ferrule |
| 13. Ejector | 41. Butt swivel |
| 14. Ejector spring | 42. Front handguard spacer |
| 15. Extractor | 43. Front handguard ferrule |
| 16. Extractor spring | 44. Front handguard |
| 17. Extractor plunger | 45. Accelerator pin |
| 18. Firing pin | 46. Operating rod catch |
| 19. Bolt | 47. Accelerator |
| 20. Safety | 48. Follower arm |
| 21. Trigger housing | 49. Operating rod spring |
| 22. Trigger pin | 50. Follower arm pin |
| 23. Trigger guard | 51. Gas cylinder lock |
| 24. Clip ejector | 52. Gas cylinder lock screw valve |
| 25. Hammer pin | 53. Rear sight |
| 26. Trigger/sear ass'y | 54. Stacking swivel |
| 27. Hammer spring housing | 55. Stacking swivel screw |
| 28. Hammer | |

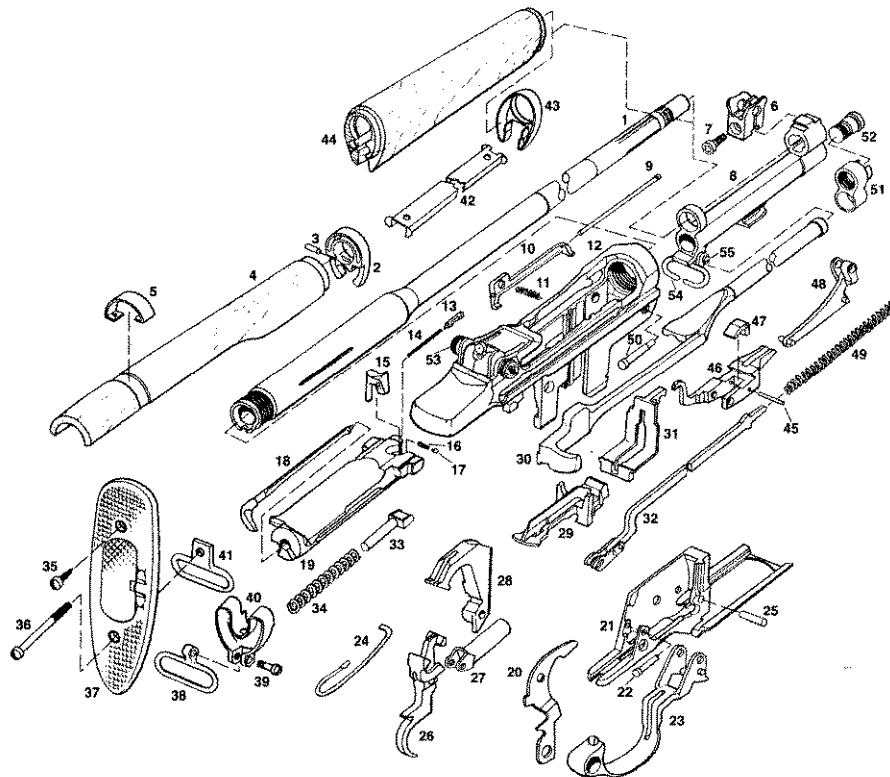

**Most gun accidents happen because
the shooter carelessly violates
the single most important safety rule:**

**KEEP THE MUZZLE
POINTED IN A
SAFE DIRECTION!**

THE CIVILIAN MARKSMAN PROGRAM
Corporation for the Promotion of Rifle Practice and Firearms Safety, Inc.