

**NOW WITH
5-YEAR WARRANTY**

Owner's Manual

Marlin[®]

MODEL 45 SELF-LOADING CARBINE CAL. 45 AUTO (45 ACP)

IMPORTANT

This manual contains operating, care and maintenance instructions. To assure safe operation, any user of this firearm must read this manual carefully. This manual should always accompany the firearm, and be transferred with it upon change of ownership.

The warranty card attached to the cover must be filled out and mailed within 10 days of purchase.

WARNING: *Keep this firearm out of the reach of children*

LIMITED WARRANTY

The Marlin Firearms Company

FIVE YEAR LIMITED WARRANTY AGAINST DEFECTS IN MATERIAL & WORKMANSHIP

This firearm warranty is good only to the ORIGINAL OWNER who has registered his ownership with The Marlin Firearms Company at 100 Kenna Drive, North Haven, Connecticut.

WARRANTY and CERTIFICATE OF OWNERSHIP card **must** be completed and mailed to The Marlin Firearms Company at the above address WITHIN TEN (10) DAYS of purchase to insure the protection of the warranty. NOTICE of defect in materials and/or workmanship **must** be received by the company WITHIN FIVE (5) YEARS from the date of purchase.

Normal wear, or damage resulting from neglect, abuse, or repairs not made or authorized by The Marlin Firearms Company are not covered by the warranty.

THIS WARRANTY GIVES YOU SPECIFIC LEGAL RIGHTS, AND YOU MAY ALSO HAVE OTHER RIGHTS WHICH VARY FROM STATE TO STATE.

MARLIN'S PERFORMANCE UNDER THE ABOVE WARRANTY

1. After notice of defect in material and/or workmanship is received by The Marlin Firearms Company, Marlin shall send instructions for shipment of the firearm; and repairs will be made and the firearm returned within a reasonable time after the firearm is received. Cost of shipping, insurance charges, etc. involved in returning the firearm to the company shall be prepaid by the original owner.
2. Cost of parts and labor performed shall be provided without charge by The Marlin Firearms Company.
3. If The Marlin Firearms Company, after receipt of the firearm, determines that the defects in material and/or workmanship were the result of abuse and/or neglect, or otherwise not covered by the warranty set forth above, Marlin shall notify such owner to that effect and give an estimate for repair. In such cases, repair, return shipping and insurance charges, etc. shall be paid by such owner.
4. In the event that The Marlin Firearms Company is unable to make warranty repairs to the firearm, it shall, within a reasonable time after its receipt, notify the owner to that effect and give him the option either to receive a replacement of the same model, if then available in its inventory, or to receive a refund, either of which, if feasible, will be made through the store of purchase.

The Marlin Firearms Company
100 Kenna Drive, North Haven, CT 06473

Before You Use This Firearm

It is very important that you read and understand this manual before using your firearm. Warnings are highlighted in red, and should be read and heeded carefully. Also follow "Marlin's Guide to Gun Safety", on page 8.

- **WARNING:** We specifically disclaim responsibility for any damage or injury occurring with a Marlin firearm in which faulty, non-standard, "remanufactured," or handloaded (reloaded) ammunition is used.
- **WARNING:** Your rifle is shipped completely assembled and should not be used or disassembled without fully reading and understanding the instructions in this Owner's Manual.
- **WARNING:** Do not use Samson brand or any Ammunition designated "45 Auto +P+" in this rifle. The pressures generated by these cartridges may cause damage to the gun, or personal injury.

How to Operate The Safety

- **WARNING:** Prior to firing, become familiar with the operation of the safety by practicing with the rifle unloaded.

The safety mechanism is a Garand-type steel lever located in the forward section of the trigger guard.

To put the rifle on **SAFE**, pull the lever rearwards as far as it will go. It will protrude into the trigger guard and the letter "S" will be visible. (See A.)

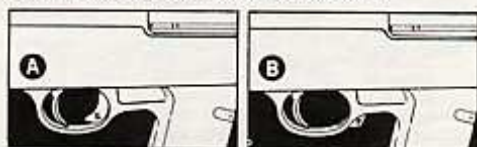

SAFE Position

FIRE Position

To move the safety to the **FIRE** position, push it forward as far as it will go. It will protrude in front of the trigger guard, and the letter "F" will be visible. (See B.)

- **WARNING:** Never disassemble the safety. It has been correctly designed, fitted and tested. Any mechanical device can fail, however, so never rely on the safety to justify careless handling. Never use a gun with a safety that does not function properly (See instructions for factory maintenance on page 7.)

Other Safety Features

1. Automatic "Last-Shot" Bolt Hold-Open

This feature is activated when the clip is empty and the last shot has been fired, or when the charging handle is pulled back fully with an empty clip in place. (See C)

The bolt will not stay open automatically unless an empty clip is locked in place.

To release bolt from automatic hold-open position, remove clip, pull charging handle to the rear, and release.

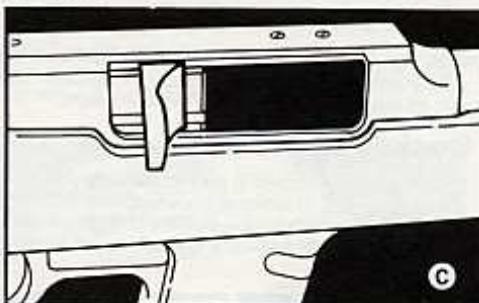

Automatic "last-shot" bolt hold open

2. Manual Bolt Hold-Open Feature

In addition to the automatic "last-shot" bolt hold-open, which stops the bolt nearly all the way back, the manual bolt hold-open device allows you to lock the bolt in the fully open position at any time. (It can be used whether or not the clip is locked in place.)

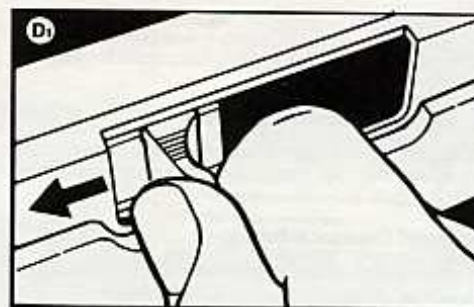

Pull charging handle all the way back.

First, pull the charging handle all the way back (See D1). Then, while holding the handle back, push the bolt hold-open button (located on the left side of the magazine housing) up as far as it will go (See D2). Bolt is now manually locked open. To close the bolt, push the bolt hold-open button all the way down, pull the charging handle back, and release it (See H&I).

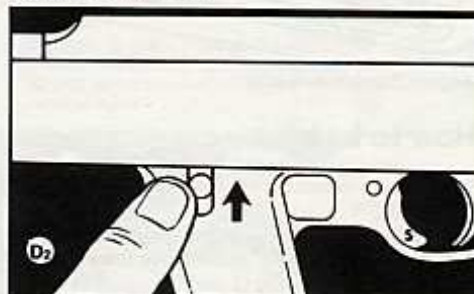

With charging handle held back, push bolt hold-open button up.

If an empty clip is in the gun, the bolt will not close because of the automatic "last-shot" hold open feature. (See C). If a loaded clip is in the gun, a cartridge will be chambered when you release the bolt.

- **WARNING:** When not in use, the safest possible way to handle your rifle is completely unloaded, with the action open, the safety on SAFE, and pointed in a safe direction.

3. Magazine Disconnect Feature

As an additional safety feature, your rifle will not fire when the clip magazine has been removed from the gun.

4. Loaded Chamber Indicator

A red indicator protrudes from the rear right side of the bolt when a cartridge is in the chamber. This is an instant visual warning that the chamber is loaded (See E).

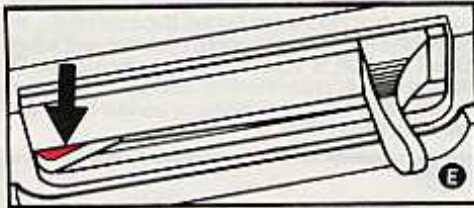

Loaded Chamber Indicator

How to Load

- **WARNING:** Before loading your rifle, always check the bore to be sure it is free of grease, oil or any other obstruction.

Depress the clip release on the left side of the magazine housing (See F), and remove the clip. Insert cartridges as shown in G.

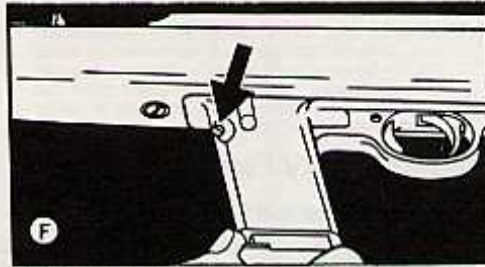

Releasing the clip magazine



Loading the clip magazine

With the gun pointed in a safe direction, and the safety on SAFE, insert the loaded magazine fully into its housing, being sure it locks in place.

Cocked and Ready

With the safety on SAFE and loaded clip locked in place, the rifle in normal shooting position, and pointed in a safe direction, pull the charging handle all the way back and let it snap forward freely (See H & I).



Pull charging handle all the way back. Let it snap forward freely.

Your rifle is now cocked and ready to fire as soon as the safety is moved to the FIRE position.

How to Fire

Push the safety to the FIRE position and, with the gun pointed at the target, squeeze the trigger. Since your rifle is a self-loader, after each shot is fired it is ready to be fired again. If you have not fired all cartridges at the target, be sure to put the safety on SAFE until you are ready to shoot again.

- **WARNING:** Because of its self-loading action, always assume that your rifle is cocked and loaded.

What to do if rifle fails to fire

- **WARNING:** If you have squeezed the trigger and the rifle does not fire, point the gun in a safe direction and, with the safety on, unload completely (See "How to Unload").

What to do after an underpowered shot

- **WARNING:** You can tell if a shot is underpowered by the unusually low report it makes. This can result in a bullet being lodged in the bore. An obstructed bore can occur if the cartridge you have fired contains insufficient powder, none at all, or if the powder fails to ignite.

Should this happen, to prevent possible injury, or damage to the gun, do not fire again.

You must unload completely, clear the action, put the safety on "SAFE", and look through the bore. If the bore is obstructed, insert a proper size cleaning rod (without a tip) from the muzzle end, and push the bullet out. If the bullet cannot be dislodged by tapping the rod, it should be removed by Marlin Gun Service.

After removal of the obstruction, check the bore for damage.

How to Unload

- **WARNING:** Before you unload, be sure your rifle is on **SAFE** and pointed in a safe direction.

Remove the clip as shown in F, and empty all cartridges. Next, clear the action by pulling the charging handle all the way back and releasing it. Then replace and lock the clip back in position. Pull the charging handle all the way back, release it, and it will lock in the automatic "last-shot" hold-open position. Finally, check the chamber visually to be sure that no cartridges remain.

Sighting

Your rifle has been sighted-in and test-fired at the factory. Due to individual shooting characteristics, however, sighting should be range verified.

1. **Vertical Correction** (elevation): To raise the point of impact, raise the rear sight, by moving the sight elevator rearward. To lower the point of impact, lower the rear sight, by moving the sight elevator forward.
2. **Horizontal Correction** (windage): To move the point of impact to the left, tap the rear sight base to the left. To move the point of impact to the right, tap the rear sight base to the right.

How to Clean your rifle

- **WARNING:** Never attempt to wipe down or clean a loaded gun. Follow instructions under "How to unload" before cleaning.

To insure proper functioning of the rifle, you must keep the action and magazine clean.

Disassembly for cleaning

With the gun empty and the safety on **SAFE**, remove the clip magazine. Next, close the action as shown in H&I.

Turn the gun upside down and loosen the front and rear take-down screws until the stock can be separated from the barreled action (These screws do not have to be removed from the stock.) (See J).

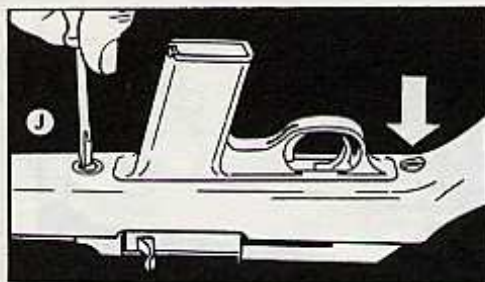

Separate stock and barreled action. Next, with punch or nail, remove front and rear take-down pins. Note: since the front pin has a head on one end, it *must* come out on the side of the receiver which has the serial number (See K). (Also be sure the headed end of this pin is on the serial number side when reassembling.)

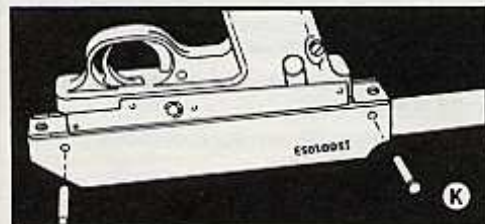

Remove take-down pins.

Remove trigger group and bolt stop (which will fall free) from receiver (See L)

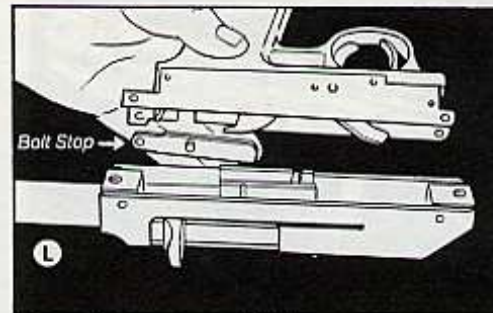

Remove trigger group and bolt stop.

Then, with forefinger, pull bolt slightly to the rear, and lift the muzzle end of the breech bolt from the receiver. As you begin to lift the bolt out, the charging handle will become free and can be removed (See M). The recoil spring and spring guide are now within easy reach for removal (See N).

Further disassembly of the gun is not recommended.

- **WARNING:** If, at this stage of disassembly, the clip is inserted into housing, and the trigger is pulled, the hammer spring and strut will fly free, and could cause personal injury.

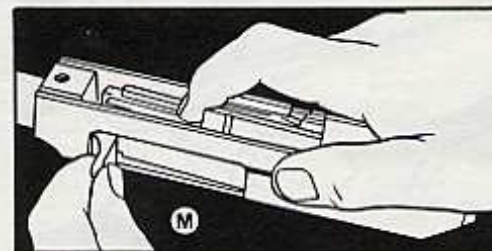

Lift breech bolt from receiver.

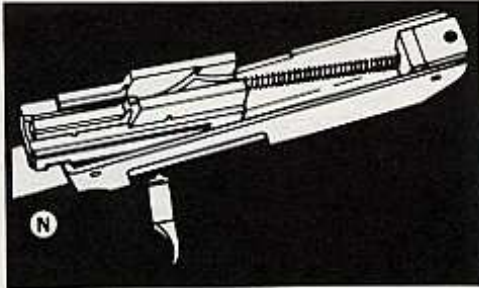

Clean the bolt, receiver and trigger group thoroughly using a toothbrush and commercial gun cleaner. Clean the bore with powder solvent and brush. For storage, wipe the bore with lightly oiled patch.

Reassembly

Insert bolt, recoil spring and rod into receiver, and reinstall charging handle through ejection port (See M). Position bolt stop in receiver as shown in O. Insert rear of trigger group into receiver, line up rear pin holes, and insert pin (See P).

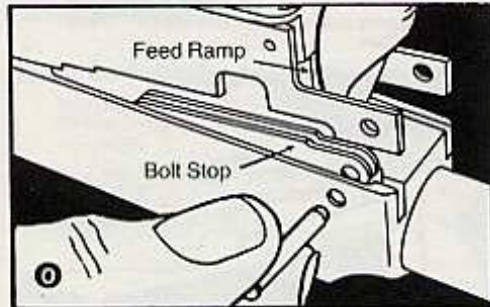

Seating front of trigger group.

Next, exert and maintain slight rearward pressure on feed ramp, as shown in O, while seating front end of trigger group. (Important: if feed ramp is not pressed rearward, and holes in bolt stop are not aligned, action will not reassemble.)

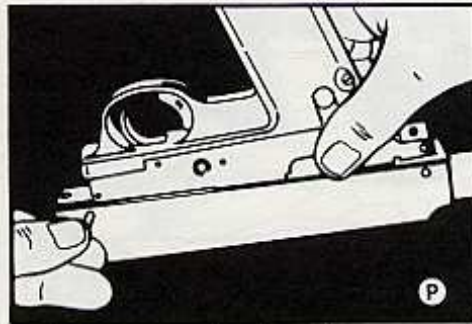

Install trigger group and insert rear pin.

Exert *slight* rearward pressure on feed ramp while aligning front pin holes.

With a nail or punch, line up holes in bolt stop with holes in front of receiver, and insert front take-down pin, with the flat-headed end on the serial number side of the receiver.

(Important: insertion of this pin should *not* require the use of a hammer.)

Replace stock and tighten take-down screws. This completes reassembly.

Model 45 Accessories

These items may be purchased from your dealer, or directly from Marlin Gun Service. (Please call Marlin Gun Service at 1-800-544-8892.)

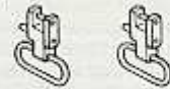

Part Name	Part No.
Quick-detachable swivels	401411



Leather carrying strap, branded with Marlin logo	420604
--	--------



Scope mount	506020
-------------------	--------



4X, 32MM Fixed Power Scope Tough 1" tube, 1/4-minute click stops.	501030
--	--------



4-shot magazine	499046
-----------------------	--------

MODEL 45 PARTS LIST

For parts prices, call 1-800-544-8892 • Conn. residents call 239-5621 (8 A.M. to 4:30 P.M., Eastern Time, Weekdays)

Be sure to mention gun serial number when ordering parts

Ill. No.	Part Name	Part No.	Ill. No.	Part Name	Part No.
1	Action Assembly Pin, Front	316997	36	Magazine Latch Retaining Screw	316390
2	Action Assembly Pin, Rear	316997	37	Magazine Latch Retaining Spring	416495
**3	Barrel	116220	38	Rear Sight Base	520241
4	Bolt Stop	516483	39	Rear Sight Elevator	320242
5	Bolt Stop Spring	416794	40	Rear Sight Leaf	216142
**6	Breech Bolt	116286		Rear Sight Assembly	516142
**	Breech Bolt Assembly (not shown)	516286		(Above 3 Parts) (Not Shown)	
7	Buffer	416182	**41	Receiver	116560
8	Cartridge Indicator	316188	**42	Recoil Pad	401202
9	Cartridge Indicator Assembly Pin	416597	**43	Recoil Pad Spacer	416203
10	Charging Handle	216250	44	Recoil Pad Screws (2)	420590
11	Ejector	316168	45	Recoil Spring	416194
12	Ejector/Magazine Disconnecter Pin	416397	46	Recoil Spring Rod	316171
**13	Ejector Pin, Rear (Staked-in)	316097	47	Safety	316161
**14	Extractor	216269	48	Safety Detent Ball	416282
15	Extractor/Cartridge Indicator Spring (2)	416894	49	Safety Detent Spring	416094
16	Extractor Pin	416598	50	Scope Mount Dummy Screws (4)	320493
17	Feed Ramp	116284	51	Sear	216151
18	Feed Ramp Spring	416795	52	Sear Spring	416394
19	Firing Pin	316297	53	Sideplate, Right Hand	216163
20	Firing Pin Assembly Pin	416597	54	Sideplate, Left Hand	316363
21	Firing Pin Spring	416294	55	Stock Complete	516113
22	Front Ramp Sight Base	220539	56	Takedown Screw, Front	316090
23	Front Ramp Sight Cutaway Hood	316145	57	Takedown Screw, Rear	316190
24	Front Ramp Sight Red Insert	416144	58	Takedown Screw Bushing, Front	416452
25	Front Ramp Sight Screws	301290	59	Takedown Screw Bushing, Rear	416452
	Front Ramp Sight Complete	516239	60	Trigger	316243
	(Above 4 Parts) (Not Shown)		61	Trigger Guard	216458
26	Hammer	216173	62	Trigger Guard/Action Assembly	516543
27	Hammer Strut	216179	63	Trigger Disconnecter	216253
28	Hammer Strut Bridge	316275	64	Trigger Disconnecter Pin	416198
29	Hammer Strut Spring	316196	65	Trigger Disconnecter Spring	407895
30	Hammer Pivot Pin Retaining Ring	416252	66	Trigger Return Spring	416994
31	Magazine, 7 Shot	416746	67	Trigger Return Spring Pin	416497
32	Magazine Disconnecter	316153	68	Trigger Block	216259
33	Magazine Disconnecter Trigger Block	216159	69	Trigger Block Spring	416794
34	Magazine Disconnecter Spring	416395	70	Firing Pin Bushing	316552
35	Magazine Latch	316548	71	Swivel Stud	420793
			72	Manual Hold-Open	516281

Specifications subject to change without notice.

MODEL 45

* Restricted availability — Part sent to qualified gunsmith only.

** Restricted availability — Part installed at factory only.

*** Non-restricted availability — Part may require some sanding or filing prior to installation.

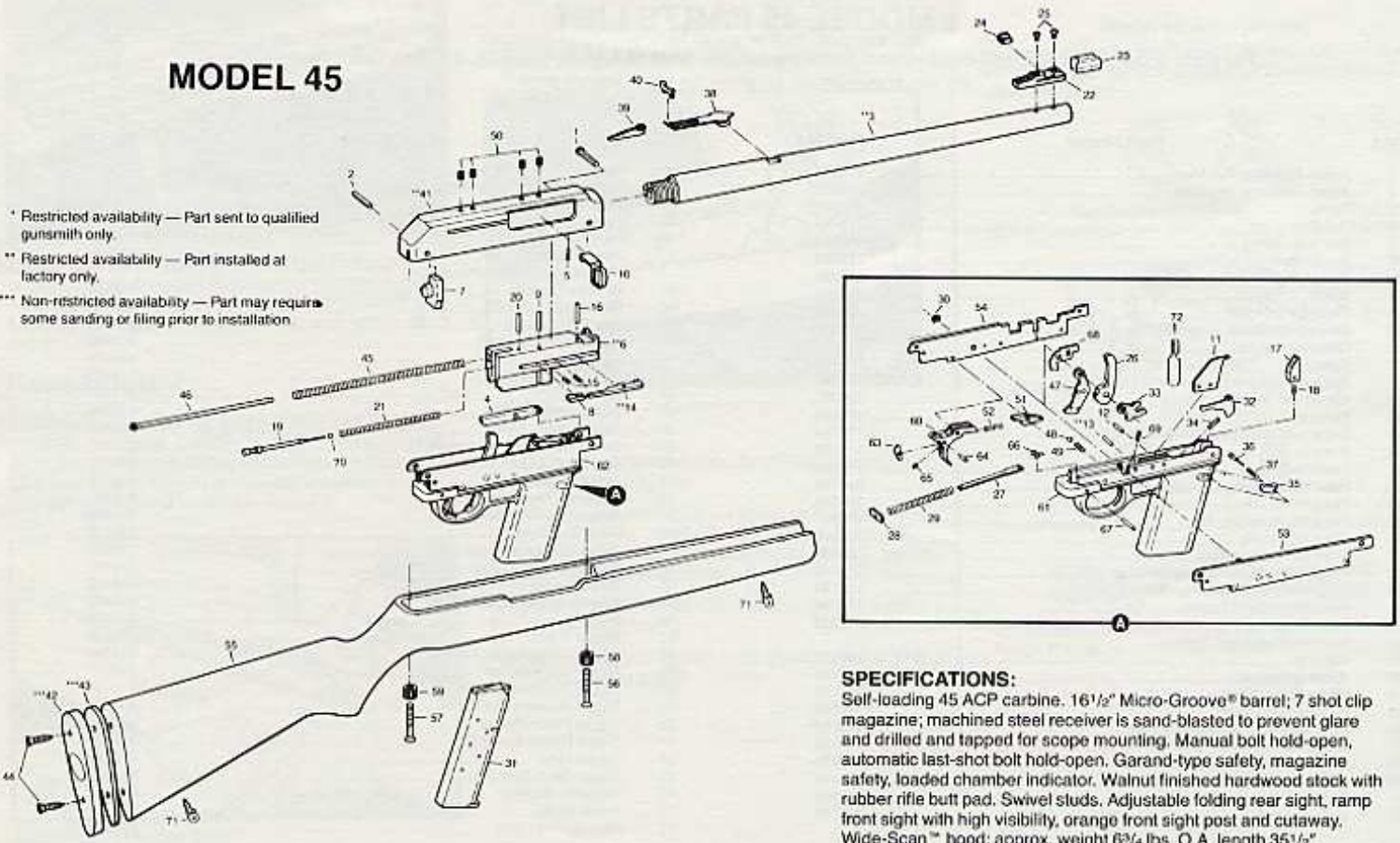

SPECIFICATIONS:

Self-loading 45 ACP carbine. 16¹/₂" Micro-Groove® barrel; 7 shot clip magazine; machined steel receiver is sand-blasted to prevent glare and drilled and tapped for scope mounting. Manual bolt hold-open, automatic last-shot bolt hold-open. Garand-type safety, magazine safety, loaded chamber indicator. Walnut finished hardwood stock with rubber rifle butt pad. Swivel studs. Adjustable folding rear sight, ramp front sight with high visibility, orange front sight post and cutaway. Wide-Scan™ hood: approx. weight 6³/₄ lbs. O.A. length 35¹/₂".

Storage

Avoid the use of oil during below freezing conditions. Condensation droplets may form soon after the gun is brought into a warm room, or it may become wet during inclement weather. In any case, all moisture should be removed. Exterior metal finishes may be wiped down with a slightly oiled cloth. For long term storage, lightly oil the bore, barrel and action with gun oil. Your gun should be completely unloaded and stored in a dry area with the action open. Never store your gun in a carrying case.

Repair Instructions

Your firearm has been designed, engineered and manufactured in accordance with Marlin's rigid quality control standards. However, any mechanical device may occasionally require adjustment or repair. Questions regarding the performance and serviceability of your firearm should be addressed to our Gun Service Division. You should include the Serial Number, Model Number and a full description of the conditions and problems involved.

Warranty Repairs

Our Warranty policy covers all our firearms against defects in workmanship or material for a period of two years from the date of purchase to the original owner. See the inside front cover of this manual for warranty details. Guns requiring warranty repairs should be returned to the factory. Be sure to follow the "Shipping and Handling" instructions on this page.

Non-Warranty Repairs

Your local gunsmith may be able to repair your gun. If not ship it to the factory, following the Shipping and Handling instructions on this page.

After receiving your firearm, we will send you an estimate of the repair cost. Repairs will begin upon receipt of your check or money order. If repairs are not possible, your gun will be returned.

Shipping and Handling

When sending your firearm to the factory you must follow these instructions:

1. Prior to mailing, be absolutely certain that the chamber, action and magazine of your firearm are not loaded (See "How to Unload" on p. 3)
2. Pack your gun carefully. Use ample cushioning material and a sturdy outer cardboard box. Do not ship in a special container which you want returned.
3. Accessories such as scopes, scope mounts, gun case, quick detach type swivels, sling straps and other special appointments should be removed prior to returning the firearm.
4. Inside the box, include a sheet with the following information: model number, serial number, description of damage or problem, and under what conditions difficulty occurs.
5. Clearly mark your return address on the outside of the box and on your instruction sheet.
6. Do not ship live ammunition under any circumstances.
7. Ship your firearm via insured Parcel Post or U.P.S. Shipment must be prepaid and addressed to:

Marlin Gun Service
Attn: Repair Dept.
100 Kenna Drive, North Haven, CT 06473

Health Warning

Discharging of firearms in poorly ventilated areas and handling ammunition may cause exposure to lead and/or lead compounds. Exposure may cause birth defects or damage to the kidney, nervous, blood forming and reproductive systems. Have adequate ventilation at all times, especially in confined areas. Wash hands thoroughly after shooting, handling ammunition, or cleaning a firearm. Do not eat or smoke during these activities.

Safety Warning

Marlin strongly recommends that you take a hunter safety course, taught by a certified instructor, before you use this firearm. Your State Fish & Game Dept. or a local gun shop can suggest courses in your area.

IMPORTANT

If you have any questions or problems relating to your new Marlin, would like additional information on safe operation, or wish to order parts or accessories, just call our Customer Service Center. A Service Representative can be reached at the numbers listed below, between 8 A.M. and 4:30 P.M. (Eastern Time), Monday through Friday.

Nationwide
1-800-544-8892
(Toll Free)

Conn. Residents
239-5621
(North Haven)



Marlin's Guide to Gun Safety

1. Handle every gun as you would a cocked and loaded gun.
2. Keep the safety ON SAFE until you are ready to shoot.
3. Be sure of your target before you shoot.
4. Before target shooting, be sure you have an adequate backstop. Remember, all rifle ammunition is dangerous at ranges up to, and in excess of a mile.
5. Never point a gun at anything you don't want to shoot.
6. Always wear protective glasses when shooting.
7. Wear hearing protectors when target shooting.
8. Do not use modified, damaged or dirty ammunition.
9. Use only ammunition of the correct caliber, size and bullet shape.
10. Cartridges that have been improperly handloaded can damage the gun and cause personal injury.
11. Avoid ricochets by never shooting at water, or any hard, flat surface.
12. Be sure no one is in path of ejecting shells.
13. Never climb or jump over a fence or other obstacle with a loaded gun.
14. Never climb a tree with a loaded gun.
15. Never pull a gun toward you by the muzzle.
16. Avoid alcoholic beverages before and during shooting.
17. Never use a gun that fails to function properly. Do not try to force a jammed action.
18. Be sure to keep the barrel and mechanism free of obstructions.
19. Before cleaning, be sure the chamber, action and magazine are completely unloaded.
20. Always unload a gun before storing, transporting, or leaving unattended.
21. Never enter a motor vehicle with a loaded gun.
22. Store guns and ammunition separately, under lock and key, beyond the reach of children.
23. Consult owner's manual before using any firearm.

Failure to follow these rules, or other instructions in this manual, can result in personal injury.

Center Fire Rifles



Lever Action Rifles. Available in the following calibers:
30/30 Win., 35 Rem., 45/70 Gov't., 444 Marlin.



Lever Action Carabines: Available in the following calibers: 44 Rem. Mag./44 S&W Spl., 357 Mag./38 Spl., 25/20 Win., 32/20 Win., 218 Bee.



Self-loading Carabines. Available in 9mm Luger and 45 Auto.

Shotgun



Bolt Action. The Original Marlin Goose Gun. 12 gauge, with extra-long barrel and recoil pad.

Marlin 22 Rifles



Lever Action. The legendary Model 39 is available in two versions: 39AS with 24" barrel and pistol grip stock, and 39TDS with 16 1/2" barrel and straight grip stock.



Self-loading. Models available with either large-capacity tubular magazines, or convenient clips.



Bolt Action. Tubular-fed repeaters, clip-fed repeaters and a single shot, as well as models chambered for 22 Win. Magnum Rim Fire.