

INSTRUCTION MANUAL FOR

BLUED &
STAINLESS
STEEL



CALIBER
.22 Long Rifle

RUGER® MARK III™

AUTOLOADING PISTOLS

STANDARD, TARGET, GOVERNMENT TARGET,
COMPETITION AND 22/45 MODELS



**READ THE INSTRUCTIONS AND
WARNINGS IN THIS MANUAL CAREFULLY
BEFORE USING THIS FIREARM**

**For Product Service on This Model Please Call:
(928) 778-6555 (See p. 30)**

**STURM, RUGER & Company, Inc.
Southport, Connecticut 06890 U.S.A.**

THIS INSTRUCTION MANUAL SHOULD ALWAYS ACCOMPANY THIS FIREARM AND BE
TRANSFERRED WITH IT UPON CHANGE OF OWNERSHIP, OR WHEN THE FIREARM IS LOANED
OR PRESENTED TO ANOTHER PERSON

State-By-State Warnings

Certain states require by law that their own specified warning notices in larger-than-normal type be conspicuously included by the manufacturer, distributor, or retail dealer with firearms sold in that state. Sturm, Ruger sells its products in compliance with applicable laws and regulations. Because our products may be sold in these states, we include the following:

California:

⚠ WARNING

“Children are attracted to and can operate firearms that can cause severe injuries or death. Prevent child access by always keeping guns locked away and unloaded when not in use. If you keep a loaded firearm where a child obtains and improperly uses it, you may be fined or sent to prison.”

⚠ ADVERTENCIA

“A los niños los atraen las armas de fuego y las pueden hacer funcionar. Ellos pueden causarse lesiones graves y la muerte. Evite que los niños tengan acceso a las armas de fuego guardándolas siempre con llave y descargadas cuando no las esté utilizando. Si usted tiene un arma de fuego cargada en un lugar en que un niño tiene acceso a ella y la usa indebidamente, le pueden dar una multa o enviarlo a la cárcel.”

Connecticut:

“UNLAWFUL STORAGE OF A LOADED FIREARM MAY RESULT IN IMPRISONMENT OR FINE.”

Florida:

“IT IS UNLAWFUL, AND PUNISHABLE BY IMPRISONMENT AND FINE, FOR ANY ADULT TO STORE OR LEAVE A FIREARM IN ANY PLACE WITHIN THE REACH OR EASY ACCESS OF A MINOR UNDER 18 YEARS OF AGE OR TO KNOWINGLY SELL OR OTHERWISE TRANSFER OWNERSHIP OR POSSESSION OF A FIREARM TO A MINOR OR A PERSON OF UNSOUND MIND.”

Maine:

“ENDANGERING THE WELFARE OF A CHILD IS A CRIME. IF YOU LEAVE A FIREARM AND AMMUNITION WITHIN EASY ACCESS OF A CHILD, YOU MAY BE SUBJECT TO FINE, IMPRISONMENT OR BOTH. KEEP FIREARMS AND AMMUNITION SEPARATE. KEEP FIREARMS AND AMMUNITION LOCKED UP. USE TRIGGER LOCKS.”

Maryland:

“WARNING: Children can operate firearms which may cause death or serious injury. It is a crime to store or leave a loaded firearm in any location where an individual knew or should have known that an unsupervised minor would gain access to the firearm. Store your firearm responsibly!”

Massachusetts:

“WARNING FROM THE MASSACHUSETTS ATTORNEY GENERAL: This handgun is not equipped with a device that fully blocks use by unauthorized users. More than 200,000 firearms like this one are stolen from their owners every year in the United States. In addition, there are more than a thousand suicides each year by younger children and teenagers who get access to firearms. Hundreds more die from accidental discharge. It is likely that many more children sustain serious wounds, or inflict such wounds accidentally on others. In order to limit the chance of such misuse, it is imperative that you keep this weapon locked in a secure place and take other steps necessary to limit the possibility of theft or accident. Failure to take reasonable preventive steps may result in innocent lives being lost, and in some circumstances may result in your liability for these deaths.”

“IT IS UNLAWFUL TO STORE OR KEEP A FIREARM, RIFLE, SHOTGUN OR MACHINE GUN IN ANY PLACE UNLESS THAT WEAPON IS EQUIPPED WITH A TAMPER-RESISTANT SAFETY DEVICE OR IS STORED OR KEPT IN A SECURELY LOCKED CONTAINER.”

New Jersey:

“IT IS A CRIMINAL OFFENSE TO LEAVE A LOADED FIREARM WITHIN EASY ACCESS OF A MINOR.”

New York City:

“THE USE OF A LOCKING DEVICE OR SAFETY LOCK IS ONLY ONE ASPECT OF RESPONSIBLE FIREARMS STORAGE. FIREARMS SHOULD BE STORED UNLOADED AND LOCKED IN A LOCATION THAT IS BOTH SEPARATE FROM THEIR AMMUNITION AND INACCESSIBLE TO CHILDREN AND OTHER UNAUTHORIZED PERSONS.”

North Carolina:

“IT IS UNLAWFUL TO STORE OR LEAVE A FIREARM THAT CAN BE DISCHARGED IN A MANNER THAT A REASONABLE PERSON SHOULD KNOW IS ACCESSIBLE TO A MINOR.”

Texas:

“IT IS UNLAWFUL TO STORE, TRANSPORT, OR ABANDON AN UNSECURED FIREARM IN A PLACE WHERE CHILDREN ARE LIKELY TO BE AND CAN OBTAIN ACCESS TO THE FIREARM.”

Wisconsin:

“IF YOU LEAVE A LOADED FIREARM WITHIN THE REACH OR EASY ACCESS OF A CHILD YOU MAY BE FINED OR IMPRISONED OR BOTH IF THE CHILD IMPROPERLY DISCHARGES, POSSESSES, OR EXHIBITS THE FIREARM.”

* * * * *

Please check with your licensed retailer or state police for additional warnings which may be required by local law or regulation. Such regulations change constantly, and local authorities are in the best position to advise you on such legal matters.

WHY ARE WE INCLUDING A FIRED CARTRIDGE CASE WITH EVERY RUGER PISTOL AND REVOLVER?

Certain states and jurisdictions now require that all newly manufactured pistols and revolvers must be accompanied by a cartridge case, which has been test fired from that gun at the factory. The case must be placed in a sealed container bearing certain information concerning this test cartridge.

At the time of retail sale in those jurisdictions, firearms dealers must forward such test cartridge to a designated destination such as their State Police Laboratory. As independent Ruger Distributors have nationwide markets without territorial restrictions, we have decided to include a fired cartridge case with all new Ruger pistols and revolvers, to minimize the possibility of inadvertent non-compliance with these laws.

Retail customers located in other states, where laws or regulations do not require the dealer to so act, may be assured that the fired cartridge case they receive with the firearm at the time of retail purchase is proof that your new Ruger firearm has undergone our normal test firing procedures during manufacture.



WARNING — LOCKING DEVICES



**DO NOT INSTALL
INSIDE TRIGGER GUARD**

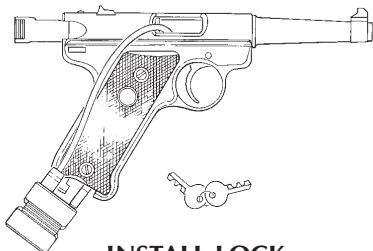

**INSTALL LOCK
AS SHOWN HERE**

This firearm was originally sold with a key-operated locking device. While it can help provide secure storage for your **unloaded** firearm, any locking device can fail. All guns are designed to fire if they are loaded and the trigger is pulled. Therefore, **never install the locking device inside the trigger guard or in any way that it can possibly pull the trigger!** Do not leave the keys in the lock.

The ultimate responsibility for secure storage of any firearm must depend upon its owner and his or her individual circumstances. **Guns should be securely stored unloaded, in a secure location, separate from their ammunition.**

See "Warning-Storage," page 28.

**NEVER INSTALL
LOCKING DEVICE
INSIDE TRIGGER GUARD**

FIREARMS SAFETY-YOUR RESPONSIBILITY
SAFETY MUST BE THE FIRST AND CONSTANT
CONSIDERATION OF EVERY PERSON WHO HANDLES
FIREARMS AND AMMUNITION.

This Instruction Manual is designed to assist you in learning how to use and care for your **RUGER® MARK III™** pistol properly. Please contact us if you have any questions about it.

Only when you are certain you fully understand the Manual and can properly carry out its instructions should you practice loading, unloading, etc. with live ammunition. If you have any doubts about your ability to handle or use a particular type of gun safely, you should seek supervised instruction. Such personalized instruction is often available from gun dealers, gun clubs or police departments. If none of these sources can help you, write to the National Rifle Association, 11250 Waples Mill Road, Fairfax, VA 22030-7400. They will assist you.

The person possessing a gun has a full-time job. You cannot guess; you cannot forget. You must know how to use your firearm safely. **Do not use any firearm without having a complete understanding of its particular characteristics and safe use.** Remember: There is no such thing as a foolproof gun.

TABLE OF CONTENTS

	Page
General Information and Mechanical Characteristics	7
Operation of Manual Safety (Illustrations)	10
Operation of Internal Lock	11
Ammunition	12
To Load and Fire	13
Operation of Magazine Disconnect	15
Operation of Loaded Chamber Indicator	15
To Unload	16
To Extract and Eject a Chambered Cartridge	18
To Clear a Malfunction (“Jam”)	19
To Minimize Malfunctions (“Jams”)	19
Basic Disassembly and Reassembly	20 - 24
Magazine Disassembly	25
Care and Cleaning	26
Storage	27
Sight Adjustment	29
Attaching Ruger Scope Rings	29
Service and Parts Policy	30
Shipping Firearms For Repair	30
Ordering Parts	31
Parts List	32 - 35
Parts Drawings	36 - 38
The Basic Rules of Safe Firearms Handling	39 - 42
Warranty Information	44

“RUGER®” is a registered U.S. trademark.
“22/45” and “Mark III” are Sturm, Ruger Trademarks.



WARNINGS OF GREAT IMPORTANCE ARE FOUND ON THE FOLLOWING PAGES:

Locking Devices	5	Loaded Chamber Indicator	16
Alterations	7	Malfunctions	19
Manual Safety	10	Disassembly	21
Ammunition	12	Lubrication	27
Lead Exposure	12	Storage	28
Firing	14	Shipping	30
Handling	15	Parts Purchasers	31

OTHER CAUTIONS AND WARNINGS APPEAR THROUGHOUT THE MANUAL.

**FIREARMS ARE DANGEROUS WEAPONS—
READ THE INSTRUCTIONS AND WARNINGS IN THIS
MANUAL THOROUGHLY AND CAREFULLY BEFORE USING.**



WARNING—ALTERATIONS



This product was designed to function properly in its original condition. Alterations can make it unsafe. Do not alter any part or add or substitute parts or accessories not made by Sturm, Ruger & Co. Inc.

DO NOT ALTER ANY GUN

GENERAL INFORMATION AND MECHANICAL CHARACTERISTICS

RUGER® MARK III pistols are differentiated from Ruger Mark I and Mark II pistols by certain external differences in markings and exterior components (magazine latch, bolt, ejection port, sights, and grip configuration) and by the presence of certain new features for which patents are pending such as internal locks, loaded chamber indicators, and magazine disconnects.

The **RUGER® MARK III** Standard model is a .22 caliber rimfire, 10-shot, magazine fed, autoloading ('blowback') operated pistol.

The **RUGER® GOVERNMENT TARGET MODEL MARK III** has a longer, heavyweight barrel and is laser targeted at the factory, just like pistols delivered to the U.S. Government for target shooting and training.

NOMENCLATURE

(All Mark III s other than 22/45 Mark III Models)

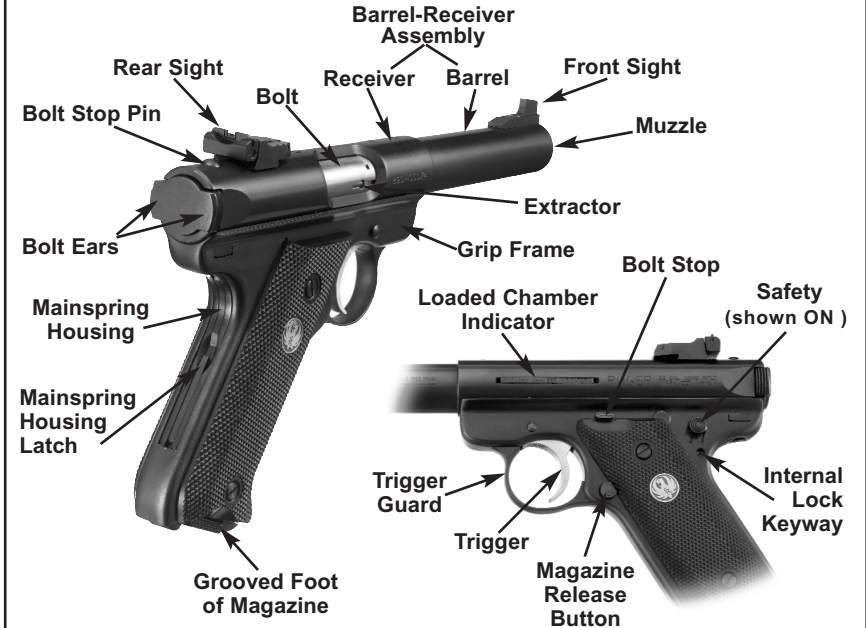

(22/45 Mark III s (P4GC shown below))

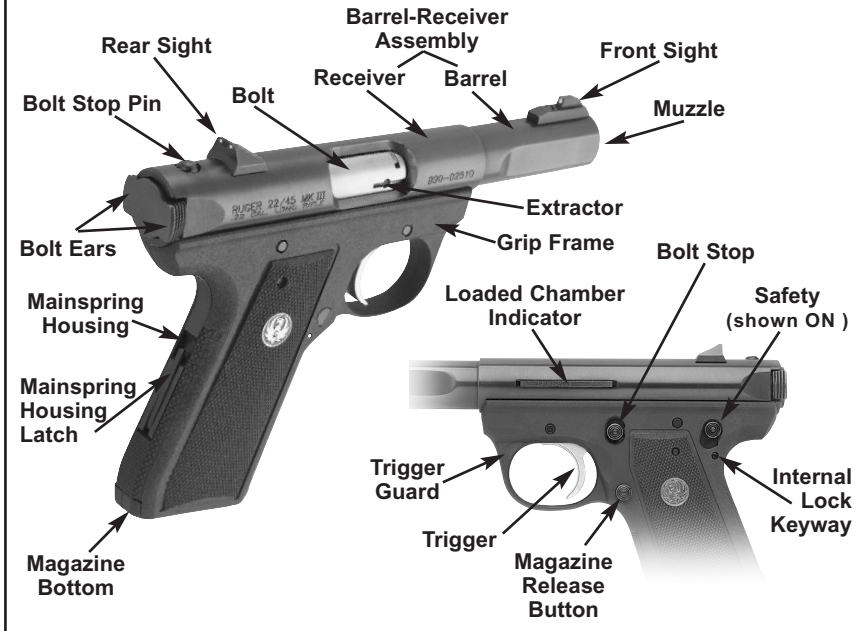

The **RUGER® COMPETITION MODEL MARK III** has a slab-sided, heavyweight barrel with target grips and a scope base supplied with optical sight mounting rings.

The **RUGER® 22/45 MARK III** has a grip frame assembly made of molded synthetic polymer, with a grip shape and angle generally similar to “1911”-style .45 caliber pistols.

All **RUGER® MARK III** pistols have the same basic operating mechanism and include the following features with which the gun user should be thoroughly familiar:

Bolt Stop: When the last shot has been fired and the magazine is empty, the bolt stop automatically holds the bolt open. When there is an empty magazine in the pistol and the bolt is retracted manually, the bolt stop will automatically hold the bolt open. If a loaded magazine is inserted in the pistol when the bolt is closed and the bolt is then retracted fully, the bolt stop will not automatically hold open the bolt. The user can actuate the bolt stop mechanism to hold the bolt open at any time by retracting the bolt and pushing up the bolt stop.

The bolt stop can be released when an empty magazine is in the pistol by drawing back slightly on the bolt and depressing the bolt stop thumbpiece. When the bolt is released, it will move forward under pressure from the recoil spring.

The bolt stop is spring-loaded or detented in position. Therefore, when there is a loaded magazine in place and the pistol is jarred, the bolt may fly forward and chamber a cartridge. **For this reason and as an essential safety practice, the safety of the pistol should always be in the “on” (S) position except when the user is firing the gun at a selected target.**

Magazines: The 10-shot magazine (Part M10MKIII) for the **RUGER® MARK III** pistol is different from all other Ruger rimfire pistols. In addition to the familiar removable plastic bottom decorated with a silver “eagle,” the M10MKIII magazine has a trigger interlock window and protrusion. (See “Magazine Nomenclature,” p. 25.) The M10MKIII is the only magazine that should be used in **RUGER® MARK III** pistols because it is designed to correctly function the bolt stop and magazine disconnect.

The **RUGER® 22/45 MARK III** pistol uses a different 10-shot magazine (Part AP10MKIII) which is identified by its removable elongated plastic bottom. The AP10MKIII magazine is distinguishable from earlier 22/45 magazines by the presence of the trigger interlock window and protrusion. (See “Magazine Nomenclature,” p. 25.) Note that the AP10MKIII is not interchangeable with the M10MKIII magazine described above. (See “Magazine Nomenclature,” p. 25.) The AP10MKIII is the only magazine that should be used in the **RUGER® 22/45 MARK III** pistols because it is designed to correctly function the bolt stop and magazine disconnect.

Safety: The safety locks the sear when the safety is “on.” Because the safety cannot be moved to its “on” (S) position unless the hammer is cocked, the safety therefore serves as a cocking indicator. The bolt can be manually retracted and released when the safety is “on” (S). This feature allows the pistol to be loaded or unloaded when the safety is “on” (S). **As shown below and elsewhere in this Manual, the safety should be “on” (the “S” fully showing) at all times except when the gun user is deliberately positioned to fire at a selected target.**

OPERATION OF MANUAL SAFETY

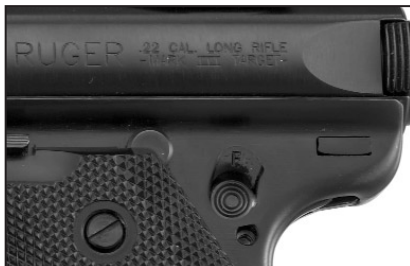

Figure 1. Safety in the “off” or “fire” (F) position. Safety is all the way down.

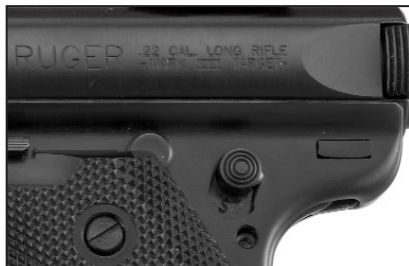



Figure 2. Safety in the “on” or “safe” (S) position. Safety is all the way up.

The Safety is not “on” unless it “clicks” fully up into the “S” position.

		WARNING—MANUAL SAFETY	
		Putting the safety between “S” and “F” can result in the pistol firing when the trigger is pulled. Always move the safety fully to its intended position and <u>check</u> it. The safety is not “on” unless it is completely “on.” Never depend on a safety mechanism or any other mechanical device to justify careless handling or permitting the pistol to point in an unsafe direction. The only “safe” pistol is one in which the bolt is open, the chamber is empty and there is no magazine in the gun.	
		NEVER PUT SAFETY 1/2 ON	

OPERATION OF INTERNAL LOCK

Never rely upon any safety mechanism or mechanical device to justify unsafe or careless handling of a firearm. When securing your pistol or to prevent unauthorized access, you should completely unload the pistol and store it in a gun safe or use the key-operated external locking device supplied with your pistol. (See Page 5.) However, for added security, and to comply with certain state and local laws, your **RUGER® MARK III** pistol is also equipped with an internal lock. When actuated, this internal lock will secure the pistol's manual safety in the "on" or "safe" position.

Before activating the internal lock on your pistol, first visually inspect the chamber and magazine to verify that they are empty and do not contain any cartridges.

To activate the internal lock, place the manual safety in the "on" or "safe" position. (Note that the pistol must be cocked to engage the safety.) Next, place the internal lock key (supplied with your pistol) into the internal lock keyway. (See "Nomenclature," p. 8.) Rotate the key fully clockwise (about 1 3/4 of a rotation from the fully unlocked position) until it stops. (See Figure 3.) Remove the key and verify that the internal lock engaged by attempting to move the safety to the "off" or "fire" position. If the internal lock is engaged, you will not be able to move the safety to the "off" or "fire" position.

To deactivate the internal lock, place the internal lock key into the internal lock keyway (see "Nomenclature," p. 8) and rotate the key counter-clockwise (about 1 3/4 turns from the fully locked position) until it stops. (See Figure 3.)

Be sure to store the internal lock key in a secure location, away from children and careless adults. Do not store your firearm with the key in the internal lock keyway. **Never lock a loaded gun – always unload the gun before locking.**

OPERATION OF INTERNAL LOCK

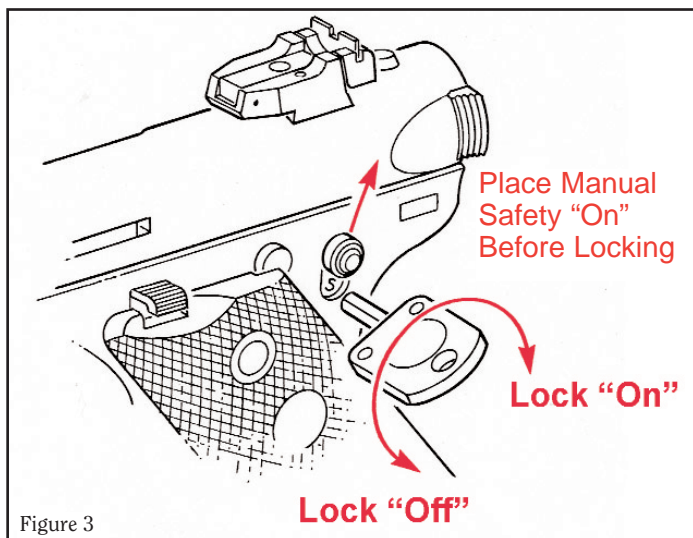

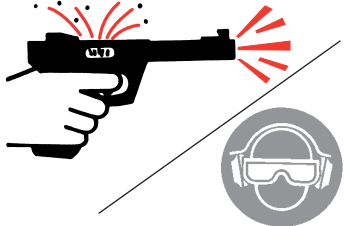

AMMUNITION

The **RUGER® MARK III** pistol is chambered only for the .22 caliber Long Rifle cartridge, standard velocity or high velocity, manufactured to U.S. Industry Standards. Do not attempt to load .22 Long, .22 Short, or any other type .22 caliber cartridge into the magazine or in the chamber of the pistol. Use of .22 shot shells is not recommended. See “Warning - Malfunctions,” p. 19.

 WARNING—AMMUNITION	
	Death, serious injury, and damage can result from the use of wrong ammunition, bore obstructions, powder overloads, or incorrect cartridge components. .22 cases are very thin and sometimes split when fired. <u>Always</u> wear shooting glasses and hearing protection.
IMPROPER AMMUNITION DESTROYS GUNS	

AMMUNITION (CARTRIDGES) NOTICE

WE SPECIFICALLY DISCLAIM RESPONSIBILITY FOR ANY DAMAGE OR INJURY WHATSOEVER OCCURRING IN CONNECTION WITH, OR AS THE RESULT OF, THE USE IN RUGER PISTOLS OF FAULTY, OR NONSTANDARD, OR “REMANUFACTURED” OR HANDLOADED (RELOADED) AMMUNITION, OR OF CARTRIDGES OTHER THAN THOSE FOR WHICH THE FIREARM WAS ORIGINALLY CHAMBERED.

 WARNING — LEAD EXPOSURE	
	Discharging firearms in poorly ventilated areas, cleaning firearms, or handling ammunition may result in exposure to lead and other substances known to the state of California to cause birth defects, reproductive harm, and other serious physical injury. Have adequate ventilation at all times. Wash hands thoroughly after exposure.
SHOOTING OR CLEANING GUNS MAY EXPOSE YOU TO LEAD	

TO LOAD AND FIRE

Practice this important aspect of gun handling (with an unloaded pistol) until you can perform each of the steps — described below — with skill and confidence. But before you do anything with the pistol, first read completely through this manual.

1. **Keep the muzzle pointed in a safe direction.** (See Rule 2, p. 39.)
2. Push the magazine release button and pull the magazine down out of the grip frame by its foot.
3. Grasp the grooved ears of the bolt and pull the bolt to the rear as far as it will go. (See Figure 4, below.) This cocks the hammer and must be done before the safety can be put on.



Figure 4

4. **Engage the safety by moving it fully upward so the “S” shows completely.** (See Figure 2, p. 10.)
5. Put ten (10) or fewer .22 caliber Long Rifle cartridges into the magazine. In loading the magazine make sure that all of the cartridges lie parallel and evenly in the magazine. The follower button on the left side of the magazine is used to lower the follower so the cartridges can be readily inserted.



CAUTION: When using the follower button, have it under control. When loading or handling the magazine, do not pull the button down and then release it suddenly. The rim of the cartridge hitting the magazine lips may set off a sensitive primer and cause the cartridge case to discharge, burst violently, and result in injury.

6. Insert magazine into pistol, taking care that the magazine is fully inserted and locked in place. Slamming the magazine into the grip frame is not necessary.
7. **Don't touch the trigger.** Pull the bolt to the rear as far as it will go. (See Figure 4, above.) Release the bolt so that it will fly forward. (On 22/45 models, the bolt stop must also be depressed to permit the bolt to fly forward.) This will place a cartridge into the firing chamber. **If the pistol is not to be fired immediately, the safety button should remain “on” — with the “S” showing.** (See Figure 2, p. 10.)

Once the safety is pushed down so the “F” shows, the pistol will fire a cartridge each time the trigger is pulled, until all of the cartridges in the magazine, and the one in the chamber, have been fired.

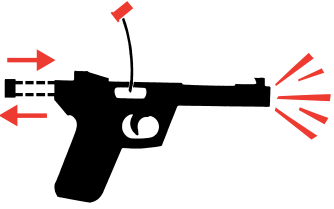

8. The pistol is ready for instant use once the safety is disengaged. Firing will automatically reload and recock the pistol. **Note that every time the trigger is pulled, if a cartridge is in the chamber and the safety is “off,” the pistol will fire — be careful!**

 WARNING — FIRING	
	The bolt automatically opens and shuts quickly while firing. Keep face and hands away from rear. Hot brass is ejected quickly and can burn you. Always wear shooting glasses and hearing protectors.
	BOLT OPENS FAST - HOT BRASS EJECTED

9. Immediately following the firing of a shot, and if a subsequent shot is not to be fired at once, put the safety in its “safe” position while the pistol is still pointing in a safe direction down range. Never put a loaded pistol down with the safety off!



10. When the last cartridge loaded into the pistol has been fired, the magazine follower presses the slide stop upward to engage the slide automatically holding the action open. **If the slide is shut, the shooter should always assume that there is a cartridge in the chamber!**

Don't rely on your memory to know if a gun or magazine is loaded. Visually inspect the magazine and the chamber.

OPERATION OF MAGAZINE DISCONNECT

Your **RUGER® MARK III** pistol is equipped with a magazine disconnect. This device prevents the trigger from being pulled if the magazine is removed from the pistol. You will not be able to use your pistol as a single loader or to fire the pistol with the magazine removed.

Remember that a round may still be in the chamber and that the pistol may still be loaded even if the magazine is removed. As always, you should not rely upon the magazine disconnect or any other mechanical device or safety to justify careless or unsafe handling of any firearm.

Don't rely on your memory to know if a gun or magazine is loaded. Visually inspect the magazine and the chamber.

OPERATION OF LOADED CHAMBER INDICATOR

You should always treat every gun as though it is loaded and always keep the muzzle pointed in a safe direction. Never rely upon any safety or mechanical device to justify unsafe or careless gun handling. In order to assist you in determining the presence of a cartridge in the chamber of your **RUGER® MARK III** pistol, it is equipped with a loaded chamber indicator, the first such device on a .22 caliber pistol. The indicator appears on the left side of the receiver. (See "Nomenclature," p. 8.)

When the chamber is empty, the loaded chamber indicator should be flush with the left side of the receiver. (See Figure 5A, p. 16.)

When the chamber is loaded, the rearmost portion of the loaded chamber indicator should protrude from the left side of the receiver, and a red dot also should be visible on the forward top portion of the loaded chamber indicator. (See Figure 5B, below.)

OPERATION OF LOADED CHAMBER INDICATOR

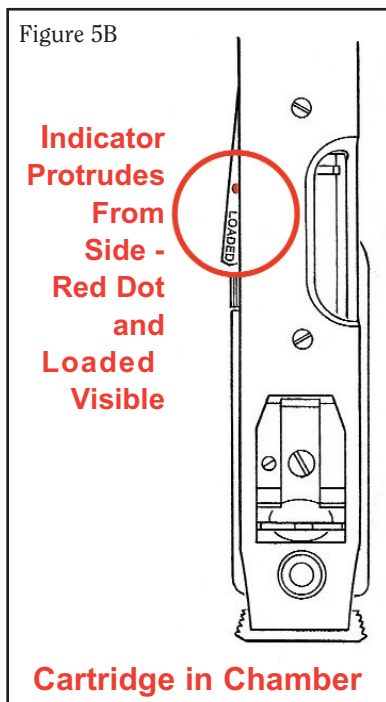
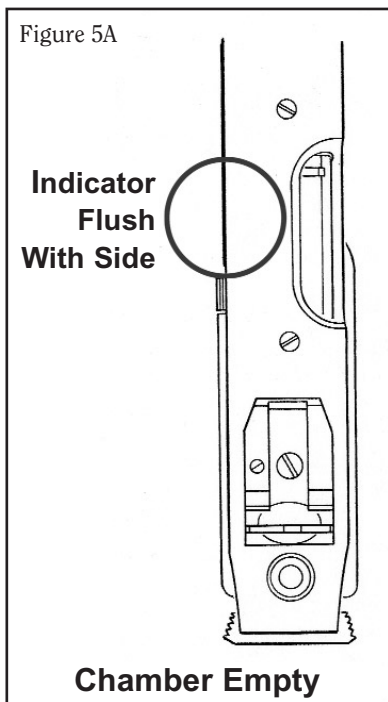

NEVER RELY ON YOUR MEMORY OR ANY LOADED CHAMBER INDICATOR TO KNOW IF A GUN IS LOADED. ANY MECHANICAL DEVICE CAN FAIL. ALWAYS VISUALLY CHECK THE CHAMBER BY RETRACTING THE BOLT AND EXAMINING THE CHAMBER TO BE SURE WHETHER IT IS EMPTY OR LOADED.

TO UNLOAD

NOTE: This sequence must be followed exactly as spelled out. Failure to do so can result in the pistol's chamber becoming unintentionally loaded with a cartridge.

1. The muzzle of the pistol must be pointing in a safe direction at all times, and fingers must be outside the trigger guard. If the pistol is cocked, put the safety "on" (S) by pushing safety button fully upward.
2. Remove the magazine from the pistol and place it where it will not get damaged or collect dirt. (REMEMBER that even though the magazine has been removed, a cartridge may still be in the chamber.)
3. Firmly hold pistol in right hand so that the right thumb is directly underneath the bolt stop. Grasp bolt ears firmly between thumb and forefinger of left hand

and briskly retract the bolt to its rearmost position. As the bolt nears the end of its retraction, the chambered cartridge should be extracted and ejected. When the bolt is fully retracted, push upward on bolt stop with thumb, then allow bolt to move forward slowly until it comes to rest against the bolt stop.

Always visually double check the chamber and the interior area of the receiver and the magazine-well to be certain there are no cartridges present. Gently shake the pistol to dislodge any cartridge which may have been ejected into the magazine-well when the bolt was retracted.

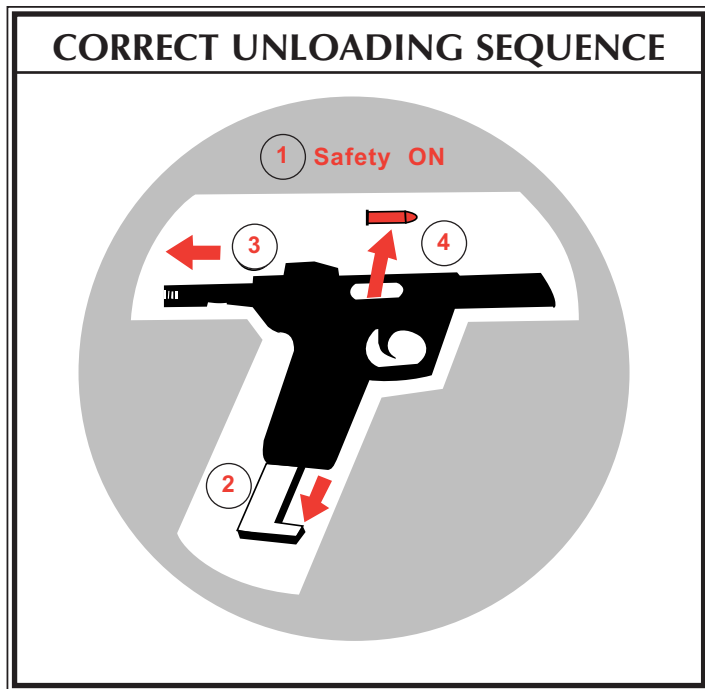

4. If desired, the bolt can be left in the open position, being held there by the bolt stop. If it is desired to close the bolt, again look to be certain the chamber is empty. Assuming that the magazine is not in the pistol and that the safety is “on” (S), retract the bolt to its rearmost position, release it, and the bolt will snap forward (on Mark III models). On 22/45 models the bolt stop button must be depressed. Keep your fingers out of the receiver!
5. **With the muzzle pointed in a safe direction**, push the safety to the “off” (F) position and pull the trigger to decock the pistol. The pistol can be dry fired as long as the firing pin stop is in place (see NOTE in step 5 on page 23).
6. If the magazine contains cartridges, they can be removed by pressing down slightly on the magazine button (to ease the spring tension) with the thumb, and then sliding the cartridges forward and out of the magazine, one at a time until emptied.
7. Push empty (unloaded) magazine into grip frame until the latch locks it in place.



TO EXTRACT AND EJECT A CHAMBERED CARTRIDGE

When the pistol is fired, the same gas pressure that drives the bullet forward also acts through the cartridge case to push the bolt to the rear. That action causes extraction and ejection of the fired cartridge case. But, when the bolt is operated by hand, there can be a failure to extract the cartridge from the chamber, or a failure to eject the cartridge clear of the pistol. These failures usually are the result of the bolt not being pulled rearward vigorously, coupled with an accumulation of bullet lubricant in the chamber. From the foregoing it is clear that the gun user must:

1. **Always visually check the chamber after opening the bolt to eject a chambered cartridge.** If the bolt is not vigorously retracted when being operated by hand, the extracted cartridge can be ‘ejected’ into the grip frame of the magazine-well.
2. Thoroughly clean the chamber and extractor as often as necessary to prevent the accumulation of grease and dirt.
3. If an empty magazine is in the pistol when the bolt is being hand retracted to extract a cartridge, the cartridge may drop on top of the magazine. Then when the bolt goes forward, the cartridge will be chambered again! **Always remove the magazine before clearing the chamber, and visually ensure that no cartridges remain in the gun.**

TO CLEAR A MALFUNCTION (JAM)

1. Be certain the muzzle is pointed in a safe direction and the safety is “on” (S).
2. If possible, first remove the magazine. It may be necessary to manually remove a jammed cartridge which has only partially been stripped from the magazine. If so, use extreme care. Lock the bolt open with the bolt stop before attempting to clear the jam. Drawing the bolt fully to the rear may bring the jammed cartridge along. **Keep your face away from the ejection port during this operation.** When attempting to clear a jam, use only wood “tools” so that a cartridge will not be ignited if you strike a primer and so that the chamber and magazine will not be damaged. A 3/16" wood dowel rod with a point on one end is useful.
3. Visually check to make sure all cartridges have been removed from the pistol. Safely dispose of any cartridges involved in a malfunction incident. Do not use damaged ammunition in any firearm.

 WARNING—MALFUNCTIONS	
	The .22 Long Rifle rimfire cartridge fires when the firing pin impacts the relatively soft cartridge case rim, and also can be “discharged” before it is chambered if its rim receives a sharp blow. If a cartridge hangs up, jams, or binds when being chambered or when being fed from the magazine into the chamber, do not attempt to force it into the chamber by pushing or striking the bolt. Any jam or feeding problem is a signal to immediately stop using the gun until it can be determined what is wrong. Most failures of a cartridge to feed or to chamber are caused by a damaged magazine, improper gun handling, or defective ammunition. Whatever the cause, rimfire cartridge jams can result in the potentially dangerous situation of a cartridge discharging before it is chambered. If this occurs, the cartridge case will rupture and its fragments will fly out of the gun with sufficient force to cause injury. Always wear shooting glasses and hearing protectors! Keep face away from chamber!
	CRUSHING RIM CAN BURST AMMO

TO MINIMIZE MALFUNCTIONS (JAMS)

1. If it appears that the gun and magazine are not at fault and that the jam was caused by the type of cartridge being used, then try another type.
2. If changing to another type or brand of cartridges does not at once eliminate malfunctions, then the following steps should be taken:

- a. Make certain the gun and the magazine are unloaded and that the safety is "on" (S). Remember, the magazine should be removed first, then check the chamber and be certain it and the magazine-well are clear of cartridges.
- b. Thoroughly clean the magazine and bolt mechanism, paying particular attention to removing accumulated grease. Use a bristle brush and solvent to remove grease and fouling from the bolt face, the extractor, the chamber, and the feed ramp. (See the "Care and Cleaning" section of this manual for detailed cleaning instructions.)
- c. Check to see that the magazine spring tension is adequate.
- d. Check the magazine lips to be certain they are free of nicks and burrs and are not deformed.
- e. Remove excess oil and solvent from all cleaned components, load the magazine, and try the firearm again. As always, proceed slowly. **Be certain bystanders are not close and that you are wearing eye and hearing protection and that your face is a safe distance from the pistol so that any discharge resulting from a jammed cartridge will not injure anyone.**

If the above procedures do not result in a smooth and reliably functioning firearm, don't use the gun. The pistol can be returned directly to our Prescott Product Service Department for repair. See the Service and Parts Policy section of this manual for packing and shipping information.

Another precaution: when using any firearm chambered for rimfire cartridges, form the habit of examining fired cartridge cases. If they have bulged heads or frequently show splits on any part of the case, the rifle or pistol should be returned to the factory for inspection.

DISASSEMBLY

Although **MARK III** pistols are designed to be disassembled and reassembled without the use of tools, some "tools" may be useful in the process, particularly when the pistols are new. Tools that may be useful include: (1) a soft rubber/plastic mallet; (2) a paper clip; and (3) a wooden dowel (1/8" - 1/4" diameter).

1. **Before beginning disassembly, be certain that the muzzle is pointed in a safe direction and that the safety is "on" (S) if the pistol is cocked.** Remove the magazine and carefully check it to verify that it is completely empty. Draw the bolt fully rearward and **visually inspect the chamber to be certain that there is no cartridge in it** and then release the bolt. Insert the empty magazine into the magazine well until it "clicks" and is fully in place. Disengage the internal lock, if necessary. (See p. 11.) Place the safety in the "off" (F) position. Point the pistol in a safe direction and pull the trigger to be sure the hammer has fallen. The hammer must be uncocked before the pistol can be disassembled. Remove the empty magazine.



WARNING — DISASSEMBLY

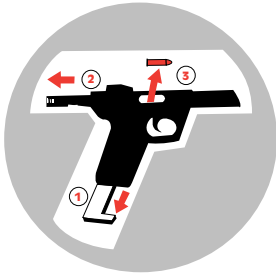

Always unload a firearm before cleaning, lubrication, disassembly or assembly.

UNLOAD BEFORE CLEANING

2. Insert a blunt, 'pointed' instrument in the oval recess of the mainspring housing (at the back of the grip) and swing the housing latch open like the blade of a pocket knife. (Some users find that a paper clip, looped over the latch, is an ideal 'instrument' for this phase of disassembly.)
3. Swing the entire housing outward on its pivot and pull downward, removing the mainspring housing and bolt stop pin. With new pistols it may be necessary to lightly tap (with a plastic hammer and wooden dowel) on the top portion of the bolt stop pin—which protrudes above the receiver—while pulling downward on the mainspring housing. Be careful not to damage the rear sight.
4. Fully insert the empty magazine into the frame. Point the muzzle upward in a safe direction and pull the trigger rearward. The bolt will drop out of the receiver or it can readily be removed.
5. With the mainspring housing, bolt stop pin (as an assembly), and bolt removed, a forward blow (with a plastic hammer) on the rear of the receiver will disengage the barrel-receiver assembly from the grip frame. No attempt should be made to remove rivets or staked pins. Further disassembly should be undertaken only by the factory.

REASSEMBLY

(The procedure is the same for all **RUGER® MARK III** pistols.)

1. Be certain the pistol is free of cartridges! The safety must be in the "off" (F) position for reassembly.
2. Keep your finger off the trigger. Place the hammer in the horizontal (cocked) position. (The hammer is visible by looking down on the grip frame and is the rectangular object inside the grip frame and near the rear. See Figure 6.)

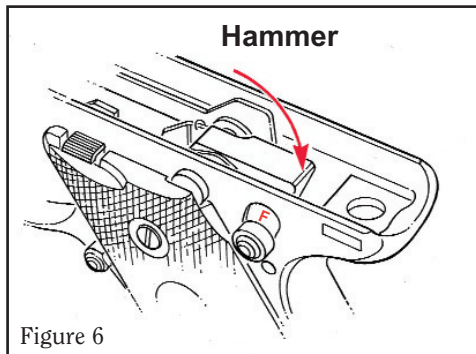
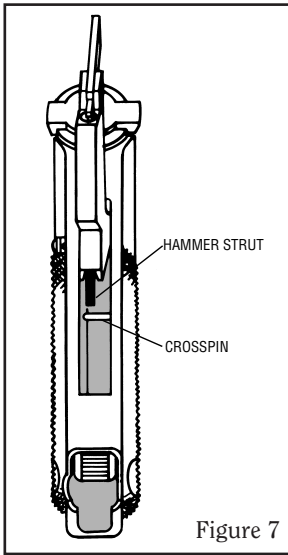

Figure 6



If you cannot place the hammer in the horizontal position, it is most likely because the hammer strut is trapped behind the crosspin (see Figure 7 – not applicable to 22/45 models). If this occurs, lift the hammer to free the hammer strut from behind the crosspin and then move the hammer into the horizontal position.

If the hammer has been rotated too far forward, it also may be difficult to rotate backwards. Inserting the empty magazine fully into the magazine well will allow the hammer to rotate backwards into a horizontal position. Once the hammer is horizontal, remove the empty magazine.

Before placing the barrel receiver onto the frame, make sure that the loaded chamber indicator pin (Part No. A02611 / Key No. 7 on p. 36) has not fallen out of the receiver.

3. Place the barrel receiver on top of the frame so that the square lug engages the square front recess on the underside of the receiver (see Figure 8A). Push the barrel rearward until it stops, with the rear end of the receiver slightly overhanging the rear end of the grip frame (see Figure 8B). If alignment cannot be achieved by hand pressure, place the pistol (muzzle down) on a padded bench and strike the rear of the grip frame immediately below the receiver with a plastic or wooden mallet. Be careful not to damage the grip frame.

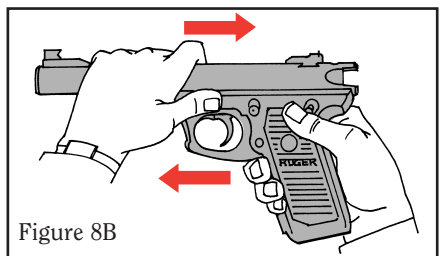
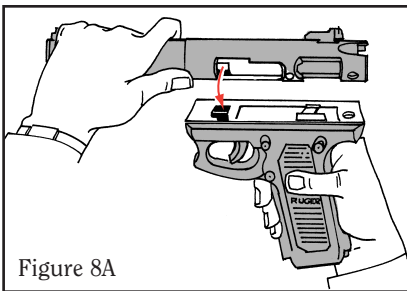

4. Fully insert the empty magazine back into the magazine well. Point the muzzle up in a safe direction and pull the trigger. Gravity should cause the hammer to return to the cocked position if it became dislodged in step 3 (see Figure 9). If not, reach into the rear of the receiver and push the hammer back down flat (into the horizontal position). When the hammer is in this position, remove the empty magazine.

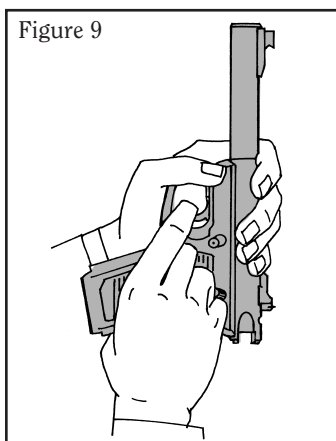

5. NOTE: Before sliding the bolt into the receiver, BE CERTAIN that the firing pin stop (part number A03500, a small pin) is in the bolt. (See Figure 10.) Without this pin, the first time the trigger is pulled on an assembled pistol, the firing pin will fly forward so far as to irreparably dent the rear end of the chamber of the barrel, making the pistol useless. Now, slide the bolt (with the recoil spring upward) fully forward into the receiver. (See Figure 10.)

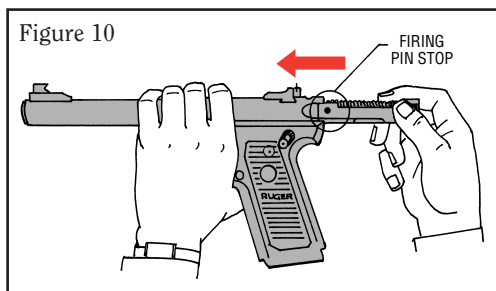

6. Insert the empty magazine into the magazine well, point the muzzle toward the ground in a safe direction and pull the trigger. The hammer should fall to its full forward position. If it does not, retract the bolt partially and manipulate the hammer through the slot in the rear of the frame until the hammer is in its full forward position. Remove the empty magazine.

Point the muzzle toward the ground. With the pistol in this position, hold the mainspring housing bolt stop pin assembly and press the bolt stop pin through the holes in the receiver and bolt until the tip of the pin protrudes beyond the top of the receiver. (See Figure 11.) You may need to tap the mainspring housing into position with a rubber or wooden mallet.

The pin must be fully in place to close the latch in Step 8. Do not yet move the mainspring housing into the frame.

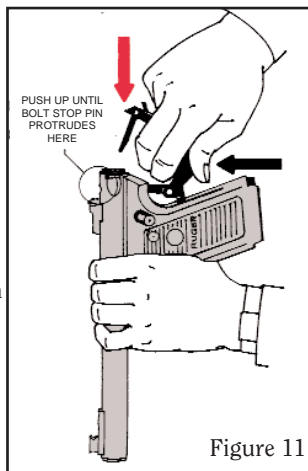

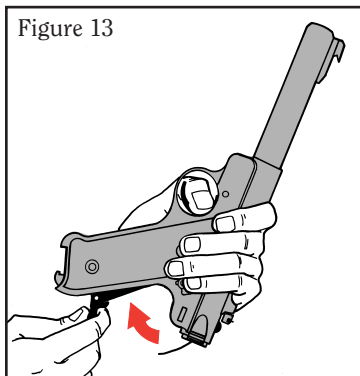
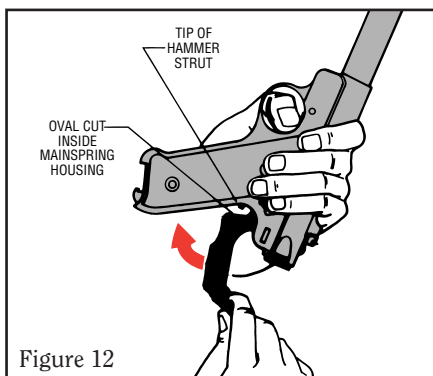

7. Now invert the pistol so that the muzzle is pointed upward. Make sure you can see the hammer strut when you lift the housing up. The hammer strut should go into the oval-shaped cut inside the mainspring housing. (See Figure 12.) Hold the trigger to the rear. While holding the pistol in this position and depressing the trigger, move the mainspring housing into its proper place in the frame. (See Figure 13.)

8. The housing latch can now be snapped shut, completing assembly. (See Figure 14.) Spring pressure should be felt just before the housing is fully shut if the internal parts are correctly aligned.

9. To determine if reassembly was performed correctly, pull the bolt backward and verify that it opens fully. If not, open the latch and repeat steps 6 - 8, above.

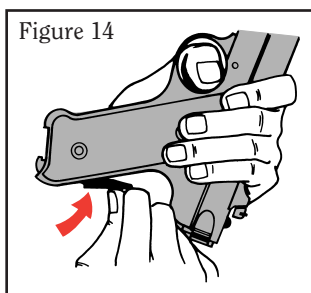

10. Replace empty magazine, **point pistol in a safe direction** and pull the trigger to uncock the gun. **Guns should not be stored loaded or cocked. Note that in order for the internal lock to be engaged, the pistol must remain cocked, and the manual safety must be put “on” safe.** (See p. 11.)

IF YOU HAVE DIFFICULTY REASSEMBLING THE PISTOL, HERE ARE SOME HELPFUL TIPS!

If the mainspring housing pulls out of the gun when swung in, the barrel/receiver assembly is not fully rearward on the frame. Repeat step 3, above.

Remember that it is essential that the hammer must be in its vertical, uncocked position as the mainspring housing is swung shut. If the housing is excessively difficult to close, the hammer is probably cocked. Repeat steps 6-9, above.

The foregoing may give the impression that reassembly is difficult, but it is quickly and easily done once properly learned.

MAGAZINE NOMENCLATURE

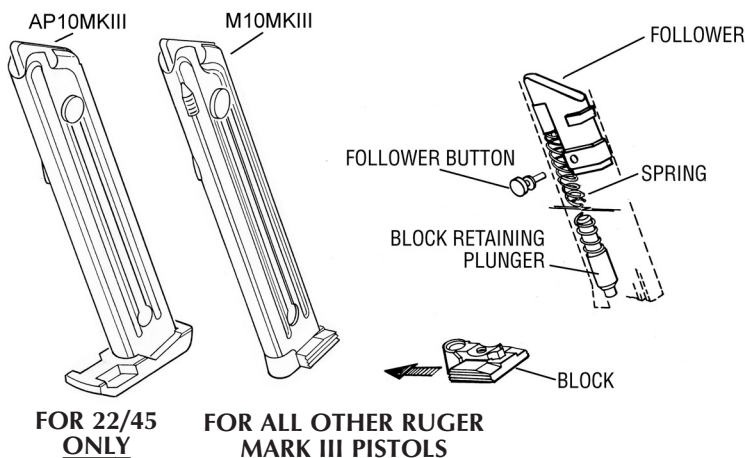

MAGAZINE DISASSEMBLY

TO DISASSEMBLE MAGAZINE: Withdraw magazine from pistol and remove all cartridges (**check chamber to be certain no cartridge remains in it**). Hold magazine upside down in left hand so that the hole in the Magazine Block is accessible.

1. With right hand, insert drift punch in hole and depress Magazine Block Retaining Plunger approximately 1/4".
2. Slide Magazine Block forward slowly **BEING VERY CAREFUL TO KEEP PLUNGER AND SPRING UNDER CONTROL**. If not contained, these parts will fly out with considerable force. Therefore keep bottom end of magazine pointed away from persons and objects.
3. With the Magazine Block fully removed, the Plunger and Spring should be slowly withdrawn.
4. Now, holding magazine flat in left hand, align the Magazine Follower Button with circular opening near the lower end of magazine body and lift out the Magazine Follower Button.
5. The Magazine Follower can then be removed.

Reassemble in reverse order, being careful to contain the Spring and Plunger as the Magazine Bottom is slid and locked into place. After reassembly has been completed, test Magazine Follower to ensure it has free movement.

Always 'ride' the Magazine Follower Button up and down with your thumb. Do not lower Follower Button and then permit it to snap up.

MAGAZINE DISASSEMBLY

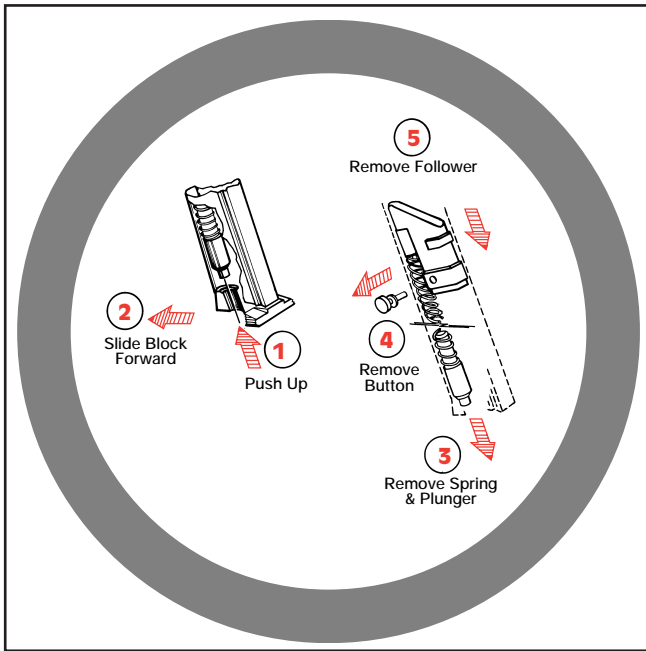

DAMAGED, NON-STANDARD, OR IMPROPERLY ASSEMBLED MAGAZINES SHOULD NOT BE USED. THEY CAN CAUSE THE PISTOL TO MALFUNCTION.

CARE AND CLEANING

Make Sure Gun is Unloaded!



Before cleaning, be certain the pistol and its magazine contain no cartridges. (See "To Unload," p. 16.)

At regular intervals, or whenever the pistol has been exposed to sand, dust, extreme humidity, condensation, immersion in water, or other adverse conditions, disassemble, clean, and oil it. Proper periodic maintenance is essential to the reliable functioning of any firearm.

To clean the pistol, proceed as follows;

1. Disassemble (field-strip) the pistol to the extent described on pages 20 - 21.
2. Using a cleaning rod, run a solvent-wetted patch through the bore several times. Then attach a solvent-wetted bristle brush to the rod and run it back and forth the full length of the bore as many times as necessary to remove grease and dirt from the bore and chamber. Clean bore with dry patches and examine. Bore fouling can contribute to reduced accuracy, and grease accumulation in the chamber can interfere with proper feeding of cartridges from the magazine.

3. Using powder solvent on a clean patch or bristle brush, remove powder residue from all components of the mechanism. After cleaning, run a dry patch through the bore, then follow with a patch that is very lightly oiled. Wipe all surfaces clean with a cloth, then wipe all surfaces with a patch or cloth that has been very lightly oiled.
4. **NOTE:** Only a light application of oil is needed to provide adequate lubrication of moving parts and to prevent rust. Excess accumulations of oil tend to attract particles of dust and dirt and may congeal in cold weather which can interfere with the safe and reliable function of the pistol.
5. If magazine becomes dirty, it should be disassembled and thoroughly cleaned (see “Magazine Disassembly” section, p. 25).
6. Before firing remove all oil and grease from the bore.

 <h2 style="margin: 0;">WARNING —LUBRICATION</h2>	
	<p>Firing a pistol with oil, grease, or any other material even partially obstructing the bore may result in damage to the pistol and serious injury to the shooter and those nearby.</p> <p>Do not spray or apply lubricants directly on ammunition. If the powder of a cartridge is affected by the lubricant, it may not be ignited, but the primer firing may push the bullet into the bore where it may become lodged. Firing a subsequent bullet into the obstructed bore may damage the pistol and cause serious injury or death to the shooter and those nearby. Use lubricants properly. You are responsible for the proper care and maintenance of your firearms.</p>
<p>IMPROPER LUBRICATION DESTROYS GUNS</p>	

STORAGE

GUNS SHOULD NOT BE STORED LOADED!

**USE THE EXTERNAL LOCKING DEVICE
SUPPLIED WITH THE PISTOL FOR STORAGE.
(SEE PAGE 5)**

Do not keep the pistol stored in a leather holster or case. Leather attracts moisture, even though the holster or case may appear to be perfectly dry.

TO RENDER THE PISTOL INOPERATIVE FOR SAFE STORAGE

Be certain that the muzzle is pointed in a safe direction and that the safety is “on” (S) if the pistol is cocked. Remove the magazine and carefully check it to verify that it is completely empty. Draw the bolt fully rearward and visually inspect the chamber to be certain that there is no cartridge in it and then release the bolt. Insert the empty magazine into the magazine well until it “clicks” and is fully in place. Place the safety in the “off” (F) position. Point the pistol in a safe direction and pull the trigger to uncock the pistol.

Using a paper clip or similar non-marring tool, pull down on the main spring housing latch located at the lower rear of the pistol grip. Swing the main spring housing upward. With the pistol pointed upward, pull the trigger. Now invert the pistol so that it is pointing downward. Keeping the pistol pointing downward swing the main spring housing back in to the pistol grip and push the latch back into the main spring housing until it is flush with the pistol grip.

When assembled in this manner, it should be impossible to fully retract the bolt to chamber a cartridge. With the muzzle pointed in a safe direction, test the pistol by attempting to retract the bolt. If the bolt cannot be retracted more than a fraction of an inch, the pistol has been assembled in an inoperative condition. It is uncocked and cannot be fired without correct reassembly.

To reassemble the pistol for firing, again using a paper clip or similar non-marring tool, pull down on the main spring housing latch and point the muzzle upward. Pull the trigger and keep the muzzle pointed in an upward direction. Swing the main spring housing back into position and shut the main spring housing latch. Test the pistol to be sure it is correctly reassembled by attempting to retract the bolt fully. If the bolt can be fully retracted, the pistol is correctly reassembled and can be loaded and fired normally.

While the pistol is less likely to be used by unauthorized persons when assembled in the above inoperative manner, it is always safest to store the pistol with the supplied external locking device correctly installed on the pistol, or to store the pistol in a gun safe or other secure location away from children and unauthorized adults. Guns should always be stored securely, unloaded and separate from their ammunition.

To operate internal lock, see instructions and warnings on page 11.

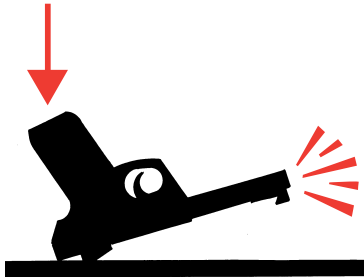
 WARNING—STORAGE	
	<p>Never place or store any firearm in such a manner that it may be dislodged. Firearms should always be stored securely and unloaded, away from children and careless adults. Use the locking device originally supplied with this firearm for storage.</p> <p>The use of a locking device or safety lock is only one aspect of responsible firearms storage. For increased safety, firearms should be stored unloaded and locked in a location that is both separate from their ammunition and inaccessible to children and any other unauthorized person.</p>
STORE SECURELY & UNLOADED	

SIGHT ADJUSTMENT

The Standard **RUGER® MARK III** pistol is equipped with a rear sight which is adjustable for windage only. The rear sight can be drifted laterally in its dovetail on the top of the slide by tapping it with a wooden or plastic headed hammer or similar implement. The front sight is fixed. Target models are equipped with adjustable sights. Turning the top (elevation) sight adjustment screw clockwise lowers the impact of the shot. Turning the horizontal (windage) sight adjustment screw clockwise moves the impact of the shot to the left.

SUGGESTED SIGHT PICTURE

Top of front sight even with top of rear sight blade. Front sight centered in notch of rear sight blade. Target bull's-eye centered on top of front sight.

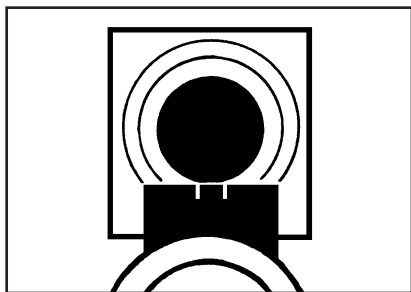

INSTRUCTIONS FOR ATTACHING THE SCOPE BASE (Target Model Only)

1. Remove the filler screws from the top of the receiver.
2. Degrease the screw holes in the receiver.
3. Degrease the scope base screws.
4. After the degreased areas are dry, place a drop of red LOCTITE adhesive/sealant or equivalent to the scope base screws.
5. Set the scope base on the receiver with the side notch aligned with the ejection port of the receiver.
6. Install the scope base screws and tighten.
7. Set the assembled pistol aside overnight to allow the adhesive to set up.

ATTACHING RUGER SCOPE RINGS (Competition Models Only)

On the Mark III COMPETITION TARGET MODEL pistol, the rings fit the removable base (A07000), which is attached as described above. Make sure the scope base screws are tight before attaching the scope ring assemblies!

Iron sights can be used with the scope base mounted on top of the receiver, so removal of the base is not normally necessary. Three "filler" screws (Part No. B-83) are provided to fill the scope base screw holes if the user decides to remove the base.

On the underside of each mounting ring assembly there is a locating "tab." By reference to this "tab," the mounting ring can be assembled to the scope so that the tab will fit correctly into the recess on the top of the receiver.

Disassemble one ring and reassemble over the scope body between the turret and the eyepiece so that the clamp nut (D-73) is positioned to the right of the scope.

Install the four top screws. Do not tighten.

Disassemble the other ring and install it on the forward section of the scope tube with the clamp nut positioned to the right of the scope. Install the four top screws. Again, do not tighten.

Assemble the rings to the scope base with the locating "tabs" engaging the recesses in the top surface of the base. Tighten the clamp nuts so that the rings are locked to the semi-circular cuts on the sides of the scope base. Rotate the scope until cross-hairs are aligned properly, and slide scope to desired eye relief.

Then tighten the eight top screws a bit at a time to grip the scope body. Sight in according to the directions with your scope.

SERVICE AND PARTS POLICY

If you have any questions with regard to the performance of your **RUGER® MARK III** pistol, please call (928-778-6555) or write our Prescott, Arizona Product Service Department, fully describing all circumstances and conditions involved. If you should return your pistol to the factory for repair, or order parts for it, please comply with the following suggestions for prompt service:



WARNING: BEFORE SHIPPING ANY FIREARM, BE ABSOLUTELY CERTAIN THAT IT AND ITS MAGAZINES ARE UNLOADED. DO NOT SHIP CARTRIDGES WITH A FIREARM.

SHIPPING FIREARMS FOR REPAIR

RUGER® MARK III pistols returned to the factory for services or repair should be sent to: Sturm Ruger & Co., Inc., Product Service Department, 200 Ruger Road, Prescott, AZ 86301-6181. Telephone: (928) 778-6555.



Guns should be sent prepaid. We will not accept collect shipments.

The Federal Gun Control Act, as well as the laws of most States and localities, do not prohibit an individual (who is not otherwise barred from purchasing or possessing a firearm) from shipping a firearm directly to the manufacturer for repair. However, before you ship your firearm to us, be certain that your State or locality does not have a law or regulation which will prohibit you from receiving it from us after it has been repaired. If such receiving is prohibited, then please have a Federally Licensed firearms dealer ship the gun to us. If it is sent to us by a dealer, it will be returned to him after being repaired. If a handgun (pistol or revolver) is shipped by an individual who does not hold a Federal Firearms License, it must be shipped via U.P.S. (Next Day Air). Persons who do not hold a Federal Firearms License are prohibited by Federal law from shipping a handgun by Mail. Handguns mailed in violation of the law are impounded by the Post Office.

Please do not include holster, custom grip panels, or custom accessories with a firearm being shipped to the factory for service. **DO NOT SEND GUN BOXES OR LITERATURE THAT YOU CONSIDER TO BE COLLECTOR'S ITEMS - THESE ARE INVARIABLY DAMAGED OR DESTROYED IN SHIPMENT.** Always insure your shipment.

Enclose a letter which includes your name, address, telephone number, serial number and model of the firearm. Describe in detail the trouble you have experienced with your firearm, or the work you wish to have done. Merely stating that the firearm “needs repair” is inadequate information. State precisely what is wrong. Please enclose copies of any previous correspondence.

Work performed will bear a net minimum labor charge of \$20.00 plus a \$20.00 shipping and handling charge. The charge for metal refinishing the **RUGER® MARK III** pistol is \$50.00 plus a \$20.00 shipping and handling charge. Custom gunsmithing service or nonstandard alterations are NOT AVAILABLE from Ruger Product Service Departments.

 WARNING –PARTS PURCHASERS	
	It is the purchaser's responsibility to be absolutely certain that any parts ordered from the factory are correctly fitted and installed. Firearms are complicated mechanisms and IMPROPER FITTING OF PARTS MAY RESULT IN A DANGEROUS MALFUNCTION, DAMAGE TO THE FIREARM, AND SERIOUS INJURY TO THE SHOOTER AND OTHER PERSONS. The purchaser and installer of parts must accept full responsibility for the correct adjustment and functioning of the pistol after such installation.
	PARTS MUST FIT CORRECTLY

ORDERING PARTS

Please contact the Arizona Product Service Department for parts availability and current prices. All parts ordered for the **RUGER® MARK III** should be sent to: Sturm, Ruger & Company, Inc., Parts Department, 200 Ruger Road, Prescott, AZ 86301-6181, telephone: (928) 778-6555.

We cannot comply with open account or C.O.D. requests. Payment in the form of a check, money order, Visa or MasterCard must accompany your order. Credit Card orders must include the account number, expiration date and whether it is a Visa or MasterCard account. Minimum parts order is \$1.00 plus a \$3.50 shipping and handling charge. Order parts by Part Name and Part Number and include the entire serial number of the firearm for which the parts are being ordered. There is a minimum net labor charge of \$20.00 plus \$20.00 shipping and handling charge if parts are factory fitted. All factory fitted parts are fit on an exchange basis only. We will not return the replaced parts.

*Parts designated by an asterisk must be factory fitted. These parts are fitted on an exchange basis only. We will not return the replaced parts. We will not return any part that is broken, malfunctioning, badly worn or has been modified. See “Warning – Parts Purchasers” above.

Because it is a serial-numbered component, the **RUGER® MARK III** pistol barrel/receiver assembly is defined as a “firearm” by Federal Law and is not offered for sale separately.

	CAUTION: A gun containing modified, broken, malfunctioning, or badly worn parts should not be fired.
---	---

RUGER® MARK III

PARTS LIST

Design, prices and specifications subject to change without notice.

SPECIFY MODEL WHEN ORDERING

(See Exploded Views on pages 36 - 38)

Key No.	Part Name	Part No.	Model
* 1	Barrel/Receiver Assembly	AB5300-512 KAB5300-512 APB5300-512 KAPB5300-512	MKIII Target - blued model MKIII Target - stainless model 22/45 MKIII - blued model 22/45 MKIII - stainless model
2	Front Sight	A03612	MKIII & 22/45 MKIII models
3	Front Sight Screw	XR07600	MKIII & 22/45 MKIII models
4	Barrel/Receiver Filler Screws, 3 Req'd	B-83	MKIII & 22/45 MKIII models (except Standard Models)
5	Loaded Chamber Indicator	A11001 KA11001	MKIII & 22/45 MKIII - blued models MKIII & 22/45 MKIII - stainless models
6	Loaded Chamber Indicator Spring	KAP04600	MKIII & 22/45 MKIII models
7	Loaded Chamber Indicator Pin	A02611	MKIII & 22/45 MKIII models
	Rear Sight Assembly, Complete - Includes Key Nos. 8 - 15 (Not Available on Standard Models)	A15901-200	
8	Rear Sight Bottom	A05900	MKIII & 22/45 MKIII models
9	Rear Sight Pivot Pin	A05601	MKIII & 22/45 MKIII models
10	Rear Sight Elevation Springs, 2 Req'd	MR05906	MKIII & 22/45 MKIII models
11	Rear Sight Base	A06102	MKIII & 22/45 MKIII models
12	Rear Sight Elevation Screw	MR05902	MKIII & 22/45 MKIII models
13	Rear Sight Blade	MR05901	MKIII & 22/45 MKIII models
14	Rear Sight Windage Spring	MR05907	MKIII & 22/45 MKIII models
15	Rear Sight Windage Adjustment Screw	E05903	MKIII & 22/45 MKIII models
	Bolt Assembly, Complete - Includes Key Nos. 16 - 24	A02111-100 KA02111-100	MKIII & 22/45 MKIII - blued models MKIII & 22/45 MKIII - stainless models
16	Bolt, Only	A02111 KA02111	MKIII & 22/45 MKIII - blued models MKIII & 22/45 MKIII - stainless models

Key No.	Part Name	Part No.	Model
17	Firing Pin Stop Pin	A03500	MKIII & 22/45 MKIII - blued models
		KA03500	MKIII & 22/45 MKIII - stainless models
18	Rebound Spring	A20000	MKIII & 22/45 MKIII - blued models
		KA20000	MKIII & 22/45 MKIII - stainless models
19	Rebound Spring Support	A03900	MKIII & 22/45 MKIII - blued models
		KA03900	MKIII & 22/45 MKIII - stainless models
20	Firing Pin	A01300	MKIII & 22/45 MKIII models
21	Recoil Spring Assembly	KA-57	MKIII & 22/45 MKIII models
22	Extractor Spring	KA20300	MKIII & 22/45 MKIII models
23	Extractor Plunger	KA02510	MKIII & 22/45 MKIII models
24	Extractor	KA02200	MKIII & 22/45 MKIII models
* 25	Grip Frame with Trigger Guard	A54002	MKIII - blued models
		KA54002	MKIII - stainless models
* 26	Grip Frame, One Piece, Plastic Trigger	AP10200	22/45 MKIII models
		A01202	MKIII & 22/45 MKIII (except Target models)
		A01203-100	MKIII Target
		A01252	22/45 MKIII Target
		A01202	22/45 MKIII
27	Trigger Spring	A20400	MKIII & 22/45 MKIII - blued models
		KA20400	MKIII & 22/45 MKIII - stainless models
28	Trigger Spring Plunger	A02508	MKIII & 22/45 MKIII - blued models
		KA02508	MKIII & 22/45 MKIII - stainless models
29	Trigger Pivot Retainer	KA04200	MKIII Models
		AP04200	22/45 MKIII models
30	Bolt Stop Assembly (See Notes A & B on Pages 36 & 37)	AN-37	MKIII - blued model
		KAN-37	MKIII - stainless models
		AP-37	22/45 MKIII models
31	Bolt Stop Plunger (See Notes A & B on Pages 36 & 37)	A04300	MKIII - blued models
		KA04300	MKIII - stainless models
		A02511	22/45 MKIII models
32	Bolt Stop Plunger Spg. (See Notes A & B on Pages 36 & 37)	KA04600	MKIII models
		AP04600	22/45 MKIII models
33	Trigger Pivot Pin	A03400	MKIII - blued models
		KA04300	MKIII - stainless models
		AP03401	22/45 MKIII models

Key No.	Part Name	Part No.	Model
* 34	Safety Assembly, Complete	AN-53-100 KA-53-100 AP-53-100	MKIII - blued models MKIII - stainless models 22/45 MKIII models
* 35	Hammer Assembly, Complete	A01803-100 KA01803-100 A01802-100	MKIII & 22/45 MKIII - blued Target models MKIII & 22/45 MKIII - stainless Target models MKIII & 22/45 MKIII Standard models
36	Magazine Disconnecter Spring	A20250	MKIII & 22/45 MKIII models
37	Magazine Disconnecter	KA01110	MKIII & 22/45 MKIII models
* 38	Disconnecter Assembly	KA011	MKIII & 22/45 MKIII models
39	Hammer Bushing	KA02513	MKIII & 22/45 MKIII models
40	Sear Spring	A03100 AP03100	MKIII models 22/45 MKIII models
* 41	Sear	A01901	
42	Bolt Stop Thumb Piece	A04700 KA04700	MKIII - blued models MKIII - stainless models
43	Hammer Pin (See WARNING, below)	A02605 KA02605 AP02613	MKIII - blued models MKIII - stainless models 22/45 MKIII models
44	Magazine Latch	A00503 KA00503 AP00504	MKIII - blued models MKIII - stainless models 22/45 MKIII models
45	Magazine Latch Spring	KAP03000	MKIII & 22/45 MKIII models
46	Magazine Latch Spring Plunger	KE-61	
47	Magazine Latch Screw	A08003	MKIII models
48	Sear Pin	A02601 KA02601 AP02612	MKIII - blued models MKIII - stainless models 22/45 MKIII models
49	Sear Spring Pin	A02603	MKIII models
50	Magazine Latch Pin, 2 Req'd	A02601	MKIII models
51	Mainspring Housing Assembly	A00910-100 AP00903-100	MKIII models 22/45 MKIII models

WARNING regarding non-Ruger Grip Panels. Note: The Hammer Pin (A02605) is prevented from drifting out of the left side of the Grip Frame by contact with the inner surface of the left Grip Panel. Therefore, be certain that the clearance cut in the left Grip Panel is the correct depth to maintain the Hammer Pivot fully seated in the Grip Frame.

Key No.	Part Name	Part No.	Model
52	Lock Pin	KA02614	MKIII & 22/45 MKIII models
53	Spring Back-up Pin	KA02616	MKIII & 22/45 MKIII models
54	Detent Plunger Lock	KV04612	MKIII & 22/45 MKIII models
55	Lock Plunger Detent Spring	KV06476	MKIII & 22/45 MKIII models
56	Hammer Spring Plunger	KA02509	MKIII & 22/45 MKIII models
57	Hammer Spring	A20100	MKIII & 22/45 MKIII models
58	Housing Latch Detent Ball	A04100	MKIII & 22/45 MKIII models
59	Housing Latch	A00700	MKIII - blued models
		KA00700	MKIII - stainless models
		AP00700	22/45 MKIII models
60	Housing Latch Pin	A02602	MKIII & 22/45 models
61	Grip Frame Filler	A00401	MKIII models
62	Grip Panel, Left	A00811	MKIII models
63	Grip Panel, Right (with medallion)	A00810-100	MKIII models
64	Grip Panel Screw, 2 Req'd	A02503	MKIII models
65	Magazine, Complete	M10MKIII	MKIII models
		AP10MKIII	22/45 MKIII
66	Internal Lock Key	KV15009	MKIII & 22/45 MKIII models
	Mark III Competition Model Component Parts Includes Key Nos. 67 - 71 (See Note C, page 38.)		
67	Scope Mount Base (3.421"), with Screws	A07000	MKIII & 22/45 MKIII models
	Scope Mount Base (4.125"), Extended, with Screws	A07001	MKIII & 22/45 MKIII models
68	Scope Base Screws, 3 Req'd	B-89	MKIII & 22/45 MKIII models
69	Scope Rings, Low, Blued	S100RL	MKIII & 22/45 MKIII models
	Scope Rings, Low, Stainless	KS100RL	MKIII & 22/45 MKIII models
70	Front Sight	A03604	MKIII - Competition model
71	Front Sight Screw	XR07600	MKIII & 22/45 MKIII models
	Also Available, but Not Illustrated		
	Weaver-Style Scope Mount Base, with Screws, Matte Silver Color	A07050G	MKIII & 22/45 MKIII models
	Weaver-Style Scope Mount Base, with Screws, Matte Black Color	A07050B	MKIII & 22/45 MKIII models
	Case Only	PGC-RF	MKIII & 22/45 MKIII models

* PARTS SO MARKED MUST BE FACTORY FITTED

RUGER® MARK III

EXPLODED VIEW

Note A — The Bolt Stop components in this group are for holding open the bolt and are not functionally related to the Bolt Stop Pin and Bolt Stop Pin Pivot. These two later components are attached to the Mainspring Housing Assembly (Key No. 51; Part No. A00910-100). See parts drawing below for relationship of parts.

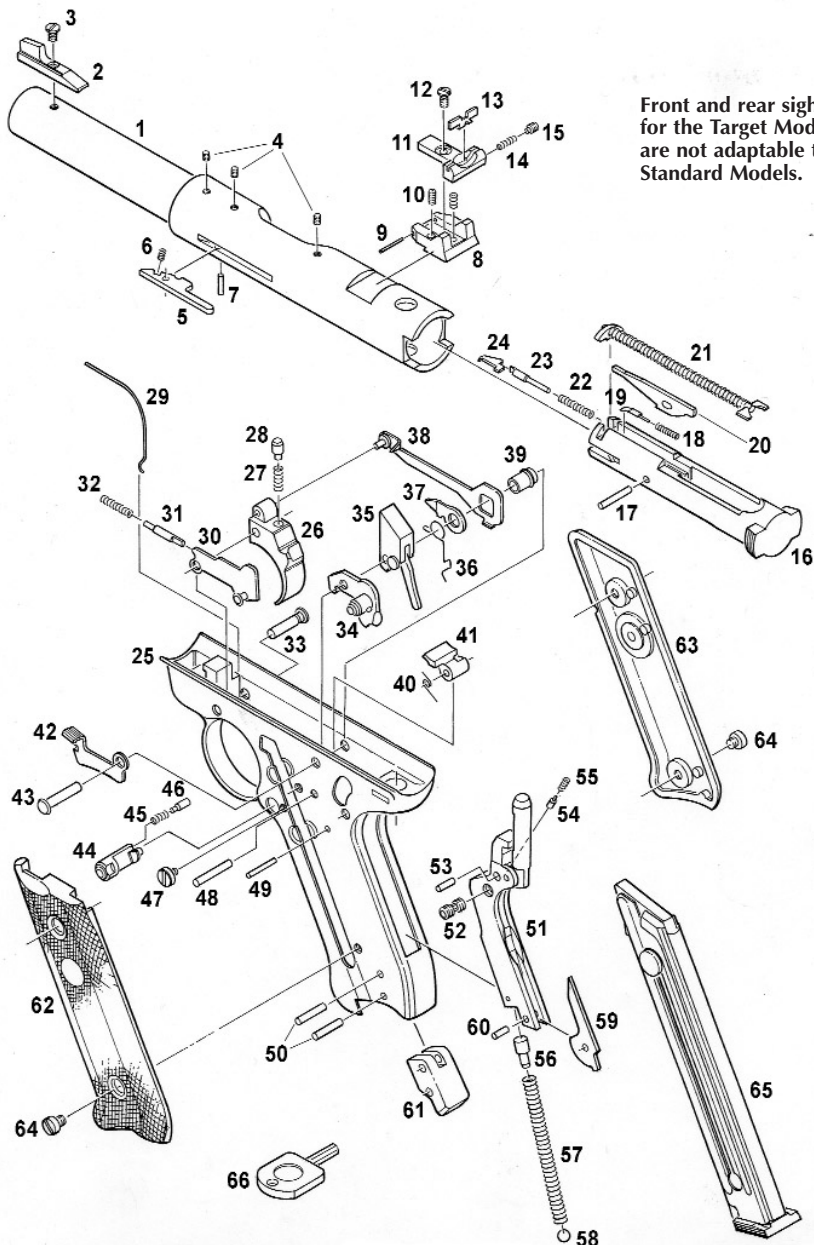

Front and rear sights for the Target Models are not adaptable to Standard Models.

RUGER® 22/45 MARK III

EXPLODED VIEW

Note B — The Bolt Stop components in this group are for holding open the bolt and are not functionally related to the Bolt Stop Pin and Bolt Stop Pin Pivot. These two later components are attached to the Mainspring Housing Assembly (Key No. 51; Part No. AP00903-100). See parts drawing below for relationship of parts.

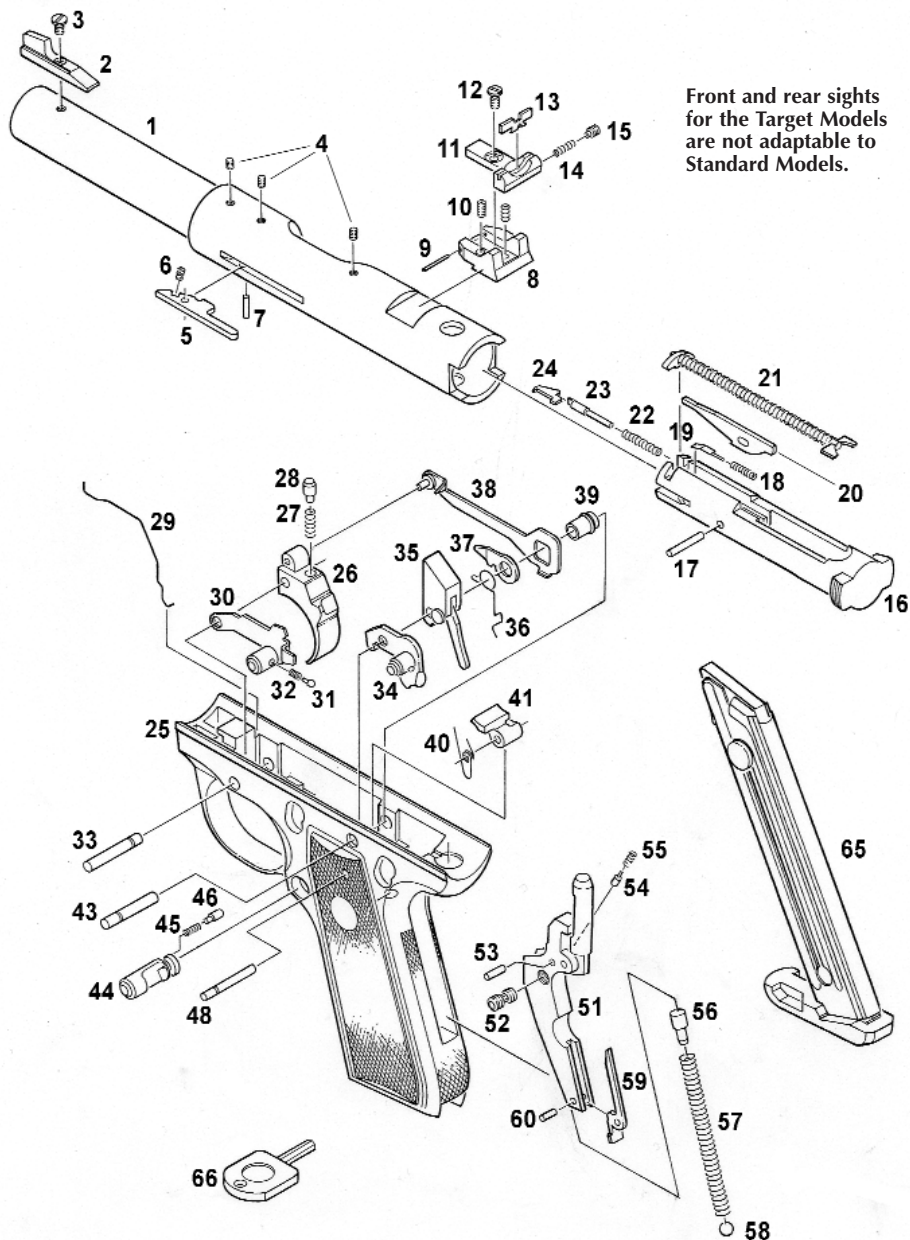

RUGER® COMPETITION MODEL COMPONENT PARTS

(All other parts the same as Mark III)

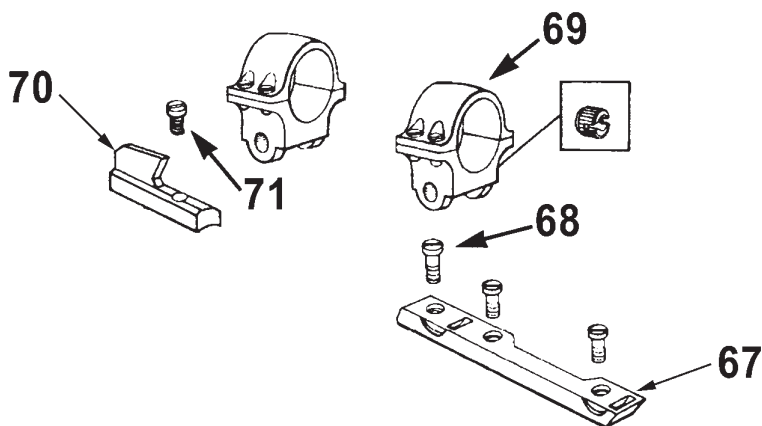

NOTE C — Scope mount bases and rings listed will fit all **MARK III** and **22/45 MARK III** pistols. Only the **MARK III** Competition model is drilled and tapped at the factory. All other models must be drilled and tapped by your local gunsmith. Drilling and tapping instructions are available on request.

THE BASIC RULES OF SAFE FIREARMS HANDLING

We believe that Americans have a right to purchase and use firearms for lawful purposes. The private ownership of firearms in America is traditional, but that ownership imposes the responsibility on the gun owner to use his firearms in a way which will ensure his own safety and that of others. When firearms are used in a safe and responsible manner, they are a great source of pleasure and satisfaction, and represent a fundamental part of our personal liberty.

Firearms do not cause accidents! Firearms accidents are almost always found to have been the result of carelessness or ignorance on the part of the shooter of the basic rules of safe gun handling.

The following rules must be observed by gun users at all times. Safe gun handling is not just desirable, it is absolutely essential to your safety, the safety of others, and the continuation of gun ownership and sport shooting as we know it today.

1. LEARN THE MECHANICAL AND HANDLING CHARACTERISTICS OF THE FIREARM YOU ARE USING.

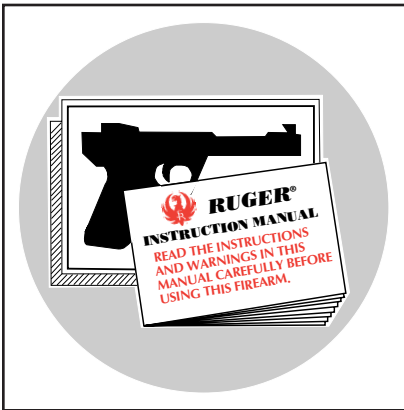

Not all firearms are the same. The method of carrying and handling firearms varies in accordance with the mechanical provisions for avoiding accidental discharge and the various proper procedures for loading and unloading. No person should handle any firearm without first having thoroughly familiarized himself with the particular type of firearm he is using, and with safe gun handling in general.

2. ALWAYS KEEP THE MUZZLE POINTED IN A SAFE DIRECTION.



Be sure of the bullet stop behind your target, even when dry-firing. Never let the muzzle of a firearm point at any part of your body or at another person. This is particularly important when loading or unloading a firearm. In the event of an accidental discharge, no injury can occur as long as the muzzle is pointing in a safe direction. A safe direction means a direction which will not permit a discharged bullet to strike a person, or to strike an object from which the bullet may ricochet.

A safe direction must take into account the fact that a bullet may penetrate a wall, ceiling, floor, window, etc., and strike a person or damage property. Make it a habit to know exactly where the muzzle of your gun is pointing whenever you handle it, and be sure that you are always in control of the direction in which the muzzle is pointing, even if you fall or stumble. Keep your finger off the trigger until you are ready to shoot.

3. FIREARMS SHOULD BE UNLOADED WHEN NOT IN USE.

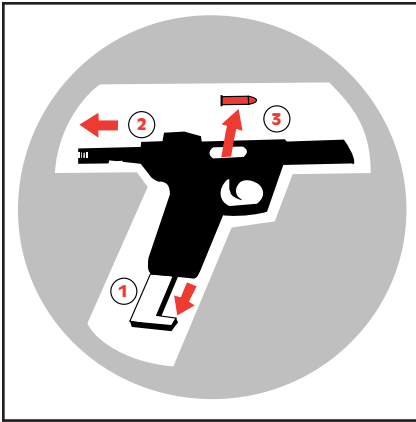

Firearms should be loaded only when you are in the field or on the target range or shooting area, ready to shoot. Firearms and ammunition should be securely locked in safes, racks or cabinets, or by using the locking device supplied with the firearm, when not in use. Ammunition should be safely stored separate from firearms. Store your firearms out of sight of visitors and children. It is the gun owner's responsibility to be certain that children and persons unfamiliar with firearms cannot gain access to firearms, ammunition, or components.

4. BE SURE THE BARREL IS CLEAR OF OBSTRUCTIONS BEFORE SHOOTING.

Even a bit of mud, snow or excess lubricating oil or grease in the bore may cause the barrel to bulge, or even burst on firing, and can cause serious injury to the shooter and bystanders. Be sure that you are using ammunition of the proper caliber and loading for the gun you are using. If the report or recoil on firing seems weak, or doesn't seem quite right, **CEASE FIRING IMMEDIATELY**, unload your firearm, and check to be sure that no obstruction has become lodged in the barrel.





5. BE SURE OF YOUR TARGET BEFORE YOU SHOOT.

Don't shoot unless you know exactly where your bullet is going to strike. Be sure of the bullet stop behind your target, even when dry-firing with an unloaded gun. If you are in the field hunting, do not fire at a movement or noise. Take the time to be absolutely certain of your target before you pull the trigger.

6. WEAR SHOOTING GLASSES AND HEARING PROTECTORS WHEN YOU SHOOT.

All shooters should wear protective shooting glasses and adequate hearing protectors when shooting. Exposure to shooting noise can damage hearing, and adequate eye protection when shooting is essential.



7. NEVER CLIMB A TREE OR FENCE WITH A LOADED FIREARM.

Put the firearm down carefully before climbing a fence, and unload it before climbing or descending a tree or jumping over a ditch or other obstruction. Never pull or push a loaded firearm toward yourself or another person. When in doubt, or whenever you are about to do anything awkward, unload your gun!

8. DON'T SHOOT AT A HARD SURFACE, OR AT WATER.

Bullets can glance off many surfaces like rocks or the surface of water and travel in unpredictable directions with considerable velocity.



9. NEVER TRANSPORT A LOADED FIREARM.

Firearms should always be unloaded before being placed in a vehicle. A suitable carrying case or scabbard should be used to carry an unloaded firearm to and from the shooting area.

10. AVOID ALCOHOLIC BEVERAGES WHEN SHOOTING.

Don't drink until the day's shooting is over. Handling firearms while under the influence of alcohol in any form, or medications that could affect your judgment or coordination, constitutes a criminal disregard for the safety of others.



A BRIEF ACCOUNT OF AN EXTRAORDINARY ACHIEVEMENT: RUGER FIREARMS

One of the few American firearms manufacturers whose management has remained in the same family since starting in business, Sturm, Ruger & Company, Inc., had its beginning in a small machine shop occupying a rented frame building in Southport, Connecticut. In January, 1949, with an initial investment of only \$50,000 and an idea, William B. Ruger and Alexander M. Sturm started production of a 22 caliber autoloading pistol—a design which was so successful that it became the cornerstone upon which one of the most comprehensive lines of sporting firearms ever made in America was established. After Alex Sturm's death in 1951, William B. Ruger continued to direct the Company until his death in 2003. Today, William B. Ruger, Jr. continues to provide guidance which has made this Company a sound and successful enterprise.

Sturm, Ruger & Company, in this relatively short time, has established itself as a leading small arms design organization, developing a unique and broad line of fine quality sporting, military and police firearms to become one of the world's most famous producers of revolvers, pistols, rifles and shotguns. Since 1949 Ruger craftsmen have built many millions of firearms.

During its five decades of growth and progress under the leadership of William B. Ruger, the Company developed a business philosophy and implemented policies which represent a constructive influence in the life of modern America. From the beginning, Sturm, Ruger & Company played a positive role in conservation efforts and has supported the interests of shooters through such groups as the National Rifle Association, National Shooting Sports Foundation, and many regional sportsmen's organizations.

The Company has always endeavored to market its firearms for constructive and recreational purposes, to emphasize the traditional aspects of shooting, to render meaningful public services and to encourage shooters in constructive, responsible, and safe participation in the shooting sports. Its motto is "Arms Makers For Responsible Citizens."

Today, Sturm, Ruger & Company is particularly mindful of those elements which have contributed to the creation of its success, and extends heartfelt thanks to its many loyal employees and customers.

A current catalog of Ruger firearms is available free upon request to
Sturm, Ruger & Co., Inc., Southport, CT 06890

WHY NO WARRANTY CARD HAS BEEN PACKED WITH THIS NEW RUGER FIREARM

The Magnuson-Moss Act (Public Law 93-637) does not require any seller or manufacturer of a consumer product to give a written warranty. It does provide that if a written warranty is given, it must be designated as "limited" or as "full" and sets minimum standards for a "full" warranty. Sturm, Ruger & Company, Inc. has elected not to provide any written warranty, either "limited" or "full", rather than to attempt to comply with the provisions of the Magnuson-Moss Act and the regulations issued thereunder. There are certain implied warranties under state law with respect to sales of consumer goods. As the extent and interpretation of these implied warranties varies from state to state, you should refer to your state statutes. Sturm, Ruger & Company wishes to assure its customers of its continued interest in providing service to owners of Ruger firearms.



STURM, RUGER & Company, Inc.
Southport, Connecticut 06890 U.S.A.

www.ruger.com

Arms Makers For Responsible Citizens[®]

**A COPY OF THE INSTRUCTION MANUAL FOR ANY RUGER
FIREARM IS AVAILABLE FROM THE FACTORY FREE ON REQUEST.
THESE INSTRUCTION MANUALS CONTAIN IMPORTANT
WARNINGS WHICH MUST BE UNDERSTOOD
BEFORE USING THESE FIREARMS.**

"10/17," "22/45," "Model 96," "Gold Label," "P90," "P91," "P93," "P94," "P95," "P97," and "Target Grey" are RUGER TRADEMARKS. "RUGER," THE STURM, RUGER LOGO, "Arms Makers For Responsible Citizens," "10/22," "All-Weather," "Bearcat," "Blackhawk," "GP-100," "M77," "Mini Thirty," "Mini-14," "Old Army," "P85," "Redhawk," "77/17," "77/22," "77/44," "77/50," "SP101," "Vaquero," "Single Six," "Security-Six," "Service-Six," and "Speed-Six," are REGISTERED U.S. TRADEMARKS. "DEERFIELD" is a registered trademark of Blount, Inc.