

INSTRUCTION MANUAL FOR

BLUED &
STAINLESS
STEEL



CALIBERS
.22 L.R., .22 Magnum
& .32 H&R

RUGER® **NEW MODEL** **SINGLE SIX® & BISLEY™** SINGLE ACTION REVOLVERS



**READ THE INSTRUCTIONS AND
WARNINGS IN THIS MANUAL CAREFULLY
BEFORE USING THIS FIREARM**

**For Product Service on This Model Please Call:
(603) 865-2442 (See p. 25)**

**STURM, RUGER & Company, Inc.
Southport, Connecticut 06490 U.S.A.**

THIS INSTRUCTION MANUAL SHOULD ALWAYS ACCOMPANY THIS FIREARM AND BE
TRANSFERRED WITH IT UPON CHANGE OF OWNERSHIP, OR WHEN THE FIREARM IS LOANED OR
PRESENTED TO ANOTHER PERSON.

XRN1, KXRN1, BRN & SSM/3-02 C
R6

State-By-State Warnings

Certain states require by law that their own specified warning notices in larger-than-normal type be conspicuously included by the manufacturer, distributor, or retail dealer with firearms sold in that state. Sturm, Ruger sells its products in compliance with applicable laws and regulations. Because our products may be sold in these states, we include the following:

California:

▲ WARNING

“Children are attracted to and can operate firearms that can cause severe injuries or death. Prevent child access by always keeping guns locked away and unloaded when not in use. If you keep a loaded firearm where a child obtains and improperly uses it, you can be fined or sent to prison.”

▲ ADVERTENCIA

“A los niños los atraen las armas de fuego y las pueden hacer funcionar. Ellos pueden causarse lesiones graves y la muerte. Evite que los niños tengan acceso a las armas de fuego guardándolas siempre con llave y descargadas cuando no las esté utilizando. Si usted tiene un arma de fuego cargada en un lugar en que un niño tiene acceso a ella y la usa indebidamente, le pueden dar una multa o enviarlo a la cárcel.”

Connecticut:

“UNLAWFUL STORAGE OF A LOADED FIREARM MAY RESULT IN IMPRISONMENT OR FINE.”

Florida:

“IT IS UNLAWFUL, AND PUNISHABLE BY IMPRISONMENT AND FINE, FOR ANY ADULT TO STORE OR LEAVE A FIREARM IN ANY PLACE WITHIN THE REACH OR EASY ACCESS OF A MINOR UNDER 18 YEARS OF AGE OR TO KNOWINGLY SELL OR OTHERWISE TRANSFER OWNERSHIP OR POSSESSION OF A FIREARM TO A MINOR OR A PERSON OF UNSOUND MIND.”

Maine:

“ENDANGERING THE WELFARE OF A CHILD IS A CRIME. IF YOU LEAVE A FIREARM AND AMMUNITION WITHIN EASY ACCESS OF A CHILD, YOU MAY BE SUBJECT TO FINE, IMPRISONMENT OR BOTH. KEEP FIREARMS AND AMMUNITION SEPARATE. KEEP FIREARMS AND AMMUNITION LOCKED UP. USE TRIGGER LOCKS.”

Maryland:

“WARNING: Children can operate firearms which may cause death or serious injury. It is a crime to store or leave a loaded firearm in any location where an individual knew or should have known that an unsupervised minor would gain access to the firearm. Store your firearm responsibly!”

Massachusetts:

“WARNING FROM THE MASSACHUSETTS ATTORNEY GENERAL: This handgun is not equipped with a device that fully blocks use by unauthorized users. More than 200,000 firearms like this one are stolen from their owners every year in the United States. In addition, there are more than a thousand suicides each year by younger children and teenagers who get access to firearms. Hundreds more die from accidental discharge. It is likely that many more children sustain serious wounds, or inflict such wounds accidentally on others. In order to limit the chance of such misuse, it is imperative that you keep this weapon locked in a secure place and take other steps necessary to limit the possibility of theft or accident. Failure to take reasonable preventive steps may result in innocent lives being lost, and in some circumstances may result in your liability for these deaths.”

“IT IS UNLAWFUL TO STORE OR KEEP A FIREARM, RIFLE, SHOTGUN OR MACHINE GUN IN ANY PLACE UNLESS THAT WEAPON IS EQUIPPED WITH A TAMPER-RESISTANT SAFETY DEVICE OR IS STORED OR KEPT IN A SECURELY LOCKED CONTAINER.”

New Jersey:

“IT IS A CRIMINAL OFFENSE TO LEAVE A LOADED FIREARM WITHIN EASY ACCESS OF A MINOR.”

New York City:

“THE USE OF A LOCKING DEVICE OR SAFETY LOCK IS ONLY ONE ASPECT OF RESPONSIBLE WEAPONS STORAGE. ALL WEAPONS SHOULD BE STORED UNLOADED AND LOCKED IN A LOCATION THAT IS BOTH SEPARATE FROM THEIR AMMUNITION AND INACCESSIBLE TO CHILDREN AND ANY OTHER UNAUTHORIZED PERSONS.”

North Carolina:

“IT IS UNLAWFUL TO STORE OR LEAVE A FIREARM THAT CAN BE DISCHARGED IN A MANNER THAT A REASONABLE PERSON SHOULD KNOW IS ACCESSIBLE TO A MINOR.”

Texas:

“IT IS UNLAWFUL TO STORE, TRANSPORT, OR ABANDON AN UNSECURED FIREARM IN A PLACE WHERE CHILDREN ARE LIKELY TO BE AND CAN OBTAIN ACCESS TO THE FIREARM.”

Wisconsin:

“IF YOU LEAVE A LOADED FIREARM WITHIN THE REACH OR EASY ACCESS OF A CHILD YOU MAY BE FINED OR IMPRISONED OR BOTH IF THE CHILD IMPROPERLY DISCHARGES, POSSESSES, OR EXHIBITS THE FIREARM.”

* * * * *

Please check with your licensed retailer or state police for additional warnings which may be required by local law or regulation. Such regulations change constantly, and local authorities are in the best position to advise you on such legal matters.

WHY ARE WE INCLUDING A FIRED CARTRIDGE CASE WITH EVERY RUGER PISTOL AND REVOLVER?

Certain states and jurisdictions now require that all newly manufactured pistols and revolvers must be accompanied by a cartridge case, which has been test fired from that gun at the factory. The case must be placed in a sealed container bearing certain information concerning this test cartridge.

At the time of retail sale in those jurisdictions, firearms dealers must forward such test cartridge to a designated destination such as their State Police Laboratory. As independent Ruger Distributors have nationwide markets without territorial restrictions, we have decided to include a fired cartridge case with all new Ruger pistols and revolvers, to minimize the possibility of inadvertent non-compliance with these laws.

Retail customers located in other states, where laws or regulations do not require the dealer to so act, may be assured that the fired cartridge case they receive with the firearm at the time of retail purchase is proof that your new Ruger firearm has undergone our normal test firing procedures during manufacture.



WARNING – LOCKING DEVICES

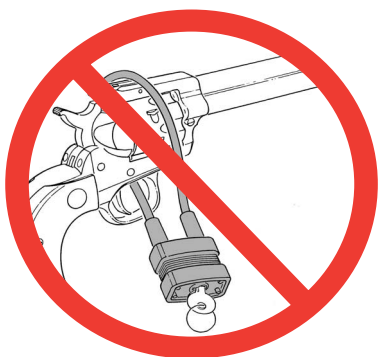

**DO NOT INSTALL
INSIDE TRIGGER GUARD**

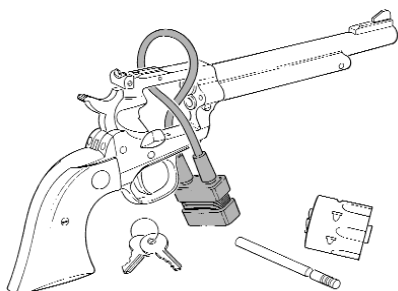

**INSTALL LOCK
AS SHOWN HERE**

This firearm was originally sold with a key-operated locking device. While it can help provide secure storage for your **unloaded** firearm, any locking device can fail. All guns are designed to fire if they are loaded and the trigger is pulled. Therefore, **never install the locking device inside the trigger guard or in any way that it can possibly pull the trigger!** Do not leave the keys in the lock.

The ultimate responsibility for secure storage of any firearm must depend upon its owner and his or her individual circumstances. **Guns should be securely stored unloaded, in a secure location, separate from their ammunition.**

See “Storage Warning” section of the manual, p. 22.

**NEVER INSTALL
LOCKING DEVICE
INSIDE TRIGGER GUARD**

FIREARMS SAFETY-YOUR RESPONSIBILITY

SAFETY MUST BE THE FIRST AND CONSTANT CONSIDERATION OF EVERY PERSON WHO HANDLES FIREARMS AND AMMUNITION.

This Instruction Manual is designed to assist you in learning how to use and care for your **RUGER® NEW MODEL SINGLE SIX®** or **BISLEY™** revolver properly. Please contact us if you have any questions about it.

Only when you are certain you fully understand the Manual and can properly carry out its instructions should you practice loading, unloading, etc. with live ammunition. If you have any doubts about your ability to handle or use a particular type of gun safely, then you should seek supervised instruction. Such personalized instruction is often available from gun dealers, gun clubs or police departments. If none of these sources can help you, write to the National Rifle Association, 11250 Waples Mill Road, Fairfax, VA 22030-7400. They will assist you.

The person possessing a gun has a full-time job. You cannot guess; you cannot forget. You must know how to use your firearm safely. **Do not use any firearm without having a complete understanding of its particular characteristics and safe use.** Remember: There is no such thing as a foolproof gun.

TABLE OF CONTENTS

	Page
General Information and Mechanical Characteristics	7
Ammunition	11
Handling	12
To Load and Fire	13
To Uncock (Decock) The Revolver	14
To Unload or Eject Cartridge Cases	16
To Remove or Replace Cylinder	16
Disassembly	18
Reassembly	19
Care and Cleaning	21
Storage	22
Care of Stainless Steel Revolvers	23
Sights	24
Service and Parts Policy	25
Parts Drawing	33 & 34
The Basic Rules of Safe Firearms Handling	35
Warranty Information	40

“Ruger”, and “Single Six” are registered U.S. trademarks.



WARNINGS OF GREAT IMPORTANCE ARE FOUND ON THE FOLLOWING PAGES:

Locking Devices	5	Safe Carrying Position	14
Alterations	7	Disassembly	17
Lead Exposure	11	Lubrication	22
Ammunition	12	Storage	23
Handling	12	Parts Purchasers	26
Firing	13	Malfunctioning Parts	27

OTHER CAUTIONS AND WARNINGS APPEAR THROUGHOUT THE MANUAL.

**FIREARMS ARE DANGEROUS WEAPONS—
READ THE INSTRUCTIONS AND WARNINGS IN THIS
MANUAL THOROUGHLY AND CAREFULLY BEFORE USING.**



WARNING—ALTERATIONS



This product was designed to function properly in its original condition. Alterations can make it unsafe. Do not alter any part or add or substitute parts or accessories not made by Sturm, Ruger & Co. Inc.

DO NOT ALTER ANY GUN

GENERAL INFORMATION AND MECHANICAL CHARACTERISTICS

The mechanism of the **RUGER® NEW MODEL SINGLE SIX*** differs significantly from that of any other single action revolver. The information and instructions which follow apply only to the New Model Single Six* revolver.

The **RUGER® NEW MODEL BISLEY** revolver has many of the features of the New Model Single Six revolvers with certain important differences, such as the hammer, trigger and grip frame.

The patented Ruger New Model mechanism incorporates a transfer bar. The transfer bar – which is raised into firing position as the trigger is pulled to the rear – transmits the energy of the hammer blow to the firing pin. This transfer bar mechanism makes a “safety” notch unnecessary.

*In this manual the words **SINGLE SIX** refer to the **NEW MODEL SINGLE SIX, NEW MODEL SUPER SINGLE SIX, and RUGER BISLEY** Revolvers in calibers .22LR, .22 WMR, and .32 H&R magnum which all utilize the same Ruger New Model mechanism.

The gate (loading gate) can be opened only when the hammer and trigger are fully forward. Opening the gate immobilizes the trigger, hammer, and transfer bar. When the gate is opened the cylinder is unlatched and can be turned for loading or ejection. When the gate is closed, the cylinder latch functions in the normal manner. The loading notch is therefore unnecessary in the New Model design.

Unlike the earlier single action revolvers which have four hammer positions – “cocked,” “loading,” “safety” and “all the way forward” – the New Model has only two hammer positions – “cocked” and “all the way forward.”

IMPORTANT SAFETY NOTE

OWNERS OF ALL “OLD MODEL” (PRE-1973) RUGER SINGLE ACTION REVOLVERS, INCLUDING BEARCATS WITH SERIAL NUMBERS BELOW 93-00000, SHOULD WRITE FOR DETAILS CONCERNING OUR FREE SAFETY CONVERSION, WHICH CAN HELP PREVENT ACCIDENTS CAUSED BY A BLOW TO THE HAMMER IF THE USER HAS FAILED TO TAKE THE BASIC SAFETY PRECAUTION OF KEEPING AN EMPTY CHAMBER UNDER THE HAMMER. See Page 27.

NOMENCLATURE

New Model Single Six (Adjustable Sight Model Shown)

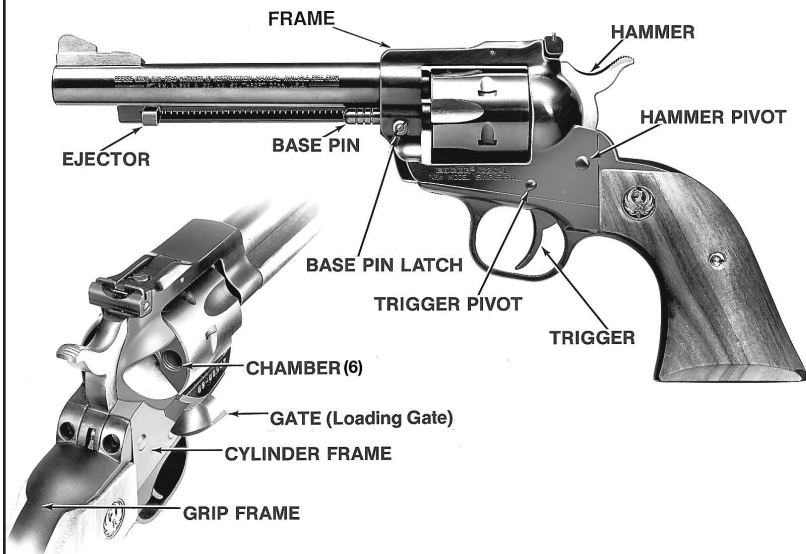

Parts referred to frequently are indicated by arrows.

NOMENCLATURE

Bisley (Fixed Sight Model Shown)

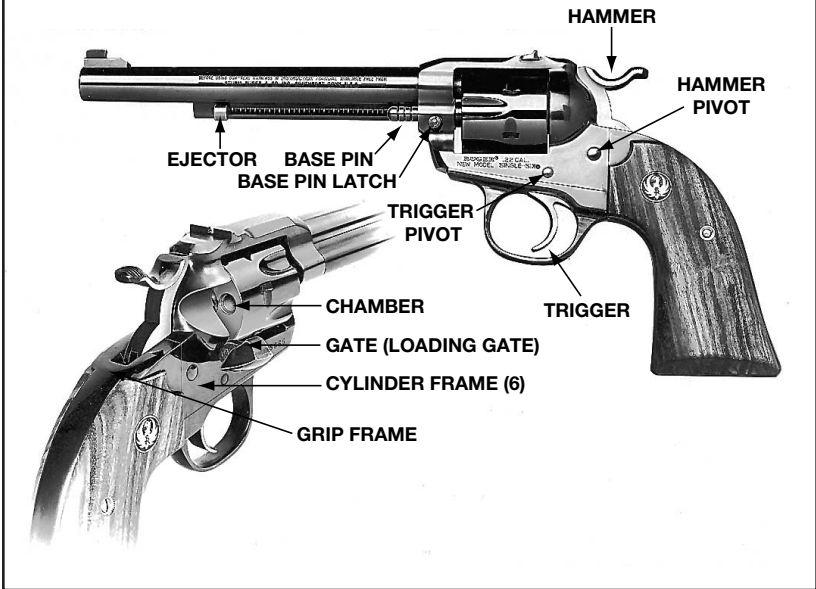

CAUTION—NUMBERED CYLINDERS

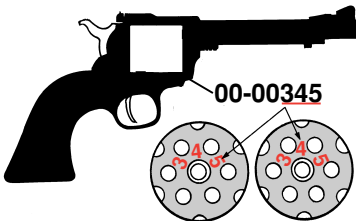

Do not accept delivery of a New Model Single Six or Bisley Convertible (a model with two cylinders) unless the numbers on the front face of both cylinders match the last three digits of the serial number on the frame. Use of the wrong cylinder can cause improper alignment or timing and may result in personal injury.

A New Model Single Six revolver (including the Bisley) manufactured with a single cylinder does not have the last three digits of the serial number marked on the cylinder.

**CYLINDERS
MUST MATCH GUN**

The mechanism of the **RUGER® NEW MODEL SINGLE SIX® & BISLEY** provides maximum security against accidental discharge. As with any other firearm, however, the New Model must be used with strict attention to correct safety practices. In addition, the revolver should be inspected frequently to assure that it is working properly.

The Ruger New Model revolver mechanism is illustrated below. The same basic mechanism is found in the entire line of Ruger New Model single action revolvers – Single-Six, Blackhawk, Super Blackhawk, Bisley, Vaquero and Hunter Models.

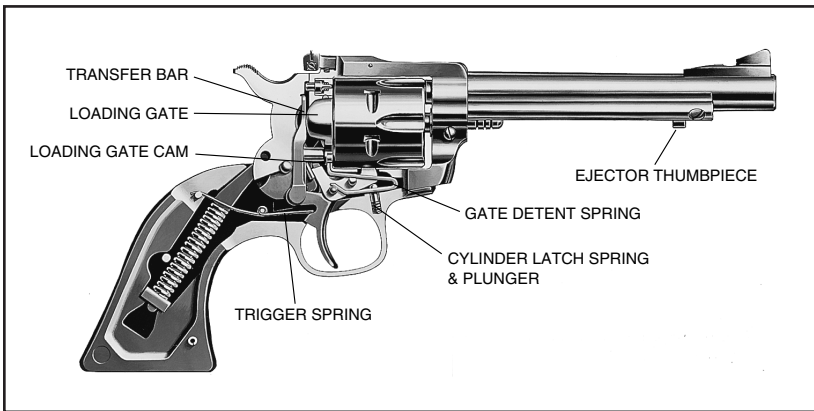

Mechanism shown at rest. Transfer bar is not in line between hammer and firing pin. This is the carrying position.

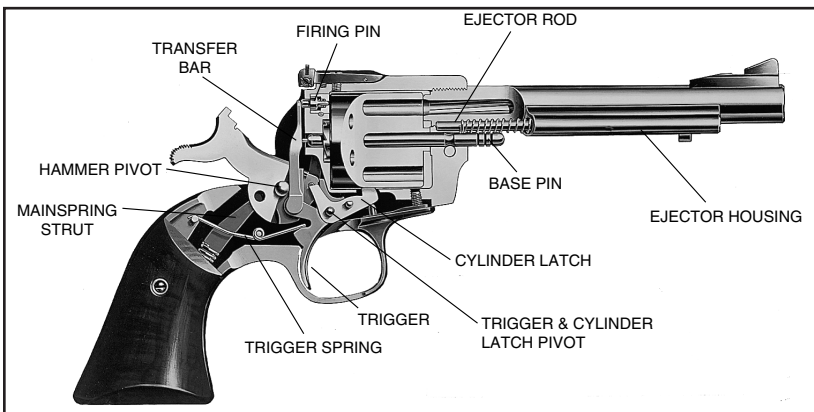

Mechanism shown with trigger pulled and hammer beginning to fall. Transfer bar is in firing position, between hammer and firing pin.



WARNING - LEAD EXPOSURE



Discharging firearms in poorly ventilated areas, cleaning firearms, or handling ammunition may result in exposure to lead and other substances known to the state of California to cause birth defects, reproductive harm, and other serious physical injury. Have adequate ventilation at all times. Wash hands thoroughly after exposure.

**SHOOTING OR CLEANING GUNS
MAY EXPOSE YOU TO LEAD**

AMMUNITION

The **RUGER® NEW MODEL SINGLE SIX®** & **BISLEY** revolvers chambered for .22 long rifle are intended to be used with any standard make of .22 long rifle, long or short ammunition in either regular, high velocity or hyper-velocity loading.

The **RUGER® NEW MODEL SINGLE SIX®** & **BISLEY** revolvers chambered for Caliber .32 H&R Magnum cartridges will also chamber the .32 S&W cartridge and the .32 S&W Long cartridge. The use of other than .32 H&R Magnum cartridges, may, in some loadings, result in unsatisfactory accuracy.

Two cylinders are furnished with some New Model Single Six revolvers. The cylinder with flutes is chambered for .22 Long Rifle cartridge. (.22 Short and .22 Long cartridges can also be fired in the Long Rifle cylinder.)

The cylinder chambered for the .22 WMR cartridge (Winchester Magnum Rimfire) is not fluted. It is marked “.22 WIN. MAGNUM CAL.”

WARNING: Fire only .22 WMR cartridges in the MAGNUM cylinder. Do not fire .22 Short, Long or Long Rifle cartridges in the MAGNUM cylinder. Such cartridges will burst and can cause injury to the shooter and persons nearby.

AMMUNITION (CARTRIDGES) NOTICE

WE SPECIFICALLY DISCLAIM RESPONSIBILITY FOR ANY DAMAGE OR INJURY WHATSOEVER OCCURRING IN CONNECTION WITH, OR AS THE RESULT OF, THE USE IN RUGER REVOLVERS OF FAULTY, OR NONSTANDARD, OR “REMANUFACTURED” OR HANDLOADED (RELOADED) AMMUNITION, OR OF CARTRIDGES OTHER THAN THOSE FOR WHICH THE FIREARM WAS ORIGINALLY CHAMBERED.

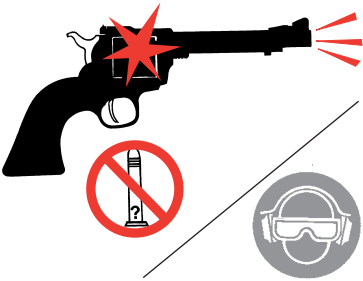
 <h2 style="margin: 0;">WARNING – AMMUNITION</h2>	
	<p>Death, serious injury, and damage can result from the use of wrong ammunition, bore obstructions, powder overloads, or incorrect cartridge components. <u>Always</u> wear shooting glasses and hearing protectors.</p>
<h3 style="margin: 0;">IMPROPER AMMUNITION DESTROYS GUNS</h3>	

HANDLING

CARRYING: Unlike “old model” single action revolvers, which should always be carried with the hammer down on an empty chamber to prevent accidental discharges caused by a blow to the hammer*, the Ruger New Model Single Six & Bisley may be carried with all chambers loaded. When the hammer and trigger are fully forward at the same time, the transfer bar is lowered out of firing position and the hammer rests directly on the frame, not on the firing pin.

* See “Important Safety Note”, p. 8.

 <h2 style="margin: 0;">WARNING – HANDLING</h2>	
	<p>Any time the revolver is loaded, the hammer is cocked and the trigger is pulled and held to the rear, it will fire. Cocking the gun or pulling the trigger should only be done when you are ready to fire immediately.</p> <p>NEVER DROP OR STRIKE ANY REVOLVER – COCKED OR UNCOCKED. CARRY AND HANDLE THE REVOLVER IN SUCH A MANNER THAT THE HAMMER WILL NOT BE STRUCK.</p>
<h3 style="margin: 0;">NEVER CARRY ANY REVOLVER WITH THE HAMMER COCKED.</h3>	

TO LOAD AND FIRE

1. **Do not load the revolver until you are ready to use it.**
2. Note – The loading gate cannot be opened unless the hammer and trigger are fully forward, and the hammer cannot be cocked once the gate is opened.
3. Open the gate. This permits the cylinder to rotate.
4. Turn cylinder clockwise, by hand, and insert cartridges in chambers.
5. Align a chamber with the barrel and close the gate. The revolver is now in its normal carrying condition – hammer and trigger fully forward and transfer bar lowered out of firing position.
6. Cocking – To fire the revolver, the hammer must first be manually cocked. When cocking the hammer, have a firm hold on the grip with the shooting hand, and **DO NOT TOUCH THE TRIGGER WHILE COCKING THE HAMMER. TOUCH THE TRIGGER ONLY WHEN YOU ARE READY TO FIRE.** With the fore portion of your thumb firmly on the hammer spur, draw the hammer fully to the rear until it stops. Then permit the hammer to move forward (it will only move slightly) until the trigger engages in the hammer at full cock.
7. Firing – Once the hammer has been cocked, a light pressure on the trigger will disengage the trigger from the hammer. The hammer will fall forward striking the transfer bar and the revolver will fire.



CAUTION: The recoil of the .32 H&R Magnum caliber causes the muzzle of the gun to flip upward with substantial force. The shooter need not be apprehensive, but be prepared. Keep a firm grip on the revolver and hold it away from your face when firing.

8. After firing, the hammer will remain down. To fire subsequent shots, fully release the trigger and repeat steps 6 & 7 above for each shot.



WARNING – FIRING

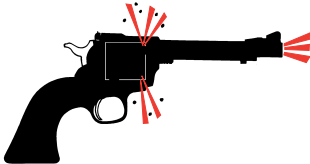



When firing any revolver, be sure all persons are a safe distance to the rear of the shooter. When fired, all revolvers discharge gas and particles through the clearance gap between the cylinder and the rear of the barrel. These particles of lead, powder grains or lubricant are projected broadly sideways at high speed and thus can injure a person who is standing too close to the revolver. When firing any revolver, always be certain that nothing – including either of your hands – is in the path of the hot gas and particles which are discharged from the front and sides of the cylinder. When shooting, adequate eye protection is essential. Shooters and bystanders must wear shooting glasses. Hearing protection must also be worn. Exposure to shooting noise can damage hearing.

**HOT GASES EXIT
BARREL/CYLINDER GAP**

DRY-FIRING: Going through the actions of cocking, aiming, and pulling the trigger of an unloaded gun is known as “Dry Firing.” It can be useful to learn the “feel” of your revolver. Be certain the revolver is unloaded and that the gun is pointing in a safe direction even when practicing by dry-firing. The Ruger New Model revolvers can be dry-fired without damage to the firing pin or other components.

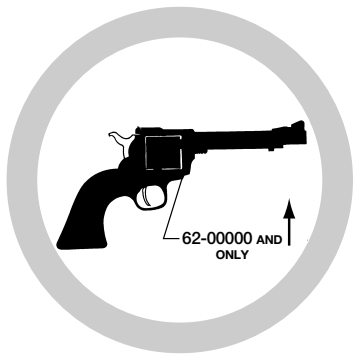
“FANNING”: NEVER fan any revolver. Fanning is an unsafe way to fire a gun and it is abusive to the revolver mechanism.

 WARNING – SAFE CARRYING POSITION	
	<p>The safe carrying position for New Model Single Six and Bisley Revolvers is with the hammer fully down and the trigger forward. In this position the hammer does not contact the firing pin. See page 10. In older (1953-1972) Single Sixes with serial numbers below 62-00000, the hammer, when in the full forward position, does rest against the firing pin.</p> <p>Accordingly, <u>never carry an “old model” revolver with the hammer fully forward and the cartridge in line with the firing pin because a light blow to the hammer can readily cause discharge.</u> It is always safest to carry the hammer down over an <u>empty</u> chamber regardless of revolvers type. See page 27 for details about our free safety conversion offer for “old model” Ruger Single Sixes.</p>
	<p>ALWAYS CARRY NEW MODEL SINGLE SIXES WITH HAMMER DOWN.</p>

TO ‘UNCOCK’ (DECOCK) THE REVOLVER

If your revolver is cocked, and you wish to let the hammer down to its forward position (against the frame), proceed as follows: **USE EXTREME CARE WHEN ATTEMPTING TO DECOCK THE REVOLVER, AS THE THUMB SLIPPING DURING THIS PROCESS CAN RESULT IN AN ACCIDENTAL DISCHARGE IF THE TRIGGER IS HELD TO THE REAR.**

1. Make certain that the revolver is pointing in a safe direction (See Rule 2, Page 35).

2. Make certain both hands are dry and not impeded in any way—gloves, bandages, cold, etc.
3. Grasp the revolver (if right handed) so that the thumb and forefinger of your left hand are firmly holding the frame, forward of the trigger guard. Thus, your left hand is in full control of the revolver (See Figure a, below).
4. Place your right thumb firmly on the hammer spur and, with your thumb securely in control of the hammer, squeeze the trigger only enough to permit the hammer to 'break free' of the trigger. At that instant, **IMMEDIATELY RELEASE THE TRIGGER** and then slowly permit the hammer, **STILL SECURE UNDER YOUR THUMB**, to move fully forward to its resting position against the frame. **NOTE:** It is imperative that finger pressure be removed from the trigger just as soon as it is free of the hammer. Then, properly, the trigger and hammer will move towards their fully forward rest positions together (See Figure b, below).

Practice this important gun handling skill with an unloaded revolver until you have developed the proper control and 'touch' to decock your revolver safely. The key to safe decocking is having the weight of the revolver controlled with one hand, while the thumb and forefinger of the 'shooting hand' control the hammer and trigger.

DECOCKING (UNCOCKING) THE REVOLVER

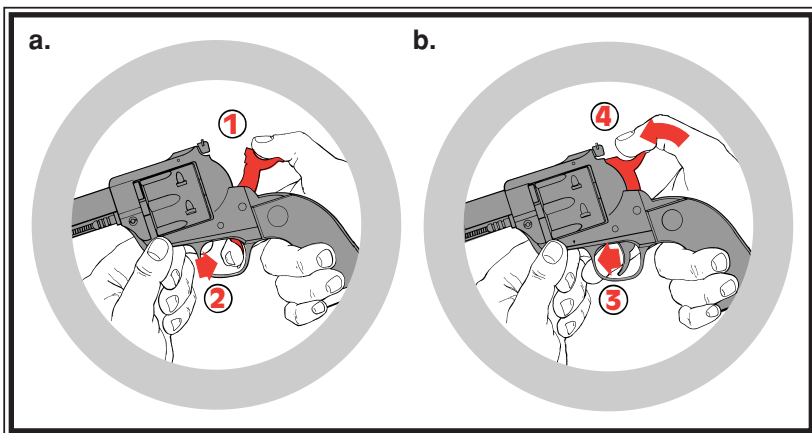

- a. With the thumb controlling the hammer as shown above, (1) squeeze trigger to permit hammer to 'break free' (2).
- b. When hammer is free, **IMMEDIATELY** release trigger (3). Then lower hammer slowly to its resting position completely down against frame (4).

The revolver is now in its normal carrying condition -- hammer and trigger fully forward and transfer bar lowered out of firing position.



CAUTION: The hammer must be carefully eased fully forward before the hammer is drawn back to the full-cock position for the first shot. The hammer should be drawn with a firm positive motion to the full-cock position for each shot, thus actuating the working parts for complete indexing. Unless this procedure is followed in any single-action revolver, the cylinder is apt to be out of index when fired.

TO UNLOAD OR EJECT CARTRIDGE CASES

Keep revolver pointed in a safe direction!
Do not attempt to unload when the hammer is cocked.

If the hammer is cocked, it must first be decocked. (See “To Uncock The Revolver”, p. 14)

Then:

1. Open the gate. This permits the cylinder to rotate.
2. Turn cylinder clockwise, by hand, to align a chamber with the ejector rod.
3. Push the ejector rod rearward, by means of the thumb-piece on its forward end, so that it slides through the chamber to push out the cartridge or fired case. Release spring-loaded ejector rod. Repeat until all chambers are empty.
4. Check to be certain that all cartridges have been removed, then close the gate.

TO REMOVE OR REPLACE CYLINDER



WARNING: Never remove, replace or carry a loaded cylinder. The cartridges can fire if their rims are struck.

1. Open the gate. This lowers the cylinder latch into the frame.
2. Press base pin latch (on left side) and withdraw base pin.
3. Remove cylinder from loading gate side of frame.

To replace cylinder, simply reverse the above procedure. Holding the gun with the barrel pointed away from you and in a safe direction, rotate the cylinder 1/4 turns in a clockwise direction to ensure that pawl is correctly positioned on cylinder ratchet, before replacing base pin. Finally, close the gate.

CORRECT UNLOADING SEQUENCE

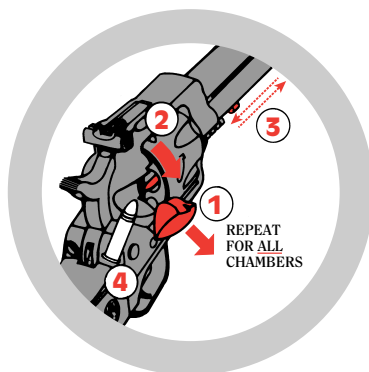

Do not eject unfired cartridges onto any surface where the cartridge rim might strike a solid object and discharge the cartridge.



WARNING – DISASSEMBLY

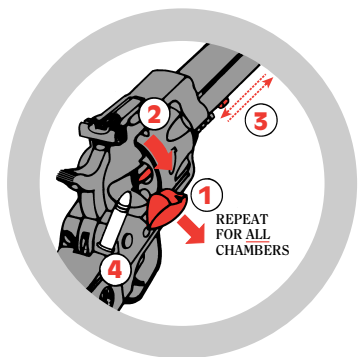

Never clean, lubricate, disassemble or work on a revolver while it is loaded. Never install or remove a loaded cylinder. A loaded cylinder can discharge if dropped or struck. Read instructions before disassembling gun.

UNLOAD BEFORE CLEANING

The user of a **RUGER® NEW MODEL SINGLE ACTION** revolver should carefully read all disassembly directions and study all the illustrations and the Parts List in this manual before attempting to take the gun apart. Know the names and location of the parts before removing any of them. Although the **NEW MODEL** revolver mechanism is composed of only a few parts, it is essential that the disassembly and reassembly operations be carried out with knowledge and care.

Only a few tools are required: A screwdriver or two to remove the grip panel and grip frame screws, and a drift punch to remove the hammer and trigger pivots (pins). A small plastic-faced hammer can be useful in drifting the trigger pivot out and in.

The tip of the screwdriver blade should perfectly fit the grip frame screw slots. A tip too large will scrape away metal, while too small a tip will damage the screw slots.

Before taking the gun apart, set up to do it properly. Cover the work surface with a soft cloth so that the gun finish (and sights) will not be damaged, and provide a tray into which the parts can be put as they are removed from the gun.

DISASSEMBLY

(Make Sure Revolver is Unloaded!)

1. Open the gate and rotate the cylinder a few times to be certain the revolver is unloaded. Leave the gate open.
2. Press in fully on the left side of the base pin latch, and while holding it in that position, withdraw the base pin. Remove the cylinder and close the gate. This is as far as you need to go for routine cleaning.

DETAILED DISASSEMBLY:

1. Remove grip panel screw and remove grip panels.
2. Draw hammer rearward to full cock position. Insert a short length (about 1") of nail or pin into the small hole at the lower end of the hammer strut. (The purpose of the pin is to confine the mainspring when the hammer is released.)
3. While maintaining thumb pressure on the hammer spur, squeeze the trigger and ease hammer down to full forward position.
4. Remove the five screws which fasten the grip frame to the cylinder frame.
5. Pull the grip frame rearward and downward to separate it from the cylinder frame. (If the grip frame does not readily separate from the cylinder frame, draw the hammer rearward a short distance.) Remove the mainspring assembly from the grip frame, but do not remove the small pin that is confining the mainspring. The mainspring assembly will later be reassembled into the frame as it is.

Do not 'lose' the pawl spring and plunger (located in a hole in the rear of the left side of the cylinder frame, just above the grip frame screw hole) or the cylinder latch spring and plunger (located in the hole above front of the trigger guard bow in the grip frame).

6. Remove the trigger pivot (pin) as follows: using a screwdriver as shown in Figure 1, p. 19, depress the gate detent spring so that the end of the spring which rests in one groove of the trigger pivot is free of the groove. Then, use a drift and hammer to push the pivot completely out of the frame.



CAUTION: Press the screwdriver blade tip against the spring carefully and be certain the blade does not slip off the spring and damage the frame or injure the person holding the gun.

- Remove cylinder latch, gate detent spring, and gate.
- Remove hammer pivot. Then remove the hammer/pawl assembly and the trigger/transfer bar assembly. (Note that the hammer is attached to the pawl and the transfer bar is attached to the trigger. See Figure 2).

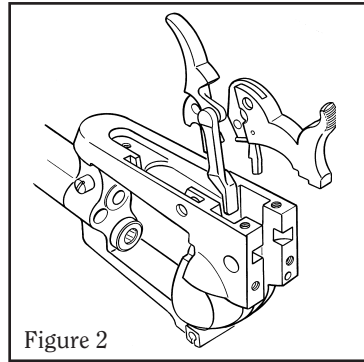
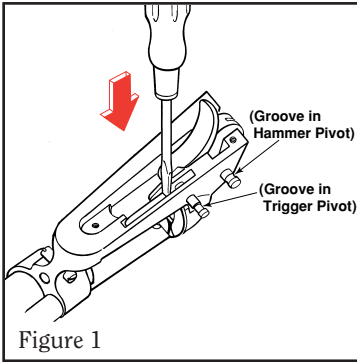

ALTHOUGH THE FOREGOING OUTLINES THE CORRECT
PROCEDURE, WE WISH TO EMPHASIZE THAT SUCH DETAILED
DISMANTLING IS SELDOM IF EVER NECESSARY.

The revolver is, at this stage, disassembled as far as it needs to be for major cleaning and maintenance. However, if it is necessary to go beyond the above steps, the following cautions and suggestions should be useful:

Ejector/Ejector Housing: Wrap one hand firmly around barrel and housing when loosening the screw. Remove screw, then carefully lift housing (which contains compressed spring and ejector rod) away from the barrel.

Base Pin Latch/Nut and Spring: The nut must be held firmly (with jaw-protected pliers) while the latch is being unscrewed. Don't lose the spring. When reassembling, be certain the nut and spring are on the left side of the frame. (See Parts Drawing).

Rear Sight: The rear sight can be removed from the frame by drifting out the pivot pin (MR05600) and removing the elevation screw (MR05902). Unless it is essential, the rear sight should not be removed because there is the risk of losing the very small elevation springs. If the sight is removed, when reassembling it is helpful to put a very tiny dab of lubricating gun grease in the recesses of the sight base. The grease will 'hold' the springs upright when the sight is positioned on the frame as the rear sight pivot pin is being reinstalled.

REASSEMBLY

(Make Sure Revolver is Unloaded!)

- Assemble pawl to hammer and transfer bar to trigger as shown in Figure 2. Partially insert hammer/pawl assembly in its recess in the frame. Insert trigger/transfer bar assembly in its slot in the frame. Then simultaneously complete insertion of the two assemblies into the frame.

2. (Refer to Figure 1). Align hammer in frame and insert hammer pivot with the grooved end of the pivot on the gate side of the frame. (The long screw, XR01901, when also inserted on the gate side, will intersect the groove and lock the pivot in place. See step number 11, p. 21).

3. Replace cylinder latch and gate detent spring as shown in Figure 3. Note that the lug on the cylinder latch fits between the arms of the gate detent spring and that the end of one of the arms of the spring is formed at a 90 degree angle. The projection thus formed, is designed to fit through the square hole in the bottom of the frame and to ride on the cam surface of the gate pivot. Note also that this projection holds the loading gate back and in place.

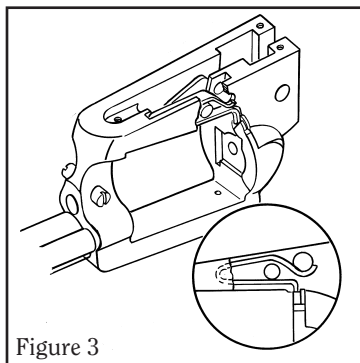
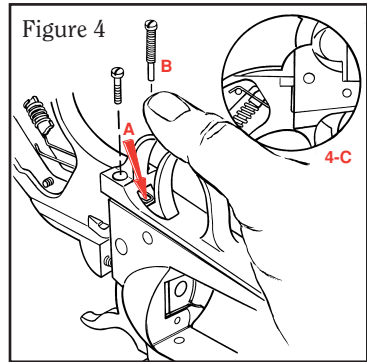

Figure 3

4. (Refer to Figure 1, p. 19). Depress the upper arm of the gate detent spring with tip of screwdriver blade and install trigger pivot. Pivot should be inserted from the gate side of the frame. The non-grooved end of the pivot should be inserted first. (It may be necessary to manipulate the trigger, the gate detent spring, and the cylinder latch to align them to receive the trigger pivot).
5. Insert the base pin, taking care to be certain the 'dished out' section of the base pin collar is adjacent to the bottom of the barrel. *The base pin must be fully inserted and locked in position by the base pin latch. If the base pin is not fully inserted and locked, the transfer bar may catch under the firing pin when the hammer is being cocked.*
6. (Refer to Figure 4, p. 21). Unhook the ends of the trigger spring (XR03700) from the grooved retaining pin on both sides of the grip frame.
7. Insert cylinder latch spring and plunger in hole in grip frame. (The spring goes in first so that the plunger is on top).
8. Insert pawl spring and plunger (plunger goes in the hole first) in the hole in the left side of the cylinder frame just above the left rear grip screw hole.
9. Install mainspring assembly in the grip frame. Be certain the strut is positioned properly. See the Parts Drawing for correct strut positioning.
10. (Refer to Figure 4, p. 21). Draw hammer to the rear slightly and place the grip frame loosely on the cylinder frame. Before pushing the grip frame forward to mate with the cylinder frame, be certain that:
 - (a) the cylinder latch plunger (XR07700) is positioned so that it will contact the bottom of the cylinder latch (rather than either side of the latch),
 - (b) the pawl spring is aligned to contact the left 'ear' of the grip frame (and not be bent as the ear contacts it).

11. See Figure 4, and note the end of the trigger spring (the arrow marked "A"). This end of the spring must be depressed so that it slides under the rear portion of the trigger when the grip frame is forward. With all the above springs and plungers aligned, fully mate the grip frame and cylinder frame and install the five grip frame screws. Note that the long screw (XR01901) should go in the grip frame hole on the gate side (Figure 4-B) of the revolver.
12. Hook the two ends of the trigger spring over the pin (KXR06300) as shown in Figure 4-C.
13. Be certain the mainspring strut seat is correctly positioned on its step in the grip frame. Then, draw the hammer back to the full cock position and remove the small pin from the mainspring strut. Pull trigger and allow hammer to fall.
14. Open the gate, withdraw base pin and install the cylinder. Reinsert the base pin and be certain it is fully seated and locked in position.
15. Before loading cartridges into the chamber, cycle the revolver several times. Check to be sure that cylinder rotates and locks correctly, that trigger returns in a positive manner when released, and that loading gate opens and closes normally.



CARE AND CLEANING

MAKE SURE GUN IS UNLOADED!



Always be certain the revolver is completely unloaded before cleaning. (See "To Unload or Eject Cartridge Cases", p. 16) At regular intervals or when the revolver has been exposed to sand, water or other adverse conditions, disassemble, clean and oil it.

To clean the revolver after firing:

1. Remove the cylinder as described on p. 16.
2. Clean the barrel from the muzzle by running a cleaning rod with a solvent coated patch through the bore several times. A bronze wire brush, of a size appropriate to the bore size, attached to the cleaning rod should then be pushed the full length of the bore several times.
3. Again swab the bore with a solvent coated patch. Then wipe the rod clean and, using a dry patch, swab the bore until it is clean.
4. Repeat the above procedure for each of the six chambers.
5. Run a lightly oiled patch through the bore and each chamber.

Some cartridges with lead bullets deposit metal fouling in the chamber throats, in the forcing cone of the barrel, and in the bore. If 'leading' is noted in your revolver, clean it out before it builds up and interferes with reliable functioning and accuracy. A special 'lead removing' cleaning tool (for bore and chambers) is available from gun stores.

The revolver's internal mechanism can be lubricated without disassembly. A few drops of light oil recommended as suitable for firearms, applied periodically about the various frame openings, will work its way into the mechanism parts. The exterior of the revolver should be cleaned with a solvent and then wiped with an oily cloth.

 WARNING – LUBRICATION	
	<p>Firing a revolver with oil, grease, or any other material even partially obstructing the bore may result in damage to the revolver and serious injury to the shooter and those nearby.</p> <p>Do not spray or apply lubricants directly on ammunition. If the powder charge of a cartridge is affected by the lubricant, it may not be ignited, but the energy from the primer may be sufficient to push the bullet into the bore where it may become lodged. Firing a subsequent bullet onto the obstructed bore may damage the revolver and cause serious injury or death to the shooter and those nearby. Use lubricants properly. You are responsible for the proper care and maintenance of your firearms.</p>
	IMPROPER LUBRICATION DESTROYS GUNS

STORAGE

GUNS SHOULD NOT BE STORED LOADED!

**USE THE LOCKING DEVICE SUPPLIED WITH THE REVOLVER FOR STORAGE.
(SEE PAGE 5)**

Do not keep the revolver in a leather, fabric or canvas holster when it is stored. These materials attract moisture, even though the holster may appear to be perfectly dry.



TO RENDER THE REVOLVER INOPERATIVE FOR SAFE STORAGE

With the muzzle pointed in a safe direction, open the loading gate and check each chamber to be sure the revolver is completely unloaded! Depress the basepin latch on the side of the frame and remove the basepin by pulling it toward the muzzle and out of the frame. Next, remove the cylinder from the frame.

Store the revolver and frame in different locations. When disassembled in this manner, this revolver is inoperable. It is impossible to fire the revolver until the cylinder and basepin have been correctly replaced.

To reassemble the revolver for firing, open the loading gate and reinsert the cylinder. Next, press the basepin latch on the frame and fully reinsert the basepin. Check to be sure the cylinder rotates freely in a clockwise direction. With the muzzle pointed in a safe direction, close the loading gate. The revolver is now reassembled and can be loaded and fired.

While the revolver is less likely to be used by unauthorized persons when disassembled in the above manner, it is always safest to store any firearm with the supplied locking device correctly installed, or to store the firearm in a gun safe or other secure location away from children and unauthorized adults. Guns should always be stored securely, unloaded and separate from their ammunition.

	
WARNING – STORAGE	
	<p>Never place or store any firearm in such a manner that it may be dislodged. Firearms should always be stored securely and unloaded, away from children and careless adults. Use the locking device originally supplied with this firearm for storage.</p> <p>The use of a locking device or safety lock is only one aspect of responsible firearms storage. For increased safety, firearms should be stored unloaded and locked in a location that is both separate from their ammunition and inaccessible to children and any other unauthorized person.</p>
STORE SECURELY & UNLOADED	

CARE OF STAINLESS STEEL REVOLVERS

Firearms made of stainless steel are relatively more resistant to corrosion than blued steel firearms. However, you should still inspect it frequently and clean, lubricate and apply an appropriate rust preventative as required.

Sometimes surface discoloration may be noted, particularly in the grip area of stainless steel handguns, resulting from perspiration. Contact with some types of holsters can also cause stains or rusting. Rusting may also occur as a result of the handgun being exposed to moisture, humidity, salt air or chemicals.

Minor discoloration can usually be removed by rubbing the stained area with an abrasive ink eraser, crocus cloth, or a “metal polishing” compound. When using any of these abrasives, proceed with care and use light pressure to achieve a blending of ‘color’ with those areas that are not discolored

Exposed surfaces on the firearm should be cleaned and wiped dry after use or after exposure to adverse conditions. If the firearm is to be stored, coat it with a light film of oil or preservative. Where the firearm is in continuing use, and the presence of oil or grease would be objectionable, then the external surfaces can be coated (after cleaning and drying) with a paste wax formulated for use on metals. Apply the wax sparingly, allow time for it to dry hard, then buff lightly with a soft cloth. When applying the wax take care that it does not get into the mechanism or on the functioning parts such as the cylinder latch, trigger or cylinder locking notches. A properly applied hard wax coating will not interfere with comfortable gun handling and it will provide a measure of protection against the formation of rust.

SIGHTS

(ON REVOLVERS SO EQUIPPED)

ADJUSTMENT – Each click of the sight adjustment screw (either windage or elevation) will move the point of impact of the bullet approximately 3/4" at a range of 25 yards. The height of the front sight has been set to take advantage of the elevation adjustment in the rear sight, considering the various ranges at which the gun is most likely to be used. Barrel length and load used affects trajectory. Therefore the shooter should determine sight settings by firing trials.

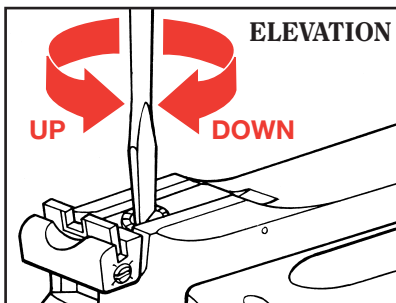

To raise point of impact: turn screw counterclockwise.

To lower point of impact: turn screw clockwise.

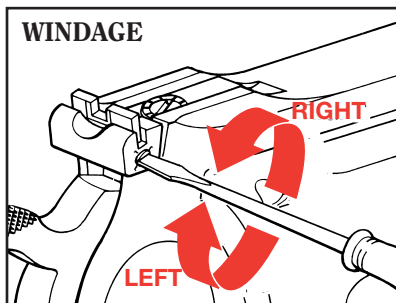

To move the point of impact to the right: turn screw counterclockwise.

To move the point of impact to the left: turn screw clockwise.

SUGGESTED SIGHT PICTURE

Top of front sight even with top of rear sight blade.
Front sight centered in notch of rear sight blade. Target bullseye centered on top of front sight.

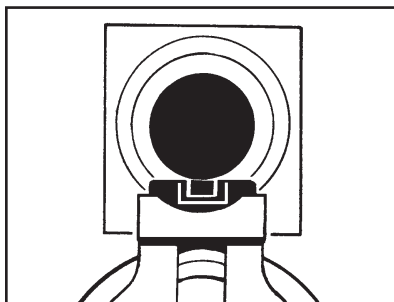

FIXED SIGHTS

Ruger® Revolvers feature a blade front sight and a fixed rear sight. They are factory set to be on target at 25 yards and cannot be further adjusted.

SERVICE AND PARTS POLICY

If you have any questions with regard to the performance of your **RUGER® NEW MODEL SINGLE SIX® or BISLEY** revolvers please write or call (603-865-2442) our Product Service Department in Newport, New Hampshire 03773, fully describing all circumstances and conditions involved. If you should return your revolver to the factory for repair, or order parts for it, please comply with the following suggestions for prompt service:



WARNING: BEFORE SHIPPING ANY FIREARM, BE ABSOLUTELY CERTAIN THAT IT AND ITS CYLINDER ARE UNLOADED. DO NOT SHIP CARTRIDGES WITH A FIREARM.

SHIPPING FIREARMS FOR REPAIR

RUGER® NEW MODEL SINGLE SIX® & BISLEY revolvers returned to the factory for repair should be sent to: Sturm, Ruger & Company, Inc., Product Service Department, 411 Sunapee St., Newport, New Hampshire 03773. Telephone (603) 865-2442.

Guns should be sent prepaid. We will not accept collect shipments.

The Federal Gun Control Act, as well as the laws of most States and localities, do not prohibit an individual (who is not otherwise barred from purchasing or possessing a firearm) from shipping a firearm directly to the manufacturer for repair. However, before you ship your rifle to us, be certain that your State or locality does not have a law or regulation which will prohibit you from receiving the rifle from us after it has been repaired. If such receiving is prohibited, then please have a Federally Licensed firearms dealer ship the gun to us. If your rifle is sent to us by a dealer, it will be returned to him after being repaired. If a handgun (pistol or revolver) is shipped by an individual who does not hold a Federal Firearms License, it must be shipped via U.P.S. (Next Day Air) Persons who do not hold a Federal Firearms License are prohibited by Federal law from shipping a handgun by Mail. Handguns mailed in violation of the law are impounded by the Post Office.

Please do not include revolver case, sling, telescopic sights or custom accessories with a firearm being shipped to the factory for service. **DO NOT SEND GUN BOXES OR LITERATURE THAT YOU CONSIDER TO BE COLLECTOR'S ITEMS – THESE ARE INVARIABLY DAMAGED OR DESTROYED IN SHIPMENT.** Always insure your shipment.

Enclose a letter which includes your name, address, telephone number, serial number and model of the firearm. Describe in detail the trouble you have experienced with your firearm, or the work you wish to have done. Merely stating that the firearm "needs repair" is inadequate information.

Work performed will bear a net minimum labor charge of \$20.00 plus a \$20.00 shipping and handling charge. The charge for rebluing the **RUGER® NEW MODEL SINGLE SIX®** or **BISLEY** revolver is \$50.00 plus a \$20.00 shipping and handling charge. Custom gunsmithing service or nonstandard alterations are NOT AVAILABLE from Ruger Product Service Departments.

 WARNING – PARTS PURCHASERS	
	<p>It is the purchaser's responsibility to be absolutely certain that any parts ordered from the factory are correctly fitted and installed. Firearms are complicated mechanisms and IMPROPER FITTING OF PARTS MAY RESULT IN A DANGEROUS MALFUNCTION, DAMAGE TO THE FIREARM, AND INJURY TO THE SHOOTER AND OTHER PERSONS. The purchaser and installer of parts must accept full responsibility for the correct adjustment and functioning of the revolver after such installation.</p>
	PARTS MUST FIT CORRECTLY

ORDERING PARTS

Please contact the New Hampshire Product Service Department for parts availability and current prices. All parts orders for the **RUGER® NEW MODEL SINGLE ACTION** revolvers should be sent to : Sturm, Ruger & Co., Inc., Product Service Department, 411 Sunapee Street, Newport, New Hampshire, 03773, 603-865-2442. We cannot comply with open account or C.O.D. orders. Payment in the form of a check, money order, Visa or Mastercard must accompany your order. Credit Card orders must include the account number, expiration date and whether it is a Visa or Mastercard account. Minimum parts order is \$1.00 plus \$3.50 shipping and handling charge. Order parts by Part Name and Part Number and include the entire serial number of the firearm for which the parts are being ordered. There is a minimum net labor charge of \$20.00 plus \$20.00 shipping and handling charge if the parts are factory fitted. All factory fitted parts are fit on an exchange basis only. We will not return the replaced parts.

Barrels, cylinders and a number of other component parts must be fitted at the factory. Company policy is to proof-test and/or function fire all barrels after fitting to the receivers in which they are to be used. This procedure ensures maximum protection to our customers. The special proof-test ammunition used in this testing is sold only to bonafide firearms manufacturers and is not available to gun shops, gunsmiths, or individuals.

Because it is a serial numbered part, the cylinder frame of the **RUGER® NEW MODEL SINGLE ACTION** revolvers is defined as a 'firearm' by Federal Law and is not offered for sale as a component part.

Parts designated by an (*) must be factory fitted. These parts are fitted on an exchange basis only. We will not return the replaced parts. We will not return any part that is broken, malfunctioning, badly worn or has been modified. See "Warning – Parts Purchasers", p. 26.

IMPORTANT – REGARDING PARTS ORDERING. Ruger New Model Single Action revolvers are manufactured in Blued steel and Stainless steel versions. **WHEN ORDERING PARTS BE SURE TO STATE WHETHER YOUR REVOLVER IS BLUED OR STAINLESS. ALSO, INCLUDE THE COMPLETE SERIAL NUMBER AND SPECIFY THE CALIBER AND BARREL LENGTH.**

NOTE: A few components, as example sight blades and grip panels, are the same for blued and stainless models.

GRIP FRAME NOTE: The New Model Super Blackhawk steel Grip Frame (Stainless steel or blued) will fit any New Model Single-Six or New Model Blackhawk revolver. However, because the Grip Frame must be 'match-polished' to fit each cylinder frame, it is furnished (as a component part) only 'in the white,' that is, not polished or blued. The Grip Frame can be factory fitted with the charges computed as follows: Price of appropriate Grip Frame, plus fitting charge of \$20.00, plus refinishing charge of \$50.00 plus a \$20.00 shipping and handling charge. If the revolver to which the Grip Frame is being fitted is a Super Blackhawk, then there is an additional charge for a pair of Blackhawk Grip Panels. Return shipping charges (UPS/AOD) are about \$20.00 per handgun.

BARREL NOTE: All barrels are marked with a safety message, ("Before using gun, read warnings in Instruction Manual available free from Sturm, Ruger & Co. Inc., Southport, CT, USA").



CAUTION: Firearm users are cautioned that a gun containing modified, broken, malfunctioning, or badly worn parts should not be fired.

SHIPPING REVOLVERS FOR INSTALLATION OF A SAFETY CONVERSION KIT:

If you would like to have any "old model" (pre-1973) Bearcat, Single-Six, Blackhawk, or Super Blackhawk revolver factory fitted with a free Conversion Kit (to help prevent accidents caused by a blow to the hammer if the user has failed to keep an empty chamber under the hammer) please write to Sturm, Ruger & Co., Dept. KC, 1 Lacey Place, Southport, CT 06490 for a box and shipping instructions. Be sure to include information as to model, caliber, and serial number. Please do not send your old model single action revolver until you receive shipping instructions and a box from us. Please note that the Kit will be fitted at our Newport, New Hampshire facility. All other servicing of "old model" single actions will also be performed at our Newport facility, but only after a Conversion Kit is first installed.

RUGER® NEW MODEL SINGLE SIX® & BISLEY

PARTS LIST

Design, prices and specifications subject to change without notice.

SPECIFY MODEL AND CALIBER WHEN ORDERING

(See Exploded Views on Pages 33 & 34.)

Part Name	Part No.	Model
* Barrel, 4 5/8" - .22 cal.	XR10601	Single-Six - Blued Models
* Barrel, 5 1/2" - .22 cal.	XR10602	Single-Six - Blued Models
* Barrel, 5 1/2" - .22 cal.	KXR10602	Single-Six - Stainless Models
* Barrel, 6 1/2" - .22 cal.	XR10603	Single-Six & Bisley - Blued Models
* Barrel, 6 1/2" - .22 cal.	KXR10603	Single-Six - Stainless Models
* Barrel, 9 1/2" - .22 cal.	XR10604	Single-Six - Blued Models
* Barrel, 4 5/8" - .32 H&R	SM10601	Single-Six - Blued Models
* Barrel, 4 5/8" - .32 H&R	KSM10601	Single-Six - Stainless Models
* Barrel, 5 1/2" - .32 H&R	SM10602	Single-Six - Blued Models
* Barrel, 6 1/2" - .32 H&R	SM10603	Single-Six & Bisley - Blued Models
* Barrel, 9 1/2" - .32 H&R	SM10604	Single-Six Model
Base Pin Assembly	XR02900A	Single-Six & Bisley - Blued Models
Base Pin Assembly	KXR02900A	Single-Six - Stainless Models
Base Pin Latch Body	XR02700	Single-Six & Bisley - Blued Models
Base Pin Latch Body	KXR02701	Single-Six - Stainless Models
Base Pin Latch Nut	XR02800	Single-Six & Bisley - Blued Models
Base Pin Latch Nut	KXR02801	Single-Six - Stainless Models
Base Pin Latch Spring	XR04700	Single-Six & Bisley - Blued Models
Base Pin Latch Spring	KXR04700	Single-Six - Stainless Models
Case Only - 4 5/8" & 5 1/2" bbls.	MPF00020-ACC	Single-Six Models
Case Only - 6 1/2" bbls.	MPF00021-ACC	Single Six & Bisley Models
Case Only - 9 1/2" bbls.	MPF00022-ACC	Single Six Models
* Cylinder - .22 L.R.	XR-1-22	Single-Six - Blued Models
* Cylinder - .22 L.R.	KXR-1-22	Single-Six - Stainless Models

Part Name	Part No.	Model
* Cylinder - .22 Mag.	XR-1-22M1	Single-Six - Blued Models
* Cylinder - .22 Mag.	KXR-1-22M1	Single-Six - Stainless Models
* Cylinder - .22 L.R.	BR-1-22W1	Bisley Model
* Cylinder - .32 H&R	SM-1-32	Single-Six - Blued Models
* Cylinder - .32 H&R	GKSM-1-32	Single-Six - Stainless Models
* Cylinder - .32 H&R	BR-1-32W1	Bisley Model
Cylinder Frame	XR00210	Single-Six - Blued, Fixed Sight Models
Cylinder Frame	XR00200A	Single-Six - Blued Models
Cylinder Frame	KXR00200A	Single-Six - Stainless Models
Cylinder Frame	BR00200	All Bisley Models
Cylinder Frame	SM00210B	Single Six - .32 H&R - Blued Models
Cylinder Frame	KSM00210A	Single Six - .32 H&R - Stainless Models
Cylinder Latch	KXR04500	All Single-Six & Bisley Models
* Cylinder Latch Spring	XR04600	Single-Six & Bisley - Blued Models
* Cylinder Latch Spring	KXR04600	Single-Six - Stainless Models
Cylinder Latch Spring Plunger	XR07700	Single-Six & Bisley - Blued Models
Cylinder Latch Spring Plunger	KXR07700	Single-Six - Stainless Models
Ejector Housing	XR12200	Single-Six & Bisley - Blued Models
Ejector Housing - Satin Finish	KXR12200	Single-Six - Stainless Models
Ejector Housing (for Short Grip Frame)	MR02208	Single-Six - Blued Models
Ejector Housing (for Short Grip Frame)	KXR12202	Single-Six - Stainless Models
Ejector Housing Screw	XR03300	Single-Six & Bisley - Blued Models
Ejector Housing Screw	KXR03301	Single-Six - Stainless Models
Ejector Rod Assembly	XR-55	Single-Six & Bisley - Blued Models
Ejector Rod Assembly	KXR-55	Single-Six - Stainless Models
Ejector Rod Spring	XR04400	Single-Six & Bisley - Blued Models
Ejector Rod Spring	KXR04400	Single-Six - Stainless Models
Firing Pin	XR02100	Single-Six & Bisley - Blued Models
Firing Pin	KXR02100	Single-Six - Stainless Models
Firing Pin - .32 H&R	MR02100	Single Six & Bisley - Blued Models

Part Name	Part No.	Model
Firing Pin - .32 H&R	KMR02100	Single Six - Stainless Models
Firing Pin Rebound Spring	KE-48	All Single-Six & Bisley Models
Front Sight, Adjustable	XR13600	Single-Six - Adjustable Sights Models
Front Sight, Adjustable - .22 cal.	BRN-36-22	Bisley Model
Front Sight, Adjustable - .32 cal.	BRN-36-32	Bisley Model
Front Sight, Fixed - .32 cal.	XR03612	Single Six - Blued Models
Front Sight, Fixed - .32 cal.	KXR03612	Single Six - Stainless Models
Front Sight Blade	XR03611	Single-Six - Blued, Fixed Sight Models
Front Sight Blade	KXR03611	Single-Six - Stainless, Fixed Sight Models
Front Sight Screw	XR07600	All Single-Six & Bisley Models
Gate	XR02400	Single-Six & Bisley - Blued Models
Gate	KXR02400	Single-Six - Stainless Models
Gate Detent Spring	XR07300	Single-Six & Bisley - Blued Models
Gate Detent Spring	KXR07300	Single-Six - Stainless Models
Grip Frame	XR00300	Single-Six - Blued Models
Grip Frame	KXR00300	Single-Six - Stainless Models
Grip Frame, Bird's Head	MR00308	Single-Six - Blued Model
Grip Frame, Bird's Head	KMR00308	Single-Six - Stainless Model
Grip Frame, Short	XR00303	Single-Six - Blued Model
Grip Frame, Short	KXR00303	Single-Six - Stainless Model
Grip Frame	BR00300	All Bisley Models
Grip Frame Screw-A-Front	XR01700	Single-Six & Bisley - Blued Models
Grip Frame Screw-A-Front	KXR01700	Single-Six - Stainless Models
Grip Frame Screw-B-Back (2 Req'd.)	XR01800	Single-Six - Blued Models
Grip Frame Screw-B-Back (2 Req'd.)	KXR01800	Single-Six - Stainless Models
Grip Frame Screw-B-Back (2 Req'd.)	BR01801	All Bisley Models
Grip Frame Screw-C-Bottom	XR01900	Single-Six & Bisley - Blued Models
Grip Frame Screw-C-Bottom	KXR01900	Single-Six - Stainless Models
Grip Frame Screw & Pivot Lock	XR01901	Single-Six & Bisley - Blued Models
Grip Frame Screw & Pivot Lock	KXR01901	Single-Six - Stainless Models

Part Name	Part No.	Model
Grip Panels, Complete (Sold in pairs only)	XR01000	Single-Six Models
Grip Panels, Complete, Simulated Ivory (Sold in pairs only)	XR01001SI	Single-Six Short Frame Models
Grip Panels, Complete, Black Micarta (Sold in pairs only)	MR01006	Single-Six Bird's Head Grip Frame Models
Grip Panels, Complete (Sold in pairs only)	BR01000	All Bisley Models
Grip Panel Dowel	KXR01400	All Single-Six & Bisley Models
Grip Panel Ferrule, Left	XR01200	All Single-Six & Bisley Models
Grip Panel Ferrule, Right, Not Illustrated	XR01100	All Single-Six & Bisley Models
Grip Panel Screw	KXR01300	All Single-Six & Bisley Models
Hammer Assembly	XR04000B	Single-Six - Blued Models
Hammer Assembly	KXR04000B	Single-Six - Stainless Models
Hammer Assembly	KXR04001B	Single-Six - .32 H&R - Stainless Models
Hammer Assembly	BR04000B	All Bisley Models
Hammer Pivot Pin	XR01601S	Single-Six & Bisley - Blued Models
Hammer Pivot Pin	KXR01601S	Single-Six - Stainless Models
Hammer Plunger	KXR04100	All Single-Six & Bisley Models
Hammer Plunger Pin	KXR04200	All Single-Six & Bisley Models
Hammer Plunger Spring	KPR04300	All Single-Six & Bisley Models
Hammer Strut	XR01500	Single-Six & Bisley - Blued Models
Hammer Strut	KXR01500	Single-Six - Stainless Models
Mainspring	XR00400	Single-Six & Bisley - Blued Models
Mainspring	KXR00400	Single-Six - Stainless Models
Mainspring Seat	XR00500	Single-Six & Bisley - Blued Models
Mainspring Seat	KXR00500	Single-Six - Stainless Models
Medallion (2 Req'd.)	XR05200	All Single-Six & Bisley Models
Pawl	KXR00702	Single-Six & Bisley - .22 cal. Models
Pawl	KSM00700	Single Six & Bisley - .32 cal. Models
Pawl Plunger	XR05100	Single-Six & Bisley - Blued Models
Pawl Plunger	KXR05100	Single-Six - Stainless Models

Part Name	Part No.	Model
Pawl Plunger Spring	XR05000	Single-Six & Bisley - Blued Models
Pawl Plunger Spring	KXR05000	Single-Six - Stainless Models
Rear Sight Base Assembly Complete (Specify whether sight has "bump" on underside)	MR15900	Single-Six & Bisley - Adjustable Sights Models
Rear Sight Detent Ball, Not Illustrated	MR05908	Single-Six & Bisley - Adjustable Sights Models
Rear Sight Blade	MR05901	Single-Six & Bisley - Adjustable Sights Models
Rear Sight Elevation Screw	MR05902	Single-Six & Bisley - Adjustable Sights Models
Rear Sight Elevation Spring (2 Req'd.)	MR05906	Single-Six & Bisley - Adjustable Sights Models
Rear Sight Pivot Pin	MR05600	Single-Six & Bisley - Blued, Adjustable Sights Models
Rear Sight Pivot Pin	KMR05600	Single-Six - Stainless, Adjustable Sights Models
Rear Sight Windage Adjusting Screw	E05903	Single-Six & Bisley - Adjustable Sights Models
Rear Sight Windage Spring	MR05907	Single-Six & Bisley - Adjustable Sights Models
Rear Sight, Fixed Sight Model	XR03500	Bisley Models
Recoil Plate	XR02000	Single-Six & Bisley - Blued Models
Recoil Plate	KXR02000	Single-Six - Stainless Models
Recoil Plate - .32 H&R	MR02000	Single Six & Bisley - Blued Models
Recoil Plate - .32 H&R	KMR02000	Single Six - Stainless Models
Recoil Plate Cross Pin	XR04900	Single-Six & Bisley - Blued Models
Recoil Plate Cross Pin	KXR04900	Single-Six - Stainless Models
Transfer Bar	KXR07200	Single-Six & Bisley Models (except .32 H&R Single Six)
Transfer Bar	KSM07201	Single-Six - .32 H&R Models
Trigger	XR03901	Single-Six - Blued Models
Trigger	KXR03901	Single-Six - Stainless Models
Trigger	BR03901	All Bisley Models
Trigger Pivot	XR03400	Single-Six & Bisley - Blued Models
Trigger Pivot	KXR03401	Single-Six - Stainless Models
Trigger Spring	XR03700	Single-Six & Bisley - Blued Models
Trigger Spring	KXR03700	Single-Six - Stainless Models
Trigger Pivot Pin	KE02800	All Single-Six & Bisley Models
Trigger Spring Retaining Pin	KXR06300	All Single-Six & Bisley Models

* PARTS SO MARKED MUST BE FACTORY FITTED

NEW MODEL SINGLE SIX®

EXPLODED VIEW

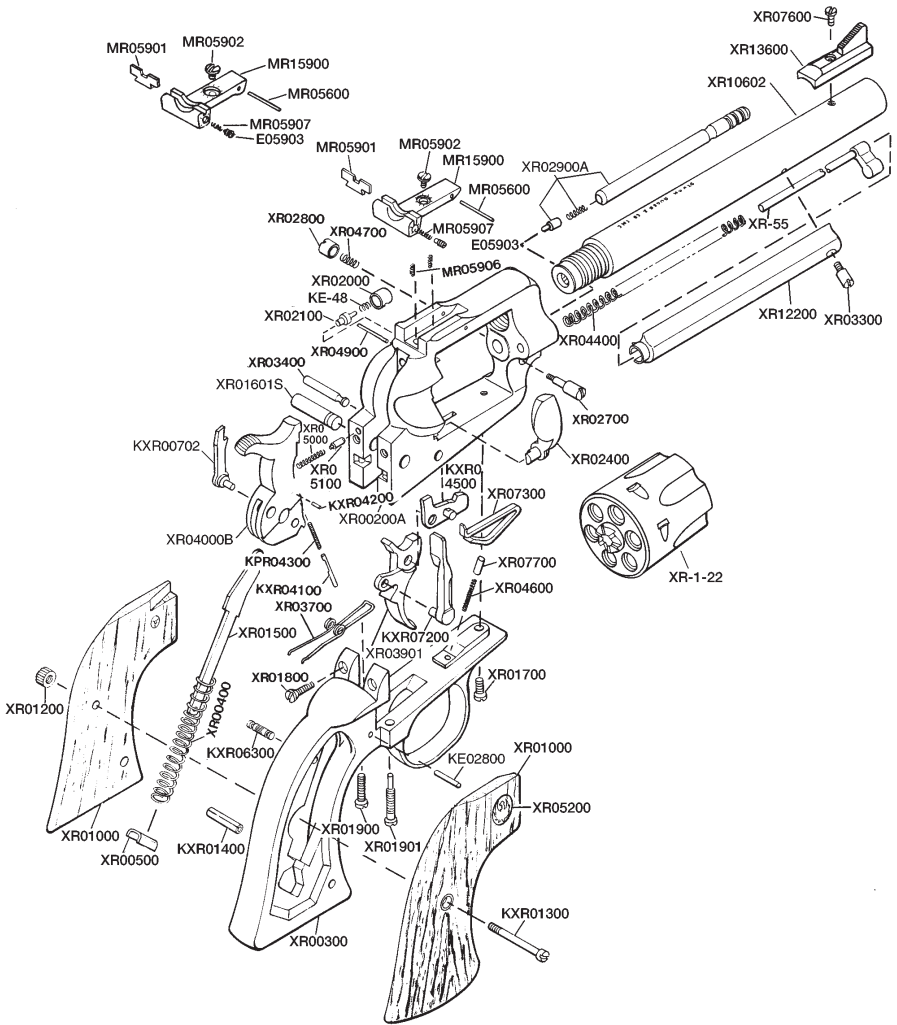

RUGER® BISLEY

EXPLODED VIEW

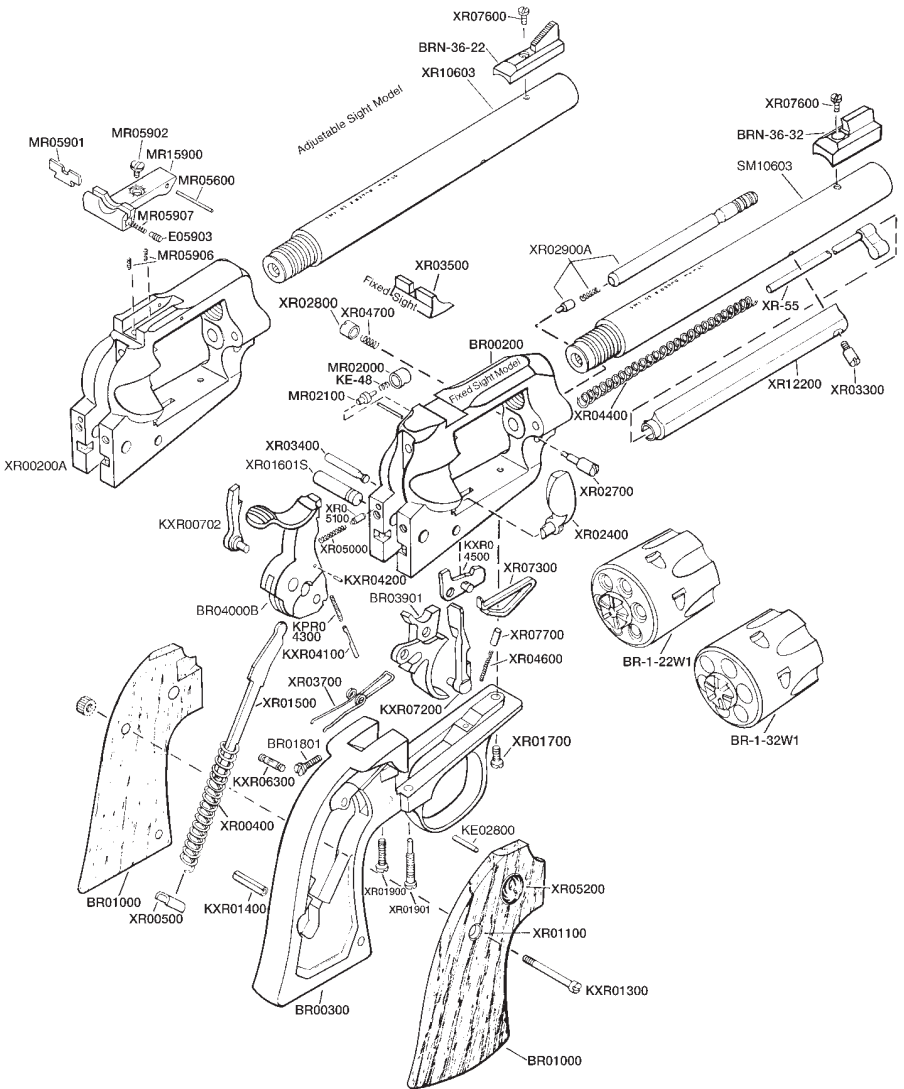

THE BASIC RULES OF SAFE FIREARMS HANDLING

We believe that Americans have a right to purchase and use firearms for lawful purposes. The private ownership of firearms in America is traditional, but that ownership imposes the responsibility on the gun owner to use his firearms in a way which will ensure his own safety and that of others. When firearms are used in a safe and responsible manner, they are a great source of pleasure and satisfaction, and represent a fundamental part of our personal liberty.

Firearms do not cause accidents! Firearms accidents are almost always found to have been the result of carelessness, or ignorance on the part of the shooter of the basic rules of safe gun handling.

The following rules must be observed by gun users at all times. Safe gun handling is not just desirable, it is absolutely essential to your safety, the safety of others, and the continuation of gun ownership and sport shooting as we know it today.

1. LEARN THE MECHANICAL AND HANDLING CHARACTERISTICS OF THE FIREARM YOU ARE USING.



Not all firearms are the same. The method of carrying and handling firearms varies in accordance with the mechanical provisions for avoiding accidental discharge and the various proper procedures for loading and unloading. No person should handle any firearm without first having thoroughly familiarized himself with the particular type of firearm he is using, and with safe gun handling in general.

2. ALWAYS KEEP THE MUZZLE POINTED IN A SAFE DIRECTION.



Be sure of the bullet stop behind your target, even when dry-firing. Never let the muzzle of a firearm point at any part of your body or at another person. This is particularly important when loading or unloading a firearm. In the event of an accidental discharge, no injury can occur as long as the muzzle is pointing in a safe direction. A safe direction means a direction which will not permit a

discharged bullet to strike a person, or to strike an object from which the bullet may ricochet.

A safe direction must take into account the fact that a bullet may penetrate a wall, ceiling, floor, window, etc., and strike a person or damage property. Make it a habit to know exactly where the muzzle of your gun is pointing whenever you handle it, and be sure that you are always in control of the direction in which the muzzle is pointing, even if you fall or stumble. Keep your finger off the trigger until you are ready to shoot.

3. FIREARMS SHOULD BE UNLOADED WHEN NOT IN USE.

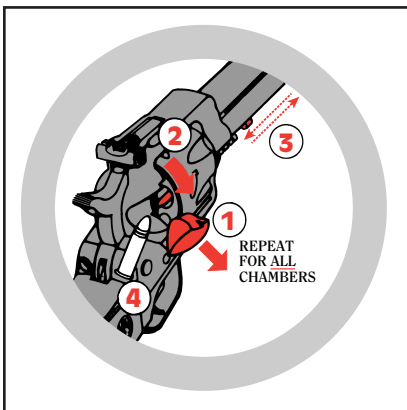

Firearms should be loaded only when you are in the field or on the target range or shooting area, ready to shoot. Firearms and ammunition should be securely locked in safes, racks or cabinets, or by using the locking device shipped with the firearm, when not in use. Ammunition should be safely stored separate from firearms. Store your firearms out of sight of visitors and children. It is the gun owner's responsibility to be certain that children and persons unfamiliar with firearms cannot gain access to firearms, ammunition, or components.

4. BE SURE THE BARREL IS CLEAR OF OBSTRUCTIONS BEFORE SHOOTING.

Even a bit of mud, snow or excess lubricating oil or grease in the bore may cause the barrel to bulge, or even burst on firing, and can cause serious injury to the shooter and bystanders. Be sure that you are using ammunition of the proper caliber and loading for the gun you are using. If the report or recoil on firing seems weak, or doesn't seem quite right, CEASE FIRING IMMEDIATELY, unload your firearm, and check to be sure that no obstruction has become lodged in the barrel.





5. BE SURE OF YOUR TARGET BEFORE YOU SHOOT.

Don't shoot unless you know exactly where your bullet is going to strike. Be sure of the bullet stop behind your target, even when dry-firing with an unloaded gun. If you are in the field hunting, do not fire at a movement or noise. Take the time to be absolutely certain of your target before you pull the trigger.

6. WEAR SHOOTING GLASSES AND HEARING PROTECTORS WHEN YOU SHOOT.

All shooters should wear protective shooting glasses and adequate hearing protectors when shooting. Exposure to shooting noise can damage hearing, and adequate eye protection when shooting is essential.



7. NEVER CLIMB A TREE OR FENCE WITH A LOADED FIREARM.

Put the firearm down carefully before climbing a fence, and unload it before climbing or descending a tree or jumping over a ditch or other obstruction. Never pull or push a loaded firearm toward yourself or another person. When in doubt, or whenever you are about to do anything awkward, unload your gun!

8. DON'T SHOOT AT A HARD SURFACE, OR AT WATER.

Bullets can glance off many surfaces like rocks or the surface of water and travel in unpredictable directions with considerable velocity.



9. NEVER TRANSPORT A LOADED FIREARM.

Firearms should always be unloaded before being placed in a vehicle. A suitable carrying case or scabbard should be used to carry an unloaded firearm to and from the shooting area.

10. AVOID ALCOHOLIC BEVERAGES WHEN SHOOTING.

Don't drink until the day's shooting is over. Handling firearms while under the influence of alcohol in any form, or medications that could affect your judgement or co-ordination, constitutes a criminal disregard for the safety of others.



A BRIEF ACCOUNT OF AN EXTRAORDINARY ACHIEVEMENT: RUGER FIREARMS

One of the few American firearms manufacturers whose management has remained unchanged since starting in business, Sturm, Ruger & Company, Inc., had its beginning in a small machine shop occupying a rented frame building in Southport, Connecticut. In January, 1949, with an initial investment of only \$50,000 and an idea, William B. Ruger and Alexander M. Sturm started production of a .22 caliber autoloading pistol—a design which was so successful that it became the cornerstone upon which one of the most comprehensive lines of sporting firearms ever made in America was established. After Alex Sturm's death in 1951, William B. Ruger continued to direct the company alone and today, as Chairman Emeritus of the Board, he continues to provide the guidance which has made this 53-year-old company a sound and successful enterprise.

Sturm, Ruger & Company, in this relatively short time, has established itself as a leading small arms design organization, developing a unique and broad line of fine quality sporting, military and police firearms to become one of the world's most famous producers of revolvers, pistols, rifles and shotguns. From 1949 thru 2000 Ruger craftsmen have built many millions of firearms.

During its five decades of growth and progress under the leadership of William B. Ruger, the company has developed a business philosophy and implemented policies which represent a constructive influence in the life of modern America. From the beginning, Sturm, Ruger & Company played a positive role in conservation efforts and has supported the interests of shooters through such groups as the National Rifle Association, National Shooting Sports Foundation, and many regional sportsmen's organizations. The company has always endeavored to market its firearms for constructive and recreational purposes, to emphasize the traditional aspects of shooting, to render meaningful public services and to encourage shooters in constructive, responsible, and safe participation in the shooting sports.

Today, Sturm, Ruger & Company is particularly mindful of those elements which have contributed to the creation of its success, and extends heartfelt thanks to its many loyal employees and customers.

A current catalog of Ruger firearms is available free upon request to
Sturm, Ruger & Co., Southport, CT 06490

WHY NO WARRANTY CARD HAS BEEN PACKED WITH THIS NEW RUGER FIREARM

The Magnuson-Moss Act (Public Law 93-637) does not require any seller or manufacturer of a consumer product to give a written warranty. It does provide that if a written warranty is given, it must be designated as "limited" or as "full" and sets minimum standards for a "full" warranty. Sturm, Ruger & Company, Inc. has elected not to provide any written warranty, either "limited" or "full", rather than to attempt to comply with the provisions of the Magnuson-Moss Act and the regulations issued thereunder. There are certain implied warranties under state law with respect to sales of consumer goods. As the extent and interpretation of these implied warranties varies from state to state, you should refer to your state statutes. Sturm, Ruger & Company wishes to assure its customers of its continued interest in providing service to owners of Ruger firearms.



STURM, RUGER & Company, Inc.
Southport, Connecticut 06490 U.S.A.
<http://www.ruger.com>

“Arms Makers For Responsible Citizens”

**A COPY OF THE INSTRUCTION MANUAL FOR ANY RUGER
FIREARM IS AVAILABLE FROM THE FACTORY FREE ON REQUEST.
THESE INSTRUCTION MANUALS CONTAIN IMPORTANT
WARNINGS WHICH MUST BE UNDERSTOOD
BEFORE USING THESE FIREARMS.**

“RUGER”, the Sturm, Ruger logo, “SINGLE-SIX”, “BLACKHAWK”, “REDHAWK”, “SECURITY-SIX”,
“SPEED-SIX”, “SERVICE-SIX”, “BEARCAT”, “OLD ARMY”, “10/22”, “MINI-14”, “MINI THIRTY”,
“RANCH RIFLE”, “M77”, “77/22”, “GP-100”, “SP101”, “P-85” and “VAQUERO”
are registered U.S. trademarks.
“77/50” is a Ruger trademark.