

COLECO

Guide No. 12230

The Official
DONKEY KONG
JUNIOR™
by Nintendo®

**INSTRUCTIONS
AND
GAME RULES**

Model No. 2398

**2 CHALLENGING
SKILL LEVELS!**

- Arcade-style joystick control
- Dazzling multi-color liquid crystal display
- Records "Best Score"
- Built-in digital clock with alarm

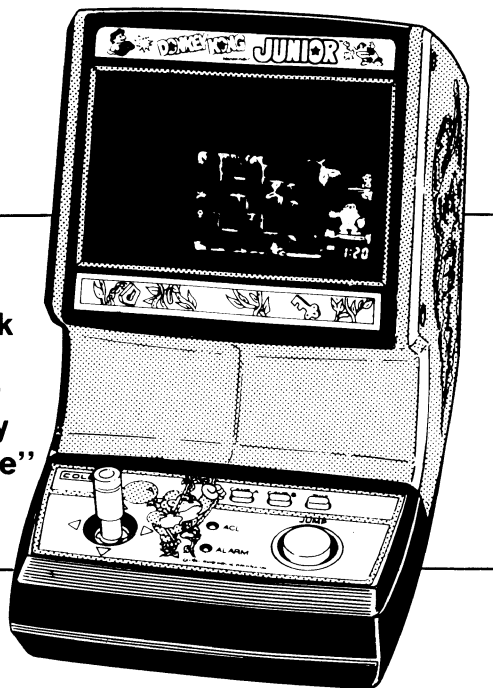

For Ages 8 to Adult

CAPTURES THE FUN AND EXCITEMENT OF THE
DONKEY KONG JUNIOR™ ARCADE GAME!

Requires 2 "C" Cell Alkaline Batteries (not included).

COLECO

Imported by: Coleco (Canada) Limitée,
4000 St. Ambrose Street,
Montreal, Quebec, Canada H4C 2C8

© 1983 Coleco (Canada) Limitée

CONTENTS

PAGE

NAME OF EACH PART AND OPERATIONS	1
TIME SET	1~2
ALARM SET · HOW TO PLAY	2
THE OPERATION OF CONTROL LEVER AND BUTTON	3~5
BATTERIES · CAUTIONS	6

NAME OF EACH PART AND OPERATIONS

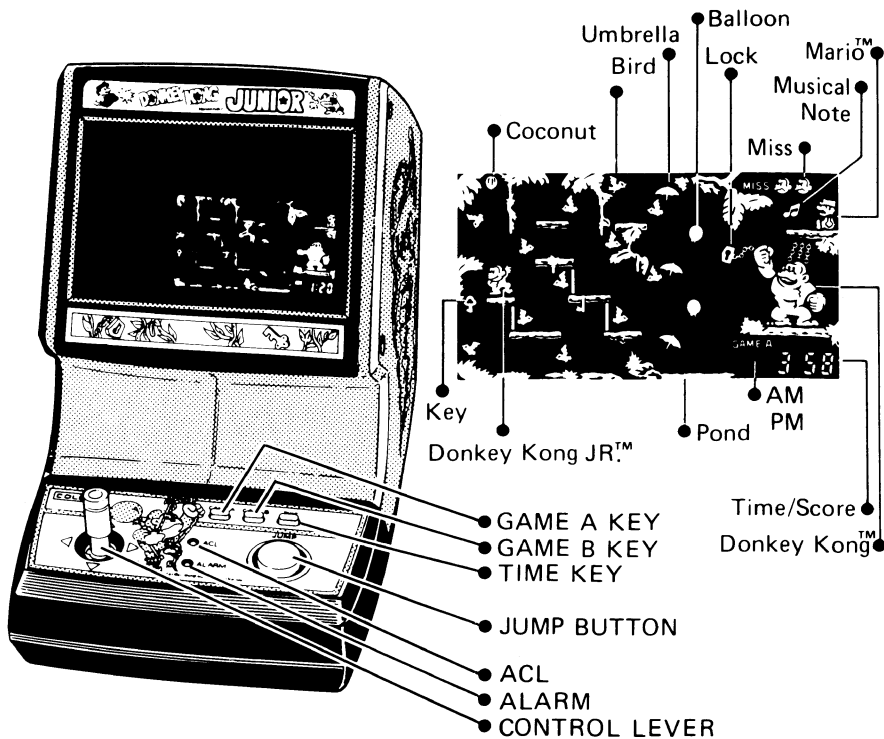

Refer to page 3 for use of Control Lever and Jump Button.

TIME SET

Push ACL switch lightly with a sharp-pointed instrument. Push lightly and do not hold the point down. A display will appear as illustrated above.

By moving Control Lever, you will control the hours. Jump Button controls the minutes. When you have set the desired time, press the TIME key and the clock will start. Pattern moves every second. To set the time without canceling high score or alarm time setting, press TIME key and, while holding it in, press and release ALARM switch. (If ACL switch is left pressed for extended period of time, battery life is shortened considerably.)



ALARM SET

Push ALARM switch lightly with a sharp-pointed instrument. Musical notes should appear. (If they do not appear, push again.) Alarm is set when Musical note marks are on the screen.



By moving Control Lever you will control the hours. Jump Button controls the minutes. After setting numbers in above manner, push TIME key to set the time as an alarm time. Check AM/PM of time.



When pre-set alarm time is reached, Mario™ whistles with musical notes. Mario™ whistles for about one minute. To turn off manually, press TIME key. Mario™ whistles without sound during game playing. Push TIME key to check the alarm time. It is indicated while the key is depressed.

HOW TO PLAY

Donkey Kong™ has been captured and chained by Mario™. Donkey Kong JR™ goes to papa's rescue with key he needs to open the locks on the chains. Junior is attacked by fierce birds. He uses umbrellas to leap from heights, and balloons to get up there, opening the locks on the way. When he opens all 4 locks, papa is free. (Each time he opens one lock, he must go back to START to retrieve the key, then sets out again.)

THE BEGINNING OF THE GAME

Press the Game key A or B, and highest previous score in Game A or B will be displayed. When key is released, game starts.

*Pressing ACL switch or removing batteries erases high score from memory.

*A game is not interrupted even if TIME key or other game key is depressed during game playing.

*Game A is for beginners and average players. Game B is for the pros. Game B requires more coordination, technique and timing.

THE OPERATION OF CONTROL LEVER AND BUTTON

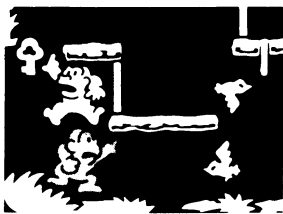

- 1** Start! After a miss or freeing Papa, Junior appears on lower left of screen. Push JUMP button for Junior to grab the flashing key. Without the key, he can't open the locks.

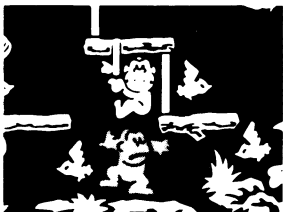

- 2** Push Jump button when Junior is under a vine and he'll grab it. Move lever toward you for Junior to climb down.



- 3** Use JUMP button and lever so that Junior avoids fierce birds. Move him to the umbrella.



- 4** Move lever away from you when Junior is under a coconut and he'll throw it. Hit a fierce bird and get extra points.
*Coconuts appear when Junior grabs the key.

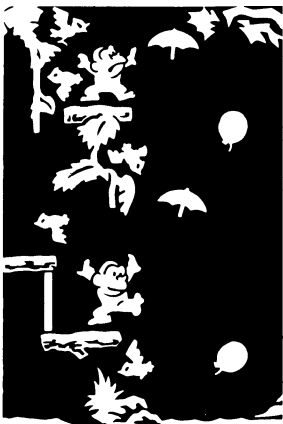

- 5** There are 2 places where Junior can grab umbrellas, as shown in picture. With Junior next to an umbrella, move lever right. If the timing is good, he rides the umbrella down. He should ride the umbrella when there are no fierce birds. Miss the umbrella and Junior falls into the water.



6

To switch from umbrella to balloon or vice versa, move lever left or right in direction of change when they are alongside.

Umbrellas move from top down, balloons from ground up.



7

When Junior is alongside a lock, move lever to right to open it. One chain holding Donkey Kong™ opens automatically.

*One key can be used only one time.

*After using key, new one appears.

Move Junior back to START to get it.



8

When Junior's key misses the lock, key falls into the water. He can't open lock without returning to START and acquires a new key.

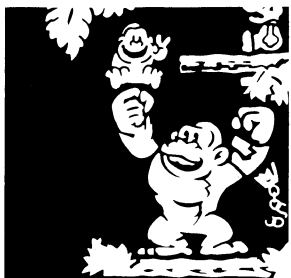

9

Open all 4 locks and Papa's chains fall off. Papa is free!!

Junior appears at START again, and the next adventure begins.

POINTS

When Junior jumps from umbrella to balloon: 1 point

When Junior opens one lock: 10 points

When Junior opens all 4 locks: 10 extra points

When Junior hits fierce bird with coconut: 1 bird, 2 points/2 birds, 4 points/3 birds, 6 points/4 birds, 8 points/5 birds, 10 points

(Maximum displayed score is 999 points.)

MISSES

When bird hits Junior. See **Fig. ①**

When Junior misses umbrella or balloon. See **Fig. ②**

When Junior falls with umbrella into water. See **Fig. ③**

When balloon bursts and Junior falls into water. See **Fig. ④**

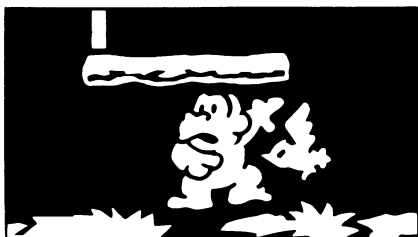

Fig. ①

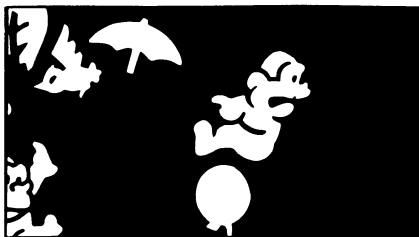

Fig. ②



Fig. ③



Fig. ④

With 3 misses game ends. When game is idle for about 5 minutes after game ends, time display returns automatically.

* Dropping a key into pond is not counted as a miss.

BONUS

When score reaches 300 points and there are one or two misses, all the misses are cleared with fanfare. If there are no misses when a 300 score is reached, game goes into "CHANCE TIME". Score flashes and all the points are awarded at double value until a miss is scored.

TO INSTALL BATTERIES

1. Slide off cover on bottom of game in direction of arrow.
2. Insert two "C" batteries, with + and - terminals as shown on diagram.
3. Replace cover.

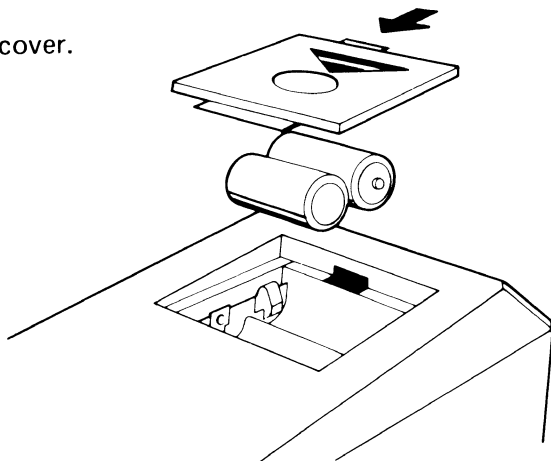

- * Two "C" batteries are required. (Batteries are sold separately.)
- * When batteries are weak, screen becomes faint and hard to see, and sounds are weak or do not function. Replace batteries. Leaving old batteries in set can cause damage.

CAUTIONS

1. Do not use pencil or pin when pressing ACL or ALARM switch.
2. As the unit is made of precise electronic components, avoid the use and storage at an extreme temperature or heavy shocks.
3. Especially at low temperatures, the response speed may slow down or the lighting may fail. As the liquid crystal is destroyed at high temperature, never leave the unit in a car which is exposed to direct sun light.
4. As exhausted batteries will give an adverse effect to the unit, replace them without delay. (If the battery is exhausted, the display of the liquid crystal will become vague and difficult to look at.)
5. Do not cover the upper side of the unit. It is required to allow light into the unit from the upper side.
6. Do not hold up the unit with a hand on a screen.
7. Wipe any dust with a soft dry cloth.
8. Do not use volatile oils such as thinner or benzene and alcohol for wiping.

90 DAY LIMITED WARRANTY

Coleco warrants to the original consumer in Canada that each video game cartridge it manufactures shall be free from factory defects in material and workmanship for 90 days from the date of purchase under normal in-house use.

If your cartridge fails to operate properly DURING THE FIRST 90 DAYS AFTER PURCHASE, return it postage prepaid and insured with your name, address, proof of the date of purchase and a brief description of the problem to COLECO (CANADA) LIMITÉE, Customer Service — Electronics, 4000 St. Ambroise, Montreal, Quebec, Canada H4C 2C8.

If your cartridge is found to be factory defective during the first 90 days, it will be repaired or replaced at no cost to you. If the cartridge is found to have been consumer damaged or abused and therefore not covered by the warranty, then you will be advised in advance of repair costs.

Coleco's sole and exclusive liability for defects in material and workmanship shall be limited to repair or replacement at its authorized Coleco Service Station, and Coleco shall in no event be liable for incidental, consequential contingent or any other damages. This warranty does not obligate Coleco to bear the cost of transportation charges in connection with the repair or replacement of defective parts.

This warranty is invalid if the damage or defect is caused by accident, act of God, consumer abuse, unauthorized alteration or repair, vandalism or misuse.

The warranty is made in lieu of any other express warranty, and except for the foregoing warranty which is exclusive, there is no other express warranty being made.

Please read the Owner's Manual carefully before using the product. If a malfunction occurs, please refer to the troubleshooting checklist in the Owner's Manual for your video system.

SERVICE POLICY

If your cartridge requires service after expiration of the 90 DAY LIMITED WARRANTY period, Coleco will service the cartridge and put it in working condition or replace it with a reconditioned unit (at our option) on receipt of your cartridge, postage prepaid and insured with your cheque in the amount of \$15.00 payable to COLECO (CANADA) LIMITÉE.

Coleco's service obligation does not apply to defects arising from abuse, misuse or alteration of the cartridge. If the cartridge is found to have been consumer damaged or abused, then you will be advised in advance of repair costs.

Please allow 4 to 6 weeks for repair and return.

All returns must

be directed to: **COLECO (CANADA) LIMITÉE**
Customer Service — Electronics
4000 St. Ambroise
Montreal, Quebec,
Canada H4C 2C8

Printed in Japan



NOTICE

This game generates and uses radio frequency energy and if not installed and used properly, that is in strict accordance with the instructions, may cause interference to radio and television reception. It has been type tested and found to comply with the limits for a Class B computing device in accordance with the specifications in Subpart J of Part 15 of FCC Rules, which are designed to provide reasonable protection against such interference in a residential installation. However, there is no guarantee that interference will not occur in a particular installation. If this game does cause interference to radio or television reception, which can be determined by turning the game off and on, the user is encouraged to try to correct the interference by one or more of the following measures:

Reorient the receiving antenna.

Relocate the game with respect to the receiver.

Move the game away from the receiver.

If necessary, the user should consult the dealer or an experienced radio/television technician for additional suggestions. The user may find the following booklet prepared by the Federal Communications Commission helpful:

If accessories are not available at your local dealer, they can be obtained from Coleco (Canada) Limited, 4000 St. Ambroise, Montreal, Quebec, Canada H4C 2C8

**PLEASE RETAIN THIS GUIDE
AND ALL LITERATURE FOR FUTURE REFERENCE**

SPECIFICATIONS

Dimension:	132mm(W) x 182mm (H) x 235mm(D)
Battery:	Two "C" batteries (not included)
Life of the battery:	Approx. three years
Accuracy of the clock:	Average daily differential within ± 3 secs. (under normal temperature)
Working temperature:	50°F ~ 104°F (10°C ~ 40°C)

DONKEY KONG JUNIOR, DONKEY KONG and MARIO are the trademarks of Nintendo of America, Inc. © 1982 Nintendo of America, Inc.

COLECO

**COLECO (CANADA) LIMITÉE, 4000 ST. AMBROISE STREET,
MONTREAL, QUEBEC, CANADA H4C 2C8**

Printed in Japan

www.handheldmuseum.com