

HP Color LaserJet CM6049f MFP

User Guide

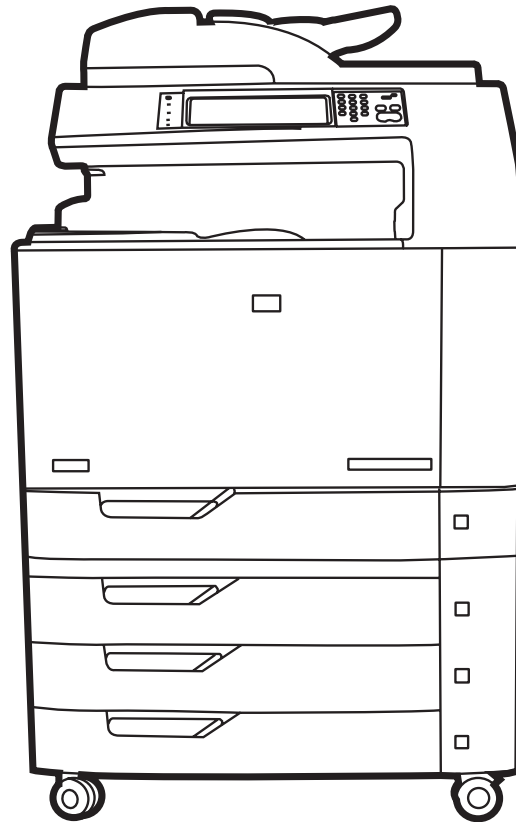

HP Color LaserJet CM6049f MFP

User Guide



Copyright and License

© 2009 Copyright Hewlett-Packard Development Company, L.P.

Reproduction, adaptation, or translation without prior written permission is prohibited, except as allowed under the copyright laws.

The information contained herein is subject to change without notice.

The only warranties for HP products and services are set forth in the express warranty statements accompanying such products and services. Nothing herein should be construed as constituting an additional warranty. HP shall not be liable for technical or editorial errors or omissions contained herein.

Part number: CE799-90904

Edition 2, 8/2019

Trademark Credits

Adobe®, Acrobat®, and PostScript® are trademarks of Adobe Systems Incorporated.

Corel® is a trademark or registered trademark of Corel Corporation or Corel Corporation Limited.

Microsoft®, Windows®, and Windows NT® are U.S. registered trademarks of Microsoft Corporation.

Windows Vista™ is either a registered trademark or trademark of Microsoft Corporation in the United States and/or other countries.

PANTONE® is Pantone, Inc's check-standard trademark for color.

UNIX® is a registered trademark of The Open Group.

ENERGY STAR® and the ENERGY STAR logo® are U.S. registered marks of the United States Environmental Protection Agency.

Table of contents

1 Product basics

Product introduction	2
Product features	3
Product walkaround	6
Front view	6
HP Color LaserJet CM6049f MFP	6
Back view	7
Interface ports	8
Serial number and model number location	9

2 Control panel

Use the control panel	12
Control-panel layout	12
Home screen	13
Buttons on the touchscreen	14
Control-panel help system	14
Navigate the Administration menu	15
Information menu	16
Default Job Options menu	18
Default Options for Originals	18
Image adjustment	19
Default Copy Options	20
Default Fax Options	21
Default E-mail Options	22
Default Send to Folder Options	23
Default Print Options	24
Time/Scheduling menu	25
Management menu	27
Initial Setup menu	29
Networking and I/O	29
Fax Setup	36
E-mail Setup	39
Send Setup menu	39
Device Behavior menu	40

Print Quality menu	48
Troubleshooting menu	52
Resets menu	58
Service menu	59

3 Software for Windows

Supported operating systems for Windows	62
Supported printer drivers for Windows	63
HP Universal Print Driver (UPD)	64
UPD installation modes	64
Select the correct printer driver for Windows	65
Priority for print settings	66
Change printer-driver settings for Windows	67
Supported utilities for Windows	68
HP Web Jetadmin	68
Embedded Web server	68
Software for other operating systems	69

4 Use the product with Macintosh

Software for Macintosh	72
Supported operating systems for Macintosh	72
Supported printer drivers for Macintosh	72
Remove software from Macintosh operating systems	72
Priority for print settings for Macintosh	72
Change printer-driver settings for Macintosh	73
Software for Macintosh computers	73
HP Printer Utility	73
Open the HP Printer Utility	73
HP Printer Utility features	73
Supported utilities for Macintosh	74
Embedded Web server	74
Use features in the Macintosh printer driver	75
Print	75
Create and use printing presets in Macintosh	75
Resize documents or print on a custom paper size	75
Print a cover page	75
Use watermarks	76
Print multiple pages on one sheet of paper in Macintosh	76
Print on both sides of the page (duplex printing)	77
Set the stapling options	77
Store jobs	78
Set the color options	78
Use the Services menu	78

5 Connect the product

USB connection	82
Network connection	83

6 Network configuration

Benefits of a network connection	86
Supported network protocols	87
Configuring network settings	88
TCP/IP	88
Internet Protocol (IP)	88
Transmission Control Protocol (TCP)	88
IP address	88
Configure IP parameters	88
Dynamic Host Configuration Protocol (DHCP)	89
BOOTP	89
Subnets	89
Subnet mask	89
Gateways	89
Default gateway	89
Configure TCP/IPv4 parameters	90
Input or change the IP address	90
Set the subnet mask	90
Set the default gateway	91
Configure TCP/IPv6 parameters	91
Network utilities	92
Other components and utilities	92

7 Paper and print media

Understand paper and print media use	94
Supported paper and print media sizes	95
Supported paper types	98
Special paper or print media guidelines	100
Load paper and print media	101
Load Tray 1	101
Print envelopes	102
Load trays 2, 3, 4, or 5	102
Load standard-sized media into trays 2, 3, 4, or 5	102
Load undetectable standard-sized media into Tray 2, 3, 4, and 5	104
Load custom-size media into tray 2, 3, 4, or 5	105
Load large size paper into Tray 3, 4, or 5	106
Load letterhead, pre-printed, or pre-punched paper	106
Change the Image Rotation setting	107

Choose the correct orientation for loading letterhead, pre-printed, or pre-punched paper	107
Configure trays	111
Configure a tray when loading paper	111
Configure a tray to match print job settings	111
Automatic media type sensing (auto sense mode)	111
Auto sense settings	112
Select the paper by source, type, or size	112
Source	112
Type and Size	113
Choose an output location	114
Standard output bins	114
Optional output accessories	114
3-bin stapler/stacker features	114
Booklet maker finisher features	115
Accessory walkaround	115
Use the booklet-making feature	116
Create a booklet from the print driver	117
Create a booklet from a copy	117
Configure the accessory operation mode	118
Select the operating mode at the control panel	118
Select the operating mode in the printer driver	118
Select the operating mode in the printer driver (Mac OS X)	118

8 Use product features

Economy settings	122
Sleep and wake	122
Set economy modes from the EWS	123
Use the stapler	124
Supported paper sizes for stapling	124
Staple print jobs	126
Job storage features for print jobs	127
Gain access to the job storage features	127
Use the proof and hold feature	127
Create a proof and hold job	127
Print the remaining copies of a proof and hold job	128
Delete a proof and hold job	128
Use the personal job feature	129
Print a personal job	129
Delete a personal job	129
Use the QuickCopy feature	130
Create a QuickCopy job	130
Print additional copies of a QuickCopy job	130
Delete a QuickCopy job	130

Use the stored job feature for copy jobs	131
Create a stored copy job	131
Print a stored job	131
Delete a stored job	131
Print photos or marketing material	133
Supported glossy paper	133
Configure the paper tray	133
Configure the driver settings	134
Print weatherproof maps and outdoor signs	135
Supported tough paper	135
Configure the paper tray	135
Configure the driver settings	135
Set the duplex alignment	136

9 Print tasks

Cancel a print job	138
Stop the current print job from the control panel	138
Stop the current print job from the software program	138
Use features in the Windows printer driver	139
Open the printer driver	139
Use printing shortcuts	139
Set paper and quality options	139
Set document effects	140
Set document finishing options	140
Set product output options	140
Set job storage options	140
Set color options	141
Obtain support and product-status information	141
Set advanced printing options	142

10 Use color

Manage color	144
Automatic or manual color adjustment	144
Manual color options	144
Print in grayscale	145
Restrict color use	145
Restrict color printing and copying from the control panel	145
RGB Color (Color Themes)	145
Match colors	147
Sample book color matching	147
Printing color samples	147
PANTONE® color matching	148
Advanced color use	149

HP ImageREt 4800	149
Paper selection	149
sRGB	149
Print in four colors — CMYK	149
CMYK ink set emulation (HP postscript level 3 emulation)	149

11 Copy

Use the Copy screen	152
Set the default copy options	152
Copy from the scanner glass	152
Copy from the document feeder	152
Adjust the copy settings	153
Copy two-sided documents	154
Copying two-sided documents manually	154
Copy two-sided documents automatically	154
Copy mixed-size originals	156
Change the copy-collation setting	157
Copy photos and books	158
Combine copy jobs by using Job Build	159
Cancel a copy job	160

12 Scan and send to e-mail

Configure e-mail settings	162
Supported protocols	162
Configure e-mail server settings	162
Use the Send E-mail screen	164
Perform basic e-mail functions	165
Load documents	165
Send documents	165
Send a document	165
Use the auto-complete function	166
Use the address book	166
Create a recipient list	166
Use the local address book	167
Add e-mail addresses to the local address book	167
Delete e-mail addresses from the local address book	167
Change e-mail settings for the current job	168
Scan to a folder	169
Scan to a workflow destination	170

13 Fax

Analog fax	172
Connect the fax accessory to a phone line	172

Configure and use the fax features	172
Digital fax	174

14 Manage and maintain the product

Information pages	176
Embedded Web server	178
Open the embedded Web server by using a network connection	178
Embedded Web server sections	179
Use HP Web Jetadmin software	182
Security features	183
Secure the embedded Web server	183
Secure Disk Erase	183
Data affected	183
Gain access to Secure Disk Erase	184
Additional Information	184
DSS authentication	184
Lock the control-panel menus	184
Set the real-time clock	185
Set the date format	185
Set the date	185
Set the time format	185
Set the time	185
Manage supplies	187
Print-cartridge storage	187
HP policy on non-HP print cartridges	187
HP fraud hotline and Web site	187
Replace supplies	188
Locate supplies	188
Supply replacement guidelines	188
Approximate replacement intervals for supplies	189
Change print cartridges	189
Change image drums	192
Install memory	195
Install DDR memory DIMMs	195
Enable memory	198
Enable memory for Windows 2000 and XP	198
Install an HP Jetdirect or EIO print server card or EIO hard disk	199
Replace the staple cartridge	201
Replace saddle stitch staple cartridges in the booklet maker	203
Clean the product	206
Clean the outside of the product	206
Clean the touchscreen	206
Clean the scanner glass	206

Cleaning the ADF delivery system	206
Clean the ADF delivery system	207
Clean the ADF rollers	208
ADF maintenance kit	210
Calibrate the scanner	211
Upgrade the firmware	212
Determine the current firmware version	212
Download new firmware from the HP Web site	212
Transfer the new firmware to the product	212
Use FTP to upload the firmware through a browser	212
Use FTP to upgrade the firmware on a network connection	213
Use HP Web Jetadmin to upgrade the firmware	214
Use MS-DOS commands to upgrade the firmware	214
Use the HP Jetdirect firmware	214
15 Solve problems	
Solving general problems	218
Troubleshooting checklist	218
Restore factory settings	219
Factors that affect product performance	219
Control-panel message types	220
Control-panel messages	221
Jams	222
Common causes of jams	222
Jam locations	223
Clear jams	223
AREA 1: Clear jams in the output bin	224
AREA 2: Clear jams in the fuser	226
Clear jams in the duplex area	230
AREA 5: Clear jams in Tray 2 and the internal paper path	233
AREA 6: Clear jams in Tray 1	236
AREA 7: Clear jams in optional Trays 3, 4, and 5	239
AREA 8: Clear jams in the optional finishing devices	242
Clear jams in the output-accessory bridge	242
Clear jams in the sorter area	243
Clear jams in the booklet maker	244
AREA 9: Clear jams in the ADF	246
Clear staple jams	247
Clear staple jams in the main stapler	247
Clear staple jams in the booklet maker	248
Jam recovery	251
Paper-handling problems	252
Product feeds multiple sheets	252

Product feeds incorrect page size	252
Product pulls from incorrect tray	252
Paper does not feed automatically	253
Paper does not feed from Tray 2, 3, 4, or 5	253
Transparencies or glossy paper will not feed	254
Envelopes jam or will not feed in the product	255
Output is curled or wrinkled	255
Product will not duplex or duplexes incorrectly	256
Understand lights on the formatter	257
HP Jetdirect LEDs	257
Heartbeat LED	257
Correct print quality and copy quality problems	258
Example print quality problems	258
Repetitive defects ruler	258
Print quality problems associated with the environment	260
Print quality problems associated with jams	260
Optimize and improve image quality	260
Use supported paper	260
Calibrate the product	260
Specify the correct paper type	260
Clean the fuser	261
Respond to control panel error messages	261
Clean the registration second transfer assembly	262
Use manual print modes	264
Print-quality-troubleshooting pages	265
Performance problems	266
Solve fax problems	267
Solve e-mail problems	267
Validate the SMTP gateway address	267
Validate the LDAP gateway address	267
Solve network connectivity problems	268
Solve network printing problems	268
Verify communication over the network	268
Solve common Macintosh problems	270

Appendix A Supplies and accessories

Order parts, accessories, and supplies	274
Part numbers	275
Accessories	275
Print cartridges	275
Image drums	275
Maintenance kits	275
Memory	276

Cables and interfaces	276
-----------------------------	-----

Appendix B Product specifications

Physical specifications	278
Electrical specifications	279
Acoustic specifications	280
Environmental specifications	281

Appendix C Regulatory information

Compliance with FCC regulations	284
Declaration of Conformity	285
Environmental product stewardship program	286
Protecting the environment	286
Ozone production	286
Power consumption	286
Toner consumption	286
Paper use	286
Plastics	286
HP LaserJet print supplies	286
Return and recycling instructions	287
United States and Puerto Rico	287
Multiple returns (more than one cartridge)	287
Single returns	287
Shipping	287
Non-U.S. returns	287
Paper	287
Material restrictions	287
Disposal of waste equipment by users in private households in the European Union	288
Material Safety Data Sheet (MSDS)	288
For more information	289
Certificate of volatility	290
Types of memory	290
Volatile memory	290
Non-volatile memory	290
Hard-disk-drive memory	290
Safety statements	291
Laser safety	291
Canadian DOC regulations	291
VCCI statement (Japan)	291
Power cord statement (Japan)	291
EMC statement (Korea)	291
EMI statement (Taiwan)	291
General telecom statement	292

Laser statement for Finland 292
Substances Table (China) 293

Index 295

1 Product basics

- [Product introduction](#)
- [Product features](#)
- [Product walkaround](#)

Product introduction

Figure 1-1 HP Color LaserJet CM6049f MFP (CE799A)



The HP Color LaserJet CM6049f MFP comes standard with the following items:

- 100-sheet multipurpose input tray (Tray 1)
- 40 ppm
- Four 500-sheet input trays
- Automatic document feeder (ADF) that holds up to 50 pages
- HP Jetdirect embedded print server for connecting to a 10/100Base-TX network
- 512 megabytes (MB) of random access memory (RAM)
- Duplexer
- Hard drive
- Analog fax

Product features

Table 1-1 Features

Speed and throughput	<ul style="list-style-type: none">● Print up to 40 ppm on letter-size paper.● Less than 11 seconds to print the first page● Recommended maximum monthly print volume of 15,000 pages● An 835 megahertz (MHz) microprocessor● Duplex at speed
Resolution	<ul style="list-style-type: none">● 600 dots per inch (dpi) with Image Resolution Enhancement technology 4800 for optimum overall imaging● 1200 x 600 dpi for detailed line work and small text
Memory	<ul style="list-style-type: none">● 512 MB of random-access memory (RAM), expandable to 768 MB by using 200-pin small outline dual inline memory modules (SODIMM) that support 128 or 256 MB of RAM.● Memory Enhancement technology (MEt) automatically compresses data to use RAM more efficiently.
User interface	<ul style="list-style-type: none">● HP Easy Select Control Panel
Drivers	<p>HP provides the following drivers for downloading:</p> <ul style="list-style-type: none">● HP Universal Print Driver (UPD): Postscript, PCL 6, PCL 5● Mac Driver● Linux● SAP● UNIX Model Script <p>Drivers for this product are available at www.hp.com/go/cljcm6049mfp_software or your country/region alternative.</p>
Languages and fonts	<ul style="list-style-type: none">● HP Printer Control Language (PCL) 6● HP Universal Printer Driver (UPD) PCL 5● HP Universal Printer Driver (UPD) postscript (PS)● Printer Management Language● 80 scalable TrueType PS typefaces
Print cartridges/image drums (4 of each)	<ul style="list-style-type: none">● Two-part toner/imaging system● Black print cartridges print up to 19,500 pages at 5% coverage● Color print cartridges print up to 21,000 pages at 5% coverage● Image drums print up to 35,000 pages at 5% coverage● Authentic HP print cartridge detection● Automatic toner strip remover

Table 1-1 Features (continued)

Paper-handling	<ul style="list-style-type: none">● Input<ul style="list-style-type: none">◦ Tray 1 (multipurpose tray): A multipurpose tray for paper, transparencies, labels, envelopes and other paper types. See Supported paper types on page 98 for a list of paper types. The tray holds up to 100 sheets of paper, 50 transparencies, or 10 envelopes. See Supported paper and print media sizes on page 95.◦ Tray 2, 3, 4, and 5: 500-sheet trays. These trays automatically detect common paper sizes and allow printing on custom-size paper. Tray 2 supports up to 279 x 432 mm (11 x 17 inches) and A3 paper sizes, and Trays 3,4, and 5 support sizes up to 305 x 457 mm (12 x 18 inches), and SRA3. See Supported paper and print media sizes on page 95 for a list of supported paper sizes. For a list of supported paper types, see Supported paper types on page 98.◦ Automatic document feeder (ADF): Holds up to 50 sheets of paper.◦ ADF duplex scanning: The ADF has an automatic duplexer for scanning two-sided documents.◦ Duplex printing: Provides automatic two-sided printing (printing on both sides of the paper).<p>The paper size range for automatic duplex printing is 175 mm to 320 mm (6.9 to 12.6 inches) x 210 mm to 457 mm (8.3 to 18 inches). The media weight range is 60–220 g/m² (16-58 lb).</p>● Output<ul style="list-style-type: none">◦ Standard output bin: The standard output bin is located underneath the scanner on the top of the product. This bin can hold up to 500 sheets of paper. The product provides a sensor that indicates when the bin is full.◦ Optional 3-bin stapler/stacker: Provides job separation in multiple output bins, convenient stapling (up to 50-sheet jobs), job offset capability, and additional output capacity. The stacker has three bins: a 100-sheet bin, a 500-sheet bin, and a 1000-sheet bin.◦ Optional booklet maker finisher: Provides convenient stapling (up to 50-sheet jobs), saddle-stitching (up to 15-sheet booklets), single-sheet v-folding, job separation and offset capability, as well as additional output capacity. The booklet maker finisher has three bins: two 1000-sheet bins and one bin that can hold up to 25 saddle-stitched booklets.◦ ADF output bin: The ADF output bin is underneath the ADF input tray. The bin holds up to 50 sheets of paper, and the product automatically stops when this bin is full.
Supported operating systems	<ul style="list-style-type: none">● Windows 2000®● Windows XP®● Windows Server 2003®● Windows Server 2008®● Windows Vista™● Macintosh OS
Connectivity	<ul style="list-style-type: none">● Local area network (LAN) connector (RJ-45) for the embedded HP Jetdirect print server● One enhanced input/output (EIO) slot● USB 2.0 connection● Optional analog fax card

Table 1-1 Features (continued)

Environmental features	<ul style="list-style-type: none">● Sleep setting saves energy.● High content of recyclable components and materials.
Security features	<ul style="list-style-type: none">● Secure Disk Erase● Security lock (optional)● Job retention● User PIN authentication for stored jobs● DSS authentication● IPv6 security
Copying and sending	<ul style="list-style-type: none">● Modes for text, graphics, and mixed text and graphics formats● Job-interrupt feature● Multiple pages per sheet● Control panel animations (for example, jam recovery)● Scan and send to e-mail<ul style="list-style-type: none">◦ Local address book for e-mail and fax◦ LDAP addressing● Send to folder● Automatic duplex (two-sided) scanning

Product walkaround

Front view

HP Color LaserJet CM6049f MFP

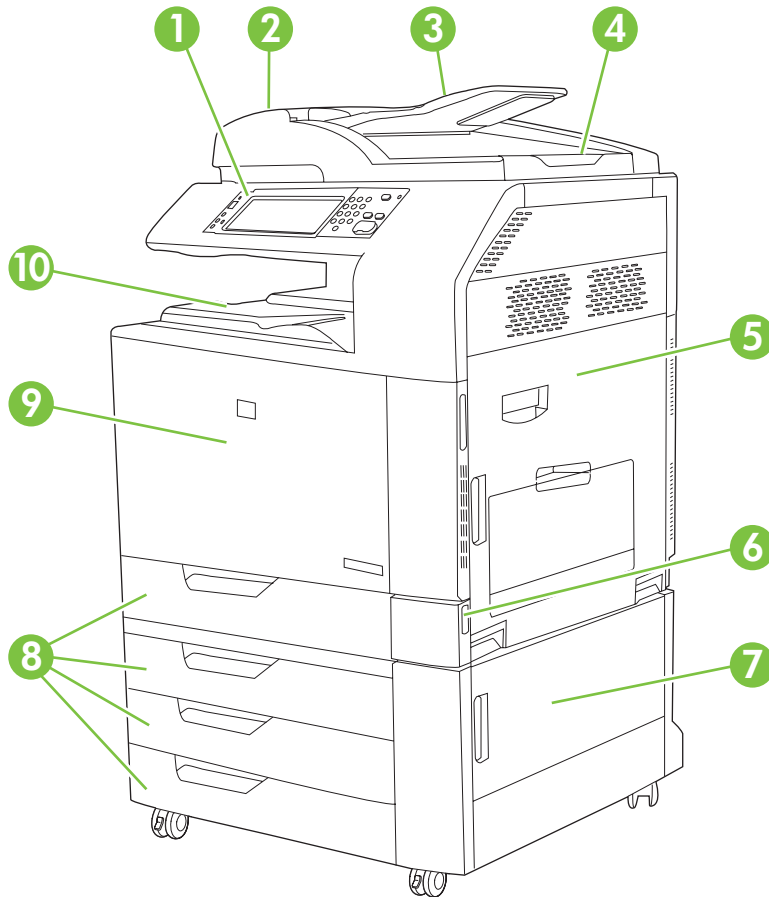

1	Control panel
2	Automatic Document Feeder (ADF) top cover
3	ADF input tray for copy/scan/fax originals
4	ADF output bin
5	Right-door (provides access to the transfer unit, transfer roller, and fuser unit)
6	On/Off switch
7	Lower right door
8	Trays 2, 3, 4 and 5
9	Front cover (provides access to print cartridges and image drums)
10	Output bin

Back view

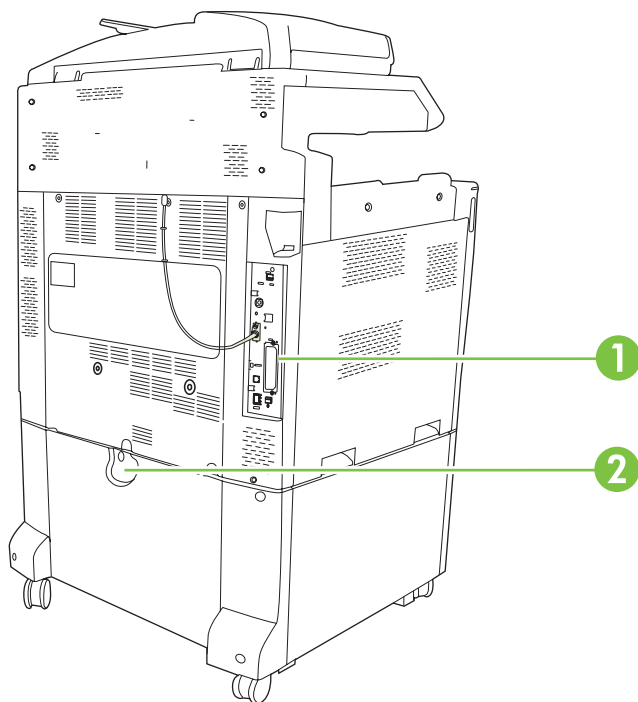

1	Interface ports and formatter
2	Lock lever for additional input bins

Interface ports

The product has five ports for connecting to a computer or a network. The ports are at the left, rear corner of the product.

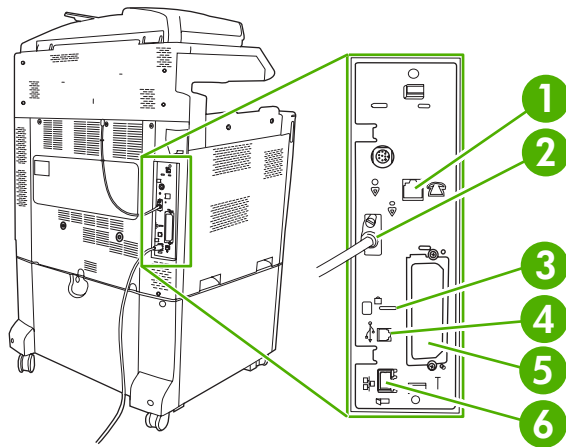

1	Fax connection (when installed)
2	Scanner cable
3	Access port for Kensington lock
4	USB 2.0 port
5	EIO expansion slot
6	Network port

Serial number and model number location

The model number and serial number are listed on identification labels located on the rear of the printer. The serial number contains information about the country/region of origin, the printer version, production code, and the production number of the printer.

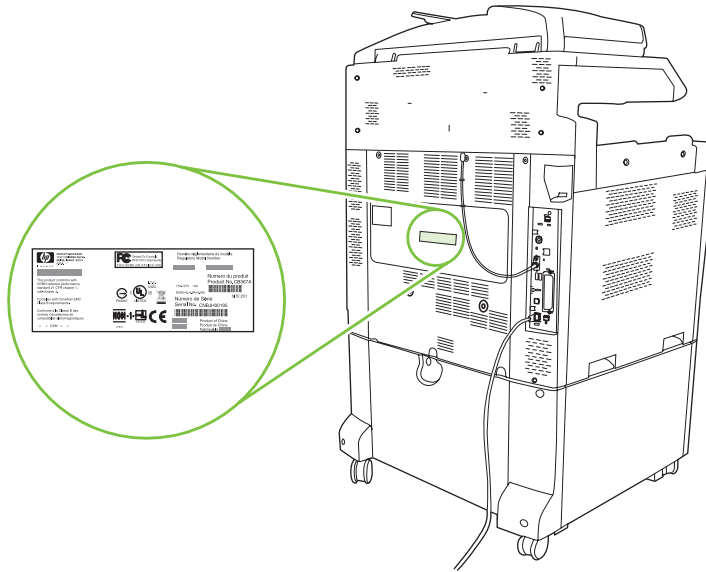

Model name	Model number
HP Color LaserJet CM6049f MFP	CE799A

2 Control panel

- [Use the control panel](#)
- [Navigate the Administration menu](#)
- [Information menu](#)
- [Default Job Options menu](#)
- [Time/Scheduling menu](#)
- [Management menu](#)
- [Initial Setup menu](#)
- [Device Behavior menu](#)
- [Print Quality menu](#)
- [Troubleshooting menu](#)
- [Resets menu](#)
- [Service menu](#)

Use the control panel

The control panel has a VGA touchscreen that provides access to all device functions. Use the buttons and numeric keypad to control jobs and the device status. The LEDs indicate overall device status.

Control-panel layout

The control panel includes a touchscreen graphical display, job-control buttons, a numeric keypad, and three light-emitting diode (LED) status lights.

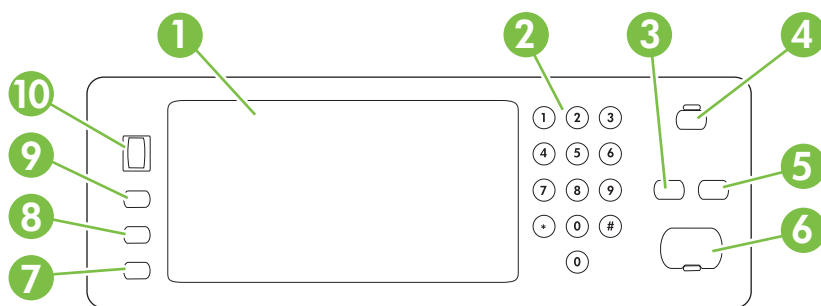

1	Touchscreen graphical display	Use the touchscreen to open and set up all device functions.
2	Numeric keypad	Allows you to type numeric values for number of copies required and other numeric values.
3	Reset button	Resets the job settings to factory or user-defined default values.
4	Sleep button	If the device is inactive for a long period of time, it automatically enters a sleep mode. To place the device into sleep mode or to reactivate the device, press the Sleep button.
5	Stop button	Stops the active job and opens the Job Status screen.
6	Start button	Begins a copy job, starts digital sending, or continues a job that has been interrupted.
7	Attention light	The Attention light indicates that the device has a condition that requires intervention. Examples include an empty paper tray or an error message on the touchscreen.
8	Ready light	The Ready light indicates that the device is ready to begin processing any job.
9	Data light	The Data light indicates that the device is receiving data.
10	Contrast-adjustment dial	Turn the dial to adjust the contrast of the touchscreen display for your viewing angle.

Home screen

The home screen provides access to the device features, and it indicates the current status of the device.



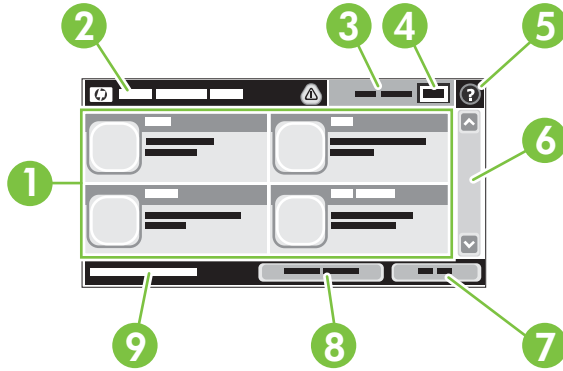



 **NOTE:** Depending on how the device has been configured, the features that appear on the home screen can vary.



1	Features	Depending on how the system administrator has configured the device, the features that appear in this area can include any of the following items: <ul style="list-style-type: none"> • Copy • Fax • E-mail • Secondary E-mail • Job Status • Network Folder • Job Storage • Workflow • Supplies Status • Administration
2	Device status line	The status line provides information about the overall device status. Various buttons appear in this area, depending on the current status. For a description of each button that can appear in the status line, see Buttons on the touchscreen on page 14 .
3	Copy type	Shows whether copies are color.
4	Copy count	The copy count box indicates the number of copies that the device is set to make.
5	Help button	Touch the Help button to open the embedded help system.
6	Scroll bar	Touch the up or down arrows on the scroll bar to see the complete list of available features.
7	Sign Out	Touch Sign Out to sign out of the device if you have signed in for access to restricted features. After you sign out, the device restores all options to the default settings.
8	Network Address	Touch Network Address to find information about the network connection.
9	Date and time	The current date and time appear here. The system administrator can select the format that the device uses to show the date and time, for example 12-hour format or 24-hour format.

Buttons on the touchscreen

The status line on the touchscreen provides information about the status of the device. Various buttons can appear in this area. The following table describes each button.



	Home button. Touch the home button to go to the Home screen from any other screen.
	Start button. Touch the Start button to begin the action for the feature that you are using. NOTE: The name of this button changes for each feature. For example, in the Copy feature, the button is named Start Copy .
	Stop button. If the device is processing a print or fax job, the Stop button appears instead of the Start button. Touch the Stop button to halt the current job. The device prompts you to cancel the job or to resume it.
	Error button. The error button appears whenever the device has an error that requires attention before it can continue. Touch the error button to see a message that describes the error. The message also has instructions for solving the problem.
	Warning button. The warning button appears when the device has a problem but can continue functioning. Touch the warning button to see a message that describes the problem. The message also has instructions for solving the problem.
	Help button. Touch the help button to open the built-in online Help system. For more information, see Control-panel help system on page 14 .

Control-panel help system

The device has a built-in Help system that explains how to use each screen. To open the Help system, touch the Help button  in the upper-right corner of the screen.

For some screens, the Help opens to a global menu where you can search for specific topics. You can browse through the menu structure by touching the buttons in the menu.

For screens that contain settings for individual jobs, the Help opens to a topic that explains the options for that screen.

If the device alerts you of an error or warning, touch the error  or warning  button to open a message that describes the problem. The message also contains instructions to help solve the problem.

Navigate the Administration menu

From the Home screen, touch **Administration** to open the menu structure. You might need to scroll to the bottom of the Home screen to see this feature.

The Administration menu has several sub-menus, which are listed on the left side of the screen. Touch the name of a menu to expand the structure. A plus sign (+) next to a menu name means that it contains sub-menus. Continue opening the structure until you reach the option that you want to configure. To return to the previous level, touch **Back**.

To exit the Administration menu, touch the Home button  in the upper-left corner of the screen.

The device has built-in Help that explains each of the features that are available through the menus. Help is available for many menus on the right-hand side of the touchscreen. Or, to open the global Help system, touch the Help button  in the upper-right corner of the screen.

The tables in the sections that follow indicate the overall structure of each menu under the Administration menu.

Information menu

Administration > Information

Use this menu to print information pages and reports that are stored internally on the device.

Table 2-1 Information menu

Menu item	Sub-menu item	Sub-menu item	Values	Description
Configuration/Status Pages	Administration Menu Map		Print	Shows the basic structure of the Administration menu and current administration settings.
	Configuration/status Pages		Print	A set of configuration pages that show the current device settings.
	Supplies Status Page		Print	Shows the status of supplies such as cartridges, maintenance kits, and staples.
	Usage Page		Print	Shows information about the number of pages that have been printed on each paper type and size.
	Color Usage Job Log		Print	A directory page that contains job-by-job color usage information. Page content includes the user name, application name, and number of black-only pages and color pages.
	File Directory		Print	A directory page that contains information for any mass-storage devices, such as flash drives, memory cards, or hard disks, that are installed in this device.
Fax Reports	Fax Activity Log		Print	Contains a list of the faxes that have been sent from or received by this device.
	Fax Call Report	Fax Call Report	Print	A detailed report of the last fax operation, either sent or received.
		Thumbnail on Report	Yes No (default)	Choose whether or not to include a thumbnail of the first page of the fax on the call report.
		When to Print Report	Never auto print Print after any fax job Print after fax send jobs Print after any fax error (default) Print after send errors only Print after receive errors only	
		Billing Codes Report	Print	A list of billing codes that have been used for outgoing faxes. This report shows how many sent faxes were billed to each code.
		Blocked Fax List	Print	A list of phone numbers that are blocked from sending faxes to this device.
		Speed Dial List	Print	Shows the speed dials that have been set up for this device.

Table 2-1 Information menu (continued)

Menu item	Sub-menu item	Sub-menu item	Values	Description
Sample Pages/Fonts	Demonstration Page		Print	Printout of a page highlighting the print capabilities of the product.
	RGB Samples		Print	Printout of color samples for different RGB values. The samples act as a guide for color matching.
	CMYK Samples		Print	Printout of color samples for different CMYK values. The samples act as a guide for color matching.
	PCL Font List		Print	A list of printer control language (PCL) fonts that are currently available on the device.
	PS Font List		Print	A list of PostScript (PS) fonts that are currently available on the device.

Default Job Options menu

Administration > Default Job Options

Use this menu to define the default job options for each function. These are used if the user does not specify other options when creating the job.

Default Options for Originals

Administration > Default Job Options > Default Options For Originals

Table 2-2 Default Options for Originals menu

Menu item	Values	Description
Paper Size	Select a paper size from the list.	Select the paper size that is most often used for copy or scan originals.
Number of Sides	1 2	Select whether copy or scan originals are most often single-sided or double-sided.
Orientation	Portrait Landscape	Select the orientation that is most often used for copy or scan originals. Select Portrait if the short edge is at the top or select Landscape if the long edge is at the top.
Optimize Text/Picture	Manually Adjust Text Printed Picture Photograph	Optimize the output for a particular type of original: text, pictures, or a mixture of both. If you select Manually Adjust , specify the mix of text and pictures that is used most often.

Image adjustment

Administration > Default Job Options > Image Adjustment

Table 2-3 Image Adjustment menu

Menu item	Values	Description
Darkness	Select a value.	Select the level of density (darkness) for the output.
Background Cleanup	Adjust the value within the range.	Increase the Background Removal setting to remove faint images from the background or to remove a light background color.
Sharpness	Adjust the value within the range.	Adjust the Sharpness setting to clarify or soften the image.

Default Copy Options

Administration > Default Job Options > Default Copy Options

Table 2-4 Default Copy Options menu

Menu item	Sub-menu item	Values	Description
Number of Copies		Type the number of copies. The factory default setting is 1.	Set the default number of copies for a copy job.
Number of Sides		1 2	Set the default number of sides for copies.
Color/Black		Auto detect Color Black (default)	Choose whether the default copy mode is color or black.
Staple/Collate	Staple	None (default) One left angled Two left Two top One right angled Two right	Set up options for stapling and collating sets of copies. If Collate is selected, the device prints a complete copy before starting on the next copy. Otherwise, the device prints the first page of all copies before printing the second page, and so on. The staple and collate feature may not be present in your product. These features depend on the optional output accessory installed.
	Collate	Off On (default)	
Output Bin		<Binname>	Select the default output bin for copies. This option is available only if an optional output accessory is installed.
Edge-To-Edge		Normal (recommended) (default) Edge-To-Edge Output	If the original document is printed close to the edges, use the Edge-To-Edge feature to avoid shadows along the edges. Combine this feature with the Reduce/Enlarge feature to ensure that the entire page appears on the copies.
Auto Include Margins		Off (default) On	This feature automatically reduces the image size during scanning so the margins are included.

Default Fax Options

Administration > Default Job Options > Default Fax Options

Table 2-5 Fax Send menu

Menu item	Sub-menu item	Values	Description
Resolution		Standard (100x200dpi) (default) Fine (200x200dpi) Superfine (300x300dpi)	Set the resolution for sent documents. Higher resolution images have more dots per inch (dpi), so they show more detail. Lower resolution images have fewer dots per inch and show less detail, but the file size is smaller.
Fax Header		Prepend (default) Overlay	Select the position of the fax header on the page. Select Prepend to print the fax header above the fax content and move the fax content down on the page. Select Overlay to print the fax header over the top of the fax contents without moving the contents down. Using this option could prevent a single-page fax from flowing onto another page.

Table 2-6 Fax Receive menu

Menu item	Sub-menu item	Values	Description
Fax Forwarding	Fax Forwarding	Off (default) Custom	To forward received faxes to another fax device, select Fax Forwarding and Custom . Then type the number of the other fax device into the Fax Forwarding Number field. When you select this menu item for the first time, you are prompted to set up a PIN. Type that PIN every time you use this menu. This is the same PIN that is used to access the Fax Printing menu.
	Create PIN		
Stamp Received Faxes	Enabled Disabled (default)		Add the date, time, senders phone number, and page number to each page of the faxes that this device receives.
Fit to Page	Enabled (default) Disabled		Shrink faxes that are larger than Letter-size or A4-size so that they can fit onto a Letter-size or A4-size page. If it this feature set to Disabled , faxes larger than Letter or A4 will flow across multiple pages.
Fax Paper Tray	Select from the list of trays. The default setting is Automatic .		Select the tray that holds the size and type of paper that you want to use for incoming faxes.
Output Bin	<Binname>		Select the default output bin, if applicable, to use for faxes.

Default E-mail Options

Administration > Default Job Options > Default E-mail Options

Menu item	Values	Description
Document File Type	PDF (default)	Select the file format for the e-mail.
	JPEG	
	TIFF	
	M-TIFF	
Output Quality	High (large file)	Selecting higher quality for output increases the size of the output file.
	Medium (default)	
	Low (small file)	
Resolution	300 DPI	Select the resolution. Use a lower setting to create smaller files.
	200 DPI	
	150 DPI (default)	
	75 DPI	
Color/Black	Color scan (default)	Specify whether the e-mail will be in black or in color.
	Black/white scan	
TIFF Version	TIFF 6.0 (default)	Specify the TIFF version to use when saving scanned files.
	TIFF (Post 6.0)	

Default Send to Folder Options

Administration > Default Job Options > Default Send To Folder Options

Menu item	Values	Description
Color/Black	Color scan	Specify whether the file will be in black or in color.
	Black/white scan (default)	
Document File Type	PDF (default)	Select the file format for the file.
	M-TIFF	
	TIFF	
	JPEG	
TIFF version	TIFF 6.0 (default)	Specify the TIFF version to use when saving scanned files.
	TIFF (post 6.0)	
Output Quality	High (large file)	Selecting higher quality for output increases the size of the output file.
	Medium (default)	
	Low (small file)	
Resolution	75 DPI	Select the resolution. Use a lower setting to create smaller files.
	150 DPI (default)	
	200 DPI	
	300 DPI	
	400 DPI	
	600 DPI	

Default Print Options

Administration > Default Job Options > Default Print Options

Table 2-7 Default Print Options menu

Menu item	Sub-menu item	Values	Description
Copies Per Job		Type a value.	Set the default number of copies for print jobs.
Default Paper Size		(List of supported sizes)	Select a paper size.
Default Custom Paper Size	Unit of measure	Millimeters	Configure the default paper size that is used when the user selects Custom as the paper size for a print job.
		Inches	
	X Dimension		Configure the width measurement for the Default Custom Paper Size .
	Y Dimension		Configure the height measurement for the Default Custom Paper Size .
Output Bin		<binname>	Select the default output bin for print jobs. If optional trays are installed, output bin options vary.
Print Sides		1-sided	Select whether print jobs are single-sided or double-sided by default.
		2-sided	

Time/Scheduling menu

Administration > Time/Scheduling

Use this menu to set options for setting the time and for setting the device to enter and exit sleep mode.

 **NOTE:** Values shown with "(default)" are the factory-default values. Some menu items have no default.

Table 2-8 Time/Scheduling menu

Menu item	Sub-menu item	Sub-menu item	Values	Description
Date/Time	Date Format		YYYY/MMM/DD (default)	Use this feature to set the current date and time, and to set the date format and time format that are used to time-stamp outgoing faxes.
			MMM/DD/YYYY	
			DD/MMM/YYYY	
	Date	Month		
		Day		
		Year		
	Time Format		12 hour (AM/PM) (default)	
			24 hour	
	Time	Hour		
		Minute		
AM				
PM				
Sleep Delay			1 Minute	Use this feature to select the time interval that the device should remain inactive before entering Sleep Mode.
			20 minutes	
			30 minutes (default)	
			45 minutes	
			1 hour (60 minutes)	
			90 minutes	
			2 hours	
		4 hours		
Wake Time	Monday		Off (default)	Select Custom to set a wake time for each day of the week. The device exits sleep mode according to this schedule. Using a sleep schedule helps conserve energy and prepares the device for use so that users do not have to wait for it to warm up.
	Tuesday		Custom	
	Wednesday			
	Thursday			
	Friday			
	Saturday			
	Sunday			

Table 2-8 Time/Scheduling menu (continued)

Menu item	Sub-menu item	Sub-menu item	Values	Description
Sleep Time	Monday		Off (default)	Use this feature to set a sleep time for each day of the week for periods when the device will not likely be in use (for example, at a certain time each evening). Setting a sleep time makes the device automatically go into a low-power mode. Select a day and then select Custom to set up a custom sleep time schedule.
	Tuesday		Custom	
	Wednesday			
	Thursday			
	Friday			
	Saturday			
	Sunday			
FAX Printing		Create PIN		If you have concerns about the security of private faxes, use this feature to store faxes rather than having them automatically print by creating a printing schedule. When you select this menu item for the first time, you are prompted to set up a PIN. Type that PIN every time you use this menu.

Management menu

Administration > Management

Use this menu to set up global device-management options.

 **NOTE:** Values shown with "(default)" are the factory-default values. Some menu items have no default.

Table 2-9 Management menu

Menu item	Sub-menu item	Values	Description	
Network Address Button	Display		Use this feature to display the Network Address button on the Home screen.	
	Hide (default)			
Stored Job Management	Quick Copy Job Storage Limit	Select the maximum number of jobs to store	Use this menu to view and manage any jobs that are stored on the device.	
	Quick Copy Job Held Timeout	Off (default)		
		1 Hour		
		4 Hours		
		1 Day		
1 Week				
Sleep mode		Disable	Use this feature to customize the sleep mode settings for this device.	
		Use Sleep Delay (default)	Select Use Sleep Delay to set the device to enter sleep mode after the delay that is specified in the Time/Scheduling menu.	
Manage Supplies	Replace Supplies	Stop at low	This menu sets the product behavior for when a print cartridge, fuser kit, or transfer kit is low. Choose Stop at low to stop printing when a supply reaches a low condition. Choose Stop at out to allow the product to continue printing until a color print cartridge is empty.	
		Stop at out (default)		
		Override at out 1		
		Override at out 2		
	Supply Low/Order Threshold	Select a value in the range. The default is 5%.	Use this menu to carry out administrative supply management tasks such as changing the threshold when supplies should be ordered.	
Color Supply Out	Stop (default)	This menu sets the product behavior when a color supply is empty. When Auto-continue black is selected, the product will continue printing using black toner only.		
	Auto-continue black			

Table 2-9 Management menu (continued)

Menu item	Sub-menu item	Values	Description
Restrict Color Use	Color printing access	Enable Color (default)	This item allows the administrator to disable or restrict color printing. To use the Color If Allowed setting, set up user permissions and/or application permissions in the embedded Web server or Web Jetadmin.
		Color If Allowed	
		Disable Color	
	Color copying access	Enable Color (default)	This item allows the administrator to disable or restrict color copying.
		Disable Color	
Color/Black Mix		Automatic (default)	This item controls how the engine switches from color mode to monochrome mode for maximum performance and print cartridge life. Choose Automatic to reset the product to the factory default setting. Choose Mostly color pages if nearly all of your print jobs are color with high page coverage. Choose Mostly black pages if you print mostly monochrome jobs or a combination of color and monochrome jobs.
		Mostly color pages	
		Mostly black pages	

Initial Setup menu

Administration > Initial Setup

 **NOTE:** Values shown with "(default)" are the factory-default values. Some menu items have no default.

Networking and I/O

Administration > Initial Setup > Networking and I/O

Table 2-10 Networking and I/O

Menu item	Sub-menu item	Values	Description
I/O Timeout		Select a value in the range. The factory default setting is 15 seconds.	I/O timeout refers to the elapsed time before a print job fails. If the stream of data that the device receives for a print job gets interrupted, this setting indicates how long the device will wait before it reports that the job has failed.
Embedded Jetdirect		See Table 2-11 Jetdirect menus on page 29 for the list of options.	

Table 2-11 Jetdirect menus

Menu item	Sub-menu item	Sub-menu item	Values and Description
TCP/IP	Enable		Off: Disable the TCP/IP protocol. On (default): Enable the TCP/IP protocol.
	Host Name		An alphanumeric string, up to 32 characters, used to identify the device. This name is listed on the HP Jetdirect configuration page. The default host name is NP1xxxxxx, where xxxxxx is the last six digits of the LAN hardware (MAC) address.
	IPv4 Settings	Config Method	Specifies the method that TCP/IPv4 parameters will be configured on the HP Jetdirect print server. Bootp: Use BootP (Bootstrap Protocol) for automatic configuration from a BootP server. DHCP: Use DHCP (Dynamic Host Configuration Protocol) for automatic configuration from a DHCPv4 server. If selected and a DHCP lease exists, DHCP Release and DHCP Renew menus are available to set DHCP lease options. Auto IP: Use automatic link-local IPv4 addressing. An address in the form 169.254.x.x is assigned automatically. Manual: Use the Manual Settings menu to configure TCP/IPv4 parameters.

Table 2-11 Jetdirect menus (continued)

Menu item	Sub-menu item	Sub-menu item	Values and Description
		Default IP	<p>Specify the IP address to default to when the print server is unable to obtain an IP address from the network during a forced TCP/IP reconfiguration (for example, when manually configured to use BootP or DHCP).</p> <p>Auto IP: A link-local IP address 169.254.x.x is set.</p> <p>Legacy: The address 192.0.0.192 is set, consistent with older HP Jetdirect devices.</p>
		DHCP Release	<p>This menu appears if Config Method was set to DHCP and a DHCP lease for the print server exists.</p> <p>No (default): The current DHCP lease is saved.</p> <p>Yes: The current DHCP lease and the leased IP address are released.</p>
		DHCP Renew	<p>This menu appears if Config Method was set to DHCP and a DHCP lease for the print server exists.</p> <p>No (default): The print server does not request to renew the DHCP lease.</p> <p>Yes: The print server requests to renew the current DHCP lease.</p>
		Primary DNS	Specify the IP address (n.n.n.n) of a Primary DNS Server.
		Secondary DNS	Specify the IP address (n.n.n.n) of a Secondary Domain Name System (DNS) Server.
	IPV6 Settings	Enable	<p>Use this item to enable or disable IPv6 operation on the print server.</p> <p>Off: IPv6 is disabled.</p> <p>On (default): IPv6 is enabled.</p>
		Address	<p>Manual Settings: Use this item to manually set IPv6 addresses on the print server.</p> <p>Enable: Select this item and choose On to enable manual configuration, or Off to disable manual configuration.</p> <p>Address: Use this item to type a 32 hexadecimal digit IPv6 node address that uses the colon hexadecimal syntax.</p>
		DHCPV6 Policy	<p>Router Specified: The stateful auto-configuration method to be used by the print server is determined by a router. The router specifies whether the print server obtains its address, its configuration information, or both from a DHCPv6 server.</p> <p>Router Unavailable: If a router is not available, the print server should attempt to obtain its stateful configuration from a DHCPv6 server.</p> <p>Always: Whether or not a router is available, the print server always attempts to obtain its stateful configuration from a DHCPv6 server.</p>

Table 2-11 Jetdirect menus (continued)

Menu item	Sub-menu item	Sub-menu item	Values and Description
		Primary DNS	Use this item to specify an IPv6 address for a primary DNS server that the print server should use.
		Secondary DNS	Use this item to specify an IPv6 address for a secondary DNS server that the print server should use.
	Proxy Server		<p>Specifies the proxy server to be used by embedded applications in the device. A proxy server is typically used by network clients for Internet access. It caches Web pages, and provides a degree of Internet security, for those clients.</p> <p>To specify a proxy server, enter its IPv4 address or fully-qualified domain name. The name can be up to 255 octets.</p> <p>For some networks, you may need to contact your Independent Service Provider (ISP) for the proxy server address.</p>
	Proxy Port		Type the port number used by the proxy server for client support. The port number identifies the port reserved for proxy activity on your network, and can be a value from 0 to 65535.
IPX/SPX	Enable		<p>Off: Disable the IPX/SPX protocol.</p> <p>On (default): Enable the IPX/SPX protocol.</p>
	Frame Type		<p>Selects the frame-type setting for your network.</p> <p>Auto: Automatically sets and limits the frame type to the first one detected.</p> <p>EN_8023, EN_II, EN_8022, and EN_SNAP: Frame-type selections for Ethernet networks.</p>
AppleTalk	Enable		<p>Off: Disable the AppleTalk protocol.</p> <p>On (default): Enable the AppleTalk protocol.</p>
DLC/LLC	Enable		<p>Off: Disable the DLC/LLC protocol.</p> <p>On (default): Enable the DLC/LLC protocol.</p>

Table 2-11 Jetdirect menus (continued)

Menu item	Sub-menu item	Sub-menu item	Values and Description
Security	Print Sec Page		<p>Yes (default): Prints a page that contains the current security settings on the HP Jetdirect print server.</p> <p>No: A security settings page is not printed.</p>
		Secure Web	<p>For configuration management, specify whether the embedded Web server will accept communications using HTTPS (Secure HTTP) only, or both HTTP and HTTPS.</p> <p>HTTPS Required (default): For secure, encrypted communications, only HTTPS access is accepted. The print server will appear as a secure site.</p> <p>HTTP/HTTPS optional: Access using either HTTP or HTTPS is permitted.</p>
	IPSEC		<p>Specify the Firewall status on the print server.</p> <p>Keep: Firewall status remains the same as currently configured.</p> <p>Disable: Firewall operation on the print server is disabled.</p>
		Reset Security	<p>Specify whether the current security settings on the print server will be saved or reset to factory defaults.</p> <p>No: The current security settings are maintained.</p> <p>Yes: Security settings are reset to factory defaults.</p>
Diagnostics	Embedded Tests		<p>This menu provides tests to help diagnose network hardware or TCP/IP network connection problems.</p> <p>Embedded tests help to identify whether a network fault is internal or external to the device. Use an embedded test to check hardware and communication paths on the print server. After you select and enable a test and set the execution time, you must select Execute to initiate the test.</p> <p>Depending on the execution time, a selected test runs continuously until either the device is turned off, or an error occurs and a diagnostic page is printed.</p>
		LAN HW Test	<p>CAUTION: Running this embedded test will erase your TCP/IP configuration.</p> <p>This test performs an internal loopback test. An internal loopback test will send and receive packets only on the internal network hardware. There are no external transmissions on your network.</p> <p>Select Yes to choose this test, or No to not choose it.</p>
		HTTP Test	<p>This test checks operation of HTTP by retrieving predefined pages from the device, and tests the embedded Web server.</p> <p>Select Yes to choose this test, or No to not choose it.</p>

Table 2-11 Jetdirect menus (continued)

Menu item	Sub-menu item	Sub-menu item	Values and Description
		SNMP Test	This test checks operation of SNMP communications by accessing predefined SNMP objects on the device. Select Yes to choose this test, or No to not choose it.
		Data Path Test	This test helps to identify data path and corruption problems on an HP postscript level 3 emulation device. It sends a predefined PS file to the device. However, the test is paperless; the file will not print. Select Yes to choose this test, or No to not choose it.
		Select All Tests	Use this item to select all available embedded tests. Select Yes to choose all tests. Select No to select individual tests.
		Execution Time [H]	Use this item to specify the length of time (in hours) that an embedded test will be run. You can select a value from 1 to 60 hours. If you select zero (0), the test runs indefinitely until an error occurs or device is turned off. Data gathered from the HTTP, SNMP, and Data Path tests is printed after the tests have completed.
		Execute	No: Do not initiate the selected tests. Yes: Initiate the selected tests.
	Ping Test		This test is used to check network communications. This test sends link-level packets to a remote network host, then waits for an appropriate response. To run a ping test, set the following items:
		Dest Type	Specify whether the target device is an IPv4 or IPv6 node.
		Dest IPv4	Type the IPv4 address.
		Dest IPv6	Type the IPv6 address.
		Packet Size	Specify the size of each packet, in bytes, to be sent to the remote host. The minimum is 64 (default) and the maximum is 2048.
		Timeout	Specify the length of time, in seconds, to wait for a response from the remote host. The default is 1 and the maximum is 100.
		Count	Specify the number of ping test packets to send for this test. Select a value from 1 to 100. To configure the test to run continuously, select 0.
		Print Results	If the ping test was not set for continuous operation, you can choose to print the test results. Select Yes to print results. If you select No (default), results are not printed.
		Execute	Specify whether to initiate the ping test. Select Yes to initiate the test, or No to not run the test.

Table 2-11 Jetdirect menus (continued)

Menu item	Sub-menu item	Sub-menu item	Values and Description
	Ping Results		Use this item to view the ping test status and results using the control panel display. You can select the following items:
		Packets Sent	Shows the number of packets (0 - 65535) sent to the remote host since the most recent test was initiated or completed.
		Packets Received	Shows the number of packets (0 - 65535) received from the remote host since the most recent test was initiated or completed.
		Percent Lost	Shows the percent of ping test packets that were sent with no response from the remote host since the most recent test was initiated or completed.
		RTT Min	Shows the minimum detected roundtrip- time (RTT), from 0 to 4096 milliseconds, for packet transmission and response.
		RTT Max	Shows the maximum detected roundtrip- time (RTT), from 0 to 4096 milliseconds, for packet transmission and response.
		RTT Average	Shows the average round-trip-time (RTT), from 0 to 4096 milliseconds, for packet transmission and response.
		Ping In Progress	Shows whether a ping test is in progress. Yes indicates a test in progress, and No indicates that a test completed or was not run.
		Refresh	When viewing the ping test results, this item updates the ping test data with current results. Select Yes to update the data, or No to maintain the existing data. However, a refresh automatically occurs when the menu times out or you manually return to the main menu.

Table 2-11 Jetdirect menus (continued)

Menu item	Sub-menu item	Sub-menu item	Values and Description
Link Speed			<p>The link speed and communication mode of the print server must match the network. The available settings depend on the device and installed print server. Select one of the following link configuration settings:</p> <p>CAUTION: If you change the link setting, network communications with the print server and network device might be lost.</p> <p>Auto (default): The print server uses auto-negotiation to configure itself with the highest link speed and communication mode allowed. If auto-negotiation fails, either 100TX HALF or 10TX HALF is set depending on the detected link speed of the hub/switch port. (A 1000T half-duplex selection is not supported.)</p> <p>10T Half: 10 Mbps, half-duplex operation.</p> <p>10T Full: 10 Mbps, Full-duplex operation.</p> <p>100TX Half: 100 Mbps, half-duplex operation.</p> <p>100TX Full: 100 Mbps, full-duplex operation.</p> <p>100TX Auto: Limits auto-negotiation to a maximum link speed of 100 Mbps.</p> <p>1000TX Full: 1000 Mbps, full-duplex operation.</p>
Print Protocols			<p>Use this item to print a page that lists the configuration of the following protocols: IPX/SPX, Novell NetWare, AppleTalk, DLC/LLC.</p>

Fax Setup

Administration > Initial Setup > Fax Setup

Table 2-12 Fax Setup menu

Menu item	Sub-menu item	Sub-menu item	Values	Description
Required Settings	Country/Region	Date Format	(Countries/regions listed)	Configure the settings that are legally required for outgoing faxes.
		Date		
		Time Format		
		Time		
	Fax Header Information	Phone Number		
	Company Name			
PC Fax Send			Disabled	Use this feature to enable or disable PC Fax Send. PC Fax Send enables users to send faxes through the device from their computers if they have the Send Fax driver installed on their PC.
			Enabled (default)	

Table 2-12 Fax Setup menu (continued)

Menu item	Sub-menu item	Sub-menu item	Values	Description	
Fax Send Settings	Fax Dial Volume		Off	Use this feature to set the volume of the tones that you hear while the device dials the fax number.	
			Low (default)		
			High		
		Error Correction Mode		Enabled (default)	When Error Correction Mode is enabled and an error occurs during fax transmission, the device sends or receives the error portion again.
			Disabled		
		JBIG Compression		Enabled (default)	JBIG compression reduces fax-transmission time, which can result in lower phone charges. However, using JBIG compression sometimes causes compatibility problems with older fax machines. If this occurs, turn off JBIG compression.
			Disabled		
		Maximum Baud Rate		Select a value from the list. The default is 33.6K.	Use this feature to set the maximum baud rate for receiving faxes. This can be used as a diagnostic tool for troubleshooting fax problems.
		TCF T.30 Delay Timer		Default (default)	This setting should be left at the default value and only changed when directed by an HP technical support agent. Adjustment procedures associated with this setting are beyond the scope of this guide.
		Custom			
	TCF Extend		Default (default)	This setting should be left at the default value and only changed when directed by an HP technical support agent. Adjustment procedures associated with this setting are beyond the scope of this guide.	
		Custom			
	Dialing Mode		Tone (default)	Select whether the device should use tone or pulse dialing.	
		Pulse			
	Redial On Busy		The range is between 0 and 9. The factory default is 3 times.	Type the number of times the device should attempt to redial if the line is busy.	
	Redial On No Answer		Never (default)	Use this feature to specify the number of times the device should attempt to dial if the recipient fax number does not answer.	
		Once			
		Twice	NOTE: Twice is available in locations other than the United States and Canada.		

Table 2-12 Fax Setup menu (continued)

Menu item	Sub-menu item	Sub-menu item	Values	Description
	Redial Interval		The range is between 1 and 5 minutes. The factory default is 5 minutes.	Use this feature to specify the number of minutes between dialing attempts if the recipient number is busy or not answering.
	Detect Dial Tone		Enabled Disabled (default)	Use this feature to specify whether the device should check for a dial tone before sending a fax.
	Dialing Prefix		Off (default) Custom	Use this feature to specify a prefix number that must be dialed when sending faxes from the device.
	Billing Codes		Off (default) Custom	When billing codes are enabled, a prompt appears that asks the user to enter the billing code for an outgoing fax. The range is between 1 and 16 digits. The default is 1 digit.
Fax Receive Settings	Rings To Answer		The range varies by location. The factory default is 2 rings.	Use this feature to specify the number of rings that must occur before the fax modem answers.
	Ring Interval		Default (default) Custom	This setting is used to adjust for some PBX ring signals. Change this setting only when directed by an HP technical support agent.
	Ring Frequency		Default (default) Custom	This setting should be left at the default value and only changed when directed by an HP technical support agent. Adjustment procedures associated with this setting are beyond the scope of this guide.
	Ringer Volume		Off Low (default) High	Set the volume for the fax ring-tone.
	Blocked Fax Numbers	Add Blocked Numbers	Type the fax number to add.	Use this feature to add or delete numbers from the blocked fax list. The blocked fax list can contain up to 30 numbers. When the device receives a call from one of the blocked fax numbers, it deletes the incoming fax. It also logs the blocked fax in the activity log along with job-accounting information.
		Remove Blocked Numbers	Select a fax number to remove.	
		Clear All Blocked Numbers	No (default) Yes	

E-mail Setup

Administration > Initial Setup > E-mail Setup

Use this menu to enable the e-mail feature and to configure basic e-mail settings.

 **NOTE:** To configure advanced e-mail settings, use the embedded Web server. For more information, see [Embedded Web server on page 178](#).

Table 2-13 E-mail Setup menu

Menu item	Values	Description
Address Validation	On (default)	This option enables the device to check e-mail syntax when you type an e-mail address. Valid e-mail addresses require the "@" sign and a ".".
	Off	
Find Send Gateways		Search the network for SMTP gateways that the device can use to send e-mail.
SMTP Gateway	Enter a value.	Specify the IP address of the SMTP gateway that is used to send e-mail from the device.
Test Send Gateway		Test the configured SMTP gateway to see if it is functional.

Send Setup menu

Administration > Initial Setup > Send Setup

Table 2-14 Send Setup menu

Menu item	Values	Description
Fax Number Confirmation	Disable (default)	When fax number confirmation is enabled, you are prompted to enter the fax number twice to verify that it has been typed correctly.
	Enable	

Device Behavior menu

Administration > Device Behavior

Table 2-15 Device Behavior menu

Menu item	Sub-menu item	Sub-menu item	Values	Description
Language			Select the language from the list.	Select a different language for control-panel messages. When you select a new language, the keyboard layout might also change.
Key Press Sound			On (default) Off	Use this feature to specify whether you hear a sound when you touch the screen or press buttons on the control panel.
Inactivity Timeout			Type a value between 10 and 300 seconds. The factory default is 60 seconds.	Specify the amount of time that elapses between any activity on the control panel and the device resetting to the default settings.
Warning/Error Behavior	Clearable Warnings		On Job (default)	Set the amount of time that a clearable warning appears on the control panel.
	Continuable Events		Auto continue (10 seconds) (default) Touch OK to continue	Configure the device behavior when the device encounters certain errors.
	Jam Recovery		Auto (default) Off On	Configure how the device handles pages that are lost during a jam.

Table 2-15 Device Behavior menu (continued)

Menu item	Sub-menu item	Sub-menu item	Values	Description
Tray Behavior	Use Requested Tray		Exclusively (default)	Control how the device handles jobs that have specified a specific input tray.
			First	
	Manually Feed Prompt		Always (default)	Specify how a prompt should appear when the type or size for a job does not match the specified tray and the device pulls from the multipurpose tray instead.
			Unless Loaded	
	PS Defer Media		Enabled (default)	Select either the PostScript (PS) or HP paper-handling model.
			Disabled	
	Use Another Tray		Enabled (default)	Turn on or off the control-panel prompt to select another tray when the specified tray is empty.
		Disabled		
Size/Type Prompt		Display (default)	Control whether the tray configuration message appears whenever a tray is opened or closed.	
		Do not display		
Duplex Blank Pages		Auto (default)	Control how the device handles two-sided jobs (duplexing).	
		Yes		
Image Rotation		Left to Right	Image rotation allows users to put paper in the input tray using the same orientation regardless of whether there is a finisher installed.	
		Right to Left		
		Alternate		

NOTE: The image rotation set in this menu will be applied any time a job does not request stapling or when the requested stapling could not be applied because of unsupported media or when the stapler is unavailable.

Select **Left to Right** to rotate the image as if it were going to be bound on the left. This setting is appropriate for print jobs where reading from left to right is the cultural norm. This is the default setting.

Select **Right to Left** to rotate the image as if it were going to be bound on the right. This setting is usually appropriate for print jobs where reading from right to left is the cultural norm.

Select **Alternate** to use a different loading orientation that might work better with preprinted forms that are used on legacy products.

Table 2-15 Device Behavior menu (continued)

Menu item	Sub-menu item	Sub-menu item	Values	Description
Multifunc Finisher or MBM-3 Bin Stapler	Operation Mode		Mailbox	This menu appears when the HP 3-bin Stapler/Stacker Accessory or the HP Booklet Maker/Finisher Accessory is attached.
			Stacker	
			Function Separator	Allows you to set the default operation mode. Mailbox assigns a user or group of users to each output bin. Stacker treats all of the output bins as a single large bin. When one bin gets full, jobs are automatically routed to the next bin. Function Separator specifies a default bin for specific types of jobs such as faxes or copies (stapler/stacker only).
	Staples		None	Sets the default staple selection for documents sent to the device when no staple value is specified.
			One Left Angled	
			One Right Angled	
			Two Left	
			Two Right	
			Two Top	
	Staples Out		Stop	Sets the default behavior when a job specifies stapling and the stapler is out of staples. Stop stops printing if the stapler runs out of staples. Continue allows a job to continue printing even when the device is out of staples.
			Continue	
	Offset		Off	Turns the job offset feature on or off. When job offset is on, each copy of a job is shifted to one side in the output bin in order to keep each copy separate from the others.
			On	
	A4/Letter Staple		Normal	Controls the speed of the print engine to prevent paper jams by using the stapler buffer. NOTE: The stapler buffer may or may not be used depending on the selected media type or on the sensed media type, if Autosense Mode is enabled. If the Normal setting is enabled, the engine speed will be normal by using the stapler buffer whenever possible. If the Alternate 1 setting is enabled, and the engine is in Autosense Mode, the engine slows down to prevent jams. If the product is NOT in Autosense Mode, the engine performs at normal speed, using the stapler buffer whenever possible. If the Alternate 2 setting is enabled, the engine always slows down to prevent jams, never using the stapler buffer.
			Alternate 1	
			Alternate 2	

Table 2-15 Device Behavior menu (continued)

Menu item	Sub-menu item	Sub-menu item	Values	Description
	Fold LTR-R & A4 - R		-4.0 mm	Adjusts the fold line for Letter and A4 size paper (booklet maker only).
			-3.5 mm	
			-3.0 mm	
			-2.5 mm	
			-2.0 mm	
			-1.5 mm	
			-1.0 mm	
			-0.5 mm	
			0.0 mm	
			0.5 mm	
			1.0 mm	
			1.5 mm	
			2.0 mm	
			2.5 mm	
			3.0 mm	
			3.5 mm	
			4.0 mm	

Table 2-15 Device Behavior menu (continued)

Menu item	Sub-menu item	Sub-menu item	Values	Description
	Fold Legal & JISB4		-4.0 mm	Adjusts the fold line for Legal and JIS B4 size paper (booklet maker only).
			-3.5 mm	
			-3.0 mm	
			-2.5 mm	
			-2.0 mm	
			-1.5 mm	
			-1.0 mm	
			-0.5 mm	
			0.0 mm	
			0.5 mm	
			1.0 mm	
			1.5 mm	
			2.0 mm	
			2.5 mm	
			3.0 mm	
			3.5 mm	
			4.0 mm	

Table 2-15 Device Behavior menu (continued)

Menu item	Sub-menu item	Sub-menu item	Values	Description
	Fold 11X17 & A3		-4.0 mm -3.5 mm -3.0 mm -2.5 mm -2.0 mm -1.5 mm -1.0 mm -0.5 mm 0.0 mm 0.5 mm 1.0 mm 1.5 mm 2.0 mm 2.5 mm 3.0 mm 3.5 mm 4.0 mm	Adjusts the fold line for Legal and 11x17 and A3 size paper (booklet maker only).
General Copy Behavior	Scan Ahead		Enabled (default)	Turn on no-wait scanning. With Scan Ahead enabled, the pages in the original document are scanned to disk and held until the device becomes available.
			Disabled	
	Auto Print Interrupt		Enabled	When this feature is enabled, copy jobs can interrupt print jobs that are set to print multiple copies. The copy job is inserted into the print queue at the end of one copy of the print job. After the copy job is complete, the device continues printing the remaining copies of the print job.
			Disabled (default)	
Copy Interrupt		Enabled	When this feature is enabled, a copy job that is currently printing can be interrupted when a new copy job is started. You are prompted to confirm that you want to interrupt the current job.	
		Disabled (default)		
	Alternative Letterhead Mode		Off (default)	This option allows loading of letterhead or preprinted paper the same way for all copy jobs, whether copying to one side of the paper or to both sides of the paper.
			On	

Table 2-15 Device Behavior menu (continued)

Menu item	Sub-menu item	Sub-menu item	Values	Description
General Printing Behavior	Override A4/Letter		No	When this feature is enabled, the job prints on letter-size paper when an A4 job is sent but no A4-size paper is loaded in the device (or prints on A4 paper when a letter-size job is sent but no letter-size paper is loaded). This option also overrides A3 with ledger-size paper and ledger with A3-size paper.
			Yes (default)	
	Manual Feed		Enabled	When this feature is enabled, the user can select manual feed from the control panel as the paper source for a job.
			Disabled (default)	
	Courier Font		Regular (default)	Select which version of the Courier font you want to use.
			Dark	
	Wide A4		Enabled	Change the printable area of A4-size paper. If you enable this option, eighty 10-pitch characters can be printed on a single line of A4 paper.
			Disabled (default)	
Print PS Errors		Enabled	Select whether a PostScript (PS) error page is printed when the device encounters a PS error.	
		Disabled (default)		
Print PDF Errors		Enabled	Select whether a PDF error page is printed when the device encounters a PDF error.	
		Disabled (default)		
Personality		Auto (default)	Select the printer language that the device should use. <i>Normally, you should not change the language.</i> If you change the setting to a specific language, the device does not automatically switch from one language to another unless specific software commands are sent to the device.	
		PCL		
		PDF		
		PS		

Table 2-15 Device Behavior menu (continued)

Menu item	Sub-menu item	Sub-menu item	Values	Description
	PCL	Form Length	Type a value between 5 and 128 lines. The factory default is 60 lines.	PCL is a set of printer commands that Hewlett-Packard developed to provide access to printer features.
		Orientation	Portrait (default) Landscape	Select the orientation that is most often used for print jobs. Select Portrait if the short edge is at the top or Landscape if the long edge is at the top.
		Font Source	Select the source from the list.	Select the font source for the user-soft default font.
		Font Number	Type the font number. The range is between 0 and 999. The factory default is 0.	Specify the font number for the user soft default font by using the source that is specified in the Font Source menu item. The device assigns a number to each font and lists it on the PCL font list (available from the Administration menu).
		Font Pitch	Type a value between 0.44 and 99.99. The factory default is 10.00.	If Font Source and Font Number indicate a contour font, use this feature to select a default pitch (for a fixed-spaced font).
		Symbol Set	PC-8 (default) (50 additional symbol sets from which to choose)	Select any one of several available symbol sets from the control panel. A symbol set is a unique grouping of all the characters in a font.
		Append CR to LF	No (default) Yes	Configure whether a carriage return (CR) is appended to each line feed (LF) encountered in backwards-compatible PCL jobs (pure text, no job control).
		Suppress Blank Pages	No (default) Yes	This option is for users who are generating their own PCL, which could include extra form feeds that cause blank pages to be printed. When Yes is selected, form feeds are ignored if the page is blank.
		Media Source Mapping	Standard (default) Classic	Select and maintain input trays by number when you are not using the device driver, or when the software program has no option for tray selection.

Print Quality menu

Administration > Print Quality

Table 2-16 Print Quality menu

Menu item	Sub-menu item	Values	Description
Adjust Color	Highlights	Cyan Density. Magenta Density. Yellow Density. Black Density +5 to -5. Default is 0.	Adjust the darkness or lightness of highlights on a printed page. Lower values represent lighter highlights on a printed page, and higher values represent darker highlights on a printed page.
	Midtones	Cyan Density. Magenta Density. Yellow Density. Black Density +5 to -5. Default is 0.	Adjust the darkness or lightness of midtones on a printed page. Lower values represent lighter midtones on a printed page, and higher values represent darker midtones on a printed page.
	Shadows	Cyan Density. Magenta Density. Yellow Density. Black Density +5 to -5. Default is 0.	Adjust the darkness or lightness of shadows on a printed page. Lower values represent lighter shadows on a printed page, and higher values represent darker shadows on a printed page.
	Restore Color Values		Sets all the density values back to the factory default settings.
Set Registration	Test Page	Print	Shift the margin alignment to center the image on the page from top to bottom and from left to right. You can also align the image on the front with the image printed on the back. Print a test page for setting the registration.
	Source	All trays Tray <X>: <contents> (choose a tray)	Select the source input tray for printing the Set Registration page.
	Adjust Tray <X>	Shift from -20 to 20 along the X or Y axes. 0 is the default. X1 Shift X2 Shift Y Shift	Perform the alignment procedure for each tray. When it creates an image, the device <i>scans</i> across the page from side to side as the sheet <i>feeds</i> from top to bottom into the device. The scan direction is referred to as X. X1 is the scan direction for the first side of a 2-sided page. X2 is the scan direction for the second side of a 2-sided page. The feed direction is referred to as Y.
Print Modes	<Paper Type>		Configure which mode is associated with which paper type.

Table 2-16 Print Quality menu (continued)

Menu item	Sub-menu item	Values	Description
Auto Sense Mode	Tray 1 sensing	<p>Full Sensing (default for Tray 1)</p> <p>Expanded Sensing (default for Trays 2-5)</p> <p>Transparency Only</p>	When Full Sensing is selected, the product recognizes light, plain, heavy, glossy, and tough paper and overhead transparencies. When Expanded Sensing is selected, the device recognizes normal paper, overhead transparencies, glossy paper, and tough paper. When Transparency Only is selected, the device recognizes only overhead transparency and non-overhead transparency types.
	Tray 2-5 Sensing	<p>Expanded Sensing</p> <p>Transparency Only (default)</p>	When Expanded Sensing is selected, the device recognizes normal paper, overhead transparencies, glossy paper, and tough paper. When Transparency Only is selected, the device recognizes only overhead transparency and non-overhead transparency types.
Optimize	Paper Curl	<p>Normal</p> <p>Reduced</p>	To help reduce paper curl, set this option to Reduced . This decreases full speed to 10 PPM (instead of 40 ppm) and 3/4 speed to 7.5 ppm (instead of 30 ppm).
	Pre-rotation	<p>Off (default)</p> <p>On</p>	Turn this feature On if horizontal streaks appear on pages. Using this feature increases the warm-up time for the device.
	Fuser Temp	<p>Normal (default)</p> <p>Alternate 1</p> <p>Alternate 2</p> <p>Alternate 3</p>	If you are seeing a faint image of the page repeated at the bottom of the page or on the following page, you should first make sure the Paper Type and Print Mode settings are correct for the type of paper you are using. If you continue to see ghost images on your print jobs, set the Fuser Temp feature to one of the Alternate settings . Try the Alternate 1 setting first and see if it solves the problem. If you continue to see the problem, try Alternate 2 and then Alternate 3. With the Alternate 2 and Alternate 3 settings you may see an extra delay between jobs.
	Tray 1	<p>Normal (default)</p> <p>Alternate</p>	If you are seeing marks on the back side of the paper when printing from Tray 1, set the mode to Alternate . This increases the frequency of the cleaning cycle.
	Gloss Mode	<p>Normal (default)</p> <p>High</p>	Chosen when stable high gloss is required. Set this feature to High for glossy print jobs, such as photos, if you notice the gloss finish decreasing after the first page is printed. This setting reduces the performance for all paper types.

Table 2-16 Print Quality menu (continued)

Menu item	Sub-menu item	Values	Description
	Light Media	Auto (default) On	Prevents the fuser from wrapping with light paper. Set this feature to On if you are frequently seeing Fuser Delay Jam or Fuser Wrap Jam messages, especially when printing on lightweight paper or on jobs with heavy toner coverage.
	Environment	Normal (default) Low Temp	Optimizes performance in extreme low temperature environments. Set this feature to Low Temp if the product is operating in a low-temperature environment and you are having problems with print quality such as blisters in the printed image.
	Line Voltage	Normal (default) 100V	Optimizes performance in low-voltage conditions. Set this feature to 100V if the product is operating in a low-voltage environment and you are having problems with print quality such as blisters in the printed image.
	Cleaning frequency	Normal (default) Alternate	Set this feature to Alternate if you are seeing defects in the printed output that repeat at 38 mm (1.5 inch) intervals. This feature increases the frequency at which the C roller is cleaned. Setting this feature to Alternate might also reduce printing speed and increase the frequency of consumable replacement.
	D-Blade bias	Normal (default) Alternate	Set this feature to Alternate if you are seeing short white vertical lines in the printed output. The Alternate setting might also cause dark spots in the printed output, so be sure to test this setting on a few print jobs.
	Waste Bin	Normal (default) Alternate	Try setting this feature to Alternate if you are seeing lengthwise toner streaks in your printed output, especially in jobs with low toner coverage.
	Discharge Brush	Off (default) On	Enable this feature in low temperature and low humidity environments if you are seeing specks of toner scattered on double-sided jobs using light-weight paper and longer than ten pages.
	Background	Off (default) On	Turn this feature On if pages are printing with a shaded background. Using this feature might reduce gloss levels.
	Heavy Mode	30 PPM (default) 24 PPM	The default setting is 30 PPM. Select the 24 PPM option to reduce the speed and improve fusing on heavy paper.
	Tracking Control	Off (default) On	Improves color stability by adjusting the bias voltage. This setting should remain On.
	Restore Optimize		Select this setting to return all the settings in the Optimize menu to the factory default settings.
Resolution	Image REt 4800 1200X600dpi		Select Image REt 4800 to produces fast, high-quality printing that is appropriate for most print jobs Select 1200X600dpi to produce the highest-quality printing available, but it may slow print speed. This setting may be useful for jobs that contain very thin lines or fine graphics.
Color REt		Enabled (default) Disabled	Enable or disable Resolution Enhancement technology (REt), which produces print output with smooth angles, curves, and edges.

Table 2-16 Print Quality menu (continued)

Menu item	Sub-menu item	Values	Description
Calibration/Cleaning			
	Process Cleaning Page	Process	Use this feature to create and process a cleaning page for cleaning excess toner off the pressure roller in the fuser. The process takes up to 2.5 minutes.
	Quick Calibration	Calibrate	Performs partial product calibrations.
	Full Calibration	Calibrate	Performs all product calibrations.
	Delay Calibration At Wake/Power On	No Yes (default)	<p>This menu controls the timing of the calibration when the printer wakes up or is turned on.</p> <ul style="list-style-type: none">• Select No to have the printer calibrate immediately when it wakes up or is turned on. The device will not print any jobs until it finishes calibrating.• Select Yes to enable a device that is asleep to accept print jobs before it calibrates. The device only accepts new jobs for a short time. It may start calibrating before it has printed all the jobs it has received. <p>NOTE: For the best results, allow the device to calibrate before printing. Print jobs performed before calibration may not be of the highest quality.</p>

Troubleshooting menu

Administration > Troubleshooting

 **NOTE:** Many of the menu items under the Troubleshooting menu are for advanced troubleshooting purposes.

Table 2-17 Troubleshooting menu

Menu item	Sub-menu item	Sub-menu item	Values	Description
Event Log			Print	This shows the event codes and their corresponding engine cycles on the control-panel display.
Calibrate Scanner			Calibrate	Use this feature to compensate for offsets in the scanner imaging system (carriage head) for ADF and flatbed scans. You might need to calibrate the scanner if it is not capturing the correct sections of scanned documents.
PQ Troubleshooting			Print	Print various diagnostic pages that help solve print-quality problems.
Fax T.30 Trace	Print T.30 Report			Print or configure the fax T.30 trace report. T.30 is the standard that specifies handshaking, protocols, and error correction between fax machines.
	When to Print Report		Never auto print (default)	
			Print after any fax job	
			Print after fax send jobs	
			Print after any fax error	
			Print after send errors only	
			Print after receive errors only	
Fax Transmit Signal Loss			A value between 0 and 30. The default is 0.	Set loss levels to compensate for phone-line signal loss. Do not modify this setting unless requested to do so by an HP service representative because it could cause the fax to stop functioning.
Fax V.34			Normal (default) Off	Disable V.34 mode if several fax failures have occurred or if phone line conditions require it.
Fax Speaker Mode			Normal (default) Diagnostic	A technician can use this feature technician to evaluate and diagnose fax issues by listening to the sounds of fax modulations.
Diagnostic Page			Print	Print a diagnostic page that includes color swatches and the EP parameters table.

Table 2-17 Troubleshooting menu (continued)

Menu item	Sub-menu item	Sub-menu item	Values	Description
Disable Cartridge Check				Use this item to enter a mode where a cartridge (or color pair of cartridge and drum) can be removed to determine which particular color is the source of a problem. In this mode, all consumable-related errors are ignored.
Paper Path Sensors				Initiate a test of the paper-path sensors.
Paper Path Test	Test Page		Print	Generate a test page for testing the paper-handling features. Define the path for the test in order to test specific paper paths.
	Source		All trays Tray 1 Tray 2 (Additional trays are shown, if applicable.)	Specify whether the test page is printed from all trays or from a specific tray.
	Destination		All bins	Select the output option for the test page. Send the test page to all output bins or only to a specific bin.
	Duplex		Off (default) On	Select whether the duplexer should be included in the test.
	Copies		Range: 1-500, Default is 1.	Select how many pages should be sent from the specified source as part of the test.

Table 2-17 Troubleshooting menu (continued)

Menu item	Sub-menu item	Sub-menu item	Values	Description	
Finishing Paper Path Test	Staples	Finishing Options	Choose from a list of available options.	Test the paper-handling features on the finisher. Select the option that you want to test.	
		Destination Bin			
		Media Size	Letter A4	Select the paper size for the test.	
		Media Type	Select from a list of types.	Select the paper type for the test.	
		Copies	Range: 2-30, Default=2	Select the number of copies to include in the test.	
		Duplex	Off On	Select whether to use the duplexer in the test.	
		Test Page	Print	Print a test page to use for the test.	
		Stack	Destination Bin	Select from a list of bins.	Select the options that you want to use to test the stacker.
			Media Size	Letter Legal A4 Executive (JIS) 8.5 x 13	
			Media Type	Select from a list of bins.	Select the type of media to use for the Finishing Paper Path Test.
Copies	1 10 50 100 500		Select the number of copies to include in the Finishing Paper Path Test.		
Duplex	Off On		Select whether to use the duplexer in the Finishing Paper Path Test.		
Test Page	Print		Print a test page to use for the test.		

Table 2-17 Troubleshooting menu (continued)

Menu item	Sub-menu item	Sub-menu item	Values	Description
	Booklet Maker	Media Size	Letter Legal A4 Executive (JIS) 8.5 x 13	Select the options that you want to use to test the booklet maker.
		Media Type	Select from a list of bins.	Select the type of media to use for the Finishing Paper Path Test.
		Copies	1 10 50 100 500	Select the number of copies to include in the Finishing Paper Path Test.
		Duplex	Off On	Select whether to use the duplexer in the Finishing Paper Path Test.
		Test Page	Print	Print a test page to use for the test.
	Manual Sensor Test			This item performs tests to determine whether the paper-path sensors are operating correctly.

Table 2-17 Troubleshooting menu (continued)

Menu item	Sub-menu item	Sub-menu item	Values	Description
Component Test		Transfer Motors		Exercise individual parts independently to isolate noise, leaking, or other issues. To start the test, select one of the components. The test runs the number of times specified in the Repeat option. You might be prompted to remove parts from the device during the test. Press the Stop button to abort the test.
		Belt Only		
		Image Drum Motors		
		Black Laser Scanner		
		Cyan Laser Scanner		
		Magenta Laser Scanner		
		Yellow Laser Scanner		
		Fuser Motor		
		Fuser Pressure Release Motor		
		Black Alienation Motor		
		Cyan Alienation Motor		
		Magenta Alienation Motor		
		Yellow Alienation Motor		
		ITB Contact/ Alienation		
		Tray 2 Pickup Motor		
		Tray 2 Pickup Solenoid		
		Tray 3 Pickup Motor		
		Tray 3 Pickup Solenoid		
		Tray 4 Pickup Motor		
		Tray 4 Pickup Solenoid		
	Tray 5 Pickup Motor			
	Tray 5 Pickup Solenoid			
	Duplexer Reverse Motor			
	Duplexer Feed Motor			
	Duplexer ReFeed Motor			
	Paper Transport Motor			

Table 2-17 Troubleshooting menu (continued)

Menu item	Sub-menu item	Sub-menu item	Values	Description
	Repeat		Once (Default) Continuous	Determines the number of times the test runs.
Print/Stop Test			Continuous value from 0 to 60,000 milliseconds. Default: 0	Isolate faults by stopping the device during the print cycle and observing where in the process the image degrades. To run the test, specify a stop time. The next job that is sent to the device stops at the specified time in the process.
Color Band Test	Test Page		Print	Prints a page that helps identify arcing in the high-voltage power supplies.
	Copies		Continuous value from 1 to 30. Default: 1	Specify the number of copies to print for the Color Band test
Scanner Tests	Lower Lamp			A service technician can use this menu item to diagnose potential problems with the device scanner.
	Sensors			
	ADF Input Motor			
	ADF Input Reverse			
	Flatbed Motor			
	ADF Read Motor			
	ADF Read Motor Reverse			
	ADF Duplex Solenoid			
	ADF LED Indicator			
Control Panel	LEDs			Verify that the components of the control panel are functioning correctly.
	Display			
	Buttons			
	Touchscreen			
Finisher Tests	Manual Sensor Test			
	Component Test			

Resets menu

Administration > Resets

Table 2-18 Resets menu

Menu item	Values	Description
Clear Local Address Book	Clear	Use this feature to clear all addresses from the address books that are stored on the device.
Clear Fax Activity Log	Yes No (default)	Use this feature to clear all events from the Fax Activity Log.
Restore Factory Telecom Setting	Restore	Use this option to restore the following settings to their factory default settings: Transmit Signal Loss, V34, Maximum Baud Rate, Speaker Mode.
Restore Factory Settings	Restore	Use this feature to restore all device settings to their factory defaults.
Reset Supplies	New Document Feeder Kit (Yes/No)	Notify the device that a new document-feeder kit has been installed.

Service menu

Administration > Service

The Service menu is locked and requires a PIN for access. This menu is intended for use by authorized service personnel.

3 Software for Windows

- [Supported operating systems for Windows](#)
- [Supported printer drivers for Windows](#)
- [HP Universal Print Driver \(UPD\)](#)
- [Select the correct printer driver for Windows](#)
- [Priority for print settings](#)
- [Change printer-driver settings for Windows](#)
- [Supported utilities for Windows](#)
- [Software for other operating systems](#)

Supported operating systems for Windows

The product supports the following Windows operating systems:

- Windows XP (32-bit and 64-bit)
- Windows Server 2003 (32-bit and 64-bit)
- Windows Server 2008 (32-bit and 64-bit)
- Windows 2000
- Windows Vista (32-bit and 64-bit)

Supported printer drivers for Windows

HP provides the following drivers for downloading:

- HP Universal Print Driver (UPD): Postscript, PCL 6, PCL 5
- Mac Driver
- Linux
- SAP
- UNIX Model Script

Drivers for this product are available at www.hp.com/go/cljcm6049mfp_software or your country/region alternative.

The printer drivers include online Help that has instructions for common printing tasks and also describes the buttons, checkboxes, and drop-down lists that are in the printer driver.



NOTE: For more information about the UPD, see www.hp.com/go/upd.

HP Universal Print Driver (UPD)

The HP Universal Print Driver (UPD) for Windows is a single driver that gives you instant access to virtually any HP LaserJet product, from any location, without downloading separate drivers. It is built on proven HP print driver technology and has been tested thoroughly and used with many software programs. It is a powerful solution that performs consistently over time.

The HP UPD communicates directly with each HP product, gathers configuration information, and then customizes the user interface to show the product's unique, available features. It automatically enables features that are available for the product, such as two-sided printing and stapling, so you do not need to enable them manually.

 **NOTE:** For more information about the UPD, see www.hp.com/go/upd.

UPD installation modes

Traditional mode

- Use this mode if you are installing the driver for a single computer.
- When installed with this mode, UPD operates like traditional printer drivers.
- If you use this mode, you must install UPD separately for each computer.

Dynamic mode

- Use this mode if you are installing the driver for a mobile computer, so you can discover and print to HP products in any location.
 - Use this mode if you are installing UPD for a workgroup.
 - To use this mode, download UPD from the Internet. See www.hp.com/go/upd, www.hp.com/go/cljcm6049mfp_software, or your country/region alternative.
-

Select the correct printer driver for Windows

Printer drivers provide access to the product features and allow the computer to communicate with the product (using a printer language). Check the installation notes and readme files for additional software and languages.

HP PCL 6 driver description

- Recommended for printing in all Windows environments
- Provides the overall best speed, print quality, and product-feature support for most users
- Developed to align with the Windows Graphic Device Interface (GDI) for the best speed in Windows environments
- Might not be fully compatible with third-party and custom software programs that are based on PCL 5

HP postscript emulation description

- Recommended for printing with Adobe® software programs or with other highly graphics-intensive software programs
- Provides support for printing from postscript level 3 emulation needs, or for postscript flash font support
- Performs slightly faster than the PCL 6 driver when using Adobe software programs

HP PCL 5 description

- Recommended for general office printing in Windows environments
- Compatible with previous PCL versions and older HP LaserJet products
- The best choice for printing from third-party or custom software programs
- The best choice when operating with mixed environments, which require the product to be set to PCL 5 (UNIX, Linux, mainframe)
- Designed for use in corporate Windows environments to provide a single driver for use with multiple printer models
- Preferred when printing to multiple printer models from a mobile Windows computer

Priority for print settings

Changes to print settings are prioritized depending on where the changes are made:

 **NOTE:** The names of commands and dialog boxes might vary depending on your software program.

- **Page Setup dialog box:** Click **Page Setup** or a similar command on the **File** menu of the program you are working in to open this dialog box. Settings changed here override settings changed anywhere else.
- **Print dialog box:** Click **Print**, **Print Setup**, or a similar command on the **File** menu of the program you are working in to open this dialog box. Settings changed in the **Print** dialog box have a lower priority and do *not* override changes made in the **Page Setup** dialog box.
- **Printer Properties dialog box (printer driver):** Click **Properties** in the **Print** dialog box to open the printer driver. Settings changed in the **Printer Properties** dialog box do not override settings anywhere else in the printing software.
- **Default printer driver settings:** The default printer driver settings determine the settings used in all print jobs, *unless* settings are changed in the **Page Setup**, **Print**, or **Printer Properties** dialog boxes.
- **Printer control panel settings:** Settings changed at the printer control panel have a lower priority than changes made anywhere else.

Change printer-driver settings for Windows

Change the settings for all print jobs until the software program is closed	Change the default settings for all print jobs	Change the product configuration settings
<ol style="list-style-type: none">1. On the File menu in the software program, click Print.2. Select the driver, and then click Properties or Preferences.	<ol style="list-style-type: none">1. Windows XP, Windows Server 2003, and Windows Server 2008 (using the default Start menu view): Click Start, and then click Printers and Faxes.	<ol style="list-style-type: none">1. Windows XP, Windows Server 2003, and Windows Server 2008 (using the default Start menu view): Click Start, and then click Printers and Faxes.
<p>The steps can vary; this procedure is most common.</p>	<p>-or-</p>	<p>-or-</p>
	<p>Windows 2000, Windows XP, Windows Server 2003, and Windows Server 2008 (using the Classic Start menu view): Click Start, click Settings, and then click Printers.</p>	<p>Windows 2000, Windows XP, Windows Server 2003, and Windows Server 2008 (using the Classic Start menu view): Click Start, click Settings, and then click Printers.</p>
	<p>-or-</p>	<p>-or-</p>
	<p>Windows Vista: Click Start, click Control Panel, and then in the category for Hardware and Sound click Printer.</p>	<p>Windows Vista: Click Start, click Control Panel, and then in the category for Hardware and Sound click Printer.</p>
	<ol style="list-style-type: none">2. Right-click the driver icon, and then select Printing Preferences.	<ol style="list-style-type: none">2. Right-click the driver icon, and then select Properties.
		<ol style="list-style-type: none">3. Click the Device Settings tab.

Supported utilities for Windows

HP Web Jetadmin

HP Web Jetadmin is a browser-based management tool for HP Jetdirect-connected printers within your intranet, and it should be installed only on the network administrator's computer.

 **NOTE:** HP Web Jetadmin 10.0 or later is required for full support of this product.

To download a current version of HP Web Jetadmin and for the latest list of supported host systems, visit www.hp.com/go/webjetadmin.

When installed on a host server, any client can gain access to HP Web Jetadmin by using a supported Web browser (such as Microsoft® Internet Explorer 4.x or Netscape Navigator 4.x or later) by navigating to the HP Web Jetadmin host.

Embedded Web server

The device is equipped with an embedded Web server, which provides access to information about device and network activities. This information appears in a Web browser, such as Microsoft Internet Explorer, Netscape Navigator, Apple Safari, or Firefox.

The embedded Web server resides on the device. It is not loaded on a network server.

The embedded Web server provides an interface to the device that anyone who has a network-connected computer and a standard Web browser can use. No special software is installed or configured, but you must have a supported Web browser on your computer. To gain access to the embedded Web server, type the IP address for the device in the address line of the browser. (To find the IP address, print a configuration page. For more information about printing a configuration page, see [Information pages on page 176](#).)

For a complete explanation of the features and functionality of the embedded Web server, see [Embedded Web server on page 178](#).

Software for other operating systems

OS	Software
UNIX	For HP-UX and Solaris networks, go to www.hp.com/support/go/jetdirectunix_software to install model scripts using the HP Jetdirect printer installer (HPPI) for UNIX. For the latest model scripts, go to www.hp.com/go/unixmodelscripts .
Linux	For information, go to www.hp.com/go/linuxprinting .

4 Use the product with Macintosh

- [Software for Macintosh](#)
- [Use features in the Macintosh printer driver](#)

Software for Macintosh

Supported operating systems for Macintosh

The device supports the following Macintosh operating systems:

- Mac OS X V10.3, V10.4, V10.5 and later

 **NOTE:** For Mac OS X V10.4 and later, PPC and Intel Core Processor Macs are supported.

Supported printer drivers for Macintosh

The HP installer provides PostScript® Printer Description (PPD) files, Printer Dialog Extensions (PDEs), and the HP Printer Utility for use with Macintosh computers.

The PPDs, in combination with the Apple PostScript printer drivers, provide access to device features. Use the Apple PostScript printer driver that comes with the computer.

Remove software from Macintosh operating systems

To remove the software from a Macintosh computer, drag the PPD files to the trash can.

Priority for print settings for Macintosh

Changes to print settings are prioritized depending on where the changes are made:

 **NOTE:** The names of commands and dialog boxes might vary depending on your software program.

- **Page Setup dialog box:** Click **Page Setup** or a similar command on the **File** menu of the program you are working in to open this dialog box. Settings changed here might override settings changed anywhere else.
- **Print dialog box:** Click **Print**, **Print Setup**, or a similar command on the **File** menu of the program you are working in to open this dialog box. Settings changed in the **Print** dialog box have a lower priority and do *not* override changes made in the **Page Setup** dialog box.
- **Default printer driver settings:** The default printer driver settings determine the settings used in all print jobs, *unless* settings are changed in the **Page Setup**, **Print**, or **Printer Properties** dialog boxes.
- **Printer control panel settings:** Settings changed at the printer control panel have a lower priority than changes made anywhere else.

Change printer-driver settings for Macintosh

Change the settings for all print jobs until the software program is closed	Change the default settings for all print jobs	Change the product configuration settings
<ol style="list-style-type: none">1. On the File menu, click Print.2. Change the settings that you want on the various menus.	<ol style="list-style-type: none">1. On the File menu, click Print.2. Change the settings that you want on the various menus.3. On the Presets menu, click Save as and type a name for the preset. <p>These settings are saved in the Presets menu. To use the new settings, you must select the saved preset option every time you open a program and print.</p>	<p>Mac OS X V10.3 or Mac OS X V10.4</p> <ol style="list-style-type: none">1. From the Apple menu, click System Preferences and then Print & Fax.2. Click Printer Setup.3. Click the Installable Options menu. <p>Mac OS X V10.5</p> <ol style="list-style-type: none">1. From the Apple menu, click System Preferences and then Print & Fax.2. Click Options & Supplies.3. Click the Driver menu.4. Select the driver from the list, and configure the installed options.

Software for Macintosh computers

HP Printer Utility

Use the HP Printer Utility to set up product features that are not available in the printer driver.

You can use the HP Printer Utility when the product uses a universal serial bus (USB) cable or is connected to a TCP/IP-based network.

Open the HP Printer Utility

Open the HP Printer Utility in Mac OS X V10.3 and V10.4

1. Open the Finder, click **Applications**, click **Utilities**, and then double-click **Printer Setup Utility**.
2. Select the product that you want to configure, and then click **Utility**.

Open the HP Printer Utility in Mac OS X V10.5

- From the **Printer** menu, click **Printer Utility**.

-or-

From the **Print Queue**, click the **Utility** icon.

HP Printer Utility features

The HP Printer Utility consists of pages that you open by clicking in the **Configuration Settings** list. The following table describes the tasks that you can perform from these pages.

Item	Description
Configuration Page	Prints a configuration page.
Supplies Status	Shows the device supplies status.
File Upload	Transfers files from the computer to the device.
Upload Fonts	Transfers font files from the computer to the device.
Firmware Update	Transfers updated firmware files from the computer to the device.
Duplex Mode	Turns on the automatic two-sided printing mode.
Economode & Toner Density	Turns on the Economode setting to conserve toner, or adjusts toner density.
Resolution	Changes the resolution settings, including the REt setting.
Lock Resources	Locks or unlocks storage products, such as a hard disk.
Stored Jobs	Manages print jobs that are stored on the device hard disk.
Trays Configuration	Changes the default tray settings.
IP Settings	Changes the device network settings and provides access to the embedded Web server.
Bonjour Settings	Provides the ability to turn on or off Bonjour support or change the device service name that is listed on a network.
Additional Settings	Provides access to the embedded Web server.
E-mail Alerts	Configures the device to send e-mail notices for certain events.

Supported utilities for Macintosh

Embedded Web server

The device is equipped with an embedded Web server, which provides access to information about device and network activities. For more information, see [Embedded Web server sections on page 179](#).

Use features in the Macintosh printer driver

Print

Create and use printing presets in Macintosh

Use printing presets to save the current printer driver settings for reuse.

Create a printing preset

1. On the **File** menu, click **Print**.
2. Select the driver.
3. Select the print settings.
4. In the **Presets** box, click **Save As...**, and type a name for the preset.
5. Click **OK**.

Use printing presets

1. On the **File** menu, click **Print**.
2. Select the driver.
3. In the **Presets** box, select the printing preset that you want to use.

 **NOTE:** To use printer-driver default settings, select **Standard**.

Resize documents or print on a custom paper size

You can scale a document to fit on a different size of paper.

1. On the **File** menu, click **Print**.
2. Open the **Paper Handling** menu.
3. In the area for **Destination Paper Size**, select **Scale to fit paper size**, and then select the size from the drop-down list.
4. If you want to use only paper that is smaller than the document, select **Scale down only**.

Print a cover page

You can print a separate cover page for your document that includes a message (such as “Confidential”).

1. On the **File** menu, click **Print**.
2. Select the driver.
3. Open the **Cover Page** menu, and then select whether to print the cover page **Before Document** or **After Document**.
4. In the **Cover Page Type** menu, select the message that you want to print on the cover page.

 **NOTE:** To print a blank cover page, select **Standard** as the **Cover Page Type**.

Use watermarks

A watermark is a notice, such as “Confidential,” that is printed in the background of each page of a document.

1. On the **File** menu, click **Print**.
2. Open the **Watermarks** menu.
3. Next to **Mode**, select the type of watermark to use. Select **Watermark** to print a semi-transparent message. Select **Overlay** to print a message that is not transparent.
4. Next to **Pages**, select whether to print the watermark on all pages or on the first page only.
5. Next to **Text**, select one of the standard messages, or select **Custom** and type a new message in the box.
6. Select options for the remaining settings.

Print multiple pages on one sheet of paper in Macintosh

You can print more than one page on a single sheet of paper. This feature provides a cost-effective way to print draft pages.

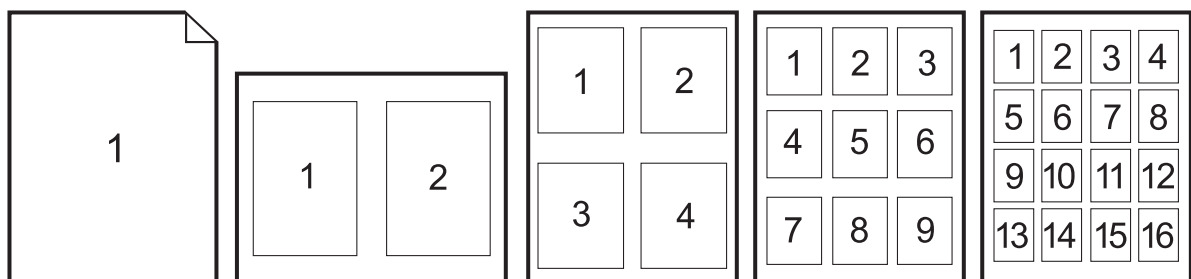

1. On the **File** menu, click **Print**.
2. Select the driver.
3. Open the **Layout** menu.
4. Next to **Pages per Sheet**, select the number of pages that you want to print on each sheet (1, 2, 4, 6, 9, or 16).
5. Next to **Layout Direction**, select the order and placement of the pages on the sheet.
6. Next to **Borders**, select the type of border to print around each page on the sheet.

Print on both sides of the page (duplex printing)

Use automatic duplex printing

1. Insert enough paper into one of the trays to accommodate the print job. If you are loading special paper such as letterhead, load it in one of the following ways:
 - For tray 1, load the letterhead paper face-up with the bottom edge feeding into the printer first.
 - For all other trays, load the letterhead paper face-down with the top edge at the back of the tray.
2. On the **File** menu, click **Print**.
3. Open the **Layout** menu.
4. Next to **Two-Sided**, select either **Long-Edge Binding** or **Short-Edge Binding**.
5. Click **Print**.

Print on both sides manually

1. Insert enough paper into one of the trays to accommodate the print job. If you are loading special paper such as letterhead, load it in one of the following ways:
 - For tray 1, load the letterhead paper face-up with the bottom edge feeding into the printer first.
 - For all other trays, load the letterhead paper face-down with the top edge at the back of the tray.

△ **CAUTION:** To avoid jams, do not load paper that is heavier than 105 g/m² (28-lb bond).

2. On the **File** menu, click **Print**.
3. On the **Finishing** menu, select **Manually Print on 2nd Side**.
4. Click **Print**. Follow the instructions in the pop-up window that appears on the computer screen before replacing the output stack in tray 1 for printing the second half.
5. Go to the printer, and remove any blank paper that is in tray 1.
6. Insert the printed stack face-up with the bottom edge feeding into the printer first in tray 1. You *must* print the second side from tray 1.
7. If prompted, press the appropriate control-panel button to continue.

Set the stapling options

If a finishing device that has a stapler is installed, you can staple documents.

1. On the **File** menu, click **Print**.
2. Open the **Finishing** menu.
3. In the **Stapling Options** drop-down list, select the stapling option that you want to use.

Store jobs

You can store jobs on the product so you can print them at any time. You can share stored jobs with other users, or you can make them private.

1. On the **File** menu, click **Print**.
2. Open the **Job Storage** menu.
3. In the **Job Storage:** drop-down list, select the type of stored job.
4. For the **Stored Job**, **Private Job**, and **Private Stored Job** types of stored jobs, enter a name for the stored job in the box next to **Job Name:**.

Select which option to use if another stored job already has that name.

- **Use Job Name + (1 - 99)** appends a unique number to the end of the job name.
 - **Replace Existing File** overwrites the existing stored job with the new one.
5. If you selected **Stored Job** or **Private Job** in step 3, type a 4-digit number in the box next to **PIN To Print (0000 - 9999)**. When other people attempt to print this job, the product prompts them to enter this PIN number.

Set the color options

Use the **Color Options** pop-up menu to control how colors are interpreted and printed from software programs.

1. On the **File** menu in the software program, click **Print**.
2. Select the driver.
3. Open the **Color Options** pop-up menu.
4. Click **Show Advanced Options**.
5. Adjust the individual settings for text, graphics, and photographs.

Use the Services menu

If the product is connected to a network, use the **Services** menu to obtain product and supply-status information.

1. On the **File** menu, click **Print**.
2. Open the **Services** menu.

3. To open the embedded Web server and perform a maintenance task, do the following:
 - a. Select **Device Maintenance**.
 - b. Select a task from the drop-down list.
 - c. Click **Launch**.
4. To go to various support Web sites for this device, do the following:
 - a. Select **Services on the Web**.
 - b. Select **Internet Services**, and select an option from the drop-down list.
 - c. Click **Go!**.

5 Connect the product

- [USB connection](#)
- [Network connection](#)

USB connection

This product supports one USB 2.0 device connection. The USB port is located on the back of the product. You must use an A-to-B type USB cable that is no longer than 2 meters (6.56 feet). The USB 2.0 port can be used to connect directly to the product and to upgrade firmware.

Figure 5-1 USB connection

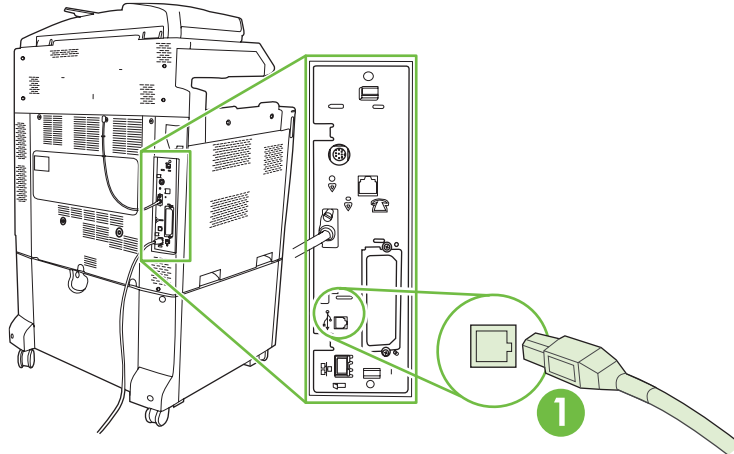

1	USB 2.0 port
---	--------------

Network connection

All product models include an embedded HP Jetdirect print server, which supports connection to a network using the local area network (LAN) connector (RJ-45) on the back of the product. For more information about configuring the product on a network see [Network configuration on page 85](#)

Figure 5-2 Network connection

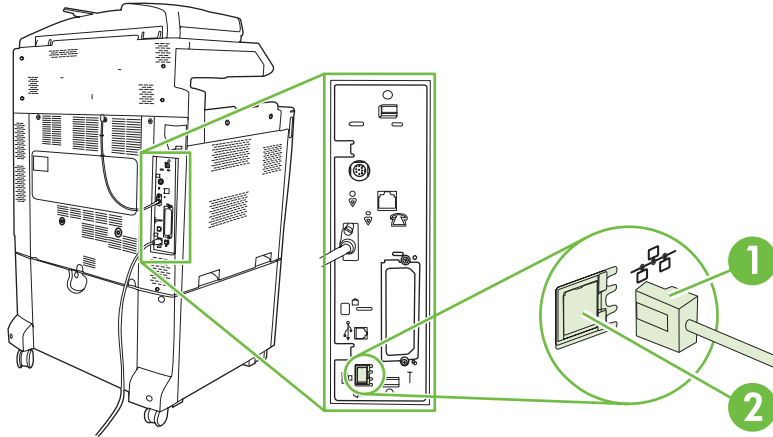

1	Network cable
2	Network port

6 Network configuration

- [Benefits of a network connection](#)
- [Supported network protocols](#)
- [Configuring network settings](#)
- [Network utilities](#)

Benefits of a network connection

Connecting the product to a network provides a number of benefits:

- All network users can share the same product.
- You can manage the product remotely, from any computer on the network, by using the embedded Web server (EWS).
- For large enterprise businesses, you can also manage the product remotely by using HP Web Jetadmin.

Supported network protocols

The product supports the TCP/IP network protocol, the most widely used and accepted networking protocol. Many networking services utilize this protocol. For more information, see [TCP/IP on page 88](#). The following table lists the supported networking services and protocols.

Table 6-1 Printing

Service name	Description
port9100 (Direct Mode)	Printing service
Line printer daemon (LPD)	Printing service

Table 6-2 Network device discovery

Service name	Description
SLP (Service Location Protocol)	Device-discovery protocol, used to help find and configure network devices. Used primarily by Microsoft-based programs.
Bonjour	Device-discovery protocol, used to help find and configure network devices. Used primarily by Apple Macintosh-based programs.

Table 6-3 Messaging and management

Service name	Description
HTTP (Hyper Text Transfer Protocol)	Allows Web browsers to communicate with embedded Web server.
EWS (embedded Web server)	Allows a user to manage the product through a Web browser.
SNMP (Simple Network Management Protocol)	Used by network applications for product management. SNMP v1 and standard MIB-II (Management Information Base) objects are supported.

Table 6-4 IP addressing

Service name	Description
DHCP (Dynamic Host Configuration Protocol)	For automatic IP address assignment. The DHCP server provides the product with an IP address. Generally, no user intervention is required for the product to obtain an IP address from a DHCP server.
BOOTP (Bootstrap Protocol)	For automatic IP address assignment. The BOOTP server provides the product with an IP address. Requires the administrator to input a product's MAC hardware address on the BOOTP server for the product to obtain an IP address from that server.
Auto IP	For automatic IP address assignment. If neither a DHCP server nor a BOOTP server is present, the product uses this service to generate a unique IP address.

Configuring network settings

You might need to configure certain network parameters on the product. You can configure these parameters from the installation software, the product control panel, the embedded Web server, or management software, such as HP Web Jetadmin.

For more information about supported networks and network configuration tools, see the *HP Jetdirect Print Servers Administrator's Guide*. The guide comes with printers in which an HP Jetdirect print server is installed.

TCP/IP

Similar to a common language that people use to communicate with each other, TCP/IP (Transmission Control Protocol/Internet Protocol) is a suite of protocols designed to define the way computers and other devices communicate with each other over a network.

Internet Protocol (IP)

When information is sent across the network, the data is broken down into small packets. Each packet is sent independently. Each packet is encoded with IP information, such as the IP address of the sender and receiver. IP packets can be routed over routers and gateways: devices that connect a network with other networks.

IP communications require no connection. When IP packets are sent, they might not arrive at their destination in the correct sequence. However, higher-level protocols and programs place the packets in the correct sequence, so IP communications are efficient.

Each node or device that communicates on the network requires an IP address.

Transmission Control Protocol (TCP)

TCP breaks the data into packets and recombines them on the receiving end by providing a connection-oriented, reliable, and guaranteed delivery service to another node on the network. When data packets are received at their destination, TCP calculates a checksum for each packet to verify that the data is not corrupt. If the data in the packet has been corrupted during transmission, TCP discards the packet and requests that the packet be resent.

IP address

Every host (workstation or node) on an IP network requires a unique IP address for each network interface. This address is used to identify both the network and specific hosts that are located on that network. It is possible for a host to query a server for a dynamic IP address each time the product boots up (for example, using DHCP and BOOTP).

An IP address contains four bytes of information, divided into sections that each contain one byte. The IP address has the following format:

xxx . xxx . xxx . xxx

△ CAUTION: When assigning IP addresses, always consult the IP address administrator. Setting the wrong address can disable other equipment operating on the network or interfere with communications.

Configure IP parameters

TCP/IP configuration parameters can be configured manually, or they can be automatically downloaded by using DHCP or BOOTP each time the product is turned on.

When turned on, a new product that is unable to retrieve a valid IP address from the network automatically assigns itself a default IP address. The IP address for the product is listed on the product Configuration page and the Network report. See [Information pages on page 176](#).

Dynamic Host Configuration Protocol (DHCP)

DHCP allows a group of devices to use a set of IP addresses that are maintained by a DHCP server. The product sends a request to the server, and if an IP address is available, the server assigns it to that product.

BOOTP

BOOTP is a bootstrap protocol used to download configuration parameters and host information from a network server.

The client broadcasts a boot request packet that contains the product hardware address. The server answers with a boot reply packet that contains the information that the product needs for configuration.

Subnets

When an IP network address for a particular network class is assigned to an organization, no provision is made for more than one network being present at that location. Local network administrators use subnets to partition a network into several different subnetworks. Splitting a network into subnets can result in better performance and improved use of limited network address space.

Subnet mask

The subnet mask is a mechanism used to divide a single IP network into several different subnetworks. For a given network class, a portion of an IP address that would normally be used to identify a node is used, instead, to identify a subnetwork. A subnet mask is applied to each IP address to specify the portion used for subnetworks, and the portion used to identify the node.

Gateways

Gateways (routers) are used to connect networks together. Gateways are devices that act as translators between systems that do not use the same communication protocols, data formatting, structures, languages, or architectures. Gateways repackage the data packets and change the syntax to match that of the destination system. When networks are divided into subnets, gateways are required to connect one subnet to another.

Default gateway

The default gateway is the IP address of the gateway or router that moves packets between networks.

If multiple gateways or routers exist, then the default gateway is typically the address of the first, or nearest, gateway or router. If no gateways or routers exist, then the default gateway will typically assume the IP address of the network node (such as the workstation or product).

Configure TCP/IPv4 parameters

If your network doesn't provide automatic IP addressing through DHCP, BOOTP, RARP, or another method, you might need to enter the following parameters manually before you can print over the network:

- IP address (4 bytes)
- Subnet mask (4 bytes)
- Default gateway (4 bytes)

Input or change the IP address

You can view the current IP address of the device from the control-panel Home screen by touching [Network Address](#).

Use the following procedure to change the IP address manually.

1. Scroll to and touch [Administration](#).
2. Scroll to and touch [Initial Setup](#).
3. Touch [Networking and I/O](#).
4. Touch [Embedded Jetdirect](#).
5. Touch [TCP/IP](#).
6. Touch [IPV4 Settings](#).
7. Touch [Config Method](#).
8. Touch [Manual](#).
9. Touch [Save](#).
10. Touch [Manual Settings](#).
11. Touch [IP Address](#).
12. Touch the IP Address text box.
13. Use the touchscreen keypad to type the IP address.
14. Touch [OK](#).
15. Touch [Save](#).

Set the subnet mask

1. Scroll to and touch [Administration](#).
2. Scroll to and touch [Initial Setup](#).
3. Touch [Networking and I/O](#).
4. Touch [Embedded Jetdirect](#).
5. Touch [TCP/IP](#).

6. Touch **IPV4 Settings**.
7. Touch **Config Method**.
8. Touch **Manual**.
9. Touch **Save**.
10. Touch **Manual Settings**.
11. Touch **Subnet Mask**.
12. Touch the Subnet Mask text box.
13. Use the touchscreen keypad to type the subnet mask.
14. Touch **OK**.
15. Touch **Save**.

Set the default gateway

1. Scroll to and touch **Administration**.
2. Scroll to and touch **Initial Setup**.
3. Touch **Networking and I/O**.
4. Touch **Embedded Jetdirect**.
5. Touch **TCP/IP**.
6. Touch **IPV4 Settings**.
7. Touch **Config Method**.
8. Touch **Manual**.
9. Touch **Save**.
10. Touch **Manual Settings**.
11. Touch **Default Gateway**.
12. Touch the Default Gateway text box.
13. Use the touchscreen keyboard to type the default gateway.
14. Touch **OK**.
15. Touch **Save**.

Configure TCP/IPv6 parameters

For information about configuring the device for a TCP/IPv6 network, see the *HP Jetdirect Print Servers Administrator's Guide*.

Network utilities

The product can be used with several utilities that make it easy to monitor and manage the product on a network.

- HP Web Jetadmin: See [HP Web Jetadmin on page 68](#).
- Embedded Web server: See [Embedded Web server on page 68](#).

Other components and utilities

Windows	Macintosh OS
<ul style="list-style-type: none">• Software installer — automates the printing system installation• Online Web registration	<ul style="list-style-type: none">• The HP Printer Utility — change device settings, view status, and set up printer-event notification from a Mac. This utility is supported for Mac OS X V10.3 and later.

7 Paper and print media

- [Understand paper and print media use](#)
- [Supported paper and print media sizes](#)
- [Supported paper types](#)
- [Special paper or print media guidelines](#)
- [Load paper and print media](#)
- [Configure trays](#)
- [Choose an output location](#)

Understand paper and print media use

This product supports a variety of paper and other print media in accordance with the guidelines in this user guide. Paper or print media that does not meet these guidelines might cause the following problems:

- Poor print quality
- Increased jams
- Premature wear on the product, requiring repair

For best results, use only HP-brand paper and print media designed for laserjets or multiuse. Do not use paper or print media made for inkjet printers. Hewlett-Packard Company cannot recommend the use of other brands of media because HP cannot control their quality.

It is possible for paper to meet all of the guidelines in this user guide and still not produce satisfactory results. This might be the result of improper handling, unacceptable temperature and/or humidity levels, or other variables over which Hewlett-Packard has no control.

△ **CAUTION:** Using paper or print media that does not meet Hewlett-Packard's specifications might cause problems for the product, requiring repair. This repair is not covered by the Hewlett-Packard warranty or service agreements.

Supported paper and print media sizes

 **NOTE:** To obtain best print results, select the appropriate paper size and type in your print driver before printing.

Table 7-1 Supported paper and print media sizes

Size	Dimensions	Tray 1	Tray 2	Trays 3, 4, 5
Letter	216 x 279 mm (8.5 x 11 in)	✓	✓ ¹	✓ ¹
Letter Rotated	279 x 216 mm (11 x 8.5 in)	✓	✓ ¹	✓ ¹
Legal	216 x 356 mm (8.5 x 14 in)	✓	✓ ¹	✓ ¹
A4	210 x 297 mm (8.27 x 11.69 in)	✓	✓ ¹	✓ ¹
A4 Rotated	297 x 210 mm (11.69 x 8.27 in)	✓	✓ ¹	✓ ¹
Executive	184 x 267 mm (7.24 x 10.51 in)	✓	✓ ¹	✓ ¹
Statement	139.7 x 215.9 mm (5.5 x 8.5 in)	✓		
8.5 x 13	216 x 330 mm (8.5 x 13 in)	✓	✓	✓
A3	297 x 420 mm (11.69 x 16.54 in)	✓	✓ ¹	✓ ¹
A5	148 x 210 mm (5.83 x 8.27 in)	✓	✓ ¹	✓ ¹
A6	105 x 148 mm (4.13 x 5.83 in)	✓		
11 x 17	279 x 432 mm (11 x 17 in)	✓	✓ ¹	✓ ¹
12 x 18	305 x 457 mm (12 x 18 in)	✓		✓
B4 (JIS)	257 x 364 mm (10.12 x 14.33 in)	✓	✓ ¹	✓ ¹
RA3	305 x 430 mm (12 x 16.93 in)	✓		✓
SRA3	320 x 450 mm (12.6 x 17.7 in)	✓		✓
B5 (JIS)	182 x 257 mm (7.17 x 10.12 in)	✓	✓ ¹	✓ ¹
8k	270 x 390 mm (10.63 x 15.35 in)	✓	✓	✓
16k	195 x 270 mm (7.68 x 10.63 in)	✓	✓	✓
Custom	98.55 x 139.70 mm to 320 x 457.2 mm (3.9 x 5.5 to 12.6 x 18 in) ³	✓		
Custom	148 x 210 mm to 297 x 432 mm (5.8 x 8.2 to 11.7 x 17 in) ²		✓	
Custom	148 x 210 mm to 320 x 457.2 mm (5.8 x 8.2 to 12.6 x 18 in)			✓

¹ Tray automatically detects paper size.

² Standard sizes within the custom range for Tray 2 are: 8.5 x 13, RA4, SRA4, 8K (270 x 390), 16K (195 x 270)

³ Standard sizes within the custom range for Trays 3, 4, and 5 are: 8.5 x 13, RA4, SRA4, 8K (270 x 390), 16K (195 x 270), RA3, SRA3, and 12 x 18

Table 7-2 Supported envelopes and postcards

Size	Dimensions	Tray 1	Trays 2, 3, 4, 5
Envelope #9	98 x 225 mm (3.88 x 8.88 in)	✓	

Table 7-2 Supported envelopes and postcards (continued)

Size	Dimensions	Tray 1	Trays 2, 3, 4, 5
Envelope #10	105 x 241 mm (4.13 x 9.49 in)	✓	
Envelope DL	110 x 220 mm (4.33 x 8.66 in)	✓	
Envelope C5	162 x 229 mm (6.93 x 9.84 in)	✓	
Envelope B5	176 x 250 mm (6.7 x 9.8 in)	✓	
Envelope C6	162 x 114 mm (6.4 x 4.5 in)	✓	
Envelope Monarch	98 x 191 mm (3.9 x 7.5 in)	✓	
Double Post Card	148 x 200 mm (5.83 x 7.87 in)	✓	
US Index Cards	102 x 152 mm (4 x 6 in) and 127 x 203 mm (5 x 8 in)	✓	

¹ Weights greater than 160 g/m² may not perform well, but will not harm the product.

The following paper sizes are supported with the optional HP 3-bin Stapler/Stacker and HP Booklet Maker/Finisher accessories.

Table 7-3 Supported paper and print media sizes for the optional HP 3-bin Stapler/Stacker and HP Booklet Maker/Finisher accessories

Size	Dimensions	Stacking ²	Angled staple (left-angled)	Angled staple (right-angled)	Two staples (top or side)	Folding	Saddle stitch
Letter	216 x 279 mm (8.5 x 11 in)	✓	✓	✓	✓		
Letter Rotated	279 x 216 mm (11 x 8.5 in)	✓	✓	✓		✓ ¹	✓ ¹
Legal	216 x 356 mm (8.5 x 14 in)	✓	✓	✓		✓ ¹	✓ ¹
A4	210 x 297 mm (8.27 x 11.69 in)	✓	✓	✓	✓		
A4 Rotated	297 x 210 mm (11.69 x 8.27 in)	✓	✓	✓		✓ ¹	✓ ¹
Executive	184 x 267 mm (7.24 x 10.51 in)	✓					
8.5 x 13	216 x 330 mm (8.5 x 13 in)	✓					
A3	297 x 420 mm (11.69 x 16.54 in)	✓	✓	✓	✓	✓ ¹	✓ ¹
A5	148 x 210 mm (5.83 x 8.27 in)	✓					
A6	105 x 148 mm (4.13 x 5.83 in)	✓					
Statement	140 x 216 mm (5.5 x 8.5 in)	✓					
11 x 17 (Ledger)	279 x 432 mm (11 x 17 in)	✓	✓	✓	✓	✓ ¹	✓ ¹

Table 7-3 Supported paper and print media sizes for the optional HP 3-bin Stapler/Stacker and HP Booklet Maker/Finisher accessories (continued)

Size	Dimensions	Stacking ²	Angled staple (left-angled)	Angled staple (right-angled)	Two staples (top or side)	Folding	Saddle stitch
12 x 18	305 x 457 mm (12 x 18 in)	✓					
B4 (JIS)	257 x 364 mm (10.12 x 14.33 in)	✓	✓	✓	✓	✓ ¹	✓ ¹
RA3	305 x 430 mm (12 x 16.93 in)	✓					
SRA3	320 x 450 mm (12.6 x 17.7 in)	✓					
B5 (JIS)	257 x 182 mm (10.12 x 7.17 in)	✓					
B6 (JIS)	128 x 182 mm (5.04 x 7.2 in)	✓					
8K	270 x 390 mm (10.63 x 15.35 in)	✓					
16K	195 x 270 mm (7.68 x 10.63 in)	✓					
Envelope 9#	98.4 x 225.4 mm (3.88 x 8.88 in)	✓					
Envelope 10#	104.77 x 241.3 mm (4.12 x 9.5 in)	✓					
Envelope DL	110 x 220 mm (4.33 x 8.66 in)	✓					
Envelope C5	162 x 229 mm (6.38 x 9.02 in)	✓					
Envelope B5	176 x 250 mm (6.93 x 9.84 in)	✓					
Envelope C6	114 x 162 mm (4.49 x 6.38 in)	✓					
Envelope Monarch	98.42 x 190.5 mm (3.88 x 7.5 in)	✓					
Double Post Card	148 x 200 mm (5.83 x 7.87 in)	✓					
4 x 6 Index Card	102 x 152 mm (4 x 6 in)	✓					
5 x 8 Index Card	127 x 203 mm (5 x 8 in)	✓					
Custom Size	98.55 x 139.70 mm to 320 x 457.2 mm (3.9 x 5.5 to 12.6 x 18 in)						

¹ Booklet maker only

² Stacking uses bins 1, 2, and 3 in the stapler/stacker, or bins 1 and 2 in the booklet maker.

Supported paper types

Table 7-4 Tray 1 paper information

Type	Specifications	Quantity	Driver settings	Paper orientation
Paper and cardstock, standard sizes	Range: 60 g/m ² (16 lb) bond to 220 g/m ² (58 lb) bond	Maximum stack height: 10 mm (0.6 in) Equivalent to 100 sheets of 75 g/m ² (20 lb) bond.	Plain or unspecified	Load preprinted or prepunched paper facing down, with the top edge leading into the tray, or toward the back of the product
Envelopes	Less than 60 g/m ² (16 lb) bond to 90 g/m ² (24 lb) bond	Up to 10 envelopes	Envelope	Short edge leading, flap toward the front of the product, facing up
Labels	Maximum 0.23 mm (0.009 in) thick	Maximum stack height: 10 mm (0.6 in)	Labels	Side to be printed on facing down
Transparencies	Minimum 0.13 mm (0.005 in) thick	Maximum stack height: 10 mm (0.6 in)	Transparencies	Side to be printed on facing down
Heavy	0.13 mm (0.005 in) thick	Maximum stack height: 10 mm (0.6 in)	Light glossy, glossy, or heavy glossy	Side to be printed on facing down
Glossy	Range: 75 g/m ² (20 lb) bond to 220 g/m ² (58 lb) bond	Maximum stack height: 10 mm (0.6 in)	Light glossy, glossy, or heavy glossy	Side to be printed on facing down
Photo media	60 g/m ² (16 lb) bond to 220 g/m ² (58 lb) bond	Maximum stack height: 10 mm (0.6 in)		Side to be printed on facing down
Cut sheet paper	60 g/m ² (16 lb) bond to 220 g/m ² (58 lb) bond	Maximum stack height: 10 mm (0.6 in)		Side to be printed on facing down
Tough paper	60 g/m ² (16 lb) bond to 220 g/m ² (58 lb) bond	Maximum stack height: 10 mm (0.6 in)		Side to be printed on facing down

Table 7-5 Trays 2, 3, 4, and 5 paper information

Type	Specifications	Quantity	Settings	Paper orientation
Paper and cardstock, standard sizes	Range: 60 g/m ² (16 lb) bond to 220 g/m ² (58 lb) bond	500 sheets of 75 g/m ² (20 lb) bond.	Plain or unspecified	Load preprinted or prepunched paper facing up, with the top toward the back of the tray or toward the right- hand side of the tray.
Labels	Maximum 0.13 mm (0.005 in) thick	Maximum stack height: 54 mm (2.1 in)	Labels	Side to be printed on facing up
Transparencies	Minimum 0.13 mm (0.005 in) thick	Maximum stack height: 54 mm (2.1 in)	Transparencies	Side to be printed on facing up
Heavy	0.13 mm (0.005 in) thick	Maximum stack height: 54 mm (2.1 in)	Light glossy, glossy, or heavy glossy	Side to be printed on facing up
Glossy	75 g/m ² (20 lb) bond to 220 g/m ² (58 lb) bond	Maximum stack height: 54 mm (2.1 in)	Light glossy, glossy, or heavy glossy	Side to be printed on facing up

Table 7-5 Trays 2, 3, 4, and 5 paper information (continued)

Type	Specifications	Quantity	Settings	Paper orientation
Photo media	60 g/m ² (16 lb) bond to 220 g/m ² (58 lb) bond	Maximum stack height: 54 mm (2.1 in)	Light glossy, glossy, or heavy glossy	Side to be printed on facing up
Cut sheet paper	60 g/m ² (16 lb) bond to 220 g/m ² (58 lb) bond	Maximum stack height: 54 mm (2.1 in)	Plain or unspecified	Side to be printed on facing up
Tough paper	60 g/m ² (16 lb) bond to 220 g/m ² (58 lb) bond	Maximum stack height: 54 mm (2.1 in)	HP Tough Paper	Side to be printed on facing up

Trays 2, 3, 4, and 5 capacity: 54 mm (2.126 in) height or 500 sheets of paper, whichever is less. Supported media types include: Cut sheet paper, labels, OHT, glossy paper, glossy film, photo media, and tough paper. Basis Weight: 60-220 g/m² (16-58 lb).

Duplex printing: Provides automatic two-sided printing (printing on both sides of the paper). The paper size range for automatic duplex printing is 175 to 320 mm (7.2 to 12.6 in) x 210 to 457 mm (8.3 to 18 in). The media weight range is 60 to 220 g/m² (16 to 58 lb)

 **NOTE:** HP Color Laser Presentation Paper, Glossy (Q2546A) is not supported with this product. Using this type of paper can cause a fuser jam that might require the replacement of the fuser. Two recommended alternatives are HP Color LaserJet Presentation Paper, Soft Gloss (Q6541A) and HP Color LaserJet Brochure Paper, Glossy (Q6611A, Q6610A).

NOTE: For a complete list of specific HP-brand paper that this product supports, go to www.hp.com/sbso/product/supplies.

Special paper or print media guidelines

This product supports printing on special media. Use the following guidelines to obtain satisfactory results. When using special paper or print media, be sure to set the type and size in your print driver to obtain the best print results.

- △ **CAUTION:** HP LaserJet printers use fusers to bond dry toner particles to the paper in very precise dots. HP laser paper is designed to withstand this extreme heat. Using inkjet paper not designed for this technology could damage your printer.

Media type	Do	Do not
Envelopes	<ul style="list-style-type: none">• Store envelopes flat.• Use envelopes where the seam extends all the way to the corner of the envelope.• Use peel-off adhesive strips that are approved for use in laser printers.	<ul style="list-style-type: none">• Do not use envelopes that are wrinkled, nicked, stuck together, or otherwise damaged.• Do not use envelopes that have clasps, snaps, windows, or coated linings.• Do not use self-stick adhesives or other synthetic materials.
Labels	<ul style="list-style-type: none">• Use only labels that have no exposed backing between them.• Use Labels that lie flat.• Use only full sheets of labels.	<ul style="list-style-type: none">• Do not use labels that have wrinkles or bubbles, or are damaged.• Do not print partial sheets of labels.
Transparencies	<ul style="list-style-type: none">• Use only transparencies that are approved for use in laser printers.• Place transparencies on a flat surface after removing them from the product.	<ul style="list-style-type: none">• Do not use transparent print media not approved for laser printers.
Letterhead or preprinted forms	<ul style="list-style-type: none">• Use only letterhead or forms approved for use in laser printers.	<ul style="list-style-type: none">• Do not use raised or metallic letterhead.
Heavy paper	<ul style="list-style-type: none">• Use only heavy paper that is approved for use in laser printers and meets the weight specifications for this product.	<ul style="list-style-type: none">• Do not use paper that is heavier than the recommended media specification for this product unless it is HP paper that has been approved for use in this product.
Glossy or coated paper	<ul style="list-style-type: none">• Use only glossy or coated paper that is approved for use in laser printers.	<ul style="list-style-type: none">• Do not use glossy or coated paper designed for use in inkjet products.

Load paper and print media

You can load different media in the trays and then request media by type or size by using the control panel.

Load Tray 1

△ **CAUTION:** To avoid jams, never add or remove paper from Tray 1 during printing.

1. Open Tray 1.

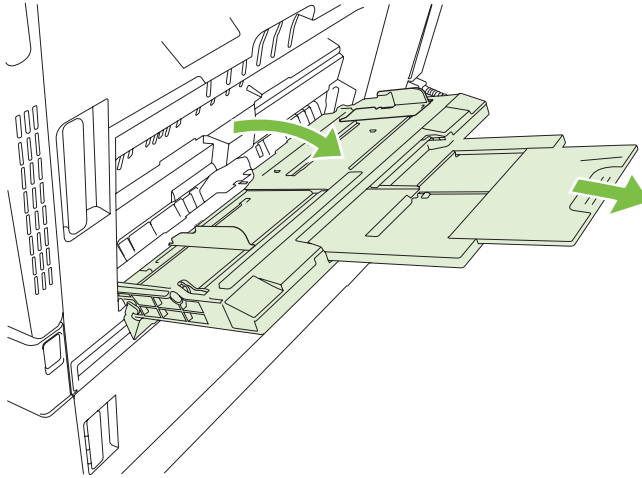

2. Set the side guides to the correct width, and pull out the tray extensions to support paper.
3. Load paper in the tray with the side to be printed on face down and the top of the paper or non-postage end facing the back of the printer.

📝 **NOTE:** For Letter Rotated and A4 Rotated sizes, place the side to be printed on face down, with the bottom of the page facing into the printer.

4. Make sure the stack fits under the tabs on the guides and does not exceed the load-level indicators.
5. Adjust the side guides so that they lightly touch the paper stack but do not bend it.

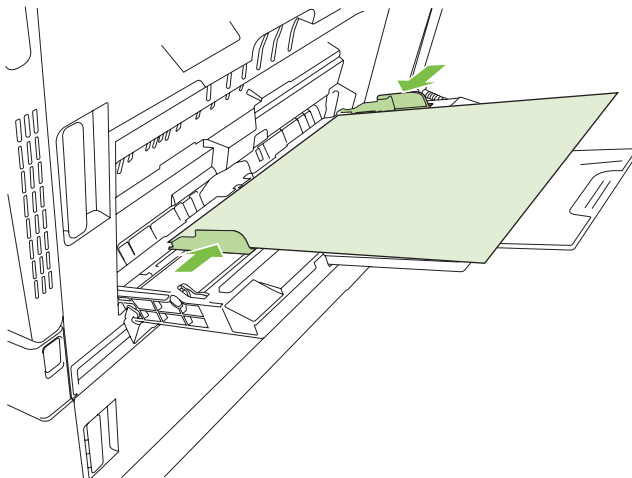

Print envelopes

If your software does not automatically format an envelope, specify **Landscape** for page orientation in your software program or printer driver. Use the following guidelines to set margins for return and destination addresses on Commercial #10 or DL envelopes:

Address type	Left margin	Top margin
Return	15 mm (0.6 in)	15 mm (0.6 in)
Destination	102 mm (4 in)	51 mm (2 in)

For envelopes of other sizes, adjust the margin settings accordingly.

Load trays 2, 3, 4, or 5

Trays 2, 3, 4, and 5 each hold up to 500 sheets of standard paper or a 54 mm (2.13-inch) stack of labels or other thick paper.

Load standard-sized media into trays 2, 3, 4, or 5

The product automatically detects the following standard sizes of media in these 500-sheet trays: Letter, Letter rotated, Legal, Executive, 11x17, A3, A4, A4 rotated, A5, B4 (JIS), and B5 (JIS).

△ **CAUTION:** Do not print envelopes or unsupported sizes of paper from the 500-trays. Print on these types of paper only from Tray 1.

1. Slide the tray from the product.

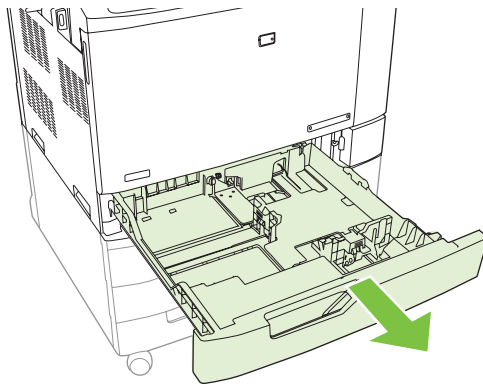

📄 **NOTE:** Do not open the input tray while it is in use. Doing so can cause jams in the product.

2. Adjust the paper width guide by squeezing the adjustment latch and sliding the guide to the size of the paper being used.

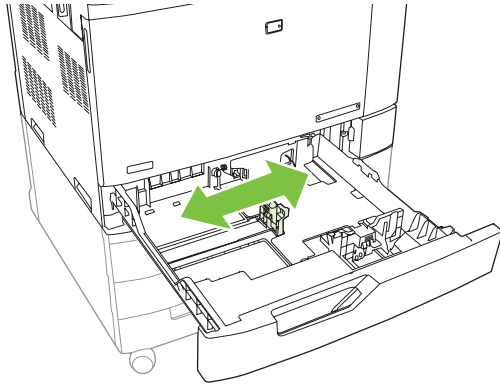

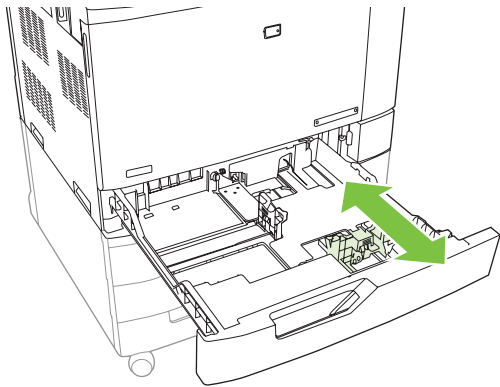

3. Adjust the paper length guide by squeezing the adjustment latch and sliding the guide to the size of the paper being used.

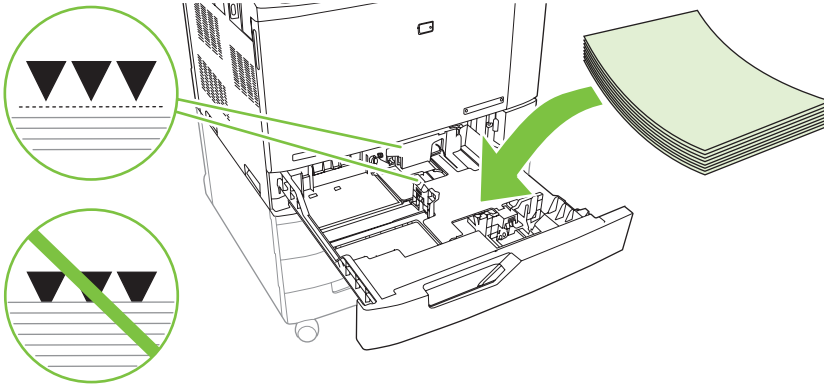

4. Load paper into the tray face up. Check the paper to verify the guides lightly touch the stack, but do not bend it.

 **NOTE:** To prevent jams, do not overfill the input tray. Be sure the top of the stack is below the tray full indicator.



 **NOTE:** For best performance, fill the tray completely without splitting the ream of paper. Splitting the ream can cause a multifeed problem. The capacity of the paper tray can vary. For example, if you are using 75 g/m² (20 lb) paper, the tray holds a full ream of 500 sheets. If the media is heavier, the tray will not hold a full ream. Do not overfill the tray.

NOTE: If the tray is not adjusted correctly, an error message might appear or the media might jam.

5. Slide the tray into the product. The control panel shows the tray's paper type and size. If the configuration is not correct, touch **Modify** on the control panel and select the correct configuration. If the configuration is correct, touch **OK**.

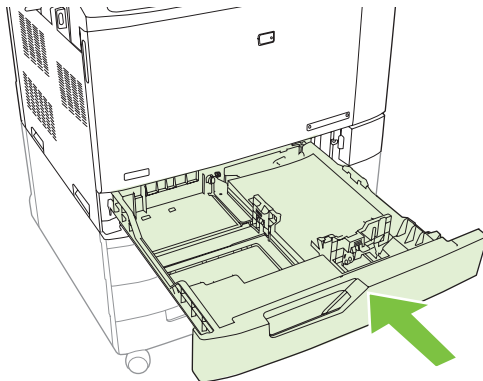

Load undetectable standard-sized media into Tray 2, 3, 4, and 5

The following undetectable standard-sized media is supported in the 500-sheet trays:

- Executive (JIS) (8.5 x 13)
- 12 x 18 (Trays 3, 4, or 5 only)
- B4 (ISO)
- RA3 (Trays 3, 4, or 5 only)

- SRA3 (Trays 3, 4, or 5 only)
- B5 (ISO)

△ **CAUTION:** Do not print envelopes or unsupported sizes of paper from the 500-sheet trays. Print on these types of paper only from Tray 1. Do not overfill the input tray or open it while it is in use. Doing so can cause paper jams.

Load custom-size media into tray 2, 3, 4, or 5

To use custom media, change the size setting on the control panel to **Custom** and set the unit of measure, X dimension, and Y dimension. See [Configure a tray to match print job settings on page 111](#) for more information.

1. Slide open the tray from the product.
2. Load the print media as described in steps 2 through 4 of the “Load detectable (standard-size) media into Tray 2, 3, 4, or 5” section. Then proceed to step 3 in this procedure.

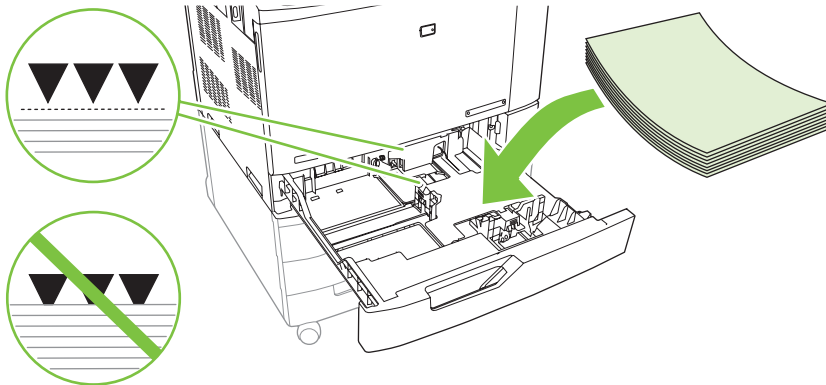

3. Slide the tray into the product. The control panel shows the tray type and size configuration. To specify specific custom dimensions, or if the type is not correct, touch **Modify** when the control panel prompts to change the size or type.

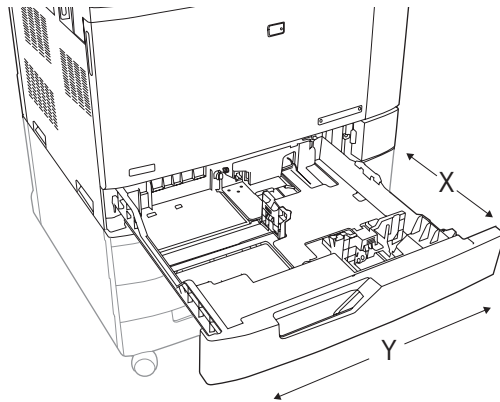

4. Select **Custom**, and then select the **Unit of measure**, **X dimension** and **Y dimension** for the custom paper size.
5. Select the paper type and then touch **Save**.
6. If the configuration is correct, touch **Save**.

Load large size paper into Tray 3, 4, or 5

Use the following instructions if you are loading 11x17, RA3, SRA3, or 12 x 18-sized paper into Tray 3, 4, or 5.

1. Slide open Tray 3, 4, or 5.
2. Adjust the paper width guide by squeezing the adjustment latch and sliding the guide to the size of the paper being used.
3. Load the paper into the tray.
4. Move the paper stop lever to the correct position for the paper being used.

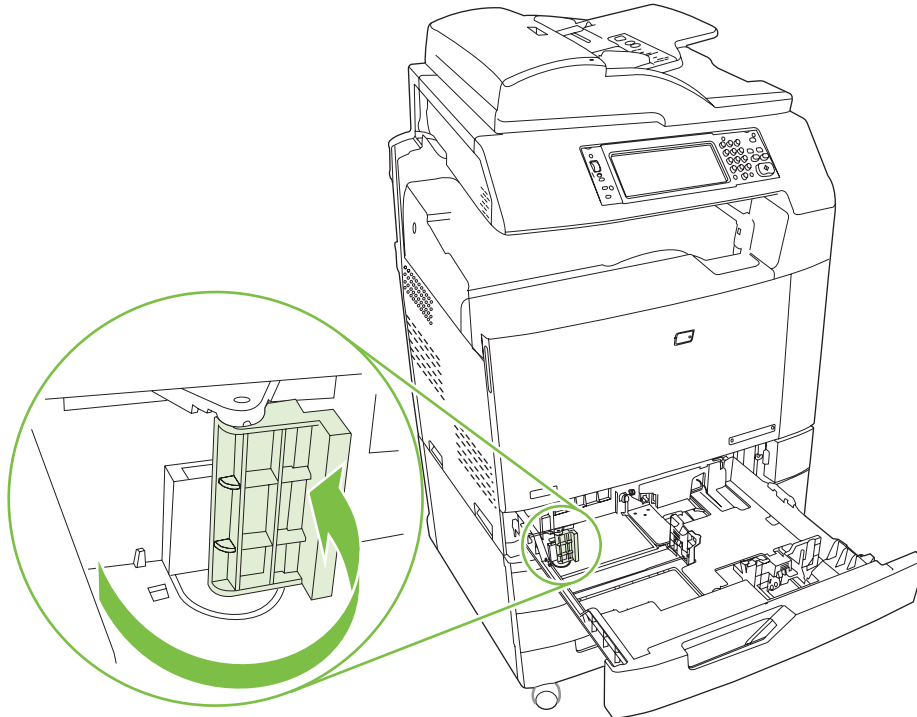

- For SRA3-sized paper, rotate the lever all the way to the left.
 - For A3- or 11x17-sized paper, rotate the lever down into the center position.
 - For RA3- or 12x18-sized paper, rotate the lever all the way to the right.
5. Slide the tray into the product. The control panel shows the tray's media type and size. If the configuration is not correct, touch **Modify** and configure the tray to the correct type and size. If the configuration is correct, touch **OK**.

Load letterhead, pre-printed, or pre-punched paper

To correctly print or copy on letterhead, pre-printed, or pre-punched paper, you need to make sure you load the paper correctly into the tray. You might also need to adjust the **Image Rotation** setting on the product control panel. The **Image Rotation** setting is used to adjust for languages that read from left to right (the default) or from right to left.

Change the Image Rotation setting

1. At the control panel home screen, scroll down and touch **Administration**.
2. Scroll down and touch **Device Behavior**.
3. Scroll down and touch **Tray Behavior**.
4. Scroll down and touch **Image Rotation**.
5. Touch the correct Image Rotation option. The default setting is **Left to right**.
6. Touch **OK**.

Choose the correct orientation for loading letterhead, pre-printed, or pre-punched paper

The tables below should be used as a guide for loading letterhead, pre-printed, or pre-punched paper. The first table shows the tray-loading orientation when **Image Rotation** is set to **Left to right**, which indicates that the language reads left to right. The second table shows the tray-loading orientation when **Image Rotation** is set to **Right to left**, which indicates that the language reads right to left. The tables also contain the following information:

- The paper type: letterhead, pre-printed or pre-punched.
- The paper tray: Tray 1 or Trays 2 through 5.
- Image orientation: Portrait (1) or Landscape (2).

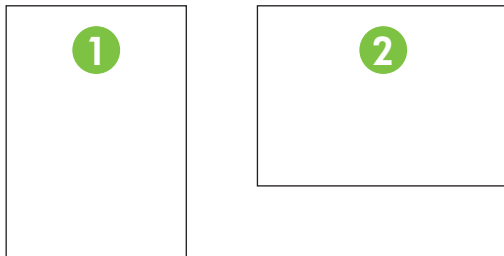

- One-sided or two-sided (duplex) printing.
- Stapling: The optional stapler/stacker or booklet maker output accessory must be attached in order to staple print or copy jobs. The staple location can be one left, one angled staple located in upper left corner; or two left, two staples located on left long edge. For more information about stapling, see [Use the stapler on page 124](#)

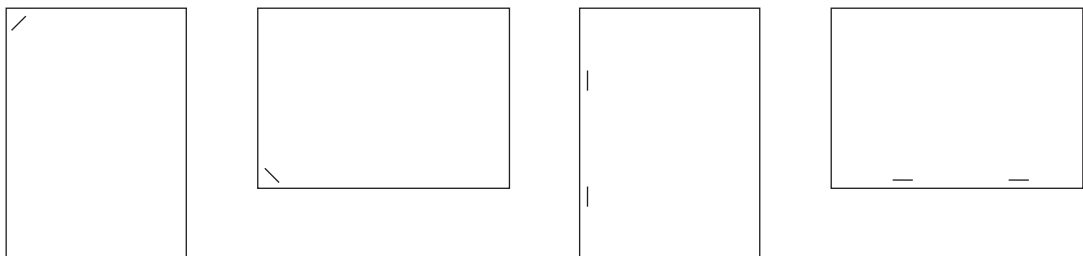

- The arrow in the paper graphic indicates the direction the paper will feed into the printer. The paper graphic indicates the direction the paper should be placed in the paper tray. The default is to load the paper so that the long edge feeds first. This results in the most efficient printing and copying.

Table 7-6 Load letterhead, pre-printed, or pre-punched paper — Image Rotation = Left to right







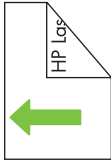
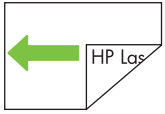

Paper type and tray	Image orientation	Duplex mode	Staple location options	How to load for long-edge feed	How to load for short-edge feed
Letterhead or Pre-printed – Tray 1	Portrait	1-sided	One left, two left		
Letterhead or Pre-printed – Tray 1	Portrait	2-sided	One left, two left		
Letterhead or Pre-printed – Tray 1	Landscape	1-sided	One left, two left		
Letterhead or Pre-printed – Tray 1	Landscape	2-sided	One left, two left		
Letterhead or Pre-printed – Trays 2-5	Portrait	1-sided	One left, two left		
Letterhead or Pre-printed – Trays 2-5	Portrait	2-sided	One left, two left		
Letterhead or Pre-printed – Trays 2-5	Landscape	1-sided	One left, two left		
Letterhead or Pre-printed – Trays 2-5	Landscape	2-sided	One left, two left		

Table 7-6 Load letterhead, pre-printed, or pre-punched paper — Image Rotation = Left to right (continued)

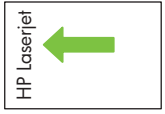
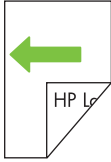
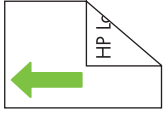
Paper type and tray	Image orientation	Duplex mode	Staple location options	How to load for long-edge feed	How to load for short-edge feed
Pre-punched – Tray 1	Portrait	1-sided or 2-sided	One left, two left		
Pre-punched – Tray 1	Landscape	1-sided or 2-sided	One left, two left		
Pre-punched – Trays 2-5	Portrait	1-sided or 2-sided	One left, two left		
Pre-punched – Trays 2-5	Landscape	1-sided or 2-sided	One left, two left		

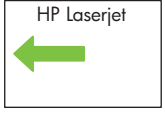
Table 7-7 Load letterhead, pre-printed, or pre-punched paper — Image Rotation = Right to left

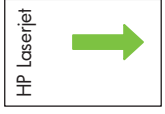

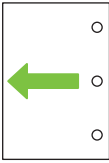
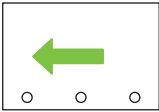
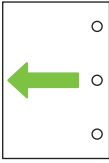
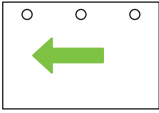
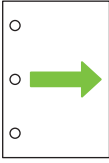
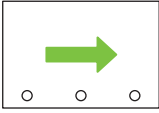
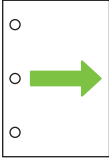
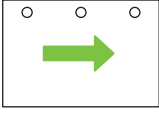

Paper type and tray	Image orientation	Duplex mode	Staple location options	How to load for long-edge feed	How to load for short-edge feed
Letterhead or Pre-printed – Tray 1	Portrait	1-sided	One right, two right		
Letterhead or Pre-printed – Tray 1	Landscape	2-sided	One right, two right		
Letterhead or Pre-printed – Trays 2-5	Portrait	2-sided	One right, two right		

Table 7-7 Load letterhead, pre-printed, or pre-punched paper — Image Rotation = Right to left (continued)

Paper type and tray	Image orientation	Duplex mode	Staple location options	How to load for long-edge feed	How to load for short-edge feed
Letterhead or Pre-printed – Trays 2-5	Landscape	1-sided	One right, two right		
Pre-punched – Tray 1	Portrait	1-sided or 2-sided	One right, two right		
Pre-punched – Tray 1	Landscape	1-sided or 2-sided	One right, two right		
Pre-punched – Trays 2-5	Portrait	1-sided or 2-sided	One right, two right		
Pre-punched – Trays 2-5	Landscape	1-sided or 2-sided	One right, two right		

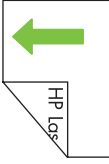
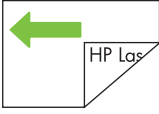
Configure trays

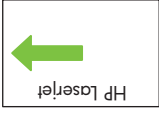
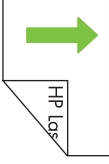
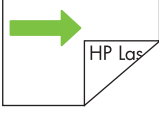
The product automatically prompts you to configure a tray for type and size in the following situations:

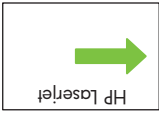
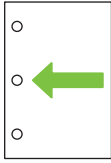
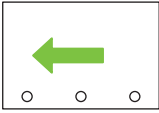
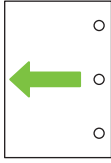
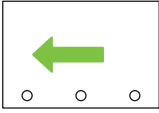
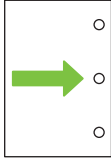
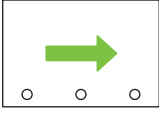
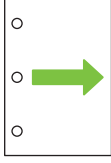
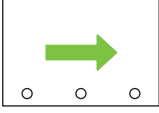
- When you load paper into the tray
- When you specify a particular tray or media type for a print job through the printer driver or a software program and the tray is not configured to match the print-job's settings

The following message appears on the control panel: **Tray <x> [type] [size] To change size or type, touch "Modify". To accept, touch "OK"**.

 **NOTE:** The prompt does not appear if you are printing from Tray 1 and Tray 1 is configured for **Any Custom** and **Any Type**.

NOTE: If you have used other HP LaserJet product models, you might be accustomed to configuring Tray 1 to **First** mode or **Cassette** mode. On the HP Color LaserJet CM6049f, setting Tray 1 size to **Any Custom** is equivalent to **First** mode. Setting size for Tray 1 to a setting other than **Any Custom** is equivalent to **Cassette** mode.

Configure a tray when loading paper

1. Load paper in the tray. Close the tray if you are using Tray 2, 3, 4, or 5.
2. The tray configuration message appears.
3. Touch **OK** to accept the detected size and type, or touch **Modify** to choose a different paper size or type.
4. Select the correct size and type and then touch **OK**.

 **NOTE:** The product automatically detects most paper sizes in Trays 2, 3, 4, and 5.

Configure a tray to match print job settings

1. In the software program, specify the source tray, the paper size, and the paper type.
2. Send the job to the product.
If the tray needs to be configured, the **Load Tray x <Type> <Size>** message appears.
3. Load the tray with the specified type and size of paper, and then close the tray.
To specify a custom size, **Modify**.
4. When the **Tray <x> Size=<Size>** message appears, touch **OK** to confirm the size.
5. When the **Tray<x> Type=<Type>** message appears, touch **OK** to confirm the type and continue with the job.

Automatic media type sensing (auto sense mode)

The automatic media type sensor functions only when that tray is configured to Any Type or Plain type. Configuring a tray to any other type, such as Bond or Glossy, deactivates the media sensor in that tray.

The HP Color LaserJet CM6049f MFP can automatically classify many paper types into one of the following categories:

- Plain
- Transparency
- Glossy
- Extra-heavy glossy
- Glossy film
- Heavy

For more control, a specific type must be selected in the job or configured in a tray.

Auto sense settings

Full sensing (default for Tray 1)

- The product recognizes light, plain, heavy, glossy, and tough paper and overhead transparencies.
- Each time the product begins a print job, it stops the first page to sense the type.
- This is the slowest mode.

Expanded sensing (default for Trays 2, 3, 4, and 5)

- Each time the product begins a print job, it stops the first page to sense the type.
- The product assumes that the second and all subsequent pages are of the same media type as the first page.
- This is the second-fastest mode, and is useful for using stacks of the same media type.

Transparency only

- The product does not stop any pages for sensing but distinguishes between transparencies (Transparency mode) and paper (Normal mode).
- This is the fastest mode and is useful for high-volume printing in Normal mode.

For more information about setting these options, see [Print Quality menu on page 48](#)

Select the paper by source, type, or size

In the Microsoft Windows operating system, three settings affect how the printer driver tries to pull media when you send a print job. *Source*, *Type*, and *Size* settings appear in the **Page Setup**, **Print**, or **Print Properties** dialog boxes in most software programs. Unless you change these settings, the product automatically selects a tray using the default settings.

Source

To print by *Source* select a specific tray for the product to pull from. If you select a tray that is configured for a type or size that does not match your print job, the product prompts you to load the tray with the type or size of print media for your print job before printing it. When you load the tray, the product begins printing.

Type and Size

Printing by *Type* or *Size* means that you want the product to pull from the tray that is loaded with the correct type and size of media. Selecting media by type rather than source is similar to locking out trays and helps protect special media from accidental use. For example, if a tray is configured for letterhead and you select plain paper, the product will not pull the letterhead from that tray. Instead, it will pull from a tray that has plain paper loaded and is configured for plain paper on the product control panel. Selecting media by Type and Size results in significantly better print quality for heavy paper, glossy paper, and transparencies. Using the wrong setting might result in unsatisfactory print quality. Always print by Type for special print media, such as labels or transparencies. Print by Size for envelopes, if possible.

- To print by Type or Size, select the Type or Size from the **Page Setup** dialog box, the **Print** dialog box, or the **Print Properties** dialog box, depending on the software program.
- If you often print on a certain type or size of media, configure a tray for that type or size. Then, when you select that type or size as you print a job, the product automatically pulls media from the tray that is configured for that type or size.

Choose an output location

Standard output bins

The product has an ADF output bin and the standard output bin for printed pages.

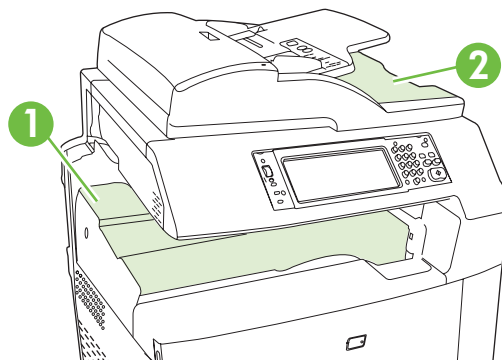

- | | |
|---|-------------------------------------|
| 1 | Standard output bin |
| 2 | ADF output bin (for copy originals) |

When you scan or copy documents by using the ADF, the originals are automatically delivered to the ADF output bin. Copies made from the scanner glass are delivered to the standard output bin or the output bin(s) on the stapler/stacker or the 3-bin mailbox.

When you send print jobs to the product from a computer, the output is to the standard output bin or the output bin(s) on the stapler/stacker or the 3-bin mailbox.

Optional output accessories

An optional 3 bin stapler/stacker or booklet-maker finisher accessory can be installed with the product. When an accessory is installed, an output accessory bridge is also added on top of the product in order to route the print jobs to the accessory output bins.

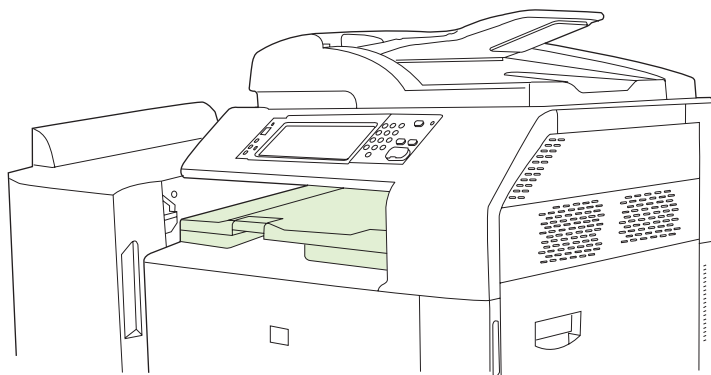

3-bin stapler/stacker features

Table 7-8 3-bin stapler/stacker features

Job offset

Each copy of a job is shifted to one side in the output bin in order to keep each copy separate from the others. (Supported paper sizes: A3, A4, A4 rotated, A5, B4, B5, Ledger, Legal, Letter, Letter rotated, Statement.)

Table 7-8 3-bin stapler/stacker features (continued)

Three operation modes	Mailbox Mode assigns each bin to a user or group of users. Stacker Mode uses all three output bins for all print jobs — when one bin is full, jobs are routed to the next bin. Function Separator Mode sends copies to bin 1, faxes to bin 2, and print jobs to bin 3.
Stapler	Built-in stapler staples jobs up to 50 sheets in size or 30 stapled jobs. Pages can be stapled in one position at the front, in one position at the back, or at two positions at the side or top.
Large-capacity output bins	The stacker has three bins: a 100-sheet bin, a 500-sheet bin, and a 1000-sheet bin.

Booklet maker finisher features

Table 7-9 Booklet-maker finisher features

Booklet-making	The booklet-making feature staples and folds print jobs of 2 to 15 pages into a booklet.
Folding	Single-sheet print jobs can be automatically folded in the center.
Job offset	Each copy of a job is shifted to one side in the output bin in order to keep each copy separate from the others. (Supported paper sizes: A3, A4, A4 rotated, A5, B4, B5, Ledger, Legal, Letter, Letter rotated, Statement.)
Two operation modes	Mailbox Mode assigns each bin to a user or group of users, and Stacker Mode uses both output bins for all print jobs — when the top bin is full, jobs are routed to the next bin.
Stapler	Built-in stapler staples jobs up to 50 sheets in size or 30 stapled jobs. Pages can be stapled in one position at the front, in one position at the back, or at two positions at the side or top.
Large-capacity output bins	The stacker has three bins: two 1000-sheet bins and one bin that can hold up to 25 saddle-stitched booklets.

Accessory walkaround

Figure 7-1 3-bin stapler/stacker accessory

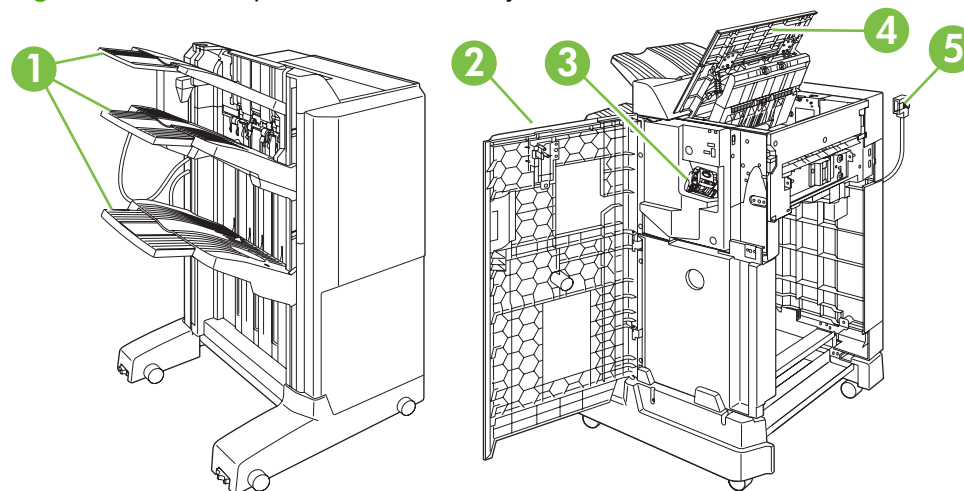

1	Output bins
2	Front door
3	Stapler unit
4	Top cover
5	Connection cable

Figure 7-2 Booklet-maker finisher accessory

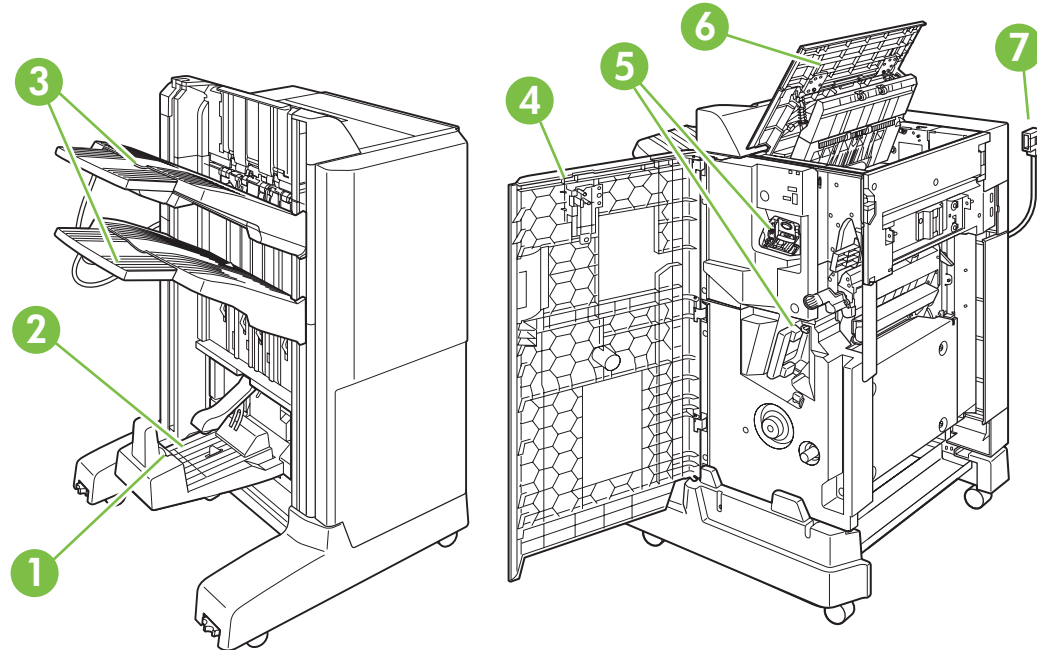

1	Booklet bin guide
2	Booklet output bin
3	Stacking output bins
4	Front door
5	Stapler units
6	Top cover
7	Connection cable

Use the booklet-making feature

You can create booklets from the print driver or by copying an original document.

Before creating a booklet, set the booklet bin guide for the size of paper being used:

- Closed: 11x17, Legal, A3, or B4
- Open: Letter Rotated, A4 Rotated

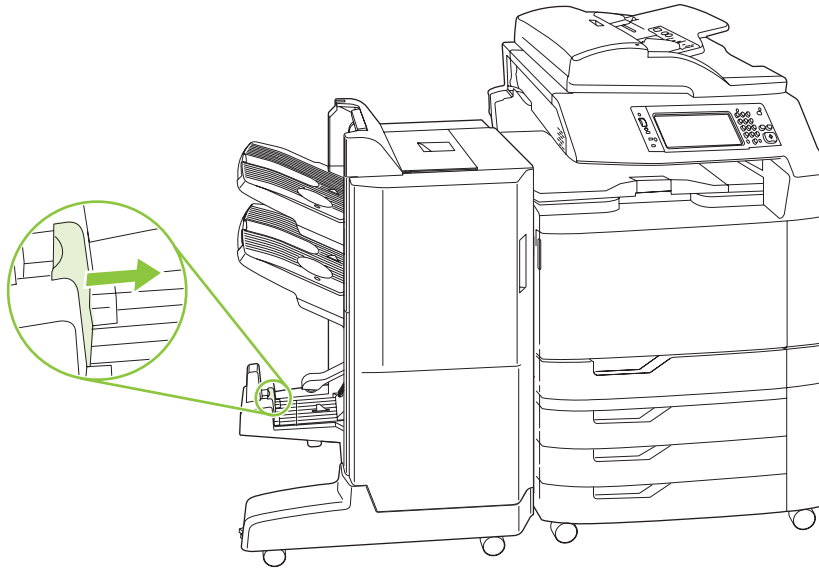

Create a booklet from the print driver

1. On the **File** menu of your software program, click **Print**.
2. Select HP Color LaserJet CM6049f MFP.
3. Click **Properties**, and then click **Booklet Printing**.
4. Set the **Paper source**, **Paper sizes**, **Paper type**, **Orientation**, **Booklet Layout**, **Print document on**, and **Staple** settings, and then click **OK**.
5. Click **OK** to print.

Create a booklet from a copy

Documents can be copied from the automatic document feeder (ADF) or by placing the document on the scanner glass.

1. From the control panel, touch **Copy**.
2. Scroll to and touch **Booklet Format**.
3. Touch **Booklet on**.
4. For **Original Sides** touch **1-sided** or **2-sided**.
5. Touch **OK** and then touch **Start**.

Configure the accessory operation mode

Select the operating mode at the control panel

You can set the operating mode for the stapler/stacker or the booklet maker at the product control panel.

1. At the control panel, touch **Administration**, and then touch **Device behavior**.
2. Touch **MBM-3 bin stapler** or **Multifunction finisher**.
3. Touch **Operation mode**, and then select the operation mode that you want to use.
 - When Mailbox Mode is used, each bin is assigned to a user or group of users. Every time a user sends a print job, the job is routed to the assigned bin.
 - When Stacker Mode is used and the optional 3-bin stapler/stacker is installed, the three bins act as a single bigger bin. When one bin gets full, jobs are automatically routed to the next bin. When Stacker Mode is used and the booklet maker finisher is installed, the two upper bins act as a single bin, and the third bin is reserved for booklets.
 - When Function Separator (3-bin stapler/stacker only) mode is used, each bin is assigned to a specific kind of job. Usually this designation is bin 1 for copies, bin 2 for fax, and bin 3 for printing. These values can be modified in the Default Job Options menus for copy, fax, and print.



NOTE: Use the product embedded Web server to assign output bins to users or groups of users. For more information see [Embedded Web server on page 178](#).

Select the operating mode in the printer driver

1. Click the **Start** button, point to **Settings**, and then click **Printers** (for Windows 2000) or **Printers and Faxes** (for Windows XP).

From your Vista computer click **Start**, click **Control Panel**, and then in the category for **Hardware and Sound** click **Printer**.

2. Right-click the HP product icon, and then click **Properties** or **Printing Preferences**.
3. Click the **Device Settings** tab.
4. Perform one of the following actions:

For automatic configuration: under **Installable Options**, click **Update Now** in the **Automatic Configuration** list.

-or-

For manual configuration: under **Installable Options**, select the appropriate operation mode in the **Accessory Output Bin** list.

5. Click **Apply** to save the settings.

Select the operating mode in the printer driver (Mac OS X)

1. In the **Apple** menu, click **System Preferences**.
2. In the **System Preferences** box, click **Print and Fax**.
3. Click **Set Up Printers**. A **Printer List** displays.

4. Select the HP product, and then click **Show Info** on the **Printers** menu.
5. Select the **Installable Options** panel.
6. In the **Accessory Output Bins** list, select correct accessory.
7. In the **Mailbox Mode** list, select the appropriate operational mode, and then click **Apply Changes**.

8 Use product features

- [Economy settings](#)
- [Use the stapler](#)
- [Job storage features for print jobs](#)
- [Print photos or marketing material](#)
- [Print weatherproof maps and outdoor signs](#)
- [Set the duplex alignment](#)

Economy settings

Sleep and wake

Set the sleep delay

Use the sleep-delay feature to select the time interval the product remains inactive before entering sleep mode. The default is one hour.

1. Scroll to and touch **Administration**.
2. Touch **Time/Scheduling**.
3. Touch **Sleep Delay**.
4. Touch the sleep-delay setting that you want and then touch **Save**.

Set the wake time

Use the wake time feature to wake the product at a set time each day.

1. Scroll to and touch **Administration**.
2. Touch **Time/Scheduling**.
3. Touch **Wake Time**.
4. Touch the day of the week for the wake time.
5. Touch **Custom**.
6. Touch **Save**.
7. Touch the appropriate options to set the correct hour, minute, and AM/PM setting.
8. If you want to wake the product at the same time each day, on the **Apply to all days** screen, touch **Yes**. If you want to set the time for individual days, touch **No**, and repeat the procedure for each day.

Set the sleep time

Use the sleep time feature to program the product to enter sleep mode at a set time each day.

1. Scroll to and touch **Administration**.
2. Touch **Time/Scheduling**.
3. Touch **Sleep Time**.
4. Touch the day of the week for the sleep time setting.
5. Touch **Custom**.
6. Touch **Save**.

7. Touch the appropriate options to set the correct hour, minute, and AM/PM setting.
8. If you want the product to enter sleep mode at the same time each day, on the **Apply to all days** screen, touch **Yes**. If you want to set the time for individual days, touch **No**, and repeat the procedure for each day.

Set economy modes from the EWS

1. From a Web browser, open the EWS. See [Embedded Web server on page 178](#).
2. Click **Settings** and then **Wake Time**.
3. Set the wake time for each day of the week.
4. Set the sleep delay for the product.
5. Click **Apply**.

Use the stapler

The automatic stapler is only available with the optional HP 3-bin Stapler/Stacker (CC517A) or HP booklet Maker/Finisher Accessory (CC516A).

Print jobs can be stapled with a diagonal staple in either top corner, with two horizontal staples at the top of the page, or with two vertical staples at either side of the page.

- Paper weight can range from 60 to 220 g/m² (16 to 148 lbs.). Heavier paper might have a stapling limit of fewer than 50 sheets.
- The optional stapler/stacker can staple jobs of up to 50 sheets of 75 g/m² (20 lb) paper. It can stack up to 1,000 sheets of paper, or 30 stapled jobs, whichever is less.
- The optional booklet maker can also staple jobs of up to 50 sheets of 75 g/m² (20 lb) paper. It can staple and fold up to 15 pages into a booklet. It can stack up to 1,000 sheets of paper, (or 30 stapled jobs) or up to 25 saddle-stitched booklets.
- If the job consists of only one sheet, or if it consists of more than 50 sheets, the product delivers the job to the bin, but does not staple the job.
- The stapler supports paper only. Do not try to staple other types of print media, such as envelopes, transparencies, or labels.

 **NOTE:** For information on loading letterhead, pre-printed, and pre-punched paper, see [Load letterhead, pre-printed, or pre-punched paper on page 106](#).

When you want the product to staple or fold a document, select the correct option in the software. You can usually select the stapler in your program or printer driver, although some options might be available only in the printer driver. Where and how you make selections depends on your program or printer driver.

If you cannot select the stapler or booklet maker finisher in the program or printer driver, select it at the product control panel.

The stapler accepts print jobs if it is out of staples, but it does not staple the pages. The product can be configured to stop printing if the staple cartridge is empty.

Supported paper sizes for stapling

In order to staple a print job, you must be a supported paper size and orientation.

Corner, angled staples are supported with the following paper sizes: A4, A4 Rotated, Letter, Letter Rotated, Legal, A3, 11 x 17, and B4 (JIS).

Two staples at the top or side of the print job are supported with the following paper sizes: A4, Letter, A3, 11 x 17, and B4 (JIS).

Saddle-stitch stapling with the booklet maker can be carried out with these sizes: A4 Rotated, Letter Rotated, Legal, A3, 11 x 17, and B4 (JIS).

As shown in the graphic below, the paper must also be loaded into the paper trays with the correct orientation.

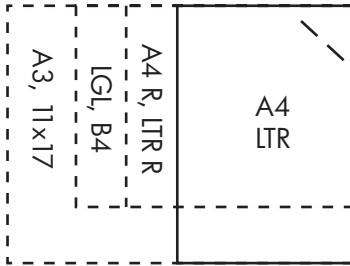
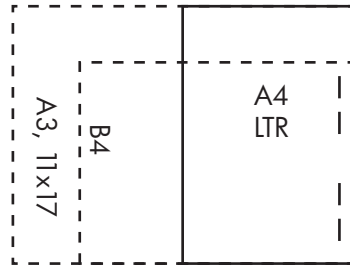
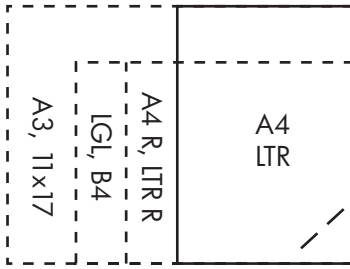

If the correct paper size or orientation is not used, the print job will print, but it will not be stapled.

 **NOTE:** For information about loading and stapling print or copy jobs on letterhead, pre-printed, or pre-punched paper, see [3-bin stapler/stacker features on page 114](#)

Staple print jobs

 **NOTE:** For staple job capacity see [3-bin stapler/stacker features on page 114](#)

Select the stapler at the control panel for printed jobs

1. Touch **Administration** and then touch **Device Behavior**.
2. Touch **MBM-3 Bin Stapler** or **Multifunc Finisher**.
3. Touch **Staples**.
4. Touch the option that you want to use: **One Left Angled**, **One Right Angled**, **Two Left**, **Two Right**, and **Two Top**.

 **NOTE:** Selecting the stapler at the printer control panel changes the default setting. It is possible that all print jobs will be stapled. However, settings that are changed in the printer driver override settings that are changed at the control panel.

Select the stapler in the printer driver for printed jobs (Windows)

 **NOTE:** The following procedure changes the default setting to staple all print jobs.

1. Open the printer driver. See [Change printer-driver settings for Windows on page 67](#).
2. On the **Output** tab, click the drop-down list under **Staple**, and select a staple option.

Select the stapler in the printer driver for printed jobs (Mac)

Select the stapler by creating a new preset in the printer driver.

1. Open the printer driver. See [Change printer-driver settings for Macintosh on page 73](#).
2. Create the new preset.

Configure the device to stop or continue when the staple cartridge is empty

You can specify whether the product stops printing when the staple cartridge is empty or if it continues printing but does not staple the jobs.

1. Touch **Administration** and then touch **Device Behavior**.
2. Touch **MBM-3 Bin Stapler** or **Multifunc Finisher**.
3. Touch **Staples Out**.
4. Touch the option that you want to use:
 - Select **Stop** to stop all printing until the staple cartridge is replaced.
 - Select **Continue** to continue printing jobs without stapling them.

Job storage features for print jobs

You can save a print job to the product hard disk without printing it. You can then print the job at any time at the control panel. The following job-storage features are available for print jobs:

- **Proof and hold jobs:** This feature provides a quick and easy way to print and proof one copy of a job and then print the additional copies.
- **Personal jobs:** When you send a private job to the device, the job does not print until you provide the required personal identification number (PIN) at the control panel.
- **QuickCopy jobs:** You can print the requested number of copies of a job and then store a copy of the job on the device hard disk. Storing the job allows you to print additional copies of the job later.
- **Stored jobs:** You can store a job such as a personnel form, time sheet, or calendar on the device and allow other users to print the job at any time. Stored jobs also can be protected by a PIN.

Follow the instructions in this section to gain access to the job storage features at the computer. See the specific section for the type of job that you want to create.

△ **CAUTION:** If you turn off the device, all QuickCopy, proof and hold, and personal jobs are deleted.

Gain access to the job storage features

For Windows

1. On the **File** menu, click **Print**.
2. Click **Properties**, and then click the **Job Storage** tab.
3. Select the job storage mode that you want.

For Macintosh

In newer drivers: Select **Job Storage** in the pull-down menu in the **Print** dialog box. In older drivers, select **Printer Specific Options**.

Use the proof and hold feature

The proof and hold feature provides a quick and easy way to print and proof one copy of a job and then to print the additional copies.

To permanently store the job and prevent the device from deleting it when space is needed for something else, select the **Stored Job** option in the driver.

Create a proof and hold job

△ **CAUTION:** If the device needs additional space to store newer proof and hold jobs, the device deletes other stored proof and hold jobs, starting with the oldest job. To permanently store a job and prevent the device from deleting it when space is needed, select the **Stored Job** option in the driver instead of the **Proof and Hold** option.

In the driver, select the **Proof and Hold** option and type a user name and job name.

The device prints one copy of the job for you to proof.

Print the remaining copies of a proof and hold job

At the device control panel, use the following procedure to print the remaining copies of a job held on the hard disk.

1. From the Home screen, touch **Job Storage**.
2. Touch the **Retrieve** tab.
3. Scroll to and touch the job storage folder that holds the job.
4. Scroll to and touch the job that you want to print.
5. Select the number of copies on the numeric keypad.
6. Touch **Retrieve Stored Job**  to print the document.

Delete a proof and hold job

When you send a proof and hold job, the device automatically deletes your previous proof and hold job.

1. From the Home screen, touch **Job Storage**.
2. Touch the **Retrieve** tab.
3. Scroll to and touch the job storage folder that holds the job.
4. Scroll to and touch the job that you want to delete.
5. Touch **Delete**.
6. Touch **Yes**.

Use the personal job feature

Use the personal job feature to specify that a job is not printed until you release it. Your job will be stored on the product and nothing will be printed until you request the job from the product's control panel. Once the job is printed, it will be automatically removed from the product's job storage. Personal jobs can be stored with or without a 4-digit personal identification number (PIN). To make the job private, a PIN must be used.

Print a personal job

You can print a personal job at the control panel after the job has been sent to the product.

1. From the Home screen, touch **Job Storage**.
2. Touch the **Retrieve** tab.
3. Scroll to and touch the job storage folder that holds the personal job.
4. Scroll to and touch the personal job that you want to print.
5. If a PIN is required, touch the **PIN** field.
6. Use the numeric keypad to type the PIN, and then touch **OK**.
7. Select the number of copies on the numeric keypad to change the number of copies to print.
8. Touch **Retrieve Stored Job**  to print the document.

Delete a personal job

A personal job is automatically deleted from the device hard disk after you release it for printing. If you want to delete the job without printing it, use this procedure.

1. From the Home screen, touch **Job Storage**.
2. Touch the **Retrieve** tab.
3. Scroll to and touch the job storage folder that holds the personal job.
4. Scroll to and touch the personal job that you want to delete.

 **NOTE:** A personal job will have a lock symbol  next to it.

5. Touch the **PIN** field.
6. Use the numeric keypad to type the PIN, and then touch **OK**.
7. Touch **Delete**.
8. Touch **Yes**.

Use the QuickCopy feature

The QuickCopy feature prints the requested number of copies of a job and stores a copy on the device hard disk. Additional copies of the job can be printed later. This feature can be turned off in the printer driver.

The default number of different QuickCopy jobs that can be stored on the device is 32. At the control panel, you can set a different default number. See [Navigate the Administration menu on page 15](#).

Create a QuickCopy job

-
- △ **CAUTION:** If the device needs additional space to store newer QuickCopy jobs, the device deletes other stored QuickCopy jobs, starting with the oldest job. To permanently store a job and prevent the device from deleting it when space is needed, select the **Job Storage** option in the driver instead of the **QuickCopy** option.
-

In the driver, select the **QuickCopy** option, and then type a user name and a job name.

When you send the job to print, the device prints the number of copies that you set in the driver. To print more quick copies at the device control panel, see [Print additional copies of a QuickCopy job on page 130](#).

Print additional copies of a QuickCopy job

This procedure describes how to print additional copies of a job stored on the device hard disk at the control panel.

1. From the Home screen, touch **Job Storage**.
2. Touch the **Retrieve** tab.
3. Scroll to and touch the job storage folder that holds the job.
4. Scroll to and touch the job that you want to print.
5. Select the number of copies on the numeric keypad to change the number of copies to print.
6. Touch **Retrieve Stored Job**  to print the document.

Delete a QuickCopy job

Delete a QuickCopy job at the device control panel when you no longer need it. If the device requires additional space to store new QuickCopy jobs, the device automatically deletes other stored QuickCopy jobs, starting with the oldest job.

-
-  **NOTE:** Stored QuickCopy jobs can be deleted at the control panel or in HP Web Jetadmin.
-

1. From the Home screen, touch **Job Storage**.
2. Touch the **Retrieve** tab.
3. Scroll to and touch the job storage folder that holds the job.
4. Scroll to and touch the job that you want to delete.
5. Touch **Delete**.
6. Touch **Yes**.

Use the stored job feature for copy jobs

You also can create a stored copy job at the control panel that can be printed at a later time.



Create a stored copy job

1. Place the original document face-down on the glass or face-up in the ADF.
2. From the Home screen, touch **Job Storage**.
3. Touch **Create**.
4. To create a Job Name, touch the **New Job** button to open the keyboard.
5. Type the name of the folder on the touch screen keyboard.
6. Select **Job Name** from the drop-down menu.
7. Type the job name on the touch screen keyboard.
8. If it is a private job, select **PIN to print**. Enter the **PIN** in the popup box.
9. Touch **OK**.
10. After all the options are set, touch **Start** to scan the document and save the file.

For information about printing the job, see [Print a stored job on page 131](#)

Print a stored job

At the control panel, you can print a job that is stored on the device hard disk.

1. From the Home screen, touch **Job Storage**.
2. Touch the **Retrieve** tab.
3. Scroll to and touch the job storage folder that holds the stored job.
4. Scroll to and touch the stored job that you want to print.
5. Touch **Retrieve Stored Job**  to print the document.
6. Select the number of copies on the numeric keypad to change the number of copies to print.
7. Touch **Retrieve Stored Job**  to print the document.

If the file has lock symbol  next to it, the job is a private job and requires a PIN. See [Use the personal job feature on page 129](#).

Delete a stored job

Jobs stored on the device hard disk can be deleted at the control panel.

1. From the Home screen, touch **Job Storage**.
2. Touch the **Retrieve** tab.
3. Scroll to and touch the job storage folder that holds the stored job.
4. Scroll to and touch the stored job that you want to delete.

5. Touch **Delete**.

6. Touch **Yes**.

If the file has lock symbol  next to it, the job requires a PIN to delete it. See [Use the personal job feature on page 129](#).

Print photos or marketing material

You can use the HP Color LaserJet CM6049f to print high-quality color photos, marketing and sales material, or other color documents on glossy paper. To maximize the quality of this output you must do the following:

- Choose the appropriate paper
- Configure the paper tray correctly
- Choose the correct settings in the print driver

Supported glossy paper

HP glossy paper product	Product code	Product size	Control panel and print driver settings
HP Color Laser Presentation Paper, Soft Gloss	Q6541A	Letter	HP soft gloss 120 g
HP Color Laser Professional Paper, Soft Gloss	Q6542A	A4	HP soft gloss 120 g
HP Color Laser Brochure Paper, Glossy	Q6611A, Q6610A	Letter	HP glossy 160 g
HP Color Laser Superior Paper, Glossy	Q6616A	A4	HP glossy 160 g
HP Color Laser Photo Paper, Glossy	Q6607A, Q6608A	Letter	HP glossy 220 g
HP Color Laser Photo Paper, Glossy	Q6614A	A4	HP glossy 220 g
HP Color Laser Photo Paper, Glossy 4x6	Q8842A	101.6 x 152.4 mm (4 x 6 in)	HP glossy 220 g
HP Color Laser Photo Paper, Glossy 10 cm x 15 cm	Q8843A	101.6 x 152.4 mm (4 x 6 in)	HP glossy 220 g

△ **CAUTION:** HP Color Laser Presentation Paper, Glossy (Q2546A) is not supported with this product. Using this type of paper can cause a fuser jam that might require the replacement of the fuser. Two recommended alternatives are HP Color LaserJet Presentation Paper, Soft Gloss (Q6541A) and HP Color LaserJet Brochure Paper, Glossy (Q6611A, Q6610A).

Configure the paper tray

Configure the paper tray for the correct paper type.

1. Load the paper into Tray 2, 3, 4, or 5.
2. After you close the tray, the control panel prompts you to configure the paper size and type.
3. If the correct size and type is displayed, touch **OK** to accept the detected size and type, or **Modify** to choose a different paper size and type.

4. When the paper size prompt appears, touch the correct size, and then touch **Save**.
5. When the paper type prompt appears, touch the correct type. See the table above to determine the correct paper type.

Configure the driver settings

Carry out the following steps to print to glossy paper from your graphics software program.

1. Select **Print** from the **File** menu of your software program.
2. Select the HP Color LaserJet CM6049f, and then click **Properties** or **Printing Preferences**.
3. From the Paper type drop-down list, select the same paper type that you configured on the product control panel.
4. Click **OK** to save the settings and **OK** to print. The print job will automatically be printed from the tray that has been configured for glossy paper, optimizing print quality for that type.

Print weatherproof maps and outdoor signs

You can use the HP Color LaserJet CM6049f to print durable, waterproof maps, signs, or menus by using HP Tough Paper. HP Tough Paper is a waterproof, tear-proof, satin finish paper that retains rich, vibrant print color and clarity even when exposed to heavy usage or weather. This avoids the expensive and time-consuming laminating that is required with plain papers. To maximize the quality of this output you must do the following:

- Choose the appropriate paper
- Configure the paper tray correctly
- Choose the correct settings in the print driver

Supported tough paper

HP paper name	Product code	Product size	Control panel and print driver settings
HP LaserJet Tough Paper	Q1298A	Letter	HP Tough Paper
HP LaserJet Tough Paper	Q1298B	A4	HP Tough Paper

Configure the paper tray

Configure the paper tray for the correct paper type.

1. Load the paper into Tray 2, 3, 4, or 5.
2. After you close the tray, the control panel prompts you to configure the paper size and type.
3. If the correct size is displayed, touch **OK** to accept the detected size, or **Modify** to choose a different paper size and type.
4. When the paper size prompt appears, touch the correct size, and then touch **Save**. When the paper type prompt appears, touch the correct type. See the table above to determine the correct paper type.

Configure the driver settings

Carry out the following steps to print to tough paper from your graphics software program.

1. Select **Print** from the **File** menu of your software program.
2. Select the HP Color LaserJet CM6049f MFP, and then click **Properties** or **Printing Preferences**.
3. From the **Paper type** drop-down list, select the same paper type that you configured on the product control panel.
4. Click **OK** to save the settings and **OK** to print. The print job will automatically be printed from the tray that has been configured for tough paper.

Set the duplex alignment

For duplexed documents such as brochures, set the registration for the tray before printing to ensure the pages align.

1. From the control panel, touch **Administration** and then touch **Print Quality**.
2. Touch **Set Registration**, and then touch the tray you are adjusting.
3. Touch **Test Page** and then touch **Print**.
4. Follow the steps on the page that prints.

9 Print tasks

- [Cancel a print job](#)
- [Use features in the Windows printer driver](#)

Cancel a print job

You can stop a print request by using the control panel or by using the software program. For instructions about how to stop a print request from a computer on a network, see the online Help for the specific network software.

 **NOTE:** It can take some time for all printing to clear after you have canceled a print job.

Stop the current print job from the control panel

- Press **Stop** on the control panel.

Stop the current print job from the software program

A dialog box will appear briefly on the screen, giving you the option to cancel the print job.

If several requests have been sent to the device through your software, they might be waiting in a print queue (for example, in Windows Print Manager). See the software documentation for specific instructions about canceling a print request from the computer.

If a print job is waiting in a print queue (computer memory) or print spooler (Windows), delete the print job there.

Click **Start**, click **Settings**, and then click **Printers** or **Printers and Faxes**. Double-click the device icon to open the print spooler. Select the print job that you want to cancel, and then press **Delete**. If the print job is not cancelled, you might need to shut down and restart the computer. If the job is not in the print spooler, use the Job Status menu from control panel to cancel the job.

Use features in the Windows printer driver

Open the printer driver

How do I	Steps to perform
Open the printer driver	On the File menu in the software program, click Print . Select the printer, and then click Properties or Preferences .
Get help for any printing option	Click the ? symbol in the upper-right corner of the printer driver, and then click any item in the printer driver. A pop-up message displays that provides information about the item. Or, click Help to open the online Help.

Use printing shortcuts

To perform the following tasks, open the printer driver and click the **Printing Shortcuts** tab.

 **NOTE:** In previous HP printer drivers, this feature was called **Quick Sets**.

How do I	Steps to perform
Use a printing shortcut	Select one of the shortcuts, and then click OK to print the job with the predefined settings.
Create a custom printing shortcut	a) Select an existing shortcut as a base. b) Select the print options for the new shortcut. c) Click Save As , type a name for the shortcut, and click OK .

Set paper and quality options

To perform the following tasks, open the printer driver and click the **Paper/Quality** tab.

How do I	Steps to perform
Select a page size	Select a size from the Paper size drop-down list.
Select a custom page size	a) Click Custom . The Custom Paper Size dialog box opens. b) Type a name for the custom size, specify the dimensions, and click OK .
Select a paper source	Select a tray from the Paper source drop-down list.
Select a paper type	Select a type from the Paper type drop-down list.
Print covers on different paper	a) In the Special pages area, click Covers or Print pages on different paper , and then click Settings . b) Select an option to print a blank or preprinted front cover, back cover, or both. Or, select an option to print the first or last page on different paper. c) Select options from the Paper source and Paper type drop-down lists, and then click Add . d) Click OK .
Print the first or last page on different paper	
Adjust the resolution of printed images	In the Print Quality area, select an option from the first drop-down list. See the printer-driver online Help for information about each of the available options.

Set document effects

To perform the following tasks, open the printer driver and click the **Effects** tab.

How do I	Steps to perform
Scale a page to fit on a selected paper size	Click Print document on , and then select a size from the drop-down list.
Scale a page to be a percent of the actual size	Click % of actual size , and then type the percent or adjust the slider bar.
Print a watermark	a) Select a watermark from the Watermarks drop-down list. b) To print the watermark on the first page only, click First page only . Otherwise, the watermark is printed on each page.
Add or edit watermarks	a) In the Watermarks area, click Edit . The Watermark Details dialog box opens. b) Specify the settings for the watermark, and then click OK .

NOTE: The printer driver must be stored on your computer for this to work.

Set document finishing options

To perform the following tasks, open the printer driver and click the **Finishing** tab.

How do I	Steps to perform
Print on both sides (Duplex)	Click Print on both sides . If you will bind the document along the top edge, click Flip pages up .
Print a booklet	a) Click Print on both sides . b) In the Booklet layout drop-down list, click Left binding or Right binding . The Pages per sheet option automatically changes to 2 pages per sheet .
Print multiple pages per sheet	a) Select the number of pages per sheet from the Pages per sheet drop-down list. b) Select the correct options for Print page borders , Page order , and Orientation .
Select page orientation	a) In the Orientation area, click Portrait or Landscape . b) To print the page image upside down, click Rotate by 180 degrees .

Set product output options

To perform the following tasks, open the printer driver and click the **Output** tab.

 **NOTE:** The options that are available on this tab depend on the finishing device that you are using.

How do I	Steps to perform
Select staple options	Select a stapling option from the Staple drop-down list.
Select an output bin	Select an output bin from the Bin drop-down list.

Set job storage options

To perform the following tasks, open the printer driver and click the **Job Storage** tab.

How do I	Steps to perform
Print one copy for proof before printing all the copies	In the Job Storage Mode area, click Proof and Hold . The product prints the first copy only. A message appears on the product control panel that prompts you to print the rest of the copies.
Temporarily store a private job on the product and print it later	a) In the Job Storage Mode area, click Personal Job . b) In the Make Job Private area, enter a 4-digit personal identification number (PIN) (optional).
Temporarily store a job on the product NOTE: These jobs are deleted if the product is turned off.	In the Job Storage Mode area, click Quick Copy . One copy of the job is printed immediately, but you can print more copies from the product control panel.
Permanently store a job on the product	In the Job Storage Mode area, click Stored Job .
Make a permanently stored job private so that anyone who tries to print it must provide a PIN	a) In the Job Storage Mode area, click Stored Job . b) In the Make Job Private area, click PIN to print , and then enter a 4-digit personal identification number (PIN).
Receive notification when someone prints a stored job	In the Job Notification Options area, click Display Job ID when printing .
Set the user name for a stored job	In the User Name area, click User name to use the Windows default user name. To provide a different user name, click Custom and type the name.
Specify a name for the stored job	a) In the Job Name area, click Automatic to use the default job name. To specify a job name, click Custom and type the name. b) Select an option from the If job name exists drop-down list. Select Use Job Name + (1-99) to add a number to the end of the existing name, or select Replace Existing File to overwrite a job that already has that name.

Set color options

To perform the following tasks, open the printer driver and click the **Color** tab.

How do I	Steps to perform
Manually adjust color settings	a) In the Color Options area, click Manual , and then click Settings . b) You can adjust the general settings for Edge Control, and settings for text, graphics, and photographs. See the online Help in the driver for information about each option.
Turn off color printing and use only shades of gray.	In the Color Options area, click Grayscale .
Change the way that colors are rendered	In the Color Themes area, select an option from the drop-down list. See the online Help in the driver for information about each option.

Obtain support and product-status information

To perform the following tasks, open the printer driver and click the **Services** tab.

How do I	Steps to perform
Obtain support information for the product	In the Internet Services drop-down list, select a support option, and click Go!
Check the status of the product, including the level of supplies	Click the Device and Supplies Status icon. The Device Status page of the HP embedded Web server opens.

Set advanced printing options

To perform the following tasks, open the printer driver and click the **Advanced** tab.

How do I	Steps to perform
Select advanced printing options	In any of the sections, click a current setting to activate a drop-down list so you can change the setting.
<p>Change the number of copies that are printed</p> <p>NOTE: If the software program that you are using does not provide a way to print a particular number of copies, you can change the number of copies in the driver.</p> <p>Changing this setting affects the number of copies for all print jobs. After your job has printed, restore this setting to the original value.</p>	Open the Paper/Output section, and then enter the number of copies to print. If you select 2 or more copies, you can select the option to collate the pages.
Print colored text as black rather than as shades of gray	a) Open the Document Options section, and then open the Printer Features section. b) In the Print All Text as Black drop-down list, select Enabled .
Load letterhead or preprinted paper the same way for every job, whether printing on one or both sides of the page	a) Open the Document Options section, and then open the Printer Features section. b) In the Alternative Letterhead Mode drop-down list, select On . c) At the product, load the paper the same way you would for printing on both sides.
Change the order in which pages are printed	a) Open the Document Options section, and then open the Layout Options section. b) In the Page Order drop-down list, select Front to Back to print the pages in the same order as they are in the document, or select Back to Front to print the pages in the reverse order.

10 Use color

- [Manage color](#)
- [Match colors](#)
- [Advanced color use](#)

Manage color

Setting color options to Automatic typically produces the best possible print quality for the most common printing requirements. However, for some documents, setting the color options manually can enhance the way the document appears. Examples of these documents include marketing brochures that contain many images or documents that are printed on a paper type that is not listed in the printer driver.

Use the printer driver to adjust color settings. For more information, see [Set color options on page 141](#) for Windows and [Set the color options on page 78](#) for Macintosh.

Automatic or manual color adjustment

The **Automatic** color adjustment option optimizes the neutral gray color treatment, halftones, and edge enhancements that are used for each element in a document.

 **NOTE:** Automatic is the default setting and is recommended for printing most color documents.

The **Manual** color adjustment option allows you to adjust the neutral gray color treatment, halftones, and edge enhancements for text, graphics, and photographs.

Manual color options

You can manually adjust color options for Edge Control, Halftones, and Neutral Grays.

Edge Control

The **Edge Control** setting determines how edges are rendered. Edge control has three components: adaptive halftoning, Resolution Enhancement technology (REt), and trapping. Adaptive halftoning increases the edge sharpness. Trapping reduces the effect of incorrect color alignment by slightly overlapping the edges of adjacent objects. The color REt option smoothes the edges.

 **NOTE:** If you notice white gaps between objects, or if you notice areas that have a slight shadow of cyan, magenta, or yellow at the edge, choose an edge-control setting that increases the trapping level.

Four levels of edge control are available:

- **Maximum** is the most aggressive trapping setting. Adaptive halftoning and color REt settings are on.
- **Normal** is the default trapping setting. Trapping is at a medium level. Adaptive halftoning and color REt settings are on.
- **Light** sets trapping at a minimal level. Adaptive halftoning and color REt settings are on.
- **Off** turns off trapping, adaptive halftoning, and color REt.

Halftone options

Halftone options affect the resolution and clarity of your color output. You can select halftone settings for text, graphics, and photographs independently. The two halftone options are **Smooth** and **Detail**.

- The **Smooth** option provides better results for large, solid-filled print areas. It also enhances photographs by smoothing out fine color gradations. Choose this option when uniform and smooth area fills are top priority.
- The **Detail** option is useful for text and graphics that require sharp distinctions among lines or colors, or for images that contain a pattern or a high level of detail. Choose this option when sharp edges and details are top priority.

 **NOTE:** Some software programs convert text or graphics to bitmap images. In these cases, setting the color options for photographs also affects how text and graphics appear.

Neutral Grays

The **Neutral Grays** setting determines the method used for creating gray colors that are used in text, graphics, and photographs.

Two values are available for the **Neutral Grays** setting:

- **Black Only** generates neutral colors (grays and black) using only black toner. This guarantees neutral colors without a color cast.
- **4-Color** generates neutral colors (grays and black) by combining all four toner colors. This method produces smoother gradients and transitions to non-neutral colors, and it produces the darkest black.

Print in grayscale

Select the **Print in Grayscale** or **Print Color as Gray** option from the printer driver to print a document in black and white.

Restrict color use

This product includes a **Restrict Color** setting. A network administrator can use the setting to restrict user access to the color printing in order to conserve color toner. If you are unable to print in color, see your network administrator.

Restrict color printing and copying from the control panel

1. Scroll to and touch **Administration** and then touch **Management**.
2. Touch **Restrict Color Use**.
3. Touch **Color printing access** or **Color copying access**.
4. Select one of the following options:
 - **Enable Color** (default). This setting allows color-printing capabilities for all users.
 - **Color If Allowed**. The setting allows the network administrator to allow color use for select users and/or applications. Use the embedded Web server to designate which users and/or applications can print in color (**Color printing access** only).
 - **Disable Color**. This setting denies color-printing capabilities to all users.
5. Touch **Save**.

For more information about restricting and reporting color usage, go to www.hp.com/go/coloraccess.

RGB Color (Color Themes)

You can change **RGB Color** settings from the printer-driver. For more information on accessing the printer driver, see [Set color options on page 141](#) for Windows and [Set the color options on page 78](#) for Macintosh.

Five values are available for the **RGB Color** setting:

- Select **Default (sRGB)** for most printing needs. This setting instructs the product to interpret RGB color as sRGB, which is the accepted standard of Microsoft and the World Wide Web Consortium (W3C).
- Select **Image optimization (sRGB)** to enhance documents in which the content is mainly bitmap images, such as .GIF or .JPEG files. This setting instructs the product to use the best color matching for rendering sRGB, bitmap images. This setting has no effect on text or vector-based graphics. Using glossy paper in combination with this setting provides the maximum enhancement.
- Select **AdobeRGB** for documents that use the *AdobeRGB* color space rather than sRGB. For example, some digital cameras capture images in AdobeRGB, and documents that are produced with Adobe PhotoShop use the AdobeRGB color space. When printing from a professional software program that uses AdobeRGB, it is important that you turn off the color management in the software program and allow the product software to manage the color space.

Match colors

The process of matching product output color to your computer screen is quite complex because printers and computer monitors use different methods of producing color. Monitors *display* colors by light pixels using an RGB (red, green, blue) color process, but printers *print* colors using a CMYK (cyan, magenta, yellow, and black) process.

Several factors can influence your ability to match printed colors to those on your monitor. These factors include:

- Paper
- Printer colorants (inks or toners for example)
- Printing process (inkjet, press, or laser technology for example)
- Overhead lighting
- Personal differences in perception of color
- Software programs
- Printer drivers
- Computer operating system
- Monitors and monitor settings
- Video cards and drivers
- Operating environment (humidity for example)

Keep the above factors in mind when colors on your screen do not perfectly match your printed colors.

For most users, the best method for matching colors on your screen to your product is to print sRGB colors.

Sample book color matching

The process for matching product output to preprinted sample books and standard color references is complex. In general, you can obtain a reasonably good match to a sample book if the inks used to create the sample book are cyan, magenta, yellow, and black. These are usually referred to as process color sample books.

Some sample books are created from spot colors. Spot colors are specially created colorants. Many of these spot colors are outside of the range of the product. Most spot color sample books have companion process sample books that provide CMYK approximations to the spot color.

Most process sample books will state which process standards were used to print the sample book. In most cases they will be SWOP, EURO, or DIC. To get optimal color matching to the process sample book, select the corresponding ink emulation from the product menu. If you cannot identify the process standard, use SWOP ink emulation.

Printing color samples

To use the color samples, select the color sample that is the closest match to the desired color. Use the sample's color value in your software program to describe the object you wish to match. Colors may

vary depending on paper type and the software program used. For more details on how to use the color samples, go to www.hp.com.

Use the following procedure to print color samples at the product using the control panel:

1. Touch **Administration** and then touch **Information**.
2. Touch **Sample pages/fonts** and then touch **CMYK samples** or **RGB samples** to print the samples.

PANTONE® color matching

PANTONE has multiple color matching systems. PANTONE MATCHING SYSTEM® is very popular and uses solid inks to generate a wide range of color hues and tints. See www.hp.com for details on how to use PANTONE Colors with this product.

 **NOTE:** PANTONE Colors generated might not match PANTONE-identified standards. Consult current PANTONE Publications for accurate color.

Advanced color use

HP ImageREt 4800

HP ImageREt 4800 print technology is a system of innovative technologies developed exclusively by HP to deliver superior print quality. The HP ImageREt system sets itself apart from the industry by integrating technology advancements and optimizing each element of the print system. Several categories of HP ImageREt have been developed for a variety of user needs.

The system uses key color-laser technologies, including image enhancements, smart supplies, and high-resolution imaging, to provide superior images for general office documents and marketing collateral. Optimized for printing on HP color laser high-gloss papers, HP Image REt 4800 provides superior results on all supported paper, and under a variety of environmental conditions.

Paper selection

For the best color and image quality, it is important to select the appropriate paper type from the product menu or from the front panel.

sRGB

Standard red-green-blue (sRGB) is a worldwide color standard originally developed by HP and Microsoft as a common color language for monitors, input devices (scanners, digital cameras), and output devices (products, printers, plotters). It is the default color space used for HP products, Microsoft operating systems, the Web, and most office software sold today. sRGB is representative of the typical Windows computer monitor today and the convergence standard for high-definition television.

 **NOTE:** Factors such as the type of monitor you use and the room's lighting can affect the appearance of colors on your screen.

The latest versions of Adobe PhotoShop, CorelDRAW™, Microsoft Office, and many other software programs use sRGB to communicate color. Most importantly, as the default color space in Microsoft operating systems, sRGB has gained broad adoption as a means to exchange color information between software programs and devices using a common definition that assures typical users will experience greatly improved color matching. sRGB improves your ability to match colors between the product, the computer monitor, and other input devices (scanner, digital camera) automatically, without the need to become a color expert.

Print in four colors — CMYK

Cyan, magenta, yellow, and black (CMYK) are the inks used by a printing press. The process is often called four-color printing. CMYK data files are typically used by and originate from graphic arts (printing and publishing) environments. The product will accept CMYK colors through the PS printer driver. The product color-rendering of CMYK is designed to provide rich, saturated colors for text and graphics.

CMYK ink set emulation (HP postscript level 3 emulation)

The product color rendering of CMYK can be made to emulate several standard offset press ink sets. In some situations, the CMYK color values in an image or document might not be suited to the product. For example, a document might be optimized for another product. For best results, the CMYK values

should be adapted to the HP Color LaserJet CM6049f. Select the appropriate color input profile from the printer driver.

- **Default CMYK+.** HP CMYK+ technology produces optimal printing results for most printing jobs.
- **Specification for Web Offset Publications (SWOP).** Common ink standard in the United States and other countries/regions.
- **Euroscale.** Common ink standard in Europe and other countries/regions.
- **Dainippon Ink and Chemical (DIC).** Common ink standard in Japan and other countries/regions.
- **Custom profile.** Select this option to use a custom input profile to accurately control color output, for example, to emulate another HP color LaserJet product. To download color profiles, go to www.hp.com and search for "CM6049 mfp color profile".

11 Copy

- [Use the Copy screen](#)
- [Set the default copy options](#)
- [Copy from the scanner glass](#)
- [Copy from the document feeder](#)
- [Adjust the copy settings](#)
- [Copy two-sided documents](#)
- [Copy mixed-size originals](#)
- [Change the copy-collation setting](#)
- [Copy photos and books](#)
- [Combine copy jobs by using Job Build](#)
- [Cancel a copy job](#)

Use the Copy screen

From the Home screen, touch **Copy** to view the Copy screen. Only the first six copy features are immediately visible. In order to view additional copy features, touch **More Options**.

Set the default copy options

You can use the administration menu to establish default settings that apply to all copy jobs. If necessary, you can override most settings for an individual job. After that job is complete, the product returns to the default settings.

1. From the Home screen, scroll to and touch **Administration**.
2. Touch **Default Job Options**, and then touch **Default Copy Options**.
3. Several options are available. You can configure defaults for all options, or for only some options.

For information about each option, see [Adjust the copy settings on page 153](#). The built-in Help system also provides an explanation of each option. Touch the **Help** button  in the upper-right corner of the screen.

4. To exit the administration menu, touch the **Home** button  in the upper-left corner of the screen.

Copy from the scanner glass

Use the scanner glass to make as many as 999 copies of small, lightweight media (less than 60 g/m² or 16 lb) or heavy media (more than 105 g/m² or 28 lb). This includes media such as receipts, newspaper clippings, photographs, old documents, worn documents, and books.

Place original documents face-down on the glass. Align the corner of the original with the upper-left corner of the glass.

To make copies by using the default copy options, use the numeric keypad on the control panel to select the number of copies, and press **Start**. To use customized settings, touch **Copy**. Specify the settings, and then press **Start**. For more information about using customized settings, see [Adjust the copy settings on page 153](#).

Copy from the document feeder

Use the document feeder to make as many as 999 copies of a document that has up to 50 pages (depending on the thickness of the pages). Place the document into the document feeder with the pages facing up.

To make copies by using the default copy options, use the numeric keypad on the control panel to select the number of copies, and press **Start**. To use customized settings, touch **Copy**. Specify the settings, and then press **Start**. For more information about using customized settings, see [Adjust the copy settings on page 153](#).

Before starting another copy job, retrieve the original document from the document-feeder output bin that is under the document feeder input tray, and retrieve the copies from the appropriate output bin.

Adjust the copy settings

The product offers several features so you can optimize copied output. These features are all available on the **Copy** screen.

The **Copy** screen consists of several pages. From the first page, touch **More Options** to go to the next page. Then touch the up or down arrow buttons to scroll to other pages.

For details about how to use an option, touch the option, and then touch the help  button in the upper-right corner of the screen. The following table provides an overview of the copy options.

 **NOTE:** Depending on how the system administrator has configured the product, some of these options might not appear. The options in the table are listed in the order in which they can appear.

Option name	Description
Sides	Use this feature to indicate whether the original document is printed on one or both sides, and whether the copies should be printed on one or both sides.
Reduce/Enlarge	Use this feature to reduce or enlarge the copied image on the page.
Color/Black	Use this feature to choose black printing or color printing.
Staple/Collate or Collate	If the optional HP Stapler/Stacker/Separator is attached, the Staple/Collate option is available. Use this feature to set up options for stapling and assembling the pages in sets of copies. If the optional HP Stapler/Stacker/Separator is not attached, the Collate option is available. Use this feature to assemble each set of copied pages in the same order as the original document.
Paper Selection	Use this feature to select the tray that holds the size and type of paper that you want to use.
Image Adjustment	Use this feature to improve the overall quality of the copy. For example, you can adjust the darkness and sharpness, and you can use the Background Cleanup setting to remove faint images from the background or to remove a light background color.
Content Orientation	Use this feature to specify the way the content of the original page is placed on the page: portrait or landscape.
Output Bin	Use this feature to select an output bin for the copies.
Optimize Text/Picture	Use this feature to optimize the output for a particular type of content. You can optimize the output for text or printed pictures, or you can manually adjust the values.
Pages per Sheet	Use this feature to copy multiple pages onto one sheet of paper.
Original Size	Use this feature to describe the page size of the original document.
Book Copy	Use this feature to scan and print pages from a book.
Booklet Format	Use this feature to copy two or more pages onto one sheet of paper so you can fold the sheets in the center to form a booklet.
Edge-To-Edge	Use this feature to avoid shadows that can appear along the edges of copies when the original document is printed close to the edges. Combine this feature with the Reduce/Enlarge feature to ensure that the entire page is printed on the copies.
Job Build	Use this feature to combine several sets of original documents into one copy job. Also use this feature to copy an original document that has more pages than the document feeder can accommodate at one time.

Copy two-sided documents

Two-sided documents can be copied manually or automatically.

Copying two-sided documents manually

Copies resulting from this procedure are printed on one side, and need to be hand-collated.

1. Load the documents to be copied into the document feeder input tray with the first page facing up, and with the top of the page leading into the document feeder.
2. Touch **Start Copy**. The odd-numbered pages are copied and printed.
3. Remove the stack from the document feeder output tray and reload the stack with the last page facing up, and with the top of the page leading into the document feeder.
4. Touch **Start Copy**. The even-numbered pages are copied and printed.
5. Collate the odd- and even-numbered printed copies.

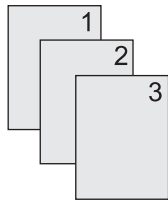

Copy two-sided documents automatically

The default copy setting is one-sided to one-sided. Use the following procedures to change the setting so you can copy from or to documents that are two-sided.

Make two-sided copies from one-sided documents

1. Load the documents to be copied into the document feeder with the first page facing up, and with the top of the page leading.
2. On the control panel, touch **Copy**.
3. Touch **Sides**.
4. Touch **1-sided original, 2-sided output**.
5. Touch **OK**.
6. Touch **Start Copy**.

Make two-sided copies from two-sided documents

1. Load the documents to be copied into the document feeder with the first page facing up, and with the top of the page leading.
2. On the control panel, touch **Copy**.
3. Touch **Sides**.

4. Touch **2-sided original, 2-sided output**.
5. Touch **OK**.
6. Touch **Start Copy**.

Make one-sided copies from two-sided documents

1. Load the documents to be copied into the document feeder with the first page facing up, and with the top of the page leading.
2. On the control panel, touch **Copy**.
3. Touch **Sides**.
4. Touch **2-sided original, 1-sided output**.
5. Touch **OK**.
6. Touch **Start Copy**.

Copy mixed-size originals

You can copy original documents that are printed on different sizes of paper as long as the sheets of paper have one common dimension. For example, you could combine letter and legal sizes, or you could combine A4 and A5 sizes.

1. Arrange the sheets in the original document so they all have the same width.
2. Place the sheets face-up into the document feeder, and adjust both paper guides against the document.
3. From the Home screen, touch **Copy**.
4. Touch **Original Size**.



NOTE: If this option is not on the first screen, touch **More Options** until the option appears.

5. Select **Mixed Ltr/Lgl**, and then touch **OK**.
6. Touch **Start Copy**.

Change the copy-collation setting

You can set the device to automatically collate multiple copies into sets. For example, if you are making two copies of three pages and the automatic collation is on, the pages print in this order: 1,2,3,1,2,3. If automatic collation is off, the pages print in this order: 1,1,2,2,3,3.

To use the automatic collation, the original document size must fit into the memory. If it does not, the device makes only one copy and a message appears notifying you of the change. If that happens, use one of the following methods to finish the job:

- Split the job into smaller jobs that contain fewer pages.
- Make only one copy of the document at a time.
- Turn off the automatic collation.

The collation setting you select is in effect for all copies until you change the setting. The default setting for automatic copy collation is **On**.

1. On the control panel, touch **Copy**.
2. Touch **Staple/Collate** or **Collate**.
3. Touch **Off**.
4. Touch **OK**.

Copy photos and books

Copy a photo

 **NOTE:** Photos should be copied from the flatbed scanner, not from the document feeder.

1. Lift the lid and place the photo on the flatbed scanner with the picture-side down and the upper-left corner of the photo in the upper-left corner of the glass.
2. Gently close the lid.
3. Touch **Copy**.
4. Touch **Optimize Text/Picture** and select **Photograph**.
5. Touch **Start Copy**.

Copy a book

1. Place the book face down on the glass with the top edge toward the rear of the glass. Align the book spine with the book icon  along the top edge of the glass.
2. Touch **Copy**.
3. Scroll to and touch **Book Copy**.
4. Touch **Book Copy On** and then touch **OK**.
5. Select the number of copies to make and adjust other settings as needed.
6. Touch **Start Copy**, or press the Start button on the control panel.
7. The following 3 options are available when **Start Copy** is touched:
 - **Copy both pages** copies the images on both the left and right side of the spine
 - **Skip left page** copies the image on the right side of the spine only
 - **Skip right page** copies the image on the left side of the spine only
8. Touch **Scan**.
9. After the last page is scanned, touch **Finish**.

Combine copy jobs by using Job Build

Use this feature to combine several sets of original documents into one copy job. Also use this feature to copy an original document that has more pages than the document feeder can accommodate at one time.

1. Touch **Copy**.
2. Scroll to and touch **Job Build**.
3. Touch **Job Build On**.
4. Touch **OK**.
5. If necessary, select the desired copy options.
6. Touch **Start Copy**. After each page is scanned, the control panel prompts you for more pages.
7. If the job contains more pages, load the next page, and then touch **Scan**.

The product temporarily saves all the scanned images. The product will begin printing copies when it has enough information to begin. Touch **Finish** to finish printing the copies.

 **NOTE:** In Job Build, if you scan the first page of a document by using the document feeder, then you must scan all of the pages in that document by using the document feeder. If you scan the first page of a document by using the scanner glass, then you must scan all of the pages in that document by using the scanner glass.

Cancel a copy job

1. Touch the **Stop** button on the control panel and then touch the job from the list.
2. Touch **Cancel Job** and then touch **OK**.

 **NOTE:** If you cancel a copy job, clear the document from the flatbed scanner or from the automatic document feeder.

12 Scan and send to e-mail

- [Configure e-mail settings](#)
- [Use the Send E-mail screen](#)
- [Perform basic e-mail functions](#)
- [Use the address book](#)
- [Change e-mail settings for the current job](#)
- [Scan to a folder](#)
- [Scan to a workflow destination](#)

Configure e-mail settings

The product offers color-scanning and digital-sending capabilities. By using the control panel, you can scan black-and-white or color documents and send them to an e-mail address as an e-mail attachment. To use digital sending, the product must be connected to a local area network (LAN).

 **NOTE:** The e-mail icon is not shown on the control panel if e-mail is not configured.

Before you can send a document to e-mail, you must configure the product.

 **NOTE:** The instructions that follow are for configuring the product at the control panel. You can also perform these procedures by using the embedded Web server. For more information, see [Embedded Web server on page 178](#).

Supported protocols

The HP Color LaserJet CM6049f MFP supports Simple Mail Transfer Protocol (SMTP) and Lightweight Directory Access Protocol (LDAP).

SMTP

- SMTP is a set of rules that define the interaction between programs that send and receive e-mail. In order for the device to send documents to e-mail, it must be connected to a LAN that has access to an e-mail server that supports SMTP. The SMTP server must also have Internet access.
- If you are using a LAN connection, contact your system administrator to obtain the IP address or host name for your SMTP server. If you are connecting through a DSL or cable connection, contact the internet service provider to obtain the SMTP server IP address.

LDAP

- LDAP is used to gain access to a database of information. When the device uses LDAP, it searches a global list of e-mail addresses. As you begin to type the e-mail address, LDAP uses an auto-complete feature that supplies a list of e-mail addresses that match the characters you type. As you type additional characters, the list of matching e-mail addresses becomes smaller.
- The device supports LDAP, but a connection to an LDAP server is not required in order for the device to be able to send to e-mail.

 **NOTE:** If you need to change the LDAP settings, you must change them by using the embedded Web server. For more information, see [Embedded Web server on page 178](#), or see the *Embedded Web Server User Guide*.

Configure e-mail server settings

Find the SMTP gateway

1. From the Home screen, touch **Administration**
2. Touch **Initial Setup**.
3. Touch **E-mail Setup**, and then touch **Find Send Gateways**.
4. Touch **Find**.

Configure the SMTP gateway address

1. From the Home screen, touch **Administration**.
2. Touch **Initial Setup**.
3. Touch **E-mail Setup**, and then touch **SMTP Gateway**.
4. Type the SMTP gateway address, either as an IP address or as a fully qualified domain name. If you do not know the IP address or domain name, contact the network administrator.
5. Touch **Save**.

Test the SMTP settings

1. From the Home screen, touch **Administration**.
2. Touch **Initial Setup**.
3. Touch **E-mail Setup**, and then touch **Test**.

If the configuration is correct, **Gateways OK** appears on the control-panel display.

If the first test was successful, send an e-mail to yourself by using the digital-send feature. If you receive the e-mail, you have successfully configured the digital-sending feature.

If you do not receive the e-mail, use these actions to resolve issues with the digital-sending software:

- Check the SMTP and address to make sure that you typed them correctly.
- Print a configuration page. Verify that the SMTP gateway address is correct.
- Make sure that the network is operating correctly. Send an e-mail to yourself from a computer. If you receive the e-mail, the network is operating correctly. If you do not receive the e-mail, contact your network administrator or Internet service provider (ISP).

Use the Send E-mail screen

Use the touchscreen to navigate through the options on the Send E-mail screen.

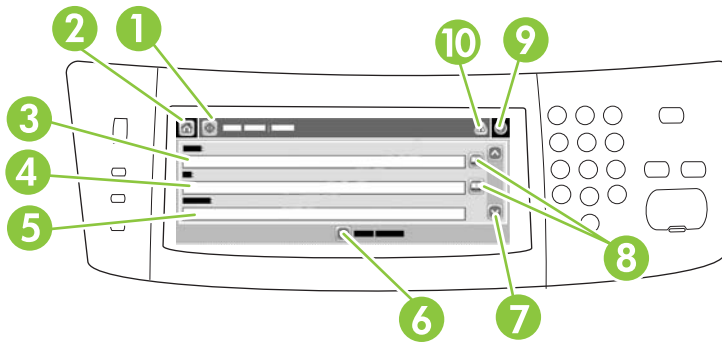

1	Send E-mail button	Touching this button scans the document and sends an e-mail file to the provided e-mail addresses.
2	Home button	Touching this button opens the Home screen.
3	From: field	Touch this field to open the keyboard, and then type your e-mail address. If the system administrator has configured the device to do so, this field might automatically insert a default address.
4	To: field	Touch this field to open the keyboard, and then type the e-mail addresses of those whom you want to receive the scanned document.
5	Subject: field	Touch this field to open the keyboard, and then type a subject title.
6	More Options button	Touch this button to change certain e-mail settings for the current scan job.
7	Scroll bar	Use the scroll bar to view and set up the CC: , BCC: , Message , and File Name fields. Touch any of those fields to open the keyboard and add the necessary information.
8	Address book buttons	Touch these buttons to use the address book to populate the To: , CC: , or BCC: fields. For more information, see Use the local address book on page 167 .
9	Help button	Touch this button for control-panel help. For more information, see Use the control panel on page 12 .
10	Error/warning button	This button appears only when there is an error or warning in the status line area. Touch it to open a pop-up screen that will help you resolve the error or warning.

Perform basic e-mail functions

The product e-mail feature offers the following benefits:

- Sends documents to multiple e-mail addresses, saving time and delivery costs.
- Delivers files in black-and-white or in color. Files can be sent in different file formats that the recipient can manipulate.

With e-mail, documents are scanned into the product memory and sent to an e-mail address or multiple addresses as an e-mail attachment. Digital documents can be sent in several graphics formats, such as .TFF and .JPG, which allows recipients to manipulate the document file in various programs to meet their specific needs. Documents arrive in near-original quality, and then can be printed, stored, or forwarded.

In order to use the e-mail feature, the product needs to be connected to a valid SMTP local area network that includes Internet access.

Load documents

You can scan a document by using either the glass or the ADF. The glass and ADF can accommodate Letter-, Executive-, A4-, and A5-size originals. The ADF can also accommodate Legal-size originals. Smaller originals, receipts, irregular and worn documents, stapled documents, previously folded documents, and photographs should be scanned by using the glass. Multiple-page documents can be scanned easily by using the ADF.

Send documents

The product scans both black-and-white and color originals. You can use default settings or change the scanning preferences and file formats. The following are the default settings:

- Color
- PDF (requires the recipient to have an Adobe Acrobat viewer to view the e-mail attachment)

For information about changing the settings for the current job, see [Change e-mail settings for the current job on page 168](#).

Send a document

1. Place the document face-down on the scanner glass or face-up in the ADF.
2. From the Home screen, touch **E-mail**.
3. If prompted, type your user name and password.
4. Complete the **From:**, **To:**, and **Subject:** fields. Scroll down and complete the **CC:**, and **BCC:** fields if appropriate. Your user name or other default information might appear in the **From:** field. If so, you might not be able to change it.
5. (Optional) Touch **More Options** to change the settings for the document that you are sending (for example, the document's original size). If you are sending a two-sided document, you should select **Sides** and an option with a two-sided original.
6. Press **Start** to begin sending.
7. When you are finished, remove the original document from the scanner glass or ADF.

Use the auto-complete function



When you type characters into the **To:**, **CC:**, or **From:** fields on the Send E-mail screen, the auto-complete function is activated. As you type the required address or name by using the keyboard screen, the device automatically searches the address book list and completes the address or name by using the first match. You can then select that name by touching **Enter**, or continue typing the name until auto-complete finds the correct entry. If you type a character that does not match any entry in the list, the auto-complete text is removed from the display to indicate that you are typing an address that is not in the address book.

Use the address book

You can send e-mail to a list of recipients by using the address book feature of the product. See your system administrator for information about configuring address lists.

 **NOTE:** You can also use the embedded Web server (EWS) to create and manage the e-mail address book. The EWS e-mail address book can be used to add, edit, or delete single e-mail addresses or e-mail distribution lists. For more information, see [Embedded Web server on page 178](#).

Create a recipient list

1. From the Home screen, touch **E-mail**.
2. Complete one of the following steps:
 - Touch **To:** to open the keyboard screen, and then type the recipients' e-mail addresses. Separate multiple e-mail addresses with a semicolon or by touching **Enter** on the touchscreen.
 - Use the address book.
 - a. On the Send E-mail screen, touch the address book button  to open the address book.
 - b. Navigate the entries in the address book by using the scroll bar. Hold down the arrow to scroll quickly through the list.
 - c. Highlight the name to select a recipient, and then touch the arrow button .

You can also select a distribution list by touching the drop-down list at the top of the screen and then touching **All**, or add a recipient from a local list by touching **Local** in the drop-down list. Highlight the appropriate names, and then touch the arrow button  to add the name to your list of recipients.

You can remove a recipient from your list by scrolling to highlight the recipient, and then touching the remove button  in the middle of the screen.

3. The names in the recipient list are placed in the text line of the keyboard screen. If you want, you can add a recipient that is not found in the address book by typing the e-mail address on the keyboard. After you are satisfied with your recipient list, touch **OK**.
4. Touch **OK**.
5. Finish typing information in the **CC:** and **Subject:** fields on the Send E-mail screen, if necessary. You can check the list of recipients by touching the down arrow in the **To:** text line.
6. Press **Start**.

Use the local address book

Use the local address book to store frequently-used e-mail addresses. The local address book can be shared between devices that use the same server to gain access to the HP Digital Sending software.

You can use the address book when you type e-mail addresses in the **From:**, **To:**, **CC:**, or **BCC:** fields. You can also add or delete addresses in the address book.

To open the address book, touch the address book button .

Add e-mail addresses to the local address book

1. Touch **Local**.
2. Touch the add button .
3. (Optional) Touch the **Name** field, and in the keyboard that appears type a name for the new entry. Touch **OK**.

The name is the alias for the e-mail address. If you do not type an alias name, the alias will be the e-mail address itself.

4. Touch the **Address** field, and in the keyboard that appears type the e-mail address for the new entry. Touch **OK**.

Delete e-mail addresses from the local address book

You can delete e-mail addresses that you no longer use.

 **NOTE:** To *change* an e-mail address, you must first delete the address and then add the corrected address as a new address in the local address book.

1. Touch **Local**.
2. Touch the e-mail address that you want to delete.
3. Touch the remove button  in the lower right corner.

The following confirmation message appears: **Do you want to delete the selected address(es)?**

4. Touch **Yes** to delete the e-mail address(es) or touch **No** to return to the Address Book screen.

Change e-mail settings for the current job

Use the **More Options** button to change the following e-mail settings for the current print job:

Button	Description
Document File Type	Touch this button to change the type of file the device creates after scanning the document.
Output Quality	Touch this button to increase or decrease the print quality of the file being scanned. A higher quality setting produces a larger file size.
Resolution	Touch this button to change the scan resolution. A higher resolution setting produces a larger file size.
Color/Black	Touch this button to determine whether you will scan the document in color or in black-and-white.
Original Sides	Touch this button to indicate if the original document is one-sided or two-sided.
Content Orientation	Touch this button to select either the portrait or landscape orientation for the original.
Original Size	Touch this button to select the size of the document: letter, A4, legal, or mixed letter/legal.
Optimize Text/ Picture	Touch this button to change the scanning procedure based on the type of document that you are scanning.
Job Build	Touch this button to activate or deactivate the Job Build mode, which enables you to scan several small scan jobs and send them as one file.
Image Adjustment	Touch this button to change the darkness and sharpness settings, or to clean up background clutter on the original.

Scan to a folder

If the system administrator has made the feature available, the device can scan a file and send it to a folder on the network. Supported operating systems for folder destinations include Windows 2000, Windows XP, Windows Server 2003, Windows Server 2008, and Windows Vista.

 **NOTE:** You might be required to supply a user name and password in order to use this option, or to send to certain folders. See your system administrator for more information.

1. Place the document face-down on the scanner glass or face-down in the ADF.
2. From the Home screen, touch **Network Folder**.
3. In the Quick Access Folders list, select the folder in which you want to save the document.
4. Touch the **File Name** field to open the keyboard pop-up screen, and then type the file name.
5. Touch **Send to Network Folder**.

Scan to a workflow destination

 **NOTE:** This device feature is provided by the optional Digital Sending Software.

If the system administrator has enabled the workflow functionality, you can scan a document and send it to a custom workflow destination. A workflow destination gives you the ability to send additional information, along with the scanned document, to a specified network or file transfer protocol (FTP) location. Prompts for specific information appear on the control-panel display. The system administrator can also designate a printer as a workflow destination, which allows you to scan a document and then send it directly to a network printer for printing.

1. Place the document face-down on the scanner glass or face-up in the ADF.
2. From the Home screen, touch **Workflow**.
3. Select the destination to which you want to scan.
4. In the Text Field field, type the data that you want to accompany the file, and then touch **Send Workflow**.

13 Fax

- [Analog fax](#)
- [Digital fax](#)

Analog fax

When the analog fax accessory is installed, the product can function as a standalone fax machine.

The HP Color LaserJet CM6049f comes with a fax accessory already installed. Specifications for the Analog Fax Accessory are available in the *HP LaserJet Analog Fax Accessory 300 User Guide*. The *Analog Fax Accessory 300 Fax Guide* and the *Analog Fax Accessory 300 Send Fax Driver Guide* are also located at www.hp.com/go/mfpfaxaccessory300.

Connect the fax accessory to a phone line

When connecting the fax accessory to a phone line, ensure that the phone line being used for the fax accessory is a dedicated line that is not used by any other devices. Also, this line should be an analog line because the fax will not function correctly if it is connected to some digital PBX systems. If you are not sure whether you have an analog or digital phone line, contact your telecom provider.

 **NOTE:** HP recommends using the phone cord that comes with the fax accessory to ensure that the accessory functions correctly.

Follow these instructions to connect the fax accessory to a phone jack.

1. Locate the phone cord that is included with the fax accessory kit. Connect one end of the phone cord into the fax accessory phone jack that is on the formatter. Push the connector until it clicks.

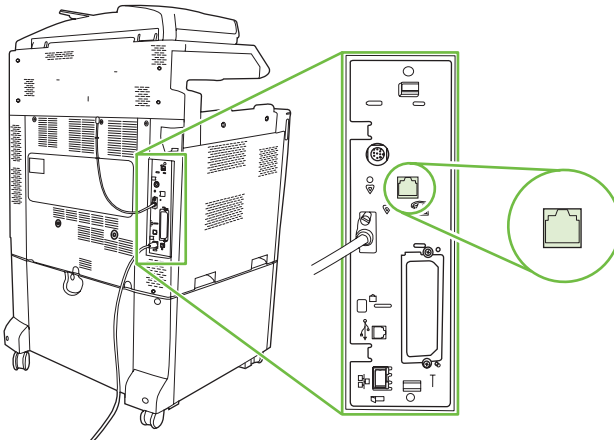

 **CAUTION:** Be sure to connect the phone line to the fax accessory port, which is located in the center of the formatter. Do not connect the phone line to the HP Jetdirect port, which is nearer the bottom of the formatter.

2. Connect the other end of the phone cord into the phone jack on the wall. Push the connector until it clicks or until it is securely seated. Because different types of connectors are used in different countries/regions, the connector might not make an audible click.

Configure and use the fax features

Before you can use the fax features, you must configure them in the control-panel menus. For complete information about configuring and using the fax accessory, and for information about troubleshooting problems with the fax accessory, see the *HP LaserJet Analog Fax Accessory 300 User Guide*. This guide is provided with the fax accessory.

Use the Send Fax driver to send a fax from a computer without going to the product control panel. See the *HP LaserJet MFP Analog Fax Accessory 300 Send Fax Driver Guide* for more information.

The *HP LaserJet Analog Fax Accessory 300 User Guide* and *HP LaserJet MFP Analog Fax Accessory 300 Send Fax Driver Guide* are both available at www.hp.com/go/mfpfaxaccessory300.

Digital fax

Digital faxing is available when you install the optional HP Digital Sending Software. For information about ordering this software, go to www.hp.com/go/digitalsending

With digital faxing, the product does *not* need to be connected directly to a phone line. Instead, the product can send a fax in one of three ways:

- **LAN fax** sends faxes through a third-party fax provider.
- **Microsoft Windows 2000 fax** is a fax modem and Digital Sender Module on a computer that allows the computer to operate as a turnkey gateway fax.
- **Internet fax** uses an Internet fax provider to process faxes, and the fax is delivered on a traditional fax machine or sent to the user's e-mail.

For complete information about using digital faxing, see the documentation that is provided with the HP Digital Sending Software.

14 Manage and maintain the product

- [Information pages](#)
- [Embedded Web server](#)
- [Use HP Web Jetadmin software](#)
- [Security features](#)
- [Set the real-time clock](#)
- [Manage supplies](#)
- [Replace supplies](#)
- [Clean the product](#)
- [ADF maintenance kit](#)
- [Calibrate the scanner](#)
- [Upgrade the firmware](#)

Information pages

Information pages provide details about the device and its current configuration. The following table provides the instructions for printing the information pages.

Page description	How to print the page from the product control panel
Menu map Shows the control-panel menus and available settings.	<ol style="list-style-type: none">1. From the Home screen, touch Administration.2. Touch Information.3. Touch Configuration/status Pages.4. Touch Administration Menu Map.5. Touch Print. <p>The content of the menu map varies, depending on the options currently installed in the device.</p> <p>For a complete list of control panel menus and possible values, see Use the control panel on page 12.</p>
Configuration page Shows device settings and installed accessories.	<ol style="list-style-type: none">1. From the Home screen, touch Administration.2. Touch Information.3. Touch Configuration/Status Pages.4. Touch Configuration Page.5. Touch Print. <p>NOTE: If the device contains an HP Jetdirect print server or an optional hard disk drive, additional configuration pages print that provide information about those devices.</p>
Supplies status page Shows print-cartridge toner levels.	<ol style="list-style-type: none">1. From the Home screen, touch Administration.2. Touch Information.3. Touch Configuration/status Pages.4. Touch Supplies Status Page.5. Touch Print. <p>NOTE: If you are using non-HP supplies, the supplies status page might not show the remaining life for those supplies.</p>
Usage page Shows a page count for each size of paper printed, the number of one-sided (simplex) or two-sided (duplex) pages, and the average percentage of coverage.	<ol style="list-style-type: none">1. From the Home screen, touch Administration.2. Touch Information.3. Touch Configuration/status Pages.4. Touch Usage Page.5. Touch Print.

Page description	How to print the page from the product control panel
Color usage job log	<ol style="list-style-type: none"> 1. From the Home screen, touch Administration 2. Touch Information 3. Touch Configuration/status Pages 4. Touch Color Usage Job Log 5. Touch Print
<p>File directory</p> <p>Contains information for any mass storage devices, such as flash drives, memory cards, or hard disks, that are installed in the device.</p>	<ol style="list-style-type: none"> 1. From the Home screen, touch Administration. 2. Touch Information. 3. Touch Configuration/status Pages. 4. Touch File Directory. 5. Touch Print.
<p>Fax reports</p> <p>Five reports show fax activity, fax calls, billing codes, blocked fax numbers, and speed-dial numbers.</p> <p>NOTE: Fax reports are available only on device models that have fax capabilities.</p>	<ol style="list-style-type: none"> 1. From the Home screen, touch Administration. 2. Touch Information. 3. Touch Fax Reports. 4. Touch one of the following buttons to print the corresponding report: <ul style="list-style-type: none"> ◦ Fax Activity Log ◦ Fax Call Report ◦ Billing Codes Report ◦ Blocked Fax List ◦ Speed Dial List 5. Touch Print. <p>For more information, see the fax guide that came with the device.</p>
<p>Font lists</p> <p>Shows which fonts are currently installed in the device.</p>	<ol style="list-style-type: none"> 1. From the Home screen, touch Administration. 2. Touch Information. 3. Touch Sample Pages/Fonts. 4. Touch one of the following buttons to print the corresponding report: <ul style="list-style-type: none"> ◦ Demonstration Page ◦ RGB Samples ◦ CMYK Samples ◦ PCL Font List ◦ PS Font List 5. Touch Print. <p>NOTE: The font lists also show which fonts reside on a hard disk accessory or DIMM.</p>

Embedded Web server

Use the embedded Web server to view product and network status and to manage printing functions from your computer instead of from the product control panel. The following are examples of what you can do using the embedded Web server:

- Determine the remaining life for all supplies and order new ones.
- View and change tray configurations.
- View and change the product control-panel menu configuration.
- View and print internal pages.
- Receive notification of product and supplies events.
- View and change network configuration.

To use the embedded Web server, you must have Microsoft Internet Explorer 5.01 or later or Netscape 6.2 or later for Windows, Mac OS, and Linux (Netscape only). Netscape Navigator 4.7 is required for HP-UX 10 and HP-UX 11. The embedded Web server works when the product is connected to an IP-based network. The embedded Web server does not support IPX-based product connections. You do not have to have Internet access to open and use the embedded Web server.

When the product is connected to the network, the embedded Web server is automatically available.

 **NOTE:** For complete information about using the embedded Web server, see the *Embedded Web Server User Guide*.

Open the embedded Web server by using a network connection

1. In a supported Web browser on your computer, type the device IP address or host name in the address/URL field. To find the IP address or host name, print a configuration page. See [Information pages on page 176](#).

 **NOTE:** After you open the URL, you can bookmark it so that you can return to it quickly in the future.

2. The embedded Web server has four tabs that contain settings and information about the device: the **Information** tab, the **Settings** tab, the **Networking** tab, and the **Digital Sending** tab. Click the tab that you want to view.

See [Embedded Web server sections on page 179](#) for more information about each tab.

Embedded Web server sections

Tab or section	Options
Information tab Provides device, status, and configuration information	<ul style="list-style-type: none">● Device Status: Shows the device status and shows the life remaining of HP supplies, with 0% indicating that a supply is empty. The page also shows the type and size of print paper set for each tray. To change the default settings, click Change Settings.● Configuration Page: Shows the information found on the configuration page.● Supplies Status: Shows the life remaining of HP supplies, with 0 percent indicating that a supply is empty. This page also provides supplies part numbers. To order new supplies, contact your dealer.● Event log: Shows a list of all device events and errors.● Usage page: Shows a summary of the number of pages the device has printed, grouped by size and type.● Device Information: Shows the device network name, address, and model information. To change these entries, click Device Information on the Settings tab.● Control Panel: Shows messages from the device control panel, such as Ready or Sleep mode on.● Print: Allows you to send print jobs to the device.

Tab or section	Options
<p>Settings tab</p> <p>Provides the ability to configure the device from your computer</p>	<ul style="list-style-type: none"> ● Configure Device: Allows you to configure device settings. This page contains the traditional menus found on devices using a control-panel display. ● E-mail Server: Network only. Used in conjunction with the Alerts page to set up incoming and outgoing e-mail, as well as to set e-mail alerts. ● Alerts: Network only. Allows you to set up to receive e-mail alerts for various device and supplies events. ● AutoSend: Allows you to configure the device to send automated e-mails regarding device configuration and supplies to specific e-mail addresses. ● Security: Allows you to set a password that must be entered to gain access to the Settings and Networking tabs. Enable and disable certain features of the embedded Web server. ● Authentication Manager: Allows you to determine which device functions will require a user to provide log-in information in order to use those functions. ● LDAP Authentication: Allows you to configure a Lightweight Directory Access Protocol (LDAP) server to limit device access to certain users. The LDAP server will require a user to provide log-in information in order to gain access to the device. ● Edit Other Links: Allows you to add or customize a link to another Web site. This link is displayed in the Other Links area on all embedded Web server pages. ● Device Information: Allows you to name the device and assign an asset number to it. Enter the name and e-mail address for the primary contact who will receive information about the device. ● Language: Allows you to determine the language in which to display the embedded Web server information. ● Date & Time: Allows time synchronization with a network time server. ● Wake Time: Allows you to set or edit a wake time for the device.
	<p>NOTE: The Settings tab can be password-protected. If this device is on a network, always consult with the system administrator before changing settings on this tab.</p>

Tab or section	Options
Digital Sending tab	<p>Use the pages on the Digital Sending tab to configure the digital-sending features.</p> <p>NOTE: If the product is configured to use the optional HP Digital Sending Software, the options on these tabs are not available. Instead, all digital-sending configuration is performed by using the HP Digital Sending Software.</p> <ul style="list-style-type: none"> ● General. Set up contact information for the system administrator. ● Send to E-mail. Configure the e-mail settings for digital sending. You can specify the SMTP server, the default "From" address, and the default subject. You can also set the maximum file size that is allowed for attachments. ● E-mail Address Book. The E-mail Address Book page enables you to add e-mail addresses into the product one at a time, and to edit e-mail addresses that have already been saved in the product. You can also use the Import/Export tab to load a large list of frequently-used e-mail addresses on to the product all at once, rather than adding them one at a time. ● Import/Export. Use this tab to import or export .CSV files containing e-mail addresses, fax numbers, or user records, so that they can be accessed on this product. You can also export e-mail, fax, or user records from the device into a file on your computer. You can then use this file as a data backup, or you can use it to import the records onto another HP device. ● Log. View the digital-sending activity log for the product. The log contains digital-sending job information, including any errors that occur. ● Preferences. Configure digital-sending defaults such as the default page-size and the default settings-reset delay. You can also configure these settings by using the product control-panel menus.
Fax tab	<p>The Fax tab contains options to configure and use the fax capabilities of the product. For additional information about fax functions, see the Fax User Guide.</p> <ul style="list-style-type: none"> ● Use the Fax Settings screen to configure the send-to-fax features for the product. ● The Fax Address Book page enables you to add fax numbers into the product one at a time, and to edit fax numbers that have already been saved in the product. You can also use the Import/Export feature on the Digital Sending tab to load a large list of frequently-used fax numbers on to the device all at once, rather than adding them one at a time. ● Use the Fax Speed Dials screen to add, edit, or delete fax speed dial entries to and from the product. You can use fax speed dials to store frequently used fax numbers or lists of up to 100 fax numbers. Up to 100 speed dial entries can be configured.
<p>Networking tab</p> <p>Provides the ability to change network settings from your computer</p>	<p>Network administrators can use this tab to control network-related settings for the device when it is connected to an IP-based network. This tab does not appear if the device is directly connected to a computer, or if the device is connected to a network using anything other than an HP Jetdirect print server.</p> <p>NOTE: The Networking tab can be password-protected.</p>

Use HP Web Jetadmin software

HP Web Jetadmin is a Web-based software solution for remotely installing, monitoring, and troubleshooting network-connected peripherals. The intuitive browser interface simplifies cross-platform management of a wide range of devices, including HP and non-HP devices. Management is proactive, allowing network administrators the ability to resolve issues before users are affected. Download this free, enhanced-management software at www.hp.com/go/webjetadmin_software.

 **NOTE:** HP Web Jetadmin 10.0 or later is required for full support of this product.

To obtain plug-ins to HP Web Jetadmin, click **plug-ins**, and then click the **download** link that is next to the name of the plug-in that you want. The HP Web Jetadmin software can automatically notify you when new plug-ins are available. On the **Product Update** page, follow the directions to automatically connect to the HP Web site.

If installed on a host server, HP Web Jetadmin is available to any client through a supported Web browser, such as Microsoft Internet Explorer 6.0 for Windows or Netscape Navigator 7.1 for Linux. Browse to the HP Web Jetadmin host.

 **NOTE:** Browsers must be Java-enabled. Browsing from an Apple PC is not supported.

Security features

Secure the embedded Web server

Assign a password for access to the embedded Web server so that unauthorized users cannot change the product settings.

1. Open the embedded Web server. See [Embedded Web server on page 178](#).
2. Click the **Settings** tab.
3. On the left side of the window, click **Security**.
4. Type the password next to **New Password**, and type it again next to **Verify Password**.
5. Click **Apply**. Make note of the password and store it in a safe place.

Secure Disk Erase

To protect deleted data from unauthorized access on the product hard drive, use the Secure Disk Erase feature. This feature can securely erase print and copy jobs from the hard drive.

Secure Disk Erase offers the following levels of disk security:

- **Non-Secure Fast Erase.** This is a simple file-table erase function. Access to the file is removed, but actual data is retained on the disk until it is overwritten by subsequent data-storage operations. This is the fastest mode. Non-Secure Fast Erase is the default erase mode.
- **Secure Fast Erase.** Access to the file is removed, and the data is overwritten with a fixed identical character pattern. This is slower than Non-Secure Fast Erase, but all data is overwritten. Secure Fast Erase meets the U.S. Department of Defense 5220-22.M requirements for the clearing of disk media.
- **Secure Sanitizing Erase.** This level is similar to the Secure Fast Erase mode. In addition, data is repetitively overwritten by using an algorithm that prevents any residual data persistence. This mode will impact performance. Secure Sanitizing Erase meets the U.S. Department of Defense 5220-22.M requirements for the sanitization of disk media.

Data affected

Data affected (covered) by the Secure Disk Erase feature includes temporary files that are created during the print and copying process, stored jobs, proof and hold jobs, disk-based fonts, disk-based macros (forms), stored fax files, address books, and HP and third-party applications.

 **NOTE:** Stored jobs will be securely overwritten only when they have been deleted through the **Retrieve Job** menu on the product after the appropriate erase mode has been set.

This feature will not impact data that is stored on flash-based product non-volatile RAM (NVRAM) that is used to store default settings, page counts, and similar data. This feature does not affect data that is stored on a system RAM disk (if one is used). This feature does not impact data that is stored on the flash-based system boot RAM.

Changing the Secure Disk Erase mode does not overwrite previous data on the disk, nor does it immediately perform a full-disk sanitization. Changing the Secure Disk Erase mode changes how the product cleans up temporary data for jobs after the erase mode has been changed.

Gain access to Secure Disk Erase

Use HP Web Jetadmin to gain access to and set the Secure Disk Erase feature.

Additional Information

For additional information about the HP Secure Disk Erase feature, go to www.hp.com/go/webjetadmin/.

DSS authentication

Optional Digital Sending Software (DSS) for the product is available for purchase separately. The software provides an advanced sending program that contains an authentication process. This process requires users to type a user identification and a password before they can use any of the DSS features that require authentication.

Lock the control-panel menus

To prevent someone from changing the product configuration, you can lock the control-panel menus. This prevents unauthorized users from changing the configuration settings such as the SMTP server. The following procedure describes how to restrict access to the control-panel menus by using the HP Web Jetadmin software. (See [Use HP Web Jetadmin software on page 182.](#))

1. Open the HP Web Jetadmin program.
2. Open the **DEVICE MANAGEMENT** folder in the drop-down list in the **Navigation** panel. Navigate to the **DEVICE LISTS** folder.
3. Select the product.
4. In the **Device Tools** drop-down list, select **Configure**.
5. Select **Security** from the **Configuration Categories** list.
6. Type a **Device Password**.
7. In the **Control Panel Access** section, select **Maximum Lock**. This prevents unauthorized users from gaining access to configuration settings.

Set the real-time clock

Use the real-time clock feature to set the date and time settings. The date and time information is attached to stored print, fax, and digital-send jobs, so you can identify the most recent versions of stored print jobs.

Set the date format

1. On the control panel, scroll to and touch **Administration**.
2. Touch **Time/Scheduling**.
3. Touch **Date/Time**.
4. Touch **Date Format**.
5. Touch the desired format.
6. Touch **Save**.

Set the date

1. On the control panel, scroll to and touch **Administration**.
2. Touch **Time/Scheduling**.
3. Touch **Date/Time**.
4. Touch **Date**.
5. Touch the appropriate options to set the correct month, date of the month, and the year.
6. Touch **Save**.

Set the time format

1. On the control panel, scroll to and touch **Administration**.
2. Touch **Time/Scheduling**.
3. Touch **Date/Time**.
4. Touch **Time Format**.
5. Touch the appropriate format.
6. Touch **Save**.

Set the time

1. On the control panel, scroll to and touch **Administration**.
2. Touch **Time/Scheduling**.
3. Touch **Date/Time**.
4. Touch **Time**.

5. Touch the appropriate options to set the correct hour, minute, and AM/PM setting.
6. Touch **Save**.

Manage supplies

Use genuine HP print cartridges for the best printing results.

Print-cartridge storage

Do not remove the print cartridge from its package until you are ready to use it.

△ **CAUTION:** To prevent damage to the print cartridge, do not expose it to light for more than a few minutes.

HP policy on non-HP print cartridges

Hewlett-Packard Company cannot recommend the use of non-HP print cartridges, either new or remanufactured. Because they are not HP products, HP cannot influence their design or control their quality.

To install a new HP print cartridge, see [Change print cartridges on page 189](#). To recycle the used cartridge, follow the instructions included with the new cartridge.

HP fraud hotline and Web site

Call the HP fraud hotline (1-877-219-3183, toll-free in North America) or go to www.hp.com/go/anticounterfeit when you install an HP print cartridge and the control-panel message says the cartridge is non-HP. HP will help determine if the cartridge is genuine and take steps to resolve the problem.

Your print cartridge might not be a genuine HP print cartridge if you notice the following:

- You are experiencing a high number of problems with the print cartridge.
- The cartridge does not look like it usually does (for example, the orange pull tab is missing, or the packaging differs from HP packaging).

Replace supplies

When you use genuine HP supplies, the product automatically notifies you when supplies are nearly depleted. The notification to order supplies allows ample time to order new supplies before they need to be replaced. For more information about ordering supplies, see [Supplies and accessories on page 273](#)

Locate supplies

Supplies are identified by their labeling and their blue plastic handles.

The following figure illustrates the location of each supply item.

Figure 14-1 Supply item locations

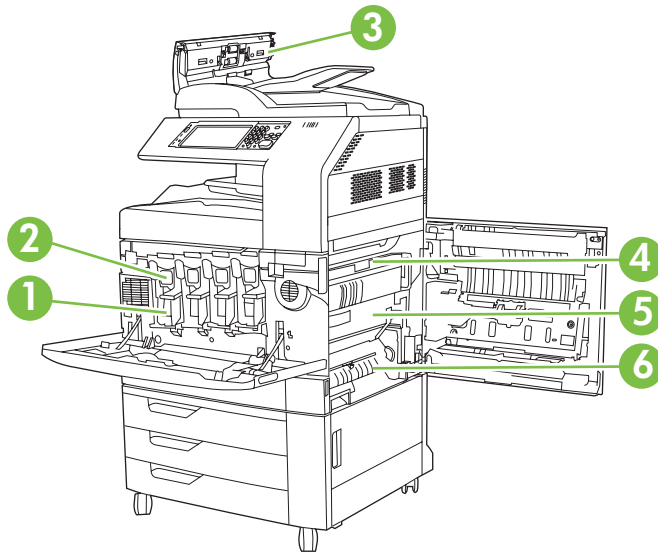

1	Image drums
2	Print cartridges
3	Document feeder kit
4	Fuser
5	Transfer unit
6	Transfer roller

Supply replacement guidelines

To facilitate the replacement of supplies, keep the following guidelines in mind when setting up the product.

- Allow sufficient space in the front and on the right side of the product for removing supplies.
- The product should be located on a flat, sturdy surface.

△ **CAUTION:** Hewlett-Packard recommends the use of genuine HP products in this product. Use of non-HP products may cause problems requiring service that is not covered by the Hewlett-Packard extended warranty or service agreements.

Approximate replacement intervals for supplies

The following table lists the estimated replacement intervals for supplies and the control panel messages that prompt when to replace each item. Usage conditions and print patterns may cause results to vary.

Item	Printer message	Page count	Approximate time period
Print cartridges	Replace <color> Cartridge	17,000 pages ¹ for color	4 months for color
		20,000 pages for black	5 months for black
Image drums	Replace <color> Drum	35,000 pages ¹	
Image transfer kit	Replace Transfer Kit	150,000 pages ²	37 months
Image fuser kit	Replace Fuser Kit	100,000 pages	25 months
Roller kit	Replace Roller Kit	100,000 pages	25 months
Stapler cartridge	Replace Stapler Cartridge	5000 staples	
Booklet maker staple cartridges	Replace Staple Cartridges 2 and 3	2,000 booklets	
Document feeder kit	Replace Document Feeder Kit	60,000 pages	50 months

¹ Approximate average A4-/letter-size page count based on 2-page jobs printed from Tray 2, with 5% coverage of individual colors.

² Approximate life is based on 4,000 pages per month.

Change print cartridges

When a print cartridge approaches the end of its useful life, the control panel displays a message recommending that you order a replacement. The product can continue to print using the current print cartridge until the control panel displays a message instructing you to replace the cartridge.

The product uses four colors and has a different print cartridge for each color: black (K), magenta (M), cyan (C), and yellow (Y).

Replace a print cartridge when the control panel displays a **Replace <color> Cartridge** message. The control panel display will also indicate the color that should be replaced (if a genuine HP cartridge is currently installed). Replacement instructions are included in the print-cartridge box.

△ **CAUTION:** If toner gets on clothing, wipe it off with a dry cloth and wash the clothes in cold water. Hot water sets toner into fabric.

📄 **NOTE:** Information about recycling used print cartridges is on the print-cartridge box.

Replace print cartridges

1. Grasp the grips on the sides of the front door and pull down to open.

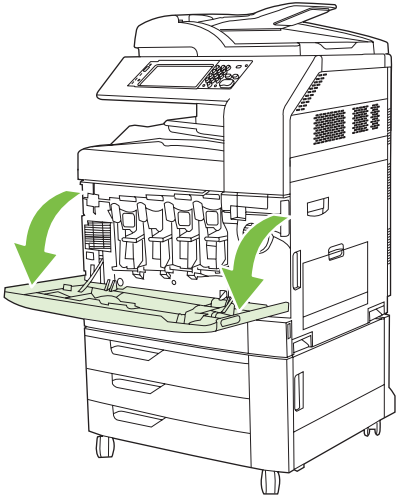

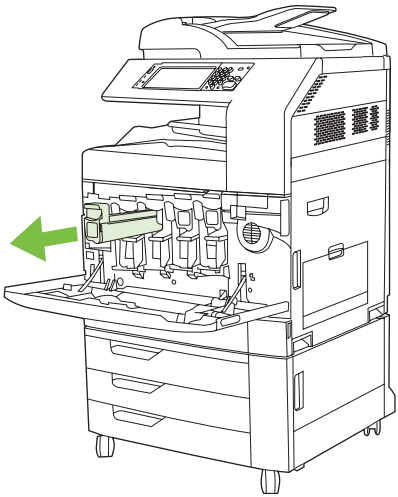

2. Grasp the handle of the used print cartridge and pull out to remove.

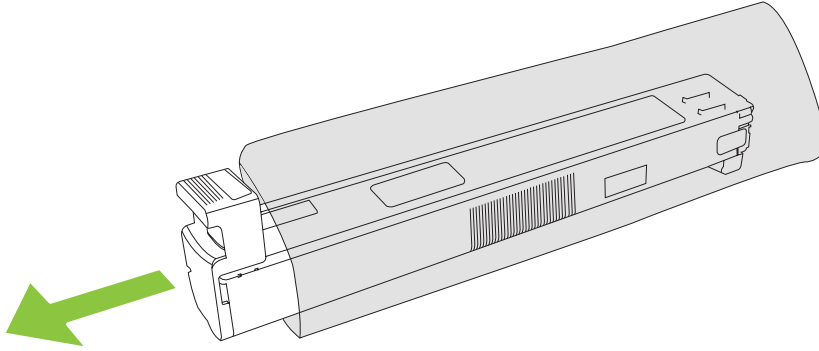

3. Store the used print cartridge in a protective bag. Information about recycling used print cartridges is on the print-cartridge box.
4. Remove additional print cartridges in the same manner.

5. Remove the new print cartridge from its protective bag.



 **NOTE:** Store the protective bag in a secure place for future use.

6. Hold both sides of the cartridge and shake up and down 5-6 times.

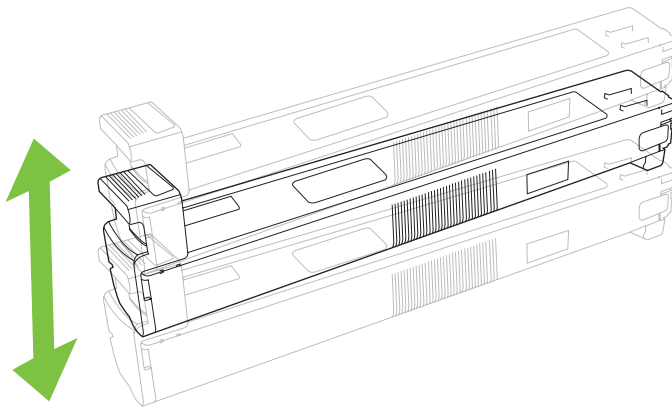

7. Align the print cartridge with its slot and insert the print cartridge until it clicks into place.

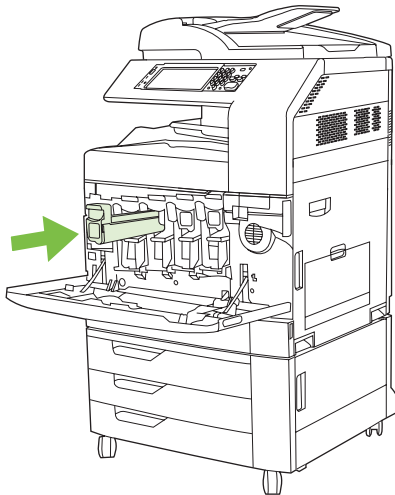

8. Insert additional print cartridges in the same manner.

9. Grasp the grips on the sides of the front door and lift up to close.

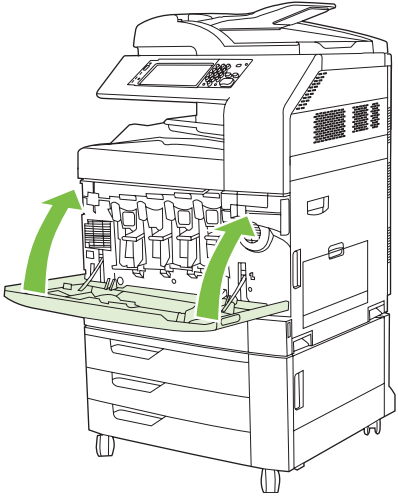

To recycle the used print cartridge, follow the instructions included with the new print cartridge.

Change image drums

When an image drum approaches the end of its useful life, the control panel displays a message recommending that you order a replacement. The product can continue to print using the current image drum until the control panel displays a message instructing you to replace the image drum.

The product uses four colors and has a different image drums for each color: black (K), magenta (M), cyan (C), and yellow (Y).

Replace an image drum when the control panel displays **Replace <color> Drum** message. The control-panel display also indicates the color that should be replaced (if a genuine HP cartridge is currently installed). Replacement instructions are included in the image drum box.

△ **CAUTION:** If toner gets on clothing, wipe it off with a dry cloth and wash the clothes in cold water. Hot water sets toner into fabric.

📄 **NOTE:** Information about recycling used image drums is on the image drum box.

Replace image drums

1. Grasp the grips on the sides of the front door and pull down to open.

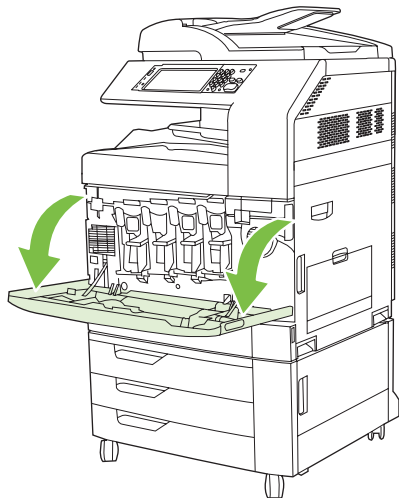

2. With one hand, lift and slowly pull the used image drum out of the product, while supporting the image drum with your other hand.

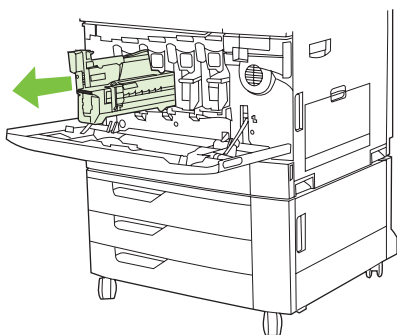

△ **CAUTION:** If reusing the same image drum, do not touch the green cylinder on the bottom of the drum because it can damage the drum.

3. Store the used image drum in a protective bag. Information about recycling used image drums is on the image drum box.
4. Remove additional image drums in the same manner.

5. Remove the new image drum from its protective bag.

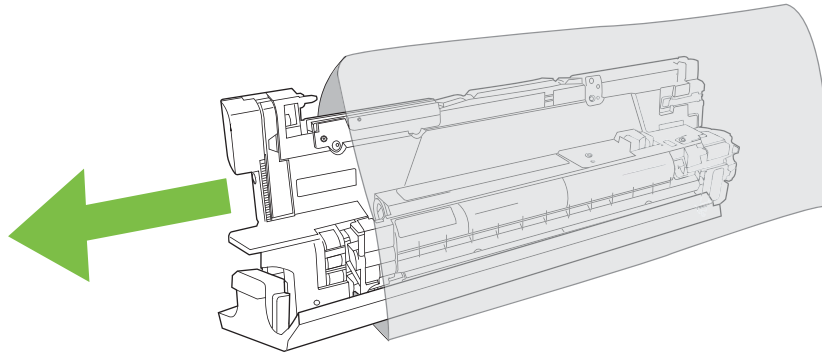

 **NOTE:** Store protective bag in a secure place for future use.

NOTE: Do not shake the image drum.

 **CAUTION:** Do not touch the green cylinder on the bottom of the image drum because it can damage the drum.

6. Align the image drum with the correct slot and insert the image drum until it clicks into place. The gray protective cover on the bottom of the drum automatically slides off as the image drum is inserted. You can discard this cover.

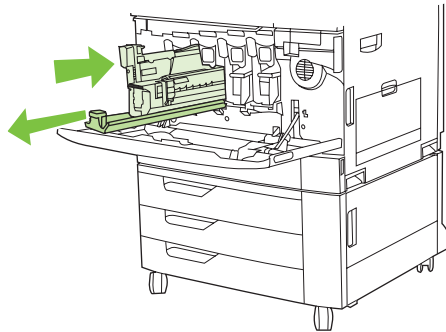

7. Insert additional image drums in the same manner.
8. Grasp the grips on the sides of the front door and lift up to close.

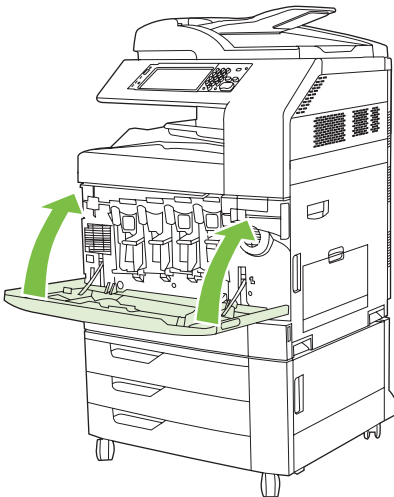

To recycle the used image drum, follow the instructions included with the new image drum.

Install memory

You can install more memory for the product.

- △ **CAUTION:** Static electricity can damage DIMMs. When handling DIMMs, either wear an antistatic wrist strap, or frequently touch the surface of the DIMM antistatic package and then touch bare metal on the product.

Install DDR memory DIMMs

1. Turn the product off.

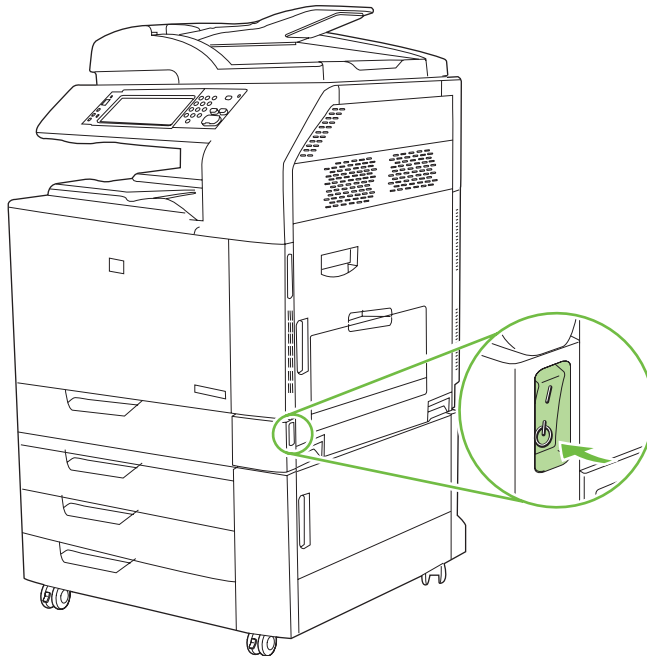

2. Disconnect all power and interface cables.

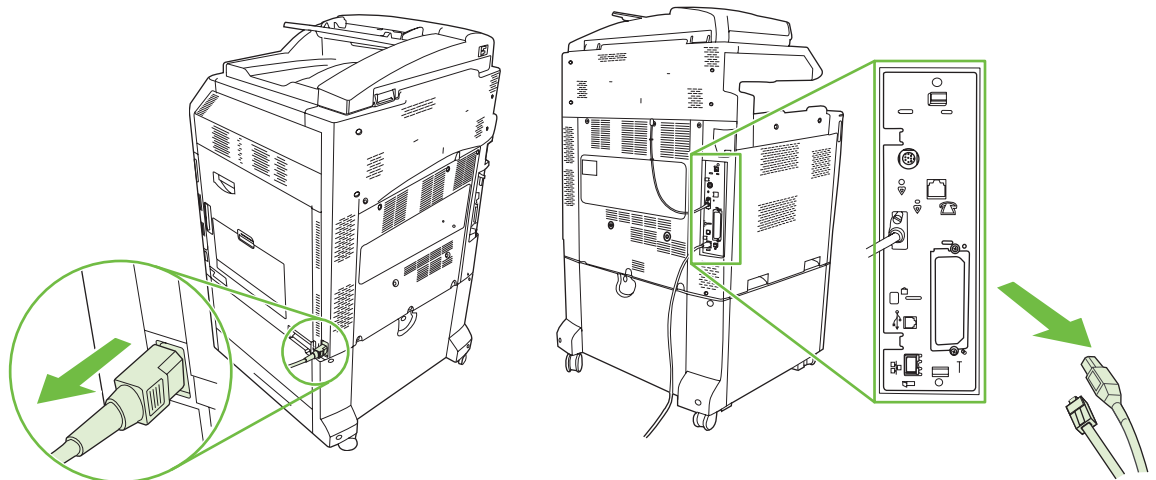

3. Locate the black formatter pressure release tabs on the formatter board in the rear of the product.

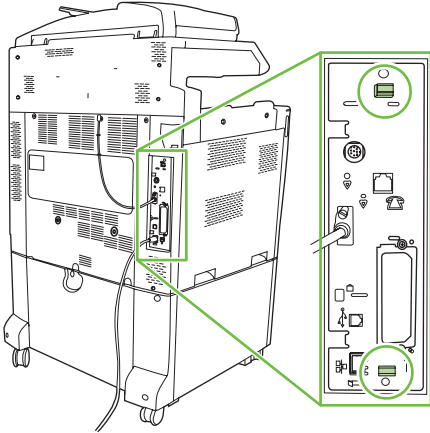

4. Gently press the black tabs toward each other.

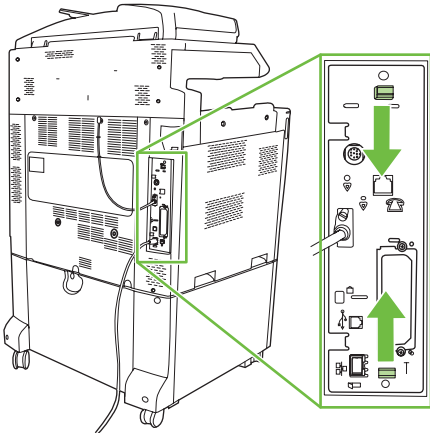

5. Gently pull on the black tabs to pull the formatter board from the product. Place the formatter board on a clean, flat, grounded surface.

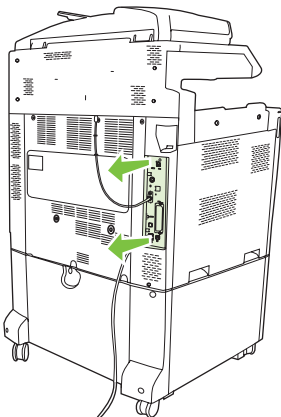

6. To replace a DIMM that is currently installed, spread the latches apart on each side of the DIMM slot, lift the DIMM up at an angle, and pull it out.

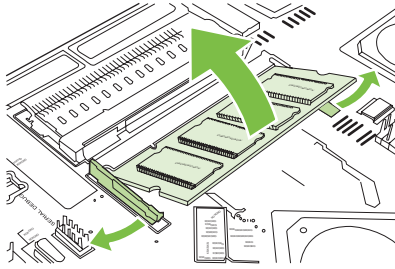

7. Remove the new DIMM from the antistatic package. Locate the alignment notch on the bottom edge of the DIMM.

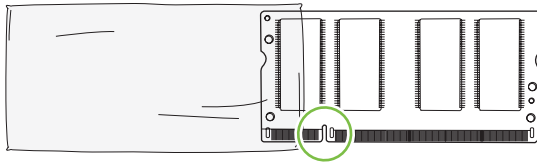

8. Holding the DIMM by the edges, align the notch on the DIMM with the bar in the DIMM slot at an angle and firmly press the DIMM into the slot until it is fully seated. When installed correctly, the metal contacts are not visible.

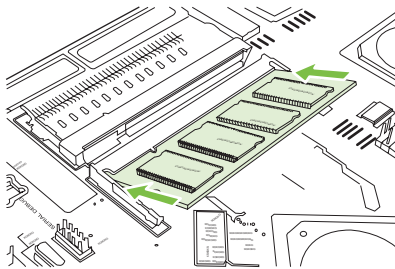

9. Push down on the DIMM until both latches engage the DIMM.

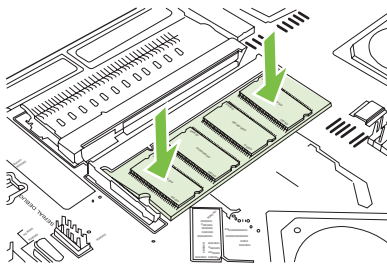

NOTE: If you have difficulty inserting the DIMM, make sure the notch on the bottom of the DIMM is aligned with the bar in the slot. If the DIMM still does not go in, make sure you are using the correct type of DIMM.

- Align the formatter board in the tracks at the bottom of the slot, and then slide the board back into the product.

△ **CAUTION:** To prevent damage to the formatter board, ensure the formatter board is aligned in the tracks.

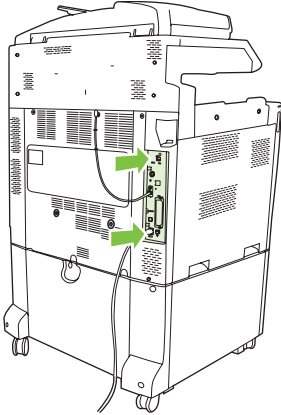

- Reconnect the power cable and interface cables, and turn the product on.

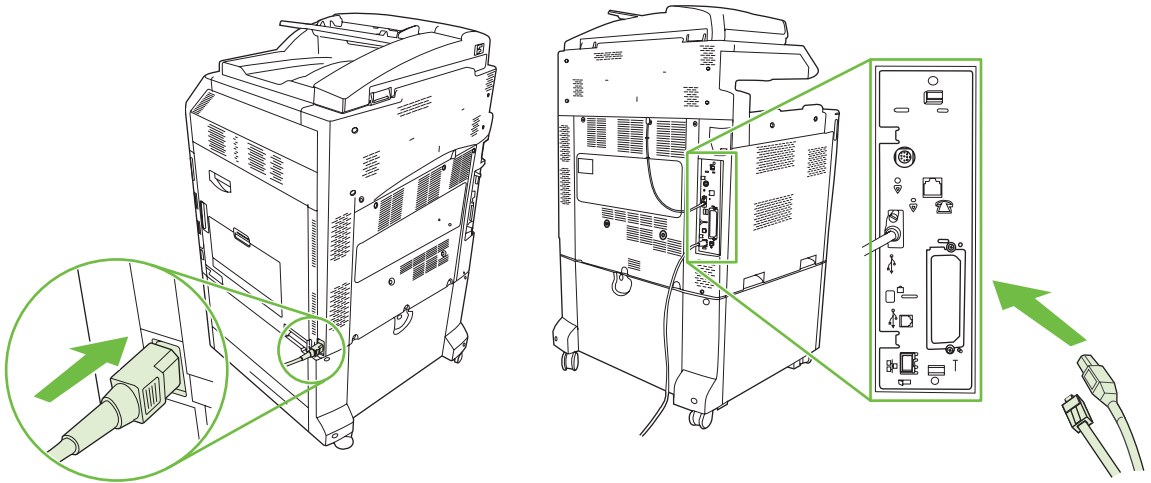

- To enable the new memory, go to [Enable memory on page 198](#).

Enable memory

If you installed a memory DIMM, set the product driver to recognize the newly added memory.

Enable memory for Windows 2000 and XP

- On the **Start** menu, point to **Settings**, and click **Printers** or **Printers and Faxes**.
- Right-click the product and select **Properties**.
- On the **Device Settings** tab, click **Printer Memory** (in the **Installable Options** section).
- Select the total amount of memory that is now installed.
- Click **OK**.

Install an HP Jetdirect or EIO print server card or EIO hard disk

The HP Color LaserJet CM6049f MFP is equipped with an embedded print server port. If desired, you can install an additional I/O card in the available EIO slot.

1. Turn the product off.

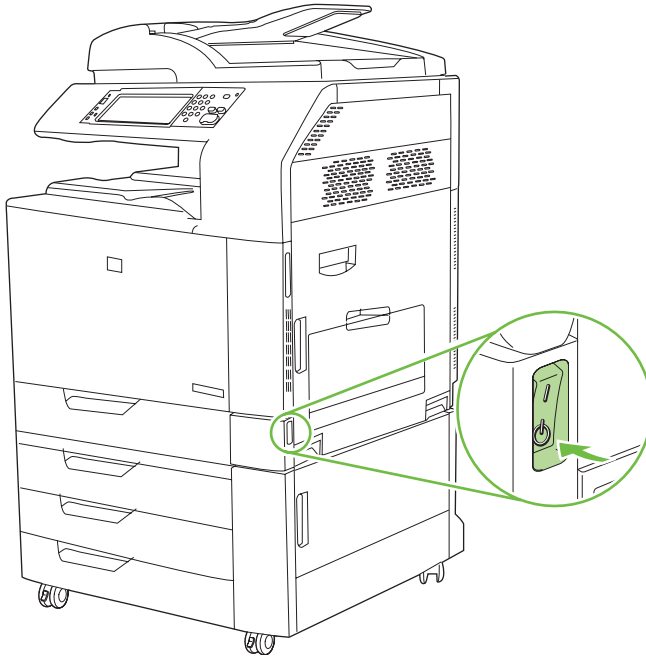

2. Disconnect all power and interface cables.

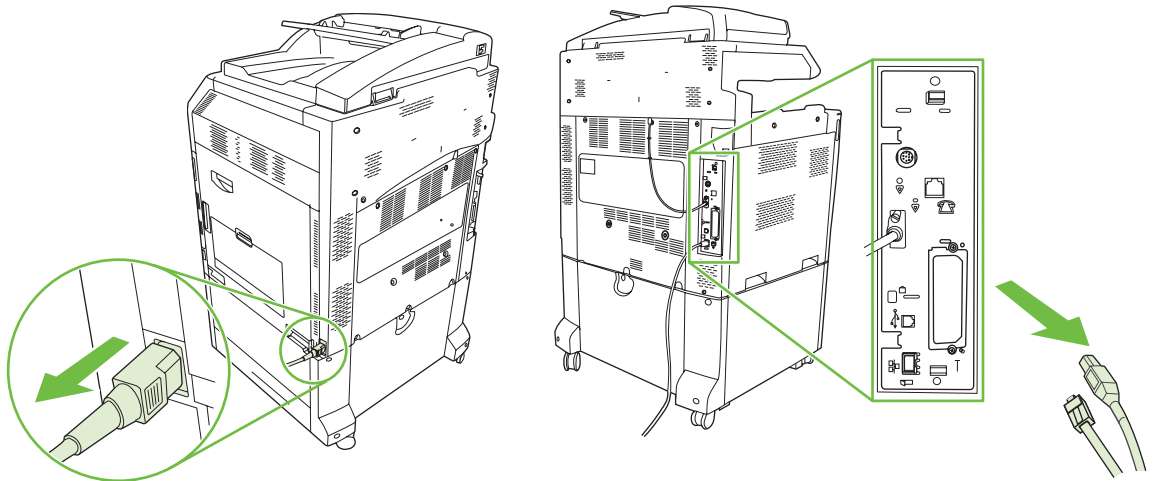

3. Locate an open EIO slot. Loosen and remove the two retaining screws holding the cover for the EIO slot, and then remove the cover. You will not need these screws and the cover again. They can be discarded.

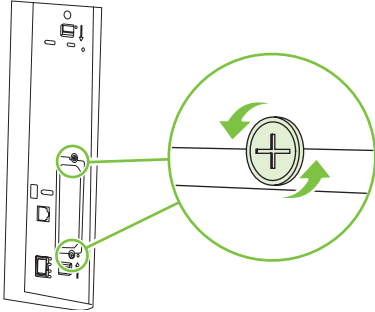

4. Firmly insert the HP Jetdirect print server card into the EIO slot.

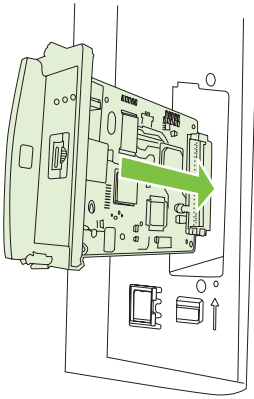

5. Insert and tighten the retaining screws that came with the print server card.

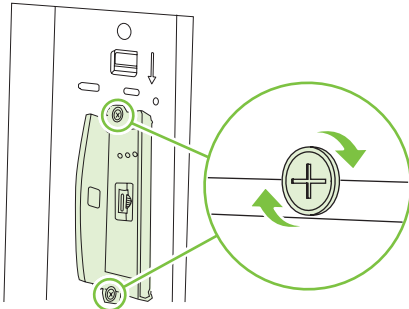

6. Reconnect the power cable and remaining interface cables, and turn the product on.

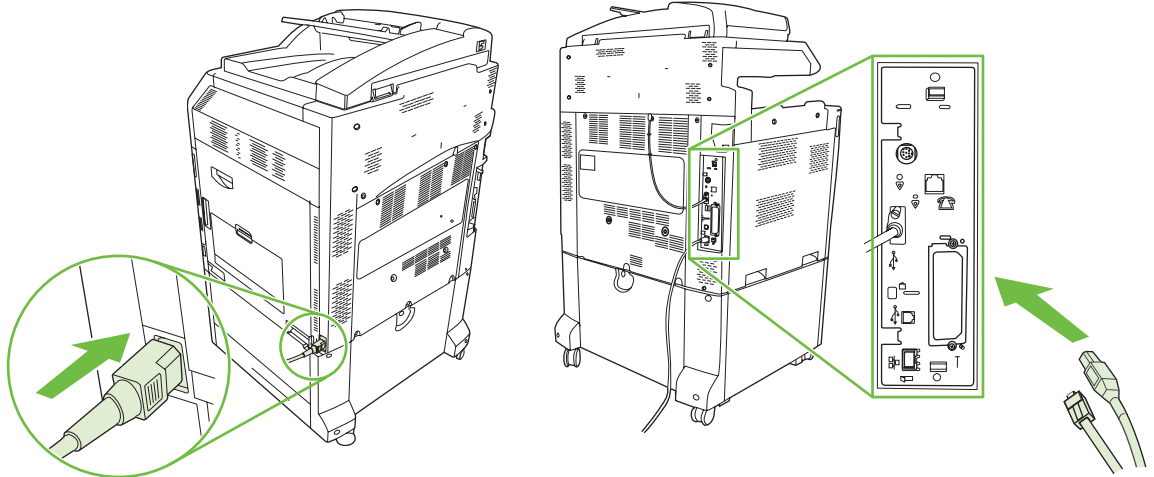

7. Print a configuration page. In addition to a product configuration page and a Supplies Status page, an HP Jetdirect configuration page that contains network configuration and status information should also print.

If it does not print, turn the power to the device off and uninstall and reinstall the print server card to ensure that it is completely seated in the slot.

8. Perform one of these steps:
 - Choose the correct port. See the computer or operating system documentation for instructions.
 - Reinstall the software, choosing the network installation this time.

Replace the staple cartridge

If the optional HP 3-bin Stapler/Stacker Accessory or HP Booklet Maker/Finisher Accessory runs out of staples while it is stapling a print job, the product automatically stops, if set to stop when out. If the product is set to continue when out, the product will continue to print without stapling.

 **NOTE:** Only replace the staple cartridge unit when the stapler/stacker or booklet maker has run out of staples. Removing the staple cartridge at other times can cause an error to occur.

NOTE: When the stapler/stacker or booklet maker runs out of staples, the stapler unit will return to its default position automatically.

Replace the staple cartridge

1. Open the front door of the booklet maker or stapler/stacker.

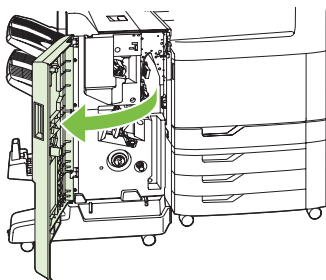

2. Push up to on the staple cartridge to remove it from the booklet maker or stapler/stacker.

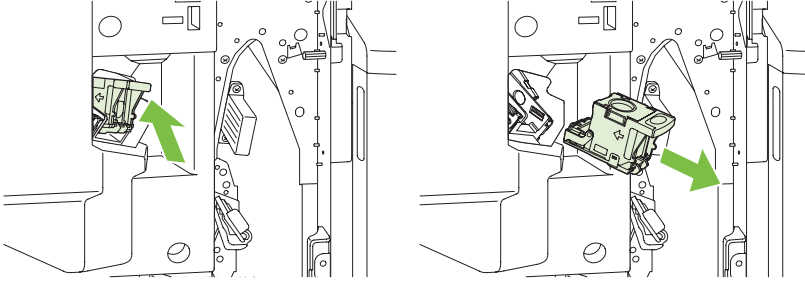

3. Insert the replacement staple cartridge unit into the stapler unit.

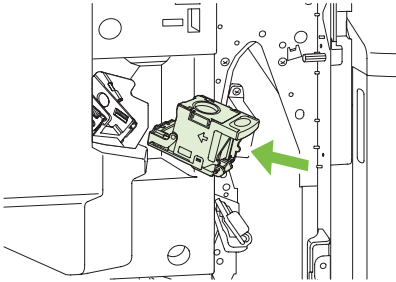

4. Push the staple cartridge unit into the stapler unit until it clicks into position.

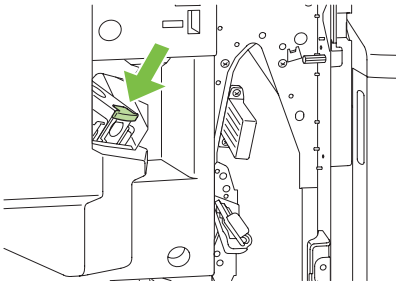

5. Close the front door.



Replace saddle stitch staple cartridges in the booklet maker

1. Open the front door of the booklet maker.

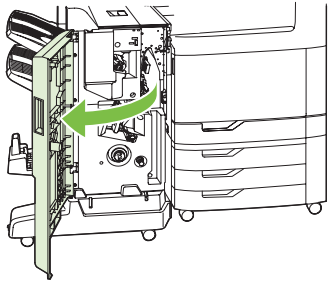

2. Grasp the blue handle and pull the staple carriage out of the booklet maker.

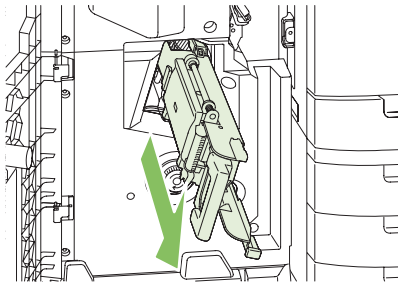

3. Grasp the small blue handle on the staple cartridge unit and pull it toward you, then swing the staple cartridge unit into an upright position.

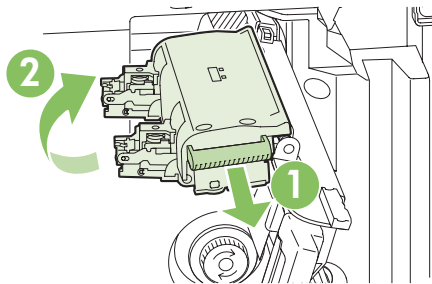

4. Grasp the edges of each staple cartridge and pull up firmly to remove the staple cartridges from the staple cartridge unit.

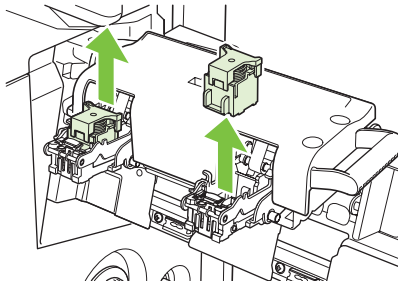

5. Unpack the new cartridges and remove the plastic packing lock from each one.

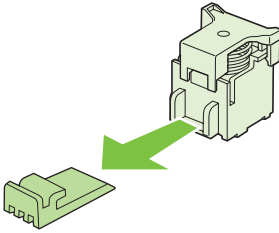

6. Hold the new cartridges so that the arrows on the cartridges align with the arrows on the staple cartridge unit and insert them into the unit.

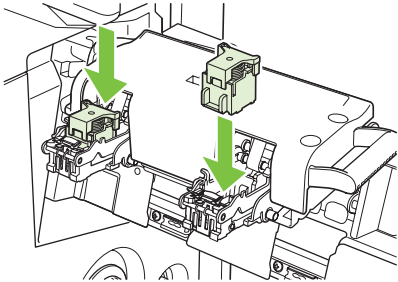

7. Pull the handle of the staple cartridge unit toward you and rotate it downward to its original position. Lock it into position by pushing in the handle.

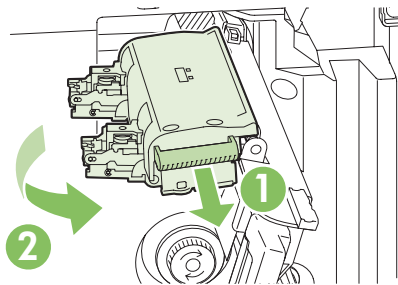

8. Push the staple carriage back into the booklet maker finisher.

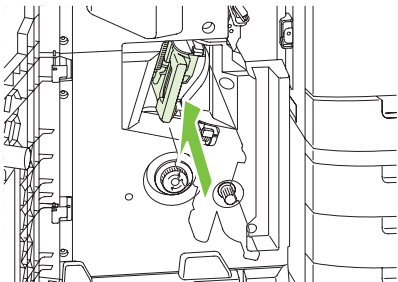

9. Close the front door of the booklet maker.

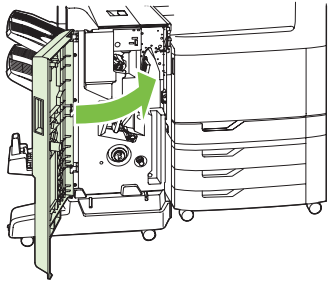

Clean the product

To maintain print quality, clean the product thoroughly every time you replace the print cartridge and whenever print-quality problems occur.

-
- ⚠ **WARNING!** Avoid touching the fusing area when cleaning the product. It can be hot.
 - ⚠ **CAUTION:** To avoid permanent damage to the print cartridge, do not use ammonia-based cleaners on or around the product except as directed.
-

Clean the outside of the product

- Clean the outside of the product if it is visibly marked.
- Use a soft, lint-free cloth dampened with water, or water and a mild detergent.

Clean the touchscreen

Clean the touchscreen whenever it is necessary to remove fingerprints or dust. Wipe the touchscreen gently with a clean, water-dampened, lint-free cloth.

-
- ⚠ **CAUTION:** Use water only. Solvents or cleaners can damage the touchscreen. Do not pour or spray water directly onto the touchscreen.
-

Clean the scanner glass

- Clean the scanner glass only if dirt is visible, or if you are experiencing a decrease in copy quality, such as streaking.
- Clean the scanner glass by wiping it gently with a clean, slightly damp, lint-free cloth. Use an ammonia-based surface cleaner only when a water-dampened cloth does not clean the scanner glass.

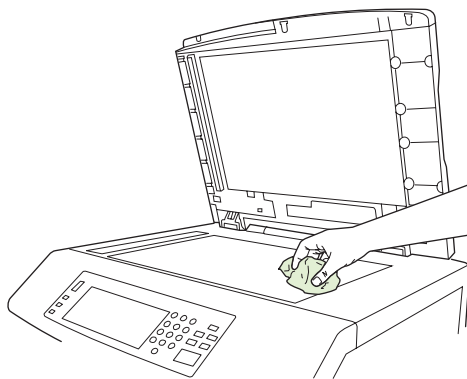

-
- ⚠ **CAUTION:** Do not pour or spray liquids directly onto the scanner glass. Do not press hard on the glass surface. (You could break the glass).
-

Cleaning the ADF delivery system

Clean the ADF only if it is visibly marked or dirty, or if you are experiencing a decrease in copy quality (such as streaking).

Clean the ADF delivery system

1. Open the scanner lid.

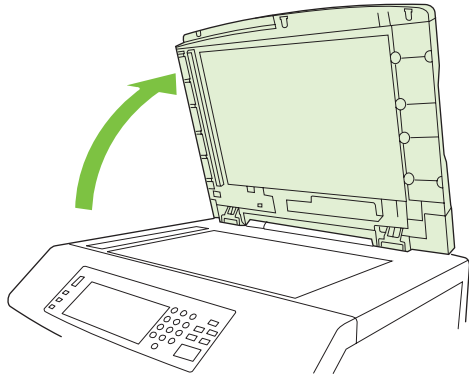

2. Locate the white, vinyl ADF backing.

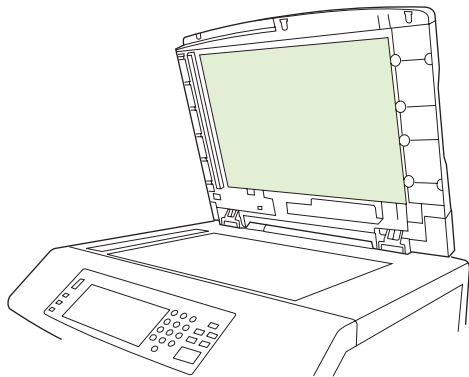

3. Clean the ADF backing by wiping them with a clean, damp, lint-free cloth. Use an ammonia-based surface cleaner only when a water-dampened cloth does not clean the ADF components.
4. Clean the scanner glass by wiping it gently with a clean, slightly damp, lint-free cloth. Use an ammonia-based surface cleaner only when a water-dampened cloth does not clean the scanner glass.
5. Close the scanner lid.

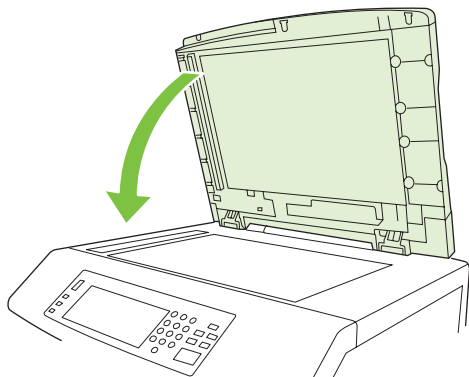

Clean the ADF rollers

You should clean the rollers in the ADF if you are experiencing misfeeds or if your originals show marks as they exit the ADF.

△ **CAUTION:** Clean the rollers only if you experience misfeeds or marks on the originals, and you notice dust on the rollers. Cleaning the rollers frequently could introduce dust into the device.

1. Pull the release lever to open the ADF cover.

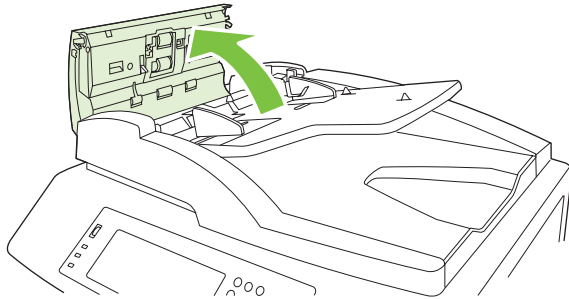

2. Locate the rollers.

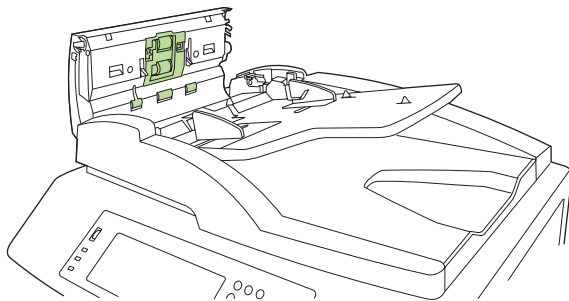

3. Wipe the rollers with a clean, water-dampened, lint-free cloth.

△ **CAUTION:** Do not pour water directly onto the rollers. Doing so might damage the device.

4. Locate the separation pad.

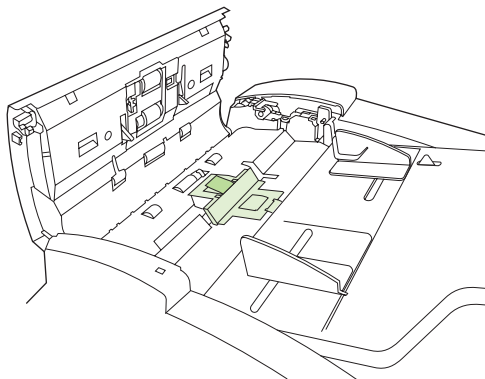

5. Wipe the pad with a clean, water-dampened, lint-free cloth.

6. Close the ADF cover.

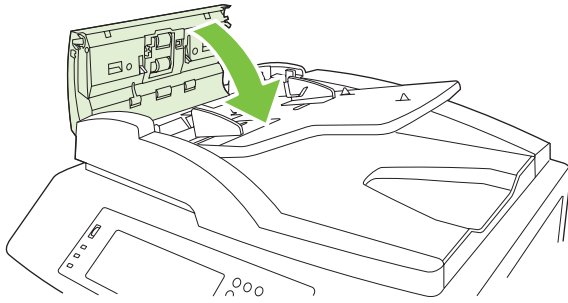

ADF maintenance kit

After feeding 60,000 pages through the ADF, a **Replace Document Feeder Kit** message appears on the control-panel display. This message appears approximately one month before the kit needs to be replaced. Order a new kit when this message appears. See [Part numbers on page 275](#) for information about ordering a new ADF maintenance kit.

The ADF maintenance kit includes the following items:

- One pick-up roller assembly
- One separation pad
- An instruction sheet

Follow the instructions that come with the kit to install it.

After replacing the kit, reset the ADF maintenance-kit count.

Reset the ADF maintenance-kit count

1. On the control panel, scroll to and touch **Administration**.
2. Touch **Resets**.
3. Touch **Reset Supplies**.
4. Touch **ADF Maintenance Kit**.
5. Touch **Yes**.
6. Touch **Save**.

Calibrate the scanner

Calibrate the scanner to compensate for offsets in the scanner imaging system (carriage head) for ADF and flatbed scans. Because of mechanical tolerances, the scanner's carriage head might not read the position of the image accurately. During the calibration procedure, scanner offset values are calculated and stored. The offset values are then used when producing scans so that the correct portion of the document is captured.

Scanner calibration should be carried out only if you notice offset problems with the scanned images. The scanner is calibrated before it leaves the factory. It needs to be calibrated again only rarely.

Before calibrating the scanner, print the calibration target.

1. Place letter- or A4-size paper in tray 1, and adjust the side guides.
2. On the control-panel Home screen, scroll to and touch **Administration**.
3. Touch **Troubleshooting**.
4. Touch **Calibrate Scanner**.
5. Touch **Calibrate** to print the first pass of the calibration target.
6. Place the first pass of the calibration target face-down in tray 1 so that the arrows are facing into the product.
7. Touch **Start** to print the second pass. The final calibration target *must* look like the following figure.

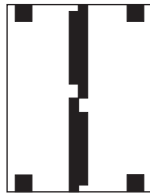

△ **CAUTION:** If the calibration target does not look like the figure shown here, the calibration process will fail and the quality of scans will be degraded. *The black areas must extend completely to the short edges of the page. If they do not, use a black marker to extend the black areas to the edge of the page.* Ensure that the paper is loaded properly.

8. Place the calibration target face-up into the ADF, and adjust the side guides.
9. After the calibration target has passed through the ADF once, reposition it face down in the ADF and touch **Start**.
10. Place the calibration target face-down on the scanner glass, touch **Start**, and scan the page. After this pass, the calibration is complete.

Upgrade the firmware

The product has remote firmware update (RFU) capability. Use the information in this section to upgrade the product firmware.

Determine the current firmware version

1. From the control panel Home screen, scroll to and touch **Administration**.
2. Touch **Information**.
3. Touch **Configuration/status Pages**.
4. Touch **Configuration Page**.
5. Touch **Print**.

The firmware datecode is listed on the Configuration page in the section called **Device Information**. The firmware datecode has this format: YYYYMMDD XX.XXX.X. The first string of numbers is the date, where YYYY represents the year, MM represents the month, and DD represents the date. For example, a firmware datecode of that begins with 20061125 represents November 25, 2006.

Download new firmware from the HP Web site

To find the most recent firmware upgrade for the product, go to www.hp.com/go/cljcm6049mfp_firmware. This page provides instructions for downloading the new firmware version.

Transfer the new firmware to the product

 **NOTE:** The product can receive an .RFU file update when it is in a "ready" state.

The elapsed time for an update depends on the I/O transfer time, as well as the time that it takes for the product to re-initialize. The I/O transfer time depends on a number of things, including the speed of the host computer that is sending the update. If the remote firmware update process is interrupted before the firmware is downloaded (while **Receiving Upgrade** appears on the control-panel display), the firmware file must be sent again. If power is lost during the flash DIMM update (while the **Performing Upgrade** message appears on the control-panel display), the update is interrupted and the message **Resend Upgrade** appears (in English only) on the control-panel display. In this case, you must send the upgrade by using the parallel port. Finally, any jobs that are ahead of the RFU job in the queue are completed before the update is processed.

Use FTP to upload the firmware through a browser

 **NOTE:** The firmware update involves a change in the format of nonvolatile random-access memory (NVRAM). Any menu settings that are changed from the default settings might return to default settings and must be changed again if you want settings that are different from the defaults.

1. Print a configuration page and note the TCP/IP address shown on the EIO Jetdirect page.
2. Open a browser window.
3. In the address line of the browser, type `ftp://<ADDRESS>`, where <ADDRESS> is the address of the product. For example, if the TCP/IP address is 192.168.0.90, type `ftp://192.168.0.90`.

4. Locate the downloaded .RFU file for the product.
5. Drag and drop the .RFU file onto the **PORT1** icon in the browser window.

 **NOTE:** The product turns off and then on automatically to activate the update. When the update process is complete, a **Ready** message displays on the product control panel.

Use FTP to upgrade the firmware on a network connection

 **NOTE:** The firmware update involves a change in the format of nonvolatile random-access memory (NVRAM). Any menu settings that are changed from the default settings might return to default settings and must be changed again if you want settings that are different from the defaults.

1. Take note of the IP address on the HP Jetdirect page. The HP Jetdirect page is the second page that prints when you print the configuration page.

 **NOTE:** Before upgrading the firmware, make sure that the product is not in Sleep mode. Also make sure that any error messages are cleared from the control-panel display.

2. Open an MS-DOS command prompt on your computer.
3. Type: `ftp TCP/IP ADDRESS>`. For example, if the TCP/IP address is 192.168.0.90, type `ftp 192.168.0.90`.
4. Go to the folder where the firmware file is stored.
5. Press **Enter** on the keyboard.
6. When prompted for the user name, press **Enter**.
7. When prompted for the password, press **Enter**.
8. Type `bin` at the command prompt.
9. Press **Enter**. The message **200 Types set to I, Using binary mode to transfer files** appears in the command window.
10. Type `put` and then the file name (for example, if the file name is `CM6049fmfp.efn`, type `put CM6049fmfp.efn`).
11. The download process begins and the firmware is updated on the product. This can take approximately five minutes. Let the process finish without further interaction with the product or computer.

 **NOTE:** The product automatically turns off and then on again after processing the upgrade.

12. At the command prompt, type: `bye` to exit the ftp command.
13. At the command prompt, type: `exit` to return to the Windows interface.

Use HP Web Jetadmin to upgrade the firmware

This procedure requires that you install HP Web Jetadmin Version 7.0 or later on your computer. See [Use HP Web Jetadmin software on page 182](#). Complete the following steps to update a single device through HP Web Jetadmin after downloading the .RFU file from the HP Web site.

1. Start HP Web Jetadmin.
2. Open the **Device Management** folder in the drop-down list in the **Navigation** panel. Navigate to the **Device Lists** folder.
3. Expand the **Device Lists** folder and select **All Devices**. Locate the product in the list of devices, and then click to select it.

If you need to upgrade the firmware for multiple HP Color LaserJet CM6049f MFP products, select all of them by pressing the **Ctrl** key as you click the name of each product.

4. Locate the drop-down box for **Device Tools** in the upper-right corner of the window. Select **Update Printer Firmware** from the action list.
5. If the name of the .RFU file is not listed in the **All Available Images** box, click **Browse** in the **Upload New Firmware Image** dialog box and navigate to the location of the .RFU file that you downloaded from the Web at the start of this procedure. If the filename is listed, select it.
6. Click **Upload** to move the .RFU file from your hard drive to the HP Web Jetadmin server. After the upload is complete, the browser window refreshes.
7. Select the .RFU file from the **Printer Firmware Update** drop-down menu.
8. Click **Update Firmware**. HP Web Jetadmin sends the selected .RFU file to the product. The control panel shows messages that indicate the progress of the upgrade. At the end of the upgrade process, the control panel shows the **Ready** message.

Use MS-DOS commands to upgrade the firmware

To update the firmware by using a network connection, follow these instructions.

1. From a command prompt or in an MS-DOS window, type the following: `copy /B FILENAME> \COMPUTERNAME>\SHARENAME>`, where <FILENAME> is the name of the .RFU file (including the path), <COMPUTERNAME> is the name of the computer from which the product is being shared, and <SHARENAME> is the product share name. For example: `C:\>copy /b C:\9200fw.RFU \\YOUR_SERVER\YOUR_COMPUTER.`

 **NOTE:** If the file name or path includes a space, you must enclose the file name or path in quotation marks. For example, type: `C:\>copy /b "C:\MY DOCUMENTS\3500FW.RFU" \YOUR_SERVER\YOUR_COMPUTER.`

2. Press **Enter** on the keyboard. The control panel shows a message that indicates the progress of the firmware upgrade. At the end of the upgrade process, the control panel shows the **Ready** message. The message **One File Copied** appears on the computer screen.

Use the HP Jetdirect firmware

The HP Jetdirect network interface in the product has firmware that can be upgraded separately from the product firmware. This procedure requires that you install HP Web Jetadmin Version 7.0 or later on

your computer. See [Use HP Web Jetadmin software on page 182](#). Complete the following steps to update the HP Jetdirect firmware by using HP Web Jetadmin.

1. Open the HP Web Jetadmin program.
2. Open the **Device Management** folder in the drop-down list in the **Navigation** panel. Navigate to the **Device Lists** folder.
3. Select the device that you want to update.
4. In the **Device Tools** drop-down list, select **Jetdirect Firmware Update**.
5. Under **Jetdirect firmware version** the HP Jetdirect model number and current firmware version are listed. Make a note of these.
6. Go to www.hp.com/go/wja_firmware.
7. Scroll down to the list of HP Jetdirect model numbers and find the model number you wrote down.
8. Look at the current firmware version for the model, and see if it is later than the version you wrote down. If it is, right-click on the firmware link, and follow the instructions on the Web page to download the new firmware file. The file must be saved into the <drive>:\PROGRAM FILES \HP WEB JETADMIN\DOC\PLUGINS\HPWJA\FIRMWARE\JETDIRECT folder on the computer that is running the HP Web Jetadmin software.
9. In HP Web Jetadmin, return to the main device list and select the digital sender again.
10. In the **Device Tools** drop-down list, select **Jetdirect Firmware Update** again.
11. On the HP Jetdirect firmware page, the new firmware version is listed under **Jetdirect Firmware Available on HP Web Jetadmin**. Click the **Update Firmware Now** button to update the Jetdirect firmware.

15 Solve problems

- [Solving general problems](#)
- [Control-panel message types](#)
- [Control-panel messages](#)
- [Jams](#)
- [Paper-handling problems](#)
- [Understand lights on the formatter](#)
- [Correct print quality and copy quality problems](#)
- [Performance problems](#)
- [Solve fax problems](#)
- [Solve e-mail problems](#)
- [Solve network connectivity problems](#)
- [Solve common Macintosh problems](#)

Solving general problems

If the product is not responding properly, complete the steps in the following checklist, in order. If the product does not pass a step, follow the corresponding troubleshooting suggestions. If a step resolves the problem, you can stop without performing the other steps on the checklist.

Troubleshooting checklist

1. Make sure the product Ready light is on. If no lights are on, complete these steps:
 - a. Check the power-cable connections.
 - b. Check that the power switch is on.
 - c. Make sure that the line voltage is correct for the product power configuration. (See the label that is on the back of the product for voltage requirements.) If you are using a power strip and its voltage is not within specifications, plug the product directly into the wall. If it is already plugged into the wall, try a different outlet.
 - d. Remove any other products plugged into the same circuit.
 - e. If none of these measures restores power, contact your dealer for support.
2. Check the cabling.
 - a. Check the cable connection between the product and the computer or network port. Make sure that the connection is secure.
 - b. Make sure that the cable itself is not faulty by using a different cable, if possible.
 - c. Check the network connection. See [Solve network printing problems on page 268](#).
3. If the product is in the READY state, check to see if any message appear on the control-panel display. If any error messages appear, see [Control-panel messages on page 221](#).
4. Ensure that the print paper that you are using meets specifications.
5. Print a configuration page (see [Information pages on page 176](#). An HP Jetdirect page also prints.)
 - a. If the pages do not print, check that at least one tray contains print paper.
 - b. If the page jams in the product, see [Jams on page 222](#).
6. If the configuration page prints, check the following items.
 - a. If the page prints correctly, then the product hardware is working. The problem is with the computer you are using, with the printer driver, or with the program.
 - b. If the page does not print correctly, the problem is with the product hardware. Contact your dealer for support.
7. Select one of the following options:

Windows: Click **Start**, click **Settings**, and then click **Printers**, or **Printers and Faxes**. Double click **HP Color LaserJet CM6049f**.

-or-

Mac OS X: Open **Print Center**, (or **Printer Setup Utility** for Mac OS X v. 10.3), and double-click the line for the **HP Color LaserJet CM6049f**.

8. Verify that you have installed the HP Color LaserJet CM6049f printer driver. Check the program to make sure that you are using an HP Color LaserJet CM6049f printer driver.
9. Print a short document from a different program that has worked in the past. If this solution works, then the problem is with the program you are using. If this solution does not work (the document does not print) complete these steps:
 - a. Try printing the job from another computer that has the product software installed.
 - b. If you connected the product to the network, connect the product directly to a computer with a USB cable. Redirect the product to the correct port, or reinstall the software, selecting the new connection type that you are using.

Restore factory settings

Use the **Resets** menu to restore factory settings.

1. Scroll to and touch **Administration** and then touch **Resets**.
2. Touch **Restore Factory Settings** and then touch **Restore**.

For more information, see [Resets menu on page 58](#).

Factors that affect product performance

Several factors affect the time it takes to print a job:

- Maximum printer speed, measured in pages per minute (ppm)
- The use of special paper (such as transparencies, heavy paper, and custom-size paper)
- Printer processing and download time
- The complexity and size of graphics
- The speed of the computer you are using
- The USB connection
- The printer I/O configuration
- The amount of printer memory installed
- The network operating system and configuration (if applicable)
- Printer personality (HP JetReady, PCL, or PS)

 **NOTE:** Although additional printer memory can resolve memory problems, improve how the printer handles complex graphics, and improve download times, it will not increase maximum printer speed (ppm).

Control-panel message types

Four types of control-panel messages can indicate the status of or problems with the device.

Message type	Description
Status messages	Status messages reflect the current state of the device. They inform you of normal device operation and require no interaction to clear them. They change as the state of the device changes. Whenever the device is ready, not busy, and has no pending warning messages, the status message Ready appears if the device is online.
Warning messages	Warning messages inform you of data and print errors. These messages typically alternate with the Ready or status messages and remain until you touch OK . Some warning messages are clearable. If Clearable Warnings is set to Job on the device Device Behavior menu, the next print job clears these messages.
Error messages	<p>Error messages communicate that some action must be performed, such as adding paper or clearing a jam.</p> <p>Some error messages are auto-continuable. If Auto-Continue is set on the menus, the device will continue normal operation after an auto-continuable error message appears for 10 seconds.</p> <p>NOTE: Pressing any button during the 10-second auto-continuable error message overrides the auto-continue feature, and the button function takes precedence. For example, pressing the Stop button pauses printing and offers the option to cancel the print job.</p>
Critical-error messages	Critical error messages inform you of a device failure. Some of these messages can be cleared by turning the device off and then on. These messages are not affected by the Auto-Continue setting. If a critical error persists, service is required.

Control-panel messages

The product provides robust control panel messaging. When a message appears on the control panel, follow the on-screen instructions to resolve the issue. If the product displays an “Error” or “Attention” message, and no steps are shown to resolve the issue, turn the product off then on. Contact your dealer for support if you continue to experience issues with the product.

To get additional information for warnings that appear in the status line, touch the Warning button



For additional information on a variety of topics, touch the Help button  in the upper-right corner of the home screen.

Jams

Common causes of jams

The product is jammed.

Cause	Solution
The paper does not meet specifications.	Use only paper that meets HP specifications. See Supported paper and print media sizes on page 95 .
A component is installed incorrectly.	Verify that the transfer belt and transfer roller are correctly installed.
You are using paper that has already passed through a product or copier.	Do not use paper that has been previously printed on or copied.
An input tray is loaded incorrectly.	Remove any excess paper from the input tray. Make sure that the stack is below the maximum stack height mark in the tray. See Load paper and print media on page 101 .
The paper is skewed.	The input-tray guides are not adjusted correctly. Adjust them so they hold the stack firmly in place without bending it.
The paper is binding or sticking together.	Remove the paper, flex it, rotate it 180°, or flip it over. Reload the paper into the input tray.
When printing on lightweight paper or on jobs with heavy toner coverage, paper is wrapping on the fuser causing Fuser Delay Jam or Fuser Wrap Jam messages.	Set the LIGHT MEDIA optimize mode on the Print Quality menu to ON .
The paper is removed before it settles into the output bin.	Reset the product. Wait until the page completely settles in the output bin before removing it.
During two-sided printing, you removed the paper before the second side of the document was printed.	Reset the product and print the document again. Wait until the page completely settles in the output bin before removing it.
The paper is in poor condition.	Replace the paper.
The internal tray rollers are not picking up the paper.	If the paper is heavier than 220 g/m ² (58 lb), it might not be picked from the tray. The rollers are worn. Replace the rollers.
The paper has rough or jagged edges.	Replace the paper.
The paper is perforated or embossed.	Perforated or embossed paper does not separate easily. Feed single sheets from Tray 1.
Device supply items have reached the end of their useful life.	Check the product control panel for messages prompting you to replace supplies, or print a supplies status page to verify the remaining life of the supplies. See Information pages on page 176 .
Paper was not stored correctly.	Replace the paper in the trays. Paper should be stored in the original packaging in a controlled environment.
Not all product packing material was removed.	Verify that the packing tape, cardboard, and plastic shipping locks have been removed from the product.

If the product still continues to jam, contact your dealer for support.

Jam locations

Use this illustration to identify locations of jams. In addition, this product provides instructions on the control panel to direct you to the location of jammed paper and how to clear it.

 **NOTE:** All areas of the product that might need to be opened to clear jams are equipped with green handles.

Figure 15-1 Jam locations



1	AREA 1: Output bin
2	AREA 2: Fuser area
3	AREA 3: Transfer area
4	AREA 4: Duplexing area
5	AREA 5: Tray 2 pickup area
6	AREA 6: Tray 1 area
7	AREA 7: Optional Trays 3, 4, and 5
8	AREA 8: Optional finishing device
9	AREA 9: ADF area

Clear jams

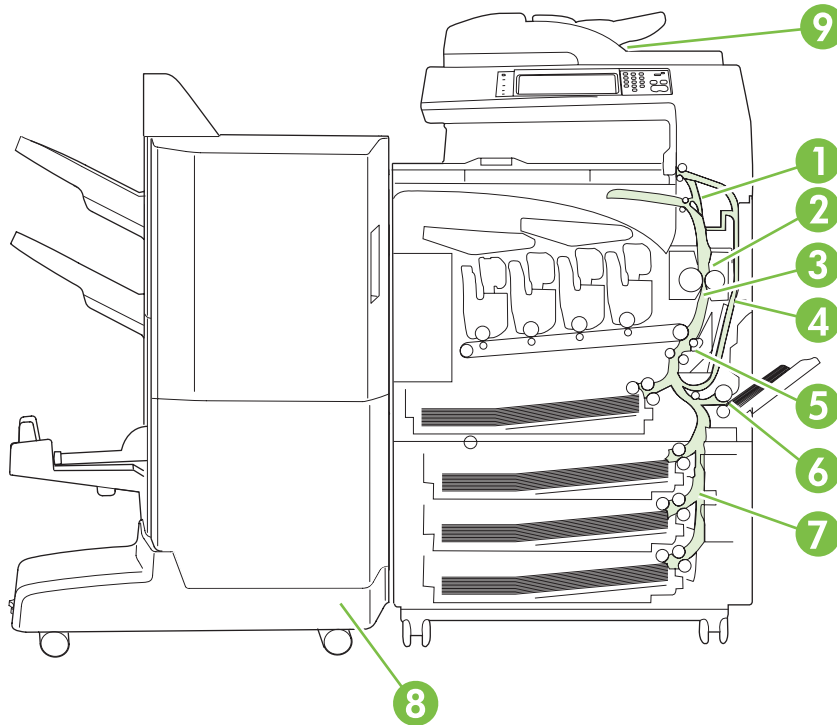
When a jam occurs, a message appears on the control-panel display that describes the location of the jam. The following table lists the messages that can appear and provides links to the procedures for clearing the jam.

⚠ WARNING! To avoid electrical shock, remove any necklaces, bracelets, or other metal items before reaching into the inside of the product.

Type of jam	Procedure
13.JJ.NT Jam below control panel	See AREA 1: Clear jams in the output bin on page 224.
13.JJ.NT Fuser Area Jam	See AREA 2: Clear jams in the fuser on page 226.
13.JJ.NT Fuser Wrap Jam	
13.JJ.NT Transfer And Fuser Jam	
13.JJ.NT Jam Inside Right Door	See Clear jams in the duplex area on page 230.
13.JJ.NT Jam In Tray 2	See AREA 5: Clear jams in Tray 2 and the internal paper path on page 233.
13.JJ.NT Transfer Area Jam	
13.JJ.NT Jam In Tray 1	See AREA 6: Clear jams in Tray 1 on page 236.
13.JJ.NT Jam In Tray 3	See AREA 7: Clear jams in optional Trays 3, 4, and 5 on page 239
13.JJ.NT Jam In Tray 4	
13.JJ.NT Jam In Tray 5	
13.JJ.NT Jam Inside Lower Right Door	
13.JJ.NT Jam In Input Accessory	
13.JJ.NT Jam In Left Accessory	See AREA 8: Clear jams in the optional finishing devices on page 242.
Jam in document feeder	See AREA 9: Clear jams in the ADF on page 246.

AREA 1: Clear jams in the output bin

1. If jammed paper is visible in the output bin, gently pull the paper to remove it.

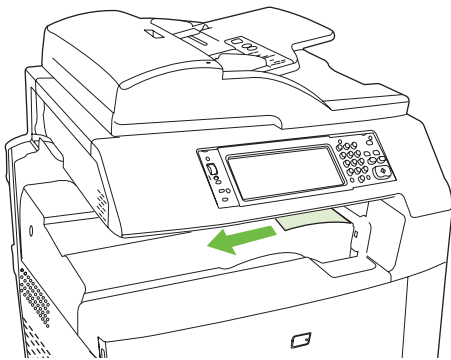

2. Open the right door.

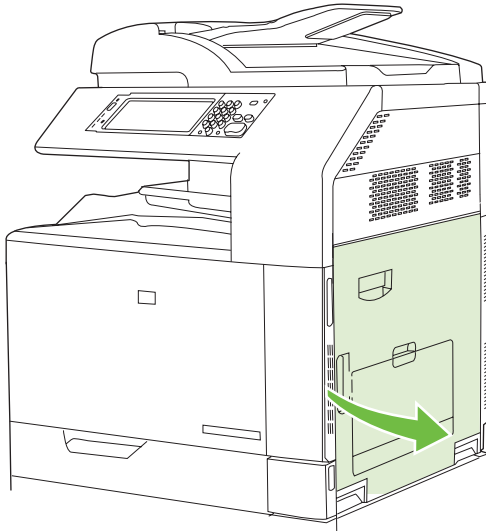

3. If paper has jammed as it enters the output bin, gently pull the paper to remove it.

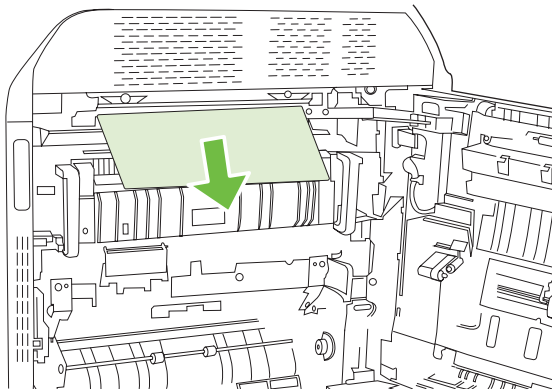

4. Close the right door.

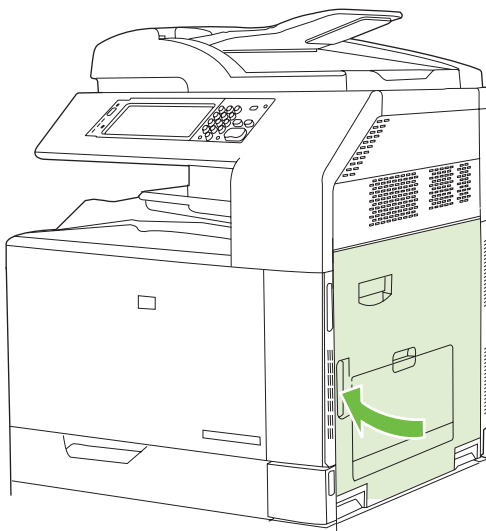

AREA 2: Clear jams in the fuser

⚠ WARNING! The fuser can be hot while the product is in use. Wait for the fuser to cool before handling it.

1. Open the right door.

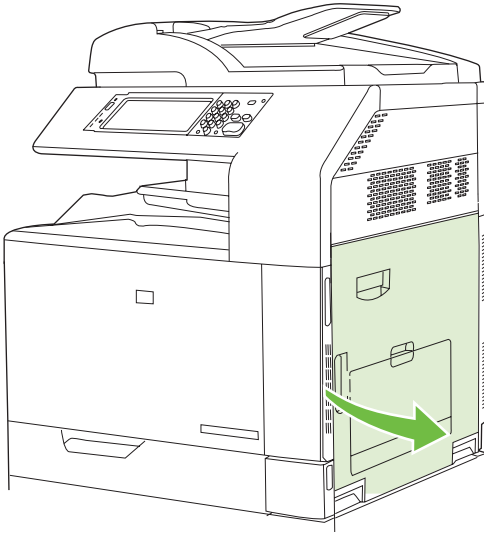

2. Lift the green handle on the transfer-access panel and open the panel.

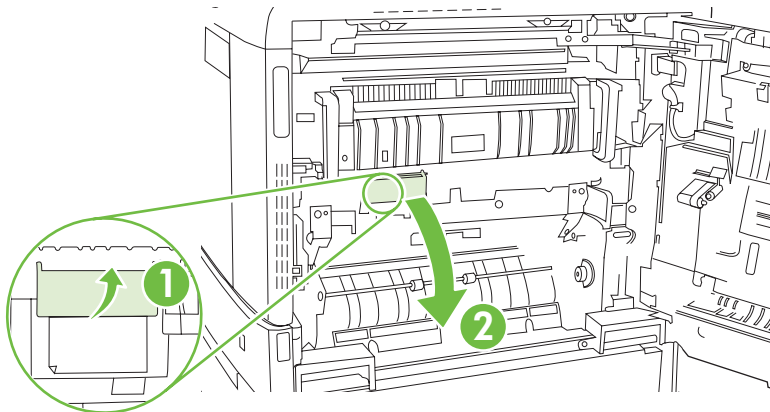

3. If paper is visible entering the bottom of the fuser, gently pull downward to remove it.

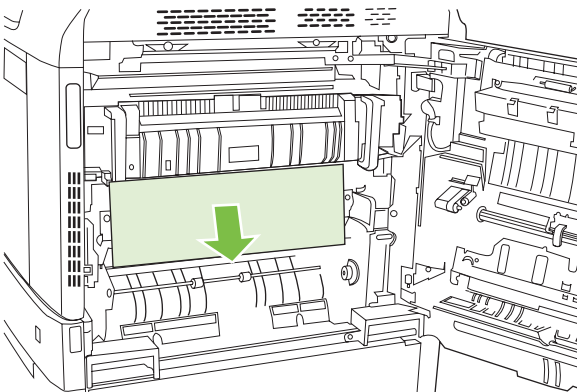

4. Close the transfer-access panel.

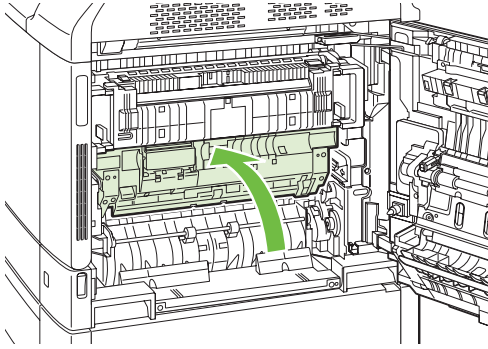

5. Open the fuser jam access door above the fuser and remove any paper that is visible. Then close the fuser jam access door.

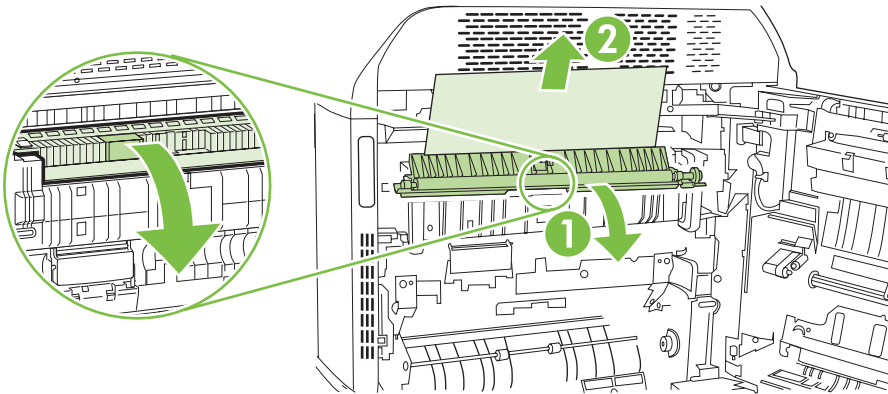

6. Paper could also be jammed inside the fuser where it would not be visible. Remove the fuser to check for jammed paper inside.

⚠ WARNING! The fuser can be hot while the product is in use. Wait for the fuser to cool before handling it.

- a. Pull the two blue fuser handles forward.

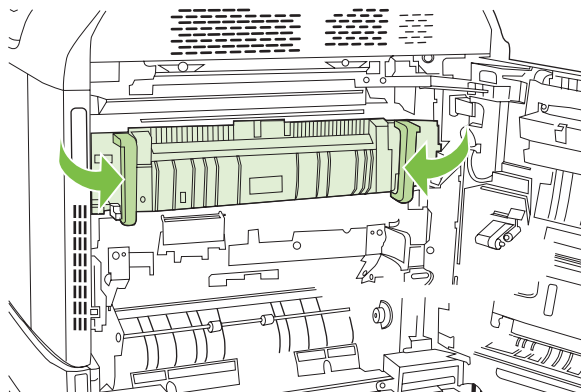

- b. Rotate the fuser-release levers down to open them.

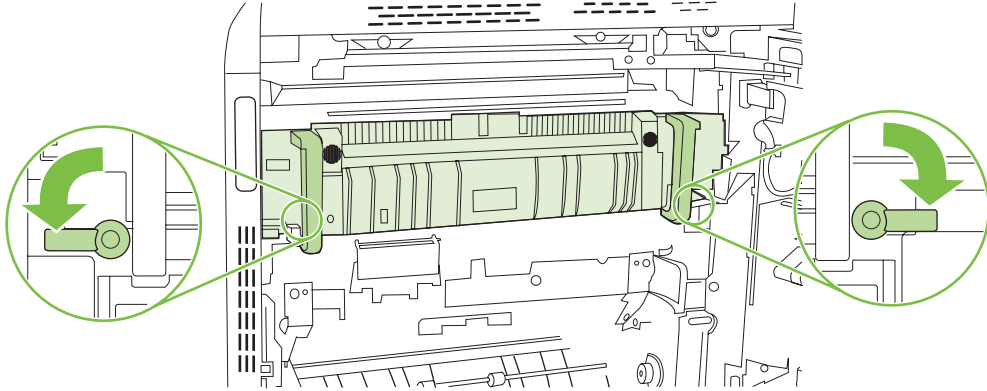

- c. Grasp the fuser handles and pull straight out to remove the fuser.

△ **CAUTION:** The fuser weighs 5 kg (11 lbs). Be careful not to drop it.

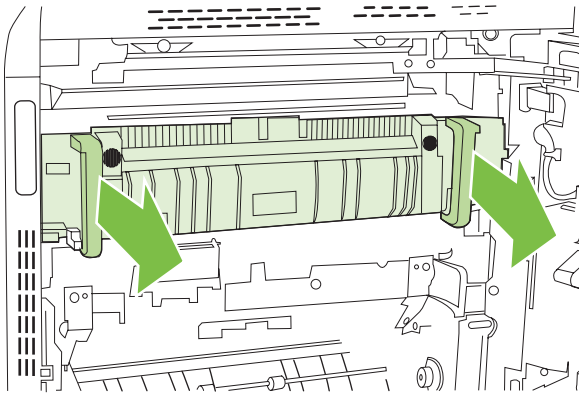

- d. Open the two fuser jam access doors by pushing and rotating the rear door backward, and pulling and rotating the front door forward. If paper is jammed inside the fuser, gently pull it straight up to remove it. If the paper tears, remove all paper fragments.

△ **WARNING!** Even if the body of the fuser has cooled, the rollers that are inside could still be hot. Do not touch the fuser rollers until they have cooled.

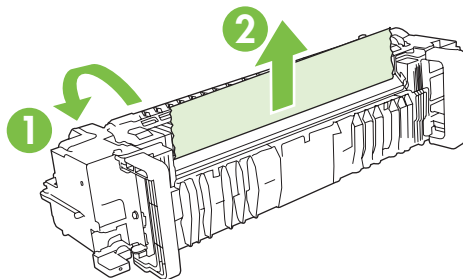

- e. Close both fuser jam-access doors and align the fuser with the arrows on the product. Push the fuser completely into the printer.

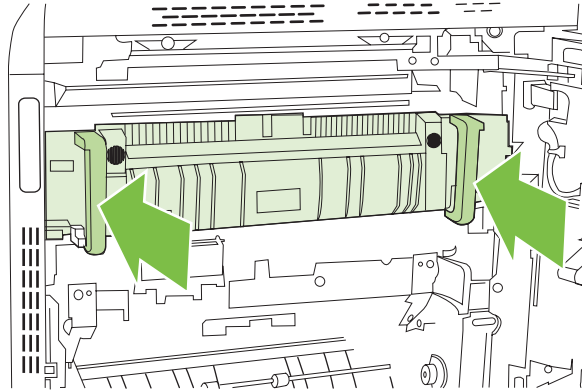

- f. Rotate the fuser-release levers up to lock the fuser into place.

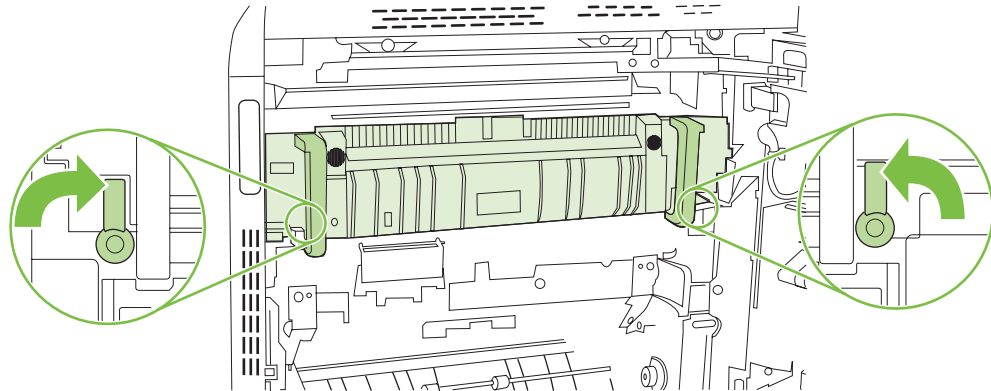

- g. Push the fuser handles back to close them.

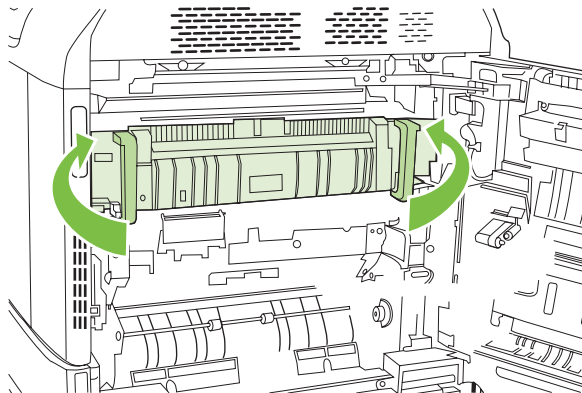

7. Close the right door.

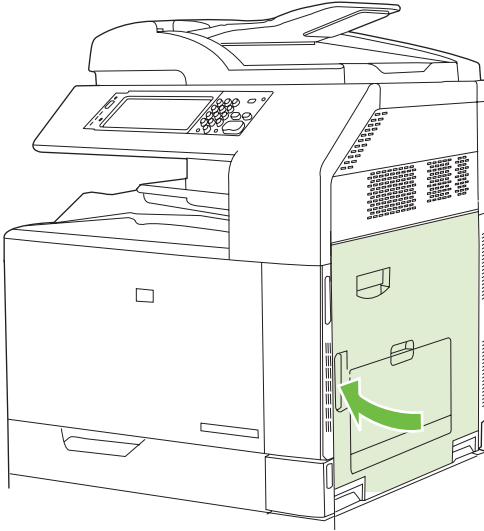

Clear jams in the duplex area

1. Check for jammed paper inside the product. Open the right door.

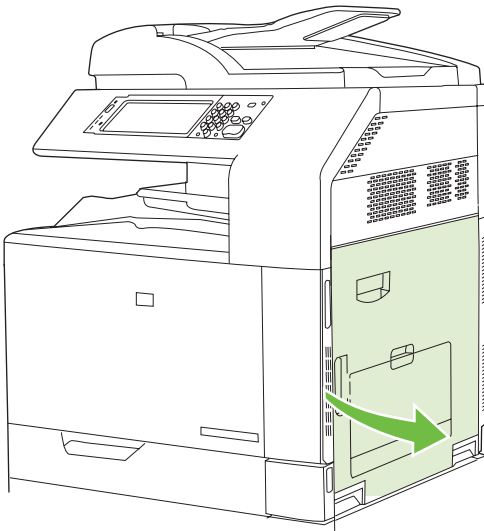

2. If paper is jammed below the duplexing unit, gently pull the paper downward to remove it.

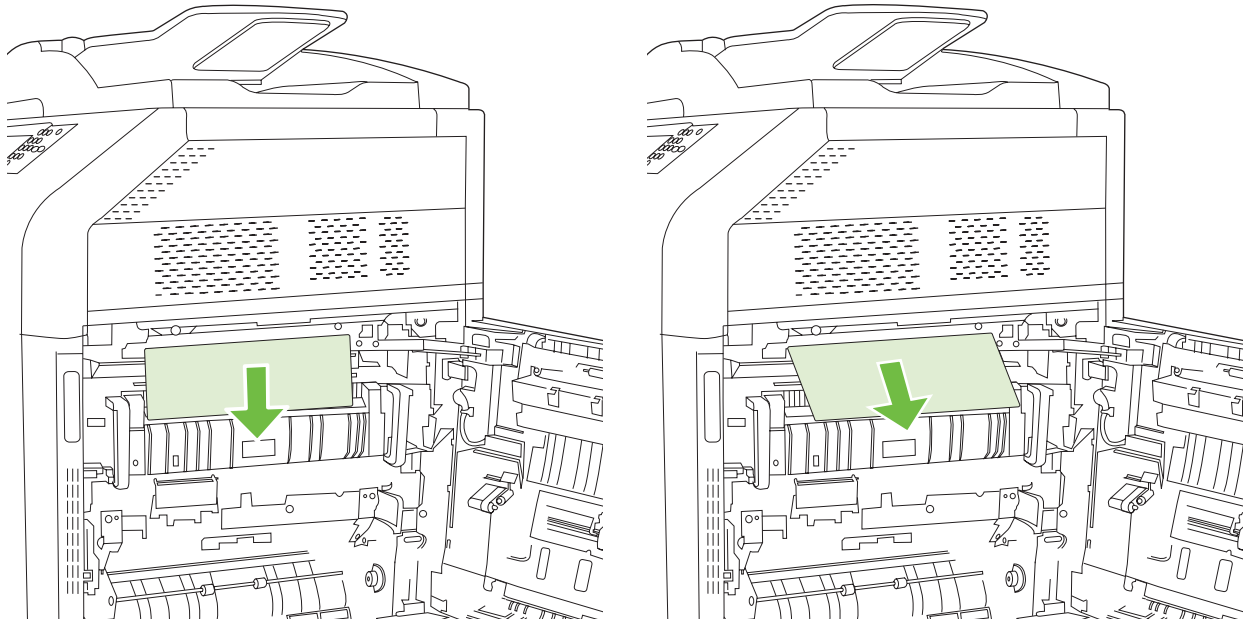

3. If paper is jammed inside the right door, gently pull the paper to remove it.

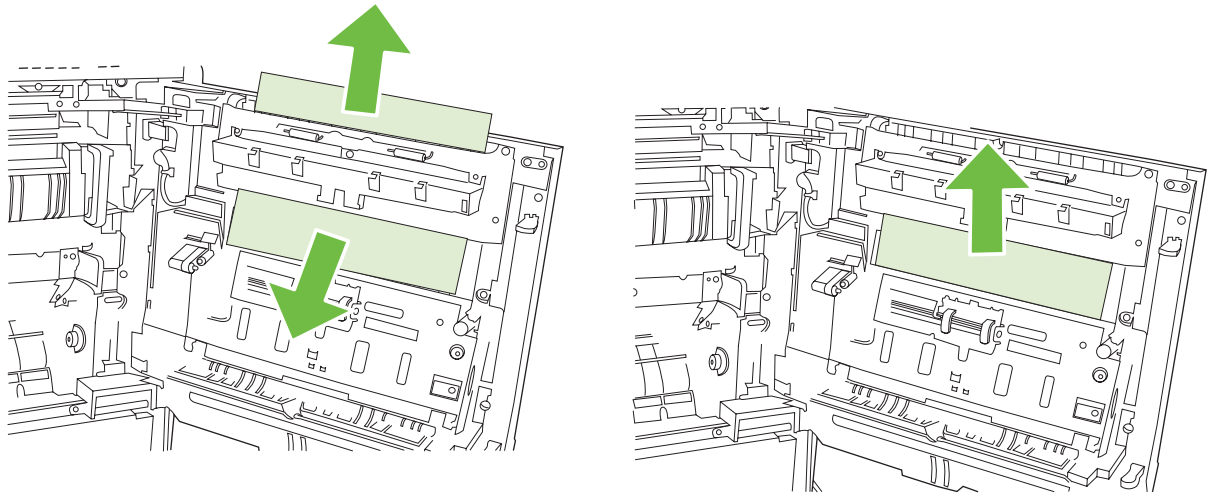

4. Lift the paper-feed cover on the inside of the right door. If jammed paper is present, gently pull the paper straight out to remove it.

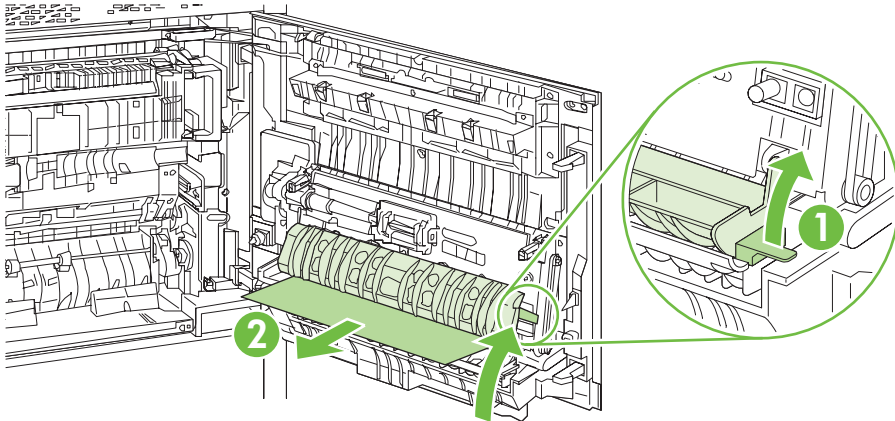

5. Lift the green handle on the transfer-assembly and open the panel.

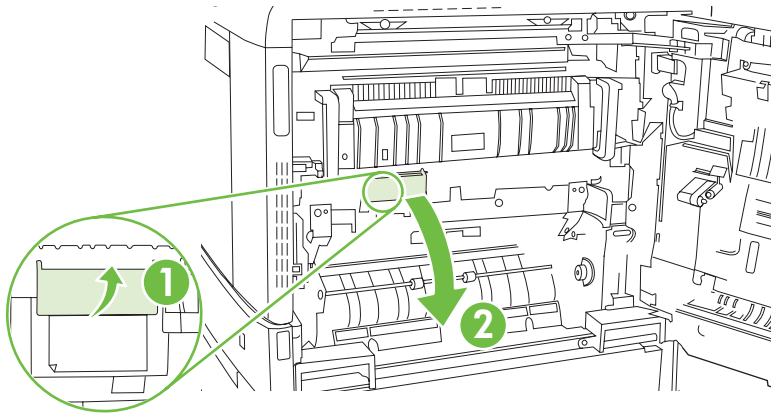

6. Gently pull the paper out of the paper path.

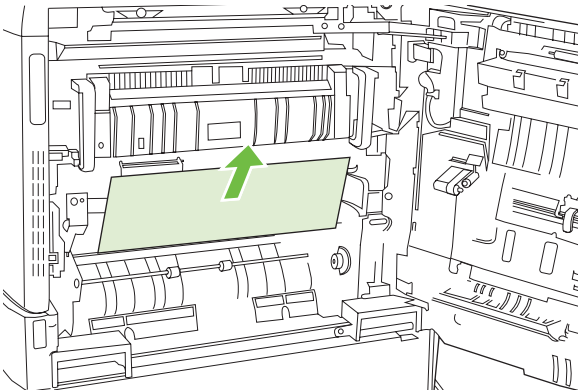

7. Close the transfer-access panel.

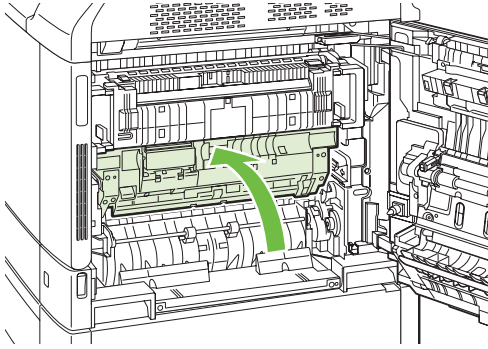

8. Close the right door.

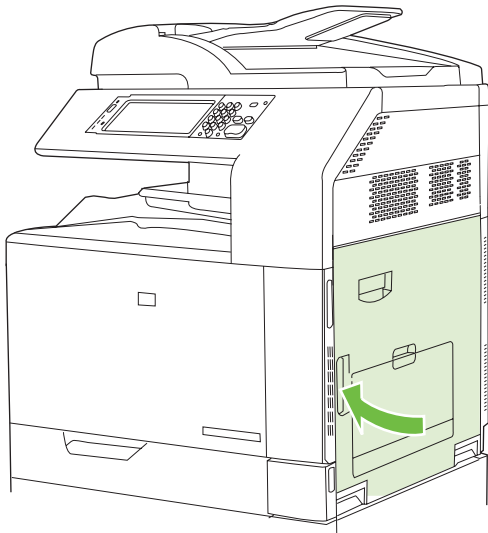

AREA 5: Clear jams in Tray 2 and the internal paper path

1. Open the right door.

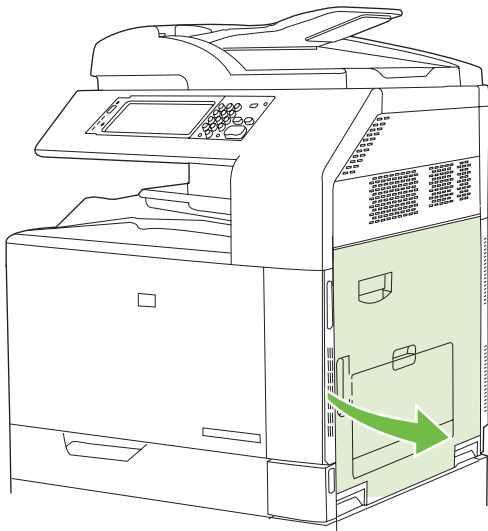

2. Lift the green handle on the transfer-access panel and open the panel.

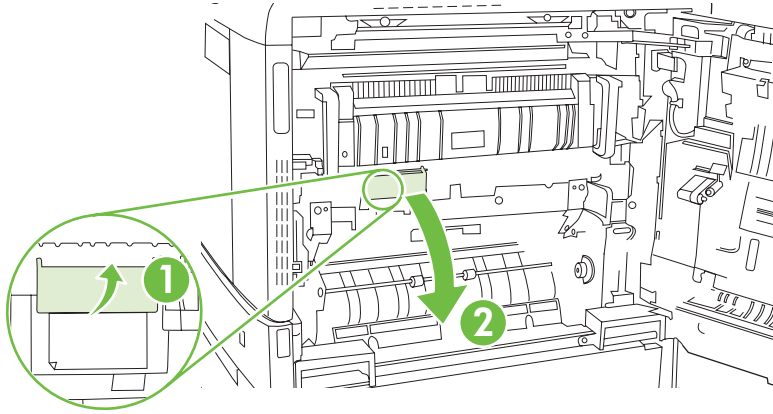

3. Gently pull the paper out of the paper path.

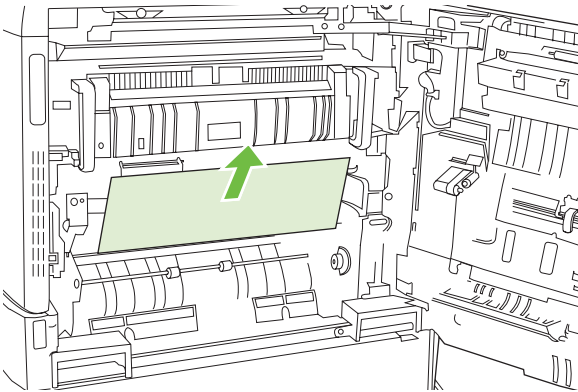

4. Close the transfer-access panel.

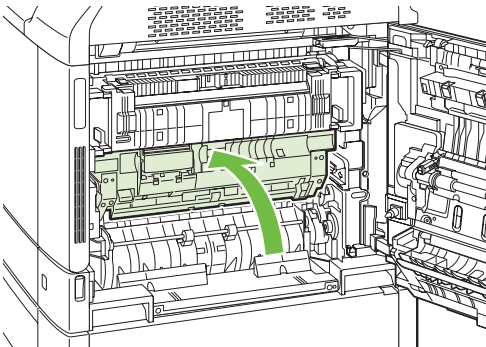

5. Open Tray 2 and make sure that the paper is stacked correctly.

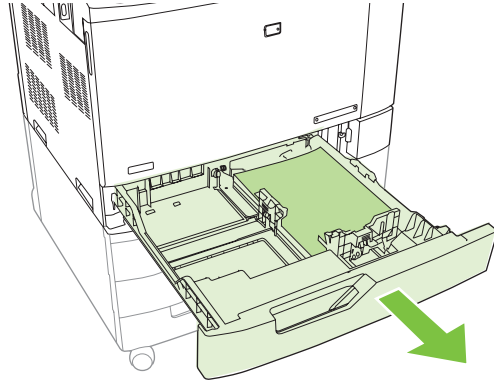

6. Pull the tray completely out of the product by pulling and lifting it up slightly.

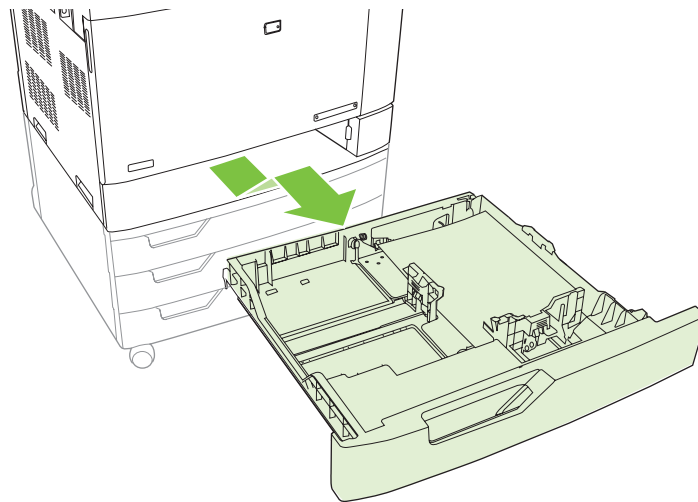

7. Remove any paper from the feeder rollers inside the product.

8. Reinsert Tray 2 by aligning the side rollers and pushing it back into the product.

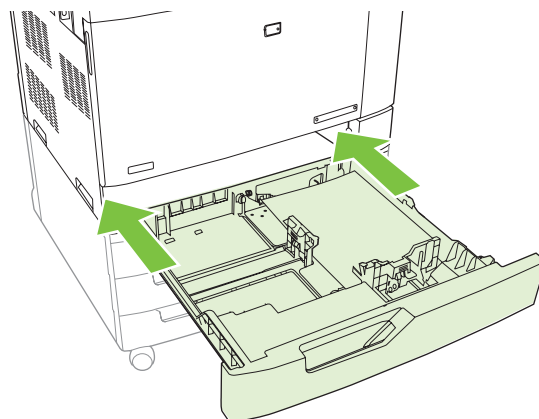

9. Close the tray.

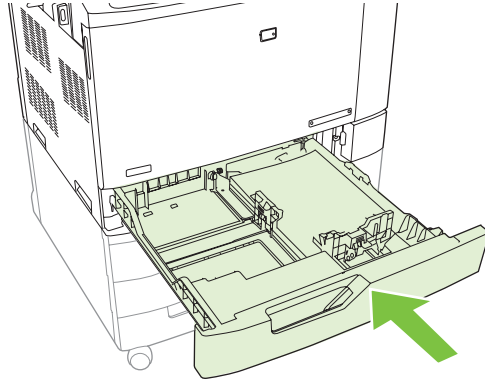

10. Close the right door.

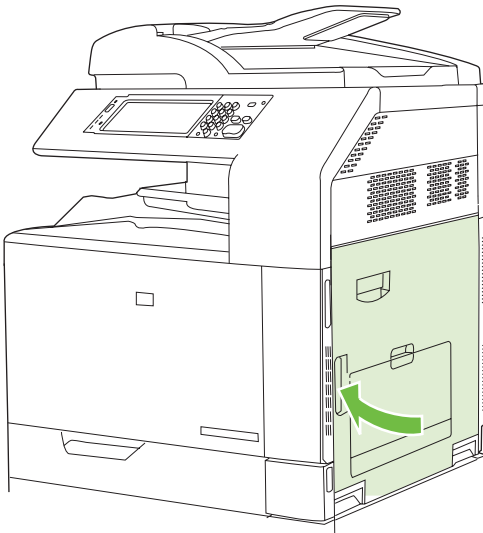

AREA 6: Clear jams in Tray 1

-  **NOTE:** Even if jammed paper is visible in Tray 1, clear the jam from the inside of the product by opening the right door.
-

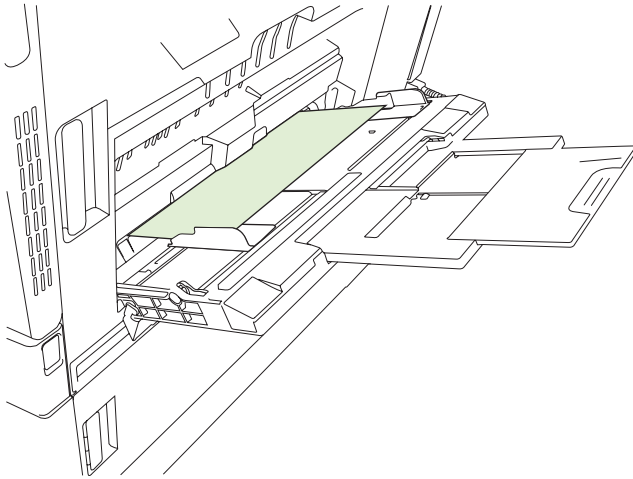

1. Open the right door.

 **NOTE:** When clearing jams of long paper (11 x 17, 12 x 18, and A3), it may be necessary to cut or tear the jammed paper before opening the right door.

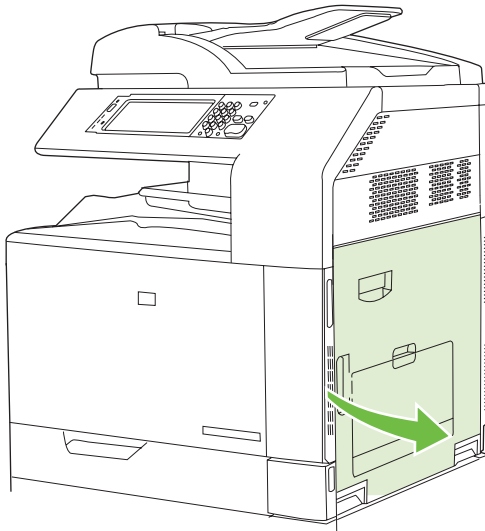

2. If paper is visible inside the right door, gently pull the paper downward to remove it.

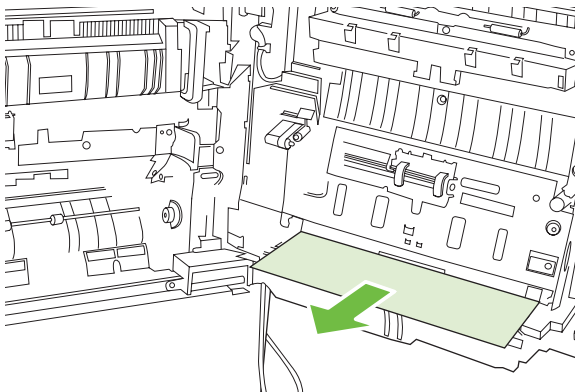

3. If paper has entered the internal paper path, lift the green handle on the transfer-access panel and open the panel.

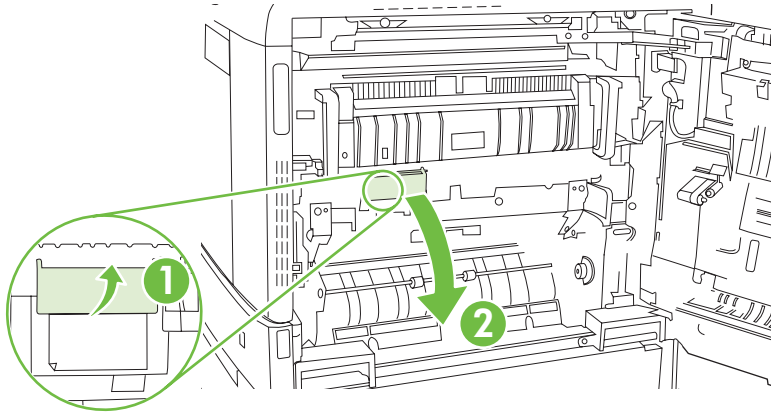

4. Gently pull the paper out of the paper path.

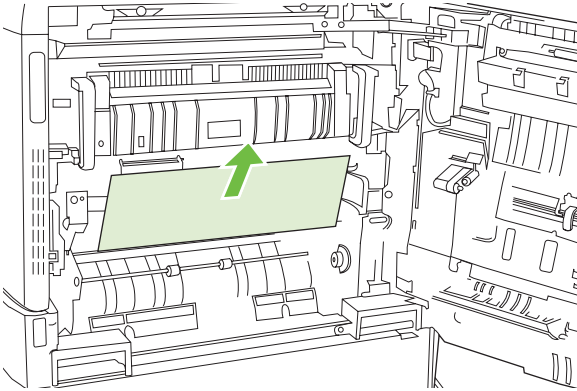

5. Close the transfer-access panel.

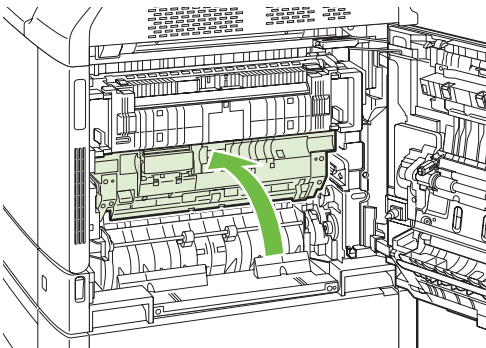

6. Close the right door.

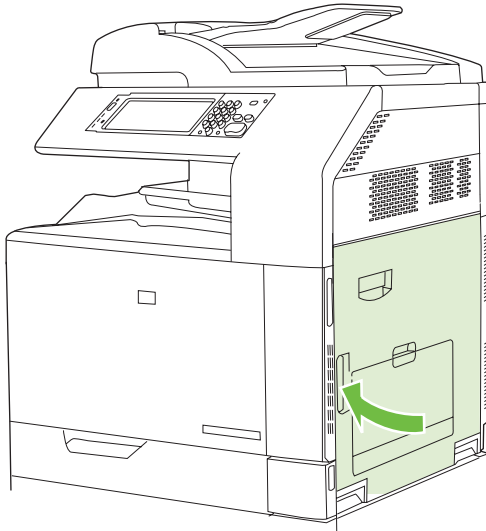

AREA 7: Clear jams in optional Trays 3, 4, and 5

1. Open the right door.

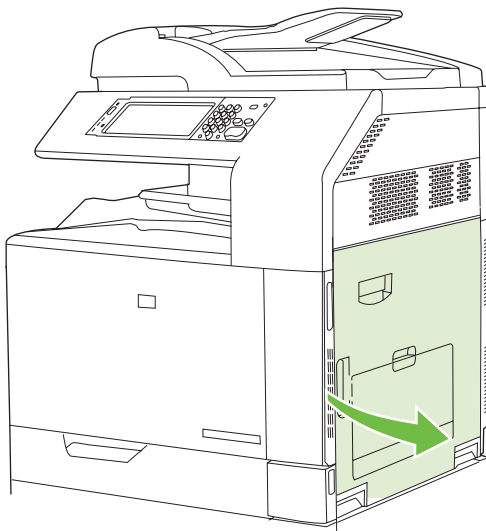

2. If paper is visible in the paper-input area, gently pull the jammed paper up to remove it.

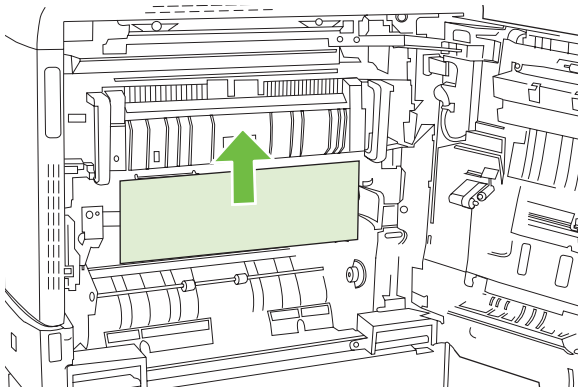

3. Close the right door.

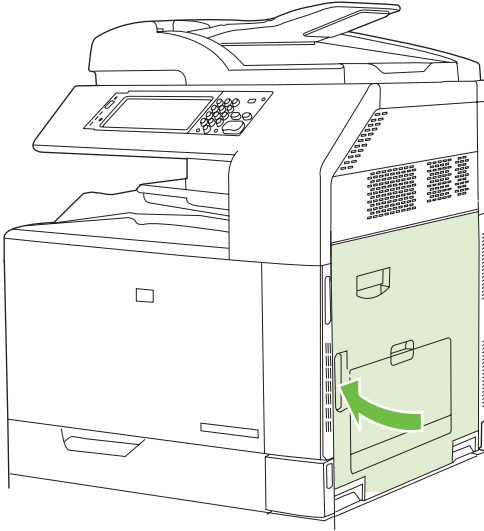

4. Open the lower right door.

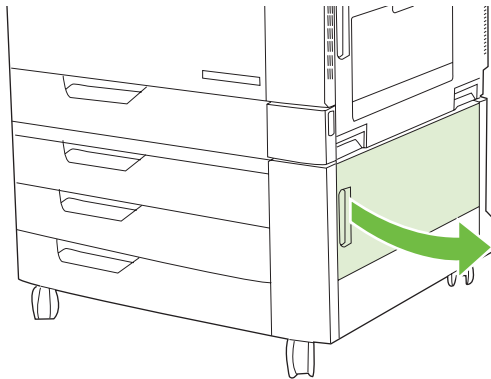

5. Gently pull the jammed paper to remove it.

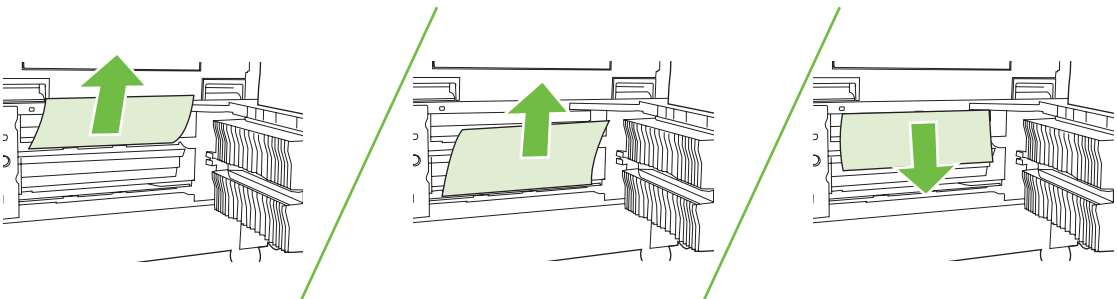

6. Open the tray that is indicated in the control-panel message, and make sure that the paper is stacked correctly.

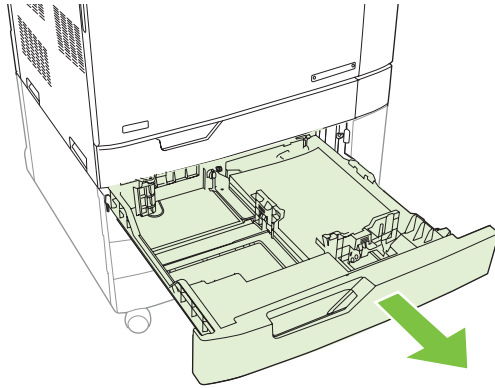

7. Close the tray.

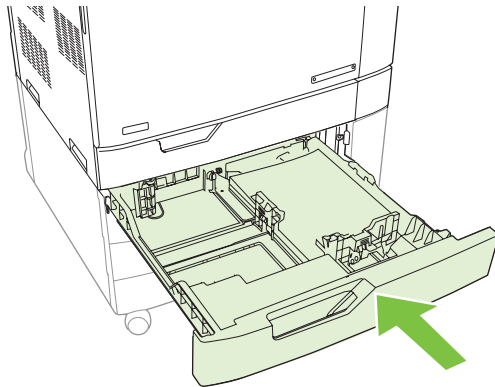

8. Close the lower right door.

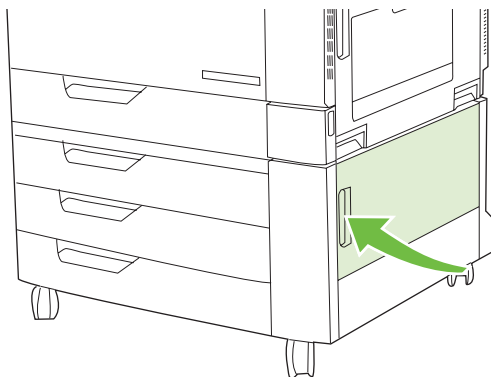

AREA 8: Clear jams in the optional finishing devices

Clear jams in the output-accessory bridge

1. Lift the latch on the top cover of the output-accessory bridge and open the top cover.

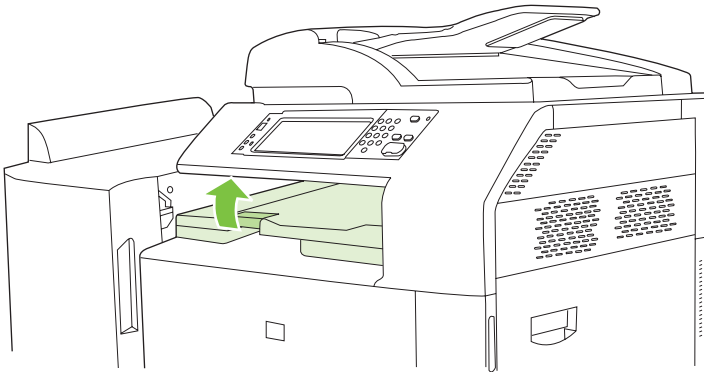

2. Gently pull the jammed paper to remove it.

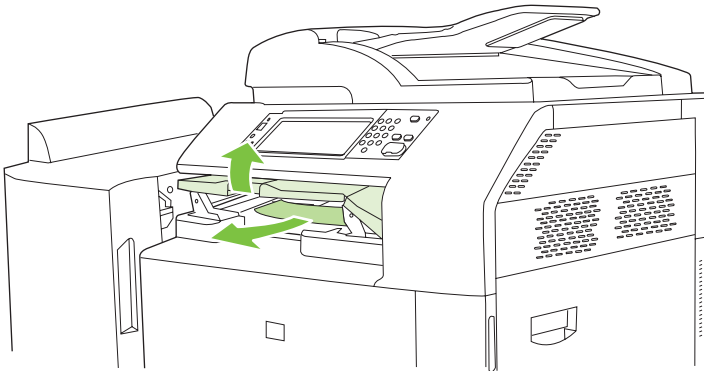

3. Close the top cover of the output-accessory bridge.

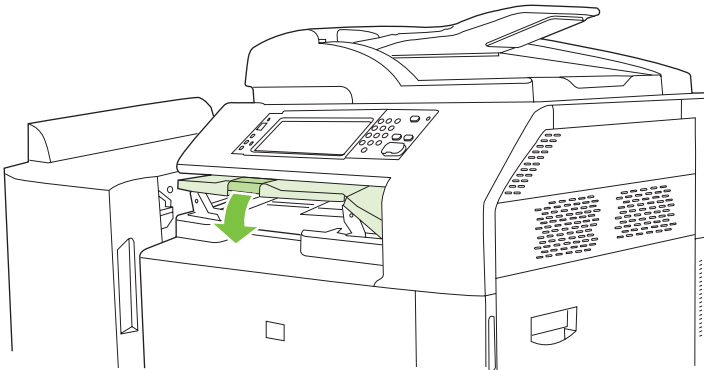

Clear jams in the sorter area

1. Lift the latch on the top cover of the finishing device, and open the top cover.

 **NOTE:** Opening the top cover releases pressure on the output-bin rollers.

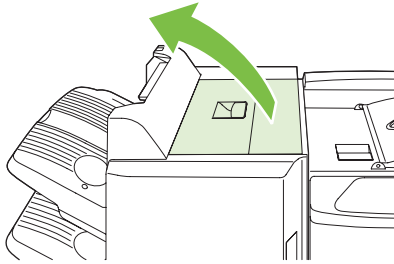

2. Remove jammed paper from the output bin or from the inside of the finishing device.

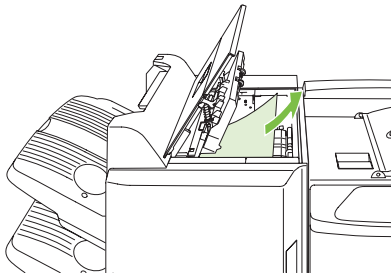
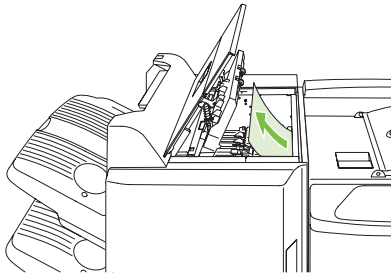
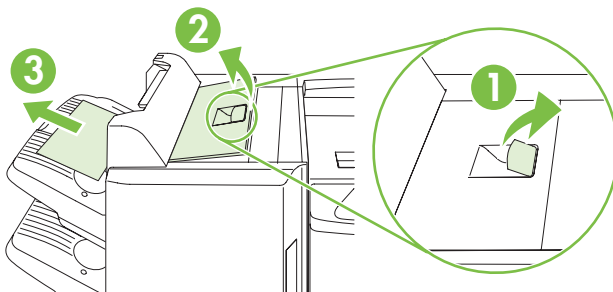

3. Close the top cover of the finishing device.

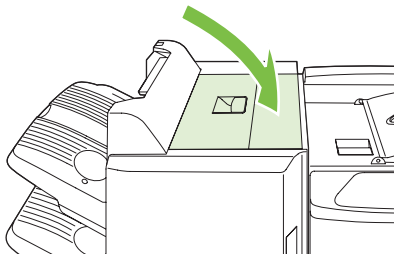

4. Lift the swing guide panel in the output bin. If you can see any jammed paper, gently pull it out.

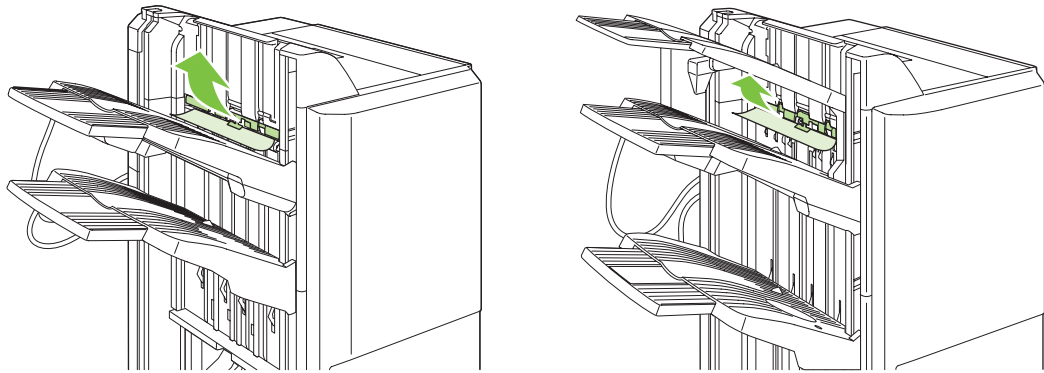

Clear jams in the booklet maker

1. If the paper is visible in the booklet output bin, gently pull the paper to remove it.

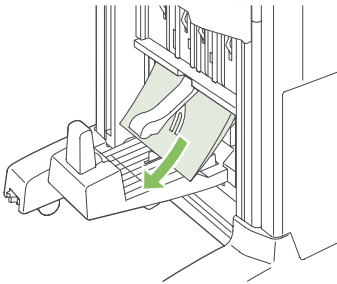

2. Open the front door of the booklet maker.

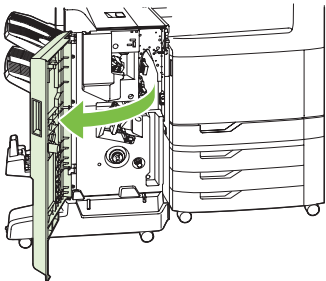

3. Push the upper delivery guide to the right, and remove any jammed paper.

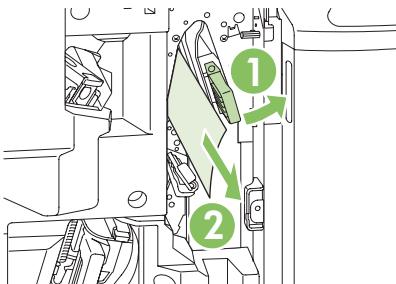

4. Push the lower delivery guide to the right, and remove any jammed paper.

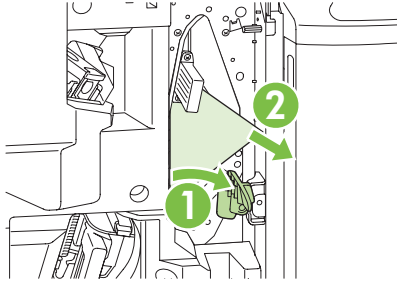

5. The positioning knob is the smaller, green dial on the right. Turn the positioning knob counterclockwise.

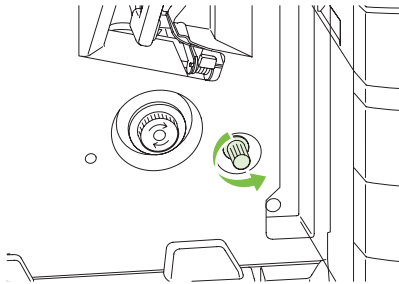

6. The jam-release knob is the larger, green dial on the left. Push in the jam-release knob, and then turn it clockwise to move any jammed paper into the output bin.

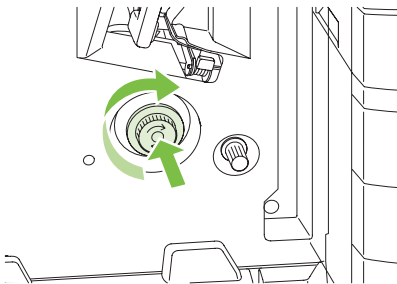

7. Close the front door of the booklet maker.

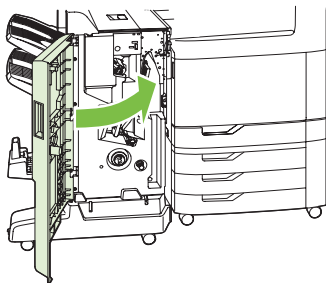

AREA 9: Clear jams in the ADF

1. Open the ADF cover.

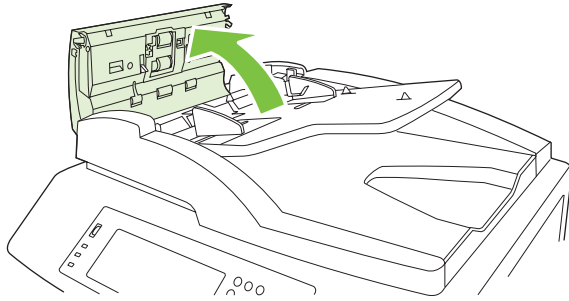

2. Remove any jammed media.

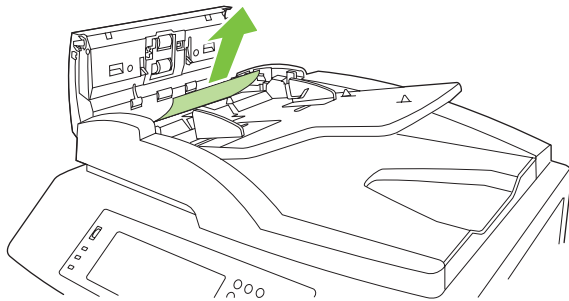

3. Close the ADF cover.

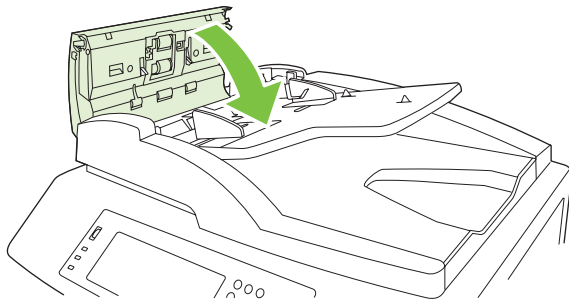

Clear staple jams

Clear staple jams in the main stapler

The HP 3-bin Stapler/Stacker and the HP Booklet maker/Finisher Accessory each have a main stapler, which is located near the top of the finishing device.

1. Open the front door of the finishing device.

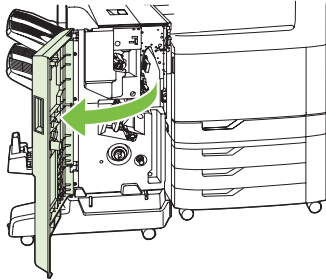

2. To remove the staple cartridge, pull up on the green handle and pull out the staple cartridge.

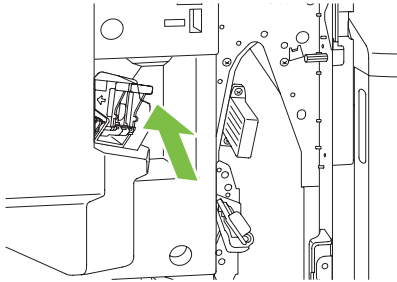

3. Lift up on the small lever at the back of the staple cartridge.

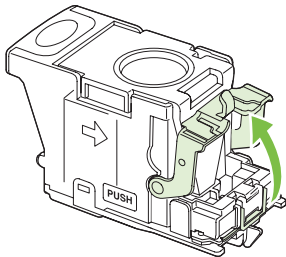

4. Remove the damaged staples that protrude from the staple cartridge. Remove the entire sheet of staples that the damaged staples were attached to.

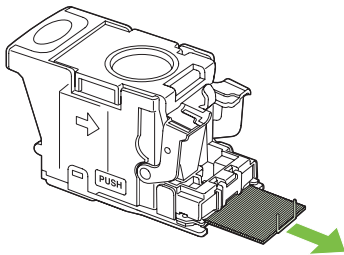

5. Close the lever at the back of the staple cartridge. Be sure that it snaps into place.

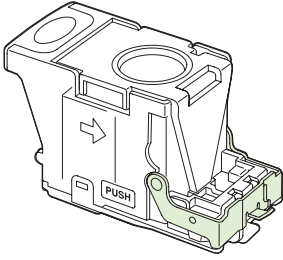

6. Reinsert the staple cartridge into the finishing device, and push down on the green handle until it snaps into place.

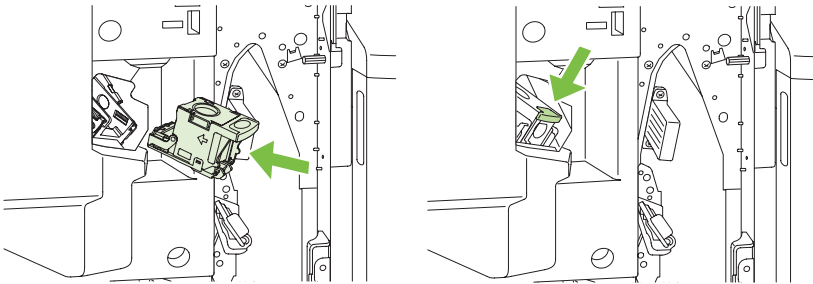

7. Close the front cover of the finishing device.

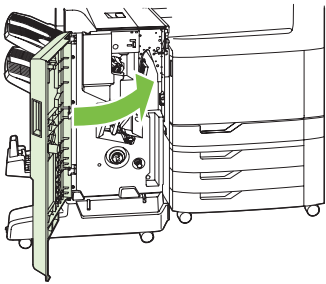

Clear staple jams in the booklet maker

The booklet maker has an additional saddle stitch stapler that is below the main stapler. The saddle stitch stapler has two staple cartridges.

1. Open the front door of the booklet maker.

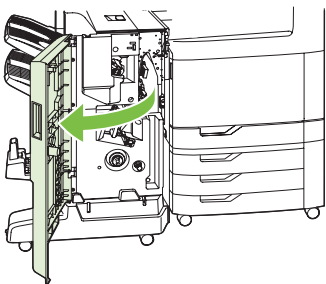

2. Push the upper delivery guide to the right, and remove any jammed paper.

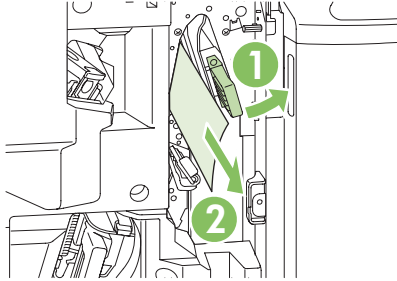

3. Grasp the blue handle for the stapler carriage and pull it straight out.

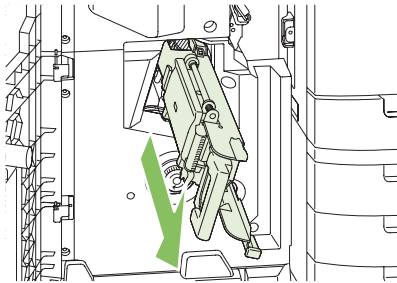

4. Grasp the handle of the blue staple cartridge unit and pull it toward you, then swing the staple cartridge unit into an upright position.

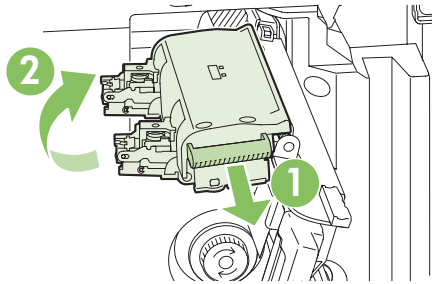

5. Check each staple cartridge for jammed staples.

- a. On each staple cartridge, press down on the green plastic tabs while lifting the jam clearance plate.

⚠ **WARNING!** Do not place your fingers or hands underneath the staple cartridge during this procedure.

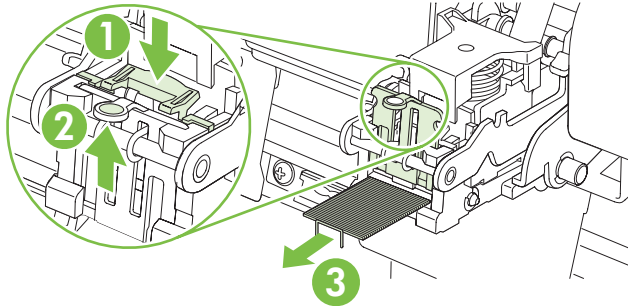

- b. Remove any jammed staples. Remove any damaged staples and the entire sheet of staples that the damaged staples were attached to.

- c. Press down on the jam clearance plate to close it.

⚠ **WARNING!** Do not place your fingers or hands underneath the staple cartridge during this procedure.

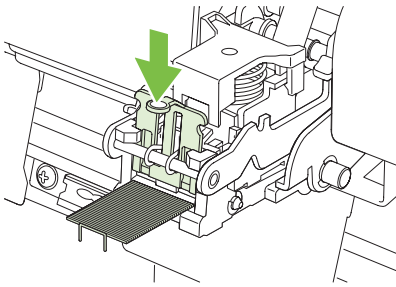

6. Pull the staple cartridge unit forward, and swing it downward to the original position. Push in on the handle to lock it into position.

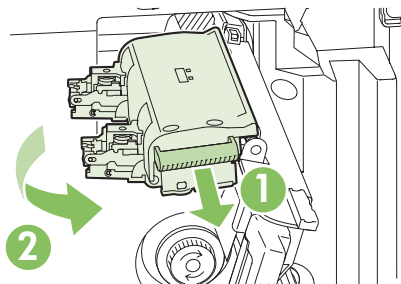

7. Push the staple carriage back into the booklet maker.

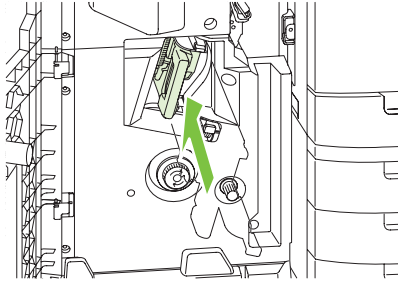

8. Close the front door of the booklet maker.

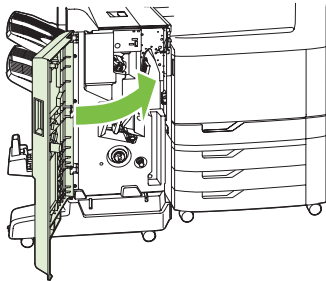

Jam recovery

This product provides jam recovery, a feature that reprints jammed pages. The following options are available:

- **Auto** — The product attempts to reprint jammed pages when sufficient memory is available.
- **Off** — The product does not attempt to reprint jammed pages. Because no memory is used to store the most recent pages, performance is optimal.

 **NOTE:** When using this option, if the product runs out of paper and the job is being printed on both sides, some pages can be lost.

- **On** — The product always reprints jammed pages. Additional memory is allocated to store the last few pages printed. This might cause overall performance to suffer.

Set the jam recovery feature

1. Touch **Administration** and then touch **Device Behavior**.
2. Touch **Warning/Error Behavior** and then touch **Jam Recovery**.
3. Touch an option and then touch **Save**.

Paper-handling problems

Use only paper that meets the specifications outlined in the *HP LaserJet Printer Family Print Media Guide*. This guide is available at www.hp.com/support/ljpaperguide.

Product feeds multiple sheets

Product feeds multiple sheets

Cause	Solution
The input tray is overfilled. Open the tray and verify that the paper stack is below the maximum stack height mark.	Remove excess paper from the input tray.
Print paper is sticking together.	Remove paper, flex it, rotate it 180 degrees or flip it over, and then reload it into the tray. NOTE: Do not fan paper. Fanning can cause static electricity, which can cause paper to stick together.
Paper does not meet the specifications for this product.	Use only paper that meets HP paper specifications for this product.
Trays are not properly adjusted.	Make sure that the paper guides match the size of paper being used.

Product feeds incorrect page size

Product feeds incorrect page size

Cause	Solution
The correct size paper is not loaded in the input tray.	Load the correct size paper in the input tray.
The correct size paper is not selected in the software program or printer driver.	Confirm that the settings in the software program and printer driver are appropriate, since the software program settings override the printer driver and control panel settings, and the printer driver settings override the control panel settings. For more information, see Change printer-driver settings for Windows on page 67 or Change printer-driver settings for Macintosh on page 73 .
The correct size paper for the tray is not selected in the product control panel.	From the control panel, select the correct size paper for the tray.
The paper size is not configured correctly for the input tray.	Print a configuration page or use the control panel to determine the paper size for which the tray is configured.
The guides in the tray are not against the paper.	Verify that the paper guides are touching the paper.

Product pulls from incorrect tray

Product pulls from incorrect tray

Cause	Solution
You are using a driver for a different product.	Use a driver for this product.
The specified tray is empty.	Load paper in the specified tray.

Product pulls from incorrect tray

Cause	Solution
The paper size is not configured correctly for the input tray.	Print a configuration page or use the control panel to determine the paper size for which the tray is configured.
The guides in the tray are not against the paper.	Verify that the guides are touching the paper.

Paper does not feed automatically

Paper does not feed automatically

Cause	Solution
Manual feed is selected in the software program.	Load Tray 1 with paper, or, if the paper is loaded, press the Start button.
The correct size paper is not loaded.	Load the correct size paper.
The input tray is empty.	Load paper into the input tray.
Paper from a previous jam has not been completely removed.	Open the product and remove any paper in the paper path.
The paper size is not configured correctly for the input tray.	Print a configuration page or use the control panel to determine the paper size for which the tray is configured.
The guides in the tray are not against the paper.	Verify that the rear and width paper guides are touching the paper.
The manual-feed prompt is set to ALWAYS . The product always prompts for manual feed, even if the tray is loaded.	Open the tray, reload the media, and then close the tray. Or, change the manual-feed prompt setting to UNLESS LOADED , so that the product prompts for manual feed only when the tray is empty.
The USE REQUESTED TRAY setting on the product is set to EXCLUSIVELY , and the requested tray is empty. The product will not use another tray.	Load the requested tray. Or, change the setting from EXCLUSIVELY to FIRST on the CONFIGURE DEVICE menu. The product can use other trays if no media is loaded in the specified tray.

Paper does not feed from Tray 2, 3, 4, or 5

Paper does not feed from Tray 2, 3, 4, or 5

Cause	Solution
The correct size paper is not loaded.	Load the correct size paper.
The input tray is empty.	Load paper in the input tray.
The correct paper type for the input tray is not selected in the product control panel.	From the product control panel, select the correct paper type for the input tray.
Paper from a previous jam has not been completely removed.	Open the product and remove any paper in the paper path. Closely inspect the fuser area for jams.

Paper does not feed from Tray 2, 3, 4, or 5

Cause	Solution
None of the optional trays appear as input tray options.	The optional trays only display as available if they are installed. Verify that any optional trays are correctly installed. Verify that the printer driver has been configured to recognize the optional trays.
An optional tray is incorrectly installed.	Print a configuration page to confirm that the optional tray is installed. If not, verify that the tray is correctly attached to the product.
The paper size is not configured correctly for the input tray.	Print a configuration page or use the control panel to determine the paper size for which the tray is configured.
The guides in the tray are not against the paper.	Verify that the guides are touching the paper.

Transparencies or glossy paper will not feed

Transparencies or glossy paper will not feed

Cause	Solution
The correct paper type is not specified in the software or printer driver.	Verify that the correct paper type is selected in the software or printer driver.
The input tray is overfilled.	Remove excess paper from the input tray. Do not load more than 200 sheets of glossy paper or glossy film, or more than 100 transparencies in Tray 2, 3, 4, or 5. Do not exceed the maximum stack height marks for Tray 1.
Paper in another input tray is the same size as the transparencies, and the product is defaulting to the other tray.	Make sure that the input tray containing the transparencies or glossy paper is selected in the software program or printer driver. Use the product control panel to configure the tray to the paper type loaded.
The tray containing the transparencies or glossy paper is not configured correctly for type.	Make sure that the input tray containing the transparencies or glossy paper is selected in the software program or printer driver. Use the product control panel to configure the tray to the paper type loaded.
Transparencies or glossy paper might not meet supported paper specifications.	Use only paper that meets the HP paper specifications for this product.
High-humidity environments may cause glossy paper not to feed, or to feed too many sheets.	Print glossy paper from Tray 2, 3, 4, or 5 for best results. Avoid printing glossy paper in high humidity conditions. When printing glossy paper, removing the paper from the wrapper and letting it rest for a few hours can improve feeding into the product. However, letting paper rest in humid environments may also cause blisters.

- △ **CAUTION:** HP Color Laser Presentation Paper, Glossy (Q2546A) is not supported with this product. Using this type of paper can cause a fuser jam that might require the replacement of the fuser. Two recommended alternatives are HP Color LaserJet Presentation Paper, Soft Gloss (Q6541A) and HP Color LaserJet Brochure Paper, Glossy (Q6611A, Q6610A). For a list of supported paper types, see [Supported paper types on page 98](#).

Envelopes jam or will not feed in the product

Envelopes jam or will not feed in the product

Cause	Solution
Envelopes are loaded in an unsupported tray. Only Tray 1 can feed envelopes.	Load envelopes into Tray 1.
Envelopes are curled or damaged.	Try using different envelopes. Store envelopes in a controlled environment.
Envelopes are sealing because the moisture content is too high.	Try using different envelopes. Store envelopes in a controlled environment.
Envelope orientation is incorrect.	Verify that the envelope is loaded correctly.
This product does not support the envelopes being used.	Refer to the <i>HP LaserJet Printer Family Print Media Guide</i> .
Tray 1 is configured for a size other than envelopes.	Configure Tray 1 size for envelopes.

Output is curled or wrinkled

Output is curled or wrinkled

Cause	Solution
Paper does not meet the specifications for this product.	Use only paper that meets the HP paper specifications for this product.
Paper is damaged or in poor condition.	Remove paper from the input tray and load paper that is in good condition.
Product speed needs to be reduced.	Set the PAPER CURL option in the Print Quality menu to REDUCED to decrease full speed to 10 ppm (instead of 40 ppm) and 3/4 speed to 7.5 ppm (instead of 30 ppm).
Product is operating in an excessively humid environment.	Verify that the printing environment is within humidity specifications.
You are printing large, solid-filled areas.	Large, solid-filled areas can cause excessive curl. Try using a different pattern.
Paper used was not stored correctly and might have absorbed moisture.	Remove paper and replace it with paper from a fresh, unopened package.
Paper has poorly cut edges.	Remove paper, flex it, rotate it 180 degrees or turn it over, and then reload it into the input tray. Do not fan paper. If the problem persists, replace the paper.
The specific paper type was not configured for the tray or selected in the software.	Configure the software for the paper (see the software documentation). Configure the tray for the paper, see Load paper and print media on page 101 .
The paper has previously been used for a print job.	Do not re-use paper.

Product will not duplex or duplexes incorrectly

Product will not duplex (print 2-sided jobs) or duplexes incorrectly

Cause	Solution
You are trying to duplex on unsupported paper.	Verify that the paper is supported for duplex printing.
The printer driver is not set up for duplex printing.	Set up the printer driver to enable duplex printing.
The first page is printing on the back of preprinted forms or letterhead.	Load preprinted forms and letterhead in Tray 1 with the letterhead or printed side down, with the top of the page toward the back of the product. For Tray 2, 3, 4 and 5, load the paper printed side up with the top of the page toward the back of the product.
The product model does not support automatic 2-sided printing.	The HP Color LaserJet CM6049f MFP does not support automatic 2-sided printing.
The product configuration is not set for duplexing.	In Windows, run the automatic configuration feature: <ol style="list-style-type: none">1. Click the Start button, point to Settings, and then click Printers (for Windows 2000) or Printers and Faxes (for Windows XP).2. Right-click the HP product icon, and then click Properties or Printing Preferences.3. Click the Device Settings tab.4. Under Installable Options, click Update Now in the Automatic Configuration list.

Understand lights on the formatter

Three LEDs on the formatter indicate that the product is functioning correctly.

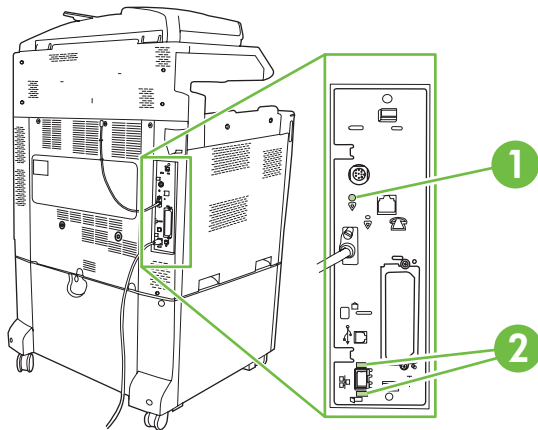

1	Heartbeat LED
2	HP Jetdirect LEDs (This LED exists only if HP Jetdirect is installed.)

HP Jetdirect LEDs

The embedded HP Jetdirect print server has two LEDs. The yellow LED indicates network activity, and the green LED indicates the link status. A blinking yellow LED indicates network traffic. If the green LED is off, a link has failed.

For link failures, check all of the network cable connections. In addition, you can try to manually configure the link settings on the embedded print server by using the product control-panel menus.

1. Scroll to and touch **Administration**.
2. Touch **Initial Setup**.
3. Touch **Networking and I/O**.
4. Touch **Embedded Jetdirect** or **EIO <X> Jetdirect**.
5. Touch **Link Speed**.
6. Select the appropriate link speed.
7. Touch **Save**.

Heartbeat LED

The heartbeat LED indicates that the formatter is functioning correctly. While the product is initializing after you turn it on, the LED blinks rapidly, and then turns off. When the product has finished the initialization sequence, the heartbeat LED pulses on and off.

If the heartbeat LED is off, the formatter might have a problem. Replace or reseal the formatter.

Correct print quality and copy quality problems

The following procedures help you define print quality problems and what to do to correct them. Often print quality problems can be handled easily by making sure that the product is properly maintained, using print media that meets HP specifications, or running a cleaning page.

Example print quality problems

Some print quality problems arise from use of inappropriate paper.

- Use paper that meets HP paper specifications.
- The surface of the paper is too rough. Use paper that meets HP paper specifications.
- The printer driver setting or paper tray setting might be incorrect. Be sure that you have configured the paper tray at the product control panel and have also selected the correct driver setting for the paper that you are using.
- The print mode might be set incorrectly, or the paper might not meet recommended specifications.
- The transparencies you are using are not designed for proper toner adhesion. Use only transparencies designed for HP Color LaserJet products.
- The moisture content of the paper is uneven, too high, or too low. Use paper from a different source or from an unopened ream of paper.
- Some areas of the paper reject toner. Use paper from a different source or from an unopened ream of paper.
- The letterhead you are using is printed on rough paper. Use a smoother, xerographic paper. If this solves your problem, consult with the printer of your letterhead to verify that the paper used meets the specifications for this product.
- Several optimize print modes can be used to address print quality issues. See [Print Quality menu on page 48](#).

Repetitive defects ruler

If defects repeat at regular intervals on the page, use this ruler to identify the cause of the defect. Place the top of the ruler at the first defect. The marking that is beside the next occurrence of the defect indicates which component needs to be replaced.

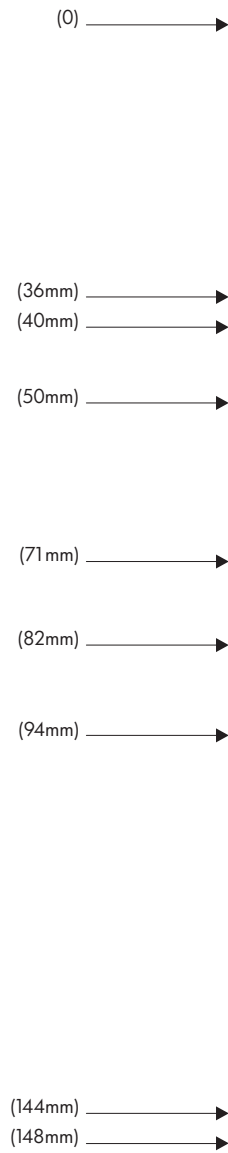

36 mm	Developer roller in an image drum. The print quality defect will be in one of the four image drums (image drum).
40 mm	Charge roller in an image drum. The print quality defect will be spots or dots sometimes caused when feeding labels and will be in one of the four image drums (image drum).
50 mm	Transfer 1 roller in the transfer unit (transfer kit).
71 mm	Transfer 2 roller in the roller kit (transfer kit).
82 mm	Tension in the transfer unit (transfer kit).
94 mm	Image drum. The print quality defect will be in one of the four image drums (image drum).
144 mm	Pressure roller in the fuser (fuser kit).
148 mm	Fusing roller in the fuser (fuser kit).

To identify if the image drum is the problem, insert an image drum from another HP Color LaserJet CM6049f, if one is available, before ordering a new image drum.

If the defect repeats at 94.0 mm (3.75 inch) intervals, try replacing the image drum before replacing the fuser.

Print quality problems associated with the environment

If the product is operating in excessively humid or dry conditions, verify that the printing environment is within specifications. See [Environmental specifications on page 281](#). Several optimization modes can also help with environmental conditions. See [Use manual print modes on page 264](#).

Print quality problems associated with jams

- Make sure that all paper is cleared from the paper path.
- If the product recently jammed, print two to three pages to clean the product.
- The paper does not pass through the fuser, causing image defects to appear on subsequent documents. Print two to three pages to clean the product.

Optimize and improve image quality

The following procedures can be used to solve most image quality problems.

Use supported paper

Using unsupported paper or other media in the product can cause a wide variety of image quality problems.

Calibrate the product

Calibration is a product function that optimizes print quality. If you experience any image-quality problems, calibrate the product.

At the control panel;

1. Touch **Administration**.
2. Scroll and touch **Print Quality**.
3. Scroll and touch **Calibration/Cleaning**.
4. Touch **Quick Calibration** or **Full Calibration**.
5. Touch **Calibrate**.

Specify the correct paper type

When you send a print job to the product, specify the type of paper you are using.

1. On the **File** menu in the software program, click **Print**.
2. Select the product, and then click **Properties** or **Preferences**.

 **NOTE:** The steps can vary; this procedure is most common.

3. Select the **Paper/Quality** tab.
4. In the **Paper Type** drop-down box, select **More...** and then select the paper type that best matches the paper that is loaded in the product.

Clean the fuser

Run the device cleaning page to keep the fuser free of toner and paper particles that can sometimes accumulate. Accumulation of toner and particles can cause specks to appear on the front or back side of your print jobs.

HP recommends that you use the cleaning page when there is a print quality issue.

A **Cleaning** message appears on the product control panel display while the cleaning is taking place.

In order for the cleaning page to work correctly, print the page on copier-grade paper (not bond, heavy, or rough paper).

Create and use the cleaning page

1. Scroll to and touch **Administration**.
2. Scroll to and touch **Print Quality**
3. Touch **Calibration/cleaning**.
4. Touch **Process cleaning page**.

Respond to control panel error messages

If you see a **54.Error <XX>** message in the event log, you might need to perform some maintenance on the product in order to avoid more errors and solve print quality problems.

1. Open and then close the right door of the product to log a **54.Error <XX>** as the latest event in the event log.
2. Scroll to and touch **Administration**.
3. Scroll to and touch **Troubleshooting**.
4. Scroll to and touch **Event Log**.
5. Touch **Print**.
6. Find the most recent event in the log.
 - If the event is a **54.OE.01 Media Sensor** event, you need to replace the registration second transfer assembly.
 - If the event is a **54.OE.02 Media Sensor** event, you need to replace the product transfer kit.
 - If the event is a **54.OE.03 Media Sensor** event, you need to clean the registration second transfer assembly and the media sensor using the following procedure.

Clean the registration second transfer assembly

1. Open the right door.

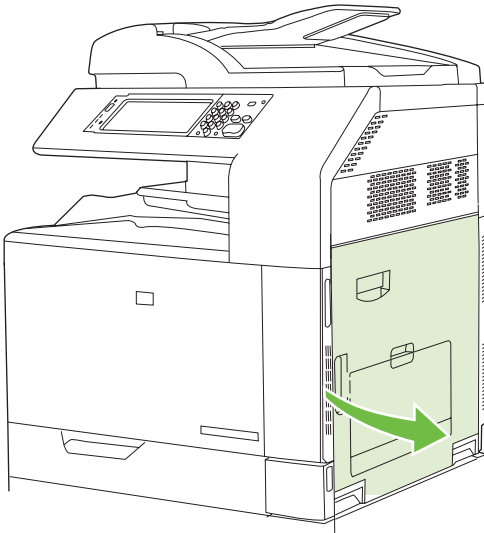

2. Locate and remove the cleaning brush.

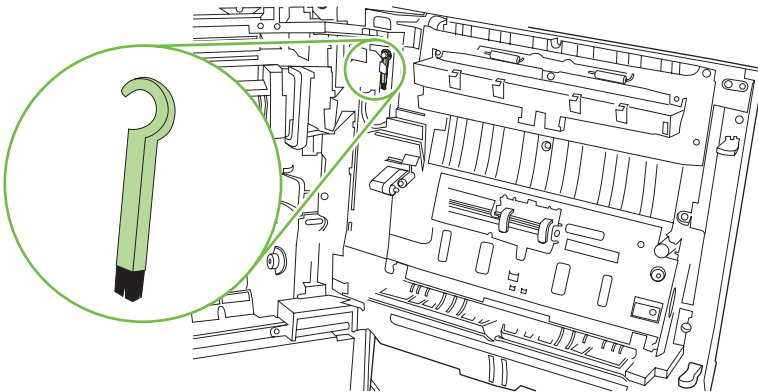

3. Lift the green handle on the transfer-access panel and open the panel.

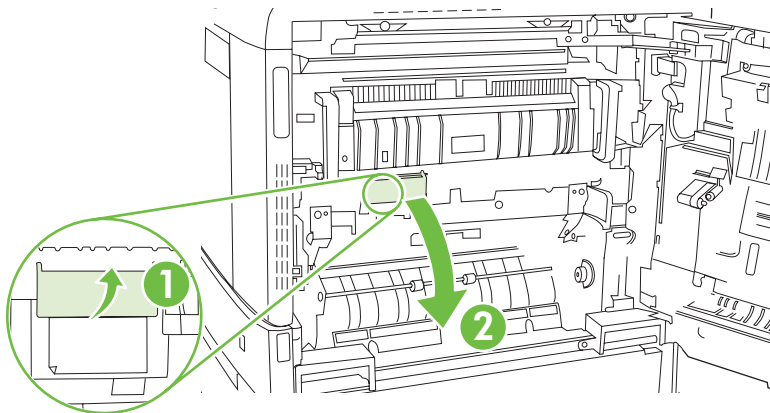

4. Clean the media sensor with the cleaning brush.

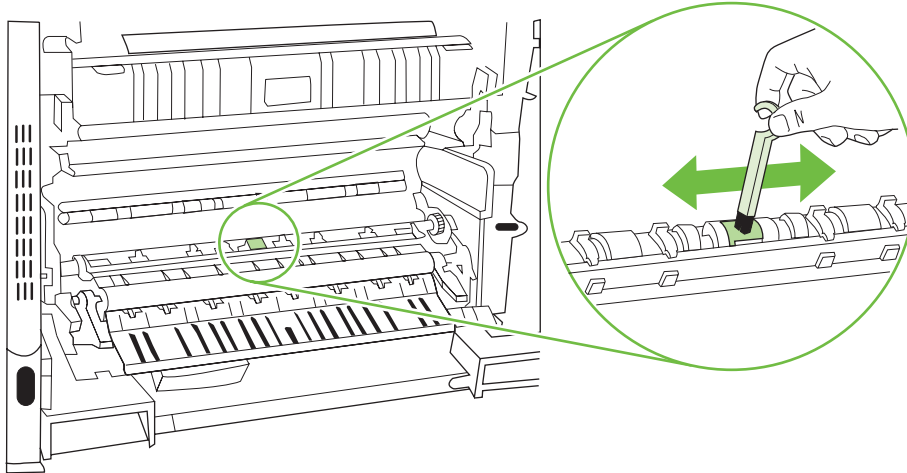

5. Close the transfer access panel, and replace the cleaning brush in its holder.

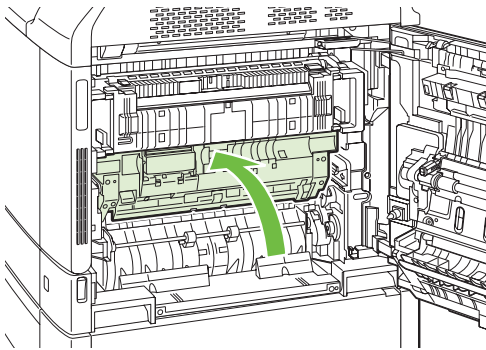

6. Close the right door.

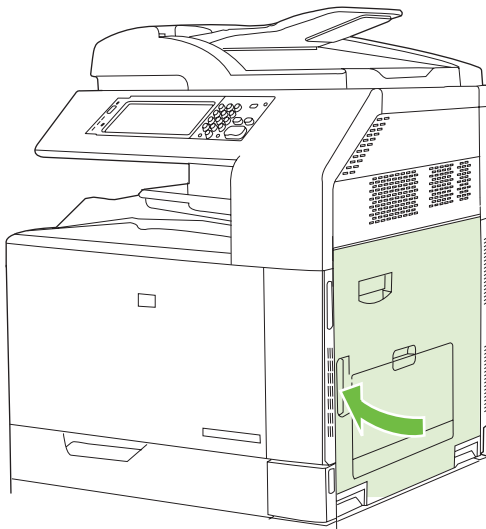

Use manual print modes

Try the following manual print modes to see if they solve the image quality problems. These options can be found in the Optimize sub-menu under the control panel Print Quality menu. See [Print Quality menu on page 48](#).

- **Fuser Temp:** If you are seeing a faint image of the page repeated at the bottom of the page or on the following page, you should first make sure the Paper Type and Print Mode settings are correct for the type of paper you are using. If you continue to see ghost images on your print jobs, set the Fuser Temp feature to one of the Alternate settings . Try the Alternate 1 setting first and see if it solves the problem. If you continue to see the problem, try Alternate 2 and then Alternate 3. With the Alternate 2 and Alternate 3 settings you may see an extra delay between jobs.
- **Light Media:** Set this feature to On if you are frequently seeing Fuser Delay Jam or Fuser Wrap Jam messages, especially when printing on light-weight paper or on jobs with heavy toner coverage.
- **Media Temp:** Set this feature to **Reduced** if you are having problems with paper sticking together in the output bin.
- **Environment:** Enable this feature if the product is operating in a low temperature environment and you are having problems with print quality such as blisters in the printed image.
- **Line Voltage:** Enable this feature if the product is operating in a low voltage environment and you are having problems with print quality such as blisters in the printed image.
- **Background:** Turn this feature on if pages are printing with a shaded background. Using this feature can reduce gloss levels.
- **Paper Curl:** Set this feature to **Reduced** if excessive curling of paper in the output bin occurs. This setting will reduce printing speed and increase the frequency of consumable replacement.
- **Pre-rotation:** Turn this feature on if horizontal streaks appear on pages. Using this feature increases the warm-up time for the device.
- **Tray 1:** If you are seeing marks on the back side of the paper or extra toner on pages when printing from Tray 1, set the mode to **Alternate**. When the mode is set to Alternate a cleaning cycle will be performed after each job that is printed from Tray 1. Using Alternate mode increase wear on all the print cartridges.
- **Tracking Control:** This setting should always be set to **On**.
- **Cleaning Frequency = Normal/Alternate:** Set this feature to **Alternate** if you are seeing defects in the printed output that repeat at 38 mm (1.5 inch) intervals. This feature increases the frequency at which the C roller is cleaned. Setting this feature to **Alternate** might also reduce printing speed and increase the frequency of consumable replacement.
- **D-Blade Bias = Normal/Alternate:** Set this feature to **Alternate** if you are seeing short, white, vertical lines in the printed output. The **Alternate** setting might also cause dark spots in the printed output, so be sure to test this setting on a few print jobs.
- **Waste Bin = Normal/Alternate:** Try setting this feature to **Alternate** if you are seeing lengthwise toner streaks in your printed output, especially in jobs with low toner coverage.
- **Discharge Brush = Off/On:** Enable this feature in low temperature and low humidity environments if you are seeing specks of toner scattered on double-sided jobs using lightweight paper and longer than ten pages.

Print-quality-troubleshooting pages

Use the built-in print-quality-troubleshooting pages to help diagnose and solve print-quality problems.

1. Scroll to and touch **Administration**
2. Scroll to and touch **Troubleshooting**.
3. Touch **PQ Troubleshooting**.
4. Touch **Print**.

The product returns to the **Ready** state after printing the print-quality-troubleshooting pages. Follow the instructions on the pages that print out.

Performance problems

Problem	Cause	Solution
Pages print but are totally blank.	The sealing tape might still be in the print cartridges.	Verify that the sealing tape has been completely removed from the print cartridges.
	The document might contain blank pages.	Check the document that you are printing to see if content appears on all of the pages.
	The product might be malfunctioning.	To check the product, print a Configuration page.
Pages print very slowly.	Heavier media types can slow the print job.	Print on a different type of media.
	Complex pages can print slowly.	Proper fusing may require a slower print speed to ensure the best print quality.
	The RLT photo fix options under HP real life technologies on the Paper/Quality tab of the print driver can cause slow printing.	De-select these options to improve print speed.
Pages did not print.	The product might not be pulling media correctly.	Make sure paper is loaded in the tray correctly. If the problem persists, the pickup rollers and the separation pad might need to be replaced.
	The media is jamming in the device.	Clear the jam. See Jams on page 222 .
	The USB cable might be defective or incorrectly connected.	<ul style="list-style-type: none">● Disconnect the USB cable at both ends and reconnect it.● Try printing a job that has printed in the past.● Try using a different USB cable.
	Other devices are running on your computer.	The product might not share a USB port. If you have an external hard drive or network switchbox that is connected to the same port as the product, the other device might be interfering. To connect and use the product, you must disconnect the other device or you must use two USB ports on the computer.

Solve fax problems

For help solving fax problems, go to www.hp.com/go/mfpfaxaccessory300.

You can also refer to the *Analog Fax Accessory 300 Fax Guide* and the *Analog Fax Accessory 300 Send Fax Driver Guide*.

Solve e-mail problems

If you are unable to send e-mails by using the digital-send feature, you might need to reconfigure the SMTP gateway address or the LDAP gateway address. Print a configuration page to find the current SMTP and LDAP gateway addresses. See [Information pages on page 176](#). Use the following procedures to check if the SMTP and LDAP gateway addresses are valid.

Validate the SMTP gateway address

 **NOTE:** This procedure is for Windows operating systems.

1. Open an MS-DOS command prompt: click **Start**, click **Run**, and then type `cmd`.
2. Type `telnet` followed by the SMTP gateway address and then the number 25, which is the port over which the product is communicating. For example, type `telnet 123.123.123.123 25` where "123.123.123.123" represents the SMTP gateway address.
3. Press **Enter**. If the SMTP gateway address is *not* valid, the response contains the message `Could not open connection to the host on port 25: Connect Failed`.
4. If the SMTP gateway address is not valid, contact the network administrator.

Validate the LDAP gateway address

 **NOTE:** This procedure is for Windows operating systems.

1. Open Windows Explorer. In the address bar, type `LDAP://` immediately followed by the LDAP gateway address. For example, type `LDAP://12.12.12.12` where "12.12.12.12" represents the LDAP gateway address.
2. Press **Enter**. If the LDAP gateway address is valid, the **Find People** dialog box opens.
3. If the LDAP gateway address is not valid, contact the network administrator.

Solve network connectivity problems

If the product is having problems communicating with the network, use the information in this section to resolve the problem.

Solve network printing problems

- Make sure that the network cable is securely seated into the product's RJ45 connector.
- Make sure that the Link LED on the formatter is lit. See [Understand lights on the formatter on page 257](#).
- Make sure that the I/O card is ready. Print a configuration page (see [Information pages on page 176](#)). If an HP Jetdirect print server is installed, printing a configuration page also prints a second page that shows the network settings and status.

 **NOTE:** The HP Jetdirect print server supports various network protocols (TCP/IP, IPX/SPX, Novell NetWare, AppleTalk, and DCL/LLC). Make sure that the correct protocols and network parameters are set correctly.

On the HP Jetdirect configuration page, verify the following items for your protocol:

- Under HP Jetdirect Configuration, the status is "I/O Card Ready."
 - Protocol status is "Ready."
 - An IP address is listed.
 - The configuration method (Config by:) is listed correctly. See the network administrator if you are not sure which method is correct.
- Try printing the job from another computer.
 - To verify that a product works with a computer, use a USB cable to connect it directly to a computer. You will have to reinstall the printing software. Print a document from a program that has printed correctly in the past. If this works, a problem with the network might exist.
 - Contact your network administrator for assistance.

Verify communication over the network

If the HP Jetdirect configuration page shows an IP address for the product, use this procedure to verify that you can communicate with the product over the network.

1. **Windows:** Click **Start**, click **Run**, and then type `cmd`. An MS-DOS command prompt opens.

-or-

Mac: Click **Applications**, click **Utilities**, and then open the Terminal application. The terminal window opens.

2. Type `ping` followed by the IP address. For example, type `ping XXX.XXX.XXX.XXX` where "XXX.XXX.XXX.XXX" is the IPv4 address that is shown on the HP Jetdirect configuration page. If the product is communicating over the network, the response is a list of replies from the product.
3. Verify that the IP address is not a duplicate address on the network by using the address resolution protocol (`arp -a`) command. At the prompt, type `arp -a`. Find the IP address in the list and compare its physical address to the hardware address that is listed on the HP Jetdirect configuration page

in the section called HP Jetdirect Configuration. If the addresses match, all network communications are valid.

4. If you cannot verify that the product is communicating over the network, contact the network administrator.

Solve common Macintosh problems

This section lists problems that can occur when using Mac OS X.

Table 15-1 Problems with Mac OS X

The printer driver is not listed in the Print Center or Printer Setup Utility.

Cause	Solution
The product software might not have been installed or was installed incorrectly.	Make sure that the product PPD is in the following hard-drive folder: <code>Library/Printers/PPDs/Contents/Resources/<lang>.lproj</code> , where <code><lang></code> is the two-letter language code for the language that you are using. If necessary, reinstall the software. See the getting started guide for instructions.
The Postscript Printer Description (PPD) file is corrupt.	Delete the PPD file from the following hard-drive folder: <code>Library/Printers/PPDs/Contents/Resources/<lang>.lproj</code> , where <code><lang></code> is the two-letter language code for the language that you are using. Reinstall the software. See the getting started guide for instructions.

The product name, IP address, or Rendezvous/Bonjour host name does not appear in the product list in the Print Center or Printer Setup Utility.

Cause	Solution
The product might not be ready.	Make sure that the cables are connected correctly, the product is on, and the ready light is on. If you are connecting through a USB or Ethernet hub, try connecting directly to the computer or use a different port.
The wrong connection type might be selected.	Make sure that USB, IP Printing, or Rendezvous/Bonjour is selected, depending on the type of connection that exists between the product and the computer.
The wrong product name, IP address, or Rendezvous/Bonjour host name is being used.	Print a configuration page in order to check the product name, IP address, or Rendezvous host name. Verify that the name, IP address, or Rendezvous host name on the configuration page matches the product name, IP address, or Rendezvous host name in the Print Center or Printer Setup Utility.
The interface cable might be defective or of poor quality.	Replace the interface cable. Make sure to use a high-quality cable.

The printer driver does not automatically set up your selected product in the Print Center or Printer Setup Utility.

Cause	Solution
The product might not be ready.	Make sure that the cables are connected correctly, the product is on, and the ready light is on. If you are connecting through a USB or Ethernet hub, try connecting directly to the computer or use a different port.
The product software might not have been installed or was installed incorrectly.	Make sure that the product PPD is in the following hard-drive folder: <code>Library/Printers/PPDs/Contents/Resources/<lang>.lproj</code> , where <code><lang></code> is the two-letter language code for the language that you are using. If necessary, reinstall the software. See the getting started guide for instructions.

Table 15-1 Problems with Mac OS X (continued)

The printer driver does not automatically set up your selected product in the Print Center or Printer Setup Utility.

Cause	Solution
The Postscript Printer Description (PPD) file is corrupt.	Delete the PPD file from the following hard-drive folder: <code>Library/Printers/PPDs/Contents/Resources/<lang>.lproj</code> , where <lang> is the two-letter language code for the language that you are using. Reinstall the software. See the getting started guide for instructions.
The interface cable might be defective or of poor quality.	Replace the interface cable. Make sure to use a high-quality cable.

A print job was not sent to the product that you wanted.

Cause	Solution
The print queue might be stopped.	Restart the print queue. Open print monitor and select Start Jobs .
The wrong product name or IP address is being used. Another product with the same or similar name, IP address, or Rendezvous host name might have received your print job.	Print a configuration page in order to check the product name, IP address, or Rendezvous host name. Verify that the name, IP address, or Rendezvous host name on the configuration page matches the product name, IP address, or Rendezvous host name in the Print Center or Printer Setup Utility.

An encapsulated PostScript (EPS) file does not print with the correct fonts.

Cause	Solution
This problem occurs with some programs.	<ul style="list-style-type: none">Try downloading the fonts that are contained in the EPS file to the product before printing.Send the file in ASCII format instead of binary encoding.

You are unable to print from a third-party USB card.

Cause	Solution
This error occurs when the software for USB products is not installed.	When adding a third-party USB card, you might need the Apple USB Adapter Card Support software. The most current version of this software is available from the Apple Web site.

Table 15-1 Problems with Mac OS X (continued)

When connected with a USB cable, the product does not appear in the Print Center or Printer Setup Utility after the driver is selected.

Cause	Solution
This problem is caused by either a software or a hardware component.	<p data-bbox="794 275 1054 300">Software troubleshooting</p> <ul data-bbox="794 327 1442 506" style="list-style-type: none"><li data-bbox="794 327 1241 352">● Check that your Macintosh supports USB.<li data-bbox="794 380 1442 432">● Verify that your Macintosh operating system is Mac OS X v10.3 or later.<li data-bbox="794 459 1442 506">● Ensure that your Macintosh has the appropriate USB software from Apple. <p data-bbox="794 533 1062 558">Hardware troubleshooting</p> <ul data-bbox="794 585 1442 968" style="list-style-type: none"><li data-bbox="794 585 1182 611">● Check that the product is turned on.<li data-bbox="794 638 1302 663">● Verify that the USB cable is connected correctly.<li data-bbox="794 690 1442 716">● Check that you are using the appropriate high-speed USB cable.<li data-bbox="794 743 1442 842">● Ensure that you do not have too many USB devices drawing power from the chain. Disconnect all of the devices from the chain, and connect the cable directly to the USB port on the host computer.<li data-bbox="794 869 1442 968">● Check to see if more than two nonpowered USB hubs are connected in a row on the chain. Disconnect all of the devices from the chain and connect the cable directly to the USB port on the host computer. <p data-bbox="842 995 1374 1020">NOTE: The iMac keyboard is a nonpowered USB hub.</p>

A Supplies and accessories

- Order parts, accessories, and supplies
- Part numbers

Order parts, accessories, and supplies

To order parts, accessories, and supplies, contact your dealer.

Part numbers

Ordering information and availability might change during the life of the product.

Accessories

Item	Description	Part number
HP 3-bin Stapler/Stacker Accessory	3-bin stapler/stacker with output accessory bridge unit	CC517A
HP 3-bin Stapler/Stacker or HP Booklet Maker/Finisher staple cartridge (upper cartridge on HP Booklet Maker/Finisher)	5000-staple replacement cartridge	C8091A
HP Booklet Maker/Finisher Accessory	Booklet maker finisher with output accessory bridge unit	CC516A
HP Booklet Maker/Finisher saddle-stitch staple cartridge (lower cartridge)	2000-staple replacement cartridge (quantity of 2)	CC383A
HP LaserJet analog fax accessory 300	Provides fax capability for the product.	Q3701A

Print cartridges

Item	Description	Part number
HP Color LaserJet black print cartridge	19,500-page black cartridge	CE830C
HP Color LaserJet cyan print cartridge	21,000-page cyan cartridge	CE301C
HP Color LaserJet yellow print cartridge	21,000-page yellow cartridge	CE302C
HP Color LaserJet magenta print cartridge	21,000-page magenta cartridge	CE303C

Image drums

Item	Description	Part number
HP Color LaserJet black image drum	35,000-page black image drum	CE304C
HP Color LaserJet cyan image drum	35,000-page cyan image drum	CE305C
HP Color LaserJet yellow image drum	35,000-page yellow image drum	CE306C
HP Color LaserJet magenta image drum	35,000-page magenta image drum	CE307C

Maintenance kits

Item	Description	Part number
Image fuser kit	110 volt	CB457A
Image fuser kit	220 volt	CB458A

Item	Description	Part number
Roller kit		CB459A
Transfer kit		CB463A
ADF roller kit		CE487A

Memory

Item	Description	Part number
200-pin DDR memory DIMM (dual inline memory module)	128 MB	Q7557A
	256 MB	Q7558A
Boosts the ability of the product to handle large or complex print jobs.		

Cables and interfaces

Item	Description	Part number
Enhanced I/O (EIO) card	HP Jetdirect 635n IPv6/IPsec Print Server	J7961G
USB cable	2-meter standard USB-compatible device connector	C6518A

B Product specifications

- [Physical specifications](#)
- [Electrical specifications](#)
- [Acoustic specifications](#)
- [Environmental specifications](#)

Physical specifications

Table B-1 Product dimensions

Product	Height	Depth	Width	Weight ¹
HP Color LaserJet CM6049f MFP	1194 mm (47 in)	635 mm (25 in)	704 mm (27.7 in)	145 kg (319 lb)

¹ Without print cartridge

Table B-2 Product dimensions, with all doors and trays fully opened

Product	Height	Depth	Width
HP Color LaserJet CM6049f MFP	1524 mm (60 in)	1079.5 mm (42.5 in)	983 mm (38.7 in)

Electrical specifications

⚠ **WARNING!** Power requirements are based on the country/region where the product is sold. Do not convert operating voltages. This can damage the product and void the product warranty.

Table B-3 Power requirements (HP Color LaserJet CM6049f MFP)

Specification	110-volt models	220-volt models
Power requirements	100 to 127 volts (± 10%)	220 to 240 volts (± 10%)
	50/60 Hz (± 2 Hz)	50/60 Hz (± 2 Hz)
Rated current	10.5 A	5.5 A

Table B-4 Power consumption HP Color LaserJet CM6049f MFP (average, in watts)

Product model	Printing	Ready	Sleep	Off
HP Color LaserJet CM6049f MFP	1265 W	251.7 W	26.5 W	0.72 W

Values subject to change. See www.hp.com/support/cljcm6049mfp for current information.

Printing and copying speeds are 40 ppm for Letter and A4 sizes.

Default time from Ready mode to Sleep mode = 60 minutes.

Recovery time from Sleep mode = less than 20 seconds

Acoustic specifications

Table B-5 Sound power and pressure level¹ (HP Color LaserJet CM6049f MFP)

Sound power level	Declared per ISO 9296
Printing ¹	$L_{wAd} = 7.1$ Bels (A) [71 dB(A)]
Copying ²	$L_{wAd} = 7.1$ Bels (A) [71 dB(A)]
Ready	$L_{wAd} = 4.7$ Bels (A) [47 dB(A)]
Sound pressure level	Declared per ISO 9296
Printing ¹	$L_{pAm} = 50$ dB (A)
Copying ²	$L_{pAm} = 52$ dB (A)
Ready	$L_{pAm} = 37$ dB (A)

¹ Values subject to change. See www.hp.com/support/cljcm6049mfp for current information.

² Configuration tested: Base model, simplex copying from ADF with A4 paper size.

Environmental specifications

Environmental condition	Recommended	Allowed	Storage/standby
Temperature (product and print cartridge)	17° to 25°C (62.6° to 77°F)	10° to 30°C (50° to 86°F)	0° to 35°C (32° to 95°F)
Relative humidity	30% to 70% relative humidity (RH)	10% to 80% RH	5% to 95%

C Regulatory information

Compliance with FCC regulations

This equipment has been tested and found to comply with the limits for a Class A digital device, pursuant to part 15 of the FCC Rules. These limits are designed to provide reasonable protection against harmful interference when the equipment is operated in a commercial environment. This equipment generates, uses, and can radiate radio frequency energy and, if not installed and used in accordance with the instruction manual, may cause harmful interference to radio communications. Operation of this equipment in a residential area is likely to cause harmful interference in which case the user will be required to correct the interference at his own expense.

Declaration of Conformity

Declaration of Conformity

according to ISO/IEC 17050-1 and EN 17050-1

Manufacturer's Name: Hewlett-Packard Company
DoC#: BOISB-0601-02-rel.6.0
Manufacturer's Address: 11311 Chinden Boulevard,
Boise, Idaho 83714-1021, USA

declares that the product

Product Name: HP Color LaserJet CM6030/CM6040/CM4349 MFP series

Accessories:³⁾ CB473A – 1x500-sheet input tray/stand
CB474A – 3x500-sheet input tray/stand
Q6999A/CC516A – Booklet Maker
Q6998A/CC517A – 3-Bin Stapler/Stacker
BOISB-0308-00 – Fax Module

Regulatory Model Number:²⁾ BOISB-0601-02

Product Options: ALL

Toner Cartridges/Drums: CB390A, CB381A, CB382A, CB383A, CB384A, CB385A, CB386A, CB387A, CE830C, CE301C, CE302C, CE303C, CE304C, CE305C, CE306C, CE307C

conforms to the following Product Specifications:

Safety: IEC 60950-1:2001 / EN60950-1: 2001 + A11
IEC 60825-1:1993 +A1 +A2 / EN 60825-1:1994 +A1 +A2 (Class 1 Laser/LED Product)
GB4943-2001

EMC: CISPR 22:2005 / EN 55022:2006 – Class A¹⁾
EN 61000-3-2:2006
EN 61000-3-3:1995 + A1
EN 55024:1998+A1 + A2
FCC Title 47 CFR, Part 15 Class A / ICES-003, Issue 4
GB9254-1998, GB17625.1-2003

Telecom TBR-21:1998; FCC Title 47 CFR, Part 68⁴⁾

Supplementary Information:

The product herewith complies with the requirements of the EMC Directive 2004/108/EC and the Low Voltage Directive 2006/95/EC, and the R&TTE Directive 1999/5/EC (Annex II), and carries the CE-Marking  accordingly.

This device complies with Part 15 of the FCC Rules. Operation is subject to the following two Conditions: (1) this device may not cause harmful interference, and (2) this device must accept any interference received, including interference that may cause undesired operation.

1) The product was tested in a typical configuration with Hewlett-Packard Personal Computer Systems.

2) For regulatory purposes, this product is assigned a Regulatory model number. This number should not be confused with the product name or the product number(s).

3) All worldwide modular approvals for analog fax accessory obtained by Hewlett-Packard under the regulatory model number BOISB-0308-00 incorporate the Multi-Tech Systems MT5634SMI Socket Modem Module.

4) Telecom approvals and standards appropriate for the target countries/regions have been applied to this product, in addition to those listed above.

Boise, Idaho , USA

March 2009

For regulatory topics only:

European Contact: Your Local Hewlett-Packard Sales and Service Office or Hewlett-Packard GmbH, Department HQ-TRE / Standards Europe, Herrenberger Straße 140, D-71034 Böblingen, Germany, (FAX: +49-7031-14-3143) www.hp.com/go/certificates

USA Contact: Product Regulations Manager, Hewlett-Packard Company, PO Box 15, Mail Stop 160, Boise, Idaho 83707-0015, USA, (Phone: 208-396-6000)

Environmental product stewardship program

Protecting the environment

Hewlett-Packard Company is committed to providing quality products in an environmentally sound manner. This product has been designed with several attributes to minimize impacts on our environment.

Ozone production

This product generates no appreciable ozone gas (O₃).

Power consumption

Power usage drops significantly while in Ready and Sleep mode, which saves natural resources and saves money without affecting the high performance of this product. To determine the ENERGY STAR® qualification status for this product, see the Product Data Sheet or Specifications Sheet. Qualified products are also listed at:

www.hp.com/go/energystar

Toner consumption

EconoMode uses less toner, which might extend the life of the print cartridge.

Paper use

This product's optional automatic duplex feature (two-sided printing) and N-up printing (multiple pages printed on one page) capability can reduce paper usage and the resulting demands on natural resources.

Plastics

Plastic parts over 25 grams are marked according to international standards that enhance the ability to identify plastics for recycling purposes at the end of the product's life.

HP LaserJet print supplies

It's easy to return and recycle your empty HP LaserJet print cartridges—free of charge—with HP Planet Partners. Multilingual program information and instructions are included in every new HP LaserJet print cartridge and supplies package. You help reduce the toll on the environment further when you return multiple cartridges together rather than separately.

HP is committed to providing inventive, high-quality products and services that are environmentally sound, from product design and manufacturing to distribution, customer use, and recycling. When you participate in the HP Planet Partners program, we ensure your HP LaserJet print cartridges are recycled properly, processing them to recover plastics and metals for new products and diverting millions of tons of waste from landfills. Please note that the cartridge will not be returned to you. Thank you for being environmentally responsible!

 **NOTE:** Use the return label to return original HP LaserJet print cartridges only. Please do not use this label for HP inkjet cartridges, non-HP cartridges, refilled or remanufactured cartridges, or warranty returns. For information about recycling your HP inkjet cartridges, please go to www.hp.com/recycle.

Return and recycling instructions

United States and Puerto Rico

The enclosed label in the HP LaserJet toner cartridge box is for the return and recycling of one or more HP LaserJet print cartridges after use. Please follow the applicable instructions below.

Multiple returns (more than one cartridge)

1. Package each HP LaserJet print cartridge in its original box and bag.
2. Tape the boxes together using strapping or packaging tape. The package can weigh up to 31 kg (70 lb).
3. Use a single pre-paid shipping label.

OR

1. Use your own suitable box, or request a free bulk collection box from www.hp.com/recycle or 1-800-340-2445 (holds up to 31 kg (70 lb) of HP LaserJet print cartridges).
2. Use a single pre-paid shipping label.

Single returns

1. Package the HP LaserJet print cartridge in its original bag and box.
2. Place the shipping label on the front of the box.

Shipping

For all HP LaserJet print cartridge recycling returns, give the package to UPS during your next delivery or pickup, or take it to an authorized UPS drop-off center. For the location of your local UPS drop-off center, call 1-800-PICKUPS or visit www.ups.com. If you are returning via USPS label, give the package to a U.S. Postal Service carrier or drop off at a U.S. Postal Service Office. For more information, or to order additional labels or boxes for bulk returns, visit www.hp.com/recycle or call 1-800-340-2445. Requested UPS pickup will be charged normal pickup rates. Information subject to change without notice.

Non-U.S. returns

To participate in HP Planet Partners return and recycling program, just follow the simple directions in the recycling guide (found inside the packaging of your new product supply item) or visit www.hp.com/recycle. Select your country/region for information on how to return your HP LaserJet printing supplies.

Paper

This product is capable of using recycled papers when the paper meets the guidelines outlined in the *HP LaserJet Printer Family Print Media Guide*. This product is suitable for the use of recycled paper according to EN12281:2002.

Material restrictions

This HP product contains a battery that may require special handling at end-of-life.

The battery contained in this product includes:

Type	Carbon monofluoride lithium battery
Weight	0.8 grams
Location	Formatter board
User removable	No



廢電池請回收

This product contains mercury in the fluorescent lamp of the control panel liquid crystal display that might require special handling at end-of-life.

For recycling information you can visit www.hp.com/go/recycle or contact your local authorities or the Electronics Industry Alliance (www.eiae.org).

Disposal of waste equipment by users in private households in the European Union

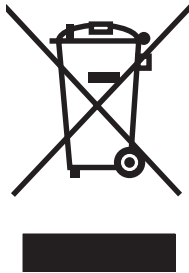

This symbol on the product or on its packaging indicates that this product must not be disposed of with your other household waste. Instead, it is your responsibility to dispose of your waste equipment by handing it over to a designated collection point for the recycling of waste electrical and electronic equipment. The separate collection and recycling of your waste equipment at the time of disposal will help to conserve natural resources and ensure that it is recycled in a manner that protects human health and the environment. For more information about where you can drop off your waste equipment for recycling, please contact your local city office, your household waste disposal service or the shop where you purchased the product.

Material Safety Data Sheet (MSDS)

Material Safety Data Sheets (MSDS) for supplies containing chemical substances (for example, toner) can be obtained by accessing the HP Web site at www.hp.com/go/msds or www.hp.com/hpinfo/community/environment/productinfo/safety.

For more information

To obtain information about these environmental topics:

- Product environmental profile sheet for this and many related HP products
- HP's commitment to the environment
- HP's environmental management system
- HP's end-of-life product return and recycling program
- Material Safety Data Sheets

Visit www.hp.com/go/environment or www.hp.com/hpinfo/globalcitizenship/environment.

Certificate of volatility

This is a statement regarding the volatility of customer data stored in memory. It also outlines how to erase secure data from the device.

Types of memory

Volatile memory

The MFP utilizes volatile memory (64MB on the board and 256MB installed, for a total of 320MB) to store customer data during the printing and copying process. When the MFP is powered off, this volatile memory is erased.

Non-volatile memory

The MFP utilizes non-volatile memory (EEPROM) to store system control data and user preference settings. No customer print or copy data is stored in non-volatile memory. This non-volatile memory can be cleared and restored to factory defaults by performing a Cold Reset or Restore Factory Defaults from the control panel.

Hard-disk-drive memory

The MFP contains an internal hard disk drive (40GB or larger) that may retain data after the MFP is powered off. The MFP also may contain additional optional compact flash storage, or an external EIO hard disk. Data stored in these devices may be from incoming/outgoing fax or email files, stored copy or print jobs, fax or email address books, or third-party solutions. Some of this data can be erased from the control panel of the MFP, but most must be erased using the Secure Storage Erase features available within HP Web Jetadmin. Secure Storage Erase features comply with U.S. Department of Defense (DOD) specification 5220-22.M.

Safety statements

Laser safety

The Center for Devices and Radiological Health (CDRH) of the U.S. Food and Drug Administration has implemented regulations for laser products manufactured since August 1, 1976. Compliance is mandatory for products marketed in the United States. The device is certified as a “Class 1” laser product under the U.S. Department of Health and Human Services (DHHS) Radiation Performance Standard according to the Radiation Control for Health and Safety Act of 1968. Since radiation emitted inside the device is completely confined within protective housings and external covers, the laser beam cannot escape during any phase of normal user operation.

△ **WARNING!** Using controls, making adjustments, or performing procedures other than those specified in this user guide may result in exposure to hazardous radiation.

Canadian DOC regulations

Complies with Canadian EMC Class A requirements.

« Conforme à la classe A des normes canadiennes de compatibilité électromagnétiques. « CEM ». »

VCCI statement (Japan)

この装置は、情報処理装置等電波障害自主規制協議会（VCCI）の基準に基づくクラスA情報技術装置です。この装置を家庭環境で使用すると電波妨害を引き起こすことがあります。この場合には使用者が適切な対策を講ずるよう要求されることがあります。

Power cord statement (Japan)

製品には、同梱された電源コードをお使い下さい。
同梱された電源コードは、他の製品では使用出来ません。

EMC statement (Korea)

A급 기기 (업무용 방송통신기기)	이 기기는 업무용(A급)으로 전자파적합등록을 한 기기이오니 판매자 또는 사용자는 이점을 주의하시기 바라며, 가정 외의 지역에서 사용하는 것을 목적으로 합니다.
-----------------------	--

EMI statement (Taiwan)

警告使用者：
這是甲類的資訊產品，在居住的環境中使用時，可能會造成射頻干擾，在這種情況下，使用者會被要求採取某些適當的對策。

General telecom statement

The HP Color LaserJet CM6049f MFP has the HP LaserJet Analog Fax Accessory 300 already installed to provide communication to the public switch telephone network (PSTN) for fax functionality. See the *HP LaserJet Analog Fax Accessory 300 User Guide* for all regulatory approval information and regulatory notices associated with the fax functionality and that device.

Laser statement for Finland

Luokan 1 laserlaite

Klass 1 Laser Apparat

HP LaserJet CM6049f, laserkirjoitin on käyttäjän kannalta turvallinen luokan 1 laserlaite. Normaalisissa käytössä kirjoittimen suojakoteloitinta estää lasersäteiden pääsyn laitteen ulkopuolelle. Laitteen turvallisuusluokka on määritetty standardin EN 60825-1 (1994) mukaisesti.

VAROITUS !

Laitteen käyttäminen muulla kuin käyttöohjeessa mainitulla tavalla saattaa altistaa käyttäjän turvallisuusluokan 1 ylittävälle näkymättömälle lasersäteilylle.

WARNING !

Om apparaten används på annat sätt än i bruksanvisning specificerats, kan användaren utsättas för osynlig laserstrålning, som överskrider gränsen för laserklass 1.

HUOLTO

HP LaserJet CM6049f - kirjoittimen sisällä ei ole käyttäjän huollettavissa olevia kohteita. Laitteen saa avata ja huoltaa ainoastaan sen huoltamiseen koulutettu henkilö. Tällaiseksi huoltotoimenpiteeksi ei katsota väriainekasetin vaihtamista, paperiradan puhdistusta tai muita käyttäjän käsikirjassa lueteltuja, käyttäjän tehtäväksi tarkoitettuja ylläpitotoimia, jotka voidaan suorittaa ilman erikoistyökaluja.

VARO !

Mikäli kirjoittimen suojakotelo avataan, olet alttiina näkymättömälle lasersäteilylle laitteen ollessa toiminnassa. Älä katso säteeseen.

WARNING !

Om laserprinterns skyddshölje öppnas då apparaten är i funktion, utsättas användaren för osynlig laserstrålning. Betrakta ej strålen. Tiedot laitteessa käytettävän laserdiodin säteilyominaisuuksista: Aallonpituus 775-795 nm Teho 5 m W Luokan 3B laser.

Substances Table (China)

有毒有害物质表

根据中国电子信息产品污染控制管理办法的要求而出台

部件名称	有毒有害物质和元素					
	铅 (Pb)	汞 (Hg)	镉 (Cd)	六价铬 (Cr(VI))	多溴联苯 (PBB)	多溴二苯醚 (PBDE)
打印引擎	X	0	X	X	0	0
复印机组件	X	0	0	0	0	0
控制面板	0	X	0	0	0	0
塑料外壳	0	0	0	0	0	0
格式化板组件	X	0	0	0	0	0
碳粉盒	X	0	0	0	0	0

3046

0：表示在此部件所用的所有同类材料中，所含的此有毒或有害物质均低于 SJ/T11363-2006 的限制要求。

X：表示在此部件所用的所有同类材料中，至少一种所含的此有毒或有害物质高于 SJ/T11363-2006 的限制要求。

注：引用的“环保使用期限”是根据在正常温度和湿度条件下操作使用产品而确定的。

Index

Symbols/Numerics

- 3-bin mailbox
 - capacity 4
 - selecting 114
 - specifications, physical 277
- 3-bin stapler/stacker
 - features 114
- 500-sheet trays
 - models including 2
 - specifications, physical 277

A

- accessories
 - 3-bin stapler/stacker 114
 - booklet-maker finisher 114
 - optional output 114
 - ordering 274
 - part numbers 275
- acoustic specifications 280
- activity log, fax 177
- address books, e-mail
 - adding addresses 167
 - auto-complete function 166
 - clearing 58
 - deleting addresses 167
 - importing 181
 - LDAP support 162
 - recipient lists 166
 - recipient lists, creating 166
- address, printer
 - Macintosh,
 - troubleshooting 270
- ADF
 - capacity 4
 - clean delivery system 206
 - maintenance kit 210
 - make copies from 152
 - sizes supported 165

- ADF output bin
 - capacity 4
 - selecting 114
- Administration menu, control panel 15
- advanced printing options
 - Windows 142
- alerts, e-mail 74
- alternative letterhead mode 142
- anticounterfeit supplies 187
- AppleTalk settings 31
- Attention light
 - locating 12
- automatic media sensing 111
- automatic two-sided printing path
 - copying documents 154

B

- billing codes report, fax 177
- bins
 - capacities 4
 - locating 6
 - selecting 114
- blank pages, troubleshooting 266
- blocked fax list, printing 177
- Bonjour Settings 74
- booklet maker
 - configuring 118
 - features 114
 - use 116
 - walkaround 116
- books
 - copying 158
- BOOTP 89
- both sides, copying 154
- both sides, printing on
 - Macintosh settings 74
- browser requirements
 - embedded Web server 178

- buttons, control panel
 - locating 12
 - touchscreen 14

C

- cabinet/stand
 - specifications, physical 277
- cable, USB
 - part number 276
- cables
 - USB, troubleshooting 266
- calibrate scanner 211
- calibrating scanner 52
- call report, fax 177
- Canadian DOC regulations 291
- cancel
 - copy jobs 160
 - print 138
- cancel a print request 138
- capacity
 - 3-bin mailbox 4
 - ADF 4
 - output bins 4
 - stapler/stacker 4
- cartridges
 - management menu 27
 - non-HP 187
 - recycling 286
 - replace 188
 - storage 187
- cartridges, print
 - Macintosh status 78
 - part numbers 275
- clean
 - about 206, 208
 - ADF delivery system 206
 - ADF rollers 208
 - fuser 261
 - glass 206

- outside of product 206
 - touchscreen 206
- clean page, printing 261
- clock
 - set 185
- collating copies 157
- color
 - adjusting 144
 - advanced use 149
 - CMYK ink set emulation 149
 - edge control 144
 - four-color printing 149
 - halftone options 144
 - HP ImageREt 4800 149
 - manage 143
 - match 147
 - neutral grays 145
 - Pantone® matching 148
 - print color samples 147
 - print in grayscale 145
 - printed vs. monitor 147
 - restrict use 145
 - sample book matching 147
 - sRGB 149
 - using 143
- color options 141
- Color tab settings 78
- colored text
 - print as black 142
- configuration page
 - Information menu 16
 - Macintosh 74
 - printing 176
- configurations, models 2
- configure
 - trays 111
- connect product 82
- connectivity
 - network utilities 92
 - USB 82
- connectivity features 4
- control panel
 - Administration menu 15
 - buttons 12
 - clean touchscreen 206
 - copy-screen 152
 - e-mail screen 164
 - E-mail Setup menu 39
 - Fax Setup menu 36
 - help 14
- Home screen 13
- Information menu 16
- Initial Setup menu 29
- layout 12
- lights 12
- locating 6
- locking menus 184
- Management menu 27
- messages, types of 220
- Resets menu 58
- Send Setup menu 39
- Service menu 59
- settings 66, 72
- Time/Scheduling menu 25
- touchscreen buttons 14
- controlling print jobs 112
- copies, number of
 - Windows 142
- copy
 - cancel 160
 - control-panel navigation 152
 - copy screen 152
 - from document feeder 152
 - from glass 152
 - Job Mode 159
 - multiple originals 159
 - photos and books 158
 - set options 152
 - settings 153
 - two-sided documents 154
- copying
 - books 158
 - collating 157
 - features 5
 - quality, troubleshooting 258
 - speed specifications 3
- counterfeit supplies 187
- cover pages 75, 139
- covers, locating 6
- custom-size paper settings
 - Macintosh 75
- D**
- Data light
 - locating 12
- date, set 185
- date, setting 25
- Declaration of Conformity 285
- default job options menu 18
- default settings
 - Resets menu 58
- defects, repeating 258
- delay, sleep 122
- density
 - settings 74
- Device Behavior menu 40
- device discovery 87
- device status
 - Macintosh Services tab 78
- DHCP 89
- diagnostics
 - networks 32
- digital faxing 174
- digital sending
 - about 162, 165
 - address books 166, 167
 - configure e-mail 162
 - control-panel settings 164
 - embedded Web server
 - settings 181
 - folders 169
 - job settings 168
 - LDAP support 162
 - loading documents 165
 - recipient lists 166
 - sending documents 165
 - Setup menu 39
 - SMTP support 162
 - validating gateway
 - addresses 267
 - workflow 170
- Digital Sending tab, embedded
 - Web server 181
- DIMMs (dual inline memory modules)
 - installing 195
 - part numbers 276
- Disk Erase feature 183
- DLC/LLC settings 31
- document feeder
 - copying two-sided
 - documents 154
- document feeder kit,
 - replacing 210
- double-sided copying 154
- double-sided printing
 - Macintosh settings 74
- dpi, settings 74

- drivers
 - Macintosh settings 75
 - Macintosh,
 - troubleshooting 270
 - presets (Macintosh) 75
 - settings 66, 67, 72, 73
 - shortcuts (Windows) 139
 - supported 63
 - universal 64
 - Windows, opening 139
- duplex
 - copying documents 154
- duplex printing
 - Windows 140
- duplex printing accessory
 - locating 6
 - specifications, physical 277
- duplexer
 - Macintosh settings 74
- duty cycle 3
- E**
- e-mail alerts 74
- economy settings
 - sleep and wake 122
- EIO cards
 - installing 199
 - part number 276
- electrical specifications 279
- embedded Web server
 - assigning a password 183
 - Digital Sending tab 181
 - features 178
- energy specifications 279
- Enhanced I/O card
 - part number 276
- envelope feeder
 - specifications, physical 277
- envelopes
 - jams 255
 - loading in tray 1 101
- environment, specifications 281
- Environmental Product
 - Stewardship Program 286
- EPS files, troubleshooting 271
- erasing hard disk 183
- Error button, control panel
 - touchscreen 14
- error messages
 - control panel 221
- e-mail alerts 74
 - types of 220
- Ethernet cards 4
- European Union, waste
 - disposal 288
- EWS
 - features 178
- Explorer, versions supported
 - embedded Web server 178
- e-mail
 - about 162, 165
 - address books 166, 167
 - auto-complete function 166
 - configure 162
 - control-panel settings 164
 - embedded Web server
 - settings 181
 - job settings 168
 - LDAP support 162
 - loading documents 165
 - problem solving 267
 - recipient lists 166
 - scan 162
 - sending documents 165
 - SMTP support 162
 - validating gateway
 - addresses 267
- E-mail Setup menu 39
- F**
- fax accessory
 - analog fax 172
 - configure features 172
 - connecting phone line 172
 - digital fax 174
 - printing schedule 26
 - solve problems 267
- Fax Activity Log
 - clearing 58
- fax reports, printing 16, 177
- Fax Setup menu 36
- faxing
 - analog 172
- faxing, digital 174
- features 2, 3
- file directory, printing 177
- File Upload, Macintosh 74
- Finnish laser safety
 - statement 292
- Firmware Update, Macintosh 74
- firmware, upgrading 212
- first page
 - use different paper 75
- folders
 - sending to 169
- fonts
 - EPS files, troubleshooting 271
 - included 3
 - list, printing 17, 177
 - Upload Macintosh 74
- formatter cover, locating 6
- formatter lights 257
- fraud hotline 187
- FTP, sending to 170
- fuser
 - clean 261
- G**
- gateways
 - configure 162
 - configuring 163
 - testing 163
 - validating addresses 267
- glass
 - clean 206
 - sizes supported 165
- graphical display, control
 - panel 12
- grayscale printing 145
- H**
- hard disk
 - erasing 183
- heartbeat LED 257
- held jobs 127
- Help button, control panel
 - touchscreen 14
- help, control panel 14
- Home button, control panel
 - touchscreen 14
- Home screen, control panel 13
- HP fraud hotline 187
- HP Jetdirect print server
 - firmware updates 215
 - installing 199
 - lights 257
 - models including 2
 - settings 29
- HP Jetdirect print servers
 - installing 199

HP Printer Utility 73
HP Printer Utility, Macintosh 73
HP Universal Print Driver 64
HP Web Jetadmin
 firmware updates 214
HP-UX software 69
humidity requirements 281

I

I/O configuration
 network configuration 88
 settings 29
image drums
 part numbers 275
 replace 192
image fuser kit, 110 volt
 part number 275
image fuser kit, 220 volt
 part number 275
Information menu 16
information pages 176
Information tab, embedded Web
 server 179
Initial Setup menu 29
installers, Windows 92
installing
 EIO cards 199
interface ports
 included 4
 locating 8
Internet Explorer, versions
 supported
 embedded Web server 178
Internet fax 174
Internet protocol (IP) 88
IP address
 BOOTP 89
 changing 90
 input 90
 Macintosh,
 troubleshooting 270
 overview 88
IP addressing 87
IPX/SPX setting 31

J

jam-access lever, locating 6
jams
 clearing 223
 common causes of 222

envelopes 255
 recovery 251
Japanese VCCI statement 291
Jetadmin
 firmware updates 214
Jetadmin, HP Web 68, 182
Jetdirect print server
 firmware updates 215
 installing 199
 lights 257
 models including 2
 settings 29
Job Mode, copying 159
job storage
 accessing 127
 features 127
 Macintosh settings 78
 personal 129
 proof and hold 127
 QuickCopy 130
 settings 27
jobs
 Macintosh settings 74

K

keys, control panel
 locating 12
 touchscreen 14
Korean EMC statement 291

L

LAN fax 174
LAN-connector 4
landscape orientation
 setting, Windows 140
languages, printer 3
laser safety statements 291, 292
LDAP servers
 connect to 162
 embedded Web server
 settings 181
 validating gateway
 addresses 267
letterhead
 load 106
letterhead paper, loading 142
lights
 control panel 12
 formatter 257
link speed settings 35

Linux software 69
load media
 configuring 101
loading
 documents, sizes
 supported 165
 scanner glass 165
 sizes supported 165
 tray 1 101
 trays 2, 3, 4 102
Lock Resources, Macintosh 74
locking
 control panel menus 184

M

Macintosh
 AppleTalk settings 31
 driver settings 73, 75
 drivers, troubleshooting 270
 HP Printer Utility 73
 problems,
 troubleshooting 270
 removing software 72
 resize documents 75
 software 73
 software components 92
 staple options 77
 supported operating
 systems 72
 USB card,
 troubleshooting 271
Macintosh driver settings
 custom-size paper 75
 Job Storage 78
 Services tab 78
 watermarks 76
mailbox, 3-bin
 capacity 4
 selecting 114
 specifications, physical 277
maintenance kit 275
manage
 EWS 178
 information pages 176
 supplies 187
Management menu 27
Material Safety Data Sheet
 (MSDS) 288
Media 93

- media
 - custom-size, Macintosh settings 75
 - first page 75
 - loading tray 2 105
 - loading tray 2, 3, and 4 104
 - loading tray 2, 3, or 4 102
 - pages per sheet 76
 - stapler support 124
 - supported sizes 95
- memory
 - enabling 198
 - features 3
 - included 2, 73
 - part numbers 276
- Menu button 12
- menu map
 - Information menu 16
 - printing 176
- menus, control panel
 - Administration 15
 - E-mail Setup 39
 - Fax Setup 36
 - Information 16
 - Initial Setup 29
 - locking 184
 - Management 27
 - Resets 58
 - Send Setup 39
 - Service 59
 - Time/Scheduling 25
- messages
 - e-mail alerts 74
 - types of 220
- models 2
- monthly duty cycle 3
- multiple pages per sheet
 - Windows 140

N

- n-up printing
 - Windows 140
- Netscape Navigator, versions supported
 - embedded Web server 178
- network
 - connection 83
- Network Folder, scan to 169
- Networking tab, embedded Web server 181

- networks
 - AppleTalk settings 31
 - configuring 88
 - configuring gateway
 - addresses 163
 - connectivity features 4
 - default gateway 91
 - device discovery 87
 - DHCP 89
 - diagnostics 32
 - DLC/LLC settings 31
 - gateways 89
 - HP Web Jetadmin 182
 - installing EIO cards 199
 - Internet Protocol (IP) 88
 - IP address 87, 88, 90
 - IPX/SPX settings 31
 - link speed settings 35
 - Macintosh settings 74
 - print servers included 2
 - protocol configuration page, printing 35
 - protocols supported 87
 - security 32
 - SMTP servers 162
 - subnet mask 90
 - subnets 89
 - TCP/IP 88
 - TCP/IP parameters 90
 - TCP/IP settings 29
 - testing SMTP settings 163
 - Transmission Control Protocol (TCP) 88
 - validating gateway
 - addresses 267
- noise specifications 280
- non-HP supplies 187

O

- on/off switch, locating 6
- online help, control panel 14
- operating environment
 - specifications 281
- operating systems supported 62, 72
- optional output accessories 114
- ordering
 - part numbers for 275
 - supplies and accessories 274

- orientation
 - setting, Windows 140
- outdoor signs
 - printing 135
- output bins
 - accessories 114
 - capacities 4
 - locating 6
 - selecting 114
 - selecting, Windows 140
 - standard 114
- output quality
 - troubleshooting 258

P

- page order, changing 142
- pages
 - blank 266
 - not printing 266
 - printing slowly 266
- pages per minute 3
- pages per sheet
 - Windows 140
- paper
 - covers, using different paper 139
 - custom size, selecting 139
 - custom-size, Macintosh settings 75
 - first and last pages, using different paper 139
 - first page 75
 - load 101
 - pages per sheet 76
 - selecting 113
 - source 112
 - stapler support 124
 - supported sizes 95
 - type 98, 113
 - type and size 113
 - type, selecting 139
- paper jams
 - ADF 246
- parallel port
 - locating 8
- part numbers
 - accessories 275
 - image drums 275
 - memory 276
 - print cartridges 275

- parts
 - order 275
 - pausing a print request 138
 - PCL drivers
 - universal 64
 - personal jobs 129
 - phone line, connecting fax
 - accessory 172
 - photos
 - copying 158
 - improving print quality 139
 - loading 165
 - printing 133
 - removing red eye 139
 - physical specifications 277
 - PINs, personal jobs 129
 - portrait orientation
 - setting, Windows 140
 - ports
 - included 4
 - locating 8
 - troubleshooting
 - Macintosh 271
 - PostScript Printer Description (PPD) files
 - included 73
 - power
 - specifications 279
 - troubleshooting 218
 - power switch, locating 6
 - PPDs
 - included 73
 - pre-printed paper
 - load 106
 - pre-punched paper
 - load 106
 - presets (Macintosh) 75
 - print cartridge
 - managing 187
 - print cartridges
 - Macintosh status 78
 - management menu 27
 - non-HP 187
 - part numbers 275
 - recycling 286
 - replacing 189
 - storage 187
 - print drivers
 - Windows 139
 - print features
 - paper quality options 139
 - print media
 - loading in tray 1 101
 - supported sizes 95
 - print on both sides
 - Windows 140
 - print paper
 - for color printing 149
 - types 98
 - print quality
 - menu 48
 - troubleshooting 258
 - print server card
 - installing 199
 - print tasks 137
 - printer languages 3
 - printing
 - outdoor signs 135
 - output bin, selecting 114
 - speed specifications 3
 - troubleshooting 266
 - weatherproof maps 135
 - printing from tray 2, 3, or 4 102
 - priority, settings 66, 72
 - private jobs
 - cancel 138
 - Windows 140
 - problem-solving
 - e-mail alerts 74
 - Error button, control panel
 - touchscreen 14
 - e-mail 267
 - jams 222
 - messages, types of 220
 - networks 32
 - paper handling 252
 - processor speed 3
 - product info 1
 - proof and hold
 - Windows 140
 - proof and hold jobs 127
 - protocol configuration page,
 - printing 35
 - protocols, network 87
 - PS Emulation drivers 63
- Q**
- quality
 - troubleshooting 258
 - Quick Sets 139
- R**
- Ready light
 - locating 12
 - real-time clock 185
 - recipient lists 166
 - recycling
 - HP printing supplies returns and environmental program 287
 - red eye, removing 139
 - regulatory statements
 - Declaration of Conformity 285
 - environmental product
 - stewardship program 286
 - remote firmware update
 - (RFU) 212
 - removing Macintosh software 72
 - repeating defects,
 - troubleshooting 258
 - replace
 - image drums 192
 - memory 195
 - supplies 188
 - reset button 12
 - Resets menu, control panel 58
 - resize documents
 - Macintosh 75
 - Windows 140
 - resolution
 - settings 74
 - specifications 3
 - troubleshooting quality 258
 - Resolution Enhancement
 - technology (REt) 74
 - resolution, adjusting 139
 - restore factory settings 219
 - REt (Resolution Enhancement
 - technology) 74
 - retention, job
 - accessing 127
 - features 127
 - personal 129
 - proof and hold 127
 - QuickCopy 130
 - rollers
 - clean ADF 208
 - ruler, repetitive defect 258

S

- safety statements 291, 292
- scale documents
 - Macintosh 75
 - Windows 140
- scanner calibration 52, 211
- scanner glass
 - clean 206
- scanning
 - speed specifications 3
- scanning to e-mail
 - about 162, 165
 - address books 166, 167
 - configure 162
 - control-panel settings 164
 - embedded Web server settings 181
 - job settings 168
 - LDAP support 162
 - loading documents 165
 - recipient lists 166
 - sending documents 165
 - settings 162
 - SMTP support 162
 - validating addresses 267
- scanning to folder 169
- scanning to workflow 170
- Secure Disk Erase 183
- security
 - EWS 183
 - locking control panel menus 184
 - secure disk erase 183
 - settings 32
- security features 5
- Send Setup menu 39
- Send to Folder 169
- Send to Workflow 170
- sending to e-mail
 - about 162, 165
 - address books 166, 167
 - embedded Web server settings 181
 - job settings 168
 - LDAP support 162
 - loading documents 165
 - recipient lists 166
 - sending documents 165
 - settings 164
- SMTP support 162
 - validating gateway addresses 267
- separator page
 - Windows 140
- serial number
 - locate 9
- Service menu, control panel 59
- Services tab
 - Macintosh 78
- settings
 - driver presets (Macintosh) 75
 - drivers 67, 73
 - priority 66, 72
 - restore factory 219
- Settings tab, embedded Web server 180
- shortcuts 139
- Sleep button 12
- Sleep mode
 - settings 25, 27
- sleep settings
 - delay 122
 - power specifications 279
 - wake time 122
- SMTP servers
 - configuring gateway address 163
 - connect to 162
 - testing 163
 - validating gateway addresses 267
- software
 - embedded Web server 68
 - HP Printer Utility 73
 - HP Web Jetadmin 68
 - Macintosh 73, 92
 - settings 66, 72
 - supported operating systems 62, 72
 - uninstalling Macintosh 72
 - Windows 62, 92
- Solaris software 69
- space requirements 277
- special media
 - guidelines 100
- special paper
 - guidelines 100
- specifications
 - acoustic 280
 - electrical 279
 - features 3
 - operating environment 281
 - physical 277
- speed dial list, printing 177
- speed specifications 3
- standard output bin
 - capacity 4
 - locating 6
 - selecting 114
- staple cartridges
 - empty, stop or continue settings 126
- staple options
 - Macintosh 77
 - Windows 140
- stapler
 - empty, stop or continue settings 126
 - jams, clearing 247
 - paper sizes supported 124
 - using 126
- stapler options
 - stapler/stacker 115
- stapler/stacker
 - capacity 4
 - configuring 118
 - selecting 114
 - specifications, physical 277
- staples
 - loading 201, 203
- stapling jobs 126
- Start button 12
- Start button, control panel touchscreen 14
- status
 - embedded Web server 179
 - Home screen, control panel 13
 - HP Printer Utility, Macintosh 73
 - Macintosh services tab 78
 - messages, types of 220
- Status button 12
- Stop button 12
- Stop button, control panel touchscreen 14
- stopping a print request 138
- storage cabinet
 - specifications, physical 277

- storage, job
 - accessing 127
 - features 127
 - Macintosh settings 74, 78
 - personal 129
 - proof and hold 127
 - QuickCopy 130
 - settings 27
- store jobs
 - Windows 140
- storing
 - print cartridges 187
- subnet mask 89, 90
- subnets 89
- supplies
 - counterfeit 187
 - locating 188
 - management menu 27
 - non-HP 187
 - ordering 274
 - part numbers 275
 - recycling 286
 - replace 188
 - replacement intervals 189
 - replacing 188
 - Resets menu 58
 - status page, printing 176
 - status, viewing with embedded
 - Web server 179
 - status, viewing with HP Printer
 - Utility 73
 - supplies 187
- supply-status, Services tab
 - Macintosh 78
 - Windows 141
- support
 - online 141
- supported media 95
- supported utilities
 - for Macintosh 74
- system requirements
 - embedded Web server 178
- T**
 - Taiwan EMI statement 291
 - TCP/IP
 - configuring 88
 - TCP/IP settings 29
 - TCP/IPv4 90
 - TCP/IPv6 91
- temperature requirements 281
- tests
 - networks 32
- time, set 185
- time, setting 25
- Time/Scheduling menu, control
 - panel 25
- timeout settings 29
- toner
 - density setting 74
- top cover
 - locating 6
- touchscreen, clean 206
- Transmission Control Protocol
 - (TCP) 88
- tray 1
 - locating 6
- tray 2, 3, 4, 5
 - load 102
- trays
 - automatic media sensing 111
 - configure 111
 - double-sided printing 77
 - included 2
 - load 101
 - Macintosh settings 74
 - select paper 112
 - specifications, physical 277
- troubleshooting
 - blank pages 266
 - checklist 218
 - control panel messages 221
 - duplexing 256
 - EPS files 271
 - gateway addresses 267
 - jams 222
 - Macintosh problems 270
 - menu 52
 - pages not printing 266
 - pages printing slowly 266
 - paper handling problems 252
 - quality 258
 - repeating defects 258
 - transparencies 254
 - USB cables 266
- TrueType fonts included 3
- two-sided copying 154
- two-sided printing
 - Macintosh settings 74
 - Windows 140
- typefaces
 - included 3
- U**
 - uninstalling Macintosh
 - software 72
 - universal print driver 64
 - UNIX software 69
 - upgrading firmware 212
 - usage page, printing 176
 - USB configuration 82
 - USB connection 82
 - USB port
 - troubleshooting 266
 - troubleshooting
 - Macintosh 271
- V**
 - validating gateway
 - addresses 267
 - voltage specifications 279
- W**
 - wake time, setting 25, 122
 - Warning button, control panel
 - touchscreen 14
 - watermarks
 - Windows 140
 - weatherproof maps
 - printing 135
 - Web browser requirements
 - embedded Web server 178
 - Web Jetadmin
 - firmware updates 214
 - Web sites
 - fraud reports 187
 - HP Web Jetadmin,
 - downloading 182
 - Material Safety Data Sheet
 - (MSDS) 288
 - universal print driver 64
 - Windows
 - driver settings 67
 - drivers supported 63
 - software components 92
 - supported operating
 - systems 62
 - universal print driver 64
 - Windows 2000 fax 174
 - workflow, send to 170

© 2009 Hewlett-Packard Development Company, L.P.

www.hp.com



CE799-90904