



HP Scanjet Enterprise 8500 fn1 HP Digital Sender Flow 8500 fn1

Service Manual





8500 fn 1

Service Manual

Copyright and license

© 2013 Copyright Hewlett-Packard Development Company, L.P.

Reproduction, adaptation, or translation without prior written permission is prohibited, except as allowed under the copyright laws.

The information contained herein is subject to change without notice.

The only warranties for HP products and services are set forth in the express warranty statements accompanying such products and services. Nothing herein should be construed as constituting an additional warranty. HP shall not be liable for technical or editorial errors or omissions contained herein.

Part number: L2717-90014

Edition 2, 10/2013

Trademark credits

Adobe®, Acrobat®, and PostScript® are trademarks of Adobe Systems Incorporated.

ENERGY STAR® and the ENERGY STAR® mark are registered U.S. marks.

Microsoft®, Windows®, Windows® XP, and Windows Vista® are U.S. registered trademarks of Microsoft Corporation.

Table of contents

1 Theory of operation	1
Flatbed scanner and ADF assembly	3
Network electronics assembly	4
User interface assembly	6
2 Removal and replacement	7
Introduction	8
Removal and replacement strategy	9
Electrostatic discharge	10
Required tools	11
Types of screws	12
Service approach	15
Before performing service	15
Backup product data	15
After performing service	15
Restore product data	16
Save and repair process	16
Post-service test	16
Quality test	17
Customer self repair (CSR) assemblies	18
ADF rollers	18
Remove the ADF rollers:	18
Separation pad	21
Update the document feeder kit replacement history	22
Set the Very Low Settings option from the control panel	22
Control-panel assembly	24
Reinstall the control-panel assembly	25
Hard disk drive	26
Remove the hard disk drive	26
Reinstall the hard disk drive	29
Reload the firmware	29

Formatter PCA	31
Reinstall the formatter PCA	36
Keyboard assembly	36
Internal assemblies	39
Flatbed scanner and ADF assembly	39
Remove the flatbed scanner and ADF assembly:	39
Reinstall the flatbed scanner and ADF assembly	42
Power-button assembly	44
Remove the power-button assembly	44
Reinstall the power-button assembly	45
Interconnect cable, scanner cable, and control-panel cable	46
Remove the scanner cable, control-panel cable, and interconnect cable	46
Interconnect PCA, fan assembly, and DC controller PCA	53
Remove the interconnect PCA, fan assembly, and DC controller PCA:	53
3 Solve problems	59
Solve problems checklist	60
Administration Menu Map	61
Preboot menu options	62
Current settings page	63
Troubleshooting process	64
Determine the problem source	64
Troubleshooting flowchart	65
Power subsystem	68
Power-on checks	68
Power-on troubleshooting overview	68
Firmware startup steps	69
Control-panel checks	73
Control-panel checks from the control panel	73
Control-panel checks from diagnostic mode	73
Generate debug data	75
Check the maintenance history	75
Check the number of scans	75
Tools for troubleshooting	76
Component diagnostics	76
LED diagnostics	76
LED indicators on the formatter	76
Interpret control-panel status lights	77
Engine diagnostics	77
Verify power to the flatbed scanner and ADF assembly	77
Test simplex scanning	78

Test duplex scanning	78
Sensor test	78
Paper present sensor	78
ADF hatch sensor	79
Flatbed cover sensor	79
Multi-Pick sensor	79
Internal test pages	80
Configuration pages	80
Configuration page	80
HP embedded Jetdirect page	82
Finding important information on the configuration pages	83
Usage page	84
File Directory page	85
Web Services Status Page	86
Use HP Embedded Web Server features	86
Information tab	87
Control panel menus	87
Administration menu	88
Reports menu	88
General Settings menu	89
Scan/Digital Send Settings menu	90
Fax Settings menu	93
Display Settings menu	94
Manage Supplies menu	95
Network Settings menu	96
Troubleshooting menu	98
Device Maintenance menu	99
Backup/Restore menu	99
Calibrate/Cleaning menu	100
USB Firmware Upgrade menu	100
Service menu	100
Interpret control-panel messages	101
Control-panel message types	101
Control-panel messages	101
20.00.00 Insufficient memory: <Device> To continue, touch "OK"	101
30.01.10 Scanner Failure	102
30.01.23 Scanner Calibration Failure	102
30.01.36 Upgrade Error Try downloading upgrade again	102
30.01.40 Scanner Communication Failure	102
30.01.47 Document Feeder Not Detected	103
30.01.YY Scanner Failure	103

31.01.02 Jam in document feeder	103
31.01.03 Document feeder pick error	104
40.00.01 USB I/O buffer overflow To continue, touch "OK"	104
40.00.02 Embedded I/O buffer overflow To continue, touch "OK"	104
40.00.03 EIO <X> buffer overflow To continue, touch "OK"	105
40.00.04 EIO <X> bad transmission To continue, touch "OK"	105
40.00.05 Embedded I/O bad transmission To continue, touch "OK"	105
49.XX.YY Error To continue turn off then on	105
57.10.01 The fan has failed Turn off and contact the administrator	106
62.00.00 No system To continue turn off then on	106
80.0X.YY Embedded JetDirect Error To continue turn off then on ...	106
98.00.0X Corrupt data in X volume	107
Cleaning disk <X>% complete Do not power off	107
Digital send communication error	107
Digital send communication error	107
Disk full Delete stored jobs	108
Document feeder bin full	108
Document feeder is empty	108
Document feeder top cover open	108
Event log is empty	108
Flatbed cover open	109
Initializing...	109
Internal disk not found	109
Internal disk not functional	109
Internal disk not initialized	109
Moving solenoid To exit press	110
Moving solenoid and motor To exit press	110
Performing Paper Path Test...	110
Replace Document Feeder Kit	110
Unable to cancel firmware update job	110
Unable to Install	111
Unable to install the firmware	111
Unsupported USB accessory detected Remove USB accessory	111
Upgrade complete To continue turn off then on	112
USB accessory needs too much power Remove USB Accessory and Turn Off then On	112
USB needs too much power	112
USB storage accessory removed Clearing any associated data	112
Event log messages	112

Show an event log	113
Clear the event log	113
Event log message table	113
Clear jams	136
Clear jams from the paper path	136
Solve paper-handling problems	138
Paper jamming, skewing, misfeeds, or multiple-page feeds	138
Paper does not feed from the product	138
Originals are curling up in the document output tray	139
The bottom of the scanned image is cut off	139
The scanned images have streaks or scratches	139
An item loaded in the document input tray jams repeatedly	139
The product has stopped working correctly	140
Clean the product	141
Clean the touchscreen	141
Clean the scanning glass, scanning strip, and automatic document feeder (ADF) duplex background	141
Clean the rollers	144
Set the Very Low Settings option from the control panel	145
Solve connectivity problems	146
Check the Ethernet connection	147
Service mode functions	148
Service menu	148
Product resets	151
Restore factory settings	151
Clean Disk and Partial Clean functions	151
Active and repository firmware locations	151
Partial Clean	152
Clean Disk	153
Preboot menu options	155
Solve fax problems	162
Internet Fax setup	162
LAN Fax setup	162
Solve e-mail problems	164
Validate the SMTP gateway address	164
Validate the LDAP gateway address	164
Product updates	165
Determine the installed revision of firmware	165
Perform a firmware upgrade	165
HP Embedded Web Server	165
USB storage device (Preboot menu)	166

USB storage device (control-panel menu)	167
4 Parts	169
Order parts by authorized service providers	170
Order parts, accessories, and supplies	170
Customer-self repair parts	170
Internal assemblies	171
Appendix A Service and support	173
Hewlett-Packard limited warranty statement	174
End User License Agreement	176
Customer self-repair warranty service	179
Customer support	180
Appendix B Product specifications	181
Physical specifications	182
Document feeder specifications	182
Power consumption	182
Environmental specifications	183
Regulatory model number	183
Appendix C Regulatory information	185
Environmental product stewardship program	186
Protecting the environment	186
Plastics	186
Power consumption	186
Material restrictions	186
Disposal of waste equipment by users in private households in the European Union	187
Chemical substances	187
For more information	187
Certificate of Volatility	188
Volatile memory	188
Non-volatile memory	188
Hard disk drive memory	188
Index	189

1 Theory of operation

 **NOTE:** The name for this product was changed to include the word “Flow”. There is no functional difference between the HP Scanjet Enterprise 8500 fn1 (L2717A) and the HP Digital Sender Flow 8500 fn1 (L2719A). Service parts containing the product name have been updated to include the words “Digital Sender” and “Flow”.

The 8500 fn1 is a fleet-compliant network scanner with an integrated legal-size flatbed scanner and single-pass duplex automatic document feeder (ADF). The input tray for the ADF holds 100 pages of standard size paper and can scan at 60 pages per minute (ppm) for simplex scanning and 120 ppm for duplex scanning.

The product has three hardware subassemblies:

- Flatbed scanner and ADF assembly
- Network electronics assembly
- User interface (control panel) assembly

Figure 1-1 Hardware subassemblies

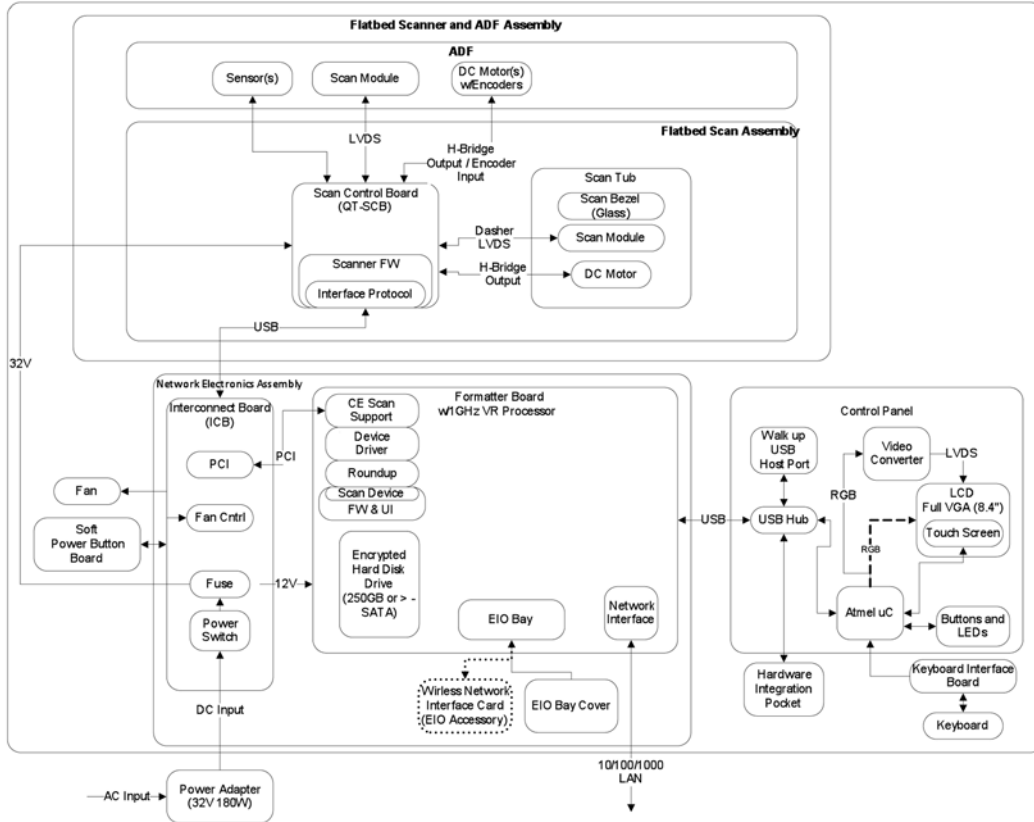

Flatbed scanner and ADF assembly

The scanner can scan paper up to 216 mm (8.5 in) x 863.6 mm (34 in) in size. Paper must be placed in the ADF input tray or on the flatbed glass before the scanning can be initiated. Output from the scanner is in .JPEG format and is transferred to a network using a Hi-Speed USB interface.

The major hardware components associated with this assembly are:

- ADF with an integrated scan module
- Flatbed scanner assembly
- Scanner control-board assembly

Network electronics assembly

The network electronics assembly controls all functions within the product and provides a connection to the external gigabit network interface for the product. This assembly only accepts files from a USB interface in .JPEG format from the flatbed scanner and ADF assembly. The assembly stores the files on the encrypted hard disk drive for additional post-scan processing and routing based on the options selected by the user.

Figure 1-2 Network electronics assembly overview

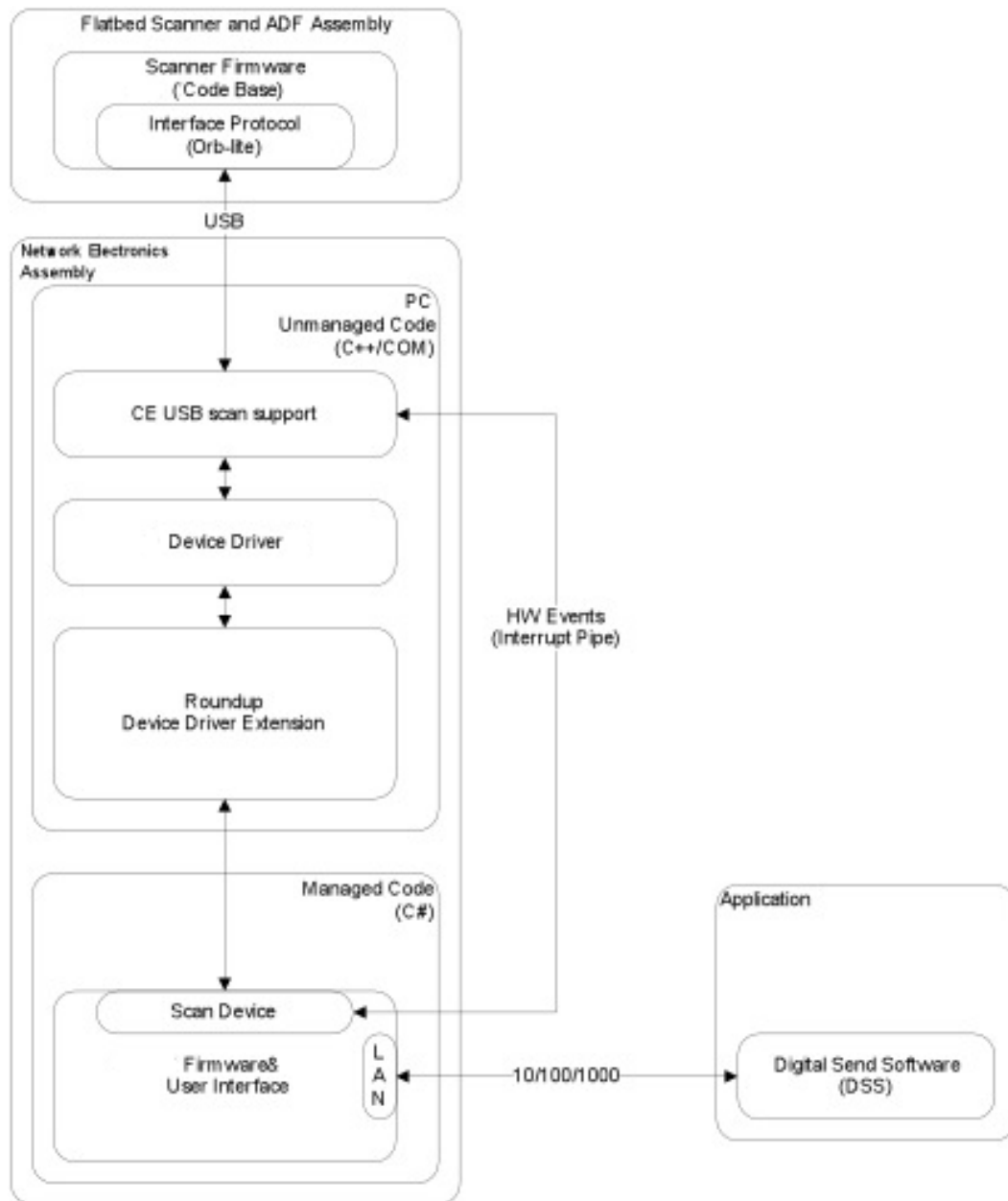
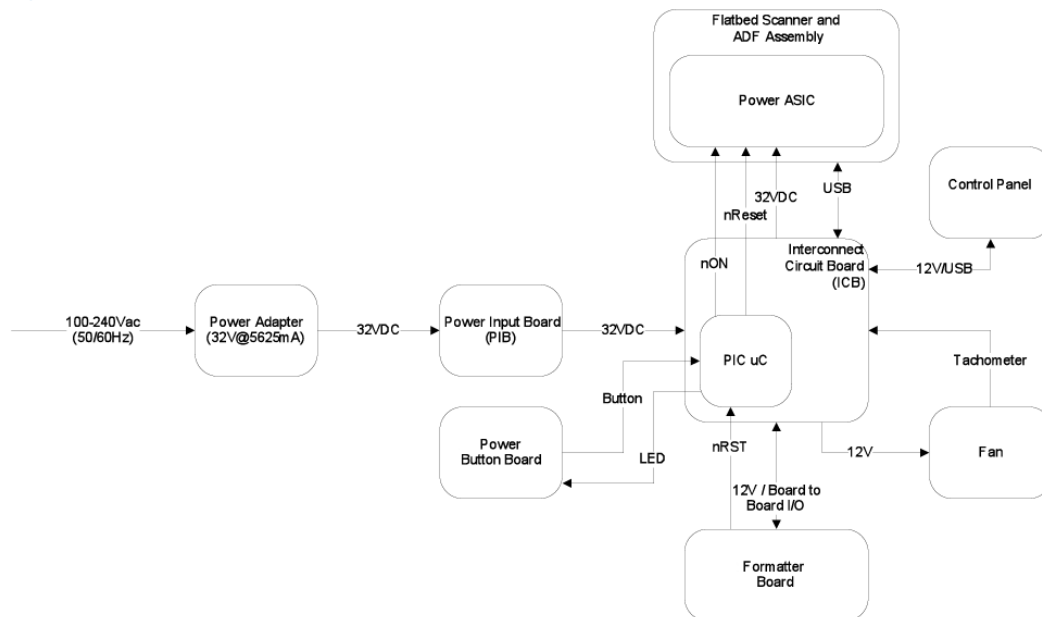

Table 1-1 Network electronic assembly components

Subassembly	Subassembly	Subassembly	Subassembly
Network electronics (formatter board)			
Interconnect circuit board (ICB)			
Power button board			
Power input board			
Interface cables	From ICB	USB cable to scanner	
		USB cable to control panel (non-standard voltages)	
		ICB cable assembly	DC power cable to scanner
			Power/reset control to scanner
			System power button board

The interconnect circuit board (ICB) subassembly within the network electronics assembly is the main communication interface for all system assemblies. This ICB controls the power sequencing of all assemblies and the system fan. All communication interfaces are routed through this assembly.

Figure 1-3 ICB connections



User interface assembly

The user interface assembly has a 203.2 mm (8 in) color LCD display with an integrated touchscreen and a full physical keyboard. The user interface assembly also includes:

- A USB-host interface connection with an integrated cover for sending output files to a USB storage accessory
- A fleet-compliant hardware integration pocket (HIP)
- Status LEDs
- Physical buttons

The user interface assembly communicates with the network electronics assembly using a USB interface through the ICB assembly.

Table 1-2 User interface assembly components

Subassembly	Subassembly
Control-panel assembly	
Physical keyboard	Keyboard interface board
Cables	24-pin FFC from control panel to keyboard interface board

2 Removal and replacement

- [Introduction](#)
- [Removal and replacement strategy](#)
- [Electrostatic discharge](#)
- [Required tools](#)
- [Types of screws](#)
- [Service approach](#)
- [Customer self repair \(CSR\) assemblies](#)
- [Internal assemblies](#)



NOTE: Your product might not appear exactly as the one shown in the photos in this chapter. Although details such as the color of the external panels and covers might be different than your product, the procedures in this chapter are appropriate for your product.

Introduction

This chapter describes the removal and replacement of field-replaceable units (FRUs) only.

Replacing FRUs is generally the reverse of removal. Occasionally, notes and tips are included to provide directions for difficult or critical replacement procedures.

HP does *not* support repairing individual subassemblies or troubleshooting to the component level.

Note the length, diameter, color, type, and location of each screw. Be sure to return each screw to its original location during reassembly.

Incorrectly routed or loose wire harnesses can interfere with other internal components and can become damaged or broken. Frayed or pinched harness wires can be difficult to find. When replacing wire harnesses, always use the provided wire loops, lance points, or wire-harness guides and retainers.

Removal and replacement strategy

 **WARNING!** Turn the product off, wait 5 seconds, and then remove the power cord before attempting to remove an assembly. If this warning is not followed, severe injury can result, in addition to damage to the product. The power must be on for certain functional checks during troubleshooting. However, disconnect the power supply during parts removal.

Never operate or service the product with the protective cover removed from the laser/scanner assembly. The reflected beam, although invisible, can damage your eyes.



The sheet-metal parts can have sharp edges. Be careful when handling sheet-metal parts.

 **CAUTION:** Do not bend or fold the flat flexible cables (FFCs) during removal or installation. Also, do not straighten pre-folds in the FFCs. You *must* fully seat all FFCs in their connectors. Failure to fully seat an FFC into a connector can cause a short circuit in a PCA.

 **NOTE:** To install a self-tapping screw, first turn it counterclockwise to align it with the existing thread pattern, and then carefully turn it clockwise to tighten. Do not overtighten. If a self-tapping screw-hole becomes stripped, repair the screw-hole or replace the affected assembly.

 **TIP:** For clarity, some photos in this chapter show components removed that would not be removed to service the product. If necessary, remove the components listed at the beginning of a procedure before proceeding to service the product.

Electrostatic discharge

 **CAUTION:**  Some parts are sensitive to electrostatic discharge (ESD). Look for the ESD reminder when removing product parts. Always perform service work at an ESD-protected workstation or mat, or use an ESD strap. If an ESD workstation, mat, or strap is not available, ground yourself by touching the sheet-metal chassis *before* touching an ESD-sensitive part.

Protect the ESD-sensitive parts by placing them in ESD pouches when they are out of the product.

Required tools

- Torx screwdrivers, size 10, 15, and 20
- Small flat blade screwdriver
- Needle-nose pliers
- ESD mat or ESD strap (if one is available)
- Penlight (optional)
- USB thumbdrive

Types of screws

This table describes the screws that are used in the product and provides guidelines to help determine where each type of screw is used. The screws can vary in length depending on the thickness of the material that is being fastened.

Always note where each type of screw is located and replace each one in its original location.

⚠ WARNING! Make sure that components are replaced with the correct screw type. Using the incorrect screw (for example, substituting a long screw for the correct shorter screw) can cause damage to the product or interfere with product operation. Do not intermix screws that are removed with one component with the screws that are removed from another component.

💡 TIP: When you are disassembling the product, place the screws into the chassis holes from which they were removed. This prevents their loss, and ensures that the proper type and length of screw for each location is used when the product is reassembled.

Table 2-1 Common fasteners used in this product

Screw type

Silver Torx head 4 x 10 mm screw with cone washer

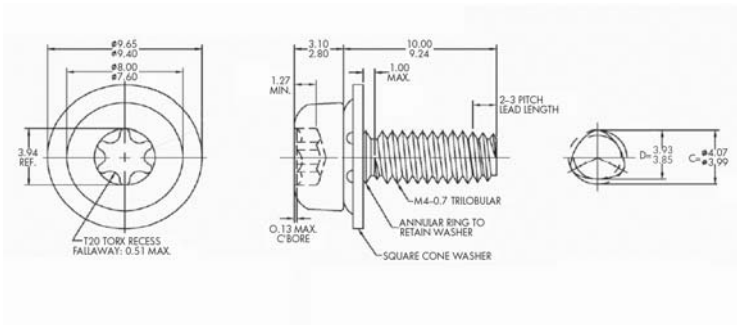

This screw type is shown in the following figure:

- [Figure 2-31 Remove the flatbed scanner and ADF assembly \(1 of 7\) on page 39](#)

Table 2-1 Common fasteners used in this product (continued)

Screw type

Silver Torx head 3 x 8 mm screw with spring washer

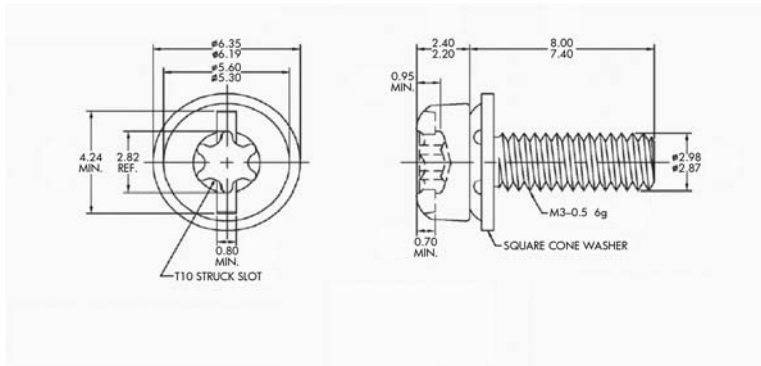

This screw type is shown in the following figures:

- [Figure 2-61 Remove the interconnect PCA on page 56](#)
- [Figure 2-65 Remove the DC controller PCA on page 58](#)

Torx head 4 x 34 mm screw

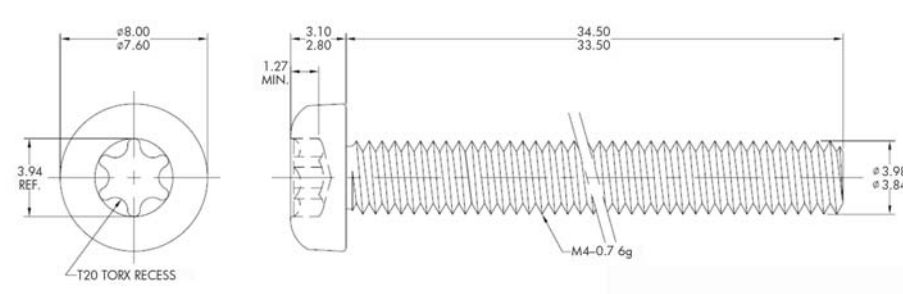

This screw type is shown in the following figure:

- [Figure 2-63 Remove the fan assembly \(2 of 3\) on page 57](#)

Torx head 3 x 10 mm screw

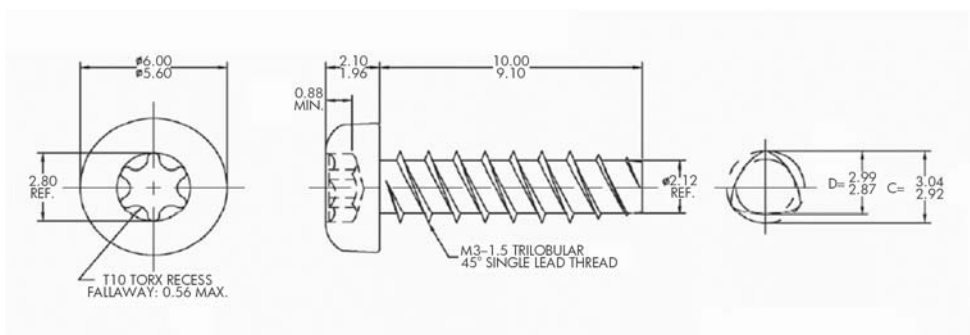

This screw type is shown in the following figures:

- [Figure 2-32 Remove the flatbed scanner and ADF assembly \(2 of 7\) on page 40](#)
- [Figure 2-38 Remove the power-button assembly \(1 of 3\) on page 44](#)

Table 2-1 Common fasteners used in this product (continued)

Screw type

Torx head 3 x 7.25 mm screw

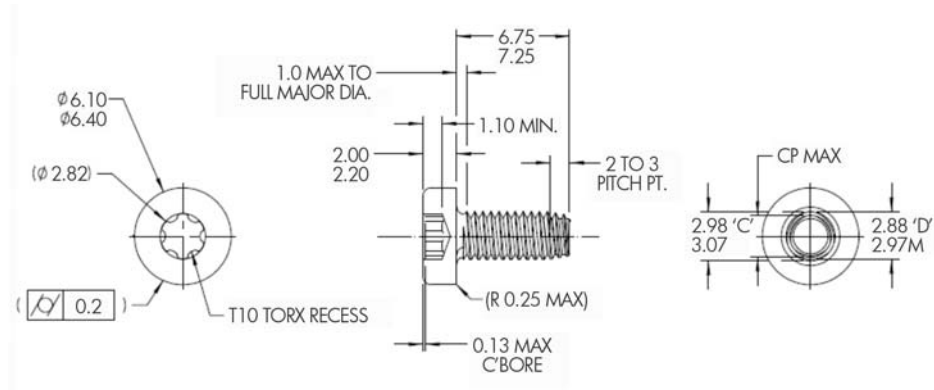

This screw type is shown in the following figures:

- [Figure 2-35 Remove the flatbed scanner and ADF assembly \(5 of 7\) on page 41](#)
- [Figure 2-41 Remove the scanner cable, control-panel cable, and interconnect cable \(1 of 4\) on page 46](#)
- [Figure 2-58 Remove the interconnect PCA, fan assembly, and DC connector PCA \(4 of 6\) on page 55](#)



Service approach

Before performing service

- Turn off the power using the power switch.
- Unplug the power cable and network cable.
- Place the product on an ESD workstation or mat, or use an ESD strap (if one is available). If an ESD workstation, mat, or strap is not available, ground yourself by touching the sheet-metal chassis *before* touching an ESD-sensitive part.

 **NOTE:** Some procedures require that you backup product data prior to replacing the assembly.

Backup product data

To ensure that customer-specific configuration information and data are preserved, back up the product data to a portable USB storage device prior to removing these assemblies. Restore the data after replacing the assembly.

 **NOTE:** You can also backup product data using the HP Embedded Web Server (EWS). The EWS backs up product data to a customer specified network folder instead of the products hard drive. See the product user guide for information.

1. From the Home screen on the product control panel, touch the [Device Maintenance](#) button.
2. Open the following menus:
 - [Backup/Restore](#)
 - [Backup Data](#)
 - [Backup Now](#)

 **NOTE:** Backups are stored on the hard disk drive, including regularly scheduled backups. You can export backups to a USB storage device from the hard disk drive.

3. Insert the portable USB storage device.
4. Touch [Export Last Backup](#)
5. Enter the password and confirm the password. Touch [OK](#).

After performing service

- Connect the network cable, and then plug in the power cable.

 **NOTE:** Some procedures require that you perform a restore step after to replacing the assembly.

Restore product data

To ensure that customer-specific configuration information and data are preserved, back up the product data to a portable USB storage device prior to removing these assemblies. Restore the data after replacing the assembly.

 **NOTE:** You can also restore product data using the Embedded Web Server (EWS). See the product user guide for information.

1. From the Home screen on the product control panel, touch the [Device Maintenance](#) button.
2. Open the following menus:
 - [Backup/Restore](#)
 - [Restore Data](#)
3. Insert the portable USB storage device.
4. Select the backup file, and then touch [Restore](#).
5. Touch [Restore](#).

Save and repair process

The save and repair process occurs automatically whenever the formatter PCA, interconnect PCA, or encrypted hard disk drive (HDD) are replaced. This process is transparent to the user.

 **CAUTION:** Replacing the formatter PCA and interconnect PCA at the same time or swapping these assemblies between products can render the product unusable.

- **Formatter PCA:** When a replacement formatter PCA is installed and the product is turned on, NVRAM values from the interconnect PCA are transferred automatically to the replacement formatter PCA. This process allows the product to return to normal operation with all of the necessary product history.
- **Interconnect PCA:** When a replacement interconnect PCA is installed, NVRAM values from the formatter PCA are transferred automatically to the replacement interconnect PCA. This process allows the product to return to normal operation with all of the necessary product history.
- **Hard disk drive (HDD):** When a replacement hard disk drive is installed and product is turned on, the replacement hard disk drive is locked to the formatter PCA of the product. The encryption key is placed in the NVRAM of the formatter PCA and copied to the NVRAM of the interconnect PCA. This allows the backed up NVRAM values from the interconnect PCA to be restored to a replacement formatter PCA when either the formatter PCA or interconnect PCA are replaced. This process also allows the hard disk drive to function when it is transferred from a defective formatter PCA to a replacement formatter PCA. The hard disk drive cannot be used in another product or accessed from outside the product.

Post-service test

Perform the following test to verify that the repair or replacement was successful.

Quality test

1. Verify that you have completed the necessary reassembly steps.
2. Verify that the power cord and network cable are correctly connected, and then turn on the product.
3. Verify that the control panel shows the product in **Ready** mode.
4. Perform the scanning features of the product to ensure the product is functioning correctly. See the product user guide for information.
5. If necessary, restore any customer-specified settings.
6. Clean the outside of the product with a damp cloth.

Customer self repair (CSR) assemblies

ADF rollers

 **NOTE:** Always replace the separation pad when replacing the ADF rollers. The ADF rollers and separation pad are included in the ADF roller replacement kit.

The ADF roller replacement kit is a consumable and is not covered under warranty or standard service agreements.

 **NOTE:** HP recommends that you replace the rollers every 100,000 scans.

Remove the ADF rollers:

 **CAUTION:** Do not touch the rollers. Oils from your fingers can impact performance.

 **NOTE:** If the product is on and you open and close the ADF hatch, the attention message **If document feeder roller cleanup is complete, clear message** displays. Touch **Cancel** to clear the message.

1. Open the automatic document feeder (ADF) hatch.

Figure 2-1 Remove the ADF rollers (1 of 1)



2. Slide your fingertip behind the tab on the roller assembly door, and then pull gently forward and down to open the door.



 **TIP:** Lift the ADF input tray slightly to make it easier to reach the tab.

Figure 2-2 Remove the ADF rollers (1 of 2)

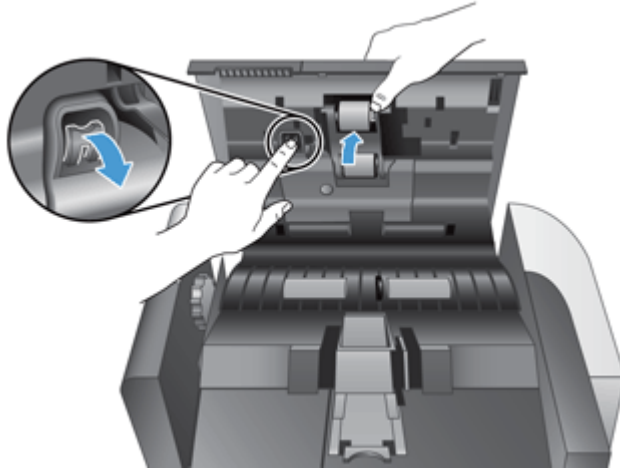

3. Holding the roller assembly door down and out of the way, grasp the roller assembly and slide it to the left to release it from the enclosure.

 **NOTE:** You might feel a slight resistance when sliding the roller assembly.

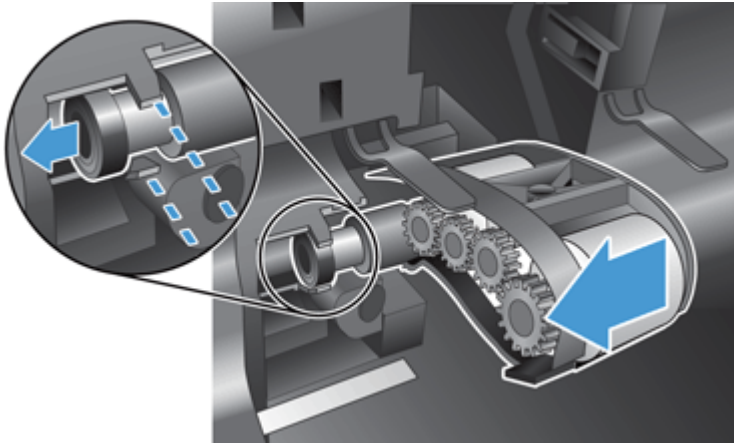

 **CAUTION:** Take care not to press down on the alignment tabs or against the tab to the right of the roller assembly.

Figure 2-3 Remove the ADF rollers (1 of 3)



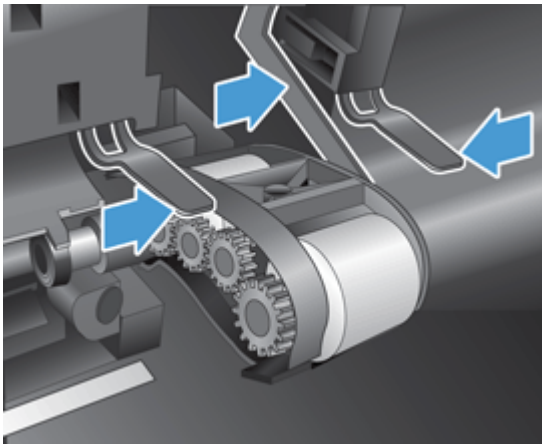
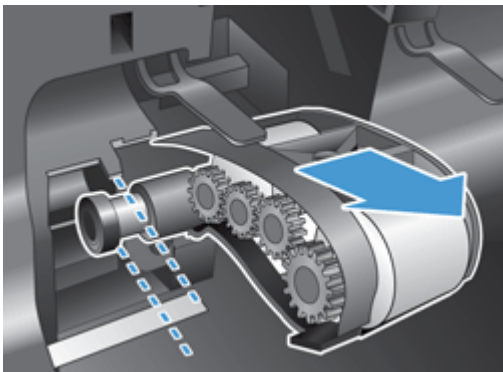

4. Remove the roller assembly.

Figure 2-4 Remove the ADF rollers (1 of 4)



Separation pad

 **NOTE:** Always replace the ADF rollers when replacing the separation pad. The ADF rollers and separation pad are included in the ADF roller replacement kit.

 **CAUTION:** Do not touch the pad. Oils from your fingers can impact performance.

1. Open the automatic document feeder (ADF) hatch.

Figure 2-5 Remove the separation pad (1 of 3)



2. Push the separation pad latch to release the separation pad.

 **TIP:** Raise the ADF input tray slightly.

Figure 2-6 Remove the separation pad (2 of 3)

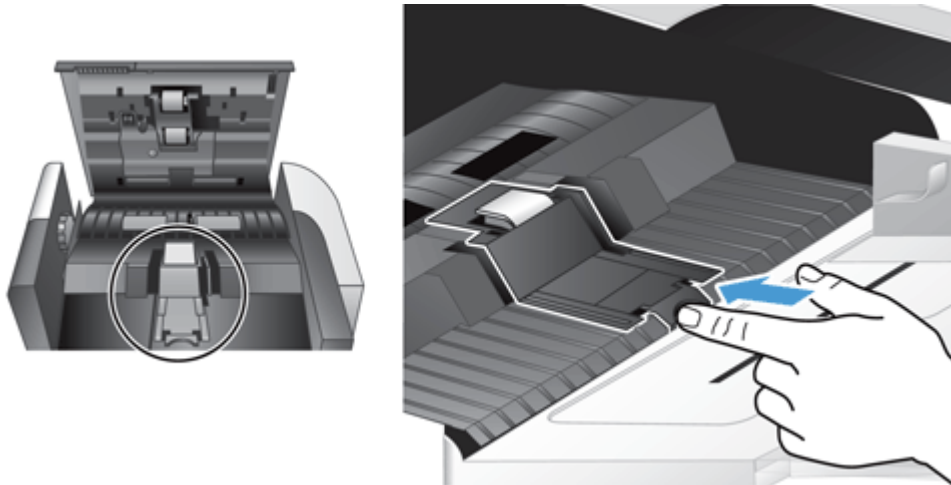

3. Lift the separation pad component to release it from its housing.

 **Reinstallation tip** Make sure the spring seats properly on the new separation pad by pressing down on the separation pad with a pencil or screwdriver after the pad is installed.

Figure 2-7 Remove the separation pad (3 of 3)



Update the document feeder kit replacement history

After installing new ADF rollers and a separation pad, update the product maintenance history:

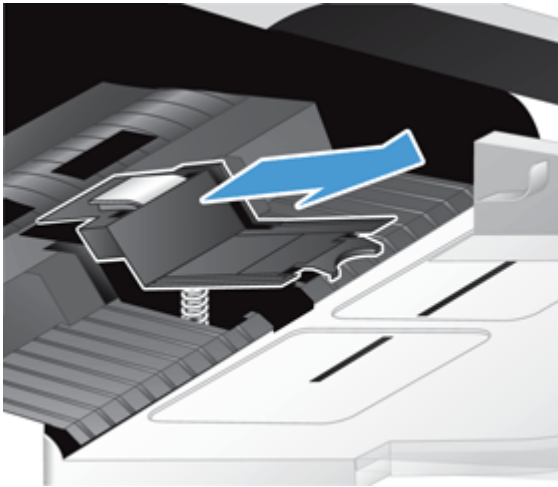
1. From the Home screen on the product control panel, touch the [Administration](#) button.
2. Open the following menus:
 - [Manage Supplies](#)
 - [Reset Supplies](#)
 - [New Document Feeder Kit](#)
3. Touch [Reset](#).

Set the Very Low Settings option from the control panel

1. From the Home screen on the product control panel, touch the [Administration](#) button.
2. Open the following menus:
 - [Calibrate/Cleaning](#)
 - [Manage Supplies](#)
 - [Supply Settings](#)
 - [New Document Feeder Kit](#)

3. In the **Document feeder kit low** box, enter a percentage of the total scans at which the product displays a message to replace the document feeder kit.
4. Select one of the following options:
 - Select the **Stop** option to set the product to stop scanning until you replace the document feeder kit.
 - Select the **Prompt to continue** option to set the product to stop scanning and prompt you to replace the document feeder kit. You can acknowledge the prompt and continue scanning.
 - Select the **Continue** option to set the product to alert you that the document feeder kit needs to be replaced, but to continue scanning.

Control-panel assembly

1. Raise the scanner lid.
2. Lift the left side of the control panel to release it from the product.

Figure 2-8 Remove the control-panel assembly (1 of 3)

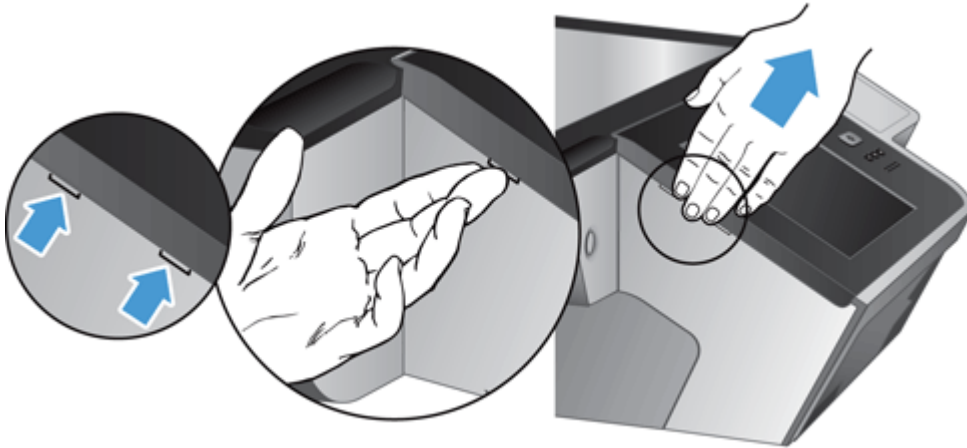

3. Disconnect the FFC (callout 1), and then gently pull the FFC through the cable restraint (callout 2).

Figure 2-9 Remove the control-panel assembly (2 of 3)

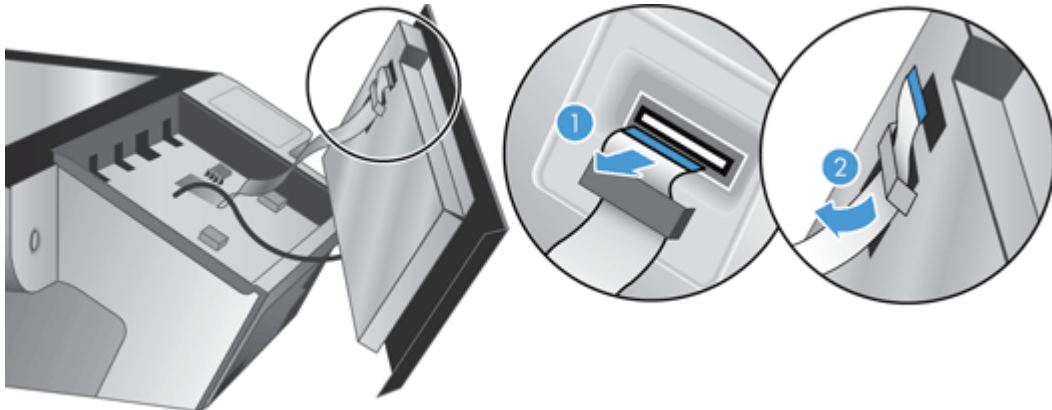

4. Disconnect the control-panel cable and then remove the control panel.

Figure 2-10 Remove the control-panel assembly (3 of 3)

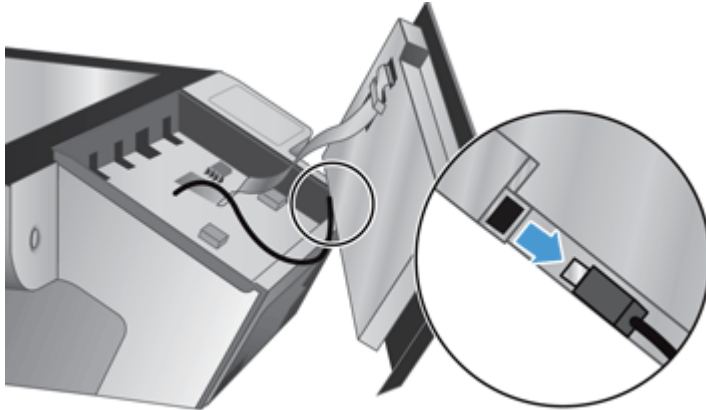

 **NOTE:** If the firmware is in a compressed file, extract the file before saving it to the USB storage device. Only files with a .bdl extension are valid firmware update files.

Reinstall the control-panel assembly

The replacement control-panel assembly ships with default calibration values. After installing a new control-panel assembly, calibrate and test the control-panel. See [Control-panel checks on page 73](#) for more information.

Hard disk drive

CAUTION:  ESD sensitive component.

CAUTION: Replacing the hard disk drive and formatter PCA, hard disk drive and interconnect PCA, or formatter PCA and interconnect PCA at the same time can render the product unusable. Swapping these assemblies between products can also render the product unusable.

Remove the hard disk drive

1. If replacing the hard disk drive, back up the product data before removing. See [Backup product data on page 15](#).
2. Loosen two thumbscrews (callout 1), and then remove the formatter.

Figure 2-11 Remove the formatter

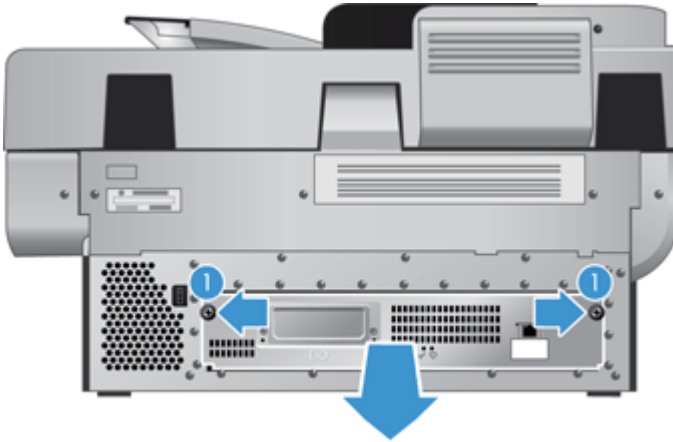

3. Disconnect the cable from the hard disk drive, gently lift the drive rail lever on the left leading edge of the hard disk drive (1), and then slide the drive forward (2). Lift the hard disk drive out of the drawer assembly.

Figure 2-12 Remove the hard disk drive (1 of 3)

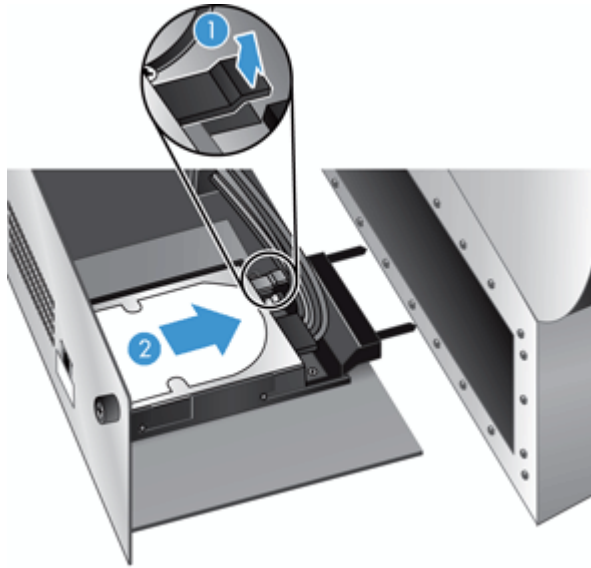

4. Remove the black plastic mounting rails from the hard drive, and then install them on the new hard drive.

Figure 2-13 Remove the hard disk drive (2 of 3)

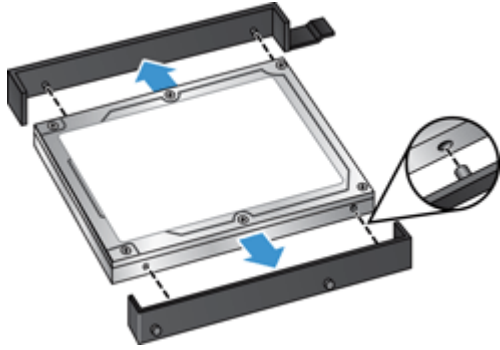
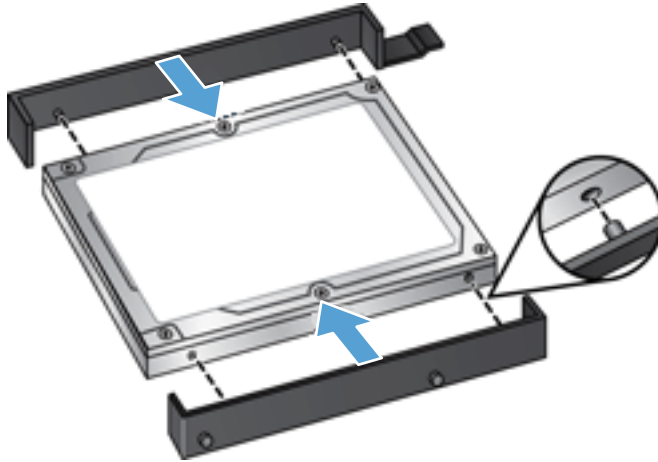



Figure 2-14 Remove the hard disk drive (3 of 3)



Reinstall the hard disk drive

 **NOTE:** The replacement hard disk drive is locked to the formatter PCA of the product the first time the product is turned on after installation. The encryption key is placed in the NVRAM of the formatter PCA and copied to the NVRAM of the interconnect PCA. This allows the backed up NVRAM values from the interconnect PCA to be restored to a replacement formatter PCA when either the formatter PCA or interconnect PCA are replaced. This process allows the hard disk drive to function when it is transferred from a defective formatter PCA to a replacement formatter PCA. The hard disk drive cannot be used in another product or accessed from outside the product.

1. Tuck the drive cable under the cable restraint.

Figure 2-15 Reinstall the hard disk drive

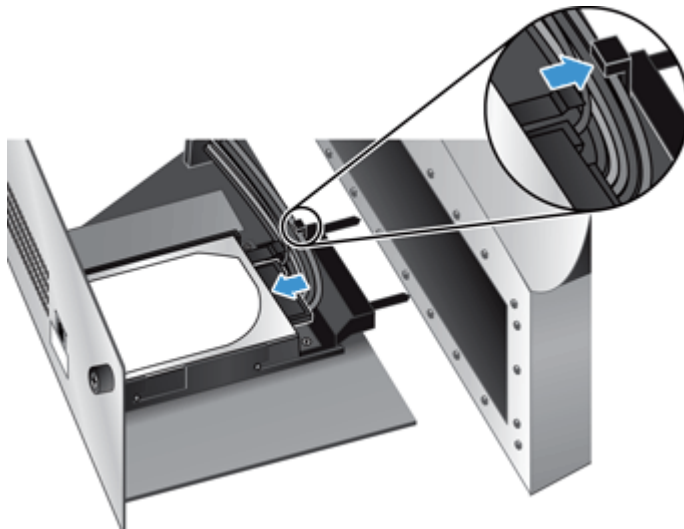







2. After installing a replacement hard disk drive, you must reload the firmware by performing a firmware upgrade.

Reload the firmware

1. Go to www.hp.com/support and select the country/region and language.
2. Select **Drivers and Software** and then search for the product. Select the product from search results.
3. Select **Cross operating system** (BIOS, Firmware, Diagnostics, etc).
4. Select the appropriate firmware update file.

 **NOTE:** If the firmware is in a compressed file, extract the .bdl file before saving it to a USB thumbdrive. Only files with a .bdl extension are valid for firmware updates.

5. Download and copy the firmware upgrade file to the root directory of a USB storage accessory. The firmware upgrade file has a .bdl extension.
6. Insert the USB storage accessory into the USB port on the bottom edge of the control panel.
7. Connect all cables and turn on the product. Error: **99.09.62 Not Bootable** or a similar message displays. Press the Start  button to continue.

8. Wait for the preboot menu to display on the control-panel display, and then press the up or down navigation arrows on the keyboard to scroll to [Administrator](#). Press the Start  button to select it.
9. Press the up or down keys on the keyboard to scroll to [Administrator](#). Press the Start  button to select it.
10. Press down arrow key on the keyboard to scroll to [Download](#). Press the Start  button to select it.
11. Press the up or down keys on the keyboard to scroll to [USB Thumbdrive](#). Press the Start  button to select it.
12. Several .bdl files might be listed. Press the up or down keys on the keyboard to scroll to the firmware upgrade file that you downloaded. Press the Start  button to select it. Wait while the file transfers. When the transfer is complete, the message **Complete** displays on the control-panel display.
13. Press and hold the power button to turn off the product (approximately 10 seconds). Remove the USB storage accessory, and then turn the product on. Wait for several minutes while the product initializes. If the upgrade is unsuccessful, try transferring the firmware upgrade file again.
14. If you created a backup of the product data prior to replacing the hard disk drive, restore the data from the device or network location where the backup was saved. See [Restore product data on page 16](#).

Formatter PCA

Remove the formatter PCA and transfer the hard drive

⚠ CAUTION:  ESD sensitive component.

CAUTION: Replacing the hard disk drive and formatter PCA, hard disk drive and interconnect PCA, or formatter PCA and interconnect PCA at the same time can render the product unusable. Swapping these assemblies between products can also render the product unusable. This procedure specifies replacing the formatter PCA and reinstalling the existing hard drive on the new formatter PCA.

📝 NOTE: If replacing the hard disk drive, back up the product data before removing. See [Backup product data on page 15](#).

1. Loosen two thumbscrews (callout 1), and then remove the formatter.

Figure 2-16 Remove the formatter (1 of 11)

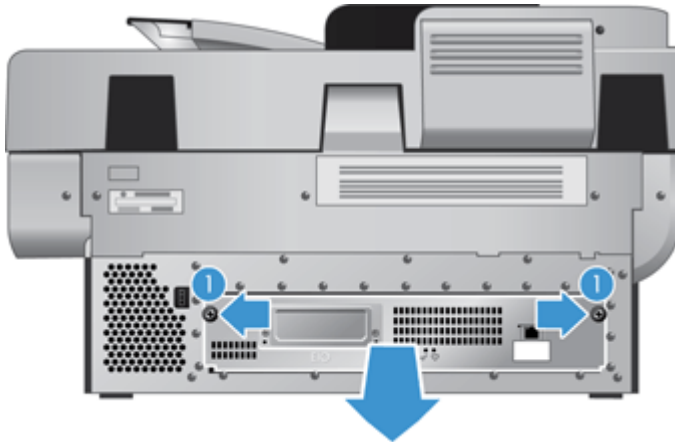

2. Slide the formatter PCA chassis out of the product.

Figure 2-17 Remove the formatter (2 of 11)

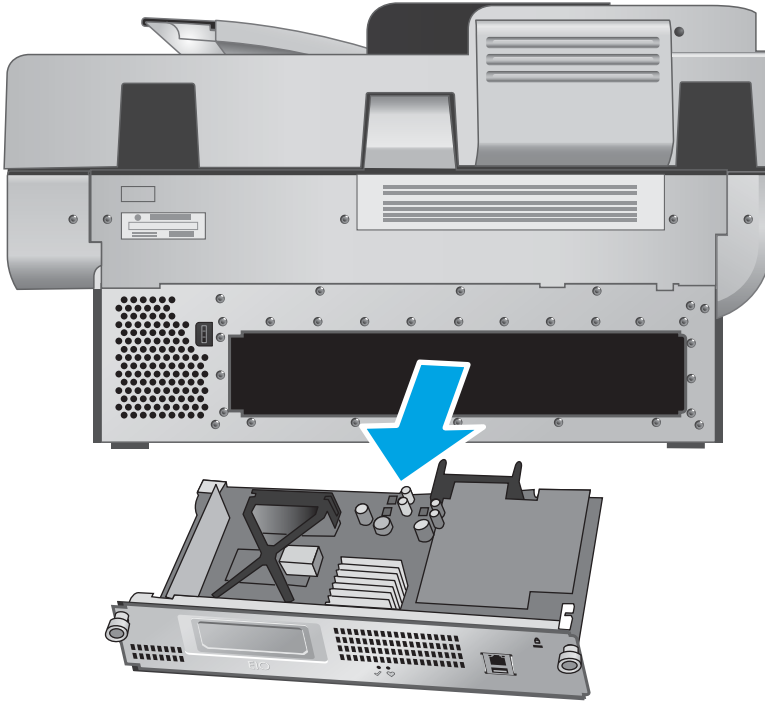

3. Disconnect the hard drive connector

Figure 2-18 Remove the formatter (3 of 11)

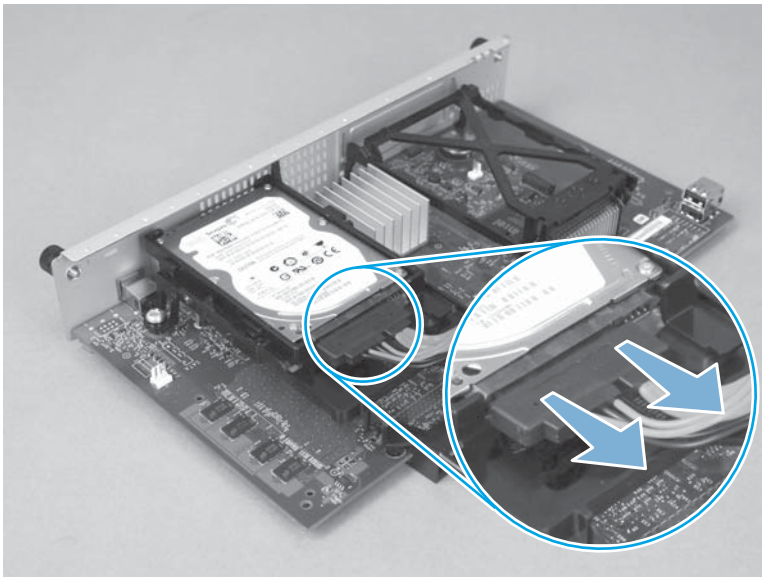

4. Release one tab (callout 1) and then slide the hard drive out of the carriage.

Figure 2-19 Remove the formatter (4 of 11)

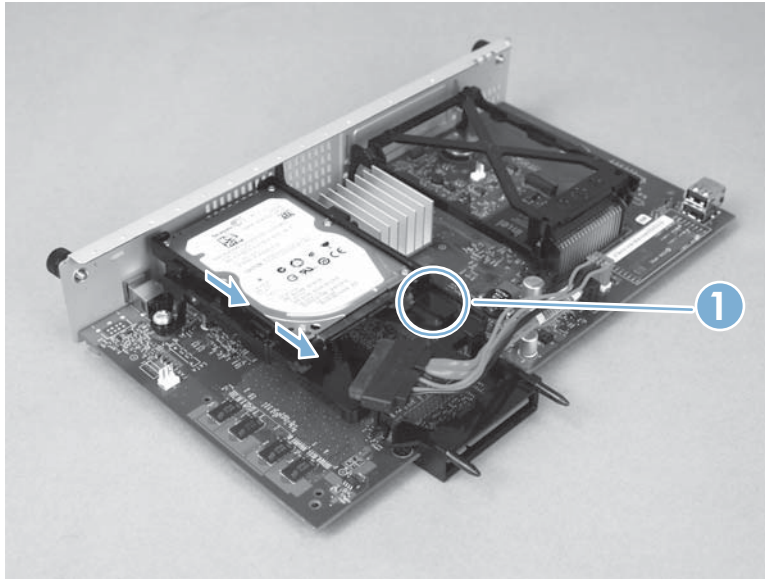
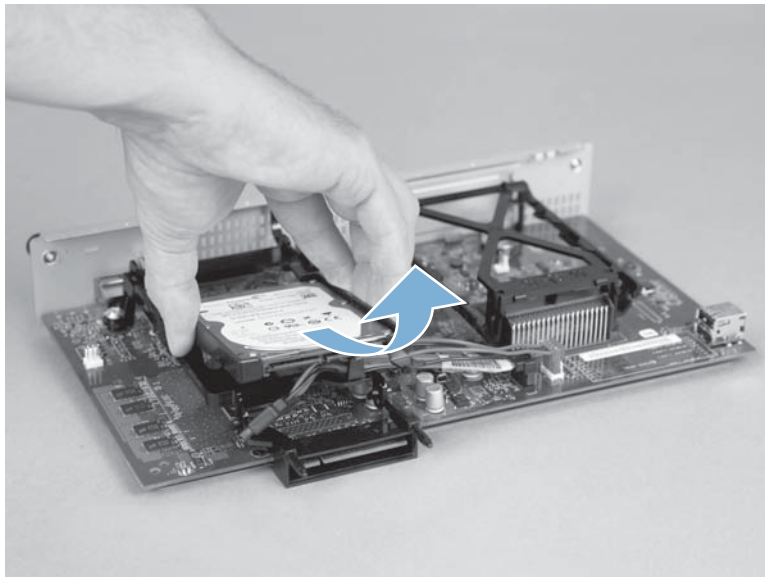

Figure 2-20 Remove the formatter (5 of 11)



5. Remove the black plastic mounting rails from the old hard drive, and then install them on the new hard drive.

Figure 2-21 Remove the formatter (6 of 11)

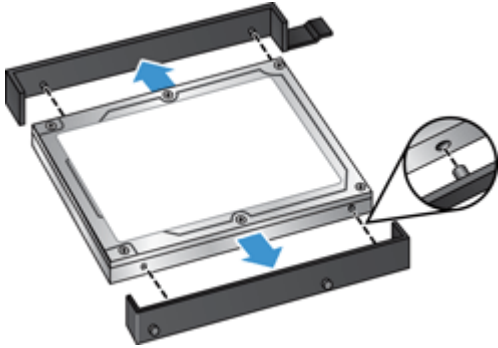
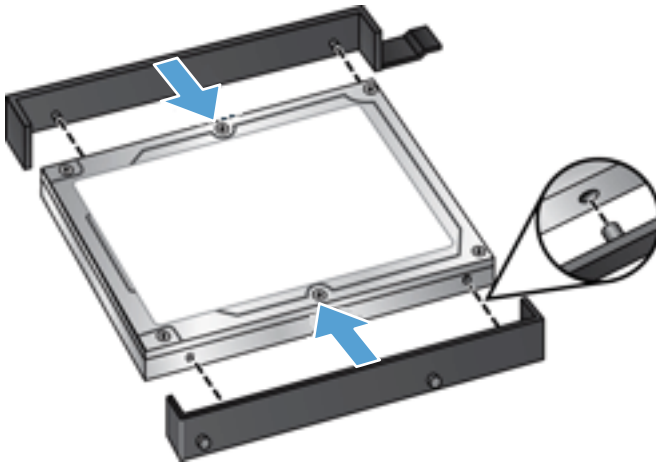
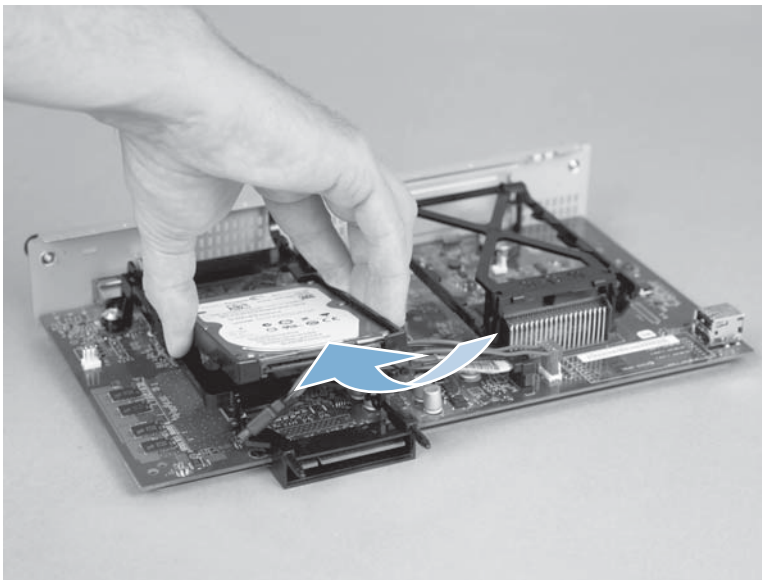

Figure 2-22 Remove the formatter (7 of 11)



6. Install the hard drive in the carriage on the new formatter.

Figure 2-23 Remove the formatter (8 of 11)



7. Reinstall the connector.

Figure 2-24 Remove the formatter (9 of 11)

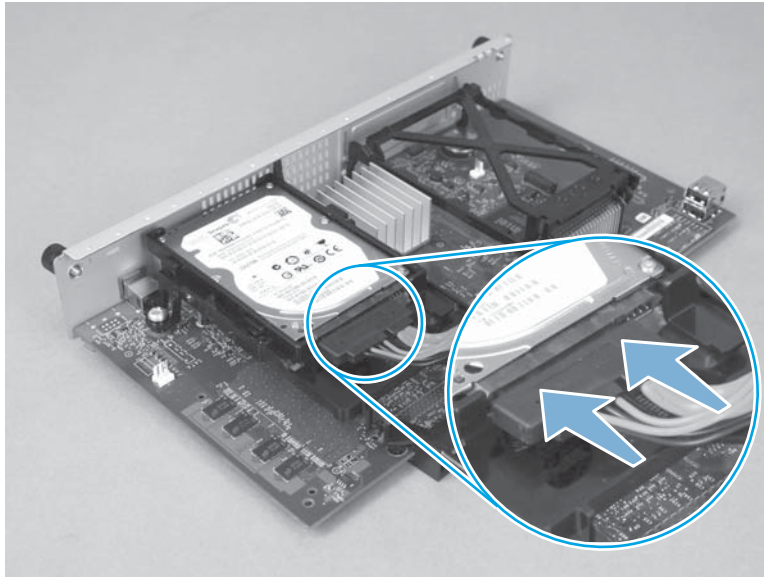

8. Slide the formatter PCA chassis into the product.

Figure 2-25 Remove the formatter (10 of 11)

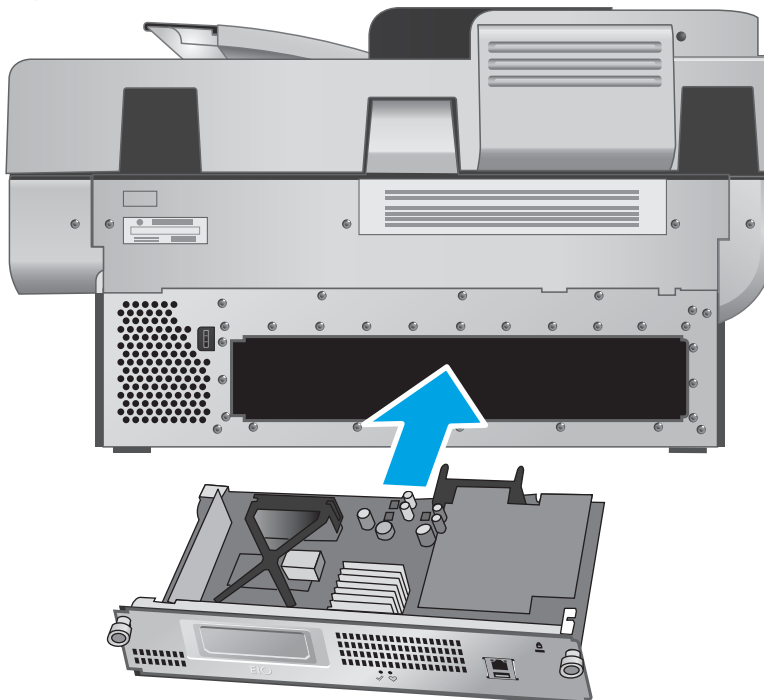

9. Tighten the two thumbscrews.

Figure 2-26 Remove the formatter (11 of 11)

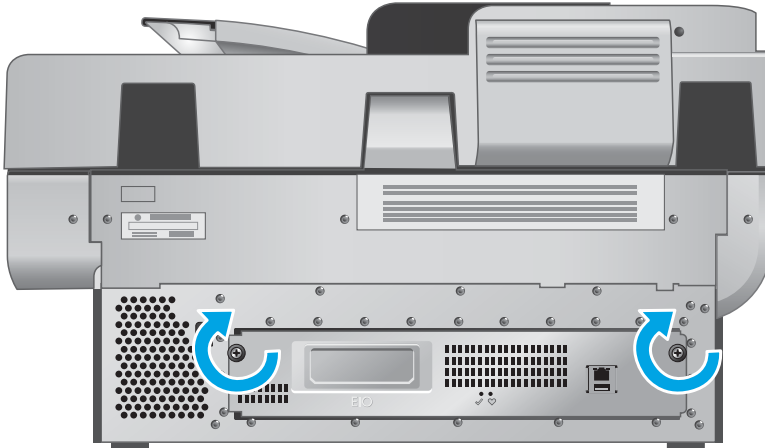

Reinstall the formatter PCA

NVRAM values including the encryption key for the hard disk drive are restored to the replacement formatter PCA from the NVRAM of the interconnect PCA when the product is turned on. The product returns to normal operation with all of the product history loaded in the NVRAM of the formatter PCA.

Keyboard assembly

1. Slide the four tabs at the top of the keyboard toward the bottom of the keyboard.

Figure 2-27 Remove the keyboard assembly (1 of 4)

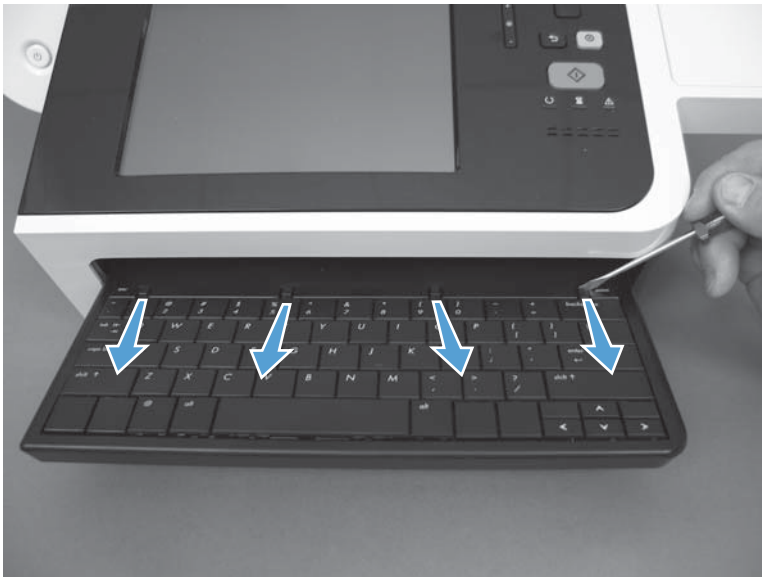

2. Release the four tabs at the bottom of the keyboard.

Figure 2-28 Remove the keyboard assembly (2 of 4)

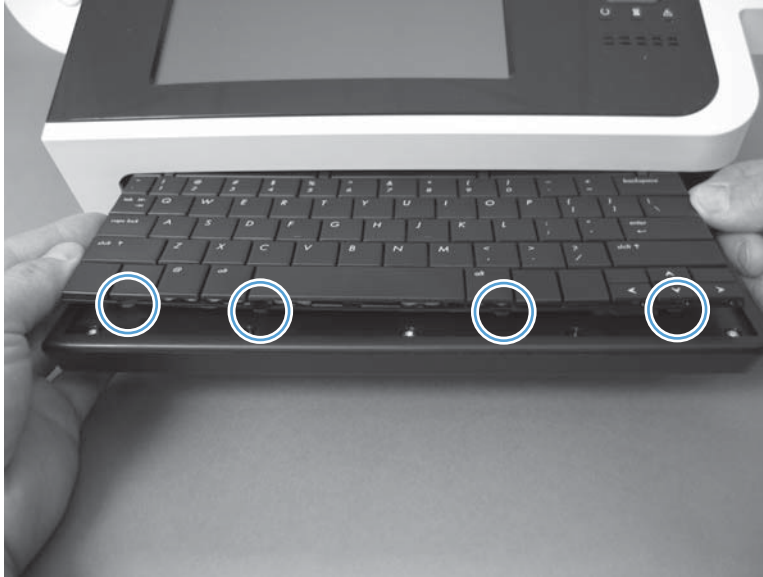

3. Lift the keyboard from the product. Note the orientation of the flat flexible cable (FFC) for reinstallation.

Figure 2-29 Remove the keyboard assembly (3 of 4)

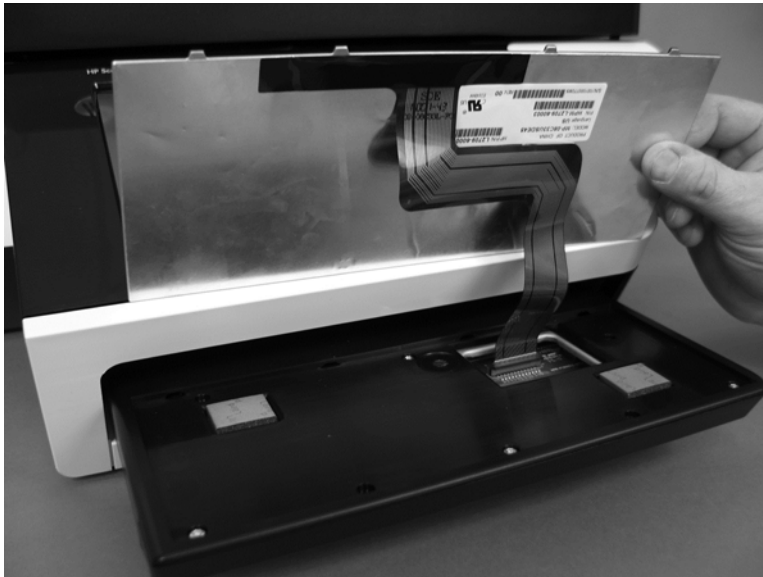

4. Release the cable lock to release the FFC, and then remove the keyboard.

Figure 2-30 Remove the keyboard assembly (4 of 4)

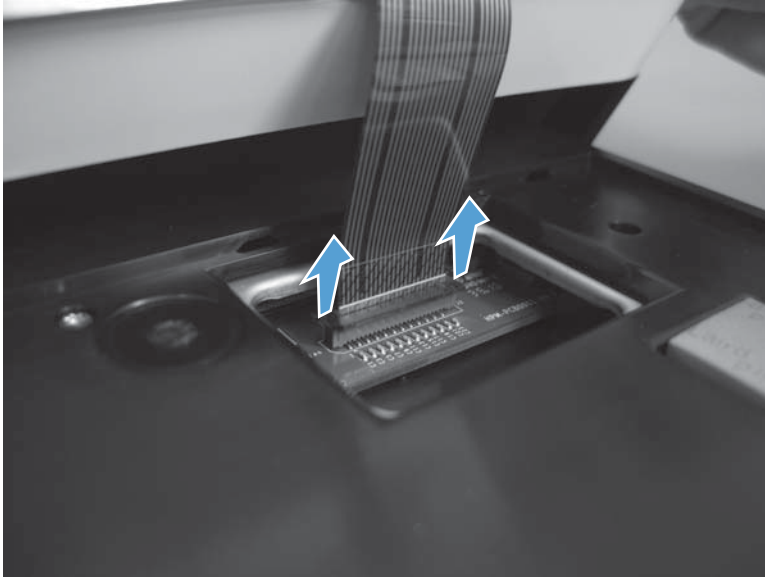

Internal assemblies

Flatbed scanner and ADF assembly

Before proceeding, remove the following components:

- Control-panel assembly. See [Control-panel assembly on page 24](#).

Remove the flatbed scanner and ADF assembly:

1. From the front of the scanner, remove four screws.

Figure 2-31 Remove the flatbed scanner and ADF assembly (1 of 7)

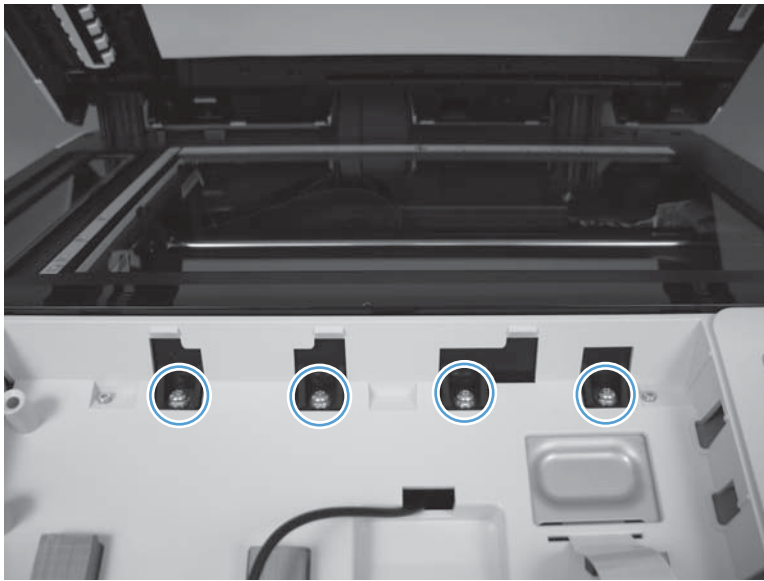

2. From the back of the scanner, remove five screws.

Figure 2-32 Remove the flatbed scanner and ADF assembly (2 of 7)

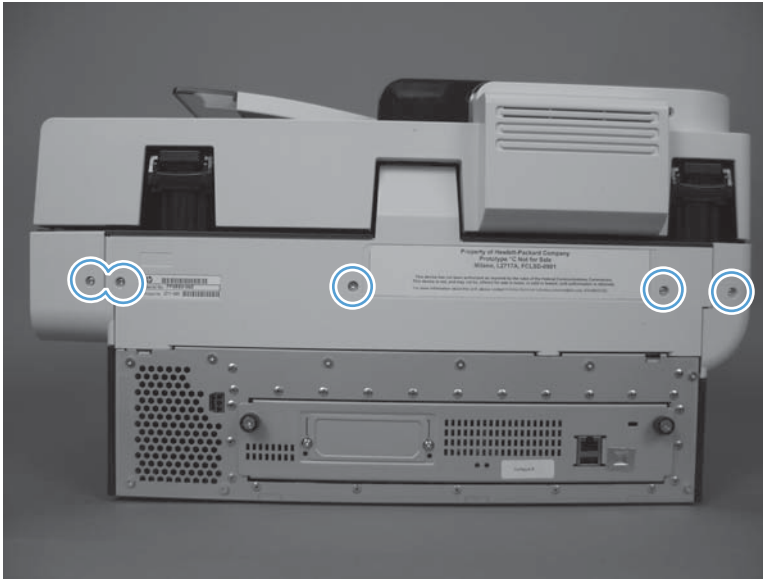

3. Carefully release the back cover.

 **NOTE:** The serial number for the product is on the back cover. Do not lose or damage the cover.

Figure 2-33 Remove the flatbed scanner and ADF assembly (3 of 7)



4. Remove the back cover.

Figure 2-34 Remove the flatbed scanner and ADF assembly (4 of 7)

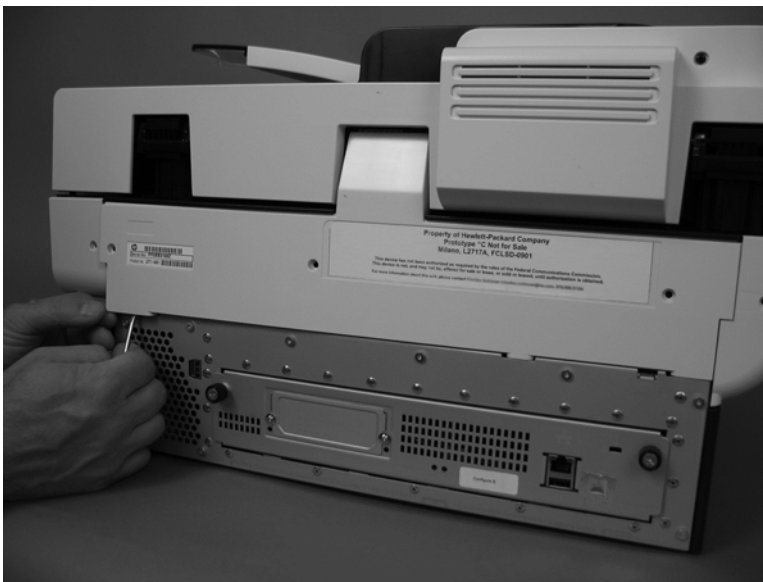

5. Remove two screws.

Figure 2-35 Remove the flatbed scanner and ADF assembly (5 of 7)

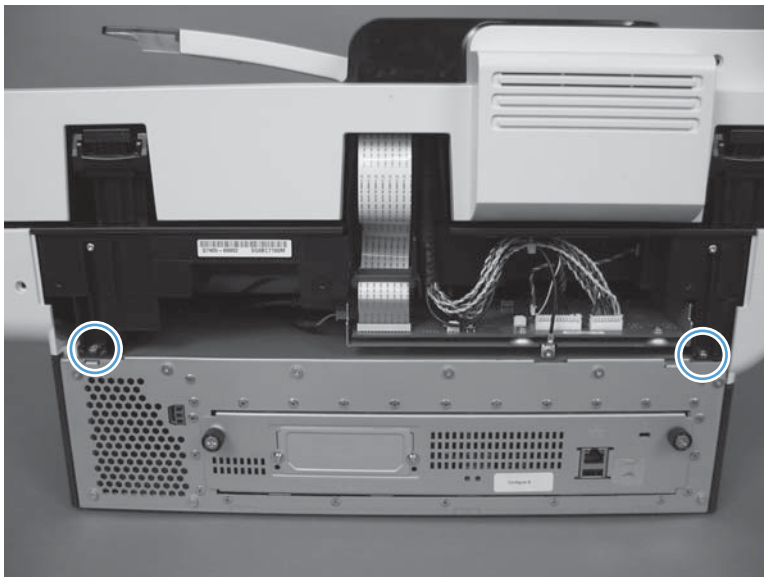

6. Lift the flatbed scanner and ADF assembly.

Figure 2-36 Remove the flatbed scanner and ADF assembly (6 of 7)

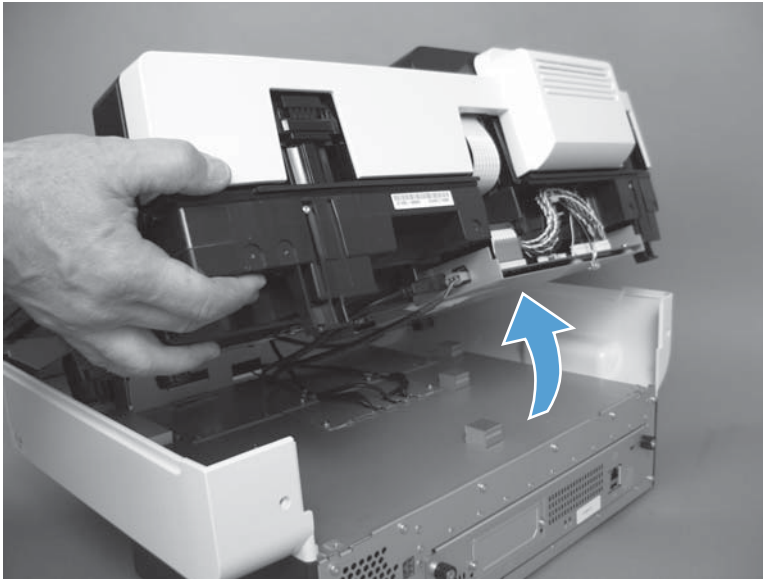

7. Disconnect three cables and then remove the flatbed scanner and ADF assembly.

Figure 2-37 Remove the flatbed scanner and ADF assembly (7 of 7)

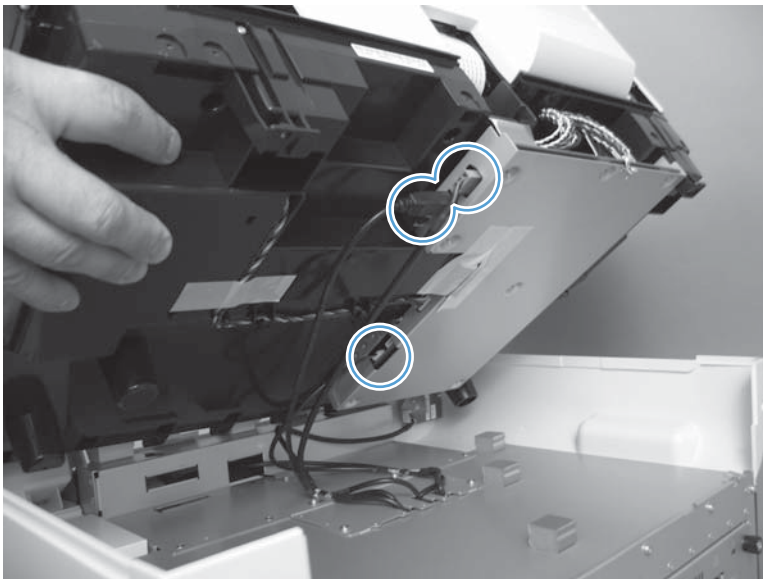

Reinstall the flatbed scanner and ADF assembly

NOTE: After the flatbed scanner and ADF assembly is replaced, the product compares the firmware version on the new assembly with the firmware on the product. If the firmware on the product is newer, the firmware on the assembly is updated. The product will restart multiple times during the update process.

After installing a new flatbed scanner and ADF assembly, reset the cycle counts.

Reset the cycle counts

1. From the Home screen on the product control panel, touch the [Device Maintenance](#) button.
2. Touch the [Service](#) button and log in.
3. Touch the [Cycle Counts](#) button.
4. Reset the following counts to 0:
 - [Document Feeder Count](#)
 - [Clean Rollers Count](#)
 - [Flatbed Count](#)
 - [ADF Simplex Count](#)
 - [ADF Duplex Count](#)



NOTE: Do not reset the [Send Scan Count](#) setting.

Power-button assembly

Before proceeding, remove the following components:

- Control-panel assembly. See [Control-panel assembly on page 24](#).
- Flatbed scanner and ADF assembly. See [Flatbed scanner and ADF assembly on page 39](#)

Remove the power-button assembly

CAUTION:  ESD sensitive component.

1. Disconnect one connector (callout 1), and remove two screws (callout 2).

Figure 2-38 Remove the power-button assembly (1 of 3)

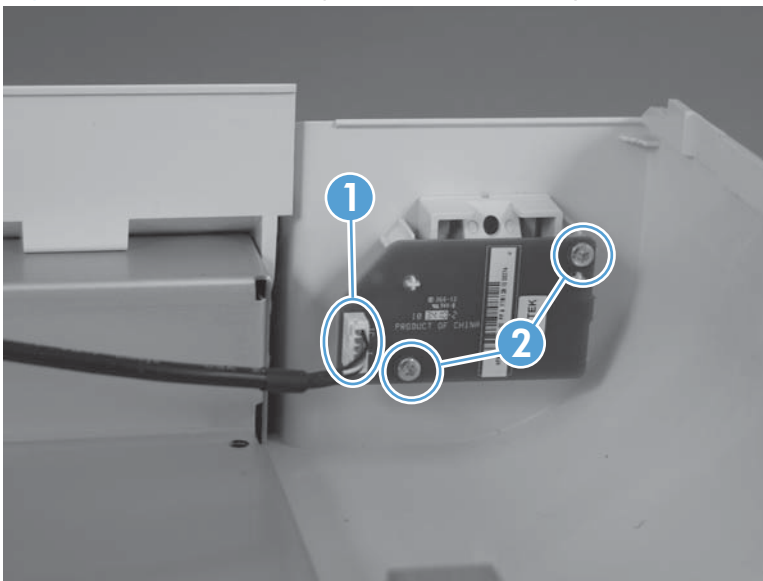

2. Remove the power-button assembly.

Figure 2-39 Remove the power-button assembly (2 of 3)

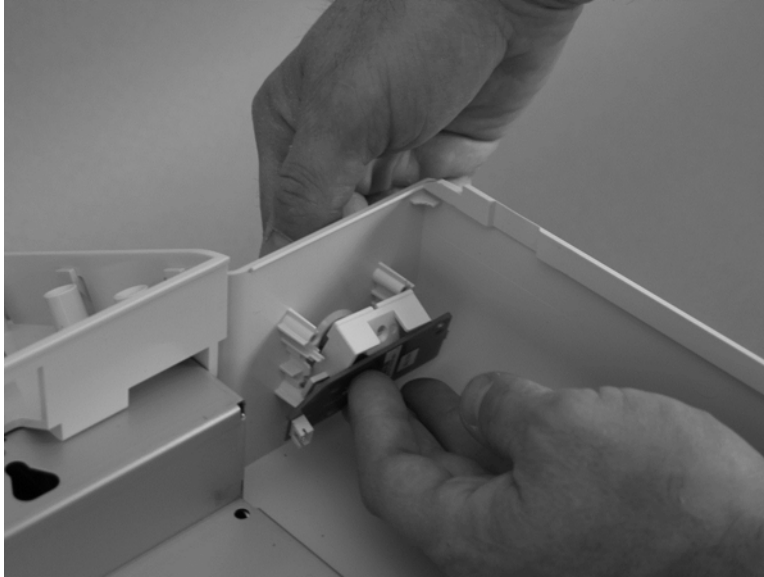

Reinstall the power-button assembly

- ▲ When installing the power-button assembly, install the button first and then install the PCA.

Figure 2-40 Remove the power-button assembly (3 of 3)

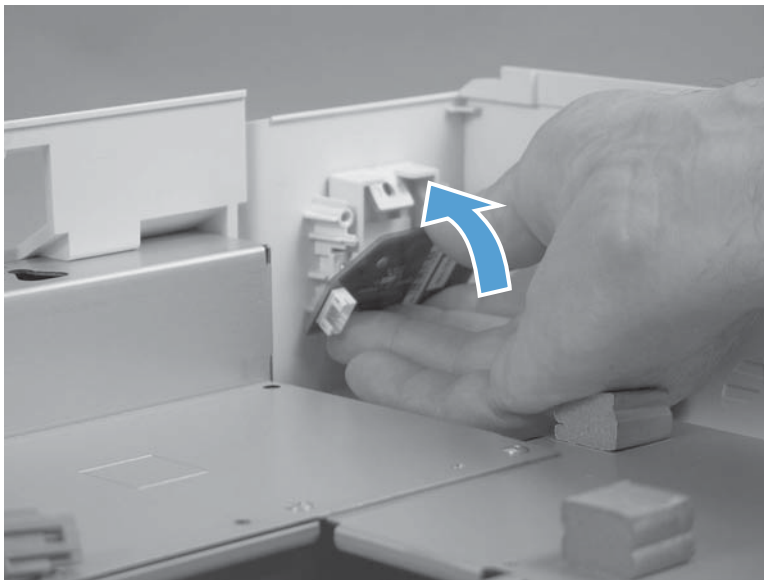

Interconnect cable, scanner cable, and control-panel cable

Before proceeding, remove the following components:

- Control-panel assembly. See [Control-panel assembly on page 24](#).
- Flatbed scanner and ADF assembly. See [Flatbed scanner and ADF assembly on page 39](#).

Remove the scanner cable, control-panel cable, and interconnect cable

1. Remove four screws

Figure 2-41 Remove the scanner cable, control-panel cable, and interconnect cable (1 of 4)

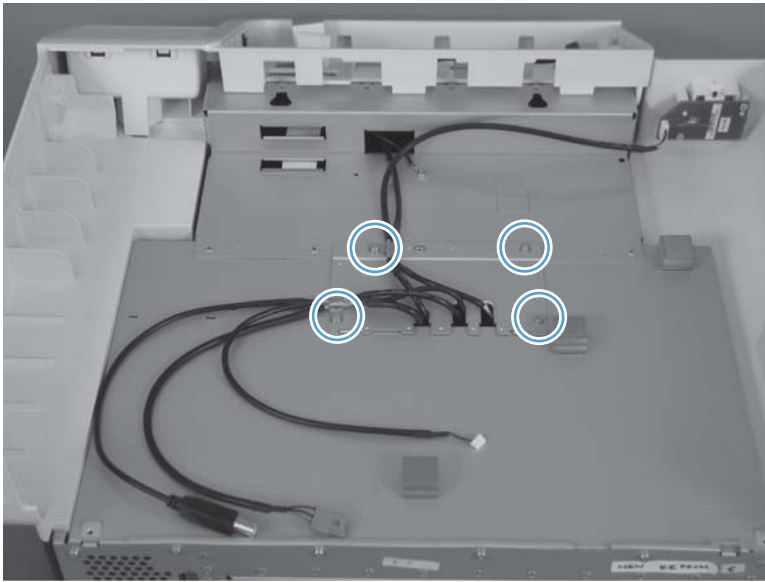

2. Release two tabs and remove the sheet-metal plate.

Figure 2-42 Remove the scanner cable, control-panel cable, and interconnect cable (2 of 4)

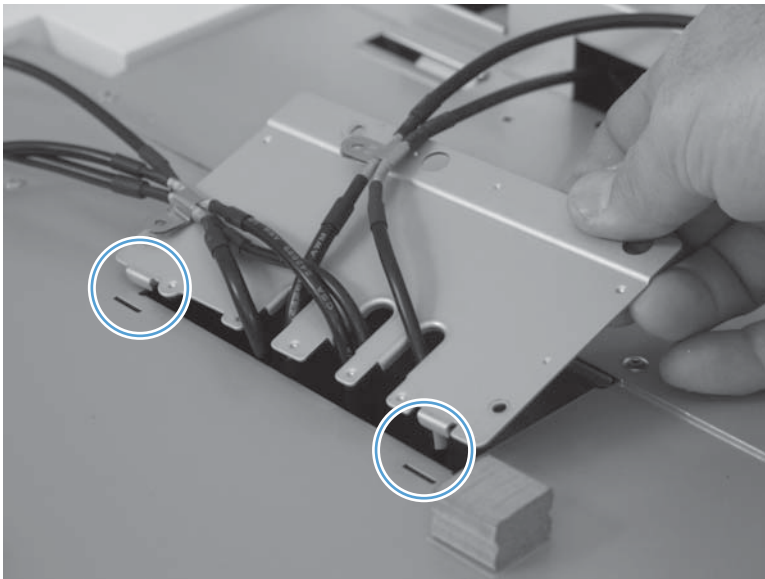

3. Disconnect three cables (callout 1).

Figure 2-43 Remove the scanner cable, control-panel cable, and interconnect cable (3 of 4)

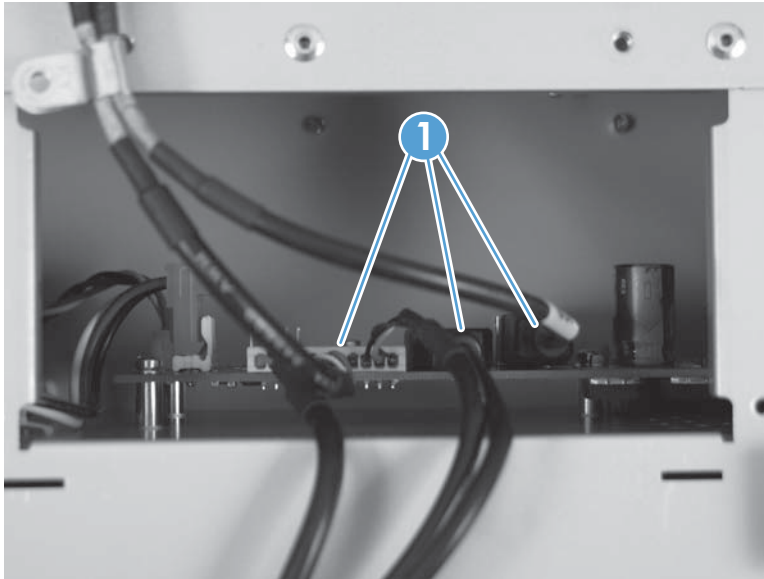

4. Identify the cable to be removed:

- Scanner cable (callout 1). See [Remove the scanner cable on page 48](#).
- Control-panel cable (callout 2). See [Remove the control-panel cable on page 49](#).
- Interconnect cable (callout 3). See [Remove the interconnect cable on page 51](#).

Figure 2-44 Remove the scanner cable, control-panel cable, and interconnect cable (4 of 4)

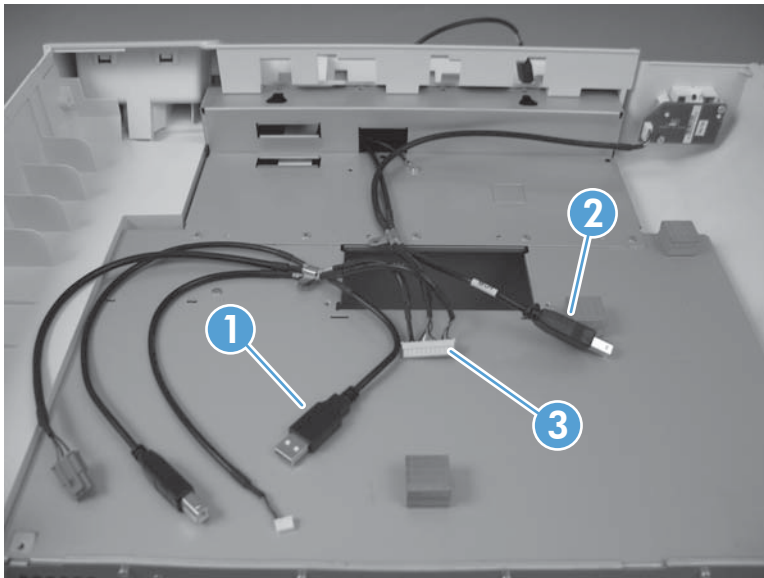

Remove the scanner cable

1. If connected, disconnect the scanner cable from the interconnect PCA.

Figure 2-45 Remove the scanner cable (1 of 3)



2. Release the cable from one cable clamp.

Figure 2-46 Remove the scanner cable (2 of 3)

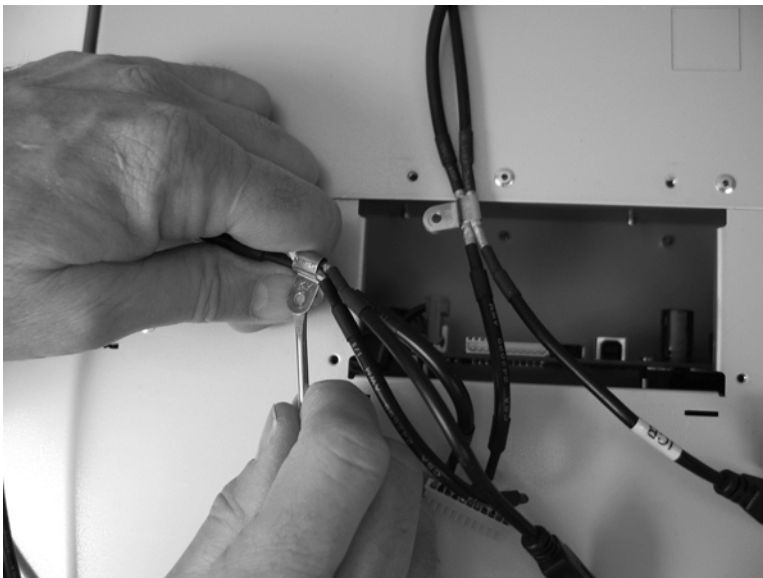

3. Remove the scanner cable.

Figure 2-47 Remove the scanner cable (3 of 3)

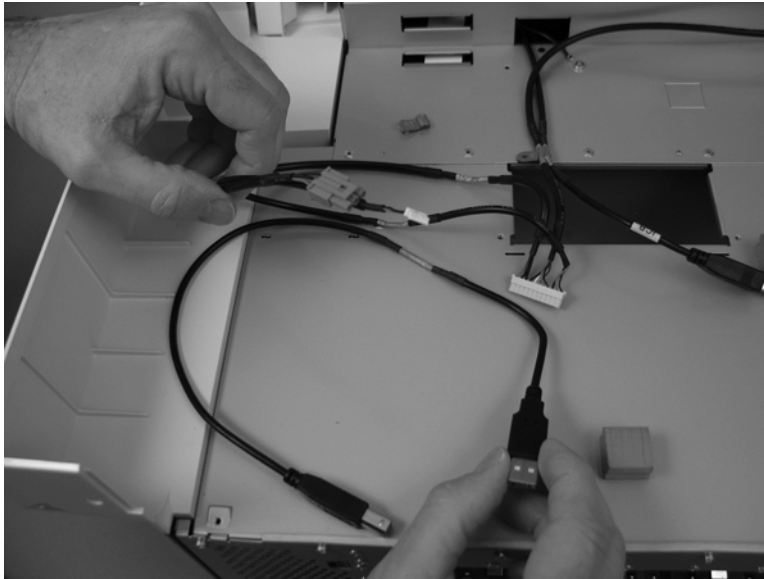

Remove the control-panel cable

1. If connected, disconnect the control-panel cable from the interconnect PCA.

Figure 2-48 Remove the control-panel cable (1 of 3)



2. Release the cable from one cable clamp.

Figure 2-49 Remove the control-panel cable (2 of 3)

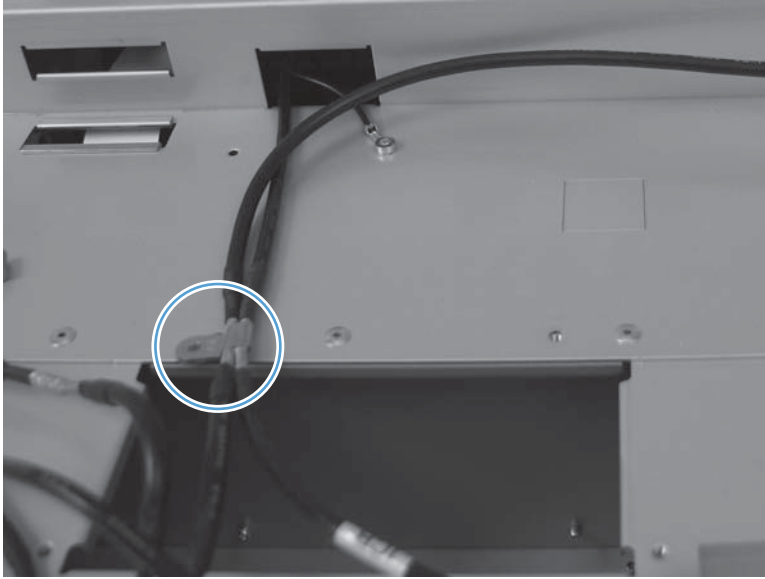

3. Remove the control-panel cable.

Figure 2-50 Remove the control-panel cable (3 of 3)

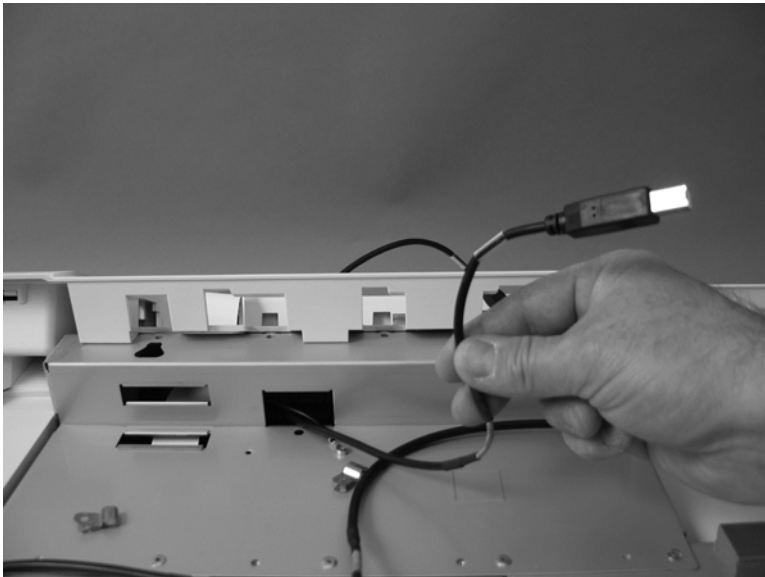

Remove the interconnect cable

1. If connected, disconnect the interconnect cable from the interconnect PCA.

Figure 2-51 Remove the interconnect cable (1 of 4)



2. Release the cable from one cable clamp.

Figure 2-52 Remove the interconnect cable (2 of 4)

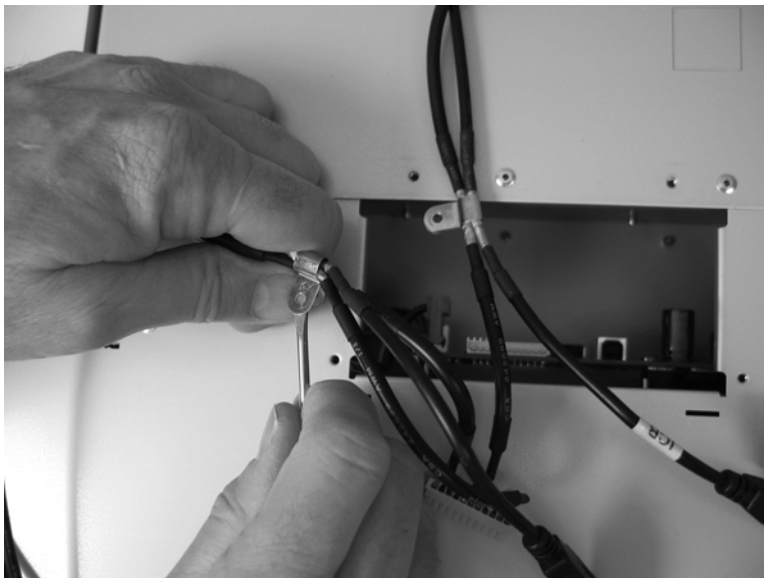

3. Release the cable from one cable clamp (callout 1) and disconnect one connector (callout 2).

Figure 2-53 Remove the interconnect cable (3 of 4)

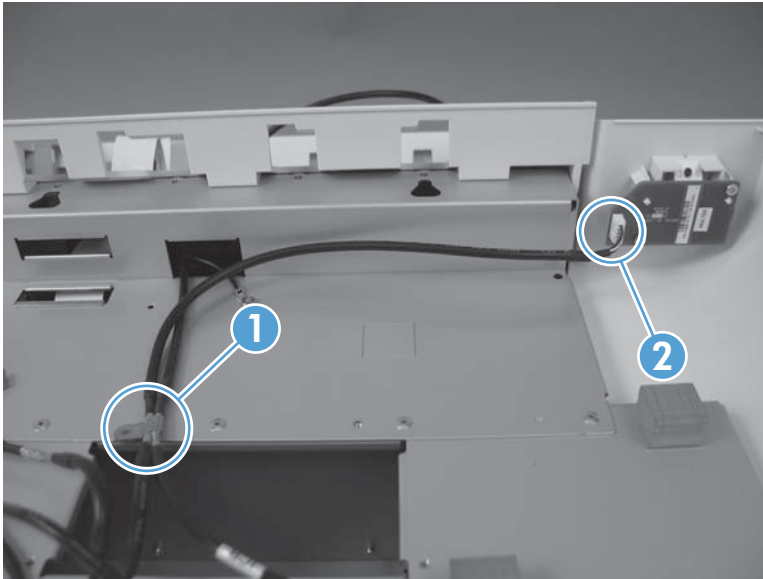

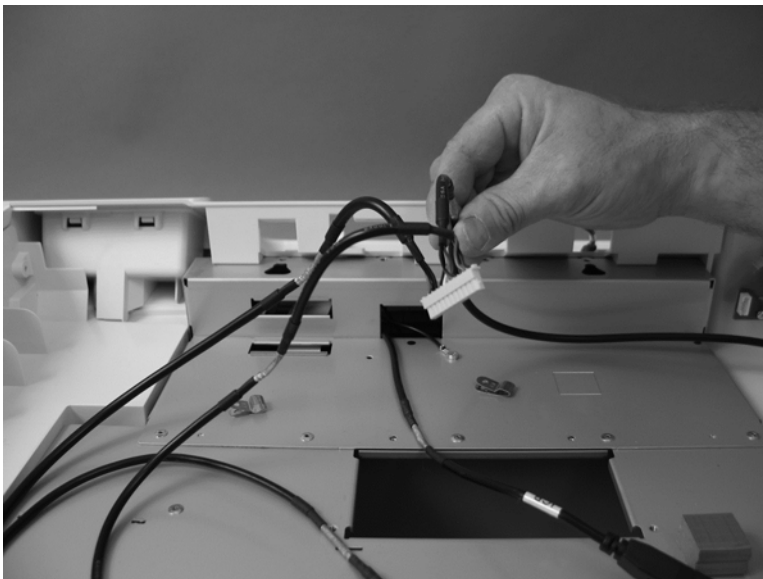

4. Remove the interconnect cable.

Figure 2-54 Remove the interconnect cable (4 of 4)



Interconnect PCA, fan assembly, and DC controller PCA

 **NOTE:** When a replacement interconnect PCA is installed and the product is turned on, it restores the NVRAM values from the NVRAM of the formatter PCA. This process allows the product to return to normal operation with all of the necessary product history.

 **CAUTION:** Replacing the hard disk drive and formatter PCA, hard disk drive and interconnect PCA, or formatter PCA and interconnect PCA at the same time can render the product unusable. Swapping these assemblies between products can also render the product unusable.

Before proceeding, remove the following components:

- Control-panel assembly. See [Control-panel assembly on page 24](#).
- Flatbed scanner and ADF assembly. See [Flatbed scanner and ADF assembly on page 39](#).

Remove the interconnect PCA, fan assembly, and DC controller PCA:

 **CAUTION:**  ESD sensitive component.

1. Remove four screws.

Figure 2-55 Remove the interconnect PCA, fan assembly, and DC connector PCA (1 of 6)

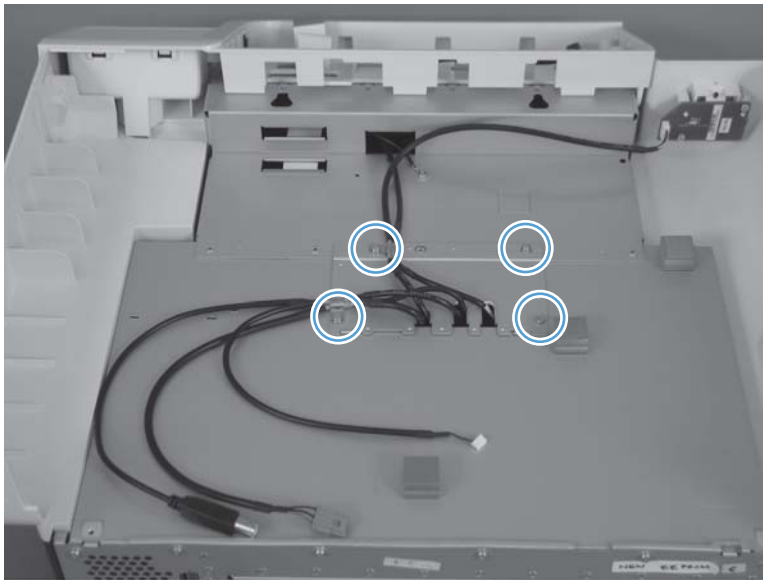

2. Release two tabs and remove the sheet-metal plate.

Figure 2-56 Remove the interconnect PCA, fan assembly, and DC connector PCA (2 of 6)

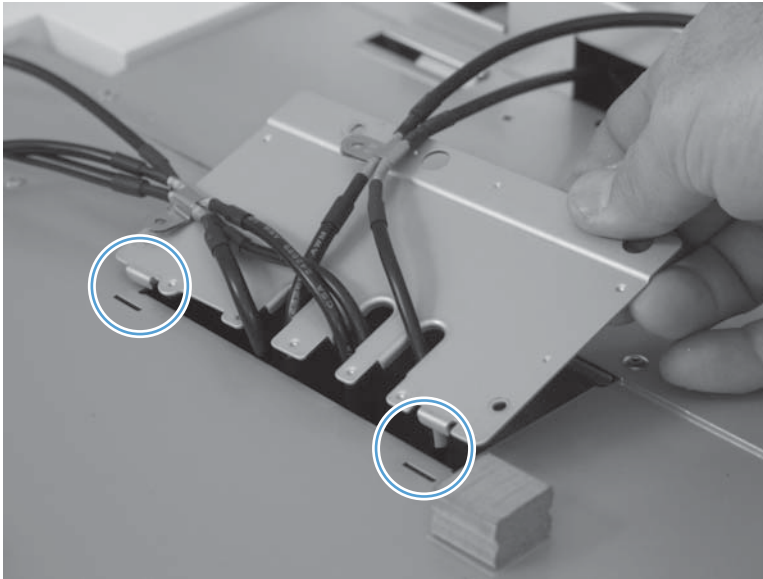

3. Disconnect three cables (callout 1).

Figure 2-57 Remove the interconnect PCA, fan assembly, and DC connector PCA (3 of 6)

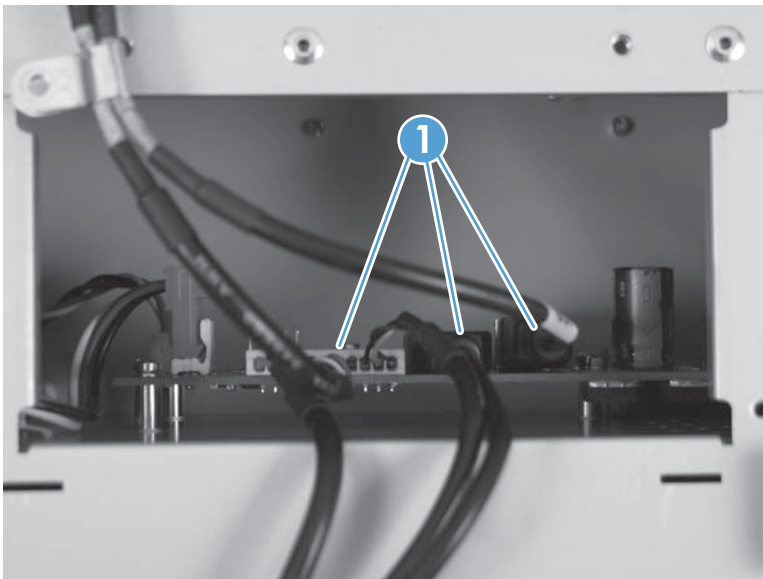

4. Remove nine screws.

Figure 2-58 Remove the interconnect PCA, fan assembly, and DC connector PCA (4 of 6)

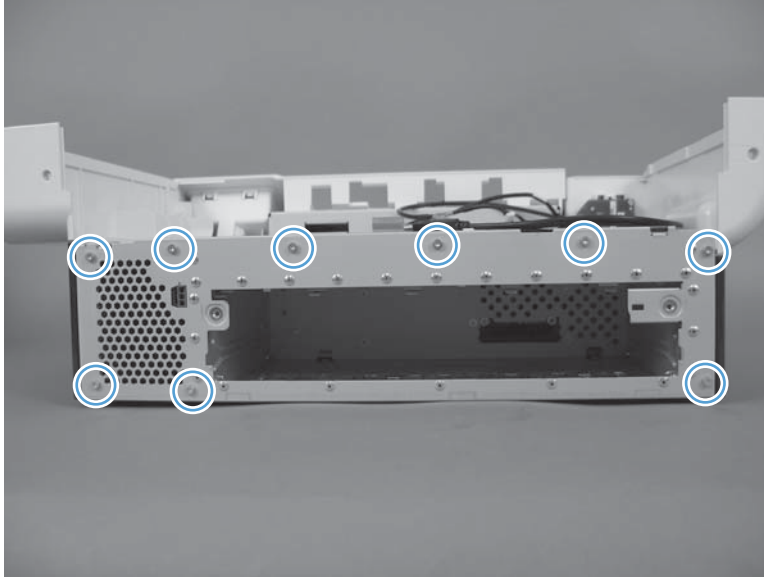

5. Slide the sheet-metal drawer out of the product.

Figure 2-59 Remove the interconnect PCA, fan assembly, and DC connector PCA (5 of 6)

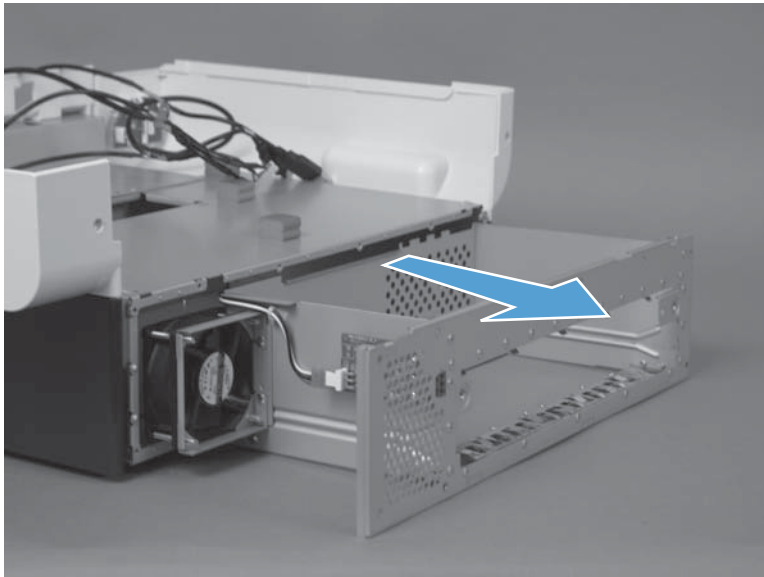

6. Identify the PCA or assembly to be removed:
 - Interconnect PCA (callout 1). See [Remove the interconnect PCA on page 56](#).
 - Fan assembly (callout 2). See [Remove the fan assembly on page 57](#).
 - DC controller PCA (callout 3). See [Remove the DC controller PCA on page 58](#).

Figure 2-60 Remove the interconnect PCA, fan assembly, and DC connector PCA (6 of 6)

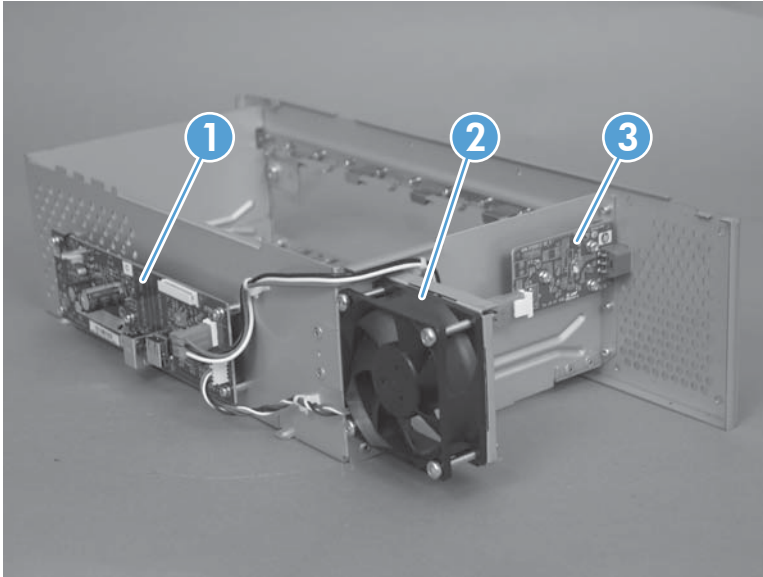

Remove the interconnect PCA

- ▲ Disconnect two connectors (callout 1), remove four screws (callout 2), and remove the interconnect PCA.

Figure 2-61 Remove the interconnect PCA

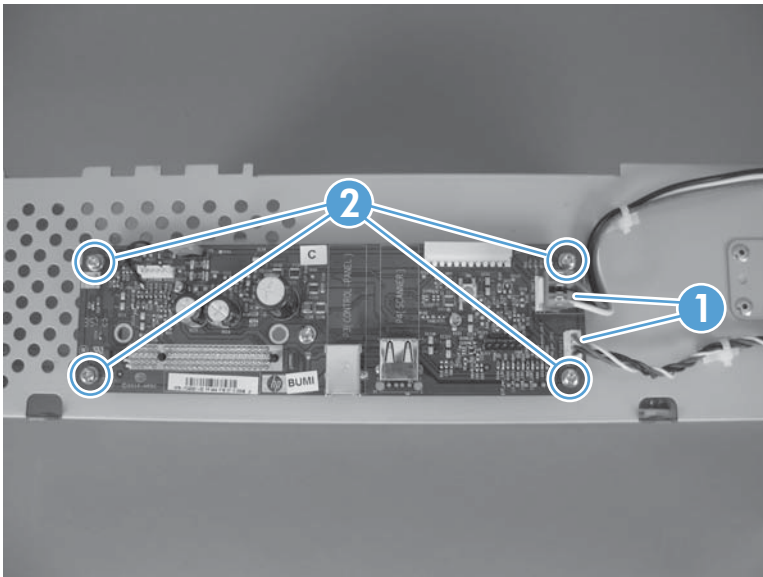

Remove the fan assembly

1. Release one cable retainer.

Figure 2-62 Remove the fan assembly (1 of 3)



2. Disconnect one connector (callout 1) and then remove four screws (callout 2).

Figure 2-63 Remove the fan assembly (2 of 3)

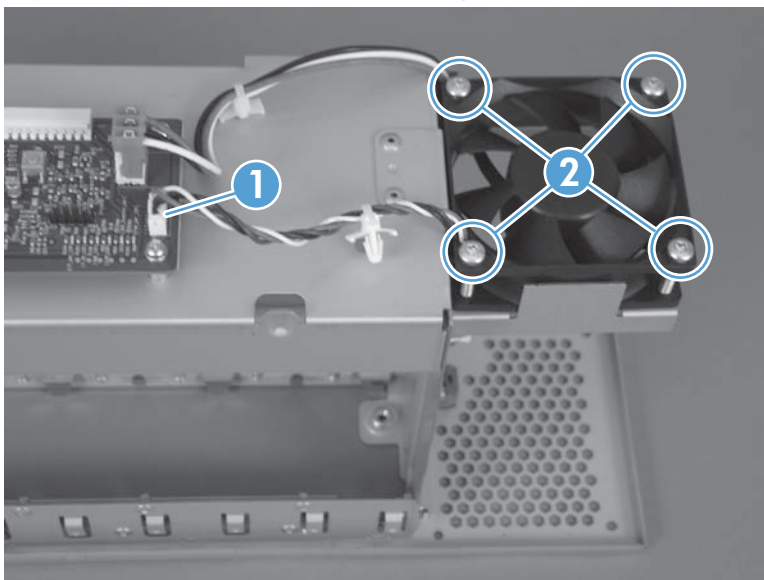

3. Remove the fan assembly.

Figure 2-64 Remove the fan assembly (3 of 3)



Remove the DC controller PCA

- ▲ Disconnect one connector (callout 1), remove three screws (callout 2), and remove the DC controller PCA.

Figure 2-65 Remove the DC controller PCA

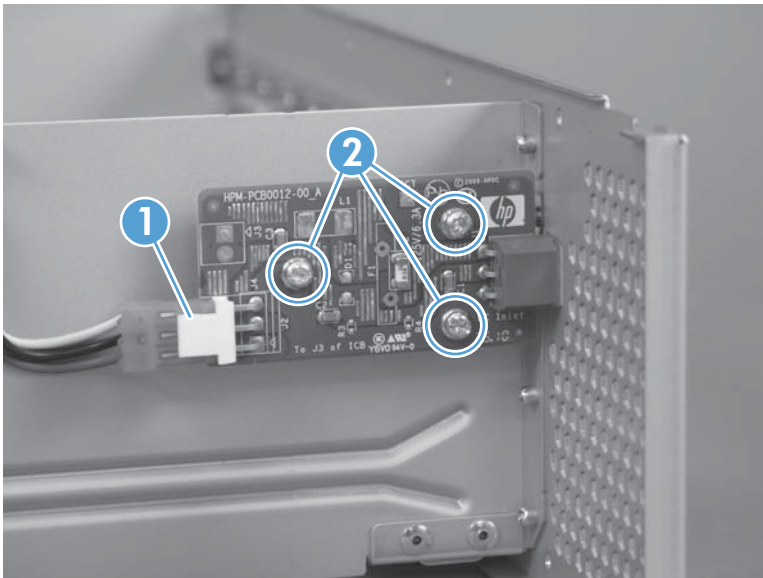

3 Solve problems

- [Solve problems checklist](#)
- [Administration Menu Map](#)
- [Preboot menu options](#)
- [Current settings page](#)
- [Troubleshooting process](#)
- [Tools for troubleshooting](#)
- [Clear jams](#)
- [Solve paper-handling problems](#)
- [Clean the product](#)
- [Solve connectivity problems](#)
- [Service mode functions](#)
- [Preboot menu options](#)
- [Solve fax problems](#)
- [Solve e-mail problems](#)
- [Product updates](#)

Solve problems checklist

Simple issues such as smudges on the scanning glass or loose cables can cause your product to produce fuzzy scans, operate in an unexpected manner, or fail to operate. Always check the following items when you encounter scanning problems.

- If scans are fuzzy, check to see if the scanning strip to the left of the scanning glass is dirty or smudged. If so, clean the scanning strip.

If you are scanning a document that will be analyzed using Optical Character Recognition (OCR), make sure that the original document is clear enough to be analyzed.

- Make sure that the Ethernet and power cables are firmly seated in their respective connectors on the back of the product, and that the power cord is plugged into a working electrical outlet or surge protector.
- Ensure that the product is receiving power.
 - Check that the green LED on the power supply case is on.
 - If the green LED is not on, ensure that power is available to the power outlet or surge protector that the power supply is plugged into.
 - If power is available to the power outlet or surge protector but the green LED is still not on, the power supply might be defective.
- Make sure that the power LED and heartbeat LED on the formatter are functioning correctly.
- Make sure that the product buttons are enabled.
- Press and hold the power button for 10 seconds to turn off the product, wait 30 seconds, and then press the Power button again to turn on the product.
- Make sure the automatic document feeder (ADF) hatch is closed.
- Verify that the product is connected to the LAN, and that the product is correctly configured to use the network.

If you continue to have problems, it is possible that the firmware or associated drivers are out of date or have become corrupted. Go to www.hp.com/support to locate firmware and driver updates for the product.

Administration Menu Map

The [Administration Menu Map](#) report presents the entire structure of the [Administration](#) menu so you can identify how to navigate to any option.

1. From the Home screen on the product control panel, touch the [Administration](#) button.
2. Open the following menus:
 - [Reports](#)
 - [Configuration/Status Pages](#)
 - [Administration Menu Map](#)
3. Touch the [View](#) button to view the report.

Preboot menu options



If an error occurs while the product is booting, an error message appears on the control-panel display. The user can access the Preboot menus. The Error menu item will not be seen if an error did not occur.

 **CAUTION:** The [Clean Disk](#), or [Format Disk](#) (in newer firmware versions), option performs a disk initialization for the entire disk. The operating system, firmware files, and third party files (among other files) will be completely lost. HP does not recommend this action unless upgrading firmware from the preboot menu.

Access the Preboot menu

1. Turn the product on.
2. Press and hold the Stop  button when the LED lights are illuminated solid.
3. Use the keyboard to navigate the menu.

Cold reset using the Preboot menu

1. Turn the product on.
2. Press the Stop  button when the [Ready](#), [Data](#), and [Attention](#) LEDs are illuminated solid.
3. On the product keyboard press the down arrow to highlight [Administrator](#), and then press the enter key.
4. On the product keyboard press the down arrow to highlight [Startup Options](#), and then press the enter key.
5. On the product keyboard press the down arrow to highlight [Cold Reset](#), and then press the enter key.
6. On the product control panel press the back arrow  button twice to highlight the [Continue](#) option, and then press the enter key on the keyboard.

 **NOTE:** The product will initialize.

Current settings page

The current settings pages provides a map of the user configurable settings that might be helpful in the troubleshooting process.

1. From the Home screen on the product control panel, touch the [Administration](#) button.
2. Open the following menus:
 - [Reports](#)
 - [Configuration/Status Pages](#)
 - [Current Settings Page](#)
3. Touch the [View](#) button to view the report.

Troubleshooting process

Determine the problem source

When the product malfunctions or encounters an unexpected situation, the product control panel alerts you to the situation. A troubleshooting flowchart helps you diagnose the root cause of the problem. The remainder of this chapter provides steps for correcting problems.

- Use the troubleshooting flowchart to pinpoint the root cause of hardware malfunctions. The flowchart guides you to the section of this chapter that contains steps for correcting the malfunction.

Before beginning any troubleshooting procedure, check the following issues:

- Are supply items within their rated life?
- Does the configuration page reveal any configuration errors?



NOTE: The customer is responsible for checking supplies and for using supplies that are in good condition.

Troubleshooting flowchart

Symptom	Check	Possible causes	Possible solutions
The control-panel display is blank, no lights are lit, and the product makes no sounds from the motors.	Is the power on?	The power cable is disconnected.	<ol style="list-style-type: none"> 1. Make sure that the power cable is connected to the power supply and a power outlet or power strip. Make sure the power supply is connected to the product. 2. If power cable is connected to a power strip, make sure that power strip is connected to the power outlet and the power strip is turned on. If the power strip has a circuit breaker, reset the circuit breaker. <p>See Power-on checks on page 68.</p>
		The power outlet is not functioning.	<p>Test the outlet by connecting the product to an outlet that is known to work.</p> <p>See Power-on checks on page 68.</p>
		The external power supply has failed.	<p>If the problem persists, replace the external power supply.</p> <p>See Power-on checks on page 68.</p>
	Are the subassemblies receiving power? See Power-on checks on page 68 .	Bad connection to the DC controller PCA	<ol style="list-style-type: none"> 1. Turn the power off. 2. Check all connections to the DC controller PCA. 3. Turn the power on. <p>See the replacement procedure for the DC controller PCA in the service manual.</p>
		Bad connection to the interconnect PCA	<ol style="list-style-type: none"> 1. Turn the power off. 2. Check all connections to the interconnect PCA. 3. Turn the power on. <p>See the replacement procedure for the interconnect PCA in the service manual.</p>

Symptom	Check	Possible causes	Possible solutions
		DC controller PCA is defective.	Replace the DC controller PCA. See the replacement procedure for the DC controller PCA in the service manual.
		interconnect PCA is defective.	Replace the interconnect PCA. See the replacement procedure for the interconnect PCA in the service manual.
The control-panel display is blank, no LED's are lit, but the other subassemblies have power.	Is the device in sleep mode?	The product is in sleep mode.	Touch the touchscreen display.
	Is the brightness of the touchscreen display turned off?	The touchscreen display brightness is off.	Press the + sign on the brightness adjustment button until the control-panel display shows.
	Are the cables to the control panel connected?	The cables are not connected.	Check the cable connections. See the replacement procedure for the control panel in the service manual.
		The control-panel display is defective.	Replace the control-panel display. See the replacement procedure for the control-panel display in the service manual.
The product stops during the startup process.	What state is the touchscreen showing?	The firmware was recently updated.	Wait 5 minutes and then restart the product.
		The formatter, interconnect PCA, or another assembly was recently replaced.	
		The firmware is corrupt.	See Firmware startup steps on page 69 .
		The firmware on an assembly is not updating.	
		The hard drive, formatter, or other assembly is defective.	
An error or warning message displays on the control-panel display.	Does the message display on the status line?	A supply limit is approaching.	Follow the instructions to resolve the warning message.
	Does message display as a full screen?	An error condition exists within the product.	Follow the instructions to resolve the error message.

Symptom	Check	Possible causes	Possible solutions
The product cannot connect to the network.	Has an IP address been assigned to the product?	The product was not configured.	Touch the Network Address button on the control panel to display the IP address.
		The product was reset to factory default settings.	Check the configuration from the control-panel display or HP Embedded Web Server.
	Are network cables connected?	The network cables are disconnected.	Check each cable connection. If the problem persists, try a different cable or port on the hub or transceiver.
	Can you ping the product using its IP address?	No network connection	Use the command prompt to ping the product from your computer. For example: ping 192.168.45.39 Ensure that the ping displays round-trip times. If you are able to ping the product, verify that the IP address configuration for the product is correct on the computer. If it is correct, delete and then add the product again. If the ping command failed, verify that the network hubs are on, and then verify that the network settings, the product, and the computer are all configured for the same network.
	Is the HP Jetdirect embedded print server functioning?	The HP Jetdirect embedded print server is not configured correctly.	Check the HP Jetdirect LEDs on the formatter. The top-left LED is green and indicates the link status. If it is off, a link has failed. The top-right LED is yellow. It blinks on and off to indicate network activity.
		The formatter is defective.	See the replacement procedure for the formatter PCA in the service manual.
	Are the link speed and duplex settings correct?	The product is not configured correctly.	The link speed and communication mode of the Jetdirect server must match the network settings. The available settings depend on the product and installed Jetdirect server. Leave the setting in automatic mode (the default setting).
	Is the protocol enabled?	The product is not configured correctly.	Check the protocol status using the HP Embedded Web Server. See the features of the HP Embedded Web server in the service manual.

Symptom	Check	Possible causes	Possible solutions
The product will not scan.	Do the flatbed scanner and document feeder start up correctly?	The firmware for the flatbed scanner and ADF assembly is corrupted.	<ol style="list-style-type: none"> 1. Verify that the flatbed scanner and ADF assembly is receiving power and the firmware is functioning by loading a sheet of paper in the input tray and verifying that the Document load/detect LED turns on. 2. Turn the product off and then on. 3. Upgrade the product firmware. See the firmware upgrade process in the service manual. 4. Restart the product.
		The flatbed scanner and ADF assembly is defective.	<p>Replace the flatbed scanner and ADF assembly.</p> <p>See the replacement procedure for the flatbed scanner and ADF assembly in the service manual.</p>

Power subsystem

Power-on checks

The basic product functions should start up as soon as the product is plugged into an electrical outlet and the power switch is pushed to the *on* position. If the product does not start, use the information in this section to isolate and solve the problem.

Power-on troubleshooting overview

Turn on the product power. If the control-panel display remains blank, random patterns appear, or asterisks remain on the display, perform power-on checks to locate the cause of the problem.

During normal operation, the main cooling fan begins to spin briefly after the product power is turned on. Place your hand on the rear cover, next to the formatter. If the fan is operating, you will feel a slight vibration and feel air passing into the product. You can also lean close to the product and hear the fan operating. When this fan is operational, the DC side of the power supply is functioning correctly.

After the fan is operating, the scanner motor turns on (unless the top cover is open, a jam condition is sensed, or the paper-path sensors are damaged). You should be able to visually determine if the scanner motor is turned on if the flatbed carriage moves as it calibrates and the scanner LED lights blink.

If the control panel is blank when you turn on the product, check the following items.

1. Make sure that the product is plugged into an active electrical outlet that delivers the correct voltage.
2. Make sure that the power switch is in the *on* position.
3. Make sure that the fan runs briefly, which indicates that the power supply is operational.
4. Make sure that the control-panel display FFC cable and USB cable are connected. Turn the power off to check this.
5. Make sure that the formatter is seated and operating correctly. The heartbeat LED should be blinking, and the connectivity LED should be illuminated.
6. Verify that the firmware for the flatbed scanner and ADF assembly is functioning by loading a sheet of paper in the input tray and verifying that the Document load/detect LED turns on.
7. Use the brightness adjustment button on the control panel to make sure that it is not all the way up or all the way down.
8. Remove any HP Jetdirect or other EIO cards, and then try to turn the product on again.



NOTE: It is important to have the control panel functional as soon as possible in the troubleshooting process so that the control-panel display can be used to help locate product errors.

Firmware startup steps

If the product stops during the startup process, note the touchscreen display number and then review the possible solutions.

Touchscreen display	Startup step	Description	Possible solutions
1	BIOS	Starts the formatter	<ol style="list-style-type: none">1. Check the lights on the formatter.2. If the lights are off, turn the product off and then make sure the formatter PCA is firmly seated in the product. Turn the product on.3. If the problem persists, replace the formatter PCA. See the replacement procedure in the service manual.

Touchscreen display	Startup step	Description	Possible solutions
2	BIOS preboot	Extracts and installs the firmware on the first startup after a firmware upgrade	<ol style="list-style-type: none"> 1. Turn the product off and then on. 2. Upgrade the firmware using the preboot menu. 3. If the problem persists, replace the formatter PCA. See the replacement procedure in the service manual.
3	Operating system startup	Starts Windows	<ol style="list-style-type: none"> 1. Turn the product off and then on. 2. Upgrade the firmware using the preboot menu. 3. If the problem persists, replace the hard drive. See the replacement procedure in the service manual.
4	Shell startup	Starts the touchscreen	<ol style="list-style-type: none"> 1. Turn the product off and then on. 2. Upgrade the firmware using the preboot menu. 3. If the problem persists, replace the hard drive. See the replacement procedure in the service manual.
5	Not used		
6	Partition manager	Sets up the hard drive	<ol style="list-style-type: none"> 1. Turn the product off and then on. 2. Check the hard drive connections and make sure the formatter PCA is firmly seated in the product. 3. If the problem persists, replace the hard drive. See the replacement procedure in the service manual.

Touchscreen display	Startup step	Description	Possible solutions
Disk check	Only Happens on hard reset	Checks the disk	<ol style="list-style-type: none"> 1. Turn the product off and then on. 2. If the problem persists, replace the hard drive. See the replacement procedure in the service manual.
7	Installation manager	Installs all other components including the scanner firmware	<p>Check the secondary EIO device</p> <ol style="list-style-type: none"> 1. If a secondary EIO device has been installed, turn the product off, remove the device, and then turn the product on. 2. If the product starts properly, verify that the firmware loaded on product supports the EIO device. 3. If the product does not start, update the product to firmware that supports the secondary EIO device and then reinstall the device. If the problem persists, replace the EIO device. <p>Check the HIP accessory</p> <ol style="list-style-type: none"> 1. If an accessory has been installed in the hardware integration pocket (HIP), turn the product off, remove the accessory and turn the product on. 2. If product starts properly, verify that the firmware on the product supports the accessory. If not, update the product to firmware that supports the accessory. 3. Reinstall the accessory. If the problem persists, replace the accessory.

Touchscreen display	Startup step	Description	Possible solutions
			<p>Check the flatbed scanner and ADF assembly</p> <ol style="list-style-type: none"> 1. Load paper in document feeder and verify that the document load/detect LED turns on. 2. If the light does not turn on, make sure all doors and hatches are closed. 3. If the flatbed scanner and ADF assembly has been recently replaced, check all cable connections and then restart the product. 4. If the product does not start, upgrade the firmware from the preboot menu. 5. If the problem persists, replace the flatbed scanner and ADF assembly. See the replacement procedure in the service manual.
8	Firmware startup process	Starts the main program that runs all other assemblies on the product	Turn the product off and then on.
Checking hardware	Hardware status check	Checks the status of all hardware.	Follow the steps displayed in the error message.
Initializing	Initializing devices	Initializes devices and key NVRAM values	Follow the steps displayed in the error message.

Control-panel checks

Control-panel checks from the control panel

1. From the Home screen on the product control panel, touch the [Administration](#) button.
2. Open the following menus:
 - [Troubleshooting](#)
 - [Diagnostic Tests](#)
 - [Control Panel](#)
3. Follow the onscreen instructions to use the following tests:
 - [LEDs](#): tests the functionality of the LEDs
 - [Display](#): conducts a series of tests on the display
 - [Buttons](#): tests the functionality of the keys
 - [Touch Grid](#): verifies that all areas respond to a touch

Control-panel checks from diagnostic mode

The product includes a diagnostic test mode for the control panel. This mode allows you to troubleshoot issues with the touchscreen, keypad, LEDs and speaker.

1. Press and hold the plus sign (+) on the brightness adjustment control toggle.
2. Press the Start  button to initiate diagnostic mode.

Many of the diagnostic tests are for factory use only. You can use the following tests:

Calibrate	Calibrates the touchscreen Use a 2 mm stylus to touch the inner portion of the targets Cal1, Cal2, and Cal3. <ul style="list-style-type: none">• Green: Best calibration values• Yellow: Allowable calibration values• Red: Unacceptable calibration values When all calibration levels display in green, press the Start  button to save.
Touch Point	Verifies that 10 strategic targets respond to touch within acceptable limits Touch each target. When successfully touched, the color of the target changes to red.

Touchscreen	<p>Verifies that all areas respond to touch</p> <p>Touch the grid to show the accuracy of the calibration. Touching the display shows as white dots. Use a 3 mm stylus to trace the gap between the two green lines.</p>
Keyboard LED	<p>Verifies the functionality of buttons and LEDs</p> <p>Touch the buttons on the control panel and observe the virtual buttons on the touchscreen. This test counts the number of times you press each button.</p> <p>Touch the virtual LEDs on the touchscreen to turn the physical LEDs on or off.</p> <p>Touch the Cancel test button to exit the test.</p>
Test Pattern	<p>Tests visual anomalies</p> <p>Use the keypad on the screen to select different background screens.</p>
Sound	<p>Tests the speaker</p> <p>Press the 1 key on the keyboard to test the sound.</p>
Panel Reset	<p>Reboots the control panel</p>

If the touchscreen does not function, use the keypad to navigate:

- Press the 3 button to move up.
- Press the 5 button to move left.
- Press the 6 button to move right.
- Press the 9 button to move down.

Exit diagnostic mode

- ▲ Do one of the following:
 - Touch the **Panel Reset** button.
 - Touch the Stop  button.

Generate debug data

Generate and export a snapshot of the system.

1. From the Home screen on the product control panel, touch the [Administration](#) button.
2. Open the following menus:
 - [Troubleshooting](#)
 - [Generate Debug Data](#)
 - [Retrieve Diagnostic Data](#)
3. Selected the file type.
4. Touch [Send To Email](#) or [Export to USB](#) to export the debug information.

Check the maintenance history

Check the maintenance history of the document feeder kit and roller cleaning.

Check the maintenance history of the document feeder kit

1. From the Home screen on the product control panel, touch the [Administration](#) button.
2. Open the following menus:
 - [Manage Supplies](#)
 - [Reset Supplies](#)
 - [New Document Feeder Kit](#)

Check the maintenance history of roller cleaning

1. From the Home screen on the product control panel, touch the [Device Maintenance](#) button.
2. Open the following menus:
 - [Calibrate/Cleaning](#)
 - [Clean Rollers](#)

Check the number of scans

1. From the Home screen on the product control panel, touch the [Device Maintenance](#) button.
2. Touch the [Service](#) button and log in.
3. Touch the [Cycle Counts](#) button.
4. Touch a scan count type.

Tools for troubleshooting

The section describes the tools that can help solve problems with the product.

Component diagnostics

LED diagnostics

LED diagnostics can identify and troubleshoot product problems.

LED indicators on the formatter

Three LEDs on the formatter indicate that the product is functioning correctly.

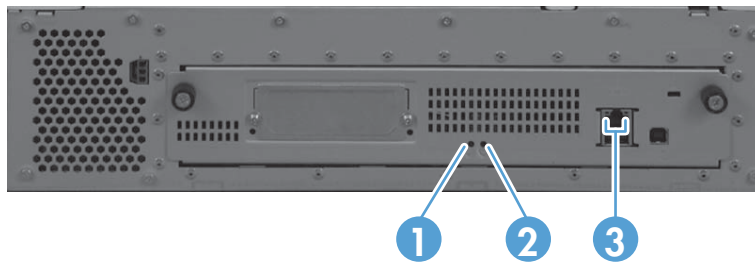

1	Power LED
2	Heartbeat LED
3	HP Jetdirect LEDs

Power LED

The power LED indicates that the formatter has power.

Formatter heartbeat LED

The heartbeat LED indicates that the formatter is functioning correctly. While the product is initializing after you turn it on, the LED flashes rapidly, and then turns off. When the product has finished the initialization sequence, the heartbeat LED pulses on and off.

HP Jetdirect LEDs

The embedded HP Jetdirect print server has two LEDs. The yellow LED indicates network activity, and the green LED indicates the link status. A blinking yellow LED indicates network traffic. If the green LED is off, a link has failed.















For link failures, check all the network cable connections. In addition, you can try to manually configure the link settings on the embedded print server by using the product control-panel menus.

1. From the Home screen on the product control panel, touch the [Administration](#) button.
2. Touch the [Network Settings](#) button, and then touch the [Embedded Jetdirect Menu](#) button.

3. Touch the **Link Speed** button.
4. Select the appropriate link speed, and then touch the **Save** button.

Interpret control-panel status lights

The product has five LEDs on the control panel that indicate product status. The table below explains how to interpret these LEDs.

LED behavior	Description
All LEDs are off.	The product is turned off.
Sleep LED  is on.	The scanner is in sleep (power conservation) mode.
Sleep LED  is flashing.	The scanner is entering or exiting sleep mode.
Sleep LED  is off.	The scanner is not in sleep mode, nor is it transitioning sleep status (on or off).
Power LED  is on.	The product is powered on.
Power LED  is blinking.	The AC adapter is plugged in to the product, and the product is turned off.
Power LED  is off.	The power supply is not providing power to the product.
Ready LED  is on.	The product is online and able to accept input.
Ready LED  is flashing.	The product is pausing a request or has stopped receiving input.
Ready LED  is off.	The product is paused and unable to accept input. This may be because the product was deliberately paused, or because the product is in an error state.
Data LED  is on.	The product has data buffered that it has finished processing and is waiting for more data to be transmitted, or the product is paused. When the Attention LED is flashing at the same time, there is an error and there is data waiting to be processed.
Data LED  is flashing.	The product is receiving or processing data.
Data LED  is off.	There is no data for the product to process.
Attention LED  is on.	The product has encountered a critical error, the nature of which is indicated on the display.
Attention LED  is flashing quickly.	The product has encountered an error which requires user intervention, such as a jam in the automatic document feeder.
Attention LED  is off.	No error condition exists.

Engine diagnostics

Verify power to the flatbed scanner and ADF assembly

Place a sheet of paper in the input tray of the document feeder. If the Document load/detect LED turns on, the flatbed scanner and ADF assembly is receiving power and the firmware has been loaded.

Test simplex scanning

1. Select an existing Quick Set from the product control panel.
2. Load a sheet of paper face-up in the input tray. Make sure the face-up side of the paper has printed material on it.
3. Touch the [Preview](#) button.
4. Scan the document and then review the scan in the preview pane.



NOTE: If the scanning-related features have not been enabled, see the system administrator.



NOTE: Test the flatbed scanner by placing a sheet of paper on the scanner glass and scanning.

Test duplex scanning

1. From the product control panel, select a Quick Set for scanning.
 - If scanning starts immediately when a Quick Set is selected, temporarily change this behavior in the EWS while testing duplex scanning.

Change the **Quick Set Start Option** from **Start instantly upon selection** to **Enter application, then user presses Start**.
 - If no Quick Sets are visible at the product control panel, they may need to be enabled in the product's EWS or added to the Home screen in the EWS.
2. In the Quick Set menu, touch the [More Options](#) button.
3. Select [2-sided](#) for the [Original Sides](#) setting.
4. Load a sheet of paper that has printing on both sides in the input tray.
5. Touch the [Preview](#) button.
6. Scan the document using the Quick Set. On the control-panel display, view the preview and verify that both sides of the page have been scanned.

Sensor test

The product must be in a Ready state to conduct sensor tests.

Paper present sensor

1. Load paper in the input tray.
2. If the Document load/detect LED turns on, the Paper Present sensor is functioning.

ADF hatch sensor

1. Open the ADF hatch.
2. On the control-panel display, verify that a warning message **Scanner Hatch open** displays on the status line.
3. Close the ADF hatch. The message **If document feeder roller cleaning is complete, clear message** displays on the control panel. Touch [Cancel](#).
4. Verify that the warning message does not display.

Flatbed cover sensor

1. Lift the document feeder until it stays open.
2. On the control-panel display, verify that a warning message displays on the status line.
3. Close the document feeder.
4. Verify that the warning message does not display.

Multi-Pick sensor

1. From the product control panel, select a Quick Set for scanning.
 - If scanning starts immediately when a Quick Set is selected, temporarily change this behavior in the EWS while testing duplex scanning.

Change the **Quick Set Start Option** from **Start instantly upon selection** to **Enter application, then user presses Start**.
 - If no Quick Sets are visible at the product control panel, they may need to be enabled in the product's EWS or added to the Home screen in the EWS.
2. In the Quick Set menu, touch the [More Options](#) button until the [Multi-feed Detection](#) menu item is visible.
3. Verify that [Multi-feed Detection](#) is set to [Enabled](#).

4. Place a self-stick note at the top left edge of a sheet of paper.

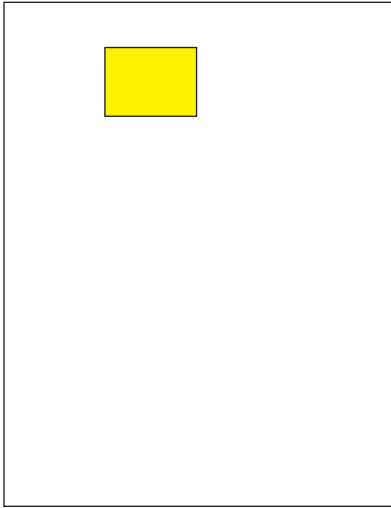

5. Load the sheet of paper in the input tray with the self-stick note face-up and scan the document using the Quick Set.
6. If the Multi-Pick sensor is functioning, the paper will jam in the ADF and the **31.13.00 Jam in document feeder** message displays on the product control panel.

Internal test pages

Internal test pages provide details about the product and its current configuration. View internal test pages from either the product control panel or from the HP Embedded Web Server (EWS). Use the following procedures to view the internal test pages from the control panel:

Configuration pages

In addition to the main configuration page, an embedded Jetdirect configuration page displays.

Configuration page

Use the configuration page to view current product settings and to help troubleshoot product problems.

1. From the Home screen on the product control panel, touch the [Administration](#) button.
2. Open the following menus:
 - [Reports](#)
 - [Configuration/Status Pages](#)
 - [Configuration Page](#)

3. Touch the **View** button to view the report on the screen.
4. Touch the **Next** button to display the embedded Jetdirect page.

 **NOTE:** The product IP address or host name is listed on the embedded Jetdirect page.

Figure 3-1 Configuration page



1	Device information
2	Installed personalities and options
3	Memory
4	Event log
5	Security

NOTE: The support key is intended for factory use only.

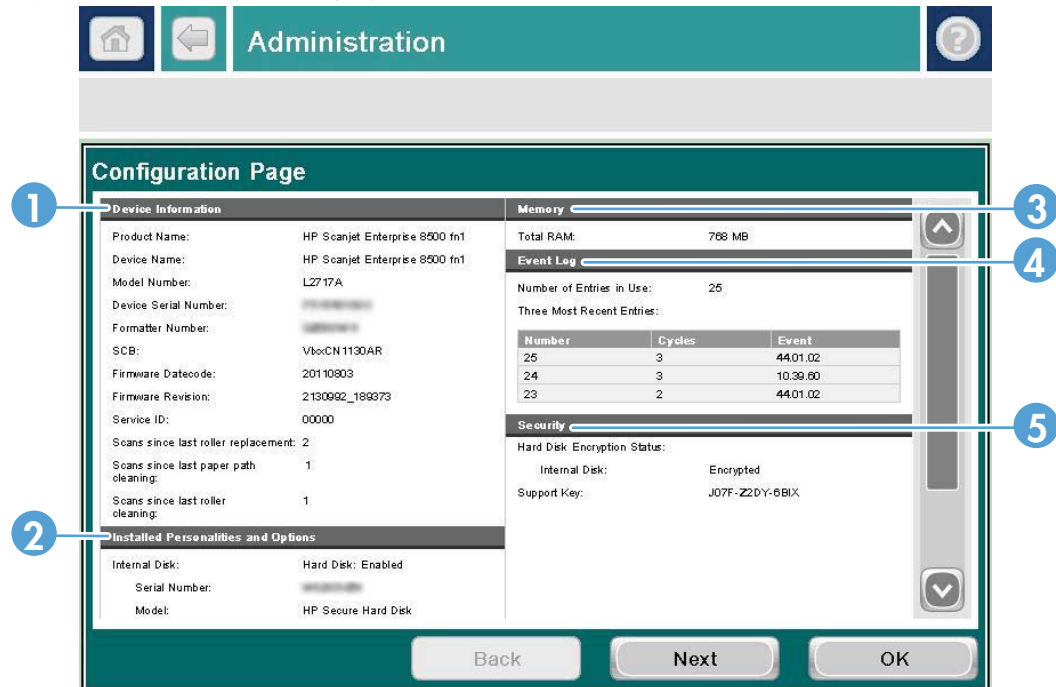
HP embedded Jetdirect page

The second configuration page is the HP embedded Jetdirect page, which contains the following information:

Figure 3-2 HP embedded Jetdirect page



- | | |
|---|--|
| 1 | General Information indicates the product status, model number, hardware firmware version, port select, port configuration, auto negotiation, manufacturing identification, and manufactured date. |
| 2 | Security Settings information |
| 3 | Network Statistics indicates the total packets received, unicast packets received, bad packets received, framing errors received, total packets transmitted, unsendable packets, transmit collisions, and transmit late collisions. |
| 4 | TCP/IP information, including domain and DNS |
| 5 | IPv4 information, including the IP address |
| 6 | IPv6 information |

Always make sure the status line under the HP Jetdirect configuration lines indicates "I/O Card Ready".

Finding important information on the configuration pages

Certain information, such as the firmware date codes, the IP address, and the e-mail gateways, is especially helpful while servicing the product. This information is on the various configuration pages.

Table 3-1 Important information on the configuration pages

Type of information	Specific information	Configuration page
Firmware date codes When you use the remote firmware upgrade procedure, all of these firmware components are upgraded.	Firmware datecode	Look on the main configuration page, under "Device Information."
	Embedded Jetdirect firmware version	Look on the embedded Jetdirect page, under "General Information."
Accessories and internal storage	Embedded HP Jetdirect	Look on the main configuration page, under "Installed Personalities and Options." Shows model and ID.
	Total RAM	Look on the main configuration page, under "Memory."
Event logs The configuration page lists only the three most recent errors. To see a list of the additional errors, view an event log from the Troubleshooting menu.		Look on the main configuration page.
Scan counts	Scans since the last roller replacement Scans since the last paper path cleaning Scans since the last roller cleaning	Look on the main configuration page, under "Device Information."

Usage page

Use the usage page to view counts of all paper sizes that have passed through the product and view lists whether they were simplex or duplex.

1. From the Home screen on the product control panel, touch the [Administration](#) button.
2. Open the following menus:
 - [Reports](#)
 - [Configuration/Status Pages](#)
 - [Usage Page](#)
3. Touch the [View](#) button to view the report on the screen.

Figure 3-3 Usage page

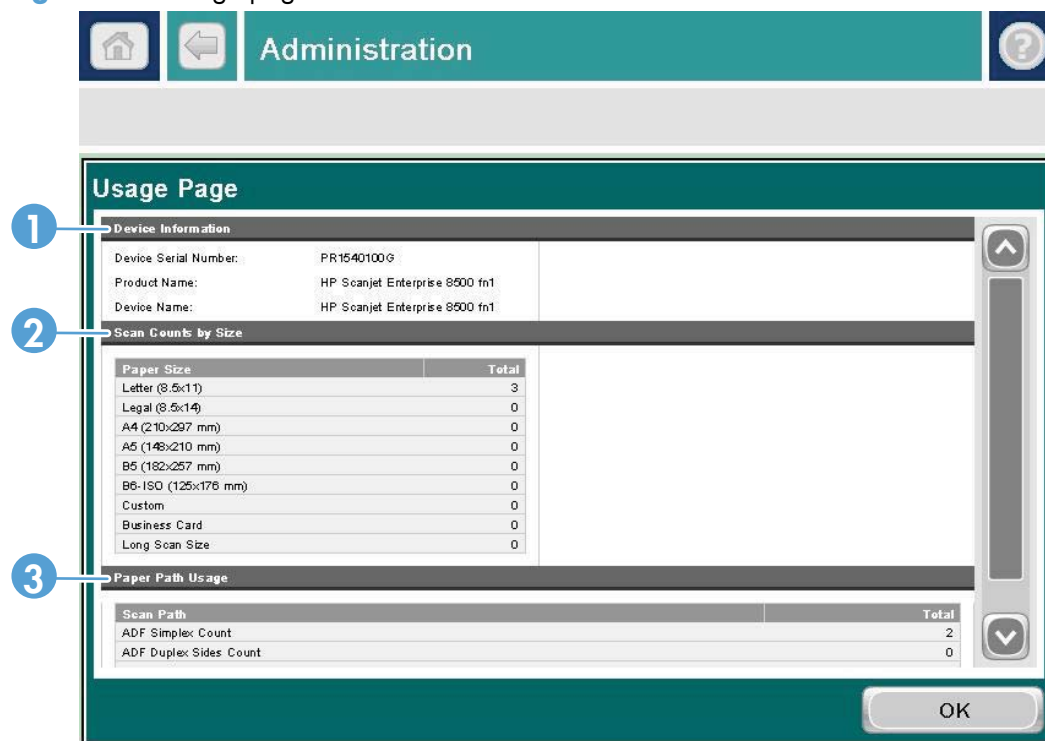

- | | |
|---|---------------------|
| 1 | Device information |
| 2 | Scan Counts by Size |
| 3 | Paper Path Usage |

File Directory page

Use the file directory page to view the file name and folder name for files that are stored in the product memory.

1. From the Home screen on the product control panel, touch the [Administration](#) button.
2. Open the following menus:
 - [Reports](#)
 - [Configuration/Status Pages](#)
 - [File Directory Page](#)
3. Touch the [View](#) button to view the report on the screen.

Figure 3-4 File directory page

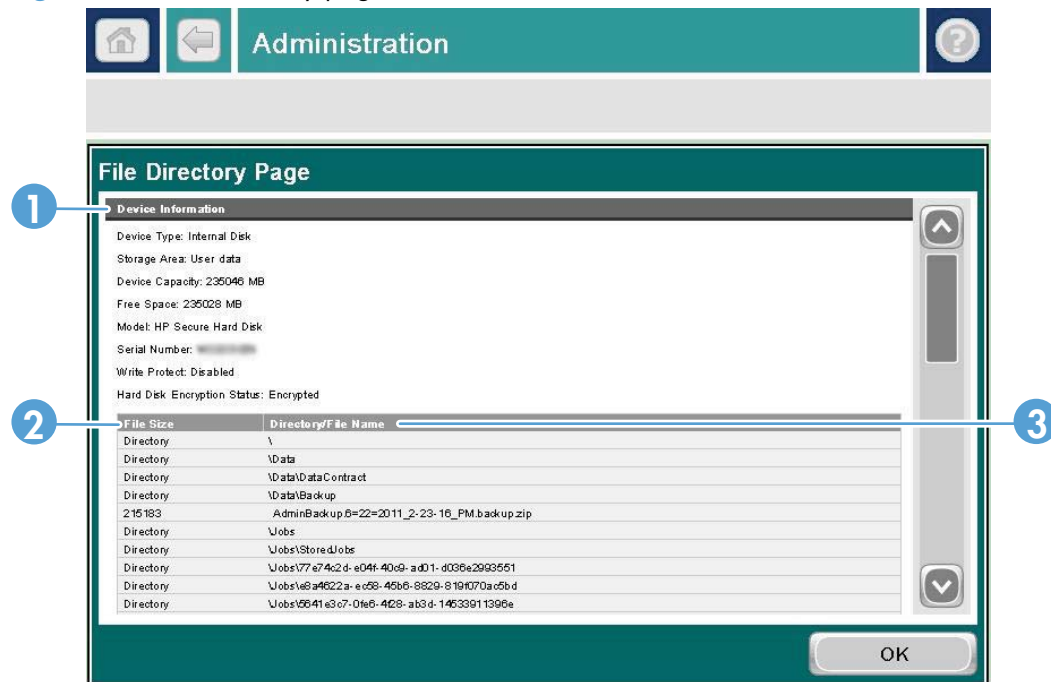

1	Device information
2	File size
3	Directory and file name

Web Services Status Page

Use the Web services status page to view the detected Web services and their locations.

1. From the Home screen on the product control panel, touch the [Administration](#) button.
2. Open the following menus:
 - [Reports](#)
 - [Configuration/Status Pages](#)
 - [Web Services Status Page](#)
3. Touch the [View](#) button to view the report on the screen.

Figure 3-5 Web services status page

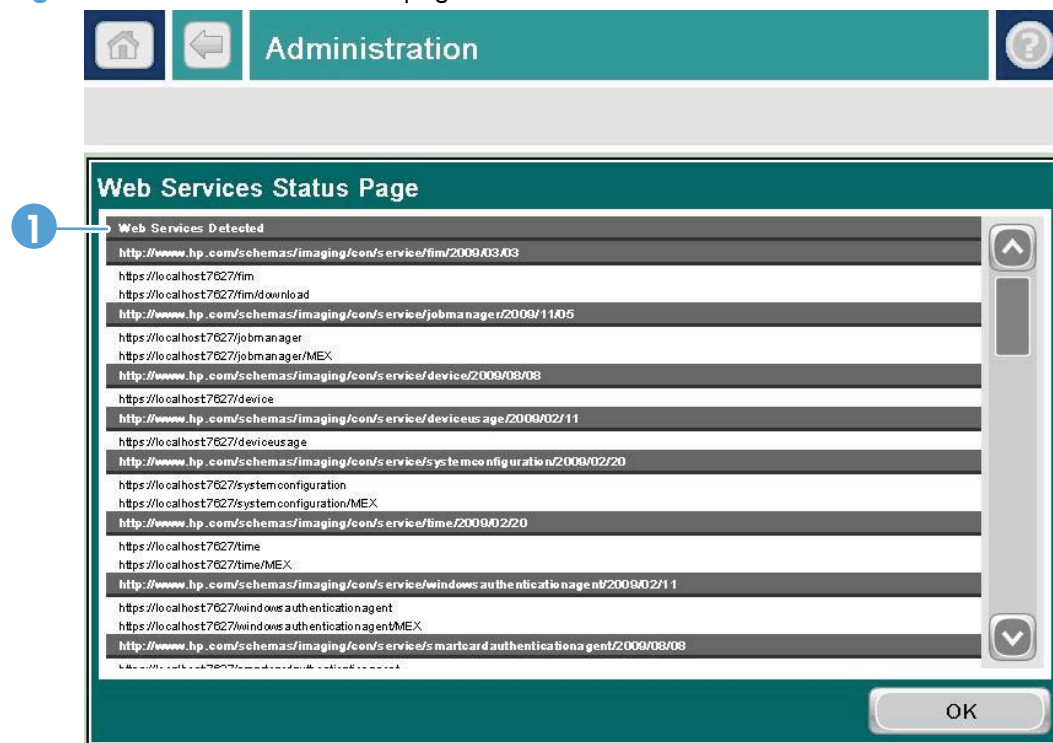

- 1 | URLs of detected Web services

Use HP Embedded Web Server features

Use the features of the HP Embedded Web Server to troubleshoot the product. To open the HP Embedded Web Server, enter the product IP address or host name in the address bar of a Web browser.



Information tab

Table 3-2 HP Embedded Web Server Information tab

Menu	Description
Device Status	Shows the product status and shows the estimated life remaining of HP supplies. The page also shows the type and size of paper set for each tray. To change the default settings, click the Change Settings link.
Job Log	Shows a summary of all jobs the product has processed.
Configuration Page	Shows the information found on the configuration page.
Event Log Page	Shows a list of all product events and errors. Use the HP Instant Support link (in the Other Links area on all HP Embedded Web Server pages) to connect to a set of dynamic Web pages that help you solve problems. These pages also show additional services available for the product.
Usage Page	Shows a summary of the number of pages the product has scanned, grouped by size, type, and paper path.
Device Information	Shows the product network name, address, and model information. To customize these entries, click the Device Information menu on the General tab.
Control Panel Snapshot	Captures a snapshot of what is currently displaying on the product control panel.

Control panel menus

The product has many menus on the control panel to help you perform tasks and configure settings.

 **NOTE:** To learn about each menu option, touch the Help  button in the upper-right corner of the screen for that option.

 **NOTE:** HP regularly updates features that are available in the product firmware. To take advantage of the most current features, update the product firmware. To download the most recent firmware upgrade, go to www.hp.com/support.

Table 3-3 Menus on the Home screen

Menu	Description
Initial Setup	This menu appears when you first turn the product on. Use it to set the language, to set the date and time, to configure essential fax and e-mail settings. After you have completed the initial setup, you have the option to hide this menu.
Fax	Use this menu to send a fax from the product. This menu is available only for products that have a fax accessory. For this menu to appear on the control panel, this feature must be set up by using the Initial Setup menu or by using the HP Embedded Web Server. Several options are available for customizing jobs. These settings are temporary. After you have finished the job, the product returns to the default settings.

Table 3-3 Menus on the Home screen (continued)

Menu	Description
E-mail	<p>Use this menu to scan documents and send them as an e-mail attachment. For this menu to appear on the control panel, this feature must be set up by using the Initial Setup menu, by using the HP Scan to Email Setup Wizard during software installation, or by using the HP Embedded Web Server.</p> <p>Several options are available for customizing jobs. These settings are temporary. After you have finished the job, the product returns to the default settings.</p>
Save to USB	<p>Use this menu to scan documents and save them on a USB storage accessory. For this menu to appear on the control panel, this feature must be set up by using the HP Embedded Web Server.</p> <p>Several options are available for customizing jobs. These settings are temporary. After you have finished the job, the product returns to the default settings.</p>
Save to Network Folder	<p>Use this menu to scan documents and save them to a shared folder on the network. For this menu to appear on the control panel, this feature must be set up by using the HP Embedded Web Server or by using the HP Save to Folder Setup Wizard during software installation.</p> <p>Several options are available for customizing jobs. These settings are temporary. After you have finished the job, the product returns to the default settings.</p>
Quick Sets	<p>Use this menu to access preset job options for jobs that you scan and send by fax or e-mail, or jobs that you scan and save to a USB flash drive, the product hard disk, or to a folder on the network.</p> <p>Set up Quick Sets by using the HP Embedded Web Server or HP Web Jetadmin.</p>
Job Status	<p>Use this menu to see the status of all active jobs.</p>
Administration	<p>Use this menu to view reports and configure default settings for the product. The Administration menu has several sub-menus. See the sections that follow for details about these menus.</p>
Device Maintenance	<p>Use this menu to calibrate and clean the product and to backup and restore data. See the sections that follow for details about these menus.</p>
Save to Sharepoint	<p>Use this menu to save scanned documents to a Microsoft SharePoint site. The document library must be created on the SharePoint site and the user must have the appropriate permissions before scanned documents can be saved. User sign in might also be required at the product.</p>

Administration menu

You can perform basic product setup by using the [Administration](#) menu. Use the HP Embedded Web Server for more advanced product setup. To open the HP Embedded Web Server, enter the product IP address or host name in the address bar of a Web browser.

Reports menu

To display: At the product control panel, select the [Administration](#) menu, and then select the [Reports](#) menu.

Table 3-4 Reports menu

First level	Second level	Values
Configuration/Status Pages	Administration Menu Map	View
	Current Settings Page	View
	Configuration Page	View
	Usage Page	View
	File Directory Page	View
	Web Services Status Page	View
Fax Reports	Speed Dial List	View

General Settings menu

To display: At the product control panel, select the [Administration](#) menu, and then select the [General Settings](#) menu.

In the following table, asterisks (*) indicate the factory default setting.

Table 3-5 General Settings menu

First level	Second level	Third level	Fourth level	Values	
Date/Time Settings	Date/Time Format	Date Format		DD/MMM/YYYY	
				MMM/DD/YYYY	
				YYYY/MMM/DD	
		Time Format		12 hour (AM/PM)	
				24 hours	
		Date/Time	Date		Select the date from the pop-up menus.
			Time		Select the time from a pop-up keypad.
	Time Zone			Select the time zone from a list.	
		Adjust for Daylight Savings		Checkbox	
Energy Settings	Sleep Schedule	A list of scheduled events displays.			
		+ (Add)	Edit		
		Edit	Delete		
			Event Type	Wake Up	
				Sleep	

Table 3-5 General Settings menu (continued)

First level	Second level	Third level	Fourth level	Values
			Time	
			Event Days	Select days of the week from a list.
	Sleep Timer Settings			Enter a value between 1 and 120 minutes. The default value is 15 minutes.
Auto Recovery				Enable Disable
Restore Factory Settings				Address Book Digital Send E-mail Fax General Security

Scan/Digital Send Settings menu

To display: At the product control panel, select the [Administration](#) menu, and then select the [Scan/Digital Send Settings](#) menu.

In the following table, asterisks (*) indicate the factory default setting.

Table 3-6 Scan/Digital Send Settings menu

First level	Second level	Third level	Fourth level	Values
E-mail Settings	E-mail Setup Wizard	E-mail Setup Wizard		
Save to Network Folder Options	NOTE: E-mail Settings only			
Save to USB Options				
NOTE: The same options are available for each of these features, except where noted.				
	Default Job Options	Image Preview		Make optional* Require preview Disable preview
		NOTE: You might need to upgrade the firmware to view this menu.		
		Default File Name		Enter name

Table 3-6 Scan/Digital Send Settings menu (continued)

First level	Second level	Third level	Fourth level	Values
		Document File Type		Select from a list of file types.
		Optimize Text/Picture	Optimize For:	Auto detect Manually adjust* Text Printed picture Photograph
		Output Quality		High (large file) Medium* Low (small file)
		Original Sides		1 sided 2 sided
			Orientation	Automatically detect Portrait* Landscape
			2-Sided Format	Book style Flip style
		Resolution		600 dpi 500 dpi 400 dpi 300 dpi 240 dpi 200 dpi 150 dpi* 100 dpi 75 dpi
		Content Orientation	Orientation	Automatically detect Portrait* Landscape
			2-Sided Format	Book style* Flip style

Table 3-6 Scan/Digital Send Settings menu (continued)

First level	Second level	Third level	Fourth level	Values
		Color/Black		Auto detect Color Black/Gray Black
		Original Size		Choose from a list of paper sizes.
		Notification		Do not notify* Notify when job completes Notify only if job fails E-mail
		Image Adjustment	Darkness	
			Contrast	
			Background Cleanup	
			Sharpness	
		Job Build		Job Build off* Job Build on
		Cropping Options		Do Not Crop Crop to paper Crop to content
		Edge Erase		Front side erase Back side erase Use inches
		Color Dropout		Disabled Remove red Remove green Remove blue
		Automatically Straighten		Enabled Disabled
		Misfeed Detection		Enabled Disabled

Table 3-6 Scan/Digital Send Settings menu (continued)

First level	Second level	Third level	Fourth level	Values
		Blank Page Suppression		Enabled Disabled*
Digital Send Service Setup	Allow Usage of Digital Sending Software (DSS) Server			Select or clear the check box. The default setting is with the check box cleared.
	Allow Transfer to New Digital Sending Software (DSS) Server			Select or clear the check box. The default setting is with the check box cleared.

Fax Settings menu

To display: At the product control panel, select the [Administration](#) menu, and then select the [Fax Settings](#) menu.

In the following table, asterisks (*) indicate the factory default setting.

Table 3-7 Fax Settings menu

First level	Second level	Third level	Fourth level	Values
Fax Send Settings	Default Options	Image Preview		Make optional* Require preview Disable preview
		Original Sides		1 sided* 2 sided
			Orientation	Portrait* Landscape
			2-Sided Format	Book style* Flip style
		Notification		Do not notify* Notify when job completes Notify only if job fails E-mail
		Content Orientation	Orientation	Portrait* Landscape

Table 3-7 Fax Settings menu (continued)

First level	Second level	Third level	Fourth level	Values
			2-Sided Format	Book style* Flip style
		Original Size		Select from a list of sizes that the product supports.
		Image Adjustment	Darkness	
			Contrast	
			Background Cleanup	
			Sharpness	
		Optimize Text/Picture	Auto detect	
			Manually adjust*	
			Text	
			Printed picture	
			Photograph	
			Optimize For:	
		Job Build		Job Build off* Job Build on
		Color Dropout		Disabled Remove red Remove green Remove blue
		Misfeed Detection		Enabled Disabled
		Blank Page Suppression		Disabled* Enabled

Display Settings menu

To display: At the product control panel, select the [Administration](#) menu, and then select the [Display Settings](#) menu.

In the following table, asterisks (*) indicate the factory default setting.

Table 3-8 Display Settings menu

First level	Second level	Values
Key Press Sound		On* Off
Language Settings	Language	Select from a list of languages that the product supports.
	Keyboard Layout	Each language has a default keyboard layout. To change it, select from a list of layouts.
Network Address Button		Display Hide
Date and Time		Show Date and Time Hide Date and Time*
Inactivity Timeout		Range: 10 – 300 seconds Default = 60 seconds
Clearable Warnings		On Job*
Continuable Events		Auto continue (10 seconds)* Press OK to continue

Manage Supplies menu

To display: At the product control panel, select the [Administration](#) menu, and then select the [Manage Supplies](#) menu.

In the following table, asterisks (*) indicate the factory default setting.

Table 3-9 Manage Supplies menu

First level	Second level	Third level	Fourth level	Values
Supply Settings	Document feeder kit	Low threshold settings		
		Document feeder kit		Enter percentage left when warning will occur
		Very Low Settings		Stop Prompt to continue Continue
Supply Messages		Low messages		On Off
Reset Supplies	New Document Feeder Kit	Maintenance history		Reset

Network Settings menu

To display: At the product control panel, select the [Administration](#) menu, and then select the [Network Settings](#) menu.

In the following table, asterisks (*) indicate the factory default setting.

Table 3-10 Network Settings menu

First level	Values
I/O Timeout	Range: 5 – 300 sec Default = 15
Embedded Jetdirect Menu EIO <X> Jetdirect Menu	See the table that follows for details. These menus have the same structure. If an additional HP Jetdirect network card is installed in the EIO slot, then both menus are available.

Table 3-11 Embedded Jetdirect Menu/EIO <X> Jetdirect Menu

First level	Second level	Third level	Fourth level	Values
TCP/IP	Enable			On* Off
	Host Name			
	IPV4 Settings	Config Method		Bootp DHCP* Auto IP Manual
		Default IP		Auto IP* Legacy
		Primary DNS		
		Secondary DNS		
	IPV6 Settings	Enable		Off On*
		Address	Manual Settings	Enable Address
		DHCPV6 Policy		Router Specified Router Unavailable* Always
		Primary DNS		
		Secondary DNS		

Table 3-11 Embedded Jetdirect Menu/EIO <X> Jetdirect Menu (continued)

First level	Second level	Third level	Fourth level	Values
	Proxy Service			
	Proxy Port			
	Idle Timeout			Range: 0-3600 Default = 270
Security	Secure Web			HTTPS Required* HTTPS Optional
	IPSec			Keep Disable*
	802.1X			Reset Keep*
	AM/PM			Enable Disable
	Reset Security			Yes No*
Diagnostics	Embedded Tests	LAN HW Test		Yes No*
		HTTP Test		Yes No*
		SNMP Test		Yes No*
		Data Path Test		Yes No*
		Select All Tests		Yes No*
		Execution Time [H]		Range: 1 – 24 hours Default = 1 hour
		Execute		No* Yes
	Ping Test	DEST IPv4		
		Packet Size		Range: 64-2048 Default = 64

Table 3-11 Embedded Jetdirect Menu/EIO <X> Jetdirect Menu (continued)

First level	Second level	Third level	Fourth level	Values
		Time		Range: 1-100 Default = 1
		Count		Range: 0-100 Default = 4
		Execute		No* Yes
	Ping Results	Packet Sent		Range: 0-65535 Default = 0
		Packet Received		Range: 0-65535 Default = 0
		Percent Lost		Range: 0-100 percent Default = 0
		RTT Min		Range: 0-4096 Default = 0
		RTT Max		Range: 0-4096 Default = 0
		RTT Average		Range: 0-4096 Default = 0
		Ping in Progress		No* Yes
		Refresh		No* Yes
Link Speed				Auto* 10T Half 10T Full 100TX Half 100TX Full

Troubleshooting menu

To display: At the product control panel, select the [Administration](#) menu, and then select the [Troubleshooting](#) menu.

In the following table, asterisks (*) indicate the factory default setting.

Table 3-12 Troubleshooting menu

First level	Second level	Third level	Fourth level	Values
Event Log				View*
Diagnostic Tests	Control Panel	LEDs	Ready LED	
			Data LED	
			Attention LED	
			Sleep LED	
			Start Green LED	
			Start Amber LED	
			Display	Start
	Buttons			
		Touch Grid		Start
Retrieve Diagnostic Data	Create device data file		Include crash dump files	
	Create zipped debug information file		Include crash dump files	Send To Email
			Clean up debug information	Export to USB
Generate Debug Data				Start

Device Maintenance menu

Backup/Restore menu

To display: At the product control panel, select the [Device Maintenance](#) menu, and then select the [Backup/Restore](#) menu.

In the following table, asterisks (*) indicate the factory default setting.

Table 3-13 Backup/Restore menu

First level	Second level	Third level	Values
Backup Data	Enable Scheduled Backups	Backup Time	Enter a time
		Days Between Backups	Enter the number of days
		Backup Now	

Table 3-13 Backup/Restore menu (continued)

First level	Second level	Third level	Values
	Export Last Backup		
Restore Data		All	Restore
		Address Book	Details
		Digital Send	
		E-mail	
		Fax	
		General	
		Security	

Calibrate/Cleaning menu

To display: At the product control panel, select the [Device Maintenance](#) menu, and then select the [Calibrate/Cleaning](#) menu.

In the following table, asterisks (*) indicate the factory default setting.

Table 3-14 Calibrate/Cleaning menu

First level	Second level	Third level	Values
Clean Rollers		Maintenance history	Reset
Clean Rollers Settings	Low threshold settings		
	Clean Rollers		Enter percentage left when warning will occur
	Very Low Settings		Stop
			Prompt to continue
			Continue

USB Firmware Upgrade menu

To display: At the product control panel, select the [Device Maintenance](#) menu, and then select the [USB Firmware Upgrade](#) menu.

Insert a USB storage device with a firmware upgrade bundle into the USB port, and follow the onscreen instructions.

Service menu

To display: At the product control panel, select the [Device Maintenance](#) menu, and then select the [Service](#) menu.

The [Service](#) menu is locked and requires a PIN for access. This menu is intended for use by authorized service personnel.

Interpret control-panel messages

Control-panel message types

Four types of control-panel messages can indicate the status of or problems with the product.

Message type	Description
Status messages	Status messages reflect the current state of the product. They inform you of normal product operation and require no interaction to clear them. They change as the state of the product changes. Whenever the product is ready, not busy, and has no pending warning messages, the status message Ready appears if the product is online.
Warning messages	Warning messages inform you of data and scan errors. These messages typically alternate with the Ready or status messages and remain until you touch the OK button. Some warning messages are clearable. If the Clearable Warnings setting is set to Job on the product Display Settings menu, the next job clears these messages.
Error messages	<p>Error messages communicate that some action must be performed, such as adding paper or clearing a jam.</p> <p>Some error messages are auto-continuable. If the Auto-continue setting is set on the menus, the product will continue normal operation after an auto-continuable error message appears for 10 seconds.</p> <p>NOTE: Pressing any button during the 10-second auto-continuable error message overrides the auto-continue feature, and the button function takes precedence.</p>
Critical-error messages	Critical error messages inform you of a product failure. Some of these messages can be cleared by turning the product off and then on. These messages are not affected by the Auto-continue setting. If a critical error persists, service is required.

Control-panel messages

20.00.00 Insufficient memory: <Device> To continue, touch "OK"

Event log error message

20.00.00

Description

The product does not have enough memory to scan the page.

The product received more data than can fit in the available memory. You might have tried to transfer too many macros, soft fonts, or complex graphics.

Recommended action

Touch the **OK** button. Some data might be lost. Reduce the page complexity or add product memory.

30.01.10 Scanner Failure

Event log error message

31.01.10

Description

The document-feeder fan error has occurred.

Recommended action

Turn the product off and then on again.

30.01.23 Scanner Calibration Failure

Event log error message

30.01.23

Description

The scanner experienced an error during the scanner calibration process.

Recommended action

Turn the product off, then on again.

30.01.36 Upgrade Error Try downloading upgrade again

Event log error message

30.01.36

Description

The product experienced an error during the scanner firmware upgrade.

Recommended action

Turn the product off, then on again.

Resend the scanner firmware upgrade.

If the error persists, replace the scanner control board.

30.01.40 Scanner Communication Failure

Event log error message

30.01.40

Description

The product experienced an internal communication error involving the CPB.

Recommended action

Turn the product off, and then on again. If this does not resolve the problem, turn the product off, unplug the power cord for 30 seconds, and then plug the product back in and turn the power back on.

30.01.47 Document Feeder Not Detected

Event log error message

31.01.47

Description

The product failed to detect the document feeder.

Recommended action

Turn the product off and then on again.

30.01.YY Scanner Failure

Description

The product was turned off and then on when the scanner was locked.

Recommended action

Turn the product off, then on again.

31.01.02 Jam in document feeder

Event log error message

31.01.02

Description

Originals are jammed inside the document feeder top cover.

Recommended action

- 1.** Open the document feeder top cover.
- 2.** Remove all paper.
- 3.** Remove the remaining pages from the document feeder input tray.
- 4.** Close the document feeder top cover.
- 5.** Place the jammed page on top of any remaining pages, and reinsert them into the document feeder.
- 6.** Align the paper guides with both edges on the paper.
- 7.** Press the **Start** button to continue.

If the message remains, check the read and exit sensors.

If the error persists, replace the flatbed scanner and ADF assembly.

31.01.03 Document feeder pick error

Event log error message

31.01.03

Description

This message displays when the document feeder cannot pick up paper.

Recommended action

1. Open the document feeder top cover.
2. Remove all paper.
3. Remove the remaining pages from the document feeder input tray.
4. Close the document feeder top cover.
5. Place the jammed page on top of any remaining pages, and reinsert them into the document feeder.
6. Align the paper guides with both edges on the paper.
7. Press the **Start** button to continue.

If message remains, check the paper guides and clean the rollers and separation pad.

If the error persists, replace pickup roller assembly, separation pad, or flatbed scanner and ADF assembly.

40.00.01 USB I/O buffer overflow To continue, touch "OK"

Description

The USB buffer overflowed during a busy state.

Recommended action

Touch the **OK** button to print the transferred data. Some data might be lost.

Check the host configuration.

40.00.02 Embedded I/O buffer overflow To continue, touch "OK"

Description

Too much data was sent to the embedded HP Jetdirect print server. An incorrect communications protocol might be in use.

Recommended action

Touch the **OK** button to scan the transferred data. Some data might be lost.

Check the host configuration.

40.00.03 EIO <X> buffer overflow To continue, touch "OK"

Description

The product displays this message when the EIO card in the indicated slot has overflowed its I/O buffer during a busy state.

Recommended action

Touch the **OK** button to continue.

40.00.04 EIO <X> bad transmission To continue, touch "OK"

Description

The product displays this message when a connection with the card in the indicated slot has been broken.

Recommended action

Touch the **OK** button to continue.

40.00.05 Embedded I/O bad transmission To continue, touch "OK"

Description

The product experienced a temporary scanning error. The connection between the product and the EIO card in the specified slot has been broken.

Recommended action

Touch the **OK** button to clear the error message and continue scanning.

49.XX.YY Error To continue turn off then on

Event log error message

49.XX.YY

Description

A firmware error has occurred. This error can be caused by software applications issues, poor-quality USB or network cables, bad network connections or incorrect configurations, invalid firmware operations, or unsupported accessories.

Recommended action

1. Turn the product off, then on.
2. If the error returns, check the following:
 - The error might be caused by a network connectivity problem, such as a bad interface cable, a bad USB port, or an invalid network configuration setting.
 - The error might be caused by a problem with the software application or a problem with the file you are scanning.
 - Upgrading the product firmware might help resolve the error. See the product user guide for more information.

57.10.01 The fan has failed Turn off and contact the administrator

Event log error message

31.01.10

Description

The fan no longer operates.

Recommended action

Replace the fan.

62.00.00 No system To continue turn off then on

Event log error message

62.00.00

Description

The product experienced an internal system failure.

Recommended action

Turn the product off, then on.

If the error persists, reload the firmware. If the error still persists, perform a firmware upgrade.

If the firmware upgrade does not resolve the problem, replace the hard disk.

80.0X.YY Embedded JetDirect Error To continue turn off then on

Event log error message

80.0X.YY

Description

The product experienced an embedded HP JetDirect print server critical error.

Recommended action

Turn the product off, then on.

If the error persists, replace the formatter.

98.00.0X Corrupt data in X volume

Event log error message

98.00.0X

Description

The product has experienced a data corruption in the volume indicated by the error message.

- **98.00.01 Corrupt data in firmware volume**
- **98.00.02 Corrupt data in solutions volume**
- **98.00.03 Corrupt data in configuration volume**

Recommended action

- Turn the product off and then on.
- Use the [Clean Disk](#) item in the [Preboot](#) menu.
- Reload the firmware.

Cleaning disk <X>% complete Do not power off

Description

A storage device is being sanitized or cleaned.

Recommended action

Do not turn off the product. The product's functions are unavailable. The product will automatically restart when finished.

Digital send communication error

Description

A digital send job failed and cannot be delivered.

Recommended action

Touch the [Hide](#) button to remove this message.

Digital send communication error

Description

A digital send job failed and cannot be delivered. The product was unable to connect to the digital send software service.

Recommended action

Verify the digital send software service is running and the devices are on the network. Try to send the job again.

Disk full Delete stored jobs**Description**

The disk is out of space.

Recommended action

Delete stored jobs.

Document feeder bin full**Description**

Too many pages are in the document feeder.

Recommended action

Remove excess paper from document feeder output bin.

Document feeder is empty**Description**

The document feeder is empty.

Recommended action

Place original in the document feeder and press the Start .

Document feeder top cover open**Description**

The document feeder jam access cover is open.

Recommended action

Close the cover.

Event log is empty**Description**

This message displays when the user has attempted to view an empty event log from the control panel.

Recommended action

Touch the [Hide](#) button to remove this message.

Flatbed cover open

Description

The scanner cover is open.

Recommended action

Close the scanner cover.

Initializing...

Description

The product is starting.

Recommended action

No action is necessary. Wait until the **Ready** message appears on the display.

Internal disk not found

Description

The product cannot find the hard drive.

Recommended action

Check the hard drive cable connections.

Internal disk not functional

Event log error message

82.0X.YY

Description

The product internal disk is not working correctly

Recommended action

Turn off the product, and then remove and reinstall the hard disk. Turn on the product.

If the error persists, replace the hard drive.

Internal disk not initialized

Description

The internal disk file system must be initialized before it can be used.

Recommended action

Initialize the internal file system.

Moving solenoid To exit press

Description

The solenoid is moving as part of a component test.

Recommended action

To exit, touch the Stop  button.

Moving solenoid and motor To exit press

Description

The solenoid and a motor are moving as part of a component test.

Recommended action

To exit, touch the Stop  button.

Performing Paper Path Test...

Description

The product is performing a paper-path test.

Recommended action

No action is necessary.

Replace Document Feeder Kit

Description

The document feeder kit has been configured to [Stop](#) when the supply reaches the very low threshold. The supply has reached the very low threshold.

Recommended action

Replace the document feeder kit or set the very low setting to [Continue](#).

Unable to cancel firmware update job

Description

The product is upgrading firmware remotely. The process cannot be canceled.

Recommended action

Firmware upgrades cannot be canceled. The product will restart with the upgrade is complete.

Unable to Install

Description

The product displays this message when one of the following conditions occurs during a firmware upgrade.

- A file I/O error occurs when there is an interruption while reading the firmware upgrade file.
- A firmware installation is already in progress, possibly by a remote service application.
- A firmware installation is pending.
- An internal system failure has occurred while doing firmware upgrades
- An unknown error occurs while doing firmware upgrades.
- The memory is full when the user is doing firmware upgrades
- The firmware upgrade file does not support this product.
- The upgrade file is invalid or corrupted while doing firmware upgrades

Recommended action

Refer to the walk-up help for each of these error conditions for specific instructions on resolving the error.

Unable to install the firmware

Description

The product was unable to install new firmware. This issue can be caused by a variety of reasons:

- The firmware upgrade was interrupted.
- A firmware upgrade is already in process.
- An internal system failure has occurred.
- An unknown error has occurred.
- The product memory is full.
- An firmware upgrade file is not supported.
- The firmware upgrade file is invalid or corrupted.

Recommended action

Download the firmware again and reinstall the firmware.

Unsupported USB accessory detected Remove USB accessory

Event log error message

40.00.04

Description

The USB accessory is not recognized and cannot be used by this product.

Recommended action

Turn off the product, remove the USB accessory, and then turn on the product. To clear this message, touch the [Hide](#) button.

Upgrade complete To continue turn off then on**Description**

The firmware upgrade is complete.

Recommended action

Turn the product off and then on.

USB accessory needs too much power Remove USB Accessory and Turn Off then On**Description****Recommended action**

Remove the USB accessory, and then restart the product.

Use a USB accessory that uses less power or that contains its own power supply.

USB needs too much power**Description**

Power requirements for the USB accessory attached to this product are beyond supported limits.

Recommended action

Detach the accessory, and then turn the product off and then on. Try a similar accessory that has its own power supply or requires less power.

USB storage accessory removed Clearing any associated data**Description**

This message displays for six seconds after removal of the USB storage accessory.

Recommended action

Touch the [Hide](#) button to remove this message.

Event log messages

The event log provides a record of the events that have occurred and the scanner page count at which the event occurred.

Show an event log

View the event log from the control panel

1. From the Home screen on the product control panel, touch the [Administration](#) button.
2. Open the following menus:
 - [Troubleshooting](#)
 - [Event Log](#)

Clear the event log

Use the [Service](#) menu to clear the event log.

1. From the Home screen on the product control panel, touch the [Device Maintenance](#) button.
2. Touch the [Service](#) button and then log in.
3. Touch the [Clear Event Log](#) button.

Event log message table

Event log message	Description	Comments
30.01.01	Scanner failure	The flatbed scanner cover is open.
30.01.06	Scanner Fan Error, power off/on	Turn the product off and then on.
30.01.08	Scanner Fan Error, power off/on	Scanner home position error Turn the product off and then on.
30.01.14	Scanner error, power off/on, check SCB	Scanner control board (SCB) error. Turn the product off and then on.
30.01.15	Scanner Error, power off/on	Scanner cannot be initialized. Turn the product off and then on.
30.01.18	Scanner Error, power off/on	Turn the product off and then on.
30.01.19	Scanner lamp error, power off/on	Scanner lamp error Turn the product off and then on.
30.01.36	Upgrade failed, must resend upgrade	SCB upgrade error Turn the product off and then on.
30.01.41	Scanner Error, power off/on	Turn the product off and then on.
30.01.42	Scanner error, power off/on, check cable	Scanner cable is disconnected. Turn the product off and then on.

Event log message	Description	Comments
30.01.40	Scanner communication failure	Memory failure Turn the product off and then on. If this does not resolve the problem, unplug the product for 30 seconds, then plug the product back in and turn the product on.
30.01.44	Power off/on, check SCB/CPB connection	SCB communication error Turn the product off and then on.
30.01.45	Scanner Error, power off/on	The event log displays the first and last characters of the filename and the line number. Turn the product off and then on.
30.01.46	Scanner error, power off/on, check formatter	Turn the product off and then on.
30.01.48	Scanner error, power off/on	Turn the product off and then on.
30.01.49	Scanner inverter fan error, power off/on	Turn the product off and then on.
30.01.50	Scanner Control Board error, power off/on	Scanner flash read/write problem Turn the product off and then on.
31.00.A1	Scanner error, power off/on, check formatter.	Check for a control-panel message, warning log entry, and email alert.
31.00.A2	Document feeder not detected.	Check for a control-panel message, warning log entry, and email alert.
31.00.A3	Scanner error, power off/on, check formatter	Check for a control-panel message, warning log entry, and email alert.
31.01.10	Document feeder fan error, power off/on	Turn the product off and then on.
31.01.47	Document feeder not detected	
31.02.E0	Add Link	Top cover interlock switch
31.13.00	Document feeder pick error	Multi-pick error detected.
31.13.01	Original document mispick	No pick.
31.13.02	Original jam at feed sensor	Jam in document feeder.
31.13.03	Document jam at register sensor	Clear jam
31.13.04	Document jam at feed and convey area	Clear jam
31.13.05	Document jam at reverse tray area	Reverse duplex jam
31.13.06	Document jam at eject area	Clear jam
31.13.07	Document jam during switchback	Clear jam

Event log message	Description	Comments
31.13.08	Document jam between duplex tray and eject	Clear jam
31.13.09	Document jam at feed convey & reverse area	Clear jam
31.13.10	Document jam at feed convey rev & eject	Clear jam
31.13.11	Document jam at convey reverse area	Clear jam
31.13.12	Document jam at convey eject area	Clear jam
32.08.A1	Boot up after abnormal shutdown	
32.08.A2	Normal shutdown	
32.08.A3	Normal boot up	
32.1C.03	Backup has started	
32.1C.06	Backup/restore failed due to configuration error	The backup or restore job ticket is invalid.
32.1C.08	Backup/restore file error	There was an error during the read or write of the backup file.
32.1C.09	Backup/restore product mismatch error	The backup file will not work with the product.
32.1C.0A	Backup file corrupt, cannot restore	The data in the backup file specified is corrupt.
32.1C.0B	Backup file/firmware version mismatch	The data in the backup file is not valid for the current version of firmware.
32.1C.0C	Backup/restore aborted by the user	
32.1C.0D	Backup/restore unknown error	
32.1C.11	Backup failed. Device busy.	The calibration subsystem backup has failed.
32.1C.12	Backup failed. Device busy.	The address book subsystem backup has failed.
32.1C.16	Failed to back up calibration subsystem	Backup was aborted because the product is busy.
32.1C.17	Failed to back up address book subsystem	Backup was aborted. Reset is in progress.
32.1C.18	Copy subsystem backup failed	
32.1C.19	Backup/restore unknown error	
32.1C.1A	Digital Send subsystem backup failed	
32.1C.1B	Print subsystem backup failed	
32.1C.1E	Copy subsystem restore failed	
32.1C.1F	Fax subsystem restore failed	

Event log message	Description	Comments
32.1C.20	Digital Send subsystem restore failed	
32.1C.21	Print subsystem restore failed	
32.1C.22	Failed to restore calibration subsystem	
32.1C.23	Failed to restore address book subsystem	
32.1C.24	Restore complete	
32.1C.25	Copy subsystem reset failed	
32.1C.26	Fax subsystem reset failed	
32.1C.27	Digital Send subsystem reset failed	
32.1C.28	Print subsystem reset failed	
32.1C.2D	Restore failed. Reboot device.	
32.1C.2E	Restore failed. Device busy.	
32.1C.2F	Reset failure	
32.1C.30	Security subsystem restore failed	
32.1C.31	Security subsystem backup failed	
32.1C.32	General subsystem restore failed	
32.1C.33	General subsystem backup failed	
32.1C.34	Email subsystem restore failed	
32.1C.35	E-mail subsystem backup failed	
32.1C.50	Failed to reset general subsystem	
32.1C.51	Failed to reset security subsystem	
32.1C.52	Failed to reset email subsystem	
32.1C.53	Failed to reset calibration subsystem	
32.1C.54	Failed to reset address book subsystem	
32.1C.55	Reset failed	
32.1C.56	Reset failed. Device busy.	
32.1C.57	Reset failed. Device busy.	
32.1C.58	Reset failed	Unknown reset error
33.01.01	Recover occurred	
33.01.02	Initial save occurred	Data received from SR clients is written into interconnect PCA NVRAM.
33.01.03	Save/Recover status OK	The save and recover functionality is now functional.
33.02.01	Used board/disk installed	A used part with data was replaced in the product.

Event log message	Description	Comments
33.02.02	Save/Recover disabled	The Save Recover Status Error is disabled.
33.02.03	Save/Recover disabled	The SR manager backups failed, but the product continues to function.
40.XX.05	USB storage accessory removed	
40.05.XX	Error	
40.06.05	USB storage accessory removed	
40.80.04	Failed to read value from NVRAM	Cannot read a contract-requested value from NVRAM. Either the value was not populated or NVRAM was unreadable.
42.10.01	HPShell: Process HPShell failed unexpectedly	
42.10.02	HPShell: Process FirstBootAgent failed unexpectedly	
42.10.03	HPShell: Process InstallationManager failed unexpectedly	
42.10.04	HPShell: Process PartitionManager failed unexpectedly	
42.10.05	HPShell: Process UsemServices failed unexpectedly	
42.10.06	HPShell: Process SystemManager failed unexpectedly	
42.10.07	HPShell: Process PdlPrint failed unexpectedly	
42.11.01	SystemManager: Config File Unknown	
42.11.02	SystemManager: Config File Does Not Exist	
42.11.03	SystemManger: Invalid Configuration	
42.11.04	SystemManager: Circular Process Dependency	
42.11.05	SystemManager: IPC Server Failed to Start	
42.11.06	SystemManager: Error Launching Processes	
42.11.07	SystemManager: Process or Service Exited Unexpectedly	
42.12.01	ComponentManager: Config File Unknown	
42.12.02	ComponentManager: Config File Does Not Exist	

Event log message	Description	Comments
42.12.03	ComponentManager: Invalid Configuration	
42.12.04	ComponentManager: Error Loading or Transitioning Component	
42.13.01	Environment: Configuration Not Detected (upgrade FW)	
42.13.02	Environment: Configuration Error (upgrade FW)	
42.23.01	ENGCOM unknown config from engine	
42.23.02	ENGCOM configuration changed	
42.33.01	SystemTime: Could Not Connect to Time Server	
42.33.02	SystemTime: Communication Failure with Time Server	
42.33.03	SystemTime: Time Server not Found	
42.33.05	SystemTime: Could Not Determine Time Setting	
42.34.01	EventLog: Corrupted Error Log File, (previous logs lost)	
42.34.02	EventLog: Corrupted Warning Log File, (previous logs lost)	
42.34.03	EventLog: Corrupted Info Log File, (previous logs lost)	
42.34.04	EventLog: Corrupted Custom Log File, (previous logs lost)	
42.34.05	EventLog: Corrupted Error Log Histogram File, (previous logs lost)	
42.34.06	EventLog: Corrupted Warning Log Histogram File, (previous logs lost)	
42.34.07	EventLog: Corrupted Info Log Histogram File, (previous logs lost)	
42.34.08	EventLog: Corrupted Custom Log Histogram File, (previous logs lost)	
42.34.09	Corrupt pre-boot event log, data has been lost	
42.38.02	Control panel firmware error	
42.40.02	DataModel: Catalog Not Available	Could not load data model catalog. Missing a file that should have been deployed with the firmware.

Event log message	Description	Comments
42.40.04	Data migration failed during firmware upgrade	Fatal error occurred while transforming the data from a prior version of firmware to the current version of firmware during a firmware upgrade. The transformation has to happen on each firmware upgrade.
42.A0.01	Open eXtensibility Platform for Devices (OXPd) Error and Event Log	
42.B0.01	Missing String ID	
42.B0.02	Missing image ID	
42.B0.03	Temporary string ID	
44.00.00	Find servers invalid DNS Configuration	
44.01.00	General Address Book services error	A general failure occurred in the address book services component.
44.01.01	Address Book invalid argument error	An invalid argument was passed to the address book services component.
44.01.02	Address Book invalid operation error	An invalid operation occurred during execution of an address book services command.
44.01.03	Address Book duplicate entry error	An attempt was made to add an entry that already exists in an address book.
44.01.04	Address Book invalid data error	An attempt was made to add an entry that contained invalid data.
44.01.05	Address Book out of memory error	The database detected an out of memory condition during execution of an address book command.
44.01.06	Address Book disk full error	The database detected a disk full condition during execution of an address book command.
44.01.07	Address Book insufficient resources error	The database has insufficient resources to complete the execution of an address book command.
44.01.08	Address Book import failure	
44.01.09	Address Book export failure	
44.01.0A	Address Book clear failure	
44.01.0B	Address Book import failure	The digital send speed dial import failed.
44.01.0C	Address Book export failure	The digital send speed dial export failed.
44.01.0D	Address Book clear failure	The attempt to clear the speed dials failed.

Event log message	Description	Comments
44.01.0E	Unexpected LDAP/Address Book Error	
44.01.0F	LDAP/AB server is invalid or unreachable	
44.01.10	LDAP/Address Book invalid credentials	
44.01.11	Invalid LDAP search root-null return	
44.01.12	LDAP Address Book invalid sign in method	The LDAP authentication method is not supported.
44.01.13	LDAP server refused operation	LDAP operations error
44.01.14	LDAP/Address Book connection failure	
44.01.15	LDAP timed out, svr reply taking too long	LDAP time limit exceeded
44.01.16	LDAP/Address Book client timeout	
44.01.17	Address Book import success	
44.01.18	Address Book export success	
44.01.19	Address Book clear success	
44.01.1A	Address Book import success	
44.01.1B	Address Book export success	
44.01.1C	Address Book clear success	
44.01.1D	Email/Fax Address Book import success	Import of a comma separated values (CSV) file to the email/fax address book has succeeded.
44.01.1E	Email/Fax Address Book import failure	Import of a comma separated values (CSV) file to the email/fax address book has failed.
44.01.1F	Email/Fax Address Book import cancel	Import of a comma separated values (CSV) file to the email/fax address book has been cancelled.
44.01.20	Fax Speed Dial Address Book import success	Import of a comma separated values (CSV) file to the fax speed dial address book has succeeded.
44.01.21	Fax Speed Dial Address Book import failure	Import of a comma separated values (CSV) file to the fax speed dial address book has failed.
44.01.22	Fax Speed Dial Address Book import cancel	Import of a comma separated values (CSV) file to the fax speed dial address book has been cancelled.
44.01.23	Email/Fax Address Book export success	Export of the email/fax address book to a comma separated values (CSV) file has succeeded.

Event log message	Description	Comments
44.01.24	Email/Fax Address Book export failure	Export of the email/fax address book to a comma separated values (CSV) file has failed.
44.01.25	Email/Fax Address Book export cancel	Export of the email/fax address book to a comma separated values (CSV) file has been cancelled.
44.01.26	Fax Speed Dial Address Book export success	Export of the fax speed dial address book to a comma separated values (CSV) file has succeeded.
44.01.27	Fax Speed Dial Address Book export failure	Export of the fax speed dial address book to a comma separated values (CSV) file has failed.
44.01.28	Fax Speed Dial Address Book export cancel	Export of the fax speed dial address book to a comma separated values (CSV) file has been cancelled.
44.01.29	Email/Fax Address Book clear success	
44.01.2A	Email/Fax Address Book clear failure	
44.01.2B	Email/Fax Address Book clear cancel	
44.01.2C	Fax Speed Dial Address Book clear success	
44.01.2D	Fax Speed Dial Address Book clear failure	
44.01.2E	Fax Speed Dial Address Book clear cancel	
44.01.2F	Address Book timeout error	DiA timeout has occurred during execution of an address book method.
44.01.30	Email/Fax address book is full	
44.01.31	Fax speed dial address book full	
44.02.00	Sign in to get Personal Contacts failed	
44.02.01	Personal Contact data not found on server	Server name for personal address book not found.
44.02.02	Personal Contact proxy address not found	Server name for personal address book not found.
44.02.03	PAB error while retrieving contacts	Proxy address not found.
44.02.04	No Personal Contacts Found	No user contacts found in personal address book.
44.02.05	Unknown Personal Contacts retrieval error	
44.02.06	Mailbox server connection failed	

Event log message	Description	Comments
44.03.00	Digital Send job state machine error	An unexpected state transition has occurred. This indicates a defect in the base digital send job code.
44.03.01	Digital Send job queue operation error	The job was unable to perform a necessary pipeline-queue operation.
44.03.02	Digital Send job invalid argument error	An invalid argument was provided to the job, either in the job-ticket or through a method call.
44.03.04	Digital Send scanner error	
44.03.05	Digital Send image processing error	The job encountered an error during the send filter processing phase of its execution and was unable to complete.
44.03.06	Digital Send image processing error	
44.03.07	Digital Send OCR error	The job encountered an error during the OCR filter processing phase of its execution and was unable to complete.
44.03.08	Digital Send metadata error	The job encountered an error during the metadata filter processing phase of its execution and was unable to complete.
44.03.09	Digital Send job retry attempt	The job is performing a recovery attempt due to an unexpected termination during the previous delivery
44.03.0B	All pages blank	Blank pages filtering was selected but all of the scanned pages are blank.
44.04.00	Digital Send job state machine error	An unexpected state transition has occurred. This indicates a defect in the email job code.
44.04.01	Digital Send job queue operation error	The job was unable to perform a necessary pipeline-queue operation.
44.04.02	Digital Send job invalid argument error	An invalid argument was provided to the job, either in the job ticket or through a method call.
44.04.05	Digital Send job maximum retries attempted	An email job failed due to maximum retry attempts.
44.04.06	Digital Send job retry attempt	
44.04.08	Digital Send job information event	
44.05.00	Digital Send job state machine error	An unexpected state transition has occurred. This indicates a defect in the folder job code.
44.05.01	Digital Send job queue operation error	The job was unable to perform a necessary pipeline-queue operation.

Event log message	Description	Comments
44.05.02	Digital Send job invalid argument error	An invalid argument was provided to the job, either in the job ticket or through a method call.
44.05.04	Digital Send job maximum retries attempted	The job failed because it reached the maximum retry attempts.
44.05.05	Digital Send job retry attempt	
44.07.03	Digital Send remote printer process error	
44.10.00	General send to e-mail error	
44.10.01	SMTP protocol error	An SMTP protocol error was encountered while trying to deliver an email job.
44.10.02	SMTP authentication error	An error occurred authenticating a user to the configured SMTP server.
44.10.03	SMTP server not configured	The email device was instructed to deliver an email yet there was neither a configured SMTP server to use nor an SMTP server identified in the ticket.
44.10.04	General send to e-mail error	An SMTP error was encountered while trying to deliver an email job.
44.10.05	SMTP server unavailable	
44.10.06	No cert available, power cycle device	
44.10.07	The certificate for signing is invalid	
44.10.08	The scanned file is too large to encrypt	
44.10.09	Unknown encryption error	
44.11.01	Invalid FTP device send attachment	
44.11.02	FTP send destination unspecified	The destination configuration is unsupported or no destinations were found in the resource ticket.
44.11.03	Invalid FTP destination credentials	Credentials associated with destination were found to be invalid or missing.
44.11.04	Invalid FTP destination server or path	Unable to connect to the supported destination type.
44.11.05	Error writing single multi-page image file	Write (copy) of the multi-page image file failed.
44.11.06	Error writing multi (file-per-page) image	Write of a image page file belonging to a multi-page image file set failed.
44.11.07	Insufficient disk space on FTP server	
44.11.08	Error processing FTP send attachments	Encountered an unexpected processing error of an attachment se to be sent to the FTP destination server.

Event log message	Description	Comments
44.11.FF	Unexpected FTP device resource error	Unexpected error occurred in the FTP device resource device code.
44.12.01	Invalid folder share attachment	The attachment pulled of the queue is incorrect.
44.12.02	Folder share not detected or is unknown	Destination configuration is unsupported or no destinations were found in the resource ticket.
44.12.03	Invalid folder share credentials	Credentials associated with destination were found to be invalid or missing.
44.12.04	Invalid folder destination server or path	Unable to connect to the supported destination type.
44.12.05	Error writing multi-page image file	Write (copy) of the multi-page image file failed.
44.12.06	Multi-page, multi-file image write error	Write (copy) of a image page file belonging to a multi-page image file set failed.
44.12.07	Insufficient disk space on folder share	
44.12.08	Error processing folder share attachments	Encountered an unexpected processing error of an attachment set to be sent to destination folder share.
44.12.FF	Unexpected folder share error	Unexpected error occurred in folder share resource device code.
44.13.00	Searchable PDF file type error	An error occurred while trying to generate a searchable PDF.
44.13.01	RTF file type error	An error occurred while trying to generate a RTF file.
44.13.02	Text file type error	An error occurred while trying to generate a text file.
44.13.03	CSV file type error	An error occurred while trying to generate a CSV file type.
44.13.04	HTML file type error	An error occurred while trying to generate a Html file type.
44.13.05	XML file type error	n error occurred while trying to generate a XML file type.
44.13.06	XPS file type error	An error occurred while trying to generate an XPS file type.
44.13.07	PDF file type error	An error occurred while trying to generate a PDF file type.
44.14.00	General send to remote printer error	General error for remote printer device.
44.14.01	Invalid printer destination	Invalid printer exception.
44.14.02	General send to remote printer error	Out of Memory Exception.

Event log message	Description	Comments
44.14.03	General send to remote printer error	File not found exception.
44.20.01	Exception while communicating with remote service	
44.34.03	Fax Modem Failure	The fax result modem failed.
44.34.E5	Not able to set fax modem variable	The firmware failed to set a variable on the modem.
44.90.00	Digital Send job state machine error	An unexpected state-transition has occurred. This indicates a defect in the Internet fax job code.
44.90.01	Digital Send job queue operation error	The job was unable to perform a necessary pipeline-queue operation.
44.90.02	Digital Send job invalid argument error	An invalid argument was provided to the job, either in the job ticket or through a method call.
44.90.03	Digital Send email processing error	Internet fax job error occurred during email device processing.
44.90.04	Digital Send job maximum retries attempted	Internet fax job failed due to maximum retry attempts.
44.90.07	Internet Fax configuration error	Failure of the Internet fax job due to a configuration error.
44.90.08	SMTP server access error	Error accessing SMTP server to send email to the Internet fax provider.
44.90.09	Internet fax domain access error	Error in accessing the Internet fax provider domain.
44.91.00	Digital Send job state machine error	An unexpected state-transition has occurred. This indicates a defect in the LAN fax job code.
44.91.01	Digital Send job queue operation error	The job was unable to perform a necessary pipeline-queue operation.
44.91.02	Digital Send job invalid argument error	LAN fax job invalid argument error. An invalid argument was provided to the job, either in the job-ticket or through a method call.
44.91.03	Digital Send folder processing error	LAN fax job error during folder device processing.
44.91.04	Digital Send job maximum retries attempted	LAN fax job failed due to maximum retry attempts.
44.91.07	Fax server access failure	Fax server access failure while trying to deliver a LAN fax job.
44.91.08	LAN fax configuration error	Cannot deliver a LAN Fax job due to a configuration error.

Event log message	Description	Comments
44.91.09	LAN fax server notification error	Error in retrieving status of LAN fax job from the server.
44.91.0A	LAN fax job notification error	Error in setting up a notification job on LAN fax completion.
44.92.00	Analog fax state machine error	An unexpected state-transition has occurred.
44.92.02	Invalid argument error	Invalid argument provided to the job, either in the job ticket or through a method call.
44.92.04	Scan device error	Error during the scan device processing phase of job execution. Unable to complete.
44.92.05	Gdi filter error	Error during the Gdi Filter processing phase of job execution and was unable to complete.
44.92.06	Send fax filter error	Error during the SendFax Filter processing phase of job execution and was unable to complete.
44.92.09	Job recovery attempt	The job is performing a recovery attempt due to an unexpected termination during the previous delivery.
44.92.0D	OCSP validation certificate missing	Digital send error indicates all pages in the job are blank.
44.A0.01	All pages in the fax job are blank	A certificate is not installed on the device.
44.A0.02	Domain Controller certificate is revoked for subject	A certificate is installed on the device, but it is no longer valid.
44.A0.03	No valid CRL found for Domain Controller	No valid CRL found for domain controller.
44.A0.04	Cannot connect to the domain server	The domain controller server hostname was not entered correctly or is not a valid hostname.
44.A0.05	Domain not recognized	The domain configured on the device is invalid.
44.A0.06	The CRL has expired	The specified CRL is no longer valid.
44.A0.07	Device-domain server date-time mismatch	The product clock is offset more than five minutes from the domain controller server.
44.A0.08	Kerberos code	Error code reported by dependency module failure.
44.A0.09	Issuer not found for Domain Controller certificate for issuer with subject	The issuer certificate of the domain controller certificate is not installed on the device.

Event log message	Description	Comments
44.A0.0A	Domain Controller certificate is revoked for subject	The domain controller certificate has been revoked.
44.A0.0B	DC issuer certificate has expired for issuer subject	The issuer certificate of the domain controller certificate is installed on the device, but it is no longer valid.
44.A0.0C	OCSP responder failure	The OCSP responder has been incorrectly configured or there has been an error.
44.A0.0D	Unable to contact OCSP server	The OCSP responder is off or not reachable.
44.A0.0E	User certificate has expired	The user is trying to authenticate with an invalid user certificate.
44.A0.0F	DC certificate validity status is unknown for subject	The OCSP responder returned an unknown status for the domain controller certificate.
44.A0.10	Kerberos server cannot verify user certificate	The user is trying to authenticate with an invalid user certificate.
44.A0.11	OCSP failed; invalid OCSP URL value	
44.A0.12	Cannot decode CDP extension or unable to get CRL from CDP	CRL was not obtained because of a decoding error or it was unavailable.
98.00.00	Partition manager unexpected exception	
98.00.01	Corrupt data in firmware volume	
98.00.02	Corrupt data in solutions volume	
98.00.03	Corrupt data in configuration volume	
98.00.04	Corrupt data in job data volume	
98.00.05	Failed to mount pre-boot partition	
98.00.06	Pre-boot mount warning	
98.00.07	File systems are dirty	
98.00.08	Secondary disk not found in NVRAM	
98.00.09	Secondary disk not found in OS	
98.00.0A	Partition not found	
98.00.0B	Volume not found or Set Mount Point failed	
98.00.0C	Failed to mount partition	
98.00.0D	Ram Disk shrink attempt failed	
98.01.00	Create extended partition failed	
98.01.01	Failed to format secondary disk	

Event log message	Description	Comments
98.01.02	Unable to format partition	
98.02.00	Unable to wipe partition	
98.02.01	Drive not found	
98.03.00	Partition scan threw exception	
98.03.01	Partition scan not found	
98.03.10	Corrupt data in firmware volume	
98.03.11	Corrupt data in configuration volume	
98.03.12	Corrupt data in job data volume	
98.03.13	Corrupt data in solutions volume	
98.03.14	Corrupt data in configuration volume	
98.03.15	Corrupt data in configuration volume	
98.03.16	Corrupt data in job data volume	
98.03.17	Corrupt data in job data volume	
98.03.20	Corrupt data in firmware volume	
98.03.21	Corrupt data in configuration volume	
98.03.22	Corrupt data in job data volume	
98.03.23	Corrupt data in solutions volume	
98.03.24	Corrupt data in configuration volume	
98.03.25	Corrupt data in configuration volume	
98.03.26	Corrupt data in job data volume	
98.03.27	Corrupt data in job data volume	
98.04.00	Data migrated to secondary disk	
98.04.01	Data migrated to internal disk	
98.04.02	Data migrated to ram disk	
98.04.03	Exception while erasing partition	
98.04.04	Failed to migrate data	
98.04.05	The original drive was not found.	
98.04.06	New drive not found	
99.00.00	Firmware Install Error	
99.00.01	Firmware download successful	A corrupted file was received. Do not replace hardware.

Event log message	Description	Comments
99.00.02	Upgrade not performed, timeout during receive	I/O error encountered when reading the header number and size. Error indicates a problem with the network environment, not the product. Do not replace hardware.
99.00.03	Upgrade not performed, error writing to disk	Check the connection to the hard disk or replace it.
99.00.04	Upgrade not performed, timeout during receive	I/O error encountered when reading the header.
99.00.05	Upgrade not performed, timeout during receive	
99.00.06	Upgrade not performed, error reading upgrade	Error encountered when reading the header number and size.
99.00.07	Upgrade not performed, error reading upgrade	Error encountered when reading the header.
99.00.08	Upgrade not performed, error reading upgrade	Unexpected error when reading image data.
99.00.09	Upgrade canceled by user	
99.00.10	An error occurred accessing the repository	
99.00.11	Upgrade not performed, the file is invalid	Upgrade canceled by user. Job canceled when reading rest of header.
99.00.12	Upgrade not performed, the file is invalid	Header size does not match version size. This indicates an invalid firmware installation manager (FIM) file. No hardware components should be replaced.
99.00.13	Upgrade not performed, the file is invalid	Header size does not match version size.
99.00.14	Upgrade not performed, the file is invalid	Header size is too small.
99.00.15	Upgrade not performed, FIM error	Error occurred during call to erase media.
99.00.16	Upgrade not performed, FIM error	Upgrade not performed, FIM error Previous JDI short stack upgrade error prevents upgrade of JDI. Indicates the JDI SS did not upgrade because the JDI upgrade failed. Logged more as a status event than an error condition.
99.00.17	Upgrade failed, must resend upgrade	Upgrade not performed, FIM error.
99.00.18	Upgrade not performed, FIM error	

Event log message	Description	Comments
99.00.19	Upgrade failed, must resend upgrade	Upgrade error occurred when getting image buffer with FIM image. This indicates that there was a network timeout or the product received an unexpected end-of-file message before receiving the full FIM image.
99.00.20	Error during preboot Installation Manager	Error during pre-boot installation manager
99.00.21	Upgrade failed, must resend upgrade	
99.00.22	Upgrade failed, must resend upgrade	
99.00.23	Upgrade not performed, the file is invalid	
99.00.24	Upgrade not performed, FIM error	
99.00.25	Upgrade skipped, matching versions	
99.00.26	Firmware Install Error	
99.00.27	Firmware Install Error	
99.00.28	Bad FIM signature was accepted	Signature was bad but accepted anyway.
99.01.00	Firmware Install Error	
99.01.10	Firmware Install Error	
99.01.20	Firmware Install Error	
99.02.00	Firmware Install Error	
99.02.01	A successful firmware installation occurred	
99.02.10	Firmware Install Error	
99.02.20	Firmware Install Error	
99.02.21	Firmware Install Error	
99.03.00	Firmware Install Error	
99.03.10	Firmware Install Error	
99.04.00	Firmware Install Error	
99.04.10	Firmware Install Error	
99.04.20	Firmware Install Error	
99.04.21	Firmware Install Error	
99.04.22	Firmware Install Error	
99.04.30	Firmware Install Error	Package path not found.
99.04.31	Firmware Install Error	Package header is null.

Event log message	Description	Comments
99.04.32	Firmware Install Error	Package path did not contain expected engine out file.
99.04.33	Firmware Install Error	Package engine out file did not exist.
99.04.34	Firmware Install Error	Invalid type request to EngineDriverAPI.
99.04.40	Firmware Install Error	Type is not a valid supported type.
99.04.41	Firmware Install Error	Revision input format invalid
99.04.42	Firmware Install Error	
99.04.43	Firmware Install Error	Engine variant is out of range.
99.04.44	Firmware Install Error	CPU ID is out of range.
99.04.45	Firmware Install Error	Device ID is out of range.
99.04.46	Firmware Install Error	Revision code is out of range.
99.04.47	Firmware Install Error	
99.04.48	Firmware Install Error	Revision has invalid digit or unexpected number.
99.04.50	Firmware Install Error	Low-level engine driver open failed.
99.04.51	Firmware Install Error	Low-level engine driver close failed.
99.04.52	Firmware Install Error	
99.04.53	Firmware Install Error	
99.04.54	Firmware Install Error	
99.04.55	Firmware Install Error	
99.04.56	Firmware Install Error	
99.04.57	Firmware Install Error	
99.04.58	Firmware Install Error	
99.04.59	Firmware Install Error	
99.04.60	Firmware Install Error	
99.04.61	Firmware Install Error	Engine boots in RFU mode.
99.04.62	Firmware Install Error	Data decoding error
99.04.63	Firmware Install Error	
99.04.64	Firmware Install Error	
99.04.65	Firmware Install Error	
99.04.66	Firmware Install Error	
99.04.67	Firmware Install Error	
99.04.68	Firmware Install Error	

Event log message	Description	Comments
99.04.7C	Firmware Install Error	Masking ROM detected (warning log only).
99.04.7D	Firmware Install Error	Masking ROM cannot be for firmware upgrade.
99.04.7E	Firmware Install Error	Invalid configuration detected (warning log only).
99.04.7F	Firmware Install Error	Invalid configuration for firmware upgrade.
99.05.00	Firmware Install Error	
99.05.10	Firmware Install Error	
99.05.20	Firmware Install Error	
99.05.30	Firmware Install Error	Package path was not found.
99.05.31	Firmware Install Error	Package header is null.
99.05.32	Firmware Install Error	Package path did not contain expected engine out file.
99.05.33	Firmware Install Error	Package engine out file did not exist.
99.05.34	Firmware Install Error	Invalid type request to EngineDriverAPI.
99.05.35	Firmware Install Error	NVRAM.csv file and SR73 engine number codes do not match. Invalid package for this engine.
99.05.36	Firmware Install Error	Different version codes on two engine package files that are for the same variant, CPU ID, or device ID for the product were detected.
99.05.40	Firmware Install Error	Type is not a valid.
99.05.41	Firmware Install Error	Revision input format is invalid.
99.05.42	Firmware Install Error	Engine ID is out of range.
99.05.43	Firmware Install Error	Engine variant is out of range.
99.05.44	Firmware Install Error	CPU ID is out of range.
99.05.45	Firmware Install Error	Device ID is out of range.
99.05.46	Firmware Install Error	
99.05.47	Firmware Install Error	
99.05.48	Firmware Install Error	Revision has an invalid digit or unexpected number.
99.05.49	Firmware Install Error	Mismatched engine ID: invalid package for this engine
99.05.4A	Firmware Install Error	Incompatible engine driver header revision (Warning Log only)

Event log message	Description	Comments
99.05.50	Firmware Install Error	Low-level engine driver failed to open.
99.05.51	Firmware Install Error	Low-level engine driver failed to close.
99.05.52	Firmware Install Error	
99.05.53	Firmware Install Error	
99.05.54	Firmware Install Error	
99.05.55	Firmware Install Error	
99.05.56	Firmware Install Error	
99.05.57	Firmware Install Error	
99.05.58	Firmware Install Error	
99.05.59	Firmware Install Error	
99.05.5A	Firmware Install Error	
99.05.60	Firmware Install Error	
99.05.61	Firmware Install Error	
99.05.62	Firmware Install Error	
99.05.63	Firmware Install Error	
99.05.64	Firmware Install Error	Illegal file format
99.05.65	Firmware Install Error	Illegal transfer
99.05.66	Firmware Install Error	RFU mode not set. RFU mode failed.
99.05.67	Firmware Install Error	Erase Flash ROM request not set. RFU mode failed.
99.05.68	Firmware Install Error	Erase Flash ROM request not cleared. RFU mode failed.
99.05.69	Firmware Install Error	
99.05.7C	Firmware Install Error	Masking ROM detected and no upgrade is needed.
99.05.7D	Firmware Install Error	Masking ROM detected and an upgrade is needed. Cannot start.
99.05.7E	Firmware Install Error	The configuration for the firmware upgrade or downgrade is invalid. No upgrade is needed.
99.05.7F	Firmware Install Error	The configuration for the firmware upgrade is invalid. The product cannot start.
99.05.80	Firmware Install Error	
99.05.81	Firmware Install Error	
99.05.82	Firmware Install Error	

Event log message	Description	Comments
99.05.83	Firmware Install Error	
99.05.84	Firmware Install Error	
99.05.85	Firmware Install Error	
99.05.86	Firmware Install Error	
99.05.87	Firmware Install Error	
99.05.88	Firmware Install Error	
99.06.00	Firmware Install Error	
99.06.10	Firmware Install Error	
99.06.20	Firmware Install Error	
99.06.21	Firmware Install Error	
99.07.00	Firmware Install Error	
99.07.10	Firmware Install Error	
99.07.20	Firmware Install Error	
99.07.21	Firmware Install Error	
99.09.00	Firmware Install Error	
99.09.60	Unsupported disk	Remove the disk to continue startup.
99.09.61	Unlocked disk	Remove or lock the disk to continue.
99.09.62	Unknown disk	Secure disk locked to another device, remove or erase and unlock to continue
99.09.63	Missing disk	Replace the disk, clear the password, and clear the disk-in-use setting to continue.
99.09.64	Disk broken	Replace the disk to continue.
99.09.65	Disk data error	Disk data error, erase the disk to clear.
99.09.66	No disk installed	Missing boot disk, check the disk.
99.09.67	Disk data error	Upgrade firmware.
99.0A.00	Firmware Install Error	
99.0B.00	Firmware Install Error	
99.0C.00	Firmware Install Error	
99.0C.01	Successful solution install	A solution bundle was downloaded successfully.
99.0C.02	Successful solution uninstall	A solution bundle was removed from the disk successfully.
99.0C.03	Solution revision already installed	The downloaded solution bundle already exists on the disk.

Event log message	Description	Comments
99.0F.01	FIM failed: Another FIM already in progress	The user tried to perform more than one installation in parallel. This is not supported.
99.0F.02	FIM installation successful: solution bundle	A solution bundle was successfully installed.
99.0F.03	Firmware upgrade over the print path disabled	Port 9100 is available for the attempted installation, which resulted in a failure.
99.0F.04	Manufacturer config bundle signature valid	A signature is valid.
99.0F.05	Manufacturer config bundle signature invalid	A signature is invalid.
99.0F.06	Config bundle signature valid	A signature is invalid.
99.0F.07	Config bundle signature invalid	A signature is invalid.
99.19.60	Unsupported disk	Unsupported secondary disk, remove to continue booting
99.19.61	Unlocked disk	Remove or lock to continue.
99.19.62	Unknown disk	The secondary disk is locked to another product, remove or erase and unlock to continue.
99.19.63	Missing disk	Clear the password; clear secondary disk-in-use setting to continue.
99.19.64	Disk broken	Replace the secondary disk.
99.19.65	Disk data error	Erase the secondary disk to clear.
99.19.66	No disk installed	The secondary disk is missing.
99.19.67	Disk data error	The secondary disk cannot start up. Update firmware.
99.29.60	Unsupported disk	Remove the external disk to continue startup.
99.29.61	Unlocked disk	Unlock the external disk.
99.29.62	Unknown disk	The external disk that is locked to another product, remove or erase, and unlock to continue.
99.29.63	Missing disk	Replace the external disk, clear the password, and clear the external disk-in-use setting to continue.
99.29.64	Disk broken	Replace the external disk.
99.29.65	Disk data error	Erase the external disk to clear.
99.29.66	No disk installed	Check the external disk.
99.29.67	Disk data error	The external disk cannot be turned on. Update firmware.

Clear jams

Clear jams from the paper path

To clear a paper jam:

1. Open the automatic document feeder (ADF) hatch.



2. Remove the originals or any obstructions from the paper path.

 **TIP:** Use the green thumb wheel on the left side of the open hatch to manually advance originals through the paper path.

3. Remove the ADF duplex background, remove any debris, and then slide the component back into its housing until it clicks into place.

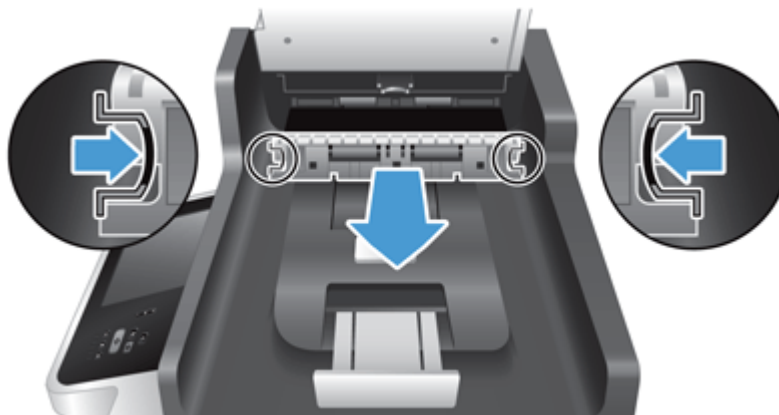

4. Close the ADF hatch until it snaps into place.
5. Reload the unscanned originals in the document feeder.
6. Resume scanning.

If you experience repeated jams:

- Ensure that the hatch door is fully closed
- Check that all necessary maintenance has been performed
- Clean the ADF rollers and separation pad
- Replace ADF rollers and separation pad
- Replace the flatbed scanner and ADF assembly

Solve paper-handling problems

Paper jamming, skewing, misfeeds, or multiple-page feeds

- Check that all rollers are in place and that the roller doors and automatic document feeder (ADF) hatch are closed.
- If the pages look skewed as they feed into the paper path, check the resulting scanned images in the software to ensure that they are not skewed.
- The pages might not be placed correctly. Straighten the pages and adjust the paper guides to center the stack.
- The paper guides must be touching the sides of the paper stack to work properly. Please ensure that the paper stack is straight and the guides are against the paper stack.
- The document feeder or output tray might contain more than the maximum number of pages. Load fewer pages in the document feeder, and remove pages from the output tray.
- Verify that there are no pieces of paper, staples, paper clips, or other debris in the paper path.
- Clean the paper path to help reduce misfeeds. If misfeeds still occur, clean the rollers. If misfeeds still occur, replace the rollers.

Paper does not feed from the product

Reload the pages into the document feeder, ensuring that they make contact with the rollers.

The automatic document feeder (ADF) hatch might not be securely latched. Open the ADF hatch and then close it by pressing firmly. The message **If document feeder roller cleaning is complete, clear message** displays on the control panel. Touch [Cancel](#) to clear the message.

A problem with the product hardware might exist. Follow this procedure to test the product:

1. Ensure that the power supply is securely connected between the product and a live electrical outlet or surge protector. Check that the green LED on the power supply case is on to verify that the power supply is functional.
2. If the power supply is connected to a surge protector, ensure that the surge protector is plugged into an outlet and turned on.
3. Press and hold the power button for 10 seconds to turn off the product, and then disconnect the power cable.
4. Wait 30 seconds.
5. Reconnect the power cable to the product, and then press the Power button.
6. Try to rescan.

Originals are curling up in the document output tray

Under dry conditions, lightweight originals such as those printed on carbonless copy paper may curl in the output tray. To minimize curl, flatten curled edges on the originals before placing them in the document feeder. If you cannot flatten curled edges, make sure the curled edges are facing down when you place the originals in the document feeder.

The bottom of the scanned image is cut off

By default, the scanning software can scan media that is up to 356 mm (14 in) long. For longer pages, the end of the document is not included in the scanned image.

The scanned images have streaks or scratches

After each step, try another scan to see if the streaks or scratches are still apparent. If so, then try the next step. For information on cleaning the product, see the **Care and maintenance** section of the product user guide.

- Check that the originals are clean and unwrinkled.
- Clean the scanning strip, which is to the left of the scanning glass.
- Clean the rollers manually.

An item loaded in the document input tray jams repeatedly

- The item might not meet the guidelines for acceptable originals.
- The item might have something on it, such as staples or self-stick notes on the original that must be removed.
- Make sure the paper guides touch the edges of the original.

The product has stopped working correctly

If the product stops scanning, follow these steps. After each step, start a scan to see if the product is working. If the problem persists, proceed with the next step.

- 1.** A cable might be loose. Ensure that the Ethernet, power supply, and power cables are properly connected.
- 2.** Ensure that the product is receiving power.
 - a.** Check that the green LED on the power supply case is on.
 - b.** If the green LED is not on, ensure that power is available to the power outlet or surge protector that the power supply cable is plugged into, and that the power cable is securely connected to the power supply and the product.
 - c.** If power is available to the power outlet or surge protector but the green LED is still not on, the power supply might be defective. See www.hp.com/support for assistance.
- 3.** Press and hold the power button for 10 seconds to turn off the product, wait 30 seconds, and then touch the Power button again to turn on the product.

Clean the product

Clean the touchscreen

Clean the touch screen whenever it is necessary to remove fingerprints or dust. Wipe the touch screen gently with a clean, water-dampened, lint-free cloth.

⚠ CAUTION: Use water only. Solvents or cleaners can damage the touch screen. Do not pour or spray water directly onto the touch screen.

Clean the scanning glass, scanning strip, and automatic document feeder (ADF) duplex background

The scanning glass, scanning strip, and ADF duplex background should be cleaned periodically or any time a scanned image has streaks.

To clean these components, follow these steps:

1. Press and hold the power button for 10 seconds to turn off the product, and then disconnect the power cable.
2. Open the scanning lid.

3. Clean the scanning glass and scanning strip with a soft, lint-free cloth that has been sprayed with a mild glass cleaner.



CAUTION: Use only glass cleaner to clean the scanning glass and scanning strip. Avoid cleaners that contain abrasives, acetone, benzene, and carbon tetrachloride, all of which can damage the scanning glass. Avoid isopropyl alcohol because it can leave streaks on the glass.

Do not spray the glass cleaner directly on the scanning glass or scanning strip. If too much glass cleaner is applied, the cleaner could leak under the scanning glass or scanning strip and damage the product.

4. Dry the glass with a dry, soft, lint-free cloth.

5. Close the scanning lid, and then raise the scan input tray until it is perpendicular to the product.



6. Press in on the ADF duplex background tabs to release the ADF duplex background, and then pull forward to remove the ADF duplex background from its housing.

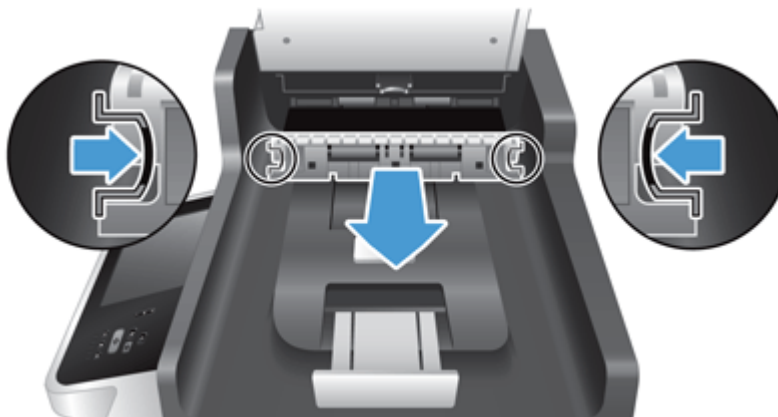

7. Wipe the scanning strip on the ADF duplex background with a soft, lint-free cloth that has been moistened with warm water.
8. Dry the ADF duplex background with a dry, soft, lint-free cloth, and then slide the component into its housing until it clicks into place.
9. Lower the scan input tray into place, and then reconnect the power supply to the product.
10. Press the Power button to turn on the product.

Clean the rollers

Clean the rollers under the following conditions:

- The product displays a message to clean the rollers.
 - You experience repeated document jams.
 - The product does not pull pages into the paper path.
 - The scanned images are elongated.
 - You frequently scan any of the following types of documents: coated paper, chemically treated documents such as carbonless paper, documents with a large amount of calcium carbonate, documents written with pencils, documents on which the toner has not fused.
1. Press and hold the power button for 10 seconds to turn off the product, and then disconnect the power cable.
 2. Open the automatic document feeder (ADF) hatch.



3. Remove any visible lint or dust from each of the feed rollers and the separation pad using compressed air or a clean lint-free cloth moistened with warm water.

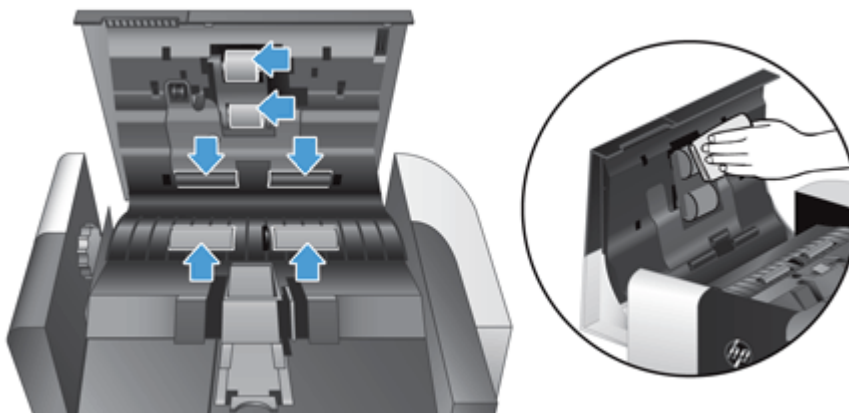

4. Close the ADF hatch, and then reconnect the power supply to the product.
5. Press the Power button to turn on the product, and then update the product maintenance history.
 - a. From the Home screen on the product control panel, touch the [Device Maintenance](#) button.
 - b. Open the following menus:
 - [Calibrate/Cleaning](#)
 - [Clean Rollers](#)
 - c. Touch [Reset](#) to record the cleaning activity and reset the counters to zero.

Set the Very Low Settings option from the control panel

Set the product to display a message to clean the rollers.

1. From the Home screen on the product control panel, touch the [Device Maintenance](#) button.
2. Open the following menus:
 - [Calibrate/Cleaning](#)
 - [Clean Rollers Settings](#)
3. In the [Clean Rollers](#) box, enter a percentage of the total scans at which the product displays a message to clean the rollers.
4. Select one of the following options:
 - Select the [Stop](#) option to set the product to stop scanning until you clean the rollers.
 - Select the [Prompt to continue](#) option to set the product to stop scanning and prompt you to clean the rollers. You can acknowledge the prompt and continue scanning.
 - Select the [Continue](#) option to set the product to alert you that the rollers require cleaning, but to continue scanning.

Solve connectivity problems

Check the following items to verify that the product is communicating with the network. Before beginning, view the information pages.

If you still cannot connect to the network after checking these items, see www.hp.com/support.

1. Are your power and power supply cables connected properly, and is the product turned on?
2. Are your network cables connected properly?

Make sure that the product is attached to the network using the appropriate port and cable. Check each cable connection to make sure it is secure and in the right place. If the problem continues, try a different cable or ports on the hub or transceiver.

3. Do the HP Jetdirect LEDs indicate a network connection and activity?

If the green LED is off, a link has failed.

4. Are the link speed and duplex settings set correctly?

Hewlett-Packard recommends leaving this setting in automatic mode (the default setting).

5. Can you "ping" the product using its IP address?

Use the command prompt to ping the product from your computer. For example:

```
ping 192.168.45.39
```

Ensure that the ping displays round-trip times.

If you are able to ping the product, verify that the IP address configuration for the product is correct on the computer. If it is correct, delete and then add the product again.

If the ping command failed, verify that the network hubs are on, and then verify that the network settings, the product, and the computer are all configured for the same network.

6. Have any software applications been added to the network?

Make sure they are compatible and that they are installed correctly.

7. Can you access the HP Embedded Web Server?

Open a browser window and enter the product IP address in the URL line.

8. Is your protocol enabled?

Use the HP Embedded Web Server to check the status of protocols.

9. Does the product appear in HP Web Jetadmin or other management application?

- Verify network settings on the Network configuration screen.
- Confirm the network settings for the product using the product control panel.

Check the Ethernet connection

1. Ensure that the Ethernet cable is firmly connected between the product and a router, Ethernet jack, or Ethernet switch.
2. If the Ethernet cable is connected to a network router or Ethernet switch, try connecting it to a different port on the router or switch.
3. Press and hold the power button for 10 seconds to turn off the product, wait 30 seconds, and then press the Power button again to turn on the product.

Service mode functions

Service menu

The **Service** menu is PIN-protected for added security. Only authorized service people have access to the **Service** menu. When you select **Service** from the list of menus, the product prompts you to type an eight-digit personal identification number (PIN). The PIN for the 8500 fn1 is 09850011.

 **NOTE:** The product automatically exits the **Service** menu after about one minute if no items are selected or changed.

1. From the Home screen on the product control panel, touch the **Device Maintenance** button.
2. Touch the **Service** button.
3. The drop-down menu shows the **User Access Code** list item. Select the **Service Access Code** list item, and then touch the **Access Code** text box. The touchscreen numeric keypad appears.
4. Type the PIN (xxxxxx).
5. Touch the **OK** button to save the PIN or the **Cancel** button to exit the screen.

 **NOTE:** The PIN displays in the **Service use only:** text box as *********.

6. Touch the **OK** button to open the **Service** menu or the **Cancel** button to exit the screen.

The following menu items appear in the **Service** menu:

Menu item	Sub-menu item	Sub-menu item	Description
Event Log			Allows you to view the product event log.
Clear Event Log			Use this item to clear the product event log.
Cycle Counts	Document Feeder Count		Set the total pages fed through the document feeder.
	Document Feeder Kit Interval		Set the number of pages until the document feeder kit must be replaced. The default is 100,000.
	Clean Rollers Count		Set the total number of pages that have been scanned since the rollers were cleaned.
	Clean Rollers Interval		Set the total number of pages scanned until the rollers must be cleaned. The default is 10,000.
	ADF Count		Set the total pages fed through the document feeder.
	Flatbed Count		Set the total pages scanned from the flatbed.

Menu item	Sub-menu item	Sub-menu item	Description
	ADF Simplex Count		Set the total single-sided pages fed through the document feeder.
	ADF Duplex Count		Set the total two-sided pages fed through the document feeder.
	Send Scan Count		Set the number of scanned pages sent to e-mail.
Serial Number			Set the serial number.
Service ID			<p>Use this item to show the date that the product was first used on the control panel. This eliminates the need for users to keep paper receipts for proof of warranty.</p> <p>Restore the service ID</p> <p>If you replace the formatter, the date is lost. Use this menu item to reset the date to the original date that the product was first used. The date format is YYDDD. Use the following formula to calculate the dates:</p> <ol style="list-style-type: none"> To calculate YY, subtract 1990 from the calendar year. For instance, if the product was first used in 2002, calculate YY as follows: $2002 - 1990 = 12$. YY = 12. Subtract 1 from 10 (October is the tenth month of the year): $10 - 1 = 9$. <ul style="list-style-type: none"> Multiply 9 by 30: $9 \times 30 = 270$ or add 17 to

Menu item	Sub-menu item	Sub-menu item	Description
			<p>270: $270 + 17 = 287$. Thus, $DDD = 287$.</p>
			<p>Convert the service ID to an actual date</p>
			<p>You can use the product Service ID number to determine whether the product is still under warranty. Use the following formula to convert the Service ID into the installation date as follows:</p>
			<ol style="list-style-type: none"> 1. Add 1990 to YY to get the actual year that the product was installed. 2. Divide DDD by 30. If there is a remainder, add 1 to the result. This is the month. 3. The remainder from the calculation in step 2 is the date.
			<p>Using the Service ID 12287 as an example, the date conversion is as follows:</p>
			<ol style="list-style-type: none"> 1. $12 + 1990 = 2002$, so the year is 2002. 2. 287 divided by $30 = 9$ with a remainder of 17. Since there is a remainder, add 1 to 9 to get 10, which represents October. 3. The remainder in step 2 is 17, so that is the date. 4. The complete date is 17-October-2002.
			<p>NOTE: A six-day grace period is built into the date system.</p>

Product resets

Restore factory settings

1. From the Home screen on the product control panel, touch the [Administration](#) button, and then touch the [General Settings](#) button.
2. Touch the [Restore Factory Settings](#) button, and then touch an option. Touch the [Select All](#) button to reset factory settings for all options.
3. Touch the [Reset](#) button to restore factory settings.

The values for each reset are as follows:

Restore factory-set defaults values

- [General](#)
 - Display and sound settings for the control panel
 - Localization settings (for example, clock format and date format)
 - Error and warning log behavior
 - Default media settings
 - Sleep mode and delay setting
 - Internal backup file maximum size
 - Oxp installer solutions, tasks and pending tasks
 - Http job defaults
 - Clears the error, warning and info logs
 - Supported media types
 - Resets JetLink connected external devices
- [Security](#)
 - Default Authentication agent
 - Authentication agents
 - Policy agents
 - Color access control

Clean Disk and Partial Clean functions

Active and repository firmware locations

The firmware bundle now consists of multiple parts. The main components are the Windows CE Operating System and the printer/peripheral firmware files.

There are two locations/partitions on the hard drive where the firmware components are stored:

- The Active – where the Operating System and firmware currently are executing
- The Repository – the recovery location

If the Active location is damaged, or a [Partial Clean](#) was performed, the product automatically copies over the OS and firmware files from the Repository location and the product recovers.

If both the Active and Repository locations are damaged, or a [Clean Disk](#) was performed, then both locations are gone and the user must upload the firmware to the product in order for it to function again.

 **CAUTION:** The [Clean Disk](#) option performs a disk initialization for the entire disk. The operating system, firmware files, and third party files (among other files) will be completely lost. HP does not recommend this action.

Partial Clean

The [Partial Clean](#) option erases all partitions and data on the disk drive, except for the firmware repository where a backup copy of the firmware file is stored. This allows the disk drive to be reformatted without having to download a firmware upgrade file to return the product to a bootable state.

Characteristics of a Partial Clean

- Customer-defined settings, third-party solutions, firmware files, and the operating system are deleted.
- Rebooting the product restores the firmware files from the Repository location, but does not restore any customer-defined settings.
- For previous HP products, a Hard Disk Initialization is similar to executing the [Partial Clean](#) function for this product.

 **CAUTION:** HP recommends backing-up product configuration data before executing a [Partial Clean](#) if you need to retain customer-defined settings. See the [Backup/Restore](#) item in the [Device Maintenance](#) menu.



Reasons for performing Partial Clean

- The product continually boots up in an error state.

 **NOTE:** Try clearing the error prior to executing a [Partial Clean](#).

- The product will not respond to commands from the control panel.
- Executing the [Partial Clean](#) function is helpful for troubleshooting hard disk problems.
- To reset the product by deleting all solutions and customer-defined settings.
- The product default settings are not properly working.

Execute a Partial Clean

1. Turn the product on.
2. Press the Stop  button when the [Ready](#), [Data](#), and [Attention](#) LEDs are illuminated solid.
3. On the product keyboard press the down arrow to highlight [Administrator](#), and then press the enter key.
4. On the product keyboard press the down arrow to highlight [Partial Clean](#), and then press the enter key.
5. Press the enter key again.
6. Press the back arrow  button to highlight [Continue](#), and then press the enter key.

 **NOTE:** The product initializes.

Clean Disk

The [Clean Disk](#) option erases the entire disk drive.

 **CAUTION:** After executing a [Clean Disk](#) option, the product is *not* bootable.

Characteristics of a Partial Clean

- Customer-defined settings, third-party solutions, firmware files, and the operating system are deleted.

 **NOTE:** Rebooting the product *does not* restore the firmware files.

- Rebooting the product restores the firmware files from the Repository location, but does not restore any customer-defined settings.
- After executing the [Clean Disk](#) function, the message **99.09.67** displays on the control panel.
- After executing the [Clean Disk](#) function, the product firmware must be reloaded.

 **CAUTION:** HP recommends that you do not use the [Clean Disk](#) option unless an error occurs and the solution in the product service manual recommends this solution. After executing the [Clean Disk](#) function, the product is unusable.

HP recommends backing-up product configuration data before executing a [Clean Disk](#) if you need to retain customer-defined settings. See the [Backup/Restore](#) item in the [Device Maintenance](#) menu.

Reasons for performing Clean Disk

- The product continually boots up in an error state.

 **NOTE:** Try clearing the error prior to executing a [Clean Disk](#).

- The product will not respond to commands from the control panel.

- Executing the **Clean Disk** function is helpful for troubleshooting hard disk problems.
- To reset the product by deleting all solutions and customer-defined settings.

Execute a Clean Disk

1. Turn the product on.
2. Press the Stop  button when the **Ready**, **Data**, and **Attention** LEDs are illuminated solid.
3. On the product keyboard press the down arrow to highlight **Administrator**, and then press the enter key.
4. On the product keyboard press the down arrow to highlight **Clean Disk**, and then press the enter key.
5. Press the enter key. again.



NOTE: When the **Clean Disk** operation is complete, you will need to reload the product firmware.

Preboot menu options

If an error occurs while the product is booting, an error message appears on the control-panel display. The user can access the preboot menus. The error menu item will not be seen if an error did not occur.

Open the preboot menu

1. Turn the product on.
2. Press and hold the Stop  button when the LED lights are illuminated solid.
3. Use the keyboard to navigate the menu.

Table 3-15 Preboot menu options (1 of 6)

Menu option	First level	Second level	Third level	Description
Continue				Selecting the Continue item exits the preboot menu and continues the normal boot process. If a selection is not made in the initial menu within 30 seconds, the product returns to a normal boot (the same as selecting the Continue item). If the user navigates to another menu, the timeout does not apply.
Sign In				Enter the administrator PIN or service PIN if one is required to open the Preboot menu.

Table 3-15 Preboot menu options (1 of 6) (continued)

Menu option	First level	Second level	Third level	Description
Administrator				<p>This item navigates to the Administrator sub menus.</p> <p>If authentication is required (and the user is not already signed in) the Sign In prompt displays. The user is required to sign in.</p>
	Download			<p>This item initiates a preboot firmware download process. A USB device interface or a network connection can be used to download firmware.</p>
		Network		<p>See Product updates on page 165.</p>
		USB Device		<p>See Product updates on page 165.</p>
		USB Thumbdrive		
Clean Disk				<p>This item reinitializes the disk and cleans all disk partitions.</p> <p>CAUTION: Selecting the Clean Disk item removes all data.</p> <p>A delete confirmation prompt is not provided.</p> <p>The system is not bootable after this action—a firmware download must be performed to return the system to a bootable state.</p>
Partial Clean				<p>This item reinitializes the disk (removing all data except the firmware repository where the master firmware bundle is downloaded and saved).</p> <p>CAUTION: Selecting the Partial Clean item removes all data except the firmware repository.</p> <p>A delete confirmation prompt is not provided.</p> <p>This allows user to reformat the disk by removing the firmware image from the active directory without having to download new firmware code (product remains bootable).</p>
Change Password				<p>Select this item to set or change the administrator password.</p>
Clear Password				<p>Select the Clear Password item to remove a password from the Administrator menu. Before the password is actually cleared, a message will be shown asking to confirm that the password should be cleared. Press the 6 button to confirm the action.</p>

Table 3-16 Preboot menu options (2 of 6)

Menu option	First level	Second level	Third level	Description
Administrator continued	Manage Disk	Clear Disk		Select the Clear Disk item to enable an external device for job storage. Job storage is normally enabled only for the boot device. This item is disabled unless the 99.09.68 error is displayed.
		Lock Disk		Select the Lock Disk item to lock (mate) a new secure disk to this product. The secure disk already locked to this product will remain accessible to this product. Use this function to have more than one encrypted disk accessible by the product when using them interchangeably. The data stored on the secure disk locked to this product always remains accessible to this product.
		Leave Unlocked		Select the Leave Unlocked item to use a new secure disk in an unlocked mode for single service event. The secure disk that is already locked to this product will remain accessible to this product and uses the old disk's encryption password with the new disk. The secure disk that is already locked to this product remains accessible to this product.
		Clear Disk PWD		Select the Clear Password item to continue using the non-secure disk and clear the password associated with the yet to be installed secure disk. CAUTION: Data on the missing secure disk will be permanently inaccessible.
		Retain Password		Select the Retain Password item to use the non-secure disk for this session only, and then search for the missing secure disk in future sessions.
	Boot Device		Secure Erase	Select the Secure Erase item to erase all of the data on the disk and unlock it, if required. This process might take a long time. NOTE: The system will be unusable until the system files are reinstalled. The process is an ATA secure-erase command one-pass overwrite. This process erases the entire disk, including firmware. The disk remains an encrypted disk.
			Erase/Unlock	Select the Erase/Unlock item to cryptographically erase all data on disk and unlock the disk to allow access to it from any product. NOTE: The system will be unusable until the system files are reinstalled. This process erases the crypto key. The disk becomes a non-encrypted disk.
			Get Status	This item provides disk status information if any is available.

Table 3-17 Preboot menu options (3 of 6)

Menu option	First level	Second level	Third level	Description
Administrator continued	Manage Disk continued	Internal Device		Select the Internal Device item to erase the internal device or view the status of the internal device.
			Secure Erase	Select the Secure Erase item to erase all of the data on the disk and unlock it, if required. This process might take a long time. NOTE: The system will be unusable until the system files are reinstalled. The process is an ATA secure-erase command one-pass overwrite. This process erases the entire disk, including firmware. The disk remains an encrypted disk.
			Erase/Unlock	Select the Erase/Unlock item to cryptographically erase all data on disk and unlock the disk to allow access to it from any product. NOTE: The system will be unusable until the system files are reinstalled. This process erases the crypto key. The disk becomes a non-encrypted disk.
			Get Status	This item provides disk status information if any is available.
		External Device		Select the External Device item to erase the external device or get status about the external device.
			Secure Erase	Select the Secure Erase item to erase all of the data on the disk and unlock it if required. This process might take a long time. NOTE: The system will be unusable until the system files are reinstalled. The process is an ATA secure-erase command one-pass overwrite. This process erases the entire disk, including firmware. The disk remains an encrypted disk.
			Erase/Unlock	Select the Erase/Unlock item to cryptographically erase all data on disk and unlock the disk to allow access to it from any product. NOTE: The system will be unusable until the system files are reinstalled. This process erases the crypto key. The disk becomes a non-encrypted disk..
			Get Status	This item provides disk status information if any is available.

Table 3-18 Preboot menu options (4 of 6)

Menu option	First level	Second level	Third level	Description
Administrator continued	Configure LAN			Select the Configure LAN item to set the network settings for the preboot menu firmware upgrade. The network can be configured to obtain the network settings from a DHCP server or as static.
		IP mode [DHCP]		Use this item for automatic IP address acquisition from the DHCP server.

Table 3-19 Preboot menu options (5 of 6)

Menu option	First level	Second level	Third level	Description
Administrator continued	Startup Options			Select the Startup Options item to specify options that can be set for the next time the product is turned on and initializes to the Ready state.
		Show Revision		Not currently functional: Check the Show Revision item to allow the product to initialize and show the firmware version when the product reaches the Ready state. Once the product power is turned on the next time, the Show Revision item is unchecked so that the firmware revision is not shown.
		Cold Reset		Check the Cold Reset item to clear the IP address and all customer settings (this item also returns all settings to factory defaults). NOTE: Items in the Service menu are not reset.
		Skip Disk Load		
		Skip Cal		Select the Skip Cal item to initialize the product the next time the power is turned on without calibrating.
		Lock Service		CAUTION: Select the Lock Service item to lock the Service menu access (both in the preboot menu and the Device Maintenance menu). Service personnel must have the administrator remove the Lock Service setting before they can open the Service menu.
		Skip FSCK		

Table 3-19 Preboot menu options (5 of 6) (continued)

Menu option	First level	Second level	Third level	Description
		First Power		<p>Not currently functional: This item allows the product to initialize as if it is the first time it has been turned on.</p> <p>For example, the user is prompted to configure first-time settings like date/time, language, and other settings.</p> <p>Check this item so that it is enabled for the next time the product power is turned on.</p> <p>When the product power is turned on the next time, this item is unchecked so that the pre-configured settings are used during configuration, and the first-time setting prompt is not used.</p>
		Embedded Jetdirect Off		<p>Check the Embedded Jetdirect Off item to disable the embedded Jetdirect.</p> <p>By default this item is unchecked so that Jetdirect is always enabled.</p>

Table 3-20 Preboot menu options (6 of 6)

Menu option	First level	Second level	Third level	Description
Administrator	Diagnostics	Memory	Do Not Run	
continued	continued		Short	
			Long	
		Disk	Do Not Run	
			Short	
			Long	
			Optimized	
			Raw	
			Smart	
		ICBConnection		
		Run Selected		
	Remote Admin	Start Telnnet		
		Stop Telnnet		
		Refresh IP		

Table 3-20 Preboot menu options (6 of 6) (continued)

Menu option	First level	Second level	Third level	Description
Service Tools				This item requires the service access code.
		Reset Password		Use this item to reset the administrator password.
		Subsystems		For manufacturing use only. Do not change these values.

Solve fax problems

Internet Fax setup

The product can send faxes by using an Internet Fax service, which requires a subscription. To find information for configuring this feature, consult the Internet Fax service provider.

The service provider should have provided the information required to set up the service. Use that information to configure the service, then follow these instructions to use the service with the product.

1. Type the product IP address into the address line of a Web browser to open the HP Embedded Web Server.
2. Select the **Fax** tab.
3. Click **Enable Fax Send**.
4. From the **Fax Send Method** drop-down list, select **Internet Fax Service**.
5. Select the **Internet Fax Setup** tab to configure the service.
6. In the area for **Internet Fax Service Settings**, use the information from the service provider to fill in the boxes for **Internet Fax Provider Domain** and the **T37 Prefix**.
7. Type the default e-mail address for the fax account in the box for **Default Fax Account E-mail Address**. If you want to use the e-mail address for the user who is signed in to the product, select the appropriate box.
8. Select the appropriate file format to use for the faxes.
9. If you are using a service in North America, you can preconfigure the area code for outgoing faxes. This step is optional.
10. Click **Apply** to save the settings.

LAN Fax setup

The LAN Fax service provider should have provided the information needed to set up the service. Use that information to configure the service, then follow these instructions to use the service with the product. Depending on the service provider, some of these settings might not be available. To see a list of supported providers, see the Fax tab on the HP Embedded Web Server.

1. Type the product IP address into the address line of a Web browser to open the HP Embedded Web Server.
2. Select the **Fax** tab.
3. Click **Enable Fax Send**.
4. From the **Fax Send Method** drop-down list, select **LAN Fax Service**.
5. Select the **LAN Fax Setup** tab to configure the service.

6. In the area for **LAN Fax Service Settings**, select the name of the LAN Fax service that you are using. Select the file format that the service uses.
7. Type the path to the LAN Fax folder in the box below **UNC Folder Path**. UNC paths follow this format:

`\\servername\sharename\foldername`
8. Type the correct Windows domain.
9. Type the username and password for the LAN Fax folder.
10. Click **Verify Folder Access** to check whether you have configured access to the folder correctly. You will be prompted for the username and password for the folder.
11. In the area for **Dialing Settings**, type the maximum number of times the product should attempt to try sending the fax if the first attempt is unsuccessful. Also type the number of minutes to wait between attempts.
12. In the **Input Settings** area, select whether to receive notification if there are errors sending the file to the network folder. If you turn on error correction mode, portions of the fax that were not successfully sent will be sent again.
13. In the area for **Output Settings**, select the appropriate transmission speed, and select whether to include a cover page that the LAN fax service provides.
14. Click **Apply** to save the settings.

Solve e-mail problems

If you are unable to send e-mails by using the digital-send feature, you might need to reconfigure the SMTP gateway address or the LDAP gateway address. View a configuration page to find the current SMTP and LDAP gateway addresses. Use the following procedures to check if the SMTP and LDAP gateway addresses are valid.

Validate the SMTP gateway address



NOTE: This procedure is for Windows operating systems.

1. Open an MS-DOS command prompt: click **Start**, click **Run**, and then type `cmd`.
2. Type `telnet` followed by the SMTP gateway address and then the number `25`, which is the port over which the product is communicating. For example, type `telnet 123.123.123.123 25` where "123.123.123.123" represents the SMTP gateway address.
3. Press **Enter**. If the SMTP gateway address is *not* valid, the response contains the message `Could not open connection to the host on port, 25: Connect failed`.
4. If the SMTP gateway address is not valid, contact the network administrator.

Validate the LDAP gateway address



NOTE: This procedure is for Windows operating systems.

1. Open Windows Explorer. In the address bar, type `LDAP://` immediately followed by the LDAP gateway address. For example, type `LDAP://12.12.12.12` where "12.12.12.12" represents the LDAP gateway address.
2. Press **Enter**. If the LDAP gateway address is valid, the **Find People** dialog box opens.
3. If the LDAP gateway address is not valid, contact the network administrator.

Product updates

To download the most recent firmware upgrade for the product, go to www.hp.com/support.

Determine the installed revision of firmware

View a configuration page to determine the installed revision of firmware.

On the configuration page, look in the section marked Device Information for the firmware datecode and firmware revision.

Firmware datecode and firmware revision examples

- 20100831 (firmware datecode)
- 103067_104746 (firmware revision)

Perform a firmware upgrade

The firmware bundle is a `xxxxxxx.bdl` file. This file requires an interactive upgrade method. You cannot upgrade the product using the traditional FTP, LPR or Port 9100 methods of upgrading. Use one of the following methods to upgrade the firmware for this product.

HP Embedded Web Server

1. Open an browser window.
2. Enter the product IP address in the URL line.
3. Select the **Firmware upgrade** link from within the **Troubleshooting** tab.





 **NOTE:** If you get a warning screen, follow the instructions for setting an administrator password from the **Security** tab.

4. Browse to the location that the firmware upgrade file was downloaded to, and then select the firmware file. Select the Install button to perform the upgrade.

 **NOTE:** Do not close the browser window until the HP Embedded Web Server (EWS) displays the confirmation page.

5. Select **Restart Now** from the EWS confirmation page, or turn the product off, and then on again using the power switch.

USB storage device (Preboot menu)

1. Copy the xxxxxxxx.bdl file to a USB storage accessory.
2. Insert the USB storage accessory into the USB port on the bottom edge of the control panel.
3. Turn the product on.
4. Press the Stop  button when the **Ready**, **Data** and **Attention** LEDs illuminate solid.
5. Press the up or down navigation arrows on the keyboard to scroll to **Administrator**. Press the Start  button to select it.
6. Press down arrow key on the keyboard to scroll to **Download**. Press the Start  button to select it.
7. Press the up or down keys on the keyboard to scroll to **USB Thumbdrive**. Press the Start  button to select it.
8. Several .bdl files might be listed. Press the up or down keys on the keyboard to scroll to the firmware upgrade file that you downloaded. Press the Start  button to select it. Wait while the file transfers. When the transfer is complete, the message **Complete** displays on the control-panel display.
9. Press and hold the power button for 10 seconds to turn off the product. Remove the USB storage accessory, and then turn the product on. Wait for several minutes while the product initializes. If the upgrade is unsuccessful, try transferring the firmware upgrade file again.
10. If you created a backup of the product data prior to replacing the hard drive, restore the data from the device or network location where the backup was saved.

USB storage device (control-panel menu)

1. Copy the firmware update file to a portable USB flash memory storage device (thumbdrive).
2. Turn the product on, and then wait until it reaches the **Ready** state.
3. Touch the [Device Maintenance](#) button.
4. Touch the [USB Firmware Upgrade](#) menu.
5. Insert the portable USB storage device with the firmware upgrade file on it into the USB port on the front of the product.
6. Touch the firmware update file, and then touch the [Upgrade](#) button.



TIP: If there is more than one firmware upgrade file on the storage device, make sure that you select the correct file for this product.

7. When the product prompts you to confirm the upgrade, touch the [Upgrade](#) button.

When the upgrade is complete, the product will initialize.



NOTE: The upgrade process can take up to 10 minutes to complete.

8. When the upgrade process is complete, view a configuration page and verify that the upgrade firmware version was installed.

4 Parts

- [Order parts by authorized service providers](#)

Order parts by authorized service providers

Order parts, accessories, and supplies

Table 4-1 Order parts, accessories, and supplies

Order supplies and paper	www.hp.com/go/suresupply
Order genuine HP parts or accessories	www.partsurfer.hp.com
Order through service or support providers	Contact an HP-authorized service or support provider.
Order using HP software	For information about using the HP software to order parts, accessories, and supplies, see the product user guide.

Customer-self repair parts

Item	Part number	Description
Pickup roller and separation pad	L2725-60002	Includes one pickup-roller assembly and one separation pad.
Control panel kit	L2717-67002 (L2717A) L2719-67001 (L2719A)	Includes touchscreen and job-control buttons
Hard drive	L2717-60012	Standard serial ATA 250 GB encrypted disk drive
Hard drive (US government FIPS)	L2717-60013	FIPS serial ATA 320 GB encrypted disk drive
Formatter PCA	L2717-67001	Formatter PCA

Part	Part number	Description
Keyboard	L2709-67001	US
	L2709-67002	UK
	L2709-60006	French
	L2709-60007	French Canadian
	L2709-60008	Russian
	L2709-60009	German
	L2709-60010	Spain

Part	Part number	Description
Power supply	0957-2260	External power supply with cable to product

Part	Part number	Description
Power cable	8121-0740	United States, Canada, Mexico
1.9 meter (6.23 ft) power cable (three conductor) from power outlet to power supply	8121-0731	Europe, Korean, Indonesian
	8121-0733	Denmark
	8121-0739	UK, HK, Sing Includes 5 amp fuse
	8121-1004	Israel
	8121-0738	Switzerland
	8121-0737	South Africa
	8121-0964	Taiwan
	8121-0742	China
	8121-0734	Philippines/Thailand
	8121-0837	Australia
	8121-0564	India
	8121-0729	Argentina
	8121-0735	Chile
8121-1071	Brazil	

Internal assemblies

 **NOTE:** Whenever available, use parts designated for the non-Flow version (L2717A) of the product on that version of the product. Parts designated for the Flow version (L2719A) version of the product may be used on the non-flow version of the product when non-Flow parts are no longer available.

Part	Part number	Description
Whole unit replacement	L2717-69001 (L2717A)	Whole unit
	L2719-69001 (L2719A)	
	L2717-69002 (L2717A)	Whole unit (UK)
	L2719-69003 (L2719A)	
	L2717-69006 (L2717A)	Whole unit (US) government FIPS
	L2719-69004 (L2719A)	
	L2717-69007 (L2717A)	Whole unit (China) with US keyboard
ADF and scanner	L2717-69004	ADF and scanner base
	L2717-69005	ADF and scanner base (China)

Part	Part number	Description
Interconnect PCA	L2717-67004	Interconnect PCA
DC controller (DCC) PCA	L2717-67005	DC input PCA
Power-button kit	L2717-60007	Power-button replacement kit
Fan assembly	L2717-67003	Fan assembly
Interconnect cable	L2717-50001	Interconnect cable
Control-panel cable	L2717-50002	ICB-to-control-panel cable
Scanner cable	L2717-50003	ICB-to-scanner cable

A Service and support

- [Hewlett-Packard limited warranty statement](#)
- [End User License Agreement](#)
- [Customer self-repair warranty service](#)
- [Customer support](#)

Hewlett-Packard limited warranty statement

HP Digital Sender Flow 8500 fn1 scanner

Model	Asia/Pacific	Americas	Europe/Middle East/ Africa
8500 fn1	1 year	1 year	1 year

1. HP warrants to you, the end-user customer, that HP hardware, accessories, and supplies will be free from defects in materials and workmanship after the date of purchase, for the period specified above. If HP receives notice of such defects during the warranty period, HP will, at its option, either replace or repair products which prove to be defective. Replacement products may be either new or equivalent in performance to new.

2. HP warrants to you that HP software will not fail to execute its programming instructions after the date of purchase, for the period specified above, due to defects in material and workmanship when properly installed and used. If HP receives notice of such defects during the warranty period, HP will replace software which does not execute its programming instructions due to such defects.

3. HP does not warrant that the operation of HP products will be uninterrupted or error free. If HP is unable, within a reasonable time, to repair or replace any product to a condition as warranted, you will be entitled to a refund of the purchase price upon prompt return of the product.

4. HP products may contain remanufactured parts equivalent to new in performance or may have been subject to incidental use.

5. This warranty does not apply to defects resulting from (a) improper or inadequate maintenance or calibration, (b) software, interfacing, parts, or supplies not supplied by HP, (c) unauthorized modification or misuse, (d) operation outside of the published environmental specifications for the product, or (e) improper site preparation or maintenance.

6. TO THE EXTENT ALLOWED BY LOCAL LAW, THE ABOVE WARRANTIES ARE EXCLUSIVE AND NO OTHER WARRANTY OR CONDITION, WHETHER WRITTEN OR ORAL, IS EXPRESSED OR IMPLIED, AND HP SPECIFICALLY DISCLAIMS ANY IMPLIED WARRANTIES OR CONDITIONS OF MERCHANTABILITY, SATISFACTORY QUALITY, AND FITNESS FOR A PARTICULAR PURPOSE. Some countries/regions, states, or provinces do not allow limitations on the duration of an implied warranty, so the above limitation or exclusion might not apply to you. This warranty gives you specific legal rights, and you might also have other rights that vary from country/region to country/region, state to state, or province to province.

7. HP's limited warranty is valid in any country/region or locality where HP has a support presence for this product and where HP has marketed this product. The level of warranty service you receive may vary according to local standards. HP will not alter the form, fit, or function of the product to make it operate in a country/region in which it was never intended to function for legal or regulatory reasons.

8. TO THE EXTENT ALLOWED BY LOCAL LAW, THE REMEDIES IN THIS WARRANTY STATEMENT ARE YOUR SOLE AND EXCLUSIVE REMEDIES. EXCEPT AS INDICATED ABOVE, IN NO EVENT WILL HP OR ITS SUPPLIERS BE LIABLE FOR LOSS OF DATA OR FOR DIRECT, SPECIAL, INCIDENTAL, CONSEQUENTIAL (INCLUDING LOST PROFIT OR DATA), OR OTHER DAMAGE, WHETHER BASED IN CONTRACT, TORT, OR OTHERWISE. Some countries/regions, states, or provinces do not allow the

exclusion or limitation of incidental or consequential damages, so the above limitation or exclusion may not apply to you.

9. THE WARRANTY TERMS CONTAINED IN THIS STATEMENT, EXCEPT TO THE EXTENT LAWFULLY PERMITTED, DO NOT EXCLUDE, RESTRICT, OR MODIFY AND ARE IN ADDITION TO THE MANDATORY STATUTORY RIGHTS APPLICABLE TO THE SALE OF THIS PRODUCT TO YOU.

End User License Agreement

PLEASE READ CAREFULLY BEFORE USING THIS SOFTWARE PRODUCT: This End-User License Agreement (“EULA”) is a contract between (a) you (either an individual or the entity you represent) and (b) Hewlett-Packard Company (“HP”) that governs your use of the software product (“Software”). This EULA does not apply if there is a separate license agreement between you and HP or its suppliers for the Software, including a license agreement in online documentation. The term “Software” may include (i) associated media, (ii) a user guide and other printed materials, and (iii) “online” or electronic documentation (collectively “User Documentation”).

RIGHTS IN THE SOFTWARE ARE OFFERED ONLY ON THE CONDITION THAT YOU AGREE TO ALL TERMS AND CONDITIONS OF THIS EULA. BY INSTALLING, COPYING, DOWNLOADING, OR OTHERWISE USING THE SOFTWARE, YOU AGREE TO BE BOUND BY THIS EULA. IF YOU DO NOT ACCEPT THIS EULA, DO NOT INSTALL, DOWNLOAD, OR OTHERWISE USE THE SOFTWARE. IF YOU PURCHASED THE SOFTWARE BUT DO NOT AGREE TO THIS EULA, PLEASE RETURN THE SOFTWARE TO YOUR PLACE OF PURCHASE WITHIN FOURTEEN DAYS FOR A REFUND OF THE PURCHASE PRICE; IF THE SOFTWARE IS INSTALLED ON OR MADE AVAILABLE WITH ANOTHER HP PRODUCT, YOU MAY RETURN THE ENTIRE UNUSED PRODUCT.

- 1. THIRD PARTY SOFTWARE.** The Software may include, in addition to HP proprietary software (“HP Software”), software under licenses from third parties (“Third Party Software” and “Third Party License”). Any Third Party Software is licensed to you subject to the terms and conditions of the corresponding Third Party License. Generally, the Third Party License is in a file such as “license.txt” or a “readme” file. You should contact HP support if you cannot find a Third Party License. If the Third Party Licenses include licenses that provide for the availability of source code (such as the GNU General Public License) and the corresponding source code is not included with the Software, then check the product support pages of HP's website (hp.com) to learn how to obtain such source code.
- 2. LICENSE RIGHTS.** You will have the following rights provided you comply with all terms and conditions of this EULA:
 - a. Use.** HP grants you a license to Use one copy of the HP Software. “Use” means installing, copying, storing, loading, executing, displaying, or otherwise using the HP Software. You may not modify the HP Software or disable any licensing or control feature of the HP Software. If this Software is provided by HP for Use with an imaging or printing product (for example, if the Software is a printer driver, firmware, or add-on), the HP Software may only be used with such product (“HP Product”). Additional restrictions on Use may appear in the User Documentation. You may not separate component parts of the HP Software for Use. You do not have the right to distribute the HP Software.
 - b. Copying.** Your right to copy means you may make archival or back-up copies of the HP Software, provided each copy contains all the original HP Software’s proprietary notices and is used only for back-up purposes.
- 3. UPGRADES.** To Use HP Software provided by HP as an upgrade, update, or supplement (collectively “Upgrade”), you must first be licensed for the original HP Software identified by HP as eligible for the Upgrade. To the extent the Upgrade supersedes the original HP Software, you may no longer use such HP Software. This EULA applies to each Upgrade unless HP provides other terms with the Upgrade. In case of a conflict between this EULA and such other terms, the other terms will prevail.

- 4. TRANSFER.**
 - a.** Third Party Transfer. The initial end user of the HP Software may make a one-time transfer of the HP Software to another end user. Any transfer will include all component parts, media, User Documentation, this EULA, and if applicable, the Certificate of Authenticity. The transfer may not be an indirect transfer, such as a consignment. Prior to the transfer, the end user receiving the transferred Software will agree to this EULA. Upon transfer of the HP Software, your license is automatically terminated.
 - b.** Restrictions. You may not rent, lease or lend the HP Software or Use the HP Software for commercial timesharing or bureau use. You may not sublicense, assign or otherwise transfer the HP Software except as expressly provided in this EULA.
- 5. PROPRIETARY RIGHTS.** All intellectual property rights in the Software and User Documentation are owned by HP or its suppliers and are protected by law, including applicable copyright, trade secret, patent, and trademark laws. You will not remove any product identification, copyright notice, or proprietary restriction from the Software.
- 6. LIMITATION ON REVERSE ENGINEERING.** You may not reverse engineer, decompile, or disassemble the HP Software, except and only to the extent that the right to do so is allowed under applicable law.
- 7. CONSENT TO USE OF DATA.** HP and its affiliates may collect and use technical information you provide in relation to (i) your Use of the Software or the HP Product, or (ii) the provision of support services related to the Software or the HP Product. All such information will be subject to HP's privacy policy. HP will not use such information in a form that personally identifies you except to the extent necessary to enhance your Use or provide support services.
- 8. LIMITATION OF LIABILITY.** Notwithstanding any damages that you might incur, the entire liability of HP and its suppliers under this EULA and your exclusive remedy under this EULA will be limited to the greater of the amount actually paid by you for the Product or U.S. \$5.00. TO THE MAXIMUM EXTENT PERMITTED BY APPLICABLE LAW, IN NO EVENT WILL HP OR ITS SUPPLIERS BE LIABLE FOR ANY SPECIAL, INCIDENTAL, INDIRECT, OR CONSEQUENTIAL DAMAGES (INCLUDING DAMAGES FOR LOST PROFITS, LOST DATA, BUSINESS INTERRUPTION, PERSONAL INJURY, OR LOSS OF PRIVACY) RELATED IN ANY WAY TO THE USE OF OR INABILITY TO USE THE SOFTWARE, EVEN IF HP OR ANY SUPPLIER HAS BEEN ADVISED OF THE POSSIBILITY OF SUCH DAMAGES AND EVEN IF THE ABOVE REMEDY FAILS OF ITS ESSENTIAL PURPOSE. Some states or other jurisdictions do not allow the exclusion or limitation of incidental or consequential damages, so the above limitation or exclusion may not apply to you.
- 9. U.S. GOVERNMENT CUSTOMERS.** Software was developed entirely at private expense. All Software is commercial computer software within the meaning of the applicable acquisition regulations. Accordingly, pursuant to US FAR 48 CFR 12.212 and DFAR 48 CFR 227.7202, use, duplication and disclosure of the Software by or for the U.S. Government or a U.S. Government subcontractor is subject solely to the terms and conditions set forth in this End User License Agreement, except for provisions which are contrary to applicable mandatory federal laws.
- 10. COMPLIANCE WITH EXPORT LAWS.** You will comply with all laws, rules, and regulations (i) applicable to the export or import of the Software, or (ii) restricting the Use of the Software, including any restrictions on nuclear, chemical, or biological weapons proliferation.
- 11. RESERVATION OF RIGHTS.** HP and its suppliers reserve all rights not expressly granted to you in this EULA.

© 2009 Hewlett-Packard Development Company, L.P.

Rev. 04/09

Customer self-repair warranty service

HP products are designed with many Customer Self Repair (CSR) parts to minimize repair time and allow for greater flexibility in performing defective parts replacement. If during the diagnosis period, HP identifies that the repair can be accomplished by the use of a CSR part, HP will ship that part directly to you for replacement. There are two categories of CSR parts: 1) Parts for which customer self repair is mandatory. If you request HP to replace these parts, you will be charged for the travel and labor costs of this service. 2) Parts for which customer self repair is optional. These parts are also designed for Customer Self Repair. If, however, you require that HP replace them for you, this may be done at no additional charge under the type of warranty service designated for your product.

Based on availability and where geography permits, CSR parts will be shipped for next business day delivery. Same-day or four-hour delivery may be offered at an additional charge where geography permits. If assistance is required, you can call the HP Technical Support Center and a technician will help you over the phone. HP specifies in the materials shipped with a replacement CSR part whether a defective part must be returned to HP. In cases where it is required to return the defective part to HP, you must ship the defective part back to HP within a defined period of time, normally five (5) business days. The defective part must be returned with the associated documentation in the provided shipping material. Failure to return the defective part may result in HP billing you for the replacement. With a customer self repair, HP will pay all shipping and part return costs and determine the courier/carrier to be used.

Customer support

Get telephone support for your country/region	Country/region phone numbers are on the flyer that was in the box with your product or at www.hp.com/support/ .
Have the product name, serial number, date of purchase, and problem description ready.	
Get 24-hour Internet support	www.hp.com/support
Get support for products used with a Macintosh computer	www.hp.com/go/macosex
Download software utilities, drivers, and electronic information	www.hp.com/support/ljm4555mfp_software
Order additional HP service or maintenance agreements	www.hp.com/go/carepack
Register your product	www.register.hp.com

B Product specifications

- [Physical specifications](#)
- [Document feeder specifications](#)
- [Power consumption](#)
- [Environmental specifications](#)
- [Regulatory model number](#)

Physical specifications

Name	Description
Scanner type	Flatbed with automatic document feeder (ADF)
Size	Width: 570 mm (20.35 in), Depth: 434.6 mm (17.1 in), Height: 206.6 mm (8.14 in)
Weight	19.1 kg (42.1 lbs)
Scanning element	Charge-coupled device (CCD)
Optical resolution	600 x 600 dpi hardware
Network specifications	<ul style="list-style-type: none">• 10/100/Gigabit Ethernet• IPSec (authentication and encryption protocols)• IPv4 and IPv6 address assignment
AC power	<ul style="list-style-type: none">• AC input for power supply: 100V–240V, ~50/60Hz, 2600mA• DC output for power supply: +32 Vdc, 5625mA, 180W
Power consumption	For power consumption information, see the regulatory_supplement.pdf file on the documentation CD.
System requirements	To view minimum and recommended system requirements, go to www.hp.com , select your country/region, search on your product model, and then search on datasheet .

Document feeder specifications

Name	Description
Paper tray capacity	100 sheets of 75g/m ² (20 lb)
Minimum paper size	68 x 148 mm (2.7 x 5.8 in)
Maximum paper size	216 x 864 mm (8.5 x 34 in)
Minimum paper weight	49 g/m ² (13 lb)
Maximum paper weight	120 g/m ² (32 lb)

Power consumption

For power consumption information, see the regulatory_supplement.pdf file on the documentation CD.

Environmental specifications

Name	Description
Temperature	Operating the product: 10° to 35° C (50° to 95° F)
	Storage: -40° to 65° C (-40° to 149° F)
Relative humidity	Operating the product: 10% to 80% noncondensing 10° to 35° C (50° to 95° F)
	Storage: up to 90% at 0° to 65° C (32° to 149° F)

 **NOTE:** In the presence of high electromagnetic fields, it is possible the output from the HP product may be slightly distorted.

 **NOTE:** HP is committed to providing our customers with information about the chemical substances in our products as needed to comply with legal requirements such as REACH (Regulation EC No 1907/2006 of the European Parliament and the Council). A chemical information report for this product can be found at www.hp.com/go/reach.

Regulatory model number

For regulatory identification purposes your product has been assigned a Regulatory Model Number. The Regulatory Model Number for your product is FCLSD-0901. This regulatory model number should not be confused with the marketing names “HP Scanjet Enterprise 8500 fn1” (L2717A) or “HP Digital Sender Flow 8500 fn1” (L2719A). Additional regulatory information about your product can be found on the regulatory_supplement.pdf file in the product documentation.

C Regulatory information

- [Environmental product stewardship program](#)
- [Certificate of Volatility](#)

Environmental product stewardship program

Protecting the environment

Hewlett-Packard Company is committed to providing quality products in an environmentally sound manner. This product has been designed with several attributes to minimize impacts on our environment.

Plastics

Plastic parts over 25 grams are marked according to international standards that enhance the ability to identify plastics for recycling purposes at the end of the product's life.

Power consumption

Power usage drops significantly while in Ready or Sleep or Auto-off mode, which saves natural resources and saves money without affecting the high performance of this product. Hewlett-Packard printing and imaging equipment marked with the ENERGY STAR® logo is qualified to the U.S. Environmental Protection Agency's ENERGY STAR specifications for imaging equipment. The following mark will appear on ENERGY STAR qualified imaging products:



Additional ENERGY STAR qualified imaging product model information is listed at:

www.hp.com/go/energystar

Material restrictions

This product's real-time clock battery or coin cell battery may contain perchlorate and may require special handling when recycled or disposed of in California. (See www.dtsc.ca.gov/hazardouswaste/perchlorate.) The batteries contained in or supplied by Hewlett-Packard for this product include the following:

8500 fn1	
Type	Lithium carbon monofluoride
Weight	2.4 g
Location	On motherboard
User-removable	No



廢電池請回收

For recycling information, you can go to www.hp.com/recycle, or contact your local authorities or the Electronics Industries Alliance: www.eiae.org.

Disposal of waste equipment by users in private households in the European Union

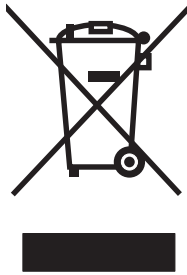

This symbol on the product or on its packaging indicates that this product must not be disposed of with your other household waste. Instead, it is your responsibility to dispose of your waste equipment by handing it over to a designated collection point for the recycling of waste electrical and electronic equipment. The separate collection and recycling of your waste equipment at the time of disposal will help to conserve natural resources and ensure that it is recycled in a manner that protects human health and the environment. For more information about where you can drop off your waste equipment for recycling, please contact your local city office, your household waste disposal service or the shop where you purchased the product.

Chemical substances

HP is committed to providing our customers with information about the chemical substances in our products as needed to comply with legal requirements such as REACH (Regulation EC No 1907/2006 of the European Parliament and the Council). A chemical information report for this product can be found at: www.hp.com/go/reach.

For more information

To obtain information about these environmental topics:

- Product environmental profile sheet for this and many related HP products
- HP's commitment to the environment
- HP's environmental management system
- HP's end-of-life product return and recycling program
- Material Safety Data Sheets

Visit www.hp.com/go/environment or www.hp.com/hpinfo/globalcitizenship/environment.

Certificate of Volatility

This statement explains the volatility of customer data stored in memory and outlines how to erase secure data from the device.

Volatile memory

The product utilizes volatile memory (1536 MB) to store customer data during the scan process. When you turn off the product, this volatile memory is erased.

Non-volatile memory

The product utilizes non-volatile flash memory (2 MB) to store system control data and user preference settings. Non-volatile memory does not store any customer scan data. To clear non-volatile memory and restore it to factory defaults, use the Embedded Web Server.

 **TIP:** You can also clear non-volatile memory from the Home screen on the control panel (touch [Administration](#), touch [General Settings](#), and then touch [Restore Factory Settings](#)).

Hard disk drive memory

The product contains one encrypted hard disk drive (160 GB or larger) that may retain data after you turn off the product, including customer jobs and temporary data such as stored scan data or fax files. To securely erase the data, start the Embedded Web Server, click the **Security** tab, click the **Protect Stored Data** entry in the left pane, click the **Erase Options** button, and then select one of the **Secure Erase** options.

The **Secure Sanitize Erase** feature meets standards for clearing disk media defined in NIST Special Publication 800-88 Guidelines for Media Sanitation and the U.S. Department of Defense Updated DSS Clearing and Sanitization Matrix.

Index

A

- accessories
 - ordering 170
- accessories installed, information 83
- ADF
 - clean duplex background 141
- Administration menu, control panel 88
- after-service checklist 15

B

- backup data 15
- Backup/Restore menu, control panel 99
- batteries included 186
- buffer overflow errors 104

C

- cable
 - removing 46
- Calibration/Cleaning menu, control panel 100
- Certificate of Volatility
 - hard disk drive memory 188
 - non-volatile memory 188
 - volatile memory 188
- checklists
 - after-service 15
 - preservice 15
- clean
 - ADF 141
 - rollers 144
 - scanning glass 141
 - scanning strip 141
 - touch screen 141
- configuration page 76
- configuration pages 80
 - information 83

- connectivity
 - solving problems 146
- control panel
 - Administration menu 88
 - Backup/Restore menu 99
 - Calibration/Cleaning menu 100
 - clean touch screen 141
 - Display Settings menu 94
 - Fax Settings menu 93
 - General Settings menu 89
 - Manage Supplies menu 95
 - menus, summary 87
 - messages, numerical list 101
 - messages, types of 101
 - Network Settings menu 96
 - removing 24
 - Reports menu 88
 - Scan/Digital Send Settings menu 90
 - Service menu 100
 - Troubleshooting menu 98
 - USB Firmware Upgrade menu 100
- control-panel
 - troubleshooting 73
- control-panel assembly
 - reinstalling 25
- control-panel cable
 - removing 46
- control-panel LEDs 77
- counts 148
 - document feeder 148
 - document feeder duplex 149
 - document feeder simplex 149
 - flatbed cycle 148
 - page, reset 148
 - reset after replacing formatter 148

- scan engine maintenance 83
- send scan 149
- See also* pages counts
- customer support
 - online 180
- cut-off images
 - troubleshoot 139

D

- data
 - backup 15
 - restore 16
 - date
 - codes for firmware 83
 - manufacture 82
 - product first used 149
 - DC controller PCA
 - removing 53
 - debug data 75
 - demo page 76
 - diagnostics
 - LED 76
 - digital sending
 - validating gateway addresses 164
 - dimensions, product 182
 - Display Settings menu, control panel 94
 - disposal, end-of-life 186
 - document feeder 182
 - document feeder count
 - document feeder pages 148
 - document feeder interval 148
 - document feeder kit
 - history 22
- ## E
- EIO cards
 - buffer overflow 104

- electrical specifications 182
- electrostatic discharge (ESD) 10
- end-of-life disposal 186
- engine diagnostics 77
- Ethernet connection
 - reset 147
- Environmental Product Stewardship Program 186
- environmental specifications 183
- error messages
 - event log, listed numerically 113
 - numerical list 101
 - types of 101
- ESD (electrostatic discharge) 10
- European Union, waste disposal 187
- event log 76
 - clear 113, 148
 - messages, listed numerically 113
- e-mail
 - problem solving 164
 - validating gateway addresses 164

F

- fan assembly PCA
 - removing 53
- fasteners, types of 12
- fax
 - Internet setup 162
 - LAN setup 162
- Fax Settings menu, control panel 93
- feed rollers
 - removing 18
- file directory page 85
- firmware
 - date codes 83
 - reloading 29
 - troubleshooting 69
 - upgrading 29
 - version information 82
- firmware, downloading new 165
- flatbed scanner and ADF assembly
 - reinstalling 42
 - removing 39
- flowchart
 - troubleshooting 65

- formatter
 - reinstalling 36
 - removing 31
 - resets after replacing 148
- formatter lights 76

G

- gateways
 - validating addresses 164
- General Settings menu, control panel 89
- generating
 - debug data 75
- glass, clean 141

H

- hard disk drive
 - reinstalling 29
 - removing 26
- heartbeat LED 76
- history
 - viewing 75
- HP Customer Care 180
- HP Embedded Web Server
 - information pages 87
- HP Jetdirect print server
 - configuration page 82
 - lights 76
- humidity specifications 183

I

- information pages
 - HP Embedded Web Server 87
- installation
 - date calculation 149
 - verify for optional accessories 80
- interconnect cable
 - removing 46
- interconnect PCA
 - removing 53
- Internet connection
 - reset 147
- Internet Fax setup 162
- IPv4 information 82
- IPv6 information 82

J

- jams 136
 - troubleshoot 139
- Jetdirect LED 76

- Jetdirect print server
 - lights 76

K

- keyboard 36
 - removing 36

L

- LAN fax setup 162
- LDAP servers
 - validating gateway addresses 164
- LEDs. *See* lights
- license, software 176
- lights
 - control panel 77
 - formatter 76
 - troubleshooting with 76
- log of events
 - clear 113
 - messages, listed numerically 113

M

- Macintosh
 - support 180
- maintenance
 - clean rollers 144, 145
- maintenance history
 - viewing 75
- Manage Supplies menu, control panel 95
- material restrictions 186
- media
 - jams 139
 - misfeeds 138
 - not feeding 138
 - troubleshoot 138
- memory
 - information 80
 - insufficient 101
- memory, hard drive 188
- menus
 - summary 87
- menus, control panel
 - Administration 88
 - Backup/Restore 99
 - Calibration/Cleaning 100
 - Display Settings 94
 - Fax Settings 93
 - General Settings 89

- Manage Supplies 95
- Network Settings 96
- Reports 88
- Scan/Digital Send Settings 90
- Service 100
- Troubleshooting 98
- USB Firmware Upgrade 100
- mercury product 186
- messages
 - event log, listed numerically 113
 - numerical list 101
 - types of 101
- misfeeds
 - troubleshoot 138
- model number 82
- multiple-page feeds 138

N

- Network Settings menu, control panel 96
- networks
 - HP embedded Jetdirect configuration page 82
 - validating gateway addresses 164

O

- online support 180
- operating environment specifications 183
- order
 - roller replacement kit 18
- ordering
 - supplies and accessories 170

P

- pages count 148
 - from product document feeder 148, 149
 - from product flatbed 148
 - from product send scan 149
 - reset 148
 - See also* counts
- paper
 - jams 139
 - misfeeds 138
 - not feeding 138
 - troubleshoot 138
- paper jams 136

- parts
 - order 18
- password
 - Service menu PIN 148
- physical specifications 182
- pliers, required 11
- port configuration information 82
- post-service tests 16
- power
 - consumption 182
 - troubleshooting 68
- power LED 76
- power-button assembly
 - reinstalling 45
 - removing 44
- preservice checklist 15
- print quality
 - test 16
- problem-solving
 - e-mail 164
 - messages, types of 101

R

- regulatory statements
 - environmental product stewardship program 186
- removing
 - cable 46
 - control panel 24
 - control-panel cable 46
 - DC controller PCA 53
 - fan assembly 53
 - flatbed scanner and ADF assembly 39
 - formatter 31
 - interconnect cable 46
 - interconnect PCA 53
 - power-button assembly 44
 - rollers 18
 - scanner cable 46
 - separation pad 21
- removing parts
 - cautions for 9
 - checklists 15
 - tools, required 11
- removing the hard disk drive 26
- replacing
 - parts 9
- Reports menu, control panel 88
- restore data 16

- restore factory settings 151
- rollers
 - clean 144
 - message setting 145
 - removing 18

S

- save and repair process 16
- scan count
 - since last maintenance 83
- Scan/Digital Send Settings menu, control panel 90
- scanner cable
 - removing 46
- scanning strip, clean 141
- scanning to e-mail
 - validating addresses 164
- scans
 - viewing history 75
- screwdrivers, required 11
- screws
 - replacing 9
 - screws, types of 12
- security settings information 82
- sending to e-mail
 - validating gateway addresses 164
- sensor
 - ADF hatch 79
 - flatbed cover 79
 - multi-pick 79
 - paper present 78
- sensor tests 77, 78
- separation pad
 - removing 21
- serial number 149
- service
 - tools, required 11
- Service ID
 - convert to date 149
 - restore 149
- Service menu options 148
- Service menu, control panel 100
- settings
 - restore factory 151
- setup
 - Internet Fax 162
 - LAN fax 162

- SMTP servers
 - validating gateway addresses 164
- software
 - software license agreement 176
 - uninstall and reinstall 140
- solve problems 59
- specifications
 - document feeder 182
 - electrical 182
 - environmental 183
 - physical 182
- static precautions 10
- status
 - messages, types of 101
- status page 76
- storage specifications 183
- streaks
 - troubleshoot 139
- supplies
 - ordering 170
- support
 - online 180

T

- TCP/IP information 82
- technical support
 - online 180
- temperature specifications 183
- test
 - duplex scanning 78
 - simplex scanning 78
- testing
 - ADF hatch sensor 79
 - flatbed cover sensor 79
 - multi-pick sensor 79
 - paper present sensor 78
 - sensors 78
- tests
 - post-service 16
 - print-quality 16
- tools, required 11
- touch screen, clean 141
- troubleshoot
 - cut-off images 139
 - jams 139
 - misfeeds 138
 - paper not feeding 138

- stops working 140
- streaks 139
- troubleshooting 59
 - checklist 60
 - configuration page 76
 - configuration pages for 80
 - control panel messages, numerical 101
 - control-panel checks 73
 - control-panel diagnostic mode 73
 - demo page 76
 - event log 76
 - event log, use for 112
 - event-log messages, numerical list 113
 - file directory page for 85
 - firmware 69
 - flowchart 65
 - gateway addresses 164
 - lights, using 76
 - power 68
 - process 64
 - reports and tools 76
 - status page 76
 - usage pages for 84
 - Web services status page for 86
- Troubleshooting menu, control panel 98

U

- updates, downloading product 165
- updating
 - document feeder kit history 22
- upgrading
 - firmware 29
- usage page 84
- USB Firmware Upgrade menu, control panel 100

V

- validating gateway addresses 164
- version, hardware firmware 82
- very low setting
 - setting 145

W

- warranty
 - customer self repair 179
 - license 176
- warranty date information 149
- Web services status page 86
- Web sites
 - customer support 180
 - Macintosh customer support 180
 - replacement parts 18, 36
 - weight, product 182



L2717-90014

