



HP DesignJet 430 Printer
HP DesignJet 450C Printer
HP DesignJet 455CA Printer
User's Guide

Setup instructions – see chapter 1



Upgrade instructions – see chapter 6



© Copyright Hewlett-Packard Company 1997, 1998

Manual part number
C4713-90021

Printed in Europe.

**Customer re-order number
C4713-60041**

All rights are reserved. No part of the document may be photocopied, reproduced, or translated to another language without the prior written consent of Hewlett-Packard Company.

AutoCAD™ is a trademark of Autodesk Inc.

HP-GL and HP-GL/2 are trademarks of Hewlett-Packard Company.

CorelDRAW™ is a trademark of Corel Corporation.

Macintosh is a product of Apple Computer Inc.

Microsoft® and MS-DOS® are registered trademarks of Microsoft Corporation.

Microsoft Windows® is a registered trademark of Microsoft Corporation.

Windows 95® is a registered trademark of Microsoft Corporation in the United States and other countries.

UNIX® is a registered trademark in the United States and other countries, licensed exclusively through X/Open Company Limited.

Notice

The information contained in this document is subject to change without notice and should not be construed as a commitment by Hewlett-Packard Company.

Hewlett-Packard assumes no responsibility for any errors that may appear in this document nor does it make expressed or implied warranty of any kind with regard to this material, including, but not limited to, the implied warranties of merchantability and fitness for a particular purpose.

The Hewlett-Packard Company shall not be liable for incidental or consequential damages in connection with, or arising out of the furnishing, performance, or use of this document and the program material which it describes.

Safety Symbols



The product is marked with this symbol when it is necessary for you to refer to the instruction manual in order to protect against damage to the product.



Hazardous voltage symbol.

WARNING

The Warning symbol calls attention to a procedure, practice, or the like, which, if not correctly performed or adhered to, could result in personal injury. Do not proceed beyond a Warning symbol until the indicated conditions are fully understood and met.

CAUTION

The Caution symbol calls attention to an operating procedure, practice, or the like, which, if not correctly performed or adhered to, could result in damage to or destruction of part or all of the product. Do not proceed beyond a Caution symbol until the indicated conditions are fully understood and met.

User's Guide



HP DesignJet 430, 450C and 455CA Printers

Finding information



This **User's Guide** for the HP DesignJet 430 , 450C and 455CA printers contains the following types of information:

- Setup
- Use
- Maintenance
- Troubleshooting
- Reference material.

To help with finding specific information, a comprehensive table of contents is provided at the front and an alphabetical index is provided at the back.

You will notice the use of symbols in the left margin and shaded backgrounds to the text. These are used to identify different types of information as follows:

430

- Information specific only to the HP DesignJet 430 is shown like this.

450C/455CA

- Information specific only to the HP DesignJet 450C/455CA is shown like this.

All other information is applicable to all printers.

The accompanying **Quick Reference Guide** contains selected information to help with everyday use of the printer. It is designed to be stored in the plastic pocket at the side of the printer.

Where to find the most commonly needed information

To find how to ...	Go to ...
Install the printer	▶ Chapter 1
Connect the printer	▶ Page 1–17
Configure the printer using the Setup Sheet	▶ Page 1–19
Load media	▶ Page 2–10
Set the print quality	▶ Page 3–15
Check cartridge alignment	▶ Chapter 5
Replace a cartridge	▶ Page 7–2
Clean the cartridge nozzles by priming them	▶ Page 7–7
Interpret the lights on the front panel	▶ Chapter 8
Clear a media jam	▶ Page 9–5
Solve print quality problems	▶ Page 9–12
Order accessories	▶ Page 10–16

To find any other information ...	▶ Go to the index at the back of this manual.
--	--

Contents

Finding information **ii**

Welcome **ix**

1 Setting up your printer

Fast track 1–2

Setup checklist 1–3

Task 1: Check that you have all the items required 1–4

Task 2: (Optional) Install a memory expansion module 1–6

Task 3: Position the printer 1–8

Task 4: Switch on 1–9

Task 5: Load the print cartridge(s) 1–10

Task 6: (Optional) Change the language 1–14

Task 7: Connect the printer to your computer 1–17

Task 8: (Optional) Configure the printer 1–19

Task 9: Set up the printer in your application software 1–24

Task 10: Send a sample or demonstration print 1–26

2 Working with media

Caring for your media 2–2

Choosing media 2–2

 Supported media types and relative costs 2–3

 Physical characteristics of media types 2–4

 HP DesignJet 450C: Recommended print quality settings and recommended media for color prints 2–5

 Typical media-type choices by application 2–6

Before loading media 2–8

Before sending your file 2–9

Loading sheet media 2–10

 To load a sheet (without the roll-feed option installed) 2–10

 To realign the sheet manually (if necessary) 2–14

Loading roll media 2–17

 To change the roll 2–17

 To feed roll media into the printer 2–21

To load a sheet with the roll-feed option installed 2–26

Unloading media 2–27

 Drying time 2–27

 To unload a sheet at the end of a print 2–28

 To unload a sheet under any other circumstances 2–28

 To cut and unload a print from a roll 2–29

3 Controlling your print's appearance

- Ways to control the print's appearance 3-2
- Page size 3-3
 - When do you need to adjust the page size in the printer? 3-4
 - To adjust the page size in the Setup Sheet 3-5
 - Page size and clipped prints 3-6
- Rotating a print 3-7
 - Can you rotate *any* drawing using the Setup Sheet? 3-7
 - To rotate a print using the printer's Setup Sheet 3-7
 - Exactly what is rotated? 3-8
 - The Rotate feature and clipped prints 3-9
 - How does Rotate interact with your software? 3-9
- Printing a mirror image 3-10
- Changing the treatment of overlapping lines (Merge feature) 3-11
- Changing the printer's logical pen characteristics 3-12
- Printing color drawings in monochrome 3-13
 - To switch from color to monochrome 3-13
 - Important points about monochrome printing 3-14
- Choosing an appropriate print quality 3-15
 - To change the print quality on the front panel 3-16
- Print quality recommendations 3-18

4 Managing your prints

- To cancel a print 4-2
- To copy a print 4-2
- To advance the media 4-3

5 Special internal prints

- Their purpose and how to print them 5-2
- Using the Black Cartridge Alignment Sheet 5-4
- Using the Color Cartridge Test Sheet 5-8
- Using the Print Quality Test Print 5-12
 - Printing the Print Quality Test Print 5-13

- 6 Reconfiguring your printer**
 - To see the current configuration of the printer 6-2
 - To change the serial interface settings 6-3
 - To change the graphics language setting for less common applications 6-3
 - To change the I/O timeout setting 6-4
 - To upgrade your printer with more memory 6-4
 - File size and memory usage 6-4
 - To upgrade your printer with a network interface 6-4
 - To upgrade the HP DesignJet 430 printer with color 6-5
- 7 Maintaining your printer**
 - Replacing cartridges 7-2
 - When to replace cartridges 7-2
 - Using genuine HP supplies 7-3
 - Before replacing cartridges 7-4
 - To replace one or more cartridges 7-5
 - Cleaning the cartridge nozzles (priming) 7-7
 - Cleaning the printer 7-9
- 8 Front-panel lights and keys**
 - Front-panel lights 8-2
 - Front-panel keys 8-7
- 9 Troubleshooting**
 - Using the documentation 9-2
 - Locating the source of your problem 9-3
 - Solving media-handling problems 9-4
 - If the printer will not accept your media 9-4
 - If the printer continually rejects your media, with the Load Media light flashing 9-4
 - Clearing a media jam 9-5
 - Solving communication problems 9-8
 - Solving problems with print position or content 9-9
 - If the print is completely blank 9-9
 - If the output contains only a partial print 9-9
 - If the print is clipped 9-10
 - If the entire print is in one quadrant of the correct printing area 9-10
 - If one print overlaps another print on the same sheet 9-10

If the output is distorted or unintelligible	9–11
If the printer has drawn a different print than the one you were expecting	9–11
If pen settings seem to have no effect	9–11
Solving print-quality problems	9–12
If there are white streaks in solid areas or gaps in lines	9–12
If there are jagged vertical or horizontal lines	9–14
If there are slightly warped lines	9–14
If there are color “shadows”	9–14
If a cartridge is not printing at all	9–14
If the print quality appears to be poor just in one part of the print	9–14
If there are blurred lines (ink “bleeds” from lines)	9–15
If there are blotchy areas (uneven fill density)	9–15
If there is other pronounced banding in area fills	9–15
If ink smears after you remove a print	9–15
Solving miscellaneous problems	9–16
If the printer does not print	9–16
If the printer seems too slow	9–16
Getting help	9–17
What to do before you call	9–17
If a repair is needed	9–18

10 Reference

Printer specifications	10–2
Interface specifications	10–8
Parallel (Centronics) cable	10–9
Serial (RS-232-C) cables	10–10
Interface cables	10–11
Regulatory notices	10–12
Ordering accessories	10–15
HP part numbers for HP DesignJet Papers and Films	10–18
HP-GL/2 and HP RTL programming information	10–19
How to order supplies and accessories	10–19

11 Glossary

Index

Documentation map

Please give us your feedback (removable pages)

Welcome

An introduction to the HP DesignJet 430, 450C and 455CA printers and their accessories

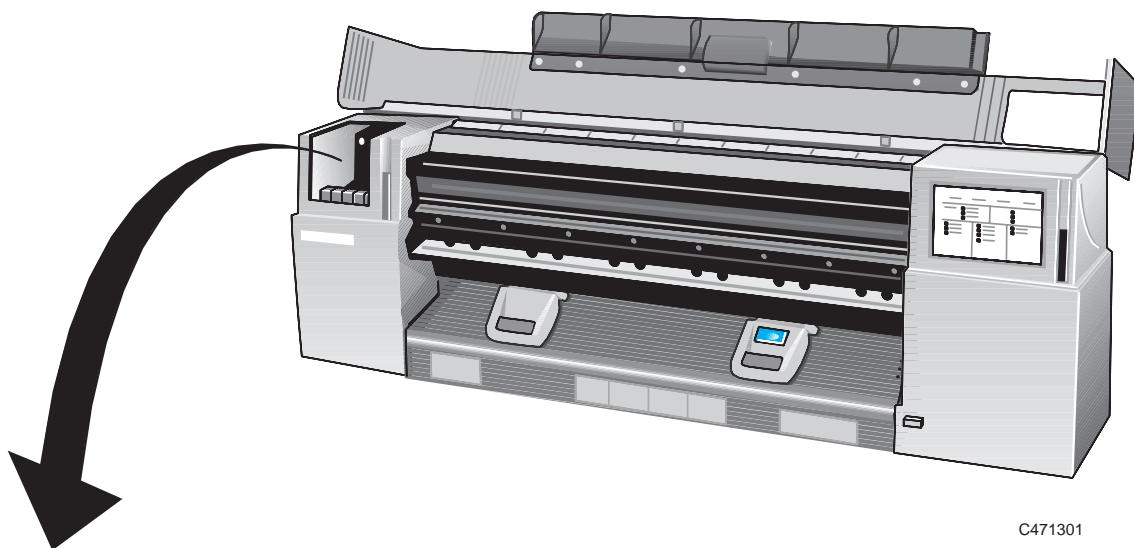

C471301

The HP DesignJet 430, 450C and 455CA are large-format inkjet printers employing HP **disposable print cartridge** technology.

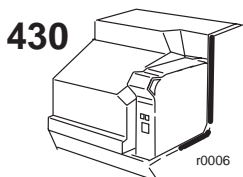

- The HP DesignJet 430 prints in monochrome and uses a single cartridge, containing black ink, one of which is supplied with your printer.

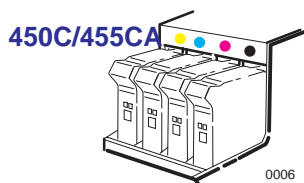

- The HP DesignJet 450C/455CA prints in color or monochrome, using yellow, cyan, magenta and black cartridges, a set of which is supplied with your printer. All other supported colors are generated using these four cartridges.

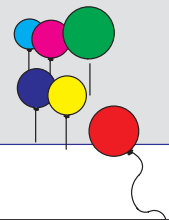

Accessories

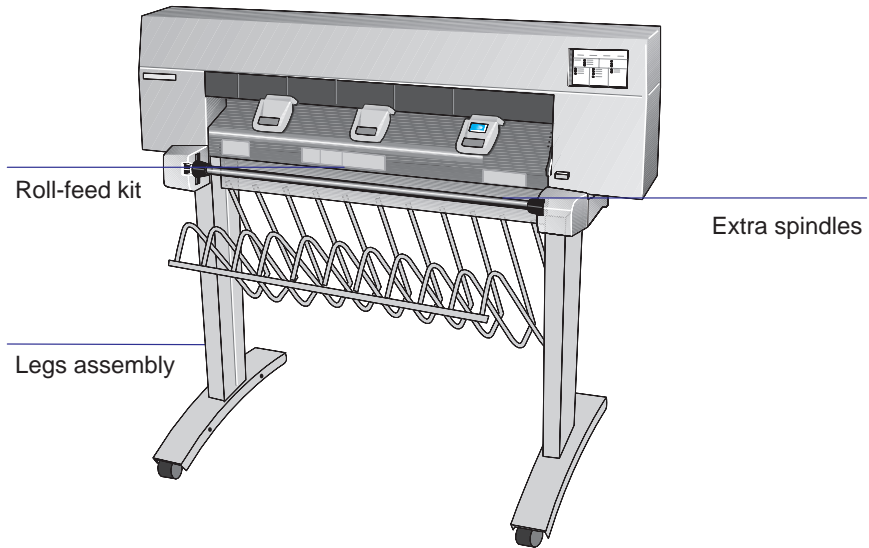

C471302

You have a large series of accessories available for use with your printer, including:

- A roll-feed kit
- A separate legs assembly
- Extra spindles for the roll-feed, for easy changing of rolls
- Memory expansion modules.

430

In addition, for the HP DesignJet 430:

- A color upgrade kit, allowing the printer to be upgraded to a HP DesignJet 450C.

For the full range of available accessories, see page 10–16.

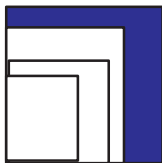

Media¹

You can print on sheet media up to E/A0 size or D/A1 size, depending on the printer model you have.

With the addition of the optional roll-feed kit, you can also print on roll media up to E/A0 or D/A1 width.

A large range of media types is supported²:

- Opaque bond
- Translucent bond
- Natural tracing paper
- Vellum
- Coated paper
- Heavyweight coated paper
- Matte and clear film.

450C/455CA

In addition, on the HP DesignJet 450C and 455CA:

- High-gloss film.
- High-gloss photo.

For best quality prints, use HP media, as your printer's configuration is optimized for it and tested with it. For details of HP media, see page 10–19 and any separate HP media literature supplied with the printer.

To indicate which media type you have loaded, use the printer's front panel.

1. It is possible that, since the publication of this document, more media types have been tested and are now supported for your printer. For the latest information, contact your HP dealer or local HP Sales and Support office.
2. There may be differences between the ways some media types are used for color and for monochrome printing. Refer to "Choosing media" on page 2–2.

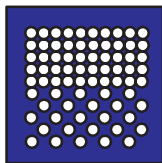

Print quality

You can choose between three print quality options:

- Best
- Normal
- Fast.

In general, the better the print quality you choose, the slower the printing routine. The highest resolution in color, for the HP DesignJet 450C/455CA, is 300 dpi (dots per inch) and the highest addressable* resolution in monochrome, for both the HP DesignJet 430 and the HP DesignJet 450C/455CA, is 600 dpi. To select a print quality option, use either the keys on the printer's front panel or the printer driver in your software.

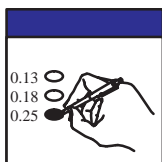

Configuration settings

By pressing the **Setup** key on the front-panel of the printer, you can print the printer's current configuration in a Setup Sheet. If you want to change any of the configuration settings (for example, line widths) you can do this by simply marking your changes on the Setup Sheet and feeding it back into the printer. The printer will read your request and re-configure itself automatically.

Each time you print one of these Setup Sheets it shows the printer's latest configuration—and so please keep the latest one filed with your Quick Reference Guide in the pocket at the side of the printer, so that a service engineer would know the current configuration even if the printer is temporarily inoperable.

* The "addressable" resolution refers to the smallest movement the print head can make between dots rather than to the size of the dot.



Software applications and drivers

To make sure that your printer prints exactly what you were expecting—in terms of size, position, orientation, color and quality—the key is to use the correct driver for the combination of your application software and your printer, and to be confident that it is configured correctly.

Two types of HP drivers are supplied with your printer:

- For users of AutoCAD™
- For users of Microsoft® Windows applications.

These drivers come with printed and online documentation to help you install and configure them correctly.

Generally, software applications include their own drivers too. For some popular applications, we have provided with this printer a set of *Software Application Notes*. If you find your own application in these notes, we recommend that you use the information they contain as an overall guide to configuring the software for your printer.

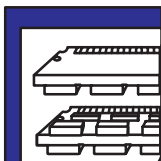

Memory

Your printer comes with a basic memory of **4MB**. Note that there is not a one-for-one relationship between the printer's memory and the maximum size of file that it can print. However, in case you need to print particularly large files, the following memory expansion modules are available; 4MB, 8MB, 16MB, and 32MB. The maximum total memory is 36MB (4 + 32). With some drivers, there are other means of printing large files—for advice, see page 9–16.

Fast track 1-2

Setup checklist 1-3

Task 1: Check that you have all the items required 1-4

Task 2: (*Optional*) Install a memory expansion module 1-6

Task 3: Position the printer 1-8

Task 4: Switch on 1-9

Task 5: Load the print cartridge(s) 1-10

Task 6: (*Optional*) Change the language 1-14

Task 7: Connect the printer to your computer 1-17

Task 8: (*Optional*) Configure the printer 1-19

Task 9: Set up the printer in your application software 1-24

Task 10: Send a sample or demonstration print 1-26

Setting up your printer



Fast track

If you meet all the following requirements:

- If you are happy with English as the language for the printer's internal prints.
- If you are experienced at installing printers or plotters.
- If you don't want to add extra memory.
- If you are going to connect the printer directly to a PC.
- If you are going to use a parallel connection.

... just follow these five steps, and skip the rest of this chapter.

- 1 If the printer is without legs, place it at the edge of a stable platform.

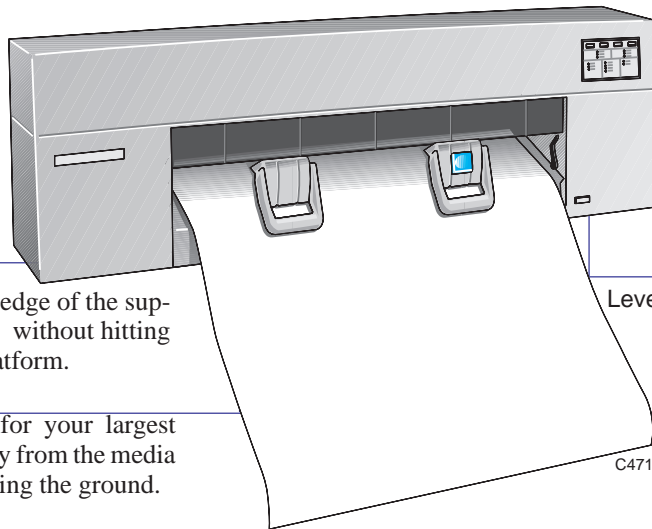

Place the printer at the edge of the support, so that sheets exit without hitting the top of the stable platform.

Leave enough space for your largest sheet size to hang freely from the media exit slot without touching the ground.

- 2 Connect the power cord and switch the printer on.
- 3 Open the cover and load the supplied print cartridge(s) into the carriage on the left of the printer. For help, use the label on the printer near the carriage and the documentation in the cartridge box. Don't forget to remove the tape from the cartridge(s).
- 4 Switch off the printer and your computer, connect the parallel cable, and then switch them on again.

- 5 Choose your driver disk(s), read the instructions on the label and follow the printed instructions that were shipped with the driver.

That's all!



Setup checklist

Having unpacked and assembled the printer, you can use the checklist below as you complete each task explained in this chapter.

Task	Page	Done? (✓)
1 Check that you have all the items required	1–4	
2 (Optional) Install a memory expansion module	1–6	
3 Position the printer	1–8	
4 Switch on	1–9	
5 Load the print cartridge(s)	1–10	
6 (Optional) Change the language	1–14	
7 Connect the printer to your computer	1–17	
8 (Optional) Configure the printer	1–19	
9 Set up the printer in your application software	1–24	
10 Send a sample or demonstration print	1–26	

Task 1: Check that you have all the items required

Task 1: Check that you have all the items required

Supplied

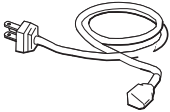

1 You will need the following items, which *were supplied with the printer*:

- **Power cord**

The power cord supplied with your printer should meet the plug requirements for your area. However, different power cords (international options) are available. If necessary, contact your dealer or HP Sales and Support Office.

- **Print cartridge(s)**

For the HP DesignJet 430:

- One black.

430



450C
455CA

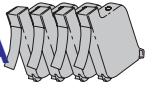

For the HP DesignJet 450C/455CA:

- One yellow
- One cyan
- One magenta
- One black.

- **Software**

The following two software packs were supplied with the printer. Whether you need them depends on what application(s) you intend to use.

- Driver for AutoCAD
- Driver for Microsoft Windows applications.

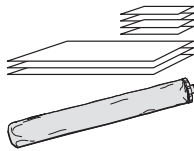

2 Inspect the printer itself and the above accessories. If you received any item in a damaged condition, notify the dealer or HP Sales and Support Office where you purchased the printer, and file a claim with the carrier.

Task 1: Check that you have all the items required**Not supplied**

3 You will also need the following items, which *were not supplied with the printer*:

- **Interface cable**

For details of suitable cables, see page 10–11.

- **Media**

For details of supported media types, see page 2–3. As part of the setup routine, you may need up to three A-size or A4-size sheets, plus whatever size sheet you prefer for a sample print.

If you have fitted the optional roll-feed assembly, you can use either roll media or cut sheets; if not, you can use only cut sheets.

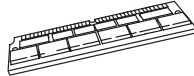
Optional

4 If you have bought one, you will also need your:

- **Memory expansion module**

For details of the memory expansion modules available, see page 10–17.

- **HP JetDirect EX print server**

This is required if you intend to connect your printer directly to a network. For details of the latest HP JetDirect EX products, contact your local HP Sales and Support Office. For configuration details, see page 1–18.

Task 2: (Optional) Install a memory expansion module

Task 2: (Optional) Install a memory expansion module

For details of the memory modules available, see page 10–17. You may install only one.

- 1 Make sure that the printer is switched OFF and that neither the power cord nor an interface cable is connected.

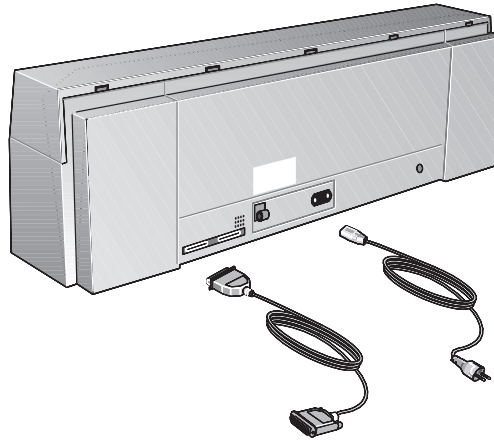

C471304

- 2 Unscrew the cover plate at the back of the printer, and remove it.

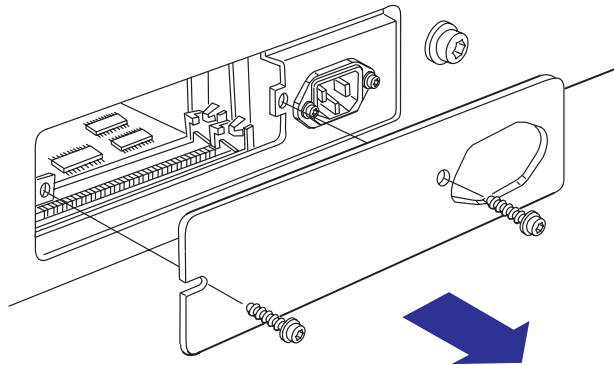

1737

Task 2: (Optional) Install a memory expansion module**CAUTION**

Before handling a memory module, either put on a grounding wrist strap and attach the end to the metal chassis of the printer, or touch the outer metal surface of the printer with your hand. Otherwise, static electricity from your body could damage the memory module.

- 3 Take the memory module out of its bag, holding the module only by the edges.
- 4 With the module's small notch on the left and the metallic edge away from you, load the module into *the slot nearest to you*. (The other slot is not for memory modules.) To do this, first hold the module at an angle, and then gradually push it back until it clicks into place vertically.

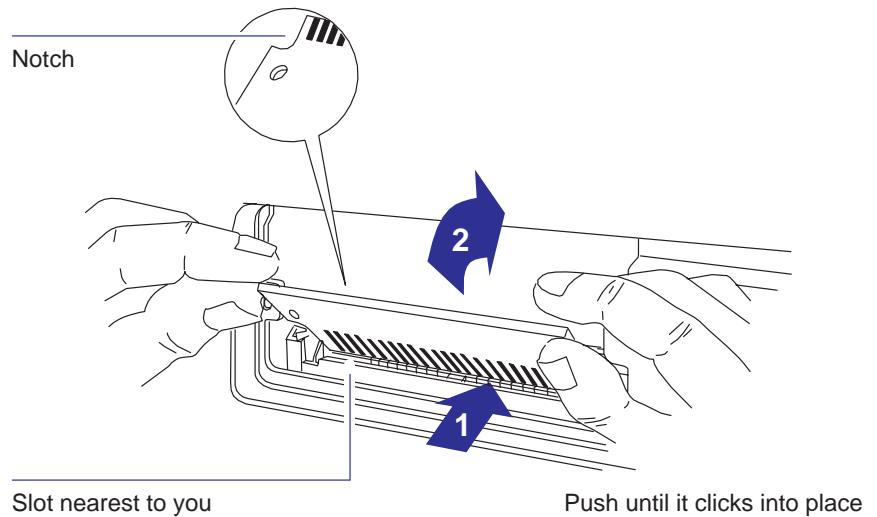

1738a

- 5 Replace the cover plate and screws.

Task 3: Position the printer

Task 3: Position the printer

- If you have fitted the optional legs assembly for stability, this task does not apply.
- If you have not fitted the optional legs kit, position the printer as shown below.
- For operating temperature and humidity, see page 10–5.
- Allow enough space above the printer to open the cover.

If the printer is without legs ...

Level surface and sturdy support. For printer weights, see page 10–4.

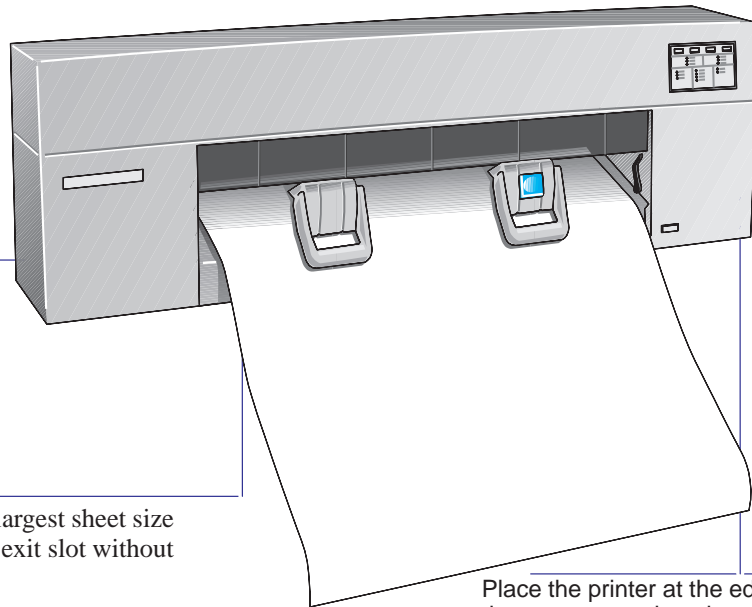

Leave enough space for your largest sheet size to hang freely from the media exit slot without touching the ground.

Place the printer at the edge of the support, so that sheets exit without hitting the top of the support.

C471303

Task 4: Switch on

WARNING

Be sure that the power cord supplied with your printer matches your ac power connection requirements. Use only three-wire (earth-grounded) power cords with this printer.

- 1 Make sure that the power switch on the front of the printer is in the OFF position (extended).

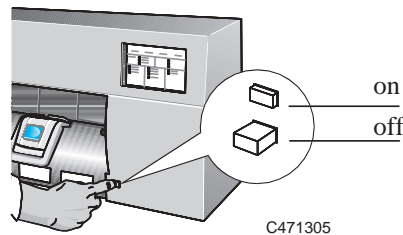

- 2 Plug the power cord into the socket at the back of the printer, and then into your power outlet.



- 3 Switch on the printer, by pushing the power switch. After you switch on, the printer will execute a self diagnostic test while flashing each of the lights for a few moments. The lights will stop and you will be ready for the next step.
- 4 If there is no sound, nor any light on the front panel, you may have a power problem. For troubleshooting information, see Chapter 9.

Task 5: Load the print cartridge(s)

- 1 Make sure that, on the front panel, the **Cartridges** light is flashing. If other lights in the upper part (the status and error groups) are on, look up their meaning in Chapter 8. Any lights in the lower part of the panel (the print quality, media type and media source groups) are not relevant at this stage.

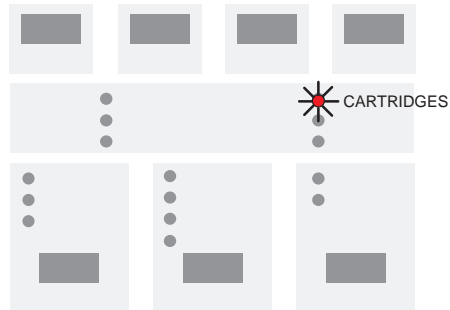

- 2 Open the cover using the small handle at the center front. If necessary, wait for the cartridge carriage to move to the service station (the area on the left of the printer).

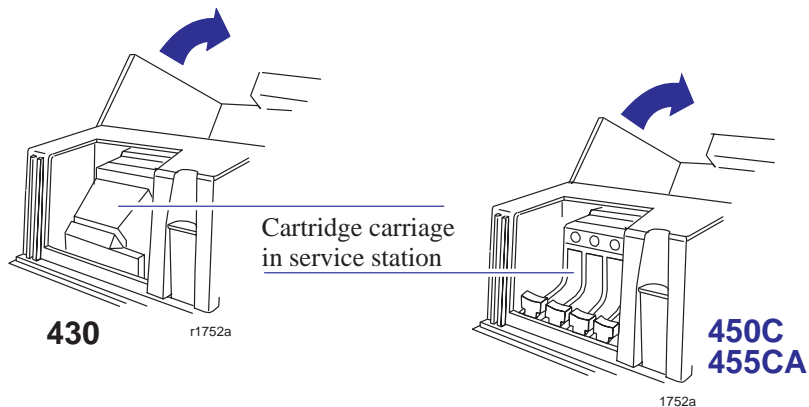

WARNING

Don't touch the plastic strip that runs the length of the printer behind the cartridge carriage. Keep hair, jewelry, clothing, and foreign objects away from the printer mechanisms.

A set of cartridges was supplied with the printer:

430

- The HP DesignJet 430 is supplied with one black cartridge.

450C/455CA

- The HP DesignJet 450C/455CA is supplied with four cartridges:
 - yellow
 - cyan
 - magenta
 - black.

For the 450C/455CA, each stall in the carriage has a dot indicating the color of the cartridge that should be installed: you *must* put the correct cartridge in the correct stall. The sequence of the stall colors is, from left to right, yellow, cyan, magenta and black.

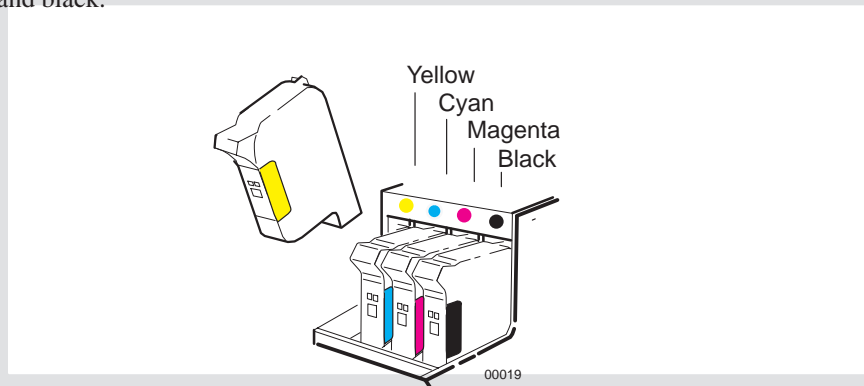

For users with color-vision deficiencies. You can also identify the colors of the cartridges by the part numbers on the boxes—see page 10–18.

Note. It is not recommended to operate the 450C/455CA with only the black cartridge loaded.

Task 5: Load the print cartridges

- 3 For each cartridge in the set:
- a Take the cartridge out of its box.
 - b Remove the colored protective tape and tab from the cartridge's nozzles.

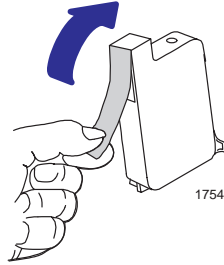

450C/455CA

c For the 450C/455CA, match the color of the cartridge's label with the color of the dot above the stall.

- d Make sure that the printer is still switched ON. (Never install cartridges with the printer switched off.)
- e Insert the cartridge in the stall. Press down lightly and push the cartridge away from you until it snaps into place.

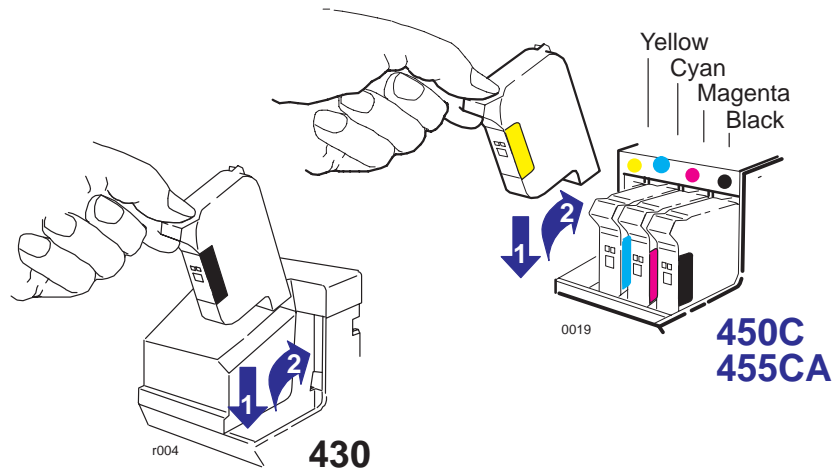

- f If it is installed correctly, the Ready light flashes three times. Otherwise, re-seat it.

Task 5: Load the print cartridges

- 4 When all the cartridges are installed, lower the cover. On the front panel, the **Ready** light should flash for up to about a minute and then go off. The **Load Media** light should then be on (together with **Media Type** and **Print Quality** lights).

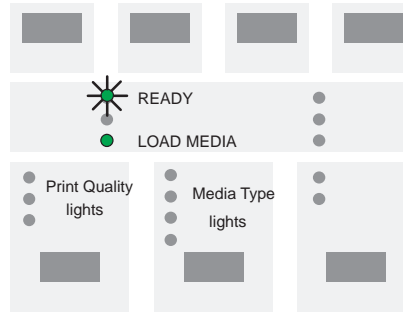

- 5 Now check your cartridge alignment by running the Black Cartridge Alignment Routine (see page 5–4) and the Color Cartridge Test Routine (see page 5–8).

Task 6: (Optional) Change the language

Task 6: (Optional) Change the language

All the printer's internal prints are available in the following languages: English, French, Italian, German, Spanish, Portuguese and Japanese. By default, the language is English. If English is what you want, then you can skip this task and go to task 7.

To change from English to any of the other languages, you must use the printer's Setup Sheet, as explained below.

- 1 Load a sheet of A-size or A4-size plain paper, in portrait orientation. For help on how to load a sheet, either refer to the pictures on the right-hand side of the printer's media-entry slot, or see the section starting on page 2–10. Don't forget to check that the Media Source is set to **Sheet**.

When the **Ready** light is on, you have loaded the sheet correctly.

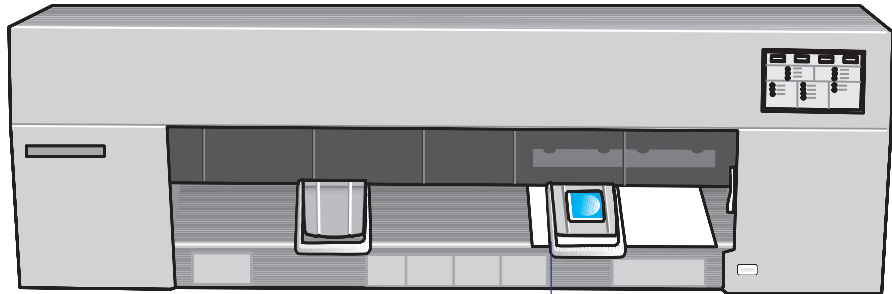

Print will be on underside.

C471307.

Task 6: (Optional) Change the language

- 2 Make sure the front-panel Media Type is set to **Paper**. If necessary, press the **Media Type** key until the **Paper** light is on.

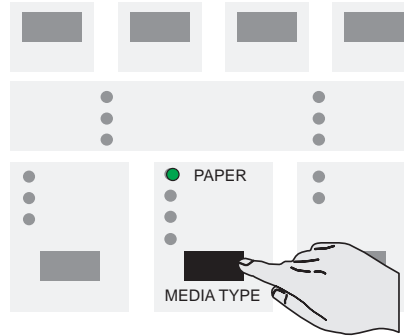

- 3 Press **Setup**.

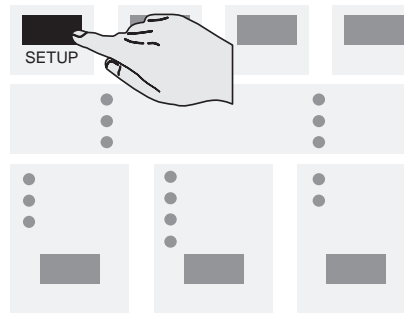

- 4 When the print has finished, wait until the **Load Media** light comes on and the printer ejects the sheet. Remove the sheet.

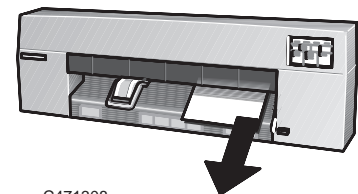
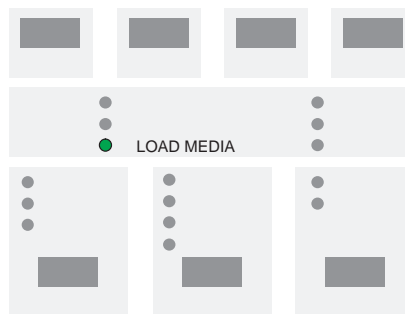

C471308.

Task 6: (Optional) Change the language

- 5 The print is a Setup Sheet in English, as shown on page 1–21.

You can ignore all the information except the box in the top left, headed “1. Language”.

Take a pencil or black pen and fill in the oval next to the language you want.

1. Language	
<input type="radio"/>	English
<input type="radio"/>	Français
<input type="radio"/>	Deutsch
<input type="radio"/>	Español
<input type="radio"/>	Italiano
<input type="radio"/>	Português
<input type="radio"/>	日本語

- 6 Reload the Setup Sheet into the printer, printed side down and with the large arrow pointing into the printer.

When the **Ready** light comes on, press **Setup** again.

The printer now reads your marks and reconfigures itself automatically.

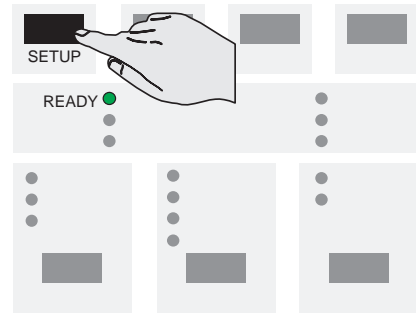

- 7 When the **Load Media** light comes on again, remove the sheet and make sure that the printer has marked your selection with a check mark. If it hasn't marked the correct language, repeat this task.

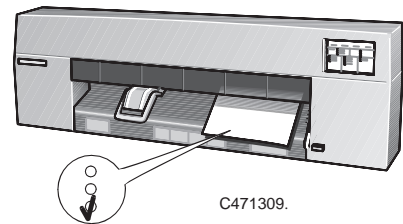
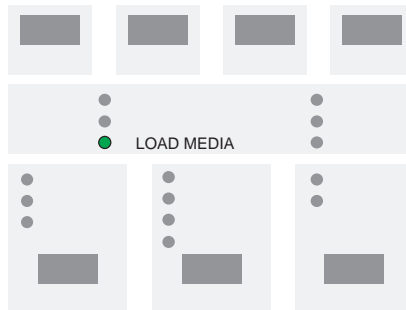

C471309.

Task 7: Connect the printer to your computer

If you are connecting the printer directly to your computer

- 1 Decide whether to use the parallel or serial interface.

If your computer and your application software support it, use the parallel interface, as it is faster. You may connect both the parallel and the serial interface simultaneously if you wish: the printer uses the interface that first receives data.

- 2 Choose an interface cable.

For a list of HP cables for various computers, see the table on page 10–11. If you are making up your own cable, refer to the interface specifications starting on page 10–8. Use shielded interface cables only.

Note on the parallel interface. The parallel interface is an IEEE-1284-compliant Centronics interface. The same cable can be used for both Centronics and IEEE-1284-compatible communication.

- 3 Switch off the printer and the computer.
- 4 Connect one end of the cable to the appropriate port on the back of the printer.

Port for parallel-interface
cable (printer end of cable:
36-pin male)

Port for serial-interface
cable (printer end of cable:
25-pin male)

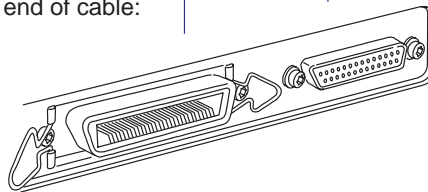

1744b

- 5 Connect the other end of the cable to your computer. For help on choosing the correct port on the computer, refer to your computer documentation.
- 6 Switch on the computer and the printer.

Task 7: Connect the printer to your computer

If you are connecting the printer directly to a network

You can connect your printer directly to a Local Area Network using an HP JetDirect EX external network interface, connected to the printer's parallel port. Various network operating systems are supported, in DOS, Unix® and Macintosh environments. For the latest information on HP JetDirect EX products, contact your local HP Sales and Support office.

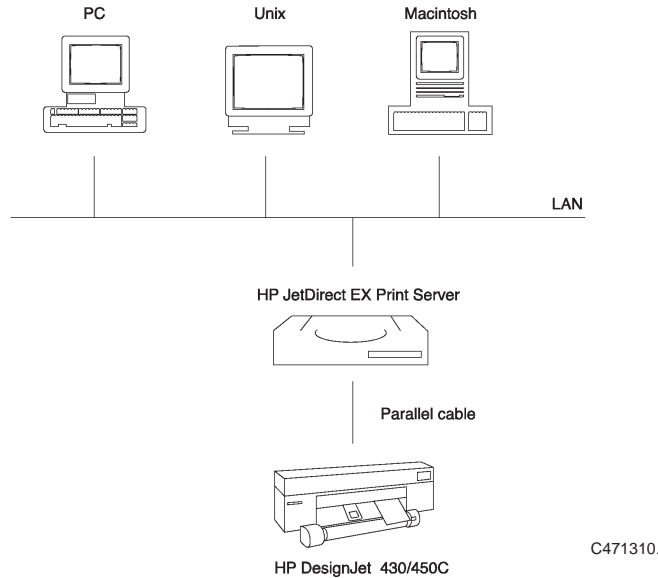

For installation of the HP JetDirect EX interface with the DesignJet 430/450C, see the Installation Guide that comes with that product.

For installation of the DesignJet 455CA with the supplied HP JetDirect EX interface, refer to the HP DesignJet 455CA Software RIP set-up guide.

In order to be able to print from your Macintosh to the HP DesignJet 430/450 you should contact your local HP Sales and Support office.

Task 8: (Optional) Configure the printer

In the majority of cases, there is no need to change any of the printer's default settings. This may be because:

- You prefer to change those settings that affect the appearance of your prints from your application software.
- The printer's factory defaults, listed on page 1–22, are acceptable.

However, if you *do* want to change the defaults, follow these steps, which explain how to print and use the **Setup Sheet**.

Note. If you changed the language from English (see task 6 above), you already know how to use this sheet, but this time it will be in your chosen language.

- 1 Load a sheet of A-size or A4-size plain paper, in portrait orientation. For help on how to load a sheet, either refer to the pictures on the right-hand side of the printer's media-entry slot, or see the section starting on page 2–10. Don't forget to check that the Media Source is set to **Sheet**.

When the **Ready** light is on, you have loaded the sheet correctly.

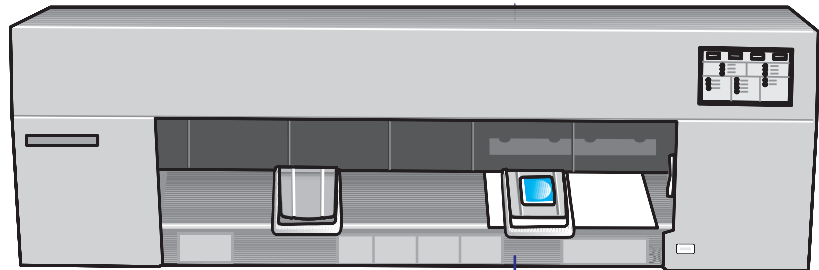

C471307.

Print will be on underside.

Task 8: (Optional) Configure the printer

- 2 Make sure the front-panel Media Type is set to **Paper**. If necessary, press the **Media Type** key until the **Paper** light is on.

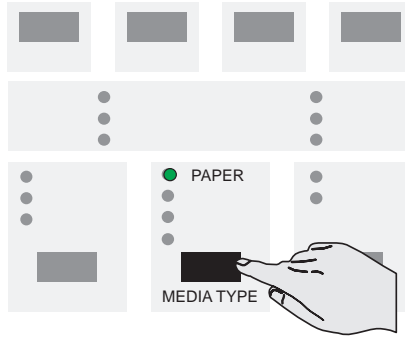

- 3 Press **Setup**.

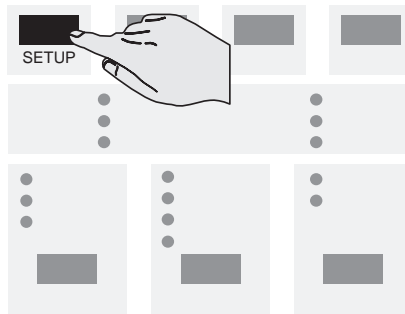

- 4 When the print has finished, wait until the **Load Media** light comes on and the printer ejects the sheet. Remove the sheet.

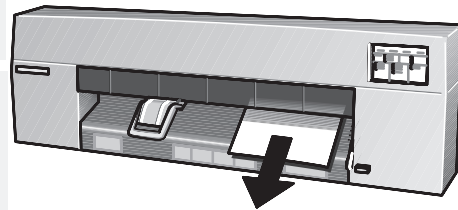
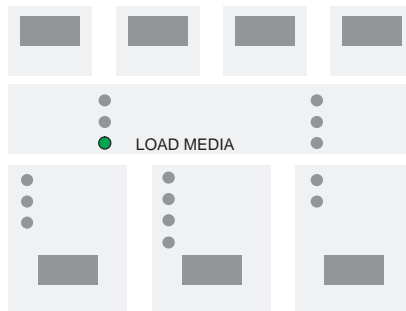

C471308.

Task 8: (Optional) Configure the printer



HP DesignJet 4xx

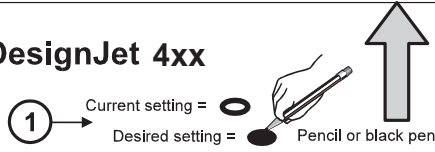

Setup Sheet
For an explanation of all the parameters on this sheet, see the User's Guide.

RAM: 4MB Standard + 14MB SIMM
Firmware Revision: A.69.69 (LD)

450C/455CA

1. Language <input checked="" type="radio"/> English <input type="radio"/> Français <input type="radio"/> Deutsch <input type="radio"/> Español <input type="radio"/> Italiano <input type="radio"/> Português <input type="radio"/> 日本語	2. Serial Interface Baud Rate <input type="radio"/> 1200 <input type="radio"/> 2400 <input type="radio"/> 4800 <input checked="" type="radio"/> 9600 <input type="radio"/> 19200 <input type="radio"/> 38400 Parity <input checked="" type="radio"/> None <input type="radio"/> Even <input type="radio"/> Odd	3. Graphics Language <input checked="" type="radio"/> HP-GL (7586B) <input type="radio"/> HP-GL/2 4. I/O Timeout <input type="radio"/> 0.5 min <input type="radio"/> 1 min <input type="radio"/> 5 min <input checked="" type="radio"/> 30 min	5. Plot Appearance <input type="radio"/> Auto rotate <input checked="" type="radio"/> Rotate off <input type="radio"/> Rotate 90° <input checked="" type="radio"/> Mirror off <input type="radio"/> Mirror on <input checked="" type="radio"/> Merge off <input type="radio"/> Merge on	6. Color/Mono <input checked="" type="radio"/> Print color as color <input type="radio"/> Print color as grayscale
--	--	---	---	---

7. Page Size Inked Area Software <input checked="" type="radio"/> Over-size <input type="radio"/> A1 <input type="radio"/> A2	JIS <input type="radio"/> B1 <input type="radio"/> B2 <input type="radio"/> B3 <input type="radio"/> B4	ANSI <input type="radio"/> E <input type="radio"/> D <input type="radio"/> C <input type="radio"/> B <input type="radio"/> A	ISO <input type="radio"/> A0 <input type="radio"/> A1 <input type="radio"/> A2 <input type="radio"/> A3 <input type="radio"/> A4	ARCH <input type="radio"/> E1 <input type="radio"/> E <input type="radio"/> C <input type="radio"/> B <input type="radio"/> A
---	---	---	---	--

8. Pen Settings <input type="radio"/> Use settings from software <input type="radio"/> Use settings from tables below If you want these pen settings to take effect, don't forget to mark the oval above.									
Pen Number									
Width (mm)	1	2	3	4	5	6	7	8	
0.13	<input type="radio"/>	<input type="radio"/>	<input type="radio"/>	<input type="radio"/>	<input type="radio"/>	<input type="radio"/>	<input type="radio"/>	<input type="radio"/>	
0.18	<input type="radio"/>	<input type="radio"/>	<input type="radio"/>	<input type="radio"/>	<input type="radio"/>	<input type="radio"/>	<input type="radio"/>	<input type="radio"/>	
0.25	<input type="radio"/>	<input type="radio"/>	<input type="radio"/>	<input type="radio"/>	<input type="radio"/>	<input type="radio"/>	<input type="radio"/>	<input type="radio"/>	
0.35	<input checked="" type="radio"/>	<input checked="" type="radio"/>	<input checked="" type="radio"/>	<input checked="" type="radio"/>	<input checked="" type="radio"/>	<input checked="" type="radio"/>	<input checked="" type="radio"/>	<input checked="" type="radio"/>	
0.50	<input type="radio"/>	<input type="radio"/>	<input type="radio"/>	<input type="radio"/>	<input type="radio"/>	<input type="radio"/>	<input type="radio"/>	<input type="radio"/>	
0.70	<input type="radio"/>	<input type="radio"/>	<input type="radio"/>	<input type="radio"/>	<input type="radio"/>	<input type="radio"/>	<input type="radio"/>	<input type="radio"/>	
1.00	<input type="radio"/>	<input type="radio"/>	<input type="radio"/>	<input type="radio"/>	<input type="radio"/>	<input type="radio"/>	<input type="radio"/>	<input type="radio"/>	
Grayscale	1	2	3	4	5	6	7	8	Color
100%	<input checked="" type="radio"/>	<input type="radio"/>	<input type="radio"/>	<input type="radio"/>	<input type="radio"/>	<input type="radio"/>	<input type="radio"/>	<input type="radio"/>	Black
80%	<input type="radio"/>	<input type="radio"/>	<input type="radio"/>	<input type="radio"/>	<input type="radio"/>	<input type="radio"/>	<input type="radio"/>	<input type="radio"/>	Red
60%	<input type="radio"/>	<input type="radio"/>	<input type="radio"/>	<input type="radio"/>	<input type="radio"/>	<input type="radio"/>	<input type="radio"/>	<input type="radio"/>	Green
40%	<input type="radio"/>	<input type="radio"/>	<input type="radio"/>	<input type="radio"/>	<input type="radio"/>	<input type="radio"/>	<input type="radio"/>	<input type="radio"/>	Yellow
20%	<input type="radio"/>	<input type="radio"/>	<input type="radio"/>	<input type="radio"/>	<input type="radio"/>	<input type="radio"/>	<input type="radio"/>	<input type="radio"/>	Blue
10%	<input type="radio"/>	<input type="radio"/>	<input type="radio"/>	<input type="radio"/>	<input type="radio"/>	<input type="radio"/>	<input type="radio"/>	<input type="radio"/>	Magenta
5%	<input type="radio"/>	<input type="radio"/>	<input type="radio"/>	<input type="radio"/>	<input type="radio"/>	<input type="radio"/>	<input type="radio"/>	<input type="radio"/>	Cyan

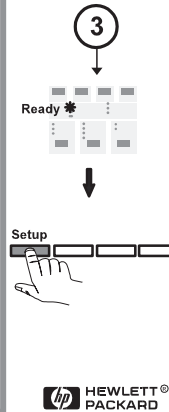
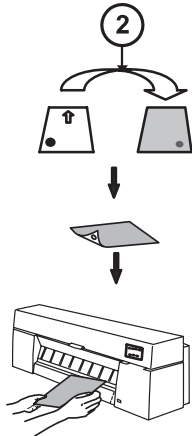

450C/455CA



Task 8: (Optional) Configure the printer

An example of a Setup Sheet is shown on the previous page. That example is for an E/A0-size printer. The items in the Setup Sheet are listed in the table below.

Setup Sheet Items and Defaults		
Item	Factory Default	Comments
Language	English	Task 6 on page 1–14 explained how to change this.
Baud Rate	9600	(Serial interface only). You must set the baud rate to be the same as that of the computer sending the data.
Parity	None	(Serial interface only). You must set the parity to be the same as that of the computer sending the data.
Graphics Language	HP-GL (7586B)	See page 6–3.
I/O Timeout	30 minutes	See page 6–4.
Rotate	Off	See page 3–7.
Mirror	Off	See page 3–10.
Merge	Off	See page 3–11.
Color/Mono	Print color as color	See page 3–13. 450C/455CA
Page Size	Software	See page 3–5. Note that not all the page-size options shown in the example are available on the D-size printer.
Pen Settings	Use settings from software	See page 3–12. Note that the color pen settings are only available on the HP DesignJet 450C/455CA. 450C/455CA

Task 8 (optional): Configure the printer

- 5 Follow the instructions on the Setup Sheet. Having marked the ovals to change the settings, reload the sheet into the printer, with the printed side down, and with the large arrow pointing into the printer.

When the **Ready** light comes on, press **Setup** again.

The printer now reads your marks and reconfigures itself automatically.

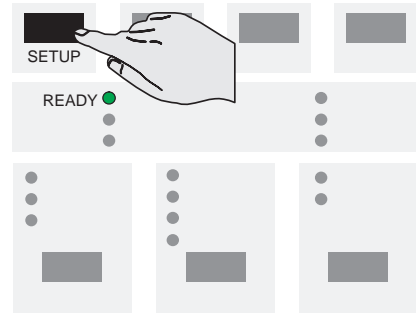

- 6 When the **Load Media** light comes on again, remove the sheet and make sure that the printer has marked your selection with a check mark.

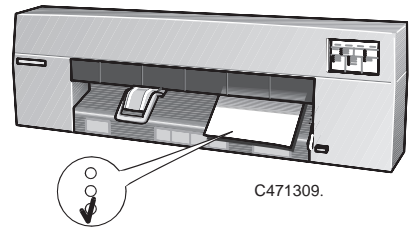
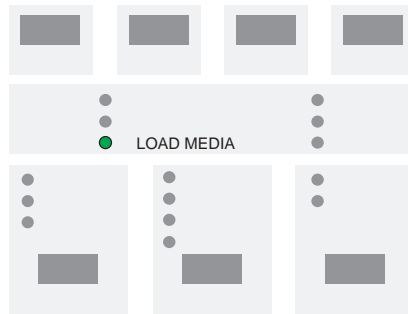

- 7 Please store this latest copy of the Setup Sheet with the Quick Reference Guide in the plastic pocket at the side of the printer, so that a service engineer would know the current configuration even if the printer is inoperable.

Task 9: Set up the printer in your application software

“Application software” is the software from which you intend to send prints to your printer—for example, a CAD system.

- What is a driver? Your application software needs to know to which type of printer it is sending information. This knowledge, and other configuration information, is held in a “driver.” A driver is a piece of software that handles communications between your application software and a peripheral, in this case a printer. Drivers are usually supplied as part of the application software, but they are also available separately. If they are supplied separately, you need to install them separately.
- AutoCAD Supplied with the HP DesignJet 430 and DesignJet 450C printers is a pack containing drivers for AutoCAD for DOS and AutoCAD for Windows. Please refer to the documentation supplied with these drivers.
- Windows applications Supplied with this printer is a pack containing a driver for applications that work with Microsoft Windows. Please refer to the documentation supplied with this driver.
- Other applications Users of other applications should first check any *Software Application Notes* supplied with the printer, to see if their application is covered there.
- For other applications, there is on the next page a general recommendation as to which device to choose when setting up this printer. Device lists are not always up-to-date with the latest printers, and so with some software you may have to choose a printer other than the HP DesignJet 430, 450C or 455CA from the device list.

455CA

Supplied with this printer is a pack containing an, HP DesignJet 455CA software RIP. Please refer to the documentation supplied with this pack.

Task 9: Set up the printer in your application software

When choosing from a device list, follow these preferences, which are listed here in priority sequence.

- **Preference 1:** **HP DesignJet 430/450C/455CA**
- **Preference 2:** **HP DesignJet 330/350C**
- **Preference 3:** **HP DesignJet 700/750C/750C Plus/755CM**
- **Preference 4:** **HP DesignJet 650C**
with a preference for C2858B/C2859B rather than C2858A/C2859A.
- **Preference 5:** **HP DesignJet 220**
- **Preference 6:** **HP DesignJet 200**
- **Preference 7:** **HP DesignJet 600**
HP DesignJet
- **Preference 8:** **HP-GL/2 Device**
or a similar option including a reference to HP-GL/2.
- **Preference 9:** Any of:
HP 7595B DraftMaster SX
HP 7596B DraftMaster RX
HP 7599A DraftMaster MX
HP 7595C DraftMaster SX Plus
HP 7596C DraftMaster RX Plus
HP 7599B DraftMaster MX Plus

If any of the options quoted above appears, then your software supports HP-GL/2. If it doesn't support HP-GL/2, then go to Preference 10.

- **Preference 10:** **HP 7586B**
This printer supports HP-GL. However, if you choose this device you may not be able to use your printer's parallel connection—depending on the application software.

Getting help

If in doubt, or if you have problems with your driver, refer to the section at the end of Chapter 9 for advice on how to get help.

Task 10: Send a sample or demonstration print

To verify a successful configuration, choose a sample print in your application and try to print it on the printer.

In case of problems, refer to Chapter 9 of this manual, “Troubleshooting”. To test whether the source of any problem is in the printer itself or in the link with your application, it is useful to print the printer’s internal demonstration print.

To print the demonstration print

- 1 If media is not already loaded, load roll media or a sheet, as explained in Chapter 2, which also provides advice on the availability and use of different media types.
- 2 Press simultaneously the two keys **Setup** and **Cancel**:

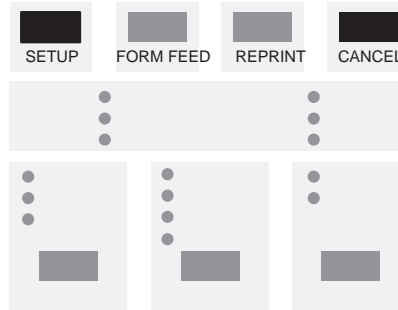

The demonstration print summarizes the printer’s main features and includes a sample CAD drawing, using a variety of line widths and colors. It is printed in the language currently configured in the Setup Sheet. To change the language, see task 6.

455CA

The demonstration print of the HP DesignJet 455CA, must be printed from the HP DesignJet 455CA software RIP. Please refer to the documentation supplied with this pack.

Caring for your media	2-2
Choosing media	2-2
Before loading media	2-8
Before sending your file	2-9
Loading sheet media	2-10
Loading roll media	2-17
Loading a sheet with the roll-feed option installed	2-26
Unloading media	2-27

Working with media

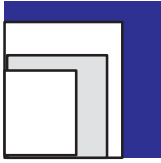

Caring for your media

- If your printer includes the legs option, make sure the media bin is installed between the printer's legs, so that uncut media doesn't drag on the floor.
- Handle film and glossy media by the edges or wear cotton gloves. Skin oils can interact with ink and cause it to smear.

Choosing media

Your printer supports many types of paper and other media types, and can operate both with sheets and, if the roll-feed option is installed, with rolls. Choosing the best media type for your requirements is the first—and most important—step in ensuring good print quality.

450C/455CA

- For **color printing**, although most supported media types are suitable, some are not recommended. For details, see the table on page 2–5.
- When choosing between **opaque paper types for monochrome printing**, be aware that you will use significantly less ink printing on coated paper types than on normal opaque bond.
- Whenever you load a roll or a sheet, you must check that the **media type** specified on the printer's front-panel is correct for the media type you are loading. It is *essential* for good print quality to specify this correctly. See the table on page 2–3.
- You should also be aware of which **print quality** setting (best, normal or fast) you are using. You can set this either from your software or from the printer's front panel. The combination of media type and print quality settings automatically tells the printer how to place the ink on the media—for example, in terms of density and number of passes of the cartridges. For more details, see the tables on pages 2–5 and 2–6.
- *For the best-quality prints, use HP media, as your printer's configuration is optimized for it and tested with it.* For details of HP media, see page 10–19 and any separate HP media literature supplied with the printer.

Supported media types and relative costs

Media type selection on the front panel	Supported HP media ¹	Non-HP media also known as ...	Relative cost
Paper	HP Opaque Bond	Plain paper Printer paper	Low
	HP Translucent Bond		Low
	HP Natural Tracing Paper	Tracing paper Extra translucent bond	Moderate
	HP Vellum		Moderate
Coated ²	HP Coated Paper	Color inkjet paper Matte paper Presentation	Low/ moderate
	HP Heavyweight Coated Paper	Heavyweight color inkjet paper Heavyweight matte paper	Moderate
Film	HP Matte Film	Poly matte film Matte polyester Mylar	High
	HP Clear Film	Translucent film Clear polyester	High
Glossy ³	HP High-Gloss Photo Paper		High
Glossy ³	HP High-Gloss White Film		High
<p>¹ From time to time, new media types may become available. Up-to-date information is available from your HP dealer or local HP Sales and Support Office.</p> <p>² HP Special InkJet paper and HP Heavyweight Special InkJet Paper are <i>not</i> supported on the HP DesignJet 430, 450C and 455CA printers.</p> <p>³ Glossy media types are not supported on the HP DesignJet 430.</p>			

Choosing media

Physical characteristics of media types

HP media	Physical characteristics			
	Base	Opacity	Matte or Glossy	Special coated side for printing?
Opaque Bond	Wood-pulp	Opaque	Matte	No. Both sides are the same. If the sheet is curled, load with the curl <i>up</i> .
Translucent Bond	Wood-pulp	Semi-opaque	Matte	
Natural Tracing Paper				
HP Vellum	Cotton-fiber	Semi-opaque	Matte	
HP Coated Paper	Wood-pulp	Opaque	Matte	Yes. Load with the coated side down. On HP Coated Paper and Heavyweight Coated Paper, look for the small notch in the corner: <ul style="list-style-type: none"> • When loading in a portrait orientation, make sure the notch is on the right side of the leading edge. • When loading in a landscape orientation, make sure the notch is on the left side of the leading edge.
Heavyweight Coated Paper				
Matte Film	Poly-ester	Semi-opaque	Matte	Yes. Load with the matte side down.
Clear Film	Poly-ester	Clear	—	Yes. Load with the rougher side down.
High-Gloss Photo Paper	Poly-ester	Opaque	Glossy	Yes. Load with the rougher side down.
High-Gloss White Film	Poly-ester	Opaque	Glossy	Yes. Load with the rougher side down.

450C
455CA

450C
455CA

Recommended print-quality settings and recommended media for color prints

HP media	Print quality (set either on the front panel or in the software)		
	Fast	Normal	Best
HP Opaque Bond	OK for monochrome, but color for CAD drawings only ¹		
HP Translucent Bond	OK for monochrome, not recommended for color		
HP Natural Tracing Paper	OK for monochrome, but color for CAD drawings only ¹		
HP Vellum			
HP Coated Paper	OK		
HP Heavyweight Coated Paper			
HP Matte Film			
HP Clear Film			
HP High-Gloss White Film	Not recommended	OK for color; not recommended for monochrome	
HP High-Gloss Photo Paper	Not recommended	OK for color; not recommended for monochrome	
¹ The limitation on the use of non-coated media for color really depends on: <ul style="list-style-type: none"> • the amount of area fill in your drawing (the more there is, the less likely that the print quality on opaque bond will be satisfactory) • the quality of the media. 			

Choosing media

Typical media-type choices by application

Application	Use	Typical choice of media	Probable choice of print quality
Computer-Aided Design (CAD) monochrome	Drafts	Opaque bond Translucent bond Natural tracing paper Vellum	Fast or Normal Fast or Normal Fast or Normal Fast or Normal
	Final versions	Opaque bond Matte or clear film	Normal or Best Normal or Best
	Archives	Vellum Matte or clear film	Best Best
	Diazo reproductions	Translucent bond Natural tracing paper Vellum Matte film	Normal or Best Normal or Best Normal or Best Normal or Best
Computer-Aided Design (CAD) and Geographical Information Systems (GIS) color	Drafts	Opaque bond Natural tracing paper Vellum Coated paper	Fast or Normal Fast or Normal
	Final versions	Coated paper Heavyweight coated paper (for durability) Matte film Clear film	Normal or Best Normal or Best Normal or Best Fast or Normal
	Archives	Matte film Clear film	Best Normal
	Overlays	Clear film	Fast or Normal

450C

Typical media-type choices by application (continued)

Imaging and graphics packages color	Matte	Opaque bond (for drafts) Coated paper Heavyweight coated paper (for durability)	Fast, Normal or Best Fast, Normal or Best Normal or Best
	Gloss	High-gloss white film	Normal or Best
	Gloss	High-gloss photo paper	Normal or Best
	Clear film	Clear film (colors not optimized for this media type)	Best

Before loading media

Specify whether you are going to load a sheet or a roll

On the front panel, if the **Roll** light is on, the printer believes you are loading a roll.
If the **Sheet** light is on, it believes you are loading a sheet.

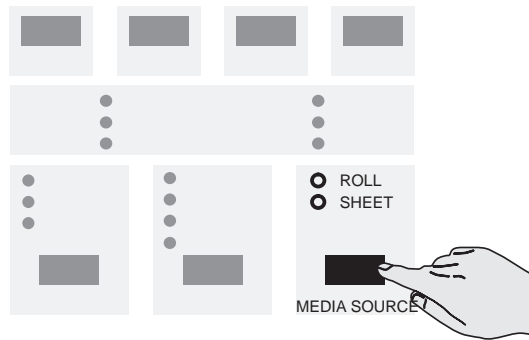

To toggle between the two settings, press the **Media Source** key.

Before sending your file

1 Specify the media type

Press the **Media Type** key until the light comes on against the name of the media type you are going to load. For an explanation of which media type category on the front panel should be used for each supported media type, see the table on page 2–3.

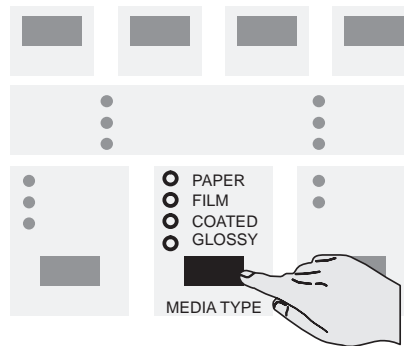

Note that, if your software printer driver allows you to specify the media type, you must specify it correctly there as well.

2 Specify the print quality setting

Press the **Print Quality** key until the light comes on against the print quality setting you require.

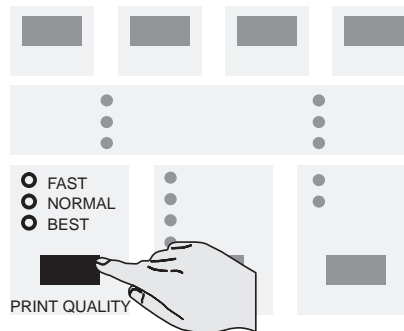

For details of each print quality setting, see the table on page 3–15.

Alternatively, you may be able to specify the print quality setting from your software printer driver. In this case, *the driver's setting* is used for the next print. During the print, the front-panel setting changes temporarily to that from the driver, and then resumes its previous setting again.



Loading sheet media

To load a sheet (without the roll-feed option installed)

To learn how to load a sheet correctly first time, follow steps 1 through 10. For subsequent help on how to load a sheet, refer to the pictures on the right-hand side of the printer's media-entry slot.

When you load a sheet, the printer checks that it is correctly aligned. If it is not correctly aligned, the printer flashes an error on the front panel, as explained in step 11 below, and you must try again. If your alignment is almost correct, you have a chance to re-align it, as explained on page 2–15.

- 1 If your printer has no legs, you'll find it easier if it is positioned at the edge of the table.
- 2 Make sure that the cover is closed and that the media lever is raised.

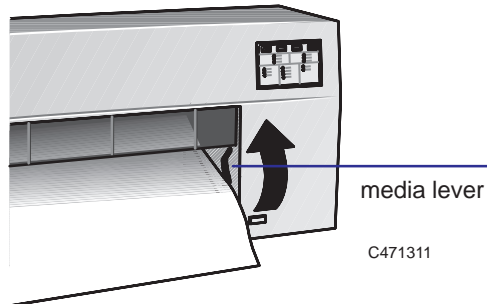

- 3 On the front panel, make sure the **Sheet** light is on, to indicate that you are going to load a sheet. Select **Sheet** by pressing the **Media Source** button.

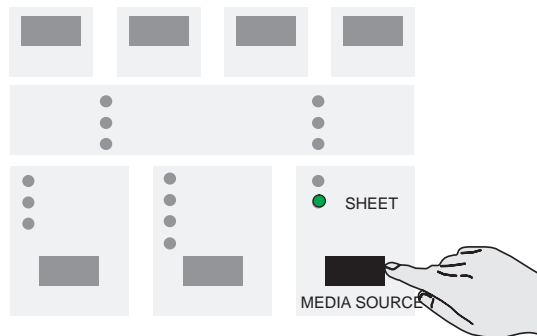

- 4 *Which way round?* You can load a sheet in either portrait or landscape orientation.

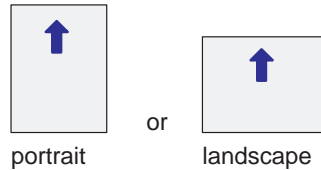

Unless you are using the **Rotate** option (see page 3–7), load the sheet in the same orientation as you have specified in your software. If you are loading an A- or A4-size sheet, portrait orientation is recommended.

- 5 *Which side down?* As you load the sheet, it is the *underside* on which the printer will print. With most media types, the two sides are different and so it is important to load the sheet correctly. See the table on page 2–4.
- 6 On the front panel, select the media type you are loading by pressing the **Media Type** button.
- 7 Hold the sheet by its edges, about 18 cm (7 in) from the top.

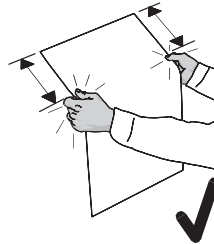

C471312

Don't hold the sheet right at the top, as you would have to adjust your grip as you push the sheet into the printer, and this would probably make you misalign it.

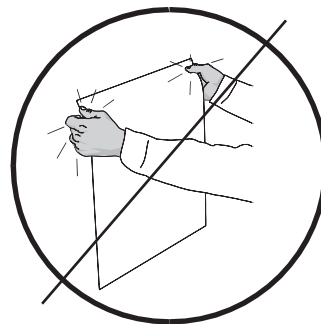

C471313

Loading sheet media

- 8 Align the right-hand side of the sheet with the dashed line on the printer.

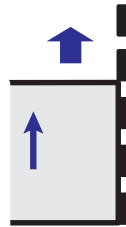

- 9 Make sure the entire top edge of the sheet—left and right—is placed inside the entry slot and under the deflectors, especially if the sheet is wider than A- or A4-size. While keeping the right-hand side aligned with the line of holes, push the sheet up into the entry slot with both hands, until you feel resistance from the grip-rollers inside the printer.

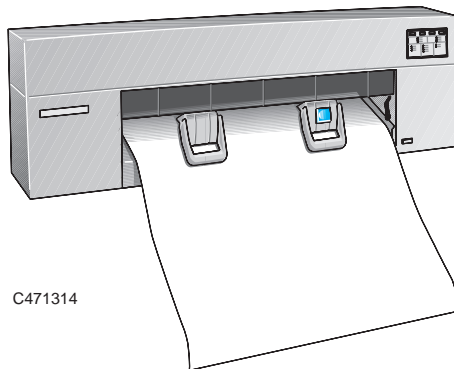

C471314

- 10 Using your right thumb, press the **Load Media** button.

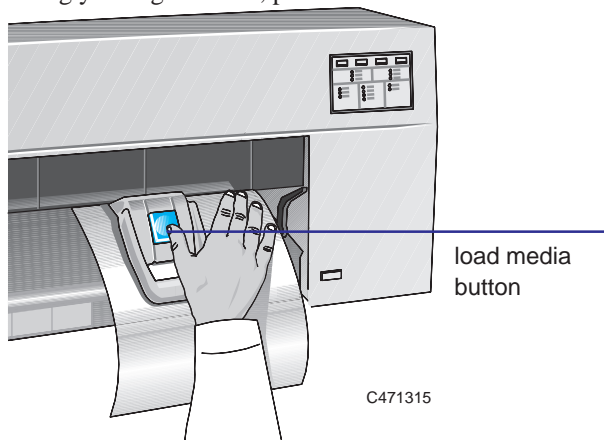

C471315

The printer will start to take the sheet from you. At this point, let go!

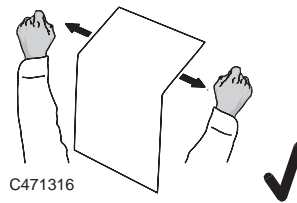

Don't touch the sheet while the printer feeds it out again a short way, as this would probably misalign it.

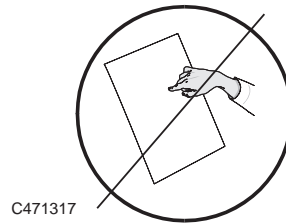

- 11 The printer takes about a minute to check the alignment. While it's doing this, the **Ready** light on the front panel flashes.

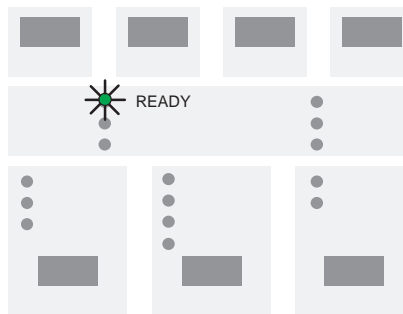

Wait until ...

- Either the **Ready** light stops flashing, but stays on:

Alignment *good*. Ready to print!

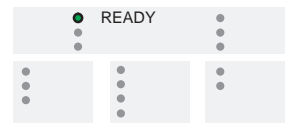

- Or the **Align Media** lights starts flashing:



Realigning sheet media

Alignment *close*. Either realign the sheet manually, as explained in the next section, or press **Cancel** to start again from step 7 on page 2–11.

- Or the **Media** light starts flashing:

Alignment *bad*. The printer has rejected the sheet. Simply remove it and start again from step 7 on page 2–11. (There’s no need to press any key.)



There is another reason why the **Media** light may flash: the sheet may be an invalid size. For supported media sizes, see page 10–3. With *very small* media sizes (B/A3-loaded in landscape or A/A4-size loaded in any orientation), there’s no middle option above: unless the alignment is good, you have to remove the sheet and start again.

To realign the sheet manually (if necessary)

- 1 If the **Align Media** light is flashing, the printer is inviting you to realign the media manually.

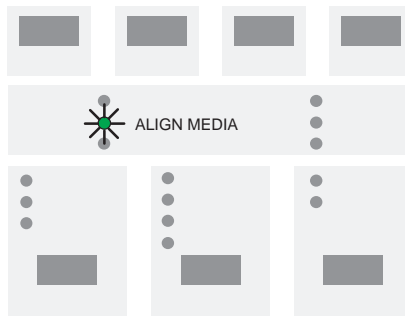

- 2 Lower the media lever to release the media.

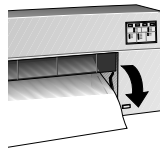

C471311B

- 3 Align the edges of the media coming *out* of the printer with the same edges going *into* the printer, by pulling them taut and aligning them by eye.

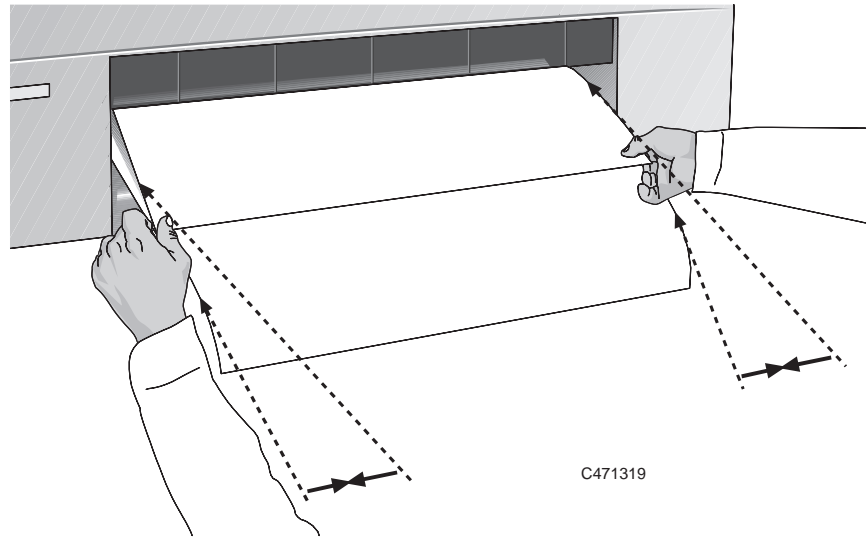

- 4 Raise the media lever.

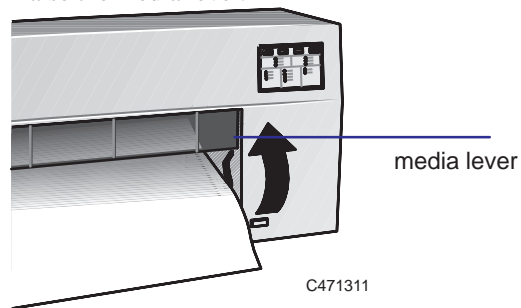

Realigning sheet media

- 5 The printer checks the alignment again. While it's doing this, the **Ready** light on the front panel flashes.

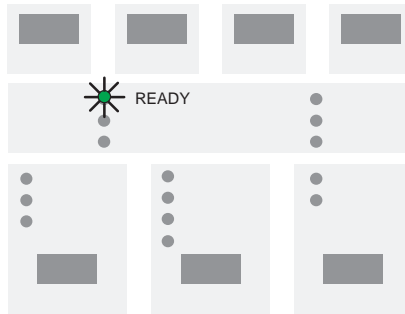

Wait until ...

- *Either* the **Ready** light stops flashing, but stays on:

Alignment *good*—ready to print!

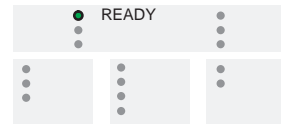

- *Or* the **Media** light starts flashing:

Alignment *bad*. The printer has rejected the sheet. Simply remove it and start again from step 7 on page 2–11.



*Notice that you have **only one chance** to realign the media manually. If it's still not right after the realignment, you have to load it again.*

Loading roll media

To change the roll

You can order spare spindles as accessories—see page 10–18. In this way, you can keep different rolls on different spindles and make this task easier. However, except where noted, this section assumes that you are using the same spindle for both the old and the new roll.

- 1 If you are using the legs option, be sure the printer wheels are locked (the brake lever pressed down) to prevent the printer from moving.

WARNING



In the next step (see next page):

Don't touch the plastic strip that runs the length of the printer behind the cartridge carriage.

Keep hair, jewelry, clothing, and foreign objects away from the printer mechanisms.

Loading roll media

- 2 *If the old roll is not used up*, then remove the media from the media path, as explained here.
 - a Lower the media lever to release the media and lift the bail.
 - b Turn the roll on the spindle to wind the media out of the printer and onto the roll.
 - c Raise the media lever.

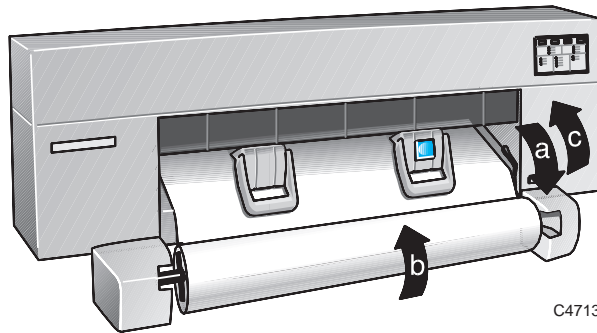

C471318

- 3 Remove the **old roll** by pulling firmly first on the left end of the spindle and then on the right. You may find that you have to push your thumbs against the cover of the roll-feed assembly while pulling the roll with your fingers to be able to release the spindle.

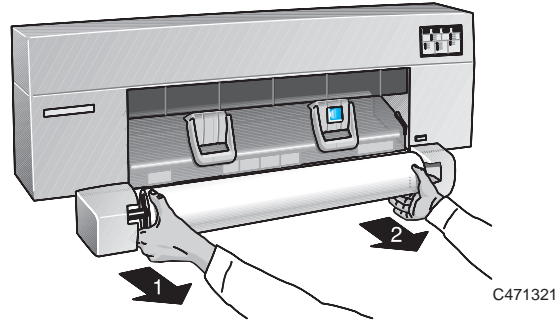

If the new roll is on a different spindle, then you can skip steps 4 and 5, and go straight to step 6.

- 4 Remove the left media stop, and then remove the roll from the spindle, with the right media stop still connected to the spindle.

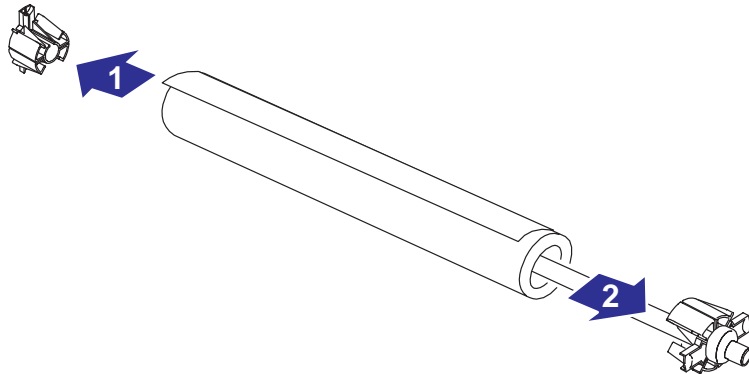

1922a

Loading roll media

- 5 Remove the **new roll** from its wrapping, place it on the spindle, so that, as the media winds up from behind the roll, the media stop still on the spindle is on the right. Push the right media stop so that it is flush against the end of the roll (2 in the illustration below). Then insert the left media stop on the left end of the spindle.

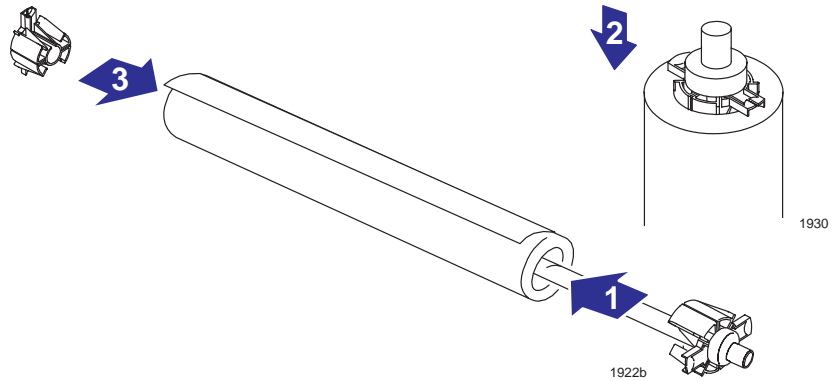

- 6 Put the loaded spindle back in the printer, pushing first the right side into place and then the left.

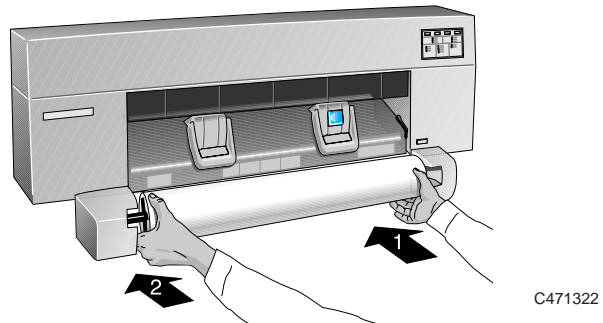

Make sure that each end of the spindle slots firmly into place with an audible “click”.

WARNING

It is important to make sure that the spindle is firmly in place, otherwise it could fall off the printer.

To feed roll media into the printer

- 1 Make sure that the cover is closed and that the media lever is raised.

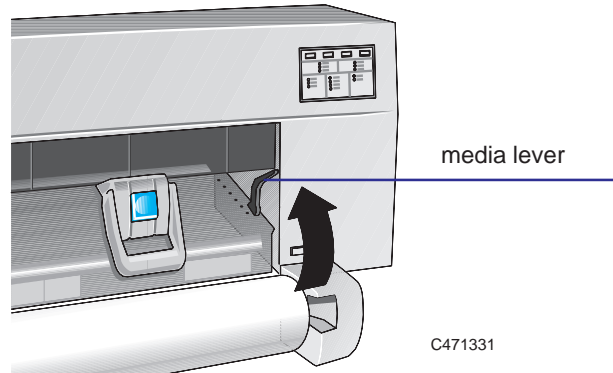

- 2 On the front panel, make sure the **Roll** light is on, to indicate that you are going to load a roll. Select **Roll** by pressing the **Media Source** button.

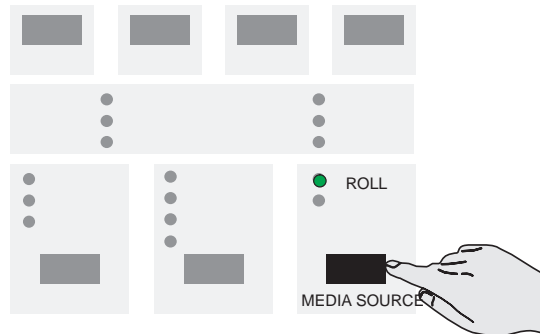

- 3 *Which side down?* As you load the roll, it is the *underside* on which the printer will print. With most media types, the two sides are different and so it is important to load the media correctly. See the table on page 2–4.
- 4 On the front panel, select the media type you are loading by pressing the **Media Type** button.
- 5 If the leading edge of the roll is uneven, you may find it easier to load if you trim it now, for example with scissors.

Loading roll media

- 6 Wind the media from the roll, leaving plenty free, and hold it ready to load into the printer. Hold the media near its edges, about 18 cm (7 in) from the top.

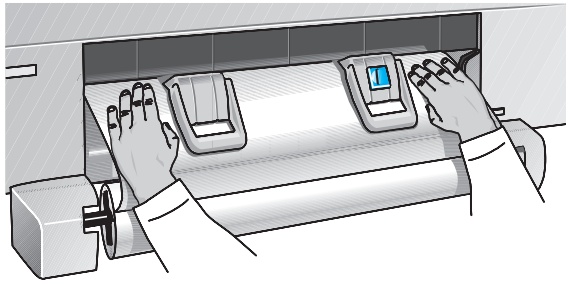

C471323

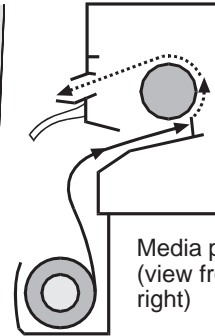

Media path
(view from right)

C471324

Don't hold the media right at the top, as you would have to adjust your grip as you push it into the printer, and this would probably make you misalign it.

- 7 Align the right-hand side of the media with the line of holes on the printer.

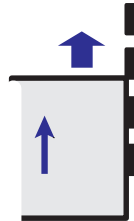

- 8 Make sure the entire top edge of the roll—left and right—is placed inside the entry slot. While keeping the right-hand side aligned with the line of holes, push the media up into the entry slot. You will feel the media come up against the media stops.

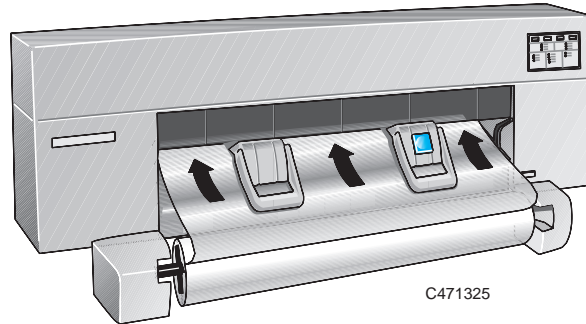

- 9 Using your right thumb, press the **Load Media** button.

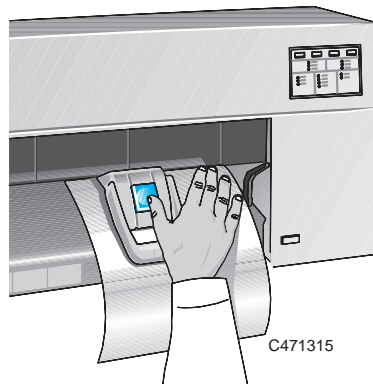

The printer will start to take the media from you. At this point, let go!

Don't touch the media while the printer feeds it out again a short way, as this would probably misalign it.

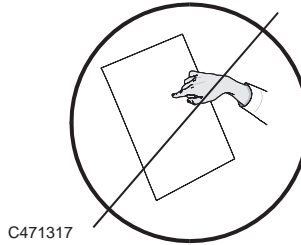

10 *Realigning the media is an essential, not optional, part of the roll-loading procedure.*

When the **Align Media** light is flashing, the printer is waiting for you to realign the media, as explained below.

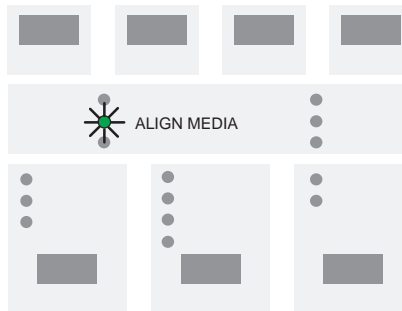

11 Lower the media lever to release the media.

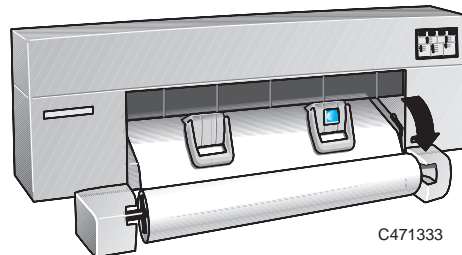

- 12** Align the edges of the media coming *out* of the printer with the same edges going *into* the printer, by pulling them taut with both hands and aligning them by eye. Make sure that the right-hand side of the media is aligned with the line of holes on the printer, and the roll. You may need to manually unroll a small amount of the media from its roll, to align the sheet satisfactorily

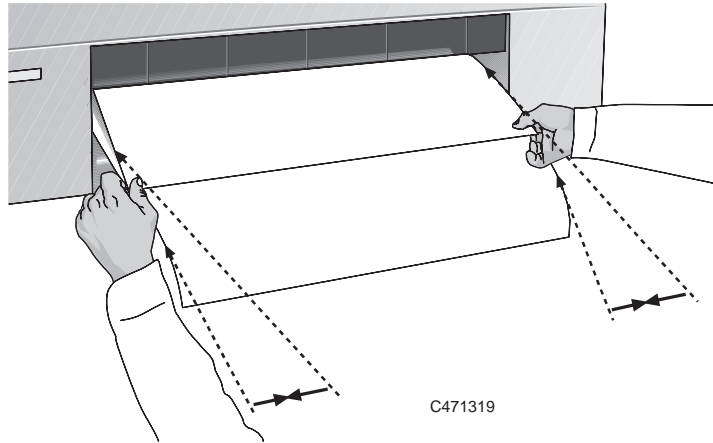

- 13** Raise the media lever.

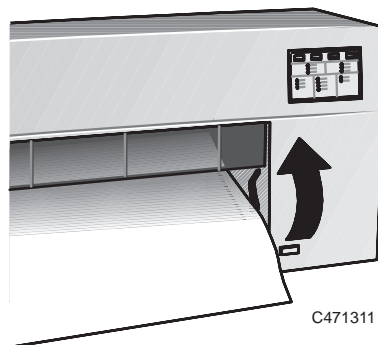

To load a sheet with the roll-feed option installed

From time to time you may want to load a separate sheet even though you normally use a roll—for example, to use the Setup Sheet.

- 1 If a roll is currently loaded in the printer, unload it as explained on page 2–18, step 2a–c, remembering to raise the media lever again when it's done.
- 2 On the front panel, make sure the **Sheet** light is on, to indicate that you are going to load a sheet.

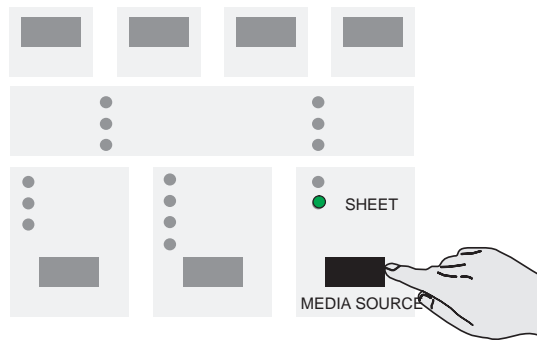

- 3 Load the sheet as explained starting with step 4 on page 2–11.



Unloading media

Drying time

On some media types, the ink needs to dry before the print is unloaded. Since the printer knows which media type you are using, it allows the appropriate drying time to elapse before the printing process is complete. During the drying time, the appropriate media type light as well as the ready will flash. After the drying time is complete, the flashing will stop, and the **Load Media** light comes on to let you know you can unload a printed roll. At any time, you can terminate the drying time by pressing the **Form Feed** key.

Typical Drying Times (minutes)		
HP Media Type	Print Quality	
	Fast	Normal or Best
HP Opaque Bond	0	1.5
HP Translucent Bond	0	1.0
HP Natural Tracing Paper	0	1.0
HP Vellum	0	3.0
HP Coated Paper	0	0.25
HP Heavyweight Coated Paper	0	0.25
HP Matte Film	Not recommended	4.5
HP Clear Film		4.5
HP High-Gloss White Film HP High-Gloss Photo Paper	Not recommended	3.0

450C
455CA

Notice that you can unload some media types immediately.

Unloading media

To unload a sheet at the end of a print

- 1 When the **Load Media** light comes on (not flashing), the print is finished.

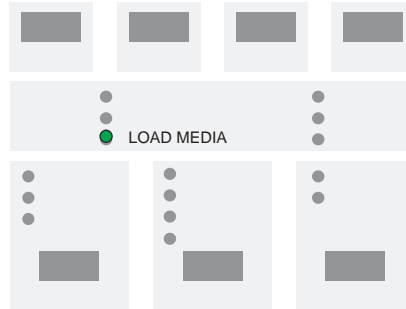

- 2 Then simply pull the sheet downwards to remove it from the printer.

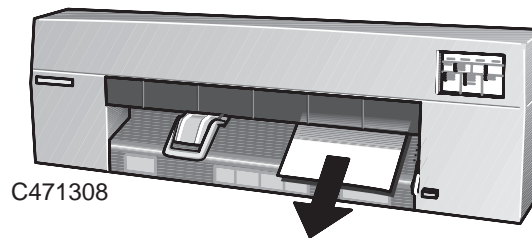

To unload a sheet under any other circumstances

Press **Form Feed**, wait for the sheet to be ejected and then simply pull it downwards to remove it from the printer.

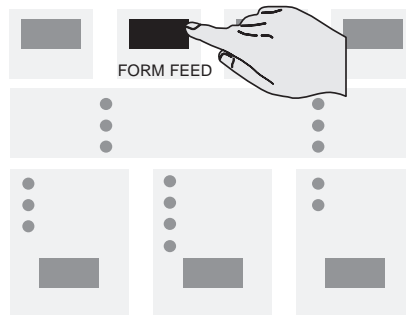

To cut and unload a print from a roll

When the print is finished, the **Ready** light stops flashing and goes off.

Your printer includes a built-in cutter. The cutter automatically cuts the roll between prints, unless you have disabled it through software or the setup sheet.

CAUTION

While the cutter is operating, keep your fingers away from the media entry slot.

If the cutter has been disabled through software and you want to cut the roll:

- 1 *Before cutting the roll, make sure that no other print has been sent to the printer.*
- 2 Press the **Form Feed** key. This activates the cutter.

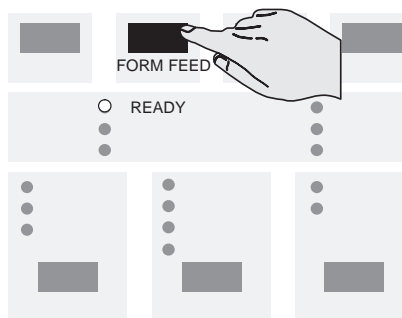

- Ways to control the print's appearance 3-2
- Page size 3-3
- Rotating a print 3-7
- Printing a mirror image 3-10
- Changing the treatment of overlapping lines (Merge feature) 3-11
- Changing the printer's logical pen characteristics 3-12
- Printing color drawings in monochrome 3-13
- Choosing an appropriate print quality 3-15
- Print quality recommendations 3-18

Controlling your print's appearance

Ways to control the print's appearance

Note: Throughout this chapter there are references to “pens”. The pens referred to are not the printer’s physical print cartridges, but “logical” pens used in a software palette.

This chapter discusses the ways in which you can control the appearance of your prints, in terms of:

- Page size
- Print orientation
- The treatment of overlapping lines
- Pen characteristics (widths and color/grayscale levels)
- Rendering color drawings in monochrome
- Overall print quality and resolution.

Apart from print quality, these controls are available using the Setup Sheet, an example of which is shown on page 1–21. Print quality can be changed from the front panel. This chapter explains the controls in the same order as in the list above.

Changing the settings of these controls using the Setup Sheet is explained on page 1–19.

It is also possible to override these settings within many applications and many software drivers. In some cases the printer is in control, in some cases the application or software driver is in control, and in other cases the printer interacts with the application or software driver. Whichever is the case in the circumstances is made clear in this chapter.

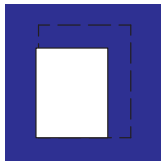

Page size

The *Page size* option applies only when using roll media, and is used to define the way in which the printer emulates a sheet of media when printing. This section explains how to make sure that the printer prints your print in the page size you want.

Terminology

Media

Page size

Margin

Printing area

Inked area

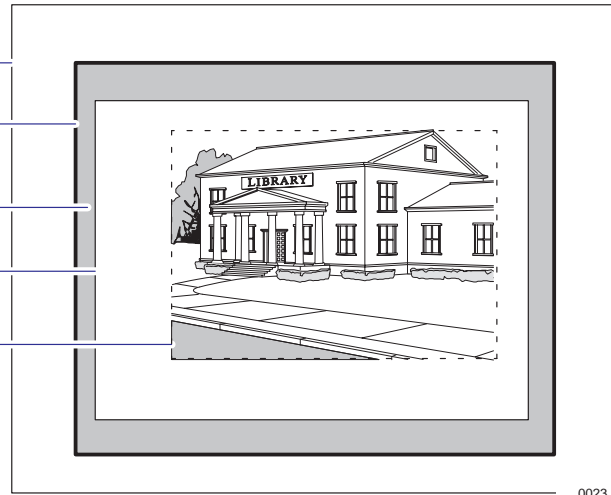

0023

Page size

This is what you can specify in your software; there it may be called “Page Size”, “Media Size”, “Paper Size”, etc., and the options may include, for example, ISO A3, ANSI Letter, Architectural E, or Custom. If the driver’s setting is “default”, the setting you specified in the Setup sheet is used. Any other software setting overrides the Setup-sheet setting, unless the latter is Inked area and you are sending a file: in this case the Setup-sheet setting takes precedence.

In AutoCAD for DOS, however, the “User Size” is the printing area.

Margins

These are fixed for the HP DesignJet 430, 450C and 455CA. The values are 17 mm on the leading and trailing edges and 5 mm on the sides.

Printing area

This is the chosen page size minus the margins. For a table showing the printing areas for standard media sizes, see page 10–7.

Inked area

This is the smallest rectangle that contains all the content of the drawing, while maintaining its relative dimensions.

When do you need to adjust the page size in the printer?

Normally you don't need to. The default setting in the printer is:

- **Software.** Depending on the driver you are using, you may not need to change the page size in the front panel. The setting of the printer interacts with your application or software driver, and if it is there, the printer uses it. (see page 3-3).

But if you wish, you can specify the page size either from your software or by using the printer's Setup Sheet, as explained here.

- If you want a printed page of the exact size that you have specified in your software, use the **Software** setting in the Setup Sheet.

With this setting, your application or your software driver is normally in control, but see the comment regarding this setting in the table on page 3-5.

See also the section on "Page size and clipped prints" on page 3-6.

- If you want your prints to be on a page meeting a specific standard (for example, ISO or ANSI), but the actual size within that standard is not important, specify the **Best** option for that standard.

For example you may want a page size that conforms to the ISO standard, but not care whether the final page size is ISO A4 or ISO A3. In this case you should specify **Best** within the **ISO** options.

With this setting, the printer interacts with your application, or software driver, and uses the smallest standard page size into which the inked area, plus margins, will fit.

- If you want all your prints on the same size paper, regardless of your print size and software/driver settings, specify a discrete page size.

For example, you may want to print an ANSI A-size print in the corner of an ANSI D-size page, leaving the rest of the page blank. In this case, specify **D** within the **ANSI** options.

With this setting the printer is in control of page size.

See also the section on "Page size and clipped prints" on page 3-6.

To adjust the page size in the Setup Sheet

Size in Setup Sheet		Comments
Inked area		The printed page size is the inked area plus margins. For a definition of "inked area", see page 3–3.
Software		The printer looks to your software for a page size instruction in HP-GL/2 (the printer's graphics language instruction set). If it is there, the printer uses that page size plus margins. If not, the printed page size is the inked area plus margins.
ISO	Best	"Best ..." options The printer chooses the smallest page size (from the ISO-series: A4, A3 etc.) that will hold the inked area of the print. For example, if the inked area of the print is between A3 and A4, the printer chooses A3 as the page size. Discrete options ISO A0/A1/A2/A3/A4 ANSI E/D/C/B/A JIS B1/B2/B3/B4 ARCH E1/E/D/C/B/A Oversize A1/A2 The printed page size is exactly the size you specify. The largest discrete page size you can specify depends whether your printer is an E-size or a D-size model.
	A0/A1/A2/A3/A4	
ANSI	Best	
	E/D/C/B/A	
JIS	Best	
	B1/B2/B3/B4	
ARCH	Best	
	E1/E/D/C/B/A	
Oversize	(No "Best" option)	
	Over A1/A2	

Page size

Page size and clipped prints

When setting your page size, be aware that with some combinations of page size and print size, the printer may print what it can, but may clip your print:

- If you specify in your software a page/print size that is larger than the physical size of the media loaded in the printer.

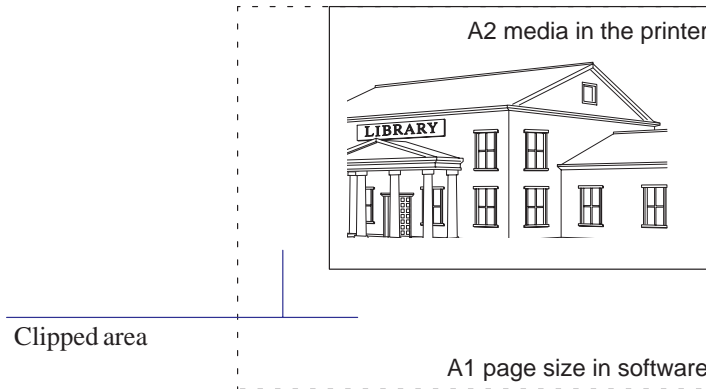

- If you specify in software a page size setting that is too small for the print, the print will be clipped, even though the physical media size may be adequate.
- If you specify a discrete page size in the Setup Sheet that is too small for the print, the print may be clipped, even though the physical media size may be adequate.

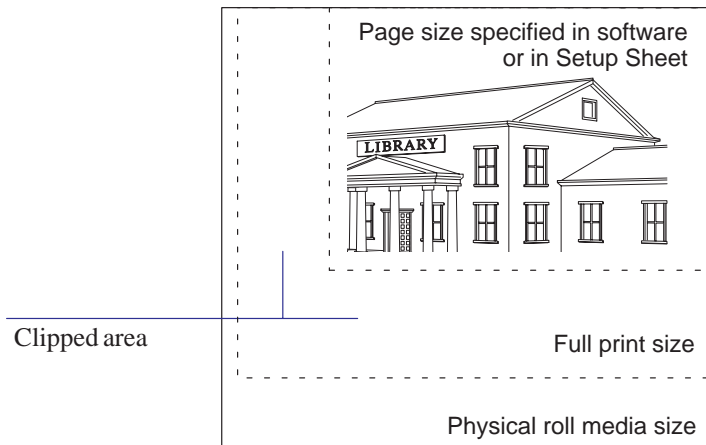

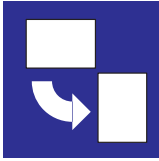

Rotating a print

Can you rotate *any* drawing using the Setup Sheet?

No. The Rotate option available in the Setup Sheet is applicable only if the file contains no raster data.

The normal line drawings of most CAD software do *not* contain raster data, and therefore you *can* use this **Rotate** option. However, if you are using one of the Microsoft Windows drivers supplied with this printer, your files *do* contain raster data and therefore you *cannot* use this **Rotate** option.

To rotate a print using the printer's Setup Sheet

Providing your print file does not contain raster data, you can rotate a print using the Setup Sheet, without changing the drawing in your software.

The available options are:

- **Auto rotate** (roll media only). With this setting, the printer will automatically rotate a print by 90°, providing it will fit on the available media, if this will save media.
- **Rotate off**. With this setting, the printer will print as requested by your software, without adding any rotation. This is the default.
- **Rotate 90°**. With this setting, the printer will rotate all prints by 90°, *counterclockwise* relative to the drawing's orientation in your software:

Rotate off



Rotate 90°

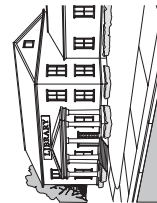

Rotating a print

Exactly what is rotated?

- With **roll media**, both the drawing and the page orientation are rotated.

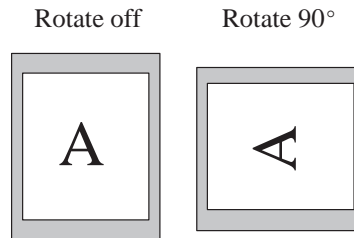

Notice that the narrow margins are always at the side, regardless of the orientation.

- With **sheet media**, the drawing is rotated, but the page orientation specified in your software is retained. (You should always load sheet media in the same orientation as you have specified in the software.)

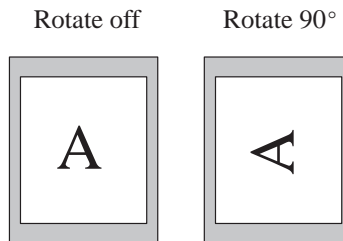

The Rotate feature and clipped prints

With either roll or sheet media, if you rotate to landscape a print whose original orientation was portrait, the media may not be wide enough for the drawing, which may be clipped. For example, rotating by 90° a portrait D/A1-size print on D/A1-size media will probably result in a clipped print. Clipping does not occur with **Auto rotate**, which checks whether the rotated print will fit.

How does Rotate interact with your software?

The printer *adds* the rotation setting to any rotation angle you specify in your software.

- For software applications which, like the printer, rotate *counterclockwise* (for example, CorelDRAW!) the result is the *sum*. For example, if your software specifies 180° rotation, and you set **Rotate 90°** in the Setup Sheet, your print's final rotation will be 270°.
- For software applications which rotate *clockwise* (for example, AutoCAD) the result is the *difference*. For example, if your software specifies 90° rotation, and you set **Rotate 90°** in the Setup Sheet, there will be no rotation.

Auto rotate behaves in the same way, if media could be saved.

Note that **Auto rotate** will rotate a print to save media, even if you have chosen a best-fit page size in the Setup Sheet (see page 1–19). However the effects may not be what you expect.

- Note that the WINDOWS driver deactivates rotation.



Printing a mirror image

You can print a mirror image of a drawing, using the Setup Sheet, without changing the drawing in your software.

The available options are:

- **Mirror off.** With this setting, the printer will print as requested by your software, without adding any mirroring. This is the default.
- **Mirror on.** With this setting, the printer will produce a mirror image of a drawing, relative to the drawing's orientation in your software:

Mirror off



Mirror on





Changing the treatment of overlapping lines (Merge feature)

The **Merge** feature provides two alternative settings for the treatment of overlapping lines in the Setup Sheet:

450C/455CA

Merge off.

A subsequent line hides a previous line where they overlap.

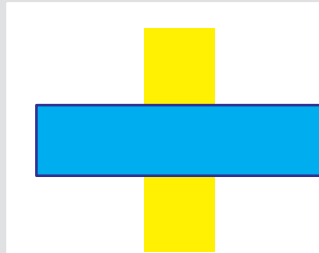

Merge on.

Overlapping lines and area fills are merged.

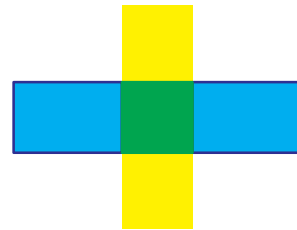

430

Merge off.

A subsequent line hides a previous line where they overlap.



Merge on.

Overlapping lines and area fills are merged.



You can set this feature from your software in some applications, for example in AutoCAD.



Changing the printer's logical pen characteristics

The characteristics of the printer's logical pens, referenced by your software, can be set either by software or by the settings for pens 1 through 8 in the Setup Sheet. The default is to use settings from the software.

Sometimes you may, for example, want to produce a set of drawings all with the same pen settings, but without having to change the software settings for the individual drawings. In this case you can choose to provide the pen settings from the printer.

If you want to provide your own settings in the printer and use those, use the **Pen Settings** section in the Setup Sheet and select **Use settings from tables below**. Using this option, you can specify the **Width** and **Color/Grayscale** of logical pens 1 through 8.

Item	Available options
Pens	1 through 8.
Width (mm)	0.13, 0.18, 0.25, 0.35, 0.50, 0.70, 1.00 Note that 0.13 mm is a one-pixel line width and renders some colors as a dot pattern.
Grayscale (%)	100, 80, 60, 40, 20, 10, 5
Color	Black, Red, Green, Yellow, Blue, Magenta, Cyan

450C/455CA

430

For the HP DesignJet 430, only pen **Width** and **Grayscale** are available.

Once you have chosen your pen settings, you can change back to **Use settings from software** and your settings will be saved for future use if you require.

Note. If you want to produce black and white drawings instead of grayscale, then, unless your driver has an option for this, choose **Use settings from tables below** and set all 8 pens to **Black/100% Grayscale**. If you are using one of the Windows drivers supplied with the printer, you must set this in the driver since the driver overrides the **Pen Settings** in the Setup Sheet.

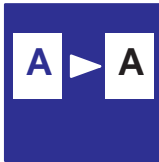

430

Printing color drawings in monochrome

You can successfully print color drawings in monochrome with either the HP DesignJet 430, 450C or the HP DesignJet 455CA.

If you send a color file to the HP DesignJet 430 and your software settings are for printing in color, the printer will automatically convert the print to grayscale.

However, if your printer is set to **Use settings from software** (the default) in the Setup Sheet **Pen Settings** (see page 3–12), you will have no control over the grayscale levels used. If you want to control these yourself, you must select **Use settings from tables below** and set them in the Setup Sheet, as described on page 3–12.

The default setting with the HP DesignJet 450C is to print color as color. However, you may want to print a color drawing in monochrome. For example:

- You may want a draft where color is not important, perhaps to check that the print is not going to be clipped
- You may want a version for photocopying in monochrome.

450C/455CA

To switch from color to monochrome

With the HP DesignJet 450C and HP DesignJet 455CA, if your application or software driver has a color/mono setting, use this, since the Setup Sheet setting is normally overridden by software. If not, you can set the printer to print in monochrome by selecting **Print color as grayscale** in the **Color/Mono** section of the Setup Sheet.

You can *force* a color print to monochrome, regardless of the application/driver setting (except with the supplied Windows driver), by additionally setting the **Pen Settings** to **Use settings from tables below** (see page 3–12).

The Setup Sheet setting also affects the printer's internal demonstration prints.

Note that if there is no color information in your print file, the printer will print only a black-and-white print, not grayscale.

Important points about monochrome printing

- The monochrome print will render colors as *grayscale*s. If you want your print printed in only *black and white*, then you should set *all* your logical pens to black, either in your software (easily achieved in CAD software by using a pen number that is 100% black) or in the Setup Sheet (see page 3–12).
- With monochrome printing, you have the option to choose between 300 and 600 dpi resolution (see page 3–15).

450C
455CA

– With the HP DesignJet 450C, the resolution on glossy media is always 300 dpi. This is because, with the **Glossy** media type selected, all printing is performed using the cyan, yellow and magenta cartridges; the black cartridge is not used.

430

– With the HP DesignJet 430, glossy media is not supported.

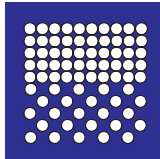

Choosing an appropriate print quality

You can control the overall print quality of your print from the printer's front panel.

Print Quality	Speed	Ink Used	Resolution	
			Monochrome	Color
Fast	Highest	Least	150 x 300 dpi.	450C/ 455CA 300 x 300 dpi.
Normal	Normal	Most	600 x 600 dpi. addressable	
Best	Lowest		(450C/455CA: except for glossy media types, on which the resolution is al- ways 300 dpi.)	

430

Note that glossy media types are not supported on the HP DesignJet 430.

Alternatively, you can specify the print quality setting from your software printer driver. In this case, *the driver's setting* is used for the next print. During the print, the front-panel setting changes temporarily to that from the driver, and then resumes its previous setting again.

For 600 dpi addressable resolution, you must set the appropriate options (for example, “color as grayscale” or “all as black” and “best” or “normal”) in the driver.

The exact printing process used by the printer varies not only with your print quality setting, but also with your specification of the media type (see page 2–3). Recommended combinations of print quality and media type are given in the table on page 2–5.

Recommended media types for various applications are given in the table on page 2–6.

General tips

By choosing **Fast**, you will get draft-quality output in the shortest time. By choosing **Normal**, and a suitable media type, you will get high-quality output in a reasonable time. By choosing **Best**, you will get the highest possible quality for the media type, but the printing time will be longer.

To change the print quality on the front panel

Use the front-panel **Print Quality** key to toggle between the three print quality settings.

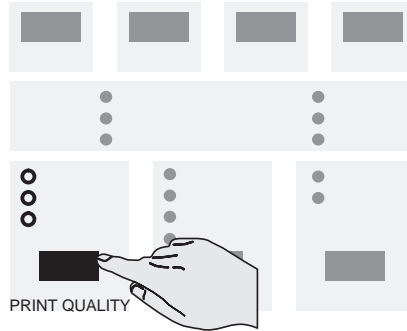

For details of each print quality level, see the table on the previous page.

The setting also affects the printer's internal demonstration prints.

You cannot change the print quality setting for a print already received by the printer.

Choosing an appropriate print quality

The setting of the following parameters in the HP DesignJet 430 define the printed output quality you get.

Driver setting in software	Actual plot content	Resolution Enhancement	Quality Level selected	Resolution (dpi)
Grayscale	Grayscale	off	Fast Normal Best	150 x 300 300 x 300 300 x 300
Grayscale	Grayscale	on	Fast Normal Best	150 x 300 600 x 600 600 x 600

The setting of the following parameters in the HP DesignJet 450 and 455CA define the printed output quality you get.

Driver setting in software	Actual plot content	Resolution Enhancement	Quality Level selected	Resolution (dpi)
Color	Color	off	Fast Normal Best	300 x 300 300 x 300 300 x 300
Color	Grayscale	off	Fast Normal Best	150 x 300 300 x 300 300 x 300
Color	Grayscale	on	Fast Normal Best	150 x 300 300 x 300 300 x 300
Grayscale	Grayscale	off	Fast Normal Best	150 x 300 300 x 300 300 x 300
Grayscale	Grayscale	on	Fast Normal Best	150 x 300 600 x 600 600 x 600

Print quality recommendations

We advise if possible not to use very large area fills with the following media :

- Opaque Bond
- Translucent Bond
- Vellum

This can cause cockle.

- In Glossy medias use **Best** to obtain good quality.
- Cartridges almost empty of ink can cause some kind of banding in imaging prints.
- When printing renders or GIS files in **Best– Paper – Mono** use the driver setting **RET=OFF** in case you get banding in the printout.
- For printing imaging files on Coated media always use **Best** quality, otherwise you can get banding in the printout.

To cancel a print 4-2

To copy a print 4-2

To advance the media 4-3

Managing your prints



To cancel a print

To cancel the current print while it is being received, or while it is printing, press **Cancel**.

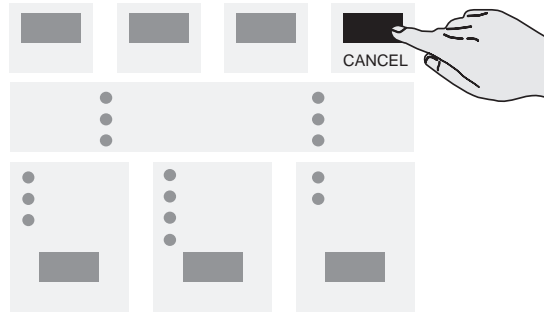

The canceled print stays in memory until you send another, and so you can subsequently use **Reprint** to print it again. Note that, for these purposes, any internal print (see chapter 5) counts as another print.

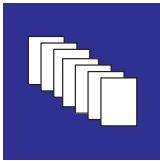

To copy a print

To print another copy of the last print, press **Reprint**.

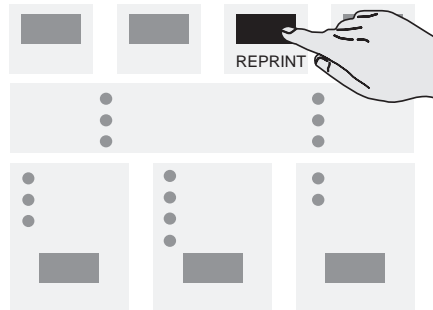

It will be printed with the same settings for **Media Type** and **Print Quality** as the original copy, even if you've changed them on the front panel.

The following prevents **Reprint** from working:

- Another file has already been sent to the printer (including internal prints, for example the Setup Sheet), or
- You have switched the printer off and on again since first sending the print.



To advance the media

Pressing the **Form Feed** key advances the media out of the media exit slot, and if roll-feed paper is loaded, cuts the paper.

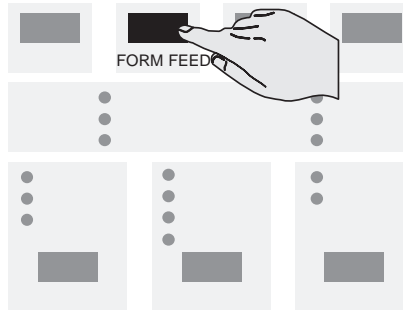

You may want to do this:

- When the printer is in continuous printing mode (that is, the automatic cutter has been disabled through the software), you have reached the end of a series of prints and want to cut the roll after the last one (see page 2–29), or
- To eject damaged media after clearing a media jam (see page 9–5).

There is no need to use **Form Feed** to unload a printed sheet from the printer—see page 2–28.



Don't press **Form Feed** while a file is being received by the printer, as this terminates the data transmission (unless you are doing this as part of a troubleshooting routine—see page 9–9).

Their purpose and how to print them	5-2
Using the Black Cartridge Alignment Sheet	5-4
Using the Color Cartridge Test Sheet	5-8

Special internal prints

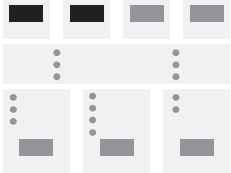
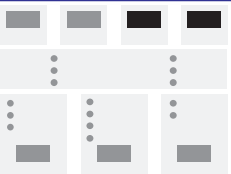

Their purpose and how to print them

Various pre-defined prints are supplied with your printer. You can print these by pressing keys, or combinations of keys, on the printer's front panel.

Print	Purpose	To print it, press ...	See page...
Setup Sheet	To configure the printer	 <p>the Setup key</p>	1–19 and chapter 3
Demonstration Print	To test the printer	 <p>the Setup and Cancel keys simultaneously</p>	1–26
Black Cartridge Alignment Sheet	To test the alignment between the two horizontal cartridge movements.	 <p>the Setup and Form Feed keys simultaneously</p>	5–4
Color Cartridge Test Sheet	To test the performance and alignment of all cartridges	 <p>the Reprint and Cancel keys simultaneously</p>	5–8

450C/455CA

Their purpose and how to print them

Print	Purpose	To print it, press ...	See page...
Service Configuration Print	<p>These prints are essentially for use by a qualified service engineer, if troubleshooting the printer.</p> <p>You may be asked to print one and read out some details over the telephone.</p>	 <p>the Print Quality and Media Type keys simultaneously</p>	—
Print Quality Test Print		 <p>the Form Feed and Media Source keys simultaneously</p>	5–12
Accuracy Calibration Print		 <p>the Form Feed and Reprint keys simultaneously</p>	—



CAUTION

Except under direction of a qualified service engineer, you are advised not to press simultaneously any other combinations of keys.

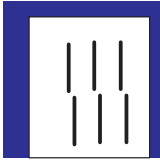

Using the Black Cartridge Alignment Sheet

Some of the circumstances in which it is useful to use the Black Cartridge Alignment Sheet are explained in chapter 9, “Troubleshooting”. It tests the alignment between the two horizontal cartridge movements—movement to the right and movement to the left—and allows you to correct any misalignment.

- 1 Load a sheet of A-size or A4-size plain paper, in portrait orientation. Make sure you have selected **Paper** as the media type on the front panel (see page 2–3). For this print, the printer sets the print quality level automatically.

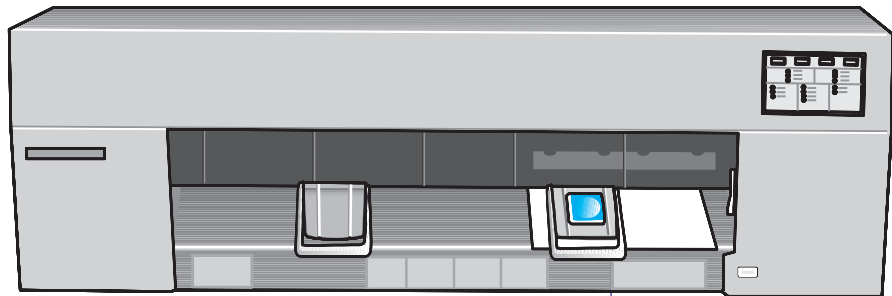

C471307

Print will be on underside.

For help on how to load a sheet, either refer to the pictures on the right-hand side of the printer’s media-entry slot, or see the section starting on page 2–10. Note that you cannot print the Black Cartridge Alignment Sheet on roll media. To load a sheet with the the roll-feed option installed, see page 2–26.

Using the Black Cartridge Alignment Sheet

- 2 When you have correctly loaded the sheet (when the **Ready** light is on and steady), press the **Setup** and **Form Feed** keys simultaneously.

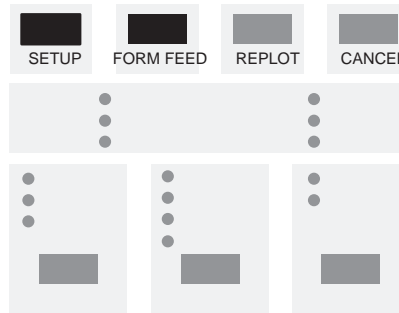

The Black Cartridge Alignment Sheet is printed. An example is shown on page 5–7.

- 3 When the **Load Media** light comes on (not flashing), the print is finished. Simply remove the sheet from the printer.

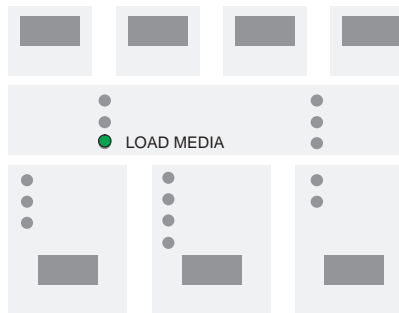

- 4 Follow the instructions on the sheet itself. As you will see, this involves you identifying the straightest set of vertical lines in each of the two boxes.
- 5 If the straightest sets are already the current selection, you need do nothing more. If not, then mark the appropriate ovals, reverse the sheet as indicated, and reload it.

Using the Black Cartridge Alignment Sheet

- 6 When the **Ready** light comes on, press **Setup**.

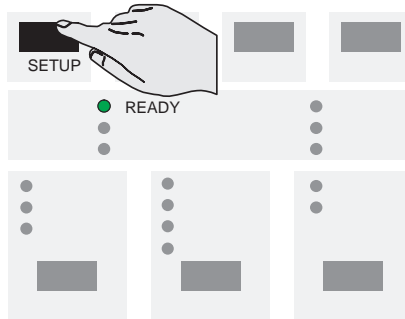

The printer now reads your marks and adjusts itself automatically.

- 7 When the **Load Media** light comes on again, remove the sheet and make sure that the printer has marked your selections with a check mark.

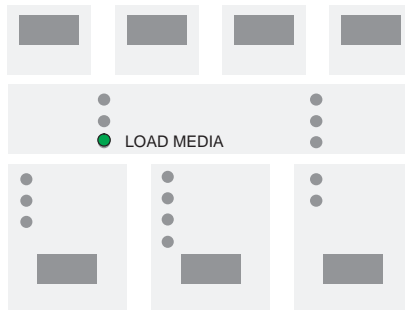

Three important points concerning the Black Cartridge Alignment Procedure:

- *Always* use the Black Cartridge Alignment Sheet immediately after printing it.
- *Never* re-use a Black Cartridge Alignment Sheet.
- Any print that was in the printer's memory before you printed the Black Cartridge Alignment Sheet has been lost and so, to print it, you must resend it.

HP DesignJet 4xx

Black Cartridge Alignment Sheet

For a full explanation of this sheet, see the User's Guide.

1 → In each of the two large boxes, mark the best set of lines by filling in the oval.

Jagged lines = bad Straight lines = good

Current Best

Pencil or black pen

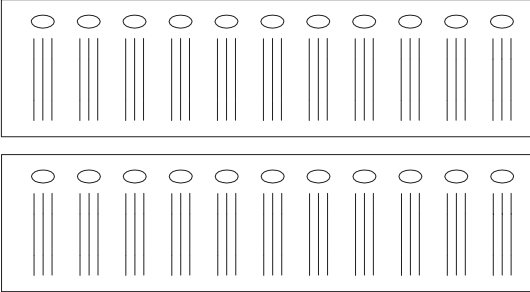

2 →

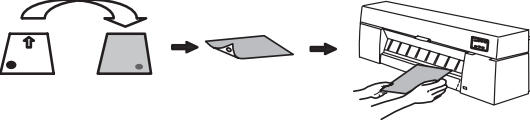

3 →

Ready*

Setup

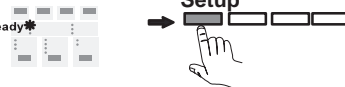

HP HEWLETT®
PACKARD
Edition 1
Revision 1.2

450C 455CA



Using the Color Cartridge Test Sheet

Some of the circumstances in which it is useful to use the Color Cartridge Test Sheet are explained in chapter 9, “Troubleshooting”. It achieves two objectives:

- It tells you which cartridge, if any, is not performing correctly.
- It lets you check the alignment of the four cartridges to each other and, if necessary, adjust it.

Three important points concerning the Color Cartridge Test Procedure:

- *Always* use the Color Cartridge Test Sheet immediately after printing it.
- *Never* re-use a Color Cartridge Test Sheet.
- Any print that was in the printer’s memory before you printed the Color Cartridge Test Sheet has been lost and so, to print it, you must resend it.

- 1 Load a sheet of A-size or A4-size plain paper, in portrait orientation. Make sure you have selected **Paper** as the media type on the front panel (see page 2–3). For this print, the printer sets the print quality level automatically.

For help on how to load a sheet, either refer to the pictures on the right-hand side of the printer’s media-entry slot, or see the section starting on page 2–10. *Note that you cannot print the Color Cartridge Test Sheet on roll media.* To load a sheet with the the roll-feed option installed, see page 2–26.

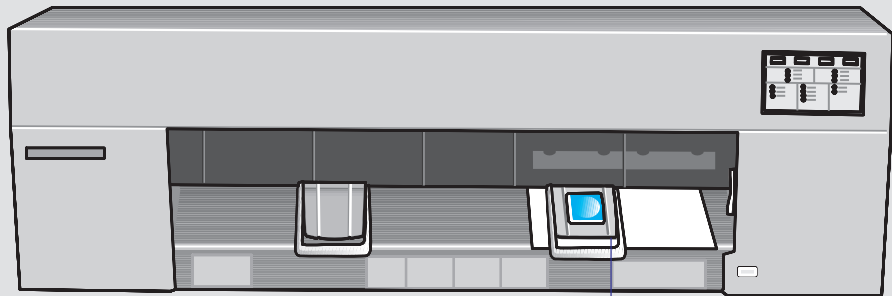

Print will be on underside.

C471307

450C 455CA

- 2 When you have correctly loaded the sheet (when the **Ready** light is on and steady), press the **Cancel** and **Reprint** keys simultaneously.

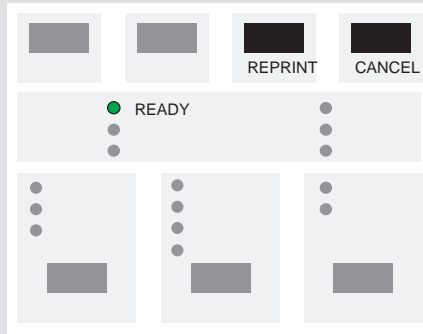

The Color Cartridge Test Sheet is printed. An example is shown on page 5–10.

- 3 When the **Load Media** light comes on (not flashing), the print is finished. Simply remove the sheet from the printer.

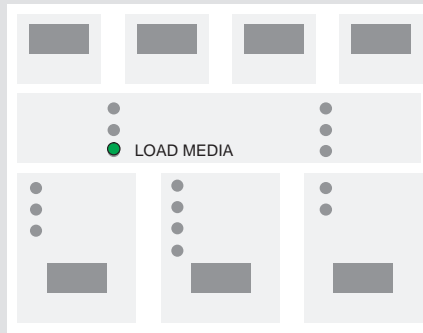

Notice that there are two parts, related to two quite distinct tasks:

- The part headed **To check the nozzles** lets you see if any of the cartridges is not printing correctly. It is to be used when cleaning the nozzles (priming)—see page 7–7. Some examples of the patterns when a cartridge is not printing correctly are shown here:

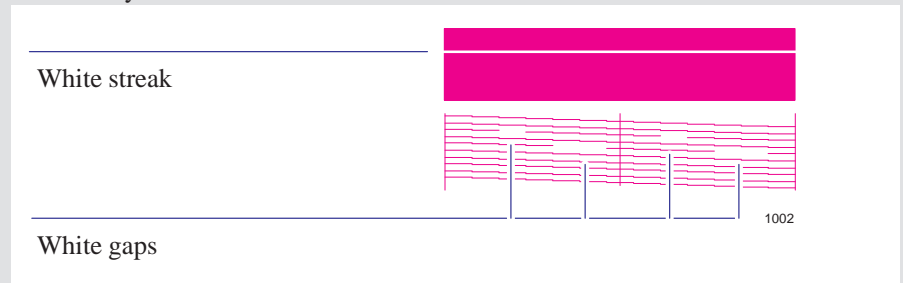

Special internal prints
Using the Color Cartridge Test Sheet

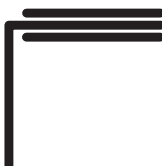

HP DesignJet 4xx

For a full explanation of this sheet,
 see the User's Guide.



**Color Cartridge
 Test Sheet**

To check the nozzles

Examine the patterns below.

If any color has gaps or streaks, then that cartridge is either *out of ink* or *needs priming* (see User's Guide).



To check the cartridge alignment

- 1 In each of the six boxes below, look for the best pair of lines.
- 2 If the current setting is not the best pair, change it by filling in the oval above the best pair.

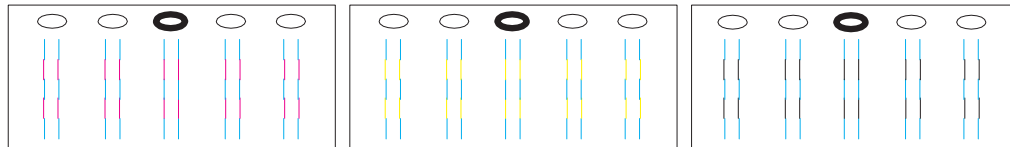
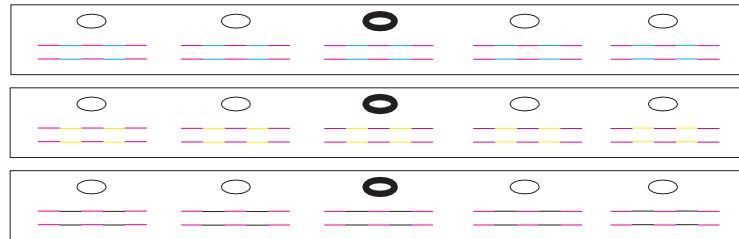
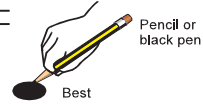
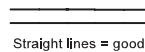
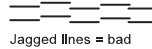

- 3 If you changed any setting, reload the sheet as shown here.

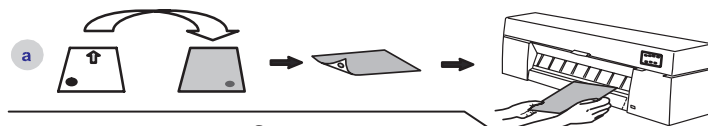

**hp HEWLETT®
 PACKARD**
 Edition 1
 Revision 1.0



450C 455CA

- The part headed **To check the cartridge alignment** lets you check and, if necessary, adjust the alignment between the cartridges, in response to a print quality problem—see page 9–12.

You don't need to use both parts of the Color Cartridge Test Sheet each time you print it.

- 4 Follow the instructions on the sheet. Notice that, if you change any of the settings on the sheet (by marking an oval different from the currently selected ones), you must reload it, as explained in steps 5 through 7, for the printer to readjust itself. Otherwise you can skip the rest of the steps.
- 5 Having marked the appropriate ovals, reverse the sheet as indicated, and reload it.
- 6 When the **Ready** light comes on, press **Setup**.

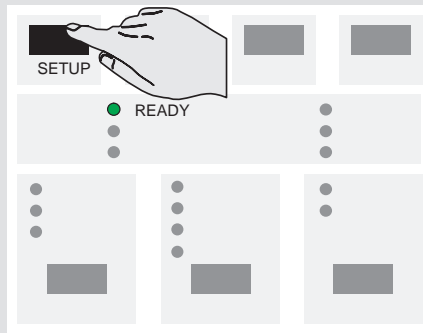

The printer now reads your marks and adjusts itself automatically.

- 7 When the **Load Media** light comes on again, remove the sheet and make sure that the printer has marked your selections with a check mark.

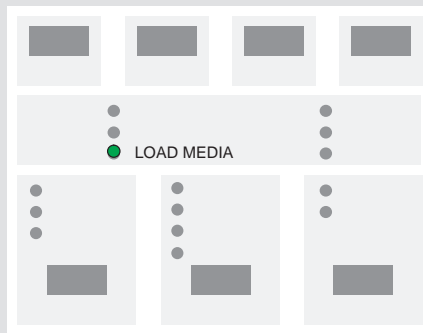

Using the Print Quality Test Print

This print contains five tests, described below. In each case, possible remedial actions are suggested. However, if the error persists, you may need to call HP for service.

The Print Quality Test Print for the HP DesignJet 430, 450C and 455CA is represented by the diagram below. You may use a 10-times magnifier to help identify print quality problems.

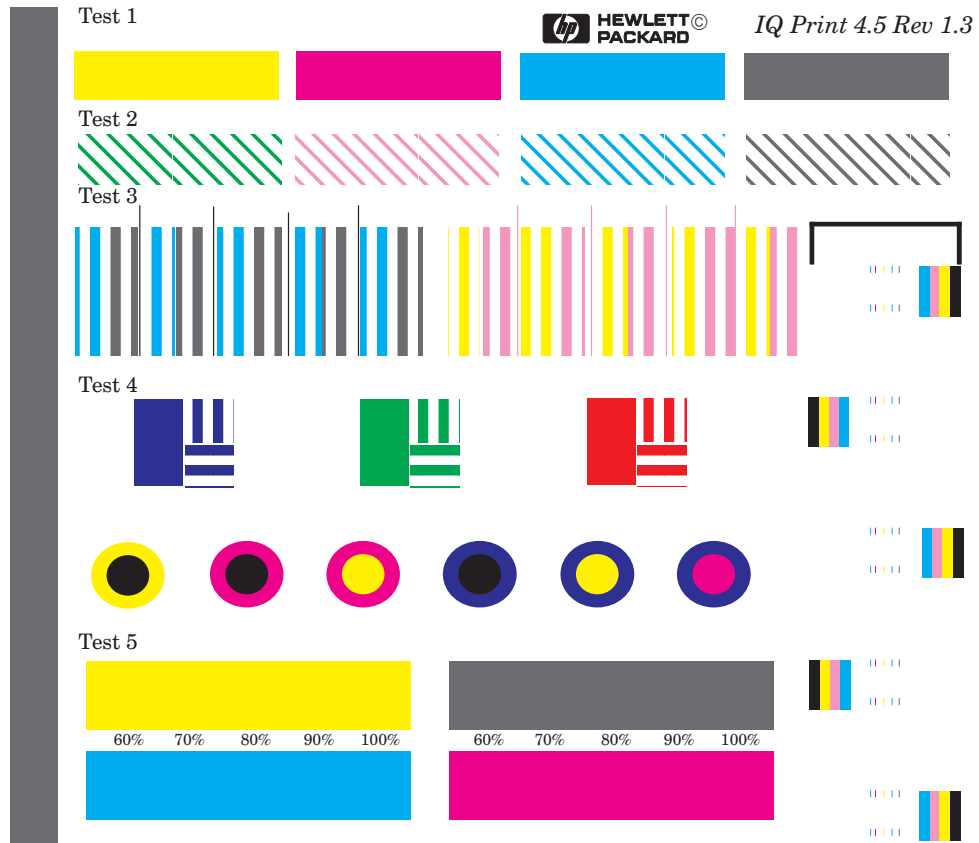

Printing the Print Quality Test Print

- 1 Before printing, set the **Media Type** and **Print Quality** on the front panel to the settings that you want to test.
 - The size of the Print Quality Test Print is B/A3 or A4 so you must use media (roll or sheet) that is this size or larger.
 - Use the same type of media that you were using when the print quality problem was discovered.
- 2 Load a sheet of media in portrait orientation.
- 3 When the **Ready** light comes on, press the **Form Feed** and **Media Source** keys together. The **Ready** light begins to flash. After a while the printer prints the Print Quality Test Print.
- 4 Study each of the test patterns in the order listed to determine the type of print quality problem.
- 5 If you encounter problems of print quality using non-HP media and after the Print Quality Test Print the same quality problems appear, you should try using genuine HP media. Repeat the Print Quality Test Print using HP Media.

Test 1 (Warm-up)

This pattern warms up the cartridges, leaving them in what should be a perfect operating condition; *you can ignore this pattern.*

Test 2 (Nozzles)

This tests all 96 nozzles of each cartridge of the printer. For each color there are 96 diagonally stepped lines, with every fifth or seventh identified by number.

There are two possible errors shown by this test (see the diagram on page 5–14):

- Nozzles not printing or weak. If the diagonally stepped lines are broken in one or more steps, it indicates that these specific nozzles may be blocked and are not printing.
- Nozzles misdirected. If the diagonally stepped lines are not equally positioned in every step, it indicates that this specific nozzles may be misdirected.

To correct these errors, try the following:

- 1 Prime the cartridges (see page 7–7) and print the Print Quality Test Print again to see if there has been any improvement.
- 2 If the error is still present, replace the failing cartridge (see page 7–2) and print the Print Quality Test Print again.

Printing the Print Quality Test Print

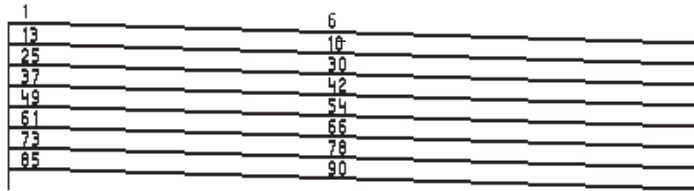

Correct

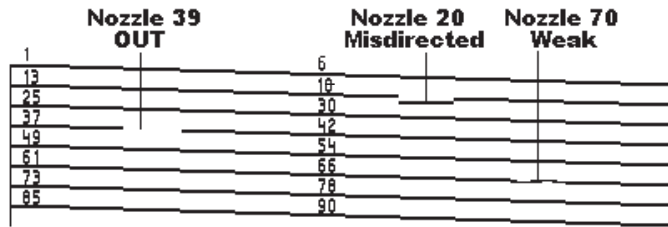

Incorrect

Test 3 (Verticals)

Vertical-line straightness is a measure of the horizontal distance between the segments of a vertical line printed in two consecutive swaths.

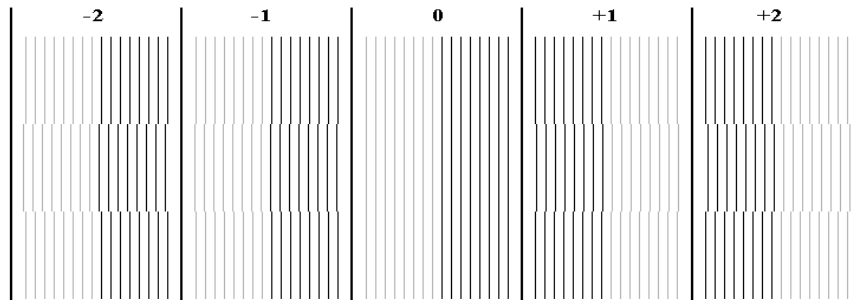

Correct

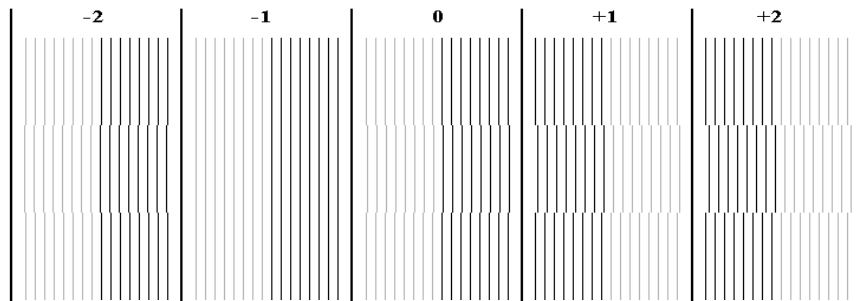

Incorrect

If the line is not perfectly straight at bias 0 in the test image (see figure above), try the following:

- 1 Perform the Black Cartridge Alignment Procedure (see page 5–4) and print the Print Quality Test Print again to see if there has been any improvement.
- 2 If the error is still present, replace the failing cartridge and print the Print Quality Test Print again.

Test 4 (Color Alignment Quality) is in two parts:

- The first of the patterns (in the upper line) tests alignment between the cyan and magenta cartridges; it should be blue with no cyan or magenta shadows. The second tests alignment between the cyan and yellow cartridges; it should be green with no cyan or yellow shadows. The third tests alignment between the magenta and yellow cartridges; it should be red, with no magenta or yellow shadows.

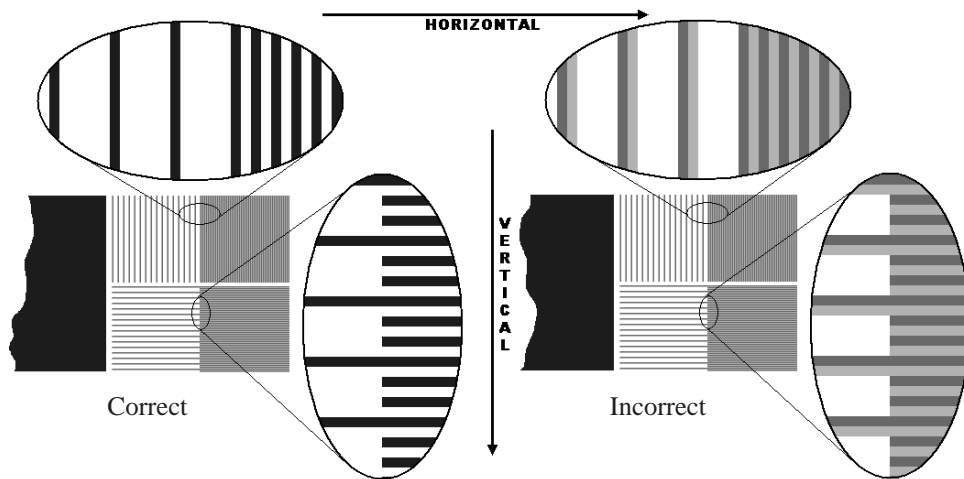

- The lower test patterns check the color alignment; there are six patterns each with two different primary colors. If there is misalignment between the primary

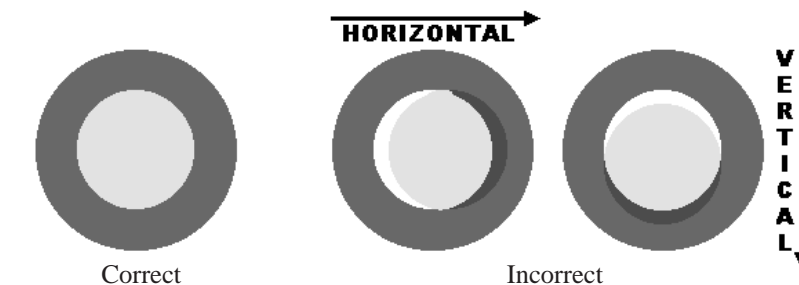

Printing the Print Quality Test Print

colors, the composite color will be present in one part of the circle and white will be visible at the opposite side of the circle. Misalignment can be horizontal or vertical, or a combination of the two.

If either set of patterns shows an alignment problem (a third color is present or there is misalignment in the boxes or the circles of the test image), try the following:

- 1 Perform the Color Cartridge Test Procedure (see page 5–8) and print the Print Quality Test Print again to see if there has been any improvement.
- 2 If the problem continues, replace the failing cartridge and print the Print Quality Test Print again.

Test 5 (Color Variation) This test produces four boxes in yellow, black, cyan and magenta. In each box there are two horizontal bands; the lower band is a 100% shade, the upper band is shaded from 100% scaling to 60%.

The purpose of this test is to determine at what percentage the upper shading becomes visible from the lower band. The best way to do this is to cover the box with a piece of paper and slide the paper horizontally across the box. Stop as soon as you see a different shade in the upper box. You can then determine the percentage scaling from the figure at the top or bottom of the box.

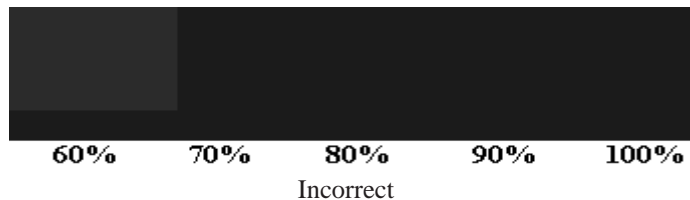
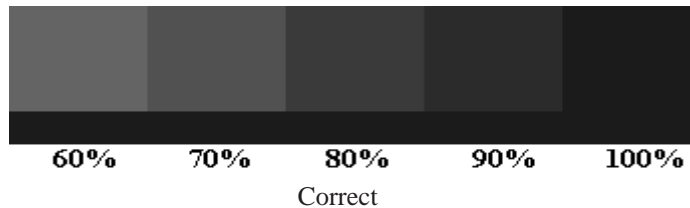

If the upper box shading is never visible or is visible only at a very low percentage, it is an indication that the cartridge is producing incorrect size ink drops. Try the following:

- 1 Replace the failing cartridge and print the Print Quality Test Print again.

6

- To see the current configuration of the printer 6-2
- To change the serial interface settings 6-3
- To change the graphics language setting
for less common applications 6-3
- To change the I/O timeout setting 6-4
- To upgrade your printer with more memory 6-4
- To upgrade your printer with a network interface 6-4
- To upgrade the HP DesignJet 430 printer with color 6-5

Reconfiguring your printer

To see the current configuration of the printer

To see the current configuration of your printer, print the Setup Sheet, as explained from page 1–19. Those items on the Setup Sheet which you may change are listed on page 1–22, together with their defaults. They are explained in the relevant chapters of this manual, for example Page Size in chapter 3 and Graphics Language in this chapter.

The following three items, which appear near the top right-hand corner of the Setup Sheet, tell you the overall configuration of the printer.

Item	Comments
RAM	This is the size, in megabytes, of the printer's main standard memory, plus the amount of memory reserved for printing. <ul style="list-style-type: none">• Choose your media size. This must be either E/A0 or D/A1. This does not correspond directly to the size of your files on the computer, as explained on page 6–4.• Choose your media size. This must be either E/A0 or D/A1. This is the total RAM, not the RAM currently free.
SIMM	This tells you if an optional memory expansion module is installed in the printer, and its size.
Firmware Revision	This is the revision number of the printer's internal code.

To change the serial interface settings

Parallel

With a parallel interface, no front-panel configuration is necessary.

Serial

With a serial interface, you should have checked the configuration (baud rate and parity) when installing the printer and, if necessary, changed it. However, you may need to reconfigure it:

- When you connect a new computer to the printer
- When you output to the printer from a new application
- If you experience problems with distorted or unintelligible prints.

To change the serial interface settings, use the Setup Sheet, as explained on page 1–19.

To change the graphics language setting for less common applications

Your software application communicates with the printer by a graphics language. The HP DesignJets 430 and 450C support HP-GL (7586B), HP-GL/2 and HP RTL.

The printer's default setting, HP-GL (7586B), is designed to work successfully with most applications. However, it is possible that with some older or less common applications, you may need to change this setting to HP-GL/2. To change the graphics language setting, use the Setup Sheet, as explained on page 1–19.

Graphics language	Comments
7586B, HP-GL/2	With this setting, most drivers will automatically switch the printer's language to the one appropriate to the data being sent, including HP-GL/2 and RTL.
HP-GL/2	Try this setting if you are sending an HP-GL/2 file to the printer and: <ul style="list-style-type: none">• Choose your media size. This must be either E/A0 or D/A1.If you have experienced print position problems• Choose your media size. This must be either E/A0 or D/A1.If you have experienced timing problems.

To change the I/O timeout setting

Some software may not write a proper file terminator at the end of the file. In this case, the printer will not know that the file is complete and will wait for more data until the end of the “I/O timeout” period. By default, this period is 30 minutes, but you can change it to as little as 30 seconds. If your printer is attached to a network, you should use a longer timeout setting than for a printer attached directly to your computer.

To change the I/O timeout setting, use the Setup Sheet, as explained from page 1–19.

To upgrade your printer with more memory

Your printer comes with a basic memory of 4MB. In case you need to print particularly large files, the following memory expansion modules are available; 4MB, 8MB, 16MB, and 32MB. The maximum total memory is 36MB (4 + 32).

For HP part numbers, see page 10–17.

For installation details, see the task starting on page 1–6.

File size and memory usage

There is no direct relationship between file size on your computer and memory used in the printer to print that file. In fact, because of file compression (and general complexity) it is often impossible to estimate how much memory will be used. In general, thicker lines (≥ 0.5 mm), complex objects (such as polylines) and fills will all use significantly more memory.

To upgrade your printer with a network interface

You can connect your printer directly to a LAN using an HP JetDirect EX print server, connected to the printer’s parallel port. See page 1–18 and page 10–18.

To upgrade the HP DesignJet 430 printer with color

The HP DesignJet 430 monochrome printer can be upgraded to become an HP DesignJet 450C color printer. For the HP part number of the upgrade kit, see page 10–16.

The upgrade kit comprises:

- A ROM SIMM, containing the code for the HP DesignJet 450C
- A set of four print cartridges: cyan, magenta, yellow and black
- A color label for installation on the printer's cartridge carriage

This section explains all the tasks necessary to install the upgrade kit.

- 1 Make sure that the printer is switched OFF and that neither the power cord nor an interface cable is connected.

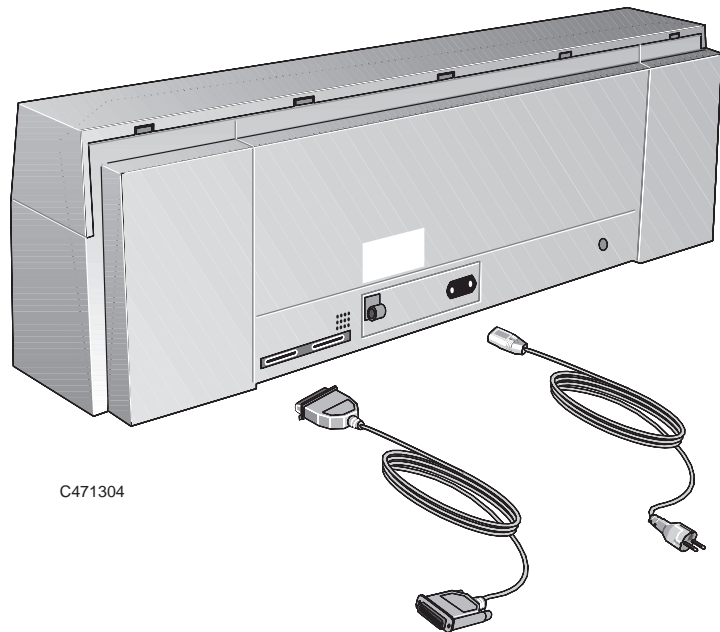

C471304

430

- 2 Unscrew the cover plate at the back of the printer, and remove it.

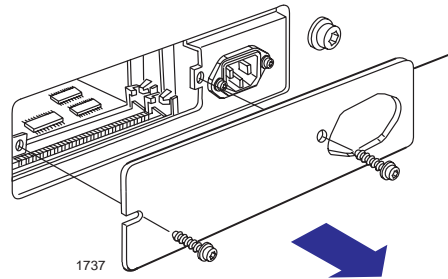

CAUTION

Before handling a memory module, either put on a grounding wrist strap and attach the end to the metal chassis of the printer, or touch the outer metal surface of the printer with your hand. Otherwise, static electricity from your body could damage the memory module.

- 3 There are two slots for SIMMs in the printer. The SIMM containing the upgrade goes in *the slot furthest from you*. If both slots are free, skip this step and go straight to step 5. If the slot nearest to you already contains a SIMM (a memory module), then you must first remove it, in order to access the other slot.
 - a Gently push aside the two clips that hold the memory module in place.

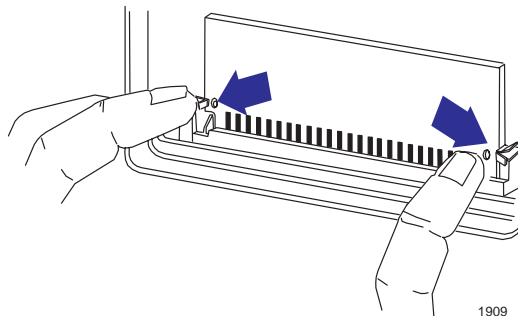

430

- b** Holding it only by the edges, carefully pull the top of the module toward you and lift it out.

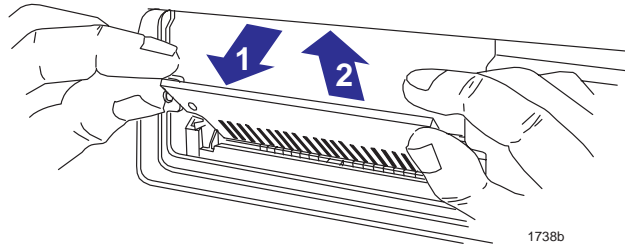

- 4** Temporarily place the module on a conductive pad, for example the one containing the new SIMM.
- 5** Take the new SIMM out of its bag, holding it only by the edges.
- 6** With the SIMM's small notch on the left and the metallic edge away from you, load the SIMM into *the slot furthest from you*. To do this, first hold the module at an angle, place the bottom edge in the slot and then push the top away from you until the module clicks into place.

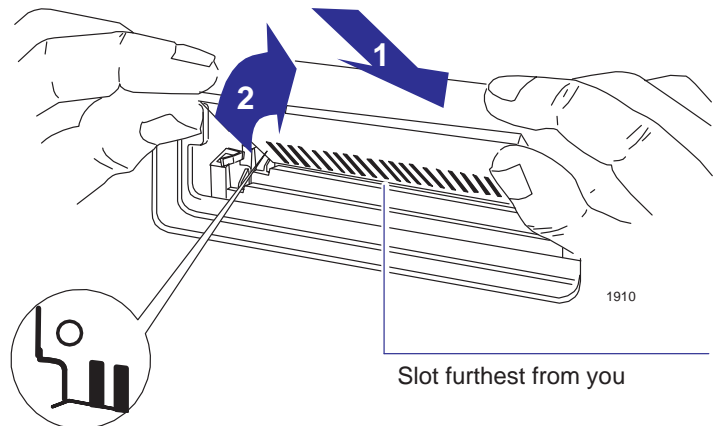

- 7** If you removed a memory module from the slot nearest to you, re-install it in the same way.

430

- 8 Replace the cover plate and screws.

WARNING



In steps 9, 10 and 11, pay special attention to this warning. Don't touch the plastic strip that runs the length of the printer behind the cartridge carriage; its edge is very sharp. Keep hair, jewelry, clothing, and foreign objects away from the printer mechanisms.

9

- a With the printer still switched OFF, raise the cover to access the cartridge carriage on the left.
- b Remove the black cartridge.

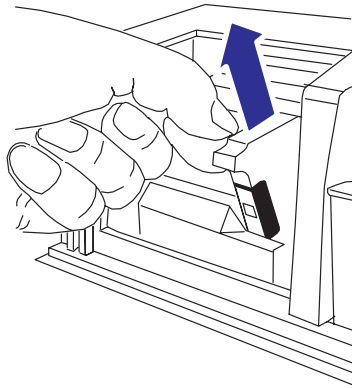

1911

430

- 10** Move the cartridge carriage out of the service station. Then remove the cover from the three left-hand cartridge slots by first squeezing on both sides, and then lifting it off.

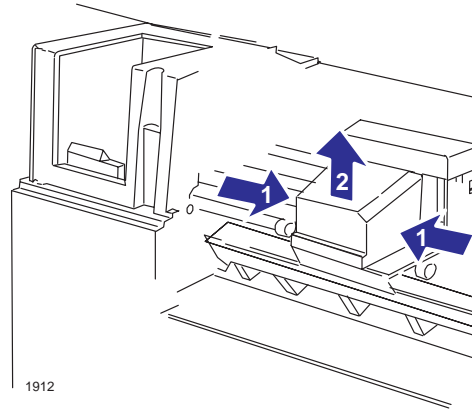

- 11** Remove the cover from the three left-hand cartridge selectors.
- a** Release the clip on the right side of the cover, at the bottom. This is easiest to see when looking down into the printer.
 - b** Lift the cover off.

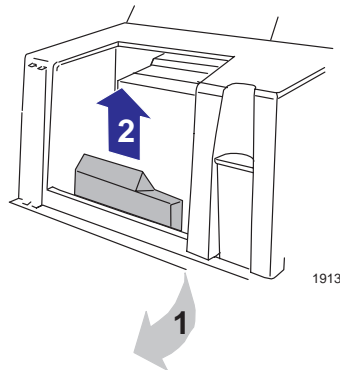

To upgrade the HP DesignJet 430 with color**430**

- 12** From the upgrade kit, take the label containing four colored dots.
 - a** Remove the protective strip from the back.
 - b** Stick the label onto the vertical panel above the cartridge stalls while the cartridge is out of its stall, as shown below. Note that the yellow dot must be on the left.
 - c** Close the cover.

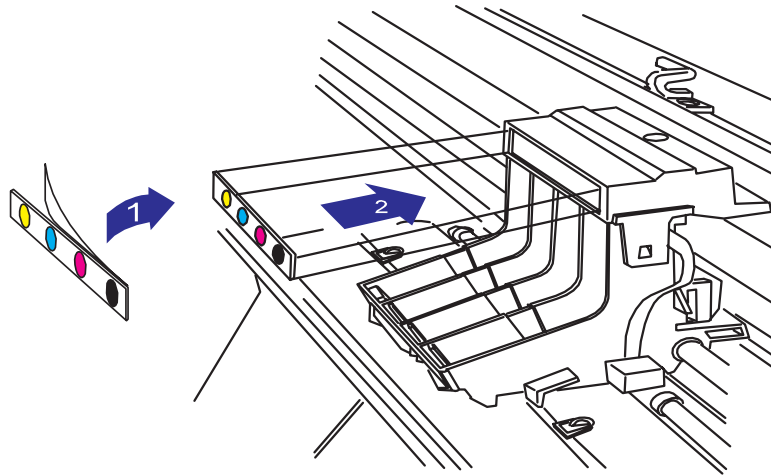

- 13** Switch ON the printer.
- 14** From the upgrade kit, take the three new colored cartridges (yellow, cyan and magenta) and, together with the black cartridge you removed earlier, install them in the printer's four vacant cartridge stalls. This procedure is explained in full from page 7-5—remember to follow the instructions for the 450C, not the 430! Be sure to match the colors of the cartridges with the colors of the dots.
- 15** Print a Setup Sheet to confirm that the printer has correctly read the new ROM SIMM and has reconfigured itself to be an HP DesignJet 450C. For instructions on how to print a Setup Sheet, see the section “Configure the printer” starting on page 1-19. The place to look is at the bottom of the Setup Sheet, which should now show a color filled circle and read “HP DesignJet 4xxx”.
- 16** Finally, reconfigure the print driver(s) you are using to indicate that your device is no longer an HP DesignJet 430 printer, but now an HP DesignJet 450C printer. Drivers for AutoCAD and for Microsoft Windows applications are supplied as part of your upgrade kit.

Replacing cartridges 7-2

Cleaning the cartridge nozzles (priming) 7-7

Cleaning the printer 7-9

Maintaining your printer

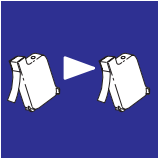

Replacing cartridges

Replaceable print cartridges are used in the HP DesignJets 430, 450C and 455CA, greatly reducing the user maintenance requirements, as these are the components that suffer the greatest wear and tear.

When to replace cartridges



Replace cartridges in the following two circumstances.

- *When you are troubleshooting print quality problems.*
See the section starting on page 9–12.
- *When either poor print quality or the ink-level indicator on the cartridge indicates that the cartridge is out of ink.*

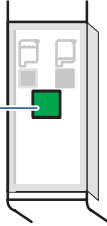
To check a cartridge's ink level



0002

-  Green = full
-  More than half-empty*
-  Black = empty

* When the ink-level indicator shows approximately half-black and half-green, be sure to have a replacement cartridge available. The ink-level indicator is *not* an exact gauge of the specific quantity of ink available over the life of the print cartridge.

To achieve the best lifetime for your pen cartridges, you should not remove them once they are installed, except to replace them.

Using genuine HP supplies

To ensure best performance, Hewlett-Packard Company recommends using only genuine HP supplies in HP inkjet printers.

Refilling an HP print cartridge pushes the electronic and mechanical components of the cartridge past its normal life cycle, creating many potential problems, such as:

- **Poor print quality.** Non-HP ink can contain components that:
 - 1) cause nozzles to become clogged, resulting in streaked copy and graying for fuzzy characters, and
 - 2) corrode the print cartridge electrical components, resulting in poor printouts.
- **Potential damage.** If ink from a refilled cartridge leaks, the excess ink may cause damage to the service station that caps the cartridge while not in use. Because this service station maintains the health of the cartridge, quality problems may occur with the print cartridge. If ink from a refilled cartridge leaks onto the electrical components in your printer, severe printer damage can occur, causing downtime and repair costs.

CAUTION

Damage resulting from the modification of or refilling of HP cartridges is specifically excluded from the coverage of HP printer warranties.

Replacing cartridges

Before replacing cartridges

Two important points:

Cartridge types	Your printer is designed to operate <i>only</i> with the four cartridge types whose part numbers are listed on page 10–18.
Taking care	Make sure you are aware of the cautions and warning below.

CAUTION

Touch only the plastic parts of the cartridge. Do not touch, wipe, or attempt to clean the cartridge nozzles or contacts; this may clog and damage the cartridge.

Each time you access the cartridges for loading or reseating, the nozzles are exposed to the air. If the nozzles are exposed to the air (except during printing) for more than a few minutes at a time, they are susceptible to clogging and drying.

It is absolutely essential to load the cartridges *with the printer switched ON*, otherwise you will get poor print quality and the reliability of your cartridges will be impaired.

450C 455CA

With the HP DesignJet 450C/455CA printers, it is absolutely essential to load the cartridges *in the correct stalls*, otherwise not only will your colors be wrong, but also print quality may be impacted.

WARNING

Don't touch the plastic strip that runs the length of the printer behind the cartridge carriage. Keep hair, jewelry, clothing, and foreign objects away from the printer mechanisms. Keep new and used print cartridges out of the reach of children.

To replace one or more cartridges

- 1 Access the cartridge carriage.
 - a Leave the printer switched *on*.
 - b Open the cover and push it right back.
 - c If necessary, wait for the cartridge carriage to move to the service station on the left.

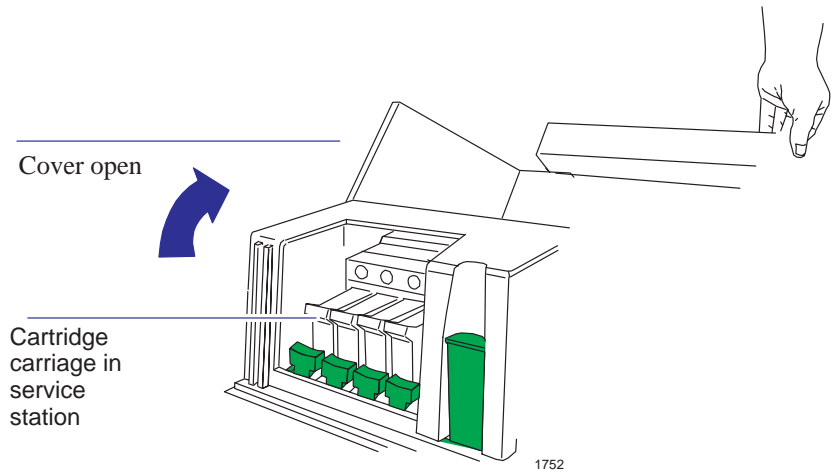

- 2 Remove the cartridge to be replaced.
 - a Press down lightly and then pull the cartridge towards you.
 - b Remove the cartridge from its stall. Discard it if it is empty or defective.

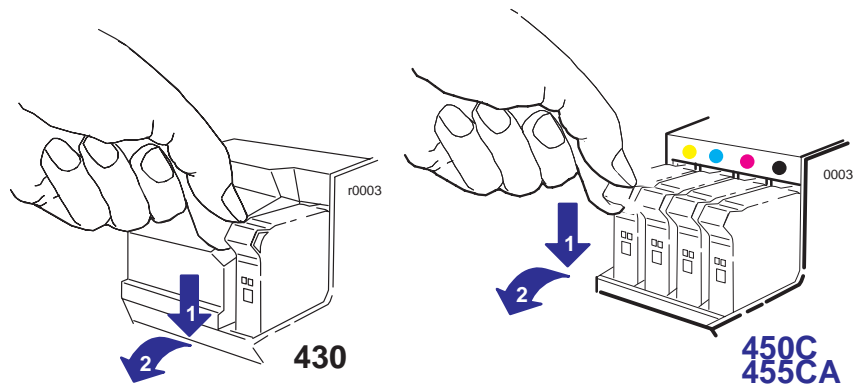

Replacing cartridges

- 3 **450C** Match the color of the cartridge's label with the color of the dot
455CA above the empty stall. *For users with color-vision deficiencies:*
you can identify the colors of the cartridges by the part numbers
on the boxes—see page 10–18.

- a Take the new cartridge out of its box.
- b Remove the colored protective tape and tab from the cartridge's nozzles.
- c Make sure that the printer is still switched *on*. Never install cartridges with the printer switched off.

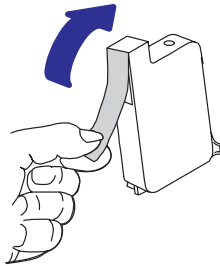

1754

- d Insert the new cartridge in the stall. Press down lightly and push the cartridge away from you until it snaps into place. If it is installed correctly, the **Ready** light flashes three times.

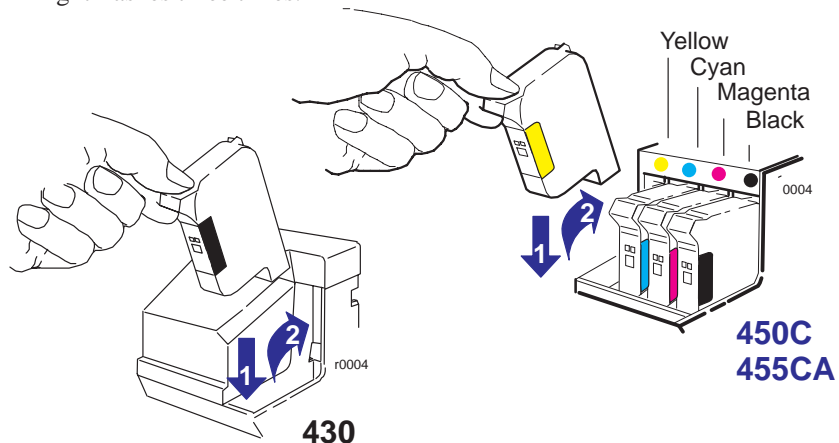

- 4 When you have finished replacing cartridges, lower the cover.

If you wish, you can now check your cartridge alignment by running the Black Cartridge Alignment Routine (see page 5–4). However, this is normally only required for troubleshooting.

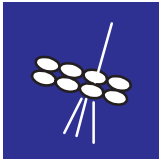

Cleaning the cartridge nozzles (priming)

To prime a cartridge is to clear clogged print nozzles manually, by using the colored plunger at the left side of the printer. Some of the circumstances in which it is useful to prime a cartridge are explained in Chapter 9, “Troubleshooting”, but essentially, if you suspect that the nozzles of a cartridge are clogged, try priming that cartridge, as explained here.

- 1 Leave the printer switched *on*. If the print in which you noticed the problem is still being printed, you will be able to check the result of the priming in the latter part of the same print. So simply go to step 2 to interrupt the print.

CAUTION

If you try to prime a cartridge while the printer is switched *off*, you could damage the cartridges.

- 2 Open the cover. If necessary, wait for the cartridge carriage to move to the service station (the area on the left of the printer).

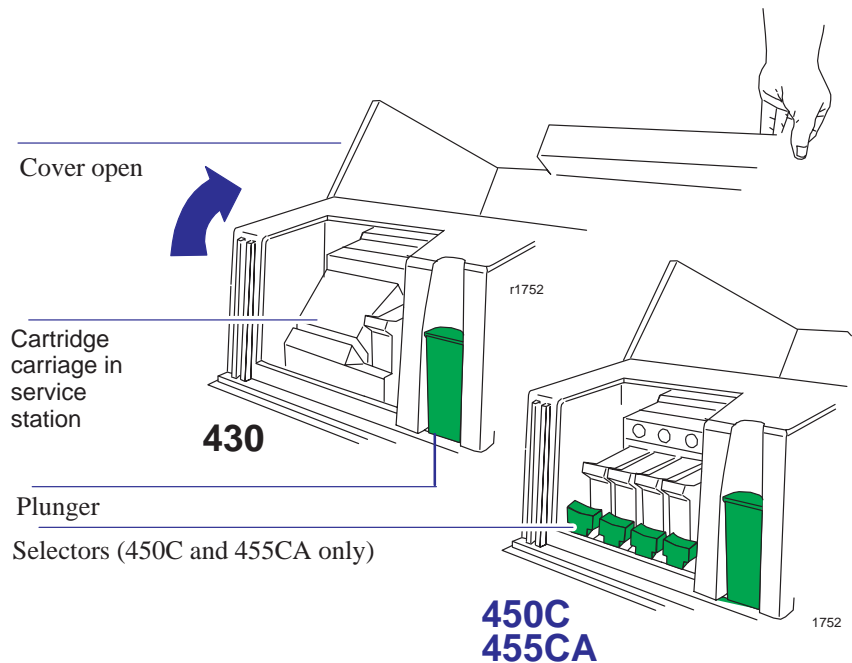

WARNING

Don't touch the plastic strip that runs the length of the printer behind the cartridge carriage. Keep hair, jewelry, clothing, and foreign objects away from the printer mechanisms.

Cleaning the cartridge nozzles (priming)

450C/455CA

3 Press the small colored selector in front of the cartridge which you want to prime.

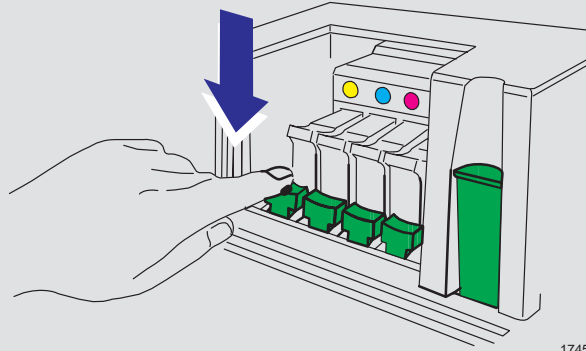

4 Firmly press the large colored plunger fully down once, and then release it.

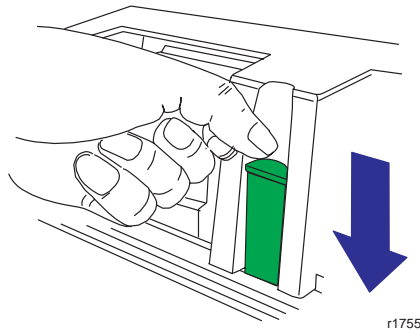

The plunger should return to its original position.

450C/455CA

5 Repeat steps 3 and 4 for any other cartridges to be primed.

Note. It is not necessary to return the selectors to their original positions.

6 Lower the cover.

7 If you interrupted the print, the printer now resumes it. Ignoring that part of the drawing immediately after the interruption (where print quality cannot be guaranteed), check the rest of the print to see if the problem has been resolved.



Cleaning the printer

Clean only the outside of the printer. Any internal cleaning and any maintenance and repairs beyond the tasks described in this chapter should be done only by a trained service technician.

When cleaning the outside of the printer, use a damp sponge or soft cloth and household cleaner.

WARNING

To avoid electrical shock, make sure that the printer is switched OFF and unplugged before you clean it. Do not let water get inside the printer.

CAUTION

Do not use abrasive cleaners on the printer.

Front-panel lights 8-2

Front-panel keys 8-6

Front-panel lights and keys

Front-panel lights

The lights on the front panel provide the means for your day-to-day “communication” with the printer. They tell you the printer’s current status and, if there is an error, the nature of the error. In order to understand the meaning of each combination of lights, you should check the table in this chapter to help you to understand the meaning. You will therefore find this table useful in troubleshooting.

Key to table starting below

This graphic ...	means ...
	<p>The fifteen lights on the printer’s front panel. The sequence of explanations in the table is:</p> <div style="display: flex; justify-content: space-around;"> <div style="border: 1px solid gray; padding: 5px; width: 15%;"> <p>1: Status group</p> </div> <div style="border: 1px solid gray; padding: 5px; width: 15%;"> <p>2: Error group</p> </div> </div> <div style="display: flex; justify-content: space-around; margin-top: 10px;"> <div style="border: 1px solid gray; padding: 5px; width: 15%;"> <p>3: Print quality group</p> </div> <div style="border: 1px solid gray; padding: 5px; width: 15%;"> <p>4: Media type group</p> </div> <div style="border: 1px solid gray; padding: 5px; width: 15%;"> <p>5: Media source group</p> </div> </div>
	This light is ON and STEADY.
	This light is ON and FLASHING.
	This light is OFF or this is the relevant light.
	The state of this light is not relevant.

No lights

Lights	Explanation and Action
	<p>If no lights are on, you may have a power problem, or the printer may be switched off.</p> <p>See Chapter 9, “Troubleshooting”.</p>



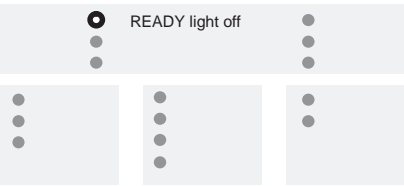
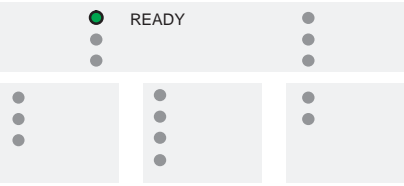
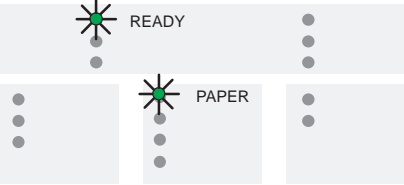
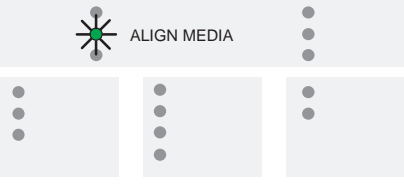
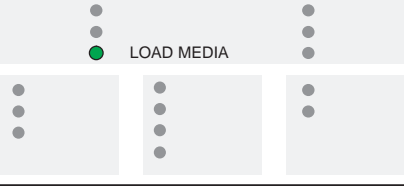
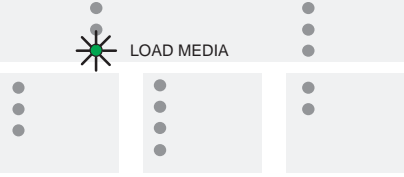



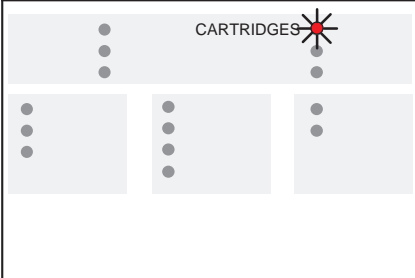
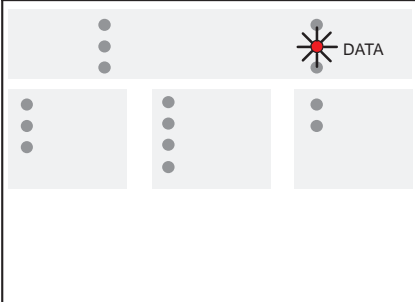
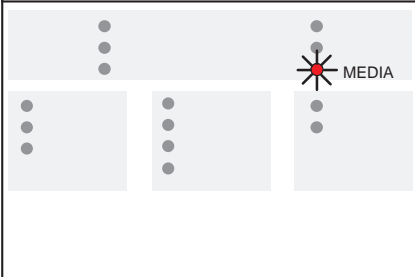
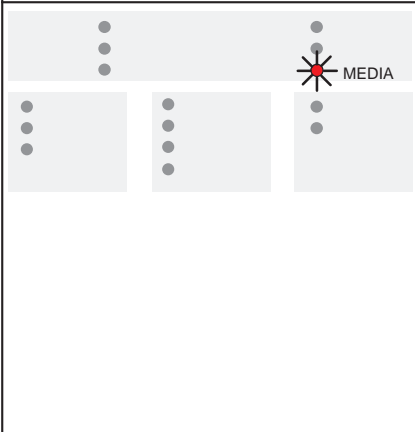

















Status group

Lights	Explanation and Action
 <p>READY light off</p>	<p>The printer is <i>not</i> ready to print.</p> <p><i>Check the state of the other lights and look them up in this table.</i></p>
 <p>READY</p>	<p>The printer is ready to print.</p> <p><i>Send your print from your computer or, for a special internal print, press the appropriate key combination—see page 5–2.</i></p>
 <p>READY</p> <p>PAPER</p>	<p>The printer is busy with a task or is receiving a file.</p> <p><i>Wait.</i></p> <p>If combined with one of the four media type group lights flashing. The printer is waiting for the media to dry. This can be terminated by pressing Form Feed</p>
 <p>ALIGN MEDIA</p>	<p>You are loading media and need to realign it.</p> <p><i>Lower the media lever, realign the media, and raise the media lever.</i></p> <p><i>See also page 2–15 for sheet media, or page 2–24 for roll media.</i></p>
 <p>LOAD MEDIA</p>	<p>The printer is ready, but you need to load media.</p> <p><i>When you are ready to print, load media.</i></p>
 <p>LOAD MEDIA</p>	<p>The printer has a file in memory, which it is waiting to print, but no media is loaded.</p> <p><i>Load media.</i></p>

Error Group

Lights	Explanation and Action
 <p>The diagram shows a top row of three lights labeled 'CARTRIDGES' with a red starburst over the rightmost light. Below are three columns of three lights each, representing other printer components.</p>	<p>Either: one of the color or black print cartridges is faulty, misplaced or missing. <i>Reseat or replace the cartridge as explained on page 7–2.</i></p> <p>Or: you have loaded a print cartridge of the wrong type for this printer. <i>For the correct part numbers of the cartridges supported by this printer, see page 10–18.</i></p>
 <p>The diagram shows a top row of three lights with the rightmost one labeled 'DATA' and a red starburst over it. Below are three columns of three lights each.</p>	<p>Either: the current print is too large for the printer's memory. <i>Look on your computer screen for any error message: some drivers, for example the Microsoft Windows driver supplied with your printer, allow you to choose a different printing mode and try to send the file again. In the case of the Microsoft Windows 95 driver shipped with the printer, the relevant field is called "Process document" in the Options dialog box.</i></p>
 <p>The diagram shows a top row of three lights with the rightmost one labeled 'MEDIA' and a red starburst over it. Below are three columns of three lights each.</p>	<p>Either: <i>Otherwise, you may need to install more memory to print this print. For information on available memory expansion modules, see page 10–17.</i></p> <p>Or: there is a problem with the serial interface. <i>The printer's settings for baud rate and parity must be the same as those of the computer sending the data.</i></p>
 <p>The diagram shows a top row of three lights with the rightmost one labeled 'MEDIA' and a red starburst over it. Below are three columns of three lights each.</p>	<p>Either: the sheet you loaded is misaligned. <i>Realign it as explained on page 2–15. A short tutorial on loading media starts on page 2–10.</i></p> <p>Or: it is an invalid size. <i>For supported media sizes, see page 10–3.</i></p> <p>Or: the media lever is lowered. <i>Raise the lever.</i></p> <p>Or: the cover is open when the printer is initializing. <i>Lower the cover.</i></p>

The advanced error group lights are used in conjunction with the front panel **CANCEL** key and are summarized in the following table.

	Lights	Explanation and Action
Advanced Error group	 ERROR GROUP <ul style="list-style-type: none">  CARTRIDGES  DATA  MEDIA 	<p>If all the Error Group lights are flashing, on the front panel, there is a system error. Press the CANCEL key, if the lights stop flashing this is recoverable. If they don't, this is a none recoverable error and requires you to contact Hewlett–Packard for support.</p> <p><i>Refer to Chapter 9, "Troubleshooting".</i></p>
	   STATUS GROUP <ul style="list-style-type: none">  CARTRIDGES  DATA  MEDIA 	<p>If all the Error Group lights are on but not flashing, on the front panel, there is a recoverable error. The way to resolve this problem is switch the printer off the on again.</p> <p><i>If a combination of Status Group green lights are on. Make a note of all the front panel lights and refer to Chapter 9, "Troubleshooting"</i></p>
Print quality group	  <ul style="list-style-type: none">  FAST  NORMAL  BEST 	<p>The current Print Quality selection is Fast, Normal, or Best, depending on which of these lights is on.</p> <p><i>See page 2–9.</i></p>
Media type group	  <ul style="list-style-type: none">  PAPER  FILM  COATED  GLOSSY 	<p>The current media selection is Paper, Film, Coated, or Glossy, depending on which of these lights is on.</p> <p><i>For an explanation of which media types this means, see page 2–3.</i></p>
Media source group	<ul style="list-style-type: none">  READY    ROLL	<p>The printer is currently set for roll media, rather than sheet media.</p> <p><i>See page 2–8 for more information.</i></p> <p>If the Ready light is off, the printer is waiting for you to cut the roll after the last print. <i>In this case, press Form Feed to cut the roll.</i></p>

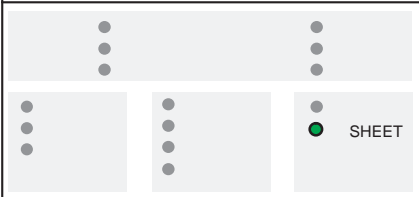
Lights	Explanation and Action
	<p>The printer is currently set for sheet media, rather than roll media.</p> <p><i>See page 2–8 for more information.</i></p>

Front-panel keys

The keys of the front panel, and their purposes, are summarized in the following table.

By pressing pairs of these keys, you can produce special-purpose prints. They are explained in Chapter 5.

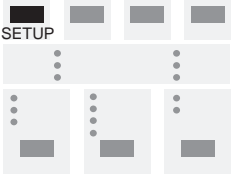
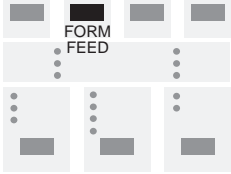
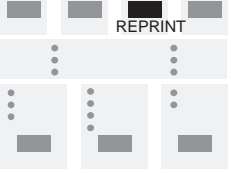
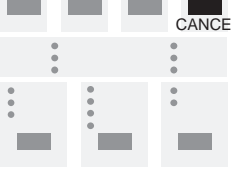
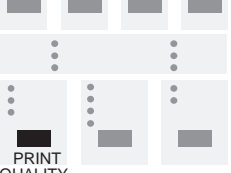
Key	Purpose	To access this function, press ...	See pages...
Setup key	To configure the printer		1–19 and 1–21
Form Feed key	To cut roll media when the internal automatic cutter has been disabled or terminate the drying time		2–28 and 2–29
Reprint key	To reprint the file that is currently loaded in the printer's memory		4–2
Cancel key	To cancel the current print		4–2
Print Quality key	To select the quality of output to be printed		2–9

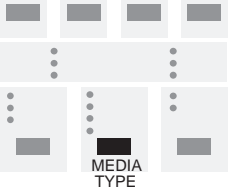
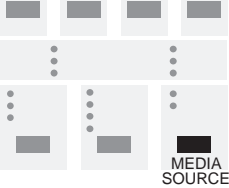
Key	Purpose	To access this function, press ...	See pages...
Media Type key	To identify to the printer the type of media loaded (plain paper, film, coated paper, or glossy paper)	 <p>The diagram shows a control panel with four buttons at the top, a central display area with three vertical columns of dots, and two larger buttons at the bottom. The button in the bottom right corner is highlighted in black and labeled "MEDIA TYPE".</p>	2-9
Media Source key	To select the type of media (sheet or roll) loaded in the printer	 <p>The diagram shows a control panel with four buttons at the top, a central display area with three vertical columns of dots, and two larger buttons at the bottom. The button in the bottom right corner is highlighted in black and labeled "MEDIA SOURCE".</p>	2-8

- Using the documentation 9-2
- Locating the source of your problem 9-3
- Solving media-handling problems 9-4
- Clearing a media jam 9-5
- Solving communication problems 9-8
- Solving problems with plot position or content 9-9
- Solving print-quality problems 9-12
- Solving miscellaneous problems 9-16
- Getting help 9-17

Troubleshooting

Using the documentation

- For the meanings of the lights on the front panel, see Chapter 8.
- If you know the problem is related to a certain task, first check the relevant section in this manual for the step-by-step procedures. Use this manual's index. For example, if you are having difficulty loading a sheet, refer to page 2–10.
- If the problem persists, refer to the appropriate section in *this* chapter. The sections are:
 - Solving media-handling problems
 - Clearing a media jam
 - Solving problems with print position or content
 - Solving print quality problems
 - Solving miscellaneous problems.
- If the problem could be related to your software driver, and you are using an HP driver, refer to the driver's own documentation and on-line help.
- If the problem has no obvious cause, read “Locating the source of your problem” on the next page.

- **If you still can't solve the problem, refer to “Getting help” on page 9–17.**

Locating the source of your problem

- 1 Check the status of the front-panel lights. For an explanation, see Chapter 8.
- 2 Test the printer, as follows:
 - a Switch the printer off.
 - b Ensure that the power cord is firmly inserted in the printer and plugged in to an outlet that you know works.
 - c Switch the printer on.
 - d Print a demonstration print (see page 1–26). If the printer prints this correctly, the problem is probably not with the printer.
- 3 Test your computer hardware and interface, as follows:
 - a Ensure that you are using the correct interface cable between the computer and the printer and that it is firmly connected to the correct ports (see pages 1–17 and 10–11).
 - b **Serial interface users only.** Check that the serial interface settings on the Setup Sheet match the requirements of your computer hardware and application software (see page 1–19).

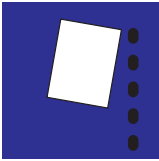

Solving media-handling problems

If the printer will not accept your media

- Is the power on? No lights on the front panel indicates no power.
- Is the media lever raised? It must be lowered.
- Is the cover raised? It must be closed.

If the printer continually rejects your media, with the Load Media light flashing

You may have:

- Loaded the media at the wrong side of the entry slot. You must load it with the right-hand edge against the perforated line on the printer.
- Loaded the media at an angle. The right-hand edge must be *parallel* to the perforated line on the printer.
- Held or pushed the surface of the media. You must hold the media only by the edges.
- Used media that is crumpled or warped or has irregular edges.
- Used hand-cut media, the edges of which do not form a right-angle or are rough. It is not recommended to use media that you have cut yourself; use only purchased sheet media.

For step-by-step media-loading advice, see page 2–10 for a sheet or page 2–21 for a roll.

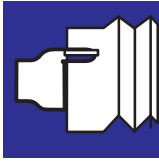

Clearing a media jam

- 1 Switch *off* the printer and open the cover.

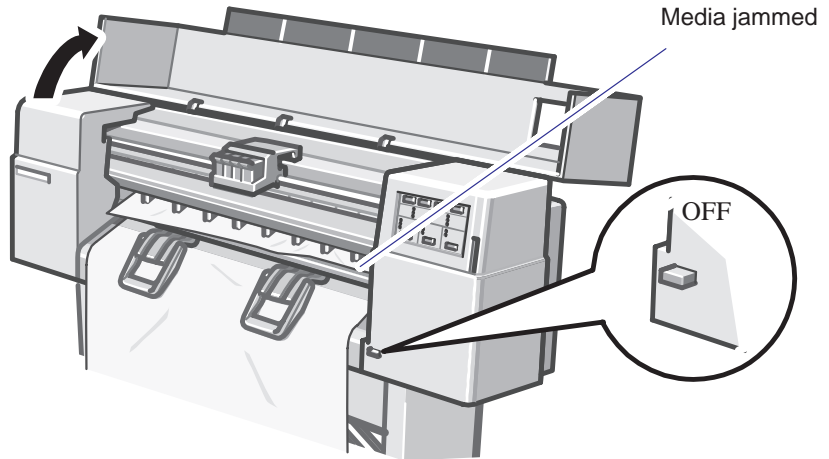

WARNING



Don't touch the plastic strip that runs the length of the printer behind the cartridge carriage. Keep hair, jewelry, clothing, and foreign objects away from the printer mechanisms.

Clearing a media jam

- 2 Push the carriage carriage all the way to the left, touching only the solid plastic parts of the carriage. Lower the media-lever and raise the bail (the black metal bar)

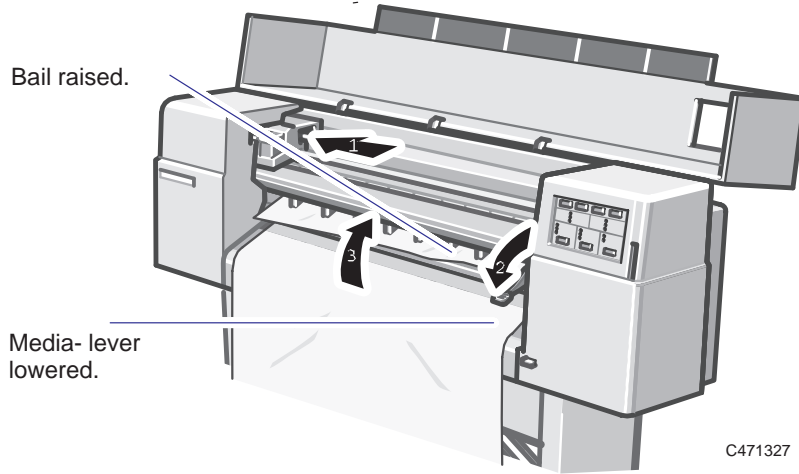

- 3 Carefully pull the main part of the jammed sheet down and out of the media-entry slot.

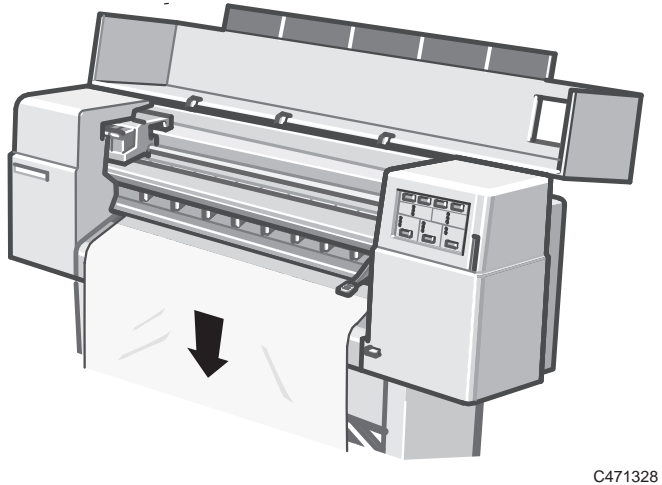

- Carefully remove any torn pieces from inside the printer. Be careful not to touch the plastic strip that runs the length of the printer behind the cartridge carriage; its edge is very sharp.

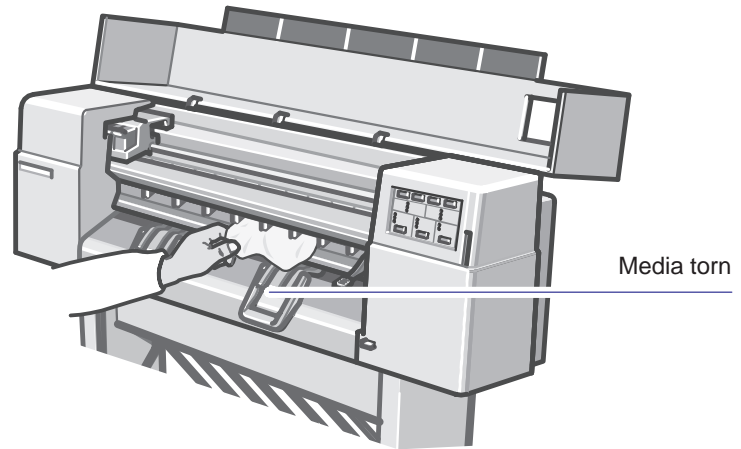

C471329

- Lower the bail, raise the media-lever, lower the cover, and switch *on* the printer.

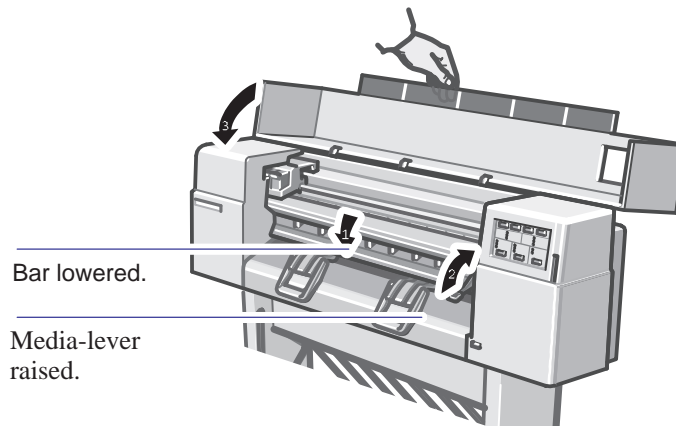

C471330

- On the front panel, press **Form Feed** to eject any pieces of media that are still in the media path.



Solving communication problems

If there seems to be some problem related to the communication between your computer and the printer

Some symptoms of a communication problem are:

- The front-panel **Ready** light does not start flashing.
- Your computer displays an error message when you are trying to print.
- Your computer or printer “hangs” while communication is taking place.
- Your printed output shows random or inexplicable errors (misplaced lines, partial drawings etc.)

Investigate the following:

- Check that you have selected the correct interface port in your software.
- Find out if the printer works correctly when receiving files from other software.
- If the printer is connected to a network, try using it when connected directly to your computer.
- If your printer is connected to your computer via any other intermediate devices, such as switch boxes, buffer boxes, cable adapters, cable converters etc., try using it when connected directly to your computer.
- Try another interface cable. For details of supported cables, see page 10–11.

Solving problems with print position or content

If you don't find the solution to your problem here, other sources of help are:

- The documentation supplied with the driver that you are using to manage the output from your software application to the printer. For example, the online and printed documentation included in the following two drivers supplied with your printer:
 - HP printer drivers for AutoCAD
 - HP printer driver for Microsoft Windows applications.
- The documentation supplied with your application software, for example the *AutoCAD Reference Manual*.

455CA

- The documentation supplied with the HP DesignJet 455CA software RIP.

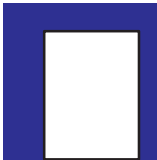

If the print is completely blank

- Check the print cartridges to be sure you have removed the protective nozzle tape from all of them.
- One or more of your cartridges may be out of ink. For an explanation of how to check if a cartridge is out of ink, see page 7–2.



If the output contains only a partial print

- Did you press **Form Feed** before all the data was received by the printer? If so, you have ended the data transmission and will have to send the print again. (You don't need to press **Form Feed** to unload a sheet.)
- The **I/O Timeout** setting in the Setup Sheet may be too short. Increase the setting and print again.

See also “If the print is clipped” on page 9–10.



If the print is clipped

This indicates a discrepancy between the actual printing area on the loaded media and the printing area as understood by your software.

- Check the actual printing area for the media size you have loaded.
 Printing area = media size minus margins.
 For media size and margins, see page 10–3. For actual printing areas, see page 10–7.
- Check what your software understands to be the printing area (which it may call “printable area” or “imageable area”). For example, AutoCAD assumes standard printing areas larger than those used in this printer.
- Ensure that the sheet is loaded in the orientation assumed by your software.
- If necessary, change the printing area in your software. For example, in AutoCAD, specify User Sizes (see the AutoCAD documentation).



If the entire print is in one quadrant of the correct printing area

- Is the page size configured in the software too small?
- Are you sure that your software doesn't believe the drawing to be in one quadrant of the page?

If neither of these possibilities explains the position of the print, there is an incompatibility between the software and the printer:

- Is your software configured for this printer? For general advice, see page 1–24. For advice specific to your software, see either the documentation supplied with the driver or any *Software Application Notes* supplied with your printer.
- If you still haven't found the solution, try changing the printer's **Graphics Language** setting, using the Setup Sheet.



If one print overlays another print on the same sheet

- The **I/O Timeout** setting in the Setup Sheet may be too long. Decrease the setting and print again.



If the output is distorted or unintelligible

There is a possible explanation if the serial interface is in use:

- If you are using a serial interface between the printer and your computer, make sure the printer's serial interface settings match the settings and requirements of your software and hardware. To check or change the printer's settings, use the Setup Sheet.

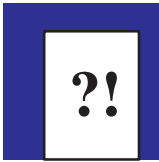

If the printer has drawn a different print from the one you were expecting

You may have pressed **Reprint** (giving you a copy of the last print) or may have accidentally initiated one of the printer's internal prints. (For a summary of these prints and how to print them, see page 5-2.)



If pen settings seem to have no effect

- You may have changed them in the Setup Sheet but forgotten to fill in the oval called "Use settings from tables below."
- You may expect the software-driven pen settings but the Setup Sheet is set to "Use settings from tables below".

Solving print-quality problems

Remember: the key to good print quality is to choose the right media—see the section starting on page 2–2.

If there are white streaks in solid areas or gaps in lines

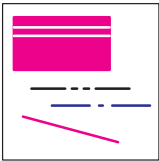

- 1 The problem may have resolved itself during the print (for example, the cartridge nozzles may have cleared themselves), and so, unless the problem occurs repeatedly all the way to the end of the print, simply try printing it again, by pressing **Reprint**.
- 2 Try choosing a higher print-quality level (see page 2–9). With lower print-quality levels, the different pattern of ink may create the impression in some drawings of white streaks or gaps.
- 3 Did you replace or reseal a cartridge with the printer switched OFF? Never do this. If you did, reseal the cartridge with the printer switched ON. Now check the cartridge alignment by running the Black Cartridge Alignment routine (see page 5–4) and, for the HP DesignJet 450C and 455CA, the Color Cartridge Test procedure (see page 5–8).
- 4 One or more of your cartridges may be out of ink. For an explanation of how to check, see page 7–2.
- 5 If the ink levels are OK, try to assess which cartridge has the problem. If the problem occurs only in one of the printer's seven "primary" colors (yellow, cyan, magenta, red, green, blue and black), then you can eliminate one or more of the cartridges. Remember that the printer's cartridges are yellow, cyan, magenta and black, and that "pure" red, green and blue are made up as follows:

$$\begin{array}{c}
 \text{red} \\
 \text{red}
 \end{array}
 =
 \begin{array}{c}
 \text{yellow} \\
 \text{yellow}
 \end{array}
 +
 \begin{array}{c}
 \text{magenta} \\
 \text{magenta}
 \end{array}$$

$$\begin{array}{c}
 \text{green} \\
 \text{green}
 \end{array}
 =
 \begin{array}{c}
 \text{cyan} \\
 \text{cyan}
 \end{array}
 +
 \begin{array}{c}
 \text{yellow} \\
 \text{yellow}
 \end{array}$$

$$\begin{array}{c}
 \text{blue} \\
 \text{blue}
 \end{array}
 =
 \begin{array}{c}
 \text{magenta} \\
 \text{magenta}
 \end{array}
 +
 \begin{array}{c}
 \text{cyan} \\
 \text{cyan}
 \end{array}$$

- 6 If you know which cartridge has the problem, then prime that cartridge to clean the nozzles, and try your print again. For an explanation of how to prime a cartridge, see page 7–7.

- 7 If you don't know which cartridge has the problem, run the Color Cartridge Test Procedure, as explained on page 5–8. Then prime the appropriate cartridge(s), as explained on page 7–7.
- 8 If the problem still occurs after priming, try reseating each cartridge to ensure good electrical connections. Then check the cartridge alignment by running the Black Cartridge Alignment routine (see page 5–4) and, for the HP DesignJet 450C and 455CA, the Color Cartridge Test procedure (see page 5–8).
- 9 If the problem is still unresolved, replace the faulty cartridge.

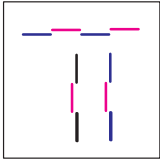

450C/455CA

If there are jagged vertical or horizontal lines

- If problem is only with vertical black or gray lines, run the Black Cartridge Alignment Procedure, explained on page 5–4.

- If problem is with any other color or orientation, run the Color Cartridge Test Procedure, explained on page 5–8.

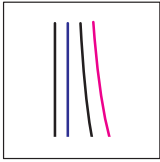

If there are slightly warped lines

- The media itself may be warped. This can happen if it has been used or stored in an extreme environment. For all environmental specifications, see page 10–5.

450C/455CA

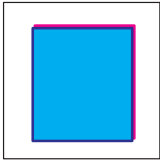

If there are color “shadows”

In the example on the left, a magenta “shadow”, which is not part of the drawing, appears at the edge of a blue object.

- The cartridges need to be re-aligned. Run the Color Cartridge Test Procedure, explained on page 5–8.

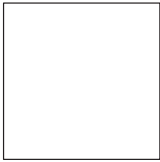

If a cartridge is not printing at all

- Look to see if the cartridge is out of ink. See page 7–2.
- Try priming the cartridge to clear the nozzles. See page 7–7.
- If it is still not printing, remove the faulty cartridge and check the print nozzles to make sure the protective tape has been removed.

If the print quality appears to be poor just in one part of the print

- Did you raise the cover during printing? Although the print continues after the interruption, the print quality in the area of the interruption cannot be guaranteed.

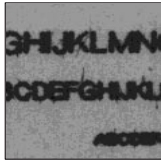

If there are blurred lines (ink “bleeds” from lines)

- Try a higher **Print Quality** level.
- Use better quality media. HP media is recommended and details are given on page 10–19.
- The printer may be operating in an area where the temperature and humidity are too high. For environmental specifications, see page 10–5.

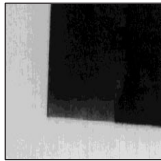

450C/455CA

If there are blotchy areas (uneven fill density)

- Use a different **Media Type** setting.
- If you are not already doing so, try using Hewlett-Packard media.
- If you are printing in color, see the table on page 2–5 for a note about which print-quality/media-type combinations are not recommended.



450C/455CA

If there is other pronounced banding in area fills

Some banding is normal, especially in dark or dense area fills. If banding is more pronounced than expected however, try the following:

- Check the print quality recommendations on page 3-18.
- For the HP DesignJet 450C or 455CA, run the Color Cartridge Test procedure (see page 5–8).
- If the banding is in a black or gray area, then, in the Setup Sheet, reduce the **Pen Settings/Grayscale %**. At the same time, make sure that **Pen Settings** are set to “Use settings from tables below,” so that your software’s settings are overridden.
- Alternatively, replace the print cartridges (see page 7–2).



If ink smears after you remove a print

- Be sure the ink is dry before you remove the sheet. For recommended ink-drying times, see page 2–27.
- When loading media, select the appropriate **Media Type** on the front panel.
- The printer may be operating in an area where the temperature and humidity are too high. For environmental specifications, see page 10–5.
- Handle media by the edges. If possible, wear gloves when you handle film. Skin oils can interact with ink and cause it to smear. Be careful not to get fiber particles onto the edge of the nozzle plate.



Solving miscellaneous problems

If the printer does not print

- You may have a power problem. If there is no activity at all from the printer, and there are no lights on the front panel, check that the power cable is connected correctly and that there is power available at the socket.
- You may have a problem with your application driver. Is your software configured for this printer? For general advice, see “Connecting to your application software” on page 1–24. For advice specific to your software, see either the documentation supplied with the driver or a relevant *Software Application Note* supplied with your printer.
- Is the **Data** light flashing on the printer’s front panel? If so, the file is too big for the printer’s memory.
 - Look at your computer screen for any error message: some drivers, for example the Microsoft Windows driver supplied with your printer, enable you to choose a different printing mode and try to send the file again. In the case of the Microsoft Windows 95® driver shipped with the printer, the relevant field is called “Process document” in the Advanced dialog box.
 - If no other printing mode is available, or if your file still doesn’t print, you may need to consider obtaining a memory expansion module. For information on memory expansion modules, see page 10–17.
- If you continue to have problems, see “Getting help” on page 9–17.

If the printer seems too slow

- Ensure that the Media Type and Print Quality front-panel settings are appropriate. For an explanation of these settings, see page 2–9.
- If you are using the Microsoft Windows 95 driver shipped with the printer, search for help on “Print speed,” which will direct you to the “Process document” field in the Advanced dialog box. If you are using the Microsoft Windows 3.1 driver shipped with the printer, check the settings in the “Print Setup / Options” dialog box, where some of the settings impact printing speed, again referring to the on-screen help system for more advice.

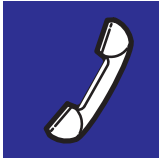

Getting help

Hewlett-Packard has support services available to help you in case you have a problem with your printer.

What to do *before* you call

- 1 Review the troubleshooting suggestions in:
 - This chapter.
 - The relevant driver documentation supplied with your printer (for users of AutoCAD and Microsoft Windows applications),
 - Any relevant *Software Application Note* supplied with your printer.
- 2 Print the demonstration print as explained on page 1–26. If the demonstration print works and does not display the problems you have found with your own prints, then the problem is probably not related to your printer.
- 3 If the problem appears to be related to your software application, first contact your software vendor.
- 4 If you still have difficulty, begin by contacting your HP dealer. The sales representative is familiar with your needs, equipment and software, and should be able to provide you with the information you want. If necessary, you can subsequently call Hewlett-Packard for support.



For a list of the support services available, refer to the *Hewlett-Packard Support Services* booklet shipped with this printer.

5 If you do call one of the Hewlett-Packard offices, please have the following information available to help us answer your questions more quickly:

- The computer you are using.
- Any special equipment or software you are using (for example, spoolers, networks, switch-boxes, modems, or special software drivers).
- The cable you are using (by part number) and where you purchased it.
- The type of interface used on your printer (RS-232-C or parallel).
- The software name and version you are currently using.
- The printer's latest setup sheet, showing the current configurations of various printer parameters. See page 6-2 and the section starting on page 1-19.
- The media type you are using.

If a repair is needed

Contact the Hewlett-Packard dealer or HP Sales and Support Office where you purchased the printer for complete service information.

Printer specifications 10-2
Interface specifications 10-8
Interface cables 10-11
Regulatory notices 10-12
Ordering accessories 10-15

Reference



Printer specifications

HP DesignJet 430 (monochrome)

C4713A = D/A1-size

C4714A = E/A0-size

HP DesignJet 455CA (color)

C6080A = D/A1-size LFP

HP DesignJet 450C (color)

C4715A = D/A1-size

C4716A = E/A0-size

C6081A = E/A0-size LFP

Functional specifications		
Cartridges	HP DesignJet 430: one: black HP DesignJet 450C/455CA: four: yellow, cyan, magenta and black. For part numbers, see page 10–18.	
Supported media types	<i>Monochrome</i>	<i>Color</i>
	Plain paper Opaque bond Translucent bond Natural tracing paper Vellum Coated paper Heavyweight coated paper Matte film Clear film High-gloss white film ³ High-gloss photo paper ³	Plain paper ¹ Opaque bond ¹ Natural tracing paper ² Vellum ² Coated paper Heavyweight coated paper Matte film Clear film High-gloss white film High-gloss photo paper ³
450C 455CA		
¹ CAD drawings only. ² CAD drawings only and HP media only. ³ <i>HP DesignJet 430</i> : Monochrome printing is <i>not</i> supported on glossy media. <i>HP DesignJet 450C</i> : Monochrome printing is supported on glossy media as long as you leave all cartridges loaded. For alternative names, HP commercial names and physical characteristics of these media types, see chapter 2. For the best-quality prints, use HP media, as your printer's configuration is optimized for it and tested with it. For details of HP media, see page 10–19 and any separate HP media literature supplied with your printer.		

Functional specifications (continued)				
Supported media sizes	<i>Width (carriage axis)</i>		<i>Length (paper axis)</i>	
	<i>Minimum</i>	<i>Maximum</i>	<i>Minimum</i>	<i>Maximum</i>
	210 mm (8.3 in)	E/A0-size printer: 917 mm (36.1 in) D/A1-size printer: 625 mm (24.6 in)	210 mm (8.3 in)	Sheet: 1.625 m (64 in) Maximum length of long-axis print on roll media: 15.2 m (50 ft)
Margins For printing area (media size minus margins), see page 10–7	Leading edge:	17 mm (0.67 in)		
	Trailing edge:	17 mm (0.67 in)		
	Sides:	5 mm (0.2 in)		
	All measurements ± 2 mm (0.08 in).			
Resolution ¹	<i>On Setup Sheet, if Color/Mono is set to:</i>			
	<i>Print color as grayscale</i>		<i>Print color as color</i>	
	Fast print quality:	150 x 300 dpi.	450C/455CA	
	Other print qualities:	600 x 600 dpi. addressable ²		
Accuracy (maximum accumulated error)	± 0.38 mm (0.015 in) or $\pm 0.2\%$ of the specified vector length, whichever is greater, at 23°C (73°F), 50–60% relative humidity, on HP Matte Film.			
Programming languages supported	HP-GL (7586B), HP-GL/2, HP RTL, PJJ			
¹ The 600 dpi resolution specified is <i>addressable</i> resolution, that is, it refers to the smallest movement the print head can make between dots rather than to the size of the dot. ² Except for glossy media types, on which the resolution is always 300 dpi.				

Printer specifications

Physical specifications				
(Unpacked)	<i>Weight</i>	<i>Length</i>	<i>Depth</i>	<i>Height</i>
Without roll-feed and legs options				
E/A0-size printer	31 kg (68.2lb)	1329 mm (52.4 in)	231 mm (9.1 in)	332 mm (13.1 in)
D/A1-size printer	26 kg (57.2 lb)	1031 mm (40.6 in)	231 mm (9.1 in)	332 mm (13.1 in)
With roll-feed option				
E/A0-size printer	(Contact HP)	1329 mm (52.4 in)	355 mm (14.0 in)	415 mm (16.4 in)
D/A1-size printer		1031 mm (40.6 in)	355 mm (14.0 in)	415 mm (16.4 in)
With legs option				
E/A0-size printer	(Contact HP)	1329 mm (52.4 in)	231 mm (9.1 in)	1165 mm (46.0 in)
D/A1-size printer		1031 mm (40.6 in)	231 mm (9.1 in)	1165 mm (46.0 in)

Power specifications	
Source	100–240V ac \pm 10%. Auto-ranging
Frequency	47–63 Hz
Consumption	70 W (2 A max.)

Acoustic specifications		
Operating sound pressure (E/A0 size)	45 dB(A)	(From a one-meter bystander position)
	(D/A1 size) 43 dB(A)	
Idle sound pressure	<20 dB(A)	

Duty cycle		
Recommended maximum number of prints per day	20	(Medium density E/A0 CAD prints)
The printer keeps an internal count of the number of prints printed. The current total is included as part of the information in the Service Configuration Print—see page 5–2. The relevant fields are called “Number of Color Prints” and “Number of Black Prints.”		

Environmental specifications		Temperature	Humidity
Operational	Mechanical and electrical:	0 to 55°C (32 to 131°F)	5% to 95% @ 40°C Non-condensing
	With cartridges and media:	15 to 35°C (59 to 95°F)	20% @ 15°C to 80% @ 35°C Non-condensing
Storage	Printer and media:	−40 to 70°C (−40 to 158°F)	90% @ 65°C
	Cartridges:	0 to 50°C (0 to 5°C and 40 to 50°C for maximum 7-day period). 32 to 122°F (32 to 41°F and 104 to 122°F for maxi- mum 7-day period).	5% to 90%
For optimal print quality and media handling:		15 to 30°C (59 to 86°F)	20% @ 15°C to 80% @ 30°C

Ecological specifications	
Energy efficiency	Standby mode: 28 watts. Printing mode: <70 watts. Compliant with Energy Star Program EPA (US).
Manufacturing process	Free of ozone-depleting chemicals (Montreal Protocol).
Plastics	Free of brominated flame retardants (PBB and PBDE). All housing parts made of same material: ABS. 90% of parts marked according to ISO 11469 standard.
Metals	Chassis made of aluminium. Shafts made of stainless steel. Enclosures made of electro-galvanized steel sheet.
Packaging	Cardboard (non-chlorine-bleached) and foam are 100% recyclable. Inks used for printing do not contain heavy metals.
User documentation	Majority recyclable, not bleached with chlorine, and printed with inks that do not contain heavy metals. For specification of this <i>User's Guide</i> , see the back cover.
Batteries	Not used.
Recyclability	Modular construction, with all releasable connecting elements snap-type, screws easy to find and disassembly done using universal tools.

Printer specifications

EMC specifications (electromagnetic compatibility)	
Canada	Canadian Department of Communications, Radio Interference Regulations Class B ¹ compliant.
European Union	89/336/EEC EMC Directive compliant. Meets EN 55022 Class B ¹ emission limits, prEN 55024–2 ESD, prEN55024–3 Radiated Immunity, prEN 55024–4 Fast Transients.
Japan	Registered VCCI Class 2 ¹ .
Korea	RRL certified.
South Africa	SABS licensed.
USA	Federal Communications Commission certified. Class B ¹ computing device. CFR 47 Part 15
Australia New Zealand	Meets AS/NZS 3548
¹ Product exhibits Class A operation when connected to LAN cables using Print Server accessories	

Safety specifications	
Information Technology Equipment (ITE), Movable, Class I, Plugable Type A, Installation Category II, Pollution Degree 2. For indoor, controlled-office environment use.	
Canada	Canadian Standards Association “Certified” ITE, CSA C22.2 No.950.
Czech Republic	EZU, IEC950 certified.
European Union	73/23/EEC Low-Voltage-Directive-compliant. Meets EN 60950.
Mexico	DGN, NOM019-SCFI-1994 certified.
Norway	NEMKO approved, EN 60950, EMKO TSE(74)DK207/94.
USA	Underwriters’ Laboratories “Listed” ITE, UL 1950.
China	CCIB certified GB 4943-90 1st Ed.

Printing area (= media size minus margins). For margins, see page 10–3.					
	Media size (and orientation of media)	Printing area (width x height) by orientation of drawing			
		inches		millimeters	
		landscape	portrait	landscape	portrait
ANSI media	A (portrait)	9.66 x 8.1	8.1 x 9.66	245 x 205	205 x 245
	A (landscape)	10.6 x 7.16	7.16 x 10.6	269 x 182	182 x 269
	B (portrait)	15.7 x 10.6	10.6 x 15.7	397 x 269	269 x 397
	B (landscape)	16.6 x 9.66	9.66 x 16.6	421 x 245	245 x 421
	C (portrait)	20.7 x 16.6	16.6 x 20.7	524 x 421	421 x 524
	C (landscape)	20.6 x 15.7	15.7 x 20.6	549 x 398	398 x 549
	D (portrait)	32.7 x 21.6	21.6 x 32.7	829 x 548	548 x 829
	D (landscape)	33.6 x 20.7	20.7 x 33.6	854 x 525	525 x 854
	E (portrait)	42.7 x 33.6	33.6 x 42.7	1084 x 854	854 x 1084
Architectural media	A (portrait)	10.7 x 8.60	8.6 x 10.7	271 x 219	219 x 271
	A (landscape)	11.6 x 7.66	7.66 x 11.6	295 x 195	195 x 295
	B (portrait)	16.7 x 11.6	11.6 x 16.7	423 x 295	295 x 423
	B (landscape)	17.6 x 10.7	10.7 x 17.6	447 x 271	271 x 447
	C (portrait)	22.7 x 17.6	17.6 x 22.7	576 x 447	447 x 576
	C (landscape)	23.6 x 16.7	16.7 x 23.6	600 x 423	423 x 600
	D (portrait)	34.7 x 23.6	23.6 x 34.7	880 x 600	600 x 880
	D (landscape)	35.6 x 22.7	22.7 x 35.6	904 x 576	576 x 904
		E1 (portrait)	40.7 x 29.6	29.6 x 40.7	1033 x 752
	E (portrait)	46.7 x 35.6	35.6 x 46.7	1185 x 904	904 x 1185
ISO media	A4 (portrait)	10.3 x 7.87	7.87 x 10.3	263 x 200	200 x 263
	A4 (landscape)	11.3 x 6.93	6.93 x 11.3	287 x 176	176 x 287
	A3 (portrait)	15.2 x 11.3	11.3 x 15.2	386 x 287	287 x 386
	A3 (landscape)	16.1 x 10.3	10.3 x 16.1	410 x 263	263 x 410
	A2 (portrait)	22.0 x 16.1	16.1 x 22.0	560 x 410	410 x 560
	A2 (landscape)	23.0 x 15.2	15.2 x 23.0	584 x 386	386 x 584
	A1 (portrait)	31.8 x 23.0	23.0 x 31.8	807 x 584	584 x 807
	A1 (landscape)	32.7 x 22.0	22.0 x 32.7	831 x 560	560 x 831
		A0 (portrait)	45.5 x 32.7	32.7 x 45.5	1155 x 831



Interface specifications

Below are the parallel and serial interface specifications. On the following page are the pin configurations for the most common HP cables referenced on page 10–11.

Parallel (Centronics) Interface	Pin	Wire/Signal Name	Source
<p>The connector on the printer is 36-pin female.</p> <p>Most existing parallel cables support IEEE-1284-compatible communication, but, for use with this printer, the cable <i>must</i> meet the specification in this table.</p>	1	$\overline{\text{Strobe}}$	computer
	2 ... 9	D0 ... D7 (data lines)	both
	11	Busy	printer
	12	PError	printer
	13	Select (SelectOut)	printer
	14	$\overline{\text{AutoFd}}$	computer
	16	GND	
	19 ... 30	GND	
	31	$\overline{\text{InIt}}$	computer
	32	$\overline{\text{Fault}}$	printer
	36	$\overline{\text{SelectIn}}$	computer

Serial (RS-232-C) Interface	Pin	Wire/Signal Name	Source
<p>The connector on the printer is 25-pin female.</p> <p>The printer is configured as DTE (data terminal equipment).</p> <p>Data is transmitted on Pin 2 and received on Pin 3.</p>	1	Protective Ground	
	2	Transmitted Data	DTE
	3	Received Data	DCE
	4	Request to Send	DTE
	6	Data Set Ready	DCE
	7	Signal Ground	
	20	Data Terminal Ready	DTE

Parallel (Centronics) cable

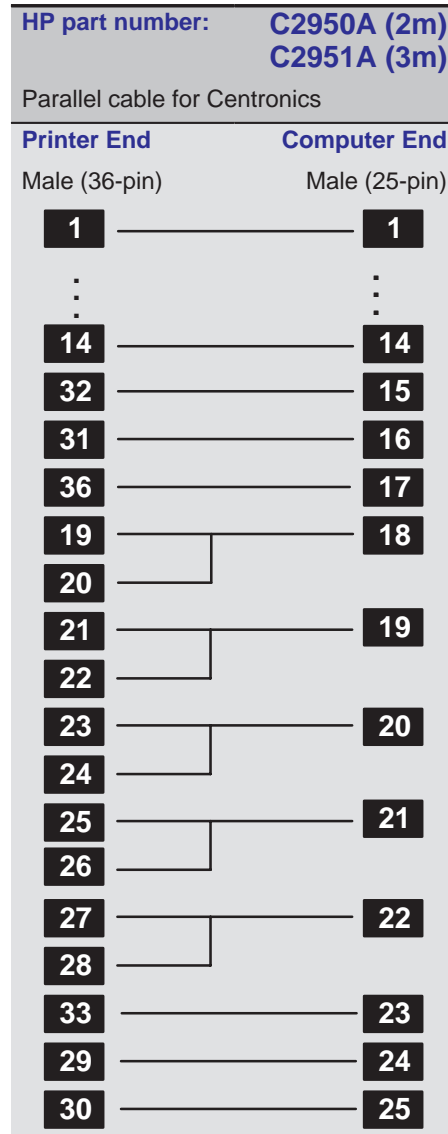

Interface specifications

Serial (RS-232-C) cables

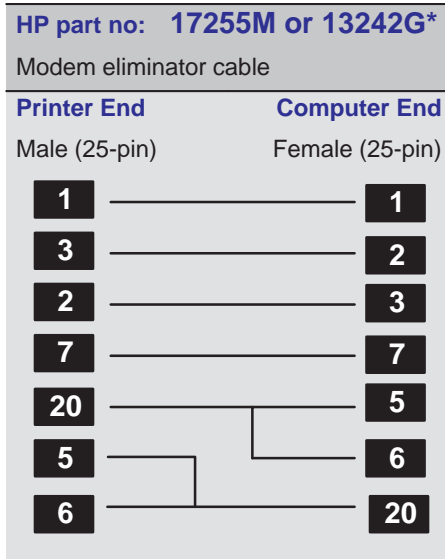
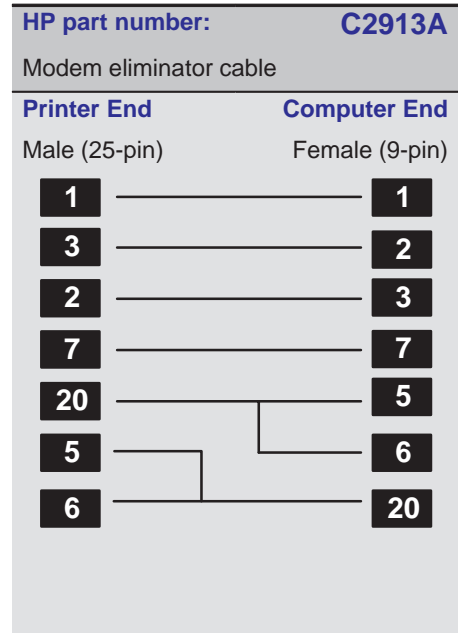
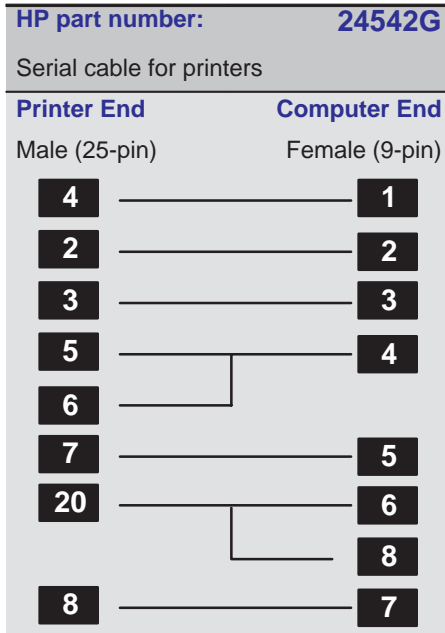

* Symmetrical: either end may be connected to the printer. Other pins are connected in the 13242G cable, but they do not affect printer operation.



Interface cables

Parallel (Centronics) Interface (IEEE-1284-compatible)			
Computer	HP Part Number	Cable length	Connector type at computer end of cable
HP Vectra PC with HP 24540A/B serial/parallel interface card using the parallel connector	C2950A	2.0 m (6.3 ft)	25-pin male
HP 9000 workstations: series 300, 400, 700	C2951A	3.0 m (9.8 ft)	25-pin male
IBM AT, IBM PS/2, IBM PC/XT and compatibles			
Serial (RS-232-C) Interface			
Computer	HP Part Number	Cable length	Connector type at computer end of cable
HP Vectra PC or HP 24541A/B serial interface card (9-pin connector)	24542G	3.0 m (9.8 ft)	9-pin female
HP 9000 workstations using 9-pin connectors.			
IBM AT and compatibles using 9-pin serial connectors			
HP Vectra PC with HP 24541A/B dual serial interface card using the 25-pin connector	17255M	1.2 m (3.9 ft)	25-pin male
HP Apollo workstation using an SPE (Serial/Parallel Expansion) option and supplied adapter cable			
DEC VAX			
Sun workstation			
IBM PC, PC/XT, IBM PS/2 and compatibles	C2913A	1.2 m (3.9 ft)	25-pin female
DEC VAX using DEC BC22D, BC03M, or equivalent	17355M	3.0 m (9.8 ft)	
Apple Macintosh Plus, SE, II Series, Classic, LC family, Quadra family, PowerBook, PowerMac	17302A	1.5 m (4.9 ft)	8-pin male mini-DIN
Extension cable	31391A	5 m (16.4 ft)	25-pin female



Regulatory notices

To obtain a Material Safety Data Sheet (MSDS)

You can obtain current Material Safety Data Sheets for the print cartridges used in the printer (HP Part numbers 51644C [cyan], 51644M [magenta], 51644Y [yellow] and 51640A [black]) by mailing a request to this address:

Hewlett-Packard Customer Information Center, 19310 Pruneridge Avenue,
Dept. MSDS, Cupertino, CA 95014, U.S.A.

Electromagnetic compatibility (EMC)

FCC Statement
(USA)

The U.S. Federal Communications Commission (in 47 cfr 15.105) has specified that the following notice be brought to the attention of users of this product:

CAUTION

Pursuant to Part 15.21 of the FCC Rules, any changes or modifications to this equipment, not expressly approved by Hewlett-Packard Company, may cause harmful interference and void the FCC authorization to operate this equipment.

This equipment has been tested and found to comply with the limits for a Class B digital device, pursuant to part 15 of the FCC Rules. These limits are designed to provide reasonable protection against harmful interference in a residential installation. This equipment generates, uses and can radiate radio frequency energy and, if not installed and used in accordance with the instructions, may cause harmful interference to radio communications. However, there is no guarantee that interference will not occur in a particular installation. If this equipment does cause harmful interference to radio or television reception, which can be determined by turning the equipment off and on, the user is encouraged to try and correct the interferences by one or more of the following measures:

- Reorient the receiving antenna
- Increase the separation between the equipment and the receiver
- Connect the equipment into an outlet on a circuit different from that to which the receiver is connected
- Consult the dealer or an experienced radio/TV technician for help.

The user may find useful the following booklet prepared by the FCC: “How to Identify and Resolve Radio-TV Interference Problems.” This booklet is available from the US Government Printing Office, Washington, DC 20402. Stock No. 004-000-00345-4.

When connected to an IEEE 802.3 or Ethernet network...	This equipment has been tested and found to comply with the limits for a Class A digital device, pursuant to part 15 of the FCC Rules. These limits are designed to provide reasonable protection against harmful interference in a commercial environment. This equipment generates, uses and can radiate radio frequency energy and, if not installed and used in accordance with the instructions, may cause harmful interference to radio communications. Operation of this equipment in a residential area is likely to cause harmful interference in which case the user will be required to correct the interference at their own expense.
Normes de sécurité (Canada)	<p>Le présent appareil numérique n'émet pas de bruits radioélectriques dépassant les limites applicables aux appareils numériques de la classe B prescrites dans le Règlement sur le Brouillage Radioélectrique édicté par le ministère des Communications du Canada.</p> <p>Le présent appareil numérique, connecté à un réseau de type IEEE 802.3 ou Ethernet, n'émet pas de bruits radioélectriques dépassant les limites applicables aux appareils numériques de Classe A prescrites dans le règlement sur le brouillage radioélectrique édicté par le Ministère des Communications du Canada.</p>
DOC statement (Canada)	<p>This digital apparatus does not exceed the Class B limits for radio noise emissions from digital apparatus set out in the Radio Interference Regulations of the Canadian Department of Communications.</p> <p>When connected to an IEEE 802.3 or Ethernet network, this digital apparatus does not exceed the Class A limits for radio noise emissions from digital apparatus set out in the Radio Interference Regulations of the Canadian Department of Communications.</p>
Korean EMI statement	<p>이 기기는 업무용으로 전자파장애검정을 받은 기기이오니 판매자 또는 사용자는 이점을 주의하시기 바라며, 만약 잘못 구입하였을 때에는 구입한 곳에서 비업무용으로 교환하시기 바랍니다.</p>

Regulatory notices

VCCI Class 1 and
Class 2 (Japan)

この装置は、第二種情報装置（住宅地域またはその隣接した地域において使用されるべき情報装置）で住宅地域での電波障害防止を目的とした情報処理装置等電波障害自主規制協議会（VCCI）基準に適合しております。

しかし、本装置をラジオ、テレビジョン受信機に近接してご使用になると、受信障害の原因となることがあります。

取扱説明書に従って正しい取り扱いをして下さい。

IEEE802.3もしくはEthernetに接続されている場合、この装置は、第一種情報装置（商工業地域において使用されるべき情報装置）で商工業地域での電波障害防止を目的とした情報処理装置等電波障害自主規制協議会（VCCI）基準に適合しております。

従って、住宅地域またはその隣接した地域において使用すると、ラジオ、テレビジョン受信機等に受信障害を与えることがあります。

取扱説明書に従って正しい取り扱いをして下さい。

Sound

Geräuschemission
(Germany)

L_{pA} < 70 dB, am Arbeitsplatz, im Normalbetrieb, nach DIN 45635 T. 19.

Telecommunications statement

Telecommunications
General Approval
(UK)

The HP DesignJet 430, 450C and 455CA printers, Models C4713A, C4714A, C4715A, C4716A, C6080A and C6081A, are approved under Approval Number NS/G/1234/J/100003 for indirect connection to public telecommunications systems within the United Kingdom.

DECLARATION OF CONFORMITY

according to ISO/IEC Guide 22 and EN 45014

Manufacturer's Name:	Hewlett-Packard Espanola S.A.	Hewlett-Packard Singapore (PTE) Ltd.
Manufacturer's Address:	Barcelona Division Avda. Graells, 501 08190 Sant Cugat del Valles Barcelona, Spain	Asia Hardcopy Manufacturing Operation 20 Gul Way Singapore 629196

declares that the product

Product Name:	HP DesignJet 430 and 450C and 400 and 455CA Inkjet Printers
Model Number (s):	HP C4713A, HP C4714A, HP C4715A, HP C4716A, HP C4722A, HP C6080A, HP C6081A
Product Accessory:	HP Jet Direct EX external print servers (1)

conforms to the following Product Specifications:

Safety: IEC 950 (1991) + A1,A2 / EN 60950 (1992) + A1,A2
CSA C22.2 No 950 (1993)
UL 1950 (1993)
NOM-019-SCFI-1994
EMKO-TSE (74) DK 207/94
GB 4943 (1990)
IEC 825-1 (1993) / EN 60825-1 (1994) Class 1 for LED

EMC: CISPR 22:1993 / EN 55022 (1994): Class B (2)
EN 50082-1 (1992)
IEC 801-2:1991/prEN 55024-2 (1992): 4KV CD, 8KV AD
IEC 801-3:1984/prEN 55024-3 (1991): 3V/m
IEC 801-4:1988/prEN 55024-4 (1993): 1KV Power Lines,
0.5KV Signal Lines
FCC Part 15 - Class B/DOC-B/VCCI-2/RRL-A
AS/NZS 3548

Supplementary Information:

The product herewith complies with the requirements of the Low-Voltage Directive 73/23/EEC and the EMC Directive 89/336/EEC and carries the CE marking accordingly.

- (1) Product exhibits class A operation when connected to LAN cables using print server accessories.
- (2) The product was tested in a typical system with a Hewlett Packard Personal Computer and second peripheral.

Sant Cugat del Valles (Barcelona),
July 1st, 1997

Jordi Balderas,
Quality Engineering Manager

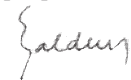

Singapore,
July 1st, 1997

Kum Yew Chan
Quality Manager



European Contact: Your local Hewlett-Packard Sales and Service Office or Hewlett-Packard GmbH, Department HQ - TRE,
Herrenberger Strasse 130, D-71034 Boeblingen, Germany (FAX: +49 7031 143143)



Ordering accessories

	HP Part Number
Cables	See page 10–11
Color Upgrade kit	
Upgrade kit to convert an HP DesignJet 430 to an HP DesignJet 450C	C4718A
Documentation	
User's Guide and Quick Reference Guide:	
	English C4713-60041
	Korean C4713-60042
	Taiwanese C4713-60043
	German C4713-60044
	French C4713-60045
	Spanish C4713-60046
	Italian C4713-60047
	Japanese C4713-60048
	Portuguese C4713-60049
	Chinese C4713-60050
Software Application Notes	English C4713-90009
Hewlett-Packard Support Services booklet (The latest edition was shipped with this printer)	Multi *
HP CAD Printer: Software/Hardware Guide (The latest edition was shipped with this printer)	English *

* This item is updated regularly. For details of the latest version available, please contact your HP dealer or sales representative.

		HP Part Number
The HP-GL/2 and HP RTL Reference Guide (see also page 10–21). Updated HP-GL/2 and RTL reference information is currently in preparation. For the latest part numbers, please contact your HP dealer or sales representative.	English	5959-9733
The Product Comparison Guide for HP Languages on HP Plotters and Large-Format Printers (see also page 10–21)	English	5959-9734
PJL Technical Reference Manual (part number also includes PCL reference information).	English	5010-3997

Drivers

Latest versions of the following were shipped with your HP DesignJet 430/450C printer:

HP printer drivers for AutoCAD for DOS and AutoCAD for Windows

These items are updated regularly. For details of the latest versions available, please contact your HP dealer or sales representative.

HP printer drivers for Microsoft Windows

Media supplies

See table on page 10–19. From time to time, new media types may become available. For up-to-date information, please contact your HP dealer or local HP Sales and Support Office.

Memory expansion modules	4 MB	C3132A
For up-to-date details of any memory expansion modules other than those listed here, contact your local authorized HP dealer.	8 MB	C3133A
	16 MB	C3146A
(1) 32 bits wide, no parity	32 MB	C3975A (1)

Ordering accessories

		HP Part Number
Network interface		
HP JetDirect EX external print servers (for LAN connection):		
For Ethernet: HP JetDirect EX Plus		J2591A
For Token Ring: HP JetDirect EX Plus 3		J2594A
Print cartridges		
Although other cartridges may appear to fit in the stalls, use only these part numbers.	Yellow	51644Y
	Cyan	51644C
	Magenta	51644M
	Black	51640A
Roll-feed kit		
	D/A1-size	C4717A
	E/A0-size	C4719A
Legs kit		
	D/A1-size	C6069A
	E/A0-size	C6070A
Spindle assembly		
The spindle assembly includes the spindle and a pair of media stops.		
For D/A1-size spindle assembly		C6238A
For E/A0-size spindle assembly		C6239A

HP part numbers for HP DesignJet Papers and Films

	Rolls		Sheets (ISO)		
	Width		A0	A1	A3
	in:	mm:			
	24	36	841 x 1189	594 x 841	297 x 420
HP Opaque Bond	C3851A	C3850A	C3856A	C3857A	
HP Translucent Bond	C3860A	C3859A	C3892A	C3893A	
HP Vellum	C3862A	C3861A			
HP Natural Tracing Paper	C3869A	C3868A	C3872A	C3873A	
HP Clear Film	C3876A	C3875A			
HP Matte Film	51642A	51642B	51642M	51642H	51642F
HP Coated Paper	C3878A	C3877A	*	*	
HP Heavyweight Coated Paper	C3880A	C3879A			
HP High-Gloss White Film	C3886A	C3885A	*	*	
HP High-Gloss Photo Paper	C3882A	C3881A	*	*	

HP part numbers for HP DesignJet Papers and Films

	Sheets (ANSI)					
	B	ANSI D	ANSI E	Arch. D	Arch. E	
	in:	11 x 17	22 x 34	34 x 44	24 x 36	36 x 48
mm:		558 x 864	864 x 1118	610 x 914	914 x 1220	760 x 1067
HP Opaque Bond		C3853A	C3852A	C3855A	C3854A	C3858A
HP Translucent Bond		C3891A	C3890A	C3896A	C3894A	C3895A
HP Vellum		C3864A	C3863A	C3866A	C3865A	C3867A
HP Natural Tracing Paper				C3871A	C3870A	C3874A
HP Clear Film						
HP Matte Film	51642C	51642G	51642K	51642J	51642N	51642L
HP Coated Paper		*	*	*	*	
HP Heavyweight Coated Paper						
HP High-Gloss White Film				*	*	

* These sizes *are* available. Please contact your HP dealer or sales representative for product numbers. From time to time new media types and sizes may become available—also contact your HP dealer or sales representative for details.

HP-GL/2 and HP RTL programming information *

The HP-GL/2 and HP RTL Reference Guide provides complete explanations and examples of the HP-GL/2 and HP RTL graphic and interfacing instructions. If you are writing an HP-GL/2 or RTL driver for your printer, you will find this guide an invaluable source of general instruction information. It is published by Addison-Wesley Publishing Company, and you can order it through most book stores (ISBN 0-201-56308-8).

For specific parameter information, refer to *The Product Comparison Guide for HP Languages on HP Plotters and Large-Format Printers*, which you can order through your HP Sales office.

How to order supplies and accessories

You can order supplies and accessories in any of the following ways:

- By calling your local authorized HP dealer.
- By contacting your local HP Sales and Support office.
- By contact one of the addresses given in *Hewlett-Packard Support Services* booklet. In the United States, the Direct Ordering number is 1-800-538-8787.

* Updated HP-GL/2 and RTL reference information is currently in preparation. For the latest part numbers, please contact your HP dealer or sales representative.



Glossary

Glossary

ANSI size An American standard paper size, for example D or E.

application The software you use to create your drawings.

baud rate The data transmission rate in a serial interface between a computer and a device, in bits per second.

CAD Computer-aided design.

cartridge Print cartridge, containing ink.

Centronics A standard for the parallel interface between computer and device.

clear film See-through, polyester media type.

clipping Losing part of a drawing at the edges.

CMYK Cyan, magenta, yellow and black. The colors of the printer's four inks, and also a standard color model.

coated paper Paper coated on one side for inkjet printing.

default A value or condition that is assumed if no other value or condition is specified.

device An external item connected to the computer: printer, plotter, tape drive etc. Your HP DesignJet is a device.

dpi Dots per inch, a measure of print resolution.

driver The software that controls the communication between a computer and a device.

entry platen The exterior part of the printer just below the media-entry slot.

front panel The control panel on the right of the printer.

GIS Geographical information system (mapping software).

graphics language A programming language telling a print device how to output graphic data. For example, HP-GL/2 or HP RTL.

grayscale Shades of gray to represent colors.

high-gloss film A glossy, opaque, polyester media type.

HP-GL One of Hewlett-Packard's standard graphics languages for plotters and printers. Produces vector data. Forerunner to HP-GL/2.

HP-GL/2 One of Hewlett-Packard's standard graphics languages for plotters and printers. Produces vector data. Newer than HP-GL.

I/O Input/output. The transmission of data between a computer and a device.

inked area The smallest rectangle that contains all the content of the drawing, while maintaining its relative dimensions.

ISO size An international standard paper size, for example A1 or A2.

JIS size A Japanese standard paper size.

LAN Local area network.

load-media button A button just above the entry platen that you must press to indicate to the printer that it is to take up the media you are loading.

long-axis printing Printing a page whose X-axis is longer than a standard page size.

margin The space around the page added by the printer to separate one page from another and to avoid printing right to the edge of the media.

matte Not glossy.

matte film Opaque, polyester media type.

media The material, usually paper, onto which the device prints.

media deflector The metal part situated between the optional E/A0-size legs, to stop the largest media sizes touching the floor.

media lever The lever that causes the printer to hold or release media: when raised it holds the media in place; when lowered it releases the media.

opaque bond Good-quality matte paper.

palette A set of logical pens defined by color and width.

PJL Printer Job Language. A programming language that controls jobs going to a printer or plotter.

parallel interface A type of interface between computer and device. Generally faster than a serial interface.

printing area Page size minus margins.

parity An error-checking method in a serial interface between a computer and a device.

raster A method for defining an image, in terms of dots rather than lines. Raster data typically needs more memory than vector data.

RGB Red, green and blue. A standard color model.

RS-232-C A serial interface standard.

RTL Raster Transfer Language, one of Hewlett-Packard's standard graphics languages for plotters and printers. Produces raster data.

Glossary

ROM SIMM A physical module containing read-only data, that can be installed in the back of the printer to provide upgrades.

serial interface A type of interface between computer and device. Generally slower than a parallel interface.

spindle The rod that holds the roll of media in the roll-feed and legs option.

tracing paper A semi-opaque matte paper type.

translucent bond A semi-opaque matte paper type.

vector A line. An image may be defined in terms of vectors rather than dots. Vector data typically needs less memory than raster data.

vellum Cotton-fiber-based, semi-opaque matte media type.

X-axis The vertical axis, as you look at the printer from the front.

Y-axis The horizontal axis, as you look at the printer from the front.

Index

A

- accessories, 1-4
 - list, 10-15
 - ordering, 10-15, 10-19
 - using genuine HP, 7-3
- accuracy specifications, 10-3
- acoustic specifications, 10-4
- addressable resolution, xii, 10-3
- Align Media, front-panel light, 8-3
- aligning cartridges, 5-4, 5-8
- aligning roll media, 2-23
- aligning sheet media, 2-12
- ANSI size, glossary definition, 11-2
- Apollo, cables to connect, 10-11
- Apple computers, cables to connect, 10-11
- application, glossary definition, 11-2
- application software, 1-24
- area fill problems, 9-15
- AutoCAD, 1-24
 - drivers, 10-16

B

- banding problems, 9-15
- baud rate, glossary definition, 11-2
- Best, front-panel light, 8-5
- Black Cartridge Alignment Sheet
 - how to print, 5-2
 - sample, 5-7
 - using, 5-4
- blank print, 9-9
- bleeding lines, 9-15
- blurred lines, 9-15

C

- cables
 - extension, 10-11
 - interface, 1-17, 10-11
 - parallel specification, 10-9
 - part numbers, 10-11
 - power, 1-4
 - problems, 9-8
 - serial specifications, 10-10
 - supplied/not supplied, 1-5
- CAD, glossary definition, 11-2
- Cancel key, 4-2

- cancelling a print, 4-2
- cartridge, glossary definition, 11-2
- cartridge carriage, 1-10
- cartridge service station, 1-10
- cartridge stalls, 1-11
- Cartridges, front-panel light, 8-4
- cartridges
 - aligning, 5-4
 - before replacing, 7-4
 - cleaning the nozzles, 7-7
 - clogged, 7-7
 - colors, 1-4, 1-11
 - environmental specifications, 10-5
 - initial installation, 1-10
 - ordering, 10-17
 - part numbers, 10-17
 - priming, 7-7
 - problems, 9-14
 - removing tab, 1-12, 7-6
 - replacing, 7-2
 - supplied, 1-4
- Centronics, 1-17
 - glossary definition, 11-2
 - cleaning the printer, 7-9
- clear film, glossary definition, 11-2
- clipped print, 9-10
- clipping
 - and page size, 3-6
 - and Rotate, 3-9
 - glossary definition, 11-2
 - troubleshooting, 9-10
- clogged cartridges, 7-7
- CMYK, glossary definition, 11-2
- Coated, front-panel light, 8-5
- coated paper, glossary definition, 11-2
- color
 - media type for, 2-5
 - of pens in palette, 3-12
 - problems, 9-12
 - switching on/off, 3-13
- Color Cartridge Test Sheet, 5-11
 - how to print, 5-2
 - sample, 5-10
 - using, 5-8
- color upgrade, 6-5
 - part number, 10-15

- color-vision deficiencies, advice for users with, 1-11
- color/monochrome switching, 3-13
- communications problems, 9-8
- configuration, current, 6-2
- configuring the printer, 1-19
 - reconfiguring, 6-1
- connecting printer to computer, 1-17
- connector
 - parallel, 1-17
 - serial, 1-17
- copying a print, 4-2
- cover, raising, 9-14
- cutter, 2-29
 - part number, 10-15
- cutting the roll, 2-29

D

- Data, front-panel light, 8-4
- DEC computers, cables to connect, 10-11
- Declaration of Conformity (EC), 10-14
- default, glossary definition, 11-2
- demonstration print, 1-26
 - how to print, 5-2
- device, glossary definition, 11-2
- device lists, 1-25
- Digital computers, cables to connect, 10-11
- dimensions of printer, 10-4
- documentation, 10-15, 10-19
- dpi, glossary definition, 11-2
- dpi (dots per inch), 10-3
- driver, glossary definition, 11-2
- drivers, 1-24, 10-16
 - supplied, 1-4
- drying time, 2-27
- duty cycle, 10-4

E

- ecological specifications, 10-5
- electrical specifications, 10-4
- electrostatic precautions, 1-7, 6-6
- EMC (electromagnetic compatibility), 10-6, 10-12

Index

-
- entry platen, glossary definition, 11-2
- F**
- Fast, front-panel light, 8-5
 - file size, and memory usage, 6-4
 - file termination, 1-22
 - filled area problems, 9-15
 - Film, front-panel light, 8-5
 - film, 10-2
 - firmware revision number, 6-2
 - Form Feed key, 4-3
 - front panel, glossary definition, 11-2
 - front-panel lights, 8-2
- G**
- gaps in lines, 9-12
 - GIS, glossary definition, 11-2
 - glossary of terms, 11-1
 - Glossy, front-panel light, 8-5
 - graphics language, glossary definition, 11-2
 - graphics languages
 - changing, 6-3
 - supported, 10-3
 - grayscale, glossary definition, 11-2
 - grayscale
 - of pens in palette, 3-12
 - printing color, 3-13
- H**
- heavyweight media, 10-2
 - help, 9-17
 - high-gloss film, glossary definition, 11-2
 - HP computers, cables to connect, 10-11
 - HP DesignJets
 - model numbers, 10-2
 - other, 1-25
 - HP JetDirect EX, 1-5, 1-18
 - HP media, 10-18
 - HP RTL, 6-3
 - documentation, 10-19
 - HP supplies, using genuine, 7-3
 - HP-GL, glossary definition, 11-2
 - HP-GL (7586B), 6-3
- HP-GL/2, 6-3
 - documentation, 10-16, 10-19
 - glossary definition, 11-2
 - humidity, 10-5
- I**
- I/O, glossary definition, 11-3
 - I/O timeout, changing, 6-4
 - IBM computers, cables to connect, 10-11
 - ink levels, checking, 7-2
 - ink problems, 9-12
 - ink-drying time, 2-27
 - inked area, glossary definition, 11-3
 - installation. *See* setting up
 - interface
 - cables, 1-17
 - Centronics, 1-17
 - choosing serial or parallel, 1-17
 - network, 1-5
 - parallel, 1-17
 - parallel specifications, 10-8
 - problems, 9-8
 - serial, 1-17, 9-3
 - serial parameters, when to change, 6-3
 - serial specifications, 10-8
 - specifications, 10-8
 - internal prints, 5-1, 5-2
 - interrupting a print, 9-14
 - intersecting lines (merge), 3-11
 - ISO size, glossary definition, 11-3
- J**
- jagged lines, 9-14
 - jammed media, 9-5
 - JIS size, glossary definition, 11-3
- K**
- keys
 - Cancel, 4-2
 - Form Feed, 2-28, 2-29
 - Media Source, 2-7
 - Media Type, 2-8
 - Print Quality, 2-8, 3-16
 - Reprint, 4-2
 - Setup, 1-20, 1-23
- L**
- LAN, 1-18
 - glossary definition, 11-3
 - languages (graphics), 10-3
 - changing, 6-3
 - documentation, 10-19
 - languages (human)
 - changing, 1-14
 - manuals available in, 10-15
 - supported, 1-14
 - legs, 10-17
 - legs assembly, 10-17
 - lever, for media jam, 9-5
 - lights, front-panel, 8-2
 - line quality problems, 9-12
 - Load Media, front-panel light, 8-3
 - load-media button, glossary definition, 11-3
 - Local Area Network, 1-18
 - location of printer, 1-8
 - logical pens, settings, 3-2
 - long-axis printing, glossary definition, 11-3
- M**
- Macintosh computers, cables to connect, 10-11
 - maintenance, 7-1
 - managing prints, 4-1
 - manuals, 10-15, 10-19
 - margin, glossary definition, 11-3
 - margins, 10-3
 - margins (printing areas), 10-7
 - matte, glossary definition, 11-3
 - matte film, glossary definition, 11-3
 - maximum media sizes, 10-3
 - Media, front-panel light, 8-4
 - media, 2-1
 - bin, 2-2
 - care of, 2-2
 - choosing, 2-2
 - drying time, 2-27
 - environmental specifications, 10-5
 - glossary definition, 11-3

-
- handling, 2-2
 - problems, 9-4
 - HP DesignJet films, 10-18
 - HP DesignJet papers, 10-18
 - jam, 9-5
 - loading
 - preliminary actions, 2-7
 - problems, 9-4
 - realignment, 2-13
 - roll, 2-20
 - sheet, 2-9
 - with roll-feed option installed, 2-26
 - tutorial, 2-9
 - physical characteristics, 2-4
 - print quality, 2-5
 - product numbers, 10-18
 - realignment, 2-13, 2-23
 - required for setting up, 1-5
 - roll or sheet, 2-7
 - sheet orientation, 2-9, 2-10, 2-20
 - sizes and printing areas, 10-3, 10-7
 - supplies, 10-16
 - type, setting, 2-8
 - type for application, 2-6
 - types supported, 2-3, 10-2
 - unloading, 2-27
 - using HP, 2-2
 - media deflector, glossary definition, 11-3
 - media lever, glossary definition, 11-3
 - Media Source key, 2-7
 - Media Type key, 2-8
 - memory, xiii, 6-2, 10-16
 - and file size, 6-4
 - expansion modules, 1-5, 10-16
 - installation, 1-6
 - upgrading, 6-4
 - Merge, 3-11
 - Microsoft Windows, driver, 10-16
 - Microsoft Windows applications, 1-24
 - minimum media sizes, 10-3
 - Mirroring an image, 3-10
 - monochrome, printing color as, 3-13
 - MSDS (Material Safety Data Sheet), 10-12
- N**
- network, 6-4
 - connections, 1-18
 - interface, 1-5
 - ordering, 10-17
 - Normal, front-panel light, 8-5
 - nozzles, checking, 5-9
- O**
- opaque bond, glossary definition, 11-3
 - options
 - See also* accessories
 - color upgrade, 10-15
 - legs, 10-17
 - memory, 1-5
 - network interface, 1-5
 - roll-feed, 10-17
 - ordering accessories, 10-15, 10-19
 - orientation, 2-9
 - overlapping lines, treatment of, 3-11
 - overlay of one print on another, 9-10
- P**
- page size, 3-3
 - adjusting, 3-4
 - and clipping, 3-6
 - palette, glossary definition, 11-3
 - paper. *See* media
 - parallel, 1-17
 - parallel interface, glossary definition, 11-3
 - parity, glossary definition, 11-3
 - part numbers, 10-15
 - PC, cables to connect, 10-11
 - pen settings, 1-22
 - seem to have no effect, 9-11
 - pens, limiting exposure, 7-4
 - pens (logical), settings, 3-2
 - pens (physical). *See* cartridges
 - physical specifications, 10-4
 - pin-outs, 10-8
 - PJL, glossary definition, 11-3
 - PJL documentation, 10-16
 - Plain, front-panel light, 8-5
 - print appearance, 3-1
 - blank, 9-9
 - clipped, 9-10
 - content problems, 9-9
 - distorted, 9-11
 - management, 4-1
 - position problems, 9-9
 - unexpected, 9-11
 - print appearance, controlling, 3-2
 - prints
 - maximum per day, 10-4
 - special internal, 5-1
 - printing area, 10-7
 - glossary definition, 11-3
 - polyester film, 10-2
 - ports
 - on computer, 1-17
 - on printer, 1-17
 - position of printer, 1-8
 - power
 - cord, 1-4, 1-9
 - socket, 1-9
 - supply, 1-9
 - power specifications, 10-4
 - priming cartridges, 7-7
 - print cartridges. *See* cartridges
 - print quality
 - changing, 3-16
 - choosing, 3-15
 - media types, 2-5
 - setting, 2-8
 - Print Quality key, 2-8, 3-16
 - print quality problems, 9-12
 - print resolution, 10-3
 - problem-solving. *See* troubleshooting
 - programming documentation, 10-19
 - programming languages, 10-3
- Q**
- quality problems, 9-12
- R**
- RAM, 6-2
 - raster, glossary definition, 11-3
 - Ready, front-panel light, 8-3
 - realigning
-

Index

-
- roll, 2-23
 - sheet, 2-13
 - recalibrate the printer, 6-11
 - recalibrating, accuracy, 6-11
 - reconfiguring printer, 6-1
 - reference, 10-1
 - regulations
 - Declaration of Conformity (EC), 10-14
 - EMC, 10-6
 - notices, 10-12
 - safety, 10-6
 - regulatory notices, 10-12
 - replacing cartridges, 7-2
 - Reprint key, 4-2
 - resolution (print), xii, 10-3
 - RGB, glossary definition, 11-3
 - Roll, front-panel light, 8-5
 - roll
 - changing, 2-16
 - loading, 2-20
 - specifying, 2-7
 - trimming, 2-25
 - unloading at end of print, 2-29
 - Roll light, 2-7
 - roll-feed assembly, 10-17
 - ROM SIMM, glossary definition, 11-4
 - Rotate
 - and clipping, 3-9
 - interaction with software, 3-9
 - Rotating a plot, 3-7
 - RS-232-C specifications, 10-8
 - RS-232-C, glossary definition, 11-3
 - RTL, glossary definition, 11-3
 - RTL documentation, 10-16, 10-19
- S**
- safety, MSDS, 10-12
 - safety specifications, 10-6
 - self test, 5-8
 - serial, 1-17
 - serial interface, glossary definition, 11-4
 - service station, 1-10
 - setting up
 - checklist, 1-3
 - fast track (quick setup), 1-2
 - full instructions, 1-3
 - Setup Sheet, 1-14, 1-19
 - defaults, 1-22
 - how to print, 5-2
 - items in, 1-22
 - sample, 1-21
 - shadows of color, 9-14
 - Sheet, front-panel light, 8-5
 - sheet
 - loading, 2-9
 - with roll-feed option installed, 2-26
 - specifying, 2-7
 - unloading, 2-28
 - unloading at end of plot, 2-28
 - sheet media, orientation, 2-9, 2-10, 2-20
 - sheet sizes supported, 10-3
 - signal specifications, 10-8
 - SIMM, slots, 6-6
 - Size, item in Setup Sheet, 3-5
 - size, printer, 10-4
 - sizes of media supported, 10-3
 - slots, for SIMMs, 6-6
 - slow printing, 9-16
 - smears, 9-15
 - software, 1-24
 - supplied, 1-4
 - Software Application Notes, 10-15
 - Software/Hardware Guide, 10-15
 - sound levels, 10-4
 - space around printer, 1-8
 - specifications, 10-2
 - acoustic, 10-4
 - ecological, 10-5
 - electromagnetic, 10-6
 - EMC, 10-6
 - environmental, 10-5
 - functional, 10-2, 10-3
 - interface, 10-8
 - physical, 10-4
 - power, 10-4
 - safety, 10-6
 - speed problems, 9-16
 - spindle
 - glossary definition, 11-4
 - removing, 2-16
 - spindle assembly, part numbers, 10-17
 - stand, 10-17
 - Sun workstation, cables to connect, 10-11
 - supplies. *See* accessories
 - support, 9-17
 - Support services documentation, 10-15
- T**
- temperature, 10-5
 - termination of files, 1-22
 - testing the printer, 5-4, 5-8, 9-3
 - throughput, 10-4
 - tracing paper, glossary definition, 11-4
 - translucent, 10-2
 - translucent bond, glossary definition, 11-4
 - trimming an uneven roll, 2-25
 - troubleshooting, 9-1
 - front-panel lights, 8-2
 - media handling, 9-4
 - media jam, 9-5
 - media loading, 9-4
 - miscellaneous problems, 9-16
 - print content, 9-9
 - print position, 9-9
 - print quality problems, 9-12
 - procedure, 9-2
- U**
- unloading
 - media, 2-27
 - print from roll, 2-29
 - sheet, 2-28
 - upgrade
 - color, 6-5
 - legs, 10-17
 - memory, 6-4
 - network, 6-4
-

V

vector, glossary definition, 11-4

Vectra computers, cables to connect,
10-11

vellum, 10-2

glossary definition, 11-4

W

warped lines, 9-14

weights, 10-4

Windows applications, 1-24

driver, 10-16

workstation, cables to connect, 10-11

X

X-axis, glossary definition, 11-4

Y

Y-axis, glossary definition, 11-4

Index

Documentation map

Printed Documentation for Users of the HP DesignJet 430 and 450C Printers

Setting up and using the printer

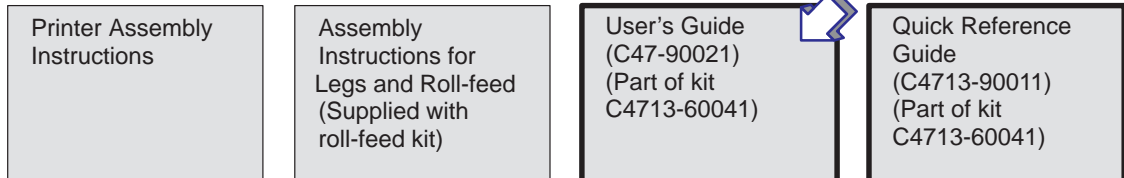

Using application software

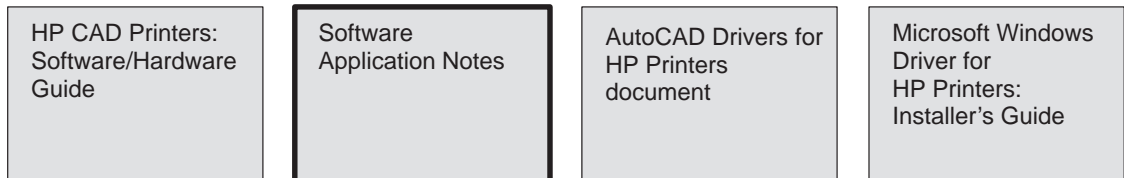

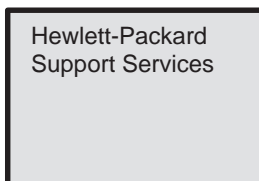

Getting support



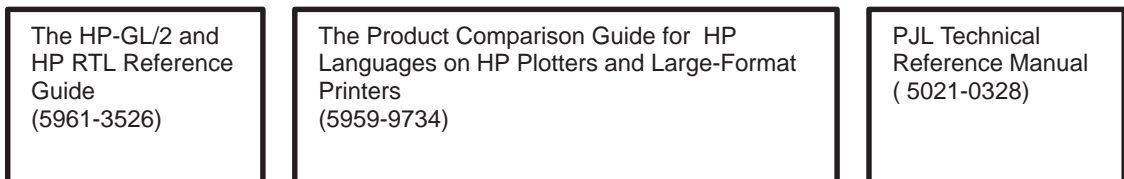

Programmer's reference



 These documents are supplied with this printer.

 These documents can be ordered separately.
For details, see under "Ordering accessories" in chapter 10.

 These documents are supplied with this printer and can be ordered separately.

 This manual.

Please give us your feedback on the quality of this documentation

If mailing to the address in
the USA (see over), fill out
this sheet.

If mailing to the address in
Spain, fill out *the other*
sheet.

Alternatively, you can fax this
form to:

**Spain (34) 3 582 1400,
Attn: Learning Products Dept.**

Name:

Job Title:

Organization:

Address:

Phone:

Circle the appropriate score

Poor



Excellent

Overall ease of use of this manual

1

2

3

4

5

Overall ease of use of the Quick Reference Guide

1

2

3

4

5

Use of language in both documents

1

2

3

4

5

Use of graphics in both documents

1

2

3

4

5

Please explain any low score:

Any other comments on any of the documentation accompanying the plotter:



Any comments?

▼ Fold here and then staple or tape the ends together ▼



NO POSTAGE
NECESSARY
IF MAILED
IN THE
UNITED STATES

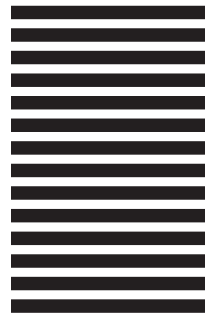

BUSINESS REPLY MAIL

FIRST CLASS MAIL PERMIT NO. 24343 SAN DIEGO, CA

POSTAGE WILL BE PAID BY ADDRESSEE



HP DesignJet Marketing Center
Hewlett-Packard Company
Building #7
16399 West Bernardo Drive
San Diego, CA 92127
U.S.A.



Please give us your feedback on the quality of this documentation

Name:

Job Title:

Organization:

Address:

Phone:

If mailing to the address in Spain (see over), fill out *this sheet*.

If mailing to the address in the USA, fill out *the other sheet*.

Alternatively, you can fax this form to:

Spain (34) 3 582 1400,
Attn: Learning Products Dept.

Circle the appropriate score

Poor



Excellent

Overall ease of use of this manual

1

2

3

4

5

Overall ease of use of the Quick Reference Guide

1

2

3

4

5

Use of language in both documents

1

2

3

4

5

Use of graphics in both documents

1

2

3

4

5

Please explain any low score:

Any other comments on any of the documentation accompanying the plotter:

Cut here



Any comments?

▼ Fold here and then staple or tape the ends together ▼



Hewlett-Packard Company
Barcelona Division
Attn: Learning Products Dept.
Avda. Graells, 501
08190 Sant Cugat del Vallès
Spain

Hewlett-Packard Limited Warranty Statement

HP Product Duration of Limited Warranty

Software:	90 Days
Ink Cartridges:	90 Days
Printheads:	1 Year
Printer and Related HP Hardware:	1 Year

A. Extent of Limited Warranty

1. Hewlett-Packard (HP) warrants to the end-user customer that the HP products specified above will be free from defects in materials and workmanship for the duration specified above, which duration begins on the date of purchase by the customer. Customer is responsible for maintaining proof of date of purchase.
2. For software products, HP's limited warranty applies only to a failure to execute programming instructions. HP does not warrant that the operation of any product will be uninterrupted or error free.
3. HP's limited warranty covers only those defects which arise as a result of normal use of the product, and do not apply to any:
 - a. Improper or inadequate maintenance or modification;
 - b. Software, interfacing, media, parts, or supplies not provided or supported by HP; or
 - c. Operation outside the product's specifications.
4. For HP printer products, the use of a non-HP ink cartridge or a refilled ink cartridge does not affect either the warranty to the customer or any HP support contract with the customer. However, if printer failure or damage is attributable to the use of a non-HP or refilled ink cartridge, HP will charge its standard time and materials charges to service the printer for the particular failure or damage.
5. If HP receives, during the applicable warranty period, notice of a defect in any software, media, or ink cartridge product which is covered by HP's warranty, HP shall replace the defective product. If HP receives, during the applicable warranty period, notice of a defect in any hardware product which is covered by HP's warranty, HP shall either repair or replace the defective product, at HP's option.
6. If HP is unable to repair or replace, as applicable, a defective product which is covered by HP's warranty, HP shall, within a reasonable time after being notified of the defect, refund the purchase price for the product.
7. HP shall have no obligation to repair, replace, or refund until the customer returns the defective product to HP.
8. Any replacement product may be either new or like-new, provided that it has functionality at least equal to that of the product being replaced.
9. HP products may contain remanufactured parts or components equivalent to new in performance or may have been subject to incidental use.
10. HP's limited warranty is valid in any country where the covered HP product is distributed by HP except for the Middle-East, Africa, Argentina, Brazil, Mexico, Venezuela, and France's "Departements D'Outre-Mer"; for those excepted areas, the warranty is valid only in the country of purchase. Contracts for additional warranty services, such as on-site service, may be available for any authorized HP service facility where the listed HP product is distributed by HP or an authorized importer.

B. Limitations of Warranty

1. TO THE EXTENT ALLOWED BY LOCAL LAW, NEITHER HP NOR ITS THIRD PARTY SUPPLIERS

MAKE ANY OTHER WARRANTY OR CONDITION OF ANY KIND, WHETHER EXPRESS OR IMPLIED, WITH RESPECT TO THE HP PRODUCTS, AND SPECIFICALLY DISCLAIM THE IMPLIED WARRANTIES OR CONDITIONS OF MERCHANTABILITY, SATISFACTORY QUALITY, AND FITNESS FOR A PARTICULAR PURPOSE.

C. Limitations of Liability

1. To the extent allowed by local law, the remedies provided in this Warranty Statement are the customer's sole and exclusive remedies.
2. TO THE EXTENT ALLOWED BY LOCAL LAW, EXCEPT FOR THE OBLIGATIONS SPECIFICALLY SET FORTH IN THIS WARRANTY STATEMENT, IN NO EVENT SHALL HP OR ITS THIRD PARTY SUPPLIERS BE LIABLE FOR DIRECT, INDIRECT, SPECIAL, INCIDENTAL, OR CONSEQUENTIAL DAMAGES, WHETHER BASED ON CONTRACT, TORT, OR ANY OTHER LEGAL THEORY AND WHETHER ADVISED OF THE POSSIBILITY OF SUCH DAMAGES.

D. Local Law

1. This Warranty Statement gives the customer specific legal rights. The customer may also have other rights which vary from state to state in the United States, from province to province in Canada, and from country to country elsewhere in the world.
2. To the extent that this Warranty Statement is inconsistent with local law, this Warranty Statement shall be deemed modified to be consistent with such local law. Under such local law, certain disclaimers and limitations of this Warranty Statement may not apply to the customer. For example, some states in the United States, as well as some governments outside the United States (including provinces in Canada), may:
 - a. Preclude the disclaimers and limitations in this Warranty Statement from limiting the statutory rights of a consumer (e.g. the United Kingdom);
 - b. Otherwise restrict the ability of a manufacturer to enforce such disclaimers or limitations; or
 - c. Grant the customer additional warranty rights, specify the duration of implied warranties which the manufacturer cannot disclaim, or not allow limitations on the duration of implied warranties.
3. FOR CONSUMER TRANSACTIONS IN AUSTRALIA AND NEW ZEALAND, THE TERMS IN THIS WARRANTY STATEMENT, EXCEPT TO THE EXTENT LAWFULLY PERMITTED, DO NOT EXCLUDE, RESTRICT, OR MODIFY, AND ARE IN ADDITION TO, THE MANDATORY STATUTORY RIGHTS APPLICABLE TO THE SALE OF HP PRODUCTS TO SUCH CUSTOMERS.

Revision: May 15th, 1998

About this edition

Edition dates are as follows:

First edition, July 1997

Second edition, July 1998

New editions are complete revisions of the manual. Change sheets, which may be issued between editions, contain additional information. The dates on the title page change only when a new edition is published. Minor corrections that do not affect the function of the product may be made at reprint without a change to the print date.

Many product updates and fixes do not require manual changes and, conversely, manual corrections may be done without accompanying product changes. Therefore, do not expect a one to one correspondence between product updates and manual revisions.



C4713-90021

Manual Part Number: C4713-90021

English

