



HP Designjet 9000s Printer series

User's Guide



Legal notices

The information contained in this document is subject to change without notice.

Hewlett-Packard makes no warranty of any kind with regard to this material, including, but not limited to, the implied warranties of merchantability and fitness for a particular purpose.

Hewlett-Packard shall not be liable for errors contained herein or for incidental or consequential damages in connection with the furnishing, performance, or use of this material.

No part of this document may be photocopied or translated to another language without the prior written consent of Hewlett-Packard Company.

Table of contents

1 Introduction

Using this guide.....	2
Introduction.....	2
How do I	2
The problem is	2
Tell me about	2
Index.....	2
The printer's main components [9000s].....	2
Front view.....	3
Rear view.....	4
The heaters.....	4
The printer's front panel.....	5
Basic printer operations and keys.....	8
The heater's front panel.....	9
Defining heater parameters.....	10
Safety precautions.....	10
General warnings.....	10
General cautions.....	12
Handling precautions.....	13
Power supply.....	13
Printer.....	13
Regular inspection and maintenance.....	13
Consumables.....	13

2 How do I perform basic operations?

Connect to a computer.....	15
Choose the system configuration.....	15
Connection procedure.....	15
Turn the power on/off.....	16
Turn on the printer.....	16
Turn on the heater.....	19
Turn the power off.....	19
Turn off the printer.....	19
Turn off the heater.....	20

3 How do I load/unload media?

Install a media roll in the printer.....	24
Remove a media roll from the printer.....	32
Replace a jammed media roll.....	33

Load cut sheet.....	34
Use the take-up reel.....	39
Set the take-up reel winding direction.....	39
Define the take-up reel winding mode.....	41
Load media on to the take-up reel.....	43
Use the media edge guard.....	47
Set the fan guard lever.....	49
4 How do I... (printing topics)	
Perform a manual media feed.....	51
Use manual nesting.....	52
Increase/reduce pressure on media.....	55
Pause or cancel print jobs.....	56
5 How do I... (ink topics)	
Replace an ink cartridge.....	59
Change the printhead height.....	61
6 How do I maintain the printer?	
Regular maintenance guide.....	65
Daily printhead maintenance.....	66
Wiper blade cleaning.....	67
Capping unit cleaning.....	72
Leave the printer off for two to four weeks.....	74
Ink system storage.....	75
Leave the printer off for less than two weeks.....	76
Clean ink system.....	76
Charge the ink system.....	77
Clean the exterior of the printer.....	78
Clean the rear cover and media feed.....	78
Clean the platen.....	79
Replace the waste ink bottle.....	81
Normal printhead recovery.....	84
IQ Print.....	85
7 How do I get the best image quality?	
Print the Image Quality print.....	88
Interpret the image quality print.....	90
Manage media types.....	91
Copy a media type to create a new one.....	91
Create a new media type.....	92
Modify media type settings.....	93
Delete a media type.....	94
Calibrate the printer.....	95
Calibrate media advance.....	95
Perform printhead position adjustment.....	98
Back feed adjustment print.....	99
Adjust heater and print mode settings.....	101

8 The problem is... (troubleshooting topics)

The problem is... (checklist).....	104
A head crash.....	105
Ink cartridge is not installed.....	108
Ink cartridge is not detected.....	108
Ink cartridge is near expiry date.....	108
Ink cartridge has passed its expiry date.....	109
An error message.....	109
Service errors.....	109
POC error messages.....	110
Engine error messages.....	110
System error messages.....	110
Operator error messages.....	110
Ink cartridge.....	110
The ink LED flashes.....	112
Waste ink bottle is not installed.....	112
Waste ink bottle is full.....	112
Media crash.....	112
Media.....	112
Error LED is flashing.....	113
Other messages.....	113
An abnormal sound.....	114

9 The problem is print quality

10 Tell me about... (basic knowledge topics)

Operating conditions.....	118
Installation space.....	118
Environmental conditions.....	118
Operating temperature and humidity levels.....	118
Places where the printer must not be installed.....	119
The power supply.....	119
Power.....	119
Dryer.....	120
Exhaust attachment.....	120
Front panel messages and printer state.....	120
Messages on the front panel.....	120
Initialization display.....	120
Online state (idle mode) display.....	121
Online state (print mode) display.....	121
Online state (print pause mode) display.....	121
Print stop and resume.....	121
Print cancel (end).....	121
Online state (print information mode) display.....	122
Offline (menu mode) display.....	122
Shutdown state display.....	123

11 Tell me about media

Storing media.....	125
--------------------	-----

Disposing of media.....	125
Using media.....	126
Handling prints.....	126
Other precautions.....	126

12 Tell me about the ink system

Ink cartridges.....	127
Replacing an ink cartridge.....	129
Ink cartridge storage and disposal.....	130
HP 790 Waste Ink Bottle.....	131
Precautions for handling the waste ink bottle.....	131
HP 790 Cap Cleaning Liquid.....	131
HP 790 Wiper Cleaning Liquid and Dropper.....	132
HP Cleaning Swabs.....	132
HP 790 Storage Kit.....	132
HP 790 Ink System Cleaning Kit.....	133

13 Tell me about waste management

General recommendations.....	136
------------------------------	-----

14 Tell me about front panel menus

Menu operations.....	140
Menu structure.....	140
Making front panel selections and settings.....	140
To define a setting.....	140
To define a value.....	141
Character list.....	142
The INK menu & messages.....	143
Replacing an empty ink cartridge.....	143
Replacing ink cartridges during printing.....	143
The ink cover is open.....	144
The ink cartridge is empty.....	144
The MEDIA menu.....	144
The MEDIA REG menu.....	145
Selecting a media type number (SELECT MEDIA).....	146
Setting a media type name (RENAME MEDIA).....	146
Media advance value (MEDIA ADV VALUE).....	146
Manufacturing default media advance value (MFNG VAL).....	147
Dry time value (DRY TIME VALUE).....	147
Print mode setting (PRINT MODE).....	147
Print direction setting (PRINT DIRECTION).....	147
Flatten time (FLATTEN TIME).....	148
Use media edge guard (USE EDGE GUARD).....	149
Media advance mode (MEDIA ADV MODE).....	149
Take-up reel mode (TUR MODE).....	149
Leading edge mode (LEADING EDGE).....	150
Vacuum level setting (VACUUM LEVEL).....	150
Initial temperature setting for the front heater (FRONT HEATER T).....	151
Initial temperature setting for the print heater (PRINT HEATER T).....	151

Initial temperature setting for the rear heater (REAR HEATER T).....	151
Color stripe setting (COLOR STRIPE).....	152
Printhead firing mode setting (IMAGE GRADIENT).....	152
Printhead height setting (PH HEIGHT VAL).....	153
Bidirectional print position (Left) adjustment (YY BIDIR DEF(L)).....	153
Bidirectional print position (Right) adjustment (YY BIDIR DEF(R)).....	153
Printhead cleaning mode (PH CLEANING).....	154
Media back feed adjustment (BACK ADJUST VAL).....	154
Media advance preference (ADVANCE PREF).....	155
Print mode preference (PRINT MODE PREF).....	155
Heater preference (HEATER PREF).....	155
Printhead rest period (PH REST PERIOD).....	155
Printhead rest time (PH REST TIME).....	156
Printhead temperature rest (PH TEMP REST).....	156
Deleting a media type (DELETE MEDIA).....	156
Copying a media type (COPY MEDIA).....	156
Pasting a media type (PASTE MEDIA).....	156
Default values for media types.....	156
Media advance calibration.....	158
Media advance calibration print.....	158
Back feed adjustment print.....	158
Media back feed adjustment value.....	159
The PH. MAIN menu.....	159
Ink system optimization (INK SYS OPT).....	159
Cap cleaning (CAP CLEANING).....	160
Wiper cleaning (WIPER CLEANING).....	160
Washing printheads (WASH PRINTHEADS).....	160
Printhead height (PH HEIGHT ADJ).....	161
The PH.RECOVERY menu.....	161
The FEED menu.....	161
The PRINTER menu.....	162
Configuration print (CONFIG PRINT).....	162
Error log information print (ERROR LOG PRINT).....	162
History print (HISTORY PRINT).....	162
The ADJUST menu.....	163
Adjustment pattern print (TEST PRINTS).....	163
Printhead nozzle position adjustment (#YY PH ROW VAL).....	163
Printhead position adjustment (#YY PH TO PH VAL).....	163
Bidirectional print position (Left) adjustment (YY BIDIR DEF(L)).....	164
Bidirectional print position (Right) adjustment (YY BIDIR DEF(R)).....	164
Bidirectional print position (Left) adjustment (YY BIDIR F.D (L)).....	164
Bidirectional print position (Right) adjustment (YY BIDIR F.D (R)).....	165
The SETUP menu.....	165
Language for front panel (LANGUAGE).....	165
BOOT version display (BOOT VERSION).....	165
Acoustic warning (BEEP).....	165
F/W version display (F/W VERSION).....	166
Main PCA version display (MAIN PCA VER).....	166
ICB board version display (CARRIAGE PCA).....	166
ASIC version display (ASIC VER).....	166

Heater H/W version display (HEATER HW VER).....	166
Heater F/W version display (HEATER FW VER).....	167
System date setting (SYSTEM DATE).....	167
System time setting (SYSTEM TIME).....	167
Factory default setting (FACTORY DEFAULT).....	167
USB address (USB ADDRESS).....	167
USB speed (USB SPEED).....	168

15 Tell me about the heaters

The heaters.....	169
Heater temperature settings.....	170
Heater preset temperature by medium.....	171
Flow of heater temperature setting.....	172
Temperature control.....	172
Maintaining the preset temperature.....	172
Maintaining the standby temperature.....	173
Turning off the heaters.....	173
The heater front panel.....	173
Display in normal mode.....	173
Display — heater on.....	174
Display — heater off.....	174
Display — heater AC power is turned off.....	174
Heater parameter setup mode.....	174
Setup items and parameters.....	174
Heater error messages.....	175

16 Tell me about printer specifications

Specifications.....	178
Ecological specifications.....	179

17 Tell me about ordering supplies and accessories

Ordering supplies.....	182
Ordering media.....	182
Ordering accessories.....	183

18 Tell me about getting help

HP Customer Care.....	185
HP Designjet Online.....	186

Index.....	187
------------	-----

1 Introduction

- Using this guide
- The printer's main components [9000s]
- The printer's front panel
- Basic printer operations and keys
- The heater's front panel
- Defining heater parameters
- Safety precautions
- Handling precautions

Using this guide

Using your printer is organized into the following chapters.

Introduction

This chapter provides a brief introduction to the printer and its documentation for new users.

How do I ...

These chapters help you to carry out various procedures such as loading media or changing an ink cartridge. Many of these procedures are illustrated with drawings.

The problem is ...

These chapters help you to solve problems that may occur while printing.

Tell me about ...

These chapters contain reference information, including the specifications of the printer, and the part numbers of media types, ink supplies, and other accessories.

Index

In addition to the table of contents, there is an alphabetical index to help you to find topics quickly.

The printer's main components [9000s]

The following front and rear views of the printer illustrate the main components.

Front view

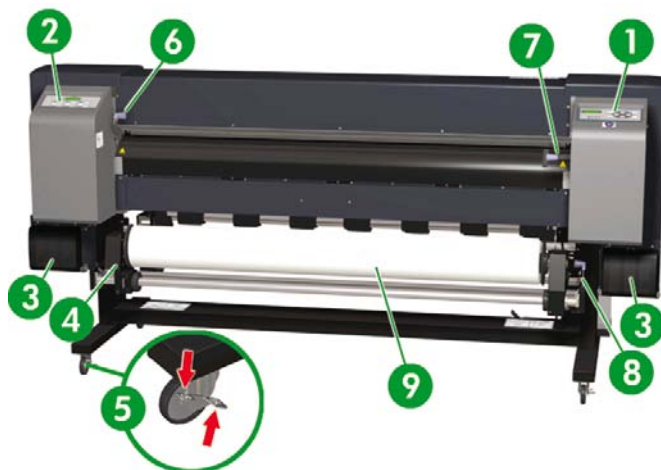

1. Printer front panel
2. Heater front panel
3. Ink supply station
4. Media hub
5. Wheel lock
6. Media pressure lever
7. Media load lever
8. Media End (ME) lever
9. Roll

Rear view

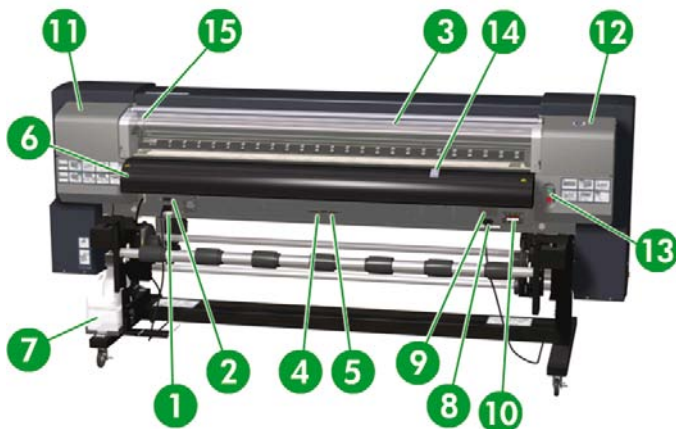

1. Printer power socket
2. Printer power on/off switch
3. Rear cover
4. USB port
5. Not used
6. Media output
7. Waste ink bottle
8. 100 V / 200 V alternation switch
9. Heater power on/off switch
10. Heater power socket
11. Cap cover
12. Wiper cover
13. Printer Online — Cancel keys
14. Fan guard lever
15. Printhead height lever

The heaters

The printer includes three heaters for fixing and stabilizing the printed image on the media. Each heater is controlled separately.

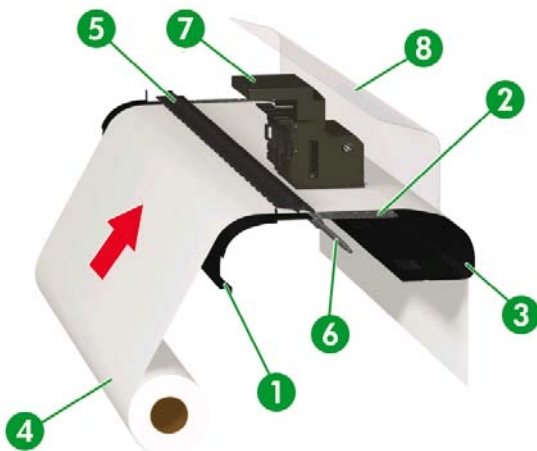

1. Front heater (preheats the media)
2. Print heater (fixes the ink on to the media)
3. Rear heater (dries the ink and stabilizes the printed image)
4. Media roll
5. Pressure roller
6. Grid roller
7. Carriage
8. Rear cover



WARNING! Do not touch heater surfaces in the paper path. This may cause burns.

The printer's front panel

Your printer's front panel is located on the front of the printer, on the right-hand side. It has the following important functions:

- It must be used to perform certain operations, such as loading and unloading media.
- It can display up-to-date information about the status of the printer, the ink cartridges, the printheads, the media, etc.
- It can provide guidance in using the printer.

- It displays warning and error messages when appropriate.
- It can be used to change the values of printer settings, changing the operation of the printer.

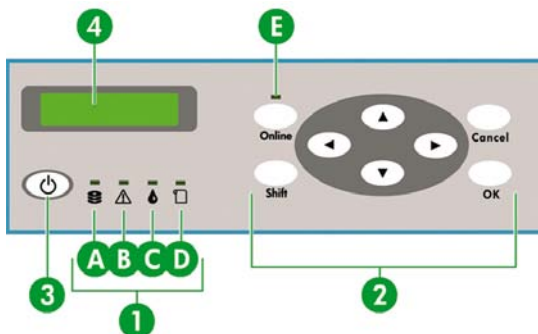

The front panel has the following components:

1. The LEDs light, flash, or turn off to indicate the status of the printer.
 - A. The green Data LED shows the data reception state.
 - Flashing: data are being received from the computer
 - Off: nothing is being received from the computer
 - B. The orange Error LED indicates whether an error has occurred.
 - On: an error has occurred
 - Flashing: warning state (take-up reel time-out error)
 - Off: normal (no error has occurred)
 - C. The green Ink LED shows the status of the ink cartridges.
 - On: all ink cartridges are present
 - Flashing: ink is running out in at least one cartridge
 - Off: no ink (ink has run out in at least one cartridge)
 - D. The green Media LED shows whether media is loaded.
 - On: media is loaded (roll or cut sheet)
 - Off: no media is loaded

- E. The green Online LED indicates whether the printer is online.
- On: online
 - Flashing: online pause mode
 - Off: offline
2. The keys set printer functions.
- The ONLINE key switches the printer online or offline and provides access to the front panel menu groups.
 - The SHIFT key is used to switch between the menu groups.
 - The CANCEL key cancels an input parameter.
 - The OK key selects a menu or enters a parameter.
 - The four arrow keys select a menu or select menu options (selection, number up/down).
3. The Power key turns the printer on and off.
4. The LCD displays information and menus.

Basic printer operations and keys

To enable menu operations:

1. Enter the offline mode by pressing the ONLINE key.
2. When the printer enters the offline mode, a menu group screen is displayed.



Menu group selection:

- Select a menu group using the ▲, ▶, ▼, and ◀ keys.
- Switch between menu group screens with the SHIFT key.

To access a menu, use the arrow key that corresponds to the menu group you want to access.

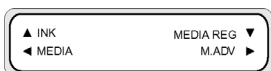

To switch to the next menu group, press SHIFT.

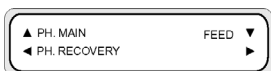

To switch to the next menu group, press SHIFT.

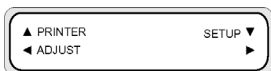

If you select a menu in the menu groups, you will then be able to select an option or submenu:

- ▲ and ▼ keys: change between menus at the same level.
- ◀ key: return to menu group selection.
- OK key: select a submenu or option so that parameters can be changed.

Setting or changing parameters:

- ▲ and ▼ keys: switch between parameters, or increase or decrease a selected value.
- ◀ and ▶ keys: change the digit you need to modify when entering a value.

Setting a parameter or canceling:

- OK key: sets a parameter.
- CANCEL key: cancels an input parameter value and returns to the submenu/option selection.

The heater's front panel

The heater's front panel is located on the front of the printer, on the left-hand side. The heater front panel displays the settings for the Front, Print, and Rear heaters. It can also be used to control the temperature settings.

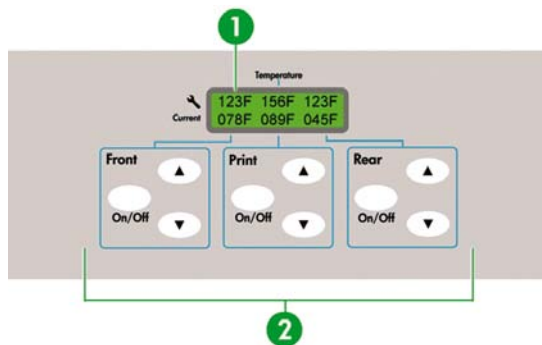

1. The display screen at the top of the panel shows the target temperature and the current temperature of each heater.
2. The three On/Off switches turn the three heaters on or off. The three pairs of ▲ or ▼ keys can be used to raise or lower the target temperatures of the heaters.

Defining heater parameters

1. On the heater front panel press the ON/OFF key, and the ▲ and ▼ keys at the same time to enter the parameter setup mode.

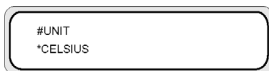

2. Select a setup parameter using the ▲ and ▼ keys on the heater front panel and press the ON/OFF key on the heater front panel to modify the setup item displayed.
3. Use the ▲ and ▼ keys to select the value and press the ON/OFF key to confirm.



NOTE If you have selected an incorrect setup value, you can press the ON/OFF key again to cancel the setting and repeat from step 2.

4. To exit the parameter setup mode, scroll to the **EXIT** option and press the ON/OFF key to select **YES**.

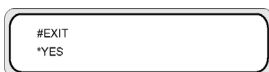

5. Press the ON/OFF key on the heater front panel to confirm.



Safety precautions

The following symbols are used in this manual to ensure the proper use of the printer and to prevent the printer from being damaged. Follow the instructions marked with these symbols.



WARNING! Failure to follow the guidelines marked with this symbol could result in serious personal injury or death.



CAUTION Failure to follow the guidelines marked with this symbol could result in minor personal injury or damage to the product.

General warnings

- Use the power supply voltage specified on the nameplate. Avoid overloading the printer's electrical outlet with multiple devices.
- Be sure the printer is well-grounded. Failure to ground the printer may result in electrical shock, fire, and susceptibility to electromagnetic interference.
- Do not disassemble or repair the printer yourself. Do not reinstall the printer in a new location. Call your local HP Service Representative for service.

- Use only the electrical cord supplied by HP with the printer. Do not damage, cut, or repair the power cord. A damaged power cord has risk of fire and electric shock. Replace a damaged power cord with an HP-approved power cord.
- Do not allow metal or liquids (except those used in HP Cleaning Kits) to touch the internal parts of the printer. Doing so may cause fire, electric shock, or other serious hazards.
- Power OFF the printer and unplug the power cable from the power outlet in any of the following cases:
 - When placing your hands inside the printer.
 - If there is smoke or an unusual smell coming from the printer.
 - If the printer is making an unusual noise not heard during normal operation.
 - A piece of metal or a liquid (not part of cleaning and maintenance routines) touches internal parts of the printer.
 - During an electrical (thunder/lightning) storm.
 - During a power failure.
- Inks used in the printer and liquids in the HP Cleaning kits contain an organic solvent (ethylene glycol monobutyl ether acetate, CAS No. 112-07-2). Observe all local, state, and federal regulations related to the handling, use, storage, and disposal of organic solvents.
- Ink and fluids used in the Cleaning Kits are combustible. Do not use or store within 8 meters (25 feet) of open flames, sparks, or other sources of ignition.
- Do not operate printer within 8 meters (25 feet) of open flames, sparks, or other sources of ignition. Do not smoke within 8 meters (25 feet) of the printer.
- Install and operate the printer in a well-ventilated area.
- The printer installation must meet local, state, and federal regulations on the emissions of volatile organic compounds in the workplace. It is the responsibility of the user to comply with these regulations. HP recommends that installations use an ink vapor extraction and exhaust system or an HP Air Purification System. Before installing a system exhausting ink vapors to the outside atmosphere, consult with your local air quality control authorities. It is your responsibility to comply with all local, state, and federal air pollution control regulations and building codes.
- Avoid contact between ink and skin, eyes, and clothing.
 - Immediately wash skin with soapy water.
 - Remove clothing soaked with ink from contact with skin.
 - Use an approved eye wash station if ink is splashed into eyes and consult a doctor if necessary.

If an approved eye wash station is unavailable, flush eyes with cold water and consult a doctor if necessary.
- Do not swallow ink. If swallowed, do not induce vomiting, but seek immediate medical attention.
- Keep ink cartridges, cleaning kits, and waste ink bottles out of the reach of children.
- Be sure all operators are trained in the use of emergency equipment such as eye wash stations and fire extinguishers and know where they are located.

General cautions

- Handle media rolls with care. They can be heavy and difficult to move in confined spaces. In some cases, two people should move and install media rolls. Dropping a media roll could cause personal injury or damage to the printer.
- Allow and maintain adequate space around printer for immediate access to safety equipment such as eye wash stations, fire extinguishers, glove and safety glass dispensers, and fireproof waste storage containers.
- Treat any media, used cleaning and maintenance supplies, and wipes soaked with ink as combustible materials. Handle and dispose of properly.
- If an Air Purification System is installed, allow adequate space for exhaust hoses from the printer. Locate these hoses and the Air Purification System so that they do not pose a trip hazard or interfere with the operation of the printer such as loading and unloading media, replacing ink cartridges, inspecting and replacing the waste ink bottle.
- Always hold the power cord by the plug when connecting and disconnecting from the power outlet. Never pull on the cord because this may damage it and create risk of fire and electric shock.
- Do not touch heater surfaces in the paper path. This may cause burns.

In order to ensure the safe operation of the printer, heed all of the cautions and warnings contained throughout this manual.

Handling precautions

These precautions are recommended to avoid damage to your printer and its components.

Power supply

- Use the power supply voltage specified on the nameplate.
- Check the printer electrical outlet for proper polarity and grounding before connecting printer. Failure to do so may result in fire and electric shock hazards.
- Be sure the printer is well-grounded. Failure to ground the printer may result in electrical shock, fire, and susceptibility to electromagnetic interference.
- Avoid overloading the printer's electrical outlet with multiple devices.
- Use only the electrical cord supplied by HP with the printer.

Printer

- Wipe the printer clean with a soft cloth. A cloth moistened with a neutral detergent may be used. Do not allow liquid to enter the printer. This may create risk of fire and electrical shock and cause a malfunction. Do not clean the printer with benzene or paint thinner. This may damage the paint.
- Never touch the printhead nozzles. They can be easily damaged or clogged.

Regular inspection and maintenance

- Clean the capping unit and wiper blade every day.
- Check the moisture of the wiper sponge every day.
- Store the ink system when leaving the printer for a long time (two weeks or more with the power off).
- Clean and charge the ink system before printing when leaving the printer for a long time.

Consumables

- Ink inside the ink cartridge is combustible. Do not expose or store near open flames, sparks, or other sources of ignition.
- HP ink cartridges must be installed before the "Install By" date printed on the cartridge. Use of the ink cartridge 3 months beyond the "Install By" date may cause deterioration in print quality or a printer malfunction.
- Do not disassemble the ink cartridges. Ink cartridges are intended for single use only.
- Avoid contact between ink and skin, eyes, and clothing.
 - Immediately wash skin with soapy water.
 - Remove clothing soaked with ink from contact with skin.
 - Use an approved eye wash station if ink is splashed into eyes and consult a doctor if necessary.

If an approved eye wash station is unavailable, flush eyes with cold water and consult a doctor if necessary.

- Use only an HP waste ink bottle. The bottle must be installed according to instructions or waste ink may overflow. An HP waste ink bottle must always be installed before turning the printer ON. Automatic and manual service cycles produce waste ink that must be contained in an HP waste ink bottle. Do not remove the cap from its tether to the HP waste ink bottle. The cap is needed to properly seal the HP waste ink bottle for disposal. Keep the HP waste ink bottle upright. Do not place on tables or shelves where it could fall. Waste ink is combustible. Keep an HP waste ink bottle containing waste ink away from open flames, sparks, or other sources of ignition. The level in the HP waste ink bottle must be checked by visual inspection to prevent overflow. If the waste ink level is above the indication line, the bottle must be replaced with an empty HP waste ink bottle.
- Place a sheet of paper under the HP waste ink bottle on the floor when removing a bottle containing waste ink. This will help clean up any ink spills. If soaked with ink, treat the paper as a combustible material and dispose of properly.
- Do not store HP ink cartridges in direct sunlight. Store HP ink cartridges in a cool, dry place. This prevents deterioration of the ink during storage.

2 How do I perform basic operations?

- Connect to a computer
- Turn the power on/off

Connect to a computer

This section describes system configuration and cable connection procedures.



NOTE Before connecting or disconnecting the USB cable, turn the printer OFF.

Choose the system configuration

The following connections are possible.

1. Printer
2. USB interface
3. Printer server (RIP)

Connection procedure



NOTE Before you connect the USB cable, you should ensure that the RIP is installed so that the printer can be detected by your operating system. Refer to the instructions that came with your RIP for installation instructions.

Connect a USB cable as follows:

1. Disconnect the USB cable from the rear of your printer if it is already connected.
2. Turn the printer off at the front panel.
3. Power off the printer using the power switch at the rear.
4. Connect a USB cable to the USB connector at the rear of the printer.
5. Connect a USB cable to the USB connector at the rear of the computer.
6. Power on the printer using the power switch at the rear.
7. Turn the printer on at the front panel.
8. On your computer, select the printer.

Turn the power on/off



WARNING! Use the power supply voltage specified on the nameplate.

Be sure the printer is well-grounded. Failure to ground the printer may result in electrical shock, fire, and susceptibility to electromagnetic interference.



CAUTION Always hold the power cord by the plug when connecting and disconnecting from the power outlet. Never pull on the cord because this may damage it and create risk of fire and electric shock.

Turn on the printer

1. Turn off (O) the printer switch on the left rear of the printer, and plug one end of the supplied power cable into the socket of the printer. Insert the other power plug of the cable into an electrical outlet.



WARNING! Avoid overloading the printer's electrical outlet with multiple devices. Use only the electrical cord supplied by HP with the printer. Do not damage, cut, or repair the power cord. A damaged power cord has risk of fire and electric shock. Replace a damaged power cord with an HP-approved power cord.

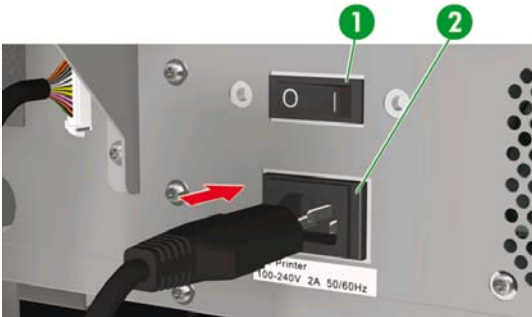

1. Printer switch
2. Power socket

2. Turn on (1) the printer switch on the left rear of the printer.

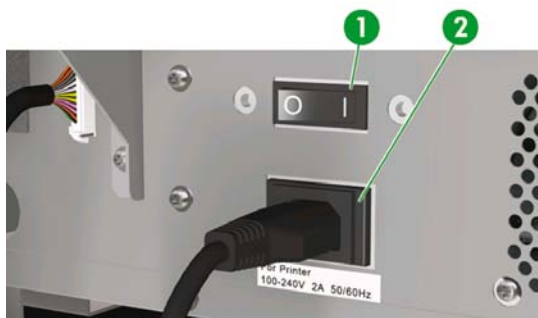

1. Printer switch
2. Power socket

3. Press the POWER ON/OFF key on the front panel.

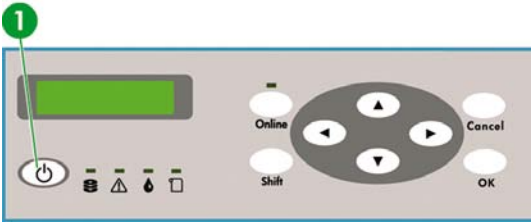

1. POWER ON/OFF key

When you press power on, the printer performs a power-on self-diagnostic test and the following message is displayed on the front panel.



(If a 64" paper roll is loaded).

When you turn the printer power on, the heater front panel display turns on. Turn on the heater power on/off switch at the rear of the printer to use the heater.

When the heater power is off, the following message is displayed on the heater front panel.



NOTE Only turn off the printer while **PRINTER READY** is displayed on the front panel except in an emergency. Do not turn off the printer while **INITIALIZING** or **PH.RECOVERY** is displayed on the front panel to avoid ink drops and damage to the printhead.

Turn on the heater

- ▲ Turn on the heater by pressing the power switch on the right rear of the printer.



1. Heater switch



NOTE Use the heater switch on the right rear of the printer only when turning the printer off completely for removal, installation, or servicing.

Turn the power off

Turn off the printer



WARNING! The printer has an internal clock which allows it to wash the printheads automatically, flushing some ink through the printhead, which keeps the printheads in good condition. This is done after the first 20 hours without printing and every 3 days. If the printer is switched off for a long period, this process does not happen. If the ink does not flow through the printheads from time to time, the ink will dry inside the nozzles, reaching a point where it is impossible to recover them and the printhead will fail. This will mean an expensive printhead replacement.

Automatic maintenance and cleaning will **not** be performed even if you turn off the printer at the front panel. The printer power switch on the rear of the printer should be used only when the printer is turned off to move it, to connect it to a computer, or to install or maintain printer parts.



CAUTION If you need to leave the printer unattended for any reason, ensure that the **printer is on**, the **ink cartridges are full**, and the **waste ink bottle is empty**, so that automatic maintenance (performed after the first 20 hours without printing and every 3 days) can be completed successfully for the time you are not present. If needed, install new ink cartridges. The ink cartridges that you replace can be reused when you return to your printer, if they still contain ink.



WARNING! Turn the printer off and unplug the power cable from the power outlet in any of the following cases;

when placing your hands inside the printer, if there is smoke or an unusual smell coming from the printer, if the printer is making an unusual noise not heard during normal operation, a piece of metal or a liquid (not part of cleaning and maintenance routines) touches internal parts of the printer, during an electrical (thunder/lightning) storm, during a power failure.



CAUTION Always hold the power cord by the plug when connecting and disconnecting from the power outlet. Never pull on the cord because this may damage it and create risk of fire and electric shock.

- ▲ Turn off the power by pressing the power on/off key on the front panel for a couple of seconds.

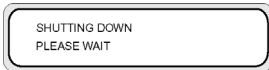

The front panel displays the message above to indicate that a shutdown process is in progress. After the process ends, the power is turned off.

If you intend to turn the printer off for a short time, you can avoid the printhead wash operation by pressing the power on/off key while pressing the CANCEL key.

The printhead wash operation is recommended.



CAUTION The printer power switch on the rear of the printer should only be used when the printer is turned off to move it, connect it to a computer, or to install or maintain printer parts.

Turn off the power on/off switch, wait for at least ten seconds, then turn it on again.

The printer washes the printheads 20 hours after the last printing process and every 3 days. We recommend that the printer power is left on.

Turn off the heater

- ▲ Turn off the heater by pressing the on/off keys on the heater front panel.

Under normal conditions of use, you do not need to turn off the heater using the heater power switch on the rear of the printer.



1. Heater switch



NOTE Use the heater switch on the right rear of the printer only when turning the printer off completely for removal, installation, or servicing.

3 How do I load/unload media?

This section describes how to load and remove media in the printer.

- Install a media roll in the printer
- Remove a media roll from the printer
- Replace a jammed media roll
- Load cut sheet
- Use the take-up reel
- Use the media edge guard
- Set the fan guard lever

Install a media roll in the printer



CAUTION Do not touch heater surfaces in the paper path. This may cause burns.

Handle media rolls with care. They can be heavy and difficult to move in confined spaces. In some cases, two people should move and install media rolls. Dropping a media roll could cause personal injury or damage to the printer.

The printer's front panel messages will guide you through the process of loading media. To install a media roll:

1. Open the rear cover and slide the media edge guards to each end of the platen.

Slide the fan guide lever to the right side of the platen to avoid obstructing the media path and damaging the media.

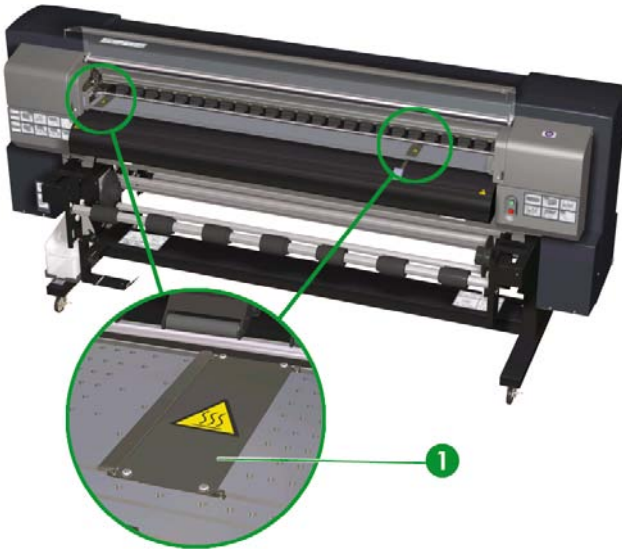

NOTE Position the media edge guards after loading the media. See How do I... [Use the media edge guard](#). Position the fan guide lever after loading the media.

2. Close the rear cover.

3. Loosen the lock on the left media hub by turning the lock anti-clockwise.

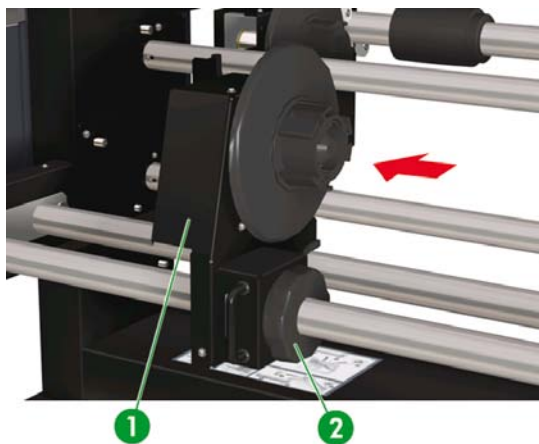

1. Sliding media hub
 2. Media hub lock
4. Adjust the position of the left media hub to allow for insertion of the roll of media.

5. You can feed the media through the media path over (externally) or under (internally) the roll according to the side of the media you want to print on. Make sure you insert the end of the roll that will allow you to print on the correct side.

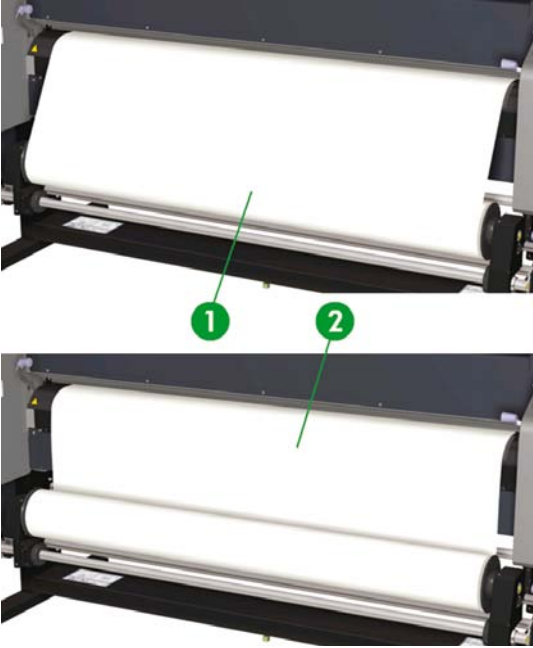

1. External (clockwise) winding
2. Internal (anti-clockwise) winding

6. Insert the roll of media into the right media stop (fixed side).

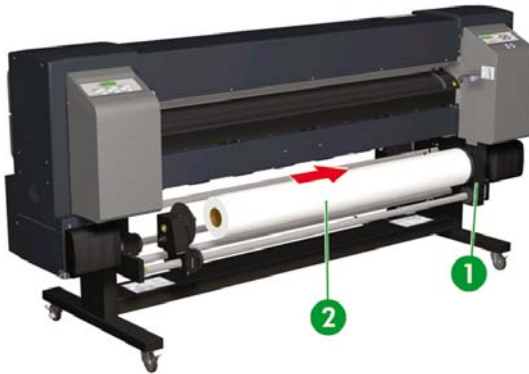

1. Media stop
 2. Roll
7. Slide the left media hub (movable side) into the core of the media roll.

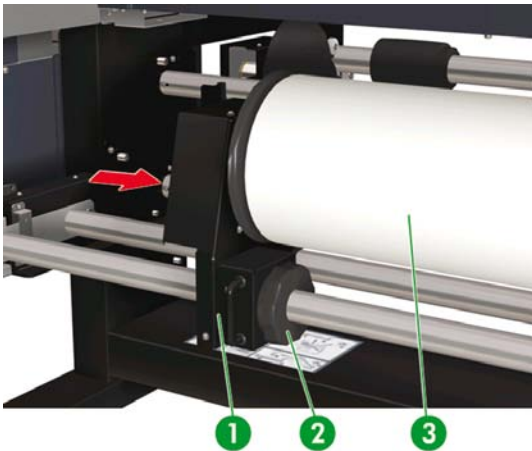

1. Media roll
 2. Media hub lock
 3. Sliding media hub
8. Tighten the left media hub lock by turning clockwise.

How do I load/unload media?

- 9. Lift the media load lever.

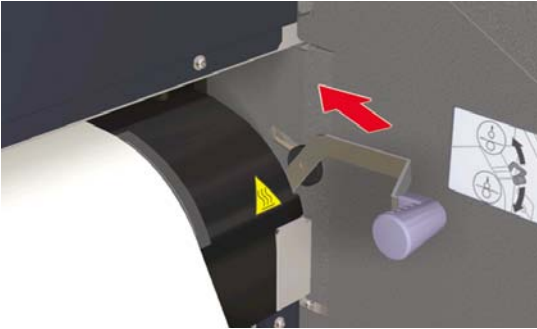

- 10. Ensure the ME (Media End) lever is in the forward position.

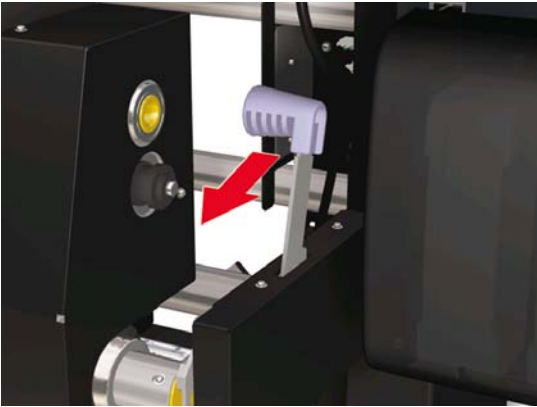

11. Feed the media until a beep sounds from the media feeder (about 200 mm).

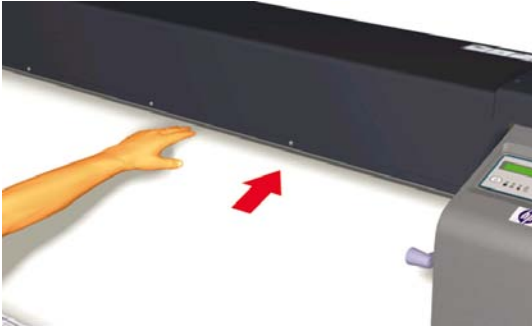

NOTE If you have problems loading media, feed the media into the printer by holding both edges of the media.

Take care that the media does not curl inside the rear cover and that the media edge guards are not obstructing the media path. See How do I... [Use the media edge guard.](#)

NOTE The vertical media line guide on the printer is for sheet media loading only. Do not use for roll media.

12. Take up any excess media by rewinding the media stop on the media roll. This will help to make sure there is even tension across the width of the media and avoid skew.



1. Rewind excess media onto the roll.

13. Lower the media load lever.

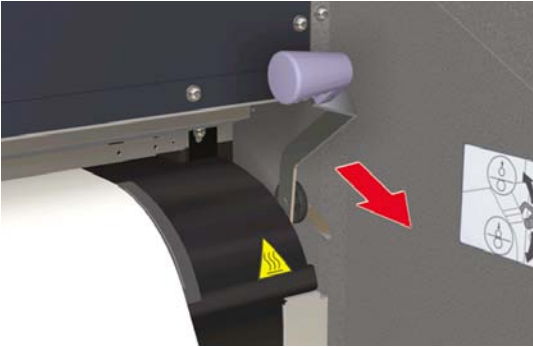

14. Open the rear cover and adjust the media edge guards and adjust the position of the fan guard lever.

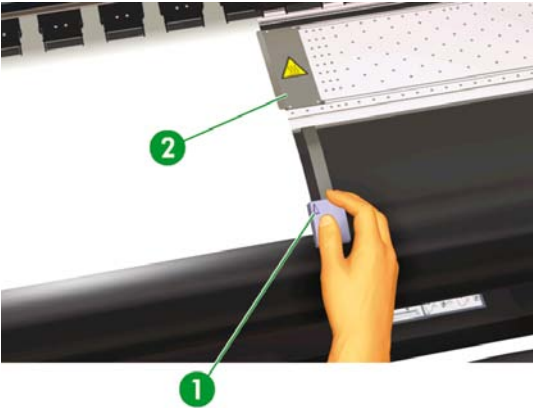

1. Fan guard lever
2. Media edge guard

To complete the loading procedure, follow the front panel instructions.



15. Confirm the position of the media edge guard and press the OK key.
16. Select media roll.

SELECT MEDIA
ROLL/SHEET: ROLL

- a. Select **ROLL** using the ▲ or ▼ keys. For the **NEST** option, see How do I...[Use manual nesting](#).
- b. Press the OK key to confirm the selection.

17. Select a media type.

SELECT MEDIA
MEDIA: TYPE02

SELECT PAPER TYPE
PAPER : XXX

- a. Select the media type with the ▲ or ▼ key.

There are five preset media types to choose from:

- Paper
- Glossy
- Matte
- Banner
- BLT_B (Backlit)

- b. Press the OK key to confirm.



NOTE If you wish to select a media type that is currently not available, then you will need to create a new media type.

SELECT MEDIA
NEW MEDIA ENTRY

- c. Select the **NEW MEDIA ENTRY** option using the ▲ or ▼ key and press the OK key (For details, see How do I...[Manage media types](#)).

Press the CANCEL key to return to the **SELECT MEDIA** menu.

18. The media will be loaded automatically.

PREPARING MEDIA
PLEASE WAIT

Remove a media roll from the printer

To remove a media roll from the printer:

1. Lift the media load lever.

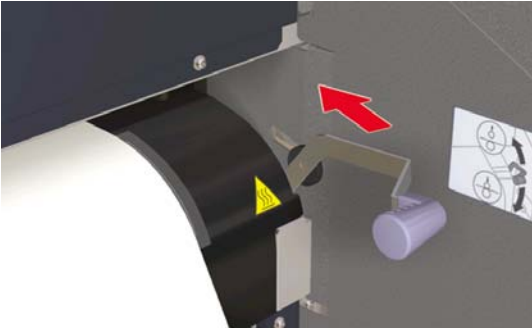

2. Loosen the left media hub lock, and pull the left media hub out of the media roll.

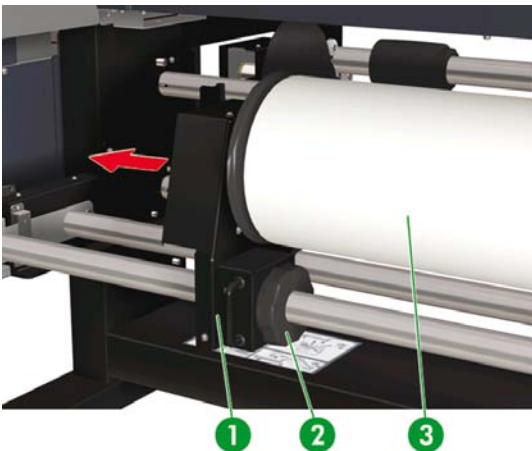

1. Left media hub
2. Lock
3. Media roll

3. Remove the media roll from the printer.



CAUTION Handle media rolls with care. They can be heavy and difficult to move in confined spaces. In some cases, two people should move and install media rolls. Dropping a media roll could cause personal injury or damage to the printer.

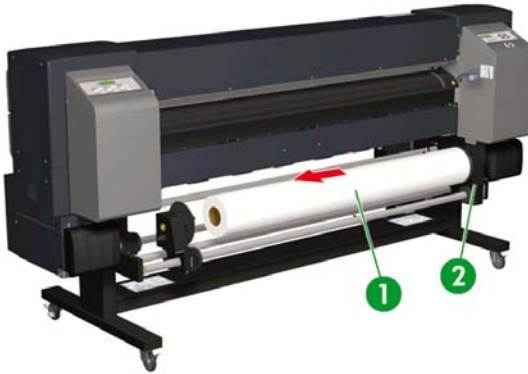

1. Media roll
2. Right media hub

Replace a jammed media roll

To replace a jammed media roll, see The problem is... [A head crash](#).

Load cut sheet

The printer's front panel messages will guide you through the process of loading media. To load cut sheet:

1. Open the rear cover and slide the media edge guards to each end of the platen.

Slide the fan guide lever to the right side of the platen to avoid obstructing the media path and damaging the media.

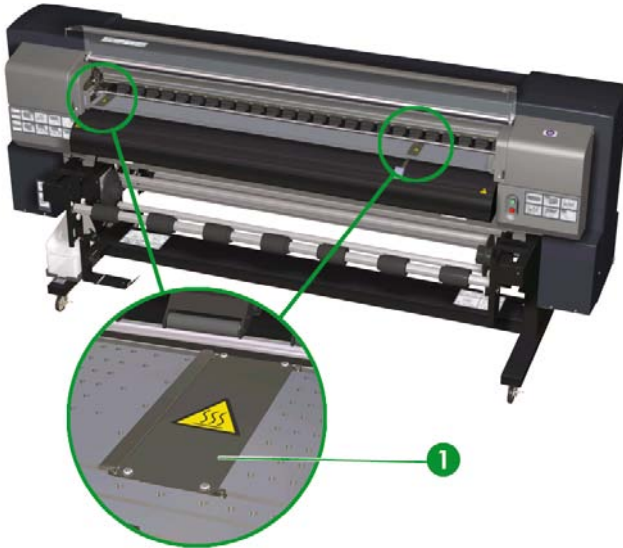

NOTE Position the media edge guards after loading the media. See How do I.. Use the media edge guard.

Position the fan guide lever after loading the media.

2. Close the rear cover.

3. Lift the media load lever.

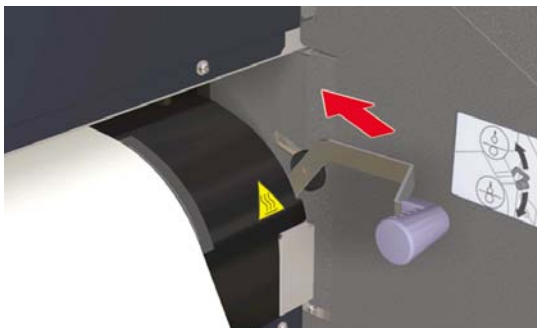

4. When installing the cut sheet in the printer, align the cut sheet to the left of the guide line.

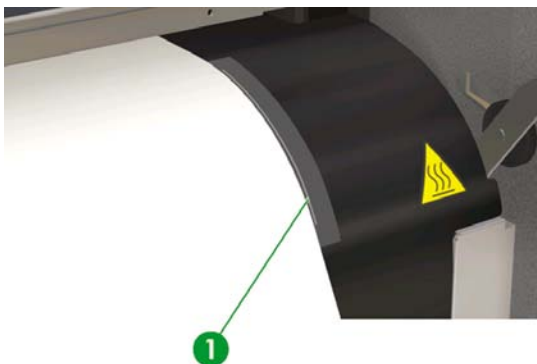

1. Guide line

5. Ensure the ME (Media End) lever is in the forward position.

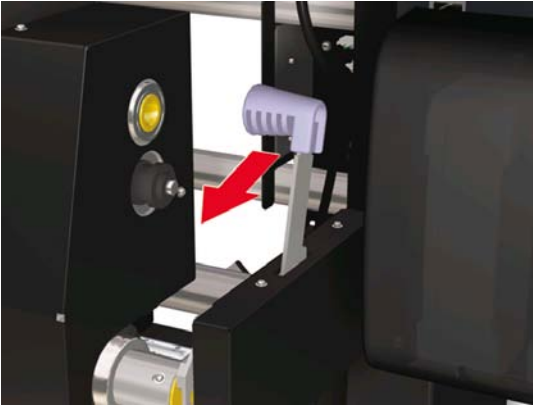

6. Feed the media until a beep sounds from the media feeder (about 200 mm).

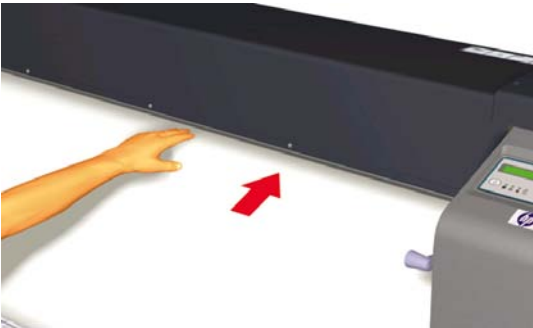

NOTE If you have problems loading media, feed the media into the printer by holding both edges of the media.

Take care that the media does not curl inside the rear cover and that the media edge guards are not obstructing the media path. See How do I... [Use the media edge guard](#).

7. Lower the media load lever.

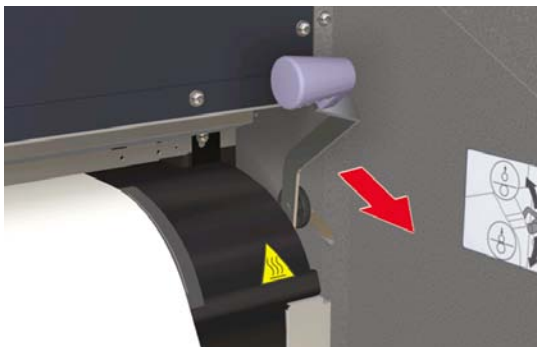

8. Open the rear cover and adjust the media edge guards and adjust the position of the fan guard lever.

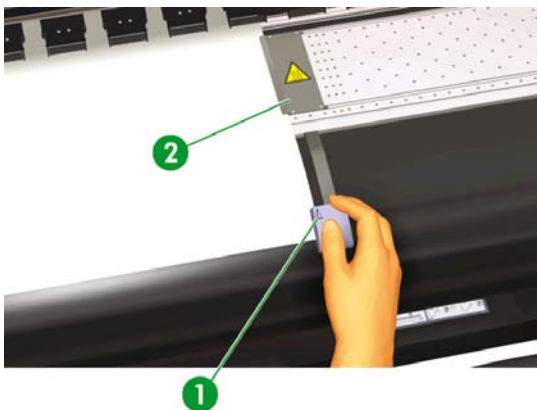

1. Fan guard lever
2. Media edge guard

To complete the loading procedure, follow the front panel instructions.

CHECK EDGE GUARD
*OK?

9. Confirm the position of the media edge guard and press the OK key.
10. Select cut sheet.

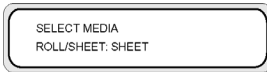

- a. Select **SHEET** using the ▲ or ▼ keys. For the **NEST** option, see How do I... [Use manual nesting](#).
- b. Press the OK key to confirm.

11. Select a media type.

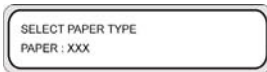
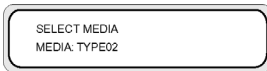

- a. Select the media type with the ▲ or ▼ key.

There are five preset media types to choose from:

- Paper
- Glossy
- Matte
- Banner
- BLT_B (Backlit)

- b. Press the OK key to confirm.



NOTE If you wish to select a media type that is currently not available, then you will need to create a new media type.

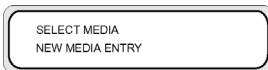

- c. Select the **NEW MEDIA ENTRY** option using the ▲ or ▼ key and press OK. See How do I... [Manage media types](#).

Press the CANCEL key to return to the **SELECT MEDIA** menu.

12. The media will be loaded automatically.



If an error message is displayed, remove the media and repeat the task.



Use the take-up reel

There are three tasks required to complete loading of media on the take-up reel. The first part of attaching a roll to the take-up reel is attaching the end of the roll (with tape) to the core tube supplied with the take-up reel. You can also use an empty cardboard tube. Both types of core must be the same length as the roll you are using.

- Set the take-up reel for clockwise or anti-clockwise winding.
- Define the winding mode.
- Load media onto the take-up reel.

Set the take-up reel winding direction

Internal (anti-clockwise) winding or external (clockwise) winding can be selected. When the take-up reel is not used, set the take-up reel switch to off.

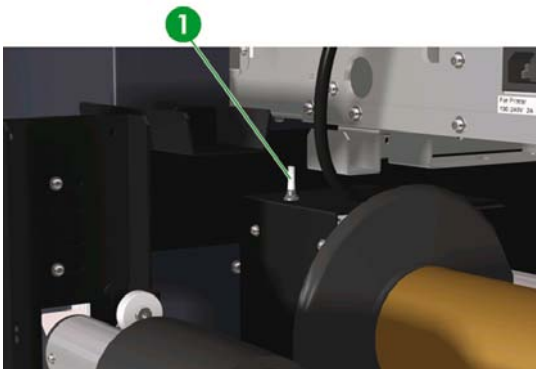

1. Take-up reel switch

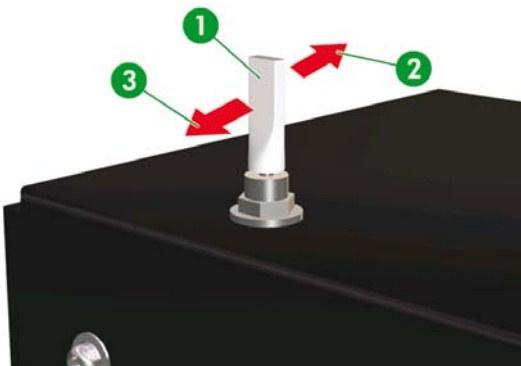

1. Take-up reel off
2. Internal (anti-clockwise) winding
3. External (clockwise) winding



NOTE For **LOOSE** winding mode, make sure that the media passes inside the take-up reel sensor.

If the take-up reel is not used, turn the take-up reel switch off.

Make sure that you change the media roll on the take-up reel before the roll size exceeds the diameter of the take-up reel media stop. Replace the core tube with a new one to avoid winding errors.

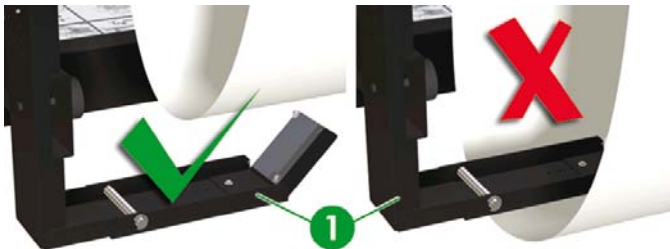

1. Take-up reel sensor

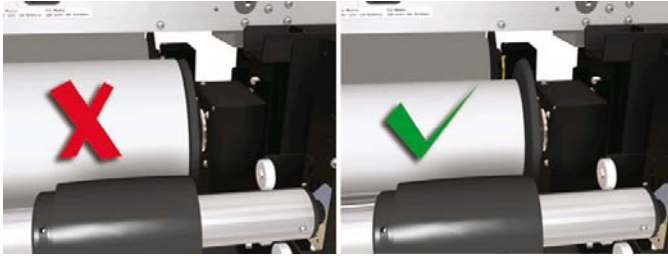

NOTE When printing without using the take-up reel, make sure the media or printing surface is not damaged or folded by the take-up reel sensor.

Define the take-up reel winding mode

The take-up reel supports two winding modes; tension winding and loose winding.

By default, use **LOOSE** winding mode. Always use **TENSION** winding mode when printing long plots or if you have problems with skew.



NOTE The HP Designjet High Speed Dryer is **not** usable with the take-up reel when in **TENSION** winding mode. Please use **LOOSE** mode when using the HP Designjet High Speed Dryer.

To set the winding mode:

- Loose: place the take-up reel roller in the top position.



1. Tension roller

- Tension winding: place the take-up reel roller in the bottom position.



1. Tension roller

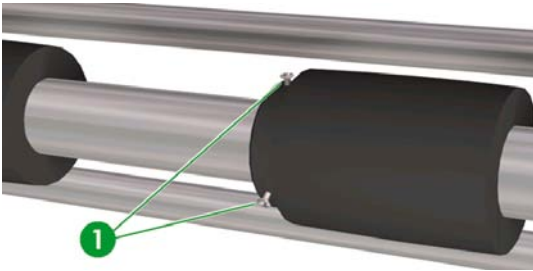

NOTE Do not change the order of the seven tension rollers as their outside diameters are different. Changing the order will cause media skew. Distribute the tension rollers to support the full width of the media.

1. Position each tension rollers by unscrewing the three screws to the left of the roller. Tighten the screws when the roller is in its final position.
2. Press the ONLINE key to view the **MEDIA REG** menu.



3. Press ▼ to select **MEDIA REG**.

4. Press ▼ to display the **TUR MODE** option.



5. Select **LOOSE** or **TENSION** and press OK to confirm.

Load media on to the take-up reel

1. Prepare the core tube and 1 m of media. Attach one edge of the media to the tube using tape.

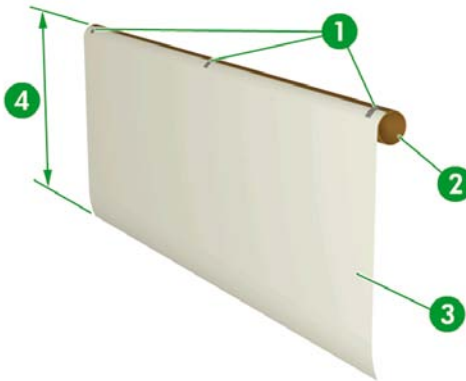

1. Tape
2. Core tube
3. Lead paper
4. Approximately 1 m



NOTE Make sure the lead paper is attached to the correct side of the tube. You may wind the media over the roll for anti-clockwise winding, or under the roll for clockwise winding.

Attach the paper to the core tube in a straight line so that media winding is even.

2. Insert the core tube with the lead paper against the left media stop.

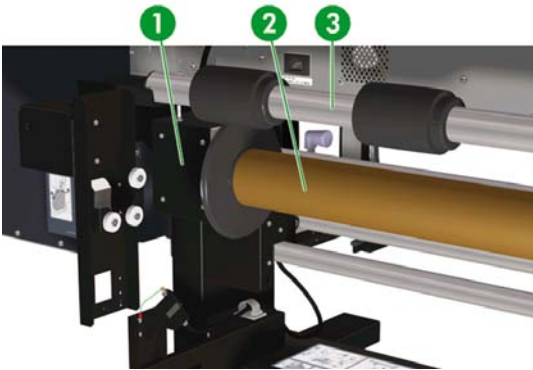

1. Left media hub
2. Media tube
3. Tension roller

3. Slide the right media hub (movable side) and insert it into the media tube.

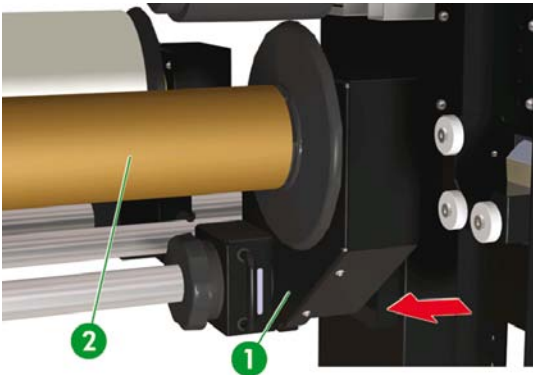

1. Right media hub
2. Core tube

4. Tighten the lock.

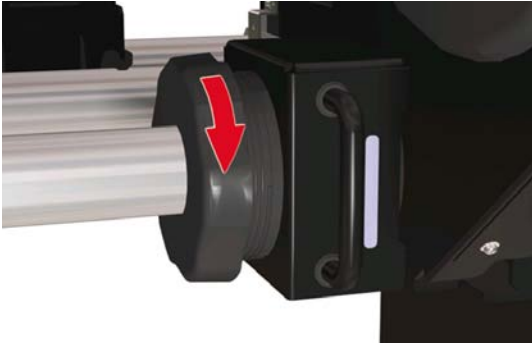

5. Load media into the printer.
 - Lift the media load lever
 - Load the media
 - Lower the media load lever

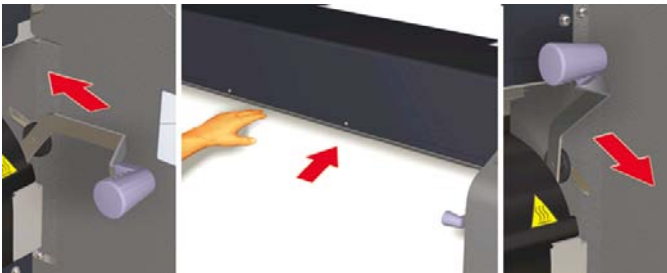

6. Feed the media into the printer using the Feed menu on the front panel (see How do I... [Perform a manual media feed](#)) until there is sufficient media at the rear of the printer to attach the lead paper on the core tube.

7. Tape the edge of the media onto the lead paper on the core tube on the take-up reel. Tape on both edges and in the center.

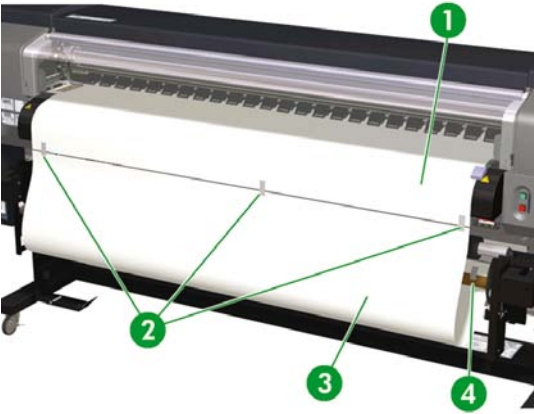

1. Lead paper
2. Tape
3. Media
4. Tape

8. Manually turn the media stop to wind some media onto the take-up reel. Remember to turn the media stop in the same direction as the take-up reel winding direction (clockwise or anti-clockwise winding).

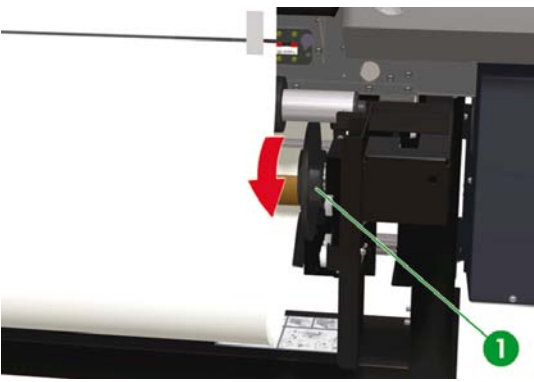

1. Right media stop

9. Check the positions of the media and take-up reel sensor, and load the media.

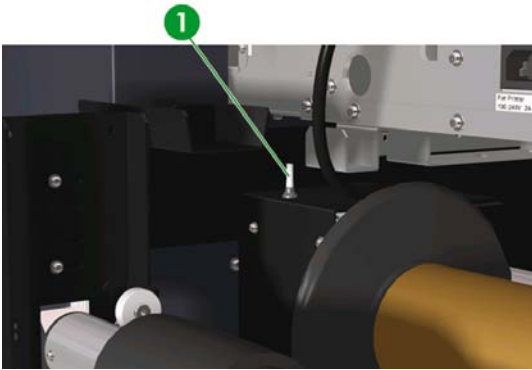

1. Take-up reel switch

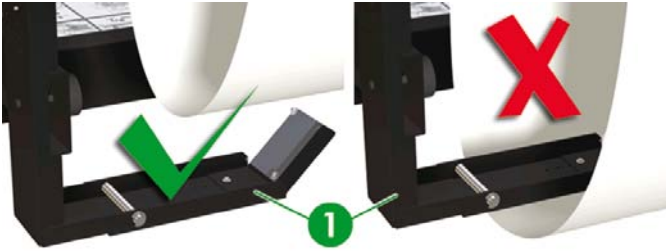

2. Take-up reel sensor in **LOOSE** winding mode.

Use the media edge guard

Set the media edge guards on the right and left of the printing path to reduce the risk of printhead crashes.

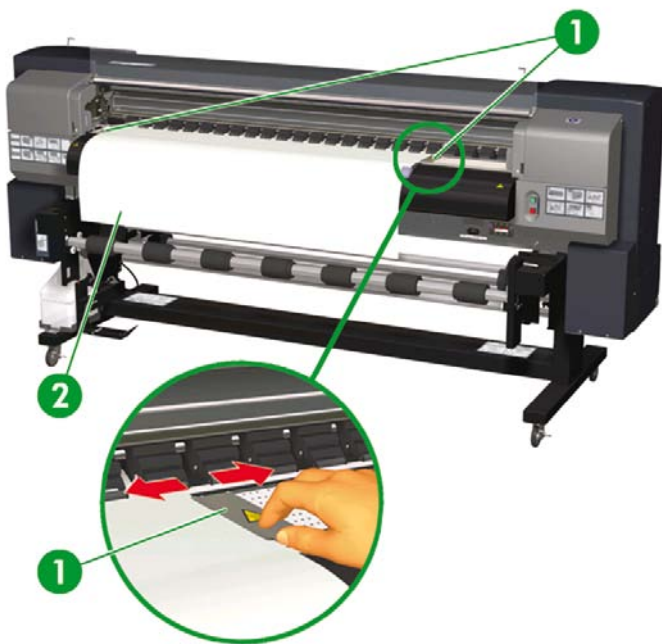

1. Media edge guards

2. Media



NOTE When using the media edge guards, the right and left margins increase from 5 mm to 10 mm.

You need to activate or deactivate use of the media edge guards on the front panel. To access the **MEDIA REG** menu:

1. Press the **ONLINE** key.

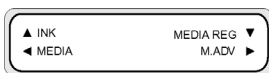

2. Press the **▼** key to see **MEDIA REG** menu options.

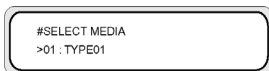

3. Select the media with which you want to use or not use the media edge guards, and press the OK key.

This setting will only apply to the selected media.

4. Scroll to **USE EDGE GUARD** using the ▲ or ▼ keys and press the OK key.



5. Select **YES** or **NO** and press OK to confirm.

Set the fan guard lever



NOTE Correct use of the fan guide lever will protect your printheads from exposure to the suction fan that could cause them to dry. When loading media, ensure that the position of the fan guard lever does not obstruct the media path.

1. Set the fan guard lever position according to the width of the media on which you are printing.
2. Align the arrow on the lever with the edge of the media.



NOTE To make sure that the fan guard lever does not come into contact with the media, that can be caused by skew on long rolls, ensure a 5 mm gap between the arrow on the fan guard lever and the edge of the media.

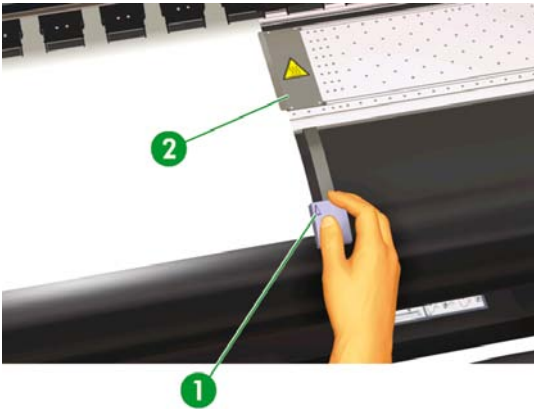

1. Fan guard lever arrow
2. Media edge guard



NOTE Do not move the fan guard lever during printing. If the fan guard lever touches the media, a media jam could occur.

4 How do I... (printing topics)

- Perform a manual media feed
- Use manual nesting
- Increase/reduce pressure on media
- Pause or cancel print jobs

Perform a manual media feed

This section describes how to feed media manually through the printing path, for example to use cut sheets without causing skew.

1. Press the ONLINE key.

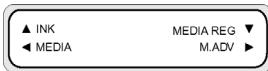

2. Press the SHIFT key to display the **FEED** menu.



3. Hold down the ▼ key.



While the ▼ key is pressed, roll media advances. If cut sheet is loaded, it is discharged.

4. When the ▼ key is released, media feeding stops and the menu group is displayed.



Use manual nesting

When printing a small-sized image, such as A4, on a 64-inch width roll, a large area of media is left blank. You can rewind the roll and nest an image in the blank area using the Origin Point Setting feature.



NOTE The manual nesting feature can be used only with roll media.

To use manual nesting:

1. Lift the media load lever.

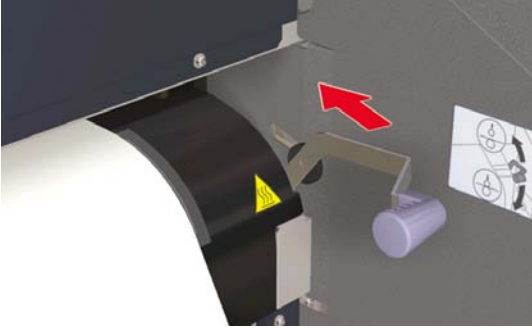

2. Rewind the media.



A. Blank area



NOTE Rewind the media only when the image is dry, to avoid smearing.

3. The front panel instructs you to load media. Load the media.



4. Lower the media load lever.

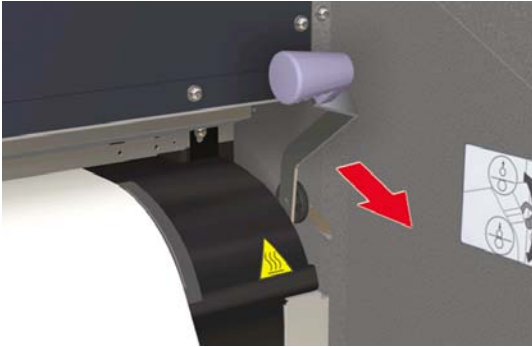

5. Select **NEST** in the **SELECT MEDIA** menu and press the OK key.

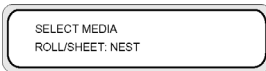

NOTE In the next steps, use the **MEDIA WIDTH** setting if you cut the media to remove the image that was previously printed. Use the **NEST ORIGIN** setting if you have not cut the media and to start printing from a point that excludes the previously printed image.

6. Enter the media width and press the OK key. The media width previously detected is displayed. (Media width input range: 290 to 1635 mm)

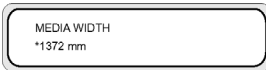

7. Input the nest origin point (print offset value for media width: origin point).



The nest origin setting is displayed.

The start position for printing is modified if either the media width or the nest origin is set.

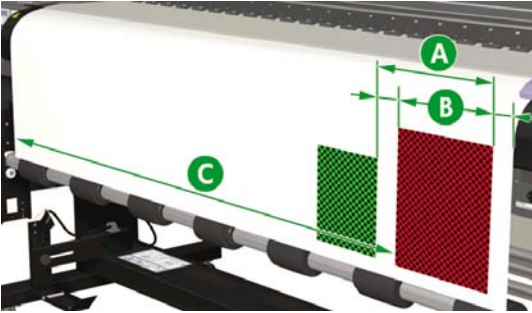

- A. Nest origin point
 - B. Print margin including the image
 - C. Media width input value
8. Select **YES** or **NO**.
- Select **YES** to increase the available area for printing. Rewind the media back onto the roll ensuring the media is present between the media output sensor and media rollers. (The first 20 – 30 mm from the front edge will not be available for printing).



- Select **NO** if the area from the media output sensor position to the print start position (the media rollers) will not be available for printing.



NOTE Ensure the media is aligned with the vertical guide line before loading.

9. Select a media type again.



SHIFT



NOTE Ensure front, right, and left margins are sufficient as you rewind the media manually.

The media width and nest origin settings cannot be saved.

Increase/reduce pressure on media

The media pressure lever allows you to change the pressure on the media exerted by the media transmission roller. This can be used to solve skew with certain types of media.

Pull the lever to the front and lift or lower to change the pressure on the media.

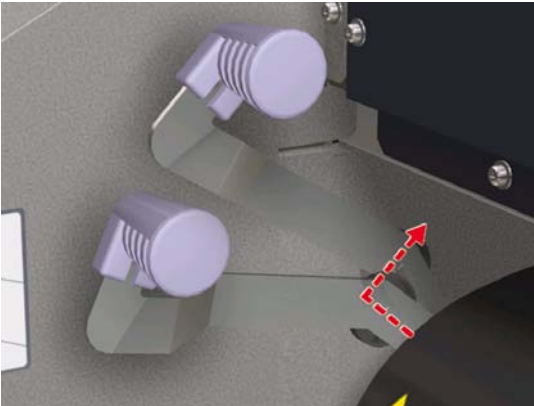

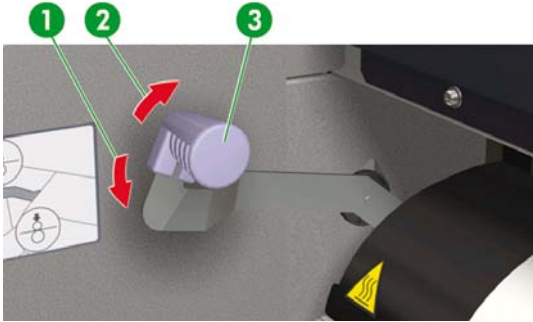

1. High pressure
2. Normal pressure
3. Media pressure lever

Pause or cancel print jobs

You can pause and cancel printing from the rear of the printer. This may be useful if there are problems with media output from the rear of the printer.



Hint We recommend that you always pause or cancel printing through your software RIP.

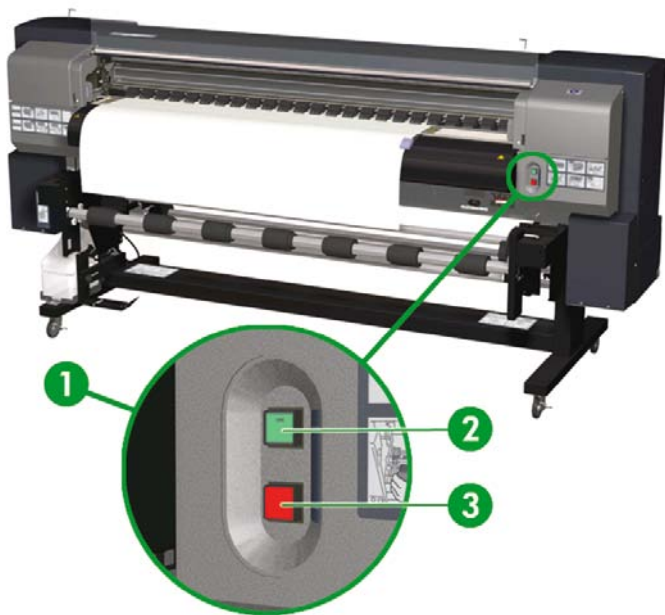

1. Print Pause/Restart and Cancel buttons
2. Press the Pause button to interrupt printing and the Restart button to continue printing after an interruption.
3. Press the Cancel button to cancel printing.

5 How do I... (ink topics)

This section describes ink cartridge topics and printhead height adjustment for the printer.

- Replace an ink cartridge
- Change the printhead height

Replace an ink cartridge



CAUTION Always use genuine HP ink cartridges. These have been designed for high-quality imaging performance and reliable printer operation. Using non-HP inks may cause poor print quality, printer malfunction, or printer failure. The hazard characteristics of different solvent inks can vary widely. HP has not conducted product safety testing for non-HP inks with this printer and is not responsible for any loss or damage that may result if non-HP inks are used.

HP ink cartridges must be installed before the "Install By" date printed on the cartridge. Use of the ink cartridge 3 months beyond the "Install By" date may cause deterioration in print quality or a printer malfunction.



NOTE

If an ink cartridge cannot be inserted, check that the color matches the slot. A mechanical key prevents an ink cartridge from being inserted into the wrong slot.

Do not shake ink cartridges before inserting into the printer.

The front panel will advise you when you need to change an ink cartridge.

OPEN L INKCOVER
REPLACE XX INK

XX: Ink name (K: Black, Lm: Light magenta, Lc: Light cyan)

OPEN R INKCOVER
REPLACE XX INK

XX: Ink name (C: Cyan M: Magenta Y: Yellow)



NOTE The printer will continue to print while you are replacing an ink cartridge.

To replace an empty ink cartridge:

1. Open the ink cover.



2. Remove an ink cartridge from the printer.



3. Insert a new ink cartridge into the printer.



4. Close the ink cover.



Change the printhead height

You can increase or reduce the printhead height depending on the thickness of the media you are using. Two tasks must be performed to change the printhead height:

- Mechanical height adjustment on the printhead carriage.
- Firmware height adjustment through the front panel.

To change the printhead height:

- 1. Press the ONLINE key.



- 2. Press the SHIFT key to display the **PH. MAIN** menu.



- 3. Press the ▲ key to enter the **PH.MAIN** menu.
- 4. Scroll to **PH HEIGHT ADJUST** on the front panel and press OK to confirm.



The following message is displayed.



The following message is displayed.



- Open the cap cover and loosen the head fixing screws (2) with a screwdriver.

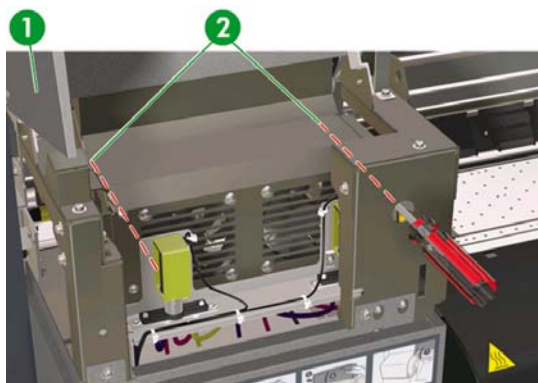

- Capping unit cover
- Head fixing screws

- Change the height of the head by lifting the head height lever to lower the head, or by lowering the head height lever to lift the head.

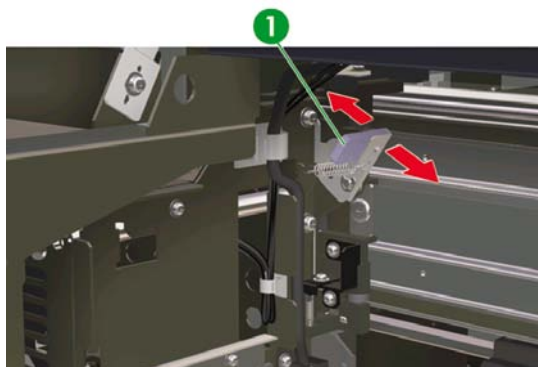

- Printhead height lever

- Tighten the head fixing screws (2) using the long screwdriver provided with your printer.



NOTE Tighten the head fixing screws while applying slight downward pressure on the head using your hand.

- Close the rear cover.

To change the printhead height on the front panel:

1. Press the ONLINE key.

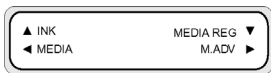

2. Press the ▼ key to display the MEDIA REG menu.

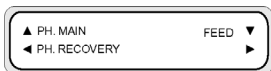

3. Scroll to the PH HEIGHT VAL option and press the OK key.

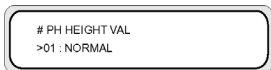

4. Select **NORMAL** or **HIGH**, according to the mechanical change you have made, and press the OK key.

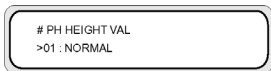

Parameters: **NORMAL** (default) or **HIGH** (for thick media).



NOTE When the printhead height is changed, a gap in printing may occur in bidirectional printing. Adjust the correction value for bidirectional printing. See [How do I...Perform printhead position adjustment](#).

6 How do I maintain the printer?

This section describes the regular inspection and maintenance procedures to be performed by users.

- Regular maintenance guide
- Daily printhead maintenance
- Leave the printer off for two to four weeks
- Leave the printer off for less than two weeks
- Charge the ink system
- Clean the exterior of the printer
- Clean the rear cover and media feed
- Clean the platen
- Replace the waste ink bottle
- Normal printhead recovery
- IQ Print

Regular maintenance guide

The printer requires regular inspection and maintenance. The table below lists all regular inspection and maintenance procedures. For details on each procedure, see the page reference.



WARNING! off the printer without following the correct procedures. Even with the storage liquid installed, never leave the printer off for more than 4 weeks. Leaving your printer off for more than 4 weeks can cause permanent damage that cannot be repaired. In all other cases make sure you observe the appropriate maintenance guidelines.



CAUTION The printer has an internal clock which allows it to wash the printheads automatically, flushing some ink through the printhead, which keeps the printheads in good condition. This is done after the first 20 hours without printing and every 3 days. If the printer is switched off for a long period, this process does not happen. If the ink does not flow through the printheads from time to time, the ink will dry inside the nozzles, reaching a point where it is impossible to recover them and the printhead will fail. If the printer must be switched off for a long period of time, the customer must use either the optional HP Ink System Cleaning Kit or HP 790 Storage Kit to recover or protect the printheads.

Automatic maintenance and cleaning will **not** be performed even if you turn off the printer on the front panel. The printer power switch on the rear of the printer should only be used when the printer is turned off to move it, to connect it to a computer, or to install or maintain printer parts.

	Category	Inspection/Maintenance
1	Daily inspection and maintenance	Wiper blade cleaning Wiper sponge cleaning — see Wiper blade cleaning Capping unit cleaning Normal printhead recovery IQ Print
2	Monthly inspection and maintenance	Normal printhead recovery
3	When leaving the printer for a long time in power off state (more than 2 weeks)	Ink system storage
4	When returning the printer from a long time leaving (more than 2 weeks)	Clean ink system Charge the ink system after cleaning the ink system
5	When returning the printer from a long time leaving (within 2 weeks) in power off state	Clean ink system Charge the ink system after cleaning the ink system
6	When leaving the printer in power off for more than one month	A service call error message will be displayed on the front panel. Contact HP Support.

Daily printhead maintenance



WARNING! Failure to perform daily maintenance procedures may result in damage to your printer printheads and will invalidate your warranty.



CAUTION If you need to leave the printer unattended for any reason, ensure that the **printer is on**, the **ink cartridges are full**, and the **waste ink bottle is empty**, so that automatic maintenance (performed after the first 20 hours without printing and every 3 days) can be completed successfully for the time you are not present. If needed, install new ink cartridges. The ink cartridges that you replace can be reused when you return to your printer, if they still contain ink.

Daily printhead maintenance will ensure optimal print quality and the life of your printheads. The ink in your HP Designjet 9000s Printer dries very quickly, so maintenance procedures ensure that the ink does not dry in the capping unit, the wiper blades

, the ink tubes and printheads.

- Wiper blade cleaning
- Wiper sponge cleaning
- Capping unit cleaning



NOTE Perform the above every day before printing.

Always use the specified cleaning liquid and HP cleaning swabs.

Wiper blade cleaning



CAUTION Make sure that the wiper cleaning liquid does not drip on to other parts of the printer. If the wiper cleaning liquid drips on to the belt or any nearby sensors, this could cause serious damage to the printer.

When the **PRINTER READY** message appears on the front panel, press the ONLINE key to take the printer offline.

1. Press the ONLINE key.



2. Press the SHIFT key to display the **PH.MAIN** menu.



3. Press the ▲ key to enter the **PH.MAIN** menu and scroll to the **WIPER CLEANING** option using the ▼ key.

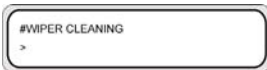

4. Press OK to select **WIPER CLEANING**.



5. Press OK to confirm.

The wiper blade is moved to its cleaning position.

The front panel displays the following message:



6. Open the rear cover and the wiper cover.



1. Rear cover
2. Wiper cover

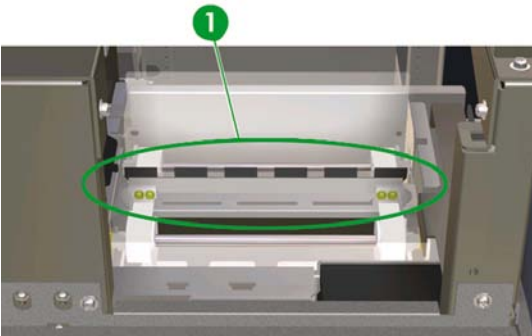

1. Wiper blade

- Dip a new HP cleaning swab into the wiper cleaning liquid.



CAUTION Make sure that you use the wiper cleaning liquid and **not** the capping liquid to clean the wiper blades. The capping liquid is not strong enough to clean the wiper blades properly and could cause damage to the printheads.

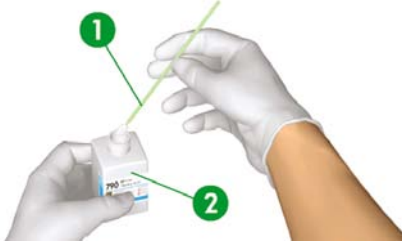

- HP cleaning swab
- Wiper cleaning liquid



WARNING! Avoid contact between ink and skin, eyes, and clothing.

Immediately wash skin with soapy water.

Remove clothing soaked with ink from contact with skin.

Use an approved eye wash station if ink is splashed into eyes and consult a doctor if necessary.

If an approved eye wash station is unavailable, flush eyes with cold water and consult a doctor if necessary.

8. Use the HP cleaning swab to clean the front and back parts of the wiper blades.



CAUTION Make sure that the wiper cleaning liquid does not drip on to other parts of the printer. If the wiper cleaning liquid drips on to the belt or any nearby sensors, this could cause serious damage to the printer.

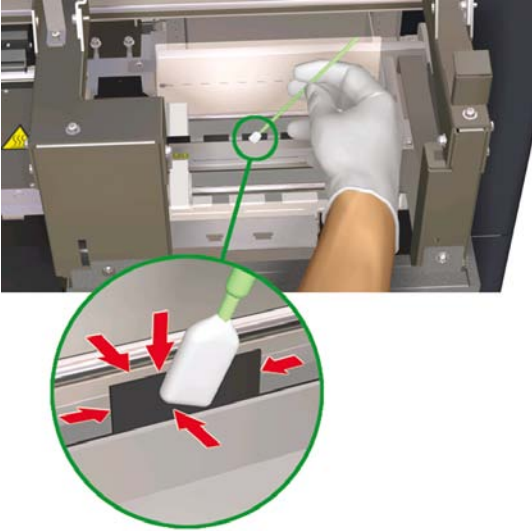

NOTE Make sure that there is no dried ink stuck on the wiper blades. Also make sure that the wiper blades are not damaged. Clean the front and back of the blades with the HP cleaning swab moistened with the HP wiper cleaning liquid.

9. Apply a full dropper of the wiper cleaning liquid on to the sponge using the dropper.

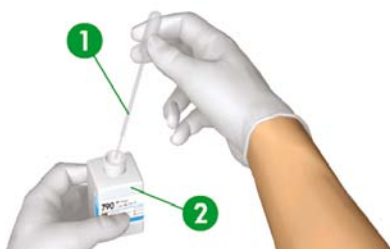

1. Dropper

2. Wiper cleaning liquid



CAUTION Make sure that the wiper cleaning liquid does not drip on to other parts of the printer. If the wiper cleaning liquid drips on to the belt or any nearby sensors, this could cause serious damage to the printer.

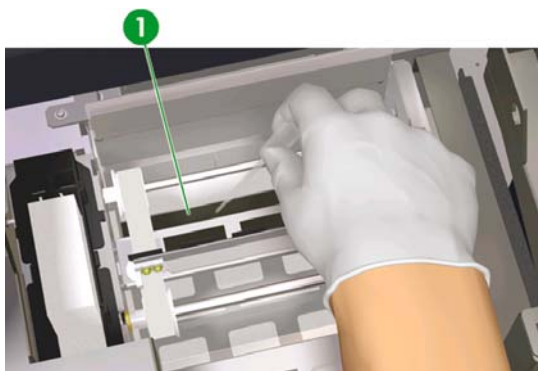

1. Wiper sponge

10. Make sure you also moisten both ends of the sponge under the belt on each side.

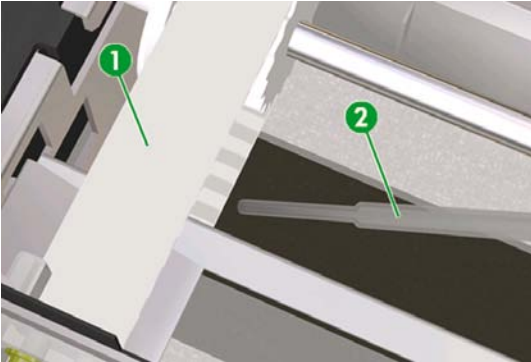

1. Belt
2. Dropper

Capping unit cleaning

This cleaning procedure will remove any dried ink and particles from the capping unit.

1. Press the ONLINE key.



2. Press the SHIFT key to display the **PH.MAIN** menu.



3. Press the ▲ key to select the **PH.MAIN** menu.
4. Scroll to the **CAP CLEANING** option using the ▼ key and press OK to select.

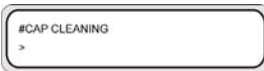

5. Press OK again to confirm your selection.

The carriage will automatically move to the wiping side of the printer so that the Capping Unit can easily be accessed. The front panel displays **CARRIAGE MOVING — PLEASE WAIT**.



CAUTION Once the carriage is out of the capping unit, the cleaning procedure must be done as quickly as possible to avoid permanent damage to the printheads. The printer will emit an acoustic warning (beep) while the carriage is out of the capping unit.

6. When the following message is displayed, open the rear cover and capping unit cover.

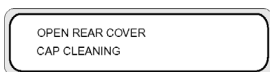

1. Rear cover
 2. Capping unit cover
7. Dip a new HP cleaning swab into the HP cap cleaning liquid.



1. HP cleaning swab
2. HP cap cleaning liquid



CAUTION Make sure that you use the cap cleaning liquid and **not** the wiper cleaning liquid to clean the capping unit, otherwise you could cause damage to the printheads.

8. Clean the top outside edges and the upper surfaces of **all** six caps. Use one side of a swab per color and then use a new swab for the next color.

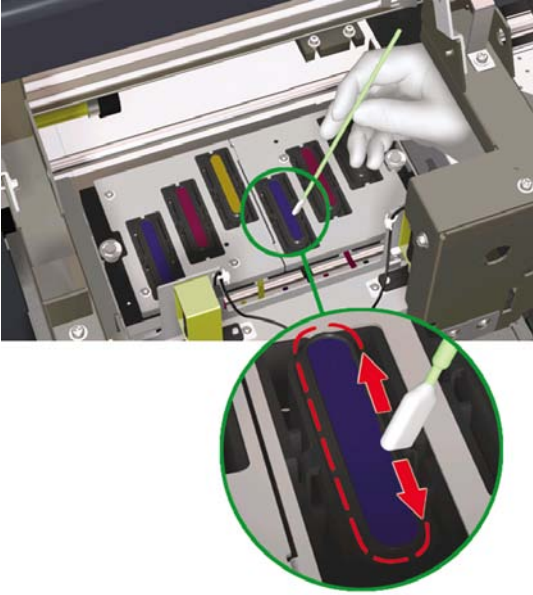

9. Close the capping unit cover and rear cover. The head carriage will return to the capping unit position (home position) automatically.

Leave the printer off for two to four weeks



WARNING! Never switch off the printer without following the correct procedures. Even with the storage liquid installed, never leave the printer off for more than 4 weeks. Leaving your printer off for more than 4 weeks can cause permanent damage that cannot be repaired. In all other cases make sure you observe the appropriate maintenance guidelines.



CAUTION The printer has an internal clock which allows it to wash the printheads automatically, flushing some ink through the printhead, which keeps the printheads in good condition. This is done after the first 20 hours without printing and every 3 days. If the printer is switched off for a long period, this process does not happen. If the ink does not flow through the printheads from time to time, the ink will dry inside the nozzles, reaching a point where it is impossible to recover them and the printhead will fail. If the printer must be switched off for a long period of time, the customer must use either the optional HP Ink System Cleaning Kit or the HP 790 Storage Kit to recover or protect the printheads.

Automatic maintenance and cleaning will **not** be performed even if you turn off the printer at the front panel. The printer power switch at the rear of the printer should be used only when the printer is turned off to move it, to connect it to a computer, or to install or maintain printer parts.

Have available the HP 790 Ink System Storage Kit. Six ink system storage liquid cartridges and six ink system purging cartridges are packed together in the storage kit.

Have available an empty waste ink bottle.

Ink system storage

This procedure allows you to empty the ink system of ink and fills it with storage liquid that will preserve the ink system if you do not intend to use the printer for a period of time (two to four weeks).



CAUTION Do not open or close the rear covers or change the position of levers while the ink system storage process is being performed, or the operation may have to be restarted from the beginning. This will result in the waste of the storage liquid. If ink system storage has to be restarted, **new** storage liquid cartridges will be needed.

1. Press the ONLINE key.
2. Press the SHIFT key to display the **PH.MAIN** menu.



3. Press the ▲ key to select the **PH.MAIN** menu and press OK.
4. Press the ▲ or ▼ keys to select the **STORE INK SYS** option and press OK.
5. When the front panel displays the waste ink bottle warning message, check whether the waste ink bottle is present and make sure it is empty.



CAUTION This process will produce over 3 liters of waste liquid so the waste ink bottle must be empty.

6. Press the OK key once the waste ink bottle has been checked.
7. Follow the instructions on the printer front panel that will guide you through each step of the process.

When the front panel refers to **PURGING CAR**, install or remove an HP 790 Ink System Purging Cartridge that came with your HP 790 Ink System Storage Kit.

When the front panel refers to **SL CARTRIDGE**, install or remove an HP 790 Ink System Storage Liquid Cartridge that came with your HP 790 Ink System Storage Kit.

8. Once the ink system storage process has been completed, the front panel will return to the Ink system optimization menu.
9. You can now turn the printer off.

When you turn on the printer again, you will have to perform the charge ink system process (see [Charge the ink system](#)).

Leave the printer off for less than two weeks



CAUTION If you need to leave the printer unattended for any reason, ensure that the **printer is on**, the **ink cartridges are full**, and the **waste ink bottle is empty**, so that automatic maintenance (performed after the first 20 hours without printing and every 3 days) can be completed successfully for the time you are not present. If needed, install new ink cartridges. The ink cartridges that you replace can be reused when you return to your printer, if they still contain ink.

To clean the ink system you will need the HP 790 Ink System Cleaning Kit (part number CB296A). This kit includes:

- Six ink system purging cartridges
- Six cleaning liquid cartridges

Clean ink system

This option allows you to clean dry ink from the ink system with cleaning liquid after the printer is powered on after being stored for less than two weeks.



CAUTION Do not open or close the rear covers or change the position of levers while the Service Clean process is being performed, or the operation may have to be restarted from the beginning. This will result in the waste of the cleaning liquid. If the Service Clean has to be restarted, **new** cleaning liquid cartridges will be needed.

1. Press the ONLINE key.
2. Press the SHIFT key to display the **PH.MAIN** menu.

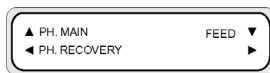

3. Press the ▲ key to select the **PH.MAIN** menu and press OK.
4. Press the ▲ or ▼ keys to select the **CLEAN INK SYS** option and press OK.
5. When the front panel displays the waste ink bottle warning message, check whether the waste ink bottle is present and make sure it is empty.
6. Press the OK key once the waste ink bottle has been checked.

- Follow the instructions on the printer front panel that will guide you through each step of the process.

When the front panel refers to **PURGING CAR**, install or remove an HP 790 Ink System Purging Cartridge that came with your HP 790 Ink System Cleaning Kit.

When the front panel refers to **CL CARTRIDGE**, install or remove an HP 790 Ink System Cleaning Liquid Cartridge that came with your HP 790 Ink System Cleaning Kit.

- The extraction process starts and you need to recheck whether the waste ink bottle is present and is **not** full. Press the OK key once the waste ink bottle has been checked.

Once the cleaning ink system process has been completed, the front panel will return to the PH.MAIN menu.

After cleaning the ink system, the ink system needs to be charged (see [Charge the ink system](#) after cleaning the ink system).

Charge the ink system

When the printer is left for a long time and you need to clean the ink system, then you will need to charge the ink system with ink. You will need ink cartridges with more than 250 cc of ink available.

If any of the ink cartridges contain less than 250 cc of ink, or if an ink system purging cartridge has been installed, a warning message is displayed on the front panel. Install a correct ink cartridge that contains more than 250 cc of ink in the indicated slot in order to continue.

To charge the ink system:

- Press the ONLINE key.
- Press the SHIFT key to display the **PH.MAIN** menu.

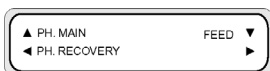

- Press the ▲ key to select the **PH.MAIN** menu.
- Select the **CHARGE INK SYS** option and press OK.
- When the front panel displays the waste ink bottle warning message, check whether the waste ink bottle is present and is **not** full. Check the waste ink bottle and press the OK key.
- The charge process starts. Check whether the waste ink bottle is present and is **not** full. Check the waste ink bottle and press the OK key.

When the ink charge process is complete, the front panel displays the Ink Charge option.

Clean the exterior of the printer



CAUTION Wipe the printer clean with a soft cloth. A cloth moistened with a neutral detergent may be used. Do not allow liquid to enter the printer. This may create risk of fire and electrical shock and cause a malfunction. Do not clean the printer with benzene or paint thinner. This may damage the paint.

Clean the outside of the printer and all other parts of the printer that you regularly touch as part of normal operation (e.g. ink cartridge doors) as required with a damp sponge or a soft cloth and a mild household cleaner such as non-abrasive liquid soap.

Clean the rear cover and media feed



NOTE Do not attempt to remove dust from media by blowing it off. This may affect print quality.



CAUTION Wipe the printer clean with a soft cloth. A cloth moistened with a neutral detergent may be used. Do not allow liquid to enter the printer. This may create risk of fire and electrical shock and cause a malfunction. Do not clean the printer with benzene or paint thinner. This may damage the paint.

1. Unload all media from the printer.
2. Open the rear cover.
3. Using a damp cloth, clean the rear cover.
4. Using a damp cloth, absorb ink deposits on the media feed.
5. Remove dust using a vacuum cleaner.

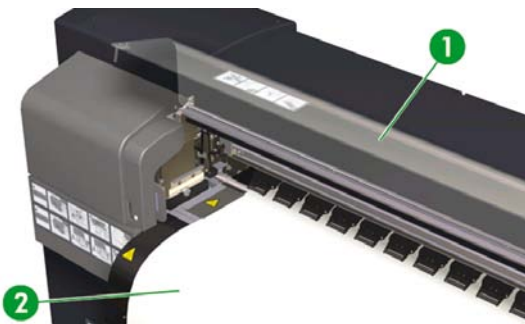

1. Rear cover
2. Media feed

Clean the platen

You should plan to clean your printer's platen on a regular basis, every few months or when needed. When glue adheres to the platen or there are ink marks on the platen, clean the platen according to the following procedures.



NOTE If you print on wide media after you have used narrower media for some time, you may find that the left side of the platen has become dirty and will leave marks on the back of the media if not cleaned.

To clean the platen:

1. Unload all media from the printer.
2. Open the rear cover.
3. Using a soft cloth, absorb ink deposits.

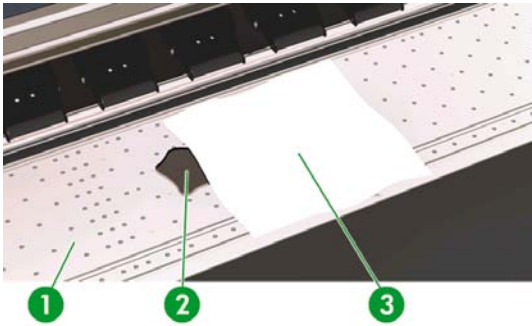

1. Platen
2. Ink
3. Soft cloth

4. Use a soft cloth slightly dampened with alcohol to wipe off loosened ink deposits from the platen.



CAUTION Do not use commercial cleaners or abrasive cleaners. Do not wet the platen directly because you will leave too much moisture behind.



5. If there are ink deposits in the vacuum holes on the platen, clean them using commercially-available 3 mm mini-cotton swabs and then wipe off loosened ink deposits with a mini-cotton swab slightly dampened with alcohol.

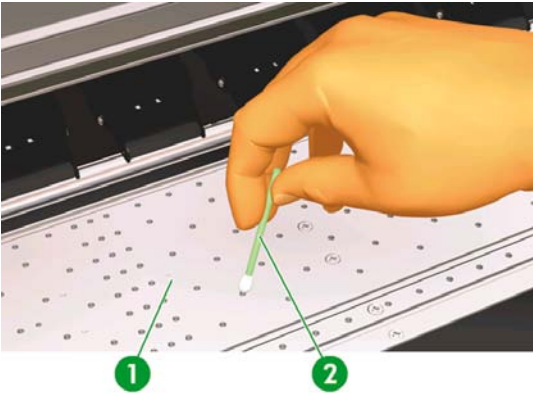

Replace the waste ink bottle



WARNING! The HP waste ink bottle has been specifically designed to contain waste ink from the printer. It is designed to work with the printer's waste ink quantity estimation system to alert the user when the bottle is full. It provides safe handling and disposal of waste ink when sealed with its attached cap.

Use only an HP waste ink bottle. The bottle must be installed according to instructions or waste ink may overflow.

An HP waste ink bottle must always be installed before turning the printer on. Automatic and manual service cycles produce waste ink that must be contained in an HP waste ink bottle.



CAUTION Do not remove the cap from its tether to the HP waste ink bottle. The cap is needed to seal the HP waste ink bottle properly for disposal.



WARNING! Always use both hands to remove and carry an HP waste ink bottle.

Keep the HP waste ink bottle upright. Do not place it on tables or shelves where it could fall.

Waste ink is combustible. Keep an HP waste ink bottle containing waste ink away from open flames, sparks, or other sources of ignition.

Never store waste ink in a glass container.

Never pour waste ink into a container filled with other chemicals.



CAUTION The level in the HP waste ink bottle must be checked by visual inspection to prevent overflow. If the waste ink level is above the indication line, the bottle must be replaced with an empty HP waste ink bottle.



NOTE Place a sheet of paper under the HP waste ink bottle on the floor when removing a bottle containing waste ink. This will help clean up any ink spills. If soaked with ink, treat the paper as a combustible material and dispose of properly.

HP recommends that you always keep a spare empty HP waste ink bottle available. Some maintenance procedures require installation of an empty HP waste ink bottle to prevent ink overflow.

The HP waste ink bottle contains organic solvents and must be disposed of in compliance with all local, state, and federal regulations. Always securely replace the cap on a full or partially-full the HP waste ink bottle after removing it from the printer to prevent ink spills.

Ensure all operators are trained in the use of emergency equipment such as eye wash stations and fire extinguishers and know where they are located.

NOTE Do not replace the waste ink bottle during printing.

The waste ink bottle must be checked on a daily basis to make sure that it is not full.

If full, it should be emptied as follows:

1. Loosen the screw and lift up the lever to release the waste ink bottle.

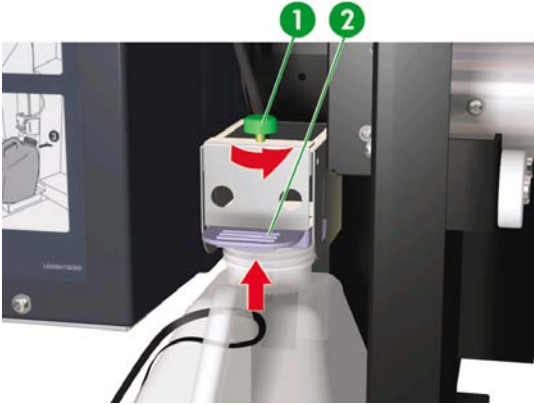

1. Screw

2. Lever

2. Carefully pull out the waste ink bottle, taking care not to spill ink on the printer or on the floor.

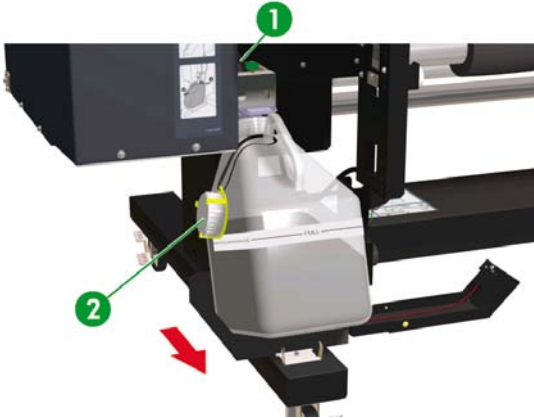

1. Screw

2. Cap

3. Pour any used ink contained in the waste ink bottle in to a suitable container.

4. Lift the lever and install the empty waste ink bottle.

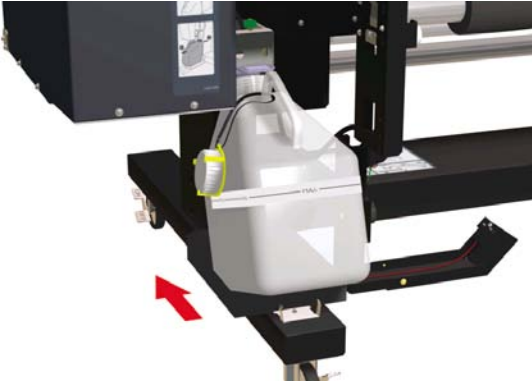

5. Lower the lever and insert the ink tube on the screw into the bottle, and tighten the screw. Make sure the waste ink bottle is securely in position.

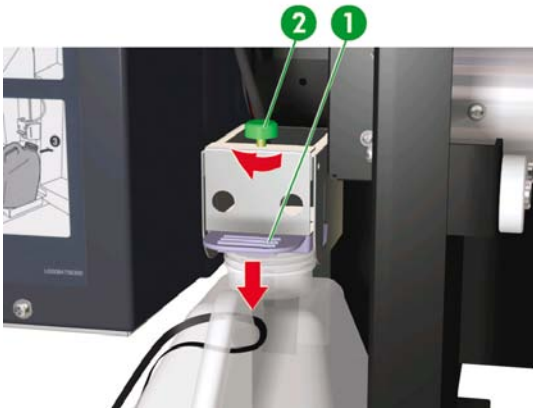

1. Lever

2. Screw

6. The front panel will request you to reset the waste ink counter.

#BOTTLE EMPTY
*NO

7. Select **YES** and press the OK key to reset the waste ink counter.



Normal printhead recovery

1. Press the ONLINE key.

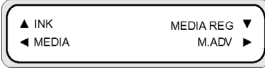

2. Press the SHIFT key to display the **PH.RECOVERY** menu.



3. Press the ◀ key to enter the **PH.RECOVERY** menu.

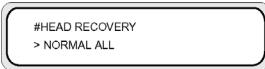

4. Press the OK key to confirm.



5. Press the ▲ or ▼ keys to select **NORMAL ALL**.



NOTE If **NORMAL ALL** is not sufficient to clean the nozzles, then try a **STRONG** option for the set of printheads that are affected. Perform the IQ Print first to determine which set of printheads are affected.

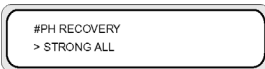
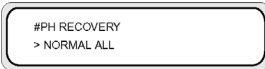

6. Press the OK key.

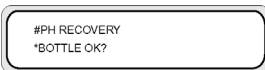

7. Make sure that the waste ink bottle is not full, and then press the OK key again.

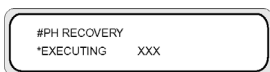

NOTE Cleaning may take several minutes.

8. When cleaning is completed, the **PH.RECOVERY** option is displayed.

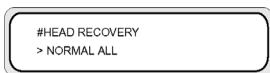

9. Press the ◀ key to return to the offline mode.

IQ Print

Use the IQ print to check that all printhead nozzles are working correctly. Perform the IQ print every day before using your printer.



NOTE Use the IQ print to check that all printhead nozzles are working correctly after cap cleaning.

7 How do I get the best image quality?

- Print the Image Quality print
- Interpret the image quality print
- Manage media types
- Calibrate the printer
- Adjust heater and print mode settings

Different types of media may give better image quality based on specific mechanical and electrical settings in your printer. To optimize image quality you can perform a series of test prints for the media type that you are using. Based on the results you can then adjust the printer settings for the media type.

To adjust the printer settings for a media type, you can modify existing media types or create new ones. Before creating or modifying a media type for the media you intend to use, print the IQ print to determine the overall quality that you get with one of the existing preset media types. Some media types may require no printer setting adjustments.

- Load your new media and select a media type that is similar to the media you are loading. See How do I... [Install a media roll in the printer](#).
- Print the IQ print. See How do I... [Print the Image Quality print](#).

If the IQ print is satisfactory you can use the preset media type for printing.

If the IQ print is not satisfactory, create a new media type or modify the one selected. See How do I... [Manage media types](#)

- Calibrate the printer for the media type. See [Calibrate the printer](#).
- Change the media type settings. See How do I... [Modify media type settings](#).
- Print the IQ print again to check the overall image quality with the new settings.

If you are still not satisfied with the image quality, you may need to make more adjustments to printer settings, such as the print mode or the heater temperature. For a description of image quality problems that you may see and the recommended solution, refer to [The problem is print quality](#).

Print the Image Quality print

Use the Image Quality print to check the overall image quality of images. Perform the Image Quality print every day before using your printer. If the image quality is satisfactory, no calibrations are required. If the image quality is not satisfactory, then you may need to adjust the media type settings. Also use the Image Quality print to check that there are no printhead nozzles out.



NOTE Use the IQ print to check that there are no printhead nozzles out after cap cleaning.



To print the IQ print:

1. Press the **ONLINE** key and press the **SHIFT** key twice.
2. Select the **ADJUST** menu using the **◀** key.



3. In the **ADJUST** submenu, scroll to **TEST PRINTS** and press the **OK** key.



4. In the **TEST PRINTS** menu scroll to the **IQ PRINT** option and press the OK key.

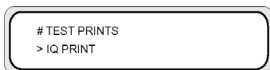

5. Press the OK key to start printing.

Interpret the image quality print

Below are examples of the print results you may see in the Image Quality Print and the recommended action.

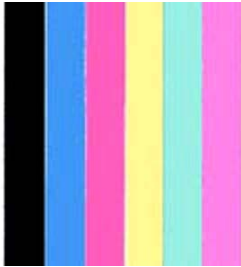

If the IQ print quality is satisfactory, you can print on the media without changing printer or heater settings.

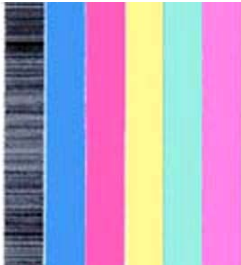

If you see banding in one color (in the black color in the image above), then there are printhead nozzles out and you will need to perform printhead recovery. See [How do I...Normal printhead recovery](#). After performing printhead recovery, print the IQ print again to check that the printhead is printing correctly.



If you see banding in all colors then you need to calibrate the printer for the media you have loaded. If you have selected a preset media type, we recommend that you create a new media type before

modifying the settings (see How do I... [Create a new media type](#)), and then calibrate the printer. See [Calibrate the printer](#). Banding may be present in the form of white lines (as in the image above), or in the form of darker lines.

If you still see banding in all colors after performing the calibrations, then try adjusting the heater temperature and/or print mode settings. See How do I.... [Adjust heater and print mode settings](#).

Manage media types

You can create new media types, or you can modify or delete existing media types by using the **MEDIA REG** menu.



Hint We recommend that you do not modify the preset media types that came with your printer. You can copy a preset media type with characteristics that are similar to the new media that you want to use, and use the copy to create a new one before changing the settings. This means that you will have to make changes to only one or two parameters and you will not need to set new values for all of the parameters.

For a complete list of the options available in the **MEDIA REG** menu, see Tell me about... [The MEDIA REG menu](#).

Copy a media type to create a new one

1. Press the **ONLINE** key.
2. Press the **▼** key to enter the **MEDIA REG** menu.



3. Select the **COPY MEDIA** option with the **▲** and **▼** keys, and press the **OK** key.

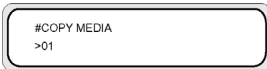

4. Select a media number using the **▲** and **▼** keys, and press the **OK** key.
Only numbers for media types that already exist are displayed.
5. To create a new media type from the copy, press the **▼** key to enter the **MEDIA REG** menu.



6. Select the **PASTE MEDIA** option with the **▲** and **▼** keys, and press the **OK** key.

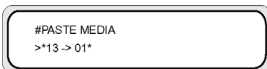

How do I get the best image quality?

7. Select a media number using the ▲ and ▼ keys.



NOTE If the number on the right is followed by an asterisk (*), the number displayed already contains media type information.

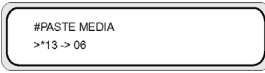

8. Press the OK key to confirm.

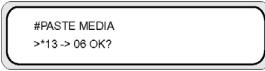

9. Press the OK key to create the new media type.

Create a new media type



Hint We recommend that you do not modify the preset media types that came with your printer. You can copy a preset media type with characteristics that are similar to the new media that you want to use, and use the copy to create a new one before changing the settings. This means that you will have to make changes to only one or two parameters and you will not need to set new values for all of the parameters.

To create a new media type:

1. Press the ONLINE key.
2. Press the ▼ key to enter the **MEDIA REG** menu.

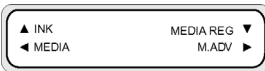

3. Scroll to the **SELECT MEDIA** menu with the ▲ and ▼ keys.

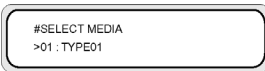

4. Press the OK key to select a media type number.

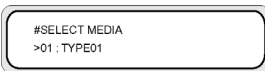

5. Select a media type number using the ▲ and ▼ keys, and press the OK key.



NOTE If a number is not available, then a new media type with that number has already been created.

Select another number.

6. Press the ▼ key and the OK key to define the name of the new media type.



7. Define the name of the new media type using the ◀ and ▶ keys to select the character to be set, and the ▲ and ▼ keys to change the character.
8. Press the OK key to confirm the media type name.



9. Press the OK key to confirm the new media type.

Modify media type settings

To modify the settings of a media type:

1. Press the ONLINE key.
2. Press the ▼ key to enter the **MEDIA REG** menu.

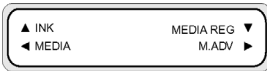

3. Scroll to the **SELECT MEDIA** menu with the ▲ and ▼ keys.

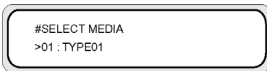

4. Press the OK key to select a media number.

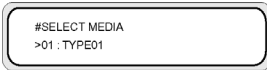

5. Scroll to the media type option you want to modify by using the ▲ and ▼ keys.

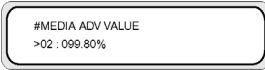

6. Press the OK key to modify the value.

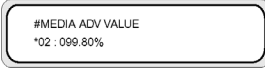

7. Press the OK key to confirm. The message below will only be displayed for newly created media types.

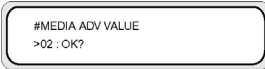

8. Press the OK key to create media type 02 and the * (asterisk) indicates that the media type has already been created. The display returns to (1) display.

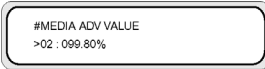

Press the CANCEL key to cancel the process. The front panel displays the top menu.

Delete a media type

Media types from 02 to 20 can be selected. Media type 01 is defined as the standard media and cannot be deleted.

To delete a media type:

1. Press the ONLINE key.
2. Press the ▼ key to enter the **MEDIA REG** menu.



3. Select the **DELETE MEDIA** option.



4. Press the OK key to select the **TYPE** using the ▲ and ▼ keys.

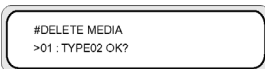

5. Press the OK key to confirm.

Calibrate the printer

You can adjust the mechanical and electrical settings of your printer based on a series of printed patterns. These patterns allow you to calibrate your printer settings for the media you are using. Based on the results of these patterns, you can optimize the performance of your printer.

Calibrate media advance

Your printer was calibrated at the factory to ensure that it advances the media accurately when using supported media types in normal environmental conditions. However, you may find it useful to recalibrate in certain circumstances:

- **Unsupported media:** different media manufacturers provide media with a wide range of properties such as thickness or stiffness, which may benefit from calibration. You can expect the best print quality when using HP's recommended media.
- **Abnormal but stable environmental conditions:** if you are printing in unusual conditions of temperature or humidity and those conditions are expected to remain stable, recalibration may be worthwhile.

However, media advance calibration assumes that you have an image quality problem and that you have already followed the appropriate troubleshooting procedure for that problem. If you have no particular problem, there is no need to perform the calibration.



NOTE This procedure describes media advance calibration for all media loaded in the printer. If you need to calibrate media advance for a specific media only, then define advance using the **MEDIA REG** option.

1. Load media widths larger than A1 size and longer than 1 m.



NOTE If you intend to use **TENSION** winding on the take-up reel, set media advance in tension winding mode.

Longer print length is required in the tension winding mode.

2. Press the ONLINE key.



How do I get the best image quality?

3. Select **M_ADV** using the ► key.

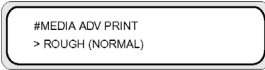

Select **MEDIA ADV PRINT** and press OK.

Select the print mode you usually use for the media you are calibrating.

Selectable print modes are **NORMAL**, **H-QUALITY**, **H-QUALITY2**, **H-DENSITY**, **H-DENSITY2**, and **DRAFT**.

Select the **NORMAL** media feed adjustment pattern if adjusting the high speed mode.

4. Press the ▲ or ▼ keys to select the **ROUGH** print mode, and press the OK key.



5. Press the OK key to print the pattern.



In this example, the color is black.

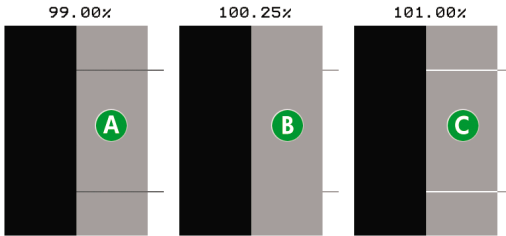

Nine patterns are printed in 0.25% steps in a range of 99.00% to 101.00%.

- A — Dark lines are visible; the value is too low.
- B — No lines are visible; the value is correct.
- C — Light lines are visible; the value is too high.



NOTE Select a mean value if the media advance value is different in every color. If you have an image that uses one particular color, then set the value based on that color.

Set a mean value if the media advance value differs between the left and right sides of the media.

Different values between the left and right sides of the media may be caused by skew.

- From the printed result, select the best media advance calibration value.
- Press the ▼ key, and then the OK key to display the current media advance calibration value.

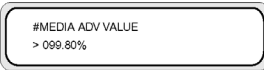

- Enter the media advance calibration value, and press the OK key.

Select the number you want to change by using the ◀ and ▶ keys and change the numeric value using the ▲ and ▼ keys.

If you need more precise media advance calibration, then you will need to print the **DETAIL** pattern as follows:

- Press the ▼ key, and then OK.

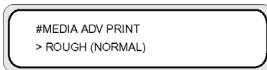

- Press the ▲ or ▼ keys to select the **DETAIL** pattern.

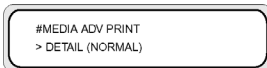

Select the same print mode as for the **ROUGH** pattern you printed previously.

- Press the OK key twice to print the **DETAIL** pattern.



- From the printed result, select the best media advance calibration value.
Five patterns are printed in 0.06% steps in a range of -0.12% to +0.12%.
- Press the ▼ key, and then the OK key to display the media advance calibration value.

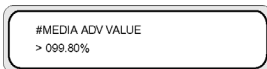

- Enter the media advance adjustment value, and press the OK key.

Set a numeric value with the ▲ and ▼ keys.

15. Press the OK key to confirm.

Perform printhead position adjustment

Use the printhead print position test patterns to calibrate the printhead position:

- Left and right printhead position.
- Printhead position — adjusts the head position for the scan axis using the black printhead as a reference.
- Left and right bidirectional printing position.

To print the printhead position patterns:

1. In the **TEST PRINTS** menu scroll to the option desired (**PH ROW**, **PH TO PH**, **BIDIR DEF**, and **BIDIR F.D.**) and press the OK key.



2. Press the OK key to start printing.

To set left and right head position adjustment values:

1. Select **ADJUST** and press the OK key.
2. Select **YY PH ROW VALUE** and press the OK key.
3. Select the head color to be adjusted, and press the OK key.
4. In the head adjustment pattern, identify the value for two lines of the selected color that are perfectly aligned.
5. Insert the value and press OK key.

Select the number you want to change by using the ◀ and ▶ keys and change the numeric value using the ▲ and ▼ keys.

To set the printhead to printhead adjustment value:

1. Select **ADJUST** and press the OK key.
2. Select **YY PH TO PH VAL** and press the OK key.
3. Select the printhead color to be adjusted, and press the OK key.
4. In the printhead adjustment pattern, identify the value where the vertical black line and the color printhead lines are perfectly aligned.
5. Insert the value and press the OK key.

Select the number you want to change by using the ◀ and ▶ keys and change the numeric value using the ▲ and ▼ keys.

To set the bidirectional printing left and right adjustment for all print modes except Fine Draft:

1. Select **ADJUST** and press the OK key.
2. Select **YY BIDIR DEF(X)** where X is L or R for left or right, and press the OK key.
3. Select the printhead color to be adjusted, and press the OK key.
4. In the printhead adjustment pattern, identify the value where two lines of the same color are aligned.
5. Insert the value and press OK key.

Select the number you want to change by using the ◀ and ▶ keys and change the numeric value using the ▲ and ▼ keys.

To set the YY BIDIR F.D (left and right) adjustment for Fine Draft print mode:

1. Select **ADJUST** and press the OK key.
2. Select **YY BIDIR F.D.(X)** where X is L or R for left or right, and press the OK key.
3. Select the printhead color to be adjusted, and press the OK key.
4. In the printhead adjustment pattern, identify the value where two lines of the same color are aligned.
5. Insert the value and press OK key.

Select the number you want to change by using the ◀ and ▶ keys and change the numeric value using the ▲ and ▼ keys.

Back feed adjustment print

This option prints a pattern so that you can adjust how much back feed is applied to a media type that you are loading.

1. Press the ONLINE key.

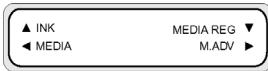

2. Press the ▶ key, and select **BACK ADJ PRINT** and the OK key.

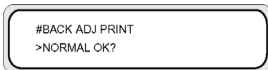

Select the print mode you usually use for the media that you are calibrating.

Select the **NORMAL** media feed adjustment print if adjusting the high speed mode.

Select a parameter based on your print mode.

Parameters:

- **NORMAL** — standard and high speed print modes
- **H-QUALITY** — high quality print mode
- **H-DENSITY** — high density print mode

- **H-QUALITY2** — high quality print mode
- **H-DENSITY2** — high density print mode
- **DRAFT** — draft print mode

Adjust heater and print mode settings

If you see banding in all colors and you have already performed media advance calibration, then you can try adjusting the heater temperature and print mode settings.

Banding in all colors may be caused by the following factors:

- Small print dot size: heat will cause a smaller dot size. The higher you set the heater temperature, the smaller the dot size is.
- Ink absorption by the media: if the media you are using is not capable of absorbing the ink as it is placed, then this can result in banding.

To improve ink placement and absorption try the following:

- Set a lower print heater temperature.
- Change the print mode to reduce the quantity of ink placed on the media.
- Change the print mode from bidirectional printing to unidirectional printing.

After each change to a setting, try printing the IQ print to check the image quality.

To change the heater temperature and print mode settings:

1. Press the ONLINE key and select the **MEDIA REG** menu with the ▼ key.



2. Select **PRINT HEATER T** in the **MEDIA REG** menu with the ▲ and ▼ keys.



Parameters: 15 °C to 55 °C, or ** to turn the heater off.



NOTE This value will only be applied if the **HEATER PREF** option is set to **HEAT PANEL**.

3. Select the number you want to change by using the ◀ and ▶ keys and change the numeric value using the ▲ and ▼ keys.

4. Press the OK key to confirm the parameter.

Print the IQ print to check the image quality.

5. To change the Print mode:

Select **PRINT MODE**. in the **MEDIA REG** menu with the ▲ and ▼ keys.

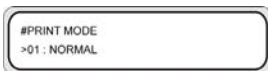

6. To change the option setting displayed, press the OK key.

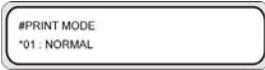

7. Using the ▲ and ▼ keys, select a print mode that places less ink on the media.

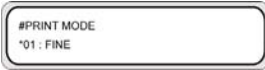

Parameters:

- **NORMAL** (4-pass)
- **H-QUALITY** (8-pass)
- **H-DENSITY** (8-pass)
- **H-QUALITY2**
- **H-DENSITY2**
- **FAST** (4-pass)
- **DRAFT** (2-pass)
- **FINE DRAFT**



NOTE This value will only be applied by the printer front panel setting if the **PRINT MODE PEF** option is set to **FRONT PANEL**.

NOTE Print modes on the printer front panel

8. Press the OK key to confirm the parameter.

Print the IQ print to check the image quality.

9. To change the print direction mode to unidirectional, select **PRINT DIRECTION** in the **MEDIA REG** menu with the ▲ and ▼ keys.



10. Select **UNIDIR** with the ▲ and ▼ keys for unidirectional printing.

11. Press the OK key to confirm the parameter.

If the image quality still does not improve, we recommend that you change the media. .

8 The problem is... (troubleshooting topics)

This section describes troubleshooting for the printer. If the problem cannot be solved, contact your dealer or our service center.

- The problem is... (checklist)
- A head crash
- Ink cartridge is not installed
- Ink cartridge is not detected
- Ink cartridge is near expiry date
- Ink cartridge has passed its expiry date
- An error message
- An abnormal sound

The problem is... (checklist)

Before deciding that there is a serious problem with the printer, check the following items.

Symptom	Items to be checked	Corrective measures
No power	Power cable connection	Check that the power cable is correctly plugged into the power outlet.
	Power supply to the outlet	Supply power to the power outlet.
	Power switch on/off	Turn on the power switch. See How do I... Turn the power on/off .
The media guide is not heated even when the heater is turned ON.	Printer status	The media guide is heated during printing. Be sure the media guide is heated by printing the test pattern.
	Heater front panel	Turn on the heater (FRONT, PRINT, or REAR) check that the media guide is heated by printing the test pattern.
The printer fails to start or operate correctly	ERROR LED and message on the front panel	See The problem is... An error message .
Cannot print	USB cable connection	Connect the USB cable correctly. See How do I... Connect to a computer .
	ERROR LED and message on the front panel	See The problem is... An error message
	ERROR LED off	Print the nozzle adjustment pattern. See How do I... Perform printhead position adjustment
The data are not processed immediately	DATA LED (flashing?)	Check the communication to the computer.
Poor print quality	Media type	Check for improvement by changing the settings of the heater temperature, print mode, RIP, etc. If there is no improvement, check that the media is supported. Replace the media with another type.
	Ink type	Use our recommended ink. See Tell me about... Ink cartridges
	Ink head cleaning	Clean the head. See How do I maintain the printer — Normal printhead recovery
	Color stripe is not set.	Set the color stripe. See Color stripe setting (COLOR STRIPE) in the MEDIA REG. Menu.
	Misdirected nozzles occurred in low printing rate color.	Set the printhead mode to HIGHLIGHT. See Printhead firing mode setting (IMAGE GRADIENT) in the MEDIA REG. Menu.

Symptom	Items to be checked	Corrective measures
	Operational temperature	Use the printer in 20 to 25 °C temperature range.
Media jams occur frequently	Media type	Check whether the media type setting matches the type of media loaded. See How do I... Install a media roll in the printer in the printer and Remove a media roll from the printer . Use our recommended media. See Tell me about Ordering media .
	Media setting	Load the media correctly. See Replace a jammed media roll
	Check whether there are any obstructions in the carriage path or the media path.	Remove any obstructions. See The Problem is.. A head crash
Print is slow	Operational temperature	Use the printer in 20 to 25 °C temperature range.

A head crash

Clear head crashes by following the instructions on the front panel.

1. A front panel instruction is displayed.

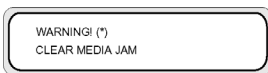

* : head crash type 1 or 2. See The problem is.. an error message — [Media crash](#).

2. Lift the media load lever and rear cover.

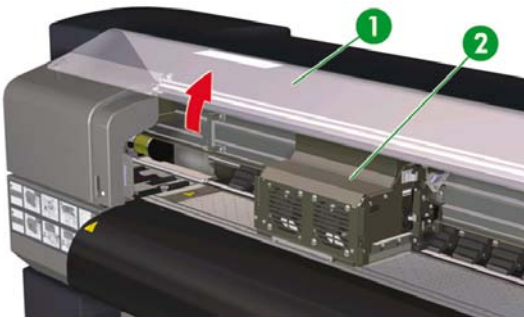
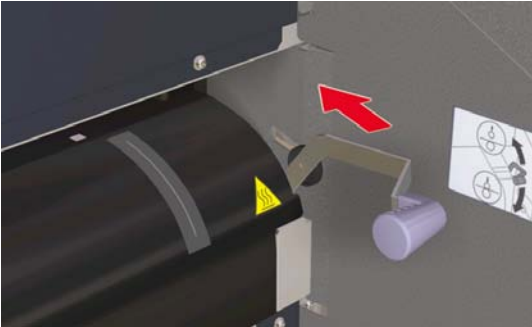

1. Rear cover
2. Carriage

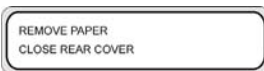

3. Remove the media, check there are no obstacles in the carriage path and the media path, and close the rear cover.



NOTE Take care not to damage the printheads when removing any media between the head carriage and the printing platen.

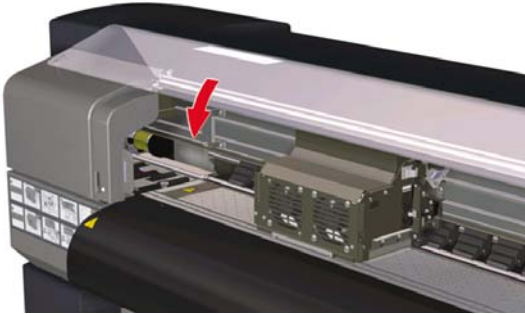

CARRIAGE MOVING
PLEASE WAIT

4. The carriage will move to its home position.
5. Load media again. See How do I... [Install a media roll in the printer.](#)

Ink cartridge is not installed

1. The front panel displays the following message.



XX: Ink name (K: Black, Lm: Light magenta, Lc: Light cyan)



XX: Ink name (C: Cyan M: Magenta Y: Yellow)

2. Replace the ink cartridge. See How do I... [Replace an ink cartridge](#).

Ink cartridge is not detected

1. The front panel displays the following message.

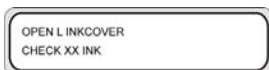

XX: Ink name (K: Black, Lm: Light magenta, Lc: Light cyan)



XX: Ink name (C: Cyan M: Magenta Y: Yellow)

2. Replace the ink cartridge. See How do I... [Replace an ink cartridge](#).

Ink cartridge is near expiry date

1. The front panel displays the following message.



YY: Ink name (K: Black, Lm: Light magenta, Lc: Light cyan; C: Cyan M: Magenta Y: Yellow)

2. Have a new ink cartridge ready to replace the ink cartridge that is near its expiry date.

Ink cartridge has passed its expiry date

1. The front panel displays the following message.

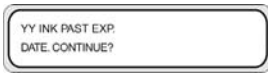

YY: Ink name (K: Black, Lm: Light magenta, Lc: Light cyan; C: Cyan M: Magenta Y: Yellow)

2. Press the OK key to continue or the CANCEL key to replace the ink cartridge. See How do I... [Replace an ink cartridge](#).

If you pressed the OK key, the following message is displayed:

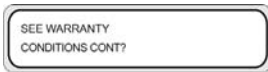

3. Press the OK key to confirm that you want to use an expired ink cartridge.

Press the CANCEL key to replace the ink cartridge. See How do I... [Replace an ink cartridge](#).

An error message

If the ERROR lamp lights, check the message displayed on the front panel. There are four types of error messages.

- Service errors: operator unrecoverable errors, such as hardware or software failure
Contact HP Support.

- Communication protocol errors

Take appropriate measures according to the error code or message.

- Operator errors

The operator can correct these errors. Take appropriate measures according to the message.

The error messages are as follows. Take appropriate measure according to the error message.



Hint If a communication error or a data error occurs, the ERROR lamp does not light. An error message appears on the front panel and disappears when the next operation is performed.

Service errors



Hint If any of the following service error messages appears, turn the power switch off and then on again. This may release the error.

POC error messages



Problem: an unrecoverable error has occurred in the engine section. This error message appears when an error is detected during self-diagnosis when the power is turned on.

Solution: contact HP Support. Make a note of the error code shown on the front panel.

Engine error messages

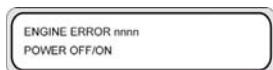

Problem: an unrecoverable error has occurred in the network controller section (hardware failure).

Solution: contact HP Support. Make a note of the error code displayed on the front panel.

System error messages

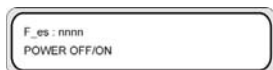

Problem: an unrecoverable error has occurred (firmware failure).

Solution: contact HP Support. Make a note of the error code displayed on the front panel.

Operator error messages

The following errors can be corrected by the operator.

Ink cartridge

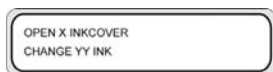

X: L (left), R (right)

YY: Y, M, C, K, Lm, Lc

Problem: there is no ink.

Solution: follow the instructions on the front panel. See How do I... [Replace an ink cartridge.](#)

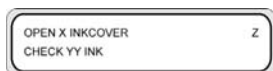

X: L (left), R (right)

YY: Y, M, C, K, Lm, Lc

Z: error code (1 to 9)

Problem: an ink cartridge error has occurred.

Solution: follow the instructions on the front panel. See How do I... [Replace an ink cartridge.](#)



X: L (left), R (right)

YY: Y, M, C, K, Lm, Lc

Problem: no ink cartridge is installed.

Solution: follow the instructions on the front panel. See How do I... [Replace an ink cartridge.](#)

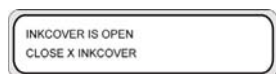

X: L (left), R (right)

Problem: the ink cover is open.

Measure: follow the instructions on the front panel.

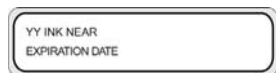

X: L (left), R (right)

YY: Y, M, C, K, Lm, Lc

Problem: the ink cartridge is nearing its expiration date.

Solution: prepare a new ink cartridge. See [Replace an ink cartridge.](#)

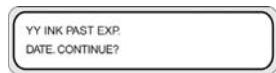

X: L (left), R (right)

YY: Y, M, C, K, Lm, Lc

Problem: the ink cartridge has passed its expiration date.

Solution: press OK and follow the instructions on the front panel. See How do I... [Replace an ink cartridge.](#)

The ink LED flashes

Problem: ink is running out (warning).

Solution: prepare a new ink cartridge.

Waste ink bottle is not installed

1. The following front panel message is displayed. The waste ink bottle is not installed.

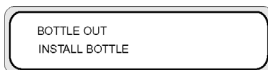

2. Insert a new waste ink bottle into the printer and install the waste ink bottle cover. See [Replace the waste ink bottle](#).

Waste ink bottle is full

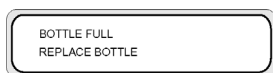

Problem: the waste ink bottle is full.

Solution: follow the instructions on the front panel. See [Replace the waste ink bottle](#).

Media crash

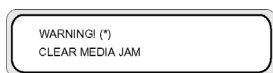

Problem: media crash (1) indicates that the carriage is blocked by obstacles in the carriage path or media feed path.

Solution: follow the instructions on the front panel. If the media jam (1) occurs frequently and there are no media jams or obstructions in the carriage path or media feed path, please contact HP Support.

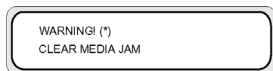

Problem: media jam (2) indicates that the media is not detected correctly. You may have selected the wrong media format when loading the media or you may be using a cut sheet with an irregular size.

Solution: follow the instructions on the front panel and check your media settings.

Media

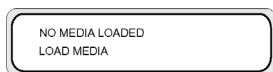

Problem: There is no media loaded in the printer.

Solution: Load media. See How do I... [Install a media roll in the printer.](#)



Problem: you have set an invalid media size (less than 297 mm wide or 64 inch wide or more).

Solution: set the correct size. See How do I... [Install a media roll in the printer.](#)



Problem: there is media skew.

Solution: Reload the media (see Loading media). Skew may be caused by ink deposits on the platen. Check the platen for ink deposits and clean any ink. See How do I... [Clean the platen.](#)



Problem: the media lever has not been lowered.

Solution: lower the media lever.

Error LED is flashing

Problem: the take-up reel is not winding the media correctly.

Solution: Check that the media is correctly detected by the take-up reel sensor. Check that the media is loaded correctly. See How do I... [Use the take-up reel.](#)

Other messages



Problem: the rear cover is open.

Solution: close the rear cover.

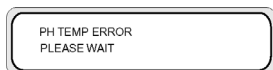

Problem: the temperature of the printheads exceeds the operating temperature range.

Solution: allow the printheads to cool by not using the printer until the printhead temperature returns to the operating temperature range.

ENV. TEMP. ERROR
CHANGE ENV. TEMP

Problem: the ambient temperature is not within the operating temperature range for the printer.

Solution: use the printer within its operating temperature range (15 °C to 30 °C).

An abnormal sound

If your printer makes an unusual sound, contact HP Support.

9 The problem is print quality

This section explains how to solve print quality problems.

Symptom	Possible cause	Corrective measure
A blank sheet of media is printed or the printed image is faded.	The printer did not receive data.	Check print data.
	The environment conditions do not meet the printer specifications.	Use the printer in the specified environmental conditions (temperature and humidity).
	Media settings are incorrect.	Check the media settings.
Parts of a drawing are missing or the print is unclear.	Foreign objects are attached to the head.	Clean the printhead from the PH.RECOVERY menu.
	The low printing ratio pattern is printed continuously at high temperature environment.	Set the printhead mode to HIGHLIGHT.
The print is blurred.	The media has been loaded the wrong side up.	Check whether the media is loaded correctly.
	The media settings are incorrect.	Check the media settings.
	The media edge guard or fan guard lever are not set correctly.	Set them correctly.
	The heater temperature is too low.	Increase the heater temperature.
The print is stained.	The leading edge of the media is curled.	Check whether the leading edge of the media is curled. If it is curled, cut the leading edge.
	The media is slightly folded or crumpled.	If the media is crumpled, feed the media and cut off the crumpled part of the media.
	The platen is stained.	Clean the platen. See Inspection & Maintenance.
The first part of a printed image is missing.	Environment temperature.	Use the printer in the specified environmental conditions.
Parts of a printed image are missing even after head cleaning is performed repeatedly.	The nozzle is clogged.	Wash the printheads.

Symptom	Possible cause	Corrective measure
Poor print quality cannot be improved even when the cleaning is performed.	The cap or wiper is stained.	Check for stains on the cap and wiper. If they are stained, clean them.
There is banding on new media	The printer requires calibration for the new media.	Adjust the printer settings for the new media. See How do I...
There is banding on media that has been calibrated and did not give banding before.	<p>If one of the following is true, try the corresponding solution and if banding has not disappeared, then go to the next possible cause and solution:</p> <ol style="list-style-type: none"> 1. The file you are printing: <ol style="list-style-type: none"> a) is new b) is not new 2. The print mode: <ol style="list-style-type: none"> a) has changed b) has not changed 3. Normal printhead recovery: <ol style="list-style-type: none"> a) did not improve banding b) improved banding 4. Strong printhead recovery: <ol style="list-style-type: none"> a) did not improve banding b) improved banding 	<p>Try one of the following solutions:</p> <ol style="list-style-type: none"> 1. a) Try using a file that did not give banding. If banding does not disappear, then see the next possible cause. b) Check that you are using the same print mode as before. 2. a) Try using the same print mode. If banding does not improve, then try a new roll of media. If you still see banding call HP support. b) Try normal printhead recovery. If banding improves, repeat normal printhead recovery until no improvement is seen and banding is still present. Call HP support. 3. a) Print the IQ print and check whether there are any printhead nozzles not working. If some printheads are not working, try strong printhead recovery for the affected printheads. 4. a) Call HP support b) Repeat normal printhead recovery until no improvement is seen and banding is still present. Call HP support.

10 Tell me about... (basic knowledge topics)

This chapter provides necessary information to operate the printer. Familiarize yourself with the basics of the printer before reading the rest of this Guide.

- Operating conditions
- The power supply
- Front panel messages and printer state

Operating conditions

This section describes the operating conditions for the printer.

Installation space

Make sure that there is sufficient space around the printer for the replacement of frequently used parts, for printing output, and for ventilation. In addition, leave the maintenance space indicated below for service repairs.

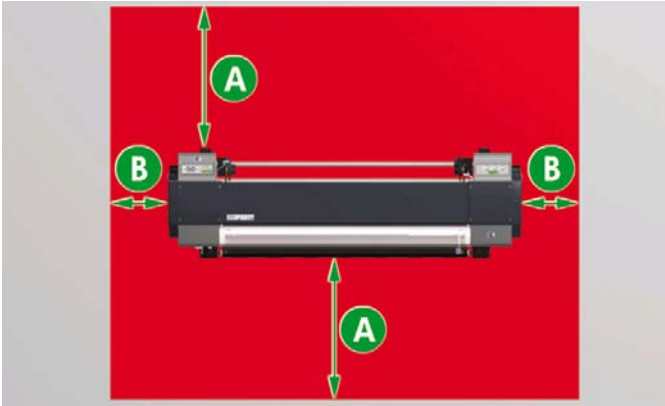

A. 1 m

B. 0.4 m

Environmental conditions

Operating temperature and humidity levels

The printer should be used within the temperature and humidity levels shown below.

Temperature: 15 °C to 30 °C

Humidity: 30% to 70%



Hint To obtain optimal print quality, operate the printer at environment temperatures between 20 – 25 °C.

When the operating temperature is below 20 °C, print speed may be reduced by one third to maintain good print quality.

When printheads reach high temperatures, the time to print is delayed.



NOTE When the printer is not used within specified operating temperature and humidity ranges, printing may be interrupted or the print quality may deteriorate.

Places where the printer must not be installed

Do not install the printer in places that are:

- In direct sunlight
- Subject to vibration
- Excessively dusty
- Subject to extreme changes in temperature or humidity conditions
- Near an air conditioner or a heater
- Places where the printer may get wet
- Subject to direct air circulation from vents
- Near a diazo copier that may generate ammonia gas
- Poorly ventilated

The power supply

Power

The power of the printer and the power of the heater are separate.

The printer has a rear power switch and a front panel power key as follows.

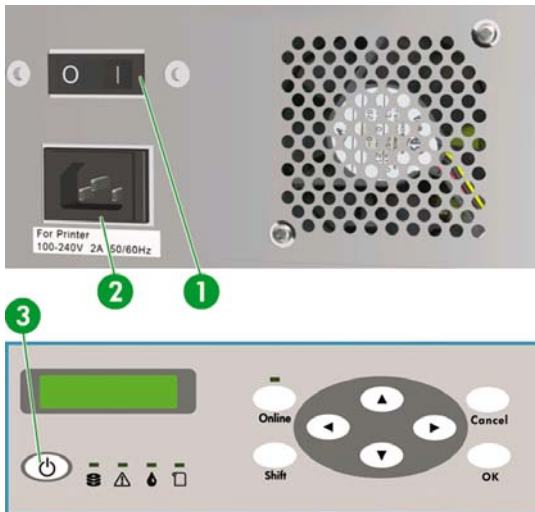

1. Printer switch

2. Power socket
3. Power on/off key

The printer is turned on by turning the printer switch on.

Afterwards, turn the printer on or off using the on/off switch on the front panel.

The heater has a power switch at the rear as follows.

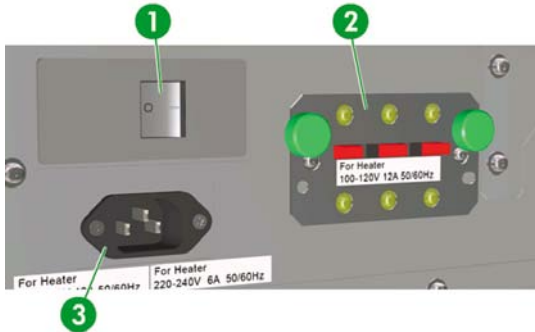

1. Heater switch
2. 100/200 V alternation switch
3. Power socket

Dryer

The optional dryer dries the output media.

Exhaust attachment

The exhaust attachment allows for the attachment of exhaust hoses to the printer.

Front panel messages and printer state

This section describes front panel messages and menu operations.

Messages on the front panel

Initialization display

The printer is being initialized.

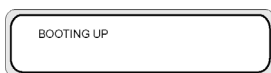



When the system starts normally, both controllers go online and enter idle mode automatically.

Online state (idle mode) display

The printer can receive data from the computer.

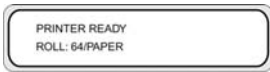

When the OK key is pressed in the menu mode, the PH.RECOVERY menu appears.

Online state (print mode) display

The printer is printing.

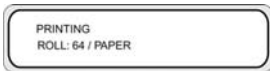

Online state (print pause mode) display

The printer is paused.

Print stop and resume

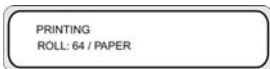

ONLINE

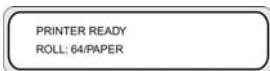

The Online LED flashes

Press the OK key in the print pause mode to start the head cleaning.

Print cancel (end)

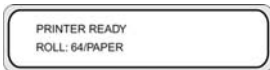

The Online LED flashes

CANCEL



Online state (print information mode) display

Media total count and ink amount are displayed.



SHIFT

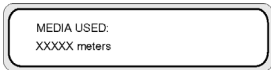

SHIFT



Three-second intervals or SHIFT

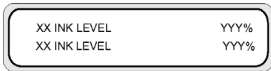

Three-second intervals or SHIFT



Then the printer returns to online idle mode.

Offline (menu mode) display

Menus can be operated in offline mode.



SHIFT

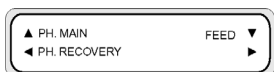

SHIFT



The arrow keys give access to menus.

When the OK key is pressed in the menu mode, the **PH.RECOVERY** menu appears.

Shutdown state display

The printer is shutting down.

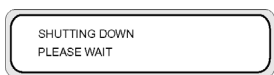

11 Tell me about media

- Storing media
- Disposing of media
- Using media
- Handling prints
- Other precautions

Choosing the correct media type for your needs is an essential step in ensuring good print quality. For best printing results, use only recommended media, whose reliability and performance have been developed and thoroughly tested. All printing components (printer, ink system, and media) have been designed to work together to give trouble-free performance and optimal print quality.

The HP Designjet 9000s Printer supports the following media types:

- Glossy vinyl chloride
- Matte vinyl chloride
- Banner

Storing media

- Always keep unused rolls wrapped in the plastic wrap to prevent discoloration. Rewrap partially used rolls if they are not being used.
- Avoid rapid changes in temperature and humidity conditions and store media in condensation-free environments.
- Do not stand a roll on its end.
- Do not stack rolls.

Disposing of media

Dispose of media according to local regulations and guidelines, where applicable.

Using media

- Avoid changes to room conditions and allow media to adapt to room conditions out of the packaging for 3 hours or more before printing.
- Low humidity may cause curling of media and high humidity may cause wrinkling.
Use media in the recommended temperature and humidity conditions (about 23 °C and 50% R.H.).
- Do not use scratched, crumpled, curled, or dusty media.
Take care not to damage the edges of roll media as this may affect media feeding.
Do not drop or wet the media.
- Handle media by the edges. Skin oils can be transferred to the printing material, leaving fingerprint marks.
- Keep the media tightly wound on the roll throughout the loading and unloading procedures.

Handling prints

- Do not touch the printed surface before the ink dries.
Handle media by the edges.
When handling media, take special care in the first 24 hours after printing.
- Rubbing the printed surface may cause color fading or color transfer.
To prevent color transfer do not stack printed images.
- Do not stack your prints together with photocopies or laser prints. The ink or toner may cause images to stick together.
- Do not rub, scratch, or hold media as this may cause the ink to peel off.
- Do not rub or leave media in damp conditions as this may cause blurring in printed images.

Other precautions

- The printing characteristics of media may change over a long period of time and colors may fade or print quality may deteriorate.
Use media in good condition.
- Media particles caused by cutting of the media may harm the media coating.
- When using vinyl (with glue), adhesive matter (with glue) may stick to the platen.
Adhesive matter on the platen may cause the media to jam.
Clean adhesive matter from the platen. See How do I... [Clean the platen](#).

12 Tell me about the ink system

- Ink cartridges
- Replacing an ink cartridge
- Ink cartridge storage and disposal
- HP 790 Waste Ink Bottle
- HP 790 Cap Cleaning Liquid
- HP 790 Wiper Cleaning Liquid and Dropper
- HP Cleaning Swabs
- HP 790 Storage Kit
- HP 790 Ink System Cleaning Kit

Ink cartridges

The printer's six ink cartridges provide yellow, magenta, black, cyan, light cyan and light magenta ink to the printheads. Ink cartridges require no maintenance or cleaning. As long as each ink cartridge is inserted correctly into its slot, the ink will flow to the printheads.



NOTE Failure to use the recommended ink cartridge may lead to a deterioration of the print quality or a printer malfunction.

The valid period of the ink is 3 months after the "Install By" date.

Do not shake ink cartridges before use.

All six color cartridges must be installed. If one of the cartridges is removed, a new one must be installed.

Ink cartridges must be installed in all six slots. The positions of ink cartridges are specified by color. (See the figure below.)

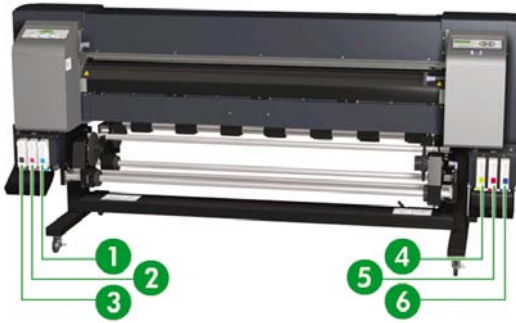

1. Light cyan
2. Light magenta
3. Black
4. Yellow
5. Magenta
6. Cyan



WARNING! Ink inside the ink cartridge is combustible. Do not expose or store near open flames, sparks, or other sources of ignition.

WARNING! Do not swallow ink. If swallowed, do not induce vomiting, but seek immediate medical attention.

Replacing an ink cartridge

You can check the ink level at any time by accessing the INK menu and pressing the ▲ key. Information on each ink cartridge is displayed at three-second intervals.

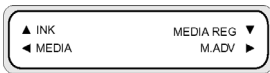

The front panel warns you when a cartridge's ink level is low or when a cartridge is empty. Printing will continue without interruption if you replace the ink when you are prompted by the front panel.

You are recommended to replace the empty cartridge with a new HP ink cartridge: see How do I... [Replace an ink cartridge](#).

Although it is possible to use refilled or non-HP ink cartridges, either choice has several serious disadvantages:

- There is some risk of damaging the printer. In this case the printer warranty will not be valid for any printer repairs that are related to the cartridge, nor for any problems due to ink contamination.
- You will invalidate the warranty of all printheads of the same color used in the printer subsequently, unless and until the whole ink system (including ink tubes) is replaced.
- Print quality may be impaired.
- The printer will be unable to estimate the ink level in the cartridge, and will report it as empty.

If you decide to use refilled cartridges, you will need to follow these instructions to make the printer use a cartridge that it believes to be empty.

1. Install the cartridge in the printer. See How do I.. [Replace an ink cartridge](#)
2. The printer will see that the cartridge is empty and ask to replace it.

The following front panel message is displayed.



XX: Ink name (K: Black, Lm: Light magenta, Lc: Light cyan)

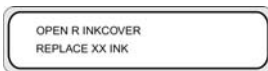

XX: Ink name (C: Cyan M: Magenta Y: Yellow)

3. Press the ▼ key and the CANCEL keys at the same time, and hold them down for at least two seconds.

- The front panel will display a series of warning messages. In response to each message, press the CANCEL key to cancel the process, or the OK key to confirm that you wish to continue.

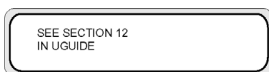

CAUTION Only press the OK key in the next step if you have read and fully understood how using non-HP ink will affect your warranty.

Press the CANCEL key to cancel the process, or the OK key to confirm.

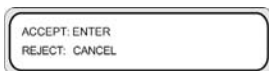

Press the CANCEL key to cancel the process, or the OK key to confirm.

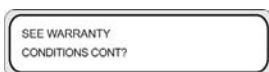

Press the CANCEL key to cancel the process, or the OK key to confirm.



- Select **CONFIRM NON-HP** using the ▼ or ▲ keys, and press the SHIFT and OK keys simultaneously to accept and end the process. Then the cartridge will be accepted, but information about the ink level will not be available.



If you insert a new non-HP cartridge, the same process above will be entered automatically. You do not need to press the ▼ and CANCEL keys.

Ink cartridge storage and disposal



CAUTION Securely put a used ink cartridge into a plastic bag and dispose of it as industrial waste. Observe any regulations for disposal of ink cartridges.



NOTE HP ink cartridges must be installed before the “Install By” printed on the cartridge. Use of the ink cartridge 3 months beyond the “Install By” date may cause deterioration in print quality or a printer malfunction.

Store ink cartridges in a dry, cool, and dark place.

Always use the recommended consumables (media, ink, etc.). Failure to follow this instruction may cause poor print quality or a breakdown.

HP 790 Waste Ink Bottle

The HP 790 Waste Ink Bottle is used for collecting waste ink that is discharged from the printer during cleaning processes. Only use our recommended HP 790 Waste Ink Bottle.



WARNING! Waste ink is combustible. Keep an HP waste ink bottle containing waste ink away from open flames, sparks, or other sources of ignition.

WARNING! Avoid contact between ink and skin, eyes, and clothing.

Immediately wash skin with soapy water.

Remove clothing soaked with ink from contact with skin.

Use an approved eye wash station if ink is splashed into eyes and consult a doctor if necessary.

If an approved eye wash station is unavailable, flush eyes with cold water and consult a doctor if necessary.

Do not swallow ink. If swallowed, do not induce vomiting, but seek immediate medical attention.

WARNING! Use only an HP waste ink bottle. The bottle must be installed according to instructions or waste ink may overflow.

An HP waste ink bottle must always be installed before turning the printer on. Automatic and manual service cycles produce waste ink that must be contained in an HP waste ink bottle.

Precautions for handling the waste ink bottle



WARNING! Always securely replace the cap on a full or partially-full the HP waste ink bottle after removing it from the printer to prevent ink spills.

The HP waste ink bottle contains organic solvents and must be disposed of in compliance with all local, state, and federal regulations.

WARNING! Always use both hands to remove and carry an HP waste ink bottle.

Keep the HP waste ink bottle upright. Do not place on tables or shelves where it could fall.

HP 790 Cap Cleaning Liquid

HP 790 Cap Cleaning Liquid is used to clean and maintain the capping unit. The HP cap cleaning liquid comes in six bottles, each containing 100 ml of cleaning liquid.



WARNING! Avoid contact between ink and skin, eyes, and clothing.

Immediately wash skin with soapy water.

Remove clothing soaked with ink from contact with skin.

Use an approved eye wash station if ink is splashed into eyes and consult a doctor if necessary.

If an approved eye wash station is unavailable, flush eyes with cold water and consult a doctor if necessary.

Do not swallow ink. If swallowed, do not induce vomiting, but seek immediate medical attention.

HP 790 Wiper Cleaning Liquid and Dropper

The HP 790 Wiper Cleaning Liquid and Dropper are used to clean and maintain the wiper blades. The HP 790 Wiper Cleaning Liquid comes in six bottles, each containing 100 ml, with ten droppers.



WARNING! Avoid contact between ink and skin, eyes, and clothing.

Immediately wash skin with soapy water.

Remove clothing soaked with ink from contact with skin.

Use an approved eye wash station if ink is splashed into eyes and consult a doctor if necessary.

If an approved eye wash station is unavailable, flush eyes with cold water and consult a doctor if necessary.

Do not swallow ink. If swallowed, do not induce vomiting, but seek immediate medical attention.

HP Cleaning Swabs

HP cleaning swabs are used for cleaning your printer parts. They are specifically designed to avoid damage to your printer. They are designed not to leave particles or fibers on your printer when you perform cleaning procedures.

HP 790 Storage Kit

The HP 790 Ink System Storage Kit is used to protect the ink tubes and printheads when the printer is switched off for less than four weeks, and to prime the ink system when the printer is turned on again. The HP 790 Ink System Storage Kit contains six Ink System Storage Liquid Cartridges and six Ink System Purging Cartridges.

HP 790 Ink System Cleaning Kit

The HP Ink System Cleaning Kit is used to try to recover the printheads and clean the ink tubes when the printer has been switched off for less than two weeks. The HP Ink System Cleaning Kit contains six Cleaning Liquid cartridges and six Ink System Purging Cartridges.

13 Tell me about waste management

It is the printer owner's responsibility to ensure that waste is disposed of in accordance with all local, state and federal regulations.

There are registered waste management companies that have been authorized by local authorities to manage waste collection and disposal and that will manage waste management and disposal on your behalf.

We recommend that you contact your local authorities for a list of authorized companies, or you can search for the nearest authorized waste disposal company on the World Wide Web.

Make sure that any waste disposal company you engage for this task is able to provide you with the necessary documentation proving their authority to manage and dispose of waste legally.

You will be legally responsible for failing to dispose of waste according to local, state and federal legislation.

When you have established an authorized waste management company, they will need to know the type of chemical that requires disposal and you will need to determine the type of agreement that best meets your requirements.

They will need to know the common name or chemical CAS number of the main solvent found in the supplies. This information can be obtained on the Material Safety Data Sheets (MSDS) available for all supplies at <http://www.hp.com/hpinfo/globalcitizenship/environment/productdata/index.html>

There are normally two types of waste disposal services. The most suitable service will depend on your waste volume production:

- Bottle by bottle and pick up on call : this may be the best option for low volume production to avoid the overheads related to arranging and ensuring secure temporary storage. You can order these bottles as needed from your local HP reseller.



- Storage in a suitable container for solvents and regular pick up: this may be the best option for high volume waste production. An authorized waste management company will be able to advise you on how this can be performed safely and in compliance with local guidelines and legislation.

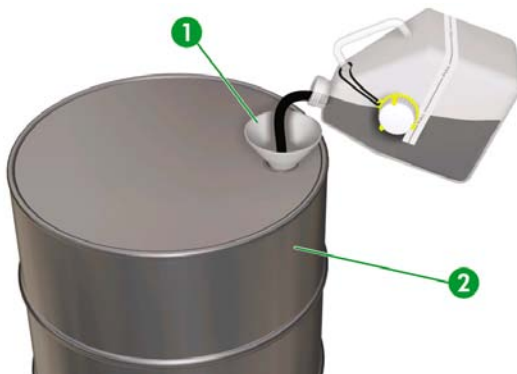

General recommendations

- The HP 790 Waste Ink Bottle is specifically designed to resist chemical interaction with waste ink. Do not use any other kind of container or bottle to collect the liquid. Consult your waste management company to ensure you are following correct and safe procedures.
- Do not dispose of materials via the sanitary sewer or drains. Hazardous waste disposal is regulated by local, state and federal regulations.

- Store the full bottle in an area that has been prepared for this purpose until it is emptied or removed by a waste management company for disposal. Consult your local authorities about requirements or for advice on storing hazardous waste.
- The bottle is provided with an undetachable cap to safely and securely close the bottle to avoid spillage when it is handled or transported.
- Use disposable latex or Nitrile(R) safety gloves to handle or transport the bottle once full.
- If you are emptying the HP supplied bottle into a larger container, use the container for this chemical exclusively. Never mix this chemical with other chemicals in the same container. This represents a serious safety hazard.

14 Tell me about front panel menus

This chapter outlines the user menu structure and operations.

- Menu operations
- The INK menu & messages
- The MEDIA menu
- The MEDIA REG menu
- Media advance calibration
- The PH. MAIN menu
- The PH.RECOVERY menu
- The FEED menu
- The PRINTER menu
- The ADJUST menu
- The SETUP menu

Menu operations

When the ONLINE key is pressed in the online idle mode, the printer enters offline mode. A menu group appears on the front panel and menu operations are enabled.



SHIFT



SHIFT

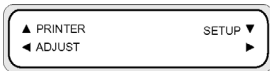

Menu structure

The Front panel menu has the following structure:

- Menu group — this menu is displayed at the first level. Some menus have several submenus.
- Second-level menus — these are submenus of the top menu group.
- Parameters — on selecting a menu item, you can select a value or command, or enter a value.

Making front panel selections and settings

To define a setting

1. Select a menu with the arrow keys.

For example, select the **MEDIA REG** menu with the ▼ key.

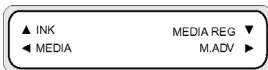

2. Select an option in the **MEDIA REG** menu with the ▲ and ▼ keys.

For example, select **PRINT MODE**. You can return to step 1 by pressing the ◀ key.



- To change the option setting displayed, press the OK key.

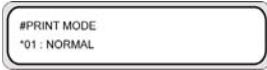

- Select a setting with the ▲ and ▼ keys.

Select **01 : FINE**.

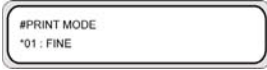

- Press OK key to confirm the parameter and return to step 2.

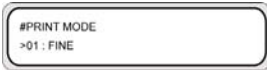

To define a value

The following example describes the MEDIA ADV. VALUE in the **ADJUST** menu.

- Select a menu with the arrow keys.

Select the **ADJUST** menu with the ◀ key.

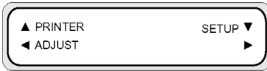

- Select a menu option with the ▲ and ▼ keys.

Select the **MEDIA ADV. VALUE** option. You can return to step 1 by pressing the ◀ key.

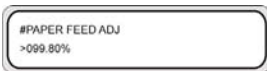

- Press the OK key.



- Select the digit to be modified using the ◀ and ▶ keys.



5. Change the value using the ▲ and ▼ keys.



NOTE To see the full list of characters available, refer to the list of characters below.



6. Press the OK key to confirm the value and return to step 2.



Character list

Character code group	Character
SHIFT ▼, SHIFT ▲	▼, ▲
Symbols	space, !, ...
Numerals	0 to 9
Upper-case letters	A to Z
Lower-case letters	a to z
Katakana: ア line	
Katakana: カ line	
Katakana: サ line	
Katakana: タ line	
Katakana: ナ line	
Katakana: ハ line	
Katakana: マ line	
Katakana: ヤ line	
Katakana: ラ line	
Katakana: ワ line	
Katakana lower-case	
Special characters	

The INK menu & messages

This INK menu is used to display ink information or replace the ink. When the ▲ key is pressed, information on each ink cartridge is displayed at three-second intervals.

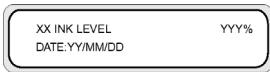

XX: Color name — K, Lm, Lc, Y, M, and C.

YYY: Amount of ink remaining.

ZZ/ZZ/ZZ: Manufacturing date of the ink cartridge

Press the SHIFT key to see information on the next color ink cartridge without waiting for three seconds.

Press the CANCEL or ◀ key to return to the previous menu.

Press the ONLINE key to end menu display and take the printer online.

Press the OK key to replace an ink cartridge. See How do I... [Replace an ink cartridge](#)

Replacing an empty ink cartridge

1. The following front panel message is displayed.



XX: Ink name (K: Black, Lm: Light magenta, Lc: Light cyan)



XX: Ink name (C: Cyan M: Magenta Y: Yellow)

2. Replace the ink cartridge. See [Replace an ink cartridge](#)

Replacing ink cartridges during printing

You can replace ink cartridges without interrupting printing.

The ink cover is open

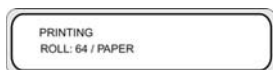

The front panel tells you to close the ink cover. Printing continues until all the ink in the system is used up. No ink from the new cartridge is supplied until you close the ink cover.

If all the ink in the system is used up, the print pause mode is activated and printing is interrupted until you close the ink cover. To restart printing, close the ink cover and press the ONLINE key.

The ink cartridge is empty

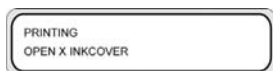

Printing continues until all the ink in the system is used up. If you replace the cartridge, printing will continue without interruption.

If you do not replace the ink cartridge and all the ink in the system is used up, the print pause mode is activated and printing is interrupted.

To restart printing, close the ink cover and press the ONLINE key.

The MEDIA menu

This menu is used to display media information or replace the media. When you press the ◀ key, information on media is displayed at three-second intervals.

To access the **MEDIA** menu:

1. Press the ONLINE key.



2. Press the ◀ key to see media information.

Media roll:

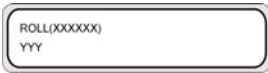

Cut sheet:

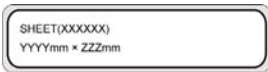

Nest:

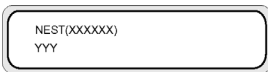

XXXXXX: media type

YYY: media width

ZZZ: media length

Press the CANCEL and ◀ keys to display the main menu in offline state.

Press the ONLINE key to take the printer online.

Press the OK key to change media settings.

The MEDIA REG menu

Use the **MEDIA REG** menu to register or modify media type parameters or create new media types in the printer. For details on the procedure, see How do I.... [Manage media types](#).

To access the **MEDIA REG** menu:

1. Press the ONLINE key.



2. Press the ▼ key to see **MEDIA REG** menu options.

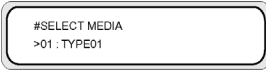

Selecting a media type number (SELECT MEDIA)

Select the media type number you intend to modify or create. You can choose from 01 to 20.

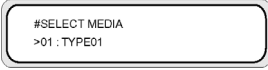

Parameters: media type number (01 to 20).



NOTE All changes to settings in the **MEDIA REG** menu will apply to the media that you select or create in the **SELECT MEDIA** option.

Setting a media type name (RENAME MEDIA)

Rename a media type you want to modify or create.

Name the media type using up to six-digit characters (or symbols). See [Character list](#) in Tell me about menus. for the list of characters.



Parameters: a six-digit character (symbol, alphanumeric, katakana, other).

Media advance value (MEDIA ADV VALUE)

Use this option to set the media advance value for the selected media type. This value is obtained from the Media Advance print. See How do I... [Calibrate media advance](#) for the step by step procedure.



NOTE This value will only be applied by the printer front panel setting if the **ADVANCE PREF** option is set to **FRONT PANEL**.

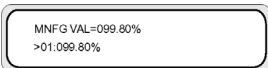
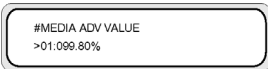

Parameters: XXX.XX% (97.00 to 103.00%)

Manufacturing default media advance value (MFNG VAL)

This option displays the manufacturing default media advance value, which is factory set. This cannot be modified by the user. Press OK to access the option to adjust the user-definable media advance value.

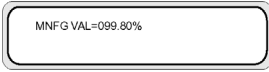

Dry time value (DRY TIME VALUE)

Use this option to define the amount of time the printhead carriage pauses between printing passes for the selected media type.



Parameters: three-digit time in seconds.

Print mode setting (PRINT MODE)

Use this option to set the default print quality for the selected media type.



NOTE This value will only be applied by the printer front panel setting if the **PRINT MODE PEF** option is set to **FRONT PANEL**.

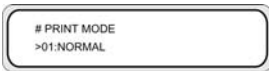

Parameters:

- **NORMAL** (4-pass)
- **H-QUALITY** (8-pass)
- **H-DENSITY** (8-pass)
- **H-QUALITY2**
- **H-DENSITY2**
- **FAST** (4-pass)
- **DRAFT** (2-pass)
- **FINE DRAFT**

Print direction setting (PRINT DIRECTION)

For the selected media type, use this option to set bidirectional printing so that the print carriage places ink on the media at every pass, or unidirectional printing so that the print carriage places ink on the media once every two passes.

```
#PRINT DIRECTION
>01.BIDIR
```

Parameters:

- **BIDIR** — Bidirectional printing gives higher printing speeds with slightly lower image quality and is more suitable for line and text images.
- **UNIDIR** — Unidirectional printing gives lower printing speeds but higher image quality.

Flatten time (FLATTEN TIME)

The printing conditions may affect the media when the printer has not printed for some time, and print quality may be affected by wrinkles or smudges on the edge of the media due to humidity and dust. For example, if you print using a higher heater temperature, this may cause wrinkling, so you can set a lower time to maintain the media in optimal condition. The **FLATTEN MEDIA** option automatically feeds and rewinds the media before printing starts.

If no data is received and the set time limit is reached, then the edge of the media roll is fed through the media path to the rear cover automatically. If the leading edge of the media roll is already present at the rear cover, the procedure is not performed.

The printer performs the procedure automatically when it is turned off; the edge of the media roll is fed through the media path to the rear cover. When using the take-up reel, the printer turns off without feeding the media through the media path.

```
# FLATTEN TIME
>01.NONE
```

Parameters:

- **NONE** — Select this parameter when you use your printer continuously and the type of media does not wrinkle.
- **30 min** — Media is passed through the media path if there is no printing for more than 30 minutes. If the printer starts printing before the 30 minute interval, the media is passed through the media path at the start of printing. Select this parameter when the printer prints in a high humidity environment frequently and the media is extremely wrinkled.
- **1 hour** — Media is passed through the media path if there is no printing for more than 1 hour. Select this parameter when the print interval is more than 1 hour and the media is extremely wrinkled.
- **2 hours** — Media is passed through the media path if there is no printing for more than 2 hours. Select this parameter when the print interval is more than 2 hours and the media is extremely wrinkled.
- **4 hours** — Media is passed through the media path if there is no printing for more than 4 hours. Select this parameter when the print interval is more than 4 hours and the media is extremely wrinkled.

Use media edge guard (USE EDGE GUARD)

Use this option to activate or deactivate the media edge guards for the selected media type. The right and left print margins are 10 mm when the media edge guards are used, and 5 mm when they are not used. See How do I... [Use the media edge guard](#).



Parameters:

- **YES** — the edge guard is used.
- **NO** — the edge guard is not used.

Media advance mode (MEDIA ADV MODE)

Use this option to set a media advance mode for the selected media type.

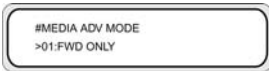

Parameters:

- **FWD ONLY** — Media is fed through the printer in the standard way.
- **BACK & FWD** — This setting checks that the media moves freely through the media path by feeding the media backwards and forwards before starting to print. This can be useful for media with adhesive coating that, in combination with the heat, may stick to the platen.



NOTE **BACK & FWD** can cause image banding.

Take-up reel mode (TUR MODE)

Use this option to set the take-up reel winding mode for the selected media type. You must set the take-up reel winding switch to the same setting as this option. See How do I... [Define the take-up reel winding mode](#).



NOTE The HP Designjet High Speed Dryer is **not** usable with the take-up reel when in **TENSION** winding mode. Please use **LOOSE** mode when using the HP Designjet High Speed Dryer.



Parameters:

- **LOOSE** — Media hangs loosely after printing and is then gathered on to the take-up reel.
- **TENSION** — Media is gathered on to the take-up reel at the same time as printing.



Hint TENSION is the recommended take-up reel mode particularly when printing on long rolls. This helps to reduce the risk of media skew.



NOTE If you see banding, perform the Media Advance calibration in the mode that you are using. See How to I...

Leading edge mode (LEADING EDGE)

This option allows you to define how the printer detects the position of the media when it is loaded or make media settings on the front panel.



NOTE This setting is not applied when you use the take-up reel.

#LEADING EDGE
>02:NORMAL

Parameters:

- **NORMAL** — Detects the leading edge of the media when you replace or load the media, and then completes media loading after checking for skew.
- **REDUCED** — Detects the leading edge of the media when you replace or load media, and then completes media loading after detecting the edge of the media by rewinding.



NOTE The recommended setting is **NORMAL**. If you select **REDUCED**, follow these instructions:

- Cut the edge of the media so that the edge of the media is parallel to the guide line and then load the media. If the edge of the media is not straight, the printer will deposit ink on the platen and that can cause a printhead crash.
- Load the media after checking that there are no wrinkles on the edge of the media. Wrinkled media can cause a printhead crash.
- Load the media after checking that there is no tape or glue on the edge of the media. If using media with tape or glue, it can cause a media jam.

Vacuum level setting (VACUUM LEVEL)

Use the **VACUUM LEVEL** option to set the suction force of the vacuum fan on the printing platen for the selected media type.

#VACUUM LEVEL
>01:NORMAL

Parameters:

- **NORMAL** — Normal fan suction level
- **LOW** — Low fan suction level

Initial temperature setting for the front heater (FRONT HEATER T)

Use this option to set the front heater temperature for the selected media type.

#FRONT HEATER T
>01:30C

#FRONT HEATER T
>01:086F

Parameters: 15 °C to 55 °C, or ** to turn the heater off.



NOTE For Celsius/Fahrenheit conversions:

$$F = (9 \times C / 5) + 32$$

$$C = 5 \times (F - 32) / 9$$

NOTE This value will only be applied if the **HEATER PREF** option is set to **HEAT PANEL**.

Initial temperature setting for the print heater (PRINT HEATER T)

Use this option to set the printer platen heater temperature for the selected media type.

#PRINT HEATER T
>01:40C

#PRINT HEATER T
>01:104F

Parameters: 15 °C to 55 °C, or ** to turn the heater off.



NOTE For Celsius/Fahrenheit conversions:

$$F = (9 \times C / 5) + 32$$

$$C = 5 \times (F - 32) / 9$$

NOTE This value will only be applied if the **HEATER PREF** option is set to **HEAT PANEL**.

Initial temperature setting for the rear heater (REAR HEATER T)

Use this option to set the rear heater temperature for the selected media type.



Parameters: 15 °C to 55 °C, or ** to turn the heater off.



NOTE For Celsius/Fahrenheit conversions:

$$F = (9 \times C / 5) + 32$$

$$C = 5 \times (F - 32) / 9$$

NOTE This value will only be applied if the **HEATER PREF** option is set to **HEAT PANEL**.

Color stripe setting (COLOR STRIPE)

A color stripe is printed on all plots. This ensures that all printhead nozzles are used in all prints, even if the printed image does not include certain colors. The color stripe avoids drying of nozzles even if they are not used for a long time because they are not needed within your printed images. This option activates or deactivates printing of the color stripe for the selected media type.



Parameters:

- **OFF** — Does not print the color stripe.
- **ON** — Prints the color stripe.



NOTE Use of the color stripe will add 40 mm (1.57 in) to your print margin.

NOTE We recommend that you set **COLOR STRIPE** to **ON** if possible. If the color stripe is not printed, this can affect printhead nozzle performance.

The color stripe is printed on the test print even if this option is set to **OFF**.

Printhead firing mode setting (IMAGE GRADIENT)

Use this option for the selected media type if you see banding or misdirected printhead nozzles and you want to achieve a more graduated placement of ink. This option modifies the printhead firing mode.

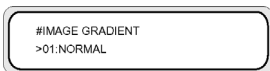

Parameters:

- **NORMAL** — Default
- **HIGHLIGHT** — Modifies the printhead firing mode



Hint The **HIGHLIGHT** mode action of the printheads can be useful to avoid nozzles out in a specific color when printing a large number of images that do not use that specific color.



NOTE **HIGHLIGHT** reduces the printing speed. We advise you to clean the printheads and reset the option to **NORMAL**.

Printhead height setting (PH HEIGHT VAL)

Use this option to set the printhead height for the selected media type. Change this setting when you change the printing carriage height. See How do I... [Change the printhead height](#).

PH HEIGHT VAL
>01: NORMAL

Parameters:

- **NORMAL** — Default.
- **HIGH** — Set for thick media.

Bidirectional print position (Left) adjustment (YY BIDIR DEF(L))

For the selected media type, use this option to adjust the position of all the printheads on the left side, when using bidirectional printing.

Enter an adjustment value based on the printhead adjustment pattern print. See How do I... [Calibrate the printer](#).

#YY BIDIR DEF(L)
>01:+00

YY: Ink color

Display order: **K -> Lm -> Lc -> Y -> M -> C**

Parameters: sign (+/-), value (-32 to +31)

Bidirectional print position (Right) adjustment (YY BIDIR DEF(R))

For the selected media type, use this option to adjust the position of all the printheads on the right side, when using bidirectional printing.

Enter an adjustment value based on the bidirectional calibration print. See How do I... [Calibrate the printer](#).

#YY BIDIR DEF(R)
>01:+00

YY: Ink color

Display order: **K -> Lm -> Lc -> Y -> M -> C**

Parameters: sign (+/-), value (-32 to +31)

Printhead cleaning mode (PH CLEANING)

Use this option to select an automatic printhead cleaning mode for the selected media type.

#PH CLEANING
>01:START & END

Parameters:

- **START & END** — Performs cleaning at the start or end of the print based on the print history record.
- **DURING PRINT** — Performs cleaning after a certain period of time even during printing.



NOTE **DURING PRINT** can cause some banding.



NOTE When the **TENSION** winding or **BACK & FWD (MEDIA ADV MODE mode)** is selected, the printer will only use **START & END** even if you have selected **DURING PRINT**.

When you select **DURING PRINT** and cleaning has interrupted printing of an image, the media will feed back so that the image that was being printed before cleaning started, can be continued. The amount of back feed can be set through the **BACK ADJUST VAL** option.

Media back feed adjustment (BACK ADJUST VAL)

This option sets the amount of back feed when printing of an image is interrupted by the automatic cleaning process.

Set a back feed adjustment value for the media based on the back feed adjustment pattern. See How do I...[Calibrate the printer](#).

#BACK ADJUST VAL
>01:+0000PULSE

Parameters: ± 2000 pulses (+5 mm), 1 pulse=2.5 μm



Hint After printing the back feed adjustment pattern, measure the start distance. Try setting the value at 0005 and reprint the back feed adjustment pattern and re-measure the distance and modify the value if necessary. Increasing the value will increase the distance.

Media advance preference (ADVANCE PREF)

Use this option to define printer front panel priority or software RIP priority for media advance settings for the selected media type. If you select software RIP priority, the printer will ignore media advance settings that are defined on the printer front panel and use the settings from the RIP.

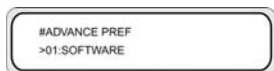

Parameters:

- **SOFTWARE** — Settings in the RIP takes priority.
- **FRONT PANEL** — Settings in the printer front panel take priority.

Print mode preference (PRINT MODE PREF)

Use this option to define printer front panel priority or software RIP priority for print mode settings for the selected media type. If you select software RIP priority, the printer will ignore print mode settings that are defined on the printer front panel and use the settings from the RIP.

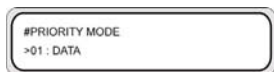

Parameters:

- **SOFTWARE** — Settings in the RIP take priority.
- **FRONT PANEL** — Settings in the printer front panel take priority.

Heater preference (HEATER PREF)

Use this option to define printer front panel priority or software RIP priority for heater settings for the selected media type. If you select software RIP priority, the printer will ignore heater settings that are defined on the printer and heater front panels and use the settings from the RIP.

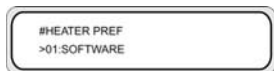

Parameters:

- **SOFTWARE** — Settings in the RIP take priority.
- **HEAT PANEL** — Settings in the printer front panel take priority.

Printhead rest period (PH REST PERIOD)

Use this option to define the number of passes the printhead carriage performs before it pauses for the selected media type.

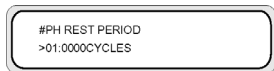

Parameters:

- **CYCLES** — Number of passes

Printhead rest time (PH REST TIME)

Use this option to define the amount of time the printing carriage will pause between passes for the selected media type.



Parameters:

- **TIME** — Time in minutes and seconds

Printhead temperature rest (PH TEMP REST)

Use this option if you want printing to pause if there is a gap between the set temperature of the media print heater and the printhead temperature is too high.



Parameters:

- **ON** — Pauses printing
- **OFF** — Printing continues

Deleting a media type (DELETE MEDIA)

Use this option to delete a registered media type.

Media types from 02 to 20 can be selected. Media type 01 is defined as the standard media and cannot be deleted. For details, see How do I... [Manage media types](#).

Copying a media type (COPY MEDIA)

Use this option to copy a registered media type. For details, see How do I... [Manage media types](#).

Pasting a media type (PASTE MEDIA)

Use this option to paste a media that you have copied over a registered media type. For details, see How do I... [Manage media types](#).

Default values for media types

Your printer comes with a set of factory-installed media types. Except for media type 01, you can modify or delete all other media types. The table below lists the default values for the factory-installed media types.

	1	2	3	4	5
NAME	PAPER	Glossy	Matte	Banner	BLT_B (Backlit)
MEDIA ADV. VALUE	(Base) +0.00%	(Base) +0.16%	(Base) +0.16%	(Base) +0.14%	(Base) +0.14%
DRY TIME VALUE	0 sec.	0 sec.	0 sec.	0 sec.	0 sec.
PRINT MODE	NORMAL	NORMAL	NORMAL	NORMAL	NORMAL
PRINT DIRECTION	BIDIR	BIDIR	BIDIR	BIDIR	BIDIR
FLATTEN TIME	None	None	None	None	None
USE EDGE GUARD	YES	YES	YES	YES	YES
MEDIA ADV. MODE	FWD ONLY	FWD ONLY	FWD ONLY	FWD ONLY	FWD ONLY
TUR MODE	LOOSE	LOOSE	LOOSE	LOOSE	LOOSE
LEADING EDGE	NORMAL	NORMAL	NORMAL	NORMAL	NORMAL
VACUUM LEVEL	NORMAL	NORMAL	NORMAL	NORMAL	NORMAL
FRONT HEATER T	None	45 °C	45 °C	45 °C	45 °C
PRINT HEATER T	None	40 °C	40 °C	40 °C	40 °C
REAR HEATER T	None	45 °C	45 °C	45 °C	45 °C
COLOR STRIPE	ON	ON	ON	ON	ON
ADVANCE PREF	SOFTWARE	SOFTWARE	SOFTWARE	SOFTWARE	SOFTWARE
YY BIDIR DEF (L)	+00&A	+00&A	+00&A	+00&A	+00&A
YY BIDIR DEF (R)	+00&A	+00&A	+00&A	+00&A	+00&A
PH CLEANING	MODE 1	MODE 1	MODE 1	MODE 1	MODE 1
BACK ADJUST VAL	0	0	0	0	0
PRINT MODE PREF	SOFTWARE	SOFTWARE	SOFTWARE	SOFTWARE	SOFTWARE
HEATER PREF	SOFTWARE	SOFTWARE	SOFTWARE	SOFTWARE	SOFTWARE

Media advance calibration

Media advance calibration is defined by using the **M.ADV** menu. Press the ► key to define and set values.

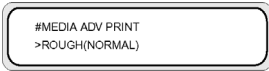

Media advance calibration print

Select **MEDIA ADV PRINT** to print a calibration pattern that will indicate optimal media advance values.

Two patterns are available: the **ROUGH** pattern prints a media advance pattern in 0.25% steps between 99.0 and 101.0 %; the **DETAIL** pattern prints a media advance pattern in 0.06% steps starting from the current setting $\pm 0.12\%$.

Use the **ROUGH** pattern to obtain your initial values; if greater accuracy is required, use the **DETAIL** pattern. The print mode selected will also affect media advance calibration patterns.

Press the CANCEL key to interrupt printing.

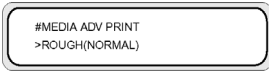

Parameters:

- **ROUGH (NORMAL)** — standard and high speed print modes
- **ROUGH (H-QUAL)** — high quality print mode
- **ROUGH (H-DENS)** — high density print mode
- **ROUGH (DRAFT)** — draft print mode
- **ROUGH (H-QUAL2)** — high quality print mode
- **ROUGH (H-DENS2)** — high density print mode
- **DETAIL (NORMAL)** — standard and high speed print modes
- **DETAIL (H-QUAL)** — high quality print mode
- **DETAIL (H-DENS)** — high density print mode
- **DETAIL (DRAFT)** — draft print mode

Back feed adjustment print

This option prints a pattern so that you can adjust how much back feed is applied to a media type that you are loading.

Select a parameter based on your print mode.



Parameters:

- **NORMAL** — standard and high speed print modes
- **H-QUALITY** — high quality print mode
- **H-DENSITY** — high density print mode
- **H-QUALITY2** — high quality print mode
- **H-DENSITY2** — high density print mode
- **DRAFT** — draft print mode

Media back feed adjustment value

Use this option to set the value for media back feed that you obtained from the back feed adjustment pattern.

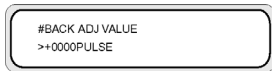

Parameters: ±2000 pulse (±5 mm)

1 pulse=2.5µm

The PH. MAIN menu

Use the **PH. MAIN** menu to maintain the cap and wiper and to clean the ink system. See [How do I maintain the printer?](#)

Press the ▲ key to enter the service menu.

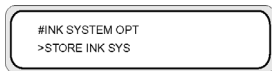

Ink system optimization (INK SYS OPT)

Use the **INK SYS OPT** option to select a service cleaning procedure.

#INK SYSTEM OPT
>STORE INK SYS

Parameters:

- **STORE INK SYS** — Use this parameter to clean the printheads and ink path with the storage liquid while the ink system is primed with ink, and then recharge the maintenance liquid in the printer to ensure long-term storage. Six storage liquid cartridges and six cartridges are mandatory.
- **CLEAN INK SYS** — Use this parameter to clean the printhead with the cleaning liquid after long-term storage. Six cleaning liquid cartridges and six purging cartridges are mandatory.
- **CAP CLEANING** — Use this option to move the printhead carriage to the wiper position so that you can clean the capping unit manually.
- **WIPER CLEANING** — Use this option to lift the wiper blade so that you can clean the wiper blade manually.
- **WASH PRINTHEADS** — Use this option to fill the cap with ink to soak the printhead (nozzle surface) in the ink for 1 to 2 hours to remove nozzle clogging.
- **CHARGE INK SYS** — Use this parameter when charging the ink system.

Cap cleaning (CAP CLEANING)

Use this option to move the printhead carriage to the wiper position so that you can clean the capping unit manually.

#CAP CLEANING
>

Parameters: none.

Wiper cleaning (WIPER CLEANING)

Use this option to lift the wiper blade so that you can clean the wiper blade manually.

#WIPER CLEANING
>

Parameters: none.

Washing printheads (WASH PRINTHEADS)

Use this option to fill the cap with ink to soak the printhead (nozzle surface) in the ink for a minimum of 1 to 2 hours to remove nozzle clogging. If possible, leave the printer overnight.

Use this option when nozzles cannot be fixed by cleaning repeatedly.

#WASH PRINTHEADS
>

Parameters: none.



NOTE Always perform Cleaning (normal) after filling the cap.

If the printhead surface is not clean even after leaving the printer overnight, then contact HP Support.

Printhead height (PH HEIGHT ADJ)

Use this menu option to adjust the printhead height.

The cap is opened after performing this operation and the carriage height can be adjusted. See How do I... [Change the printhead height.](#)



Parameters: none.

The PH.RECOVERY menu

This menu is used to clean the printheads of the printer. See How do I... [Normal printhead recovery.](#)

Press the ◀ key to select the **PH.RECOVERY** menu options.



◀ key

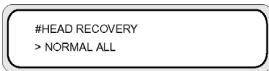

Parameters:

- **NORMAL ALL** — Performs normal cleaning of all the printheads.
- **STRONG ALL** — Performs strong cleaning of all the printheads.
- **STRONG Lc,Lm,K** — Performs strong cleaning of light cyan, light magenta and the black printheads.
- **STRONG Y,M,C** — Performs strong cleaning of cyan, magenta and the yellow printheads.

The FEED menu

This option allows you to feed media through the printing path. Press and hold down the ▼ key to feed the media through the printing path. If a cut sheet is used, it is discharged.



When you press the ▼ key, a media feeding message appears on the front panel.



When the ▼ key is released, media feeding stops and the top menu appears on the front panel in offline mode.

The PRINTER menu

This menu is used to print reports on the printer status.

When the ▲ key is pressed, you can select the report that you want to print.



Configuration print (CONFIG PRINT)

This option prints information on the printer, panel settings, and media type information.



Parameters: none.

Error log information print (ERROR LOG PRINT)

This option prints error log information saved in the printer.



Parameters: none.

History print (HISTORY PRINT)

This option prints maintenance information on the printer.

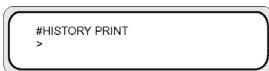

Parameters: none.

The ADJUST menu

This menu is used to set mechanical adjustment parameters. For details on how to print the patterns, see [Calibrate the printer](#).

When the ◀ key is pressed, mechanical adjustment parameters can be set.



Adjustment pattern print (TEST PRINTS)

This menu is used to print the adjustment patterns for adjusting the printer mechanically and electrically.

When the CANCEL key is pressed during printing, the print can be stopped.



Parameters:

- **IQ PRINT.** Prints a block pattern with black and another color.
- **PH ROW.** Prints the printhead alignment pattern.
- **PH TO PH.** Prints the printhead to printhead alignment pattern.
- **BIDIRECTION DEF.** Prints the bidirectional printing adjustment pattern.
- **BIDIRECTION F.D.** Prints the bidirectional printing adjustment pattern for Fine Draft print mode.

Printhead nozzle position adjustment (#YY PH ROW VAL)

Adjusts the spitting angle of the printhead nozzles.

Enter an adjustment value according to the PH ROW pattern.



YY: Ink color

Display order: K -> Lm -> Lc -> Y -> M -> C

Parameters: sign (+/-), value (-32 to +31)

Printhead position adjustment (#YY PH TO PH VAL)

Adjusts the printhead to printhead position.

Enter an adjustment value according to the PH TO PH adjustment pattern.

```
#YY PH TO PH VAL
# +01
```

YY: Ink color

Display order: K -> Lm -> Lc -> Y -> M -> C

Parameters: sign (+/-), value (-32 to +31)

Bidirectional print position (Left) adjustment (YY BIDIR DEF(L))

Use this option to adjust the printhead bidirectional printing position (Left).

Enter an adjustment value according to the BIDIRECTION DEF adjustment pattern.

```
#YY BIDIR DEF(L)
>01:+00
```

YY: Ink color

Display order: K -> Lm -> Lc -> Y -> M -> C

Parameters: sign (+/-), value (-32 to +31)

Bidirectional print position (Right) adjustment (YY BIDIR DEF(R))

Use this option to adjust the printhead bidirectional printing position (Right).

Enter an adjustment value according to the BIDIRECTION DEF adjustment pattern.

```
#YY BIDIR DEF(R)
>01:+00
```

YY: Ink color

Display order: K -> Lm -> Lc -> Y -> M -> C

Parameters: sign (+/-), value (-32 to +31)

Bidirectional print position (Left) adjustment (YY BIDIR F.D (L))

Use this option to adjust the printhead bidirectional printing position (Left), in fine draft print mode

Enter an adjustment value according to the BIDIRECTION F.D. adjustment pattern.

```
#YY BIDIR F.D(L)
>01:+00
```

YY: Ink color

Display order: K -> Lm -> Lc -> Y -> M -> C

Parameters: sign (+/-), value (-32 to +31)

Bidirectional print position (Right) adjustment (YY BIDIR F.D (R))

Use this option to adjust the printhead bidirectional printing position (Right) in fine draft print mode.

Enter an adjustment value according to the BIDIRECTION F.D. adjustment pattern.

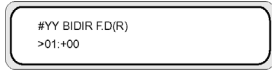

YY: Ink color

Display order: K -> Lm -> Lc -> Y -> M -> C

Parameters: sign (+/-), value (-32 to +31)

The SETUP menu

This menu is used to set or display printer setup options. When the ▼ key is pressed, printer setup options can be set.

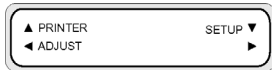

Language for front panel (LANGUAGE)

This option sets Japanese or English for messages displayed on the front panel. The initial value is English.



Parameters: ENGLISH, JAPANESE.

BOOT version display (BOOT VERSION)

This option displays the BOOT version.

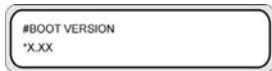

Parameters: none.

Acoustic warning (BEEP)

This option sets the acoustic warning on or off.



```
#BEEP
>ON
```

Parameters: ON, OFF

F/W version display (F/W VERSION)

This option displays the engine firmware version.



```
#PRINTER FW VER
*X.XX_YY
```

Parameters: none.

Main PCA version display (MAIN PCA VER)

This option displays the version number of the main PCA.



```
#MAIN PCA VER
*X.X
```

Parameters: none.

ICB board version display (CARRIAGE PCA)

This option displays the version number of the printer carriage PCA.



```
#CARRIAGE PCA
*X.X
```

Parameters: none.

ASIC version display (ASIC VER)

This option displays the ASIC version.



```
#ASIC VERSION
*X.XX
```

Parameters: none.

Heater H/W version display (HEATER HW VER)

This option displays the heater hardware version.



```
#HEAT HW VERSION
*XX.X
```

Parameters: none.

Heater F/W version display (HEATER FW VER)

This option displays the heater firmware version. If the heater cannot be recognized, "--.-" is displayed.



Parameters: none.

System date setting (SYSTEM DATE)

This option sets system date used in the unit in YY (year), MM (month), DD (day).



Parameters: 00/01/01 to 99/12/31.

System time setting (SYSTEM TIME)

This option sets the time for your printer.



Parameters: 00 : 00 to 23 : 59.

Factory default setting (FACTORY DEFAULT)

This option sets all parameter values to default factory settings.

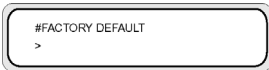

Parameters: none.

USB address (USB ADDRESS)

This option displays the printer USB address.

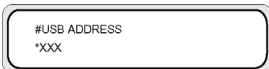

Parameters: none.

USB speed (USB SPEED)

This option sets the USB port speed.



Parameters: HIGH, FULL

15 Tell me about the heaters

This chapter describes temperature control, the heater front panel, parameter setup mode operations, and error messages of the heater controller.

- The heaters
- Heater temperature settings
- Heater error messages

The heaters

The printer includes three heaters for fixing and stabilizing the printed image on the media. Each heater is controlled separately.

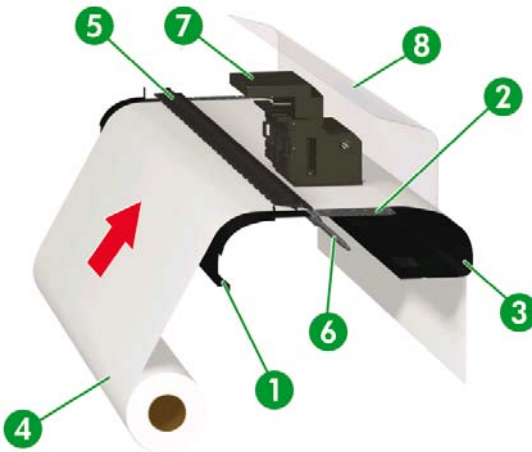

1. Front heater (preheats the media)
2. Print heater (fixes the ink on to the media)
3. Rear heater (dries the ink and stabilizes the printed image)

4. Media roll
5. Pressure roller
6. Grid roller
7. Carriage
8. Rear cover



WARNING! Never touch the heaters, as they can cause burns, and always take care when touching printer components near the heaters.

Heater temperature settings

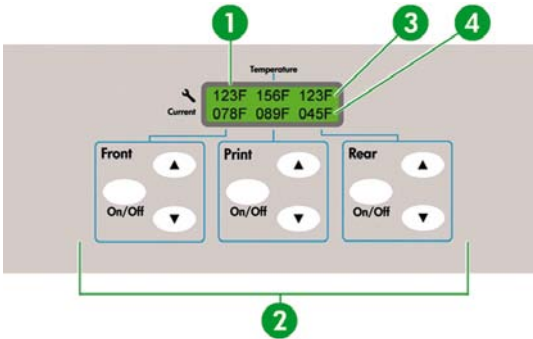

1. Heater front panel
2. Heater on/off and temperature setting keys
3. Preset temperature
4. Current temperature

Heater temperatures are preset automatically for all media types. Under normal operating conditions you do not need to set the temperature.

Use the heater front panel only when you need to make fine adjustments to the heater temperature.

- On/off setting: use ON/OFF key for each heater.
- Temperature setting: use the up key or down key for each heater.

- Front panel display (when the heater is turned on):
 - Upper line: preset temperature for each heater
 - Lower line: current temperature for each heater
- Front panel display (when the heater is turned off):
 - Upper line: OFF for each heater
 - Lower line: current temperature for each heater

The default temperature range is set between 15 °C and 55 °C.

Heater preset temperature by medium

The heater preset temperature for each media type is listed below. Preset the heater temperature according to the media you use.

Medium	Media type	Front	Print	Rear	Print mode
Glossy vinyl chloride	Glossy	45°C	40°C	45°C	4-pass bidirectional
Matte vinyl chloride	Matte	45°C	40°C	45°C	4-pass bidirectional
Banner	Banner	45°C	40°C	45°C	4-pass bidirectional

We recommend that the front heater, the print heater and the rear heater be set to lower than 50 °C, 45 °C and 50 °C, respectively. When the print heater is set to higher than 45 °C, we recommend setting the printhead motion mode to **HIGHLIGHT**.



NOTE When the print heater temperature is set too high, fixing of the ink on the media is improved, but media wrinkle or mat print may be caused. Adjust heater temperature according to the media type and environmental temperature.

When the print heater temperature is set to high, the printer may print at low speed to ensure stable print quality.

Set the front/rear heater temperature 5 °C higher than the print heater temperature. Bad temperature balance between the front/rear heater and print heater may cause the media to wrinkle.

Flow of heater temperature setting

1. If you select the media type when loading the media, the initial temperature value of each heater for that media is set on the heater front panel:
 - If the initial temperature value has been set, the heater turns on but heating does not start.
 - If the initial temperature value is set to **, the heater turns off. The set temperature on the heater front panel displays **OFF**.
2. If the printing job data are sent from the host (PC), either of the following operations is performed before the print starts:
 - a. If the **HEATER PREF** set for the media is **SOFTWARE**:
 - The temperature set in the RIP (print data, job) overwrites the temperature set on the heater front panel, and the heating starts. Heating does not start if the temperature value is set to **OFF**.
 - If the temperature is not set in the RIP (print data, job), heating starts with the temperature set on the heater front panel.
 - b. If the **HEATER PREF** set for the media is **HEAT PANEL**:
 - The temperature set in the RIP is ignored and heating starts with the temperature set on the heater front panel.
3. Printing starts when the current temperatures of the front, print, and rear heaters all reach the value exceeding set temperature -2°C .

 If the current temperature is higher than the set temperature, printing starts without waiting for the temperature to drop. Even after printing has started, the temperature control makes sure that the heaters maintain the set temperature.
4. During printing, the temperature can be adjusted by using the heater ▲ or ▼ keys on the heater front panel.

 Even after printing has finished, the changed temperature is applied as the set temperature.
5. The print job returns to step (2).

To set the initial temperature value of front, print, and rear heaters, and the **HEAT PREF** setting (heater), see Tell me about... [The MEDIA REG menu](#).



Hint The heater front panel displays the set heater temperature in all cases.

Temperature control

The following tables describe how heater temperature is controlled.

Maintaining the preset temperature

Function:

To heat the media to reduce the ink drying time, improve fixing of ink to media, and to protect media from media wrinkling.

Status:	Status of maintaining each heater temperature at the preset temperature on the heater front panel.
Conditions:	<ol style="list-style-type: none"> 1. If the heater ON/OFF setting on the heater front panel is set to ON and a print command is received. 2. Under condition (1) above, and the time specified by the delay time after the print end command was received.

Maintaining the standby temperature

Function:	To shorten the time needed to reach the preset temperature to start printing.
Status:	<p>Status of maintaining the heater temperature at the specified standby temperature (35 °C) for all heaters.</p> <p>When the preset temperature is lower than the specified standby temperature (35 °C), the printer maintains the preset temperature.</p>
Conditions:	If the standby time has been set, after reaching the preset temperature.

Turning off the heaters

Function:	To prevent excessive current consumption, to protect the media from damage by the heat from the heaters, and to protect the user from getting burned from touching the heaters when printing is not performed.
Status:	Status of reaching the environmental temperature slowly.
Conditions:	In all cases except when maintaining the preset temperature or the standby temperature.
Start of heating:	The print start command is received and heating starts. Printing does not start until the heaters have reached the preset temperature.
Start of print:	The heaters reach the preset temperature and printing starts.
End of print:	The print end command is received and printing finishes.

The heater front panel

Display in normal mode



	Front heater	Print heater	Rear heater
Preset temperature	AAA	BBB	CCC
Current temperature	XXX	YYY	ZZZ

U stands for the temperature unit: C (Celsius) or F (Fahrenheit).

The temperature is measured every 5 seconds and refreshed.

Display — heater on



When each heater is heated, a plus sign (+) is displayed in place of the unit of each heater current temperature on the second line. The unit display is restored at the completion of heating. In the display example shown above, the front heater is heated.

Display — heater off

OFF is displayed in the setup temperature display area of the heater that is turned off. The temperature unit of the heater that is turned off is not displayed. The current temperature area is displayed as it is.



Display — heater AC power is turned off

TURN ON HEATER POWER SWITCH is displayed on the front panel.



Heater parameter setup mode

This mode is used when the operator sets the heater control system parameters.

Setup items and parameters

The setup items and parameters are listed in the table below.

No.	Item	Item display (upper line)	Parameters display (lower line)	Description	Initial value
1	Temperature unit	UNIT	CELSIUS FAHRENHEIT	–	CELSIUS

No.	Item	Item display (upper line)	Parameters display (lower line)	Description	Initial value
2	Heat suspending time after printing	DELAY TIME	00 to 30 MINUTES	UNIT: minute	05 MINUTES
3	Standby heating time after completion of DELAY TIME	STANDBY TIME	0, 30, 60, 90, 120, ENDLESS	Unit: minutes	30
4	Version display	VERSION	FW=vv.r HW=vv.r	Display only	–
5	Diagnostics	DIAGNOSTICS	NO, YES	NO: Does not perform the diagnostics. YES: Performs the diagnostics.	NO
6	Display language	LANGUAGE	ENGLISH JAPANESE	–	ENGLISH
7	Exit setup mode	EXIT	YES, NO	YES: Exits the parameter setup mode. NO: Does not exit the parameter setup mode.	YES

*1 Display only, ON/OFF key is ignored.

Heater error messages

When the following error messages are displayed on the heater front panel, contact HP Support.

- System error



- The relay board cannot be detected

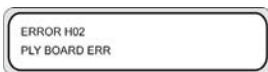

- Front heater thermistor temperature error (-10 °C or less, 70 °C or more)



- Rear heater thermistor temperature error (-10 °C or less, 70 °C or more)



- Print heater thermistor temperature error (-10 °C or less, 70 °C or more)



- Front heater thermistor did not reach the preset temperature after 15 minutes



- Rear heater thermistor did not reach the preset temperature after 15 minutes



- Print heater thermistor did not reach the preset temperature after 15 minutes



- Switch test error occurs in the diagnostics



- Zero cross error occurs in the diagnostics



16 Tell me about printer specifications

- Specifications
- Ecological specifications

Specifications

Item	Specification / Function
Print technology	Piezo-electric inkjet printheads
Resolution — High quality	720 dpi × 720 dpi
Resolution — Standard	720 × 720 dpi
Resolution — Fine draft	540 × 720 dpi
Resolution — Draft	720 × 360 dpi
Print speed	About four minutes / A0 with 4-pass printing (changes according to surrounding temperature and printhead temperature)
Media feed/delivery direction	Front media supply, rear media delivery
Media type	PVC, banner, Vinyl chloride, Tarpaulin
Media width	Maximum 64 inches
Ink cartridge	Six colors (black, cyan, magenta, yellow, light magenta, light cyan) 1000 ml capacity
Noise	Standby: 45 dB(A) or less, operating: 60 dB(A) or less (continuous sound)
Heat output	Printer: 720000 J/H or less, heater: 5148000 J/H or less
Maximum print guaranteed range	Area excluding top, bottom margins (5 mm) and right and left margins (5 mm); when using the media edge guard, right and left margins will be 10 mm
Power supply voltage	100 to 240 VAC
Frequency	50/60 Hz ±1 Hz
Power consumption	Printer: 200 W or less (operating), heater: 1440 W or less (operating)
External dimensions	2525 mm (W) × 785 mm (D) × 1195 mm (H) ±10 mm
Weight	230 kg or less (excluding media roll and ink)
Operating temperature/humidity range	15 to 30 °C / 30% to 70% RH (no condensing)
Non-operating temperature/humidity range	5 to 35 °C / 10% to 80% RH or less (no condensing)
Installation space	3325 mm (W) × 2785 mm (D) × 1700 mm (H)
Maintenance space	3325 mm (W) × 2785 mm (D) × 1700 mm (H)

Ecological specifications

For the up-to-date ecological specifications of your printer, please go to <http://www.hp.com/> and search for "ecological specifications".

17 Tell me about ordering supplies and accessories

- Ordering supplies
- Ordering media
- Ordering accessories

Ordering supplies

The following ink supplies can be ordered for your printer.

Table 17-1 Ink cartridges

Cartridge	Capacity (cm ³)	Part number
HP 790 Black	1000	CB271A
HP 790 Cyan	1000	CB272A
HP 790 Magenta	1000	CB273A
HP 790 Yellow	1000	CB274A
HP 790 Light Cyan	1000	CB275A
HP 790 Light Magenta	1000	CB276A
HP 790 Waste Ink Bottle	—	CB299A

Table 17-2 Maintenance and Cleaning Kits

Name	Item number	Remarks
HP 790 Ink System Storage kit	CB297A	6 Ink System Storage Liquid Cartridges, 6 Ink System Purging Cartridges
HP 790 Ink System Cleaning kit	CB296A	6 Ink System Cleaning Liquid Cartridges, 6 Ink System Purging Cartridges
HP Cap Cleaning Kit	CB294A	
HP Wiper Cleaning Kit	CB293A	

Ordering media

The following paper types are currently provided for use with your printer.



NOTE This list is likely to change over the course of time. For the latest information, see <http://www.hp.com/go/designjet/supplies/>.

Table 17-3 HP Paper

Name	Part number	Size
HP Premium Scrim Banner	Q8678A	36 in x 164 ft.
HP Premium Scrim Banner	Q8679A	54 in x 100 ft.
HP Universal Scrim Banner	Q8680A	36 in x 164 ft.
HP Universal Scrim Banner	Q8681A	54 in x 100 ft.
HP Premium Self Adhesive Vinyl	Q8682A	54 in x 150 ft.
HP Premium Self Adhesive Vinyl	Q8683A	60 in x 150 ft.
HP Premium Backlit Film	Q8684A	36 in x 66 ft.
HP Premium Backlit Film	Q8685A	54 in x 66 ft.
HP Universal Photo-Realistic Paper	Q8686A	36 in x 150 ft.
HP Universal Photo-Realistic Paper	Q8687A	54 in x 150 ft.

Ordering accessories

The following accessories can be ordered for your printer.

Name	Product number
HP Designjet 9000s Air Purifier System 220V	Q6668A
HP Designjet 9000s Air Purifier System 110V	Q6668B
HP Designjet 8000s/9000s APS filter	Q6679A
HP Designjet High Speed Dryer	Q6667A
ONYX PosterShop 6.5 for HP Designjet	Q6669A
Media cover for HP Designjet 9000s series	Q6680A

18 Tell me about getting help

- HP Customer Care
- HP Designjet Online

HP Customer Care

As your strategic support partner, we make it our business to help keep your business running smoothly. HP Customer Care offers award-winning support to ensure you get the most from your HP Designjet.

HP Customer Care provides comprehensive, proven support expertise and leverages new technologies to give customers unique end-to-end support. Services include setup and installation, troubleshooting tools, warranty upgrades, repair and exchange services, phone and Web support, software updates, and self-maintenance services. To find out more about HP Customer Care, please visit us at:

<http://www.hp.com/go/designjet/>

or call the phone number in the *Customer Service Guide* provided with your printer.

What to do before you call:

- Review the “The problem is” troubleshooting suggestions in this guide.
- Review the relevant driver documentation supplied with this printer (for users sending PostScript files or those using Microsoft Windows).
- If you have installed third-party software drivers and RIPs, refer to their documentation.
- If the problem appears to be related to your software application, first contact your software vendor.
- If you still have difficulty, refer to the HP Support Services booklet provided with your printer. This document contains a comprehensive list of various support services available to help solve printer problems.
- If you call one of the Hewlett-Packard offices, please have the following information available to help us answer your questions more quickly:
 - The printer you are using (the product number and the serial number, found on the label at the back of the printer)
 - If there is an error code on the front panel, note it down; see The problem is... [An error message](#)
 - The computer you are using

- Any special equipment or software you are using (for example, spoolers, networks, switch-boxes, modems, or special software drivers)
- The cable you are using (by part number) and where you purchased it
- The type of interface used on your printer (FireWire, USB, or network)
- The software name and version you are currently using
- If the problem is a system error it will have an error number; record the error number and have it ready

HP Designjet Online

Enjoy a world of dedicated services and resources to ensure you always get the best performance from your HP Designjet products and solutions.

Register at HP Designjet Online, your large-format printing community at <http://www.hp.com/go/designjet/> for unrestricted access to:

- Downloads — the latest printer firmware, drivers, software, media profiles, etc.
- Technical support — online troubleshooting, customer care contacts, and more
- Forums for direct contact with the experts, both HP and your colleagues
- Warranty tracking online, for your peace of mind
- Technical documentation and training videos
- Latest product information — printers, supplies, accessories, software, etc.
- Supplies Center for all you need to know about ink and media

By customizing your registration for the products you have purchased and your type of business, and by setting your communication preferences: you decide the information you need.

Register at HP Designjet Online for the best performance.

HP Designjet Online is available in English, German, French, Italian, Spanish, Portuguese, Japanese, Korean, Simplified Chinese, and Traditional Chinese.

Index

A

- accessories
 - ordering 183
- ADJUST menu 163
- adjustment patterns 88
- adjustment patterns; printhead
 - position 98

C

- calibration
 - media advance 158
- cap cleaning, menu 160
- characters, front panel 142
- cleaning and maintenance
 - consumables
 - ordering 182
- cleaning kits
 - ordering 182
- components of printer [9000s] 2
- connections 15
- Customer Care 185

D

- Designjet Online 186

E

- ecological specifications 179
- error messages
 - heater 175

F

- FEED menu 161
- front panel
 - character list 142
- front panel, heater 9
- front panel, printer 5

H

- handling precautions 13
- heater
 - error messages 175
 - parameter setup 174
 - temperature settings 170
- HP Customer Care 185
- HP Designjet Online 186

I

- ink
 - front panel information 143
- ink cartridge
 - ordering 182
- INK menu 143
- ink system optimization, menu 159
- install media 24
- IQ print 88

L

- load sheet media 34

M

- maintenance
 - cap cleaning menu 160
 - ink system opt. menu 159
 - ordering consumables 182
 - wash printheads menu 160
 - wiper cleaning menu 160
- maintenance, printhead recovery
 - menu 161
- media
 - front panel information 144
 - install 24
 - loading sheet 34
 - unloading 32
- media advance calibration
 - calibration; media advance 95
- MEDIA menu 144

- MEDIA REG menu 145

media types

- default values 156
- ordering 182
- weights 182
- widths 182

menu

- ADJUST 163
- cap cleaning 160
- FEED 161
- INK 143
- ink system opt 159
- MEDIA 144
- MEDIA REG 145
- PH. MAIN 159
- PRINTER 162
- printhead height 161
- printhead recovery 161
- SETUP 165
- wash printheads 160
- wiper cleaning 160
- menu, using 140

O

- ordering
 - accessories 183
 - ink cartridges 182
 - maintenance and cleaning
 - consumables 182
 - media 182

P

- PH. MAIN menu 159
- power on/off 16
- printer information, reports 162
- PRINTER menu 162
- printer's main components [9000]
 - 2
- printhead height, menu 161

printhead position adjustment 98
printhead recovery, menu 161

S

safety precautions 10
SETUP printer menu 165
specifications
 ecological 179
support services
 HP Customer Care 185
 HP Designjet Online 186

U

unload media 32
using this guide 2

W

wash printheads, menu 160
wiper cleaning, menu 160

